



Durham's Toy Company

# Beach

AUTOMATIC  
OVEN  
COOKING



BEACH FOUNDRY Limited  
— OTTAWA —

TORONTO -- WINNIPEG -- CALGARY, VANCOUVER

TX 657  
Ole  
B43  
1920z  
P444

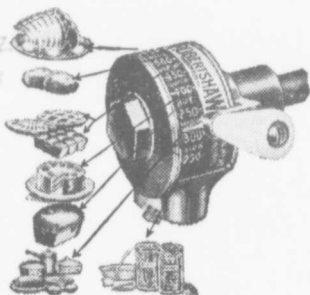

The

*"The  
White Handle  
Oven Heat Controller"*

1. Automatically maintains the correct oven temperature. You do not have to stay in or even near the kitchen when cooking.
2. Eliminates guesswork and the pies, cakes, biscuits, cookies, etc., are just right every time.
3. Roasts all kinds of meats and fowl—rare, medium or well done—deliciously and without a single failure.
4. Boils cereals, soups and vegetables in the oven at the same time you roast meats and bake desserts.
5. Cooks a whole meal in the oven at one time without attention whatsoever. You can leave the house for a period of three to five hours and return to find the whole meal cooked perfectly, ready for serving. Replaces the fireless cooker.
6. Cans all your fruits and tomatoes in the oven, the scientific way.
7. Makes all your peach butter, apple butter, tomato butter, etc., in the oven. No stirring necessary.
8. Dries and sterilizes dishes in the oven giving them a clean, polished surface and affords a warming closet of large capacity.
9. Saves more gas than its cost per year and eliminates loss of foods.
10. Requires no experience and having no parts which can deteriorate or wear out, it will operate correctly throughout the entire life of your Gas Range.

**Don't Spend Your Time in the Kitchen  
Let the AutomatiCook Do the Cooking**

NATIONAL LIBRARY  
CANADA  
BIBLIOTHÈQUE NATIONALE

900033



## *Requires No Experience*

In using the Robertshaw AutomatiCook and the Time and Temperature Charts, no experience whatever is required. You simply prepare the foods or mix the ingredients in the usual way, or follow any reliable recipe book, and then refer to the Chart for the cooking directions. In this Chart you will find listed the food to be cooked (or a similar one) and the proper temperature and the length of time given for cooking each class of food.

The Cooking and Canning Charts have been compiled very carefully by experts and cover practically every class of food, but if the particular article of food being prepared is not listed in the charts, select a similar food and follow the time and temperature given for it.

## *The AutomatiCook*

The Robertshaw AutomatiCook is so simply and durably constructed, having no parts which can deteriorate or wear out, that it will control the oven temperature accurately throughout the entire life of your gas range and it is recommended by Gas Companies, Bureaus of Home Economics and Gas Range Manufacturers everywhere.



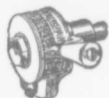

## Cooking Chart

In preparing the foods use any reliable recipe book, and if the article of food being cooked is not listed in this chart, select a similar food and follow the time and temperature given for it.

Article of Food	Set To	Preheat Oven	Bake or Roast	Reset To	Bake or Roast Total Time
<b>BREAD, BISCUITS, ETC.</b>					
Bread, Yeast .....	350° F.	15 Min.	45 to 60 Min.		
Baking Powder Biscuits ..	450° F.	20 Min.	12 to 15 Min.		
Yeast Biscuits .....	400° F.	20 Min.	20 Min.		
Muffins .....	400° F.	20 Min.	25 Min.		
Pop-Overs .....	450° F.	20 Min.	30 Min.	350° F.	45 Min.
<b>COOKIES, ETC.</b>					
Corn Cake .....	400° F.	20 Min.	20 to 25 Min.		
Ginger Bread .....	325° F.	10 Min.	35 Min.		
Vanilla Cookies .....	450° F.	20 Min.	10 Min.		
Drop Bran Cookies .....	425° F.	20 Min.	12 Min.		
Molasses Cookies .....	375° F.	15 Min.	18 Min.		
<b>CAKES</b>					
Plain Cake (sheet or cup)...	375° F.	15 Min.	30 Min.		
Loaf Cake .....	350° F.	15 Min.	45 Min.		
Layer Cake .....	375° F.	15 Min.	20 Min.		
Fruit Cake (large) .....	275° F.	15 Min.	3 to 4 Hrs.		
Sponge Cake .....	320° F.	15 Min.	1 Hr.		
Angel Food Cake .....	320° F.	15 Min.	1 Hr.		
<b>PIES</b>					
Pastry Shell .....	500° F.	20 Min.	12 Min.		
Apple Pie .....	450° F.	20 Min.	30 Min.	400° F.	40 Min.
Rhubarb Pie .....	450° F.	20 Min.	30 Min.	400° F.	40 Min.
Goose Berry Pie .....	450° F.	20 Min.	30 Min.	400° F.	40 Min.
Cherry Pie .....	450° F.	20 Min.	30 Min.	400° F.	40 Min.
Open Cross Cut Pie .....	450° F.	20 Min.	20 Min.		
Pumpkin Pie .....	450° F.	20 Min.	10 Min.	325° F.	40 Min.
Custard Pie .....	450° F.	20 Min.	10 Min.	325° F.	40 Min.
<b>CUSTARDS, ETC.</b>					
Meringue .....	300° F.	20 Min.	15 Min.		
Puff Paste .....	550° F.	25 Min.	12 Min.		
Individual Custards .....	325° F.	15 Min.	40 Min.		
Large 1 qt. Custards .....	325° F.	15 Min.	75 Min.		
<b>POTATOES</b>					
Small Potatoes .....	500° F.	20 Min.	25 Min.		
Medium Potatoes .....	500° F.	20 Min.	40 Min.		
Large Potatoes .....	500° F.	20 Min.	60 Min.		
<b>CASSEROLE DISHES</b>					
Casserole Uncooked Food...	350° F.	10 Min.	2¼ to 3 Hrs.		
Scalloped Dishes .....	500° F.	20 Min.	12 Min.		
<b>ROAST BEEF</b>					
Beef Roasts (3 to 4 lb.) (Uncovered—Boned and Rolled)					
Rare .....	550° F.	20 Min.	20 Min.	450° F.	45 Min.
Medium .....	550° F.	20 Min.	20 Min.	450° F.	1 Hr.
Well done .....	550° F.	20 Min.	20 Min.	450° F.	1¼ Hrs.
Beef Roasts (3 to 4 lbs.) (Covered—Boned and Rolled)					
Rare .....	550° F.	25 Min.	30 Min.	450° F.	50 Min.
Medium .....	550° F.	25 Min.	30 Min.	450° F.	1¼ Hrs.
Well done .....	550° F.	25 Min.	30 Min.	450° F.	1½ Hrs.



## Cooking Chart, Continued

In preparing the foods use any reliable recipe book, and if the article of food being cooked is not listed in this chart, select a similar food and follow the time and temperature given for it.

Article of Food	Set To	Preheat Oven	Bake or Roast	Reset To	Bake or Roast Total Time
<b>LARGER BEEF ROASTS</b>					
Larger Beef Roasts (Uncovered—Boned and Rolled)					
Rare .....	550° F.	20 Min.	20 Min.	450° F.	12 Min. per lb.
Medium .....	550° F.	20 Min.	20 Min.	450° F.	15 Min. per lb.
Well done .....	550° F.	20 Min.	20 Min.	450° F.	18 Min. per lb.
<b>MISCEL. ROASTS</b>					
Loin of Pork Roast ..	500° F.	20 Min.	30 Min.	450° F.	25 Min. per lb.
Fresh Ham Roast ..	500° F.	20 Min.	30 Min.	450° F.	30 Min. per lb.
Loin of Veal Roast ..	500° F.	20 Min.	30 Min.	450° F.	25 Min. per lb.
Lamb Roast (young) ..	500° F.	20 Min.	30 Min.	450° F.	20 Min. per lb.
Spring Lamb (rare) ..	500° F.	20 Min.	30 Min.	450° F.	15 Min. per lb.
Yearling Lamb (cov'd pan)	550° F.	25 Min.	30 Min.	450° F.	20 Min. per lb.

*Note: The 'Uncovered Pan' label is positioned vertically between the 'Larger Beef Roasts' and 'Miscel. Roasts' sections.*

**Poultry:** Correct time for roasting Poultry is 20 minutes to the pound. When an uncovered pan is used, set Pointer at 500 degrees F. (allowing 20 minutes for the oven to preheat) and roast for 15 minutes. Turn fowl, reset to 450 degrees F. for ten minutes, then reset to 400 degrees F. for the remainder of the time. When a covered roaster is used, set Pointer at 550 degrees F. (allowing 20 minutes for oven to preheat) and roast for 20 minutes. Reset to 500 degrees F. for 10 minutes, then reset to 400 degrees F. for the remainder of the time. For Tender Turkeys weighing over 8 lbs., reduce the final cooking temperature to 350 degrees instead of 400 degrees.

**Fish:** Best temperature for baking fish is 425 degrees F. to 450 degrees F. Time required for baking will depend upon the size and thickness of the fish—varying from 20 minutes to about one hour.

## Hints for Cake Baking

All cakes can be divided into two classes, sponge and butter cakes.

After baking sponge cakes, pans should be inverted and cake should hang in pan until cool. Do not turn butter cakes. They should cool for 5 to 10 minutes before being removed and should be turned out on wire racks.

Note that small cakes and layer cakes require higher temperatures.

Never jar or move a cake until baking is entirely completed.

Pans for angel and sponge cakes should not be greased.

If cakes are not brown enough to suit, raise the temperature 25 degrees for the last few minutes of baking.

Heavy cakes result from too much sugar or butter. To prevent coarse grain cakes, do not use too much raising ingredients, cream well the butter and sugar and beat the batter sufficiently.

A solid or bready cake results from too much flour.

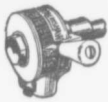

## Automatic Cooking

### DIRECTIONS

#### LIGHTING UP THE OVEN

In lighting up the Oven be sure that the Oven Burner Cock is open full because the AutomatiCook takes care of the gas supply, and it is necessary only to open the Oven Gas Cock when lighting the oven burner and to turn it off when the cooking is completed. The AutomatiCook throughout the entire cooking process, will automatically increase or decrease the oven burner flame to the proper volume for maintaining the set oven temperature.

#### PREHEATING THE OVEN

As the foods must never be put into the oven before it is heated to the set temperature, time will be saved if the oven is lighted while the foods are being prepared.

The time given in the Cooking Chart for preheating the Oven is generally sufficient but it is easy to determine when the oven is fully heated, for just as soon as the set temperature is reached, the AutomatiCook will decrease the size of the Oven Burner flame.

#### TWO CLASSES OF COOKING

The Robertshaw AutomatiCook can not only be used in cooking single articles of food, such as in ordinary baking or roasting, but in addition, any entire meal which can be cooked in a Fireless Cooker, can be cooked in a Gas Range Oven equipped with the AutomatiCook. The Robertshaw AutomatiCook therefore makes one appliance in the kitchen serve as both Gas Range and Fireless Cooker.

#### COOKING SINGLE FOODS

Baking and Roasting are greatly simplified by the use of the AutomatiCook, and correct results are assured in advance, by cooking according to the time and temperature indicated in the cooking chart. Roasts are best seared in the oven as directed by the cooking chart, then roasted for the specified length of time. The Robertshaw AutomatiCook roasts and bakes deliciously and eliminates the constant supervision.

#### WHOLE MEAL COOKING

Whole meals, consisting of meats, fish, vegetables, cereals, macaronies, puddings, etc., can be prepared and cooked, ready for serving, with practically no attention or time spent in the actual cooking. A person may leave the house for a period of three to five hours and return to find the meal cooked perfectly, ready for serving.

To cook entire meals in a temperature controlled oven, no previous experience is necessary as only a few rules are to be observed. For those combinations of meals which include roast meats, it is necessary first to sear the meat in an uncovered pan and then **cover** it for the roasting process. For the vegetables and other foods, simply prepare these, and place in the oven in covered pans for the required length of time. Do not baste nor add water during the cooking process, as the juices and flavors will be retained in the covered pans.

In whole meal cooking, it is never necessary to open the oven doors nor change the temperature setting.

In cooking vegetables in covered pans for long periods, very little water should be added, especially to potatoes.

**Pastries, Biscuits** and similar fast cooking foods should be cooked separately and not with whole meals, as they require but a short time to cook and at a very high temperature. If prepared in advance, pastries, biscuits, etc., can be baked while the rest of the meal is being served.



### WHOLE MEAL COOKING (Continued)

**To cook a three hour meal:** First, sear the meat, then place all the foods in **tightly covered pans**, set the AutomatiCook at 275° and remove after three hours.

**For a four or five hour meal,** the same instructions apply except that the temperature must be set at 250°.

A few suggestions for whole meals, showing different articles of foods, will be found on the following page.

### POULTRY AND FISH

Complete instructions for roasting Poultry and Baking Fish are given at the bottom of the Cooking Chart, Page 3.

### SOUPS AND CEREALS

Soups, cereals, and foods of like nature can be cooked in the oven safely over night, with the Control Pointer set at 250°, or for periods as long as ten hours, without attention.

### BROILING OR TOASTING

Broiling or Toasting can be done either in the Baking Oven or the Broiling Oven, with the Control Pointer set at the mark "Broil." If done in the Broiling Oven, set the Pointer at "Broil" and regulate the height of the flame by operating the burner cock by hand.

### PEACH BUTTER, APPLE BUTTER, ETC.

Peach Butter, Apple Butter, Tomato Butter, etc., can be made in the oven and the AutomatiCook eliminates the constant tedious stirring. Prepare in the usual way and place the kettle in the oven with the pointer set at 250 degrees. No stirring throughout this long cooking process is necessary as the butter will not burn nor stick to the vessel.

### DRYING DISHES IN THE OVEN

Dishes and silverware can be dried in the Oven with the Control Pointer set at 250°.

### BRIEF EXPLANATION OF THE COOKING CHART

The Cooking Chart on Pages 2 and 3 has been compiled very carefully and covers practically every class of food. If the food to be cooked is not listed, select a similar food and follow the time and temperature given for it. Move the White Handle of the AutomatiCook to the temperature mark indicated in the first column opposite the article of food to be cooked, open the oven gas cock full, light the burner and allow the oven to preheat for the time specified in the second column. The foods can be prepared while the oven is preheating and when the oven is fully heated, put the food in the oven and allow it to cook for the length of time given in the third column.

Some articles of food must be cooked at two temperatures, first at a high temperature and then at a lower temperature, and in the fourth column you will find the lower temperature to which the AutomatiCook should be reset when required. The fifth column shows the total time that the food should be cooked.

### COOKING EXAMPLES

**Baking Powder Biscuits:** Set the pointer at 450 degrees. Turn on the gas and light the oven burner. After 20 minutes, place the biscuits in the oven and allow to bake from 12 to 15 minutes.

**Roasts (6 lb. medium):** Set the pointer of the AutomatiCook at 550 degrees. Turn on the gas and light the oven burner. Allow 20 minutes for the oven to become heated. Then place the roast in the oven and let sear for 20 minutes. Then reset the pointer to 450 degrees and let roast for 70 minutes, a total of 90 minutes, or 15 minutes to the pound.

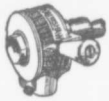

## *A Few Suggestions for Whole Meals*

Many different articles of food can be combined together for Whole Meal Cooking in the oven and your own experience and preference can dictate your choice of foods for the whole meal.

A number of different foods are listed below which may serve as a guide for your whole meal cooking.

For a three hour meal, the White Handle should be set at 275° and for a four or five hour meal, set at 250°.

### MEATS

Roast Chicken  
Stewed Chicken  
Fried Chicken  
Casserole Chicken  
Roast Ribs of Beef  
Beef Pot Roast  
Meat Stews  
Beef Loaf  
Stuffed Steak  
Stuffed Fish  
Baked Fish  
Roast Ham  
Scalloped Ham  
Roast Lamb  
Roast Pork  
Pork Tenderloins

### VEGETABLES

Roast Potatoes  
Brown Potatoes  
Pan Roasted Potatoes  
French Fried Potatoes  
Scalloped Potatoes  
Mashed Potatoes  
Roast Sweet Potatoes  
Candied Sweet Potatoes  
Carrots  
Peas  
Navy Beans  
Lima Beans  
Green Beans  
Wax Beans  
Asparagus  
Onions  
Tomatoes  
Celery  
Macaroni & Cheese  
Spaghetti  
Squash  
Beets  
Scalloped Corn  
Turnips  
Parsnips

### DESSERTS

Bread Pudding  
Lemon Pudding  
Rice Pudding  
Boiled Rice  
Stewed Prunes  
Stewed Apricots  
Stewed Figs  
Stewed Peaches  
Apple Brown Betty  
Apple Tapioca Pudding  
Fig Tapioca Pudding  
Baked Apples  
Apple Sauce  
Rhubarb Sauce  
All uncooked  
Desserts and Fruits





## Oven Canning Instructions

The Oven is a quick, simple convenient means for canning which may be relied upon and the fruits and tomatoes will retain their natural coloring, shape and flavor.

If the chart directions are carefully followed not one jar canned should spoil.

Avoid the possibilities of failure in oven canning by using only fresh fruits and vegetables.

All jars should be inspected for nicks and imperfections that would prevent a perfect seal.

We recommend that only new rubber rings be used, a fresh supply each season and the rubber rings should be dipped in boiling water before using and jars and covers should be thoroughly washed and scalded.

As the first step for oven canning of fruits and tomatoes, arrange the utensils; two large pans of boiling water, one for scalding the jars, tops, rubbers, etc., and one for scalding the products if they are to be packed hot. All products to be canned should be washed thoroughly and prepared for cooking. Those with earth clinging to them should have special attention and thoroughly washed and cleaned. Peaches, apricots and tomatoes have a skin which must be removed before packing them into jars, and this is best done by immersing the product in boiling water, using a wire basket, collander or square piece of cheese cloth. Allow the fruit to remain in the boiling water just long enough to loosen the skin, then dip in cold water and peel before packing in jars.

In preparing pineapple for canning, pare and remove the eyes. Then cut up the pineapple, removing the hard centre core.

For such fruits as raspberries, cherries, blackberries, etc., pack these into scalded jars immediately after being washed and the boiling syrup poured over them.

The syrup for canning fruits can be thin, medium or thick, depending upon the sweetness of the fruit itself. For a thin syrup, bring one part of sugar and three parts of water to the boiling point. For a medium syrup, one part of sugar to two parts of water, and for a thick syrup, one part of sugar to one part of water.

Fill the jars to within one inch of top and place the jars in the oven two inches apart.

Immediately upon removal from the oven, seal the jars tightly and then turn upside down until cool.

Keep in a dark place where it is cool but not in a place where the products are liable to freeze.

*Oven Canning Chart on the Following Page*

**BEACH OVEN CANNING CHART****FRUITS AND TOMATOES**

List of Products	Preparation	Filling and Handling Jars	Processing Period in the Oven
Apples, whole	Cook in sirup until somewhat transparent. Pack hot. Cover with sirup.	Fill jar to within 1 inch of top with liquid. Adjust scalded rubbers and partially clamp covers.	250° for 50 min.
Apples, quartered or sliced.	Pack in jars; cover with boiling sirup.	Same as above.	275° for 1 hour.
Apriots	Immerse in boiling water until skins slip. Cold dip, peel, pit and cut. Pack in jars, add boiling sirup.	Same as above.	275° for 1 hour.
Blackberries, Blueberries, Currants, Dewberries, Huckleberries, Loganberries, Raspberries	Pack in jars. Fill with boiling hot, medium sirup.	Same as above.	250° for 1 hour.
Cherries	Pack in hot jars. Cover with boiling sirup of desired sweetness.	Same as above.	250° for 1 hour.
Gooseberries	Pack in jars, fill with boiling thick sirup.	Same as above.	250° for 1 hour.
Peaches	Immerse in boiling water until skins slip. Cold dip, peel, pit, and cut. Pack in jars, add boiling sirup.	Same as above.	275° for 1 hour.
Pears	Pare, cook 4 to 8 minutes in boiling medium sirup. Pack hot in jars; fill with boiling sirup.	Same as above.	275° for 1 hour.
Pineapple	Pare and core. Cut up. Pack, using boiling thin sirup.	Same as above.	275° for 1 hour.
Plums	Prick surface of skin. Pack, using boiling medium sirup.	Same as above.	275° for 1 hour.
Rhubarb	Cut up. Measure and add one-fourth as much sugar. Bake in covered dish until tender. Pack hot.	Fill jar to within 1 inch of top, adjust scalded rubbers and partially clamp covers.	250° for 30 min.
Strawberries	Add 1 cup of sugar and 2 table-spoonfuls of water to each quart. Simmer 15 minutes. Stand over night. Reheat to boiling and pack.	Same as above.	250° for 50 min.
Tomatoes	Scald, peel. Pack and cover with boiling tomato juice. Add 1 tea-spoonful of salt to each quart jar.	Same as above.	275° for 30 min. and then 250° for 30 min.

The time periods above are based on the use of quart glass jars. For pint glass jars, five minutes less time may be used.

**SPECIAL NOTE:**

The Bureau of Home Economics, United States Department of Agriculture, does not advise the processing or canning of non-acid vegetables when the interior of the jar does not exceed 212°, the boiling point, and for this reason we only recommend in this booklet, the canning of fruits and tomatoes in the oven.

For the canning of all non-acid vegetables, the U. S. Department of Agriculture recommends the use of a pressure canner.

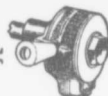

## Beach's Tested Time and Temperature Recipes

### Bread

1 cup milk. 5 or 6 cups bread flour. ½ cake compressed yeast  
 1 cup boiling water. ½ teaspoon lard or none. dissolved in a table-  
 1½ teaspoons salt. ½ teaspoon sugar or none. spoon luke-warm water.

Scald milk and add water. Measure salt, sugar and lard into a mixing bowl, pour over the boiling liquid and cool until lukewarm. Add dissolved yeast. Stir in 1 cup flour at a time, beating thoroughly at each addition. Turn on floured board; knead until smooth and elastic. Wash, dry and grease the bowl, lay in dough, brush top with butter, cover with a clean cloth and a granite plate. Let rise to double its bulk. Then re-knead and let rise second time to double its bulk. Set pointer at 350° F., preheat for 15 minutes, place bread in oven to bake 45 to 60 minutes.

### Parker House Rolls

1 cup milk, scalded and cooled to proper temperature. 1 tablespoon sugar let rise, add 1/3 cup melted butter; flour to knead, about two cups.  
 1 cake yeast soaked in ¼ cup milk or water, 1 teaspoon salt  
 ½ cup flour. Beat thoroughly, cover,

Knead until elastic. Roll in a sheet 1/3" thick and cut with a biscuit cutter. Grease in centre, brush lower half with melted butter, fold and press edges together. Place in greased pan 1" apart, brush with butter, let rise. Set pointer at 400° F., preheat 20 minutes. Bake 15-20 minutes.

### Chocolate Layer Cake

1/3 cup butter. ½ cup milk. soda.  
 1 cup sugar. ½ cup milk, 2 sq. choco- ½ teaspoon salt.  
 2 eggs yolks or 1 egg late—  
 and 1 yolk. 1½ cups flour, 1 teaspoon

Grate Chocolate and mix it with well-beaten egg-yolks. Add ½ cup milk and cook in double boiler until mixture is smooth and creamy, stirring constantly. Remove from fire, add sugar, butter and salt. Dissolve soda in ½ cup milk and add to rest of ingredients. Add flour slowly and stir until smooth. Turn into well greased pan.

Set pointer at 375° F., preheat 15 minutes, place cake in oven and bake 20 minutes.

### Pastry for Pie Shells

3 cups pastry flour. 1 cup lard. 1 cup cold water.  
 1 teaspoon salt.

Cut in lard, mix with as little water as possible. Toss on floured board, roll lightly. In baking pastry for pie shells, tarts, etc., line pie plate.

Set pointer at 550° F., preheat 25 minutes, bake 10-15 minutes.

### Plain Cake

For layers or plain loaf cake.

1/3 cup butter. ¾-1 cup milk. few grains salt.  
 1½ cup sugar. 2 cups flour. Flavoring.  
 2 eggs. 3 teaspoons baking powder.

Cream the butter, add sugar, add eggs, leaving one egg white for icing. Beat this mixture well. Sift dry ingredients and add alternately with the milk. Add flavoring. Turn into buttered tins, set pointer at 375° F., preheat 15 minutes, place cake in oven and bake 20 minutes.

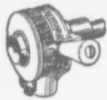

### White Loaf Cake

½ cup butter. 1 teaspoon flavoring. 2 teaspoons baking powder.  
1 cup sugar. 2/3 cup milk. 3 egg whites.  
½ teaspoon salt. 2 cups cake flour.

Cream sugar and butter, add salt, flavoring and flour and milk alternately. Beat well.

Lastly fold in white of eggs beaten stiff. Set pointer at 350° F., preheat 15 minutes, place cake in oven and bake 45 minutes.

### Pastry Tarts

1 cup raisins. Juice and grated rind of 1 egg.  
1 cup sugar. 1 lemon. 1 cracker.

Chop raisins, add sugar, egg, cracker finely rolled, add lemon juice and rind. Roll pastry ⅛ inch thick, cut in strips or with large cookie cutter.

Place one teaspoon mixture on one-half of strips, moisten edges, place over upper crust.

Set pointer at 550° F., preheat 25 minutes, place tarts in oven, bake 12 minutes.

### Angel Cake

Whites of 8 eggs. 1 cup sugar. ¼ teaspoon salt.  
1 teaspoon cream of tartar. ¾ cup flour. ¾ teaspoon vanilla.

Beat whites of eggs until frothy, add cream of tartar, and continue beating until eggs are stiff; then add sugar gradually. Fold in flour mixed with salt and sifted four times, and add vanilla. Set pointer at 320° F., preheat 15 minutes. Place cake in oven and bake 60 minutes.

### Apple Pie

6 tart apples. Small piece of butter. ¼ to ½ cup sugar.  
few grains nutmeg.

Line pie plate with pastry, cut apples in quarters, and then slice thinly into pie, sprinkle with the sugar and nutmeg or cinnamon, dot with butter. Put on upper crust.

Set pointer at 450° F., preheat 20 minutes, place pie in oven and bake 30 minutes, then reset pointer at 400° F. and continue baking for 10 minutes.

### Fruit Cake

1 lb. butter. 1 lb. flour. ½ lb. citron, sliced.  
1 lb. brown sugar. 4 nutmegs. 1 teaspoon mace.  
10 eggs. 3 lbs. currants. ½ teaspoon cloves (scant).  
1 cup molasses. 3 lbs. raisins, cut in two.

Set pointer at 275° F., preheat 15 minutes, place cake in oven and bake 3 to 4 hours.

### Baking Powder Biscuits

4 cups flour. 4 teaspoons baking powder. few grains salt.  
¼ cup shortening. 1 cup cold milk.

Mix dry ingredients and cut in shortening, add milk. Toss on floured board, roll into shape, cut, place on buttered pan. Set pointer at 450° F., preheat 20 minutes, place biscuits in oven and bake 12 to 15 minutes.

### Pop-Overs

1 cup flour. ¾ cup milk. ½ teaspoon melted butter.  
¼ teaspoon salt. 2 eggs.

Mix salt and flour; add milk gradually, add eggs beaten until light, and butter; beat 2 minutes. Turn into hissing hot buttered iron gem pans. Set pointer at 450° F., preheat 20 minutes. Place pop-overs in oven and bake 30 minutes, then reset pointer at 350° F. and continue baking 15 minutes.



### Pumpkin Pie

2 eggs. few grains nutmeg. 1½ cups milk.  
 3 tablespoons sugar. few grains salt. 1½ cups pumpkin.

Beat eggs slightly, add sugar and milk. Line plate with paste. Strain in mixture and sprinkle with nutmeg and a little sugar. Set pointer at 450° F., preheat 20 minutes, place pie in oven and bake 10 minutes, then reset pointer at 325° F. and continue baking 30 minutes.

### Soft Molasses Cookies

1 cup molasses. Flour. 2 teaspoons ginger.  
 1¾ teaspoons soda. ½ cup shortening, melted. 1 teaspoon salt.  
 1 cup sour milk.

Add soda to molasses and beat thoroughly; add milk, shortening, ginger, salt and flour. Enough flour must be used to make mixture of right consistency to drop easily from spoon. Let stand several hours in a cold place to thoroughly chill. Toss one-half mixture at a time on slightly floured board and roll lightly to one-fourth inch thickness. Shape with a round cutter first dipped in flour. Place on a buttered sheet.

Set ROBERTSHAW at 375° F., preheat oven for 15 minutes. Place cookies in oven and bake for 18 minutes.

### Twin Mountain Muffins

¼ cup butter. 1 egg. 2 cups flour.  
 ¼ cup sugar. ¾ cup milk. 3 teaspoons baking powder.

Cream the butter; add sugar and egg well beaten; sift baking powder with flour, and add to the first mixture, alternating with milk. Pour into buttered tin muffin pans and set ROBERTSHAW at 400° F., preheat oven for 20 minutes. Place muffins in oven and bake 25 minutes.

### Nut Cookies

Yolks 2 eggs. 1 cup chopped nut meats. 6 tablespoons flour.  
 1 cup brown sugar. Whites 2 eggs. few grains salt.

Beat yolks of eggs until thick and lemon-colored, add sugar gradually, nut meats, whites of egg beaten until stiff, and flour mixed with salt. Drop from tip of spoon on buttered sheet.

Set ROBERTSHAW at 425° F., preheat oven for 20 minutes. Place cookies in oven and bake 12 minutes.

### Baked Custard

4 cups scalded milk. Few gratings nutmeg. ¼ teaspoon salt.  
 4 to 6 eggs. ½ cup sugar.

Beat eggs slightly, add sugar and salt, pour on slowly scalded milk; strain in buttered mould, set in pan of hot water.

Set ROBERTSHAW at 325° F., preheat oven for 15 minutes. Place custard in oven and bake for 40 minutes.

For cup custards allow four eggs to four cups milk; for large moulded custard, six eggs; if less eggs are used custard is liable to crack when turned on a serving dish.

### CASSEROLE COOKING

This is one of the easiest as well as the most economical ways of preparing food—cheap cuts of meat are rendered tender by this method.

Cut the meat into small pieces, then flour and season it. Put it in a buttered casserole dish, place in oven. Have ROBERTSHAW set at 550 degrees to sear and brown the pieces of meat. Use one tablespoon of cornstarch for each cup of water added for gravy. Put in vegetables. (See casserole dishes in cooking chart on page 2).

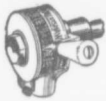

#### Macaroni with Cheese

1 pint boiled macaroni. 1 cup thin white sauce. Buttered crumbs.  
Salt and pepper.  $\frac{1}{2}$  cup (scant) chopped cheese.

Put macaroni and cheese in layers in a buttered baking dish, moisten with sauce, cover with crumbs and bake with a whole meal, or set ROBERTSHAW at 350 degrees, preheat oven for 10 minutes. Place in macaroni and refer to casserole dishes in cooking chart on page 2.

#### Macaroni with Tomato

1 teaspoon chopped onion. 1 tablespoon flour.  $\frac{1}{2}$  teaspoon salt.  
1 tablespoon butter.  $1\frac{1}{2}$  cup strained tomato. 1 pt. boiled macaroni.

Fry onion in butter until slightly colored, add flour; when well mixed, add gradually the tomato and salt, making sauce.

Put macaroni into buttered baking dish, pour over the sauce and bake with whole meal, or set ROBERTSHAW at 350 degrees, preheat oven for 10 minutes. Place in macaroni, and refer to casserole dishes in cooking chart on page 2.

#### Casserole of Beef

2 or 3 lbs. of beef from 1 onion. Parsley.  
top round. 1 sliced carrot.  $\frac{1}{2}$  teaspoon whole mixed  
1 can tomatoes. 2 stalks of celery. spices.

Wipe beef, tie into shape to fit casserole, salt and pepper it, and roll in flour until thickly coated.

Place in casserole which you have already heated in oven with 3 tablespoon fat.

Have ROBERTSHAW set at 550 degrees, preheat oven 10 minutes, place in meat and sear until meat is well browned.

Now add other ingredients to casserole, reset ROBERTSHAW. Refer to casserole dishes in cooking chart on page 2.

If you wish to serve potatoes with this dish, add with other ingredients at time of lowering temperature in oven.

Veal, lamb and chicken are equally delicious casserole and give wonderful possibilities for using cheaper cuts of meats.

When casseroles lamb chops, make a bed of vegetables underneath, using potatoes, carrots, parsnips and turnips.

#### Boston Baked Beans

1 pint navy beans.  $\frac{1}{2}$  tablespoon salt. 1 cup boiling water.  
 $\frac{1}{2}$  lb. lean pork. 3 tablespoon molasses. few grains mustard.  
1 small onion.

Cover beans with cold water, soak over night.

Drain off water in morning, cover with fresh water, heat slowly: cook until skins burst, which is best determined by taking a few beans on the end of a spoon and blowing on them; if beans are done, skins will burst.

Drain off water and put beans into an earthen pot and bury in the onion and the pork which has been cut into small pieces, reserving three or four pieces for the top.

Mix salt, mustard and molasses, pour over beans, add the one cup of hot water and enough more water to completely cover beans. Cover pot.

Set ROBERTSHAW at 275° F., light gas, preheat oven for 10 minutes. Place beans in oven and cook for six hours.

#### Beefsteak Pie

Cut remnants of cold beef into one-half inch cubes and put into a buttered baking dish, cover with boiling water, add two or three small onions, four or five potatoes cut in small pieces, few grains salt and pepper.

Set ROBERTSHAW at 350° F., preheat 10 minutes, place beef in oven and cook one hour. Remove from oven, let cool.

Cover with baking powder biscuit mixture or pie crust. Return to oven and bake for 45 minutes at 350° F.



### Meat Pie II

Use beefsteak pie recipe, substituting uncooked beef, veal, lamb or chicken for the beef. Cut into small pieces, cover with boiling water, add onions, potatoes, salt and pepper, and a small carrot cut in lengths if so desired.

Place into a buttered baking dish. Set ROBERTSHAW at 250° F., preheat 10 minutes, place pie into oven and cook for 3 hours. Remove, cool; cover with baking powder biscuit or pie crust.

Set ROBERTSHAW at 350° F., preheat 10 minutes. Place in pie and bake 45 minutes.

### WHOLE MEAL COOKING

By using the ROBERTSHAW an entire meal can be cooked in the oven without attention, the same as in a fireless cooker. This is often a great convenience and is one of the great advantages of using the ROBERTSHAW. As the cooking requires no attention the cook may be absent from three to five hours and upon returning find a perfectly cooked meal. Meat, fish, vegetables, puddings, etc., may be cooked together.

Meats should first be seared for 20 to 30 minutes. Then place the different foods in oven in separate COVERED dishes and turn pointer to 250° F. Leave in oven from 4 to 5 hours. If it is desired to shorten time the meal may be cooked for 3 hours at about 275°, which temperature is obtained by turning the pointer to a position halfway between 250° and 300°. The temperature and the time may be changed in accordance with the individual taste of the operator.

#### Method of Preparing Food for Oven Dinners

1st—All meats are seared or browned at a high temperature in an uncovered roaster. This requires from 15 to 30 minutes according to size of roast. Turn pointer to 530°

Note—Beef is the one meat not adaptable to long oven-dinner cooking; but pot roast of beef is excellently cooked in this manner.

2nd—After meat has been seared, place cover on roaster, and at this time all other foods are placed in the oven, vegetables in cold salt water, puddings as mixed. Temperature is then reduced to desired degree, for whatever time housewife desires to be free.

275 degrees for a 3-hour meal.

250 degrees for a 4 or 5-hour meal.

Note—In winter time, when one is unable to obtain young, tender vegetables, as a precaution against having an undercooked vegetable, such vegetables as beets, turnips, carrots and sometimes onions, should be placed in oven while meat is browning. This starts the cooking of these vegetables more quickly than when put into oven at time temperature is reduced.

#### Typical All-Oven Dinners

The following sample menus are for dinners which can be fully prepared in the bake oven, all foods being put in at one time and taken out at one time.

Many other combinations may be used.

#### MENU I

Baked Ham with Potatoes.

Buttered Beans.

Creamed carrots.

Bread Pudding.

#### DIRECTIONS:

Set ROBERTSHAW at 250 degrees, preheat 10 minutes. Prepare entire meal and place in oven at one time. Bake 4 hours.

#### Baked Ham with Potatoes

Put slice of ham one-inch thick in baking dish. Wash and pare potatoes, cut in thick slices and place around ham.

Pour over enough sweet milk to cover both ham and potatoes. Bake in an uncovered dish.



### Creamed Carrots

Peel, dice and put in boiling water. Cover utensil, place in oven. When removed, season and serve with cream sauce.

### Buttered Beans

Wash and cut up beans, place in boiling water, place in oven. When removed, season with salt, pepper and butter.

### Bread Pudding

½ of 1 lb. loaf of stale bread. ¼ cup sugar. 1 pint milk.  
2 tablespoons butter. 3 eggs.  
⅛ teaspoon salt.

Cut bread into small cubes, mix together the sugar, salt, milk and eggs, well beaten. Flavor with 1 teaspoon of vanilla or a little grated nutmeg or chocolate. Pour over bread, place in a buttered pudding dish, dot with butter. Bake uncovered.

### MENU II

Roast Lamb or Veal. Baked Tomatoes. Graham Pudding.  
Creamed Cauliflower. Browned Potatoes.

#### DIRECTIONS:

Set ROBERTSHAW at 500 degrees, preheat 20 min. Place roast in oven, sear uncovered 30 minutes, cover and reset ROBERTSHAW at 250 degrees, place entire meal in oven and cook 4 or 5 hours.

#### Roast Lamb or Veal

Wipe a 6 lb. roast of lamb with damp cloth. Rub outside with flour, salt and pepper. Place in roaster and sear uncovered 30 minutes. Reset ROBERTSHAW at 250°.

Add 3 cups water, pare potatoes, place around meat. Cook covered, 4 or 5 hours.

#### Creamed Cauliflower

Wash and separate into small sections one medium sized cauliflower. Place in pot, add boiling water, add 1 teaspoon salt. Place in oven covered. At serving time season with butter or serve with white sauce.

#### Baked Tomatoes

Cut out blossom end of tomato, fill with butter, pepper and salt. Place in baking dish, add ½ cup water. Cover, place in oven.

#### Graham Pudding

¼ cup butter. 1 teaspoon salt. 1 teaspoon cinnamon.  
2 teaspoons baking powder. 2 cups graham flour. ½ cup molasses.  
¾ cup sweet milk. ½ teaspoon soda. 1 egg.  
1 teaspoon cloves. ½ cup sugar. 1 cup raisins.

Melt butter, add molasses, sugar, milk and egg well beaten. Mix and sift dry ingredients. Add to first mixture. Then add raisins, turn into a buttered pudding dish. Cook covered.

### MENU III

Fried Chicken. Creamed Onions. Bellevue Pudding.  
Butter Beans. Mashed Potatoes. Creamy Sauce.

#### DIRECTIONS:

#### Fried Chicken

Dress, clean and cut up a fowl. Dip in egg and roll in cracker crumbs, which have been buttered. Place in roaster for 15 minutes at 450 degrees to start searing.

Reduce temperature to 275 degrees, cover and bake for 3 hours. Serve with cream sauce.





**Potatoes**

Place potatoes in cold salt water and cook in oven with chicken at 275 degrees for 3 hours. Serve mashed.

**Butter Beans**

Place beans in boiling salt water and cook in oven with other foods at 275 degrees for 3 hours. Season with butter, pepper and salt.

**Onions**

Place onions in boiling salt water and cook in oven with chicken at 275 degrees for 3 hours. Cover with 1 cup white sauce at serving time.

**Bellevue Pudding**

1 cup molasses.	1 teaspoon soda.	1 teaspoon cinnamon.
4 tablespoons shortening.	1 cup sweet milk.	1 teaspoon cloves.
2 cups bread flour.		

Dissolve soda in milk. Melt shortening, add molasses, milk and dry ingredients, turn into a greased mould, cover and bake 3 hours with dinner. Serve with creamy sauce.

**Creamy Sauce**

1 cup powdered sugar.	1 egg well-beaten.	1 teaspoon vanilla.
¼ cup butter.	¼ cup boiling water.	

Rub sugar and butter to a cream, add eggs and beat well. Just before serving, add boiling water and vanilla.

**MENU IV**

Baked Fish.	Chocolate Pudding.	Stewed Tomatoes.
Boiled Onions.	Stewed Potatoes.	

**DIRECTIONS:**

Set ROBERTSHAW at 500 degrees, preheat oven 10 minutes, place fish in roaster and sear for 10 minutes, uncovered. Reset ROBERTSHAW to 250 degrees for four or five-hour meal; place other foods in oven covered.

**Stewed Potatoes**

Wash, pare and slice five or six potatoes, place in covered baking dish in layers, seasoning each layer with salt, pepper and butter and sprinkle over each layer a little flour.

When dish is filled with potatoes cover with milk and lay over top layers of bacon.

Place in oven while fish is searing and cover when temperature is reduced.

**Boiled Onions**

Pare and place onions in pot, add boiling water, add salt, place in oven covered and cook with meal. Season with butter, pepper and salt.

**Stewed Tomatoes**

Skin and cut in pieces six or eight ripe tomatoes, place in pot, add cold water to cover, 1 teaspoon salt, little pepper and good size piece of butter.

Cover and place in oven to cook with meal.

**Chocolate Pudding**

4 tablespoon butter.	1 teaspoon vanilla.	3 teaspoon baking powder.
1 cup sugar.	1 cup milk.	2 sq. Baker's chocolate
2 eggs.	2 cups flour.	melted.
few grains salt.		

Cream butter, add sugar and eggs, beat well, add flour, baking powder, salt; mixed alternately with the milk.

Lastly, beat in the melted chocolate and pour into a covered buttered pudding dish. Pudding can be steamed two hours or baked 1 to 3 hours in a covered dish with whole meal.



**MENU V—All-Oven Vegetable Dinner**

Mashed Potatoes.  
Spinach.

Baked Eggs.  
Creamed Onions.

Prune Souffle.

**DIRECTIONS:**

Set ROBERTSHAW at 275 degrees, preheat oven for 10 minutes, then place in all foods and cook three hours at 275 degrees, or four hours at 250 degrees.

**Potatoes**

Wash and pare eight medium sized potatoes, place in saucepan, cover with cold water and add 1 teaspoon salt. Place in oven covered.

At serving time, when all foods are removed from oven, mash, season with butter, pepper and salt and milk.

Arrange around the edge of serving platter in a border, keeping one-half of potato for centre of platter to arrange eggs on.

**Spinach**

Wash thoroughly 2 quarts of spinach. Place in saucepan, pressing down well, add boiling water, add 1 teaspoon salt. Place in oven covered.

At serving time remove from oven, drain off water, chop spinach with a knife. Place in a mould on platter inside of potato border.

**Creamed Onions**

Pare 1 quart white onions, place in saucepan, add boiling water, add 1 teaspoon salt. Place in oven covered. At serving time remove from oven, drain well and cover with 1 cup of white sauce.

Place onions in a mould on serving platter inside of potato border.

**Baked Eggs**

On serving platter upon which you have just arranged the vegetables, on the potato bed in centre of platter make four little nests, by pressing down with a large spoon, thus forming four small wells or holes.

Into these break four fresh eggs; place platter in oven.

Set ROBERTSHAW at 375 degrees and bake for 15 minutes.

**Prune Souffle**

1/3 lb. prunes.  
1/2 teaspoon lemon juice.

Whites 5 eggs.

1/2 cup sugar.

Pick over and wash prunes, then soak several hours in cold water to cover; cook in same water until soft; remove stones and rub prunes through a strainer, add sugar and cook five minutes; the mixture should be of the consistency of marmalade. Beat whites of eggs until stiff, add prune mixture gradually when cold, and lemon juice. Pile lightly on buttered pudding dish. Place in oven with whole meal.

The foregoing sample menus will give you a general idea of the food combinations which are suited for whole meal oven cooking. Other combinations along similar lines can easily be evolved to suit your individual taste.

INSTRUCTIONS

*for the care and adjustments of the*  
**Robertshaw AutomatiCook**

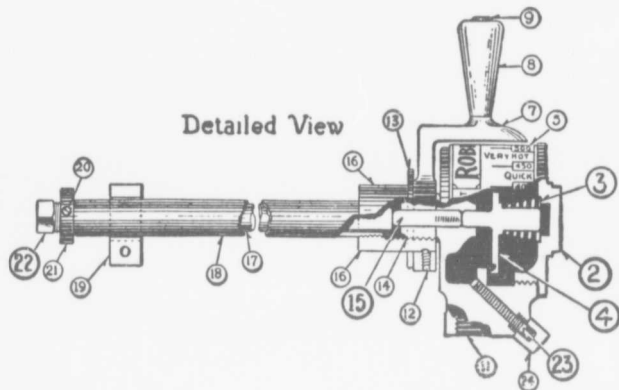

The minimum burner flame Pilot and the Independent Pilot must be properly adjusted by the person installing the Range.

To adjust the minimum burner flame pilot, move the Pointer of the AutomatiCook up to the 500 degree mark, then light the gas in the burner and allow the oven to heat for about 10 minutes. Then move the pointer down to the 250 degree mark. This closes the valve seat. Any gas then passing to the burner is through the minimum burner flame port and this should burn about  $\frac{1}{8}$  in. high over the entire burner. If the flame is too high, turn screw (23) to the right (clockwise) to reduce it, and if the flame is too low, turn screw (23) to the left. The adjusting screw (23) is located underneath the knurled protecting cap (24) on the body of the AutomatiCook.

The Independent Pilot light is the small yellow flame that burns near the oven burner so that it will ignite the burner and be ignited by it. It is a precautionary pilot and serves to relight the burner in case the minimum burner flame pilot is improperly adjusted and goes out. It is entirely independent of the AutomatiCook and will burn at the same height regardless of the temperature. It is lighted with the burner and extinguished when the burner is shut off. Turning the small screw at the end of this Pilot regulates the length of flame, which should be adjusted to about  $\frac{3}{4}$  inch in length.

The temperature setting seldom has to be changed but should it be necessary, this is done by turning plug (22) at the end of the Thermostatic tube. Turning plug (22) to the right (clockwise) raises the oven temperature and to the left lowers it. The Pointer must be held rigidly in one position while the plug (22) is being turned and turning the plug one face of its hexagon end changes the temperature 50 degrees.

To clean the valve parts it is simply necessary to remove cap (2), take out the disc (4), the spring (3) and the gland pin (15). Clean all these parts thoroughly, especially the valve seat, and replace parts.

**Cleaning the Valve Parts Does NOT Change the Temperature Setting.**

