

doc
CA1
EA
2001C52
ENG



 UNIVERSITY OF
CAMBRIDGE

Scott Polar Research Institute



Carleton
UNIVERSITY

Geotechnical Science Laboratories

Contaminants in Freezing Ground

Collected Proceedings of 2nd International Conference

2-5 July 2000

Organised by

Scott Polar Research Institute, Cambridge University

in association with

Geotechnical Science Laboratories, Carleton University, Ottawa

held at

Fitzwilliam College, Cambridge, United Kingdom



PART I

Dept. of
 Min. Cons. / Natural Resources
 FEB 10 2005
 Division of Environmental
 Assessment

Contaminants in Freezing Ground
 Collected Proceedings of 2nd International Conference

PART I

16752276

International Conferences on Contaminants in Freezing Ground

First Conference: Cambridge, UK 1997

Second Conference: Cambridge, UK 2000

Third Conference: Hobart, Australia 2002

International Steering Committee (1999-2002):

Chairman: Peter J. Williams, Geotechnical Science Laboratories, Carleton University, Ottawa, Canada

Co-chairman: W. Gareth Rees, Scott Polar Research Institute, Cambridge University, United Kingdom

Jaime Aguirre-Puente, Centre National de la Recherche Scientifique, Paris, France

Evgenny Chuvilin, Department of Geocryology, Moscow State University, Moscow, Russia

Deborah Goodings, University of Maryland, U.S.A.

Arne Instanes, Norwegian Geotechnical Institute, Oslo, Norway

Ian Snape, Australian Antarctic Division

T. Les White, Geotechnical Science Laboratories, Carleton University, Ottawa, Canada

Enquiries and Proceedings:

Second Conference, Cambridge, UK 2000: www.freezingground.org/conf2000

Third Conference, Hobart, Australia 2002: www.aad.gov.au/science/cfg3/

The Second International Conference on
Contaminants in Freezing Ground
July 2-5, 2000, Fitzwilliam College, Cambridge, U.K.

SPONSORS:

EUROPEAN UNION (INTAS)
CANADIAN POLAR COMMISSION
U.S. ARMY, EUROPEAN RESEARCH OFFICE



ANGLO SIBERIAN OIL COMPANY plc,
ARCTIC FOUNDATIONS INC,
JACQUES WHITFORD ENVIRONMENT LIMITED

PART I

Publication assisted by GOVERNMENT OF CANADA



Department of Foreign Affairs
and International Trade

Ministère des Affaires Étrangères
et du Commerce international

Copyright © 2001, Conference Secretariat

Contaminants in Freezing Ground. Collected Proceedings of 2nd International Conference

Publisher: Conference Secretariat, Ottawa, Canada

ISBN 0-9689860-0-5

General Editor: Peter J. Williams

The Collected Proceedings has three parts. Part I is published by the Conference Secretariat of the 2nd International Conference. Part II is a Special Issue of Cold Regions Science and Technology (Vol. 32, Nos. 2-3, 2001 - published by Elsevier), and Part III a Special Issue of Polar Record, (Vol. 37, No. 202, 2001 - published by Cambridge University Press). The three parts have been packaged together by the Conference Secretariat to form *Contaminants in Freezing Ground. Collected Proceedings of 2nd International Conference*.

All rights reserved. The use of any part of this publication reproduced, transmitted in any form or by any means, electronic, mechanical, photocopying, recording, or otherwise, or stored in a retrieval system, without prior consent of the publishers is an infringement of copyright law.

Please forward any comments or questions regarding this publication to:

Conference Secretariat
% Geotechnical Science Laboratories
Carleton University
1125 Colonel By Drive
Ottawa, Ontario K1S 5B6
Canada

The best effort has been made to ensure this publication is of the highest level of accuracy. However, the authors, publishers, and all others directly or indirectly involved with this publication do not assume responsibility or liability for errors or omissions.

Printed in Canada

TABLE OF CONTENTS

- i Foreword
- ii Acknowledgements
- iii Introduction
- Papers:**
- 1 The establishment of a simple, low cost, bio-remediation pilot project in Cambridge Bay, Nunavut
R.W. McCullough and R. L. Burkill
- 7 Microstructural alteration in permafrost-affected soils due to hydrocarbon contamination: implications for subsurface transport
T.L. White, P.J. Williams, Y. Marchand and W.G. Rees
- 23 Fate and transport of pollutants in freezing soil and the application of geoenvironmental centrifuge physical modelling
Mazyar Zeinali, Deborah J. Goodings and Alba Torrents
- 33 Effects of hydrocarbon contaminants on the temperature and moisture regimes of cryosols of the Ross Sea region, Antarctica
Megan Balks, John Kimble, Ron Paetzold, Jackie Aislabie and Iain Campbell
- 41 Microbial activity measurements for a soil quality assessment of highly crude oil contaminated soils in the Russian tundra at the Arctic Circle
Lothar Beyer, Wiebke Huyke, Stephan Hüttmann, Inna Arhegova and Tatiana V. Titarenko
- 49 Could microorganisms in permafrost hold the secret of immortality? What does this mean?
Anatoli Brouchkov and Peter J. Williams
- Posters:**
- 57 Potential changes of environmental contamination in permafrost regions caused by anthropogenic global warming
O.A. Anisimov
- 58 COLDREM - soil remediation in a cold climate: A national Swedish research program
Bo Mattiasson and Ingegerd Ask
- 59 Flocculation of a bacterial suspension by a cationic polyelectrolyte
Xavier Châtellier, Jean-Yves Bottero and Jean Lepetit
- 61 Laboratory study of unfrozen water content of diesel contaminated frozen sandy soil using time domain reflectometry (TDR) cable tester
Djaouida Chenaf and Karim Hadj-Rabia
- 62 Measurements of petroleum-infiltration rates in frozen soils from Bethel, Alaska, for secondary containment design
Michael R. Lilly, Craig A. McCauley, Daniel M. White, and David M. Nyman
- 63 Permafrost and frozen-soil investigation and reporting methods for waste-containment facilities
Michael R. Lilly and David M. Nyman
- 64 Natural attenuation of hydrocarbon impacts in a cold weather climate, Sable Island, Nova Scotia, Canada
Eric G. Parsons, Stephen D. Locke and Raymond St. Pierre

TABLE OF CONTENTS continued

Workshops

- 65 Characteristics, behaviour and longevity of microorganisms in frozen ground, with regard to their use in bioremediation
- 67 Large-area monitoring and assessment of ground contamination
- 69 Fundamental studies relating to contaminant remediation

Other Initiatives

- 68 Russian Information Transfer Project: Scott Polar Research Institute, University of Cambridge
- 68 Cold Regions Bioremediation Project
- 69 Virtual Conference on Contaminants in Freezing Ground
- 71 **Conference 2000: photo page**

Foreword

The Arctic is often considered a pristine environment, remote from regions of high density population and major industry, and unaffected by many of the problems of pollution and contamination found in lower latitudes. There is now increasing evidence of degradation in the North from both hemisphere-wide atmospheric transportation of pollutants, as well as from local economic development activities. Early studies in Arctic North America and Scandinavia illuminated the sources, pathways and fate of contaminants transported by atmosphere circulation, such as Arctic haze. More recently the work of the Arctic Monitoring and Assessment Programme (AMAP) has drawn attention to other environmental compartments and their various pathways and process - the terrestrial and freshwater domain and the marine domain. All three compartments are of course not separate but integrated in a web of interactions which determine the fate of contaminants in the Arctic. Considerable attention has focused upon improving understanding of terrestrial process - in the snow pack, in wetlands, in rivers, ground water and lakes; as well as of marine process - in estuarine regions (including fjords), the near shore and the open ocean. One major component of environment of the North - frozen ground - has not, however, received as much investigation to date. Yet frozen ground has an important role in relation to ground water and drainage, to the storing of contaminants and to their release - such substances as PCBs, heavy metals, hydrocarbons from oil extraction and nuclear materials. It is timely and welcome that research into and discussion of contamination in this setting should now receive active attention. A thorough knowledge of patterns and processes can assist in the development of policy measures for limiting or preventing release at local level and for remediation and clean-up of terrain already subject to contamination. The organisers and sponsors of the 2nd International Conference held in Cambridge should be congratulated on an important collaboration.

Professor David J. Drewry
President, International Arctic Science Committee, and Vice-Chancellor, University of Hull, United Kingdom

Prof. Drewry was the keynote speaker at the Conference Dinner

Acknowledgements

Conferences like this one are, these days, dependent on the financial input of organisations and companies, whose interests may be closely allied to the subjects under discussion or who have a more general involvement in the subject area. It is important, too, that all who might valuably participate do so. This is where others assist, who in the course of, and sometimes beyond their normal duties, loyally help to produce a successful event, holding costs down and facilitating participation.

The International Conference Secretariat, managed by Eric Williams, provided registration, publicity and other administrative functions ahead of the meeting. He was joined by Mrs. Else Groves, Carleton University, in running the secretariat office and in providing extensive services to participants on-site, during the Conference. With participants from 12 countries, with complex funding and travel arrangements, such help was much appreciated by many participants who personally benefitted. Fitzwilliam College Conference Office has much experience, but the nature of this Conference provided some extra challenges. The consideration of Mr. Tim Heath, College Manciple, and his staff in the College Conference Office, was much appreciated and his personal attention to details of the Conference Dinner made this a memorable event.

From a different perspective, Eric Williams has prepared the item in hand, Part 1, of the Collected Proceedings, through all the stages from receiving contributions to final layout. Elsevier and Cambridge University Press have both been considerate in providing reprints under favourable terms, of the Special Issues of *Cold Regions Science and Technology* and *Polar Record* which constitute Parts 2 and 3 of the Collected Proceedings. Professor Brian Masterson, Chemex International Plc, also generously assisted the publication of the Collected Proceedings.

The Circumpolar Programme of the Canadian Government's Department of Foreign Affairs and International Trade provided funds which allowed the preparation of the Collected Proceedings to the standard achieved, and also allowed a copy to be presented to each registrant at the forthcoming Third International Conference on Contaminants in Freezing Ground, Hobart, April 2002. This kind of continuity between conferences is especially important in a relatively new and rapidly expanding topic. The Department's initiative is both a credit to all those whose work is represented in the Collected Proceedings and a significant aid towards activities globally, whereby scientific expertise can be brought to bear most effectively on pressing problems of contaminant remediation in cold regions worldwide.

Peter J. Williams
W. Gareth Rees
Conference Co-chairmen

Introduction

Contaminated ground has become a widely recognised problem over the last two or three decades. Storage and waste disposal of all kinds, as well as accidental spillage, urban development, the re-use of land earlier made toxic and the spreading over time of contaminating materials have resulted in regulatory requirements for costly clean-up procedures which may themselves cause further disturbance. Most of the concern for ground contamination has been directed towards the heavily-populated and temperate climate areas of the world. Only in the last decade has much attention been given specifically to contaminant problems and their remediation in the Polar and other cold regions of the world. This belated attention was stimulated in part by the extensive waste materials of military origin, that received public attention following the end of the Cold War. Industrial development, oil and gas, mining and other activities in the cold regions have also proven (sometimes dramatically) to be major sources of pollution and represent bigger risks in the future. The aboriginal and local populations, although particularly exposed to the effects, have not been heard in their concerns to the extent that more crowded and central populations have. Like most things in the Polar and cold regions, contaminant remediation is inherently more difficult and more expensive than elsewhere. Ironically, cleaning up for some of mankind's activities has become itself a major industry, dependent on research and technology.

When by the mid-nineties concern led to international meetings on the topic, there was a realisation that ground contamination in the polar and cold regions was an extensive problem which required specific consideration beyond the detailed and sophisticated studies already carried out for temperate lands. The First International Conference on Contaminants in Freezing Ground was held in Cambridge in 1997. Its conception was a plan for a meeting of a few colleagues with interests in the topic - a meeting which grew so that it became the First Conference, with a registration of 33.

The Proceedings of that Conference constituted a special issue of *Polar Record* (vol. 35, number 192, 1999, Cambridge University Press). The Proceedings illustrated the fundamental effects of freezing on water movements in frozen ground, the manner in which the microscopic structure and arrangement of particles are modified by freezing, the conditions frozen ground presents for microbiological life, the characteristics of freezing ground determined by remote sensing and the special characteristics of freezing ground and their thermodynamic significance. It also was apparent how all these aspects of the behaviour of freezing ground are modified by the presence of contaminants, often even in very small concentration. Given the special attributes of freezing ground from a geotechnical and scientific point of view, it is not surprising that in considering the problems that arise from ground contamination, remediation must be approached on the basis of the thermodynamic nature of freezing of porous media and the consequent hydraulic, thermal and mechanical changes that take place and their geotechnical and environmental significance.

The three-part *Contaminants in Freezing Ground: Collected Proceedings of the Second Conference* (which was also held in Cambridge but with 60 participants from twelve countries) are a commentary on the development of a multi-disciplinary topic. The journals, *Polar Record* and *Cold Regions Science and Technology*, published special issues containing those papers which passed their own double review procedures; these are papers which bear directly on the Polar or cold regions as an environment, or which describe science and technology for application in the cold regions. They constitute the *Second* and *Third Parts* of the Proceedings. This *First Part* consists of contributions that for different reasons fell outside those journals' requirements. In some cases the items included are at the front edge of research and, as such, not available in other than a preliminary and perhaps speculative form. Another paper, rather than being the direct product of research, reviews the complex background upon which such research must be built. Others describe engineering practice and, sometimes, the item deals with a topic which, at first site, is far removed from ours. The manner in which the surfaces of bacteria relate to their surroundings at the microscopic scale is an apparently abstruse aspect of polymer and colloid physics - which however, should help us further understand the effectiveness of microbial activity in bioremediation. Papers dealing with bioremediation practices and techniques show increasing complexity. It may eventually prove, as in other spheres of society's dysfunction and well-being, that the extraordinary achievements of biotechnologists will be of prime importance in answering the challenge of contaminant remediation.

The *Collected Proceedings*, in defining the importance of freezing in the response of soil to contamination, leads us to a further conclusion - the importance of freezing is not limited to the Polar or cold regions. Wintertime freezing of the surface layer of the ground occurs over large areas otherwise regarded as temperate, and consequently the study of contamination in freezing soils has far wider application.

The demands that contaminant remediation poses for science and technology are diverse. Contaminant clean-ups often engage engineers, but the techniques do not draw upon well-established standard procedures. Neither engineers, soil scientists, hydrologists, chemists, nor microbiologists alone have the knowledge needed. It is vital that there is a coming together of knowledgeable people world-wide, unhampered by the subdivisions, dating from a century or more ago, that often characterise our educational and other research establishments. Contaminant remediation must surely be one of the most pressing multidisciplinary, international tasks within Arctic and cold regions studies, and well as having significant application elsewhere.

Peter J. Williams

The establishment of a simple, low cost, bio-remediation pilot project in Cambridge Bay, Nunavut

R.W. McCullough¹, R. L. Burkill²

¹Jacques Whitford Environment Limited, 3 Spectacle Lake Drive, Dartmouth, Nova Scotia, B3B 1W8, Canada

²Transport Canada, Programs and Divestiture, 330 Sparks Street, Place de Ville, Tower C, Ottawa, Ontario, K1A 0N5, Canada

Contents

Introduction	1
Methodology	1
Fieldwork	1
Results	4
Conclusions	5
Bibliography	5

Introduction

Conventional soil remediation techniques have proven cost prohibitive in the Arctic mainly due to climatic conditions and the high cost of transportation.

In an attempt to reduce the cost of remediation an engineered bio-pile was constructed with a simple vapour extraction system installed within the pile to extract volatilized hydrocarbons from the soil. A nitrogen rich fertilizer was added to the soil. The site, at Cambridge Bay, Nunavut, is contaminated with diesel fuel resulting from years of careless fuel handling and from fuel that has leaked from the storage tanks associated with the emergency stand-by generators.

The bio-pile constructed at Cambridge Bay was intended to be functional but installed using very simple and somewhat laborious methods of construction and maintenance. The bio-pile is built on a base of Styrofoam (SM) insulation (figures 1&2), and a waterproof high-density polyethylene liner (HDPE) Liner. A vapour extraction system, consisting of 100-mm diameter slotted flexible PVC piping was installed within the bio-pile (figure 3). The exhaust for the system was extended away from the pile and fixed to the wall of the building on site. The header piping was completed with the installation of a wind driven extractor turbine (Venmar) which provides a small vacuum to the system to extract volatilized hydrocarbon product from the soil (figure 4). A nitrogen rich fertilizer was added to the soil to be used in the bio-pile and mixed in thoroughly. A Urea 40-0-0 mixture of fertilizer was used because of the amount of available nitrogen in the compound, and thus less fertilizer would need to be shipped from the south. Approximately 50 % of the soil from the existing stockpile was used in the bio-pile construction, the

remaining 50% of the stockpile is maintained as a control pile consisting of diesel contaminated soil placed on the HDPE liner.

Thermocouples were installed in both piles to monitor the soil temperatures, which are recorded constantly to a data logger system. Ambient temperature is also monitored and recorded in the datalogger.

Site Description

Cambridge Bay is a hamlet of 1400 people situated on the south shore of Victoria Island, one of Canada's Arctic Islands.

Methodology

- To construct a bio-pile to enhance the microbial growth within the soil by providing optimal growth conditions;
- To mix the soil using mechanical means to disburse the nutrients, break down clay or silt lumping, and;
- To create aeration first through mechanical mixing and then with the installation of a passive vapour extraction system.

Because this is a pilot study, it is not known what the effect of vapour extraction will have on the soil. There may be excess cooling of the soil from the piping and there may not be a large benefit from this technique. In addition, the quantity and type of fertilizer used is experimental.

Fieldwork

Bio-Pile Construction

The site work was carried out on 30 August 1999 to 5 September 1999.

The nutrients we chose to add to the soil contained only nitrogen (urea 40-0-0). The nutrients were placed on the soil using the 100:10:1:1 ratio where for every 100 kg of TPH in the soil, 10 kg of nitrogen, 1 kg of phosphorus and 1 kg of potassium are added for nutrient content. Fifty percent of the fertilizer was delivered to the surface of the soil in the existing stockpile, which was to be used in the bio-pile.

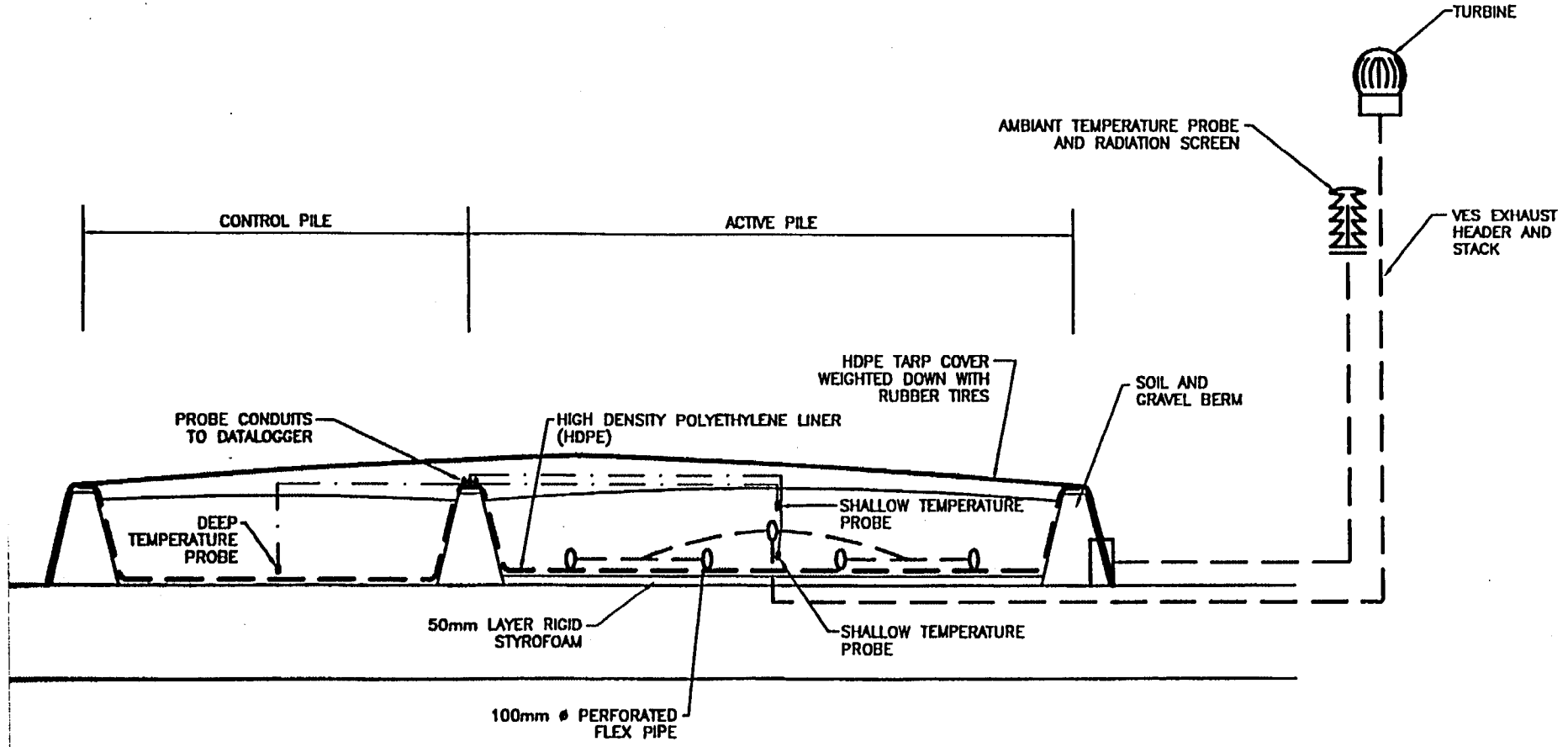

Figure 1. Cross section of biopile('active') and control pile (not to scale)

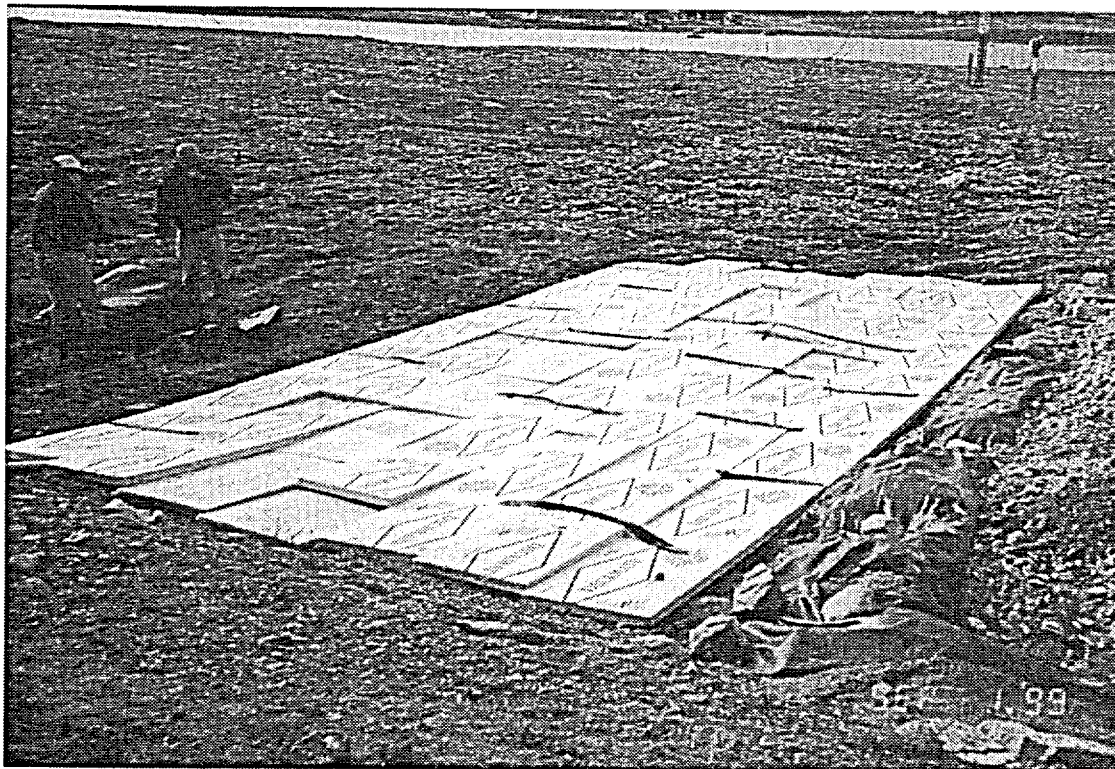

Figure 2. Placement of Styrofoam insulation on tundra to protect treatment pile from permafrost temperatures. HDPE liner being laid out at left.



Figure 3. Placement of vapour extraction/aeration system piping on HDPE liner prior to bio-cell berm construction.



Figure 4. View to southeast showing vapour extraction exhaust stack attached to the side of the transmitter building. The turbine is visible at top of pipe.

The soil was also aerated and loosened in the process. The simple vapour extraction system was installed, the flexible 100-mm diameter PVC pipe being fitted with a protective nylon sock and placed on the surface of the HPDE lining. The wind blowing across the venmar turbine will exert a small vacuum to the piping. Once all soil was in place both the control pile and the bio-pile were covered with an HDPE tarp (figure 5).

Temperature Monitoring

As the bio-pile was being constructed, temperature thermocouples were buried at various depths in the soil and connected to a four-channel data logger, Campbell Scientific Model CS 510. The

temperature of the soil and ambient air has been monitored constantly since the installation of the system.

Results

- The soil temperatures generally follow the ambient temperature trend with a slower reaction time due to the latent heat within the soil pile;
- Generally the soil maintains a temperature approximately 5 to 10 degrees warmer than the ambient temperature. From the graph, a one or two day lag in temperature is noted from an ambient temperature anomaly to the reaction time noted in the soil temperature;
- The soil temperature in the bio-pile when compared to the control pile maintains a lower temperature (-2 to -7 °C) through the winter months from October to April, due likely to the increased airflow through the extraction system piping. Both soil piles appear to react in the same manner to temperature changes, however the active pile reached cooler internal temperatures;
- During the "warmer" fall months, the temperature in the bio-pile is warmer than the stockpile, possibly due again to the extraction system piping, which is pulling warmer air into the pile. This will prove to be a key function of the piping once warmer ambient temperatures collect.

Vapour Extraction System

The vapour extraction system began to operate immediately upon installing the turbine to the exhaust stack. The system is passive and requires only wind to generate a slight vacuum on the piping and subsequently the soil within the pile.

- volatile organic compounds measurements indicated a relatively constant concentration of 70 to 75 ppm in the exhaust gas.
- The concentration of oxygen remained constant for the three days of monitoring at a level of 20.8 %; and
- The concentration of carbon dioxide (CO₂) remained zero percent for the three days of testing.

Costing

This pilot project work was intentionally designed to be simple using local materials and local personnel.

The cost of the actual construction and commissioning of the bio-pile was less than \$75/m³. The final cost of the system including all

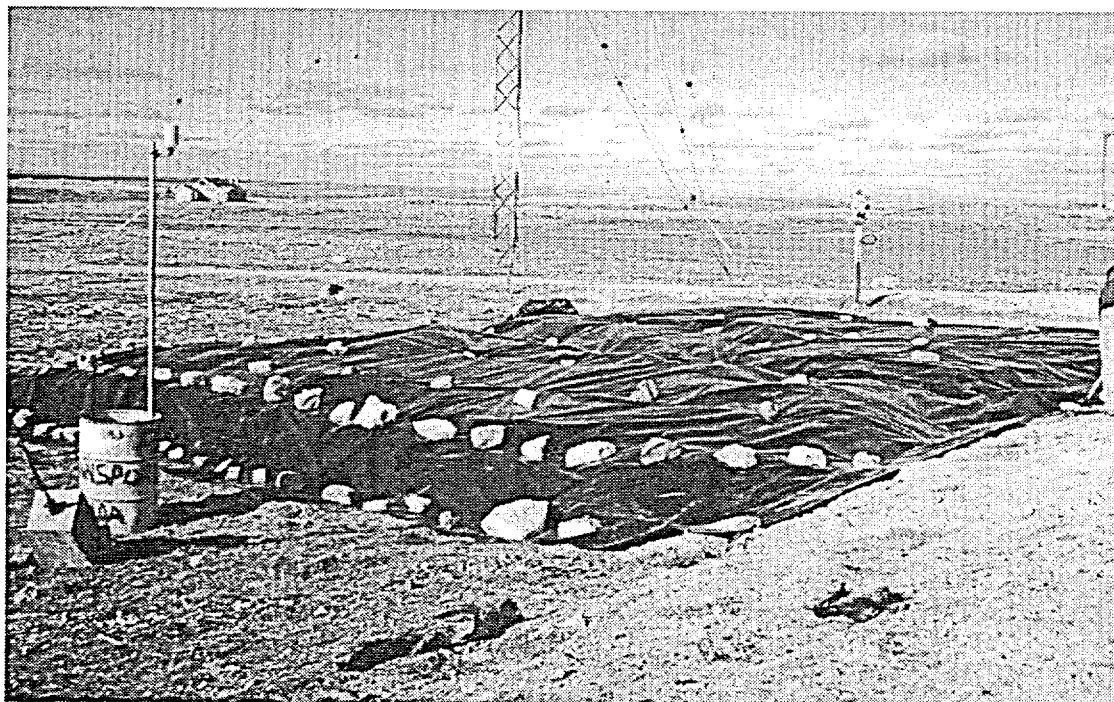

Figure 5. View to northeast of completed pile. Ambient temperature probe visible at left. Tarp covers both the active and control piles.

maintenance is expected to double, approaching \$150 to 200/m³ over the lifetime of the study. Now that a design has been established, that portion of the costing will be eliminated from other projects.

Conclusions

The results from the vapour extraction readings taken from the exhaust stack of the system following installation, indicate that volatilization is occurring and the slow removal of the gases is remediating the soil. It would appear that even with no active remediation, the biological process of degradation is taking place slowly, as the concentrations of hydrocarbon compounds in the stockpile indicated a slight reduction in concentration over the time period between the site assessment in 1997 and the bio-pile construction in 1999. The laboratory analysis of the soil sample shows the lighter hydrocarbons compounds, (benzene and toluene), are now below the detection limit of the laboratory. The effect of pro-active remediation on the soil will only be fully understood as the process continues. It is expected that active remediation will occur at a reasonable pace in the Arctic conditions encountered in Cambridge Bay, Nunavut.

Acknowledgements

We wish to thank the following people for their help. Moe Baksh, Nav Canada; Lisa Whynott, JWEL; Paolo Mazzocco, JWEL

Bibliography

- Bell, D.D. 1995. On-site bioremediation in northern climates. Proceedings of Conference at the Royal Military College of Canada – Kingston, Ontario, Canada, Techniques and technologies for hydrocarbon remediation in cold and arctic climates. *Canadian Society for Civil Engineering*.
- Geological Survey of Canada. 1993. Surficial Geology, Cambridge Bay, District of Franklin, Northwest Territories, GSC “A” Series Map, No. 01825A.
- Larochelle, Y., and T. Hergel. 1998. Phase I and Phase II Environmental Site Assessment, Jacques Whitford Environment Limited, Ottawa, Canada.
- Larochelle, Y., and T. Hergel. 1998. Phase II Environmental Site Assessment, Jacques Whitford Environment Limited, Ottawa, Canada.
- Pouliot, Yvan. 1995. Biopile technology for the remediation of hydrocarbon contaminated sites in northern regions: full-scale case studies. Techniques and technologies for hydrocarbon remediation in cold and arctic climates. *Canadian Society for Civil Engineering*. 1995.
- Pouliot, Yvan., and Jean-Luc Sansregret. 1999. Bioremediation of hydrocarbons-

contaminated sites in northern regions: a synthesis of full-scale projects. *Proceedings, Assessment and Remediation of Contaminated Sites in Arctic and Cold Climates (ARCSACC)*. Edmonton '99.

Travis, Michael D. 1990.

Bio-remediation of petroleum spills in arctic and subarctic environments. *Northern Engineer*. 1990. 22(2):4-12.

Tumeo, Marc A., and David A. Guinn. 1997.

Evaluation of bioremediation in cold climates. *Journ. Cold Regions Engineering*. 11(3):221-231.

Whyte, Lyle G., et al. 1999. Bioremediation

assessments of hydrocarbon-contaminated soils from the high arctic. *Bioremediation Journal* 3(1):69-79, Battelle Memorial Institute.

Whyte, Lyle G., and Charles W. Greer. 1999.

Biodegradation of petroleum hydrocarbons at low temperatures. *Proceedings, Assessment and Remediation of Contaminated Sites in Arctic and Cold Climates (ARCSACC)*. Edmonton '99.

Microstructural alteration in permafrost-affected soils due to hydrocarbon contamination: implications for subsurface transport

T.L. White¹, P.J. Williams¹, Y. Marchand², and W.G. Rees³

¹Geotechnical Science Laboratories, Carleton University, 1125 Colonel By Drive, Ottawa, ON K1S 5B6, Canada

²Marie Curie Fellow (European Union), Scott Polar Research Institute, University of Cambridge, Lensfield Road, Cambridge, England CB2 1ER

³Head, Remote Sensing Group, Scott Polar Research Institute, University of Cambridge, Lensfield Road, Cambridge, England CB2 1ER

ABSTRACT. Contamination modifies the microstructure of soils. Such changes will inevitably cause changes in soil thermal, mechanical and hydrological properties. As a further consequence, depth of annual freeze thaw (depth to permafrost), frequency of soil movements on slopes, disturbances to drainage and other effects may be expected to produce changes in vegetation and terrain which will often increase with time. To investigate this relationship of microstructure modification (by contaminants) to changes in ground surface conditions in a region with permafrost, a study has been made of the sites of two 24 year-old experimental oil spills: An artificial spill of 7600 litres of crude oil, created in February 1976, and another of similar size in July 1976. Located at the Caribou-Poker Creeks Research Watershed in Alaska, these spills are probably the most closely investigated of any in the Arctic.

The density, moisture content, porosity, hydraulic conductivity and contaminant content of samples from each site and from a control site were measured. The microstructure was examined optically and by scanning electron microscope. The effects of contamination are evident including (unexpectedly) in the 'control' site, indicating wider spread of oil than expected. Changes in vegetation are clearly visible but the spill sites are not large enough for these to be analysed at the presently available precision of remote sensing.

Contents	
Introduction	7
Objectives of Research Project	9
Field Reconnaissance	9
Microstructural Observations	14
Hydraulic Conductivity Observations	18
Resulting Terrain Modifications and Remote Sensing	19
Conclusions	20
References	20

Introduction

Earlier field studies

Following oil, gasoline or other hydrocarbon contamination it is important to know what will happen to various hydraulic, thermal and geotechnical properties of soils. Freezing soils behave differently to unfrozen soils. The majority of surface hydrocarbon spill studies have addressed what impacts petroleum spills have on vegetation and the depth of the active layer (Collins et al 1993). While many studies report the rate of contaminant spreading on the surface, these reports are generally descriptive and are limited to the short term migration (1-5 years) through the active layer.

In 1976 two large-scale experimental crude oil spills were made in the Caribou-Poker Creeks Research Watershed (Figure 1) located 48 km north of Fairbanks, Alaska by CRREL researchers.

Sparrow et al (1978). The experimental spills each consisted of 7600 litres of Prudhoe Bay crude oil and took place in the winter (February 1976) and summer (July 1976) to test what happened when crude oil was spilled in permafrost-underlain black spruce forest of interior Alaska. In 1990 these spill sites were revisited by CRREL research personnel to assess the long term effects on permafrost and vegetation, as well as changes in oil chemistry.

For the original study (Johnson et al, 1980) a distribution map of the oil in each of the two spills was prepared showing the extent of the spills and

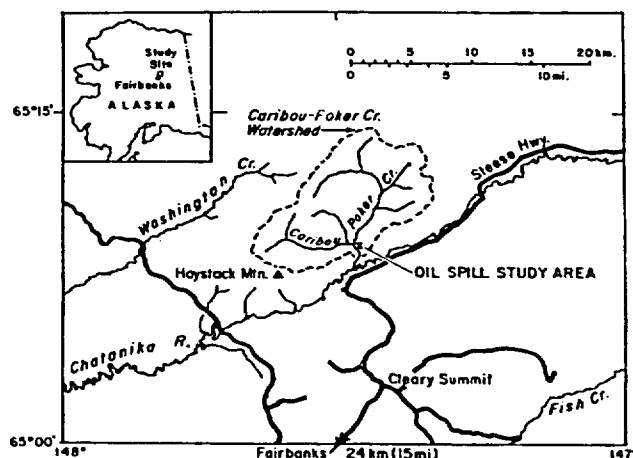

Figure 1: Caribou-Poker Creeks Research Watershed and experimental crude oil spill site

areas where oil was visible on the surface. Collins (1993) expanded the original study to include subsurface observations in 1990 (Figure 2) using wooden dowels pushed into the soil to visually inspect for the presence of hydrocarbons. In general, the thickness of the zone within the soil profile affected by hydrocarbon contamination was observed to thin out as a function of distance down slope of the points of release. The vertical distribution of subsurface crude oil was generally beneath the O1 and O2 horizons characterised by living moss and peat layer and contained within the A1 and C1 horizons characterised by mineral soil to a depth of between 20 to 30 cm below surface. At the upper end of the slope (3.5 m from point of release) maximum depth of oil penetration was observed to be 15 to 21 cm. At 34 m down slope the oil-affected soil horizons extended to 25 to 30 cm depth. Collins (1993) found it was difficult to ascertain whether or not the oil had moved vertically any deeper at either spill site because a zone of water saturation was encountered between 40 cm to 60 cm beneath the surface in 1990.

Contaminant transport in soils exposed to freezing

The ease with which any fluid can be transported

through soil is dependent upon the properties and relative volumes of all fluids present. Introduction of contaminants of low-water solubility such as hydrocarbons into a porous medium results in a two-phase flow system, each with its own effective permeability and thermodynamic characteristics. In seasonally frozen soils such as those in the active layer at Caribou-Poker Creeks, the water to hydrocarbon ratio will control the relative permeability of the soil to each of the fluids. Increasing hydrocarbon saturation of soil for example, should decrease the permeability of the soil to water as soil pores and particle surfaces become occupied by oil. This decreases the channel widths available for the migration of water and hydrocarbons.

Laboratory studies of microstructure (White and Coutard, 1999) and field work in permafrost terrain have revealed, however, the dynamics of soils affected by freezing (cryosols) and the role of contaminants in this regard. Significant increases in hydraulic conductivity of an experimental silt took place when low concentrations of diesel fuel were introduced into the soil water (White 1999). A four-fold increase in hydraulic conductivity ($2.9 \times 10^{-4} \text{ cm s}^{-1}$ to $9.8 \times 10^{-4} \text{ cm s}^{-1}$) relative to uncontaminated material was observed where hydrocarbon

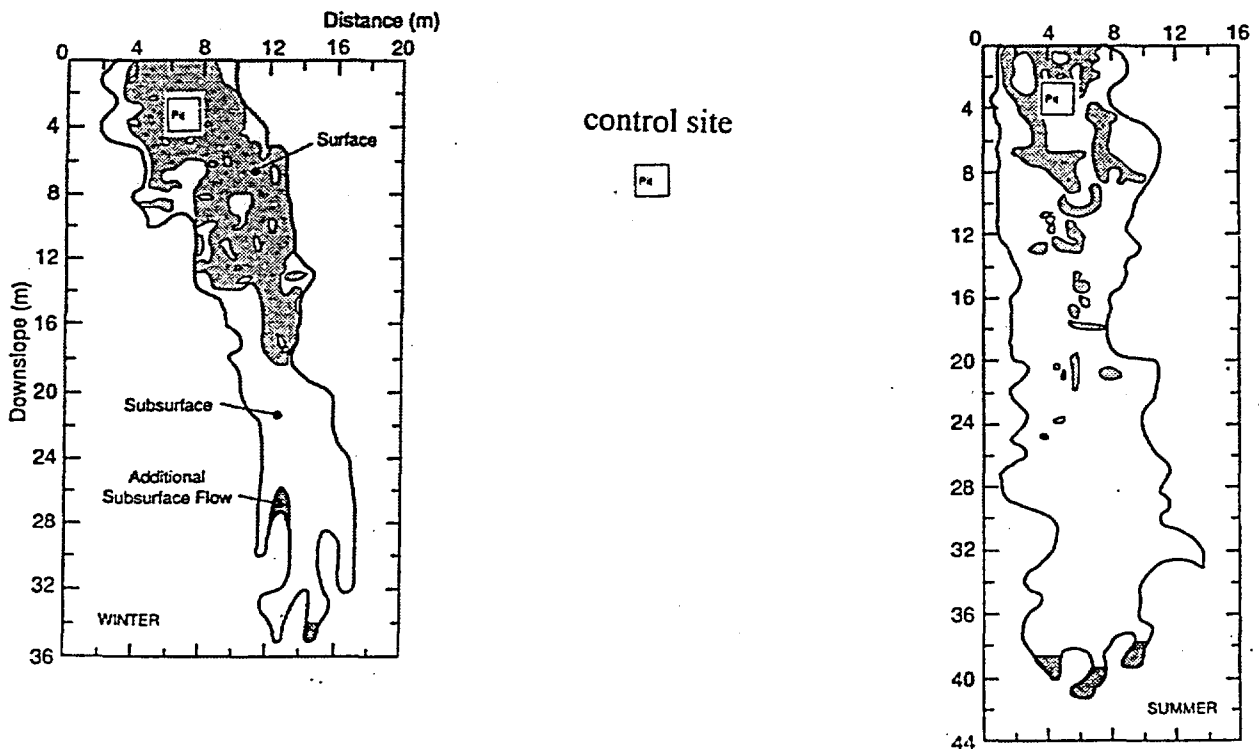

Figure 2: Winter and summer experimental spills and location of soil sampling pits. Distance between spill zones not to scale.

concentrations were 50 and 200 ppm TPH (total petroleum hydrocarbons), in a silt subjected to four freeze-thaw cycles. When TPH values approached 1000 ppm hydraulic conductivity decreased from $2.9 \times 10^{-4} \text{ cm s}^{-1}$ (uncontaminated silt) to between $5.3 \times 10^{-5} \text{ cm s}^{-1}$ and $8.48 \times 10^{-5} \text{ cm s}^{-1}$.

These differences in hydraulic conductivity were explained by White and Coutard's (1999) observations on interparticle and inter-aggregate porosity. Inter-aggregate porosity (between aggregates) increased from 25 to 29% for TPH concentrations of 10 ppm, and to 33% with TPH concentrations of 100 ppm. On the other hand, sharp declines in inter-aggregate porosity (to 10%) were observed to take place when TPH concentrations exceeded 1000 ppm.

When an organic contaminant at low concentration of 50 to 200 ppm enters the pore space of a soil containing clay minerals such as smectite, the organic molecules (which have a low dielectric constant) begin to replace the water molecules in the double layers that surround clay minerals. There is a tendency for the particles to move closer together and form aggregates as reported by White and Williams (1999) and White (1999). In contrast when organic contaminant concentrations exceed 1000 ppm a significant effective stress is apparently created which may prevent the development of new macroporosity (between aggregates), causing the soil to consolidate *as a whole*. The double layer surrounding the clay minerals also undergoes shrinkage, and there is a significant reduction in the overall permeability of the soil.

Objectives of research project

The two spills of crude oil made in the Caribou-Poker Creeks Research Watershed provide a unique opportunity to examine *insitu* microstructural alteration of the active layer and to determine what implications these changes have for sub-surface migration of contaminants. The research project described in this interim report had two principal objectives:

1. To compare for the Caribou-Poker Creeks Research Watershed, the microstructure of seasonally frozen soils over permafrost in the uncontaminated and contaminated states.
2. To relate the identified microstructure to macroscopic properties such as hydraulic conductivity and from this to predict the rates of subsurface migration of the contaminant.
3. To ascertain the effects thus produced in the terrain, and to examine the remote sensing of these effects.

Field reconnaissance

Field observations were carried out in September 1998. Undisturbed contaminated soil samples from the summer and winter spill sites were obtained along with samples from a control site situated between the two spill sites (Figure 2).

The soils which are classified as histic pergelic cryaquest (US classification) are affected by permafrost (and thus are cryosols). Johnson et al (1980) reported that this lay 40–60 cm below the surface where the control site was located in the current project. The cryosol profile is characterized by a 5 cm layer of moss and lichen above a 15 cm thick horizon of undecomposed peat (O1). This lies above a 5 cm horizon of decomposed black organic peat (O2) which lies on top of a 5 cm thick layer of dark grey silt (A1). Below the silt is a grey-brown mineral soil (C1) which extends down 300 cm to a schist bedrock.

The cryosols examined in the excavated sampling pits situated in the summer and winter spill sites were clearly contaminated by crude oil. The presence of the hydrocarbons was readily discerned by sight (thin dark bands in the A1 horizon) and by smell for the O1 and C1 horizons.

The vertical distribution of the subsurface crude oil included oil visible along some roots penetrating down from the O1 and O2 horizons into the A1 horizon. Oiled zones (bands) were visually discernable in the O2, A1 and C1 horizons with band thickness varying from 1 to 3 mm in thickness up to 10 to 15 mm thick.

Undisturbed soil samples were obtained from three excavated sample pits situated in the summer and winter spill zones and at the control site situated between these two zones. Kubiena box samples for analysis of the micromorphology of the soils and adjacent core samples were taken every 15 to 20 cm beginning at the surface and extending downward until a water-saturated zone was encountered within the C1 horizon. This zone of saturation was encountered at 80 cm below surface for the summer spill site and control site and at 120 cm below surface for the winter spill site. The active layer is now deeper than Collins (1993) had found. The mineral soils at depth become saturated within the active layer during thaw periods because the underlying permafrost is essentially impermeable. Table 1, derived from analysis of core samples taken at the sites, shows bulk density, moisture content and porosity as a function of depth for all three sample sites.

TABLE 1: CARIBOU - POKER CREEKS WATERSHED**CONTROL SITE**

Depth in Active layer (cm)	Bulk Density g/cm ³	Moisture Content % (dry weight)	Porosity %	Hydraulic Conductivity K _s (cm s ⁻¹)	TPH (ppm)
15	1.17	69.5	77.2	1.69 x 10 ⁻³	326
30	1.39	35.8	37.8	1.38 x 10 ⁻³	218
40	1.23	30.8	34.2	1.56 x 10 ⁻³	172
60	1.41	37.9	38.9	1.32 x 10 ⁻⁴	53
80	1.33	17.2	29.6	1.61 x 10 ⁻⁵	1.2

SUMMER SPILL SITE

Depth in Active layer (cm)	Bulk Density g/cm ³	Moisture Content % (dry weight)	Porosity %	Hydraulic Conductivity K _s (cm s ⁻¹)	TPH (ppm)
15	1.17	90.1	100	7.32 x 10 ⁻³	291
30	1.59	33.9	36.1	4.39 x 10 ⁻³	2.3
40	1.57	30.5	33.0	2.25 x 10 ⁻³	1.3
60	1.52	37.9	42.0	6.77 x 10 ⁻⁵	1.8
80	1.02	29.5	30.8	1.12 x 10 ⁻⁵	2.5

WINTER SPILL SITE

Depth in Active layer (cm)	Bulk Density g/cm ³	Moisture Content % (dry weight)	Porosity %	Hydraulic Conductivity K _s (cm s ⁻¹)	TPH (ppm)
15	0.83	52.1	87.2	4.69 x 10 ⁻³	863
30	1.26	51.3	54.7	4.47 x 10 ⁻³	8.3
40	1.57	33.0	35.6	1.44 x 10 ⁻³	1.4
60	1.62	25.2	28.2	6.84 x 10 ⁻⁵	1.9
80	1.58	36.2	37.8	5.7 x 10 ⁻⁵	2.1
100	1.55	24.8	35.3	3.5 x 10 ⁻⁴	0
120	1.32	28.0	47.0	9.67 x 10 ⁻⁴	0

O1 Horizon Undecomposed Peat, 15 cm beneath surface

A1 Horizon Dark Grey Silt, 30 cm beneath surface

Optical Microscope (*frames are 12 mm wide*)

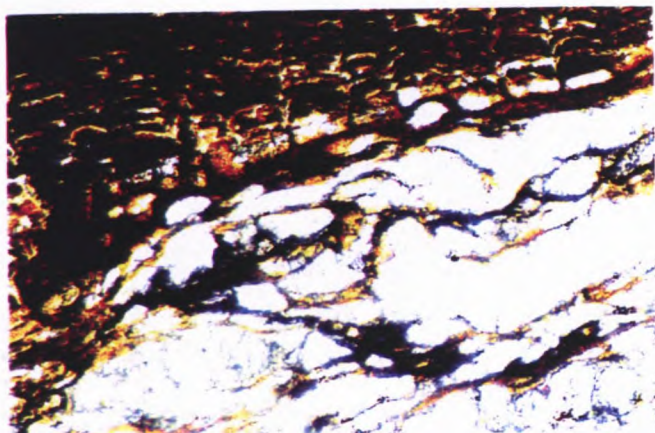

Plate 1: Control Site

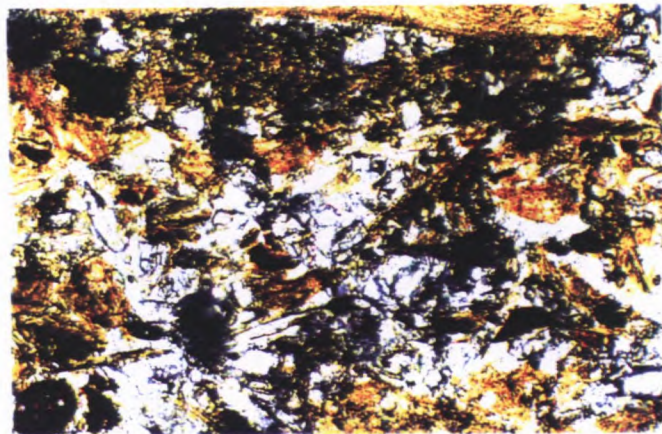

Plate 7: Control Site

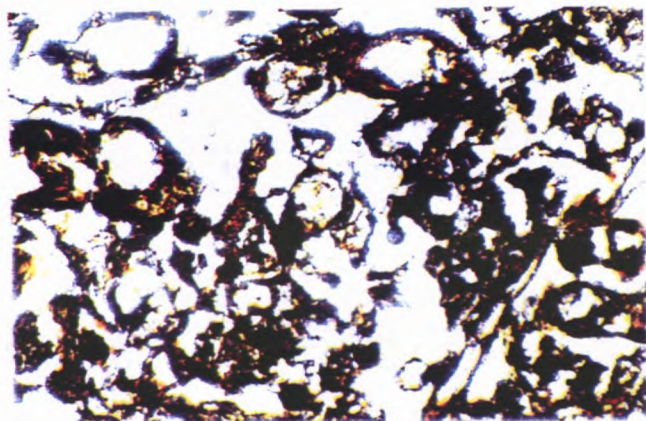

Plate 2: Summer Site

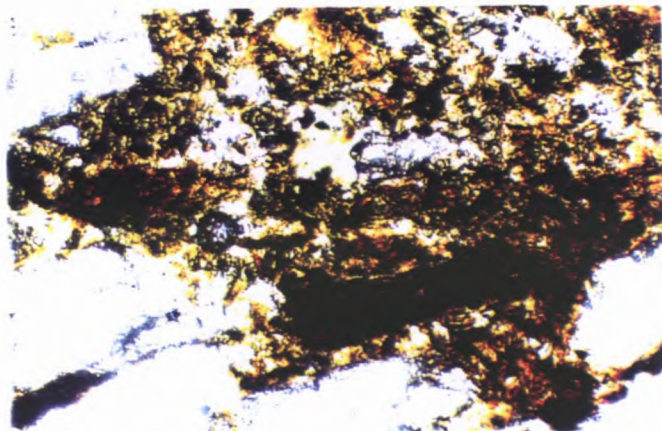

Plate 8: Summer Site

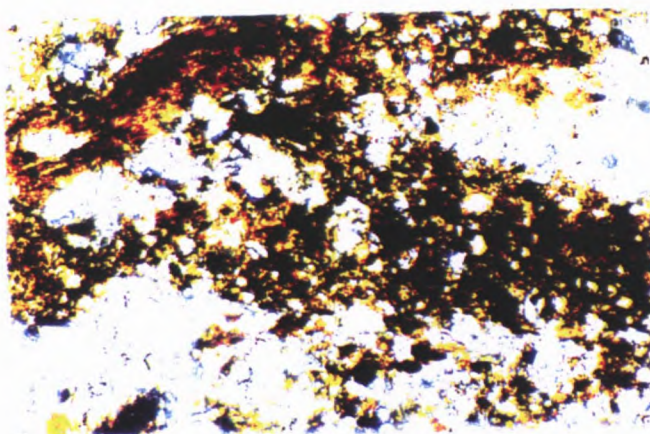

Plate 3: Winter Site

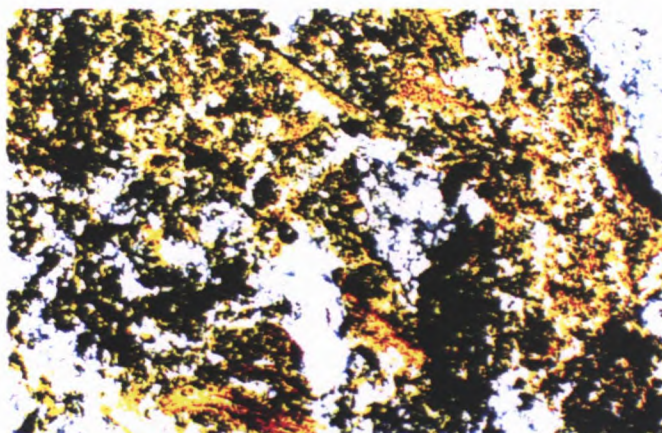
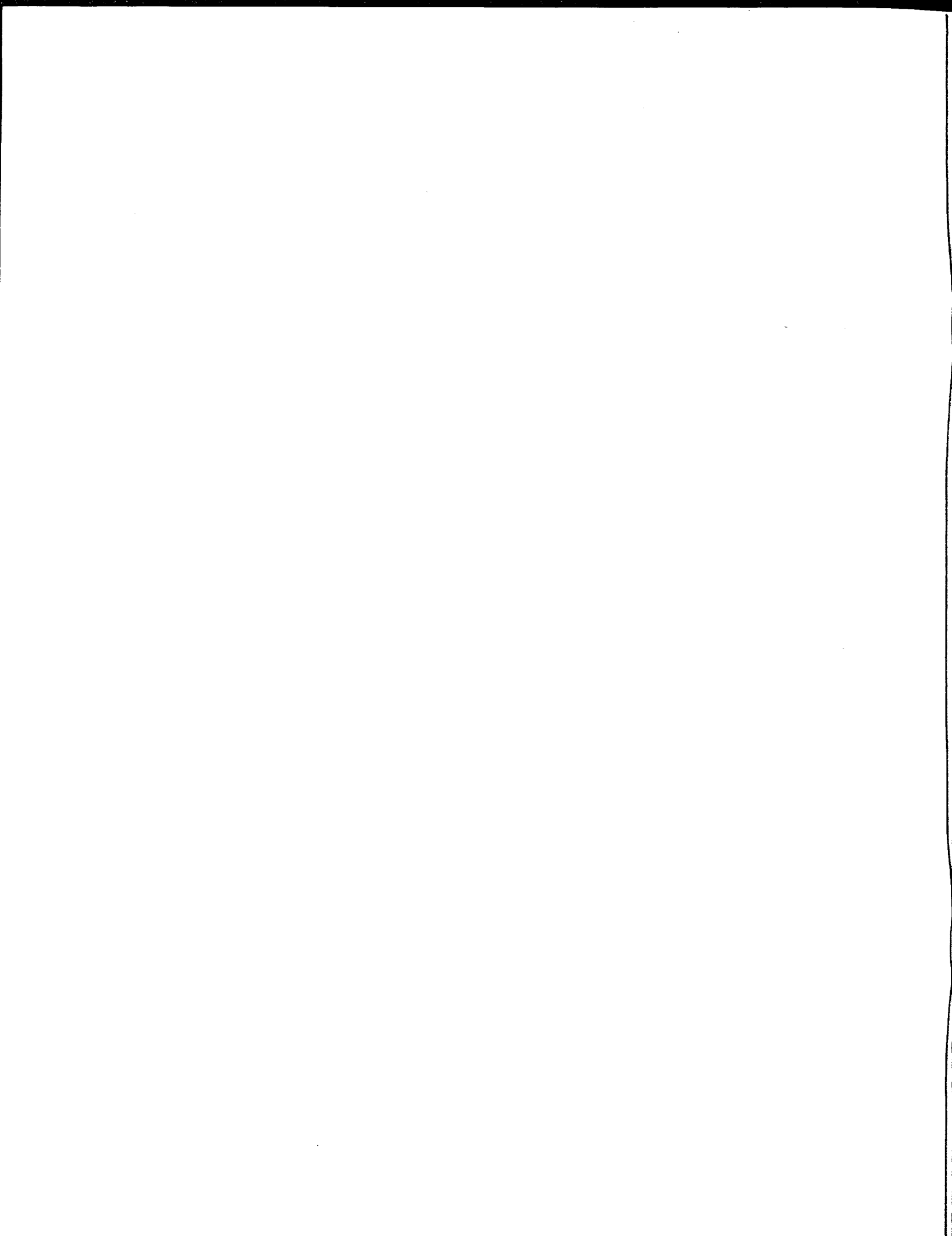

Plate 9: Winter Site



O1 Horizon Undecomposed Peat, 15 cm beneath surface

A1 Horizon Dark Grey Silt, 30 cm beneath surface

SEM

SEM

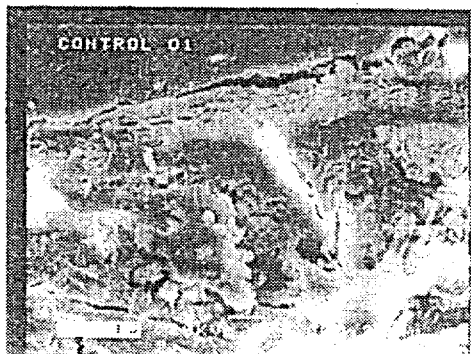

Plate 4: Control Site

Plate 10: Control Site

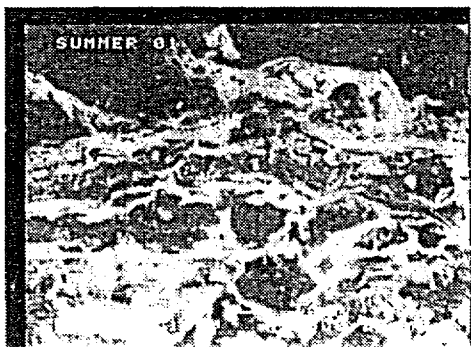

Plate 5: Summer Site

Plate 11: Summer Site



Plate 6: Winter Site

Plate 12: Winter Site

Microstructural observations

Thin sections of soil were prepared from the undisturbed samples after soil water and immiscible hydrocarbon contaminants had been removed and replaced by acetone. They were then impregnated with a polyester resin containing a fluorescent dye (Uvitex PB, Ciba-Geigy). The methodology for soil-water removal, sample impregnation, and thin-section preparation is widely documented, having been described by Fitzpatrick (1984).

The use of thin sections facilitates the description of the arrangement of soil particles and pores, and provides information on the particular features and how they are associated with properties such as hydraulic conductivity. Morphology of the thin sections was described according to a glossary of micromorphology terminology (Fitzpatrick, 1984; Howes and White, 1991). Soil fabric descriptions were made from vertically oriented thin sections at 12 x magnification. This magnification showed the gross morphology that characterises the structure of the soil fabric.

Optical and scanning electron microscope (SEM) micrographs from undisturbed soil samples taken from the contaminated summer and winter spill sites and the selected control site (assumed to have been uncontaminated) are illustrated in micrographs Plate 1 to 23. They show various morphologies with differences in soil aggregation and porosity. There are two major factors important for the microstructure. Soils in the active layer are exposed to bi-directional freezing and thawing annually, and thus have been frozen and thawed many times. Secondly, immiscible contaminants of different concentrations have a significant impact on pore water chemistry and dielectric constants which also modify the microstructure.

Distinct gross morphologies characteristic of contaminated soils, are seen in all the samples *including those sampled from the selected control site*. It is consequently not possible to make direct comparisons of uncontaminated and contaminated materials but only to point out these characteristics as we recognise them from other studies (White and Williams, 1999). The optical thin sections prepared from contaminated and control sites for soil horizons O1 (Plates 1 to 3), A1 (Plates 7 to 9) and C1 (Plates 13 to 15) in the active layer show evidence of soil aggregation. The aggregates are the dark, apparently dense zones, best seen in Pls. 19 and 20. All three soil horizons examined in the 'summer-', 'winter-' and control-sample pits show structures at the interparticle and interaggregate level, associated with the presence of immiscible hydrocarbon compounds. Total petroleum hydrocarbon (TPH)

determinations (Table 1) confirmed the presence of hydrocarbons in all three horizons for the three sample locations. TPH concentrations decreased as a function of increasing depth in the three profiles.

In the O1 horizon the morphology is characterised by moderately decomposed organic particles with inclusions of sphagnum moss fragments. Organic fragments tend to be clustered together, the aggregation being due to immiscible hydrocarbon compounds. Undecomposed peat which makes up the O1 horizon has become clogged by hydrocarbons (black film surrounding organics, Plates 1 to 3). SEM micrographs (Plates 4 to 6) reveal additional information on how the peat fibres have been affected by hydrocarbons. Peat which has a high absorption capacity associated with its high surface areas absorbs the hydrocarbons along its outer surfaces; its internal cellular structure, however, remains intact. Immiscible compounds present in the film water at the surface of particles and unfrozen soil water are responsible for lowering the dielectric constant of the soil water. This results in a tendency for the clay and silt size particles to move closer together and to form aggregates (see especially Plates 19 to 23).

In the A1 horizon (Plates 7-12) the morphology is characterised by dense soil fabric consisting of silt and clay size mineral material, with fine organic material distributed throughout (which is evidence of faunal activity). Dark patches are the discrete structural units (aggregates) in which contaminants have accumulated.

In the C1 horizon the morphology is characterised by planar pores in a fine granular matrix which is often aggregated, forming mullgranoidic fabric components. Optical microscope observations (Pls. 13, 14) show planar pores (White and Williams 1999). Pl. 13 shows clearly a zone of compaction along the upper boundary of a planar pore. Hydrocarbon contaminants, which appear black, have accumulated there.

In the A1 and C1 horizons, the clay and silt size minerals show the "signature" aggregate structures which identify contaminated soil at the microscopic scale. They appear to confirm that cation exchange sites present on the surface and along the edges of the clay size minerals have become occupied by immiscible hydrocarbon compounds present in the soil water. However, close packing of the particles within the aggregates also results from the effective stresses that develop in the silt because of cryogenic processes, along with the reduction of surface area and thickness of the adsorbed water layers of the clay-size minerals and organic particles by the contaminant. The formation

C1 Horizon Grey Brown Silt, 40 cm beneath surface

Aggregation of Contaminated Silt

Optical Microscope (*frames are 12 mm wide*)

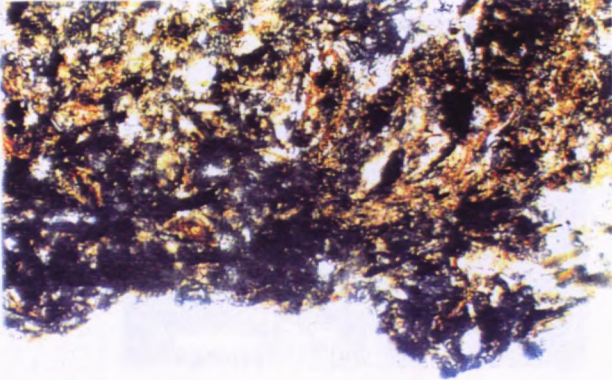

Plate 13: Control Site

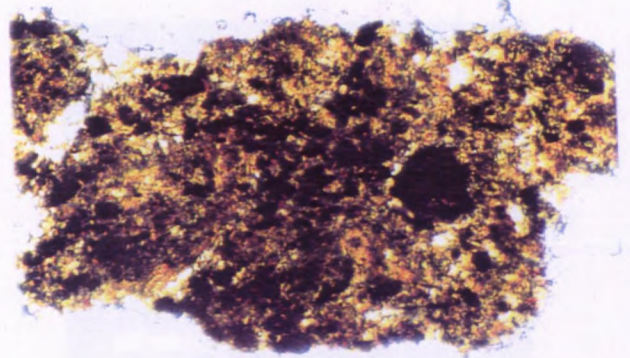

Plate 19: Control Site

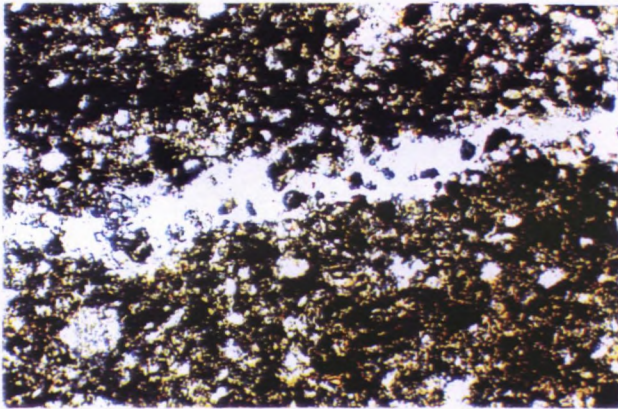

Plate 14: Summer Site

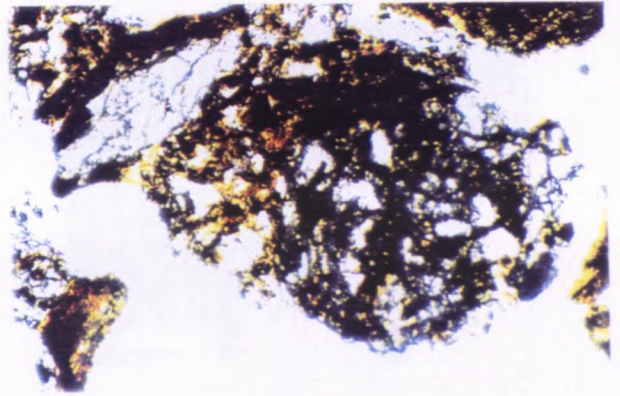

Plate 20: Winter Site

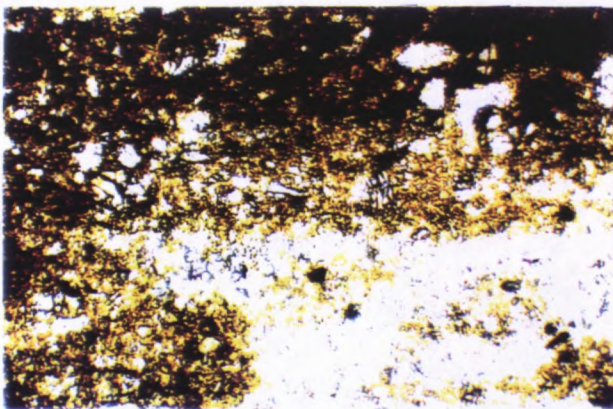
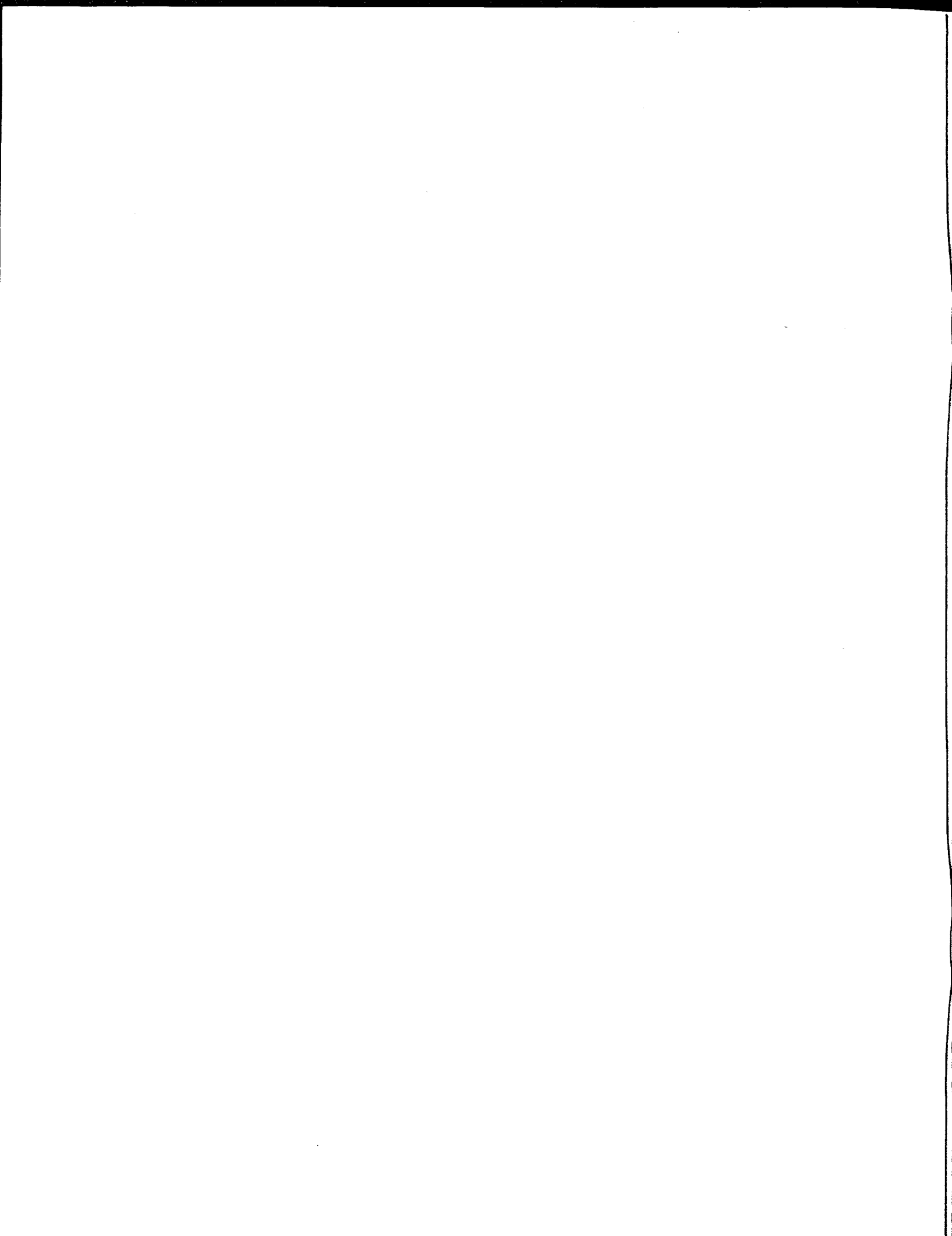

Plate 15: Winter Site



C1 Horizon Grey Brown Silt,
40 cm beneath surface

SEM



Plate 16: Control Site

Aggregation of Contaminated Silt

SEM

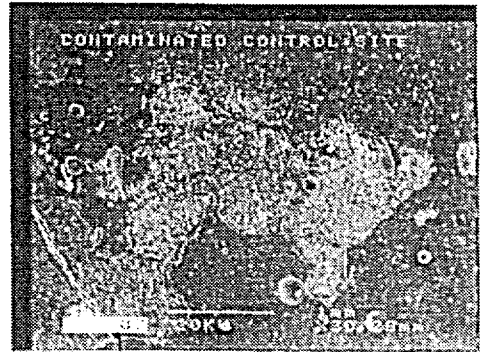

Plate 21: Control Site



Plate 17: Summer Site



Plate 22: Summer Site

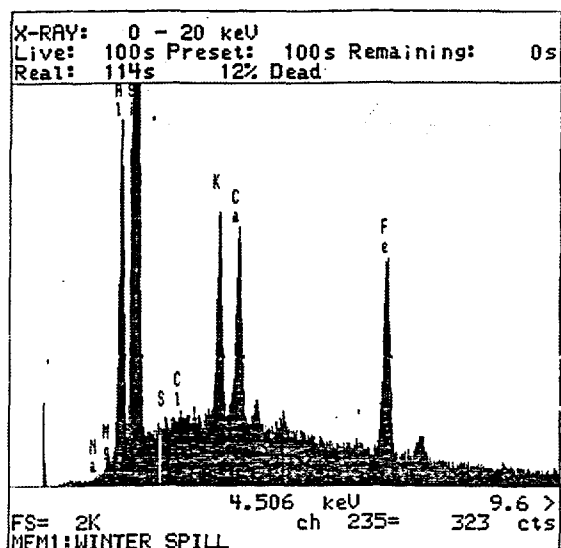
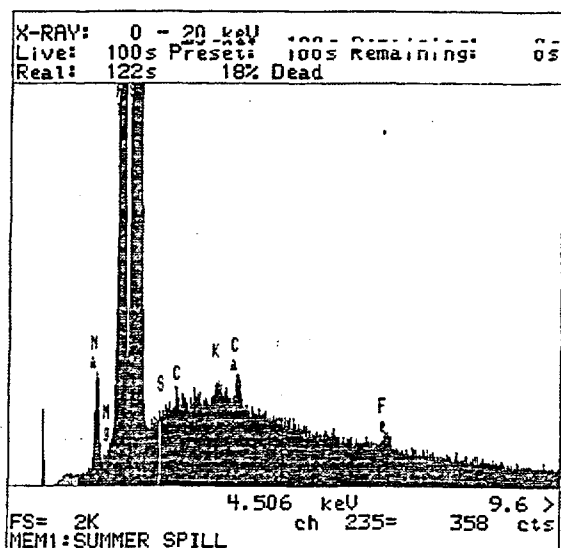
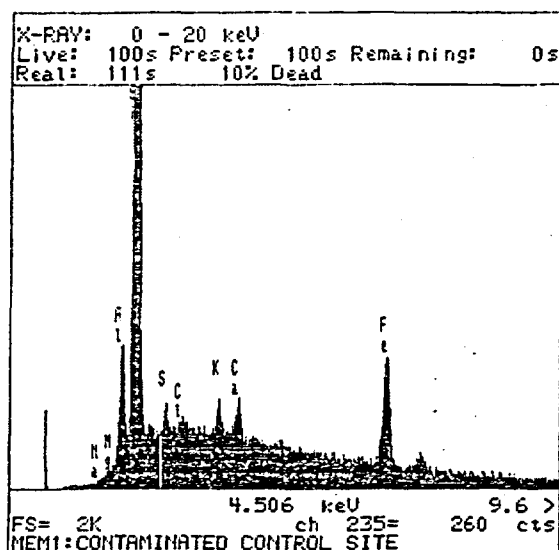

Plate 18: Winter Site



Plate 23: Winter Site

Figure 3: X-Ray Diffraction Patterns for Soil Aggregates



of aggregates results in increasing macroporosity between the aggregates (see plates 21-23) and an increase in the permeability of the soil following thaw, as noted above.

The aggregate structures and associated interaggregate porosity leads to a relatively large hydraulic conductivity, which can account for the subsurface contamination of O1, A1 and C1 horizons of the control site situated between the summer and winter spill sites. X-ray diffraction patterns (Figure 3) for soil aggregates sampled from all three sites confirm the presence of sulphur, an element present in Alaska crude oil used in the experimental spills.

Hydraulic conductivity observations

Hydraulic conductivity determinations were made on core samples using the falling-head permeameter and the results are shown in Table 1.

In a two-liquid phase flow system such as that with soil water and crude oil the effective permeabilities are dependent on the saturation percentage of each fluid and the wettability of the soil with respect to these two fluids. When two fluids are in contact with a solid, one usually has greater affinity for the solid than the other. In permafrost-affected soils (cryosols) such as the study sites' histic pergelic Cryaquest, which contain clay size minerals, polar water molecules are attracted to negatively charged clay-sized mineral surfaces more strongly than are non-polar organic molecules. In a water wet silty clay, therefore, an organic liquid such as crude oil will generally be the non-wetting liquid. The movement of liquid contaminants and modification to the microstructure of a freezing soil is influenced by factors including temperature, temperature gradient, moisture content (above and below 0°C) and mineralogical composition. The permeability of the soil to the contaminant must relate closely to the soil structure. Equally important, the surface area of soil particles and aggregates and the geometry of pore space define the environment in which hydrocarbon breakdown will occur as a result of biological or chemical agents.

Significant increases in hydraulic conductivity of the Caribou-Poker Creeks silty clay soils probably took place when the crude oil and some of its weathered components were introduced into the O1 horizon (-15cm) and made their way through to the A1 (-30 cm) and C1 (-40 cm) horizons. Table 1 shows a correlation between TPH and hydraulic conductivity for all three sites. Corresponding porosity values for the horizons show a similar correlation presumably reflecting the inter-aggregate porous structure.

At depths of 60 cm below the surface the hydraulic conductivity for the 'summer' ($6.77 \times 10^{-5} \text{ cm s}^{-1}$) and 'winter' ($6.84 \times 10^{-5} \text{ cm s}^{-1}$) spill sites was observed to be lower by an order of magnitude compared to the control site ($1.32 \times 10^{-4} \text{ cm s}^{-1}$). This can be explained by the control site sample at 60 cm depth, showing a TPH of 53ppm - compared to a barely detectable 2.1 and 1.8ppm respectively, at the 'summer' and 'winter' spill sites at the same depth. At the control site, subsurface transport of hydrocarbons into the soil has occurred in more recent years and the elevated TPH concentration (53ppm) might be ascribed to the shorter period over which biodegradation of the contaminant has occurred.

The effects of contaminants on hydraulic conductivity can be explained by the observations, noted above, of inter-particle and inter-aggregate porosity (White and Coutard, 1999) as a consequence of contamination. Note that none of the samples in the present study approached a contaminant concentration of 1000 ppm - the level at which White and Coutard found hydraulic conductivity started to decline.

Resulting terrain modifications and remote sensing

Characteristic microstructures of the kind demonstrated, must have significant effects on the macroscopic properties of the soil. These effects are particularly significant in two respects. Firstly, the thermal properties of the soil are significantly changed. This is because the unfrozen water contents and the associated latent heat quantities of soils are largely controlled by moisture adsorption and capillarity which depend on microstructure. Associated with the changes in thermal properties, will be changes in the depth of active layer, and in the temperature regime as a function of depth and time. Secondly, change in the hydraulic properties affects the movement of water (and, in the event, contaminants) and associated phenomena such as drainage, the amount of frost heave, and soil strength. Together it is the thermal, thermodynamic and hydraulic behaviour of the soils that gives rise to the ground surface features, the terrain, characteristic of the cold regions.

These surface features include slope movement phenomena, subsidence (including thermokarst) and development of various forms of patterned ground (Williams and Smith 1989). Associated with this, there will also be modifications in the species composition of the vegetation. The changes are easily recognised by the experienced observer on the site. Once conditions

are disturbed (for example, by contamination, but also by 'natural' events), the changes occur progressively, often over tens or even hundreds of years.

At a contaminated site, progressive changes are also a key to prediction of future behaviour of the contaminant and thus can provide a basis for designing appropriate remedial responses.

A review of the literature and an earlier visit showed that the Caribou-Poker Creeks CRREL experimental oil spills site, could give significant information of the changes in terrain and vegetation following the addition of a contaminant. In fact, this site is apparently the best documented and longest running experimental site in North America. It has been monitored (and various thermal and other conditions measured) on a regular basis, from its inception in 1976.

Compared with the sites of accidental oil spills in Russia and elsewhere (Marchand, 1999; Marchand and Rees, 1999; Marchand and Rees, 2000) the Caribou-Poker Creeks site is small indeed. Vegetation changes were clear, and there was some modification of terrain, with the effects decreasing towards the limits of the affected ground. Hand samples reveal different stages of breakdown of the soil - clearly recognised by smell. The small site, being rather uniform in morphology and soil, exposure etc., does not however, show the range of modifications to be expected over larger areas. Modifications in depth of seasonal thaw and resultant changes in subsurface drainage, aided by the structural modifications to the soils described in previous sections, could be mapped out given sufficient time, and there is already a significant quantity of observations.

The site proved too small for significant interpretation by remote sensing imagery, at the presently available precision, although it is likely that some further interpretation will be possible in future years as precision increases.

The importance of the site lies in the possibility of detailed interpretations being made of the changes that are taking place in the ground and terrain, following from the microstructural modifications revealed by the soil analyses. Information in such detail is not available from any of the much larger sites, in Russia. The latter work has shown that effects of contamination on the vegetation cover are readily visible if the area is large enough. The species composition, which is more relevant than biomass as an indicator of subsurface modification, is also presently not easily distinguished by remote sensing.

Conclusions

Studies of the microstructure of samples from the experimental oil spill sites have shown the characteristic effects of contamination. Samples investigated were taken from various parts of the soil profile in the active layer, and include peats, mixed organic and mineral soils, with samples having various grain size compositions. The microstructures apparently reflect the effect of bi-directional freezing (upwards from the permafrost, downward from the ground surface) with multiple freeze-thaw cycles (extending over thousands of years or longer). Superimposed on these effects are those due to the addition, in the last twenty five years, of oil and its breakdown products, which are adsorbed and retained along the surfaces of mineral particles and organic material. The contaminant is responsible for a characteristic aggregation. The findings are interpreted on the background of earlier experimental and field investigations of microstructure in uncontaminated and contaminated soils.

Measurements of hydraulic conductivity of the samples from the Caribou-Poker Creeks site give values which are, at least in part, due to interaggregate porosity developed as a result of contamination. These hydraulic conductivities facilitate the subsurface transport of immiscible hydrocarbon contaminants through the O1, A1, and C1 horizons.

This subsurface transport has apparently been responsible in more recent years for the contamination of the selected 'control' site situated between the winter and summer spill zones. Additional field sampling should now be undertaken to collect soil samples from an uncontaminated control site situated up slope from the two large scale spill zones and to evaluate the spatial extent of the subsurface migration of hydrocarbon contaminants between the original summer and winter spill zones.

Observations in the field at the Caribou-Poker Creeks site show the effects of contamination after more than two decades on the vegetation cover and its species composition and also on the form and nature of the surface layers more generally. Remote sensing is, at present, still barely capable of revealing these changes when the area affected is as small as that at the Caribou-Poker Creeks site. The effects there, however, are an analogue for the large spills that have occurred in Russia and the neighbouring republics, and which are indeed recognisable in current remote-sensing images. With the improvement in remote sensing imagery, and a better understanding of the processes, such as may be gained from intense monitoring and further

investigations at the Caribou-Poker Creeks site, it will be possible to apply remote sensing to observing and then to predicting the course of changes due to contamination. Remote sensing should then be an important part of an integral strategy for the devising of appropriate and cost-effective bioremedial or other responses. The work reported in this paper indicates the potential of the experimental spill sites for establishing in detail, the relation between soil microstructure, terrain modification, and the prediction of the future course of events at spill sites in otherwise natural conditions.

Acknowledgements

This research was initiated under contract with the European Research Office of the US Army, London, England. Our US colleagues, especially Jerry Comati, European Research Office, US Army and Dr. Charles Collins, CRREL, Fairbanks, Alaska were generous with their time. Total petroleum content was determined by Dr. R. Burk of Carleton University.

References

- Collins, M.C., C.H. Racine, and M.E. Walsh. 1993. *Fate and effects of crude oil spilled on subarctic permafrost terrain in interior Alaska*. U.S. Army Cold Reg. Res. Engg. Labs. Report 93-12, 20 pp.
- Fitzpatrick, E.A.. 1984. *The Morphology of Soils*. New York: Chapman and Hall.
- Howes, J. E., and T.L. White, 1991. *Glossary of terminology for soil micromorphology*. Geotechnical Science Laboratories, Carleton University. Ir60. 37 pp.
- Johnson, L.A., E.B. Sparrow, T.F. Jenkins, C.M. Collins, C.V. Davenport, and T.T. McFadden. 1980. *The fate and effect of crude oil spilled on subarctic permafrost terrain in interior Alaska*. U.S. Army Cold Reg. Res. Engg. Labs. Report 8029.
- Marchand, Y. 1999. Industries des hydrocarbures, environnement et teledetection dans le domaine polaire Russe. *Rev. de Geographie de Lyon* 74(3):267-274.
- Marchand, Y., and W.G. Rees. 1999. Remote sensing and GIS for oil contamination of frozen terrain. *Proc. Cold Regions Engineering - Putting Research into Practice*. 16-19 August, Lincoln, New Hampshire, USA. 363-373.
- Marchand, Y., and W.G. Rees. 2000. Applications of remote sensing to oil contamination of frozen terrain. *Proc. Conf.: Permafrost and Actions of Natural or Artificial Cooling*. Int. Inst.

- Refrigeration. Orsay, France. pp.46-56
- Sparrow, E.B., C.V. Davenport, and R.C. Gordin. 1978. Response of microorganisms to hot crude oil spills on subarctic thiaga soil. *Arctic* 31(3): 324-338.
- White, T.L. 1999. Hydraulic properties of hydrocarbon contaminated permafrost affected soils. *Conference on Assessment and Remediation of Contaminated Sites in Arctic and Cold Climates*, Edmonton, Alberta.
- White, T.L., and J-P Coutard. 1999. Modification of silt microstructure by hydrocarbon contamination in freezing ground. *Polar Record* 35 (192): 34-41.
- White, T.L., and P.J. Williams. 1999. The influence of soil microstructure on hydraulic properties of hydrocarbon contaminated freezing ground. *Polar Record* 35 (192): 20-25.
- Williams, P.J., and M.W. Smith. 1989. *The Frozen Earth. Fundamentals of Geocryology*. Cambridge Univ. Press. 306p
- Williams, P.J., W.G. Rees, D.W. Riseborough, and T.L. White. 2000. Strategies for development of cost-effective amelioration procedures for oil spills in cold regions. In: *Proc., Wkshp. on Models for Cold Regions Contaminant Hydrology: Current Uses and Future Needs*. USA Cold Regions Res. Eng. Labs. Lewis Publishers -CRC Press. LLC. Pp. 39-56.

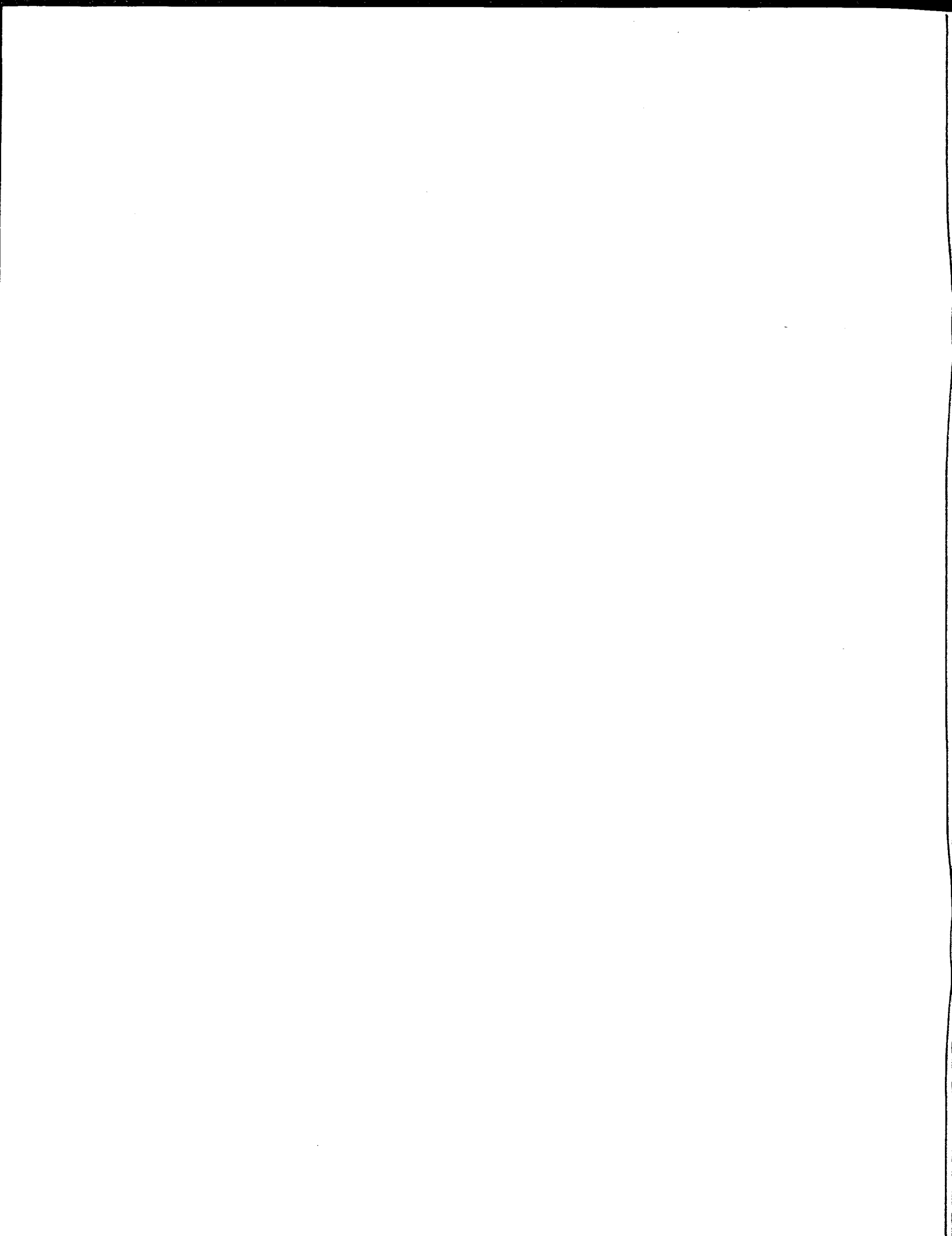

Fate and transport of pollutants in freezing soil and the application of geoenvironmental centrifuge physical modelling

Mazyar Zeinali, Deborah J. Goodings, and Alba Torrents

Department of Civil and Environmental Engineering
University of Maryland, College Park MD 20742, USA

ABSTRACT. It is essential to understand the dominant features of fate and transport of pollutants released into soil, in order to plan effective engineering response, including containment and remediation. Significant progress has been made in understanding mobility of pollutants in unfrozen soil, however, surprisingly little is understood about mobility in a freezing environment in which behavior will be dramatically different. Processes that govern fate and transport of contaminants in unfrozen ground are reviewed. Effects of freezing on that contaminant fate and transport are discussed, but remain largely unknown. The next body of research must involve experimental investigations into full system response to identify at once the overall behaviour and the dominant factors that dictate that behaviour. Full scale tests are desirable, but their size and duration make them impractical for initial parametric studies. Geoenvironmental centrifuge modeling is identified as a powerful alternative using small, short duration physical models that capture the essential self-weight driven influences missing from conventional small model testing.

Contents

Introduction	23
Sorption as an Equilibrium and Non-Equilibrium Process	24
Fluid Transport in Freezing Soil	26
Application of Geoenvironmental Centrifuge Modelling	28
Summary and Conclusions	29
References	30

Introduction

The soil environment is a multifaceted system consisting of complex compartments that include biota, solid, liquid, and gas phases. When a contaminant is introduced into this environment, it can move through the soil by a combination of physical processes including dispersion, diffusion, and advection. In addition, it can interact physically or chemically with any and/or all compartments, of which sorption processes are central for pollutant transport. Sorption onto particle surfaces can limit movement or the particles can act as source for the contaminant through release or desorption (the reverse process of sorption), allowing re-entry into the pore fluid either in solution or as colloids. Reliable data on these interactions is needed for the engineering prediction of transport and design of remedial methods. With such a high degree of heterogeneity and different processes at work, predicting pollutant movement is a daunting task to say the least. Notwithstanding that complexity, significant progress has been made in understanding fate and transport of pollutants in unfrozen soil. However, surprisingly little is understood about the effect on those processes of a freezing environment.

Understanding whole system response, rather than isolated element response, is essential for effective planning of containment and remediation measures under any conditions. In certain respects, data of pollutant transport gathered from the field provides the best information on transport processes, although the lack of experimental control creates difficulty in identifying the effects of individual components, to relate the information to other sites. Full scale laboratory studies are a possible alternative, however these are typically difficult to handle because of their huge size, and the times for development of prototypical seepage conditions will often require years. Environmental experimentalists and numerical modellers are left, then, to work together to assemble acceptable predictions of these events. They develop those predictions primarily from isolated pieces of the puzzle derived typically from laboratory tests that do not simulate field conditions, and certainly do not capture whole system response. Because the freezing process has a very major influence on contaminant mobility, this makes the task of fitting together what is known of uncontaminated soil freezing processes, with what is known of fate and transport of contaminants in unfrozen soil, very difficult indeed when whole system response is not known.

The option of using conventional small scale physical models of a whole system is unsuccessful because in the absence of recreating full scale stresses in those small models they fail to capture essential interactions of soil freezing which is known to exert strong influence on fluid transport. Small scale centrifuge modelling of contaminant transport is emerging as a new and powerful

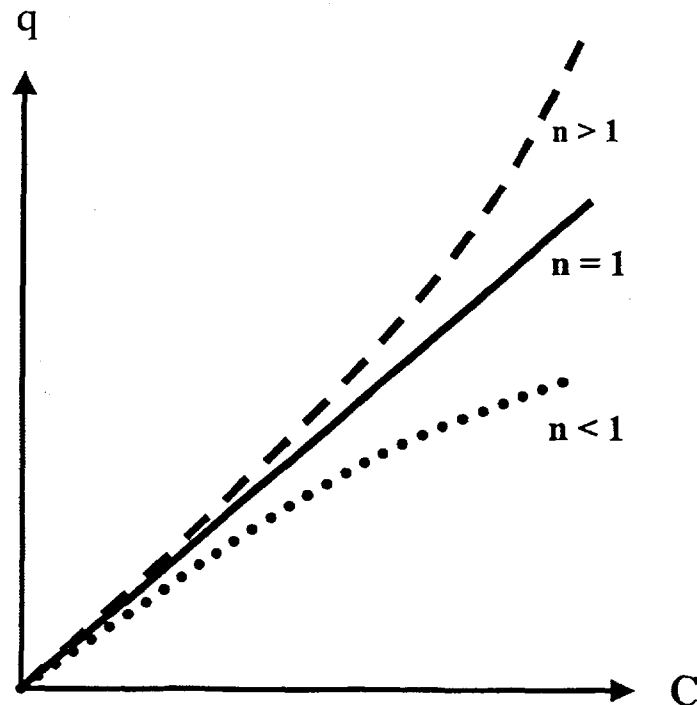

Fig. 1. Freundlich isotherm for values $n=1$, $n<1$, and $n>1$

laboratory tool to simulate realistic, and therefore complex whole system environmental response quickly. It involves simply taking the conventional small scale model, and conducting the same freezing and contaminant release test while the model, of scale 1:N is subjected to N times earth's gravity to bring into similarity all self-weight fluid and soil stresses. In unfrozen soils, centrifuge models have been used successfully to explore transport of non-sorbing contaminants driven by self-weight, capillary tension, concentration gradients, temperature gradients, and pressure gradients, but not involving the chemical processes of sorption. In uncontaminated soil, they have been used to examine the interaction between freezing, subsequent warming, and resulting fluid transport.

The object of this paper is twofold: to consider the effects of soil freezing on fate and transport of contaminants through soil; and then to consider the application of centrifuge modelling to study this problem.

Sorption as an Equilibrium and Non-Equilibrium Process

Sorption is the transfer of molecules from the solution phase into the solid phase and encompasses both adsorption (partitioning onto surfaces) and absorption (penetration into the subsurface). Generally, the sorption of a pollutant at equilibrium onto a particle surface can be described by the Freundlich isotherm (Equation 1). The Freundlich

equation is empirical and yields useful information about the sorption reaction. In this isotherm, the amount of pollutant adsorbed onto the particle surface (q) is dependent on the total pollutant concentration in solution (C). Here, K_F is known as the Freundlich equilibrium constant (a measure of sorption capacity of the sorbing surface and the pollutant being sorbed) and n is a measure of the nonlinearity (or sorption intensity) of the sorption process.

$$q = K_F C^n \quad [1]$$

Figure 1 illustrates this general relationship for any pollutant. As shown, three general types of curves are observed. For $n=1$, the adsorption is linear and there is no change in the attraction of the pollutant to the surface as a function of concentration. At higher concentrations, in the case where n is less than 1, a decreasing percentage of the pollutant will sorb to the surface as the concentration of the pollutant increases. This could be due to a variety of reasons including the reduction of the number of available reactive sites. And finally, in the situation where n is greater than 1, pollutant adsorption increases with increasing solution concentration. In this relationship, q can be predicted for other concentrations once K_F and n are identified. However, in order to predict movement through a whole system, rather than at a single point, additional

processes must be considered.

The solution to the one-dimensional dispersion advection equation (equation 2; Ogata-Banks, 1961) can be used to describe the general one dimensional steady state transport of a contaminant at any point in any homogeneous porous media with no chemical processes taking place.

$$\frac{\partial C}{\partial t} = D_h \frac{\partial^2 C}{\partial z^2} - v \frac{\partial C}{\partial z} \quad [2]$$

$$\frac{\partial C}{\partial t} = D_h \frac{\partial^2 C}{\partial z^2} - v \frac{\partial C}{\partial z} - \frac{\rho_s}{\theta} \frac{\partial q}{\partial t} \quad [3]$$

When these processes of sorption described in equation 1 are relevant, the equation must be modified (equation 3; where D_h is the hydrodynamic dispersion coefficient, C is the solution phase concentration, z is distance (in the direction of flow), v is the pore water velocity, ρ_s is the density of the solid phase, θ is void volume fraction, and q is the mass of pollutant sorbed per unit mass of solid). Equation 3, which characterizes the change of pollutant concentration over time at any point in the soil, incorporates the sorption process into equation 2 with the additional term. However, this term is a generalized one and the relationship in equation 1 between q and C is needed. Many researchers have shown that the adsorption of pollutants onto soil particles is characterized by two distinct phases involving an initial period in which adsorption occurs relatively rapidly, followed by a second period of slower pollutant exchange onto the surface (Leenheer and Ahlrichs, 1971; Karickhoff, 1980; Ball and Roberts, 1991). This has led to the development of several approaches to solve equation 3. Weber and Miller (1988), Miller and Weber (1988), Weber *et al.* (1991) present an in-depth review for many of these approaches. Two are presented here.

The first approach is to assume that it is not essential for true equilibrium to develop in a test, but that the initial rapid step of the two-segmented process is fast enough and accounts for a high enough percentage of the pollutant in question that we can assume an "applicable equilibrium". Figure 2 illustrates the two stage sorption phenomena with the rapid initial step for a general pollutant where the time for "applicable equilibrium" concept can be shown. After the time when the sorption reaction is 95 % complete (time of "applicable equilibrium", t_{ae}), the change in sorption is minimal over a relatively long period of time. The initial period represented by the portion of the graph to the left of

the break in the independent axis can be on the order of minutes to hours while the time required for the final 5% completion can be on the order of weeks to months. Therefore, for any study that allows a contact time between the sorbing pollutant and the soil particles of $t \geq t_{ae}$, equilibrium can be assumed and an equilibrium representation relating q to C is sufficient.

% sorbed

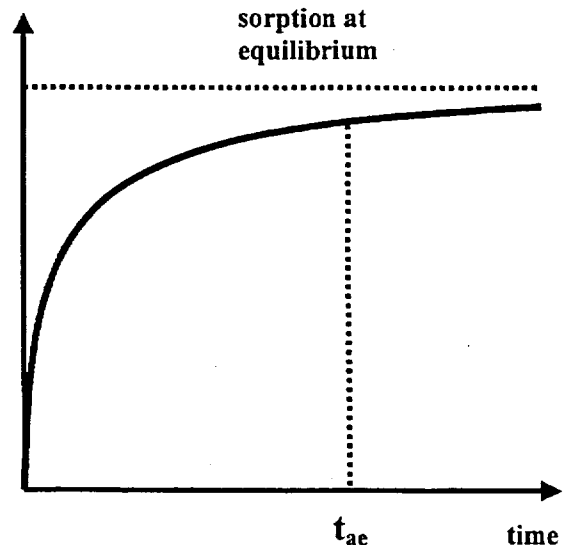

Fig. 2. Two phase sorption kinetics for a general pollutant.

In terms of the applicability of this to specific heavy metal contaminants, Christensen (1984) found that greater than 95% of cadmium was sorbed within 10 minutes and Krishnamurti *et al.* (1999) found cadmium sorption to two soils to be more than 97% complete in less than 15 minutes in the concentration range of 1-50 mg Cd/l. Furthermore, in a study of lead sorption and desorption onto goethite, Eick *et al.* (1999) found lead sorption was greater than 95% complete in less than 20 minutes at low concentrations (0.10 and 0.25 mM Pb) where less than a 2% increase in sorption was measured from day 5 to week 12 of the experiments. Similarly, lead sorption was more than 90 % complete in less than 30 minutes for a higher concentration (0.50 mM Pb) and almost no difference in the amount sorbed was noticed at day 5 in comparison to week 12.

With this approach, the transport equation can be modified by the introduction of the Freundlich isotherm into equation 3 yielding equation 4 (assuming that the Freundlich isotherm can describe the process adequately). The relevant parameters (K_F and n) of equation 4 can be

determined for any pollutant/soil combination by performing preliminary batch and column experiments. These experiments can yield both the input parameters and insight into the degree of equilibrium achieved.

$$\frac{\partial C}{\partial t} = D_h \frac{\partial^2 C}{\partial z^2} - v \frac{\partial C}{\partial z} - \frac{\rho_s}{\theta} K_F n C^{n-1} \frac{\partial C}{\partial t} \quad [4]$$

$$\frac{dq}{dt} = \frac{dq_f}{dt} + \frac{dq_s}{dt} \quad [5]$$

The second approach in solving equation 3 is to use a combination of equilibrium and first-order kinetics to describe the sorption process. In this approach, the sorption process is represented by two parts (equation 5) where q_f is the amount sorbed associated with the initial rapid phase and q_s is the amount sorbed associated with the later slow phase of sorption. Using this relationship, equation 3 is now modified as represented in equation 6.

$$\left(1 + \frac{\rho}{\theta} \frac{\partial q_f}{\partial C}\right) \frac{\partial C}{\partial t} = D_h \frac{\partial^2 C}{\partial z^2} - v \frac{\partial C}{\partial z} - \frac{\rho_s}{\theta} \alpha (q_{s,e} - q_s) \quad [6]$$

where

$$q_f = K_{F,f} C^n$$

$$q_s = K_{F,s} C^n$$

Lower case f in equation 6 represents parameters associated with the initial fast phase while s denotes those related to the second slow phase. The term α is an equilibrium/first-order rate constant and $q_{s,e}$ is the equilibrium pollutant mass associated with the solid phase normalized by the pollutant solid phase mass for the slow sorption- rate component. Miller and Weber (1988) more rigorously represent equation 6 and in their column reactor studies of the sorption of hydrophobic contaminants by aquifer materials, show its applicability to nitrobenzene transport.

Desorption, can also be an issue in contaminant migration through soil. For example, a sorbed pollutant can be released if the solution concentration in contact with the soil decreases (i.e. a rain event) or the concentrations of other constituents in solution change making it more favorable for mass transfer into the solvent. It is important to note that the rate of desorption and the rate of sorption can be quite different and hence the applicable equilibrium equations and values of parameters must be modified to account for this discrepancy. For example, although lead sorption

was shown to be greater than 95 % complete in less than 20 minutes by Eick *et al.* (1999), only 38% to 62% of lead had desorbed at 6.5 hours over the concentration range of 0.10-0.50 mM Pb. Weber, et al. (1991) have presented transport equations that include kinetic terms to account for the sorption and desorption, although these are first-order rates and may have limited applicability.

When soil freezing becomes a concern, both the driving forces and the processes of sorption, desorption, and transport of pollutants through unfrozen soil remain relevant, however the introduction of freezing brings into play other mechanisms that change the picture radically. The equations discussed above for unfrozen soil must, at a minimum, be modified due to the changes imparted to the soil and pollutant. The following sets out what we know and don't know about these processes and changes.

Fluid Transport In Freezing Soil

Consider the simplest case of a horizontal soil surface, with a homogeneous, fine grained soil profile saturated with uncontaminated water, and freezing temperatures above the soil surface that have persisted for some time. The thermal gradient and the phase changes associated with the freezing process generate a suction gradient that causes seepage of pore fluid toward the freezing soil. This upward flow can dominate and even reverse the direction of flow developed when the soil was unfrozen. Also the soil skeleton is no longer fixed, as is typically assumed in unfrozen soil, since the formation of ice causes the soil skeleton to expand.

Figure 3 shows the idealized soil profile undergoing cooling. T_f refers to the freezing temperature of the pore fluid; T_c and T_w , are the cold and warm side boundary temperatures. The role of the frozen fringe is especially important in seepage and freezing development because it controls the upward flow of water by its permeability which changes as ice forms in its pores. The whole system is changing with time, also, with the freezing process penetrating further into the soil, as long as T_c continues to decrease; and the upper portions of the soil are heaving upward as ice lenses continue to grow.

The pore fluid seepage velocity and quantity created by the freezing process depend on several factors, some of which are quite different from those controlling seepage in unfrozen soils. In soil with uncontaminated pore water, these include the following.

1) The availability of space into which that pore fluid can flow above the frozen fringe is governed by two factors: the thickness and degree of

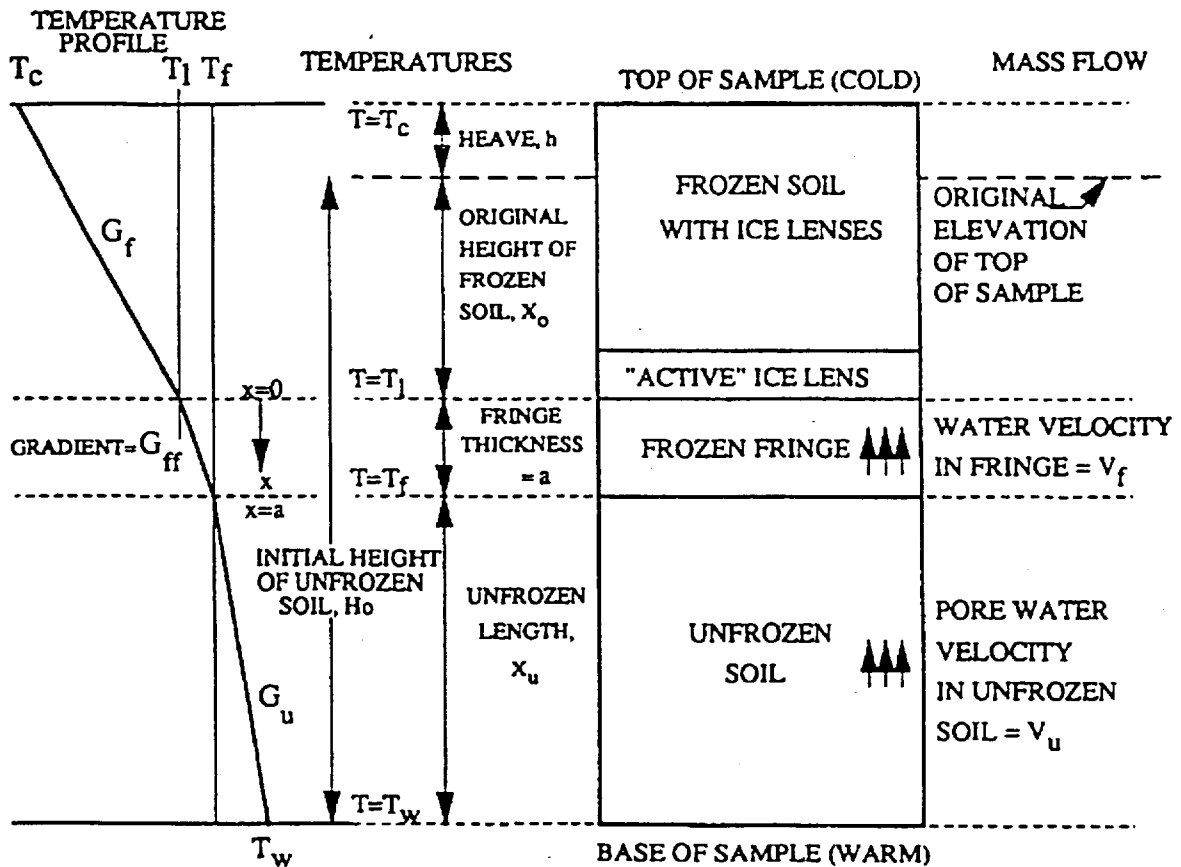

Fig. 3. Frost heave in idealized kinetics for a general pollutant

saturation of the active ice lens zone; and the magnitude of soil overburden opposing growth of ice lenses and expansion of the soil skeleton. More available pore space (ie, a thicker active ice lens zone, and saturation less than 100%), and less overburden pressure (which allows easier expansion of the soil skeleton through ice lens development and frost heave) provides greater volume for pore fluid.

2) The temperature gradient, both in the vicinity of freezing in the frozen fringe, G_f , and overall, governed by T_c and T_w , affects both the duration and the rate of flow. As temperature gradients increase, especially G_f in the frozen fringe, seepage is reduced because permeability of the frozen fringe decreases. In addition, if T_c falls quickly, the frozen fringe and the active ice lens zones penetrate faster, allowing less time for flow to occur to any particular point.

3) In order for seepage to occur, there must be a reservoir of accessible pore fluid. This depends on the proximity of the groundwater table, and the pore fluid content in soil above the groundwater table. In this case a higher groundwater table and greater general availability of pore fluid will increase flow volume.

4) The soil pore size influences both the ability of the soil to sustain continuous capillary pumping in response to the thermally induced suction, and the rate of flow. Smaller pores will allow the capillary suction pumping to draw water from a greater distance, on the one hand, but their small size will limit the quantity of flow that reaches the active layer during the freezing period. Pore size, both initially in the unfrozen state, and after pores begin to fill with ice, is relevant.

5) As pore ice forms, it does so starting at the center of the pores. Unfrozen pore fluid can persist as a film on particle surfaces at temperatures well below 0°C for water. This creates unfrozen seepage conduits along the particle surfaces that feed the growth of ice lenses above the frozen fringe. These conduits remain open at lower temperatures in fine grained soils, but exist even in gravels. For example, at -4°C , West Lebanon gravel can sustain an unfrozen water content of 1%; Fairbanks silt can sustain an unfrozen water content of 3%; and Umiat Bentonite can sustain an unfrozen, uncontaminated water content as high as 42% (from Andersland and Ladanyi, 1994).

6) The effect of the suction on the pore

structure is also a factor. Whereas frost heave expands the soil skeleton, clayey soils will consolidate under sustained high suction, thereby reducing effective permeability and void ratio.

The introduction of a fluid phase contaminant will alter fluid migration, even before one considers effects of contaminant sorption or desorption on particle surfaces, although the nature of the changes remains largely unknown at present. This first level of change is due to effects the contaminant may have on pore fluid density, viscosity, surface tension, and threshold temperatures for changes in state that will influence the response to every one of the six factors listed above.

Henry (1988) considered the various effects solutes might have on migration of water and solutes, as they relate to frost heave. She pointed out, first, that concentration gradients will induce migration of solutes. Second, ions that become attached to particle surfaces may reduce or increase the thickness of the unfrozen seepage conduits on the particle surfaces, and at the same time change chemical potential and freezing point. Third, a solute may act to disperse soil particles, or it may cause them to flocculate, which will change permeability of the soil. Fourth, thermal dispersion may propel ions away from the cold front, or attract them toward it. And fifth, depending on the rate of freezing, solutes will be expelled from the pore solution, thereby increasing in concentration as freezing proceeds; they may even reach a threshold concentration that then causes them to precipitate.

Henry concludes the discussion of individual effects by pointing out that a single solute may have effects that work against each other, and the net result may depend on solute concentration and other environmental factors. Indeed, contaminants may be propelled either toward or away from the advancing cold front. They may become concentrated, infiltrate ice rich zones, and lead to ice erosion, which can undermine the usefulness of either naturally frozen or artificially frozen soil barriers to contain contaminants on a temporary basis. Alternatively, the temperature gradient could attract the now concentrated contaminant to an amended soil barrier either to capture the contaminant for removal or for accelerated insitu remediation.

Immiscible contaminants with properties that are temperature sensitive, especially in their viscosity, and that change state at a higher temperature than water, may choke off seepage. For example, the viscosity of oil increases as it is cooled, and as cooling continues, waxes may crystallize, blocking off seepage passages. Even

without crystallization, it may become trapped in pores, thereby blocking seepage. The result may be that transport is retarded, redirected, or even halted in place by the freezing/cooling process.

Contaminants with densities and viscosities that are greater than water will be more difficult to draw toward the freezing front. In the absence of water in the soil, this may lead to development of greater suctions, and in compressible (clayey) soils, this may lead in turn to freeze consolidation due to that suction. Alternatively, at shallow depth, where overburden pressures are small, freeze induced fissuring may develop that increases effective permeability of the soil. This may be a problem when the soil is frozen, but it will especially be a problem when the soil is thawed.

Consider now the factors that govern sorption and desorption processes, discussed in the previous section for unfrozen soils, which may also be significantly altered. Pollutant concentration, C , in equation 1 may be greater if freezing causes pure water to be extracted from the contaminant solution. In addition K_F is likely to be temperature sensitive, increasing as temperature decreases due to the fact that sorption is generally an exothermic process. Together these would predict greater solid phase concentration, q , which could be ideal if the contaminant is attracted to an amended soil barrier for accelerated insitu remediation, provided there is sufficient contact time to develop sorption equilibrium. Alternatively, partitioning into the solid phase may increase and the pollutant may become more mobile during the thawing process due to possible increase in colloidal matter.

In reconsidering equation 6 developed for unfrozen soil, the sorption process may become discontinuous in freezing soils (i.e it is no longer a two phase process) and sorption/desorption may have to be represented by a model other than the Freundlich isotherm. For instance, it may be necessary to use a two-pronged approach where equation 5 is used to model sorption in unfrozen soil, and a different, as yet undetermined, representation is used (equation 7) when the soil is freezing. In this equation, the function representing the amount sorbed at any time ($f_{q_{freez}}$) is expected to be a function of time (t), temperature (T), and fluid phase concentration (C).

$$\frac{\partial q}{\partial t} = f_{q_{freez}}(t, T, C) \quad [7]$$

Application of Geoenvironmental Centrifuge Modelling

It is clear, then, that fluid phase contaminants

released into cooling and freezing ground will complicate an already complex event. It is possible to study each of these possible effects individually using small, isolated elements of soil, however this poses a major problem in assembling the composite picture of the combined effects. With respect to the freezing alone, Konrad and Seto (1994) observed that local, self-evolving, internal conditions of pore pressures, temperature gradients, soil overburden pressures, and soil compressibility within a full height soil column are essential factors in the development of fluid flow, and ice development. In addition, Henry (1988) concluded that individual conflicting effects of solutes on fluid migration during freezing may combine to produce quite different whole system consequences depending on concentration, initial distribution, and other environmental factors. To understand the dominant mechanisms, then, it is essential to study whole system response first. This can either be undertaken with a full scale soil column in a real time experiment where 6 months of freezing and cooling requires a 6 month long experiment. Or it can be undertaken in a small scale model tested, including the freezing process, while accelerated on a geoenvironmental centrifuge, to bring into similarity all fluid flow and soil self-weight factors. In that model, all heat flow and fluid movement will develop to scale and will occur faster by a factor of (the model scale)², so that processes taking place over 6 months in real time may be simulated in 4.9 hours in a model of scale 1:30 tested at 30g.

The idea of modeling uncontaminated soil freezing on the geoenvironmental centrifuge was first hypothesized by Miller and Miller (1956) based on their experimental and theoretical work in soil freezing. The primary attraction of centrifuge modeling lay not so much in the reduction of the size of the soil column being tested, since soil freezing seldom penetrates more than 1m in seasonally frozen soil, but rather in the radical reduction in duration of experiments. Yang & Goodings (1998) confirmed that models of columns of uncontaminated soil frozen at 1g constructed at different scales cannot simulate full scale freezing effects in a much larger (1g) soil column. However, when they froze the same size columns under increased accelerations on the geoenvironmental centrifuge, to make all stress conditions simulate a single full scale soil column, model columns constructed to different scales all simulated the same full scale freezing event, thereby confirming Miller and Miller's hypothesis. Yang & Goodings further confirmed the significance to the freezing processes of simulating realistic temperature regimes, as Konrad and Seto stressed.

Many centrifuge model studies of

contaminant migration without sorption, and without freezing have been successfully completed by various researchers (see, for example, Arulanandan, et al., 1988; Illangasekare et al., 1991; Hellawell and Savvidou, 1994; Hensley & Schofield, 1991; Hensley & Randolph, 1994; and Griffioen & Barry, 1998; Savvidou, 1988; Hensley and Savvidou, 1993). Only Gurung *et al.* (1998) have used the geoenvironmental centrifuge to explore modelling of sorption, conducting rapid tests of conventional breakthrough columns. They studied the migration of zinc through dredge soil models using a centrifuge operating at 50 g. In analyzing their results, they used a modified form of equation 4 with $n=1$, and found a good correlation ($R^2 > 0.99$) for their experimental data, from which they concluded that centrifuge modelling of sorption of zinc was valid for their test conditions. Although this is not proof for all pollutants in all soils, it serves to establish the potential.

Only Han *et al.* (1999) have modelled contaminant transport in freezing soil. Their contaminant was a simple, but nonetheless interesting, non-sorbing fluid: ethylene glycol, or antifreeze. They simulated a 6 month period of freezing and thawing, releasing the ethylene glycol from a buried reservoir into pure silt with no organic content. They initiated the release at different times during freezing. Patterns of transport varied according to the relationship between the moment of contaminant release and the depth of freezing that had occurred. When the ethylene glycol was released with no subsequent freezing, the contaminant was trapped in the soil pores surrounding the reservoir. When the ethylene glycol was released after freezing had penetrated well below the reservoir, the effect was similar. When the ethylene glycol was released, followed immediately by the initiation of freezing, the contaminant was drawn upward to the soil surface in a distinct plume. Patterns of behavior, in retrospect, are explainable. They were not, however, predictable. Although these models were only preliminary in nature and largely qualitative, they highlighted new, unanticipated patterns of behavior, and at the same time, established a precedent for the application of centrifuge modeling in contaminant transport in freezing soils.

Summary and Conclusions

It is essential to understand the dominant features of fate and transport of pollutants released into soil, in order to plan effective engineering response, including containment and remediation. Significant progress has been made in understanding mobility of

pollutants in unfrozen soil, however, surprisingly little is understood about mobility in a freezing environment in which behavior will be dramatically different. Processes that govern fate and transport of contaminants in unfrozen ground are discussed. Effects of freezing on that contaminant fate and transport are discussed, but remain largely unknown.

The next body of research must involve experimental investigations into full system response to identify at once the overall behaviour and the dominant factors that dictate that behaviour. This will be essential before either numerical modelling or experiments on small, isolated elements of soil can be used to identify details of system response. Full scale tests are desirable, but their size and duration make them impractical for initial parametric studies. Geoenvironmental centrifuge modeling is identified as a powerful alternative using small, short duration physical models that capture the essential self-weight driven influences missing from conventional small model testing; the groundwork to date, both with and without freezing, both with and without sorption effects, but not all together, has laid the foundation for extension of its application into research into fate and transport of contaminants in freezing ground.

References

- Andersland, O.B., and B. Ladanyi. 1994. *An Introduction to Frozen Ground Engineering*. Chapman & Hall, NY.
- Arulanandan, K., P.Y. Thompson, B.L. Kutter, N.J. Meegoda, K.K. Muraleetaran, and C. Yogachandran. 1988. Centrifuge modeling of transport processes for pollutants in soils, *ASCE Geotechnical Engineering Jour.* 114(2): 185-205.
- Ball, W.P. and P.V. Roberts. 1991. Long-term sorption of halogenated organic chemicals by aquifer materials-Part 2. Intraparticle diffusion. *Environ. Sci. & Technol.* 25, 1237-1249.
- Christensen, T.H. 1984. Cadmium soil adsorption at low concentrations: 1. Effect of time, cadmium load, pH and calcium. *Wat. Air Soil Pollut.* 21, 105-114.
- Eick, M.J., J.D. Peak, P.V. Brady, and J.D. Pesek. 1999. Kinetics of lead adsorption/desorption on goethite: residence time effect. *Soil Sci.* 164, 28-39.
- Griffioen, J.W., and D.A. Barry. 1998. Development and testing of an experimental apparatus for modelling solute transport in partially saturated media, *Proc. of Int. Centrifuge Conference '98*, pp 583-588. Balkema, Rotterdam.
- Gurung; S. B., M.S.S. Almeida., and K.B. Bicalho. 1998. Migration of zinc through sedimentary soil models. *Proc. Int. Conf. Centrifuge 98*, Tokyo, Sept 23-25, 1998, Kimura, Kusakabe and Takemura, (eds.), pp589-594.
- Han, S.J., D.J. Goodings, A. Torrents., and M. Zeinali. 1999. "Underground Leakage into Frozen Ground". *ASCE Journal of Cold Regions Engineering* 13(2):103-112.
- Hellawell, E.E., and C. Savvidou. 1994. A study of contaminant transport involving density driven flow and hydrodynamic cleanup, *Proc. of Int. Centrifuge Conference '94*, pp.357-362, Balkema, Rotterdam.
- Henry, K. 1988. *Chemical effects in soil freezing*. US Army Cold Regions Research Engineering Laboratory Report 88-17.
- Hensley, P.J., and M.F. Randolph. 1994. Modelling contaminant transport in saturated sand, *Proc. XIII Int Conf Soil Mech. Fdn. Engg.*, New Delhi, pp. 1557-1560.
- Hensley, P.J., and C. Savvidou. 1993. Modelling coupled heat and contaminant transport in groundwater, *Int. J. Numer. Anal. Methods Geomech.* 17: 493-527.
- Hensley, P.J., and A.N. Schofield. 1991. Accelerated physical modelling of hazardous waste transport, *Geotechnique* 41(3):447-466.
- Illangasekare, T.H., D. Dnidarcic., M. Al-Sheridda, and D.D. Reible. 1991. Multi-phase flow in porous media, *Proc. of Int. Centrifuge Conference '91*, pp. 517-523, Balkema, Rotterdam.
- Karickhoff, S. W. Sorption Kinetics of Hydrophobic Pollutants in Natural Sediments. in *Contaminants and Sediments, Vol. 2, Analysis, Chemistry, and Biology*, R. A. Baker, Ed., Ann Arbor Science, Ann Arbor, MI, 1980, pp. 193-205.
- Konrad, J.-M., and Seto, J.T.C. 1994. Frost heave characteristics of undisturbed sensitive Champlain Sea clay, *Canadian Geotechnical J.* 31(2):285-298.
- Krishnamurti, G. S. R., P.M. Huang, and L.M. Kozak. 1999. Sorption and desorption kinetics of cadmium from soils: influence of phosphate. *Soil Sci.* 64: 888-898.
- Leenheer, J. A. and J.L. Ahlrichs. 1971. A kinetic and equilibrium study of the adsorption of carbaryl and parathion upon soil organic matter surfaces. *Soil Sci. Soc. Am., Proc.* 35, 700-704.
- Miller, E.E. and R.D. Miller. 1956. Physical

- theory for capillary flow phenomena. *Jour. Applied Physics* 27 (4): 324-332.
- Miller, C. T. and W.J. Jr. Weber. 1988. Modeling the sorption of hydrophobic contaminants by aquifer materials-II column reactor systems. *Wat. Res.* 22: 465-474.
- Nixon, J.F. 1992. Discrete ice lens theory for frost heave beneath pipelines. *Can. Geotech. J.* 29(3): 487-497
- Ogata, A. and R.B. Banks. 1961. *A Solution of the Differential Equation of Longitudinal Dispersion in Porous Media*, U.S. Geological Survey Professional Paper 411-A.
- Savvidou, C. 1988. Centrifuge modelling of heat transfer in soil, *Proc. of Int. Centrifuge Conference '88*, pp. 583-591, Balkema, Rotterdam.
- Weber, W. J. Jr. and C.T. Miller. 1988. Modeling the sorption of hydrophobic contaminants by aquifer materials- I. Rates and equilibria. *Wat. Res.* 22: 457-464.
- Weber, W. J. Jr., P.M. McGinley, and L.E. Katz. 1991. Sorption phenomena in subsurface systems: concepts, models and effects on contaminant fate and transport. *Wat. Res.* 25: 499-528.
- Yang, D., and D.J. Goodings. 1998. Climatic soil freezing modelled in a centrifuge, *ASCE Journal of Geotechnical Engineering* 124 (12): 1186-1194.

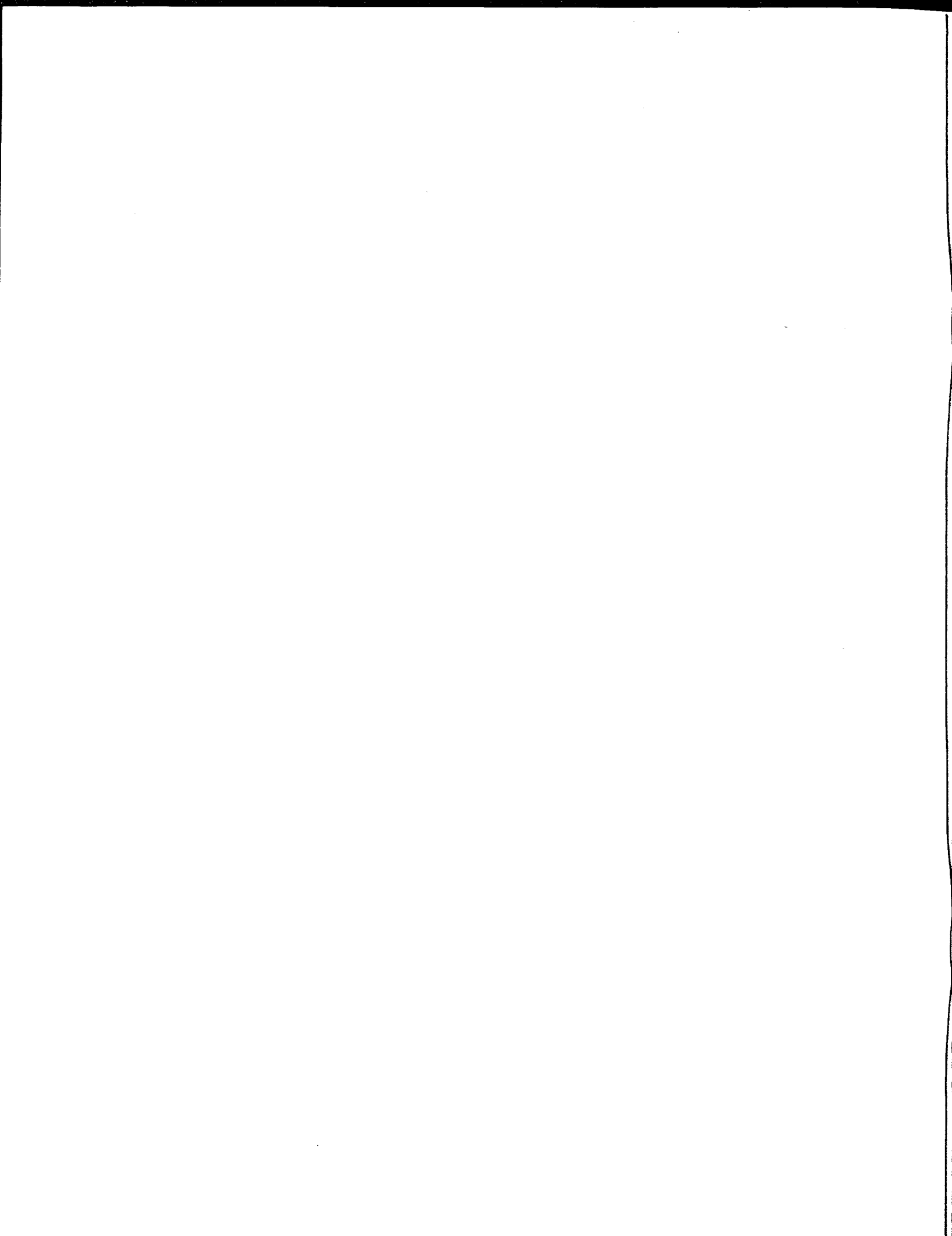

Effects of hydrocarbon contaminants on the temperature and moisture regimes of cryosols of the Ross Sea region, Antarctica

Megan Balks¹, John Kimble², Ron Paetzold², Jackie Aislabie³, Iain Campbell⁴

¹Earth Sciences, University of Waikato, Private Bag 3105, Hamilton, New Zealand

²Natural Resources Conservation Service, USDA, Lincoln NE 68508, USA

³Landcare Research, Private Bag 3127 Hamilton, New Zealand

⁴Land and Soil Consultancy Services, Nelson, New Zealand

ABSTRACT. Soils in the Ross Sea region of Antarctica are formed in an arid and relatively pristine environment. Hydrocarbon spills occur when fuel oils are moved or stored. We are investigating how the biological, chemical and physical properties of Antarctic soils are impacted by hydrocarbon contamination by comparing the properties of existing oil-contaminated sites with those of nearby controls. Soil samples were collected from oil-contaminated, and control sites, at Scott Base (Lithic Haplorthel), the old Marble Point Camp (Glacic and Typic Haplorthel), and Bull Pass in the Wright Valley (Typic Anhyorthel). Hydrocarbon levels were elevated in fuel-contaminated samples. Chemical characterisation of hydrocarbons at spill sites identified predominantly *n*-alkanes with lesser amounts of polyaromatic hydrocarbons.

Climate stations were installed at all three locations. The climate stations continuously measure a number of parameters including: soil moisture and temperature at a number of depths; solar radiation; wind speed and direction; air temperature; relative humidity; and soil electrical conductivity. Soil surface temperatures intermittently above 0° C were recorded at all three sites from October through to February, with soil temperatures of > +18° C recorded in December/January, even though air temperatures rarely exceeded +2° C. Of the three sites, Bull Pass was warmest in summer and coldest in winter, while Scott Base was the windiest site and the coolest in summer. Soil surface temperatures in summer fine weather were generally 1–2° C warmer, and sometimes more than 7° C warmer, at the Scott Base and Marble Point hydrocarbon-contaminated sites than their respective control sites. The increased temperature extended at least 20 cm into the soil at both sites. It is likely that the increased temperatures are the result of decreased albedo, and possibly some increase in thermal conductivity as a result of the presence of hydrocarbons. Some of the hydrocarbon contaminated soils were weakly hydrophobic, whereas the control soils did not exhibit any hydrophobicity. Total soil available water capacity was low and reported field soil moisture contents are often lower than the moisture content at 1500 kPa tension.

Contents

Introduction	33
Materials and Methods	34
Results and Discussion	35
Conclusion	37
References	38

Introduction

Soils in the Ross Sea region of Antarctica are formed in an environment of low precipitation and mean annual air temperatures of less than -10° C. Because of the slow rate at which Antarctic soil processes operate, the soils are considered to be particularly susceptible to human-induced damage (Campbell *et al.* 1998a). All human activities in Antarctica depend on fuels for transport and energy, hence the most widespread contaminants are petroleum related (Cripps and Priddle, 1991). At most Antarctic sites where intensive human activity has been undertaken fuel spills have occurred, and they have been reported at most major bases (e.g. Kerry 1990, Tumeo and Wolk 1994, Cripps and Shears 1997, Balks *et al.* 1998, Aislabie *et al.* 1998). Oil

contamination of soil was also a consequence of the Dry Valley Drilling Project (Parker and Howard 1977). Hydrocarbons can accumulate in Antarctic soils and migrate into the subsurface (Balks *et al.* 1998), and changes in microbial diversity have been reported at fuel contaminated sites (Aislabie *et al.* 1998). Very little is known of the effects of hydrocarbon contaminants on soil physical properties in Antarctic soils.

The gravimetric moisture content of the active layer of soils in the Ross Sea region of Antarctica is typically between 1 and 10% (Campbell *et al.* 1994, 1997a). There is some seasonal variability at sites where snow-melt has been shown to result in an increase in soil moisture content to values of up to 15% for short periods (up to 14 days, Campbell *et al.* 1997a). Within the underlying permafrost in coastal areas, moisture contents are variable ranging from lenses of ice (100% moisture), to moisture contents of less than 10%, with an average of about 40% (Campbell *et al.* 1998b). In dry inland areas soil moisture contents, in both the permafrost and the active layer are generally less than 10%. Moisture retention in

Antarctic soils is likely to be low due to the coarse soil textures. The osmotic effect of salts in soils from an older surface in the Dry Valleys was shown to play a major role in determining the soil water potential (Klingler and Vishniac 1988). However, very little investigation has been undertaken into the available water capacity of Antarctic soils.

Summer soil surface temperatures ranging from +18 to -15° C have been reported for short measurement periods for three sites in the Ross Sea region (Campbell *et al.* 1997b), and for a whole year, giving a range from +15 to -34° C, at Marble Point (Balks *et al.* 1995). The main factor affecting the diurnal thermal regime of Antarctic soils in summer is surface albedo (Campbell *et al.* 1997b). It is hypothesised that where fuel spills result in formation of a dark surface coating, thus decreasing the surface albedo, the soil's capacity to absorb heat will be increased.

In this paper we present preliminary data on the moisture and temperature regimes of hydrocarbon-contaminated and nearby control soils from three contrasting sites in the Ross Sea region of Antarctica.

Materials and Methods

Site and soil description

Hydrocarbon-contaminated and nearby control sites were identified at Scott Base, Marble Point, and near Bull Pass in the Wright Valley (Figure 1). At Scott Base, a hydrocarbon-contaminated site was sampled near a former storage area for drums of hydraulic and lubricating oils. At Marble Point, the soil sampled was situated near the old Marble Point camp that was inhabited from 1957 to about 1963 (Broadbent 1994). Oil stains were visible on the surface of the soil and it is assumed they have been there for over 30 years. The hydrocarbon-contaminated soil sampled in the Wright Valley came from a spill site near Bull Pass that occurred during seismic bore-hole drilling activities in 1985. The sampled site at Bull Pass was down-hill from

the bore-hole and it is likely the fuel flowed to the sampling site along the interface between the soil and the relatively impermeable underlying bedrock. At each of the three sites, the extent of the contamination appears to be limited to less than 100 m².

The soils at the three sampling sites have

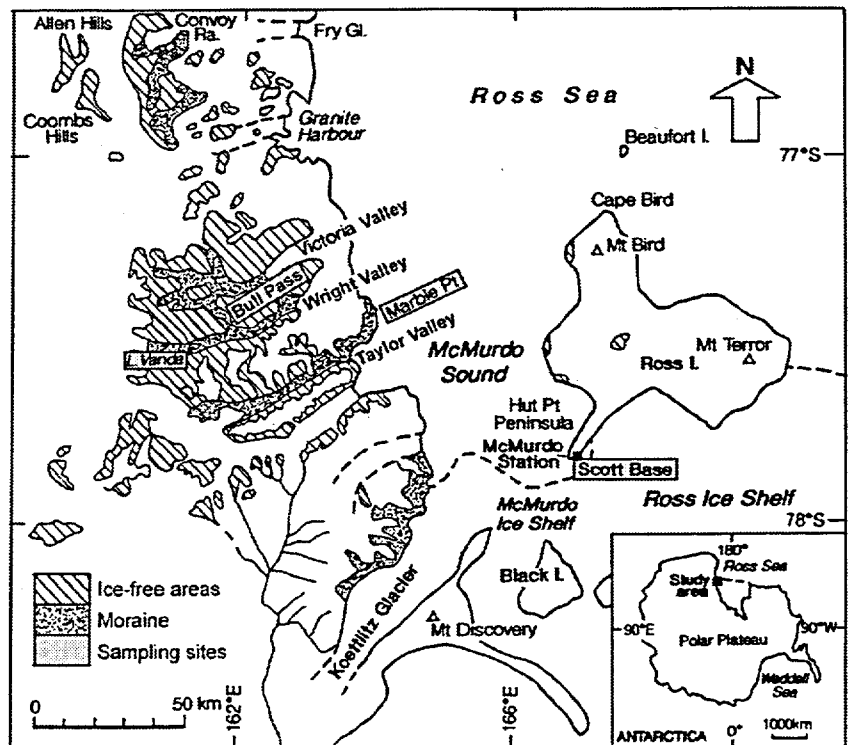

Figure 1 Location of oil-spill sampling sites at Scott Base, Marble Point, and Bull Pass.

differing parent materials and climates, leading to a range in soil properties and differences in soil classifications (Table 1). The control sites were all within 400 m of the oil-contaminated sites and the contaminated soils were generally similar to those of the adjacent control sites. However, in the contaminated soil at the Marble Point site, the glacial (ice saturated) layer, that was described in the control site and is widespread in the Marble Point area, was not observed. At the Bull Pass contaminated site, the granite bedrock was encountered at a depth of 65 cm, whereas bedrock was at a depth greater than 1 m at the control site.

Hydrocarbon analyses of soil

For total petroleum hydrocarbon (TPH) analyses, approximately 50 g of soil were placed in tin cans, and stored at room temperature until analysis in New Zealand. Levels of TPH were determined by extracting the samples in methylene chloride, then

Table 1. Soil and site descriptions for control sites at Scott Base, Marble Point and Bull Pass.

	Scott Base	Marble Point	Bull Pass
GPS location	77°50'53.9"S 166°45'40.7"E	77 ° 25' 9.9" S 163 °40'55.1"E	77°31'05.7"S 161°51'57.3"E
Site description	200 m directly up-hill from Scott Base. Slope of 6° to SE, 60 m above s.l.	Marble Point old camp, 60 m east of lake edge. Slope of 3° to E, 60 m above s.l. 30% surface rock cover.	400 m east of Bull pass camp in Wright Valley. Slope of 4° to S, 250 m above s.l. 20% surface rock cover.
*Soil Classification	Lithic Haplorthel	Glacic Haplorthel	Typic Anhyorthel
Parent lithology and material	Predominantly mafic, scoriaceous basalt dominated till over scoria basalt bedrock.	Predominantly calcareous, marble dominated glacial till with common granite and gneiss.	Predominantly siliceous, silt dominated glacial till over granite bedrock.
Brief Soil Description	Stony, gravelly sands derived mainly from basalt with ice-cemented permafrost below about 30 cm.	2 cm of desert pavement gravels over sandy gravel with > 30 % boulders/stones. Ice-dominated horizon from 87—100+ cm.	2 cm of gravel desert pavement over 1+ m of silt with a few large rocks. Visible salt accumulation on profile face. No ice-cement.

*Soil classifications are those of Soil Survey Staff (1998).

analysing the extracts by capillary gas chromatography with a flame ionisation detector as outlined in EPA Methods 8015.

Climate data collection, and soil moisture retention and hydrophobicity determination

Soil climate stations were established at the three control sites, each in an undisturbed area typical of the surrounding terrain and soils, and in hydrocarbon-contaminated sites at Scott Base and Marble Point. A CR10X-2M data logger is installed at each site with above-ground sensors to record air temperature, relative humidity, solar radiation, and wind speed and direction. Thermistors and Vitel sensors are installed at depths of up to 1.2 m to measure soil moisture and temperature contents. Data are collected at a maximum of 1-hour intervals and downloaded annually.

Soil moisture retention was determined using a Haines apparatus (2.5 and 5 kPa) and pressure plate apparatus (10, 20, 40, 100, 300 and 1500 kPa) following the methods of Klute (1986). Field-moist soil samples, sieved through an 8 mm sieve, were repacked to achieve a bulk density of

approximately 1.6 g cm⁻³. Soil hydrophobicity was determined using the molarity of ethanol droplet method of Carter and Hamilton (1995).

Results and Discussion

Hydrocarbon analysis

Hydrocarbon levels were elevated at all the contaminated sites (Table 2). The concentrations of the hydrocarbons in the contaminated soils sampled vary due to differences in the mixtures of hydrocarbons spilled, the amount and rate at which they were spilled, soil permeability, and the time since spillage. At the contaminated sites, hydrocarbon levels ranged from below detectable limits to 29 100 µg g⁻¹ dried soil. These levels were within the ranges reported for contaminated soils from around the H. Arctowski Polish station (Kryszowska 1990), McMurdo Station (Tumeo and Wolk 1994), Palmer Station (Kennicutt *et al.* 1992) and Davis station (Green and Nichols 1995).

Fuel oils spilled on Antarctic soils can move into subsurface soils (Balks *et al.* 1998, Gore *et al.* 1999). Hydrocarbons were detected in subsurface

soils from all the contaminated sites sampled (Table 2). The mobility of the spilled fuel depends on the fuel's physical characteristics (Gore *et al.* 1999). Lighter fuels such as JP8 jet fuel or Diesel Fuel Arctic (DFA) are highly mobile, whereas heavier hydraulic and lubricating oils are less mobile. At the DFA-contaminated Bull Pass site, hydrocarbons were detected at high levels at the 60 cm depth where the mobile fuel was perched on bedrock. In contrast, at Marble Point hydrocarbon levels were below detectable levels in soil from the 27–40 cm depth, in the soil reported here, where a relatively less mobile oil had not penetrated a clay-rich soil horizon of low permeability. At Scott Base, soil sampling was limited by the presence of ice-cemented ground at about 20 cm depth in early December. It is likely that the ice-cemented permafrost surface, at about 35 cm at Scott Base, restricts downward movement of fuels.

Chemical characterisation of the hydrocarbon contaminants from all sites identified *n*-

alkanes and aromatic compounds (Table 2), some of which occur on the USEPA Priority Pollutant List. While hopanes, a constituent of hydraulic and lubricating oils, were detected in soil from the former Marble Point Camp site (Weston and Aislabie, submitted), we have not yet analysed soils from the Scott Base site for hopanes.

Climate data and soil temperature profiles

Comparison between the three study sites (Table 3) indicates that Scott Base is markedly cooler and windier than either Marble Point or Bull Pass. Bull Pass has the longest period in which air temperatures exceed zero.

Comparison of temperature profiles between hydrocarbon-contaminated and control sites (Figure 2) at Scott Base and Marble Point indicates that during fine weather the summer soil temperature at the contaminated-soil surface is often warmer (by up to 7° C) than at the adjacent control

Table 2: Levels of total petroleum hydrocarbons (TPH)^A, classes of hydrocarbons, identified at each site using GC^B, and the description of site contamination for three locations in the Ross Sea region, Antarctica.

Location	TPH μg g ⁻¹ dry weight	Class of Hydrocarbons	Description of site contamination
Scott Base: drum storage site			
0–2 cm	25 100	C10–C40 <i>n</i> -alkanes	Storage area for drums of hydraulic and lubricating oils. Hydrocarbons spilled during movement and distribution.
10–20 cm	4190	polyaromatic hydrocarbons	
Marble Point: Old Marble Point Camp site			
0–3 cm	29100	C13–C40 <i>n</i> -alkanes	Oil stains on soil surface at site of Old Marble Point Camp assumed to be hydraulic and lubricating oils.
3–12 cm	18300	polyaromatic hydrocarbons	
12–27 cm	200	hopanes	
27–40 cm	<20		
40–55 cm	<20		
55–75	<20		
Bull Pass: seismic bore-hole site			
0–2 cm	<30	C9–C15 <i>n</i> -alkanes	Diesel fuel Arctic was spilled in 1985 during seismic bore-hole drilling. Contaminated surface soil was removed. Sample site was down-slope from original spill site.
2–8 cm	260	monoaromatic compounds	
8–16 cm	1260		
16–35 cm	960		
35–50 cm	2470		
50–60 cm	9000		
60–65 cm	9500		

^ATotal petroleum hydrocarbon levels in soil from control sites near the spill sites were <30 μg g⁻¹ dried weight, except for the Scott Base site which was < 500 μg g⁻¹.

^BData from Aislabie *et al.* (1999), Weston and Aislabie (submitted).

Table 3 Climate data (for 1999) from three sites in the Ross Sea region

Parameter	Scott Base	Marble Point	Bull Pass
<i>Air temperature ° C</i>			
Max.	1	3.5	6
Min.*	<-40	<-40	-53
Mean	-20	-19	-22
<i>Period where air temp. intermittently > 0° C</i>	Mid Dec-early Feb	Early Dec-mid Feb	Early Nov-late Feb
<i>Wind speed ms⁻¹</i>			
Max	27	18	
Min	0	0	
Mean	5	3	
<i>Soil surface temp. ° C</i>			
Max	20	18	28
Min	-45	-40	-56
Mean	-17	-20	-20
<i>Depth to permafrost, P (cm)</i>	30<P<45	45<P<60	45<P<75

* Temperature sensors at Scott Base and Marble Point do not register below -40° C.

sites. The increased temperature is evident at least to the 20 cm depth.

At the Marble Point site, it is possible that the increased temperature and thermal conductivity in the soil, has, over the 30 years since the spill occurred, led to an increase in the depth to permafrost and lowering, or possibly destruction, of the glacial layer at the contaminated site. Work is continuing to confirm this hypothesis.

Soil hydrophobicity and moisture retention

Some of the oil-contaminated samples displayed

weak hydrophobicity (0.2 on the ethanol droplet molarity scale of Carter and Hamilton (1995)) while there was no evidence of hydrophobicity in the control soils at any of the sites sampled. The hydrophobicity of the oil-contaminated sites was unexpectedly low and is not likely to limit moisture penetration into the soil. Moisture retention of control soils (Figure 3) indicates that the soils, in their field moisture content of 1-5 % in the surface 10 cm, are at or below a 1500 kPa tension, thus confirming the limited availability of water near the surface of these soils.

Figure 3 Soil moisture retention for control soils From Scott Base, Marble Point and Bull Pass.

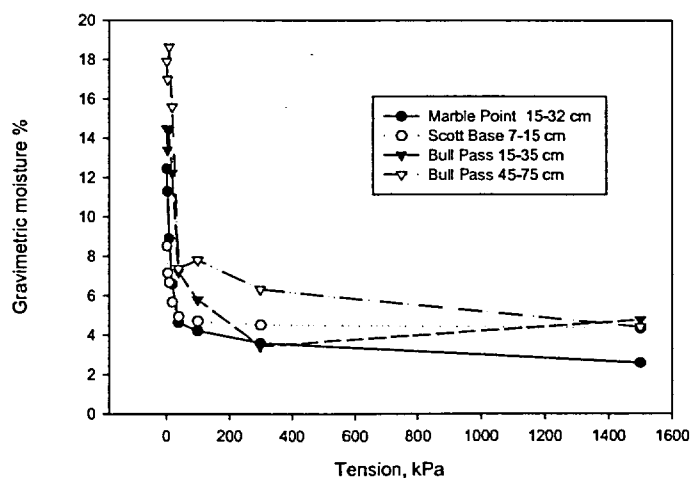

Conclusion

Significant hydrocarbon contamination has been shown to occur at the three sites sampled. Where hydrocarbons accumulate at the soil surface they are contributing to increased soil temperatures during sunny periods. This is likely to be the result of a decrease in surface albedo and an increase in soil thermal conductivity due to the presence of the hydrocarbon material. Work is continuing to elucidate the effects of the hydrocarbons on soil moisture properties.

Acknowledgements

This work was supported by funding from the Foundation for Research, Science and Technology, New Zealand (C09601). Antarctica New Zealand provided logistic

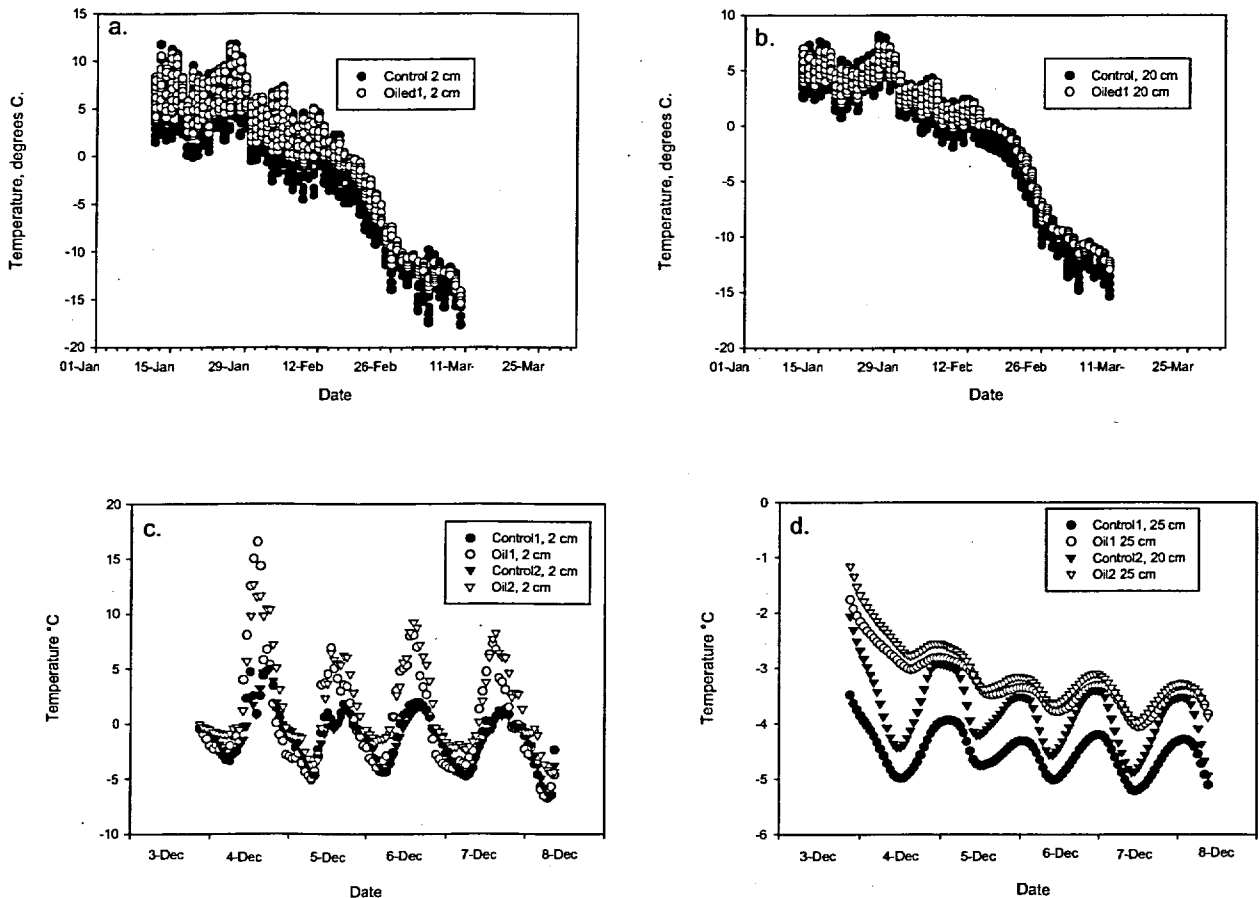

Figure 2: Soil temperatures at hydrocarbon contaminated and control sites at a. Marble Point 2 cm depth, b. Marble Point 20 cm depth, c. Scott Base 2 cm depth, d. Scott Base at 20 and 25 cm depth. All data are from 1999.

support.

References

- Aislabie, J., M. McLeod, R. Fraser. 1998. Potential of biodegradation of hydrocarbons in soil from the Ross Dependency. *Antarctica. Applied Microbiology and Biotechnology* 49:210–214.
- Aislabie, J., M. Balks, N. Astori, G. Stevenson, and R. Symons. 1999. Polycyclic aromatic hydrocarbons in fuel-oil contaminated soils, Antarctica. *Chemosphere* 39: 2201–2207.
- Balks, M.R., D.I. Campbell, I.B. Campbell, and G.G.C. Claridge. 1995. Interim results of 1993/4 soil climate, active layer, and permafrost investigations at Scott Base, Vanda and Beacon Heights, Antarctica. University of Waikato, *Antarctic Research Unit Special Report* No. 1. 64p.
- Balks, M.R., J. Aislabie, and J.M. Foght. 1998. Preliminary assessment of the constraints to biodegradation of fuel spills in Antarctic soils. Symposium 38, *Proceedings 16th World Congress of Soil Science*, on CD-Rom
- Broadbent, N.D. 1994. An archaeological survey of Marble Point, Antarctica. *Antarctic Journal of the United States* 19:3–6.
- Campbell, D.I., R.J.L. MacCulloch, and I.B. Campbell 1997b. Thermal Regimes of some soils in the McMurdo Sound region, Antarctica. In W.B. Lyons, C. Howard-Williams and I. Hawes (eds) *Ecosystem Processes in Antarctic ice-free landscapes*. Balkema, Rotterdam pp 45–56.
- Campbell, I.B., G.G.C. Claridge, D.I. Campbell, and M.R. Balks. 1994. The effect of human activities on moisture content of soils and underlying permafrost from the McMurdo Sound region, Antarctica. *Antarctic Science* 6:307–14.
- Campbell, I.B., G.G.C. Claridge, M.R. Balks, and D.I. Campbell. 1997a. Moisture content in soils of the McMurdo Sound and Dry

- Valley region of Antarctica. In W.B. Lyons, C. Howard-Williams and I. Hawes (eds) *Ecosystem Processes in Antarctic ice-free landscapes*. Balkema, Rotterdam, pp 61-76.
- Campbell, I.B., G.G.C. Claridge, D.I. Campbell, and M.R. Balks. 1998a. The soil environment of the McMurdo Dry Valleys, Antarctica. In: Priscu JC (Editor) *Ecosystem dynamics in a polar desert. The McMurdo Dry Valleys, Antarctica*. American Geophysical Union, Washington DC, pp 297-322.
- Campbell, I.B., G.G.C. Claridge, D.I. Campbell, and M.R. Balks. 1998b. Permafrost Properties in the McMurdo Sound - Dry Valleys Region of Antarctica. In: Lewkowicz AG, and Allard M. (eds) *Permafrost*. Seventh International Conference, June 23-27, 1998, Yellowknife, Canada.
- Carter, D.J., and G.J. Hamilton. 1995. Water repellency - the molarity of ethanol droplet test. In: Coughlan KJ, McKenzie NJ, McDonald WSA and Creswell HP (eds). *Australian Soil and Land Survey Handbook series*. Volume 5. Soil Physical Measurement and interpretation for Land Evaluation. Australian Collaborative Land Evaluation Program.
- Cripps, G.C., and J. Priddle. 1991. Hydrocarbons in the Antarctic environment. *Antarctic Science* 3: 233-250.
- Cripps, G.C., and J. Shears. 1997. The fate in the marine environment of a minor diesel fuel spill from an Antarctic Research Station. *Environmental Monitoring and Assessment* 46: 221-232.
- Gore, D.B., A.T. Reville, and D. Guille. 1999. Petroleum hydrocarbons ten years after spillage at a helipad in Bungar Hills, East Antarctica. *Antarctic Science* 11:427-429.
- Green, G., P.D. Nichols. 1995. Hydrocarbons and sterols in marine sediments and soils at Davis Station, Antarctica: a survey for human derived contaminants. *Antarctic Science* 7:137-144.
- Kennicutt, I.I., T.J. McDonald, G.J. Denoux, and S.J. McDonald. 1992. Hydrocarbon contamination on the Antarctic Peninsula. I. Arthur Harbor - subtidal sediments. *Marine Pollution Bulletin* 24:499-506.
- Kerry, E. 1990. Microorganisms colonizing plants and soil subjected to different degrees of human activity, including petroleum contamination, in the Vestfold Hills and MacRobertson Land, Antarctica. *Polar Biology* 10:423-430.
- Klingler, J.M., and H.S. Vishniac. 1988. Water Potential of Antarctic Soils. *Polarforschung* 5:231-238.
- Klute, A. 1986. Water retention: Laboratory Methods. In: A. Klute (ed.) *Methods of Soil Analysis, Part 1, Physical and Mineralogical Methods* (2nd edition). *Soil Science Society of America*. pp 635-686.
- Krzyszowska, A. 1990. The content of fuel oil in soil and effect of sewage on water nearby the H. Arctowski Polish Antarctic Station (King George Island). *Polskie Archiwum Hydrobiologii*. 37:313-326.
- Parker, C., and R.V. Howard. 1977. The first environmental impact monitoring and assessment in Antarctica. *The Dry Valley Drilling Project. Biology and Conservation* 12: 163-177.
- Soil Survey Staff. 1998. Keys to Soil Taxonomy. Eighth edition. United States Department of Agriculture, *Natural Resources Conservation Division*. 326p.
- Tumeo, M.A., and A.E. Wolk. 1994. Assessment of the presence of oil-degrading microbes at McMurdo Station, *Antarctic Journal of the United States*. 29:375-377.
- Weston, R., and J. Aislabie. Organic geochemical description of the fate of spilt fuel oil in soils of western McMurdo Sound, Antarctica. *Organic Geochemistry* (submitted).

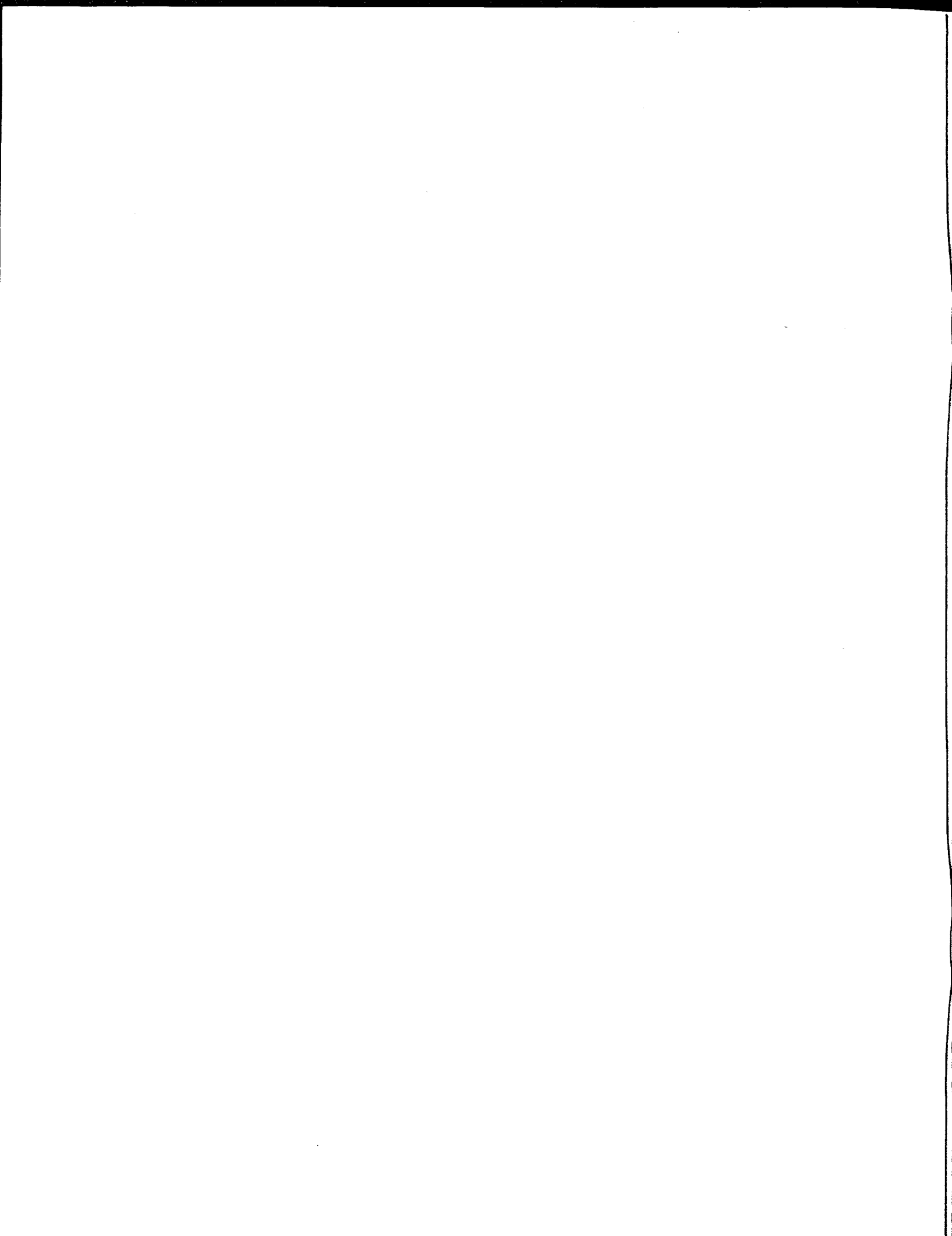

Microbial activity measurements for a soil quality assessment of highly crude oil contaminated soils in the Russian tundra at the Arctic Circle

Lothar Beyer¹, Wiebke Huyke¹, Stephan Hüttmann², Inna Archegova³ and Tatiana V. Titarenko⁴

¹ Institute of Polar Ecology, University of Kiel, Wischhofstraße 1-3, Building 12, D-24148 Kiel, Germany, Email: lbeyer@ipoe.uni-kiel.de, *current postal address*: Soil Science Germany, International Soil Consultancy, Hinter dem Klosterhof 8, D-25524 Itzehoe, Germany

² Groth & Co. (GmbH & Co.), Environmental Technology and Consult Section, Feldmannstraße 1, D-25524 Itzehoe, Germany,

³ Institute of Biology, Komi Scientific Center, Ural Branch of the Russian Academy of Sciences, 167610 Russia, Komi Republic, Syktyvkar, Kommunisticheskaya St. 28

⁴ KomiArcticOil JSC, Vozeyskaya St. 21-A, Usinsk, 169706, Komi Republic, Russia

ABSTRACT. Crude oil-polluted and non-polluted soils of the subpolar tundra region were investigated with commonly used enzymatic activity tests and microbial biomass determinations (microbial basal respiration, substrate-induced biomass-C and chloroform-fumigation biomass-C, arginine ammonification, dehydrogenase, β -glucosidase and arylsulfatase activities). The purpose was to obtain information about the suitability of the tested methods to characterize the microbial soil conditions affected by oil pollution and/or cold environmental soil conditions. Recommendations for the application of the methods for investigation of selected soil microbial activity in cold climates are given. Detailed information on soil minerals, organics, texture etc., the degree of oil pollution, the age of the contamination and suitability of the microbial activity methods themselves are required for an interpretation. We urgently recommend (I) to test the method for its suitability before any data collection in series and (II) the general application of ecophysiological ratios between two parameters instead of single parameters.

	Contents	
Introduction		41
Methods		41
Results and Discussion		43
Conclusions		46
References		46

Introduction

The Upper Vozey oil field in the subpolar region of the Komi Republic close to the Arctic Circle has one of the most prominent oil resources in Russia west of the Ural mountains. Defective pipeline systems and obsolete oil extraction techniques during the Soviet era have produced extensive oil pollution: up to 30% crude oil in the soil and oil lakes on the soil surface everywhere. It is proposed that the contamination be removed, the soils remediated and the sites be recultivated. In order to control the efficiency of these treatments selected environmental indicators must be applied to characterize soil quality (Ad-hoc-Arbeitsgruppe, 1995; Pankhurst et al., 1998). In the first period commonly used enzymatic activity tests and microbial biomass determinations (Alef, 1991; Schinner et al., 1996) were tested for their effectiveness in characterizing the microbial conditions in soils affected by oil pollution as well as under cold environmental conditions.

Methods

The soil survey and soil description was carried out according to the US Soil Taxonomy (Soil Survey Staff, 1998). Most non-biological methods are described in detail in Schlichting et al. (1995). Dry mass was determined gravimetrically after burning the oven-dried (105°C) soil sample at 600°C for 24 h. Total organic carbon (TOC) was calculated by measuring the evolved CO₂ after dry combustion. Crude oil was measured after extraction with 1,1,2-trichlorotrifluoroethane using an IR spectroscope (Hüttmann, 1999). Crude oil carbon (Oil-C) was estimated as follows: Crude oil x 0.86 [(CH₂)_n]. The biogenic organic carbon (C_{bioorg}) was defined as TOC - Oil-C. Total nitrogen (N_t) was measured by Kjeldahl extraction in a flow injection analyzer (Jones, 1991). The pH value was measured in 0.02 N CaCl₂.

The CFE-microbial biomass-C (CFE-C_{mic}) was determined by the chloroform-fumigation-extraction (CFE) procedure according to Vance et al. (1987). After soil fumigation with chloroform for 24h, carbon was extracted from the soil with 0.5 M K₂SO₄ and determined after dry combustion (see TOC determination). The extracted carbon was converted into biomass carbon with the k_{EC} factor 0.37. The SIR-microbial biomass-C (SIR-C_{mic}) was indirectly determined by substrate induced

respiration (SIR). An optimal dose of glucose was added to 100 g fresh soil and incubated at 22 °C for 6h. The CO₂ evolution was measured in a SaproMat and converted into biomass carbon by calculation. Both C_{mic} results are given in µg C g⁻¹ soil dry mass. Microbial basal respiration (R_{mic}) was determined in the same way without the addition of glucose and the results are given in µg CO₂-C g⁻¹ h⁻¹ g⁻¹ soil dry mass. The metabolic quotient (qCO₂) was calculated from the results for R_{mic} and C_{mic} (R_{mic}/SIR-C_{mic} × 10³) and expressed as mg CO₂-C g⁻¹ C_{mic} h⁻¹. The C_{mic}/C_{bioorg} ratio reflects the C_{mic} in % C_{bioorg}.

The enzyme tests and biomass determinations were carried out according to Alef (1991) and

Schinner et al. (1996). For the determination of arginine ammonification (ARG) moist soil samples were incubated for 3h at 37°C. Ammonium released by arginine deaminase activity (=arginine ammonification) was extracted with 2 M KCl, and determined colorimetrically after the indophenol reaction. The results are given in µg NH₄-N g⁻¹ soil dry mass. Dehydrogenase activity (DHA) was measured with the 2,3,5-triphenyltetrazolium chloride (TTC) method according to Thalmann (1968). The moist soil sample was incubated TTC for 24 h at 30°C. After the reduction of TTC the triphenyltetrazolium formazan (TPF) was measured colourimetrically at 546 nm and the results are expressed in µg TPF g⁻¹ soil dry mass. β-glucosidase

Table 1. Selected properties of soils in the oil exploitation area of the Upper Vozey oil field in Russian subpolar tundra region of the Komi Republic close to the Arctic Circle (Usinsk)

Horizon ^A	Depth cm	DM	Oil-C mg g ⁻¹	TOC DM	C _{bioorg}	C _{bioorg} Oil-C	N _t mg g ⁻¹	C _{bioorg} Nt	pH ^B
Moist mineral soil (<i>Histic Cryaquept</i>) under ruderal grass vegetation with oil contamination									
1.0	Oil & C	0-2	946	92.5	150.7	58.2	0.63	ND	ND
1.1	C	-15	687	46.5	76.9	30.4	0.65	1.32	23.0
1.2	O	-30	255	33.5	363.8	330.5	9.87	5.83	56.7
1.3	Bg	-55	872	0.4	3.3	2.9	7.25	0.26	11.2
... without oil contamination									
2.1	C	0-10	616	0.9	48.3	47.4	52.7	1.98	23.9
2.2	O	-30	107	1.8	393.8	392.0	217	6.03	65.3
2.3	ABg	-42	818	0.03	10.5	10.5	350	0.59	17.8
Peat soil (<i>Sphagnic Cryofibris</i>) without oil contamination									
3.1	Oi	0-30	215	2.8	499.5	496.7	177	4.69	105.8
3.2	Oe	-60	136	4.3	493.4	489.1	113	20.57	23.8
Peat soil (<i>Sphagnic Cryofibris</i>) with oil contamination									
4.1	Oi	0-17	261	1.3	361.5	360.2	359	11.19	32.1
4.2	Oe	>17 ^C	126	3.1	439.7	436.6	141	15.16	28.8
Moist mineral soil (<i>Histic Cryaquept</i>) under an open pine and birch forest with oil contamination									
5.0	Oil & C	0-5	134	3.8	349.3	345.5	90.9	9.53	35.1
5.1	O	-18	118	1.8	481.7	479.9	266	4.01	119.7
5.2	A	-38	574	0.1	96.7	96.6	966	4.93	19.6
5.3	Bg	-50	856	0.03	15.0	15.0	500	0.98	15.3
... without oil contamination									
6.1	O	0-15	177	2.9	389.0	386.1	133	8.32	46.4
6.2	A	-24	827	0.1	3.9	3.8	38.0	0.34	11.2
6.3	Bg	-47	856	0.02	2.9	2.9	145	0.34	8.5

ND: not determined, DM: dry mass, Oil-C: oil derived carbon, TOC: total organic carbon, C_{bioorg}: soil derived and biogenic organic carbon, N_t: total nitrogen

^A according to Soil Survey Staff (1998)

^B in 0.02 N CaCl₂

^C oil-polluted-water table 10 cm below surface

activity (β -GL) was determined by adding β -glucosido-saligenin as substrate to the moist soil and incubating for 3h at 37°C. Saligenin released from the substrate was determined colourimetrically after colouring with 2,6-dibromchinon-4-chlorimide at 578 nm. The results are given in μg saligenin g^{-1} soil dry mass. Arylsulfatase activity (ARYL) was measured according to Tabatabai & Bremner (1970). After the addition of a p-nitrophenylsulfate solution, soil samples were incubated at 37 °C for 1 h. The p-nitrophenol released was colourimetrically quantified at 420 nm. The results are given as μg phenol g^{-1} soil dry mass.

Results and discussion

Typical soils of the subpolar tundra region (moist to wet mineral soils and peat soils) were investigated which had an easily detectable and visible high degree of crude oil contamination and compared to soils with no detectable contamination (Table 1). The degree of pollution was extremely high by European bioremediation standards (e. g. Germany: 0.5 - 1 mg g^{-1} soil dry mass (e. g. LAGA, 1997). This was already found with the visibly and organoleptically 'uncontaminated' soils (Table 1: soil 2: 0.9 - 1.8, soil 3: 2.8 - 4.3, soil 6: 2.9 mg g^{-1} soil dry mass). In some horizons the oil-derived carbon content was higher than the biogenic and soil-derived carbon (C_{bioorg}), so the ratio between them was <1 . This means ecologically that the natural carbon source in the soil is smaller than that from the pollution. This suggest a significant impact on carbon-consuming soil microbiota. In the mineral soils this ratio decreased with increasing oil contamination (Table 1). This was not detectable for the peat soils. The extremely high C_{bioorg}/N_i ratios in the organic layers (O horizons) and peat layers (Oi, Oe horizons) suggest that the oil extraction method used (German H18-method) is not appropriate for quantitative extractions of the mineral oil carbohydrates; this has been a general methodological problem for years (Hüttmann, 1999). However, from the viewpoint of the current paper this is of minor importance because the not-extractable oil components are strongly fixed to the soil matrix and therefore little or probably not bioavailable.

The CFE biomass carbon level (CFE- C_{mic}) was similar to those known from temperate soils in North Germany (Table 2). The CFE- C_{mic} procedure showed no lower levels of microbial biomass for the cold tundra soils, despite the suggestion that the microbial activity would be much lower due to the cold conditions (Schmidt, 1999). The reaction of CFE- C_{mic} with oil was not exactly clear. This means statistically CFE- C_{mic} was not significantly

correlated positively or negatively with the oil content. Probably for the microbes it makes no difference where the carbon sources are coming from - if it is natural or pollution-derived carbon. This is in line with the observations of Schmidt (1999), who showed the positive impact of the native soil carbon level (C_{bioorg}) on CFE- C_{mic} in the mineral arctic soils, while Jørgensen et al. (1995) discovered the same pattern for an oil-derived carbon source. Nevertheless, the relative CFE- $C_{\text{mic}}/C_{\text{bioorg}}$ ratio (percentage of CFE- C_{mic} from C_{bioorg}) and the oil carbon content (Oil-C) showed significant correlations (Huyke, 2001). The CFE- $C_{\text{mic}}/C_{\text{bioorg}}$ ratio was higher in the upper soil horizons and increased with increasing oil content. Obviously crude oil promotes the microbial biomass, which was also detectable by comparing the data of the peat soils.

On the other hand it might be possible that with the extraction of CFE- C_{mic} oil compounds are also extracted (Jørgensen et al., 1995). Statistically this would cause a "pseudo" correlation between CFE- C_{mic} and Oil-C and of course an overestimation of the microbial biomass values. In addition CFE- C_{mic} did not reflect the commonly known low microbial activity of arctic soils (Schmidt, 1999) in comparison to soils of the temperate climate (Beyer, 1998).

In contrast to the CFE- C_{mic} the SIR- C_{mic} was very low in comparison to data from temperate soils (Table 2). This was surprising with such high C_{bioorg} . Nevertheless a strong correlation between SIR- C_{mic} and C_{bioorg} was detected ($r = 0.85$). With the commonly used SIR method for the cold and subarctic soils, the microorganisms are probably not able to use the applied glucose as substrate within the methodological time limit of 6 hours, because the microbes are not adapted to the high temperatures in the laboratory. If so, the commonly used procedure for the SIR method would be inappropriate for the investigated cold soils. The application of another substrate to glucose should be preferred, as Hüttmann (1999) has proposed for diesel-contaminated soils, and the incubation should be modified with a longer time period. However, in comparison to soils of temperate climates SIR- C_{mic} showed a significantly lower level of the microbial biomass. This was not found with the CFE- C_{mic} data. For this reason SIR- C_{mic} reflects reality in a better way than CFE- C_{mic} does. However, for the CFE- C_{mic} one has to keep in mind the possible extraction errors, which would induce the already discussed overestimation of the microbial biomass. In every case the results suggest that quantitative data are not available from either of the microbial biomass

Table 2. Microbial biomass carbon, microbial basal respiration and ecophysiological parameter of the investigated soils

	C_{bioorg}	Oil-C	CFE- C_{mic}	$\frac{C_{\text{mic}}}{C_{\text{bioorg}}}$	$\frac{C_{\text{mic}}}{\text{Oil-C}}$	SIR- C_{mic}	$\frac{C_{\text{mic}}}{C_{\text{bioorg}}}$	R_{mic}	$q\text{CO}_2$
Moist mineral soil (<i>Histic Cryaquept</i>) under ruderal grass vegetation with oil contamination									
1.1	30.4	46.5	1424	4.68	3.06	14.1	0.046	0.15	10.6
1.2	330.5	33.5	480	0.15	1.43	47.0	0.014	0.46	9.8
1.3	2.9	0.4	2	0.07	0.50	2.0	0.068	0.01	5.2
... without oil contamination									
2.1	47.4	0.9	327	0.69	36.3	13.1	0.027	0.06	4.6
2.2	392	1.8	1462	0.37	81.2	207.0	0.053	0.61	2.9
2.3	10.5	0.03	27	0.26	90.0	0.7	0.006	0.004	5.7
Peat soil (<i>Sphagnic Cryofibris</i>) without oil contamination									
3.1	496.7	2.8	231	0.05	8.25	7.8	0.002	0.11	14.1
3.2	489.1	4.3	340	0.07	7.91	10.7	0.002	0.16	14.9
Peat soil (<i>Sphagnic Cryofibris</i>) with oil contamination									
4.1	360.2	1.3	ND	NA	NA	19.7	0.005	0.17	8.6
4.2	436.6	3.1	1933	0.44	62.4	56.0	0.013	0.33	5.9
Moist mineral soil (<i>Histic Cryaquept</i>) under an open pine and birch forest with oil contamination									
5.0	345.5	3.8	2704	0.78	71.2	ND	ND	ND	ND
5.1	479.9	1.8	1536	0.32	85.3	103.8	0.022	0.40	3.9
5.2	96.6	0.1	182	0.19	182	6.9	0.007	0.08	11.6
5.3	15.0	0.03	33	0.22	110	0.8	0.005	0.03	3.8
... without oil contamination									
6.1	386.1	2.9	1587	0.41	54.7	103.2	0.027	0.53	5.1
6.2	3.9	0.1	11	0.28	11.0	0.5	0.013	0.003	5.6
6.3	2.9	0.02	7	0.24	35.0	0.3	0.010	0.002	6.1
P ^A	70.6	ND	1402	1.99	NA	ND	ND	ND	ND
C ^A	16.6	ND	168	1.14	NA	311	1.97	0.42	1.45
F ^A	177.0	ND	942	0.60	NA	ND	ND	ND	ND

^A P: pasture, C: cultivated land, F: forest, unpublished data from long-term control sites in North Germany

ND: not determined, not detectable; NA: not available

C_{bioorg} : soil derived and biogenic organic carbon (in mg g⁻¹ soil dry mass)

C_{mic} : microbial biomass carbon, CFE: chloroform fumigation extraction method, SIR: substrate-induced method (both in µg g⁻¹ soil dry mass), R_{mic} : basal respiration (µg CO₂-C g⁻¹ h⁻¹ g⁻¹ soil dry mass)

$q\text{CO}_2$: metabolic quotient: basal respiration/biomass carbon ($R_{\text{mic}}/\text{SIR}-C_{\text{mic}} \times 10^3$)

methods. Nevertheless similar maxima and minima confirm a comparable indicator tendency of both methods, e.g. the somewhat irregular reaction to the impact of crude oil on the soil.

The metabolic quotient ($q\text{CO}_2$) calculated from the ratio between the microbial basal respiration (R_{mic}) and SIR- C_{mic} was nearly always lower with decreasing oil impact. This would justify its application as a stress indicator (Anderson, 1994; Wardle & Ghani, 1995). In every case such a ratio

should have preference instead of using the directly measured and absolute data. The application of the C/N ratio in soil science, instead of using the pure C or N data is a comparable example (AG Boden, 1994). C and N contents in soils have only a limited geo-ecological value, but the C/N ratio is an important source of soil information with respect to the turn-over processes in soil (Beyer, 1998). In pasture soils the indication of the oil impact by using the $q\text{CO}_2$ was most striking (Table 2: soil 1 and 2).

Table 3. Selected enzyme activities of the investigated subpolar soils

	C _{bioorg}	Oil-C	DHA	β-GL	ARG	ARYL
Moist mineral soil (<i>Histic Cryaquept</i>) under ruderal grass vegetation with oil contamination						
1.1	30.4	46.5	313	4	1.1	7
1.2	330.5	33.5	412	18	2.6	ND
1.3	2.9	0.4	7	1	ND	5
... without oil contamination						
2.1	47.4	0.9	431	19	11.7	39
2.2	392	1.8	131	82	39.4	7
2.3	10.5	0.03	2	2	1.4	ND
Peat soil (<i>Sphagnic Cryofibris</i>) without oil contamination						
3.1	496.7	2.8	NA	14	11.0	2
3.2	489.1	4.3	NA	20	11.7	NA
Peat soil (<i>Sphagnic Cryofibris</i>) with oil contamination						
4.1	360.2	1.3	NA	49	11.6	NA
4.2	436.6	3.1	NA	17	9.5	NA
Moist mineral soil (<i>Histic Cryaquept</i>) under an open pine and birch forest with oil contamination						
5.0	345.5	3.8	522	96	63.2	226
5.1	479.9	1.8	195	50	40.8	7
5.2	96.6	0.1	132	18	1.8	35
5.3	15.0	0.03	6	3	3.1	3
... without oil contamination						
6.1	386.1	2.9	277	118	18	ND
6.2	3.9	0.1	51	2	0.9	4
6.3	2.9	0.02	<1	<1	3.4	3
Pasture ^A	70.6	ND	197	127	6.6	ND
Cultivated land ^A	16.6	ND	72	68	4.7	455
Forest ^A	177.0	ND	6	138	8.9	ND

^Aunpublished data from long-term control sites in North Germany

ND: not determined, not detectable; NA: not available

C_{bioorg}: soil derived and biogenic organic carbon in mg g⁻¹ soil dry mass (DM) DHA: dehydrogenase activity in µg TPF g⁻¹ soil dry mass, β-GL: β-glucosidase in µg saligenine g⁻¹ soil-DM, ARG: arginine ammonification in µg NH₄-N g⁻¹ soil-DM, ARYL: arylsulfatase in µg phenol g⁻¹ soil-DM

Nevertheless a far-reaching interpretation of qCO₂ should be avoided due to the extremely low level R_{mic} and SIR-C_{mic}, which might affect the mathematical calculation within the measurement errors (Alef, 1991, Schinner et al., 1996). In addition, the observed CFE data raise the question as to whether crude oil contamination really induces a stress situation for the microorganisms if oil in soil enhances the microbial biomass instead of restricting it (Table 2).

For the enzyme activities we found similar disappointing results as for the biomass estimations. Dehydrogenase (DHA) and arylsulfatase activities (ARYL) were not suitable for the investigations of

peat soils due to the brown color of the extract which derived from the humic compounds (Alef, 1991). This was also found for deposits in brown coal mining areas (Kolk et al., 1996). Obviously this effect was not induced directly from the crude oil as the data from the mineral soils suggest. The DHA reacts positively on oil as the comparison between the samples 5.1 and 6.1 suggests: DHA was significantly higher with a low C_{bioorg} and a high oil content. This was also found for the soil samples 1.2 and 2.2. Negative impacts of oil on DHA were only observed with very high contents (e.g sample 1.1). In comparison with temperate soils the DHA was much higher. However the peat soils β-glucosidase

activity (β -GL) and arginine ammonification (ARG) were highly correlated to the C_{bioorg} , but not to the Oil-C. The absolute data of both enzymes are also not appropriate indicators for the assessment of soil microbiology damage by crude oil. Using β -GL relative to C_{bioorg} ($\beta\text{-GL}/C_{\text{bioorg}}$) a weak negative correlation was found ($r = -0.53$) with the Oil-C. Beyond this in the peat soils β -GL was highest with the lowest C_{bioorg} and simultaneously the lowest Oil-C. For the ARG nothing similar was found. Comparing soil 1 and 2 the oil-contaminated one showed the lowest values, whereas the opposite behaviour was observed for the soil pair 5 and 6. Due to the limited data source for the arylsulfatase activity (ARYL, not enough soil material) statements for the ARYL are of limited use. However, the data suggest that the reaction of the ARYL was similar to that of the DHA.

Conclusions

One biomass determination and some of the enzyme activities were enhanced with the occurrence of crude oil in soil, whereas others show the opposite pattern. Only with extremely high crude oil contaminations could we document a negative impact on these microbial indicators.

The CFE-biomass ($\text{CFE}-C_{\text{mic}}$), the dehydrogenase activity (DHA) as well as the arylsulfatase activity (ARYL) estimation are correlated positively with the crude oil content up to values which are much higher than any European remediation threshold value. Currently it is not possible to distinguish between the effect of Oil-C and soil-derived biogenic C on soil microbial parameters during the processes of remediation and recultivation. Beyond this the observed level of these microbial parameters in the cold tundra soils was similar to those known from temperate soils. Therefore $\text{CFE}-C_{\text{mic}}$, DHA and ARYL are not appropriate for the assessment of soil quality of oil-spilled soils in general and especially for the investigated subarctic tundra soils. To us it seems questionable to use these laboratory methods for the characterization of the microbial properties of the cold soils.

In contrast, the metabolic quotient ($q\text{CO}_2$) calculated from the microbial basal respiration (R_{mic}) and the SIR-biomass ($\text{SIR}-C_{\text{mic}}$) estimation is an appropriate indicator reflecting high oil contaminations in soil. The same was observed for the specific β -glucosidase activity ($\beta\text{-GL}/C_{\text{bioorg}}$), which is correlated negatively with the oil content. The indication of soil damage using the stress parameter $q\text{CO}_2$ (Beyer, 1998) or the specific

enzyme activities ($\text{activity}/C_{\text{bioorg}}$) (Tscherko et al., 2001) minimizes the impact of the native soil organic matter content on soil microbial properties.

Both tested biomass methods (SIR, CFE) may be influenced by methodological problems with their application to crude-oil contaminated and subarctic soils. The interpretation of the results may also be influenced by the soil material (mineral or organic materials), by degree of oil pollution, by the age of the contamination, the age of the oil products and by the method used itself.

Before any microbial investigation of cold tundra soils or other polar soils we urgently recommend testing the method for its suitability prior to any data collection in series. Our data suggest that not all the commonly used microbial parameters are appropriate for application in cold soils and/or oil contaminated soils. Beyond this the application of ecophysiological ratios between two microbial parameters or the specific enzyme activities should be given preference instead of using single parameters.

References

- Ad-hoc-Arbeitsgruppe. 1995. *Biologische Testmethoden für Böden*. DECHEMA-Fachgespräche Umweltschutz. DECHEMA, Frankfurt.
- AG Boden. 1994. *Bodenkundliche Kartieranleitung*. Schweizerbart, Stuttgart. 4. Auflage.
- Alef, K. 1991. *Methodenhandbuch Bodenmikrobiologie*. Ecomed, Landsberg.
- Anderson, T.-H. 1994. A community-level physiological approach for studying microbial communities. In: Ritz, K.; Dighton, J. and K. E. Giller (eds.). *Beyond the Biomass*. Wiley & Sons, Chichester. pp. 67-76.
- Beyer, L. 1998. Bodenorganismen. In: Blume et al. (Hrsg.). *Lehrbuch der Bodenkunde*. Enke, Stuttgart. S.70-81.
- Hüttmann, S. 1999. *Untersuchungen zur mikrobiellen Dynamik, Prozeßkontrolle und Beschleunigung des mikrobiellen Kohlenwasserstoffabbaus in mineralverunreinigten Bodenmaterialien mit dem Mietenwendeverfahren*. Schriftenreihe Institut für Pflanzenernährung und Bodenkunde der Universität zu Kiel Nr. 47.
- Huyke, W. 2001. Bewertung und Sanierung hochgradig rohölverschmutzter Böden in der Russischen Tundra am Arktischen Wendekreis. Unpublished diploma thesis, University of Kiel.
- Jørgensen, R. G., Schmaedeke, F., Windhorst, K. and B. Meyer 1995. Biomass and activity of

- microorganisms in a fuel oil contaminated soil. *Soil Biology and Biochemistry* 27, 1137-1143.
- Jones, J. B. 1991. *Kjeldahl Method for the Nitrogen (N) Determination*. Micro-Macro Publishing, Athens.
- Kolk, A. and R. F. Hüttl. 1996. Anwendung bodenmikrobiologischer Untersuchungsmethoden zur Charakterisierung der mikrobiellen Biomasse und ihrer Aktivitäten von tertiären, aschemelierten Kippensubstraten des Niederlausitzer Braunkohlereviere. *Mitteilungen der Deutschen Bodenkundlichen Gesellschaft* 81, 291-294.
- LAGA. 1997. Anforderungen an die stoffliche Verwertung von mineralischen Reststoffen/Abfällen. *Mitteilungen der Länderarbeitsgemeinschaft Abfall (LAGA)* 20, 1-96. Erich Schmidt Verlag, Berlin.
- Pankhurst, C. E.; Doube, B. M. and V. V. S. R. Gupta. 1998. *Biological Indicators of Soil Health*. CAB International, Wallingford.
- Schinner, F.; Öhlinger, R.; Kandeler, E. and R. Margesin. 1996. *Methods in Soil Biology*. Springer, Berlin.
- Schlichting, E.; Blume, H.-P. and K. Stahr. 1995. *Bodenkundliches Praktikum*. Blackwell, Berlin.
- Schmidt, N. 1999. Mikrobiologische Eigenschaften und Habitate in Permafrostböden der Taimyr Halbinsel, Mittelsibirien. *Berichte zur Polarforschung* 340, 1-183.
- Soil Survey Staff. 1998. *Keys to Soil Taxonomy*. USDA-NRCS, Washington. 8th edition.
- Tabatabai, M. A. and J. M. Bremner. 1970. Arylsulfatase activity in soils. *Soil Science Society America Journal* 34, 225-229.
- Thalman, A. 1968. Zur Methodik der Bestimmung der Dehydrogenaseaktivität im Boden mittels Triphenyltetrazoliumchlorid (TTC). *Landwirtschaftliche Forschung* 21, 249-258.
- Tscherko, D., Kandeler, E., Beyer, L., Bölter, M.; Blume, H.-P. and J. Chen 2001. Microbial biomass and enzyme activity of soil transects in the Maritime Antarctica (King-George-Island, West Antarctica). *Antarctic Science* (in press).
- Vance, E. D., Brookes, P. C. and D. S. Jenkinson. 1987. An extraction method for measuring soil microbial biomass C. *Soil Biology and Biochemistry* 19, 703-707.
- Wardle, D. A. and A. Ghani. 1995. A critique of the microbial metabolic quotient (qCO_2) as a bioindicator of disturbance and ecosystem development. *Soil Biology and Biochemistry* 27, 1601-1610.

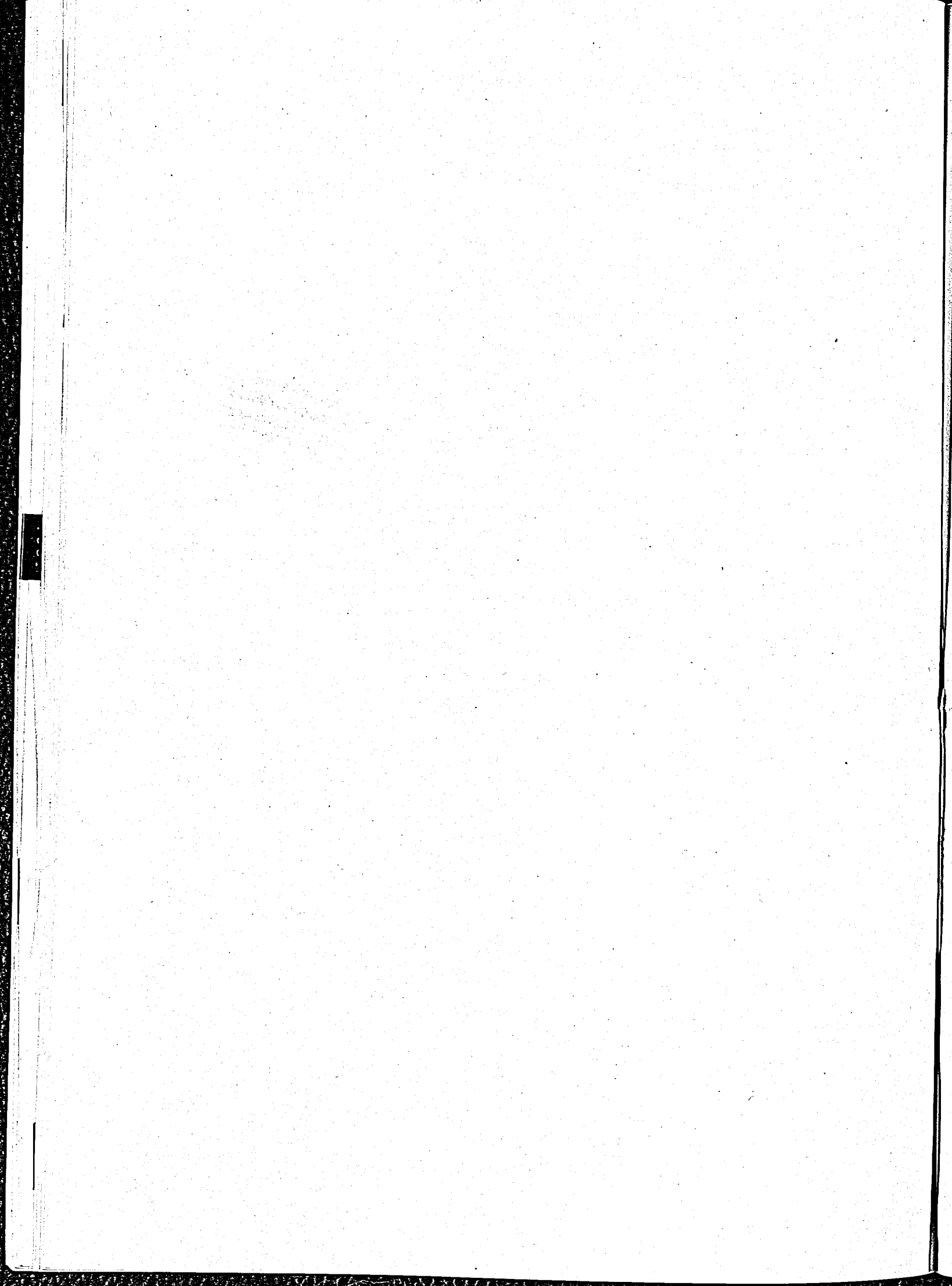

Could microorganisms in permafrost hold the secret of immortality? What does this mean?

Anatoli Brouchkov¹ and Peter J. Williams²

¹Geocryology Laboratory, Institute of Environmental Geoscience, Russian Academy of Sciences, Moscow. E-mail: brouchkov@hotmail.com ; *presently*: anatoli@nenp.hokudai.ac.jp

²Geotechnical Science Laboratories
Carleton University, Ottawa. E-mail: pjw1005@magma.ca

ABSTRACT. For more than a century there have been reports of living organisms in permafrost, some of which are claimed to be millions of years old. Interest in organisms surviving in extreme environments (extremophiles) has been stimulated recently by reliable evidence of bacterial growth in many quite different and unexpected situations. Such bacteria can have an abnormal longevity. This paper examines frozen ground as an environment for microorganisms and a comparison is made with the characteristics of those living in other extreme environments. It seems certain that some species of bacteria survive in permafrost for long periods of time - far in excess of their 'normal' life span. The characteristics of 'permafrost' bacteria are such that they present opportunities for biotechnical engineering of species so as to increase their effectivity in bioremediation of contaminated ground in cold regions.

Contents

Introduction	49
Importance of sampling techniques	50
Relationship with the unfrozen water: no way in and no way out?	50
Microorganisms in permafrost: are they really living?	50
Relationship with unfrozen water: can the microorganisms divide?	52
Thousands of years of life?	53
Conclusions	54
References	54

Introduction

Extremophiles are organisms which live in apparently quite unsuitable environments (Horikoshi and Grant, 1998). Ashcroft (1999) in her wide-ranging discussion of physiological adaptation to extreme circumstances, considers, in addition to human beings, organisms that live at great depths in Antarctic glaciers and others that live deep in the high temperatures and pressures of the Earth's crust. Parkes (2000) reviews convincing cases of bacteria in diverse environments which have remained viable over inordinate lengths of time.

Living (or at least viable) bacteria apparently occur deep in solid-frozen ground (permafrost) in the cold regions (see the review by Gilichinsky and Wagener, 1995) and these appear to be living 'fossils'. Some 'come to life' and reproduce in the laboratory. Apparently isolated from the world as we know it, for perhaps millions of years, they might be regarded as a threat, perhaps of past diseases or plagues which they might carry. But the many people who have unwittingly handled

permafrost samples through the years do not seem to have suffered. On the other hand such bacteria may give clues to the very origin of life in holding the secret, if not of eternal life, at least of delaying mortality.

Fredrickson and Onstott (1996) review the many questions raised by evidence of living microorganisms deep in the earth's crust, notably where temperatures are high and water scarce. Kushner (1978) reviewed bacterial activity at temperatures near and below freezing point. In this paper, we consider the conditions that occur tens or hundreds of metres down in the frozen layers of the earth - the permafrost. Rather than reexamining the individual cases reported (a few of which are from a century ago) cited by Gilichinsky and Wagener, we consider present-day knowledge of frozen ground as an environment and its implications for the physiology of psychrophile (cold-loving) bacteria and other organisms. For example, are living bacteria as old as the permafrost itself or can contamination with more recent bacteria have occurred? Do the bacteria reproduce in the permafrost? Where in the microstructure of frozen ground are the bacteria actually located? And to what extent are 'normal' metabolic processes taking place? - or are they inactive and cryopreserved?

Answers to such questions are important. The survival of DNA in organisms over hundreds of thousands of years has great significance in studies of evolution (Tiedje, 2001). Perhaps the possibility of survival of pestilential organisms in old burial sites should not be too lightly dismissed. Conditions on Mars are such that the recent evidence of moist, frozen soils there (Kargel and Strom, 1992), suggests these are the most likely, perhaps only, situation where life could exist on that planet in a

form similar to that on Earth.

Recently attention has been drawn to gas (methane) hydrates in permafrost that spread through the pores and appear to be of a biogenic origin distinct from that of currently-extracted major gas deposits lying at greater depths (Yakushev and Chuvilin, 2000). Understanding the microbiology of permafrost also has more immediate practical implications, in developing bioremediation procedures where bacterial activity is used to overcome contamination in freezing ground.

Importance of sampling techniques

Techniques for sampling in permafrost for microbiological studies (Vishnivetskaya et al. 2000) are not well-established. The requirement is for biological cleanliness and absolute avoidance of contamination while the sample is brought to the surface and subsequently. Proper procedures are expensive and time-consuming. S.S. Abysov (Abysov et al. 1979., Abysov et al., 1982), of Russia's Institute of Microbiology, and specialists at the St. Petersburg Mining Institute developed the technique for drilling ice cores without contaminating the samples, used at the Vostok Station in the Antarctic since 1974. It involves taking liquid samples from the melting interior of the drill cores.

Because frozen soils are not always able to flow on thawing, our (AB's) suggestion was to penetrate a drilled sample (1, in fig. 1) with another sterilized pipe (2, fig.1). This procedure was used recently (1999-2000) for investigating permafrost on the Kara Sea coast. The pipe (2, fig.1) is sealed with hot plastic prepared in aseptic conditions, and the frozen soil transported to the laboratory. Samples from 3 to 4 metres depth in permafrost, at a temperature of about -4°C , were taken to the Institute of Microbiology for examination. Fig 2 shows micrographs of bacteria found in the samples. The viability of these bacteria has not yet been established and in any case, only a few of the individuals present are likely to be viable (Fredrickson and Onstott, 1996). Their state of preservation is noteworthy (and typical) in that the sediments are believed to have been frozen for at least 10,000 years.

Relationship with the unfrozen water: no way in and no way out?

An important characteristic of permafrost is that some water, held tightly onto the surfaces of mineral particles by electrochemical forces, or under the influence of capillary forces, occurs in even hard-frozen permafrost (Williams and Smith 1991). The

thin liquid layers provide a route for water flow, which is normally from the warmer to the colder parts (Derjaguin and Churaev, 1986). The water may carry solutes and small particles and thus perhaps, bacteria, but its movement is extremely

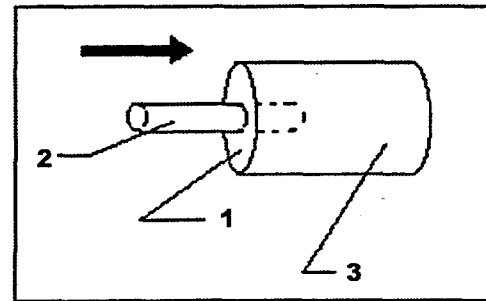

Fig. 1. Diagram of device for taking sample from interior of frozen core.

slow (Burt and Williams, 1976). The equation for the water transfer is well-known:

$$\frac{\partial W_{uf}}{\partial t} = a \frac{\partial^2 W_{uf}}{\partial x^2} \quad (1)$$

Where W_{uf} – unfrozen water content, t – time, sec, x – coordinate, cm; and a – diffusion coefficient, which has a value of about $10^{-7} \text{ cm}^2 \text{ s}^{-1}$ (Foundations of Geocryology, 1995; Brouchkov, 1998). At a few degrees below $^{\circ}\text{C}$ it may thus take thousands of years to move a metre. A bacterium of greater size than the thickness of the water layer is likely to move much more slowly than the water. The microorganisms are about 0.3 to 1.4 microns in size, while the thickness of the water films is usually less. It depends on particle size, mineral composition and decreases sharply with temperature, to less than 1 micron by about -0.5°C .

One concludes that microorganisms in permafrost have been isolated, certainly from the ground surface, trapped among the mineral particles and ice, for many orders of magnitude longer than a normal lifespan and maybe millions of years. The longest, *continuously* frozen permafrost is variously estimated as between one and three million years old.

Microorganisms in permafrost: are they really living?

Abysov's investigations at the Vostok station (Abysov et al. 1979; Abysov et al. 1982) revealed bacteria, fungi, diatoms and other microorganisms which were probably carried to Antarctica by winds. The ages of these individuals could be more than half a million years. Bacteria have been found 3,600

Fig. 2. Micrographs showing bacteria found in samples from 3 m depth in permafrost in marine sediments on the Kara Sea coast. The sediments are believed to have been frozen continuously over at least the last 10,000 years.

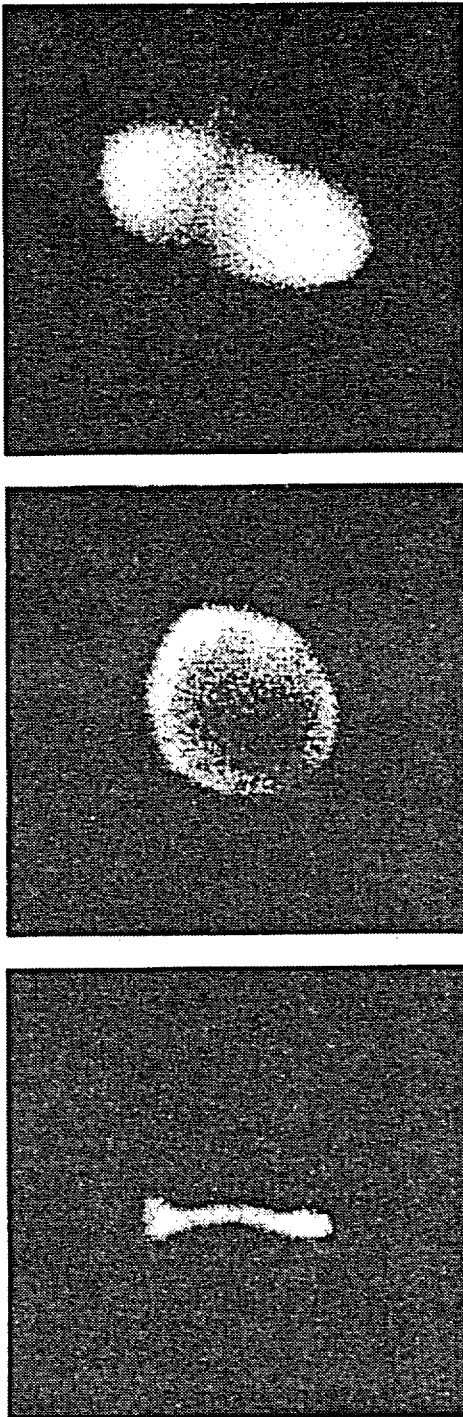

metres deep beneath the Antarctic ice sheet, just above the sub-glacial Lake Vostok. Organisms within the lake itself are presumably living and reproducing in the normal way, and may have done so since the lake was isolated. However, ice which was hundreds of thousands of years old and at a depth which could not have been contaminated from the surface or from below in recent time, was thought by Abyzov et al. (1982) to contain viable bacteria.

Freezing temperatures in themselves certainly do not preclude bacterial growth. Forster (1887) first established that bacteria grow at 0°C . Although most microorganisms do not grow at temperatures below 0°C (Foter and Rahn, 1936), certain bacteria and fungi can be physiologically active and Friedman (1994) and Rivkina et al. (2000) note metabolic activity in permafrost bacteria at -20°C . Hubbard et al. (1968) also reported a living bacterial population in cold Antarctic permafrost. Others reporting evidence concerning bacterial activity in soils below 0°C , include Flanagan and Veum (1974); Bunt and Lee (1970); Kalinina, Holt and McGrath (1994); and Clein and Schimel (1995).

Water is the solvent for the molecules of life, and availability of water is a critical factor affecting the growth of all cells. But the particular water which is unfrozen in permafrost, although at less than 0°C and in the presence of ice, differs from 'ordinary' water. It has a modified energy content, or potential, being similar in this respect to the last water in a drying soil. Being 'bound' to the soil mineral particle surfaces it is not available to plants, which commonly wilt when the soil moisture content falls below a critical amount.

Many plants in cold regions have xerophytic characteristics (adapted to dry conditions) presumably because they are repeatedly exposed to the frozen condition of low water content around their roots. The thin layer of 'bound' water on the soil particles, in fact, tends to pull water to itself. This is also the cause of frost heave of the soil, with accumulation of water as 'excess' ice (Williams and Smith, 1991). But some organisms, including, presumably, those in the permafrost, can mount a counter attractive force so as to resist being desiccated in this way. Thus certain fungi are able to take in water even when this has a potential (cryosuction) of -7 MPa (Bruehl et al., 1972). Nevertheless, while it is certain that bacteria survive in freezing soils at temperatures several degrees below 0°C , it remains hard to believe that organisms could survive a water potential of -36 MPa which is that predicted for water in a soil at -3°C (Williams and Smith, 1991). Perhaps the unfrozen water in the

frozen soil is not entirely analogous to that in the dry soil.

Interestingly, from a thermodynamic point of view, the potential of water is changed in an analogous manner by the presence of dissolved salts. The freezing point falls below 0°C, increasingly so as the concentration of salts increases. The recent discovery of bacteria living in salt deposits and also apparently of enormous age (Vreeland et al. 2000) raises scientific questions similar to those discussed in this paper. How do the halophytic bacteria resist the osmotic forces (similar in magnitude to the forces induced by freezing) which would be expected to extract almost all the water from the cells?

When soils are at -2 or -3°C, the remaining water is in layers so thin that a bacterium could not be fitted in. The microorganism may be partly frozen in the ice, or perhaps somehow makes room for itself. Added to this problem is that the small quantities of water themselves become an increasingly strong osmotic solution. The concentration of dissolved salts in most soils is small but, since solutes are expelled from ice on freezing, the small fraction of liquid water remaining can assume a strong concentration (Williams, et al. 1998). Thus some permafrost bacteria may have even more in common with the salt deposit bacteria. Most bacterial species, of course, would be killed by the high salt concentrations in the water layers in the freezing soils.

The ability of microorganisms to live under freezing conditions depends on the presence of liquid water but it must also be available water. If the cell becomes dehydrated, there is a lack of water for chemical reactions, the effect of the lack of water on protein structure, and shrinking of the plasma membrane occurs with collapse of the transport system.

Yeasts and moulds are capable of growing at temperatures much lower than those required for bacterial growth. Adaptation to growth, or at least survival, at low temperatures has been extensively studied in the Antarctic sea-ice, where a range of flagellates have been observed, which grow at around -2°C. Water inside cells in *Mytilus edulis* and *Littorina rudis* does not freeze at -20°C (Kanwisher, 1955). There is an active bacterial life in frozen Antarctic saline lakes at temperature as low as -48°C according to Meyer et al. (1962).

So-called organic cryoprotectors are complex mechanisms protecting cells from ice crystallization. Some organisms are able to live for years in a supercooled state (DeVries, 1982). Supercooling is a thermodynamically unstable (and

temporary) state, in which the temperature has fallen below the freezing point without freezing occurring; it is quite distinct from the unfrozen water with the reduced potential described above. When freezing of supercooled water does occur, rather large and disruptive ice crystals form suddenly. It seems unlikely that the water present in bacteria could remain in the supercooled state over such long periods of time as in the permafrost and any such abrupt freezing would probably be fatal.

Denaturation of protein can occur under freezing conditions. Psychrophilic bacteria are adapted to their cold environment by having unsaturated fatty acids in their plasma membranes. Some psychrophiles have been found to contain polyunsaturated fatty acids, which generally do not occur in prokaryotes (the group of organisms, including bacteria, which do not have a membrane around the cell nucleus). Some microorganisms when frozen, may go into an anabiotic state becoming inactive. Human sperm are routinely frozen yet retain their viability, although it is not known for how long they can do so.

Thus today, there is much and varied evidence in favour of the survival of microorganisms in ice and frozen ground. But are the individuals that have been found themselves of enormous age, or are they descendants of innumerable generations?

Relationship with unfrozen water: can the microorganisms divide?

The adaptive responses to low temperature are poorly characterized for microorganisms. Metabolic activity and especially the ability of microorganisms to divide is greatly limited in the conditions of the environment within the permafrost. For example, the bacteria *Pseudomonas* grow about ten thousand times slower at -2°C than at 26°C, but they do still grow (Harder, Veldkamp, 1971). It was shown that many microorganisms cease growing near 0°C (Foter and Rahn, 1936).

There are many conditions that can affect cell division (Green et al., 1989). These conditions include the availability of water, nutrients, salt concentration, pH, and temperature, and they are associated with enzyme function, protein stability, and plasma membrane integrity.

In spite of evidence of their activity, it remains unclear whether the microorganisms can divide in the frozen soil. The single bacterial cell is trapped and not even free to move or expand within the unfrozen water layer. Where could its offspring possibly go? At any rate they could not be produced at even a minute fraction of the rate associated with bacteria at above-freezing temperatures.

Probably some microorganisms divide if only because of the significant degree of microbial activity at temperatures below 0°C. But for the most part it appears unlikely. In any case, the microorganisms in permafrost are on the very edge of survival, and their ability to get enough water for division from thin layers of unfrozen water is uncertain. Accordingly this means that some live (without subdivision), if not forever (since accidents could befall them), at least for extraordinarily long times.

Thousands of years of life?

Moss remains alive yet dormant while frozen for 40,000 years in the permafrost of the Kolyma Lowlands of northeastern Siberia according to Gilichinsky (1994). It is established that organisms resume metabolic activity upon thawing after being frozen for tens of thousands and maybe millions of years. The seeds of *Lupinus arcticus* found in permafrost 15,000 years old are able to grow (Gilichinsky, 1994), as well as microorganisms from Antarctic ice aged 10,000-13,000 years (Abyzov et al., 1979). According to Gilichinsky there are three types of life-forms found in permafrost: active ones that eke out a living in thin water layers between grains of soil and ice, viable but inactive forms that are frozen in suspended animation, and the frozen carcasses of microbes that gave up.

If microorganisms in permafrost occur that are alive but not able to divide, what mechanism keeps them alive? First, protein and DNA stability must be considered (Dean, 1978). The proteins of cells are frequently not stable; many proteins and enzymes have an extremely short (in minutes) period of life. At the same time, studies of spontaneous thermal disintegration of some enzymes have shown that maximum half-disintegration period is about 12,000 days (Segal et al., 1969). But that is orders of magnitude less than the survival times we seek to explain.

Decreasing water content inside a cell causes transfer to anabiosis, a condition in which it is believed (from experiments) that organisms may have no chemical and biological activity (Hinton, 1968; Clegg, 1973; Goldovsky, 1986). On the other hand, cell structures in anabiosis would be affected by temperature changes, radiation, and pressure. The cytoplasm of a cell is not completely frozen, very likely it is not frozen at all at the temperatures of -2 to -5°C commonly found in permafrost. In anabiosis the cytoplasm is not in a state of thermodynamic equilibrium. So tissue is probably slowly destroying itself even inside permafrost. There is also a spontaneous thermal disintegration

because the temperature is far from absolute zero. It must also be remembered that freezing soils, themselves, are rarely in a state of equilibrium. Virtually always there are gradients of temperature and potential, such that there is usually a very slow translocation of ice and water underway. Over a 'geological' time scale the microstructure of the materials of the permafrost and the distribution of ice goes through continuous modifications (Williams, 1988) because it is very close to its melting point.

The molecular basis of thermal stability of biological materials is a significant, as yet unsolved, problem (Baker and Agard, 1994; Jaenicke et al., 1996). In general, the stability of a protein is defined as the free energy change, G , for the reaction folded-unfolded under physiological conditions. Most proteins are characterized by values of $G = 5-15$ kcal mol⁻¹. In terms of thermodynamics, the fraction of residues in random coil regions divided by the fraction of residues in ordered regions (k) would appear as the following:

$$k = \exp(-G/RT) \quad (2)$$

where G is the free energy change for the thermal transition of one residue from an ordered region to a random coil one, kcal mol⁻¹; T - temperature, °K; R - gas constant, ~0.001989 kcal mol⁻¹ °K⁻¹.

Another similar expression (Regel et al., 1974) could probably be written for an approximate estimation of time of existence t_e of proteins:

$$t_e = t^* \cdot \exp(G/RT) \quad (3)$$

where t^* - period of temperature fluctuations of molecules, normally about 10⁻¹² - 10⁻¹³ s. Calculations on the basis of (3) show that even for $G=30$ kcal mol⁻¹ the time of existence of molecular connections is less than 300 years. Also for the period of temperature fluctuations of molecules 10⁻⁸ - 10⁻⁹ sec and $G=20$ kcal mol⁻¹ the time of existence of molecular connections is less than one year. Maximal value of energy of activation described is about 45 kcal mol⁻¹; normally it is much less (Alexandrov, 1975). These calculations are very approximate and extreme, but they do show how unstable proteins and DNA are. Small, but specific changes of temperature, unpredictable influence of radiation, chemical reactions in the permafrost environment and unfrozen solution in the cell are certainly other processes leading to destruction of biological material.

Thus, live microorganisms in permafrost apparently have special mechanisms of repair of cell structures otherwise prone to collapse because of the

huge duration of their existence. In this case, they should have special structural and biochemical features which are different from other microorganisms as we know them and which have a life expectancy many orders of magnitude less. They might have something like the smaller chromosome and two DNA rings found recently by specialists at the Institute for Genomic Research (Battista et al., 1999) in *Deinococcus radiodurans*, which can survive a dose of radiation 3,000 times greater than that needed to kill a human being.

Conclusions

Frozen soils contain bacteria which reproduce on the thawing of the material around them. For those found at depth, among mineral particles and ice, it seems impossible that they have originated at the surface of the ground in recent time and then migrated down to where they were found. It is also difficult for these organisms to reproduce while in the permafrost - at least they could do so only rarely and possibly at great intervals of time.

Thus, the living microorganisms in permafrost, in common with other extremophiles, apparently have special mechanisms of repair of cell structures, necessary for their survival. They may have the key to a life lasting for thousands of years. A life, that is, which could be terminated by an external event, but not by internal failure of the organism. Comparison of the structure, genetic apparatus, and biochemical features of permafrost's microorganisms to those of 'normal' microorganisms as we know them, could reveal this mechanism.

Understanding these permafrost organisms and their relationship to their cold environment has immediate practical implications. The fact that very old, viable bacteria occurring at depth in permafrost can be prompted to reproduce, presents imaginative possibilities, for example for the decontamination of buried contaminants. At the very least, in applying microbiological techniques to the expensive problems of cold regions decontamination, we should be exploring the extraordinary nature of these permafrost organisms and the possibilities they present for application of biotechnological procedures.

Acknowledgments

The authors express their appreciation of personal discussions with S.S. Abyzov (Russian Academy of Sciences) and his colleagues, to David Gilichinsky, Russian Academy of Sciences, and to James M. Tiedje, Michigan State University. We alone take

responsibility for endeavouring to relate their expertise to the problems of contamination of freezing soils.

References

- Abyzov, S.S., N.E. Bobin, and B.B. Kudrashov. 1979. Microbiological studies of the glacier of Central Antarctic. *Bulletin of Russian Acad. Sciences. Biological Instalment* 6: 828-836.
- Abyzov, S.S., V.Y. Lipenkov, N.E. Bobin, and B.B. Kudrashov. 1982. Microflora of the glacier of Central Antarctic and methods of control of sterile sampling of ice core for microbiological studies. *Bulletin of Russian Acad. of Sciences. Biological installment* 4: 537-548. (In Russian).
- Alexandrov, V.Ya. 1975. *Cells, Macromolecules and Temperature*. Leningrad. Nauka. (In Russian).
- Ashcroft, Frances. 1999. *Life at the Extremes*. Harper Collins. 326pp.
- Baker, D., and D. Agard. 1994. Kinetics versus thermodynamics in protein folding. *Biochemistry* 33: 750509.
- Battista, J.R., A.M. Earl, and M-J. Park. 1999. Why is *Deinococcus radiodurans* so resistant to ionizing radiation? *Trends Microbiol.* 7: 362-365.
- Brouchkov, A. 1998. *Frozen Saline Soils of the Arctic coast. Their Origin and Properties*. Moscow. Moscow University Press. (In Russian).
- Bruehl, G.W., B. Cunfer, and M. Toivinanen. 1972. Influence of water potential on growth, antibiotic production, and survival of *Cephalosporium gramineum*, *Can. J. Plant Sci.* 52: 417-423.
- Bunt, J.S., and C.C. Lee. 1970. Seasonal primary production in Antarctic sea ice at McMurdo Sound in 1967. *J. Mar. Res.* 28: 304-320.
- Burt, T.P. and P.J. Williams. 1976. Hydraulic conductivity in frozen soils. *Earth Surface Processes* 1, (3): 349-60.
- Clegg, J.S. 1973. Do dried cryptobioties have a metabolism? In: *Anhydrobiosis*. Stroudsburg: Dowdon et al., pp. 141-146.
- Clein, J.S., and J.P. Schimel. 1995. Microbial activity of tundra and taiga soils at sub-zero temperatures. *Soil Biol. Biochem* 27: 1231-1234.
- Dean, R.T. 1978. *Cellular Degradative Processes*. A Halsted Press Book. John Wiley and Sons, New York.
- Derjaguin, B.V., and N.V. Churaev. 1986. Flow of

- nonfreezing water interlayers and frost heaving. *Cold Regions Science and Technology* 12:57-66.
- DeVries, A.L. 1982. Biological antifreeze in coldwater fishes. *Comp. Biochem. Physiol.* 73A:627-640.
- Flanagan, P.W., and A.K. Veum. 1974. Relationships between respiration, weight loss, temperature and moisture in organic residues on tundra. In: *Soil Organisms and Decomposition in Tundra* (Eds A.J.Holding, O.M.Heal, S.F.Maclean, Jr. and P.W.Flanagan), pp. 249-277, Swedish IBP Committee, Stockholm.
- Forster, J. 1887. Ueber einige Eigenschaften leuchtender Bakterien, *Zentr. Bacteriol. Parasitenk. Infekt. Hyg.* 2:337-340.
- Foter, M.J., and O. Rahn. 1936. Growth and fermentation of bacteria near their minimum temperature. *J. Bacterio.* 32:485-499.
- Fredrickson, J.K., and T.C. Onstott. 1996. Microbes deep inside the earth. *Scientific American*, 275:68-73.
- Friedmann, E. I. 1994. Permafrost as microbial habitat. In: D. A. Gilichinsky (ed.): *Viable Microorganisms in Permafrost*. Russian Academy of Sciences, Pushchino, Russia, pp. 21-26.
- Gilichinsky, D., ed. 1994. *Viable Microorganisms in Permafrost*. Russian Academy of Sciences. Pushchino Scientific Center, 115 p. WDC No. 95000398. CRREL No. 49003822.
- Gilichinsky, D., and S. Wagener. 1995. Microbial Life in Permafrost: A Historical Review. *Permafrost and Periglacial Processes* 6:243-250.
- Goldovsky, A.M. 1986. *Anabiosis and its Practical Significance*. Leningrad. Nauka. (in Russian).
- Green, N.P.O., G.W. Stout, and D.J. Taylor. 1989. *Biological Science*. Cambridge University Press. Ed. R.Soper.
- Harder, W., and H. Veldkamp. 1971. *Competition of Marine Psychrophilic Bacteria at Low Temperatures*. Antonie van Leeuwenhoek 37:51-63.
- Hinton, H.E. 1968. Reversible suspension of metabolism and the origin of life. *Proc. Roy. Soc. Ser. B* 171:43-56.
- Horikoshi, K., and W.D. Grant (Eds.). 1998. *Extremophiles. Microbial Life in Extreme Environments*. Wiley-Liss. 322 pp.
- Hubbard, J.S., R.E. Cameron, and A.V. Miller. 1968. Soil studies - desert microflora. XV. Analysis of Antarctic dry valley soils by cultural and radiorespirometric methods, *Space Prog. Summary No. 37-52*, 3, pp. 172-175.
- Jaenicke, R. 1996. Stability and Folding of Ultrastable Proteins: Eye Lens Crystallins and Enzymes from Thermophiles. *FASEB J.* 10:84-92.
- Kalinina, L.V., J.G. Holt, and J.J. McGrath. 1994. Identity of bacterial from Siberian permafrost soils. In *IUMS Congresses '94*; 7th International Congress of Bacteriology and Applied Microbiology Division; 7th International Congress of Mycology Division, Prague, Czech Republic, July 3-8, 1994.
- Kanwisher, J. 1955. Freezing in intertidal animals. *Biol. Bull.* 109:56-63.
- Kargel, J.S., and R.G. Strom. 1992. The Ice Ages of Mars. *Astronom.* 20, (12):40-45.
- Kushner, D.J. (Ed.) 1978. *Microbial Life in Extreme Environments*. 465 pp.
- Meyer, G.H., M.B. Morrow, O. Wyss, S.E. Berg, and J.L. Littlepage, J.L. 1962. *Science* 138, (3545):1103-1104.
- Morita, R.Y. 1975. Psychrophilic bacteria. *Bacteriol. Rev.* 39:144-167.
- Parkes, R.J. 2000. A case of bacterial immortality? *Nature* 407:844-855.
- Regel, V.R., A.I. Slutsker, and E.E. Tomashevsky. 1974. *Kinetic Nature of Strength of the Solid Materials*. Nauka, Moscow. (In Russian) 560pp.
- Rivkina E.M., E.I. Friedman, C.P. McKay, and D.A. Gilichinsky. 2000. Metabolic activity of permafrost bacteria below the freezing point. *Appl. and Environmental Microbiology.* 66, 8:3230-3233.
- Segal, H.L., T. Matsuzawa, M. Haider and G.J. Abraham. 1969. *Biochem. Biophys. Res. Commun.* 36, 5:764-770.
- Shi, T., R. H. Reeves, D. A. Gilichinsky, and E. I. Friedmann. 1997. Characterization of viable bacteria from Siberian permafrost by 16S rDNA sequencing. *Microbial Ecology* 33:169-179.
- Tiedje J.M., T. Vishnivetskaya, M. Pnder, J. Urbance, S. Kathariou, J. McGrath, and D. Gilichinsky. 2001. Phylogenetic and phenotypic analysis of microorganisms recovered from ancient Siberian permafrost. *Abstracts, Int. Conf. Conservation and Transformation of Matter and Energy in the Earth Cryosphere*. Puschino, Russian Acad. Sci., Consolidated Scientific Council on Earth Cryology. 21-22.

- Vreeland, R.H., W.D. Rosenzweig, and W.W. Powers. 2000. Isolation of a 250 million-year-old halotolerant bacterium from a primary salt crystal. *Nature* 407: 897-900.
- Vishnivetskaya T., S. Katharion, J. McGrath, D. Gilichinsky, and J.M. Tiedje. 2000. Low temperature recovery strategies for the isolation of bacteria from ancient permafrost sediments. *Extremophiles* 4: 165-173
- Williams, P.J. 1988. Thermodynamic and mechanical conditions within frozen soils and their effects. *Proc. 5th. Intern. Conf. Permafrost* 1: 700-705.
- Williams, P.J. and M.W. Smith. 1991. *The Frozen Earth*. Cambridge University Press. pp. 306
- Williams, P.J, T.L. White and J.K. Torrance. 1998. The significance of soil freezing for stress corrosion cracking. *Int. Pipeline Conf. Calgary*. Amer. Soc. Mech. Engineers. Book Number G1075A, 1:473-478
- Yakushev V.S., and E.M. Chuvilin. 2000. Natural gas and hydrate accumulations within permafrost in Russia. *Cold Regions Science and Technology* 31:189-197
- Yershov, E.D.(ed.). 1995. *Foundations of geocryology*. Volume 1. Physico-chemical foundations of geocryology. Moscow University Press. (In Russian).

POSTERS

The following abstracts refer to posters displayed at the Conference.

Potential changes of environmental contamination in permafrost regions caused by the anthropogenic global warming

O.A. Anisimov

State Hydrological Institute, 2-nd Line V.O., 23, St.Petersburg, 199053, Russia

Accidental hydrocarbon spills from pipelines may be caused by landslides or uneven settlement of pile foundations. Stability of slopes and bearing capacity of the foundations decrease with permafrost temperature rise, thus, the anthropogenic global warming may enhance the potential contamination in the Arctic.

Scenarios of climate change derived from general circulation models predict approximately 1°C increase of the global-mean air temperature by the middle of the 21st century, with much greater increase (2-3°C) over the high latitudes. Permafrost models may be used to evaluate the effects of climate change on the ground surface temperature and the depth of seasonal thawing. Results of calculations suggest 1.5 - 2.5°C temperature increase and 30%-50% increase of seasonal thaw depth in the next 50 years. Such changes will enhance the landslide activity and may cause 30% to 60% loss of the bearing capacity of permafrost, which can exceed the safety factor incorporated in the design of existing constructions and provoke abrupt hydrocarbon spills from the pipelines.

A hazard index was constructed using data on the seasonal thaw depth, ground temperature and ice content, to regionalize the permafrost with respect to potential contamination caused by instability of pile foundations and slopes. Maps, calculated for the conditions of the future climate, show that the pipelines in West Siberian oil and gas fields located in the ice-rich permafrost, are of particular concern. The Trans-Alaska pipeline spans two areas of high hazard potential, and special efforts are needed to prevent pipeline destruction caused by warmer climate.

COLDREM - soil remediation in a cold climate: a national Swedish research program

Bo Mattiasson, program director COLDREM. Email:

bo.mattiasson@biotek.lu.se

Ingegerd Ask, technology coordinator COLDREM. Email:

ingegerd.ask@biotek.lu.se

Dept. of Biotechnology, Lund University

P.O. Box 124, S-221 00 Lund, Sweden

In order to develop and evaluate new cost-efficient methods for remediation of soil and groundwater in the Nordic countries, the interdisciplinary soil remediation research program COLDREM was launched with the support of the Foundation for Strategic Environmental Research (MISTRA). The research is organized around two target sites, an old gasworks site in Stockholm and a chlor-alkali site outside of Gothenburg. Both sites are heavily polluted with organic compounds and heavy metals.

One limiting factor in the soil will be oxygen. A different approach is to supply the alternative electron acceptor Fe^{3+} . This was done by adding chelating substances, assuming that the iron present in the soil was sufficient but needed to be mobilized. The approach is developed in laboratory experiments concomitantly with pilot scale studies at the gasworks site. It may be possible to mobilize organic compounds by '*in situ* soil wash'. This is achieved by pumping water through the soil volume. By this operation, a contaminated aqueous stream is generated which can be treated in high cell density reactors. In an *ex situ* slurry experiment, soil from the old gasworks site, contaminated mainly with PAHs, is treated in laboratory-scale bioslurry reactors. Together with the addition of detergent the use of vegetable oil will be studied.

Psychrophiles/psychrotrophs play an important role in environmental biotechnology since cold-adapted microorganisms have the ability to be catalytically efficient at low temperatures. Monitoring of the indigenous micro-flora is a key issue for optimization and prediction of bioremediation processes *in situ*. Changes in the microbial flora in PAH-contaminated soil during remediation, or in a bioreactor during treatment of PAHs are studied by means of analyzing the genetic material that can be extracted.

From the chlor-alkali site, which contains high concentrations of heavy metals, soil fungi were isolated and stressed with mercury to assess the complexing capacity and selectivity of produced metabolites. To test physico-chemical methods as a remediation process, the contaminated soil will undergo experiments in comparison to a model system contaminated with mercury as well as a mixture of heavy metals, using electroreclamation.

There is a number of supporting methods within COLDREM where co-operation between projects is performed and further techniques are being studied. Chemical analysis of the pollution situation at start, during and after the remediation constitute an important part of the program.

Flocculation of a bacterial suspension by a cationic polyelectrolyte

Xavier Châtelier, Jean-Yvès Bottero and Jean Lepetit

CEREGE, Aix-en-Provence and University of Marseille, France

Introduction

a) Context: The physico-chemical properties of bacterial surfaces are still quite poorly understood, although they play an important role in many processes (infections, biofilms formation, water purification etc). These properties are controlled by specific interactions, but also by short-range or long-range more general interactions. The long-range interactions may be of electrostatic nature, but can also be mediated by macromolecules. The presence of exocellular polymers is for instance known to be determinant for the formation of biofilms or for the flocculation of bacterial suspensions. In some other situations the polymers produced by the bacterial cells prevent them from interacting with other particles.

b) General methodology: Simplified systems may be useful to understand better the many mechanisms which may be involved in the various situations that can be encountered. Focusing on the problem of bacterial flocculation, we examined a model system consisting in a suspension of a pure bacterial strain (*Escherichia coli* B4) and of a synthetic polymer (quaternized polyvinylpyridine: PVPQ). The aim of our work is to understand how the polymer adsorbs on the bacterial surfaces, in which conditions the bacterial surfaces stick to each other, due to the presence of the polymer, and what are the properties of the bacterial aggregates in terms of size and structure. Noting that these questions have been investigated by many authors in the last two decades for abiotic colloidal suspensions (clays, silica, latex etc.), we have based ourselves on the assumption that their methods and results may be adapted to "biocolloids" like bacteria.

c) The model system:

Polymers: the polymers are positively charged. Their degree of polymerization is on the order of 5000, and the degree of quaternization is on the order of 80%. The Odijk-Skolnick-Fixman theory predicts that the persistence length of such chains is about 8 nm, leading to a gaussian radius of gyration in solution on the order of 200 nm, and to an overlap concentration of a few tenths of mg/l. The surface of a cell can be covered by at most about 100 non overlapping chains.

Bacteria: the cells are extracted from the growth medium while in exponential phase and washed 6 times in ultrapure water with added NaCl at an ionic strength of $4 \cdot 10^{-3} M$. Their surface carries a negative charge. The zeta potential was measured and we obtained -47 mV, suggesting an effective surface charge density at the shear plane of $8 \cdot 10^{-3} C \cdot m^{-2}$. The surface area of one bacterium is about $6 \cdot 10^{-12} m^2$.

Adsorption of the polymer on the surface

a) Adsorption isotherm: PVPQ is a polymer which has the characteristics of absorbing strongly the light at 225 nm. We used this property to determine its adsorption isotherm on the bacterial surfaces. The polymer was added to the bacterial suspension in increasing quantities. After gentle stirring for 21 hours, the samples are centrifuged and the supernatant is analyzed by spectrophotometry. The spectrum of the optical density in the suspension allows an estimation of the remaining concentration of polymer, and thus of the quantity of non adsorbed polymer. The quantity of adsorbed polymer can then be estimated.

Results: the adsorption isotherm shows that the bacterial surfaces can adsorb large quantities of polymer, on the order of 40 mg/g, namely about 5000 chains on each cell. These quantities are comparable with usual values for clays, latex etc

b) Electrophoretic mobilities: the polymer was added to the bacterial suspensions as mentioned above. After the stirring period, sedimentation of the aggregates was allowed for one to two hours. The supernatant was diluted and analyzed with a zetalyzer (Malvern 3000). The electrophoretic mobilities were interpreted in terms of the zeta potential, i.e. the electrostatic potential at the shear plane, using the Schmoluchowski approximation of the Henry formula. The measurements show that the adsorption of the polymer results in a charge inversion of the cells.

c) Interpretation: the isoelectric point corresponds to adsorbed quantities on the order of 30 mg/g, suggesting

that the surface charge density of the bacterial cells is on the order of 0.3 C.m^{-2} . This value is much larger than expected from the zeta potential of the pure bacterial suspension ($8.10^{-3} \text{ C.m}^{-2}$). We conclude that the chains adsorb through a very thin surficial layer close to the surface, within the lipopolysaccharidic brush, mainly within the Stern layer, as the charged groups on the chains replace the cations condensed on the surface. This mechanism increases the entropy of the system.

The polymer layer of adsorption at saturation may be thought of as a network of polymeric rods crossing each other at distances on the order of 1 nm. Below the plateau of adsorption, the distance between crossing points increases.

Flocculation of the suspension

a) Optimum of flocculation: the polymer was added to the bacterial suspension, as mentioned above. After the stirring period, sedimentation of the samples was allowed for one to two hours. The optical density of the supernatant was then measured at 450 nm (optical path: 1 cm). A low optical density is the sign of a strong flocculation, since aggregated bacteria are removed from the suspension during the sedimentation period.

Results: three regimes are observed, as expected by previous studies on abiotic colloids. At low polymer dosages, a partial flocculation of the suspension occurs, increasing with the quantity of polymer added. At intermediate dosages, the flocculation is optimal; in our case, almost all bacterial cells aggregate, and the value of the optical density is close to zero. At large polymer dosages, the cells are redispersed by the polymer.

Interpretation: we believe that our results can be explained by electrostatic arguments. The bridging mechanism does not play a role here, since the chains are stuck on the surface and no loop can extend towards the solution. When the quantity of adsorbed polymer increases, the overall electrostatic repulsion between the cells decreases, vanishes at the isoelectric point, and then increases again. The redispersion regime can thus be explained by an electrostatic restabilization of the suspension. The flocculation of the cells can be explained by a "patch" mechanism, as proposed by other authors for abiotic colloids. The positively charged surface on one cell would attract the negatively charged regions on another cell.

b) Size and structure of the aggregates: the distribution of size and the structure of the aggregates was investigated with a granulometer: a laser beam is diffused by the suspension. The intensity diffused is recorded as a function of the wave vector.

Results: we find that the size polydispersity of the aggregates is very large at low polymer dosages and small at the optimum of flocculation. In this regime, a plateau in the slope of the scattering curve suggests that the aggregates have a self-similar structure with a fractal dimension of 1.9.

Interpretation: these results suggest that aggregates formed in the regime of the optimum of flocculation correspond to a diffusion-limited-aggregation process, while those formed at low polymer dosages correspond to a reaction-limited aggregation process. At the optimum of flocculation, bacterial cells stick to each other easily; while at low polymer dosages, they aggregate only where the area of contact is covered by some polymer.

Conclusions

We have shown that methods and concepts of modern polymer and colloid physics can be successfully applied to bacterial surfaces in order to describe quantitatively their interfacial properties and the properties of the aggregates that they form. Extension of our work to weakly charged and to negatively charged polymers could lead to some new insights on biofilm formation and biofilm structures. Further studies with mixed suspensions of bacteria and mineral particles, may also lead to a better quantitative description of soil microstructures. Further details and references can be found in our detailed paper, submitted April 2000, to the journal "Langmuir".

References

- Châtellier X., J.Y. Bottero. and J. Le Petit. 2001. Adsorption of a cationic polyelectrolyte on *Escherichia coli* bacteria. Part 1: adsorption of the polymer. *Langmuir*, 17:2782-2790.
- Châtellier X., J.Y. Bottero. and J. Le Petit. 2001. Adsorption of a cationic polyelectrolyte on *Escherichia coli* bacteria; Part 2: interactions between the bacterial surfaces covered with the polymer. *Langmuir*, 17:2791-2800.

Laboratory study of unfrozen water content of diesel contaminated frozen sandy soil using time domain reflectometry (tdr) cable tester

Djaouida Chenaf¹ and Karim Hadj-Rabia

Royal Military College of Canada, Civil Eng. Dept. P.O. Box 17 000, Stn Forces, Kingston, Ontario K7K 7B4, Canada

The results presented in this paper are part of a laboratory investigation of unfrozen water content changes due to diesel contamination using the Time Domain Reflectometry (TDR) cable tester. This laboratory investigation is part of an ongoing study of the mobility of petroleum oil lubricants as contaminants in permafrost, carried out at the geotechnical laboratory of the Royal Military College of Canada. The unfrozen water content is one of the most important parameters governing contaminant movement in frozen soils. The use of TDR to determine the unfrozen water content of clean and contaminated soil is achieved by measuring the dielectric properties of the solids-water-ice mix and solids-water-ice-diesel mix. Five clean and six contaminated soil columns (poorly graded sand) have been prepared: 3 clean columns at 12% fluid content; 2 clean columns at 20% fluid content and 6 columns at 20% and different diesel contents of 2%, 7%, 12%, 17%, 25%, 50%. Temperature profiles and dielectric signals were taken at three levels within each column: Top, middle and bottom. The equation of Roth et al. (1990) was used to convert the dielectric signals to unfrozen water content values. Both the dielectric constant and unfrozen water content were plotted against temperatures for each test (Chenaf and Hadj-Rabia, 2000)^{*}. These results allowed the determination of the influence of diesel content on temperature diffusion and therefore on ice phase, dielectric properties and unfrozen water content in frozen soil.

^{*}Chenaf, D. and Hadj-Rabia, K. (2000). Petroleum Oil Lubricant Mobility in Permafrost: laboratory study of unfrozen water content of diesel contaminated soil using time domain reflectometry cable tester. Research progress report submitted to DGE-DND, 120 p.

¹Contact person

Measurements of petroleum-infiltration rates in frozen soils from Bethel, Alaska, for secondary containment design

Michael R. Lilly¹, Craig A. McCauley², Daniel M. White³, and David M. Nyman⁴

¹Hydrogeologist, GW Scientific, P.O. Box 81538, Fairbanks, AK 99708; e-mail: mlilly@gwscientific.com

²Research Assistant, Water and Environmental Research Center, University of Alaska-Fairbanks, P.O. Box 755860, Fairbanks, AK 99775-5860; e-mail: ftcam@uaf.edu

³Associate Professor, Water and Environmental Research Center, University of Alaska-Fairbanks, P.O. Box 755860, Fairbanks, AK 99775-5860; e-mail: ffdmw@uaf.edu

⁴Environmental Engineer and P.E., Restoration Science and Engineering, 911 W. 8th Ave., Anchorage, AK 99501; e-mail: nymo@alaska.net

Industrial facilities in Arctic climates often have facilities for storage and distribution of petroleum fuels. Secondary containment at these facilities commonly includes berms, catchment basins, and ditches. Various fuel-spill scenarios influence design for secondary containment. Containment berms and basins often require lining with synthetic fabrics, grouts, or treated-soil liners. A fuel-storage facility in Bethel, Alaska is presently undergoing secondary containment design and construction. We conducted field tests at the Bethel facility to measure fuel-infiltration rates in frozen soil. Laboratory tests provided data on samples with controlled moisture contents, soil types, and freezing temperatures. Field and laboratory tests identified potential fuel-penetration depths with time.

We used ASTM Method D 5093-90, using a double-ring infiltrometer with a sealed-inner ring, for field tests. Infiltration rates were measured in frozen, ice-saturated, silty sand. The average infiltration rate was $4.3 \times 10^{-8} \text{ cm s}^{-1}$. Three different types of soils were retrieved for laboratory testing. Organic-rich silty sand, silty-sand fill material, and sandy silt represent the three main soil types at the facility. We used a falling-head permeameter to measure hydraulic conductivities of laboratory samples. Samples were disturbed and compacted at densities typical of site conditions. Testing occurred at saturated and unsaturated soil-moisture contents in a cold room at -4°C (25°F). Our tests used a Diesel #2/Jet A-50 fuel mixture (heating fuel) consisting of predominantly Jet A-50. Laboratory results indicate hydraulic conductivities decrease as ice saturation increases. Environmental site conditions in Bethel result in active layer and permafrost sandy soils meeting Alaska standards for liners in petroleum facilities.

Permafrost and frozen-soil investigation and reporting methods for waste-containment facilities

Michael R. Lilly¹, and David M. Nyman²

¹Hydrogeologist, GW Scientific, P.O. Box 81538, Fairbanks, AK 99708; e-mail: mlilly@gwscientific.com

²Environmental Engineer and P.E., Restoration Science and Engineering, 911 W. 8th Ave., Anchorage, AK 99501; e-mail: nymo@alaska.net

Industrial and community facilities in Arctic climates often include storage and distribution of petroleum fuels, solid-waste landfills, and other waste-containment structures. These facilities commonly include berms, catchment basins, and ditches requiring lining with synthetic fabrics, grouts, or treated-soil liners. Incorporation of permafrost and frozen soils benefits many facility-design goals, depending on the nature of environmental site conditions. Evaluation of site conditions and reporting of environmental conditions is critical for proper design and evaluation of integrating permafrost and frozen soils into these facilities, and associated operations and management. Climatic conditions, geologic and hydrogeologic characteristics, thermal properties and potential temporal changes, and adequate permafrost descriptions are important elements for these applications. Frozen coarse-grain deposits, or fractured bedrock, with low ice contents will not provide a barrier for waste containment. However, ice-rich fine sands can provide better barriers than synthetic liner materials. A fuel-storage facility in Bethel, Alaska is presently undergoing secondary containment design and construction. This facility presents a good test case for a site with appropriate conditions for using permafrost and frozen soils in the containment design. Infiltration rates were measured in frozen, ice-saturated, silty sand. The average infiltration rate was $4.3 \times 10^{-8} \text{ cm s}^{-1}$. Tests used a Diesel #2/Jet A-50 fuel mixture (heating fuel) consisting of predominantly Jet A-50. Laboratory results indicate hydraulic conductivities decrease as ice saturation increases. Environmental site conditions in Bethel result in active layer and permafrost sandy soils meeting Alaska standards for liners in petroleum facilities. Other facilities have conditions where permafrost or frozen soils do not have appropriate conditions for environmental barriers.

Natural attenuation of hydrocarbon impacts in a cold weather climate, Sable Island, Nova Scotia, Canada

Eric G. Parsons, Stephen D. Locke², and Raymond St. Pierre³

¹Jacques Whitford Environment Limited, Dartmouth, Nova Scotia

²Public Works and Government Services Canada - Environmental Services, Halifax, Nova Scotia

³Environment Canada, Bedford, Nova Scotia

Sable Island, located approximately 300 kilometres (km) east of Halifax, Nova Scotia, is notorious for the number of shipwrecks which have occurred along its coastline. The island is also well known for the Sable Island wild horses. The island has been used as a light and weather station, as a base for scientific studies, and as a support base for the off-shore oil industry. It is also in close proximity to the Sable Offshore Energy Project. Sable Island is a crescent shaped series of sand bars and dunes, with the main body of the island approximately 27 km long and is defined by two well developed systems of sand dunes paralleling the north and south beaches. The geology of Sable Island is unique to Nova Scotia in that the complete sequence of surficial materials are sand sized particles. The groundwater present under Sable Island is reportedly unconfined and extends the entire length of the island.

The island, although not an arctic site, routinely records sub-zero temperatures during the winter months. The open island environment, island geology and severe winter conditions result in frozen soil conditions that will affect the use of natural attenuation for treating subsurface impacted soils and groundwater.

In 1995, an environmental site assessment on the island identified soil and groundwater impacts resulting from diesel and gasoline releases. The soil and groundwater impacts were identified at locations on the island where hydrocarbon products were either stored and/or consumed. A follow up study was completed in 1996 with the installation of monitor wells for groundwater sampling. During 1995/1996 investigations, baseline soil and groundwater conditions were determined along with a number of natural attenuation indicators, such as dissolved oxygen, inorganic parameters etc.

On determining the extent and severity of soil and groundwater impacts; the second objective of the study was to determine options for the remediation of the identified impacts. A variety of passive and active remedial options were screened for cost, effectiveness and applicability. Based on the unique habitat associated with the island, it was deemed necessary to remediate the site using a non-intrusive approach. The non-intrusive approach selected was natural attenuation. However, little was known on whether the unique geological conditions and severely cold seasonal weather conditions of the island could support natural attenuation.

The natural attenuation program commenced in 1998 with the collection of two rounds of soil and groundwater samples. The soil and groundwater samples were tested for natural degradation chemical indicators. The chemistry results indicate that natural attenuation is taking place in this unique island environment. In addition, the chemistry results were evaluated using several natural attenuation models to predict a future endpoint for the natural attenuation program.

WORKSHOP SESSIONS

The Conference allocated two sessions to simultaneous Workshops. Participants were generally free to move from one workshop to another, but each Workshop had an appointed Rapporteur and Chairman. Discussions were intense, wide-ranging and often were continued later informally outside the Conference rooms.

The themes of the four workshops were:

1. Characteristics, behaviour and longevity of microorganisms in frozen ground, with regard to their use in bioremediation.

This workshop was presented in association with INTAS (European Community)

2. Large-area monitoring and assessment of ground contamination

This workshop was presented in association with the Arctic Monitoring and Assessment Programme (AMAP)

3. Fundamental studies relating to contaminant remediation.

4. Case histories and practical procedures.

Summary reports for the first three workshops appear below and on the following pages.

Characteristics, behaviour and longevity of microorganisms in frozen ground, with regard to their use in bioremediation

Chairman: Bernard Stonehouse

Rapporteur: Olga Tutubalina

The workshop started with a presentation by Lothar Beyer on microbial activity measurements for a soil quality assessment in an area of the Russian tundra highly contaminated by crude oil (Usinsk oil spill). The crude oil content in the soil reached 30% and such a soil would ideally be a subject of oil removal, remediation and recultivation. Suitable methods were needed to describe the soil quality after recultivation. The use of common enzymatic activity tests and microbial biomass determination was complicated because some of the enzymatic activities were enhanced by crude oil. Therefore the test methods themselves were tested for suitability and sustainability. Ecophysiological ratios, namely the ratio of the biogenic organic carbon (C_{bioorg}) to the total nitrogen (N_t) proved the most successful indicators.

In the following discussion Bernard Stonehouse underlined that oil is a fertiliser and asked whether the soils in question had a high organic content, and whether there was a management strategy for the soils in the Usinsk region. Lothar Beyer illustrated the properties of one peat and two mineral soils in the study area and outlined the local treatment of the soils which consisted of removal of the crude oil (mechanically or by burning) and by planting of grass. After the removal a considerable amount of oil (up to 1.8 mg g^{-1} at 1 m depth) still remained in the soil. Vladimir Ostroumov then inquired what happened with oil in the bottom of the active layer, but the presenter noted that there was no significant permafrost in the areas studied. Further questions were on the soil water content (15 - 30%), methods to estimate specifically soil carbon (this was difficult, and the only indication of the oil carbon was the unusually high C_{bioorg}/N_t ratio). Ivan Gogotov inquired about the properties of the oil contaminant and the nature of microorganisms in the area. He also proposed a general remediation approach: i) removal of the upper contaminated soil layer (15-20 cm); ii) immobilisation of the residual oil by phototrophic bacteria. The bioremediation would be facilitated by Usinsk's relatively hot continental summer. However, the focus of the presented project was rather on the methods for soil quality assessment than remediation, as it was important to develop indicators, not influenced heavily by the presence of the oil carbon. It was generally concluded that the current methods provided chemical, not biological measurement. Some agricultural guidelines for soil quality assessment exist for temperate regions, but are not applicable in the area. Peter Williams noted that even very low levels of contamination change microstructure

of the soil, thus affecting the thermal regime and microbial activity, and so the age and amount of contamination was important. Unfortunately multiple spills occurred in the Usinsk region and their age was not recorded. Answering final questions Lothar explained that although in addition to control of the hydrocarbon content assessments of the biological state of the soil were needed, they were too expensive at the moment to use for the large contaminated areas in question.

The second presenter was Oleg Anisimov, who focussed attention of the participants on the implications of climate change for the permafrost regime and bioremediation. He emphasized that, firstly, wide-scale remediation was on the agenda (350,000 km of pipelines in Russia are associated with tens of thousands of hydrocarbon spills). Secondly, the *transport* of oil within the ground water and soil horizons had to be considered. Global warming might cause deepening of the active layer. Different regions where spills occur should be ranked according to their risk potential. Thirdly, the geographical classification and ranking of assessment methods was needed. Bernard Stonehouse asked whether global warming and advance of the tree line to the north would necessarily mean more ground water available and massive pollution of rivers and streams. Oleg Anisimov reasoned that this is generally unlikely, because the deepening active layer will reduce the surface runoff. Therefore, if the active layer lies above the level of ground water the negative effects would be small. However, if the ground water level were to be higher than the active layer, the contamination would be dramatic. Answering the further question on the time range of the future climate change, Oleg Anisimov expressed the opinion that it would be most likely centuries, but, as is known, the most significant changes are expected in the Arctic (possibly up to 2°C over 50 years). This may influence prospects for bioremediation.

Anatoly Brouchkov spoke on the energy of spores and bacteria and their capacity for long life (in the frozen state). This was supplemented by the remarks of Ivan Gogotov on the wide temperature range in which certain bacteria exist, depending on pH, temperature, water and dielectric potential. This gives the possibility of continuous cultivation of microorganisms for bioremediation and restoration of ecological systems.

Xavier Chatellier raised the question of the organisation of bacteria and biofilms, and asked how this was modified in the frozen ground. Anatoly Brouchkov responded with the following set of research questions: i) what are the ways of heating the frozen ground? ii) what are the rates of contamination in permafrost and how are they connected with unfrozen water? iii) what are the relationships between microbes, soil, ice, and unfrozen water? Anatoly emphasised that the vast scales of contamination in Russia suggested natural attenuation as the main bioremediation method. Xavier noted that hydrophobicity of soils can be changed by adding certain components and Anatoly briefly overviewed the Arctic saline ground (cryopegs) with lower freezing temperatures and the associated environmental problems (including unsuitability for storage of radioactive waste).

In the final part of the discussion Bernard Stonehouse emphasised that extensive treatment of soils *in situ* using artificial heating may be expensive, and lead to further destruction of soil. He asked what would be the effect of global warming as a natural regulator. Oleg Anisimov agreed with Bernard's points saying that areas of current infrastructure on permafrost should not be heated, and noted that with global warming the probability of oil spills will increase and called for assessment of off-site remediation potential. The question was raised to which extent the remediation should go. Oleg Anisimov reinforced the earlier points about the natural attenuation approach in Siberia as the only feasible, in view of the large scale of the problem. Anatoly Brouchkov stressed that preventing further oil pollution in Siberia was not only a financial, but also a moral matter for all sides involved. Xavier Chatellier concluded by wishing that much larger funding were available for remediation in Siberia.

Fundamental studies relating to contaminant remediation

Chairman: Jaime Aguirre-Puente

Rapporteur: J. Kenneth Torrance

This workshop considered the role of basic or fundamental research studies in relation to the Conference theme of contamination. By fundamental studies is usually meant research devised for the sake of 'finding out', of increasing knowledge in an area, but not directly motivated by immediate practical need.

The great differences between miscible and immiscible substances (those that dissolve in soil water and those that do not) and the significance this has in freezing and thawing soils was examined.

The group considered the need for those who are responsible for contaminant clean-up, for background knowledge. Such background knowledge is the information that has derived from the research categorised as fundamental, and, without which, it is not possible to develop new techniques.

The problem of lack of communication between scientists engaged in the fundamental research and those engineers, technologists and others who are working on actual clean-ups was serious. The workshop recommended that at the 3rd. Conference, there be one or more plenary sessions devoted to fundamental research findings bearing on the problem of contamination in freezing soils. It was considered important that these be plenary sessions, such that there would be a cross-fertilisation of ideas ensuring that the latest findings of research scientists could be brought to bear on the expensive procedures for contaminant clean-up.

Large-area monitoring and assessment

Chairman: W. Gareth Rees Rapporteur Vitaly Kimstach

Vitaly Kimstach outlined the Arctic Monitoring and Assessment Programme (AMAP) and its mandate, activities and plans to 2003.

These were discussed and the group then made the following recommendations:

1. Greater use should be made of remote sensing techniques for generating supporting information on the distribution and effects of Arctic ground pollution.
2. The implications of Arctic studies for the Southern Hemisphere, particularly on long-range transport of pollutants and of bioaccumulation in the food chain, should be investigated.
3. The results of studies of contaminants in freezing ground, represented by the range of investigations presented at the Cambridge Conferences in 1997 and 2000 (the 'Contaminants in freezing ground community'), should be used by AMAP for the assessment of contaminant pathways in the Arctic.
4. Conversely, AMAP recommends that the 'Contaminants in Freezing Ground' community should include consideration of a wider range of pollutants, especially PCBs, and climate-change effects and rates.
5. Mechanisms should be established for the exchange of information between the CFG community and AMAP

Other Initiatives

relating to the International Conferences on Contaminants in Freezing Ground

Russian Information Transfer Project: Scott Polar Research Institute, University of Cambridge

The permafrost in Russia and other countries of the Eurasian land mass underlies a far greater area than that in North America. The region has provided home to indigenous peoples and migrant populations much larger than those of Northern Canada and Alaska and much more extensive industrial development has occurred. It is not surprising that the history of studies of soil freezing and permafrost is a far longer one in Russia and its neighbouring countries than elsewhere. Geocryology (or 'permafrost studies' as the subject was called until two or three decades ago) has been a university specialisation in Russia for many years and hundreds of people have graduated as specialists in the field. The wealth of detailed research and the technology for the cold regions developed in Russia is often poorly understood in English-speaking countries.

In part, this results from the difficult conditions for exchanges of scientific information, especially that relating to Siberia and to the gas or oil-producing regions, during the cold war years. Subsequently, with a freeing-up of communications, it has become evident that the extensive advantages of a free flow of scientific and other information, are all too often restricted by problems of translation.

Drawing on its extensive collections, and multilingual staff, Scott Polar Research Institute has developed a programme for making available up-to-date, technically accurate and easily understandable translations relating to various key questions in cold regions science and management. The translations include maps, books, and notably, the English version of the Russian 'permafrost' journal (published by the Academy of Sciences) - which is to appear shortly. Materials provided under the project, include basic and applied science for cold regions, applicable to such areas of engineering activity as construction and design for pipelines and other infrastructure, environmental remediation, cartography, gas hydrates, geographic information systems, remote sensing, climate change, microbiology and other topics. A broad range of related materials concerning political, social, anthropological, economic and other studies is also available. These materials include much information which is important to those engaged in transfer of expertise between companies, governments and others, especially where circumpolar industrial and scientific ventures are underway. Further details are found at the website: www.spri.cam.ac.uk/ritp/home.htm

Cold Regions Bioremediation Project

(Contributed by Dennis Filler, DMF@shanwil.com)

Petroleum contamination of the arctic environment is a consequence of military history and oil and natural gas exploration in the northern hemisphere. This year alone, 234 releases at exploration infrastructure have been reported on Alaska's North Slope, four of which directly impacted tundra. Greater than 85 percent of these incidents were petroleum related. In the Antarctic, hydrocarbon contamination is predominately associated with activity at scientific research stations. Typically, 10 and 20 spills are reported each year, and there is a well documented history of large spills that have not yet been remediated. The existing legacy of on-land spills and the potential for future spills are recognized as posing some of the most pressing environmental threats to cold region environments. The challenges that extreme climate and frozen ground present requires innovative remediation, and sometimes enhancement of environmental conditions.

The Cold Regions Bioremediation Project (CRBP) was launched in Spring 2001. A professional consortium representing countries in both hemispheres is working to produce a monograph for cold regions hydrocarbon bioremediation. The guide will compile research generated from both pilot tests and bench-scale remediation projects. Look for the publication in 2003-2004.

We at the CRBP take a proactive stance toward preserving the world's cold regions environments for future generations. The demand for resource development in cold regions is growing. Our vision is that development and preservation are mutually inclusive toward that inevitability.

Virtual Conference on Contaminants in Freezing Ground

At the First Conference (1997) it was decided to establish a Virtual Conference on the world wide web; this was recognised as desirable particularly because specialists and practitioners in matters of cold regions ground contamination tend to be widely dispersed. It was agreed that the initial members would be those who had registered for the First Conference, that the Virtual Conference would be password protected and that subsequent members would pay a fee of US \$75.- (which also provided a copy of the First Conference Proceedings) - initially for a period of one year. The Conference organisers undertook to establish the Virtual Conference as an 'arm's length' undertaking with there being no financial involvement on the part of the Universities. The modest income provided by the new members, was augmented by a small grant from the Canadian Polar Commission. This allowed participation by northern communities, especially indigenous peoples, through selected persons who would essentially manage 'institutional' membership. Visits to the site remained relatively few, however, partly because of the lack of activity due to limited funding, as well as the infrequency of contributions posted by members.

At the Second Conference there was further discussion of the Virtual Conference and its potential value. There was strong support for a proposal to fund the Virtual Conference by sponsor payments from companies who, in return, would receive appropriate identification on the Virtual Conference site. Participation by members at large would be free of charge and this could be expected to increase the number of site visitors. More generally it would lead to a more thorough and effective use of the Virtual Conference as a means of rapid and ongoing communication between consultants, contractors, local agencies and organisations, researchers, students and others. Unfortunately, due to circumstances largely outside the control of the Conference Secretariat and potential sponsors, this development has for the most part, not yet taken place. The use of web communications and of this kind of remote conferencing has advanced substantially over the last year or two and the number of people able to fully benefit has grown substantially along with computer and net skills generally. Consequently decisions are expected at the Hobart meeting (3rd. Conference) concerning the future operation of the Virtual Conference (web site: www.freezingground.org/vc)

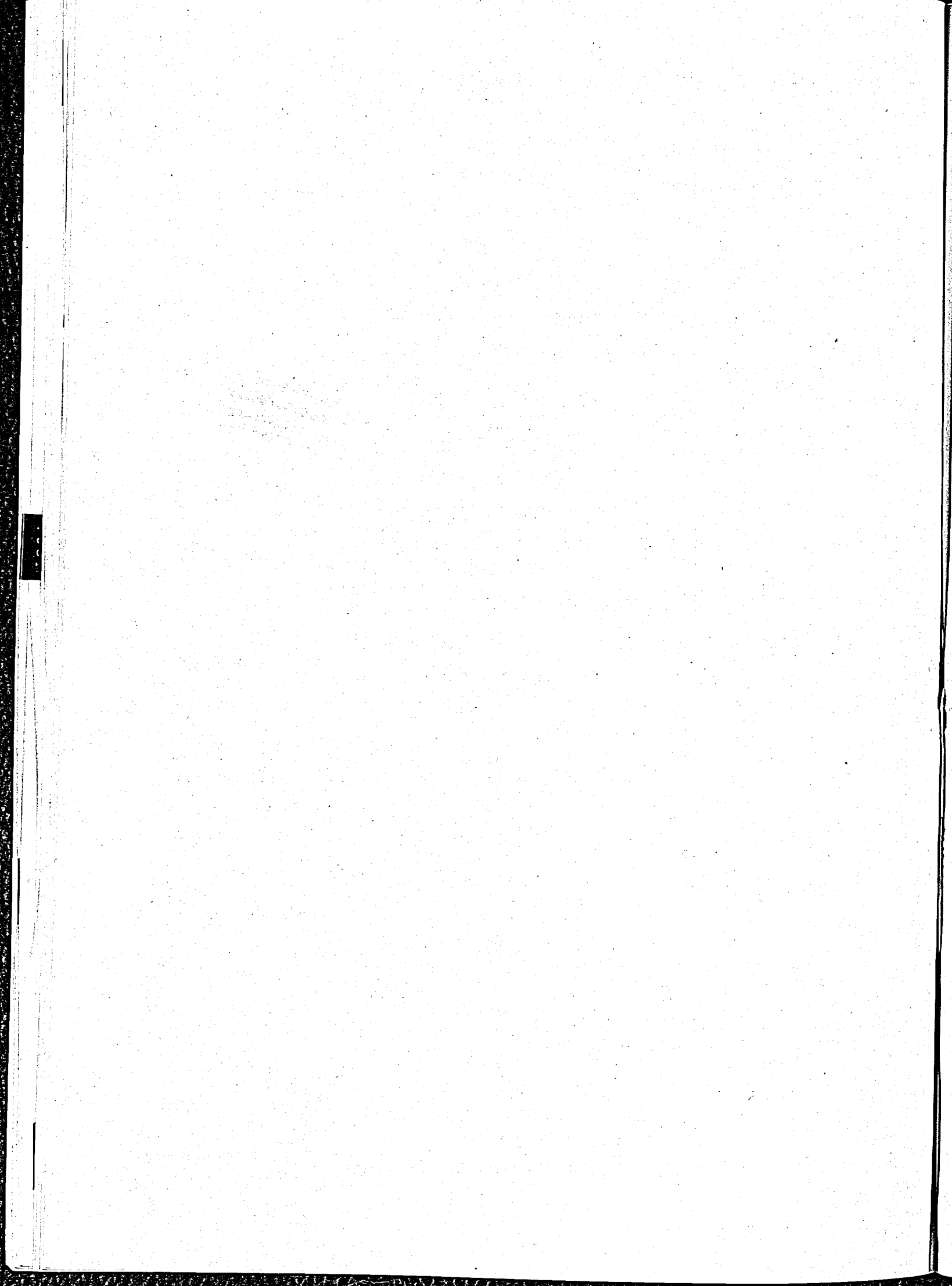



Left: Ian Snape extends invitation of Tasmanian Premier Jim Bacon to hold next Conference in Hobart. Far right, H.E. Roy MacLaren, High Commissioner for Canada.



Displays



Conference Dinner



Conference Secretariat: Else Groves and Eric Williams



Mr. C.L.M. Pratt, Bursar, Fitzwilliam College and Professor Keith Richards, Director, Scott Polar Research Institute, listen to Dr. David Drewry, President, International Arctic Science Committee, and Vice-Chancellor, University of Hull.

LIBRARY E A / BIBLIOTHÈQUE A E



3 5036 01042160 3

DOCS

CA1 EA 2001C52 ENG

International Conference on
Contaminants in Freezing Ground
(2nd : 2000 : Fitzwilliam College,
Cambridge, U.K.)

The Second International Conferenc
on Contaminants in Freezing Ground