

Technical and Bibliographic Notes / Notes techniques et bibliographiques

The Institute has attempted to obtain the best original copy available for filming. Features of this copy which may be bibliographically unique, which may alter any of the images in the reproduction, or which may significantly change the usual method of filming, are checked below.

L'Institut a microfilmé le meilleur exemplaire qu'il lui a été possible de se procurer. Les détails de cet exemplaire qui sont peut-être uniques du point de vue bibliographique, qui peuvent modifier une image reproduite, ou qui peuvent exiger une modification dans la méthode normale de filmage sont indiqués ci-dessous.

- Coloured covers/  
Couverture de couleur
- Covers damaged/  
Couverture endommagée
- Covers restored and/or laminated/  
Couverture restaurée et/ou pelliculée
- Cover title missing/  
Le titre de couverture manque
- Coloured maps/  
Cartes géographiques en couleur
- Coloured ink (i.e. other than blue or black)/  
Encre de couleur (i.e. autre que bleue ou noire)
- Coloured plates and/or illustrations/  
Planches et/ou illustrations en couleur
- Bound with other material/  
Relié avec d'autres documents
- Tight binding may cause shadows or distortion along interior margin/  
La reliure serrée peut causer de l'ombre ou de la distorsion le long de la marge intérieure
- Blank leaves added during restoration may appear within the text. Whenever possible, these have been omitted from filming/  
Il se peut que certaines pages blanches ajoutées lors d'une restauration apparaissent dans le texte, mais, lorsque cela était possible, ces pages n'ont pas été filmées.
- Additional comments:/  
Commentaires supplémentaires:

- Coloured pages/  
Pages de couleur
- Pages damaged/  
Pages endommagées
- Pages restored and/or laminated/  
Pages restaurées et/ou pelliculées
- Pages discoloured, stained or foxed/  
Pages décolorées, tachetées ou piquées
- Pages detached/  
Pages détachées
- Showthrough/  
Transparence
- Quality of print varies/  
Qualité inégale de l'impression
- Continuous pagination/  
Pagination continue
- Includes index(es)/  
Comprend un (des) index
- Title on header taken from: /  
Le titre de l'en-tête provient:
- Title page of issue/  
Page de titre de la livraison
- Caption of issue/  
Titre de départ de la livraison
- Masthead/  
Générique (périodiques) de la livraison

This item is filmed at the reduction ratio checked below/  
Ce document est filmé au taux de réduction indiqué ci-dessous.

10X	12X	14X	16X	18X	20X	22X	24X	26X	28X	30X	32X
										✓	

# THE RURAL CANADIAN.

Vol. III. No. 4.

Toronto, April, 1884.

\$1 per annum, in advance.

Ladies, see our Select List of Music, Page 65. Three dollars worth of Music sent to any one remitting \$1.00 for the RURAL CANADIAN. A choice List of Songs, Duets, Choruses, etc., to select from.



A SYLVAN RETREAT.

\$3.00 worth of Sheet Music Sent Free, see Page 65. If you don't want the RURAL CANADIAN yourself, secure a Subscriber, and \$3.00 worth of Music will at once be forwarded to your Address.



**MOTHERS—**

Don't forget the little ones at this season of the year.



**BOYS' SUITS**

From this Size up.



**INSPECT OUR ELEGANT NEW STYLES FOR SPRING & SUMMER**

The Public, generally, exacting, economical, and critical buyers included, are urgently requested to call and examine our late arrivals of

**FINE TWEEDS, SERGE, AND WORSTED SUITINGS,**  
— AND —  
**Gents' Furnishings.**

Good judges of Fine Fabrics, Neat Patterns, and Artistic Shapes, will find among our mammoth collection of New and Seasonable Designs, many choice selections of Superior Goods, which will be found Desirable Bargains in Price as well as quality. **WE LEAD IN QUALITY, FIT, AND PRICE.** Careful comparison cannot fail to convince you of this fact. We simply ask you to come and see our goods, assuring all that **HIGH GRADES AND ONE UNIFORM LOW PRICE** will be found in every department of this New and Attractive display of Late Styles. **DON'T MISS THIS CHANCE; MAKE A NOTE OF IT.**

**OUR SECOND SATURDAY'S 4 HOURS SALE.**—Last Saturday we had a four hours' sale, during which time we gave the working men of Toronto their choice of all our overalls for 40 cents per pair all round. During the sale hours hundreds were sold, and we have been requested by many of our customers to give them the same chance again. This we may do some other day, but **NEXT SATURDAY** we will sell all our **WOOLLEN UNDERWEAR AND DRAWERS** for 60 cents each, which have been sold all the season at \$1, and been considered the best value in the city at that price.

NOTE.—Hours of sale from 12 noon until 2 p.m., and from 7 p.m. until 9 p.m., and only come for those goods at this special price between the hours mentioned.

Yours for Economy and Solid Satisfaction,

**P. JAMIESON,**

**PALACE CLOTHING HOUSE, Cor. Yonge & Queen Sts.**

**NEW Vegetables** <sup>3/5</sup> *specialty.*

**GREGORY'S SEED CATALOGUE**

1854-1884

My Vegetable and Flower Seed Catalogue for 1884, the result of thirty years' experience as a Seed Grower, will be sent free to all who apply. All my Seed is warranted to be fresh and true to name, so far that should it prove otherwise, I agree to re-ship orders gratis. My collection of vegetable Seed, one of the most extensive to be found from any American Catalogue, is a large part of it of my own growing. As the original introducer of Eclipse Root, Burbank Potatoes, Marblehead Early Corn, the Hubbard Squash, and scores of other new Vegetables, I invite the patronage of the public. In the gardens and on the farms of those who plant my seed will be found my best advertisement.

**JAMES J. H. GREGORY, Seed Grower, Marblehead, Mass.**

<sup>2/6</sup>

**THE OLD RELIABLE Halladay Standard WINDMILL.**

28 YEARS IN USE. GUARANTEED SUPERIOR TO ANY OTHER MAKE. 17 SIZES, 1 TO 40 HORSE-POWER.

For Pumping, Grinding Feed, Sawing Wood, Running Straw Cutters, Root Pulpers, or Any Other Machinery.

**Peter Henderson & Co's SEEDS PLANTS**

COLLECTION OF

embraces every desirable Novelty of the season, as well as all standard kinds. A special feature for 1884 is, that you can for **\$5.00** select Seeds or Plants to that value from their Catalogue, and have included, without charge, a copy of Peter Henderson's New Book, "Garden and Farm Topics," a work of 250 pages, handsomely bound in cloth, and containing a steel portrait of the author. The price of the book alone is \$1.00. Catalogue of "Everything for the Garden," giving details, free on application.

**PETER HENDERSON & CO. SEEDSMEN & FLORISTS, 35 & 37 Cortlandt St., New York.**

Also manufacturers of 1 X 1 Feed Mills, to be operated by the above or any other power, and will grind from six to twenty-five bushels per hour, according to size. Also, *Heres'* Haying Tools. Pumps, wood or iron, for deep wells, a specialty. Sole Agents in Canada for the U. S. Wind Engine and Pump Co., of Batavia, Ill. The most extensive manufacturers of Windmills in the world. Also, Agents for "Knowles' Steam Pumping Machinery." We send free to all the most complete and extensive, illustrated Catalogue ever published in the above line. Write your name and address on a post-card, and mail to

**Ontario Pump Co., TORONTO, ONTARIO.**

State where you saw this advertisement.



Vol. III. No. 4.

Toronto, April, 1884.

\$1 per annum, in advance.

### RURAL NOTES.

THE sugar maple, the elm, the oak and the hickory are varieties of trees well adapted for cleared lands. They are hardy and picturesque, and form good wind-brakes.

IF low lands are given a coating of sand or gravel in early spring their productions may be very considerably increased. It warms them up and makes more available their supply of plant food.

THE pruning of grape vines and training them upon trellises should be attended to just as soon as the snow is off the ground, and before vegetation starts. They never thrive so well as when they start well.

MR. DRYDEN, of South Ontario, has carried a useful and practical measure through the Legislature in the session just closed. It deals with the glanders disease, and has the merit of being readily put in operation.

WHEN there comes a day for ploughing or cultivating the ground for spring crops the farmer ought to be ready for it; that is not the day for mending harness, going to the blacksmith's shop, or cleaning up seed-grain.

THERE should be good judgment used in the selection of breeding fowls. Vigorous females, as well as males should be selected. We mean by this that the colour of plumage, symmetry, and the carriage that denotes good health, should be considered.

ONE of the most valuable of the conditions of success in fruit culture is business honesty. The man who gives short measure, or who does not deliver a quality equal to sample, don't deserve success, and his sins are sure to find him out.

IT is not yet too late to warn farmers to procure reliable corn-seed before planting time. The safest way is to test it and see that it possesses vitality. The crop was so generally injured by last fall's frost, that sound seed this spring may be regarded as the exception rather than the rule.

KEROSENE OIL is a good insecticide, but it should never be applied alone. A good way is to beat it up well with soap and water and spray it over vines, plants or trees which are

troubled with insects. The cheapest and most odorous kerosene is the best for this purpose.

THE way to a colt's heart is through his mouth, and it soon learns to obey the hand that feeds it. Kindness, patience, and firmness will enable a boy to teach a colt anything; and nothing so much interests a boy in farm work as to be given a young colt to care for as his own property.

IT is a curious fact that whenever sheep suffer from disease or starvation a weak spot is developed in the wool then growing upon them, and experts are sure to discover it and mark down the price accordingly. The lesson is, that it never pays to starve sheep that are kept for their wool product.

TOO many sorts of vegetables, like too many varieties of apples in an orchard, are not profitable to the farmer, however they may be to the market gardener. Enough to supply one's own needs is as much as the ordinary farmer can afford to grow, and it is better not to experiment with new varieties.

THERE appears to be only one successful treatment of the grape mildew, and that is the burning of all affected leaves. There are two varieties of mildew, one of which attacks the upper and the other the lower surface of the leaves. The latter is much less injurious than the former, and usually yields to a treatment of sulphur dust.

THE Early Rose variety of potatoe in this Province has had its day, and farmers who continue to grow it are almost certain to be losers. Not only is the quality bad, but the yield is small. Those who have imported potatoes for seed from the Maritime Provinces, and especially from that portion of New Brunswick adjoining Maine, report the results to be very satisfactory. The Copper variety is one of the best.

Cows supplying milk for the cheese factories in this Province give an average return of about twenty-eight dollars per season. Ten hens laying each fifteen dozen eggs in the year would give a better return than one cow at the average Toronto price for eggs, and taking care and feeding into account the balance is still more decidedly in favour of the hens. Still it is not advisable for every man to go into hen-farming.

GOOD work may be done by farmers in the first days of spring by transplanting handsome young maples, beeches, basswoods, etc., from their woods to suitable spots in their clearings—in the neighbourhood of the house or barn, along the lane, the line fences or the street. A farm judiciously planted with shade trees is not only more attractive than one that is not, but it is worth more for grazing and grain-growing purposes and is invariably more saleable.

IT is yet a disputed question whether large or small or medium sized potatoes are the best for seed, and as a matter of fact good crops have been grown from all sizes. Two or three rules may be safely followed, viz.: (1) Select for seed the very best and soundest tubers; (2) Keep them cool and dry, so that they will not be weakened by sprouting; and (3) when the time comes plant them in good soil, give them the cleanest cultivation, and protect them from the beetle.

THE Commissioner of Agriculture has rendered important service to the farmers of the Province by giving them a law which deals with the subject of noxious weeds. Hitherto Canada thistles were alone on the proscribed list, but now a number of others are added and provision is made for putting the law in force by one officer appointed for each municipality. The appointment of such an officer is optional with the council, but in the case of a petition by a certain number of property-holders it is mandatory. The Act also deals in the same way with the diseases affecting fruit trees known as yellows and black-knot.

A MASSACHUSETTS farmer, Edward Burnett, of Southboro', tells that himself and his father before him had been breeding Jersey cattle for many years without much thought about the bull except to use one that was a good specimen of the breed. But it occurred to Mr. Burnett that with a good average lot of females he ought to have the best blooded bull that money could buy, and he proceeded to put his new idea in practice. The result was stated a few weeks ago, at a meeting of the Vermont Dairyman's Association. Many of his calves and heifers are now worth more than their dams, and the value of his herd has trebled in three years. We think there are some breeders in Ontario who might relate a like experience.

## FARM AND FIELD.

## THE CANADA THISTLE.

The Canada thistle—which by the way is a misnomer, as it is a native of the Old World—may be known from all other thistles by the small size of the flower-heads, which are always purple, and not generally more than half an inch, or at most, two-thirds of an inch in diameter. Add to this the excessively prickly character of the leaves, and the general bushiness of the stems, which rarely exceed two or three feet in height, and we have characters which will enable anyone readily to recognize the pest. The Canada thistle like most others is, strictly speaking, a biennial; that is it gets a start in life one year and then the next grows up, produces an abundance of flowers and seeds, and then decently dies. That is, the other species die decently. Here is just where the Canada thistle does not follow the custom of all well-behaved thistles. During the second year of its life, which should be its last, it quickly sends out underground a number of stems which secretly penetrate the soil and get a good foothold, so that when the parent plant dies these hidden offshoots do not suffer. Thus, while the plant itself dies at the end of the second year, its underground stems do not. Each of the latter will act just as the parent plant did, so that while each plant dies out on time, the patch of thistles is perennial.

Now as to the destruction of the pest, it is evident that every method resorted to must take into account these underground stems. It is not enough merely to prevent its seeding. That would check it only in one particular, and the least important one at that. More radical treatment must be resorted to. Let me enumerate several methods which will prove successful if thoroughly carried out; 1. No plant, even though it be a Canada thistle, can live without having green leaves exposed to the sunlight. If no leaves are allowed to appear, as by persistent hoeing, any Canada thistle patch may be starved out. The difficulty is that in such a contest between a farmer and his thistles, the farmer gets tired out sooner than the thistles do. 2. Plough up the patch, and carefully pick out every underground part of the thistles that can be found by repeated harrowing. After the lapse of a few weeks repeat the process, and then again, and again. This is tedious and expensive, but in some cases it will pay. 3. In the early part of the season cut off every plant at the surface of the ground, and drop on the top of the root a small handful of salt. Some recommend the addition of copperas. This can only be resorted to when the patch of thistles is limited in extent. I know a chemist who destroyed a small patch of thistles in his door-yard by pouring a spoonful of oil of vitrol (sulphuric acid) on the top of the root. *Prof. C. E. Bessey, Iowa, Agricultural College, in N. Y. Tribune.*

THE discovery has been made in England that ammonia may with suitable appliances be obtained from blast furnaces, and one iron firm finds that it has been blowing \$150,000 into the air every year. As a result of this discovery the cost of sulphate of ammonia has been reduced by nearly thirty per cent.

## A PORTABLE FENCE.

In the annual report of the Ontario Agricultural College and Experimental Farm, just published, Mr. Jas. McIntosh, of the mechanical department, gives a description of a moveable fence which for durability and simplicity would be hard to excel. It will supersede the mortise hurdle; and any farmer with saw, hammer and material can easily build it. The accompanying cut will give a good idea of the construction. The report says:

"The pieces are all one inch thick, of common pine or pickings; the lower pieces are

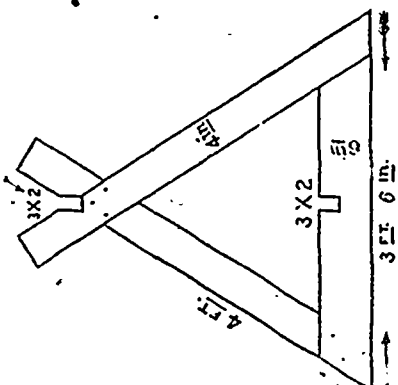
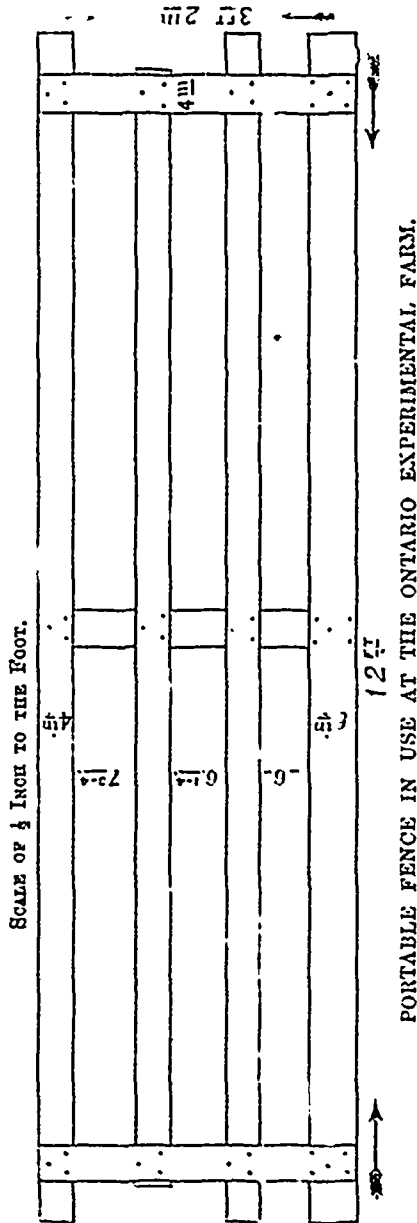

six inches wide, all the others four inches, the head being an equilateral triangle of which the base is three feet six inches long. The standing pieces are four feet long with notches cut as shown for receiving the ends of panels, which are twelve feet long, three feet two inches high, and nailed together on three uprights with two and a half inch wrought nails. It will be seen that when in position the fence is three feet five inches high, and I have never heard any complaint of cattle or sheep getting over it."

## CARE OF TREES AFTER BEING TRANSPLANTED.

Trees that are not on cultivated land should receive especial care until they have been set more than two years. Trees that do well the first year often die the second because, supposing them to be out of danger, they receive no especial care. It is very well understood that a tree must be looked after the first year, but not understood as well as it should be, that they need particular attention the second year. In our climate the sun is very hot, and we often have long-continued dry weather, sometimes so long as to dry the earth below the roots of trees that have been set but a few years. As a tree full of leaves exhales a very large quantity of water every day, the roots, to keep the tree full, exhaust the moisture from the soil so rapidly that when capillary action is checked by hard-baked crust on top, there is not enough moisture drawn from below to supply water in sufficient quantities to keep life in the tree.

To keep the soil in a condition to rapidly draw the moisture from below, the top should either be well cultivated or well shaded, the later may be best done by mulching, if done before the dry weather commences. The mulch should, if possible, be applied early in the spring. It is wonderful what a difference it makes in the moisture of the soil, whether it be well mulched or left exposed to bake in the sun.

Trees that stand where they are exposed to the hot sun, and have no lateral branches to protect the trunk for several feet above the ground, need something more than cultivation or mulching; they need to have something to prevent the hot sun from shining on the trunks. This can easily be done by winding around the trunks coarse matting, leaving it loose enough for the air to circulate freely.

During the first year after a tree is set, if the land is not to be cultivated, water should be applied during dry weather twice a week, and when applied it should be in quantities to moisten the earth several feet from each tree. It is rarely necessary to stake a tree except in very exposed positions; but when staking is resorted to, great care should be taken to prevent the limbs and trunk from chaffing, by winding matting where they touch the stakes. Trees that are mulched rarely ever require watering the second year, but sometimes in a season of protracted drought, it would be good policy to water them occasionally; in fact, in very dry places it is sometimes necessary to do so to save the life of the tree.—*Massachusetts Ploughman.*

THERE are several ways to make drains. One good and permanent drain is made of bricks placed lengthwise in rows four inches apart and close together at the ends. These are covered with bricks placed crosswise. This makes a solid, enduring and strong drain and admits water very rapidly. Stones may be used in the same way, but need to be placed carefully to avoid displacement. A cheaper drain, but a good one, is made by laying short round poles on each side of the drain and covering them with long ones, or with short pieces of plank placed across, leaving many crevices for the water to soak through.

## HOW TO DESTROY BURDOCKS.

Docks are most numerous in the rich grounds adjacent to the house and barn, and in the fence corners. As each one, when permitted to go to seed, produces about 10,000 seeds, they are bound to spread and occupy all the ground. The burdock is annoying and disagreeable, owing to the fact that the burs adhere to everything they come in contact with. The colts get their manes and tails filled with them, they cling to the faces and tails of the calves and cows, and the dog is tormented by their adhering to his soft hair. In fact, they are a perfect nuisance.

The best way to get rid of the docks is to spade them out, and lay the root up to dry. If that is considered too laborious a job, take a sharp hoe and cut them off just below the surface of the ground, and in a few weeks go over them again, cutting all off that have sent out new leaves. Going over them a few times in this way will finish them all.

In half a day's time a man with a sharp hoe will generally cut all such weeds that are growing on an ordinary farm, and it is culpable negligence if they are not destroyed. I find no difficulty in keeping the weeds cut and all the odd chores about the buildings done in parts of rainy days, when there is not time after the rain is over to go into the fields before dinner or supper.

The same treatment may be applied to wild carrots and wild parsnips, for as far as my observation extends they only become noxious weeds when they are permitted to ripen their seeds in fence corners, and the vicinity of the garden or farm buildings.

When weeds and berries are allowed to fill up the fence corners and thrive along the roadside, the farm presents a very unthrifty and unsightly appearance. A few of the half days that are spent at the village tavern, grocery or store, talking politics, if not in some worse way, will eradicate them all, thus adding much to the convenience and looks as well as to the value of the premises.—*Examiner*.

## GETTING IN DEBT.

While there is some very good advice given to farmers on the subject of debt, there is a great amount of impracticable platitudes and sentimental twaddle furnished by hobbyists whose advice followed closely would be about as dangerous as the practices they would guard us against.

Credit, like fire, is a good servant, but a bad master. Because a large conflagration breaks out occasionally, destroying millions of dollars worth of property, people don't shriek from the house-tops, "don't, don't use fire! It is dangerous in every way."

Credit is one of the corner-stones of business, and the commerce of the nation is in a healthy and prosperous condition in the proportion that the credit of the people is sound and well established.

Credit may be and is often abused, but so is every good thing. If a farmer is offered an improved farm implement on time, which will increase the production of his fields fifty or a hundred per cent., he is unwise to refuse the credit that is offered him. Of course it is not the correct policy to get in debt for any-

thing when you have the cash to pay for it, but if you haven't that desirable commodity, the next best thing is your credit, which should be protected and guarded as sacredly as your honour.

We would advise every young man to get in debt just as soon as possible for a home of his own. Then let him get the help of a good wife, one who is easily broken in to work double, and what an incentive and spur that debt will be!

We agree with those extremists who oppose debt in any form, that no person should get in debt for luxuries. We simply urge that credit should, and can be, used with discretion and "good horse sense," and that the farmer is just as capable of advantageously using credit in this way as any other class of people.

—*Western Ploughman*.

## TO VENNOR.

Vennor, you miserable old frawd!  
A settin' down an' writing lies,  
An' makin' out as how  
That you'r a proffet!  
You awt to be ashamed!  
A purty proffet you air—  
A makin' 'onest farmers think,  
In Minnesoty, that they  
Could raise green peas an' cabbig  
In Janivary, an' ood feest  
On cowcumpers an' lettis,  
An' sich like gardin' sass,  
An' plow, an' hawl manuer,  
An', in thair shurt-sleeves,  
Set around on fences,  
A whitin' an' a-tawkin' pollytix  
Awl winter. An' here the merkery  
Has got 'way down so low  
It's frose, an' busted  
My forty-cent thermometer!  
You miserable, contemptible,  
Old frawd; you'd better quit  
A makin' almanax an' go,  
An' hire out to a seekahan boss  
To shovel snow!  
You ask "of you're to blame  
Bekaws it's ben so cold?"  
Of course you air!  
The wether-clurk wuz mad,  
Bekaws of your a-tryin'  
To run the thing;  
An' fur the last six weeks  
He's ben o' turnin' of the crank,  
An' sendin' down  
These Manitoby waves,  
An' awl the time he's ben a-laffin,  
An' a-pokin' fun at you;  
Whilo you, you miserable old frawd,  
Hey ben a posin'  
As a wether proffet,  
An' a-makin' of yourself  
Rediculus.  
You tho't as how you'd git  
Your name in histry,  
Alongside of Elishy's, ez a proffet;  
But it'll be remembered,  
Along with your mild winter.  
An' broken, busted, old thermometers,  
An' frosted heels, an' ohilblains,  
An' handid down,  
To fewcher generations,  
Jest as a frawd!  
Bekaws, that's what you are!

—*H. Leslie*.

THE farmer, says *Farm and Home*, who went carefully through his fields last year, and selected the choicest ears from the corn crop, and carefully cured them for seed, may expect a good crop this year if the seed is carefully planted, tilled and harvested. But there must be care through it all. A slovenly farmer is as much out of place as a slovenly housekeeper. It is as true in agriculture as anywhere else that "there is no excellence without labour." There are, now-a-days, many labour-saving machines for the use of farmers which may tend to make them a little indolent. But just so soon as a man becomes absolutely lazy, just so soon he has outlived his usefulness on the farm. A lazy or careless man has no business to live anywhere—certainly not on a farm.

## HOUSEHOLD HINTS.

If you put soda in the water with which you are to wash windows, you will find that finger marks, putty stains, etc., will be much more easily removed than if clear water alone is used.

STALE bread may be utilized in making a good breakfast dish. Cut it in thin slices and, when toasted uniformly brown, spread it with butter, and heap on each slice some ham, minced and mixed with eggs, and fried nicely. Serve very hot.

A FOLDED newspaper, or part of a newspaper folded, is good for a holder and saves burning the fingers, spoiling the temper, or soiling a dish towel when in haste to remove a boiling pot, open an oven door or take up a hot poker or pan.

FARMERS' PUDDING: One-half pint of molasses, half a pint of water, two teaspoonfuls of saleratus, one teacupful of any kind of berries, rolled and thickened with flour, and steam three hours. Raisins are nice to use in place of berries.—*N. Y. Times*.

As an inducement to the greater utilization of buttermilk in bread making, it is stated that it contains four to five per cent. of milk sugar and a-half per cent. of mineral salts, and that after settling for cheese-making it also contains one per cent. of nitrogenous matter and nearly as much of butter fat.

To freshen lawn or sateen dresses that will not wash, sprinkle them with cold starch, i.e., clear starch, made thin with cold water, and not boiled. Let them lie an hour or two, and iron. If there are any especially soiled places they may be washed out in the cold starch without fear of making the colours run.

ONE of our valued contributors, Mrs. Annie L. Jack, sends the following to the *Rural New Yorker*: The best yeast is made as follows: Boil a handful of hops in two quarts of water ten minutes: strain, and add to the liquor one cup of sugar, six grated potatoes, and a tablespoonful of salt. Let it simmer half an hour, add a cupful of good yeast when lukewarm, and let it rise without being in any way chilled.

NEW way of serving oatmeal.—Take a dessertspoonful of oatmeal; place it, in the morning, in a tumbler, and fill up with new milk. Let it stand all day, and take it for supper or for a nightcap. The grains will have been softened by their long soaking in the milk, and in can be eaten with a spoon. This is said by its advocates to be a specific against neuralgia, and is also soundly recommended for sedentary folks.—*Farm and Household*.

PIRON describes, in the *Moniteur Industrielle*, a new process for rendering paper or cloth water-proof, and at the same time protecting it from change. He employs an alcoholic solution of the agreeable oil used to perfume Russia leather, and which is obtained by distilling white birch bark. The oil dissolves readily in alcohol, but is no longer soluble after it has once dried and become oxidized to a resin. The thin film of resin formed by impregnating the fabric, does not detract from its pliability in the least, and its aromatic odour protects it from insects. It protects, quite well, from sea water, acids, and moderate changes of temperature.

**GARDEN AND ORCHARD.****STRAWBERRY CULTURE.**

Ellwanger & Barry, of Rochester, N. Y., give the following directions for the garden culture of strawberries: For family use it is recommended to plant in beds four feet wide, with an alley two feet wide between. These beds will accommodate three rows of plants, which may stand fifteen inches apart each way, and the outside row nine inches from the alley. These beds can be kept clean, and the fruit can be gathered from them without setting the feet upon them.

Culture in hills is the best mode that can be adopted for the garden. To obtain fine, large, high-flavoured fruit, pinch off the runners as fast as they appear, repeating the operation as often as may be necessary during the summer. Every runner thus removed produces a new crown at the centre of the plant, and in the fall the plants will have formed large bushes or stools, on which the finest strawberries may be expected the following season. In the meantime the ground among the plants should be kept clear of weeds and frequently stirred with a hoe or fork.

Where the winters are severe, with little snow for protection, a slight covering of leaves or litter, or the branches of evergreens, will be of great service. This covering should not be placed over the plants till after the ground is frozen, usually from the middle of November till the first of December, the time varying in different localities. Fatal errors are often made by putting on too much and too early. Care must also be taken to remove the covering in Spring, just as soon as the plants begin to grow.

Before the fruit begins to ripen, mulch the ground among the plants with short hay, or straw, or grass mowings from the lawn, or anything of that sort. This will not only keep the fruit clean, but will prevent the ground from drying and baking, and thus lengthen the fruiting season. Tan bark can also be used as a mulch.

The strawberry may be successfully grown in any soil adapted to the growth of ordinary field or garden crops. The ground should be well prepared by trenching or ploughing at least eighteen to twenty inches deep, and be properly enriched as for any garden crop. Of course, if the land is wet, it must be thoroughly drained. In the Northern States the season for planting in the spring is during the months of April and May. It may then be done with safety from the time the plants begin to grow until they are in blossom. This time is preferred by successful cultivators for setting out large plantations of layer plants. A bed of strawberries managed in accordance with the directions contained in the above paragraphs will give two full crops; and should then be spaded or ploughed down, a new one having been, in the meantime, prepared to take its place.

For field culture on a large scale the same directions with regard to soil, time of planting, protection and mulching as given above are applicable. The matted row system—the mode of growing usually pursued—has its advantages for field culture, but cannot be recommended for the garden. In the field, experts

usually plant in rows three to four feet apart, and the plants a foot to a foot and a-half apart, in the row. In this case much of the labour is performed with the horse and cultivator. The number of plants required for an acre, at any given distance apart, may be ascertained by dividing the number of square feet in an acre, 43,560, by the number of square feet given to each plant, which is obtained by multiplying the distance between rows by the distance between the plants. Thus, strawberries planted three feet by one foot, give each plant three square feet, or 14,520 plants to the acre.

**PECULIARITIES OF THE APPLE.**

The earliest sorts, June and July apples, generally bear annually, or a full crop one year and a fair or moderate crop the next. Having delivered their crops early they have August and September for continued growth and recuperation, and are enabled to form mature fruit-buds for the next season. We have a striped June apple tree that has seldom or never failed to give a good crop every year.

The late winter sorts have not this advantage, as growth for the season is over after the fruit is gathered, and the natural consequence is that there are few or no fruit-buds for the next year. Late summer and early fall apple trees may be induced to give fair crops almost every year if they have generous soil, with abundant nutrition; otherwise, like the late winter sorts, the next season is required to form fruit-buds and their bearing is restricted to every other year. So it pays to feed and take care of the trees.

The apple trees requires good rich soil and plenty of it to insure annual crops and healthy growth. The soil naturally is never too rich, and the trees are rarely surfeited or injured by heavy manuring—but this is sometimes the case. As a rule orchards are grievously mismanaged or neglected. The cultivation of young trees should be as regularly and carefully done as that for the corn and vegetable crops. The surface needs frequent but shallow stirring, especially under the branches if high-topped. If low, which is best, especially for southern orchards, no ploughing should be attempted immediately under the trees to bruise the fruit and branches.

We believe low-branched trees are better for several reasons. No sun-scald can affect the trunks, no suckers are produced from torn roots, the feeding roots and trunks are protected from the three o'clock sun. The best fruit is always on the middle and lower branches; and the convenience of gathering the fruit without bruising is far greater with low-headed trees. The windfalls are but little injured. If straw or soft litter is spread beneath, the apples can be shaken off with little or no bruising, but it is best to hand-gather. With these advantages low heads must be the most profitable as well as natural.

As a rule, red apples sell much the best in market, hence we find the Baldwins in most common demand. While this apple is a good keeper, its quality, every one knows, is inferior to many varieties that might be named. However, our orchard should consist largely of Baldwin trees.

**MISCELLANEOUS.**

THINGS seem to die, but die not; the spring showers  
Die on the bosom of the motherly earth,  
But rise again in fruits and leaves and flowers;  
And every death is nothing but a birth.

It is easy to start tomato plants in the kitchen window and good ones, too. A little sawdust on the soil will prevent baking.

HOT-BEDS for raising seedling plants for the garden are to be started about six weeks before the time at which it will be safe to set out the plants. Sashes should be got ready; paint if need be and replace broken lights.

HERE is a hint for potato-growers. A man used one quart of sawdust in each hill of potatoes in one plot and none in another. The sawdust-hills yielded nearly twice as much as the others and the tubers were larger and smoother.

TEST the seeds by placing fifty or a hundred between sheets of blotting paper, two or three on each side. Keep it damp, warm and dark. Radish seed will germinate in ten hours; cabbage in eighteen, and corn in thirty-six. That's easily done, and it may save you much trouble, time and money.

A MASSACHUSETTS farmer who raises asparagus extensively says that an application of salt is of no use whatever, being only a practice that has been handed down through several generations. Perhaps the necessity for salt is lessened when asparagus is raised near the sea, where the soil and atmosphere are both impregnated with salt.

A WRITER in *Gardening Illustrated* says that if young shoots of the tomato are taken off and propagated like bedding plants, they will make a less rampant growth than seedlings, and be more fruitful. Cuttings prove best for pot culture; they are then to be kept near the glass with a temperature of about fifty degrees. They will make fine plants by spring.

WEEDS on gravel walks may be destroyed and prevented from growing again by a copious dressing of the cheapest salt. This is a better method than hand-pulling, which disturbs the gravel and renders constant raking and rolling necessary. One application early in the season, and others as may be needed, while the weeds are small, will keep the walks clean and bright.

IN planting an orchard, thoroughly plough and pulverize the whole field and work manure into the soil as for a grain crop. It can hardly be too rich; only avoid putting the manure in contact with the roots of the trees. Set the trees about as deep as they grew in the nursery rows; many die out from too deep setting. Fill all the interstices of the roots with fine soil and tramp it down carefully around them. It is better to mulch heavily than to water frequently in dry weather.

IN planting trees this spring heed these suggestions: Plant as early as possible; expose the roots to the air as short a time as possible, and don't plant too deep, work the fine dirt down nicely among the roots and tramp it solid to exclude all air; if fine manure is to be applied, spread it on the dirt after the hole has been half filled, if it is coarse spread it on top, for a mulch; lean the top of the tree strongly toward the one o'clock sun, stake to hold it there, prune the top one-half, and then trust to Providence.

**BEES AND POULTRY.****TO MAKE BEE-KEEPING PROFITABLE.**

Isaac Hutching, an American authority on the apiary, gives the following advice on the subject: "To make bee-keeping profitable we should keep the best strains of Italian bees in preference to the black or German bees. Some of the new races of bees may prove equal, or superior to the Italians, but they have not been sufficiently tested to warrant a change. The dollar queen traffic, if rightly managed, will be a blessing to the intelligent apiarists, as it will open a market for the small and inferior queens that might otherwise find their way into the class of tested queens. I believe that bees winter better and build up quicker in the spring, where they are well packed with chaff or dry sawdust on their summer stands, than they do when wintered in a cellar. Spring dwindling, I believe, in most cases, is a result of cellar wintering. Those who winter in a cellar use a single walled hive, and when they put them out in the spring the sun will warm them so that many will fly out when the air is so cold that they become chilled and never return. If we have a few days of warm weather, and they have all the brood that they can care for, one cold night will drive the bees into a cluster and leave the brood to die. The bee-hive needs protection from the rays of the sun and the cold storms and winds of early spring, as much as it does in the winter months when there is no brood to chill. We should encourage breeding early in the spring, remembering that it is the early bees that store the surplus honey. The old box hive is a thing of the past with all progressive bee-keepers. A movable comb hive is indispensable to profitable bee-keeping. As soon as the weather will admit in the spring we should examine each colony, so that we may know if they are in need of any of our aid. No. 1 may have lost their queen; No. 2 may be short of stores; No. 3 may be weak in numbers and need a frame of ripe brood. It would be very difficult to ascertain the wants of a colony in a box hive without movable comb frames. I should be very sorry to have a colony die for want of food or care, after they have survived our cold winter. If our bees are well wintered and well cared for in the spring, they will be ready to divide the swarm before the white clover honey harvest. If we divide it should be done at least ten days before the honey flow commences, and the honey sections should be put on soon after, so that the bees may get settled down to business in season to give us good return. In dividing, leave each colony as strong as it will do, and not induce swarming."

**FEEDING YOUNG CHICKS.**

On this subject our excellent contemporary *Farm and Garden* writes:—Young chicks cannot procure green food at this season, and consequently are subject to constipation which sometimes destroys a whole brood. The chief trouble is feeding raw soft food. This is not injurious, however, if it consists of all that is required for the growth of the chicks. In the early stages the feathering is very rapid, which

accounts for the constant appetite of the chicks, which keep their crops full all the time. But there is such a thing as starving the chicks even in the midst of plenty, and that is the policy often pursued by those who feed liberally but not the right kind. Corn meal certainly serves to create heat in the chicks, a very essential matter, for they should be warm and comfortable, but the chick in its first stages demands material for bone and feathers, and in order to eat enough corn meal to supply the natural want in that direction the internal organs are impaired and the chick droops. Neglect will so retard a chick that it cannot recover. The loss of a single meal will often do this, and hence the necessity for regularity in feeding. The demand for the production of bone and feathers is mostly for lime, and this should be accompanied by iron and phosphoric acid. Lime may be given in the shape of bone meal, ground fine, oyster shells, or as old mortar pulverized. Even slacked lime is appropriated for use, and the food also contains traces of it. Iron exists in all vegetation in minute quantities, but a little copperas solution to the drinking water will supply all that is needed.

The best method of feeding is to allow nothing the first twenty-four hours. Then give hard boiled egg for a day or two. It is well after that time to mix together one part corn meal, two parts ground oats, and one part wheat bran (ship stuff) moistened with boiling water to a crumbly dough. Once in a while give mashed potatoes, and occasionally vary with a little hard boiled eggs, chopped cabbage, boiled turnips, etc., keep warm and dry, feed regularly, and keep them up on stormy days.

**TIME TO THINK AND REVIEW.**

*An Exchange* gives the following "good and timely" advice:

As the spring advances it will be well to review the past season's work, and see where-in we have failed; to try and avoid like mistakes in the future. The winter and early spring is a good time to read upon the subject in hand, then there will be less danger of failures in the time to come. Hives and fixtures necessary for the season's work should all be secured in times. Do not wait until you are in urgent need of these things before ordering, but order early and thus avoid not only the loss of time, but bees and honey, for time with us is money, for which we work. The writer knows from experience of what he writes.

On the amount of surplus secured depends the profit of the apiary, and for this end, it should be our aim. The honey crop should consist of both comb and extracted honey. For the former, large sections are best for home consumption or for a home market, but for the general market, the one pound sections are the favourites. But let the object sought be what it may, the first and most important part of it all is to be ready in time, for in this may depend the entire success of a season's work.

FEEDING twice a day is often enough. Three times a day will make Brahmas, Cochins, Plymouth Rocks, and Wyandottes too fat to lay.

**SALT FOR POULTRY.**

A writer in the *Country Gentleman* has settled this much-discussed question to his satisfaction. He says:—To get at the true facts I have been feeding salt to all my poultry, young and old alike, and closely watching the result. I have fed it in cold mush and hot, in bran and everything else, all the spring and summer (so far) with the following results:—The poultry will eat all kinds of salted food in preference to unsalted; they are better in general health; not a louse of any kind in young or old (the first year I have been able to say so), and they are all beginning to moult, many of them laying as though not moulting. Eggs are cheap now, and the hens will be ready for fall laying when the weather is cold and eggs scarce. This may or may not be the result of feeding salt largely to them, but I am compelled to believe this to be so, as there are some other peculiarities. I have noticed one feature which may not be in favour of salt—the hens being more persistently inclined to sit, it being very difficult to break off the inclination; they sit much closer than usual. All seem voraciously fond of green food of any kind, and have eaten a large quantity of clover, grass, young corn and other similar food. My observations lead me to conclude that salt is a needed condiment for all our poultry, and in all points beneficial to them. Pigeons are excessively fond of salt in any form, and why should not our poultry be also? Such being the true status, it behooves us to consider their needs and attend to them.

**THE COST OF KEEPING A HEN.**

The cost of keeping a hen depends upon her ability to forage, and the labour bestowed upon her by her owner. As sheep are considered the scavengers of the farm they may be said to have suitable companions in poultry. It is a saving of material to convert refuse into saleable eggs, and the result of the hen's efforts in that direction should not be entered in the account-book, and if it does she should be credited, as an offset, with the amount saved that would otherwise be wasted. Her feed has been estimated by some practical poultry breeders as the value of a bushel of corn, but such a calculation cannot be relied upon, as it costs more to keep a hen in Quebec than it does in Virginia, with the advantage of an earlier spring, in favour of a southern climate, to say nothing of the many open days of winter when but little snow is on the ground. She will also begin to lay earlier and larger, wean her chicks sooner, and require less care and attention, which are items of cost. Then, again, no two hens are the same. Breeds make a difference, and the *kind* of feed has an influence. The cheapest is sometimes too dear, as it is not the kind demanded. No one can safely state the cost of keeping a hen, except for his own section.

As the spring comes so will vermin. White-wash with carbolic acid in it will prevent them.

KEEP fat hens on ground oats, and avoid corn or wheat. The best remedy for this trouble is exercise, and the more active the fowl the less liability in that direction. Leg-horns are usually exempt from being too fat.



## HORSES AND CATTLE.

## HORSE BREEDING.

With respect to the class or the breed of an animal which has the greatest loss attending its production, undoubtedly the race horse stands first. Here, indeed, the breeding is a speculative matter, and this is chiefly owing to the large sums paid for the parent stock in the first instance, the great uncertainty there is for finding a good sale for the progeny, even though the pedigree is all that can be desired, or its ultimately proving suitable for racing purposes. Even hunters, hacks and roadsters in the present day are scarcely bred with profit, though it is true if properly reared and managed till four or five years old they may sell for a good sum of three figures. They are, however, until they attain that age, eating money. They should also be

## EARLY FINISHED BEEF.

This a very fair illustration of what was, according to all accounts, the heaviest steer of his age in Canada, and possibly even in the United States, or Europe, during 1883.

The question of the early maturing of beef cannot be too often held up to our farmers, and it is very satisfactory to find that Ontario is as alive in this as any other country. The animal in this example was a pure bred short-horn, calved 6th May, 1881, bred by Mr. C. Hodgson, Whitevale, Ontario, and bought by us from Mr. Hope, of Bow Park, when nineteen months old, so all we had to do was to finish him. In build "The White Duke," was by no means perfect, nor equal to some others from which he took honours in the show ring. Possibly, no fault could be found with anything forward of the loins, but he was decidedly deficient in width and depth of hind-

## TO CURE TIMIDITY IN A HORSE.

Timidity is a fault in a horse which can usually be cured, but only by a course of kind and patient treatment. Rough usage will never accomplish that end, but is only calculated to make the trouble more deep-seated. An experienced horseman recommends the following treatment for such an animal: If he scares at any object, speak to him kindly and let him stop and look at it; give him a few gentle strokes on the neck with your hand, speaking kindly to him all the time, and gently urge him toward the object he scared at; be careful not to urge him too hard at first; above all do not whip him; give him time to see that he is not going to be hurt; when you can do so let him smell of the object provided it is some offensive carcass; he will not scare at it again. When this has been done several times he will have gained

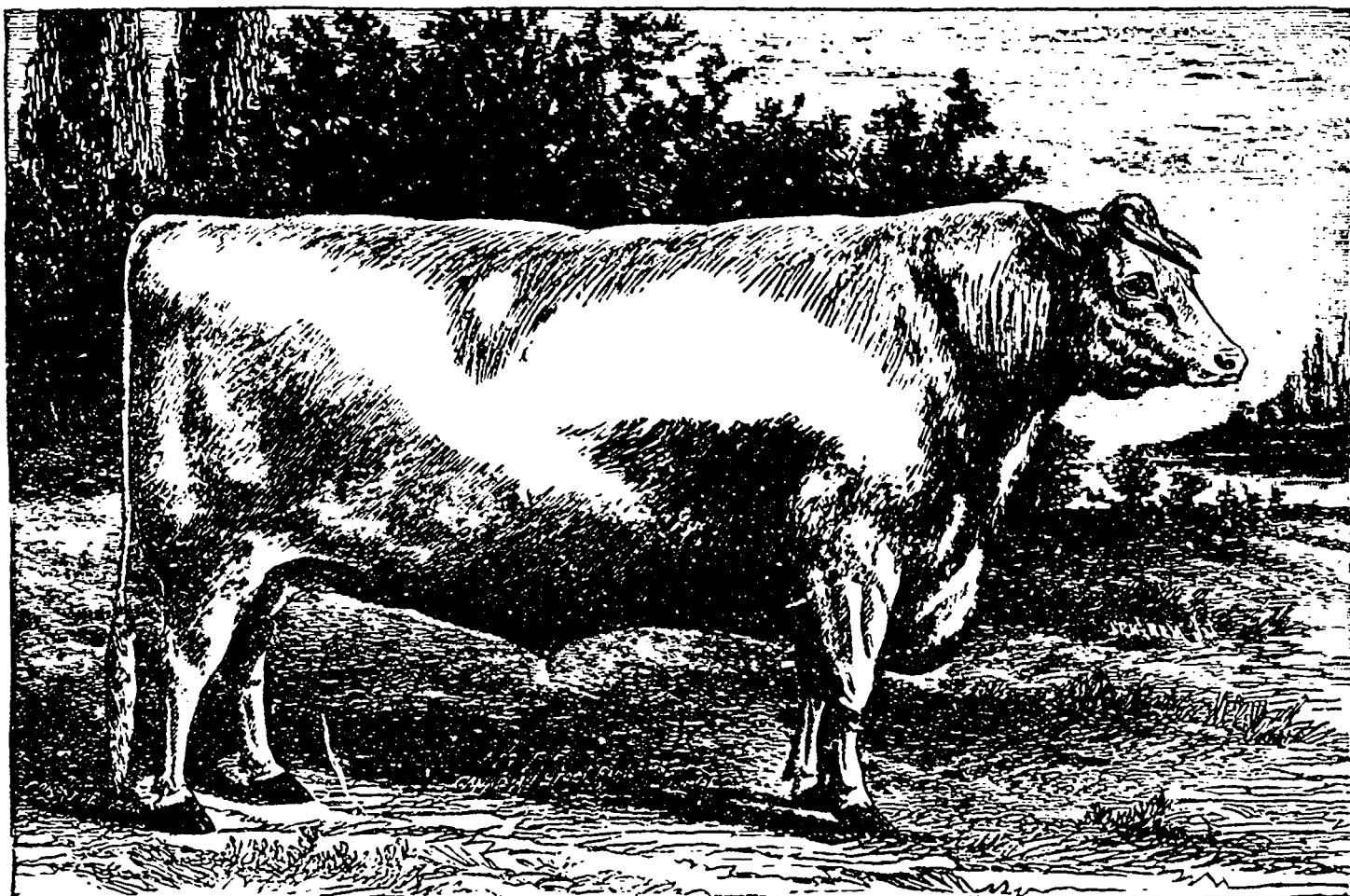

WHITE DUKE.

bred by those who can afford a great expense in the first instance. Cart horses (draft horses) are the only horses whose breeding is most likely to be unattended with loss, as they can always be kept more cheaply and turned to use at two years old and earn their own living from that time forth. They are the least unprofitable, and as they now realize prices equal to any other class, they should serve as guidance for any farmer as to whether he will go in for breeding or not. To make horse breeding profitable, the attention of the farmer must be forcibly directed to the reduction and prevention of losses, both generally and individually, as much as possible. In every single instance where the cause has once been determined, it must be removed. If this is done—occur what may—the breeder will always have the consolation of knowing, that he has not himself to blame. —*English Exchange.*

SUBSCRIBE for the RURAL CANADIAN.

quarters—(the illustration shows a better flank and hams than the animal possessed). In handling and quality otherwise, he was a good average but nothing more, but in width and filling of fore-quarters, with a delightful head, nothing better could be desired. When killed at Toronto, on 17th December, 1883, this steer weighed 2,110 lbs. (having lost 85 lbs. by show handling), and gave 72 lbs. of butcher's meat to every 100 lbs. of his live weight. With this very large proportion there was no coarseness, nor patchyness, but good moulding and fine graining throughout. When asked, as I have often been, what we fed "The White Duke" upon, the best answer I could give was "ask me what he did not get."—*Prof. Brown, in Report of Ontario Agricultural College.*

ALL the treatment a nervous horse needs is kindness and quiet handling. If beaten or spoken to roughly they become more excited and nervous than ever.

confidence in you and in himself. The timidity will soon wear off and your horse will be cured.—*Stockman.*

## RAISE YOUR COWS.

The New England *Farmer* says: "We have tried both buying and raising cows, and find the advantages are greatly in favour of the latter method of replenishing stock. A calf that is raised on the farm, if kindly treated, feels very much as though she belonged to the farm, if not to the family. It will be a very poor fence or a very short pasture that will tempt her to leave her own home surroundings. She knows her own pasture and her own home, and becomes very much attached to both, while the purchased animal is almost sure to be lonesome and home-sick when first put in with a herd of strange, and perhaps vicious animals. Almost every fresh introduction of a strange animal is followed by a general fight for mastery.

### THE GENERAL-PURPOSE COW.

This forms the basis for discussion among different breeders of dairy cows. Is there any such thing as a general-purpose cow? and, if so, is she, or is she not, what the majority of farmers want? Just at this moment, when milking breeds are being introduced, this is a very important question. Suppose, to get at our ideas in figures, we take two native cows. Flora gives 5,000 pounds of milk per year for five years. She is valued at, say \$50. Jennie gives 3,500 pounds of milk per year for five years. She is valued at \$50. Flora is poor in flesh, and, as we say, "milks herself poor." Jennie is in good condition and can be readily fattened when desired. The calves from Flora are poor, while those from Jennie are in good flesh. Flora's milk at, say, \$1 per 100 lbs. for five years is worth \$250. Assume she sold for \$10, the value therefrom is \$260. Jennie's milk at the same price is worth \$175; assume she sold for \$50 as beef, this makes \$225. Now if the steer calves are worth, say \$8 from one cow they are worth, say \$6 from the other. Aside from this there is a risk of losing the use of either cow for milk at any time through unavoidable circumstances. But one can be fattened, the other cannot. Hence more risk is taken on the poor than on the medium cow. And you will invariably find that the average buyer selects for his general purposes; and I think he is wise in so doing. Now the example given was not intended to be complete in all the details, but to merely illustrate what seems to me to be the best cow of the two mentioned. When a man buys natives he is compelled to make just about such decisions. We think that under the present management of farms the majority of farmers want cows that approach as near as possible to the general-purpose cow. We sincerely believe they will be of more profit, all things considered. There are cows that continue remarkably well the qualities of milk, butter, cheese and beef, and though not excelling in either are more profitable in all. Professor Morrow, of Champaign, Ill., says that what the average farmer wants is a general-purpose cow. To advocate strenuously this theory is repulsive to some breeders, but the theory is a good one and liberally endorsed by many representative dairymen in Iowa. It is true the farmer must specialize in his risk to be successful, but there is a limit to that specialization beyond which it is not profitable to go.—*J. N. Muncey, in Breeder's Gazette, Chicago.*

### A BLACK DIAMOND.

Sybill's Darling 2nd (4611), bred by James Argo, of Cairdseat, Aberdeenshire, Scotland—

the property of the Ontario Experimental Farm. Calved March 27th, 1880.

Sire, Etonian (1658.) Dam, Sybill's Darling, 4050, by Ballot (634). Dam, Fred's 5th Darling, 2363, by Scotland (725). Dam, Fred's 2nd Darling, 1046, by Reform (408). Dam Sybil, 974, by Black Prince of Bogfern (501). Dam, Ann of Bogfern, 539, by Banks o' Dee (12). Dam, Young Matilda, 177.

This young Aberdeen Angus poll cow, as selected for us by Mr. Hunter, of Alma, has already made her mark in breeding records,—her first calf, a bull, "Marquis of Huntly," by "Meldrun" (1759), brought \$550 when ten months old, at our public sale in September last. She is an unusually even animal, with all the build of a model beef—on the small side though—and so we were tempted with an offer of \$2,000 for her, last year. Cost, delivered at Guelph from Scotland, was \$373. But with all my respect for beefers, I think no cow is a cow unless she can raise her own calf.—*Prof. Brown, in Report of Ontario Experimental Farm.*

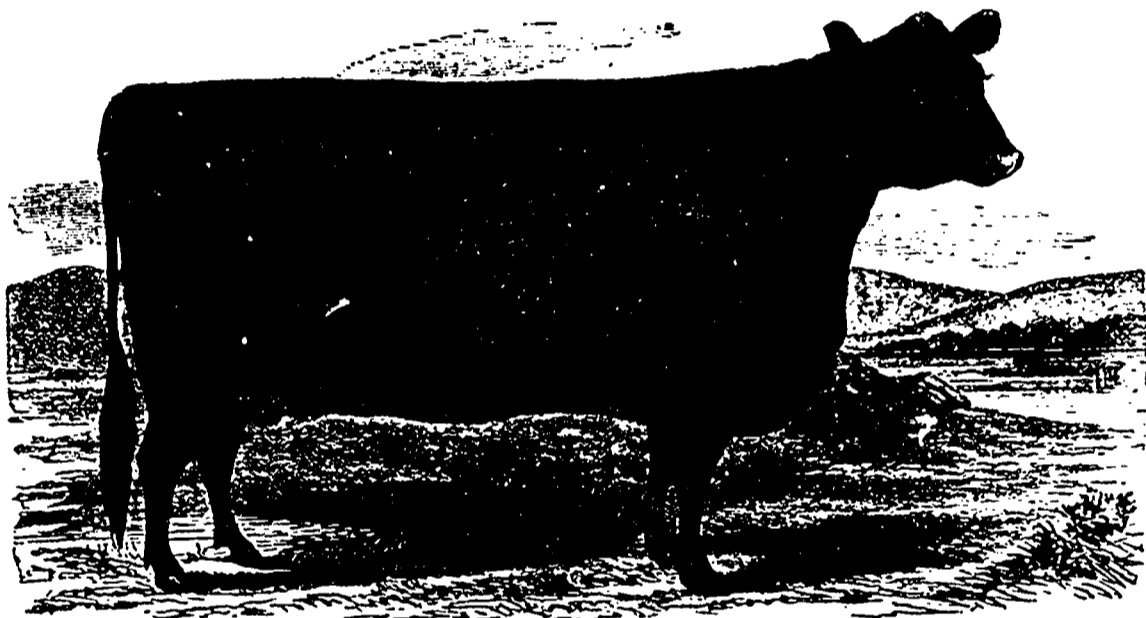

SYBILL'S DARLING 2ND (4611).

### TRAINING VICIOUS HORSES.

A very simple method and an improvement upon the Rarey system of training vicious horses was exhibited at West Philadelphia recently, and the manner in which some of the wildest horses were subdued was astonishing. The first trial was made on a kicking or "balking" mare, which her owner said had allowed no rider on her back for at least five years. She became tame in about as many minutes, and allowed herself to be ridden about without a sign of her former wildness. The means by which the result was accomplished was a piece of light rope, which was passed around the front jaw of the mare just above the front teeth, crossed in her mouth, thence secured back of her neck. It was claimed that no horse will kick or jump when thus secured, and that a horse after receiving the treatment a few times, will abandon his vicious ways forever. A very simple method was also shown by which a kicking horse could be shod. It consisted in connecting the animal's head and tail by means of a rope fastened to the tail and then to the bit, and then drawn tightly enough to incline the animal's head to one side. This, it is claimed, makes it absolutely impossible for a horse to

kick on the side of the rope. At the same exhibition a horse, which for many years had to be bound on the ground to be shod, suffered the blacksmith to operate on him without attempting to kick while secured in the manner described.

### BEDDING FOR ANIMALS.

The farmer who takes pains to "make up the bed" for his cow or horse, gains ten times more than the cost of the labour of so doing, says the *Prairie Farmer*. If all the material is passed through the cutter previous to being used for bedding, it not only adds to the comfort of the animal, but assists in the matter of cleanliness by reason of its great power of absorption. For this reason sawdust is becoming a favourite, as its fineness not only admits of its being handled easily, well spread in the stall, and promptly removed, but after having absorbed the liquid flows of the stall, still readily mixes with the matter in the manure heap. The merit of sawdust is due to its fineness and to its absorptive quality. If any bedding is plentiful, fine and absorptive, it prevents loss of manure by intimately mixing with it, and as the droppings are more readily incorporated with a great mass of absorbent material the risk of evaporation and escape of gases is lessened. Now, if the labour of cutting is to be taken into account, it is more than balanced by facility in spreading the fine manure when it is hauled to the field

The cutting can be done in winter or during the wet days, and it is a luxury to spread nice, finely-divided manure. Good, fine, clean bedding adds to the thrift and health of the animals, is cooler in summer and warmer in winter, and those who use it prevent much loss.

WHEN a horse falls lame at uncertain and irregular intervals, and suddenly recovers and as suddenly gets lame again, it indicates that the cause is rheumatism, which is a form of inflammation arising from a disordered and usually acid state of the blood, and attacks the fibrous structures, the muscles and tendons of the body. It is frequently constitutional and hereditary, and shifts from place to place without warning and very suddenly, and it may as rapidly disappear by warmth, the heat of the sun or a change of the weather, rainy, warm weather being favourable. Indigestion will cause it to appear, or a cold, or even exposure to a slight change of temperature. The most effective remedy is alkaline salts, as acetate of potassa or hyposulphate of soda, given in one-ounce doses and continued for a week or two. Local applications of hot fomentations to the limb affected, or of stimulating liniment, will be useful. No corn should be given, and soft mashes of bran or oats and linseed should form the bulk of the food.

## SHEEP AND SWINE.

### ARE HEAVY HOGS PROFITABLE?

The question is asked by the *Swine Breeders' Journal*, and it proceeds to discuss the matter. It says: "The above question is often asked and then answered by referring to some person who has sold a lot of heavy hogs at the very highest market price. Just as though it cost no more to raise a 400 or 500 pound hog than it does to raise one weighing 200, when at the same time it is a well established fact that it costs nearly if not quite double per pound to raise a hog weighing 500 that it does to raise a hog that only weighs 200 pounds. Now, it takes very good feeding, ordinarily, to make ten pounds of pork to the bushel of corn, and often requires a good deal of "house-slop" and grass mixed in to make even that gain, and at that rate it takes fifty bushels of corn to make 500 pounds of pork. The corn at fifty cents per bushel—the present market price—would be worth \$25; 500 pounds of pork at six cents per pound would be worth \$30; here, then, you have \$5 for your trouble and risk in the hog, house-slop and grass thrown in, not an extra profit for the labour and risk incurred, say you? But then it is a fact, well understood by careful feeders, that you can't make ten pounds of pork per bushel if you feed your hogs till they weigh 400 or 500 pounds, and I here venture the assertion that in most instances where such heavy hogs are marketed they cost more than they bring on the market. Take the average farmer who carries his pigs through the winter as stockers, runs them on grass the next summer and then feeds them out in the fall so as to weigh from 400 to 500 pounds or even 300, and in a large majority of cases the corn and grass they eat is worth more than the hog would sell for, especially so where the hogs are kept in a muddy pen and the corn fed to them in the mud. I will also venture the assertion that there are more farmers who make less than six pounds to the bushel of corn than that make ten pounds to the bushel.

As a general thing farmers are poor calculators. They worry and work along until they get a "right smart" lot of hogs together, then they "calculate" that it will take a "right smart lot of corn" to feed them out. Finally they get their hogs ready for market, and that, too, perhaps, after feeding them through the very worst season of the year, regardless of cost, and possibly get them to weigh 300, 400 or 500 pounds; they sell them at the top of the market, and, of course, get a "right smart" sum of money for them, and away they run to the first editor they can find and report their sale. In the next issue of this paper the said editor gives a wonderful account of how Farmer So-and-so is getting rich raising hogs, and hog-raising pays, etc., when probably if he had kept a correct account of the cost of these hogs—those very twelve hogs that averaged 444 pounds which Joe Anderson's father sold for \$26.65 each, cost the said Joe Anderson's father over \$30 per head in corn and grass. There have been hundreds of hogs marketed within the last three months that, although they were sold at a high price, yet the corn required to feed

them would have brought more money had it been marketed the same time the hogs were sold, and for these reasons we conclude that even if a farmer sells heavy hogs at a high price, it is not conclusive evidence that he makes money thereby. Take the figures of the Chicago Fat Stock Show, and you will soon see that there is no money in feeding stock until they attain such extra heavy weights; but when we hear of a farmer selling hogs at six and seven months old that weigh from 225 to 250 pounds each, we think we can figure out a little profit in hog-raising, or when we hear of a farmer selling hogs at from eight to nine months old that average from 300 to 350 pounds each, we conclude there is some money in them; and, further, it is proof positive that such farmers are good feeders, and that they keep the best breed of hogs and understand their business.

### MANAGEMENT OF SHEEP.

It will pay any farmer who pays any attention to raising sheep, to separate his lambs from the rest of his flock, his yearlings from the elder ones, and so on until nothing but stout, heavy sheep remain. Lambs need more grain than the older and stouter of the flock, and the old, poor ones need more than the lambs. Give plenty of grain to the ewes for the first four months after breeding, and ground feed, for the best results in raising lambs. Oats, rye, corn and bran mixed in equal parts, with a little flax-seed meal added, makes a good feed. For breeding purposes get the best buck you can procure. For fine style get one that has very wrinkly, long, staple and very oily wool, built with short legs set wide apart, straight on the back, broad between the eyes, white face and Roman nose. This is the kind that has given me the best results. Give bucks all the grain (except rye) that they want, grind and feed it with their hay and corn fodder. Have good sheds, beds and plenty of troughs to feed in, with salt and tar in each, and good sheep will be the result.—*Farming World*.

### PARASITIC DISEASE OF SHEEP.

I want, says a correspondent of the *Country Gentleman*, to ask information about a disease among my sheep. I have recently lost three with the following symptoms: First, I would see them standing aloof from the rest of the flock when feeding, not apparently noticing anything, ceasing to ruminate, with unusual brightness of eyes. When approached they would walk off with an unsteady gait, perhaps going to their hay or fodder and eating in an indifferent way as if they did not care to eat. They would continue to eat a little as long as they could stand, which would be from six to ten days after first taken. After death I examined all three of them; I found the heart, lungs and kidneys in a natural state, but the liver seemed to be nearly rotten, with several small, irregular in form, gristly substances in it. I was fearful of fluke, but on the very closest examination I could find none. The fourth stomach and the intestines were almost entirely covered with irregular shaped lumps from the size of a split pea to the size of two large grains of corn, and filled with a greenish substance of a consistency

from that of corn meal dough to that of grit, some being so gritty and gristly that one couldn't cut them with a knife. They had been fed for some three weeks on good clover hay and corn fodder in a lot without shelter. The clover hay had been pretty heavily salted when put in the barn. I have been sheep farming for several years, and never but once before had any to die for which I could not account, and then I think they died from grub in the head. These had grubs, but I know they were not the cause of their death.—*W. P. C., Campbellsburg, Ky.* [I am quite sanguine that proper research would demonstrate the disease in your sheep to be parasitic. The gristly substances spoken of in the liver were probably hydatids or bladder worms. Should you have another case, put some specimens in a jar of alcohol and send by express to me. It is not fluke disease. Possibly the "lumps" you describe are parasitic cysts, having undergone degeneration, and being partially filled with calcareous matter.]

Henry Lane, of Cornwall, Vt., gives the following cure for stretches in sheep: Exercise; drive them about the yard; seize them by the hind legs and jerk them backward. The disease is caused by the telescoping of the intestines, and this treatment sometimes brings them into place, and the sheep recovers.

A flock of sheep will work up a more valuable pile of manure from the same feed than any other stock. In winter their tread is not so heavy as to prevent light fermentation of the manure pile, which is thus fitted for immediate service. In summer they deposit their droppings more evenly than any other grazing animal during the day time, and at night will select some dry, poor knoll to enrich. The Spanish proverb is true which says: "The foot of the sheep is golden."

J. S. B. writes to an exchange: Milk alone, and especially sour milk, and given as it usually is to excess, is not a sufficient food for young pigs. It should be given in moderate quantity and with corn-meal. A quart at one feed is quite enough, if a quart of meal is mixed with a gallon of milk. The very common paralysis of the hind parts of young pigs is most frequently caused by indigestion, and too much sour milk will surely produce it. Ground bone will be entirely useless as a remedy; the best remedy is to prevent it by reasonable feeding. Barley-meal is as good as corn-meal; shorts are not so good unless plenty of bran is added. A very little salt is beneficial.

FOWLS are as profitable as any other stock the farmer can keep, and more so, provided he pays to them the same attention, and is as much interested in them, as in his other stock. In a majority of cases fowls are merely kept on the farm because they cannot well be dispensed with, and not because the farmer wishes to reap any profit therefrom. As a general thing, you will find that poultry on farms belong to no special breed, but that they are a mixed up mess. Unless the farmer keeps birds that come from a good stock, and feeds them regularly, he cannot expect any profits.

Scientific and Useful.

If the brass top of a kerosene lamp has come off, it may be repaired with plaster of Paris wet with a little water, and will be as strong as ever.

If your children are troubled with worms give them Mother Graves' Worm Exterminator; safe, sure, and effectual.

To wipe dust from papered walls take a clean, soft piece of flannel. Of course it must not be damp, but the dry flannel will remove the dust.

ILL-FITTING boots and shoes cause corns. Holloway's Corn Cure is the article to use.

DOUGHNUTS.—One cup sugar, one spoonful thick cream, a large cup sweet milk, two eggs, salt, nutmeg, spoonful cream-tartar, one-half spoonful soda.

MUCH IN A LITTLE.—Many proprietary medicines, if they cure at all, require such a large quantity to produce effect that it makes them very uncertain and expensive remedies. Not so with Burdock Blood Bitters. It is highly concentrated, and for all diseases of blood, liver and kidneys, one or two bottles will cure more than gallons of the weak mixtures usually sold. Send for facts and figures.

PLAIN JUMBLES.—One cup butter, one one half cup sugar, one egg, one teaspoonful soda in one cup sour milk, spice to taste, flour sufficient to roll in strips.

MRS. D. MORRISON, Farnham Centre, P. Q., writing about Dr. Thomas' Electric Oil, says: George Bell used it on his son, and it cured him of rheumatism with only a few applications. The balance of the bottle was used by an old gentleman for Asthma, with the best results. It acts like a charm.

ROAST DUCKS.—Wash and dredge with flour. Make a bread dressing, stuff and sew up. Put into the oven and baste every five or ten minutes. Make a gravy of browned flour and water and add the giblets, which have been chopped fine and stewed; season and add to the duck when roasted.

O. BORTLE, of Manchester, Ontario Co., N. Y., writes: "I obtained immediate relief from the use of Dr. Thomas' Electric Oil. I have had asthma for eleven years. Have been obliged to sit up all night for ten or twelve nights in succession. I can now sleep soundly all night on a feather bed, which I had not been able to do previously to using the Oil."

THE FEIN CANNOT GAIN IN WEIGHT if they are troubled with dyspepsia, because the food is not converted into the due proportion of nourishing blood which alone can furnish the elements of flesh. But there is no reason, when this wearing, attenuating disease is conquered by Northrop & Lyman's Vegetable Discovery, why there should not be an appreciable gain in weight, which indeed is usually the case. It is a peerless remedy also for Constipation, Liver Complaint, Kidney troubles, and roots out all impurities from the blood.

SNOW PYRAMID.—Beat to a stiff foam the whites of half-a-dozen eggs, add a small teaspoonful of currant jelly, and whip all together again. Fill as many saucers as you have guests, half full of cream, dropping in the centre of each saucer a tablespoonful of the beaten eggs and jelly in the shape of a pyramid.

MR. H. F. MCCARTHY, Chemist, Ottawa, writes: "I have been dispensing and jobbing Northrop & Lyman's Emulsion of Cod Liver Oil and Hypophosphites of Lime and Soda for the past two years, and consider that there is no better preparation of the same kind in the market. It is very palatable, and for chronic coughs it has no equal."

SORE THROAT.—This common and painful affection may be readily cured by the prompt application of Hays's Yellow Oil, taking it internally at the same time according to directions. In croup, asthma, colds, swollen glands, rheumatism and other painful diseases it is equally efficacious.

DELMONICO PUDDING.—Three pints milk, five eggs, four tablespoonfuls corn starch, sweetened to taste. Boil starch in the milk five minutes, beat the eggs, leaving out the whites of three, pour them into the starch. Flavour to taste. Put into a dish, bake. When nearly done spread the whites beaten to a froth, sweetened and flavoured, over the top of the pudding.

MISS MARY CAMPBELL, Elm, writes: "After taking four bottles of Northrop & Lyman's Vegetable Discovery and Dyspeptic Cure, I feel as if I were a new person. I had been troubled with Dyspepsia for a number of years, and tried many remedies, but of no avail, until I used this celebrated Dyspeptic Cure." For all impurities of the Blood, Sick Headache, Liver and Kidney Complaints, Constipation, etc., it is the best medicine known.

NEW SPECIAL PREMIUMS.

SHEET MUSIC PRESENTED

To the Sender of Every New Subscriber to

"THE RURAL CANADIAN" FOR 1884.

TEN SEPARATE PIECES of the valuable full-size Sheet Music, selected with great care and classified below, will be PRESENTED and sent, postpaid, anywhere in Canada or the United States, to any person who immediately sends us ONE NEW subscriber (or their own subscription, if new) to THE RURAL CANADIAN for 1884, at the regular rate of \$1 a year. This Sheet Music is printed on the best music paper, and is full-size. In ordering, give the number of each piece of the ten wanted, also the numbers of two or three extra which we might substitute if any of those specially needed were all disposed of. Address plainly—

C. BLACKETT ROBINSON, 5 JORDAN STREET, TORONTO.

- 119 Sweethearts Sullivan 30
123 Take Back the Heart Claribel 30
124 Tar's Farewell Adams 35
125 That Traitor Love Roocke 30
126 Then You'll Remember Me Balfo 30
128 Then Art So Near and Yet so Far Reichardt 50
130 Three Sailor Boys Marzials 35
131 Tui Voice is Near Wrighton 25
132 Tis Not True (Non e ver) Mattel 50
133 Tis But a Little Faded Flower Thomas 50
134 Time of Apple Blossoms Campana 30
135 Tired Lindsay 35
623 Twenty Years Ago Gatty 30
136 Twickenham Ferry Marzials 35
140 Unforgotten Days Roocke 35
623 Unforgotten Song Barri 30
141 Waiting Blumenthal 40
142 Waiting for Me Hancock 35
144 Warrior Bold Adams 3
145 Watering Mother Oliver 35
146 Way thro' the Wood Dolby 60
147 Weary Gabriel 30
148 We'd Better B'de a Weo Claribel 35
150 What Jack Will Say Piusini 50
624 What Need Have I the Truth to Tell Claribel 35
153 When the Heart is Young Deon 35
625 When the Dew Begins to Fall (Waltz song) Turner 75
154 When the Swallows Homeward Fly Abt 30
465 When the Leaves are Turning Brown Craunton 40
155 When Red Leaves Fall Hatton 30
156 When the Swallows Come Piusini 30
157 Will He Come Sullivan 50
159 Yes, Sir Wakefield 35
160 You and I Claribel 30

Songs with Choruses.

SENTIMENTAL, NEGRO AND MINSTREL SONGS.

- 163 Angels, Hear the Little Prayer Wyatt 40
163 Baby's Empty Cradle Skelly 40
626 Beautiful Eileen, the Maid of the Lea Gleason 40
165 Carry Me Back to Old Virginia Negro 30
166 Columbia's Noble Men Turney 25
167 Darling, Has Your Love Grown Cold Pummer 35
627 Dear Friends of Long Ago Scott 35
168 Down by the Old Mill Stream Reid 35
628 Eileen's Message Turnbull 35
498 Father is Dead and Mother is Poor Holloway 20
169 Grandmother's Chair Read 35
171 Ill See That Your Grave is Kept Green Clayton 35
629 I've Just Been Down to the Gate Wilson 40
173 Lads That Live Next Door Tucker 40
175 Little Snow White Hands Gabriel 35
176 Lullaby Rammet 40
177 My Grandmother's Watch Conway 35
178 One Sweet Kiss before We Part Turney 35
179 Only a Word, Love Turney 35
180 Over the Garden Wall Fox 35
181 Passed Within the Gates Ajar Peck 40
630 Peep Boo Wilson 40
182 Poor Orphan Boy Duncan 40
499 Pretty as a Butterfly (Song and Dance) Bobby Newcomb 40
184 Sentless Rose (A) Conway 35
185 Scenes of My Youth Turney 35
187 Send Me an Answer from over the Sea Pratt 40
186 Somebody's Grandpapa Wood 40
632 Shady Tree, Babbling Brook Wilder 35
189 Sunbeam in the Strain Conway 35
190 Stony Long Ago Danks 35
191 Sweet Girl May I be There Turney 35
491 Swinging on de Golden Gate Lyons 40
634 Sweet Birtle Murphy 40
121 They Say I am Nobody's Darling Tucker 40
122 This Wedding Ring of Mine Bobby Newcomb 40
123 Visions of the Past Russell 35
124 When First I Saw My Darling's Face Danks 25
632 When the Clouds Go Rolling By Gabriel 40
633 We Never Speak as We Pass By Milford 40

Comic Songs, and Songs and Dances.

- 193 Bread and Cheese and Kisses Lyon 35
197 Cackle, Cackle, Cackle Bagal 35

- 200 Don't Blame Me, for I Didn't do it. Duncan 40
772 For Goodness Sake don't Say I Told You. Lloyd 30
765 I'm a Member of the Club Martyn 40
201 I have Come Home for Dinner, Kate. Lyon 25
202 I'll Get Rid of My Mother-in-Law. Duncan 40
203 I Won Her Little Heart when Dancing. Musgrave 30
204 Jeremiah, Blow the Fire. Tony Pastor 30
205 Lady Dahl. Birbeck 35
207 Maid and Maggie. Phillips 35
208 My Love Nance. Bobby Newcomb 40
209 Naughty Clara. Knowles 30
636 O You Little Darling. Yanoni 40
210 Too Late to Marry. Pratten 40
211 Torpedo and the Whale. Audran 25

Sacred Solos, Duets, Trios and Quartettes.

- 501 Abide With Me. Old Popular Melody 20
215 Ashamed of Jesus. Field 40
216 Ave Maria. Gounod 35
502 Arise, Arm, Ye Brave. Haudel 35
503 And the City Hath No Need of the Sun. Whittington 35
504 Ave Sanctissima. Old Song 20
600 But the Lord is Mindful of His Own. Mendelssohn 30
505 Christmas Hymn. Holloway 20
217 Cleansing Fires. Virginia Gabriel 40
218 Father of Mercies. Barringer 25
219 Forgive Me Not. Glover 30
610 He Giveth His Beloved Sleep. Abt 30
606 In Heaven, O Jehovah, is Fixed Thy Throne, Christians' Prayer. Spohr 50
507 I Sought the Lord and He Heard Me. Costa 50
508 I Think of Thee. Redhead 50
509 I'll Star of the East (duett). Scotch 50
511 The Nightfall on the Sea 20
509 Jerusalem the Golden Old Popular Tune 30
510 The Lord is My Shepherd (Quartette). Martin 35
220 Let Music Break on This Good Morn. Christmas Carol. 25
221 Lord be with Me in My Walk. Schroeder 30
222 Nearer, My God, to Thee. Barton 50
511 O Clothe our Valleys with Ripening Corn. Spohr 40
513 O Let Those Whose Sorrow. Wilson 20
505 Pilgrims of the Night. Holloway 20
625 The Palms (Les Borneaux). Faure 40
223 Rest in Jesus. Hymn 20
224 Saviour, Breathe an Evening Blessing. Spencer 25
508 Star of the East. Scotch 20
225 To Jesus our Exalted God. Braun 35
227 When I View the Mother Holding Sacred 30

Duets.

- 423 All's Well. Braham 30
640 Come When the Soft Twilight Falls. Schum 35
220 Don't Thou Love Me, Sister Ruth? Parry 25
221 Emblem of Constancy (duett). Turney 30
222 Ever, Ever Thine (duett). Brown 50
223 Gobble Duett (from Mascoffe). Audran 40
425 Has Sorrow Thy Young Days Shaded. Tom Moore 15
224 Hunting Tower (duett). Demar 40
226 I Would That My Love (duett). Mendelssohn 35
227 In the Starlight (duett). Glover 40
424 Labour Watch. Williams 40
426 Over the Mountain. Holloway 10
228 Wandering in the May-Time. Glover 60
641 What Are the Wild Waves Saying Glover 20
229 When I Behold Thee (duett from Mascoffe). Audran 40
240 When Ye Gang Awa, Jamie (duett). Demar 40

Quartettes and Choruses.

- 626 Bridal Chorus (from Lohengrin) (quartet). Wagner 35
627 Coast is Clear (quartet). Meyerbeer 50
427 Farewell. German Volkalled 10
628 Hymn of Columbia (National Hymn). Bodworth 30
429 Silent Night (6-part song). Bernby 30
600 Sleep my Child (Solo Voice). Eaton 20

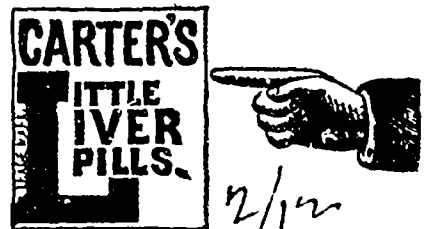

CURE

Sick Headache and relieve all the troubles incident to a bilious state of the system, such as Dizziness, Nausea, Drowsiness, Distress after eating, Pain in the Side, &c. Whilst their most remarkable success has been shown in curing

SICK

Headache, yet Carter's Little Liver Pills are equally valuable in Constipation, curing and preventing this annoying complaint, while they also correct all disorders of the stomach, stimulate the liver and regulate the bowels. Even if they only cured

HEAD

Ache they would be almost priceless to those who suffer from this distressing complaint; but fortunately their goodness does not end here, and those who once try them will find these little pills valuable in so many ways that they will not be willing to do without them. But after all sick head

ACHE

Is the base of so many lives that here is where we make our great boast. Our pills cure it while others do not.

Carter's Little Liver Pills are very small and very easy to take. One or two pills make a dose. They are strictly vegetable and do not grip or purge, but by their gentle action please all who use them. In vials at 25 cents; five for \$1. Sold by druggists everywhere, or sent by mail.

CARTER MEDICINE CO., New York City.



Combined Milk Bucket and Stool. (DOMINION PATENT.)

This Milk Bucket and Stool is invaluable to farmers and all persons connected with the selling, buying, or handling of milk.

BY ITS USE—

The milk is kept pure and clean. It saves every drop of milk. It is convenient for milking, and does away with the old-fashioned stool. Every Canadian farmer should have them and use them.

Manufactured by the

"ONTARIO MILK BUCKET M'FG CO." 159 Queen St East Toronto.

Sold in every county of Ontario by special agents.

RENNIE'S SELECT Field, Garden AND Flower SEEDS ARE THE BEST THE HANDSOMEST AND MOST COMPLETE CATALOGUE FOR 1884 FREE TO ALL INTERIOR PURCHASERS. WM. RENNIE, TORONTO.

SEED CORN!

Pre-ENGLISH or GREEN fodder. 10 lb. high. 2 1/2 to 3 1/2 tons per acre not unusual. Stock raised 1800 lbs. clean. Same good price by mail. Dairy and Farm produce. Correspondence: J. W. WILSON, 101 York St. N. Y.

Fewer colic, unnatural appetite, fretfulness, weakness and convulsions are some of the effects of worms in children; destroy the worms with Dr. Low's Worm Syrup.

## GOOD PAY TO AGENTS.

Agents wanted in every village, town, and township, to make a thorough canvass for the RURAL CANADIAN. Liberal inducements. Work to commence at once. For full particulars address

C. BLACKETT ROBINSON,  
Publisher.

Jordan Street, Toronto.

## The Rural Canadian.

TORONTO, APRIL, 1884.

THE *Farming World*, published at Cincinnati, O., is a well-conducted, wide-awake agricultural journal, which we gladly place on our exchange list. Its correspondence department covers a broad range of interesting and useful topics.

ROTATION in the garden is as necessary as in the field. Different kinds of vegetables require different kinds of food. While manuring will help much, it is in every way desirable to reverse the order of planting every year. Better crops will result

FOR people who have not a hot-house a few boxes in the windows are very convenient for starting early bedding plants. Cabbage, lettuce, tomatoes, etc., may be started in this way, and transplanted as soon as the ground and the season is ready for them.

A MORRIS (Manitoba) correspondent, when remitting his subscription for the RURAL CANADIAN, says: Times are not good hereabouts, wheat, 50 cts.; oats, 12½; barley, no sale; hay, \$4.00 per ton. We hope in the near future that our friend may be able to give a more cheering report of the farmer's prospect in his neighbourhood and throughout the great North-West.

THE transplanting of raspberry, blackberry, and currant bushes should be attended to in the first warm days, for the new shoots that will bear next year's fruit start early and it is better to place them where they are wanted before growth begins. These fruits are luxuries which every farmer may enjoy, and a little land, a little manure, and a little intelligent labour will furnish them.

A HEAVY clay, with a stiff clay subsoil, will be improved by subsoiling. By subsoiling is meant breaking and loosening the subsoil so as to permit water to sink freely through it, and to admit air and warmth, but not ploughing it up to the surface to cover or replace the top soil. Subsoiling is done by peculiarly shaped ploughs, which penetrate sixteen or eighteen inches deep, and do not disturb the upper soil. The subsoil plough may be run behind the common plough in the furrow.

OUR scrupulous contemporary, the *Orillia Packet*, is sure that an engraving of a pair of turkeys in the last number of the *Rural Canadian* was inaccurately described. In previous days, in a Western county of Ontario, a person was tried for stealing fowls. In summing up the case the judge intimated that any of the jurors who desired, might ask a question. One wide awake farmer, snapping his fingers, schoolboy fashion, said he had a question to ask, "Were the stolen fowls male or female?" The judge replied that was immaterial. Our friend of the *Packet* holds with the juror rather than the judge. There is nothing like accuracy in these matters.

## GLANDERS IN HORSES.

Few men knowing anything about horses and the diseases to which they are subject but recognize how desirable it is to have some effective way of dealing with animals suffering from glanders. Although this is peculiarly a horse disease, it is by no means confined to that class of animals. Cattle may take it, and so may sheep; so, too, may human beings. And the terrible characteristic of glanders is, that it is incurable. It is contagious and abominable as leprosy, and almost as much to be dreaded. Yet it is by no means uncommon to find men who own horses affected with the disease, and who persistently refuse to either destroy or isolate them. As a rule, they usually find their way into the hands of a class of men known as horse-traders—and a horse-trader is generally admitted to be the most unscrupulous man to be found in a community. Hitherto we have had no law in the country by which men who exposed glandered horses could be reached by the law, and there was neither authority to destroy nor isolate a diseased beast, nor to punish the man who owned him or trafficked in him. The Dominion Act on the subject of contagious diseases affecting live stock is, so far as glanders is concerned, a complete farce. But a Bill has been passed by the Ontario Legislature during the session just closed, which it is confidently believed will meet a long-felt want. Under this Act, which was introduced and carried through by Mr. Dryden, any two magistrates are clothed with ample authority to cause the destruction or isolation of any glandered animal, and to punish any person who knowingly traffics in any such animal. The provisions of the Act are very simple, and the machinery of the law may easily be put in motion. At the same time, adequate protection is given to any person who is the owner of animals suffering from this disease, and no injustice is likely to be done by even its stringent operation.

## DO POTATOES RUN OUT?

We sometimes hear it said that neither potatoes nor any other seed ever run out excepting through careless or improper cultivation. Doubtless there is much to be said in support of the theory that vitality of seeds may be maintained by supplying the proper nutriment, but the experience of the best farmers teaches them that varieties run out in the course of years and that new ones must be introduced. Thirty-five years ago the Pinkeye potato was a general favourite, but in time it degenerated and was finally given up altogether. At a later period every farmer planted the Peach-blow, a potato of such excellent quality that ever since every new variety is measured by old men by the standard of the Peach-blow. But by-and-bye this ran out also, and the Rose took its place. Does anyone need to be told that the Rose has degenerated? A dozen years ago it yielded prolific crops, and its flesh was white and mealy. Look at it to-day. The yield has greatly fallen off, and the flesh has become spongy and discoloured. The purple streaks one sees in it now awakens grave doubts as to the healthful character of the Rose, and one only requires to look at the large proportion cast aside at the table to be

convinced that the Rose has lived its full time. We trust that the farmers of the country generally will recognize this fact, and that this year they will plant some new variety. If they do not, depend upon it they will be the largest losers. They will not only lose in getting a reduced yield, but also in getting a reduced price. But it will be asked, what variety can be planted instead of the Rose? There are several good ones, and among others the White Elephant and the Beauty of Hebron. We also think it would be well if farmers sent for a supply of seed to the Lower Provinces, and especially New Brunswick. There is perhaps no part of the continent in which better potatoes are grown than in that Province.

## THE DEPARTMENT OF AGRICULTURE.

Session after session at Ottawa committees are appointed to enquire respecting the best means of promoting agriculture, but so far as we can see, nothing of a practical or useful nature has yet resulted from the enquiries made. As a rule these committees have been appointed for one political object or another, and when the immediate object aimed at was realized there was an end to the matter. This year has seen a repetition of the same old movement, but we hope to see more good come of it. One thing can be said of the present committee, and that is that it is not a merely political one. Fisher, of Quebec, and Mr. Bain, of our own Province, are practical and sensible men, and whatever they can do to promote the cause of agriculture in the Dominion and to make the work of the Department of that name something more than a fiction, we may with some confidence expect to see done. There is a great deal which the Department of Agriculture at Ottawa might do to advance the interests of the farmer in the several Provinces, and especially in the way of directing the attention of Europeans to the splendid opportunities open to them here; but the fact is that the Department is only a department of agriculture in name, and that it will never accomplish anything until it is reconstructed on a different basis, and officered by able and practical men. We trust that the committee of this session will be able to make some useful suggestions to that end.

## "SITTING ON" AN AGRICULTURAL JOURNAL.

At the recent meeting in Guelph of the Ontario Agricultural and Experimental Union, our good friend of the *Farmers' Advocate* was brought up standing and, in our opinion, very properly so. Our Western contemporary has always been grumbling at the management of the College. Its fault-finding with the Government always seemed to us one-sided, partizan, and, of course, grossly unfair. The graduates of the College are evidently of the same opinion, and gave unmistakable expression to their views in terms following.

Mr. Ramsay submitted a resolution to the effect that the ex-students of the Agricultural College present desire to place on record their condemnation of the course pursued in the past by the editor of the *Farmers' Advocate* in decrying the College at every opportunity, and in publishing false assertions in reference to its operations. The resolution was promptly seconded by another ex-student. Mr. Weld stigmatized the resolution as a concerted scheme, and wished the students to substantiate their reports. Mr. Rennie, Hamilton,

stated that he had read Mr. Weld's paper for three years, and could heartily endorse the resolution as true in every particular. He asserted, without contradiction from Mr. Weld, that a letter written by him (Mr. Rennie) in reference to the case of the death of the spring lambs already referred to, was refused insertion in the *Farmers' Advocate* on one pretext and another, even insinuating that he had been induced to write the letter by the college authorities, which statement he characterized as utterly false. Another ex-student condemned the coarse and scurrilous attacks of the *Advocate*, and wished Mr. Weld to instance a case in which he had offered any suggestion for its improvement. The scene was of a lively character, Mr. Weld being given every opportunity of defending himself. Prof. Brown and Principal Mills suggested the withdrawal of the resolution, which was acceded to, the mover expressing himself to the effect that unless the College got fair play from the *Advocate* the resolution could be brought up again that year and passed.

It matters little what course the *Advocate* decides to take in the premises. The College has succeeded in the past in spite of adverse criticisms in its columns and in the speeches of Opposition members of the Assembly. It will continue to succeed, and prove itself an increasing power for good, even should these malicious attacks be continued.

#### RURAL TOPICS AT McHENRY'S.—II.

BY JEAN BAPTISTE.

It was a spring rain-storm that crowded McHenry's store, when the conversation of which I took notes took place, and the men were all sitting on the counter looking over a thin book that the store-keeper had thrown at Paul Quesnel.

"Golly!" said that worthy Canadian, trying to imitate the English sound in this expletive, but making a dismal failure, "three hundred and fifty varieties of potatoes this book says, how can a fellow tell which to plant?"

"I stick to the old 'Chilli,'" said Pete Duffy. "Garden Chillis are most bulk on the ground of any of yer new-fangled sorts."

The store-keeper was measuring out some molasses, and as he wiped his fingers on a canvas bag he said with slow deliberation, "Wal, I tried some of the new sorts last spring. There's 'Rosy Morn.' It didn't turn out much, but the 'White Star' is a tearer. Early? N-no, but it keeps well, and stands drouth in a dry season. It's as dry an' floury as meal, and pure white in flesh, and then the leaves don't attract them potato bugs. Somehow they can't manage to eat 'em all. I guess they grow too fast and are too strong in the vine."

Several of the men spoke in favour of the "Mammoth Pearl," which was selected from over 2,500 seedlings, and gives big crops in spite of the bugs, is free from rot and never hollow.

Francois Laberge thought there was nothing like new land for soil, and wood ashes for fertilizers for the potato, and he said that scab was caused by putting on too much fresh manure, though you couldn't feed a potato too much of the right sort.

The store-keeper said he had sprouted some tubers in damp sand, with a little moss over it, beside the kitchen stove, and allowed they would be a good fortnight earlier than if only planted out of doors. It was the new early kind, "Sunrise."

Pete Duffy said he could beat that all hollow by putting single eyes in three-inch pots, then a little earth, and plunge them in the hot-bed.

Paul Quesnel said he believed in clover sod turned under in the fall for his potato crop; and he knew from experience that ashes prevented the rot in bad years.

So they talked and smoked till the fire burned low and McHenry put up the shutters and then stretched himself with a loud yawn that gave us the hint to trudge home, and by this time the frogs were piping, and the stars out.

#### A BED OF LILIES.

BY ANNIE L. JACK.

In laying out our gardens in early spring it would be well to consider if we could not have permanent flower beds of such plants as will not need yearly renewal. There is nothing finer after roses than a bed of lilies of various kinds, and a succession of bloom can be obtained from June until frost comes. Of course the Japan lilies *L. Anratum* comes first, the showiest and most perfect. It varies greatly in the time of flowering, being altogether uncertain—plants that bloom in July one year may wait until September the next.

To my taste the loveliest lily of all is the *L. Longiflorum*, and *Candidum*. In rich moist land it grows with very little care and is hardy in Canada, if slightly covered with coarse litter. They are propagated by division of the bulbs, and the small bulblets on the stem flower in three years. The perfume of these lilies is overpowering, it is often called the "virgin's lily," and is a type of purity. The *L. Lancifolium* is very beautiful, as is the *L. Chalcedonicum*. A bed of lilies should be a little removed from the house, in a somewhat shaded situation and with a thick border of Lily of the Valley, a group of *Anratums* in the centre, and a row of the *Funkia* or Day Lily nearer the edge with *Longiflorums* and other choice kinds to fill spaces, it can be made a bed of great beauty all through the season. And it is a pleasant recreation to a weary heart, to see the developments of the different species, to help in the cultivation of these beautiful creations, and to "Consider the lilies how they grow."

#### APPEARANCES.

Appearances may often deceive, but the world judges things by them. The outward show and semblance are generally taken as a token of the intrinsic value. This is characteristic of men, who for the greater part take no trouble to think for themselves, but take their opinions as they do their clothes, ready-made. But it is foolish to strive against a swift current when one can reach the desired end so much more easily by going with it, and therefore it is best to accommodate one's self to the popular habits and make a show of virtue, whether we have it or not. In regard to this popular habit, however, it is very often a true index to the character of the man whose surroundings are noted; and a slovenly front yard, a toppling fence, a dislocated gate, a reeking, filthy barnyard, and general looseness and untidiness about the homestead, are pretty certain to indicate a careless, unthrifty farmer. On the contrary, a homestead about which neatness and order everywhere prevail, where the stock is well kept, the buildings and yards clean, the fences in good order, the

gates substantially hung, and always closed and fastened; the orchards neatly trimmed and pruned, the lawn green and closely mowed, the shrubs, trees, and flower borders well kept; all these necessarily proclaim the owner an orderly, industrious, thrifty farmer, whose prosperity may be measured by the prevailing appearance of his surroundings.

Thus one may travel along the roads and note down as he goes, with a good deal of accuracy, the character of the inhabitants. He may get a deeper and still more accurate test if he goes behind the scenes and views the back yards, the rear fences, and the distant fields. If the hindsight is similar to the front view, the owner may be put down very safely as an upright, honest, consistent man, in whom there is no deceit or guile, and who does not put on a show for the sake of appearances and to get a reputation which is not wholly deserved; so that appearances really do not deceive when they are tested thoroughly, but only when the outward show is partial, superficial, and but thinly disguised.

Every farmer should be jealous of the appearance of his home for his own credit. He will stand well with his neighbours and be respected by strangers in proportion to his deserts in this respect. It is his duty to himself, as well as to his neighbours, to thus enhance the reputation and value of his locality. It is a virtue, too, to be encouraged for its results upon the man himself. It is disciplinary. It is a part of a man's training which does not end until he dies, for it has a great effect upon his general habits and character. Still more important is the fact that it is a training for his children, and helps to form their character and strengthen their self-respect, which is a very important factor in the problem of the young person's moral life. For all these reasons this timely subject should receive careful attention and should be put in practice forthwith. One need not say he has not the means to make a show and to expend money upon the adornment of his home. This is not what is meant. It is putting the best appearance upon what we have and not striving for something we cannot reach. A farmer in homespun, if his dress is scrupulously clean and neat, is quite as respectable as another in broadcloth. It is the manner and not the material which counts. A plain board fence, if neatly and strongly put up, and a rough gate evenly hung and provided with a good latch, which should be used, and a smooth plot in front of the house, if nothing more than grass, with tidy footpaths and a clean, well fenced barn-yard in the rear, will serve to mark the man as well as the ornamental scroll-work fence of his richer neighbour. In fact, plainness, if it is neat and substantial, is better than the greater pretense of the more elaborate show, brilliant in all fashionable colored paints and the gaudy flowers chosen chiefly for their conspicuous colours.—*N. Y. Times*.

THE Monarch Horse Hoe and Cultivator combined is the latest improvement in agricultural implements, designed for hoeing (with horse), potatoes, corn, beets, cabbage, turnips, etc. See advertisement of Monarch Mfg. Co., in another column.

SUBSCRIBE FOR THE RURAL CANADIAN.

## THE DAIRY.

## A CHAPTER ON COWS.

Farmers strive to raise or buy the best of cows. Probably not one in five hundred will make, on flush pasture, 10 lbs. of butter a week, and 300 lbs. of cheese in six months, or 100 lbs. of butter for the same time, is more than the average. I had a large rough cow that made twelve pounds of butter a week and held on well to her milk; she was very well marked, according to the French rule, and a huge feeder. A large pale white and red cow, with large neck, head and horns, made nine pounds a week, but we did not think her so good as cows that made seven pounds and held on to their milk better. An ordinary sized cow made nine pounds a week, but soon shrunk in milk. A fine grade cow made ten pounds and held out well. Of cows I have seen, a small, sleek-coated cow made ten pounds in a week; a handsome cow made fourteen pounds—a very busy feeder; a large rough cow made seventeen pounds; a large, fat Durham, with the best of pasture and all the feed she could eat, was claimed to make twenty pounds a week; a large, ordinary looking cow made fourteen pounds, but she went dry long. We tried three cows lately—in March. A handsome cow made 2½ lbs. a week; it took thirty-six pounds of her milk for one of butter. A white cow with thick neck and large horns also made two and a-half pounds; it took twenty-six pounds of her milk for one of butter—these were farrow cows. A broad and fresh cow made ten pounds in six days. So it would seem best to buy and raise cows that would make good beeves and try them, retaining only the good milkers. A good time to buy a cow is four or five months previous to her calving. Sit down and milk her; note the quantity and quality of the milk; get some of the milk and see what cream rises.

From forty years' experience with cows; from all I could learn from others; from seeing most of the remarkable cows I could hear of, it seems thus about them: A cow should have a good constitution; to have this she can't be too broad on the back, and full back of the forelegs; then the broader over the loins and to the tail the better, and as straight down behind as you can get; in short, a cow that will make a good beef, for this is what she comes to. Then, if you can have the head and neck small, milk-veins large, horn small and green, and be well marked in the escutcheon, and sleek-coated, all the better; but these latter points are not essential to a good cow, as experience has abundantly proved. Cows in their native condition give but little milk, and only for a few months of the year. But with domestic cows, trained from young heifers to give most milk, and to hold on; bred from the best milkers, and stimulated through life to give the most milk; they that make the best use of what they use, in accumulating flesh, should be most profitable, when that propensity is diverted to producing milk. But only experience can test a cow. To have cows come up to be milked, give them a very little salt each time; keep them hungry for it. Have well-bedded and very open stables in summer.

Fasten the cows in their stalls by a light rail fastened behind them. We have straw around our cows and close to their backs. Keep them as close as possible in cold weather; and well ventilated as possible in warm weather; we keep them in in winter except when they go to water. Our cows, without grain, are as fat in spring as in fall, and we milk them until within six weeks of calving.—*J. B. Smith, in N. Y. Tribune.*

## JERSEY COW, "MARY ANNE."

We present our readers this month with the likeness of the famous Jersey cow "Mary Anne," of St. Lamberts, 9770. This wonderful animal is the pride of the Oaklands herd, and must be of special interest to Canadians, seeing she is thoroughly Canadian in birth, breeding, and ownership. She occupies the proud position of having made the best record of butter in seven days and in thirty-one days ever made by any cow of any breed. "Mary Anne" is at present on a test, endeavouring to raise the record for a year. She is not yet at her prime, being only four years old. She is not only a wonderful cow, but belongs to a family, nearly all of whom have



JERSEY COW, "MARY ANNE."

proved themselves extraordinary butter-makers. Her test of 27 lbs., 9¼ oz. of butter in seven days, and her present year's record of seven months, amounting to 6,405 lbs., 12 oz. of milk, and 653 lbs., 14¾ oz. of butter, is simply marvellous. The reputation enjoyed by the Oaklands farm under the reign of "Bertha Morgan," will be still further increased by the doings of her successor, "Mary Anne," of St. Lambert. We wish long life and prosperity to this "Jersey Lily."

BUTTER AND MILK RECORD OF THE JERSEY COW "MARY ANNE," OF ST. LAMBERT, 9770 (FOUR YEARS OLD), AS FAR AS TESTED.

Date.	Milk.	Butter.
May 29 to June 28, 31 days,	1,173lb. 8oz.	106lb. 12½oz.
June 29 to July 29, 31 days,	1,066 " 4 "	102 " 6 "
July 30 to Aug. 29, 31 days,	973 " 8 "	102 " 10½ "
Aug. 30 to Sept. 29, 31 days,	1,002 " 0 "	105 " 5½ "
Sept. 30 to Oct. 30, 31 days,	876 " "	94 " 6 "
Oct. 31 to Nov. 30, 31 days,	675 " "	73 " 15 "
Dec. 1 to Dec. 31, 31 days,	634 " 8 "	68 " 7½ "

7 months, 217 days, 6405lbs. 12oz. 653lbs. 14¾ oz.

LORD LISGAR, 1066 (SON OF VICTOR HUGO, 197), HAS SIBED

Duchess of St. Lambert, 5111, with butter test of 15 lbs. 13 oz. in seven days.

Clematis, of St. Lambert, 5478, with butter test of 14 lbs. 3 oz. in seven days.

Jolie, of St. Lambert, 5126, with butter test of 15 lbs. 13½ oz. in seven days.

Sweet Briar, of St. Lambert, 5481, with butter test of 14 lbs. 3 oz. in seven days.

LORD LISGAR, 1066, SIBED THE DAMS OF

Minnette, of St. Lambert, 9774, with butter test of 17 lbs. 4 oz. in seven days.

Diana, of St. Lambert, 6636, with butter test of 16 lbs. 6 oz. in seven days.

Cowslip, of St. Lambert, 8949 (at rate of by repeated tests), 15 lbs. in seven days.

Uinta, of St. Lambert, 5743, with butter test of 14 lbs. 10 oz. in seven days.

Nora, of St. Lambert, 14880, with butter test of 14 lbs. 7 oz. in seven days.

Moss Rose, of St. Lambert, 5114, with butter test of 14 lbs. 0½ oz. in seven days.

Juliette, of St. Lambert, 5483, with butter test of 18 lbs. in seven days.

Honeyuckle, of St. Anno's, 18674, with second calf, with butter test of 14 lbs. 10 oz. in seven days.

Jessie Brown, of Maxwell, 7266, 6 lbs. 8 oz. in three days, equal to 14 lbs. 7 oz. in seven days.

LORD LISGAR'S SON, LORD ATLMER, 1067, SIBED

Melia Ann, 5444, with butter test of (on grass alone) 18 lbs. 0½ oz. in seven days.

LORD LISGAR'S SON, BARONET, 2240, SIBED

Chamomilla, 7552, with butter test of 6 lbs. 10 oz. in seven days.

Uinta, 5743, with butter test of 14 lbs. 10 oz. in seven days.

Dairymaid, of B., 9352, two years old, with butter test of 12 lbs 8 oz in seven days.

Variella, 6337, 7 lbs. 13 oz. for three days, equal to 18 lbs. 3½ oz. in seven days.

Bonnie 2nd, 5742, with butter test of 14 lbs. 11½ oz. in seven days.

LORD LISGAR IS G. O. SIRE OF

Mary Anne, of St. Lambert, 9770, with butter test of 27 lbs. 9¼ oz. in seven days.

Judith Coleman, 11391, at two years eleven months old, with butter test of 17 lbs. 5 oz. in seven days.

Alpha Juda, 11889, with butter test of 15 lbs. 1½ oz. in seven days.

## THE COST OF MAKING GOOD BUTTER.

Occasionally something of a mistake is made in supposing that it costs very much more to make good butter than it does to make bad butter. We begin with the cow in butter-making operations. Now it costs just as much to keep a poor cow as it does a good cow, and if we raise her from a calf, it costs just as much to get her, whether she is good, bad, or indifferent. If we purchase her, the good cow will cost more to start with, but her yield will more than make up the difference, so that it may be considered as settled that a poor cow costs as much as a good one. The character of the food has to do with making good butter, of course. If the cow is left to pick up her living by the road side, it will cost less than if she is kept on good pasture. But as to that matter, a cow ought to be well and humanely taken care of if she is not in milk at all. So with a good cow and good feed we have made a start. Cleanliness is the next request. It begins with the hands and milk pail. It costs a little time, and time is money, or the old adage is out of joint, to wash the hands and the milk pail. But that cost ought not to be considered, for the pail and the hands ought to be washed anyhow. Then the udder should be cleaned and the other parts of the cow from which dirt would be apt to fall into the milk, brushed off. But do the cleaning before the milking begins. Do not follow the plan sarcastically described by T. H. E. Monroe, Wis., in a recent article, and which was so ludicrous that it has been widely copied. Having maintained cleanliness up to the time of straining the milk continue it all through the operation of raising the cream and making the butter. Keep the cream at an even temperature, by lowering it in the well, if you have no creamer; but get a creamer, if you have much of a dairy. Now we admit that there is somewhat greater cost attending these operations than there would be in a slipshod system, but it is not so very much greater after all.

THE cheesemakers are running their best market—the home market—by flooding the country with miserable skins which nobody wants.

## WHAT IS ANATTO?

Cheese has for a long time been coloured with anatto, and, of late years, it has come in use, not only in creameries, but in home dairies, to give colour to butter. The increasing use of the substance, especially in winter, naturally leads many to ask: "What is anatto, and is it harmless?" The name which came with the substance from South America, has a great variety of spellings besides that given above, which is the simplest and the one we first learned: it is given in different books as *annato*, *annata*, *annotta*, *arnotta*, *arnota*, and so on. The substance is the product of a small South American tree, *Bixa orellana* belonging to a small family to which it gives its name (*Bixineæ*), of which we have no representatives. Systematically, the family is placed near that of the violets. The tree rarely exceeds twelve feet in height, has a handsome head, and each branch is terminated by a cluster of flowers of the colour of peach-blossoms. The pods are at first of a fine rose colour, becoming brown as they ripen; they are covered with bristles, and contain numerous seeds, the important product. Each seed is surrounded by a dark red pulp, to remove which, they are placed in water and allowed to ferment, with frequent stirring. When the seeds are free from pulp they are strained out and the pulp allowed to settle. It is afterwards placed in kettles, evaporated to a thick paste, which is the anatto of commerce. It is made into rolls weighing from two to four pounds, which are covered with canna leaves and packed in wicker baskets, or more generally of late in boxes. Anatto, when fresh, has much the consistency of putty, a dark, brownish-red colour, and with a somewhat disagreeable odour. It has long been used in dyeing, though on silks the colour is not very fast. To colour common cotton stuffs of a dull orange, it is often used in domestic dyeing, with potash as a mordant. So far as we are aware, the various butter colourings in the market are chiefly, if not entirely, solutions of anatto, made by the aid of some form of potash or soda. It seems better suited than anything else to give pale winter butter the colour of that made when the cows have good pasturage. It is entirely harmless, we think. It has long been added to chocolate in South America, for both colour and flavour, and is used by Indian tribes in that country to paint their bodies. One writer says that it is about the only clothing the natives have to protect them from mosquitoes and other insects.

## A CURE FOR KICKING COWS.

Two correspondents of the *Western Stock Journal* give their methods of curing kicking cows, respectfully, as follows: A year or two since I got, in trade, a handsome three-year-old heifer, one of the most vicious kickers I ever saw. One of my men who milks tried various devices, without effect, and finally took a common garden hoe, passed the end in front of the off hind leg (the right leg behind) and behind the above gammel joint of the left hind leg of the heifer. Then sitting down on the right to milk, he put the handle of the hoe well up under his left arm and began milking. The heifer could not stir either hind legs,

and after one week she could be milked safely without fettering, and proved to be a valuable and gentle animal. Of course she was tied in the stable like the other cows; but on being turned out to grass, could be milked anywhere without trouble.

The annoyance of having a full pail of milk kicked over by a vicious cow is to say the least of it exasperating. Having had considerable experience with such animals, trying every expedient I could think or hear of, I at last hit upon a device that proved effectual, in the shape of a milking stool so constructed as to shield the pail from the kick. Take a piece of plank two feet long and ten inches wide; bore holes and put two legs of suitable length at each end. Put a "dashboard" (or perhaps it might more properly be called a "kick-board") at one end, of height and width at the top to correspond to the pail with two pieces nailed on each side back to the seat board to strengthen and keep it in position. This device will not keep a cow from kicking, but will save your milk everytime.

## VARIETY OF CHEESE PRODUCT.

It is a noticeable fact that with all the American love for doing things differently from others, with all the American inventive skill, the great mass of the cheese made in this country is much alike. Some is much better than others, but most is made after one model. This is not nearly so true of the cheese made in European countries. There an almost endless variety is to be seen—variety in size, shape, colour, taste, and smell. Some of the European cheese is exceedingly distasteful to American palates and nostrils, but all meet a want. The total consumption is greater because of this attempt to meet the fancies of many classes of consumers. Many of these classes are largely represented in this country, and have not forgotten their old tastes. We often lament the fact that the cheese consumption in this country is small compared with the population; yet little successful effort has been made to increase it by adapting the product to the tastes of these large classes of foreigners.

There are practical difficulties in the way. Small cheese, and those of peculiar size or flavour, usually cost somewhat more labour in the making, but often they can be sold at prices considerably above those current for standard cheese. At the first dairy convention we attended, the desirability of having cheese made of such a size that they could be sold for family use without cutting, was presented. Yet little advance has been made in introducing such cheese. The arguments in their favour are as strong as ever, and we do not believe it impracticable to secure a satisfactory trade in them.

Some of the English and continental styles of cheese are much liked by many Americans, and we do not see why they may not be successfully manufactured in this country on a larger scale than has yet been done. Whatever helps to increase the consumption of cheese, especially of cheese of good quality, will be of direct service to the dairy interest. It is not proposed that the foreign demand be neglected, but that increased attention be given to the cultivation of the home demand. —*Breeder's Gazette, Chicago.*

## CREAM

"THE gain on a flock of sheep may be called a wether profit," says one. "Good for ewe," says the other.

YOUNG man, try to cultivate a hunted look. Then people will think you're hounded to death by leap-year proposals.

WILL some of our brother agricultural writers please inform us why it is that the biggest potatoes always grow on top of the peck measure?

"CHARITY vaunteth not itself, is not puffed up," and yet some men expect a puff every time they give a dollar to an indigent old woman's society.

"THERE are 1,400,000,000 people upon the earth at present, according to the latest statistics," said Mrs. Smith, looking up from the paper. "Only think of it! and we haven't had a caller for two days!"

JOSH BILLINGS says:—"There is one thing about a hen that looks like wisdom: they don't kackle much until after they have laid their egg. Sum pholks are alwuz a bragging and kackling what they are going to do before hand."

A LADY whose conscience was softened by a recent revival, called on a clergyman, in a remorseful spirit, to tell him she had spoken disparagingly of his sermons. "That's nothing my child," was the reply, "I don't think much of them myself."

A SMALL boy in Maine listened demurely to the story of Samson's tying the fire-brands to the tails of foxes and then sending them through the Philistines' corn, and at the conclusion of the narrative asked innocently: "Auntie, did it pop?"—*N. Y. Independent.*

"YOU gave my wife the wrong medicine," exclaimed a man, entering a drug store. "I hope no harm has resulted," replied the druggist, tremulously. "Oh no, she's all right," "How do you know it was the wrong medicine?" "Why, because it helped her immediately."

"I SHOULD think that actors would get dreadfully tired of saying the same things over and over again, night after night." And then Mrs. W. ly went on to tell for the nine hundred and ninety-ninth time about the funny thing that happened to her at the mountains summer before last.

DURING a dense fog, a Mississippi steamboat took landing. A traveller, anxious to go ahead, came to the unperturbed manager of the wheel, and asked why they stopped. "Too much fog. Can't see the river." "But you can see the stars overhead." "Yes," replied the urbane pilot; "but until the biler busts we ain't going that way." The passenger went to bed.

A SCOTCH minister called to catechize a wife who had a drunken husband lying concealed under his bed. Sent for a jug of molasses to make a batch of molasses cakes, the darkey had fallen into a stream, having imbibed too freely of liquor. His name was Adam. The preacher did not know this, and put his first query, "What made Adam fall?" "I don't know," was the answer of the ashamed woman. "When he fell where did he hide?" Putting her head under the bed she shouted to her boozy lord, "Come out, Adam, the preacher knows all about it!"



## HOME CIRCLE.

## SWEET HERBS.

We do not grow many of the so-called sweet herbs in this country. Sage is, perhaps, the leading plant of this group found in the Canadian farm garden. The sage plant is so named because, in olden days it was thought the leaves of this aromatic herb, when eaten, strengthened the mental faculties, and therefore made people sage.

The sage plant can be propagated early by cuttings, but many find it more convenient to grow it from seed. Sage seed is quite apt to be poor and should be tested before sowing. It is best to prepare the soil in the fall for the next spring's sowing. The seed can go into the ground so soon as it can be worked. A light exposed spot is best for growing sage, but the soil should be rich. The seed is sown in rows, wide enough apart for handy cultivation with the hoe. The crop is ready as soon as the plant is in full flower. Tie the plants in bunches and sell green; or, if the market is distant, let the sage dry and ship when convenient.

*Thyme* is another sweet herb similar to sage, and needs nearly the same treatment in growth. Mr. Joseph Harris writes: If preferred, the seed may be sown where the plants are intended to remain. Sow in rows twenty-one inches apart, and drill in seed as shallow as possible, dropping three or four seeds to each inch of row. It will be necessary to mix the seed with three or four times its bulk of fine, dry sand, or the drill will sow it too thick. The plants of thyme are cured the same as for sage.

*Summer Savory*.—The seed may be sown in a window-box, and the plants set out in early spring. The plants will usually be of good size if the seed is sown in open ground. The further culture is much the same as thyme.

*Sweet Marjoram* does not bear transplanting well, and it is better to sow a plenty of the seed, and thin out to six inches in the row.

*Rosemary* needs to be in hills, fifteen inches each way.

*Coriander* is easily grown and the young leaves are good for salads. A light soil is best.

*Fennel* is much like coriander, and, like it, easily grown.

*Rue* is an old-time sweet herb. The seed may be sown in rows eighteen inches apart, and the second year every alternate plant transplanted with a plenty of earth.

*Anise* is grown in much the same way without the thinning recommended for Rue.

*Caraway* is familiar as flavouring seeds mixed in the cakes, etc. The leaves are also used in soups and salads. This plant is cultivated like the coriander.

*Lavender* is grown for the delicate perfume it possesses, and is largely used by tobacco manufacturers. Much of that now used is imported, we are informed, and it would seem that here is a plant deserving more at the hands of the American herb-growers. The plants may be grown from seed, propagated by cuttings. Sow the seed in a window-box, and set in open ground when warm weather comes, setting the plants about twenty inches apart each way. The stems are cut from the

bushes when in flower, tied in bundles and dried. The dried flowers and leaves when placed among clothing give it a pleasing odour.

## AN APRIL GIRL.

The girl that is born on an April day  
Has a right to be merry, lightsome, gay;  
And that is the reason I dance and play  
And frisk like a mote in a sunny ray,—  
Wouldn't you  
Do it, too,

If you had been born on an April day?

The girl that is born on an April day  
Has also a right to cry, they say;  
And so I sometimes do give way  
When things get crooked or all astray—  
Wouldn't you  
Do it, too,

If you had been born on an April day?

The girls of March love noise and fray;  
And sweet as blossoms are girls in May;  
But I belong to the time mid-way,—  
And so I rejoice in a sunny spray  
Of smiles and tears and hap-a-day,—  
Wouldn't you  
Do it, too,

If you had been born on an April day?

Heigho! and hurrah! for an April day,  
Its cloud, its sparkle, its skip and stay!  
I mean to be happy whenever I may,  
And cry when I must; for that's my way.  
Wouldn't you  
Do it, too,

If you had been born on an April day?

—Mary Mapes Dodge; St. Nicholas for April.

## HOW TACKS ARE MADE.

Described in a few words, the process of making tacks is as follows: The iron, as received from the rolling mills, is in sheets from three inches to twelve inches wide, and from three feet to nine feet in length, the thickness varying according to the kind of work into which it is to be made, from one-eighth to one thirty-second of an inch. These sheets are all cut into about three-foot pieces, and by immersion in acid cleaned of the hard outside flinty scale. They are then chopped into strips of a width corresponding to the length of the nail or tack required.

Supposing the tack to be cut is an eight-ounce carpet tack, the strip of iron as chopped and ready for the machine, would be about eleven-sixteenths of an inch thick, and three feet long. This piece is placed firmly in the feeding apparatus, and by this arrangement carried between the knives of the machine.

At each revolution of the balance wheel the knives cut off a small piece from the end of this plate. The piece cut off is pointed at one end, and square for forming the head at the other. It is then carried between two dies by the action of the knives and these dies coming together form the body of the tack under the head. Enough of the iron projects beyond the face of the dies to form the head, and, while held firmly by them, a lever strikes this projecting piece into a round head. This, as we have said before, is all done during one revolution of the balance wheel, and the knives, as soon as the tack drops from the machine, are ready to cut off another piece. These machines are run at the rate of about 250 revolutions per minute. The shoe-nails machines for cutting headless shoe-nail are run at about 500 revolutions per minute, and cut from three to five nails at each revolution. When we think of the number of machines being now run in the United States, viz., about 1,700, and of the quantity of tacks and nails they can produce, it is as

much a mystery where they go as it is what becomes of the pins.

The tack maker of fifty or sixty years ago worked as follows: He took a small rod of iron, and after heating it in a charcoal fire, hammered it down so as to make a point, then a small piece was cut off, placed in a vice worked by foot power, and the head formed by a few blows of the hammer.—*Scottish American Journal*.

## WHY HE REFORMED.

There was a drunkard in Arkansas town who became a sober man through a kind Providence granting him what Burns longed for:

"Oh wad some power the gife gie us,  
To see oursel as ithers see us!"

One day several acquaintances, on asking him to drink, were surprised to hear him say, "You must excuse me, gentlemen, for I can't drink anything." To their question, "What is the matter with you?" he said:

"I'll tell you. The other day I met a party of friends. When I left them I was about half drunk. I would not have stopped at this, but my friends had to hurry away to catch a train.

"To a man of my temperament, to be half drunk is a most miserable condition, for the desire for more is so strong that he forgets his self-respect in his efforts to get more to drink.

"Failing at the saloons, I remembered that there was a half-pint of whiskey at home, which had been purchased for medicinal purposes.

"Just before reaching the gate I heard voices in the garden, and looking over the fence I saw my little son and daughter playing. "No, you be ma." said the boy, "and I'll be pa. Now you sit here an' I'll come in drunk. Wait now till I fill my bottle."

"He took a bottle, ran away, and filled it with water. Pretty soon he returned and entering the play-house, nodded idiotically at the little girl and sat down without saying anything. Then the girl looked up from her work and said:

"James, why will you do this way?"

"Whizzer way?" he replied.

"Gettin' drunk."

"Who's drunk?"

"You are, an' you promised when the baby died that you wouldn't drink any more. The children are almost ragged, an' we haven't anything to eat hardly, but you still throw your money away. Don't you know you're breakin' my heart?"

"I hurried away. The acting was too life-like. I could think of nothing all day but those little children playing in the garden, and I vowed that I would never take another drink, and I will not, so help me God!"

## LAND-BIRDS IN MID-OCEAN.

The appearance of some of the smaller varieties of migratory birds, such as sparrows, swallows, doves, etc., several hundred miles away from the nearest land is by no means an unusual occurrence on the ocean. About these little erratic visitors there are some curious and interesting facts. Their appearance is almost always one at a time, though I have known a considerable number, repre-

senting, perhaps, as many different varieties, to accumulate in the course of a day. It is usually, though not always, in stormy or unsettled weather.

The first curious fact about these birds is that they never appear to be tired out; whereas birds are often met with near the land with their strength quite exhausted. A second curious fact about them is their preternatural tameness where there is no cat or dog on board, and the crew show no disposition to molest them, as exhibited by their apparently seeking rather than avoiding the presence of man.

Another curious fact about them is the recovery of all their native wildness and their instinctive avoidance of man's presence on approaching the land. The first time I noticed this fact was with a pair of olive-coloured ring-doves, which, from their remarkable tameness and familiarity, I was led to believe had been bred in a domestic state and perhaps on shipboard. I kept them in the skylight in the cabin, where they seemed to be quite contented; but on approaching the land they became the wildest of the wild. One of them escaped and flew away. I succeeded in taking the other into port, where I gave it its liberty. Now, I am certain that these birds could not have been apprised of the approach to the land through the medium of any of their ordinary senses. This curious circumstance led me to notice more particularly the conduct of other varieties of these little wanderers upon the ocean so far from their native habitat, and I find that they nearly all exhibit to a greater or less extent the same curious characteristics.—George W. Grim, in *Popular Science Monthly*.

HEALTHFULNESS OF MILK.

If any one wishes to grow fleshy, a pint of milk taken on retiring at night will soon cover the scrawniest bones. Although we see a good many fleshy persons now-a-days, there are a great many lean and lank ones, who sigh for the fashionable measure of plumpness, and who would be vastly improved in health and appearance could their figures be rounded with good solid flesh.

In a case of fever and summer complaints, milk is now given with excellent results. The idea that milk is feverish has exploded, and it is now the physician's great reliance in bringing through typhoid patients, or those in too low a state to be nourished by solid food. It is a mistake to scrimp the milk pitcher. Take more milk and buy less meat. Look to your milk-man; have large-sized, well-filled milk pitchers on the table each meal, and you will have sound flesh and save doctors' bills.

WINTER SLEEPERS AND THEIR FOOD.

There are some kinds of animals that hide away in the winter that are not wholly asleep all the time. The blood moves a little, and once in a while they take a breath. If the weather is at all mild, they wake up enough to eat.

Now, isn't it curious that they know all this beforehand? Such animals always lay up something to eat, just by their side, when they go into their winter sleeping-places. But those

that do not wake up never lay up any food, for it would not be used if they did.

The little field-mouse lays up nuts and grain. It eats some when it is partly awake of a warm day. The bat does not need to do this, for the same warmth that wakes him wakes all the insects on which he feeds. He catches some, and then he eats. When he is going to sleep again he hangs himself up by his hind claws. The wood-chuck, a kind of marmot, does not wake, yet he lays up dried grass near his hole. What is it for, do you think? On purpose to have it ready the first moment he wakes in the spring. Then he can eat and be strong before he comes out of his hole.

How many things are sleeping in the winter! Plants, too, as well as animals. What a busy time they do have in waking up, and how little we think about it!

FOR THE RURAL CANADIAN.

THE COMMON CAUSE.

BY R. H. MANCHÉE.

The town was wrapt in darkest gloom,  
Save when a pale moon-beam  
Peeped through the clouds, then left, and made  
The darkness darker seem.

In all the air there brooded, too,  
A sense of mystery,  
And nothing brake the silence  
Save the May-bugs' minstrelsy.

Naught else, I trow, disturbs the hour  
When ghosts and goblins walk,  
And skeletons come from their graves  
To have a friendly talk.

When out the gloom nrope a scream  
That pierced the affrighted sky,  
And roused the townsmen from their dreams  
And made their babies cry.

Quick 'thwart the windows flashed the lights,  
And heads popped out in fear  
To see if some assassin had  
His trade been plying near.

Again the wail! each asks his mate  
In timorous tone, "What's that?"  
The moon shines forth, reveals the cause—  
Drat the infernal cat!

MAGIC SQUARE.

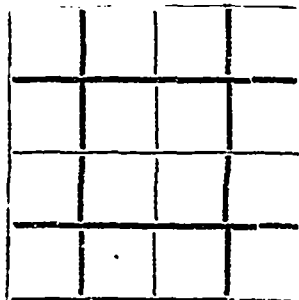

9-8-5-4-3-6-4-7-4-4-9-8-6-2-4-1.

Place these sixteen figures in the sixteen vacant squares of the diagram in such a manner that the sum of twenty-one may be obtained by combining four of the figures in fourteen different ways, namely:—

The figures in each of the four lines reading across to amount to twenty-one;

The figures in each of the four lines reading up and down to amount to twenty-one.

The four corner figures to amount to twenty-one.

The four central figures to amount to twenty-one.

The four figures (2) above and (2) below the central figures to amount to twenty-one.

The four figures (2) right and (2) left of

\* Mark Twain's "Sketches."

the central figures to amount to twenty-one.

The diagonals from the upper left-hand corner to the lower right-hand corner to amount to twenty-one.

The diagonals from the upper right-hand corner to the lower left-hand corner to amount to twenty-one.

ECONOMY IN A FAMILY.

There is nothing which goes so far toward placing young people beyond the reach of poverty as economy in the management of household affairs. It matters not whether a man furnishes little or much for his family, if there is a continual leakage in his kitchen or parlour, it runs away he knows not how, and that demon want cries "More!" like the horse-leech's daughter, until he that provides has no more to give. It is the husband's duty to bring into the house, and it is the duty of the wife to see that nothing goes wrongfully out of it. The husband's interest should be the wife's care, and her greatest ambition to further his welfare or happiness, together with that of her children. This should be her chief aim and the theatre of her exploits, the bosom of her family, where she may do as much toward making a fortune as he can in the counting-room or workshop.

It is not the money earned that makes a man wealthy—it is what he saves from his earnings. Self-gratification in dress, indulgence in appetite, or more company than his purse can well entertain, are equally pernicious. The first adds vanity to extravagance, the second fastens a doctor's bill to a long butcher's account, and the latter brings intemperance, the worst of all evils in its train.—*Christian Advocate*.

A MISUNDERSTANDING.

"I thought I would take a run up and see if you didn't want to buy a sewing machine," said the agent to farmer Grimes.

"I don't know as I do," replied the farmer, "I've got most of my spring sowing done."

"But won't you need it for sewing in the summer?"

"Look here, young feller, we don't sow in the summer. We cuts, an' gathers, an' binds."

"Oh, well, this machine gathers and binds."

"Mebbe you'll be telling me next that your machine will haul in the crap an' put it in the barn. Don't come around here with any of your big stories."

"Don't be ruffled, my dear sir; I thing you do not understand me. I mean a machine to sew cloth, not grain."

"Ahem! you do, do you? Then you'd better go talk to the wimmin. It's a good thing you didn't mean the other kind, for if you'd kept on telling me about your wonderful machine for plantin' an' reapin', you'd got me rippin' and tearin' 'til I'd basted you."—*Texas Siftings*.

HERE is a fair sample of a small boy's diary, as given by an exchange: "Got up and washed me—had breakfast—slid down hill—had a fight with Willie Smith—we won't speak any more—wore a hole in the toe of my new boot steering my sled—eat supper—pa spanked me about the boot—went to bed—bully good day."

# THE LOST LETTER.

## SONG AND CHORUS.

Words and Music by

Author of "Grandfather's Clock," "Marching through Georgia," "Phantom Footsteps," etc., etc.

HENRY C. WORK.

Moderato.

1. In the
2. Both were
3. It was
4. "When she
5. From the

post - of - fice win - dow was one bro - ken pane; In the wains - cot there was one loose - n'd board; And con -  
 faith - ful and true, 'Twas a gos - sip's re - mark, that had cloud - ed lov - ing hearts with con - cern. Then, a -  
 just on the mor - row the car - pen - ter came, Such de - fec - tions in that wall to re - pair; And he  
 learns how she wrongs me, my darl - ing will write! "Mus'd the lov - er, as he watch'd for the mail; But his  
 time - crumbl - ed pile came the time - fad - ed sheet, With its an - cient su - per - scrip - tion and date; And from

ven - ient - ly near was the broad oak - en ta - ble, Where the mail from the bag had been pour'd, 'Twas a  
 last came a quar - rel; and she, in her an - ger, Bade him go, ne - ver - more to re - turn. Oh, how  
 ham - mer'd and sang, and de - part - ed un - mind - ful Of the hearts he had thus bur - ried there. And in  
 let - ter came not, and, dis - heart - en'd and hope - less, For a land far a - way he set sail. Oh! the  
 ex - ile the lov - er, the yet faith - ful lov - er, Hast - en'd home, but to seal his ill fate. 'Twas his

morn - ing in May, with a sweet o - dor'd breeze; And it hap - pen'd un - no - tie'd by all, That a  
 soon she re - pent - ed! how great was her grief, And how hum - bly she penn'd her re - call! But that  
 heaps on the ta - ble, all safe and se - cure, There lay ma - ny a val - ue - less scrawl, Where that  
 long wea - ry years of sus - pense and re - gret, And of pres - age per - plex - ing with - al, Since that  
 most cru - el pang that he might not ex - plain To the sleep - er be - neath her black pall, How that

most pre - cious mis - sive, a love - la - den let - ter Flut - ter'd, down thro' the gap in the wall.  
 most pre - cious mis - sive, that love - la - den let - ter Flut - ter'd, down thro' the gap in the wall.  
 most pre - cious mis - sive, that love - la - den let - ter Flut - ter'd, down thro' the gap in the wall.  
 most pre - cious mis - sive, that love - la - den let - ter Flut - ter'd, down thro' the gap in the wall.  
 most pre - cious mis - sive, that love - la - den let - ter Flut - ter'd, down thro' the gap in the wall.

Chorus.

Soprano. Two lives wreck'd by a zeph - yr!..... Two hearts crush'd by the fall, When that  
 Alto. Two lives wreck'd by a zeph - yr!..... Two hearts crush'd by the fall, When that  
 Tenor. Two lives wreck'd by a zeph - yr!..... Two hearts crush'd by the fall, When that  
 Bass. Two lives wreck'd by a zeph - yr!..... Two hearts crush'd by the fall, When that

Piano.

most pre - cious mis - sive, that love - la - den let - ter, Flut - ter'd down thro' a gap in the wall.  
 most pre - cious mis - sive, that love - la - den let - ter, Flut - ter'd down thro' a gap in the wall.

## YOUNG CANADA.

## WAS IT STEALING?

"I wonder, when I go over to Minnie's this afternoon, and take my doll, if her mother won't give us some crackers and some raisins, and let us take Minnie's new china tea-set her brother Tom gave her last Christmas, and play visiting and have some milk and water and sugar for tea? I'm just going to ask her."

All this little Hattie Hastings thought one pleasant morning just after breakfast, as they all knelt in the dining-room at the family altar, and her father was offering a prayer that God would preserve her from accident, and help them to be good and kind and true all through that day.

Was that Hattie's time to be thinking of dolls and playthings? Or was it God's time, when she should have listened respectfully to the prayer her father offered? Did she take God's time for her own?

Was it stealing?

"What a lovely hat Sarah Peters has! I must tell mother to get me a pale blue hat with a long feather and satin ribbon. It will be so becoming, and you can wear pale blue with almost any dress. I must ask Sarah Peters who her milliner is. There is such a style to her hats."

This is what Miss Minnie Washburne thought to herself one Sabbath afternoon at Sabbath-school during prayer, as she looked at the new hat that her friend had on, instead of reverently bowing her head and listening as the superintendent invoked the blessing of God upon officers and teachers and scholars.

There is a time for thinking of ribbons and feathers and hats. Did Minnie take that time? or did she take a sacred hour of that day which God has commanded us to keep holy?

Was it stealing?

In that same Sabbath school, during that same prayer, Jimmy Townsend sat with his head bowed in reverent attitude, but this is what he was thinking:

"How my printing-press does need painting! But I really can't spare the money to get the paint now. Still, there's Sam's father's order—he said it must be done this week—but he never pays for a dog's age, so I can't count on that. I wonder if mother could possibly lend a fellow the money to get the paint?"

Jim means to be a good boy. His mother is a widow. He earned the money to buy his printing-press by going errands and shovelling the snow from the sidewalks before and after school, and now he takes his spare time to print cards for the neighbours, and occasionally he gets an order from a business man.

When he had been given six days in which to plan for work and money-getting, and painting his press, was it honest for him to take a part of the day God kept for Himself in which to think of these things?

Was it stealing?

A soft answer turneth away wrath.

## THE YEAR'S TWELVE CHILDREN.

January, worn and gray,  
Like an old pilgrim by the way,  
Watches the snow, and shivering sighs  
As the wild curlew 'round him flies;  
Or, huddled underneath a thorn,  
Sits praying for the lingering morn.

February, bluff and cold,  
O'er furrows striding scorns the cold,  
And with his horses two abreast  
Makes the keen plough do his behest.

Rough March comes blustering down the road,  
In his wrathful hand the oxen goad;  
Or, with a rough and angry haste,  
Scatters the seeds o'er the dark waste.

April, a child, half tears, half smiles,  
Trips full of little playful wiles;  
And laughing, 'neath her rainbow hood,  
Seeks the wild violets in the wood.

May, the bright maiden, singing goes,  
To where the snowy hawthorne blows,  
Watching the lambs leap in the dells,  
List'ning the simple village bells.

June, with the mower's scarlet face,  
Moves o'er the clover field apace,  
And fast his crescent scythe sweeps on  
O'er spots from whence the lark has flown.

July, the farmer, happy fellow,  
Laughs to see the corn grow yellow;  
The heavy grain he tosses up  
From his right hand as from a cup.

August, the reaper, cleaves his way,  
Through golden waves at break of day;  
Or in his waggon, piled with corn,  
At sunset home is proudly borne.

September, with his baying hound,  
Leaps fence and pale at every bound,  
And casts into the wind in scorn,  
All cares and dangers from his horn.

October comes, a woodman old,  
Fenced with tough leather from the cold;  
Round swings his sturdy axe, and lo!  
A fir branch falls at every blow.

November cowers before the flame,  
Blear crone, forgetting her own name!  
Watching the blue smoke curling rise,  
And broods upon old memories.

December, fat and rosy, strides,  
His old heart warm, well clothed his sides,  
With kindly word for young and old,  
The cheerier for the bracing cold,  
Laughing a welcome, open flings  
His doors, and as he goes he sings.

## "NOBODY KNOWS."

The late Professor Sophocles, Harvard University, a native Greek, was a man of great learning, and a voluminous author. He was a man of whom scholars heard and read more and knew less than of any other distinguished man in the country.

He lived alone, cooked his own meals and got up many queer dishes. He was something of a wit, and knew how to wake up students, though he was not a very successful teacher.

It is said that in a class room he asked a student what was done with the bodies of the Greeks who were killed at Marathon.

"They were buried, sir."

"Next."

"Why, they—they—were burned."

"Next."

"I—I—don't know, professor."

"Right! Nobody knows."

## WHAT I SAW.

I am an English sparrow. I live close by people's windows, and, once in a while, I peep inside. It isn't good manners, but folks don't mind me. I see many things that I don't understand, and I see some that I understand very well.

One morning I happened to hop down on the window-sill of a very old and ugly house. Inside I saw a man and a woman having a fight. They talked very loud and very cross, and scratched each other's faces shamefully. Away in a dark corner, so dark I could just barely see, sat a little girl with a very white face. In fact, her face was all I could see, excepting a little bit of a white kitten that she hugged in her arms. I don't like cats. I'm afraid of them, for they are very wicked, indeed. But I did feel very sad to see the man snatch that little kitten from the little-girl's arms and throw it into the fire. I heard the little girl screaming and crying, and then I saw the man catch her by the hair, and I was so afraid he would throw her into the fire, too, that I flew off as fast as I could. I'm going back to-morrow and peep in again, to see if she is still there.

The church steeple is a nice place to sit. I can see all over town, and out into the country and away down the river. There is a big brick house next door to the church, and there are vines up to the windows. I sometimes sit among these vines and watch the people inside. There is a tall man lives here who comes out of the house carrying a cane and wearing a funny hat like a stove-pipe. He always goes into the church when the bell rings. There is a little girl in the house, too, and a very pretty woman. The little girl is always carrying a little baby in her arms. I don't believe it is a live baby, for it never cries. The little girl cries a good deal, and stamps her foot and shakes her head, and looks dreadful. They have a big dog in the yard who never looks half so cross, but they keep a chain around his neck for fear he may hurt some one. I should think they would be more afraid of the little girl, for she is bigger than the dog. I should think her baby would be afraid of her, for I know I am dreadfully afraid of her, and I shan't go back again very soon.

## BEER.

Beer is regarded by many as a healthy beverage. Let me give you a few of the ingredients used in its manufacture. The adulterations most commonly used to give bitterness are gentian, wormwood, and quassia; to impart pungency, ginger, orange peel and caraway. If these were all there would be small need of warning the young against the use of beer on account of its injurious ingredients. But when there are added to preserve the frothy head, alum and blue vitriol; to intoxicate, coculus, nux vomica and tobacco; and to promote thirst, salt—then indeed does it become necessary to instruct and warn the innocent against the use of this poisonous beverage. Boys and girls, never touch it.

## NUMBER ONE.

"I always take care of Number One," said one of a troop of boys at the end of a bridge, some wanting to go one way and some another.

"That's you, out and out," cried one of his companions. "You don't think or care about anyone but yourself; you ought to be called 'Number One.'"

"If I did not take care of Number One, who should, I should like to know?" cried he. True. Number One was right. He ought to take care of himself—good care.

"But does not that smack a little of selfishness?" the boys ask. "Number One thinks of nobody but himself."

Nobody but himself; that certainly is selfish, and therefore wrong. But Number One is committed to our own care. "What sort of care?" is the all-important question.

*The cure of his soul.* Number One has a soul to be saved from sin and from hell; Number One has a soul to be won to Christ, to holiness and to heaven. Here is a great work to do.

*Take care of his habits.* Make Number One industrious, persevering, self-denying, and frugal. Give him plenty of good, healthy work to do. Teach him how best to do it, and keep him from lounging and all idle company.

*Take care of the lips of Number One.* Let truth dwell on them. Put a bridle in his mouth, that no angry, back-biting tale shall come from it. Let no profane or impure words escape. Let the law of kindness rule his tongue, and all his conversation be such as becomes a child of God.

*Take care of the affections and feelings of Number One.* Teach him to love God with all his heart, and his neighbour as himself; to care for others and share with others; to be lowly in mind, forgiving, gentle, sympathizing, willing to bear and forbear, easily entreated, doing good 'o all as he has opportunity.

This is the care to take of Number One, and a rich blessing will he prove to his home and neighbourhood and to himself. Boys, you all have Number One to take care of, and a responsible charge it is.

## A HINT FOR GIRLS.

Many a girl is rude in little matters more from thoughtlessness than anything else, like the two mentioned in this incident:

"Cecelia, let us try the piano while we are waiting for Nellie to appear."

"Why, no, Tillie, I do not like to. What would Nellie's mother think of us?"

"She wouldn't care. Why should she? The piano's here to be played upon, isn't it?"

"Yes after we have been invited."

"O, Cecelia, you are too particular! I always sit down and play if I have to wait for anybody."

"But suppose somebody in the house is sick, Tillie, or lying down," persevered Cecelia.

This was an argument which appealed to Tillie's good nature, and she desisted with a half smiling, half-vexed: "Well, I presume you do not object to my examining this album."

Cecelia smiled and with a deprecating "O, Tillie!" opened a bound copy of the *Aldine* for her own inspection.

In a few moments Nellie entered the room and in the course of the call invited both her young friends to "perform," which they did much to the satisfaction of all three.

A peculiar smile passed between Tillie and Cecelia a day or two after, when their teacher in giving them a few rules of common etiquette said:

"Fourth. Never play on the piano or other musical instrument until you have been in-

years of age, and the youngest twelve. They have supported an invalid father and their mother all the time, and now have property worth considerably over \$5,000, houses from which the rent is \$20 per month, and \$200 stock in a building and loan association. They have educated themselves the meanwhile, remaining from school this year in order that they might work the harder and build a home for their parents that is to have a front parlour and a bay window in it. These little fellows have been carriers, newsboys, errand boys and apprentices about the *Constitution* office, and one of them is now assistant mailing clerk. Their net savings from their sales and salaries, exclusive of their rents, have been \$20 per week for this year. Next year they can do better, and by the time the oldest of the brothers is of age they ought to have a comfortable little fortune.

What these boys have done other boys can do. The whole secret is steadiness, sobriety, industry, and economy. There are few lessons more important for boys than that the smallest amount—no matter how little it may be—will make a great fortune, if it is only saved and invested, and that the smallest income—no matter how small—will make a man independent, if he will only live inside of it and compound his surplus. If these boys will only keep cleanly hearts, and genial souls, and broad hearty impulses, they will not only be rich, but useful men.

## CHARMING GIRLS.

The popular belief among young girls is that it is only a pretty face that will bring to them the admiration which they naturally crave. No books have a larger sale than those giving rules for beauty, recipes to destroy fat or freckles, and to improve the skin or figure.

Now, no recipe will change the shape of a nose or the colour of an eye. But any girl by baths and wholesome food, and by breathing pure air, can render her complexion clear and soft. Her hair, nails, and teeth can be daintily kept. Her clothes, however cheap can be fresh and becoming in colour. She can train her mind, even if of ordinary capacity, to be alert and earnest; and if she adds to these a sincere, kindly, sunny temper, she will win friends and love as surely as if all the fairies had brought her gifts at her birth.

But it is of no use for a woman whose person is soiled and untidy, and whose temper is selfish and irritable at home, to hope to cheat anybody by putting on fine clothes and a smile for company. The thick, muddy skin, and soured expression will betray her.

"John," said an artist the other day to a Chinaman who was unwillingly acting as a model, "smile. If you don't look pleasant I'll not pay you."

"No use," grumbled the washerman. "If Chinaman feelee ugly all the time, he lookee ugly," which is true of every other man and woman as well as John Chinaman.



SNAKE CHARMERS.

vised to do so by your host or hostess." But when Miss Agar reached "Seventh: After ringing the door-bell it is ill-bred not to wait a reasonable time for the bell to be answered before ringing again," both looked down ashamed, for both recollected transgressions of that law of politeness, which they resolved not to infringe again.

## FOUR GEORGIA BOYS.

These four young boys started a few years ago delivering and selling newspapers. They made ten cents apiece the first morning they went to work, and for two stormy winters thereafter they went barefooted, through the snow and sleet in the freezing dawn, on their morning rounds. From the very first they saved a certain percentage of their earnings, which they wisely invested in Atlanta real estate. The oldest of them is now eighteen

WHAT IT WAS WORTH TO HIM.

How Geo. L. Hall (Traveller for the great Chicago Soap Factory of Allen B. Wristley), while on a commercial tour to Canada was made happy.

We give his experience in his own words: "On my last trip to Canada, I was advised to try Dr. Carson's Stomach Bitters for Dyspepsia, Liver Complaint and Biliousness. Up to that time I was continually taking pills and other medicines, but they only gave me temporary relief. I did not seem to digest my food properly, and I was afflicted with headache and sour stomach. Well, I got a bottle of the Doctor's Stomach Bitters, and, I tell you of what anything I have ever used. It did not sicken or gripe me, and I have felt like a new man ever since I started taking it. I tell you what, gentlemen, Dr. Carson's Stomach Bitters is far ahead of any medicine we can get over on our side of the lines, and you may be sure I don't go out of Canada without a fresh supply. I have just struck the medicine that suits my case to a knock-down." Dr. Carson's Stomach Bitters is the best and safest blood purifier one can take; it has no equal as a spring medicine. Sold in large bottles at 50 cents by all druggists and dealers in Patent Medicines. Try a bottle this spring and you will never regret it.

No journal of its class has attracted so much attention during the past twelve months as the TURF, FIELD AND FARM, published weekly at 39 and 41 Park Row, New York. It has discussed breeding theories in such a way as to make a marked impression upon the thoughtful public mind and to draw out the views of many able students of the problem of reproduction. It has shed a great deal of light on an important question, and its opinions have been widely quoted. Its reports of running and trotting meetings have been models of clearness and accuracy, and its Field and Kennel department has been better than ever. The first bench show, the first gun trial and the first field trial in America were given, at the suggestion and under the direction of the TURF, FIELD AND FARM, and so there is a logical reason for the paper being recognized as an authority upon dogs and guns as well as horses. The athletic and aquatic champions have signed in its office articles of agreement for their important contests, and the paper is extensively read by men fond of these vigorous sports. Much space is given to the two great intellectual games, chess and checkers, and on these it speaks with authority. The dramatic department bears the stamp of scholarship and originality. The amount of fresh and original matter published by the TURF, FIELD AND FARM is astonishing, and it is gratifying to learn that the circulation of the paper is rapidly increasing. In ability, circulation and influence it is second only to its great rival, the London Field.

RELIABLE BREEDERS.

Cards of four lines or less inserted in this column, and a copy of the RURAL CANADIAN sent for one year, for 85 per annum. Each additional line, or part of a line, \$1.50 per annum. Terms: Cash in advance.

W.M. SMITH, Columbus, Ont., breeder and importer of Clydesdales, Cotswolds and Shorthorns. Choice young stock for sale. Satisfaction guaranteed.

JAMES GRAHAM, Port Perry, Ont., breeder of Durhams, Cotswolds and Berkshires of the most approved blood. Choice young stock for sale.

THOMAS GUY, breeder of Avshire Cattle, Leicester and Southdown Sheep and Berkshire Pigs, Sydenham Farm, Oshawa, Ont.

THOMAS IRVING, Logan's Farm, Montreal, breeder of Avshire Cattle, Clydesdale Horses, Yorkshire and Berkshire Pigs, and Leicester Sheep.

W.M. SHER, "Clear Spring Farm," Sunderland P. O., Ont., breeder and dealer in Shorthorn Cattle and Shropshire-downs.

FERTILISERS, SEND FOR CIRCULAR and price-list, FETER R. LAMB & CO., Toronto.

VIRGINIA FARMS VERY CHEAP. Climate mild-taxes low-health perfect. Schools and Churches convenient. Send stamp for Catalogue. C. D. Epps, Nottoway, C. H., Va.

SEWING MACHINES

2/3 OF ALL KINDS Repaired or Built Over LIKE NEW.

All Work Warranted. Needles, Oil, and Parts for All Machines.

D. C. Evans, 22 Queen St. West (near Yonge), TORONTO.

Sparkles.

We grow broader, not by seeing error, but by seeing more and more of truth.

The first step toward spilling a child is to laugh and call him smart when he sasses yer.

NOTHING except what flows from the heart can render even external manners pleasing.

An old agricultural correspondent writes us to know "whether hogs pay." Some hogs pay and some do not. Quite a number take the paper several years and then send it back marked "Refused."

The old gentleman who got tripped up while trying to cross the ball-room remarked, as he slowly crawled to a perpendicular, that it was always pleasant to be thrown in the company of young people.

WHAT a beautiful example of simplicity is set by that useful animal, the domestic cat, which rises at three o'clock a.m., washes its face with its right hand, gives its tail three jerks, and is ready dressed for the day?

LIZZIE: "Aunt, do you like to eat chocolate drops?" Aunt: "Yes, very much." Lizzie (after much thought): "Then I think I'd rather give my paper of chocolate drops to grandmamma to keep."

"MAMMA, where's papa gone to?" asked a little girl one day. "He's gone to town to earn more bread and butter for you, darling." "Oh, mamma, I wish he would sometimes earn buns!" sighed the child.

SCENE: An Irish cabin. Pat is ill. Doctor has just called: "Well, Pat, have you taken the box of pills I sent you?" "Yes, sir, be jabers, I have, but I don't feel any better yet; may be the lid hasn't come off yet!"

WHEN a man's wife comes in and sees him razor in hand, and with his face all lather, and asks him, "Are you shaving?" it is a provoking thing for him to answer, "No; I am blacking the stove." But it is in human nature so to reply, when women will do such things.

MINISTER—"Well, John, I've nae doot, frae your long experience, ye cood occupy the poolpit for an afterneen yersel', should an emergency occur." Beadle: "Hoots, ay, sir, there's nae difficulty in that; but then where in the hael parish wad ye get enybody qualified to act as beadle?"

A MAN rushed up to a woman looking in a show-window, and grasping her by the arm angrily exclaimed, "Come on; I'm tired of waiting for you." Then noticing he had made a mistake he drew back with. "O I beg your pardon, madam; I mistook you for my wife." "I thought so," she answered, and passed on.

"MR. SMITH, do you know the character of Mr. Jones?" "Well, I rather guess I do, Jedge." "Well; what do you say about it?" "Well, he ain't so bad a man after all." "Well, Mr. Smith, what we want to know is, Mr. Jones of a quarrelsome and dangerous disposition?" "Well, Jedge, I should say that Tom Jones is very vivid in verbal exercise, but when it comes to personal adjustment, he hain't eager for the contest."

THE FALSE PROPHET.—He who prophesies falsely of the weather, leaves off his flannels and overshoes, and catches cold, is indeed unwise. If you follow this false prophet your rescue lies in taking Hagyard's Pectoral Balsam. It is the best cough cure and the safest throat and lung remedy known to medical science.

A BOSTON paper tells us that once in the course of an argument for a man tried for manslaughter, based on the assumption of self-defence, General Butler informed the jury that "we have it on the highest authority that all that a man hath he will give for his life." Judge Hoar, counsel on the other side, rose and retorted by quickly saying that he had "long wondered what General Butler considered the highest authority, and was very glad to have the question settled," and proceeded to read to the court from the Book of Job, "And Satan answered the Lord and said, All that a man hath will he give for his life."

PECTORIA.

Something we all want in this climate is "Pectoria" the great 25-cent cough and cold cure. Pectoria is put up in 25-cent bottles, and cures Coughs, Colds, Bronchitis, soreness or oppression of the Chest, and all affections of the Lungs and Throat. At this season of the year the Great "Pectoria" should be on hand in every household. Pectoria has a large sale throughout Canada, and is acknowledged to be one of the greatest of Cough medicines. Never say die until you have tried Pectoria, it will surely cure you.

SPECIAL OFFER.

To encourage settlement and cultivation of the Company's lands in the Red River Valley, all of the lands (not timbered) now owned by the

ST. PAUL, MINNEAPOLIS

-AND-

MANITOBA RY. CO.

IN THE COUNTIES OF

NORMAN, POLK, MARSHALL

RITTSON, in Minnesota, outside of

a five mile limit from the road,

will, during the year 1884,

be sold to

ACTUAL SETTLERS

in lots of not less than 160 acres, nor more than 320 acres at the

Low Price

-OF-

\$3 PER ACRE.

The terms of payment will also be very liberal, only 50 CENTS an acre down, the balance in six annual payments at 7 per cent interest.

This offer will be open only between the 1st day of March and the 31st day of December, 1884.

First applicants will have their choice from the entire field without reserve.

FIRST COME, FIRST SERVED.

At these prices and terms, EVERY FARMER, EVERY FARMER'S SON, EVERY CLERK, EVERY MECHANIC, EVERY LABOURING MAN, can secure a home with the smallest possible outlay.

It presents the opportunity for every one to secure 160 acres of his own choice of land for only \$80 down and six annual payments of \$66.67 with interest.

It is the most liberal offer ever made by any Railroad Land Grant Company. The terms are better than can be obtained from the Government, and the lands included in the offer are the most productive of any unoccupied lands in the United States.

They are the cheapest lands, considering location and quality, in the United States and every home seeker should take advantage of this offer without delay.

Write for Maps, general descriptive matter and other information, to

J. B. POWER,

Land and Immigration Commissioner,

ST. PAUL, MINN.

30 DAYS TRIAL

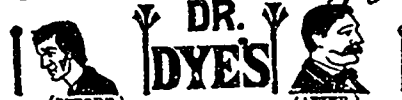

DR. DYES' PECTORAL BALM. (BEFORE) (AFTER) ELECTRO-VOLTAIC BELT and other ELECTRIC APPLIANCES are sent on 30 Days TRIAL TO MEN ONLY, YOUNG OR OLD. Those suffering from NERVOUS DEBILITY, LOSS OF VITALITY, WASTY WEAKNESSES, and all those diseases of a PERSONAL NATURE, resulting from ABUSES and OTHER CAUSES. Speedy relief and complete RESTORATION TO HEALTH, VIGOR and MANHOOD GUARANTEED. Send at once for Illustrated Pamphlet free. Address VOLTAIC BELT CO., Marshall, Mich.

FERRY'S SEED ANNUAL FOR 1884

Will be mailed FREE to all applicants and to customers of last year, without ordering it. It contains illustrations, prices, descriptions and directions for raising all Vegetable and Flower Seeds, Plants, etc. Available to all. D.M. FERRY & CO. WINDSOR, Ont.

Land Transfer & Real Estate Agency.

Farms bought or exchanged for North-West land, and Dakota and Minnesota etc. Business chances sold at best advantage. Commissions, Commercial Law, and General, solicited. Information can be had by mail or personal application. 5 per cent. on all transactions. O. H. MACDONALD, No. 7 Bond St., Toronto, Ont.

Burdock BLOOD BITTERS

WILL CURE OR RELIEVE. BILIOUSNESS, DYSPEPSIA, INDIGESTION, JAUNDICE, ERYSIPELAS, SALT RHEUM, HEARTBURN, HEADACHE, DIZZINESS, DROPSY, FLUTTERING OF THE HEART, ACIDITY OF THE STOMACH, DRYNESS OF THE SKIN, And every species of diseases arising from disordered LIVER, KIDNEYS, STOMACH, BOWELS OR BLOOD. T. MILBURN & CO., Proprietors, Toronto.

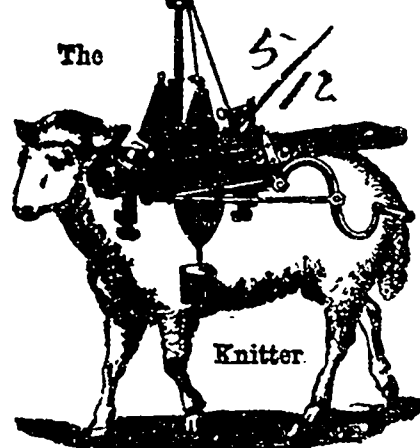

Lamb Knitting Machine

The family favourite and standard manufacturing machine.

The LAMB KNITTING MACHINE makes all sizes of socks and stockings, cardigan jackets, shirts, drawers, combination suits, scarfs, caps, mitts, and in fact anything a family would want. It is not a common circular machine making only one size. You can make any size, narrow and widen the same as in hand knitting. It is as far ahead of the common circular machine as the binder is ahead of the old cradle. It is always ready to do any kind of work; is complete, simple, and everlasting, knits over twenty garments in ten different stitches. On receipt of \$1 we will send you one pair full fashioned ladies' stockings, narrowed on the back, and one pair ladies' mitts. You can then see the actual work of the most wonderful and perfect knitting machine ever invented. Send for catalogue and price list.

J. M. STATTON, Sole Agent for the Dominion, 44 CHURCH STREET, TORONTO.

25 BEAUTIFUL FANCY MIXED CARDS, no two alike, with name, 10c.

25 COMIC TRANSPARENT CARDS, 10c Agents wanted. Send for samples, 15c.

QUEEN CITY CARD HOUSE 150 YONGE STREET, TORONTO.

The Only Weekly Bee Paper in the World

THE BEE JOURNAL,

[Established in 1861] Monthl' \$2.00 a Year, Weekly, \$2.00 (Invariably in advance)

not only sustains its former excellent reputation, but exceeds the expectations of its best friends, by advancing progressive ideas upon Bee Culture. It is the BEST AND MOST THOROUGHLY PRACTICAL PUBLICATION ON BEES AND HONEY IN THE WORLD, and all those who keep bees should take the Weekly BEE JOURNAL. It is edited by THOMAS G. NEWMAN, whose reputation is world-wide. Send for a sample copy. Address: BEE JOURNAL, Chicago, Ill.

DR. W. SMITH M.D.

3/12 ENGLAND, SPECIALIST. Nervous Debility in all its various forms, and Private Diseases in all their different stages successfully treated. Dr. Smith has an extended experience of over 20 years in the Hospitals of London and Paris, and can be consulted free from 10 a.m. to 1 p.m., 3 to 6, and 7 to 9 p.m., on all diseases of a private nature requiring skill and experience. Letters answered when stamp enclosed. Office: 181 King St. West, TORONTO.





# SPRING STYLES HATS

JUST IN.

English and American

Granville, Vanderbilt,

Ripon.



FEDORA,  
LOTUS CLUB,

ALL THE LATEST STYLES.

## JOSEPH ROGERS

141 King Street East,

FIRST HAT STORE WEST OF MARKET.

Bronze Medal, 1882. First Prizes every time Exhibited at Toronto Exhibition.

GREAT AMMONIUM CONDENSER

GYPSUM

OR PURE

# LAND PLASTER

The Cheapest and best Fertilizer in the World.

Maximum effect when used with Manure, as it saves half of the virtue which otherwise escapes as ammonia into the air. Scatter on manure heaps, on Barn-yard, on manure in the fields and under Cattle's bedding. \$100 to \$200 Profit on every ton of Gypsum used, is the result of numerous experiments.

## THE GRAND RIVER PLASTER CO.

Has entirely new and improved machinery for the manufacture of pure white Land Plaster.

By a patent process, not used elsewhere in Canada, the Gypsum, besides being pulverized to a fineness hitherto unknown in the Dominion, is purified during manufacture, and therefore the benefits accruing from using this Land Plaster are greater than any other.

ONTARIO SCHOOL OF CHEMISTRY, TORONTO, March 16th, 1881.

W. H. MERRITT, Esq.,

My DEAR SIR,—In accordance to your request, I have obtained Average Mercantile Samples of Land Plaster from dealers in Toronto, and beg to report as follows:—

	Grand River White.	Oswego Grey.	Paris G e
Calcium Sulphate (Fertilizer)	77.18	52.00	54.00
Carb. Lime Magnesia (Useless)	trace	15.27	15.01
Iron and Alumina	trace	1.50	1.60
Insoluble Matter	1.27	8.75	15.60
Water and Organic Matter	21.55	22.48	13.60
	100.00	100.00	100.00

The insoluble matter consists of clay and sand, being the residue left after boiling with hydro-chloric acid.

Yours obediently,

THOMAS HEYS, Analytical Chemist.

The above analysis adds theoretical proof to the practically known facts that the Grand River White is 25 per cent, purer than any other Land Plaster on our Market.

Our testimonials are numerous, and are highly flattering, but the best proof of appreciation at the hands of our farmers is the steadily increasing demand.

OFFICE  
GRAND RIVER PLASTER

15 Toronto St., TORONTO.

# WHAT IS CATARRH?

(From the Toronto (Canada) "Mail")

## A New Treatment

FOR THE  
RAPID AND  
PERMANENT  
CURE OF

to be had only  
of  
A. H. DIXON & SON

No 305 KING ST. WEST. TORONTO, CANADA.

305 King Street West, Toronto, and get full particulars and treatise free by enclosing stamp.

What the Rev. E. B. Stearns, D. D., a Clergyman of the London Conference of the Methodist Church of Canada, has to say in regard to A. H. Dixon & Son's New Treatment for Catarrh.

Messrs. A. H. Dixon & Son:  
Dear Sirs,—I write of the 13th inst. to hand. It seems unnecessary to be true that I am cured of Catarrh, but I know that I am. I have had no return of the disease and never felt better in my life. I have tried so many things for catarrh, suffered so much and for so many years, that it is hard for me to realize that I am really better.  
I consider that mine was a very bad case. It was aggravated and chronic, involving the throat as well as the nasal passages, and I thought I would require the three treatments, but feel fully cured by the two sent me, and I am thankful that I was ever induced to send to you.  
You are at liberty to use this letter, stating that I have been cured at two treatments, and I will gladly recommend your remedy to some of my friends who are suffering.  
Yours, with many thanks,  
RST. J. B. STEVENSON.

OAKLAND, ONTARIO, CANADA, March 17, 1883.

RST. J. B. STEVENSON.

Catarrh is a mucous-purulent discharge caused by the presence and development of the vegetable parasite ammonia in the internal lining membrane of the nose. This parasite is only developed under favorable circumstances, and these are: Mottled state of the blood, as the lighted corpuscle of tubercle, the germ poison of syphilis, mercury, toxæmia, from the retention of the effete matter of the skin, suppressed perspiration, badly ventilated sleeping apartments, and other poisons that are germinated in the blood. These poisons keep the internal lining membrane of the nose in a constant state of irritation, ever ready for the deposit of the seeds of these germs, which spread up the nostrils and down the fauces, or back of the throat causing ulceration of the throat; up the Eustachian tubes, causing deafness; burrowing in the vocal cords, causing hoarseness; usurping the proper structure of the bronchial tubes, ending in pulmonary consumption and death.

Many attempts have been made to discover a cure for this distressing disease by the use of inhalents and other ingenious devices, but none of these treatments can do a particle of good until the parasites are either destroyed or removed from the mucous tissue.

Some time since a well-known physician of forty years' standing, after much experimenting, succeeded in discovering the necessary combination of ingredients which never fails in absolutely and permanently eradicating this horrible disease, whether standing for one year or forty years. Those who may be suffering from the above disease should, without delay, communicate with the business managers, Messrs. A. H. DIXON & SON,