

**CIHM  
Microfiche  
Series  
(Monographs)**

**ICMH  
Collection de  
microfiches  
(monographies)**



**Canadian Institute for Historical Microreproductions / Institut canadien de microreproductions historiques**

**© 1994**

Technical and Bibliographic Notes / Notes techniques et bibliographiques

The Institute has attempted to obtain the best original copy available for filming. Features of this copy which may be bibliographically unique, which may alter any of the images in the reproduction, or which may significantly change the usual method of filming, are checked below.

L'Institut a microfilmé le meilleur exemplaire qu'il lui a été possible de se procurer. Les détails de cet exemplaire qui sont peut-être uniques du point de vue bibliographique, qui peuvent modifier une image reproduite, ou qui peuvent exiger une modification dans la méthode normale de filmage sont indiqués ci-dessous.

- Coloured covers/  
Couverture de couleur
- Covers damaged/  
Couverture endommagée
- Covers restored and/or laminated/  
Couverture restaurée et/ou pelliculée
- Cover title missing/  
Le titre de couverture manque
- Coloured maps/  
Cartes géographiques en couleur
- Coloured ink (i.e. other than blue or black)/  
Encre de couleur (i.e. autre que bleue ou noire)
- Coloured plates and/or illustrations/  
Planches et/ou illustrations en couleur
- Bound with other material/  
Relié avec d'autres documents
- Tight binding may cause shadows or distortion  
along interior margin/  
La reliure serrée peut causer de l'ombre ou de la  
distorsion le long de la marge intérieure
- Blank leaves added during restoration may appear  
within the text. Whenever possible, these have  
been omitted from filming/  
Il se peut que certaines pages blanches ajoutées  
lors d'une restauration apparaissent dans le texte,  
mais, lorsque cela était possible, ces pages n'ont  
pas été filmées.
- Additional comments:/  
Commentaires supplémentaires:

- Coloured pages/  
Pages de couleur
- Pages damaged/  
Pages endommagées
- Pages restored and/or laminated/  
Pages restaurées et/ou pelliculées
- Pages discoloured, stained or foxed/  
Pages décolorées, tachetées ou piquées
- Pages detached/  
Pages détachées
- Showthrough/  
Transparence
- Quality of print varies/  
Qualité inégale de l'impression
- Continuous pagination/  
Pagination continue
- Includes index(es)/  
Comprend un (des) index
- Title on header taken from:/  
Le titre de l'en-tête provient:
- Title page of issue/  
Page de titre de la livraison
- Caption of issue/  
Titre de départ de la livraison
- Masthead/  
Générique (périodiques) de la livraison

This item is filmed at the reduction ratio checked below/  
Ce document est filmé au taux de réduction indiqué ci-dessous.

10X	12X	14X	16X	18X	20X	22X	24X	26X	28X	30X	32X
<input type="checkbox"/>	<input type="checkbox"/>	<input type="checkbox"/>	<input type="checkbox"/>	<input type="checkbox"/>	<input type="checkbox"/>	<input type="checkbox"/>	<input checked="" type="checkbox"/>	<input type="checkbox"/>	<input type="checkbox"/>	<input type="checkbox"/>	<input type="checkbox"/>

The copy filmed here has been reproduced thanks to the generosity of:

Canadiana department  
North York Central Library

The images appearing here are the best quality possible considering the condition and legibility of the original copy and in keeping with the filming contract specifications.

Original copies in printed paper covers are filmed beginning with the front cover and ending on the last page with a printed or illustrated impression, or the back cover when appropriate. All other original copies are filmed beginning on the first page with a printed or illustrated impression, and ending on the last page with a printed or illustrated impression.

The last recorded frame on each microfiche shall contain the symbol  $\rightarrow$  (meaning "CONTINUED"), or the symbol  $\nabla$  (meaning "END"), whichever applies.

Maps, plates, charts, etc., may be filmed at different reduction ratios. Those too large to be entirely included in one exposure are filmed beginning in the upper left hand corner, left to right and top to bottom, as many frames as required. The following diagrams illustrate the method:

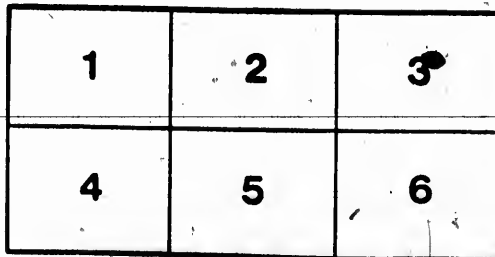
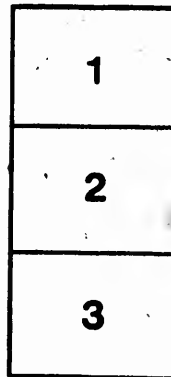
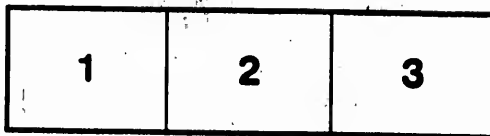

L'exemplaire filmé fut reproduit grâce à la générosité de:

Canadiana department  
North York Central Library

Les images suivantes ont été reproduites avec le plus grand soin, compte tenu de la condition et de la netteté de l'exemplaire filmé, et en conformité avec les conditions du contrat de filmage.

Les exemplaires originaux dont la couverture en papier est imprimée sont filmés en commençant par le premier plat et en terminant soit par la dernière page qui comporte une empreinte d'impression ou d'illustration, soit par le second plat, selon le cas. Tous les autres exemplaires originaux sont filmés en commençant par la première page qui comporte une empreinte d'impression ou d'illustration et en terminant par la dernière page qui comporte une telle empreinte.

Un des symboles suivants apparaîtra sur la dernière image de chaque microfiche, selon le cas: le symbole  $\rightarrow$  signifie "A SUIVRE", le symbole  $\nabla$  signifie "FIN".

Les cartes, planches, tableaux, etc., peuvent être filmés à des taux de réduction différents. Lorsque le document est trop grand pour être reproduit en un seul cliché, il est filmé à partir de l'angle supérieur gauche, de gauche à droite, et de haut en bas, en prenant le nombre d'images nécessaire. Les diagrammes suivants illustrent la méthode.

**MICROCOPY RESOLUTION TEST CHART**

(ANSI and ISO TEST CHART No. 2)

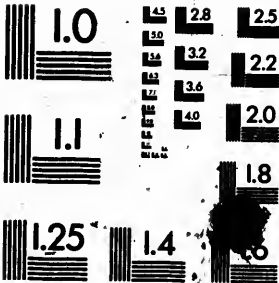

**APPLIED IMAGE Inc**

1653 East Main Street  
Rochester, New York 14609 USA  
(716) 482 - 0300 - Phone  
(716) 288 - 5989 - Fax

# NOXON BROS

Manufacturers

Manufacturing Co  
(LIMITED.)

“  
OF  
**STANDARD**  
SEEDING &  
HARVESTING  
MACHINES.



**INGERSOLL,**  
ONTARIO,  
CANADA.

Revised Clark & Co. 2 to 6/1908

Thirty-Seventh Year . . . .

Annual  
Catalogue

SEEDING and  
HARVESTING  
MACHINERY

MANUFACTURED BY

Noxon Bros. Manufacturing Co., Ltd.

OFFICE and FACTORY

INGERSOLL, ONTARIO, CANADA

Transshipping Branch Warehouses:

Toronto, Ont., 86 Front Street.  
Montreal, Que., 222 to 226 St. Paul Street.  
Ottawa, Ont., 197 Wellington Street.  
London, Ont., 125 King Street.  
Guelph, Ont., Cork Street.



Telegraph and Express Offices in Main Office of  
Company, Ingersoll.  
Great North Western Telegraph.  
Canadian Pacific Telegraph.  
Dominion Express.  
Canadian Pacific Express.

WEBBER PRINTING CO., 80 LOMBARD ST.  
TORONTO

# INTRODUCTORY

**T**HIS ISSUE of our Annual Catalogue, marks the THIRTY-SEVENTH YEAR of the establishment of our business. For over one-third of a century our business relations with the farming community, have existed, and during that time the value of our business transactions have amounted to many millions of dollars. From an original and comparatively small and humble beginning our business has kept pace with the development of the country, making a steady and solid growth, so necessary to thorough success, and witnessing a constant and ever increasing trade, until the past season's business has far exceeded, in volume, that of any previous year in the history of our Company. We have always endeavoured to be fully in touch with the spirit of the times, and in our productions we have aimed to reflect the most progressive and advanced ideas and inventive genius of the age. Our factory has had the closest and most attentive supervision by active and practical members of our Firm, even to the smallest details, and has also been from time to time supplemented by the latest improved labor-saving machinery, and is to-day, without question, the best equipped Implement Manufactory in Canada. This enables us to turn out work the most perfect in all its parts, and capable of giving the very highest degree of satisfaction and service to the purchaser. We are, therefore, in a position to give to the farming community the most perfect goods at a price fully as low, if not lower, than any other firm, and fully in keeping with the economical necessities of the times; and as we stand alone in our old time position of business independence, untrammelled by any combinations or alliances, we are prepared to continue to extend to the farming community the same disinterested regard for our and their mutual interest, which has characterized our course in the past. We flatter ourselves, that our efforts to produce only the best and highest class of goods, have achieved a substantial measure of success, and we have every assurance that these efforts have met with a most hearty and practical appreciation from the farming community. We have no higher aim than to merit the good will of the farming community, and to that end our greatest efforts will be directed.

## Noxon New No. 8 Steel Binder



**WHAT THE HARVESTING** of the grain crop of the world to-day is very largely dependent upon the aid of the Self Binding Harvester is but an indication of the great aid that science and manufactures has been to agriculture. If by one mighty sweep of the arm of some gigantic force, every Self Binding Harvester should be obliterated, the muscles of agricultural strength would be paralyzed, and the wheels of commerce would be retarded, if not turned backward in their course to such an extent that even civilization itself could hardly withstand the shock. Amidst all the wonderful achievements and marvelous results of an age illuminated by the glow of intellectual brilliancy, and resounding with the march of human progress, agriculture to-day holds a position of proud pre-eminence, and which all other industries are compelled to concede, it holds by the right of its being the source and foundation of all their necessities. Then is it any wonder that the highest intellectual genius of our age acknowledges no more desirable field, for the employment of its researches or services, than at the fountain head, the source of the world's food supply, and from whence all the streams of commerce start upon their course, turning on their way the myriads of wheels of the world's industries. The most progressive among those engaged in the noble occupation of agriculture will be found to be those who are the most alert, and quickest to recognize any advantages offered in the way of improvements, or superiority in appliances for use in their calling. The successful results attending our appeals to the sound, practical judgment of the agriculturist have been so thoroughly satisfactory, that we have the greatest pleasure in bringing to their notice our new and latest improved No. 8 Steel Binder, feeling confident that the great advancement, which it illustrates, in practical binder construction, will at once find a host of admirers. A studied regard for whatever, either in principle, mechanical devices, or material could be best employed to produce the best machine has ever been our aim. **Wherever Steel suggested itself** as being preferable for any part, **there it has been used with no unstinted hand**, as to quantity or quality. Malleable iron, too, has been pressed into requisition, with a generosity, which, with the wrought iron and brass used, leaves but little material to be supplied from other sources. **The result is a Binder which stands above the adverse criticism of the most exacting purchaser**, or the most critical investigation of the expert mechanic, and which has, from its performance in the field, during past harvest, established a reputation, which leaves little or nothing to be added to, so perfect does its record stand. **All the parts of our Binder harmonize as to strength.** We do not build a weak foundation frame, and then attempt to strengthen the Binder by using unnecessary material in other parts.



## Noxon New No. 8 Steel Binder.



**NO MACHINE WAS EVER CONSTRUCTED IN WHICH THE DEMANDS UPON IT ARE MORE COMPLETELY MET IN EVERY WAY, THAN IN THIS PERFECT STRUCTURE OF STEEL.**

Neither do we put any extra weight of material in any part for the sake of using a cheaper, but more bulky material. **We use the best and most appropriate material for each particular part. In our Foundation Frame we use Steel, and obtain the greatest strength by having the fewest possible joints.** Wherever the continuity of any material is broken, or in other words, wherever a joint has to be made, there every means has to be resorted to, by using extra labor and weight of material, and then with but partial success, to endeavor to restore the strength and solidity, which has been sacrificed. The steel in the frame of our Binder is as continuous as practicable to make it.

## The Main Gear Frame

Is made of **one solid piece of flanged steel**, upon which all the connected bearings for the shafting are firmly bolted. **This can never bend or twist**, and the shafting and gearing all run as true, snug and free as the working parts of an engine, or other well constructed machine. **This feature cannot be too closely looked into**, as some makers have attempted to avoid the expense of securing absolute rigidity and strength in their Main Gear Frame, by using a chain drive from main drive wheel, which, while it adapts itself to the twisting and changing position of the working parts, caused by the use of a cheaper, weaker and inferior construction, shifts the expense from the shoulders of the manufacturer to those of the purchaser, in the shortened life of the machine, as well as additional expense in needed repairs. **In this main gear frame of steel, we have a drive wheel** so large and so broad that furrows are crossed with an ease and steadiness which does not jar or rack the machine, and upon soft ground does not sink in and make the draft very heavy, nor does it go over rough and uneven ground with that unsteady, jerky motion so characteristic of smaller drive wheels. **No Binder can do good work with an unsteady, uneven motion.**

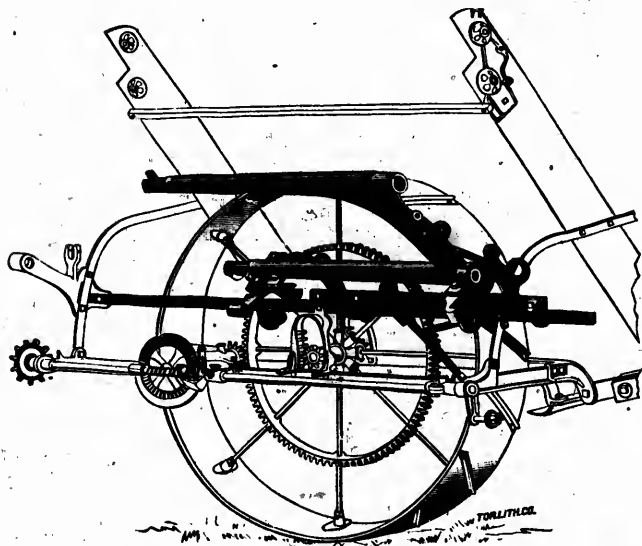

### Solid as a Rock.

The Binding Attachment on this Steel Binder is carried on the Main Gear Frame, and not on the Elevator Frame, as in other Binders. Just see how solid it is. No chance to rack or strain the Carrying Frame on rough ground or deep furrows.

The  
any Bin  
Ground  
the Bin  
easily a

This  
Wheel  
locked

We use  
we use  
continuity of  
extra labor  
n sacrificed.

## Our Drive Wheel

Is so strongly constructed, with its Steel Spokes and Tire, that it well earns its reputation of being

### The Strongest and Lightest Binder Drive Wheel Made.

It is so constructed that by the aid of the adjusting nuts, if ever necessary the rim of the wheel can be tightened on the spokes to any tension required.

Whoever has had any experience with a shaky, creaky old Drive Wheel, will appreciate the perfect construction of ours. Our Drive Wheel is carried in malleable yokes, in which it works to raise and lower the height of cut.

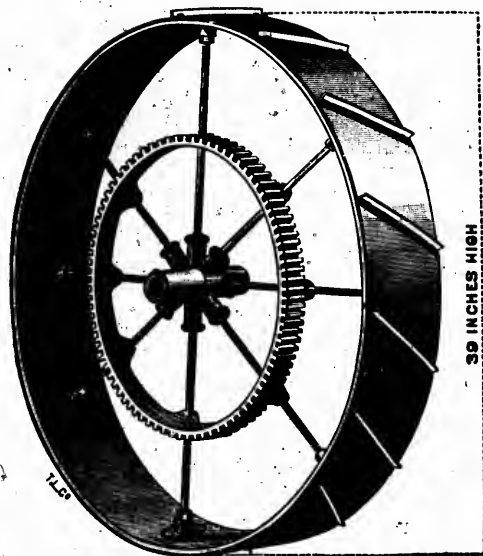

The largest and strongest Drive Wheel used in any Binder, Banded with Steel, Steel Spokes, Steel Ground Grips. Never gets rickety or creaky. Carries the Binder through furrows or over rough ground, easily and steadily.

No chance for the Steel Spokes to work loose in this Drive Wheel. Cast solidly into the hub and gearing. Note the iron plate with expansion nuts on each spoke solidly locked. Wheel can be tightened in a few minutes, at any time, if ever needed. The grandest wheel ever made.

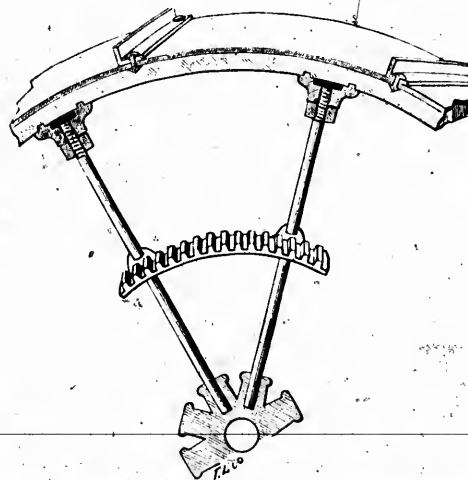

This connection of the Steel Spoke to rim of Drive Wheel never gave trouble. The expansion nut is firmly locked in place, cannot become loose.

on the Main  
nders. Just  
rying Frame

## The Noxon Platform Frame of Steel

Is formed of a solid continuous bar at the back running from a solid connection with the gear frame, to a connection with the cutter bar at its outer end, making a **continuous outline of steel**, perfect in its disposition and unrivalled as to strength. For low cutting, especially on uneven or lumpy ground, **the right kind of a cutter bar is of the greatest importance.**

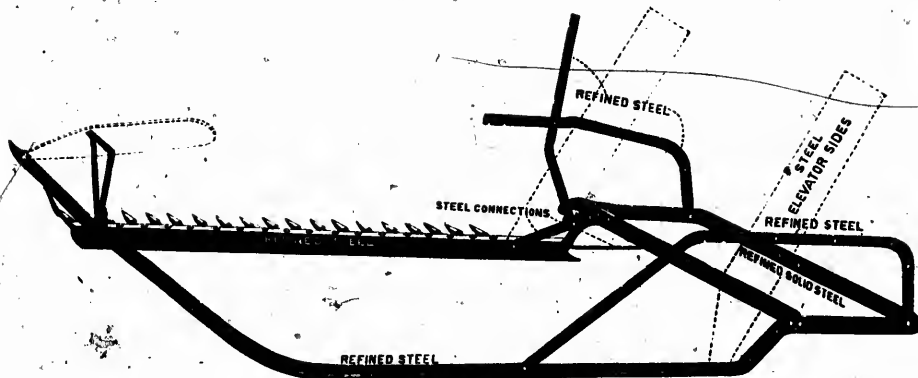

What more is to be desired about this Frame of Steel. Notice particularly how few joints there are and how strong they are made. No weak joints or twisting about it.  
**GOOD FOR A LIFETIME.**

## The Noxon Steel Finger Bar



The usual shape of Cutter Bar on other Binder. Just right to clog with dirt and stones.



Just notice how close this Cutter Bar can get to the ground. No grain lying too flat for it to pick up. Slides over all dirt and stones and will not clog.

# The Noxon Improved Steel Cutter Bar

It is made in the most perfect shape for low cutting, and taking up lying grain. Instead of having a square corner to crowd dirt and

other obstructions ahead of it, it is rounded on the front side, so that it will slide over anything which it may encounter.

A most important part of a proper cutting

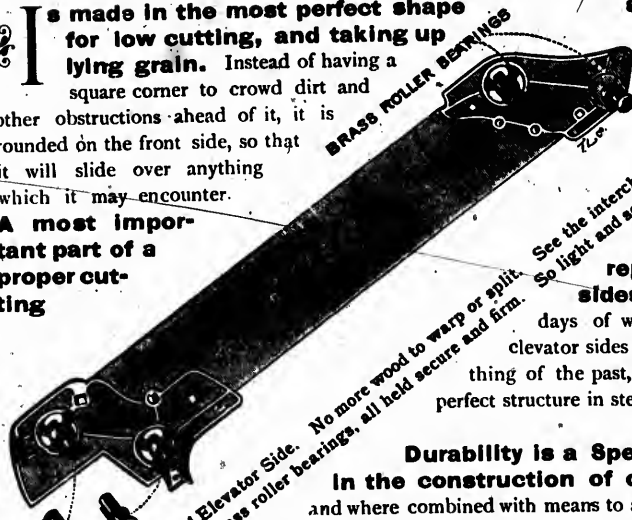

BRASS ROLLER BEARINGS

This is our Steel Elevator Side. No more wood to warp or split. See the interchangeable. So light and so strong.

No more wood to warp or split. See the interchangeable. So light and so strong.

**Durability is a Special Study with us in the construction of our No. 8 Binder,**

and where combined with means to avoid any chance of needless friction, or cramping in the working parts, a very important double object is attained. To entirely avoid this, we use the

**best of perfectly true, cold rolled steel for the journals of our canvas rollers. These run in self adjustable, interchangeable,**

**able, brass thimble bearings, accurately bored out and fitted, which makes bearings practically indestructible, as to wear, and absolutely free from any cramping or extra friction, and causing our No. 8 Binder to run much lighter than any other made. The canvas rollers are all capped by the ends of the rollers projecting into a recess in the elevator sides, completely.**

apparatus is a good guard, and our malleable steel faced guard fills this requirement to a nicety. Our Steel Cutter Bar has a malleable connection to the gear frame at its inside end, which makes the most rigid and strong connection possible. To thoroughly complete this frame of steel

**the SIDES OF THE ELEVATOR FRAME, which in other machines are of wood, have been replaced in this by**

**sides of steel, so that the days of warped and split wooden elevator sides are with this machine a thing of the past, as it stands alone as a perfect structure in steel.**

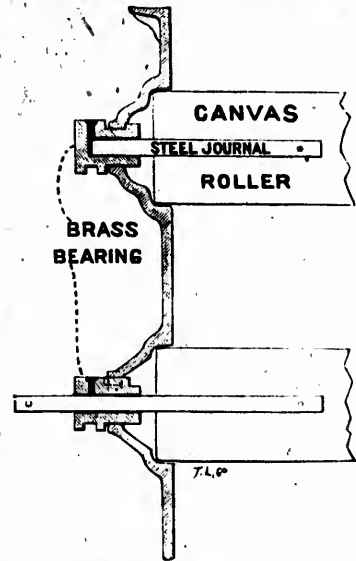

Our outside oiling safety capped end Canvas Rollers. See how the end of the roller is protected. No possibility for damp most durable ever made. All bearings

straw to wind. The hardened steel journals with self adjusting Brass Bearings are the best and oiled from outside of machine. No searching and trouble to find oil holes.

# The Noxon New Cord-Saving Steel Knotter

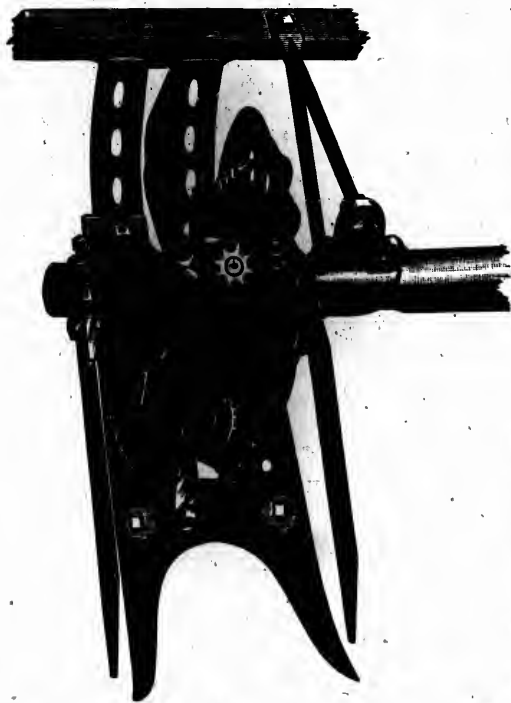

Examine closely the construction of this Knotter. **The knotter is the most important part of a Binder.** An otherwise well constructed Binder with a poor knotter is perfectly useless. Our knotter is very simple; always ties, makes a great saving in twine. Knife cuts but one cord—does not get out of adjustment.

**Avoiding any possibility of straw winding at the ends of the rollers,** so usual with other binders, when the straw is green or damp. **Many other Binders** which would otherwise have been successful **have entirely failed in their binding and knotting mechanism.** How many are there in use to-day, which will clog and stick fast where the straw is green or damp, or give almost unbearable annoyance, from missing sheaves, and no apparent means of preventing it? This arises from faulty workmanship, added to the greater fault of a wrong principle in construction, in which case no remedy can be applied short of an entire replacing of the part, by something more practical. **Many knotters work sufficiently well for a time when new,** to satisfy the purchaser, but after some wear takes place, develop such defects and weakness as to make it impossible for them to do satisfactory work, even with the constant tinkering bestowed upon them.

**The Knotter used by us for the past five years is so simple in construction, so free from any weak or delicate parts, so positive in its movements and so certain in its work,** that it has removed all the elements of uncertainty and doubt, from this part of the operation of the Binder. **It practically takes care of itself,** and its successful working does not depend upon any nicety of adjustment, or freedom from conditions found in the field, but **will faithfully do its work under all circumstances. It has fewer and stronger parts than any other Knotter made, and is the only Knotter made which does not cut off, drop or waste a single particle of Twine.** This is something that interests every farmer. **Every dollar saved in the twine bill adds just so much to the earnings of the farm,** and in these days of necessary close economy, **how can money be made easier than by saving in this way.** No pieces of twine being cut off, **there are no pieces to be drawn into the Knotter and cause it to miss tying.**

## The Most Reliable Binding Mechanism Made.



Does not load a Binder down with needless weight. Makes a neat, round, well-formed, tightly bound sheaf. Discharges sheaf easily. Perfect trip. Does not get out of order.

We had experience with other styles of Knotters, and we know by comparison where the great superiority of our simple, cord-saving Steel Knotter is, as well as what the direct saving would be in the twine bill from its use. We have also experimented extensively with the binding mechanism of our Steel Binder, and after careful study have so devised and adjusted it that it binds a tight, well-formed sheaf, and discharges it with the least possible expenditure of power.

## Separate Parts of Knotter.

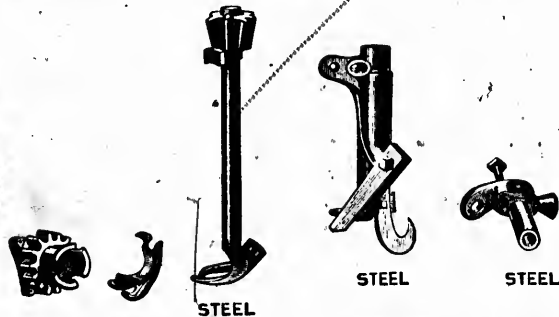

These separate parts of our Knotter show how simple and strong it is. They are all so easily understood that no person ever has any trouble with our Knotter.

In the Knotter is where many other Binders are seriously defective, as many a farmer fully realizes who has had to tug and sweat in the heat of a harvest day, pulling out a bundle from the Binder which it would not discharge. **The three discharge arms** of our Binder discharge the sheaf with a gentle and easy motion, making a perfect separation from the unbound grain. **Nothing is more essential to a well-formed tidy sheaf than that the butts should be square and even**, and in order to accomplish this, the butter must be something more than merely in name. We have watched the action of all kinds of perishable canvas butters, as well as reciprocating butters, and are thoroughly convinced that **the reciprocating butter is the only one that will do proper work**, as this kind of motion alone will move the straw to secure an even butt, while it is

# The Best Driven and Strongest Reel ever Adapted

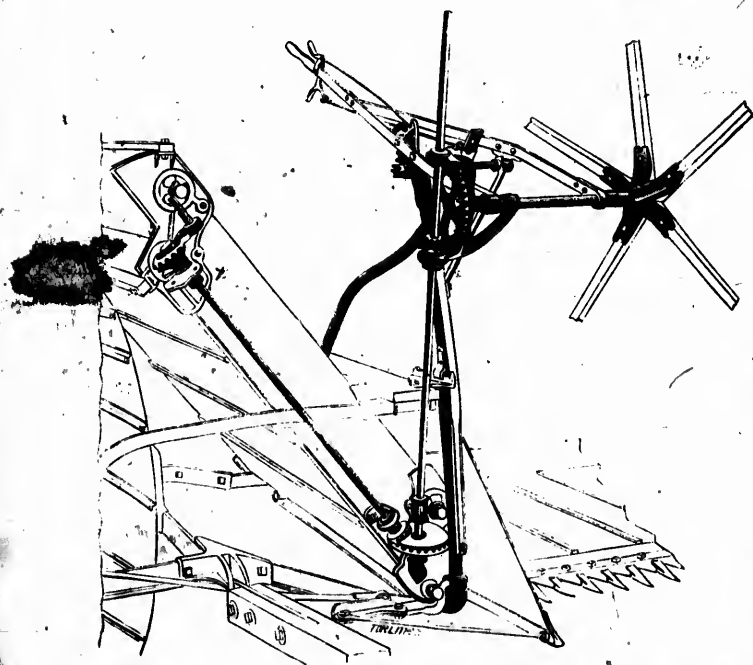

Perfectly balanced and easily handled. Never cramps or binds. Runs perfectly steady and not effected by high winds.

falling from the elevating canvas into the binding receptacle, the only point in its passage at which it is free from restraint and can be freely acted upon.

## Our positive motion direct geared reel is driven by an upright shaft

with bevel gear and perfectly free to move up or down, backward or forward, without the least cramping or binding. **This is the only positive plan for driving a Reel** to cause it to run perfectly steady, and not to be affected by the wind. **Both ends of the Machine can be readily raised or lowered from the driver's seat**, and is easily operated by any boy capable of driving a team. The machine being so well balanced, the tilting requires but the slightest effort from the driver, and does not take the driver's attention from his team: **As we use the widest elevating canvas of any Canadian makers**, our machine has the capacity to handle the tallest grain without the least difficulty. **We make our No. 8 Binder to thoroughly satisfy the farmer**, and their success in the past give us the fullest assurance that they will succeed in doing so.



TO THE

THE SIZE

ENOUGH

FEATURES

THEY V

MADE.

A BINDER



pted

g receptacle,  
from restraint

direct  
n by

down, back-  
or binding.  
driving a  
nd not to be  
Machine  
from the  
boy capable  
balanced, the  
e driver, and  
n: As we  
s of any  
e capacity to  
the least  
Binder to  
eir success in  
ll succeed in



## Noxon No. 8 Steel Binder

 IS UNSURPASSED BY ANY OTHER MACHINE OF THE KIND MANUFACTURED. THE INTENDING PURCHASER WILL BE AMPLY REPAID BY GIVING IT THE MOST THOROUGH AND CRITICAL EXAMINATION. ITS GOOD POINTS ARE SO MANY AND OF SUCH IMPORTANCE TO THE FARMER, THAT IT MUST TAKE THE LEADING POSITION AMONG IMPLEMENTS OF ITS CLASS.

THE BEST MATERIAL AND THE BEST WORKMANSHIP ONLY IS USED IN ITS CONSTRUCTION, THE SIZE, WIDTH OF FACE AND GENERAL CONSTRUCTION OF ITS DRIVE WHEEL IS UNEQUALLED

ITS MAIN FRAME IS THE PERFECTION OF LIGHTNESS, STRENGTH AND SOLIDITY.

THE KNOTTER IS MADE TO TIE, AND IT DOES IT EVERY TIME. THE KNOTTER SAVES ENOUGH IN TWINE TO MAKE IT AN OBJECT FOR THE FARMER TO LOOK FULLY INTO THIS GREAT FEATURE OF OUR BINDER, AS IT WILL SAVE HIM MONEY. THE SHEAVES ARE BOUND SO THAT THEY WILL STAND ANY AMOUNT OF HANDLING WITHOUT COMING APART.

THE REEL IS THE MOST PERFECT, BEST WORKING AND EASIEST CONTROLLED OF ANY MADE. WHATEVER IS OF BENEFIT TO A BINDER IS THERE, AND WHATEVER SHOULD NOT BE IN A BINDER IS NOT THERE.



## Noxon No. 7 Steel Binder

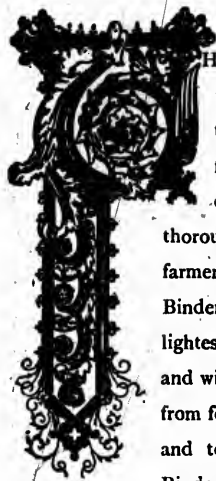

THE NUMBER OF THESE MACHINES manufactured and sold by us during the past few years, and the unexcelled reputation which they have earned for themselves in the Canadian harvest fields, makes it unnecessary that any lengthy or detailed description of it should be given in this Catalogue. The accompany illustration of it fully confirms its record for compactness, lightness and general neatness, whilst its construction of the best quality of steel and iron, with workmanship of the highest grade, and its very superior working qualities, constitute it a thoroughly first class Binder in every respect. We have thousands of testimonials from the most reliable and progressive farmers in Canada, all speaking in the very highest terms of praise as to the satisfaction it has given them. These Binders are all supplied with our new perfect cord-saving knotter, and which, as their past record proves, will handle the lightest as well as the heaviest and most tangled crops that grow in a manner not equalled by any other Binder made, and with perfect ease for one pair of horses. These are not any old stock of Binders found unsaleable and carried over from former years, but all new goods manufactured for the coming harvest, from new material purchased this season, and to meet a demand from a class of customers, who, having been familiar with the operation of our No. 7 Binder in the field, have formed such an opinion of them as to cause their selection in preference to one with which they are not familiar, and well knowing that any farmer makes no mistake in purchasing a machine with such a record as the Noxon No. 7. It has cut and bound the grain upon thousands of Canadian farms during several years past, and its mechanical principles and construction have been so firmly established that there is no longer any question in the minds of the farming community as to the value of this thoroughly satisfactory and reliable binder, a fact amply proven by the largely increased number manufactured and sold by us each year since we commenced its manufacture.



rs, and the  
unnecessary  
stration of it  
best quality  
nstitute it a  
progressive  
em. These  
l handle the  
inder made,  
carried over  
this season,  
of our No. 7  
with which  
Noxon No  
nciples and  
to the value  
by us each

# Noxon No. 7 Steel Binder



**THE THOUSANDS OF THESE MACHINES IN USE SPEAK FOR THEMSELVES**



## Noxon Steel Hoosier Drill

**THE STEEL HOOSIER DRILL** stands unrivalled in all the really good and practical features that go to make up the best, and it can be relied upon to do its work accurately, expeditiously and well. **The great advantage and superiority of our adjustable feed** gave the Hoosier a boom that sent it with one grand stride directly to the highest point in public favor, a position it is eminently worthy of, and in which it is firmly established by its unequalled merits. It is quite easy to make broad sweeping claims of superiority on paper, and it is freely indulged in by manufacturers of inferior drills. We have observed that the most inferior ones are blown the loudest, and the greatest stress is placed on various traps that are employed on them to attract the attention of the farmers, and draw it away from the many defects in their feed and other vital parts. **Each succeeding year furnishes additional and stronger evidence that the superiority claimed by us actually exists in the Hoosier** and not on paper alone, and of the fact that the extravagant claims indulged in by the makers of "Shoddy" Drills are hollow and false. **The natural result is a rapidly increasing demand for the Hoosier Drill, and a corresponding decrease for others** that fail to come up to the point of merit claimed for them. This also explains why it is that we are obliged to keep up a constant increase in capacity to keep it equal to the demand, while others have to expend their energy in endeavoring to keep the demand up to the capacity. **Rival manufacturers are forced to acknowledge the superiority of the Hoosier, and to admit that it is the standard and leading grain drill of the world.** It had combined opposition to contend with, but finally and triumphantly won its way to high favor on the basis of true merit.

**Our adjustable force feed** is without exception the best grain or grass feed in existence, and the unquestionable popularity of the Hoosier is in no small degree due to the well known and acknowledged superiority of its feed over all others. **The feed is the most vital part of a seeding machine,** and one that has a poor feed cannot do good work, nor give satisfaction in the highest degree, no matter how good it may be in other respects, **hence the feed should receive the most careful attention** in the selection of a Grain Drill, and it should be remembered that **the one with the best feed should be chosen** when other things are equal. Special attention is therefore invited to the following description, which in connection with the foregoing cuts will convey a clear understanding of the construction and efficiency of our feed.

# Noxon Steel Hoosier Drill

FRONT VIEW.

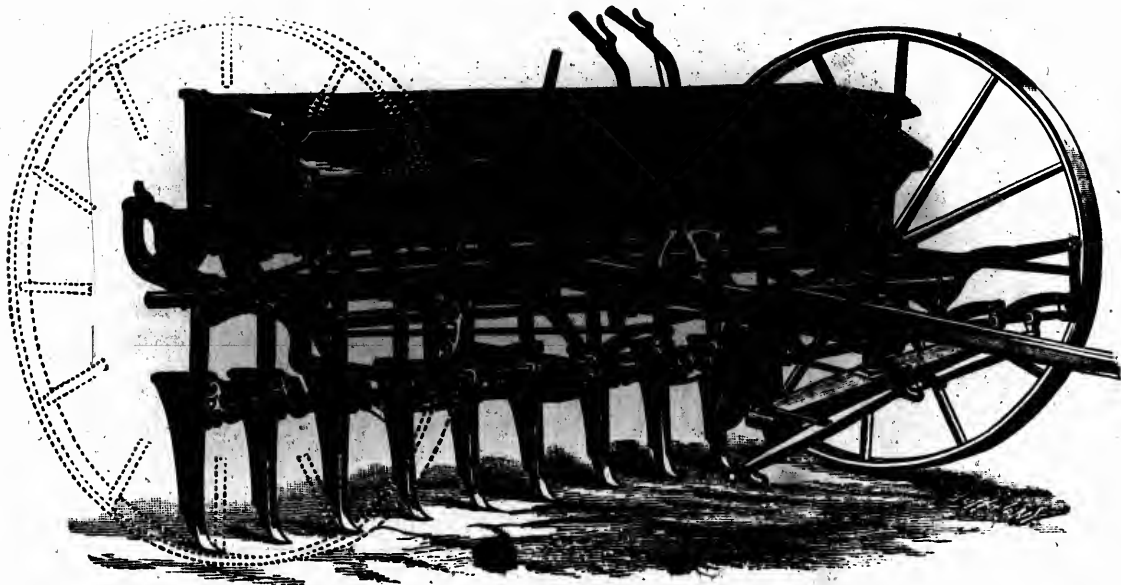

NOXON STEEL HOOSIER DRILL WITH GROUND WHEEL BROKEN AWAY  
TO SHOW CONSTRUCTION OF FRAME, ETC.

# Noxon Steel Hoosier Drill

REAR VIEW

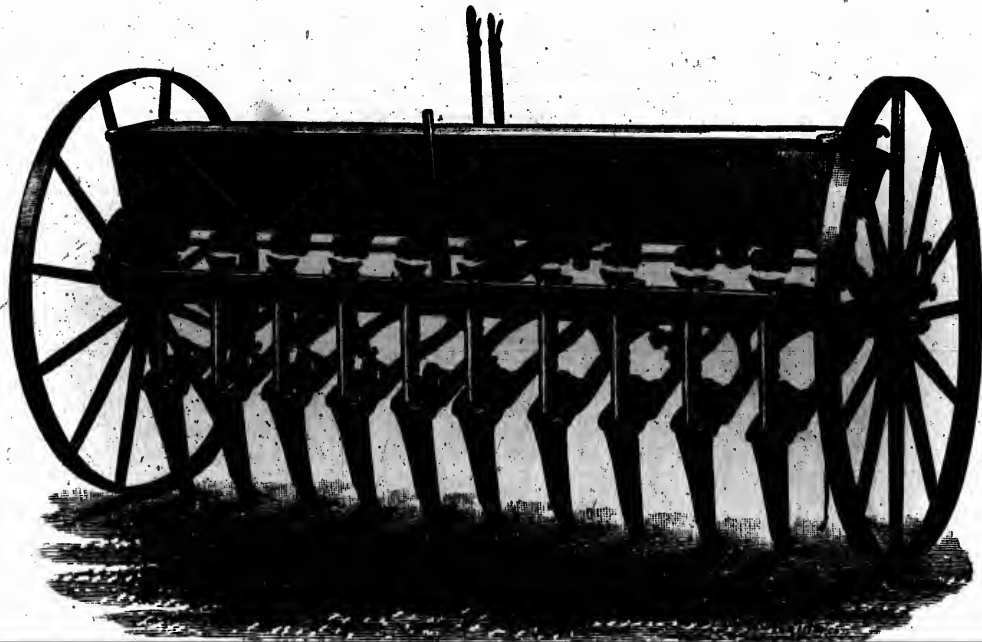

THE BEST AND ONLY PERFECT DRILL MADE

the left  
flutes o  
When t  
is then  
the ros  
quantit  
attache  
Consec  
it can  
**is to**  
**the d**  
merely  
connec  
the gra  
for eac  
**haza**  
merits  
imple

Is cor  
hoppe  
desire  
put in



Feed set to sow small quantity

## The Hoosier Force Feed



Feed set to sow large quantity

Underneath the hopper, within the feed cups, which are attached to the bottom of the hopper, are a series of fluted feed rolls. In the left hand side of each cup is a rosette or scalloped ring, which revolves with the feed roll. The scallops of this ring fit into the flutes or grooves of the roll. The feed rolls are all fastened to a square rod, called the feed rod, which is moved lengthwise by a lever. When the lever stands to the furthest point to the left, the entire surface of all the feed rolls is within their respective cups, and the feed is then set at its greatest capacity. The movement of the lever to the right causes a corresponding portion of the feed rolls to pass through the rosette or scalloped rings, and that portion of them passed through is removed from contact with the grain so that there will be a less quantity of grain forced out. **Our feed cups all sow the same quantity** because the feed rolls are all substantially attached to the same shaft, so that **one cannot be moved without moving them all** an equal distance simultaneously. Consequently **the change is uniform in all cups**. The lever for changing quantity is provided with a thumb nut, with which it can be securely fastened when the indicator shows the desired quantity. **All that has to be done to change quantity, is to loosen the thumb nut, move the lever to the right or left, until indicator point shows the desired quantity;** then tighten the thumb nut again. **It is a positive force feed** in reality and construction, not merely in name. The liability of one or more cups sowing more or less than the others is very great when set screws are used in connection with the feed, as they are liable to get loose and let the parts slip and cause uneven sowing, which will not be discovered until the grain comes up, when the damage done cannot be remedied for that crop. There are drills on the market that have one set screw for each cup, and some that have more than that. **Our feed has no set screws** to render it trappy and unreliable. **We hazard no contradiction in saying that our improved Force Feed is the best in existence,** and its merits in connection with the many other good qualities of the Hoosier Drill, make a combination of excellence rarely seen in one implement.

## Our Force Feed Grass Seeder

Is constructed and regulated on the same principles as the grain feed. The grass seed hopper is attached to the front of the grain hopper, and by means of reversible grain scatterers, the seed can be distributed with equal regularity in front or rear of the hoes as may be desired. When the hoes are raised the Seeder is out of gear, and there will be no flow until the hoes are let down again and the drill put in motion, so there will be no waste of seed when turning at the ends.

## Our Improved Double Hoe Shifter

Moves half the hoes forward, and the other half the same distance in the opposite direction; hence the balance of the drill remains undisturbed, and the distance moved is not enough to cramp the tubes. The hopper is placed so as to balance weight that would otherwise rest upon the neck of the team. This in connection with the double-trees being attached beneath the tongue so that the pull is inclined upward, makes the weight very light on the horses, which is a point that cannot be too highly regarded.

## Our New Improved Spring Hoe



This Perfect Hoe Lock is made for use; does not stick fast and bends over to get go of an obstruction. Always comes to its place quickly when obstruction is passed.

**T**HIS CUT represents our Improved Spring Hoe, which has been tested with the most flattering results. The Hoe in the upright position, shows its position when passing through the ground unobstructed, and the other the position it assumes when an obstacle is encountered. The construction of the hoe is such, that **there is no draft whatever on the Spring when passing through unobstructed ground.** It is held firmly and rigidly in position by means of a lock, until it comes into contact with an obstruction. The sudden and severe jerk it receives, when brought in contact with an obstruction, unlocks it and causes it to assume the position shown in the cut; when it gives back, a very powerful steel wire spring of the very best quality is compressed. Just as soon as the Hoe passes the obstruction, the powerful action of the spring forces it back into proper position again and locks it. Then, all pressure is removed from the spring, and it has nothing more to do until another obstruction is encountered.



## The Means of Regulating the Depth of the Hoes

That a very serious defect existed in all drills made before the introduction of the New Improved Steel Hoosier, has been thoroughly exemplified in the fact, that since the New Hoosier with the instantaneous means of regulating the depth of the Hoes was placed upon the market, its sale has farther than ever outstripped and distanced all its competitors. The farming community were quick to appreciate the advantages of being able to deposit seed grain at a uniform and even depth in all kinds and varying conditions of soil, with a certainty and precision only possible

with the unexcelled advantages possessed by this drill. It will be readily understood that a Drill Hoe or cultivator tooth attached to a draw bar perfectly free in its movements to rise and fall, must have some means of controlling the depth at which it will enter the ground and the seed be deposited in consequence. In all other Drills this has sought to be accomplished by changing the position and angle of each tooth separately upon the draw head to which it was attached, and, in many cases, securing it by a bolt and nut, necessitating the use of a wrench for this purpose. This method, while partially accomplishing its purpose, leaves the angle of the draft the same in all cases, and would draw the tooth out of the ground, were it not counteracted, as far as possible, by setting the tooth at an angle to prevent it. The principle of lowering the front end of the Draw Bar by a lever, which is a special feature in the New Steel Hoosier, overcomes this difficulty

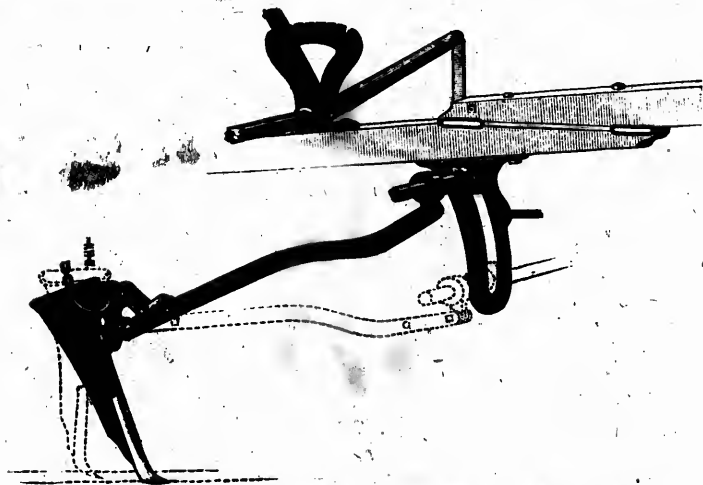

Look into this method of regulating the depth of the teeth. Is it not perfection itself. A simple movement of the lever does it. The greatest invention ever applied to a Drill.

completely, as by this means, as shown in cut by dotted lines, when a greater depth is desired the line of draft is lowered which has the effect of drawing the hoe into the ground, instead of lifting it out as in the other drills, and, consequently

the Hoes work much more steadily and much lighter in draft. A peculiar and very important form of the bottom of the tooth causes the heel of the tooth to come into contact with the ground when the front of the draw bars are raised, and as a consequence prevents the tooth from going into the ground at any other than the exact depth desired. This very important improvement is covered by letters patent and can be used only upon the Hoosier, and, which as a consequence, makes it the only perfect drill in the market. The lever for controlling the depth, as well as the lever for shifting the hoes, and, in fact, all the controlling devices of the Hoosier are convenient to the hand of the driver, and can be operated with but the slightest exertion. The Grain and Grass Feed Indicators work to an accurate scale, which has been thoroughly tested for different kinds of grain, and the drill will sow absolutely correct with ordinary samples of clean grain.



The hoes are taken off or put on draw bars so quickly that less than one minute's time is needed to make the change of all the hoes on a combined Drill.

## The Means of Changing the Hoes

Upon the Draw Bars is very simple, and which is illustrated in accompanying Cut. The T head stud on Drill Hoe is inserted in the opening in draw bar head, when the hoe is given a one quarter turn and securely locked in its place by a spring thumb latch, and this latch has merely to be raised when the hoe can as readily be taken off.

## Our Wind Proof Scatterers

In Broadcasting deposit the seed so near the ground, that it is not affected by the wind, and at the same time makes the most thoroughly even and perfect distribution of the seed.

That the great superiority of the Hoosier will cause it to go on in its march of supremacy is perfectly assured, and the position which we to-day occupy as being the leading Drill manufacturers in Canada, is due to its superior advantages together with the great vigilance we have exercised in keeping it where it has always stood, **A LONG WAY AHEAD OF ALL COMPETITORS.**



## Noxon No. 32 Improved Buckeye Mower



**I**N SOME SECTIONS the Buckeye Mower, owing to its adaptability to the peculiar conditions and nature of the country has a reputation which secures for it a preference over any other Mower.

Where the ground is rough and uneven, or where obstructions in the way of stones, etc., are met with, the Buckeye is especially adapted for use on account of the ease and facility with which the cutter-bar can be raised to pass over any obstruction. **Our No. 32 Buckeye Mower is the most perfect** and efficient machine of this class manufactured. Wherever any defects exist in other makes of this style of Mower, we have carefully remedied them, and the result proves how well we have succeeded, as it has given the best of satisfaction wherever used. **It is made with accurately bored and fitted bearings** for the crank shaft, which can be instantly tightened with a wrench, and thereby overcomes the annoyance and trouble in many Mowers from lost motion upon the knife, and consequently lack of cutting power. **The tilting arrangement is made with ball and socket connections** which prevents any binding or cramping. **All the working and cutting parts** are fitted up in the same careful manner as our other Mowers, so that it does clean, smooth cutting in all kinds of grass, and upon all kinds of bottom.

The levers are all very handy, which enables the operator to handle the machine with the greatest ease, to pass over obstructions or upon rough land, where an easy and quick control of the cutter bar is required.

## Noxon No. 32 Improved Buckeye Mower

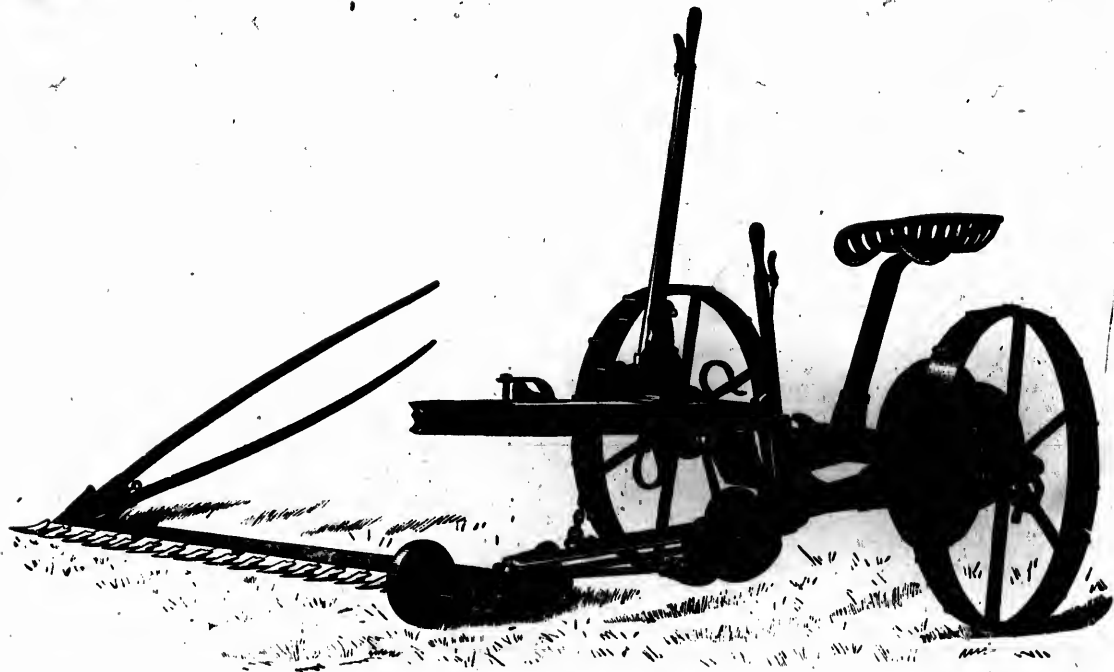

the ground  
this ten  
pressure  
to cause  
readily a  
To acc  
**played**  
**Hoosie**  
followin

As no



## Noxon No. 9 Cultivator



**H**AVING watched for years the operation and general working principles of Spring Tooth Cultivators, we have been impressed with the evident fact that any spring tooth held in a fixed position at its front end and forced into the ground solely by pressure applied at some point upon the tooth is wrong in principle, as the strain upon an elastic tooth when in hard ground has a tendency to force it back into a trailing position, and, as a consequence, its action is not nearly so effective as if presenting a more acute angle to the surface of the ground. This defect suggested the necessity of overcoming this tendency of the teeth to trail or spring back with the pressure of increased labor, and also the employment of some means to cause the teeth to take a greater hold and to enter the soil more readily as the depth to which they are designed to run increases. To accomplish this, the same general principle employed with such great success in our celebrated Hoosier Drill suggested itself and is applied as shown in the following cut.

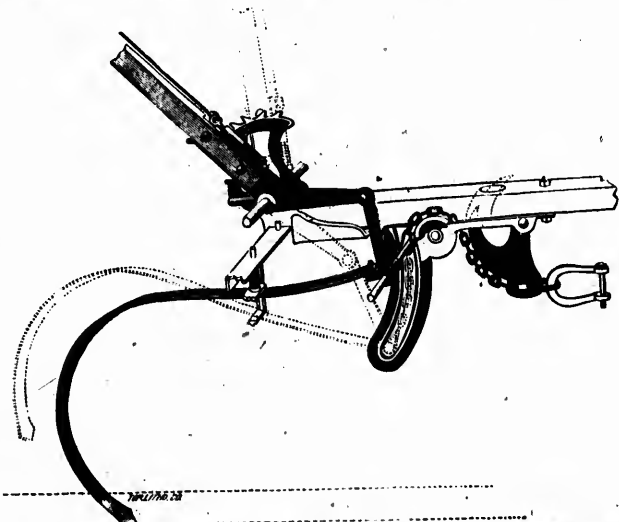

As noticed, the teeth are hinged to a steel rod at their front. Notice how the draft of the horses forces the teeth into the ground. No pulling and tugging on the lever to do this. Any boy can operate this Cultivator.

end and rest at a point, back of their hinged end, in a loop or fulcrum which firmly controls the teeth sideways, and at the same time permits of the greatest freedom in moving up and down. Over each tooth, at this point, is placed an oil tempered crucible steel spring, which allows the tooth to raise, when necessary to pass over any obstruction, but of sufficient tension to hold it firmly to its work, and this, together with the changing of the angle of tooth as the depth increases, makes this Cultivator do better work and run much lighter than any other Spring Tooth Cultivator made. The carrying of the point of the tooth forward at the same time that the depth increases, as will be noticed by dotted lines in illustration, gives the tooth a cutting action in the soil instead of merely forcing its way through by crowding the earth from in front of it. This cutting action causes the teeth to run steady and more free from jumping motion, as well as much less liable to clog in weedy or grassy soil, than other styles of Cultivators, and, as a consequence, the soil is left in much better condition. The depth of the teeth is controlled by a lever at the side of the operator, by which the draw bar, carrying the front end of the teeth, is raised, which, as seen by cut, forces the point downwards and by means of convenient notches for lever, the teeth are controlled at any depth desired. This independent action of each tooth is also of the greatest advantage as any obstruction causes but one tooth to raise from its work instead of raising the whole of the teeth, where several are attached, as in other Cultivators. The draft is arranged so that the draft of the horses is applied by means of a chain attached to the draw bar and carried over a pulley to which the whiffletrees are attached, as shown, to force the teeth into the ground, and all that the operator has to do, is merely to move the lever to the notch indicating the depth desired, when the teeth will enter the ground readily. This feature will be fully appreciated by persons familiar with the working of other Spring Tooth Cultivators. The wheels are large, with good width of face, making it run light and steady upon rough or uneven ground. The success this Cultivator has met with places it far ahead of anything on the market.



## Noxon No. 9 Cultivator

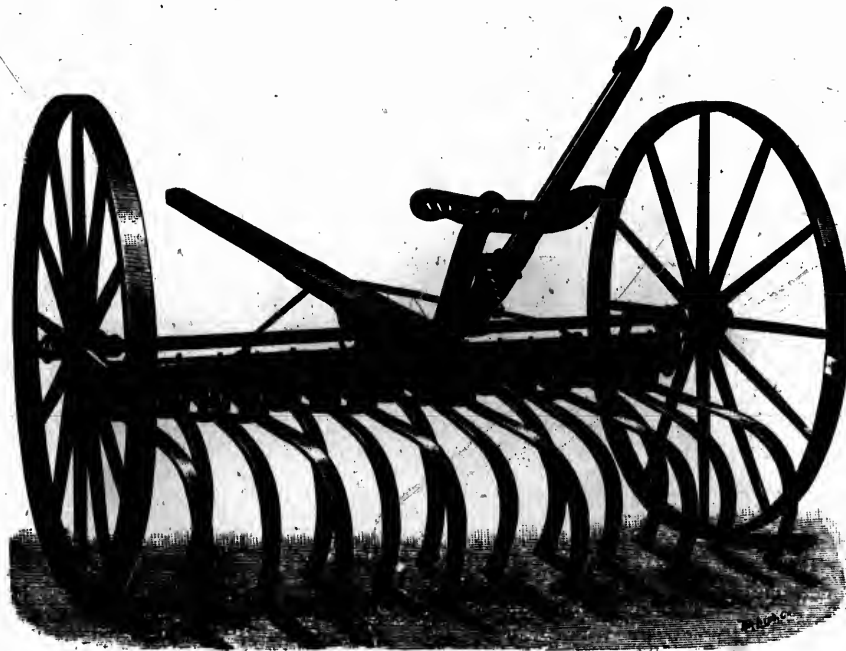

**Noxon No. 9 Spring Tooth Cultivator, an implement constructed upon new and thoroughly correct mechanical principles, and the only Spring Tooth Cultivator which will do perfect work.**



## Noxon No. 10 Combined Cultivator Feeder

**T**HIS IS OUR No. 9 CULTIVATOR with a seeding attachment applied to it, thereby making it **the most complete and perfect spring tooth Broadcast Seeder in the market.** By reference to the description of the No. 9 Cultivator upon another page, the general principles of construction and operation will be readily understood, and when we say that by the addition made to the Cultivator of a grain and grass seed box with our celebrated Hoosier force feed, it will need no further assurance as to its being a **perfect Broadcast Seeding Machine.** The seed box or hopper can be readily attached or removed so that it can be quickly and easily changed for use as a cultivator alone or a spring tooth seeder. **Each tooth being independent of any other in its action follows perfectly the inequalities of the surface of the ground and the bottom of a furrow or other depression, is as thoroughly worked as the higher portions, so that a fine uniform seed bed is always made and the grain evenly covered.** The flow of grain or grass seed immediately ceases when the teeth are dropped to the ground, so that no ground is missed in seeding. **It makes a perfectly even distribution of the seed both grain and grass, and owing to the superior action of the teeth the seed is covered much more evenly and at a more uniform depth than with any other spring tooth cultivator or harrow made.**



# Noxon No. 10 Spring Tooth Cultivator and Feeder

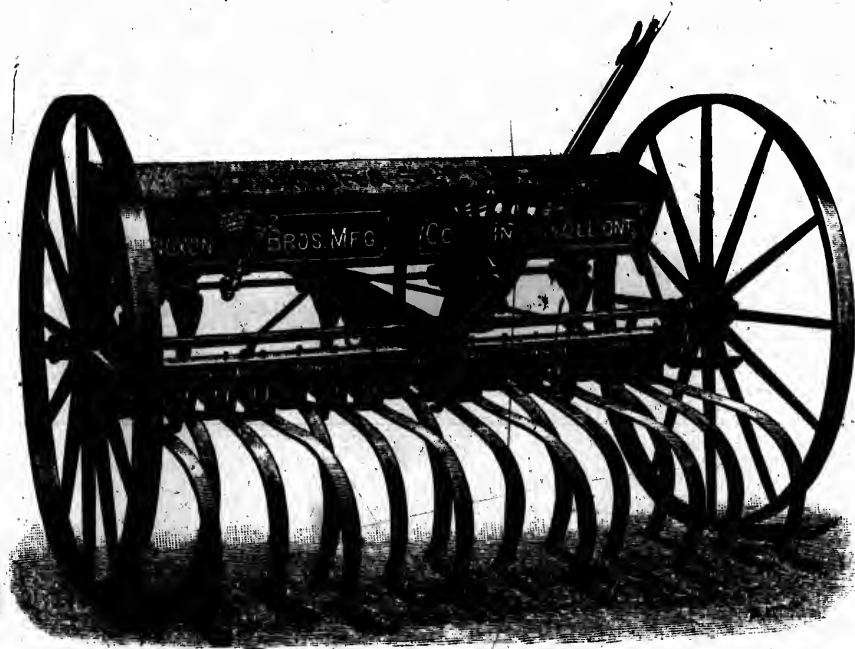

**WITH GRAIN AND GRASS SEEDING ATTACHMENT**

**The most complete and best working implement of the kind ever made.**

most  
description  
readily  
with our  
leading  
use as a  
ly the  
ughly  
ered.  
eeding.  
e teeth  
culti-



## Noxon No. 24 Combined Mower and Reaper



**BEFORE THE GENERAL** introduction of the Self Binder this machine held the leading place as the standard harvesting implement and still holds that position upon small farms or in new sections of the country. **The combined machine is an excellent Mower, and has no superior as a Reaper. It weighs less than 1,000 pounds, and is very light in draught and easily handled by a light team of horses, even upon hilly or uneven ground. Having two drive wheels without gearing in them it will work upon soft, wet ground, where machines with the gear in the drive wheel will not.** It is just the machine for use upon new or comparatively rough ground, as the hinged bar and platform, together with the two drive wheels, **make a perfectly flexible machine,** and enables it to adapt itself to the inequalities of uneven ground without danger of the knives coming in contact with any projections, and leaving a uniform and even stubble over the whole field. **The gearing is all neatly enclosed,** and the whole of the bearings and working parts are thoroughly fitted up and constructed upon the latest mechanical principles. Any of its parts can be readily removed and replaced if necessary. **The rakes are completely under control** of the driver, and at the same time can be set to deliver automatically any one or more or all in succession, if desired. We are safe in declaring that there never has been any other machine of this class produced that can at all compare with it upon small or rough farms where a Self Binder would not be required, as but a few minutes suffice to change it to a Mower, not surpassed by any Single Mower, and as a Harvester it has never been equalled by any single Reaper.

# Noxon No. 24 Combined Mower and Reaper



standard  
s of the  
superior  
ought  
Having  
where  
for use  
rfectly  
contact  
and the  
its parts  
ime can  
een any  
required,  
equalled



## Noxon No. 5 Single Drive Wheel Reaper

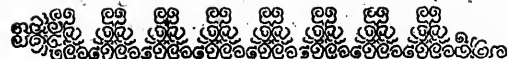

**T**HIS MACHINE IS SO SIMPLE, so able, so available, so easy and so handy, and so varied in capacity, and so unrivalled as to lightness of draft, that it always fills the buyer with satisfaction. Where grain is grown in small quantities, or where the Self Binding Harvester needs supplementing, our No. 5 Reaper is a popular Machine, **it is easy to handle.** The driver easily raises the entire machine to cut high, or as quickly lowers it to cut low, by a lever close at his hand. Both sides move at once, so without stoppage or delay he raises it for high grain and drops it for badly lodged and tangled grain instantaneously. The lodged grain which leans from the machine, he easily picks up by using the tilting lever. **It makes bundles of any size desired. Light draft and easy handling** are insured by the two wheels being on the same line. There is therefore no straining, no difficult tilting, and no tearing up of the soil in turning. **The main wheel has the widest face of any Single Reaper main wheel made,** and the whole machine being driven by the main axle has no gearing near the rim to grind, to wear or fill with dust and dirt. **The cutting apparatus is the best.** The guards are steel faced and attached to an angle steel cutter bar. **The rakes are under the absolute control of the driver,** as by simple pressure of his foot they can any of them be made to deliver a bundle. **It cannot be surpassed in any of its excellent qualities as a first class Reaper.**

# Noxon No. 5 Single Drive Wheel Reaper



city, and  
is grown  
a popular  
ly lowers  
ises it for  
eans from  
nd easy  
earing up  
he whole  
g appa-  
bsolute  
rpassed



## Noxon No. 30 Rear Cut Mower

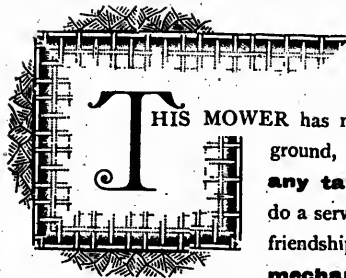

**T**HIS MOWER has made for itself a record unrivalled by any competitor. In all kinds of grass, upon all kinds of ground, and in the hands of all classes of farmers, **it has never flinched or failed to accomplish any task demanded of it.** Its sinews of steel and arms of iron possess the strength and power to do a service which has justly won for it the praise of its most exacting patrons, as well as the warmest friendship of the most practically critical portion of the farming community. **The design and mechanical arrangement** of this machine is the growth of years of experience and gradual perfection, in all its parts, so that now **it stands alone as being the perfection in simplicity, durability and efficiency of Rear Out Mowers.** No other Rear Out Mower made is so simple, and no other has all its parts so thoroughly and exactly adapted to the duty each part has to perform as in this. A steel axle, of ample size and strength, is used to carry the gearing and frame upon drive wheels, which are of a size our extensive experience has taught us, are of **the best to give the highest results in speed, ease and smoothness** in working upon all kinds of land. This shaft carries a square gear wheel which turns with, or is disengaged from the shaft by means of a clutch, and operated by a lever, and, when out of gear, leaves all the gear or working parts free from any motion or wear whatever. This wheel engages with a pinion connected with a bevel wheel, which drives a pinion upon the crank shaft. **All the gearing, shafting and working parts are securely held in their relative and proper positions by being enclosed in a solid frame of iron,** which is tightly closed by a cover to exclude all the dust or dirt. **The bearings are all of unusual length** and provided with the best facilities for oiling. **You must have a good crank shaft and bearings in a good Mower.** This part of it will not stand the jerk and strain necessary to drive a knife to do good, clean, easy cutting, unless, it is properly proportioned and fitted up.

**Here is how we make our crank shaft and fittings in this sensible, reliable Mower.** We do not economize in cost by shortening up our crank shaft and contracting our frame. **We make our crank shaft a good length and give it good long bearings in the sleeve** which we show here, and which is accurately bored out and fitted to the shaft, with a nicety found



## Noxon No. 30 Rear Cut Mower

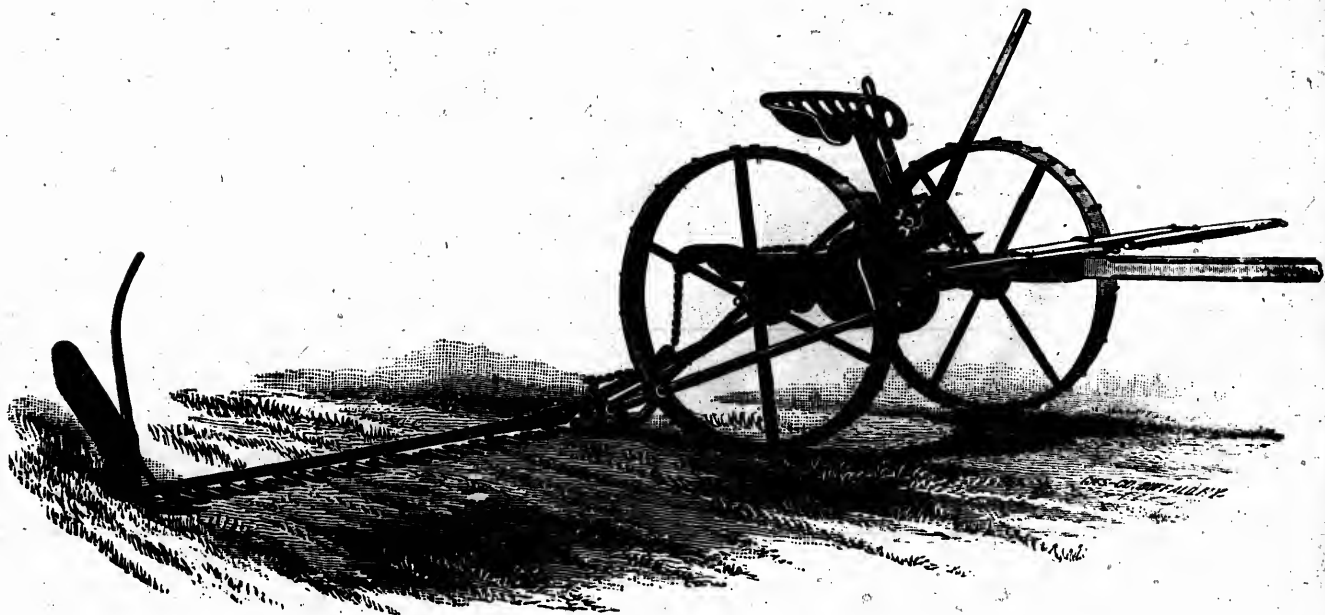

kinds o  
**omplish**  
power to  
e warmest  
**ign and**  
perfection,  
**urability**  
s parts so  
s used to  
**to give**  
gear wheel  
es all the  
eel, which  
**In their**  
o exclude  
**ou must**  
necessary

nomize in  
**it good**  
ety found

only in the higher classes of mechanical work. This sleeve, with its shaft, is firmly bolted in the frame of the machine with a firmness making it all but equal to one solid piece of iron.

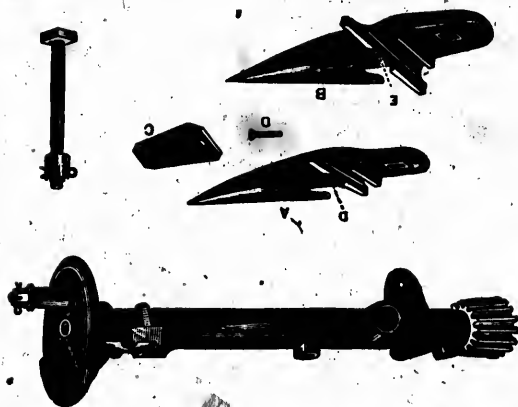

**The whole of the gearing and working parts are so arranged that they cannot move or get one iota out of place.** So firmly and accurately are they held that **they cannot bind or cramp in the least,** and for this reason our Mower honorably earns the reputation of being **the lightest running Mower in the market.** A thing of such great importance as the pitman has not escaped our closest attention. We have tried many different kinds, and for this machine we find that a pitman, of a size to be strong and light, of the best quality of second growth ash, with malleable iron fittings, all securely rivetted, cannot be surpassed. With a pitman of this kind, connected at the hardened crank pin with a pitman box of equal hardness, makes **a crank connection which will outwear the life of the best Mower.** The knife connection is by a ball upon the knife head, upon which the pitman clamps with ready means of tightening, to take up any lost motion. All these means and

appliances are for practical every-day use and not merely to talk about, in order to draw the attention of the intending purchaser away from some more serious defects and objectionable features which exist in other Mowers.

**We do not lose sight of the very great importance of the cutting apparatus. We use the very best knives that are to be had,** made from the very best quality of steel to withstand the very severe usage they sometimes meet with and yet to retain for the longest possible time, a thoroughly good and easy cutting edge. We show how **our extra annealed malleable iron guards are fitted with a steel plate of same quality of steel as our knives,** against the edges of which the knives make a shearing cut, reducing the power required to do the cutting, to the lowest possible limit. **These plates can be replaced by new ones in a very short time,** and in that way keep the cutting part in the very best condition. **The shape of the shafts and guards** are such that the cutter bar can be tilted to catch anything in the way of a crop upon the ground, and, when required, can be made to run at any height desired. **This simplicity and strength of this Mower** must commend it to all who have a proper appreciation of these desirable qualities. **The method of its construction** has been so studied that any farmer can take every portion of it apart and replace it in the field if necessary, with only such tools as are usually furnished with a Mower. This means a saving of very valuable time in the unusual event of necessity for replacing any part in the busy season.



a firmness  
ole of the  
they can-  
d accurately  
ast, and for  
being the  
f such great  
a. We have  
pitman, of a  
th ash, with  
ssed. With  
th a pitman  
h will out-  
ction is by  
s with ready  
e means and  
chaser away

very best  
s meet with  
annealed  
st the edges  
ese plates  
st condition.  
op upon the  
lower must  
has been so  
are usually  
in the busy



## Noxon No. 31 Front Cut Mower

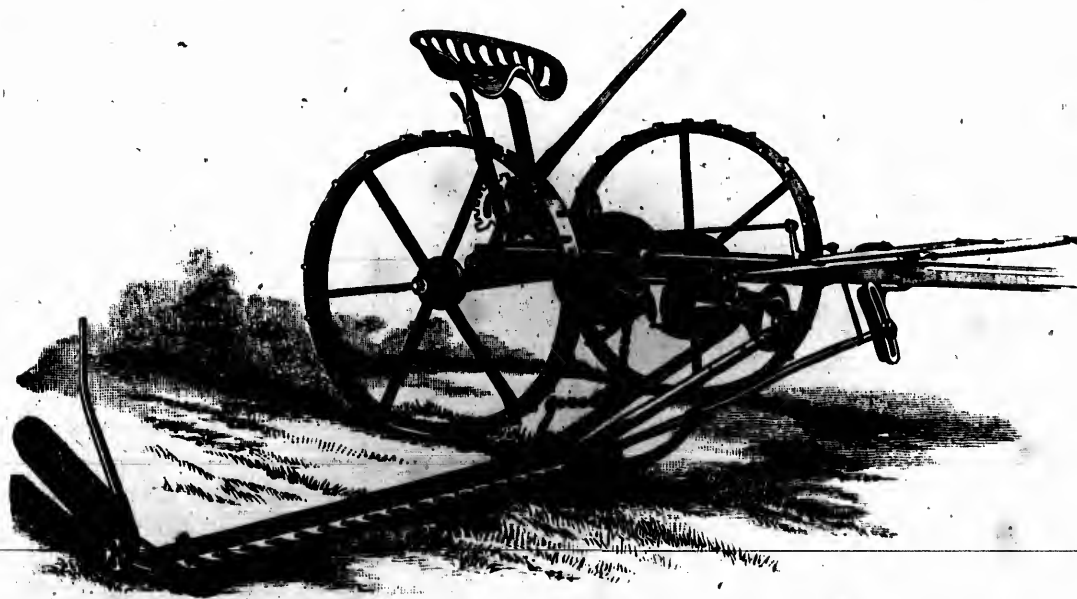

## Noxon No. 31 Front Cut Mower



**T**HAT THE PRINCIPLE of all former styles of front cut Mowers is somewhat defective is quite apparent upon an intelligent examination of their mode of construction. **All front cut Mowers** have heretofore been constructed with a push bar extending from the cutter bar back to some point at the rear part of the main frame. The point at which it is attached to the frame of machine being considerably higher than the point of attachment to cutter bar **causes the strain or stress of the cutter bar to have a tendency to raise the machine from the ground** and to that extent diminish its cutting power. This tendency to diminish the power is strongest in heavy cutting and just at a time too when the greatest driving power of the machine is required. **In this machine an entirely new principle is adopted** in the application of the draw bar principle of the Rear Cut to the Front Cut Mower, **producing a combination possessing the advantages of both styles of Mowers**. This is accomplished by practically moving the cutter bar and draw bar connections of the rear cut Mower ahead of the drive wheels, **thereby constructing a front cut Mower with all the advantages of the rear cut Mower** so far as having a **perfect floating cutter bar**, which enables it to pass over any unevenness of ground or other obstacles without the least difficulty. **The ease and facility of controlling all its movements** are unexcelled by any other Mower, as **all the levers are convenient to the hand of the driver**. **The same general characteristics of strength, simplicity, and ease of draft** are found in this as in other Mowers, and which makes it **a strong, effective and serviceable machine.**

## Noxon No. 33 Giant Rear Cut Mower



**HIS LARGE, POWERFUL MACHINE** fills the demand for a wider cut Mower than usually supplied. We make it with cutter bar of 19 sections in width. In constructing it we have taken our No. 30 Mower as a model, as no safer and more secure foundation for the building of a successful and desirable Mower for heavy work can be found than this popular machine. *What we have aimed to produce* in this new Mower, *is the greatest capacity for a large amount of work with the least expenditure of power*, added to the greatest simplicity, strength and durability. In general construction it follows closely upon the lines of our No. 30 Mower, but with the necessary modifications and changes in its construction to bring all its parts in harmony with the increased duties required of them, so that *no portion will be found weak or defective* when put to a practical test in the most difficult cutting. *A wide cutter bar extending out to the side of a machine must of necessity have upon the other side of the centre of the draft a counter balancing weight*, so that the machine may run without side draft and without jerking the tongue from side to side. *We have so arranged the resistance* in this machine that *the increased draft of the wide cutter bar is thoroughly counteracted* and balanced, causing the machine to run as steady and true as any narrow cut Mower made. *The same general excellence and superiority* in the construction of all its working parts so fully explained in the description of our No. 30 Mower will be found in this machine. Among these may be mentioned *the simple gear, the powerful drive of the knife, the perfect rolling tilt* that never binds the joints, *and the superior cutter bar* built in the manner described in referring to our No. 30 Mower. *In all that goes to make a first-class machine* for heavy work *it stands second to none* manufactured, and will give the purchaser such grand satisfaction as to cause him to speak of it in the highest terms of praise.

## Noxon No. 20 Ratchet Dump Rake

**A** STRONG, SIMPLE GOOD WORKING RAKE is appreciated by the farming community, and for this reason the Noxon No. 20 Rake is a favorite with the thousands of Canadian purchasers. Being operated by ratchets it is a positive dump, and never fails to dump by a slight pressure by either hand or foot. It will form a large windrow without dragging the top. The weight of the driver prevents the teeth from falling heavily, but they drop sufficiently quick to avoid missing any ground. The dumping lever forms a perfect lock which holds the teeth firmly to their work, and which ensures good clean work upon all conditions of ground.

---

## Noxon No. 22 Ratchet Dump Rake

**T**HIS RAKE is the same in principle as our No. 20 Rake, but is more particularly adapted to very rough or uneven land, as it is made with trail teeth instead of glide teeth, which enables it to do nice clean work upon any kind of land, and for the newer or rougher sections of the country has no equal. It dumps easily either as a hand or horse dump, and will give the best of satisfaction to the purchaser.

## Noxon No. 20 Ratchet Dump Rake



..... We have received from our Patrons Hundreds of Voluntary .....

# TESTIMONIALS

We Publish a few here. They are all similar to these in general expression. See our Testimonial Sheets for Testimonials from the best Farmers in all Sections.

From JAS. M. SQUIER, Barley Exporter, Wellington P.O.  
Prince Edward Co.

As to the advantage in using Self Binders in harvesting barley, I would say that last fall I was through a part of this country, looking after prime grades of barley, calling at nearly every farm. In many cases I found a pure bright grain, and in the adjoining farm the grain would be quite dark. On asking the cause of this of the farmer, the invariable reply would be, "My neighbor, whose grain is bright, has a Self Binder, and I have none." In my opinion the general use of Self Binders will give us a more uniform and brighter grade of barley.

F. C. ERB, Moorefield P.O., Wellington Co.

I am highly pleased with the way your Light Steel Binder performs its work. I find I can take up lodged grain fully equal to any reaper. The raising and lowering device is perfection itself. I can cut a stubble varying from 2 to 18 inches. It is a sure knoter and the simplest in construction. The machine is the lightest in draft and the most durable of any I have seen. The large drive wheel is perfect, I am always sure of a day's cutting when I hitch on my binder.

THOMAS Y. ROBINSON, Moorefield P.O., Wellington Co.

There are more Noxon Binders in this neighborhood than of all other kinds, and all who use the Noxon, speak most highly of them. The simplicity of the working part, together with solidity of construction, makes a machine which will stand any amount of service. It makes a considerable saving in twine. The rounded finger bar is a great improvement in low cutting upon rough ground. It makes a good sure tidy sheaf.

HENRY W. SCHNIDER, Glen Allen P.O., Wellington Co.

I am pleased to say that my binder runs very smoothly and evenly; no side draft or neck weight. It is a sure knoter and saves twine. I consider it a great advantage to raise and lower both ends without getting off the seat. I have cut my corn with it, which stood from 6 to 10 feet high; but in doing this the great secret is to know how to use the reel property, as without this it is not so easy to accomplish it.

JOHN SHEEHAN, Sombra P.O., Kent Co.

I am well pleased with my Noxon Binder. For simplicity, good working and saving of twine by the knoter, I think it is the best I have ever used. My neighbor could not cut the half of his barley with his machine, so I told him to take mine, which he did, and it worked in good shape, and he thinks there is no other can do the work as good. In all its parts I think there is none equal to it.

JOHN O'REILLY, Caledonia P.O., Haldimand Co.

During the two years that I have had a Noxon Steel Binder I have cut with it over 200 acres of land each year, and never used more than two horses on it, although some of it is the roughest land in this section. It has cost me nothing but what I paid for oil since I purchased it. The knoter is very simple, as it never missed tying a sheaf during the two years which I have used it, and there is no waste of twine. It makes the neatest sheaf I have ever seen tied by a binder.

The  
desired  
had my  
trouble  
neighb  
with re  
acres a  
saying  
drive v  
ness of  
bar is  
passin

Th  
satisf  
lightn  
horses  
lying  
to the  
ing it  
forme  
a goo  
variet  
of all.

I  
It is t  
strong  
adjust

W  
Draft  
draft  
sure,  
round  
down  
whole

## NOXON IMPLEMENTS ARE PRAISED BY PURCHASERS

**GEORGE AUGER, Walsingham P.O., Norfolk Co.**

The No. 7 Steel Binder I purchased from you is all that can be desired in the way of a binder. As I have only a pair of ponies, I had my doubts about them handling it on sandy soil, but I had no trouble at all, and it worked so well that it is both my own and my neighbors' choice from the expressions I have heard them make with regard to it. The tilting qualities are perfect. I cut over 30 acres and it never missed one sheaf. It cannot be surpassed in the saving of twine. It is free from useless bolts or joints, and the large drive wheel is of great advantage in the way of draught and steadiness of running on rough and uneven ground. The round finger bar is of great advantage both in picking up down grain and passing over uneven ground.

**SAMUEL HARRIS, Caledon P.O., Peel Co.**

The light Steel Binder I purchased from you has given good satisfaction. I prefer it to other binders for the following reasons: lightness of draught (we never had cause to use more than two light horses on the heaviest or worst ground), its capacity for taking up lying grain owing to its rounded finger bar enabling it to get close to the ground without clogging, the perfect action of the reel, enabling it to take up grain lying as flat as it could be, and making well formed and well tied sheaves. The knotter is very simple and ties a good knot compared with other machines. There are a great variety of machines in this locality, but I think the Noxon the best of all.

**JOHN H. HILLOCK, Caledon P.O., Peel Co.**

I consider the Noxon No. 7, Steel Binder, the best in the market. It is the easiest worked, sure to tie and needs less twine. Very strong and simple; nothing to get out of repair. The reel is easily adjusted for any condition of crop.

**JOHN BEARISTO, Baltic P.O., P.E.I.**

We are perfectly well satisfied with the Binder in every way. Draft is light on smooth or uneven ground, and no difference in draft when the machine is binding. The knotter is very simple, sure, and saves twine. Gear frame is strong and firm. The rounded finger bar is a great improvement in taking up lodged or down grain. The reel is very easily worked, and I believe the whole machine to be as simple and strong as any machine made.

**JAMES PETERS, Arva P.O., Middlesex Co.**

I can highly recommend the Noxon Binder to any farmer needing one. It makes a good shaped, well-bound sheaf. The threshers said they never saw nicer and better bound sheaves than mine. I cut six acres of oats in three and a half hours with my binder without sweating my two horses in the least. It is truly a twine saver, and no man can operate it without being pleased with it. The large drive wheel is a great improvement on rough or uneven ground. The frame and all the parts seem to be as solid and firm as when I commenced to use it. I think the raising and lowering both ends by one lever without getting off the seat is a great advantage.

**DONALD McDONALD, Corbin P.O., Quebec.**

The Binder which I bought from you is a perfect "daisy." I see but very little difference in the draft on uneven land owing to the large drive wheel, and I consider the knotter cannot be beaten as it works first-class, gives no trouble, and makes quite a saving in twine, in fact, I do not see how a machine could be very much improved, so far as the working qualities are concerned.

**ISAIAH IRWIN, Blackstone P.O., Durham Co.**

The Binder which I purchased from the Noxon Mfg. Co., runs almost as easy as our little reaper, and with less side draft and weight on horses necks. The knotter is so simple there is nothing to get wrong with it, and it takes less twine to make a knot than any that I know of. You can tie as tight or slack as you like and it makes a nice square sheaf, and does not discharge a sheaf on the head to shell the grain out, as some machines do. The reel and tilt, in fact, all levers are so easy to work that a boy ten year old could operate them without any trouble while the horses are in motion.

**AUGUSTUS WILSON, Vienna P.O., Elgin Co.**

I think the Noxon Binder is the best in the market, and would advise anyone wanting to get a good binder to purchase one. It makes a perfect sheaf, ties it tight, and makes splendid work in all kinds of crop. The knotter is a great advantage in saving twine, and as there is no piece cut off, it is not liable to become clogged from the loose piece of twine, like some knotters. The binder runs very steady and nice over rough or uneven ground, and the whole machine is almost perfect.



## NOXON IMPLEMENTS ARE PRAISED BY PURCHASERS.

**J. A. & W. W. McKENNA, Brampton P.O., Peel Co.**

I never saw a binder which runs as nice and easy as the Noxon Binder, as I can operate mine with two small horses. It is very simple, and although I had only seen one other binder before, I got mine I put it up and worked it without any difficulty. It makes a neat, square sheaf, and can be tied as tight as you like. The rounded finger bar is a very great advantage in passing over rough or uneven ground or stones, and you can cut as close to the ground as you like without clogging the knives with dirt, etc. It is a very simple knoter and takes less twine than any binder I know of, and I have seen twelve different kinds of binders at work. The binder has a very simple gear and a very strong steel frame, which keeps it perfectly stiff and rigid.

**H. BATTERMAN, Williamsford P.O., Grey Co.**

My Noxon Binder works well on rough and uneven ground as well as on soft or light soil. It is light on the horses both as regards draft and neck weight. It ties a firm knot and makes considerable saving in twine. The sheaf is tightly bound and stands handling without coming apart or getting loose.

**THOMAS FLAVELLE, Glasgow P.O., Ontario Co.**

My Noxon Binder will cut and handle the heaviest kind of grain without clogging or choking, and runs one-third lighter than any other binder I have seen. As I am the only one who has one of your binders in this neighborhood I have offered to compete with any other in a fair field. It cannot be surpassed in short or lodged grain, and it is convenient for taking up and making a good clean job.

**WILLIAM PARKER, Empire P.O., Haldimand Co.**

My binder works so well that I think you will have no difficulty in selling more in this vicinity, as my neighbors say they will buy the Noxon on account of being so well pleased with mine. I like the way the reel works, particularly in short or lodged grain, where it works splendidly and is easily adjusted; in fact, the whole machine appears to me to be splendidly adapted for the work it is required to do.

**SAMUEL LEIGHTON, Ruskview P.O., Simcoe Co.**

I consider the Noxon Binder A 1 in every respect. It makes a good snug, tight sheaf. The machine is very simple and runs very light. The reel is first-class and easily handled. The knoter works good and saves twine, in fact, the whole machine is well built, light and strong, and gives good satisfaction.

**WILLIAM MARTIN, Belmont P.O., Middlesex Co.**

I have had no person examine my Noxon Binder yet but said it was the most perfect machine that they ever saw, it has so light and strong an appearance. Everyone surely knows that a large wheel is a great advantage over a small one, as it will not drop into every little hole, and in that way it runs steadier as well as easier. We have used all kinds of twine in our machine, and I have not missed a sheaf in 40 acres cutting. As for strength, any man can judge for himself who is any judge of machinery by looking at the machine. The rounded finger bar is just what we want, for we can get close to the ground without clogging up. The appearance of the sheaf is A 1, as the butter makes them perfectly square and even.

**JAMES LAVELLE, Pembroke P.O., Renfrew Co.**

I think your Binder to be the most durable, easiest handled, and freest running machine of any made, for smooth or rough ground. The sheaf is very neat, securely tied, easily handled, and the whole machine has the fewest joints of any made. The round finger bar makes it the best adapted for going over rough or uneven ground. I have a new and rough farm, and hesitated for some time about purchasing a binder, but I can say after using it that it will do perfect work on any kind of ground.

**WILLIAM McDOWELL, Ashgrove P.O., Halton Co.**

I could not ask any better machine than the Noxon Steel Binder, and I do not think there is any to beat it. It is simple, easy to handle, and will gather up lying grain; in fact, I was surprised at the way it would work in bad grain. The knoter is superior to anything I have seen, and taking it altogether, it is everything that could be desired.



## NOXON IMPLEMENTS ARE PRAISED BY PURCHASERS.

### WM. LAWLER, Maxwell P.O., Grey Co.

I consider the Noxon Binder perfect so far as my experience goes with it. It cannot be beaten in making a sheaf, and the butter is so easily handled in long or short grain that it makes a sheaf perfectly square and even. I consider the machine second to none for strength and lightness so far as draft is concerned. There is less side draft than any single reaper I ever saw work. I cut 40 acres, and I never saw it miss a sheaf excepting when the twine broke, and some of my neighbors told me to be careful in thistley grain and not cut more than half width, but I put it in and cut as wide as possible and it never choked. The frame is first-class, and a party that ran another make of binder for two years examined mine and said he wished he could get around the drive wheel of his, as it was easier to get at for oiling, etc., and also that ours is so much more simple than his, and he considered it a great advantage on that account.

### JAMES BROWN, Galt P.O., Waterloo Co.

I consider the Noxon Binder the best in the market, and would not exchange mine for any I have seen. I find that two horses will handle the Noxon Binder with greater ease than three can any other I have seen. Your machine throughout is simple, light and strong, with no useless joints or bolts, and the threshers say they would rather thresh after the Noxon Binder than any other. I consider the large drive wheel a very great advantage in going over rough ground.

### JOHN CORBETT, Kincardine P.O., Bruce Co.

Having operated another make of binder for two seasons, and one which is represented as being second to none in the market, I am in a position to appreciate the difference between yours and others, and have no hesitation in giving the preference to the Noxon Binder in every particular. The great advantage of being able to raise both ends of the machine with one hand enables the driver to raise or lower the machine and still have command of his team without stopping. It certainly possesses very great advantage over other machines in being able to cut close to the ground and pick up lodged or lying grain where the ground is not smooth. The knotter never misses, and makes a nice tight sheaf and saves considerable twine over other knotters.

### WM. G. BROWN, Port Albert P.O., Huron Co.

The Noxon Binder which I bought is light in draft, owing to the large drive wheel. The main gear frame is strong and firm. It is very evenly balanced, and convenient in raising or lowering both ends at the same time. It appears to be as strong as steel and good workmanship can make it, and it properly attended to with oil and ordinary care, there never need be any trouble with it.

### MALCOLM McINNES, Priceville P.O., N.S.

It would be impossible to find any fault with the Noxon Steel Binder, for it does its work perfectly if properly handled. I am perfectly satisfied with it in every respect, as it does better than I expected any binder could do, and I believe it surpasses any other binder in the market. I have cut nearly 35 acres and believe I never missed over five sheaves the whole season.

### H. J. CHITLEY, Salmon Point P.O., Prince Edward Co.

Your light steel harvester, is as its name implies, a machine made principally of steel from the foundation up. As steel is the material most largely used in its construction, it has no weak points to get racked or loose from the work it is required to perform. It is a machine that will stand hard knocks, and it will always come out with flying colors on the top of the heap. It is the surest tying machine of any I have seen, and I have seen all kinds; and it saves twine besides.

### JAMES SMITH, Shakespeare P.O., Oxford Co.

I cut my crop of 200 acres, and I never use more than two horses on my Noxon Binder owing to its being so well balanced and free from side draft. It is very light on the team as it appears to run very easy owing to its large drive wheel. I am very much pleased with the simplicity of the knotter, and I can cut all day without missing a sheaf, unless the cord tangles or something of that kind. It saves considerable cord over any other knotter that I know of. I think the rounded finger bar a great improvement in working on uneven ground or over furrows, as it seems to go over them as easily as a stone boat. I very much like the plan of raising and lowering both ends of the machine at once without leaving the seat.

## NOXON IMPLEMENTS ARE PRAISED BY PURCHASERS.

### ABRAM HALPENNY, Arnprior P.O., Renfrew Co.

From what I have been able to judge of my Noxon Binder I think it is perfect in every respect. The draft is as light as could be desired for machine doing the same work. I find that it did not miss a sheaf, and did not use nearly as much twine as others have used in binding the same amount of grain. The strength of the main gear frame is a great improvement, as it is solid and firm and has very few joints. The sheaf is neat, well bound, and stands handling without coming to pieces.

### DONALD A. McDONALD, Clear Spring P.O., P.E.I.

I think the Noxon Binder surpasses all others I ever saw, and I cannot find any fault with it. The form and general appearance of the sheaf is good. The reel is easily adjusted with the left hand while the other is occupied in guiding the team. I have had no trouble with the knoter and do not expect it, as it appears to be very strong and simple, not liable to get out of order. It is very economical in twine and misses no sheaves.

### JOHN WELDON, Carlsruhe P.O., Bruce Co.

The knoter of my Noxon Binder is simple, saves a lot of twine, and ties sure. The large drive wheel is a great improvement for making it run even on soft or uneven ground. I like the way both ends can be raised or lowered from the seat. It makes a nice round and even sheaf and is very easy to handle. The steep deck keeps the grain from choking, and it is very easily shifted, binding long or short grain. It is very handy for folding up in passing through gates.

### ROBERT VEITCH, Clarksburg P.O., Grey Co.

My crop last season was very heavy and a great deal of it badly tangled, and my Noxon Binder picked it all up and made a first-class job. There is a splendid tilt on it which enables the driver to raise or lower the finger bar almost instantly to suit the varying condition of the crop. It makes a neat sheaf and ties it as tight as required. As to the draft, I think it beats them all, as I work mine with a pair of small sized colts the whole season. I do not believe the knoter could be better so far as sure tying qualities are concerned. As for strength and durability, I think it is just the thing.

### JAMES DAVIS, Oliver P.O., Oxford Co.

I was in a field with my Noxon Binder where a couple of other binders were at work, and the grain was so badly lodged that the other binders missed one side of the field almost entirely, and I had to go and pick up and make a good job where they would not work at all, as the rounded finger bar on my machine would allow me to get close down to the ground without getting stuck. Also, the ease of adjusting the reel on my machine enabled me to adapt it to the different conditions of the grain, without taking too much of my attention from my team, and besides, I could raise and lower my whole machine with one hand while the machine was going, if necessary. It ties and delivers easily, a first-class sheaf, tight and square, and you can count on every sheaf being tied without any twine being wasted. The large drive wheel goes over stones, through furrows or any unevenness without jarring or injuring the machine as a good many do. The whole machine appears to be solid and strong.

### ALEXANDER HOUSE, Fergus P.O., Wellington Co.

My Noxon Binder is very light draft, easily tilted, and no side draft or neck weight. Any boy that is able to drive a team can take the knoter to pieces and put it together without a mistake, and it does not waste a particle of twine. It ties sure every time and makes a well formed, nicely bound sheaf. The rounded finger bar is a great advantage. The knoter is very easily shifted to tie the sheaf in the centre where the grain is in uneven lengths. I can raise or lower my binder and do not need to stop the horses to do it, while the drivers of other machines have to scramble off. I can drive my binder through a gateway 11 feet wide. It is a great advantage in being able to take the binder inside in case of a storm or at night, and while I have my binder safely housed others are running after trucks, and put in half an hour loading it. Mine can cut just as long grain as any open, back binder, and it won't go dribbling out behind.

### ROBERT LLOYD, Chesley P.O., Bruce Co.

My Noxon Binder appears to me to be the simplest in construction and the lightest draft of any I have seen. It makes a good sheaf, well bound, and any person knowing how to drive a team can work the machine readily. I like the arrangement for raising, as you can easily pass over a stone or any other obstruction without stopping.

## NOXON IMPLEMENTS ARE PRAISED BY PURCHASERS.

### JOHN R. M. KINNON, Deloro P.O., Hastings Co.

I can drive my Noxon Binder on hills without upsetting, while others have to stand on the outside of the table to keep the machine from tipping over. It ties a good sheaf and you can tie as tight or loose as you like, and save from one to two inches of twine on every sheaf, which is quite an item in a season's cutting. The large drive wheel is of great advantage, making it run light and steady. The tilt is the handiest I have seen.

### JAMES J. BEAUMONT, Alport P.O., Muskoka.

I have much pleasure in stating my entire satisfaction with your No. 7 Binder. I have used binders in the Old Country and was very much struck with the following points in your Binder: Lightness of draft both on smooth and uneven ground, freedom of weight on horses' necks, and it does not appear to make any difference in draft when binding or delivering a sheaf, which I think shows simplicity and free working of the knotter and binding parts. The saving in twine in comparison with the machine hired by me two years since is considerable. One special feature is ease and convenience in tilting to pick up lodged grain, as well as the advantage of raising both ends of the binder by one lever. I would say it is the best machine I have seen work either here or in the Old Country, and I have seen machines work from the best makers here and there.

### CHRISTOPHER WREN, Uzbridge P.O., Ontario Co.

Judging from the appearance and working of my Noxon Binder, I believe it will last longer than any other binder in the market. The knotter is simple and sure to tie. The large wheel is of great advantage in passing over furrows, etc. The means of raising and lowering both ends of the binder by one lever is far in advance of those with two levers. In fact the whole machine needs only be seen in operation to be thoroughly appreciated.

### GEO. SULLIVAN, Pembroke P.O., Renfrew Co.

My Noxon Steel Binder never missed a sheaf during harvest and used very little twine. The draft is light, with no side draft or neck weight. I have seen no binder with so few bolts or joints. My neighbors, who were helping me to thresh last fall, said they saw no sheaves tied as neat as mine.

### J. & R. MAYNES, Forks Road P.O., Welland Co.

With regard to the Noxon Binder, we like it well owing to its simplicity, lightness and good working qualities, and like it better than any we have seen. It makes a tight, good-looking sheaf, and the rounded finger bar never becomes choked in any kind of grain, when running the binder close to cut short or lodged grain. It suits us well in every particular, as it is strong, light and works well.

### S. D. CRONK, Wellington P.O., Prince Edward Co.

We had never used a binder on our farm before purchasing the Noxon, which we put upon new land and it worked well. We even bound our fodder corn with it. I was surprised that the draft was so light. The knotter is very simple and there is no wast of twine. The whole machine seems to be very strong and simple and well put together. The tilt is so easily done that a boy can work it without any trouble. The raising and lowering is far ahead of any other that I have seen.

### R. I. SPOOR, Wolf Island P.O., Frontenac Co.

The No. 7 Steel Binder suits me well. It is compact and very strong. I have cut 75 acres of crop this season without a mishap. The threshers say that the sheaves bound with the Noxon Binder are the best and neatest of any they handle. The rounded finger bar is a great advantage in picking up down grain or in cutting upon uneven ground.

### JAMES SHEA, Sheenborough P.O., Quebec.

The Noxon Binder I purchased from your agent pleased me very well. I was very particular as there were six different kinds of binders in our section, and I wanted to get the best. I wanted a neighbor who had another binder to cut a field for me before I purchased a binder. He looked at the field and said he would be able to cut it but would not guarantee to tie it all, as the straw was so short. I did not think myself that a binder could be got to cut and tie it, until I got the Noxon, and after going a few rounds I saw at once that it was well fit to do the work, as it cut and tied it first-rate. The Noxon Binder takes the lead in our township, it is so handy to regulate for all kinds of grain and on all kinds of ground, I am pleased with the sheaf, as it is tight and neat in every way.

NOXON IMPLEMENTS ARE PRAISED BY PURCHASERS.

PROFESSOR SHAW, Manager of the Ontario Agricultural College Farm.

GUELPH, Dec. 13, 1890.

THE MESSRS. NOXON BROS., Ingersoll, Ont.

DEAR SIRS—I take pleasure in replying to your enquiry regarding the working of the Improved Steel Frame Hoosier Seed Drill, purchased from your agent Mr. D. Tolton, in the spring of the present year. We find that it does excellent work. As it is a twelve hoe Drill, we can put in from an acre and a half to two acres more in a day with one team than when we used the ten hoe Drill. This is of itself a great advantage in the hurry of seed time. It is light of draft and easily operated. When the cultivator teeth are attached, we find no implement equal to it for bringing to the surface any clods that may be in the soil, when they are then easily crushed with the roller. This renders it of much value in preparing a fine seed bed, especially for a root crop. I believe it would be of much service in extracting and gathering the roots of couch-grass when in the soil. We regard it as an excellent Seed Drill.

Yours &c.,  
THOS. SHAW.

JOHNSTON E. STORY, Foreman Ontario Agricultural College Farm.

GUELPH, Jan. 19, 1891.

NOXON BROS. MANUFACTURING CO.

GENTLEMEN—The Combined Steel Frame Hoosier Grain Drill and Broadcast Seeder purchased of your agents, Messrs. Tolton Bros., has given us satisfaction in every sense of the word. The machine is so simple and conveniently arranged, that the driver has complete control, and can adjust it without loss of time. He can change from drill to broadcast seeding. He can regulate the hoes to run at the desired depth, which is a very important feature when sowing land that is not uniform. He can set the hoes in a line or zigzag, overcoming the difficulty of clods or manure gathering in the hoes. He can throw the grass seed attachment in or out of gear where only a portion of the field is to be seeded down. The drill hoes can be removed and the cultivator teeth attached in five minutes, making the cheapest an best cultivator I ever used.

The machine is light of draft. Ours being the twelve hoe drill, I find that an ordinary team can sow from 12 to 15 acres per day. I like your force feed. It is accurate, and does not crack or bruise the grain. I have no hesitation in recommending the Hoosier to intending purchasers, and wish the manufacturers success.

Yours very truly,  
JOHNSTON E. STORY, Farm Foreman.

JOHN SMITH, Nassagaweya P. O., Halton Co.

We find your improved Steel Hoosier Drill complete in every respect. The advantages in instantly changing the depth of the teeth are great, as the lever for this as well as for giving the teeth zigzag are just at your hand. As for draft, a team can work it every day the year round, one horse can draw it easier than two can some other drills.

M. & E. AUGUSTINE, Sparta P. O., Elgin Co.

Your Steel Hoosier Drill sows all kinds of grain the most even of any we ever used or saw used. It is the lightest draft drill we ever used. The draft on the horses' necks is mere nothing. We can control the depth of the teeth to a nicety. It is the most durable drill in our section of country.

R. J. McLEAN, Ruskview P. O., Simcoe Co.

I find the Hoosier Drill to be all you represent it to be and sows all kinds of grain to satisfaction. I can change the hoes from drilling to broadcasting in less time than any other drill. It does good work as a cultivator. There is one great advantage your drill has, it is light on the horses' necks.

JOHN BAYLISS, Clifford P. O., Wellington Co.

There was a good many other agents at me to sell me a drill before I purchased, but I am glad I took a Hoosier, for I like it better than any I have seen. I have tried it with all kinds of grain, and I think it is the very best kind of a feed. Altogether it is undoubtedly the best drill in the market, and anyone wanting a drill should give it a trial.

JAMES COOK, Gordonville P. O., Wellington Co.

We are perfectly satisfied that the Hoosier Drill can't be beat. It sows all kinds of grain as well as grass seed perfectly even. I don't think you could improve on the way of regulating the teeth. The draft is easy on a team. As a cultivator it leaves a good seed bed. All parties I have heard talking of the Hoosier say it can't be beat for simplicity, durability and working qualities.

## NOXON IMPLEMENTS ARE PRAISED BY PURCHASERS.

### WM. N. DANIEL, Mount Elgin P. O., Oxford Co.

I am well pleased with the Steel Hoosier Drill. I think the ease in changing the hoes from drilling to broadcasting is just grand. The regulating the depth of the hoes by a lever is very convenient and my neighbors who have seen it work say it is the best drill they have seen.

### GEO. W. HILBORN, Tarbert P. O., Wellington Co.

Having had no experience in the use of a drill, I was told by my neighbors that I couldn't go astray in buying a Noxon Hoosier, and after using it I have not seen one that suited me so well. I consider the regulating the depth of the teeth a great improvement. It makes a grand cultivator and I can tear up the ground any depth I like.

### WALLACE LONEY, Tyotown P. O., Glengarry Co.

The Hoosier Drill I can recommend as being economical of both seed and labor. It is light on the team. The simple manner in which the feed is changed for different kinds of grain is unexcelled. The lever attachment for regulating the depth of the drill hoes is very satisfactory and the convenience in doing this places the Hoosier ahead of any other drill.

### COLIN WALKER, Alvinston P. O., Lambton Co.

I am thoroughly pleased with your New Improved Steel Hoosier Drill. I have used other drills and none of them pleased me as well as the Hoosier, as it has a great advantage over any other I have seen in the way of regulating the depth of the hoes. It is very light draft on a team, and so easily handled that any boy that can drive a team can work it.

### WM. COOPER, Fenlon P. O., Victoria Co.

I am well pleased in every way with your Hoosier Seeder. I have had 12 years experience with other seeders before purchasing yours. The Hoosier sows different kinds of grain correctly. The advantage of the lever for instantly regulating the depth of the hoes is the grandest idea I ever saw and it works to perfection. The plan of changing from drill to broadcast is grand and saves time and trouble. All intending purchasers should inspect the Hoosier.

### N. BICKNELL, Armow P. O., Bruce Co.

Your Steel Hoosier appears to be all right. As a cultivator I think it surpasses many other makes on account of the splendid means of changing the depth of the teeth. I could not wish anything more convenient than the plan of changing the drill for broadcast teeth.

### ANDREW GREEN, Dunlop P. O., Huron Co.

I am highly pleased with your Hoosier force-feed and never saw anything to equal it. The advantage of regulating the depth of the hoes is very great. I have used it as a cultivator on fall ploughing, and have never seen its equal in making a seed bed.

### XAVIER DESROCHE, Lafontaine P. O., Simcoe Co.

In sowing all kinds of grain the Hoosier Drill gives good satisfaction. It is a great advantage in being able to set the teeth for any depth while the team is in motion.

### PETER V. LEMON, Alton P. O., Peel Co.

My Steel Hoosier Drill is the lightest running drill I ever saw. I sowed about 80 acres with a span of roadster colts with ease. It is very handy to change depth of hoes in any kind of soil. It sows all kinds of grain very exact. As a cultivator it will tear up the soil no matter how hard.

### GEO. MCGIRR, Alliston P. O., Simcoe Co.

The No. 47 Hoosier Drill has given better satisfaction than any drill I ever had, and I have used several kinds, but none to come up to the Hoosier. As for lightness and correct sowing they have no equal, as any man once trying one will have no other.

### JOHN CLARK, Jr., Crumlin P. O., Middlesex Co.

In my estimation there is none to compare with your Steel Hoosier Drill, and I can't see where you can improve it, and in my estimation is the best Drill made. The lever for regulating the depth is the greatest improvement I have seen on any Drill, and it works like a charm. As a Cultivator it works splendid.





## NOXON IMPLEMENTS ARE PRAISED BY PURCHASERS.

**JNO. W. KETT, Clanbrassil P. O., Haldimand Co.**

The Steel Hoosier Drill did its work well and I am well satisfied with it. I think the means of changing depth of hoes while in motion a great advantage, as I have sowed wheat that never came up, from being put in too deep, because it was so much trouble to change the old kind of drill while this can be changed at once. It is light of draft. I drilled about 30 acres of wheat with a pair of three-year-old colts.

**LEVI WILLIAMS, Wauposse P. O., Prince Edward Co.**

After thoroughly testing the New Improved Steel Hoosier Drill it is with pleasure that I speak of its merits. The force feed gives perfect satisfaction in all kinds of grain, no breaking of grain, and for regularity of feeding it is all that could be desired. The advantage of regulating the depth of the Drill Hoes without stopping the team is indispensable to any perfect drill, and it is difficult to over-estimate its value in hard or loose soil when one considers the satisfaction it gives the farmer and the increase in products and quality of crop. The convenience in changing from drilling to broadcasting, is worth 10 per cent. to the purchaser, and can be properly appreciated only by those who experienced the bother in a hurried time by the old method. It makes a good cultivator and is light of draft. I can cheerfully recommend it to farmers as an implement without a superior in the market.

**PETER REIDE, Linwood P. O., Waterloo Co.**

My Hoosier Seed Drill sows all kinds of grain correct. It draws easy for my team. I can change the hoes from drilling to broadcasting in two minutes easy.

**EDWARD BURSELL, Paris Station P. O., Brant Co.**

The Hoosier Drill I purchased from you has given me every satisfaction. I have used it with all kinds of grain, and it comes up nice and even. The lever for regulating the depth of the teeth is so easily worked and yet so efficient. The changing of the hoes from drilling to broadcasting is made a pleasure with the Hoosier, while with some drills it takes half an hour, and a disagreeable one at that. I was very much surprised when I used the cultivator teeth; I thought as a cultivator it would not amount to much, but now I often use it in preference to my spring-tooth cultivator.

**ROBERT GALLAGHER, Linton P. O., York Co.**

I have never seen your Hoosier Drill at work, but purchased one upon its reputation. It gives me entire satisfaction as well as being pronounced complete by all who have seen it work. It sows all kinds of grain evenly and does not bunch it as some other drills do, in oats especially. The adjustable wind proof scatterer is excellent and not found on any other drill. It starts to sow the instant the team moves. The advantage of regulating the depth of the hoes is unequalled by anything I have ever seen. I cultivated a field with it of ploughed sod, which no spring tooth cultivator would work in without clogging. I would not have the slightest hesitation in recommending it to my brother farmers.

**THOS. D. HOLLYWOOD, Port Burwell P. O., Elgin Co.**

I am well pleased with your Drill as far as I have used it. The means of instantly changing the depth of the teeth is one of the many advantages which pleases me very much as it is so convenient. I consider the convenience in changing the teeth on the draw bars is worth more than the difference in price between your drills and the common drills sold. It is lighter on a team than a harrow.

**AUGUS GRANT, Appin P. O., Middlesex Co.**

I consider the Hoosier the best drill on the market. The running of the hoes deep or shallow, at the will of the operator, is a grand invention.

**H. D. HILDRETH, Tweeside P. O., Wentworth Co.**

The Hoosier Drill I purchased from you gives entire satisfaction. It sows more correctly than any drill I ever used. I would have no other drill if for no other reason than the convenience of the Hoosier of regulating the depth of the hoes while the team is going.

**JOHN FARRELL, Linwood P. O., Waterloo Co.**

Your Steel Hoosier Drill has given entire satisfaction, as your force feed is the best I have used. In regulating the hoes it cannot be beat. The draft is very light and no weight on horses' necks. I think intending purchasers cannot do better than by purchasing a Hoosier.

## Our Manufactures comprise the following list of Seeding and Harvesting Machinery :

- No. 5 Noxon Single Drive Wheel Reaper.
- No. 7 Noxon Light Steel Binder.
- No. 7 Noxon Light Steel Binder, Wide Cut.
- No. 8 Noxon New Light Steel Binder.
- No. 8 Noxon New Light Steel Binder, Wide Cut.
- No. 9 Noxon Spring Tooth Wheel Cultivator.
- No. 10 Noxon Spring Tooth Wheel Cultivator, with  
Grain Sower
- No. 11 Noxon Spring Tooth Wheel Cultivator, with  
Grain and Grass Seed Sower.
- No. 20 Noxon Ratchet Hand or Horse Dump Rake.
- No. 22 Noxon Ratchet Hand or Horse Dump Rake,  
Scratch Tooth.
- No. 24 Noxon Two Wheel Combined Reaper and  
Mower with three Knives.
- No. 25 Noxon Two Wheel Single Reaper with two  
Knives.
- No. 30 Noxon Rear Cut Mower.
- No. 31 Noxon Front Cut Mower.
- No. 32 Noxon Buckeye Mower.
- No. 33 Noxon Giant Rear Cut Mower, Wide Cut.
- No. 47 Hoosier Steel Frame Combined Drill, 10 Hoes  
and set of Cultivator Teeth.
- No. 50 Hoosier Steel Frame Single Broadcast Seeder,  
10 Teeth.
- No. 51 Hoosier Steel Frame Single Drill, 10 Hoes.
- No. 55 Hoosier Steel Frame Combined Drill, 12 Hoes  
and set of Cultivator Teeth.
- No. 56 Hoosier Steel Frame Combined Drill, 14 Hoes  
and set of Cultivator Teeth.
- No. 57 Hoosier Steel Frame Single Drill, 12 Hoes.
- No. 58 Crown Steel Frame Combined Drill, 10 Hoes  
and Set of Cultivator Teeth.
- No. 59 Crown Steel Frame Single Broadcast Seeder,  
10 Teeth.
- No. 60 Crown Steel Frame Single Drill, 10 Hoes.
- No. 61 Hoosier Steel Frame, Single Drill, 14 Hoes.
- No. 62 Hoosier Steel Frame Single Broadcast Seeder,  
12 Teeth.
- No. 63 Hoosier Steel Frame Single Broadcast Seeder,  
14 Teeth.



ESTABLISHED 1856.

INCORPORATED 1872.

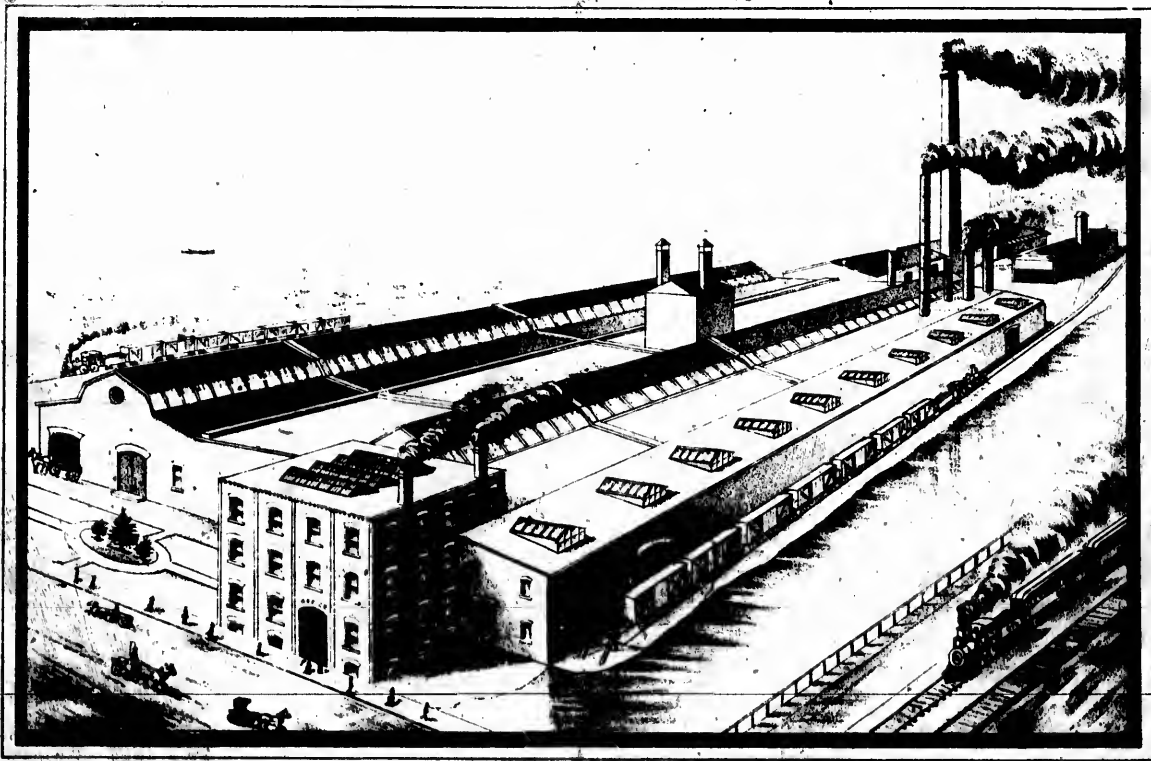

WORKS OF THE NOXON BROS M<sup>FG</sup> CO. (LIMITED)  
1 GERSOLL, ONT. CANADA.

