

Technical and Bibliographic Notes / Notes techniques et bibliographiques

The Institute has attempted to obtain the best original copy available for filming. Features of this copy which may be bibliographically unique, which may alter any of the images in the reproduction, or which may significantly change the usual method of filming, are checked below.

L'Institut a microfilmé le meilleur exemplaire qu'il lui a été possible de se procurer. Les détails de cet exemplaire qui sont peut-être uniques du point de vue bibliographique, qui peuvent modifier une image reproduite, ou qui peuvent exiger une modification dans la méthode normale de filmage sont indiqués ci-dessous.

- | | |
|--|--|
| <input type="checkbox"/> Coloured covers/
Couverture de couleur | <input type="checkbox"/> Coloured pages/
Pages de couleur |
| <input type="checkbox"/> Covers damaged/
Couverture endommagée | <input type="checkbox"/> Pages damaged/
Pages endommagées |
| <input type="checkbox"/> Covers restored and/or laminated/
Couverture restaurée et/ou pelliculée | <input type="checkbox"/> Pages restored and/or laminated/
Pages restaurées et/ou pelliculées |
| <input type="checkbox"/> Cover title missing/
Le titre de couverture manque | <input checked="" type="checkbox"/> Pages discoloured, stained or foxed/
Pages décolorées, tachetées ou piquées |
| <input type="checkbox"/> Coloured maps/
Cartes géographiques en couleur | <input type="checkbox"/> Pages detached/
Pages détachées |
| <input type="checkbox"/> Coloured ink (i.e. other than blue or black)/
Encre de couleur (i.e. autre que bleue ou noire) | <input checked="" type="checkbox"/> Showthrough/
Transparence |
| <input type="checkbox"/> Coloured plates and/or illustrations/
Planches et/ou illustrations en couleur | <input checked="" type="checkbox"/> Quality of print varies/
Qualité inégale de l'impression |
| <input checked="" type="checkbox"/> Bound with other material/
Relié avec d'autres documents | <input checked="" type="checkbox"/> Continuous pagination/
Pagination continue |
| <input checked="" type="checkbox"/> Tight binding may cause shadows or distortion
along interior margin/
La reliure serrée peut causer de l'ombre ou de la
distorsion le long de la marge intérieure | <input type="checkbox"/> Includes index(es)/
Comprend un (des) index |
| <input type="checkbox"/> Blank leaves added during restoration may appear
within the text. Whenever possible, these have
been omitted from filming/
Il se peut que certaines pages blanches ajoutées
lors d'une restauration apparaissent dans le texte,
mais, lorsque cela était possible, ces pages n'ont
pas été filmées. | Title on header taken from: /
Le titre de l'en-tête provient: |
| <input type="checkbox"/> Additional comments: /
Commentaires supplémentaires: | <input type="checkbox"/> Title page of issue /
Page de titre de la livraison |
| | <input type="checkbox"/> Caption of issue /
Titre de départ de la livraison |
| | <input type="checkbox"/> Masthead /
Générique (périodiques) de la livraison |

This item is filmed at the reduction ratio checked below /
Ce document est filmé au taux de réduction indiqué ci-dessous.

10X	14X	18X	22X	26X	30X
<input type="checkbox"/>	<input type="checkbox"/>	<input type="checkbox"/>	<input type="checkbox"/>	<input checked="" type="checkbox"/>	<input type="checkbox"/>
12X	16X	20X	24X	28X	32X

The Canadian Patent Office

RECORD



Vol. III.—No. 7.

JULY, 1875.

Price in Canada \$2.00 per An.
United States - \$2.50

CONTENTS.

INVENTIONS PATENTED,	85
INDEX OF INVENTIONS,	LXXXV
INDEX OF PATENTERS,	LXXXV
ILLUSTRATIONS,	95

INVENTIONS PATENTED.

No. 4648. LEONARD W. RUSSELL, Gananoque, Ont., 17th April, 1875, for 5 years: "Improvements in Fence Corners." (Perfectionnements aux angles des clôtures)

Claim.—1st. The braces C and DD, in a fence corner acting for the double purposes of braces or stays, to the perpendicular: B B, and also for rests or supports for the rails of the fence; 2nd. The combination of the base A, with the braces C and DD, together with the perpendiculars BB.

No. 4649. BYRON SLOPER, Montreal, Que., 17th April, 1875, for 5 years: "Improvements on a Hydrogen Generator and Carburettor combined." (Perfectionnements à un générateur-carburateur à gaz hydrogène.)

Claim.—1st. The reservoir A, generators B, B, draw-tubes C, C, trap-screws D, D, reversed T-shaped pipe E, having cocks h, h, and drop valves e, e the over flow-pipes F, F, in combination with a carburettor and purifier combined G, surrounded by a jacket H, filled with water; 2nd. The combined condenser and scrubber I, in combination with a carburettor G; 3rd. The carburettor G, so arranged in contact with the generators B, B, that the heat caused by the combustion of the acid and the iron is utilized to restore the calorific lost by the evaporation of the oil; 4th. The combination of the float-valve J, with the carburettor G, to regulate automatically the quantity of fluid in the carburettor at any desired point.

No. 4650. SAMUEL R. BAILEY, Boston, Mass., U. S., 17th April, 1875, for 5 years: "Wood Bending Machine." (Machine à courber les bois.)

Claim.—1st. In the process of bending wood, the employment of a heated metallic form, over and upon which the wood is bent and shaped; 2nd. A wood bending form consisting of a hollow metallic structure, of a suitable shape to impart the desired configuration to the wood bent over upon it, and provided with apertures or openings for the entrance and discharge of the agent by means of which heat is imparted to its metallic walls; 3rd. The combination of a series of hollow metallic wood bending forms, so connecting or communicating with each other, that the heating agent when introduced into one of said forms, may be free to pass or diffuse itself through the whole series; 4th. The combination with the wood bending form or forms of the frame or frames for supporting the same, and the means for bending the wood upon the forms carried by said frame or frames; 5th. A wood bending mechanism composed of a hollow internally heated form, and means for bending and retaining upon said form, the wood to be shaped; 6th. The combination of the strap G, block Z, or its equivalent, and clamp F with the form A; 7th. The construction of the strap C, as formed F with the block Z, or its equivalent, and the shoulders v, v, and the combination of such strap with the form A, and its abutments p, p, and the furcated wedge X.

No. 4651. WILLIAM G. RAWBONE, Toronto, Ont., 17th April, 1875, for 5 years: "Improvements in Cartridge Creasers." (Perfectionnements aux appareils de sauge des cartouches.)

Claim.—1st. The pressure lever G, with cam G₁, link F, and cam G₂, in combination with the arm A₁, with creaser bit C, and arm A₂ with head B; 2nd. The lever arm A₂, adjusting pin D, and spring E, or its equivalent, in combination with the upper arm A₁.

No. 4652. SAMUEL H. HALL, Belle Plaine, Iowa, U. S., 20th April, 1875, for 15 years: "Tan Vat." (Cuve de tannerie.)

Claim.—1st. The dash board E, and pendants C, C, applied to an oscillating bar B, in combination with the racks D, D.

No. 4653. JOHN B. PORTER, Yarmouth, N. S., 20th April, 1875, for 5 years: "Clothes Ironing Table." (Table à repasser le linge.)

Claim.—1st. Placing an ironing table A, on cross legs D, affixed to one end, leaving the other end of table free and the press board B, placed on the top of table A, and held by the clatch G, and the hinging of the legs to underside of table A, and the iron stand C.

No. 4654. ELI TIFFANY, Bennington, Vt., U. S., 20th April, 1875) for 5 years: "Circular Knitting Machine" (Machine à tricoter circulaire.)

Claim.—1st. The combination of the longitudinally grooved needle cylinder having separate endwise-movable latch-needles thereon, the needle reciprocating cam cylinder, the tubular cast off guard L, on the end of the needle cylinder, and the yarn-guide G, on the cam-cylinder, so that the loop on each needle shall surround the open latch and stem thereof and thereby hold open the latch while the yarn is being presented to the needle for a new loop; 2nd. The slotted needle cylinder A, having the divided adjustable needle holding spring N, upon its smaller upper part, in combination with the needle reciprocating cam-cylinder E, surrounding the larger lower part of the needle-cylinder, and having its cam slot F, extended near to its upper end so as to permit the needles to be separately removed; 3rd. In combination with the needle-cylinder A, and removable cam-cylinder E, around the lower part of the needle-cylinder, the detachable guard O, having one end in a perforation P, in the needle cylinder, and the other end part extended over the end of the cam-cylinder, and the middle part secured in a slot Q, in the needle-cylinder by means of the divided adjustable ring N; 4th. In combination with the fixed needle-cylinder A, and the rotary cam-cylinder E, having the grooved pulley R, and the removable elastic friction ring S, in the groove of the pulley and the rotary driving disc T, mounted on the adjustable stud V; 5th. In combination with the fixed needle cylinder A, and the surrounding rotary cam cylinder E, having thereon the projecting elastic friction ring S, and a fixed end-bearing at its base, the rotary driving friction disc T, having one side pressed against the said fixed end-bearing and mounted upon an axis directed away from, or to one side of, the axis of the cam-cylinder; 6th. The tubular longitudinally grooved needle-cylinder A, cast or formed of soft anti-friction metal and upon a hard metal tubular core Y extending through and beyond the slotted smaller portion of the cylinder and constituting the cast off part L thereof; 7th. The tubular rotary cam-cylinder E cast or formed on one piece only and having through it a straight slot F, Fig. 1 and S in combination with the longitudinally grooved cylinder A, from which the shanks of the needles project outward into the said straight groove or slot in the cam cylinder.

No. 4655. ANDREW G. GRAY, St. John, N. B., 20th April, 1875, for 5 years: "Improvements on Mowing Machines." (Perfectionnements aux faucheuses.)

Claim.—1st. The wheels A and A', having teeth B, formed on their inner sides and made fast to the axle to maintain their relative positions, in combination with the bars C and C', top piece E, bottom piece F, lever G, pivot H, and joint I. 2nd. The combination of the bars C and C', with top-piece E, bottom-piece F, and shaft b, cam D, lever G, rod g, hand-lever h, link e, and slot a; 3rd. The combination of the guide-bar K with the pin k.

No. 4656. SVEN RYDBECK, Red Wing, Ma., U. S., 20th April, 1875, for 5 years: "Improvements on Mortising Machines." (Perfectionnements aux machines à mortaiser.)

Claim.—1st. The combination of the screw-spindle D, sectional pivoted nut GG, and adjustable yoke H, h, h, H; 2nd. The combination of the screw-spindle D, sectional pivoted nut G; G', adjustable yoke I, h, h, H, shaft F, gear-wheel E, D, spur wheel I, and adjustable rack I; 3rd. The combination of the screw-spindle D, auger C, rigidly secured thereto, chisel D, and parts b and b'; 4th. The frame A, and chisel and auger in combination with the gauge-rods K, k, k', the heads k, of which project downward to below the base A, of the machine, 5th. The frame A, and chisel and auger, in combination with the gauge rod M, slot l at m, and carrying an adjustable slide M, m.

No. 4657. ISAAC LEVY, Ellaville, Florida, U. S., 20th April, 1875, for 5 years: "Improvements on Machines for Making Fence Pickets." (Perfectionnements aux machines à faire les pieux de clôture.)

Claim.—1st. The combination with the table or carriage K, of the slotted side bars O, O, the end connecting or cross-bar N, and the clamping screws P, P, said parts forming the end extension; 2nd. The clamping device consisting of the spring N, pivoted lever M, link R, and ratchet-bar S, said parts being combined and arranged with the table R, to hold the picket thereof, by pressure applied laterally.

No. 4658. WILLIAM PEAKER and EDWARD O. RUNIONS, Brampton, Ont., 20th April, 1875, for 5 years: "Hot Air Dumb Stove." (Poêle sourd à air chaud.)

Claim.—The pipes F, F, F, door I, and base K.

No. 4659. JOSEPH S. KEMP, Magog, Que., 21st April, 1875, for 5 years: "Manure Spreading Machine." (Machine à distribuer les engrais.)

Claim.—1st. The combination of the sides A and A', with the frame work B, axle C, shafts a and a', the six sided pulleys e, chains d, d, lugs e, guard f, rollers 1, and crank H; 2nd. In combination with the shaft a, and wheel D or D', the wheel train g, having wheel A, driving pinion i, and clutch pins k, and lever E, spring F, cut h G, and pin q; 3rd. The roller J, having teeth l, in combination with the gears k, wheel D' or D, belt m, pulleys n and n', bar L, and lever E; 4th. In combination with the guard f, the lever E, spring F, catch G, and pin q; 5th. In combination with the comb M, having transoms r, and teeth s, the lever t, and spring u; 6th. In combination with the pole N, axle C, and frame work B, the bar P, and pin R; 7th. The combination of stationary gears to hub of wheels D, and D', for the same purpose as pinion i, also the use of both gears or belts from axle C, and shafts a and a', to pulleys n or n', or roller J.

No. 4660. BARKER C. YOUNG, Boston, Mass., U. S., 21st April, 1875, for 5 years: "Buckle Attachment." (Ajustage des boucles.)

Claim.—The improved buckle attachment B, composed of the plate f, and the perforated projection g, when the latter is arranged at or in close proximity with one edge of and in other respects with the said plate; also the buckle provided with the hook in combination with the plate j, and perforated projection g.

No. 4661. WILLIAM SHEA, Trenton, Ont., 21st April, 1875, for 5 years: "Milk Cooler." (Rafraichissoir à lait.)

Claim.—1st. An ice or water containing vessel A, for floating in milk pans or cans, having tubular passages B, 2nd. The vessel A, having an annular tubular buoy C; 3rd. The combination of the removable buoy C, and vessel A, attachable as described.

No. 4662. WILLIAM J. MANSELL, Toronto, Ont., 21st April, 1875, for 5 years: "Self-Acting Car-Coupling." (Attelage automatique de wagons.)

Claim.—1st. The tongue A, pivoted on the pin d, to the draw-head B, and at such an angle to the said draw-head B, that the strain of the link comes against the end of the tongue A; 2nd. The tongue A, having the wings b', in combination with draw-head B.

No. 4663. WILLIAM H. LANDON, Princeton, Ont., 21st April, 1875, for 5 years: "Improvements on Stoves." (Perfectionnements aux poeles.)

Claim.—1st. The combination of oven A, below the fire-box B, b, Fig. 1; 2nd. The combination of saddle shaped top plate S, and fire-box B, fig. 1.

No. 4664. WILLIAM J. WAUCHOPE, Executor of the will of ANDREW WAUCHOPE, Niddrie, Scot., and JOHN COWAN, Pengo, Eng., 21st April, 1875, for 5 years: "Gas Manufacture." (Fabrication du gaz.)

Claim.—The construction and arrangement of the gas retort D, in combination with and capable of being worked, concurrently with the kiln A, B, C.

No. 4665. CHARLES GAOUETTE, and LOUIS GAOUETTE, Ste. Anne de Stukeley, Que., 22nd April, 1875, for 5 years: "A Varnish." (Un vernis.)

Claim.—A compound composed of turpentine, paint, oil (boiled) japan oil, benzine, rosin and balsam gum mixed and boiled together in the proportion set forth.

No. 4666. JULIUS S. SHAILER, Boston, Mass., and WILLIAM COREY, Manchester, N. H., U. S., 22nd April, 1875, (Assignees of B. C. Stevens), for 5 years: "Improvements on Knitting Machines." (Perfectionnements aux machines à tricoter.)

Claim.—1st. In combination with the cylinder N, and dial A, the mechanism for giving a continuous circular and reciprocating semi-circular motion to the plate M, consisting of the pinion K, ring L, rack G, pinions I, and D, ring J, and stop J; 2nd. The mechanism for operating the dual-needles, consisting of the latch b', arch d', cam A, and plate M; 3rd. The dial A, and its operative mechanism, applied upon a hinged arm V, so that it can be readily removed out of the way, to facilitate the operation of the machine on different work; 4th. The combination with the circular plate M, of the shifter T, hooks U, U, and ring S, for operating the cams R, R; 5th. In combination with the revolving plate M, and toothed rings J, L, the locking pin J, for changing the movement of the machine; 6th. The reversing hooks U, U, in combination with the shifter T; 7th. A needle-cylinder containing two separate independent sets of needles operated by two separate independent cams.

No. 4667. GEORGE W. DUBUISSON, Toms River, N. J., U. S., 22nd April, 1875, for 5 years: "Method of Treating Jute, Gunny and Manila for the Manufacture of White Paper." (Mode de traitement du chauvre du Bengale, de la natte de jonc et de la manille pour la fabrication du papier blanc.)

Claim.—1st. The method or process of disintegrating the fibre of jute, gunny and manilla, and other fibrous plants and preparing them for bleaching by the use of potash; 2nd. The method of repeatedly using the potash solution in the treatment of jute, gunny and manilla, after such solution is restored by leaching through leached ashes.

No. 4668. WILLIAM PATESON, Bramley, Ont., 23rd April, 1875, for 5 years: "Improvements on Milking Machines." (Perfectionnements aux machines à traire le lait.)

Claim.—1st. The collars b', in combination with the tubes B; 2nd. The double spring clips D, in combination with the tubes B and A.

No. 4669. SAMUEL BRILLINGER, St. Catharines, Ont., 23rd April, 1875, for 5 years: "Improvement in Paint Brushes." (Perfectionnement des pinceaux.)

Claim.—1st. The combination and arrangement of the conical screw B, and expanding nut a, a, the said screw screwing directly in the sectional or non sectional nut, without the interposition or agency of other parts; 2nd. In combination with the sectional nut a, a, the defenders c, c.

No. 4670. JOHN B. BAUGH, Detroit, Mich., U. S., 23rd April, 1875, for 5 years: "Improvements on Dies for Welding Links." (Perfectionnements aux étampes à souder les mailles.)

Claim.—The combination of the wedge-shaped-dies B, C, having grooves E, with the bed A, and lever H.

No. 4671. THOMAS WEISS, Bethlehem, Pa., U. S., (Assignee of P. B. Cunningham), 23rd April, 1875, for 5 years: "Improvements on Shovels." (Perfectionnements aux pelles.)

Claim.—A shovel in which are combined a metal tongue A, secured to the handle with a socket c, formed for its reception in the blade.

No. 4672. HUGH L. WALKER, Guelph, Ont., 23rd April, 1875, for 5 years: "Sewing Machine Shuttle." (Navette de machine à coudre.)

Claim.—1st. A spring plate D, having any required number of notches a, in combination with a spring plate C; 2nd. The plates C and D, rivetted together as shown and pivoted at b, to the shuttle A, in combination with the bobbin B; 3rd. The notch F, and bridge G, in combination with eye hole E; 4th. The pin g, in combination with the slot h, in the plate C.

No. 4673. MELVIN WILSON, Strathroy, Ont., 23rd April, 1875, for 5 years: "Improvements in Harrows." (Perfectionnements aux herses.)

Claim.—1st. The chains D, arms E, cross-bar F, rack G, and lever H, when combined with the frame A, and axle-tree B, of a sulky-harrow; 2nd. The rods of attaching the harrow to the tongue N, by means of chains I, J, front-bar K, and chains L, M.

No. 4674. PETER B. CUNNINGHAM, Freehold, Pa., U. S., 23rd April, 1875, for 5 years: "Improvements on Running Gear for Vehicles." (Perfectionnements aux trains de voitures.)

Claim.—1st. The circle B, provided with cams B₁, B₂, on opposite sides th^e extreme point of each cam being provided with a recess x; 2nd. The combination with the axle C, and wheels C₁, of the frame C₂, C₃, C₄, and rollers D₁, to act against the cam circle B; 3rd. The friction-roller e, upon the extended journal of the roller D₁, in combination with the L-shaped-arm b₁; 4th. The flanged tube a, attached to the axle C, in combination with the frame B₁, and the king-bolt a₂, both of the latter attached to the bottom of the wagon body; 5th. The tongue E, pivoted in a slot on the bar C, in combination with the bar C₁ and plate d; 6th. The combination of the two springs a₁, G₁, surrounding the axle G, and the stiff rods e, plates e₁, and cross-bar G; 7th. The jointed rod e₂, in combination with a vehicle axle and a single spring

No. 4675. WILLIAM CHARLES CHARTIERS, and MATTHEW MCKAIN, Pittsburgh, Pa., U. S., 27th April, 1875, for 15 years: "Nut Machine." (Machine à noix.)

Claim.—1st. The combination of the swage arms G, swages I, cutter F, and blunt punches f, for swaging, nicking, and partially punching two or more blanks, at one operation; 2nd. The combination of the hollow press-screw L, supported in a suitable cross-head, the press-plate K, the dies E₁, and the eye-punches m, n; 3rd. The nut-box H, having a dividing or centro-piece h and the stop b₁, in combination with the dies E; 4th. In combination with the cylindrical axially pivoted eye-punch, press lies, and the boxes, the cutters and punches, for the purpose of previously nicking and partially punching the blank.

No. 4676. JAMES P. LOCKEY, Northwick, Eng., 27th April, 1875, for 5 years: "Apparatus for Evaporating Liquids and Heating Gas Retorts or Calcining Minerals." (Appareil à vaporiser les liquides et chauffer les cornues à gaz ou calciner les minerais.)

Claim.—1st. The arrangement of two furnaces A, A, heating the reverberatory furnace or kiln B, (so that by alternate firing the smoke can be consumed) in combination with the evaporating pan F; 2nd. The arrangement of furnaces A, and kiln B, with the flue E, and steam-jet for forcing the current of heated gases under the evaporating pan or drying floor F; 3rd. The combination of the pan F, with the furnaces A, (and kiln B) arched over so as to prevent the direct radiant heat of the furnace from burning the pan F; 4th. The combination of flue or flues D, D, and concentric steam-jet with the baffle walls or partitions R, R, beneath the pan F.

No. 4677. CHARLES JEWELL, Monmouth, Ill., U. S., 27th April, 1875, for 5 years: "Grain Binder." (Lieuse à grain.)

Claim.—1st. The hollow-shaft J, sleeve K, catch L, hook-rod M, and rod N, arranged to operate with the frame P, and needle c; 2nd. The slide Q, constructed and arranged to operate with the frame P, needle c, and its operating devices; 3rd. The shafts B, and c₁, and needle arm C, arranged to operate with the connecting rod j₁, segmental gear j, and pinion j₂, when combined and arranged to operate with the tying device and cutting device.

No. 4678. BENJAMIN F. BRITTON, New York, U. S., 1875, for 10 years: "Duplex Comb." (Peigne pliant.)

Claim.—A duplex comb composed of a main comb with one or more swinging hair-retaining auxiliary combs

No. 4679. CHRISTOPHER GULLMANN, Forestville, N. Y., U. S., 27th April, 1875, for 5 years: "Improvements on Sewing Machines." (Perfectionnements aux machines à coudre.)

Claim.—1st. The combination of a slotted lever strap g, with a rod F, connected to the needle-lever E; 2nd. The combination with the shuttle and its race of a shuttle driving lever H, so that the shuttle passes through the loop close up to the under side of the cloth plate and returns in a plane below that occupied by the point of the needle, thus holding the needle thread taut; 3rd. The shuttle carrier hinged to a shuttle lever H, which moves on a universal joint, in combination with a latch S, and spring t; 4th. The combination with the feed-bar K, of a lever strap r, eccentric u, and adjustable fulcrum pin d; 5th. The combination of the eye s₁, adjusting k₁, rod j₁, and hook i₁, with the adjustable plate r₁, and with the needle slide D; 6th. The combination of the bell crank lever m₁, and sliding pin n₁, with the needle lever E, and with the presser slide of a sewing machine; 7th. The combination of the throat plate P, jaws r₁, s₁, and pin u₁.

No. 4680. THOMAS B. DOOLITTLE, Bridgeport, Ct., U. S., 27th April, 1875, for 5 years: "Improvements on Conductors' Hand Alarms and Registers." (Perfectionnements aux signaux et registres à mains des conducteurs.)

Claim.—1st. The combination with the barrel A, of the register gears and push rods B; 2d. In combination with the barrel A, register gears and push rods B, the striker F, and bell E; 3d. The barrel A, with the sliding plates L, M, for exposing to view the interior; 4th. The push rod B, provided with suitable spring C; 5th. The combination with the barrel A, and suitable hooks or rings, the hand strap or straps R, R, for securing the instrument to the hand; 6th. The case for an alarm register consisting of a round, oval or equivalent formed barrel A, adapted to be held on or in the hand, and containing the registering mechanism and the perforated case D, for the bell; 7th. The combination with the registering devices and with the alarm mechanism of the straight push rod B, provided with spring arms J, K, operating the register and the alarm; 8th. An arm register embodying in its construction an oval, round or equivalent formed barrel carrying the registering mechanism, and adapted to be carried on or in the hand, a gong containing case, attached to said barrel, a series of registering wheels, an alarm apparatus and a straight push rod, provided with spring arms and actuating the register and alarm; 9th. A holder adapted to pass over the back of the hand and around the wrist for the purpose of supporting a check or alarm indicator or fare register in the palm of the hand of the user

No. 4681. WILLIAM L. WALKER, and BENJAMIN G. DEVOE, Kenton, Ohio, U. S., 27th April, 1875, for 5 years: "Improvements on Metallic Fences." (Perfectionnements aux clôtures métalliques.)

Claim.—1st. The base A, provided with a base plate a, and the standards or uprights a₁, a₂, in combination with the post rail or two rails a₃; 2nd. The base A, in combination with the post B, a₁ and base b₂; 3rd. The ornamental fastening clamp F; 4th. The clamp G, formed in two parts g₁, h, the part g₁ having a shank g₂, provided with a longitudinal slot g₃, and the projecting studs g₄, in combination with the part h, having a slot h₁, flange h₂, recesses h₃; 5th. The ornamental parts E, of which f₁ form circles or segments of circles in combination with the pickets D, ornamental clamps F, and horizontal rails C; 6th. The ornamental parts E, clamps F, rails C, in combination with the base A, post B, and clamp G.

No. 4682. ARCHIBALD SPENCE, Montreal, Que., 27th April, 1875, for 5 years: "Improvements on Boilers for Heating Water or Raising Steam." (Perfectionnements aux chaudières pour chauffer l'eau ou produire de la vapeur.)

Claim.—1st. A boiler for hot water or steam composed of sections A, with connecting pipes B, B₁, and B₂; 2nd the pipes B, and B₁, provided with filling strips X; 3rd. In combination with the sections A, the chambers B, E, E₁, provided with water ways F, F₁; 4th The combination of the sections A, pipes B, B₁, and B₂, with or without filling pieces X, pipes G, and G₁, and chambers E, E₁.

No. 4683. CANDIDUS BILHARZ, Pittsylvania Court House, Va., U. S., 27th April, 1875, for 5 years: "Improvements on Hammers." (Perfectionnements des marteaux.)

Claim.—1st A hammer head; 2nd. The combination of a movable jaw G, with a hammer head, or instrument for drawing nails.

No. 4684. GEORGE McNAUGHTON, Brooklyn, N. Y., U. S., 27th April, 1875, for 15 years: "Steam Engine." (Machine à vapeur.)

Claim.—1st. A hollow valve B, having induction port D, and opposite balance port D, the induction port E, and opposite balance port E, and exhaust ports F, F₁, discharging exhaust steam through covered exhaust ports F, F₁, at the end of the valve in combination with the casing A, having induction port a, and induction ports b, and c. 2nd. The conical valve R, operating in a correspondingly formed seat by the screw spindle O₁. 3rd. The screw J, cog-wheel O, latch-lever P, and spring O₂, operated by the spindle O₁, of the valve R, 4th. The frame L, and spring N, in combination with the spindle K, for operating the valve B; 5th. The spiral spring W, applied to the shaft of the governor; 6th. The slide blocks X, the rocking-blocks Y, and Z₁, connecting-rod Z, and rocking link M, in combination with a governor for operating the valve B; 7th. The rocking link M, in combination with a rock shaft M₂, and rocking arm M₃.

No. 4685. BERNARD DOUCE, Constantinople, Turkey, 27th April, 1875, for 5 years: "Paper Bag Machine." (Machine à faire les sacs de papier.)

Claim.—1st The combination of the bands X, Y; 2nd The combination of the bands X, Y, with the folders 24, lifters 25, plate K, L, M, N, holders 31, and grating 35; 3rd. The combination of the bands X, Y, with the draw-rollers 5, 6, and 7, 8; 4th. The combination of the rollers 1 and 2.

No. 4686. DAVID P. COREY, Consecon, Ont., 27th April, 1875, for 5 years: "Improvements on Car-couplers." (Perfectionnements aux atelages de wagons.)

Claim.—1st. The draw-head A, with the guides b, b, and springs so that the draw-link is certain to be correctly directed and entered by the action of said guides and springs, and the certainty of action of the draw-pin dropping into position and becoming secure; 2nd. The regulation of the height of the draw-head, so that it may accommodate and bring draw-heads on different cars to the same level.

No. 4687. SAMUEL KEIM, Attoona, Pa., U. S., 27th April, 1875, for 5 years: "Mill Stone Dress." (Rhabillage des meules.)

Claim.—1st. The dress of the runner stone having the lands all running to a point near the eye, and the furrows terminating in curved or semi-circular edges, in the dress of the bed-stone, having the furrows tangential to a smooth eyes encircling part, the diameter of which is equal to the distance of diametrically opposite terminal points of the lands of the runner.

No. 4688. RUFUS NUTTING, Wheaton, Ill., U. S., 27th April, 1875, for 5 years: "Improvements in Lanterns." (Perfectionnements aux lanternes.)

Claim.—1st. The adjustable case A, in combination with a lantern; 2nd. The detachable pedestal B, provided with a screw for combining it with a lantern fount; 3rd. The lantern pedestal B, in sections detachably joined together; 4th. The screw C, attached to the bottom of a lantern fount; 5th. The sides of the automatic fount D, semi-circular in form, in combination with a fount top and burner; 6th. The fount top F, in combination with a fount and burner; 7th. The ballast E, in combination with the bottom of a lantern or lamp fount; 8th. The automatic fount D, in combination with a burner and a globe-chimney or other protector; 9th. The V-shaped filling trough G, in combination with a fount; 10th. The detachable brace chamber H, in combination with a lantern fount and protector bottom; 11th. The automatic dampers H₂, in combination with the brace chamber H, or the wind break of a lantern below the burner; 12th. Automatic dampers poised and hung in combination with a lantern above or below the burner; 13th. The screw I₁, attached to a lantern bottom, in combination with a burner and fount; 14th. The perforated concave

bottom I, in combination with a perforated chamber II, and a burner; 15th. The bottom I, in combination with the beaded plate M; 16th. The swedged vertical strips K, in combination with the guards K₁, and studs P; 17th. The curved strips L, in combination with the guards K, K₁, and studs P; 18th. The beaded plate M, attached to the strips K, and L, in combination with the panels I₁, and bottom I; 19th. The chambers U, in combination with the perforated concave bottom I, and a burner; 20th. The canopy O, in combination with the studs P, and passages S; 22nd. The canopy O, in combination with the studs P, and chamber V; 23rd. The chamber V, in combination with canopy O, and tube 3; 24th. The chamber V, in combination with the canopy O, and bracket Q; 25th. The chamber V, detachable in combination with the canopy O, or a lantern top; 26th. The chamber V, in combination with the bracket Q, and cowl W; 27th. The pin O₁, in combination with the chamber V, and canopy O, or a lantern top; 28th. The cowl W, constructed, poised and combined with a lantern top; 29th. The tube 3, attached to the chamber V, in combination with the detachable passages S; 30th. The passages S, in combination with the tube 3, and studs P; 31st. The passages S, detachable; 32nd. A passage for cooling and conducting heated air from above the flame of a lantern or lamp, down towards the flame, made of paper or other like non-conducting material; 33rd. The spring Q, in combination with a lantern top end and handle; 34th. The handle 4, detachable in combination with a lantern; 35th. The handle 4, jointed for the purpose described, in combination with a lantern; 36th. In a coal-oil lantern or lamp burner, the combination of two or more small wick tubes, for dividing the flame into several parts for more oxygen; 37th. A coal-oil burner with several small wick tubes, each having the wick moving-orifice 7, near the lowest end; 38th. A coal-oil burner, with several small wick tubes in combination with a cone or dome reflector; 39th. In wick tubes having the orifice 7, the enlargement 8 at the upper end; 40th. The perforated reversible stopper 8₁, in combination with wick tubes having the orifice 7, and enlargement 8; 41st. A wick tube of a lantern or lamp burner, corrugated or grooved for separate wicks; 42nd. A coal-oil burner with several wick tubes, one or more of them inclined or curved in combination with ratchet wheel and shaft; 43rd. A coal-oil burner in combination with a globe-chimney or other flame protector; 44th. The screw 9, attached to the upper side of a lantern or lamp burner; 45th. The hunting chamber 10, having the orifice 11; 46th. The gas vent 12, attached to the top of the chamber 10; 47th. The flame covers 13, having air channels and flame hidings in combination with a coal oil burner; 48th. In flame covers 13₁, having channels and hidings, adjustable in combination with a coal oil burner; 49th. The cowl W, bracket Q, chamber V, tube 3, passages S, canopy O, studs P, bottom I, and chamber V, in combination with a globe or other protector; 50th. The cowl W, bracket Q, chamber V, canopy O, studs P, and bottom I, in combination with a globe, or other flame protector; 51st. The horizontal detachable reflector 14, in combination with the door of a flame protector; 52nd. The detachable vertical reflector 14₁, in combination with the door of a flame protector; 53rd. The detachable candle socket 15, having screw attached to it as shown, in combination with the pedestal B; 54th. The detachable candle socket 15, in combination with the protector bottom I; 55th. The detachable candle socket 15, provided with an upper and lower screw, in combination with a globe or other flame protector.

No. 4689. WILLIAM C. EDGE, Newark, N. J., U. S., 27th April, 1875, for 5 years: "Machine for and Process of making the Heads of Chain Swivels." (Machine et procédé pour faire les têtes des mailles tournantes.)

Claim.—1st. The process of forming swivel heads from sheet metal blank a, by first forming each blank into a cup a₁, then elongating said cup, next forming it into a pear shape and lastly finishing it by turning between a stationary mould C, and reciprocating mould B; 2nd. The combination of the die d, guide ring e, plunger h₁, pin i, and spring j₁, all arranged for the purpose of contracting the open end of the cup shaped swivel head blank; 3rd. The reciprocating mould B, combined with the stationary mould C, and handle A, the opposite faces of the two moulds having cavities for the reception of a swivel head blank a₁, which is to be formed into a swivel head a₂, by the operation of the moulds; 4th. The process of adapting a sheet metal swivel head blank to the reception of a handle A, and to the operation of the moulds B, C, by punching a square hole through the end of the blank previous to the insertion within said moulds.

No. 4690. DANIEL K. WEST, London, Eng., 28th April, 1875, for 10 years: "Improvements in Steam, Water or other Engines." (Perfectionnements aux machines à vapeur, hydrauliques et autres.)

Claim.—1st. The combination of the parallel cylinders K, and the cone ended pistons P, with the disc B; 2nd. The combination of the parallel cylinders K, and the pistons P, having piston rods p, with the universal joint a, b, c; 3rd. The combination of the coned under surface L, of the disc B, with the coned bearing surface of the frame E; 4th. The combination of the described engine with the circular valve H; 5th. The combination of the described engine with the arrangement of oil passages e, and lastly the combination of the coned surface of the disc B, with the coned surface of the frame E, for the purpose of generating centrifugal force in air or other fluid.

No. 4691. THEODORE FITZ RANDOLPH, Morris-town, N. J., U. S., 28th April, 1875, for 5 years: "Ditching Machine." (Machine à fossoyer.)

Claim.—1st. The combination of the sliding block P, screws Q, S, arm R, and shoe O, the latter being pivoted between its extremities and near the middle thereof, to the sliding block, and rigidly secured to or formed in one piece with the arm R; 2nd. The ball-bearing D, pivots E, and lugged plate F, in combination with the king bolt G, the forward axle H, and the forward draft bar C, of the ditcher; 3rd. The combination of the two drums I, the two screw wheels H, the two swivelled screws I, J, and the two cords or chains K, with the frame work B, of the ditcher and with the axle L, swivelled to the rear end of the rear draft bar K, of the ditcher; 4th. The combination of the swivelled screw rod D, the two swivelled screw wheel nuts C, and the two screws A, with the front and rear draft bars C, K, and with the frame work H, B, and ditching wheel A.

No. 4692. ALLAN CUMMINGS, New York, U. S., 28th April, 1875, for 5 years: "Improvements on Screws." (Perfectionnements aux vis.)

Claim.—1st. A screw or bolt of any form or shape, the head of which is provided at its centre with an angular, oval, oblong or round cavity or hole, either with or without the use of the usual slot, 2nd. A screw or bolt provided in its head with a half round slot, either with or without a cavity extending below it, to take the place of the ordinary slot, 3rd. A screw or bolt provided in its head with a V shaped slot, either with or without a cavity extending below it, to take the place of the ordinary slot.

No. 4693. EBENEZER HILL, Jr., South Norwalk, Ct., U. S., 28th April, 1875, for 5 years: "Improvements in Linings for Cylinders." (Perfectionnements des renforts de cylindres.)

Claim.—The combination of a lining B, having a flange b, and a stuffing box C, provided with a screw thread to secure the lining in a cylinder A.

No. 4694. ALEXANDER MITCHELL, Wilkesbarre, Pa., U. S., 28th April, 1875, for 5 years: "Spark Arrester." (Arrête-flammèches.)

Claim.—1st. A spark disintegrating screen in which notched bars G, are combined with two sets of rods; 2nd. In a locomotive smoke box, the tubes I, having flaring lower ends and communicating above with the chimney, in combination with nozzles m, from which jets of live steam may be projected into said tubes.

No. 4695. JOHN J. COBB, Grand Rapids, Mich., U. S., 28th April, 1875, for 5 years: "Improvements on Sides and Wings for Cutter Sleighs." (Perfectionnements aux caisses de traineaux.)

Claim.—1st. The metallic cutter sides U, R, L, with flanges S, and mouldings N, E; 2nd. The body-sill G, bent at the joint M, forming an arch either one-half or of the entire back of cutter; 3rd. The metallic wing B, with flanges A, A, divided near the centre of wing B, and each flange bent at right angles with the concave portion of the same.

No. 4696. RANDALL BENTLEY, Owen Sound, Ont., 28th April, 1875, for 5 years: "Improvement on Roofs for Buildings." (Perfectionnements aux toitures de bâtiments.)

Claim.—1st. The cutting of square scantling diagonally in two E, E. 2nd. The cutting of the rectangular troughs and pieces A, B, C, D, A, B, C, D, from each of the triangular pieces E, F, E, E, F, E. 3rd. The combination of the rectangular troughs and pieces A, B, C, D, A, B, C, D, in the construction of roofed buildings.

No. 4697. JAMES E. WISNER, Friendship, N. Y., U. S., 28th April, 1875, for 5 years: "Fertilizer Sower." (Distributeur d'engrais.)

Claim.—1st. The combination of two independent wheels and axles with the two independently moving feed-rollers F, G; 2nd. The feed-rollers F, G, combined with the adjustable inclined plates or blocks I, arranged with their rear edges, over the centres of the rollers.

No. 4698. CHARLES R. SNYDER, Minneapolis, Ma., U. S., 28th April, 1875, for 5 years: "Ladies' Work Table." (Table à ouvrage.)

Claim.—A lady's work-table constructed with compartments or drawers, and provided with the top A, removable from the frame by means of side arms B, or other manner, whereby the top can be drawn over and adapted for use as a lap-board.

No. 4699. HENRY BEHNIN, and JUSTUS DIEHL, New-York, U. S., 28th April, 1875, for 5 years: "Improvements on Pianos and Organs." (Perfectionnements aux pianos et aux orgues.)

Claim.—A name board for pianos or organs having a longitudinal concave groove cut into the front or outer side.

No. 4700. CHARLES W. JENKS, Somerville, Mass., U. S., 28th April, 1875, for 5 years: "Shirt Bosom." (Devant de chemise.)

Claim.—1st. An open front or open side shirt on which the lower half or portion of the bosom is unattached to the shirt front, except by the upper portion or rest of the said bosom, being sewed or connected at its edges to the front. 2nd. In combination with the bosom B, made whole or in pieces of one or more solid backs D, E, of linen or other proper material.

No. 4701. CHARLES KENNEDY, Aurora, Ill., U. S., 28th April, 1875, for 5 years: "Wire Fence." (Cloture en fil métallique.)

Claim.—1st. A fence wire provided with indentations c or bonds d, to prevent the barbs from slipping or turning on the wire. 2nd. A barb for a wire fence having a slanted or open cylinder or extension a. 3rd. A wire fence consisting of posts A, wires B, and barbs E, secured to the wires by pressure.

No. 4702. PETER GENDRON, Toledo, Ohio, U. S., 29th April, 1875, for 5 years: "Carriage Wheel." (Roue de voiture.)

Claim.—A vehicle wheel having its hub A, B, C, cast in one piece with sockets for receiving the bolts d, in combination with the caps b, nuts h, and spokes D, having hooks k.

No. 4703. SAMUEL MORRELL, and CHRISTOPHER REINHARDT, Montreal, Que., 29th April, 1875, for 5 years: "Spring Bottom Bedstead." (Couchette à fond à ressort.)

Claim.—1st. In combination with any bedstead, the rods E, E, holding the ends of the slats F, and secured by springs to the head and foot of the bedstead; 2nd. In combination with the longitudinal framing of any doubling up bedstead, the combination of the rods C and E, springs D and slats F; 3rd. In combination with a y bedstead, the bars I, carried at both ends by springs K, attached to the rails L, and supporting bars H, on which the slats F, rest.

No. 4704. JOHN MOULTON, Ossipee, and SAMUEL R. THOMPSON, Portsmouth, N. H., U. S., 29th April, 1875, for 5 years: "Bark Rasping Machine." (Machine à triturer l'écorce.)

Claim.—1st. The combination of the drum D, having spirally arranged cutters and journaled in the bed-plate B, with the lugged frame K, having screws C, and spring-bars c, c, c, c, the latter carrying the drum L, and rollers M, N, of the spurred bars d, the drum D, being roted in an opposite direction to the rotation of the drum L, and rollers M, N; 2nd. In combination with rotating endless spurred bars and rotating cutter drum of a bark rasping machine, an adjustable sectional bed plate B, supported by a lever T. 3rd. The combination of the belt-pulley S, hand lever R, notched flange v, and belt pulley F.

No. 4705. EDWARD W. GRANT, (Assignee of H. Niemann), Ypsilanti, Mich., U. S., 29th April, 1875, for 5 years: "Improvements on Step-ladders." (Perfectionnements aux échelles à queues.)

Claim.—1st. The combination with a step-ladder, having rear legs hinged thereto, of the plates E, provided with longitudinal slots e, and transverse slots d, and brace G, pivoted to the lower end of the rear legs, and connected at its upper end by rods s. 2nd. The feet h, h, pivoted on the lower ends of the legs D.

No. 4706. JOHN DOMAN, Owen Sound, Ont., 30th April, 1875, for 5 years: "Snow-plough." (Charrue à neige.)

Claim.—1st. The inclined plane A, with sides C, C, in combination with the slotted guides H, and lifting screw K, and the projecting wings B, B, with sides C, C, C, C, C, C, hinged or stationary as may be found most suitable and convenient. 3rd. The vertical knives E, E, and horizontal knife F, in combination with the inclined plane A, and sides C, C. 4th. The guide D, hinged in combination with the wings B, B, and sides C, C, C, C; 5th. The combination of the whole.

No. 4707. JOHN W. ELLIOTT, Toronto, Ont., 30th April, 1875, for 5 years: "Improvements in Stoves." (Perfectionnements dans les poeles.)

Claim.—1st. The water reservoir A. pivoted by the pipe C. in combination with the pocket or scabbard D. or its equivalent; 2nd. The water reservoir A. in combination with the steam pipe J. and hot air pipe I; 3rd. The mica L. bound with the metallic tip M. in combination with the knob n.

No. 4708. SAMUEL SHERWOOD, Independence, Iowa, U. S., 30th April, 1875, for 5 years: "Water Wheel." (Roue hydraulique.)

Claim.—In combination with the wheel I, i, J, the buckets K, formed with a very large broad mouth or receiving end, and a small delivery or bottom discharge end, and blades K₁, placed in a very gradual and down-wardly curved position on the wheel, the top portion of the blades being separated some distance apart, and the lower ends brought nearer together and projected by an inclosing flaring rim or band L.

No. 4709. BARNABAS A. HIGGINS, New-Portland, Me., U. S., 30th April, 1875, for 5 years; "Machine for Bending Wood for the Handles of Shovels, &c." (Machine à plier les bois des manches de pelles, &c.)

Claim.—The forms Q and S, constructed and combined with each other as described, and mechanism for forming the tops of shovel-handles, &c.

No. 4710. JEAN B. CAMYRÉ, and LOUIS A. DESSAULLES, Montreal, Que., 5th May, 1875, for 5 years: "Improvements in the Manufacture of Cigars" (Perfectionnements dans la fabrication des cigares.)

Résumé.—1o. Un cigar b, ayant un vide intérieur c, dans toute sa longueur pour le passage de l'air, et se terminant par le trou d, ou le tube e, afin d'éviter d'un caser, couler ou perforer l'extrémité pour le fumer; 2o. Le procédé de fabrication décrit, et la formation du vide intérieur c, au moyen de la broche a, ou d'un équivalent.

Claim.—1st. A cigar b, having an interior conduit c, throughout its length, for the passage of air, ending in the hole d, or tube e, in order to avoid breaking, cutting or perforating the extremity before smoking; 2nd. The process of manufacturing, and the formation of the interior conduit, by means of the skewer a, or its equivalent.

No. 4711. JOSEPH MORIN, St. Hyacinthe, Que., 8th May, 1875, for 5 years: "Concentric Guide for Planing and Grooving Machine Irons." (Guide concentrique des lames des machines à raboter et embouvetter.)

Résumé.—1o. La rondelle ou épaulement E, fixé ou mobile sur l'arbre des rabots rotatifs; 2o. L'anneau c, fixé ou mobile sur le porte-lames des bouvettes.

Claim.—1st. The collar or shoulder E, fixed or movable on the arbour of the rotary planes; 2nd. The ring c, fixed or movable on the iron-holder or the grooving plane.

No. 4712. DOMINIQUE SPINELLI, Montreal, Que., 8th May, 1875, for 5 years: "Process for the Saponification of Mineral Oils." (Procédé de saponification des huiles minérales.)

Résumé.—L'emploi de la paraffine, de l'huile ou de la graisse de pétrole dans la fabrication du savon.

Claim.—The use of paraffine, or of petroleum oil or grease in the manufacture of soap.

No. 4713. SAMUEL HALL, Toronto, Ont., 7th May, 1875, (Extension of Patent No. 418), for 5 years: "Churn Dasher." (Piston de baratte.)

Claim.—The form of the dasher as applied to the ordinary dasher, and crank-churns and not any other part of these churns; the alteration of the plane or flat surfaces of the dashers now in ordinary use whether in churns worked by crank or by the more common upright or vertical motion into curved surfaces; and the method of attaching the handle to the dasher, and also the knobbed or ribbed piece of handle.

No. 4714. EDWARD G. SCOVIL, Saint-John, N. B., 12th May, 1875, (Extension of Patent No. 415), for 5 years: "Machine for the Charging of Heavy Piles for Heating Iron Preparatory to Rolling." (Machine à charger les masses pesantes pour chauffer le fer à laminer.)

Claim.—The combination of the buggy and the peel B, and the making the peel B, with rollers G in it

No. 4715. LOUIS GODDU, Boston, Mass., U. S., 15th May, 1875, for 5 years: "Improvements on Boot and Shoe Nails." (Perfectionnements aux clous de chaussures.)

Claim.—The nail rod described, consisting of a series of nails joined together as shown.

No. 4716. WILLIAM BROWN, Easton's Corners, Ont., 15th May, 1875, for 5 years: "Improvements on Farm Gates." (Perfectionnements aux barrières.)

Claim.—The post B, rotating axially on plates C, entering the gate post and having a flanged roller D, pivoted to said post for sustaining the gate whereby both post and roller swing with the gate in opening or closing.

No. 4717. STANISLAS M. BARRÉ, Montreal, Que., 15th May, 1875, for 5 years: "Ironing Board." (Table à repasser.)

Claim.—1st. The combination of the board A, with clamps B, pins C, and stops D; 2nd. The combination of the board E with cross-pieces F, and hooks G, 3rd. The combination of the boards A, and E, with the hooks G.

No. 4718. JOSEPH P. BASS, (Assignee of E. A. Weston), Bangor, Me., U. S., 15th May, 1875, for 5 years: "Improvements on Photograph Burnishers." (Perfectionnement aux brunissoirs de photographies.)

Claim.—1st. The combination of a rotating and reciprocating feed roll C, with a burnishing tool e, whereby a continuous motion is communicated to the article to be burnished as it passes over said tool; 2nd. The combination of the eccentric groove f, in the arbour of the feedroll with the pin b, in the journal of the standard.

No. 4719. RICHARD B. PALMER, Chicago, Ill., U. S., 15th May, 1875, for 5 years: "Improvements on Earth Auger." (Perfectionnements aux tarières à terre.)

Claim.—1st. The earth auger cylinder described, formed of two semi-cylindrical parts A and B, the part A having one vertical edge turned over and forming an air-tube d, and the two parts connected together by bolts or rivets; 2nd. The auger-bottom C, twisted as described, and the greatest portion elevated above the cutting edge or bit e, and provided with the knife G.

No. 4720. J. DU FUY BREWER, Muncy, Pa., U. S., 15th May, 1875, for 15 years: "Improvements in Fishways." (Perfectionnements aux passes migratoires.)

Claim.—1st. The alternately inclined offsets C, C, and D, D, forming the passages a, and b, b, 2nd. The covering boards G, G, arranged above the passage in the bottom of a fishway; 3rd. The combination of the alternately inclined offsets C, C, and D, D, and passages a, and b, b, with the covering boards G, G.

No. 4721. PHILO W. HART, Camden, N. Y., U. S., 15th May, 1875, for 5 years: "Improvements in Clothes Pounders for Washing." (Perfectionnements aux battoirs à linge.)

Claim.—1st. The body H, of a clothes-pounder provided with a central opening B, from which extend lateral openings C, communicating with the groove E, in combination with the shield D, whereby the water air circulates upwardly and laterally through the central opening; 2nd. A clothes-pounder provided with the vertical openings A, B, having cavities F, G, lateral channels C, and annular groove E, all communicating with each other.

No. 4722. JOHN OUTERSON, and ANDREW OUTERSON, Windsor Locks, Ct., U. S., 15th May, 1875, for 5 years: "Improvements on Filters." (Perfectionnements aux filtres.)

Claim.—1st. The use and application of disintegrated and cleaned paper making stock (not including pulp) to the purpose of a filter; 2nd. The containing vessel described having the shelf *g*

No. 4723. HENRY A. PAYNE, Adams, N. Y., U. S., 15th May, 1875, for 5 years: "Improvements on Hub Boxes and Bands." (Perfectionnements aux boîtes et aux frettes de moyeux)

Claim.—1st. The bar *B*, formed on the box *B*, and having a bevelled flange *a* and *s*, *r*s *b*; 2nd. The combination of the cap band *C* having bevelled flange *c*, with the band *B*, and hub-box *B*, the band having bevelled flange *a*.

No. 4724. WILLIAM R. BARTON, Georgetown, and CLARENCE E. BARTON, Cambridge, Mass., U. S., 15th May 1875, for 5 years: "Improvement on Welt Knives." (Perfectionnements aux tranchets à trépointes.)

Claim.—1st. The haft *A*, provided with the head-stock *B*, the knife *D* provided with the flang *E*, the clamp *G*, provided with the lip *F*, and the finger *I*, provided with the guard *J*; 2nd. The curved cutting edge *K*, and point *e*; 3rd. The burisher *M*, *L*.

No. 4725. AARON L. COREY, and EDWARD W. GRANT, Ypsilanti, Mich., U. S., 15th May, 1875, (Extension of Patent No. 4643), for 5 years: "Chain Pump Bucket." (Godet de Pompe à chapelet.)

Claim.—1st. The elastic chain pump bucket *A*, having the annular groove *a*; 2nd. The link *B*, nut *c*, screw eye bolt *C*, and washer *d*, in combination with an elastic expansible pump-bucket *A*.

No. 4726. AARON L. COREY, and EDWARD W. GRANT, Ypsilanti, Mich., U. S., 17th May, 1875, (Extension of Patent No. 4643), for 5 years: "Chain Pump Bucket." (Godet de pompe à chapelet.)

No. 4727. BENJAMIN TOLTON, and ANDREW TOLTON, Eramosa, Ont., 18th May, 1875, for 5 years: "Harvester Attachments for Cutting Pease" (Disposition des moissonneuses pour les pois.)

Claim.—1st. The guards *F*, having a hinged connection with the pivot rod *D*, and constructed with a slot *b*, for receiving the point of the guards *B*; 2nd. The attachable bar *C*, bolted to the cutter bar *A*, having a pivot rod *D*, for hinging the guards *F*; 3rd. The reversible or changeable platform *J*, having attachable connection with the pivot rod *D*.

No. 4728. PHINEAS P. MAST, Springfield, Mass., U. S., 18th May, 1875, for 5 years: "Improvements on Feeding Mechanism for Grain Drilling Machines." (Perfectionnements aux mécanisme d'alimentation des semoirs-tra-seurs.)

Claim.—1st. A force-feed for grain drilling machines, consisting of two vertical rotating discs or wheels so arranged that the grain passes between them in a continuous stream and that the distance between them may be increased or diminished at will in order to vary the rate of feed, and to adapt the machine for feeding different kinds of grain; 2nd. In combination with a feed cup or case *A*, two vertical feed wheels or discs *B*, and *C*, one or both made adjustable laterally in relation to the cup and to each other; 3rd. In combination with the cup or case *A*, the vertical rotating discs or wheels *B* and *C*, the former being movable laterally in the cup, and the latter being provided with the peripheral groove *b*, and held from moving laterally by the screw or pin *c*, entering the groove; 4th. In combination with the feed wheel or disc *C*, the disc *B*, provided with the hub *d*, passing through the disc *C*; 5th. The laterally adjustable disc *B*, provided with the corrugated lace and the polygonal hub, in combination with the disc *C*, also provided with the corrugated face.

No. 4729. WILLIAM R. BARTON, Georgetown, and CLARENCE E. BARTON, Cambridge, Mass., U. S., 18th May, 1875, for 5 years: "Peg Cutter Handle." (Manche de couteau à couper la cheville.)

Claim.—The peg cutter handle *A*, provided with the rest *D*, and haft *B*.

No. 4730. DAVID McDONALD, Hamilton, Ont., 18th May, 1875, for 5 years: "Door Fastener." (Ferme-porte.)

Claim.—The combination of plates *A*, *B*, *C*, *D*, united by rivet *E*, the plate *B*, recessed at *e*, and the plate *C*, provided with points *F*, *F*.

No. 4731. THOMAS I. ROBERTSON, Madison, N. Ca., U. S., 18th May, 1875, for 5 years: "Improvements on Tobacco Presses." (Perfectionnements des presses à tabac.)

Claim.—The clamp formed of two blocks *A*, *B*, made of hard wood notched across the grain upon their inner sides, and held together by two or more bolts *C*

No. 4732. JOHN ABELL, Woodbridge, Ont., 18th May, 1875, for 5 years: "Improvements on Reaping Machines." (Perfectionnements aux moissonneuses.)

Claim.—The combination of the notches *D* and *D*, on the standard with the handle *E*, or the equivalent on the cam.

No. 4733. JOHN B. JONES, Montreal, Que., 18th May, 1875, for 5 years: "Improvement on Railway Signals for Level Crossings." (Perfectionnements aux signaux de railroutes pour les traverses sur terrain plan.)

Claim.—1st. In combination with the bell *A*, the clapp *r*, bar *b*, guide *c*, and spring *h*; 2nd. In combination with the bar *b*, the notch *g*, lever *d*, pivot *e*, spring *j*, and cord *f*; 3rd. The combination of the bar *b*, pin *l*, and spring *k*; 4th. In combination with the cord *f*, the collar *t*, lever *s*, spring *u*, and shaft *n*; 5th. In combination with the rail *e*, the lever *o*, having toe *p*, block *m*, having stop *q*, shaft *n*, and spring *r*.

No. 4734. WILLIAM J. COPP, Hamilton, Ont., 18th May, 1875, for 5 years: "Improvements on Cooking Stoves." (Perfectionnements aux poeles de cuisines.)

Claim.—The front hollow cold air duct *B*, in combination with the air chamber *C*, down ports *D*, and ducts *E*.

No. 4735. JAMES H. ASHDOWN, Renfrew, Ont., 18th May, 1875, for 5 years: "Improvements on a Machine for Tilting Barrels." (Perfectionnements à une machine à pencher les fûts.)

Claim.—1st. The application of the lever *d*, with cogs *E* and *F*, and ratchet *O*; 2nd. The combination of the rack *G*, and pinion *K*, with the tilting frame *b*.

No. 4736. MOSES JOHNSON, Lockport, N. Y., U. S., 18th May, 1875, for 15 years: "Improvements on Hoes." (Perfectionnements aux houes.)

Claim.—1st. The contracted portion *b*, of a hoe curved transversely; 2nd. Bars *B*, *B*, combined with the contracted curved portion *b*.

No. 4737. WELLINGTON WARREN, Chicago, Ill., U. S., 18th May, 1875, for 5 years: "Improvements on Centre-piece." (Perfectionnements aux rosaces.)

Claim.—A centre-piece for ceilings, composed of one or more pieces of sheet metal spun or struck up in dies, and painted or coloured to form a complete substitute for the ordinary stucco centre-piece.

No. 4738. DAVID RENSILAW, Cohasset, Mass., U. S., 18th May, 1875, for 5 years: "Improvements on Steam Generators." (Perfectionnements aux générateurs de vapeur.)

Claim—1st. A section for a sectional boiler, consisting of an upper and lower boiler, each having two lower pipes G, the pipes H, arranged above and at the same distance from each of the pipes G, and connected to each of the pipes G, by a series of pipes I and K; 2nd. A boiler consisting of an upper water body H, H, and the steam drum L, the upper water body opening into the steam drum, and two lower water bodies G, G, the upper water body being connected to each of the lower water bodies by a series of pipes J, and K.

No. 4739. CARL W. SULZBACH, Virginia City, Nev., U. S., 19th May, 1875, for 15 years: "Apparatus for preventing Steam Boilers from Exploding." (Appareil pour empêcher l'explosion des chaudières à vapeur.)

Claim—1st. The combination and arrangement of the float cylinder A, regulating cylinder E, safety cylinder C, alarm wheel K, floats D, E, and F, levers 1, 2, and 4, valves 4, 5, and 6, and pipes 7, 8, and 9; 2nd. The combination and arrangement of the cylinder H, (to operate the ball shift I when connected by the pipes 7 and 8) with the floats D and E, levers 1 and 2, and valves 4 and 5; 3rd. The safety cylinder C, having the conical piston G, to operate the hook rods I and N, and the jointed leg L, (for the purpose of discharging the counter weight Q), and opening the safety valve when operated by means of the float F; 4th. The pipe 9 (having the opening or pipe U, to operate the alarm wheel K) in combination with the crank K, wire T, and ball J, when operated by means of the float F.

No. 4740. JOHN BEST, (Assignee of Z. B. Cusher), Chicago, Ill., U. S., 18th May, 1875, for 15 years: "Improvements on Flat Irons." (Perfectionnements aux fers à repasser.)

Claim—1st. The double or two part hollow iron with holes to admit air and shaped to be fitted into each other and fastened by the groove in the spindle at the front and the button in the back; 2nd. The spindle S, or axis passing lengthwise through the iron with the grooves M, to hold fast the front of the two parts of the iron, and the projections at the front and back of the iron to hold the handle, lever and catch; 3rd. The construction and application of lamp A, with jets or burners J, J, and fastenings F, F, suspended from the spindle S; 4th. The construction and application of the lever L, to the spindle S, and handle H; 5th. The construction and application of two springs G, to the handle H, and the lever L.

No. 4741. HENRY BAUGHMAN, Doran's Gold Mine, S. Ca., U. S., 18th May, 1875, for 5 years: "Saw Gummer and Sharpener." (Appareil à affûter et donner la voie aux scies.)

Claim—1st. The flanged and slotted tapping clamp P, in combination with the clamp L and block K, for holding a hand saw while being operated upon by the gummying wheel A; 2nd. The opening K, formed in the block K, for the escape of the shavings; 3rd. The swinging frame T, and guide pulleys U, U, in combination with the adjustable frame S, and guide pulleys Q, Q.

No. 4742. PLATT C. INGERSOLL, Greenpoint, Brooklyn, N. Y., U. S., 18th May, 1875, for 5 years: "Improvement on Bed Bottoms." (Perfectionnement des fonds de lits.)

Claim—1st. The combination of the slat C, spring H, and metallic strip G, having its ends passed through the slats C, and fastened down on the upper side of the slat C; 2nd. The combination with a slat C, of the loops or staples E, and supporting bars D; 3rd. The strips J, of leather or other fabric, in combination with the slats C, and loops or staples E.

No. 4743. JOHN ASH, Montreal, Que., 18th May, 1875, for 5 years: "Compound to prevent the Bites of poisonous Insects, Mosquitos, &c." (Composition préservant des morsures des insectes venimeux, maringouins, etc.)

Claim—The combination of camphor, Stockholm tar and olive oil in the proportions specified.

No. 4744. RICHARD DUDLEY, Erie, Pa., U. S., 18th May, 1875, for 5 years: "Spring for

Supporting Waggon Tongues." (Ressort pour supporter les limons de voitures.)

Claim—1st. The springs A, a, when attached at their back ends either to the rear of the bounds B, B, or around the axle or bolster E, and the front ends projecting into an adjustable yoke D; 2nd. The springs A, a, as constructed and attached, and connected at the front ends by means of the yoke D, with adjusting holes d, d, and in combination with the bounds B, B, and tongue A, A.

No. 4745. ALONZO W. OLDS, Green Oak Station, Mich., U. S., 18th May, 1875, for 5 years: "Improvements on Fences." (Perfectionnements aux clôtures.)

Claim—The combination of the posts A, A', braces B, B', rails D, and wire binder C.

No. 4746. DAVID S. CORNELL, Warwick, Ont., 18th May, 1875, for 5 years: "Improvements on Washing Machines." (Perfectionnements aux laveuses.)

Claim—The rigid plates E, E, connecting the journals of the feed-rollers D, D, D, at both ends, (the springs F, F, supporting the journal bearings of said rollers), whereby the rollers D, D, combinedly have a yielding depression from the fixed roller B, when the clothes are fed to the machine.

No. 4747. RICHARD DAINE, Dartmouth, N. S., 18th May, 1875, for 5 years: "Improvements on Stove-pipe Dampers." (Perfectionnements aux clefs de tuyaux.)

Claim—1st. The combination of thimble A, and damper; 2d. The combination of thimble A, and damper with stop-bar C.

No. 4748. CHARLES O. GARDINER, Springfield, Ohio, U. S., 18th May, 1875, for 5 years: "Improvements on Seeding Machines." (Perfectionnements aux semoirs.)

Claim—1st. A horse feed for grain drills consisting of a feed cup or case, and a vertically laterally adjustable feed wheel mounted therein; 2nd. A horse feed for grain drills consisting of a vertically revolving disc or wheel A, mounted within the cup or case B, one side of said cup being left open of the full diameter of the wheel and the opposite side having a central opening for the hub of the wheel only, so that said wheel may be adjusted laterally with reference to the case to regulate the feed; 3rd. In combination with the case B, the laterally adjustable feed-wheel A, provided with the teeth d, on its side at the outer edge, facing the vertical wall of the case; 4th. In combination with the feed cup or case having its side wall provided with the central opening, the vertically adjustable feed wheel or disc A, provided with the hub C, and mounted in the cup as shown, so that the grain is fed between the side faces of the cup and wheel; 5th. In combination with a vertically feed wheel or disc, a feed cup having an internal shoulder or gauge-point F; 6th. In combination with the feed wheel A, and driving shaft H, the sleeve H, mounted on the shaft and provided with the spiral groove, and the fixed stud K, bearing in said groove as shown; 7th. The slide E, in combination with the lower L, and the laterally adjustable wheel A; 8th. In combination with the shaft K, and its spiral threaded stud K, the collar M, having the arm L, attached and the fixed stud K, the spiral scale N; 9th. A spiral scale as shown, in combination with a lever which both swings about a centre and moves laterally; 10th. The slide or cut off E, provided with the shoulder n, in combination with the hub C, and the cap provided with the corresponding shoulder.

No. 4749. JOHN NOLAN, Malone, N. Y., U. S., 19th May, 1875, for 5 years: "Improvements on Water Wheels." (Perfectionnements aux roues hydrauliques.)

Claim—1st. The concave convex disc A, and ring B, each having an inwardly sloping periphery and respective rims a, b, arranged parallel, and buckets C; 2nd. The buckets C, arranged tangentially between the rims a, b, and having a graduated curve descendingly between the periphery of the disc A, and ring B.

No. 4750. JOSEPH D. HUSBAND, Jr., St. Louis, Mo., U. S., 19th May, 1875, for 5 years: "Fire Kindler." (Allumeur de feu.)

Claim—1st. A fire kindler made from a block of suitable material constructed with draft flues for admitting the draft into or through the block for intensifying the heat and obviating smothering of the

flames; 2nd. In the manufacture of fire-kindlings, a block constructed with a series of fins or partitions to form air-passages or draft flues; 3rd. The combination in fire-kindlings of a block possessing a head or body, provided with a series of partitions and a series of air passages or draft flues, saturated or impregnated with a suitable inflammable material or agent; 4th. A block of suitable material constructed with draft flues, or partitions varying in size for admitting draft into or through the block to intensify the heat, and secure gradual combustion and rapid ignition of the kindler; 5th. The combination of an igniting wick with a fire kindler, constructed of a block of suitable material, having a series of draft flues for admitting draft into or through the block.

No. 4751. MONA LESSER, Montreal, Que., 19th May, 1875, for 5 years: "Improvement on the Manufacture of Cigars." (Perfectionnement dans la fabrication des cigares.)

Claim.—1st. The process of forming or shaping the pointed end in a heated mould; 2nd. A mould for forming the pointed end of a cigar, having a conical or other shaped recess B.

No. 4752. LOUIS J. HERARD, Montreal, Que., 19th May, 1875, for 5 years: "Cooking Stove." (Poêle de cuisine.)

Claim.—1st. The introduction of the double bridge *i*; 2nd. The introduction of a sheet iron oven *b*, instead of cast iron as in ordinary stoves, thereby reducing the cost and facilitating the repairs of such ovens.

No. 4753. FREDERICK J. DAVIS, Newport, Vt. U. S., 19th May, 1875, for 5 years: "Block Lock Shoe Last." (Breveté de forme de chaussures.)

Claim.—In combination with the last A, and block B the spring C, pin F, spring G, and tumbler D, provided with the hook E.

No. 4754. PHILO W. HART, Camden, N. Y., U. S., 19th May, 1875, for 5 years: "Lath Machine." (Machine à lath e.)

Claim.—The combination of the cap E, spring F, cap-bearing *l*, of the upper roller-shaft and the screw-bolt J, whereby the said screw and spring secure both the cap and the cap-bearing; the table or bed-plate B, attached to the frame A, by bolts working in slots C, so that it may be vertically adjusted, and having the elongated slot *e*, and openings *g*; in combination with the right angled gauge-plate D, having the lug *d*, adapted to the slot *e*, and the pins *f*, adapted to the holes *g*, in the adjustable guide-table; the yoke *h*, extending transversely across the frame A, and having at each end a standard I, in which the feed-rollers have their bearings, said yoke being adjustably attached to the frame, whereby the feed rollers can be caused to revolve in a plane parallel to the planes of revolution of the saws, or obliquely thereto.

No. 4755. ARTHUR TRACY, Pickering, Ont., 19th May, 1875, for 5 years: "Horse-power." (Manège pour un cheval.)

Claim.—1st. The mode in which the spur-wheels D, D, act on the central pinion E; 2nd. The combination with the square pinion E, and spur-wheels D, D, the two bull-pinions and the driving-wheel B.

No. 4756. ALFRED B. SHERATON, Saint-John, N. B., 19th May, 1875, for 10 years: "Machine for Cleaning and Beating Carpets and other Fabrics." (Machine à nettoyer et battre les tapis et autres tissus.)

Claim.—The combination of the chains and the cylinder, the application of the cone pulleys to suit the various qualities of carpet, the covering of the chains with rubber-tubing and leather straps beneath, to prevent injury to the carpet.

No. 4757. PERCIVAL N. RUGG, Compton, Que., 19th May, 1875 for 5 years: "Wash Bench." (Banc de blanderie.)

Claim.—The iron grooves having a circular formation A, A, and B, the soap-holder and its stem F, also the return piece C.

No. 4758. JOHN D. LAWLOR, Montreal, Que., 19th May, 1875, for 5 years: "Washing Machine." (Machine à laver.)

Claim.—1st. The rectangular-box A, and the combination of adjustable sides A', and the inclined or vertical wash boards C, and C'; 2nd. The roller or cylinder B, when taken in combination with the spring-rod *m*, and regulating spring *m* 2; 3rd. The roller *h*, and its regulating connections, when taken in combination with the flexible concave wash board E, and the spring-rod *h*.

No. 4759. JOHN AIKMAN, North Norwich, Ont., 19th May, 1875, for 5 years: "Improvements in Hinges." (Perfectionnements dans les pentures.)

Claim.—The combination and arrangement of the several parts, namely: the lever F, working in the hinge on the pivot E, and fitting through the stile of the blind B, in connection with the holder L (or its equivalent) the slot H, in the lower part of hinge C, in connection with the lever F, and the shoulder *l*.

No. 4760. MONA LESSER, Montreal, Que., 19th May, 1875, for 5 years: "Improvements on Cigars." (Perfectionnements des cigares.)

Claim.—A cigar having an indentation B, at the inhaling end.

No. 4761. DAVID W. DAVIS and SAMUEL H. DAVIS, Detroit, Mich., U. S. 19th May, 1875, for 5 years: "Art of preparing Fish for Market." (Art de préparer le poisson pour le marché.)

Claim.—1st. The mode of preparing fish for transportation and market by freezing them into cakes suitable to be packed in casks or other packages; 2nd. An improved method of preparing fish for market in the series of cakes B, of frozen fish, arranged as to size and height to completely fill the barrel or package C.

No. 4762. GEORGE W. HOWELL, Covington, Ky., U. S., (Co-Inventor with and Assignee of C. P. HOWELL,) 19th May, 1875, for 5 years: "Metal Creasing Machine" (Machine à plisser le métal.)

Claim.—1st. The former *d*, having an axle bearing on the end of the driving-shaft D, with which it revolves concentrically while both revolve concentrically to the metal-blank, in combination with suitable mechanism for holding semi-circular sheets of metal while the same are being creased; 2nd. The linked jaws *p*, *p*, arranged to move on two centres, in combination with suitable mechanism for creasing semi-circular sheets of metal between their surfaces; 3rd. The combination of plates E, E, jaws *p*, *p*, and former *d*, adapted to form curves and creases in sheet metal for pipe-elbows; 4th. Jaws *p*, *p*, in combination with the pulleys and levers *h* for operating the jaws automatically; 5th. Plates E, E, in combination with the pulleys, crank and rods described, for automatically operating the same; 6th. The nose cam J, in combination with carriage K, pawl *h*, and ratchet H, 7th. In a pipe elbow metal-creasing-machine, the yoke G, having two hinged semi-circular leaves *b*, *b*, adapted to embrace the metal blank on its inner and outer peripheries, and thereby preserve its circularity while feeding it into the machine; 8th. In a pipe elbow-creasing-machine, the coil-shifter *n*, *m*, in combination with the yoke G, and the described feeding device, whereby the metal blank is automatically released from the further action of the former at the instant the desired number of creases are formed.

No. 4763. THOMAS WARREN, Flint, Mich., U. S., 19th May, 1875, for 5 years: "Improvements on Stop Motion for Steam Engine Governors." (Perfectionnements au mouvement d'arrêt des gouverneurs des machines à vapeur.)

Claim.—1st. The L-shaped sleeve C, C, forming bearings for the head D, and the shaft G, and the collar I, in combination with the frame B, and bracket B; 2nd. The combination with the shaft G, of the countershaft P, suspended by the radius arms O, from the shaft N.

No. 4764. JOHN WILSON and RICHARD BOWKER, Toronto, Ont., 19th May, 1875, for 5 years: "Machine for the Clipping of Horses and Sheep." (Machine à tondre les chevaux et les moutons.)

Claim.—1st. The configuration of the comb *a*, and knife *b*, in the device N; 2nd. The adjustable-post K, in combination with the counter-shaft G, guides Q, Q, and spiral-spring O; 3rd. The combination of the adjustable post K, with the mandrel I, pulley I, universal joint-couplings J, J, and *h*, *h*, and the rods L, M; 4th. The combination of the various parts of the device N, namely: The comb *a*, knife *b*, pinion *c*, wheel *d*, the under plate *e*, the upper plate *f*, universal-joint-coupling *h*, and handle *g*, 5th. The combination with the device N, of any suitable motive-power, for giving motion to the same by the mechanism specified.

No. 4765. SAMUEL W. BENHAM, Sweetsburgh, Que., (Assignee of M. B. Hubbell,) 4th June, 1875, for 5 years: "Fire Kindler." (Allumeur de feu.)

Claim.—1st. The spoon burner or holder A, A, or in any other forms which may embody the principles of the said invention; 2nd. A compound to be used therein and therewith of any inflammable liquid or oil with either ashes, sand, gravel, brick dust, or any other non-combustible matter of a powdery or porous nature.

No. 4766. HAMILTON L. SMITH, Westminster, Eng., 4th June, 1875, for 5 years: "Single Rail Railway." (Railroute à un rail.)

Claim.—The method of steadying or guiding in a cortical position vehicles running on a single rail by means of one or more sets of guide wheels or rollers mounted on the top or at the sides of the vehicle so as to bear against guide-timbers or rails fixed above the ground, the said means of guiding being also applicable for the purpose of driving and braking.

No. 4767. ISAAIE FRÉCHETTE and LOUIS COTÉ, St. Hyacinthe, Que., 4th June, 1875, for 5 years: "Improvements on Stiffeners for Boots and Shoes." (Perfectionnements aux contreforts de chaussures.)

Claim.—The mode of separating a sheet of leather or leather board or other material into strips for being converted into shank stiffeners, such consisting in cutting it in serpentine-lines *a, b*, arranged as shown in figure 4, and with each of such cuts either square or oblique to the opposite-sides of the strip, in combination with the mode of separating a sheet of leather into strips, viz: by serpentine cuts arranged as described, the mode of separating each of said strips into a series of shank stiffeners, such consisting in cutting it transversely and obliquely to its opposite surfaces in the wider parts of the strip.

No. 4768. LEWIS J. ATWOOD, Waterbury, Ct., U. S., 4th. June, 1875, for 5 years: "Improvements on Lamp Burners." (Perfectionnements aux becs de lampes.)

Claim.—The combination in a lamp burner, of a deflector hinged at one side, an air distributor above the base of the chimney, a chimney rest connected to the air-distributor, and chimney holding-springs, surrounding the chimney rest and extending above the bottom of the hinged deflector.

No. 4769. GEORGE M. MOWBRAY, North Adams, Mass., U. S., 4th. June, 1875, for 5 years: "Im-

provements on Explosive Compounds." (Perfectionnements aux compositions explosives.)

Claim.—A combination of nitro-glycerine with finely divided mica or muscovy-talc.

No. 4770. JOHN STRUTHERS, Alma, Ont., 4th June, 1875, for 5 years: "Improvements on Snow-Ploughs." (Perfectionnements aux charries à neige.)

Claim.—The flat-top H, of a Snow-Plough, a Snow Guard G, and the rear end of the two square-chambers E, E, turned upwards and outwards, in combination with a Snow-Plough A.

No. 4771. JULIUS E. WATEROUS, Brantford, Ont., 4th June, 1875, for 5 years: "Improvements in Steam Surface Condensers and Feed Water Heaters for Steam Engines." (Perfectionnements aux condensateurs de surface de vapeur et aux chauffeurs de l'eau d'alimentation des machines à vapeur.)

Claim.—1st. The combination of the movable case G, surrounding the tubes K, and connected to the upper and lower heads at joints H, H; 2nd. The combination of the flattened tubes E, E, surrounded by water through which the steam passes connecting chambers C, D, and F.

No. 4772. THOMAS E. WEBBER, Pittston, Me., U. S., 4th June, 1875, for 5 year: "Harness Lug-Lining." (Doublure de bracelets de harnais.)

Claim.—A harness-lug-lining formed with the body *a*, shaft seat *c*, projecting ears *d, d*, and clinching-points *b, b*.

No. 4773. CHARLES D. WILSON, Elmwood, Ill., U. S., 4th June, 1875, for 5 years: "Improvements on Compounds for Picture Frames." (Perfectionnements aux compositions à cadres d'images.)

Claim.—A compound composed of straw, wood, rag or manilla-pulp mixed with gum, shellac, alcohol, glue, molasses, glycerine, and a solution of copper: in about the proportions specified.



INDEX OF INVENTIONS.

Auger, earth, R. B. Palmer..... 4719
 Bag, (paper) machine, B. Douce..... 4685
 Bark rasping machine, J. Moulton, & S. R. Thompson..... 4704
 Barrels, machine for tilting, J. H. Ashdown..... 4735
 Bed bottoms, P. C. Ingersoll..... 4712
 Bedstead, spring bottom, S. Morrell, & C. Remhardt..... 4703
 Boilers for heating water or raising steam, A. Spence..... 4682
 Boots and shoes, stiffeners for, I. Fréchette, and Louis Côté..... 4767
 " " nails, Louis Goddu..... 4715
 Buckle attachment, B. C. Young..... 4680
 Car coupler, D. P. Corey..... 4686
 " coupling, self acting, W. J. Mansell..... 1756
 Carpet, &c., machine for cleaning and beating, A. B. Sheraton..... 4756
 Carriage wheel, P. Gendron..... 4702
 Cartridge cresers, W. G. Rawbone..... 4651
 Centre pieces, W. Warren..... 4737
 Chain swivel, machine for, and process of, making, W. C. Edge..... 4689
 Churn dasher, S. Hall..... 4713
 Cigars, manufacture of, J. B. Camyré, & L. A. Dessaulles..... 4710
 " " M. Lesser..... 4751
 " " "..... 4760
 Clipping horses and sheep, machine for, J. Wilson, and R. Bowker..... 4764
 Comb, duplex, B. F. Britton..... 4678
 Conductors' hand alarms and registers, T. B. Doolittle..... 4680
 Cylinders, lining for, E. Hill, Jr..... 4693
 Ditching machine, F. Fitz Randolph..... 4691
 Door fastener, D. McDonald..... 4730
 Explosive compounds, G. M. Mowbray..... 4769
 Fence, A. W. Olds..... 4745
 " corners, L. W. Russell..... 4648
 " metalle, W. L. Walker, & B. G. Devos..... 4681
 " pickets, machine for making, J. Levey..... 4657
 " wire, C. Kennedy..... 4701
 Fertilizer sower, J. E. Wisner..... 4697
 Filter, J. & A. Outerson..... 4722
 Fire kindler, S. W. Benham..... 4765
 " " J. D. Husband..... 4750
 Fish, preparing for market, D. W. & S. H. Davis..... 4761
 Fishways, J. Du Pay Brewer..... 4720
 Flat irons, J. Best..... 4740
 Gas manufacture, W. J. Wauchope, & J. Cowan..... 4664
 " retorts, apparatus for treating, &c., J. P. Lockey..... 4676
 Gate, farm, W. Brown..... 4716
 Grain binder, C. Jewell..... 4677
 " drilling machine, feeding mechanism for, P. P. Mast..... 4728
 Hammer, C. Bilharz..... 4683
 Harness lug-huling, T. E. Webber..... 4772
 Harrow, M. Wilson..... 4673
 Harvester attachment for cutting pease, B. & A. Tolton..... 4727
 Hinge, J. Alkman..... 4759
 Hoes, M. Johnson..... 4736
 Horse-power, A. Tracy..... 4755
 Hub boxes and bands, H. A. Payne..... 4723
 Hydrogen generator and carburetter combined, B. Sloper..... 4649
 Ironing board, S. M. Barré..... 1717
 " table, J. B. Porter..... 4653
 Iron, machine for charging heavy piles of, for heating preparatory to rolling, E. G. Scovill..... 1711
 Knitting machine, J. S. Shaller..... 4666
 " circular, E. Tiffany..... 4654
 Lampburners, L. J. Atwood..... 1768
 Lantern, R. Nutting..... 4688
 Lath machine, P. W. Hart..... 4751
 Links, dies for welding, J. B. Baugh..... 4670
 Liquids, apparatus for evaporating, etc., J. P. Lockey..... 4676
 Manure spreading machine, J. S. Kemp..... 4659
 Metal creasing machine, G. W. Howell..... 4762
 Milk cooler, W. Shea..... 4661
 Milking machine, W. Pattenon..... 4668
 Mill stone dress, S. Kelm..... 4687
 Minerals, apparatus for calcining, &c., J. P. Lockey..... 4676
 Mortising machine, S. Rydbeck..... 4656
 Mowing machine, A. G. Gray..... 4655
 Nut machine, W. Charles, and M. McKuhn..... 4675
 Paint brushes, S. Brillinger..... 4669
 Paper, white, treating, &c., for manufacture of, G. W. Dubulsson..... 4667
 Peg cutter handle, W. R. & C. E. Barton..... 4729
 Photograph burnishers, J. P. Bass..... 4718

Planoes and organs, H. Behning, & J. Diehl..... 4699
 Picture frames, compounds for, C. D. Wilson..... 4773
 Planing and grooving machine, concentric guide for, J. Morin..... 4711
 Poisonous insects, &c., compound to prevent the bite of, J. Ash..... 4743
 Pump bucket, chain, A. L. Corey, & B. W. Grant..... 4725
 Railway signals for level crossing, J. B. Jones..... 4733
 " single rail, H. L. Smith..... 4760
 Reaping machines, John Abell..... 4732
 Roof for buildings, R. Bentley..... 4696
 Saponification of mineral oil, D. Spinell..... 4712
 Saw gummer and sharpener, H. Baughman..... 4711
 Screw, A. Cummings..... 4692
 Seeding machine, C. O. Gardner..... 4748
 Sowing machine, C. Gullmann..... 4679
 " " shuttle, H. L. Walker..... 4672
 Shirt front, C. W. Jenks..... 4700
 " hoe last, block lock, F. G. Davl..... 4753
 shovel, T. Wells..... 4671
 " machine for bending wood for handles of, B. A. Higgins..... 4709
 Sleighs, cutter, sides and wings for, J. J. Cobb..... 4695
 Snow plough, J. Doman..... 4706
 " " J. Struthers..... 4770
 Spark arrester, A. Mitchell..... 4694
 Steam boilers, apparatus for preventing explosion of, C. W. Sulzbach..... 4739
 " engine, G. McNaughton..... 1684
 " " D. K. West..... 4690
 " " surface condensers, and feed water heaters for, J. E. Waterous..... 4771
 " " governors, stop motion for, T. Warren..... 4763
 " generators, D. Renshaw..... 4738
 Step ladder, E. W. Grant..... 4705
 Stove, J. W. Elliott..... 4707
 " W. H. Landon..... 4663
 " cooking, W. J. Copp..... 4731
 " " L. J. Herard..... 4752
 " hot air dumb, W. Peaker, and E. O. Ranlons..... 4658
 " pipe damper, R. Dalne..... 4747
 Tan vat, S. H. Hall..... 4742
 Tobacco presses, T. I. Robertson..... 4731
 Varnish, C. & L. Gaouette..... 4665
 Vehicles, running gear for, P. B. Cunningham..... 4674
 Waggon tongues, spring for supporting, R. Dudley..... 4744
 Wash bench, P. N. Rugg..... 4755
 Washing, clothes pounders for, P. W. Hart..... 4721
 " machine, D. S. Corneil..... 4746
 " " J. D. Lawlor..... 4758
 Water engines, D. K. West..... 4690
 " wheel, J. Nolan..... 4749
 Welt knives, W. R. & C. E. Barton..... 4724
 Wheel, water, S. Sherwood..... 4708
 Wood bending machine, S. R. Bailey..... 4650
 Work table, C. R. Snyder..... 4698

INDEX OF PATENTEES.

Abell, John, reaping machines..... 1732
 Alkman, John, hinge..... 1759
 Ash, John, compound to prevent the bites of poisonous insects, &c..... 1743
 Ashdown, James H., machine for tilting barrels..... 1735
 Atwood, Lewis J., lamp burners..... 1768
 Bailey, Samuel R., wood bending machine..... 4659
 Barré, Stanislas M., ironing board..... 4717
 Barton, William R. and Clarence E., welt knives..... 4721
 " " " peg cutter handle..... 1729
 Bass, Joseph P., (assignee) photograph burnishers..... 1718
 Baugh, John B., dies for welding links..... 4670
 Baughman, Henry, saw gummer and sharpener..... 1711
 Behning, Charles, and J. Diehl, planoes and organs..... 1699
 Benham, Samuel W., fire kindler..... 1765
 Bentley, Randall, roofs for buildings..... 4696
 Best, John, (Assignee) flat iron..... 4710
 Bilharz, Candidus, hammer..... 1683
 Bowker, Richard, and John Wilson, machine for the clipping of horses and sheep..... 1761
 Brewer, J. DuPuy, fishways..... 1720
 Brillinger, Samuel, paint brushes..... 4669
 Britton, Benjamin F., duplex comb..... 1678
 Brown, William, farm gates..... 4716
 Camyré, Jean B., and L. A. Dessaulles, manufacture of cigars..... 4710

Charles, William, and M. McKain, nut mach. de.....	4675	McNaughton, George, steam engine.....	4684
Cobb, John J., slides and wings for cutter sleighs.....	4695	Mansell, William J., self-acting car-coupling.....	4662
Copp, William J., cooking stoves.....	4731	Mast, Phineas P., feeding mechanism for grain drilling machines.....	4728
Corey, Aaron L., and E. W. Grant, chain pump bucket.....	4725, 1726	Mitchell, Alexander, spark arrester.....	4694
Corey, David P., car coupler.....	4636	Morin, Joseph, concentric guide for planing and grooving machine irons.....	4711
Cornell, David S., washing machine.....	4746	Morrell, Samuel, and C. Reinhardt, spring bottom bedstead.....	4703
Côté, Louis, and Isaie Fréchette, stiffeners for boots and shoes.....	4767	Moulton, John, and S. R. Thompson, bark rasping machine.....	4704
Cowan, John, and W. J. Wauchope (executors) gas manufacture.....	4664	Mowbray, George M., explosive compounds.....	4769
Cummings, Allan, screw.....	4692	Nolan, John, water wheel.....	4749
Cunningham, Peter B., running gear for vehicles.....	4674	Nutting, Rufus, lantern.....	4688
Dalme, Richard, stove pipe damper.....	4747	Olds, Alonzo W., fence.....	4745
Davis, David W. and Samuel H., art of preparing fish for market.....	4761	Onterson, John and Andrew, filter.....	4722
" Frederick J., block lock shoe last.....	4753	Palmer, Richard B., earth auger.....	4719
Dessaulles, Louis A., and J. B. Camyré, manufacture of cigars.....	4710	Patteson, William, milking machine.....	4666
Devoe, Benjamin G., and W. L. Walker, metallic fence.....	4681	Payne, Henry A., hub boxes and bands.....	4723
Diehl, Justus, and H. Behning, pianos and organs.....	4699	Peaker, William, and E. O. Runlons, hot air dumb stove.....	4653
Doan, John, snow plough.....	4706	Porter, John B., ironing table.....	4653
Doolittle, Thomas B., conductors' hand alarms and registers.....	4680	Rawbone, William G., cartridge creasers.....	4651
Douce, Bernard, paper bag machine.....	4685	Reinhardt, Christopher, and S. Morrell, spring bottom bedstead.....	4703
Dubulsson, George W., jute, &c., for manufacture of white paper.....	4667	Reushaw, David, steam generators.....	4738
Dudley, Richard, spring for supporting waggon tongues.....	4744	Robertson, Thomas I., tobacco presses.....	4731
Edge, William C., machine for and process of making chain swivels.....	4639	Rugg, Percival N., wash bench.....	4757
Elliot, John W., stove.....	4707	Runlons, Edward O., and W. Peaker, hot air dumb stove.....	4658
Fitz Randolph, Theodore, ditching machine.....	4691	Russell, Leonard W., fence corners.....	4348
Fréchette, Isaie, and Louis Côté, stiffeners for boots and shoes.....	4767	Rydbeck, Sven, mortising machine.....	4756
Gaouette, Charles and Louis, varnish.....	4665	Scovil, Edward G., (extension) machine for charging heavy piles for heating iron preparatory to rolling.....	4711
Gardiner, Charles O., seeding machine.....	4748	Shaller, Julius S., knitting machine.....	4666
Gen'ron, Peter, carriage wheel.....	4702	Shen, William, milk cooler.....	4661
Goddu, Louis, boot and shoe malls.....	4715	Sheraton, Alfred B., machine for cleaning and beating carpets, &c.....	4756
Grant, Edward W., (assignee) step ladder.....	4705	Sherwood, Samuel, water wheel.....	4708
" " and A. L. Corey, chain pump bucket.....	4726	Sloper, Byron, hydrogen generator and carburetter combined.....	4649
Gray, Andrew G., mowing machine.....	4655	Smith, Hamilton I., single rail railway.....	4768
Gullmann, Christopher, sewing machine.....	4679	Snyder, Charles R., work table.....	4698
Hall, Samuel, churn dasher.....	4713	Spence, Archibald, boilers for heating water, or raising steam.....	4682
" " H., tan vat.....	4652	Splnelli, Dominique, saponification of mineral oils.....	4712
Hart, Philo W., clothes pounders for washing.....	4721	Struthers, John, snow ploughs.....	4770
" " lath machine.....	4754	Sulzbach, Carl W., apparatus for preventing steam boilers from exploding.....	4739
Harard, Louis J., cooking stove.....	4752	Thompson, Samuel R., and J. Moulton, bark rasping machine.....	4704
Higgins, Barnabas A., machine for bending wood for handles of shovels.....	4709	Tiffany, Eli, circular knitting machine.....	4654
Hill, Ebenezer, Jr., linings for cylinders.....	4693	Tolton, Benjamin and Andrew, harvester attachment for cutting pease.....	4727
Howell, George W., (co-inventor and assignee) metal creasing machine.....	4762	Tracy, Arthur, horse power.....	4755
Husband, Joseph D., fire kindler.....	4750	Walker, Hugh L., sewing machine shuttle.....	4672
Ingersoll, Platt C., bed bottoms.....	4742	" William L., and B. G. Devoe, metallic fence.....	4681
Jenks, Charles W., shirt front.....	4700	Warren, Thomas, stop motion for steam engine governors.....	4763
Jewell, Charles, grain blinder.....	4677	" Wellington, centre pieces.....	4737
Johnson, Moses, hoes.....	4736	Waterous, Julius E., surface condensers and feed water heaters for steam engines.....	4771
Jones, John B., railway signals for level crossings.....	4733	Wauchope, William J., and J. Cowan, gas manufacture.....	4664
Kelm, Samuel, mill stone dress.....	4687	Webber, Thomas E., harness lug huling.....	4772
Kemp, Joseph S., manure spreading machine.....	4659	Weiss, Thomas, shovel.....	4671
Kennedy, Charles, wire fence.....	4701	West, Daniel K., steam, water or other engines.....	4690
Landon, William H., stove.....	4663	Wilson, Charles D., compound for picture frames.....	4773
Lawlor, John D., washing machine.....	4758	" John, and R. Bowker, machine for clipping of horses and sheep.....	4764
Lesser, Mona, manufacture of cigars.....	4751	" Melvin, harrow.....	4673
" " cigars.....	4760	Wisner, James E., fertilizer sower.....	4697
Levy, Isaac, machine for making fence pickets.....	4657	Young, Barker C., buckle attachment.....	4660
Lockey, James P., apparatus for evaporating liquids, heating gas retorts or calcining minerals.....	4676		
McDonald, David, door fastener.....	4730		

THE
CANADIAN PATENT OFFICE RECORD.

ILLUSTRATIONS.

Vol. III.

JULY, 1875.

No. 7.

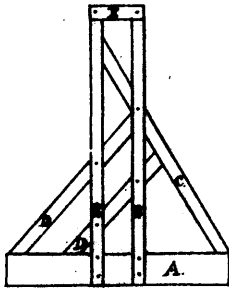

4648 Russell's Improvements in Fence Corners.

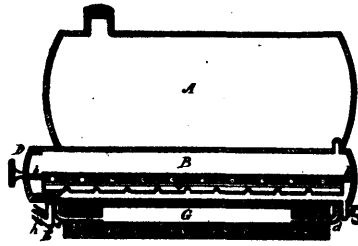

4649 Sloper's Improvements on a Hydrogen Generator and Carburetter Combined.

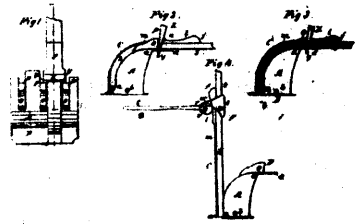

4650 Bailey's Wood Bending Machine.

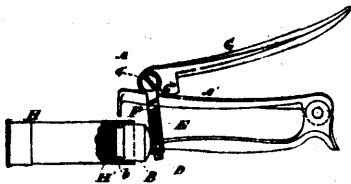

4651 Rawlone's Improvements in Cartridge Creasers.

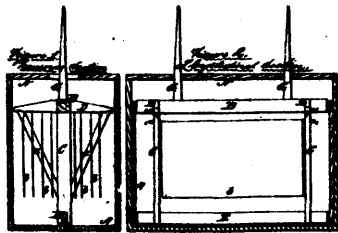

4652 Hall's Tan Vat.

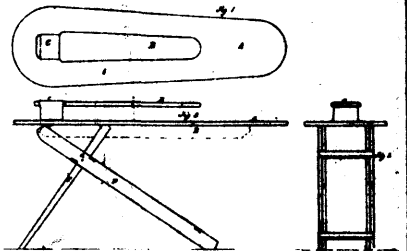

4653 Porter's Clothes Ironing Table.

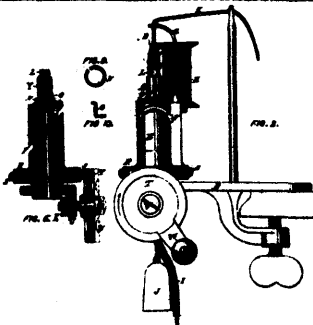

4654 Tiffany's Circular Knitting Machine.

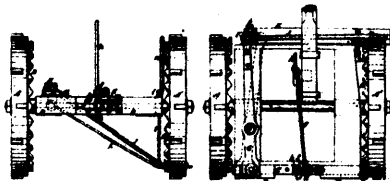

4655 Gray's Improvements on Mowing Machines.

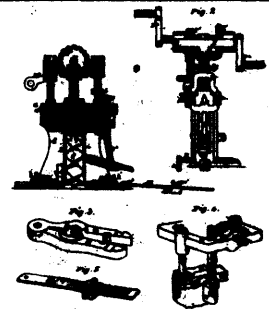

4656 Rydbeck's Improvements on Mortising Machines.

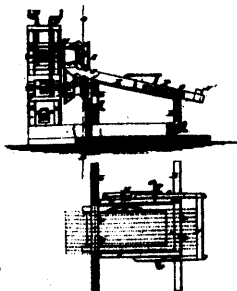

4657 Levy's Improvements on Machines for making Fence Pickets.

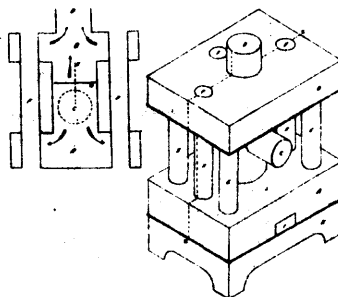

4658 Peaker & Runions' Hot Air Dumb Stove.

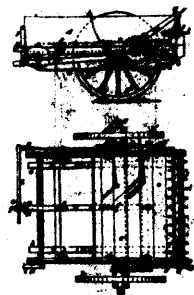

4659 Kemp's Manure Spreading Machine.

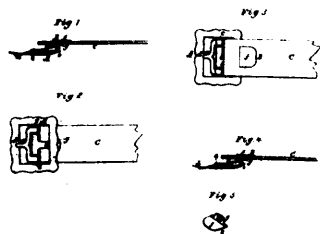

4660 Young's Buckle Attachment.

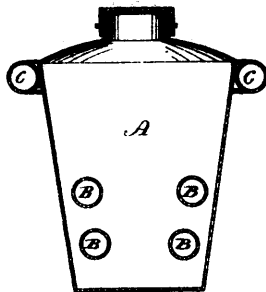

4661 Shea's Milk Cooler.

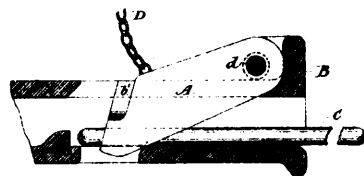

4662 Mansell's Self-acting Car-coupling.

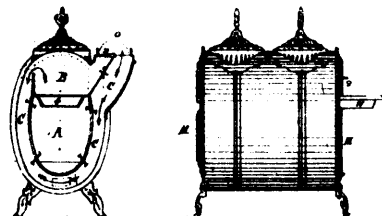

4663 Landon's Improvements on Stoves.

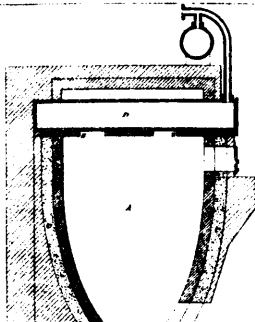

4664 Wauchope & Cowan's Gas Manufacture.

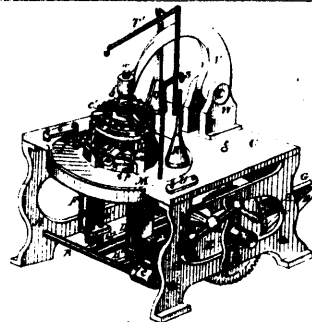

4666 Stevens' Improvements on Knitting Machines.

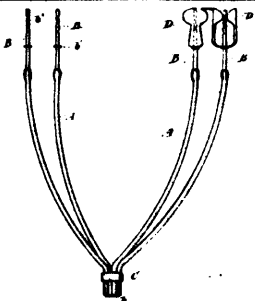

4668 Patteson's Improvements on Milking Machines.

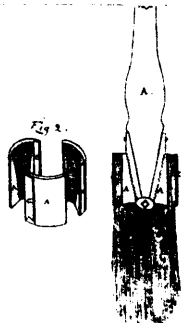

4669 Brillinger's Improvements in Paint Brushes.

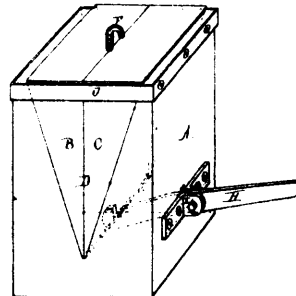

4670 Baugh's Improvements on Dies for Welding Links.

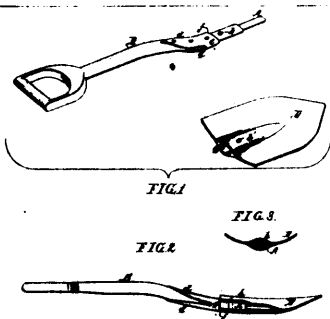

4671 Cunningham's Improvements on Shovels

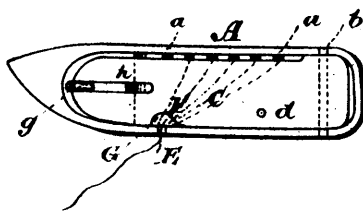

4672 Walker's Sewing Machine Shuttle.

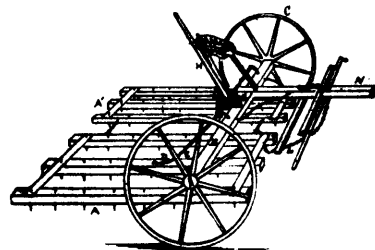

4673 Wilson's Improvements in Harrows.

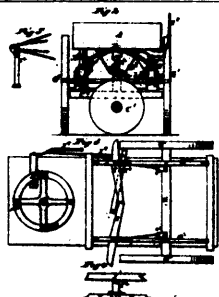

4674 Cunningham's Improvements on Running Gear for Vehicles.

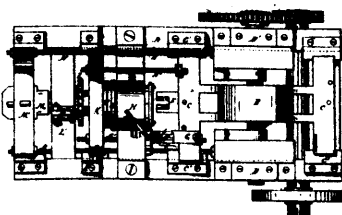

4675 Charles & McKain's Nut Machine.

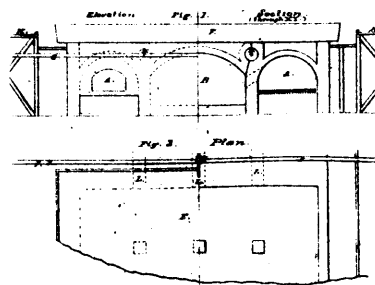

4676 Lockey's Apparatus for Evaporating Liquids and Heating Gas Retorts or Calcining Minerals.

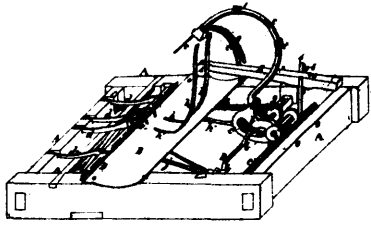

4677 Jewell's Grain Binder.



4678 Britton's Duplex Comb.

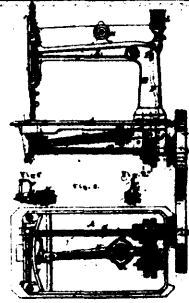

4679 Gullmann's Improvements on Sewing Machines.

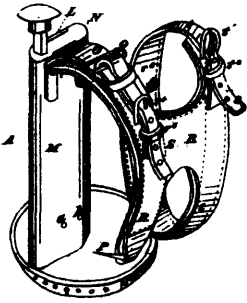

4680 Doolittle's Improvements on Conductor's Hand Alarm and Registers.

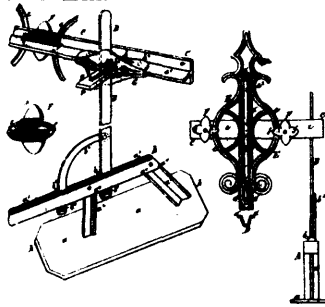

4681 Walker & Devoe's Improvements on Metallic Fences.



4682 Spence's Improvements on Boilers for Heating Water or Raising Steam.

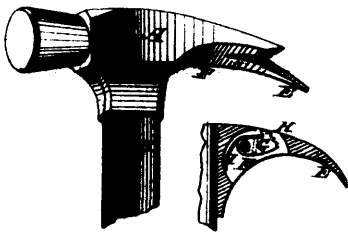

4683 Bilharz's Improvements on Hammers.

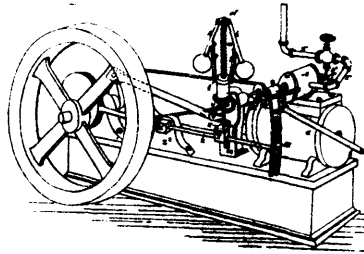

4684 McNaughton's Steam Engine.

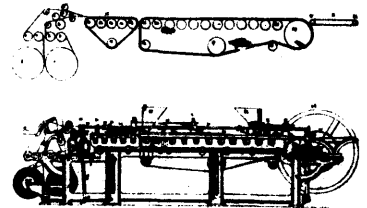

4685 Douce's Paper Bag Machine.

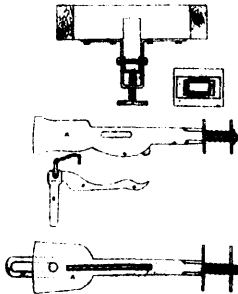

4686 Corey's Improvements on Car-couplers.

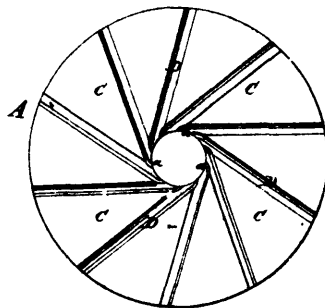

4687 Keim's Mill stone Dress.

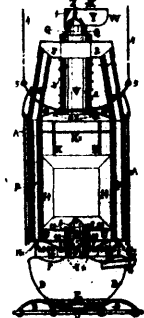

4688 Nutting's Improvements in Lanterns.

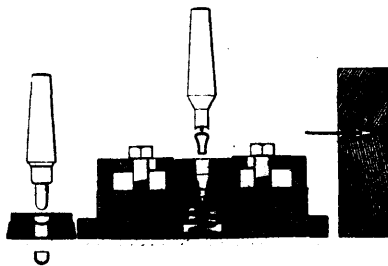

4689 Edge's Machine for and Process of Making the Heads of Chain Swivels.

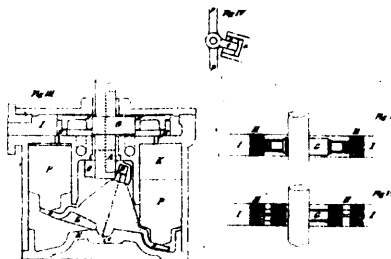

4680 West's Improvements in Steam, Water or other Engines.

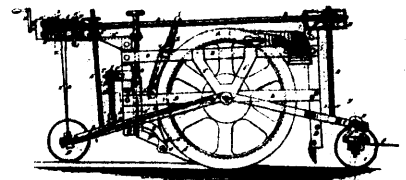

4691 Fitz Randolph's Ditching Machine.

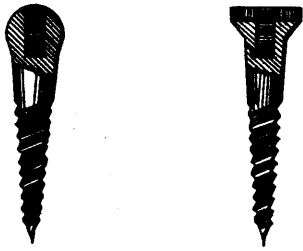

4692 Cummings' Improvements on Screws.

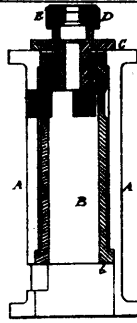

4693 Hill's Improvements in Linings for Cylinders.

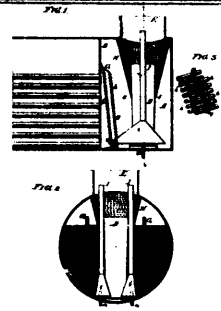

4694 Mitchell's Spark Arrester.

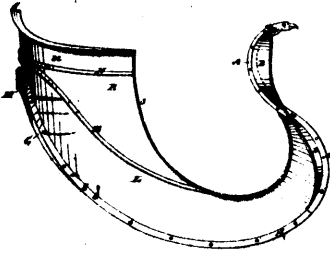

4695 Cobb's Improvements on Sides and Wings for Cutter Sleighs.

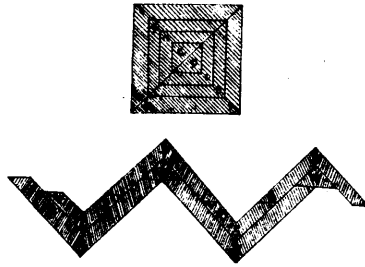

4696 Bentley's Improvements on Roofs for Buildings.

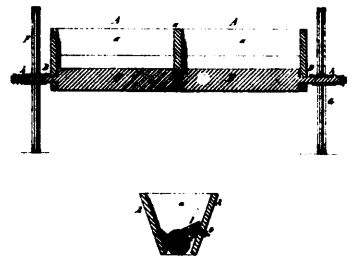

4697 Wisner's Fertilizer Sower.

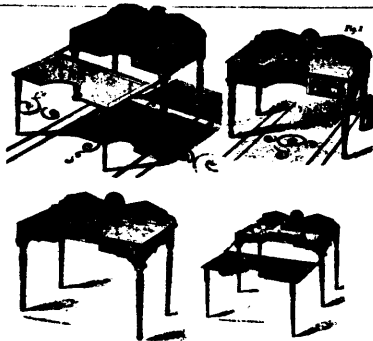

4698 Snyder's Ladies' Work Table.

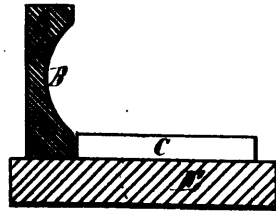

4699 Behning & Diehl's Improvements on Pianos and Organs.

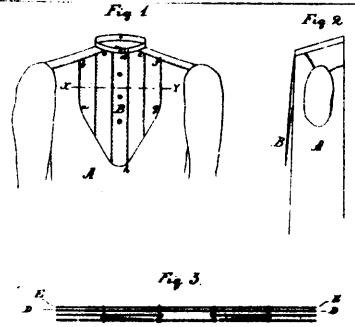

4700 Jenks' Shirt Bosom.

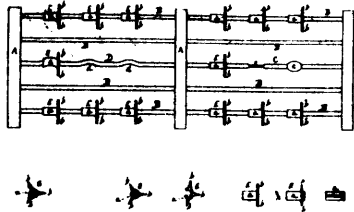

4701 Kennedy's Wire Fence.

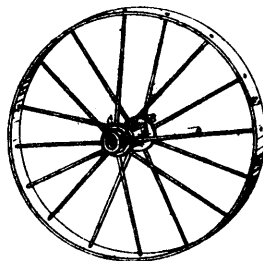

4702 Gendron's Gariage Wheel.

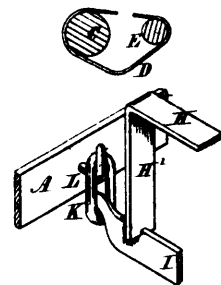

4703 Morrell & Reinhardt's Spring Bottom Bedstead.

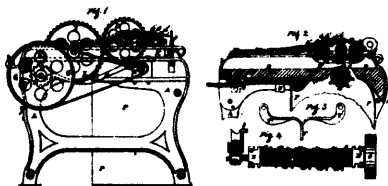

4704 Moulton & Thompson's Bark Rasping Machine.

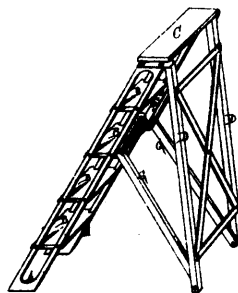

4705 Niemann's Improvements on Step-ladders.

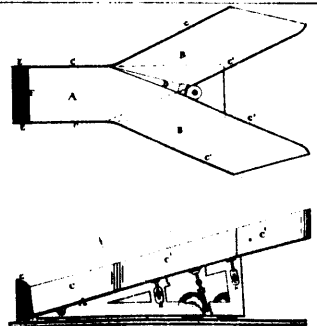

4706 Doman's Snow-plough.

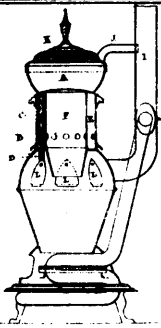

4707 Elliott's Improvements in Stoves.

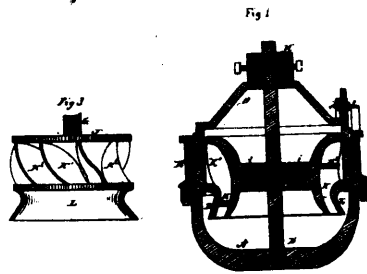

4708 Sherwood's Water Wheel.

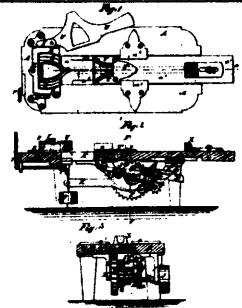

4709 Higgins' Machine for Bending Wood for the Handles of Shovels, &c.



4710 Camiré & Dessalles' Improvements in the Manufacture of Cigars.

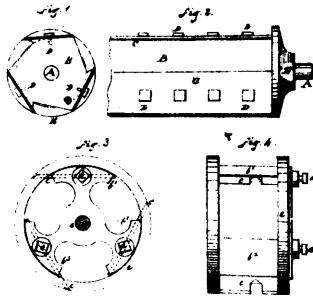

4711 Morin's Concentric Guide for Planing and Grooving Machine Irons.



4715 Goddu's Improvements on Boots and Shoe Nails.

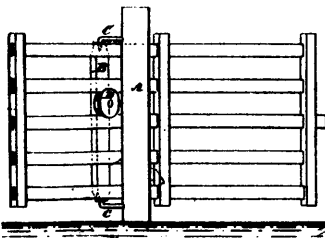

4716 Brown's Improvements on Farm Gates.

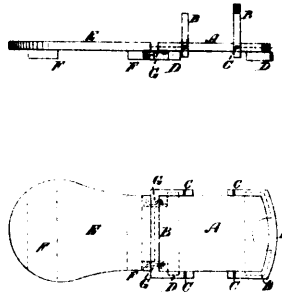

4717 Barré's Ironing Board.

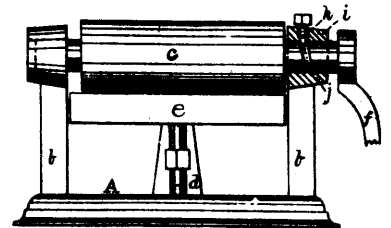

4718 Weston's Improvements on Photograph Burnishers.

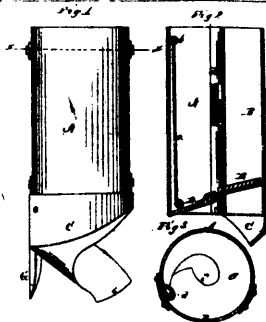

4719 Palmer's Improvements on Earth Auger.

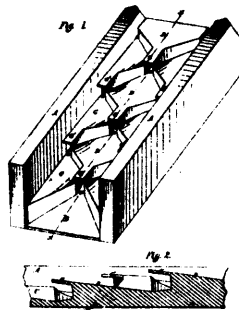

4720 Du Puy Brewer's Improvements in Fishways.



4721 Hart's Improvements in Clothes Pounders for Washing.

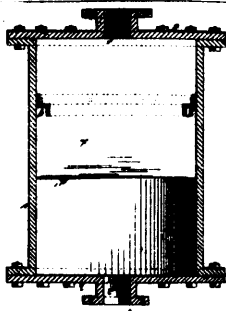

4772 Outerson's Improvements on Filters.

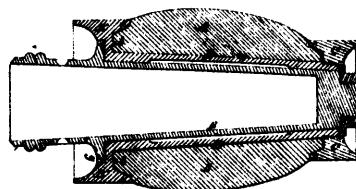

4723 Payne's Improvements on Hub Boxes and Bands.

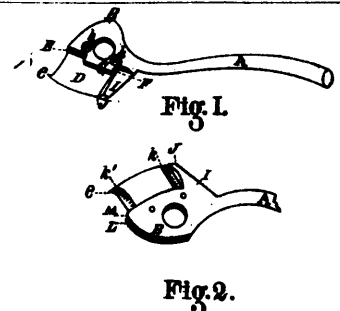

4724 Barton's Improvement on Welt Knives.

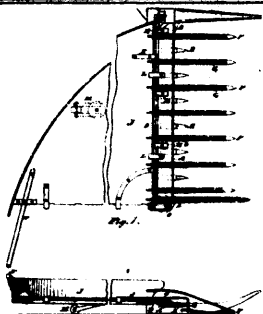

4727 Tolton's Harvester Attachments for Cutting Pease.

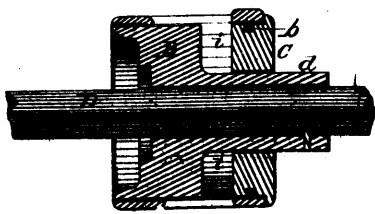

4728 Mast's Improvements on Feeding Mechanism for Grain Drilling Machines.



4729 Barton's Peg Cutter Handle.

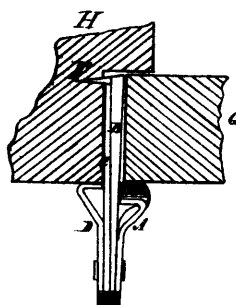

4730 McDonald's Door Fastener.

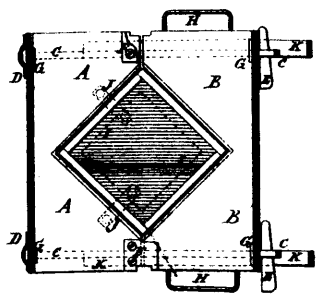

4731 Robertson's Improvements on Tobacco Presses.

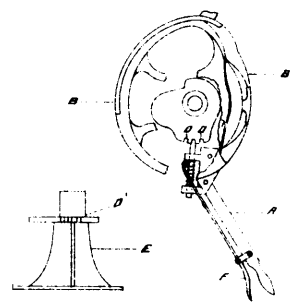

4732 Abell's Improvements on Reaping Machines.

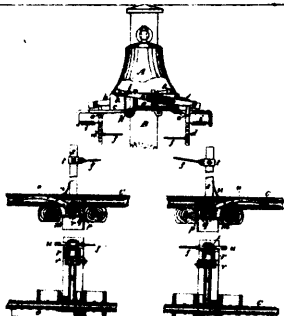

4733 Jones' Improvement on Railway Signals for Level Crossings.

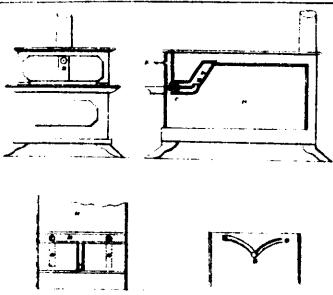

4734 Copp's Improvements on Cooking Stoves.

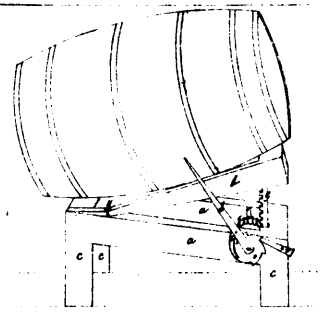

4735 Ashdown's Improvements on a Machine for Tilting Barrels.

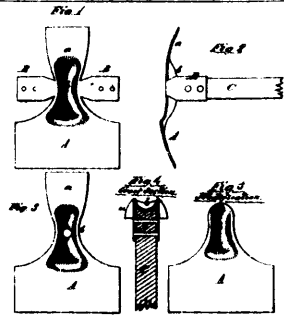

4736 Johnson's Improvements on Hoes.

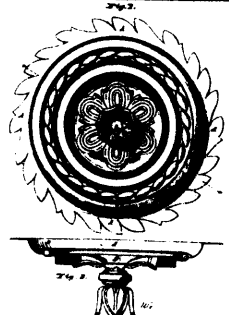

4737 Warren's Improvements on Centre-pieces.

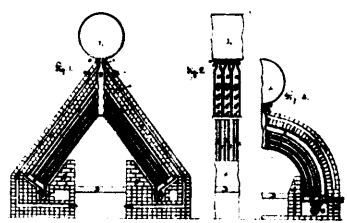

4738 Renshaw's Improvements on Steam Generators

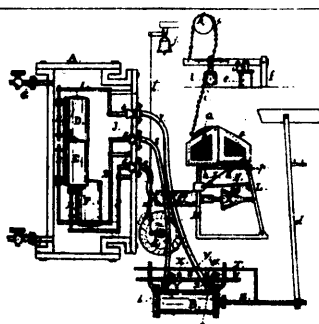

4739 Sulzbach's Apparatus for Preventing Steam Boilers from Explosion.

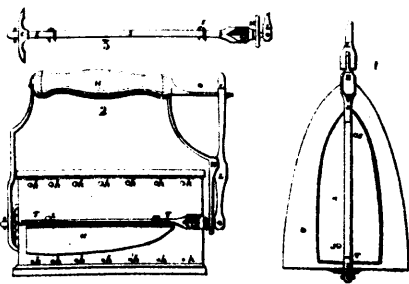

4740 Custer's Improvements on Flat Irons.

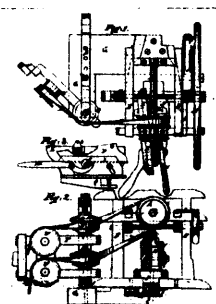

4741 Baughman's Saw Gummer and Sharpener.

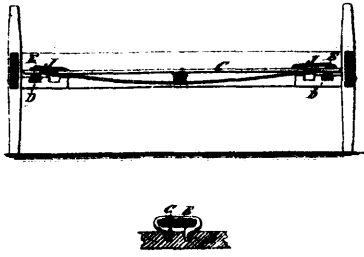

4742 Ingersoll's Improvement on Bed Bottoms.

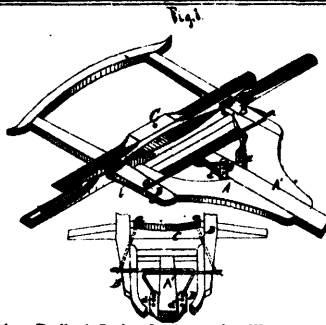

4744 Dudley's Spring for Supporting Waggon Tongues.

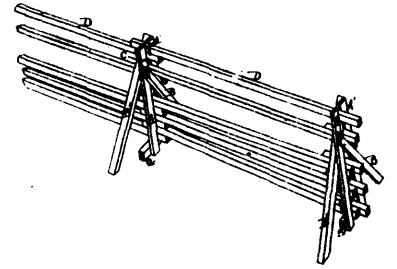

4745 Olds' Improvements on Fences.

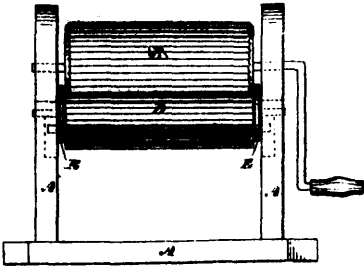

1746 Cornell's Improvements on Washing Machines.

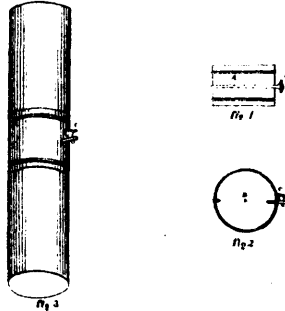

1747 Daine's Improvements on Stove-pipe Dampers.

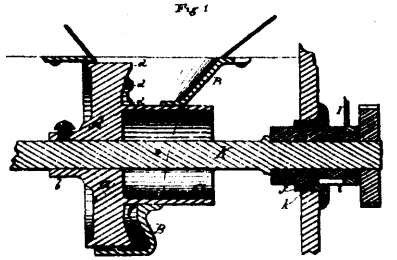

1748 Gardiner's Improvements on Seeding Machines.

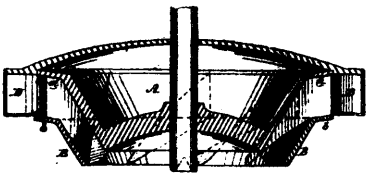

4749 Nolan's Improvements on Water Wheels.

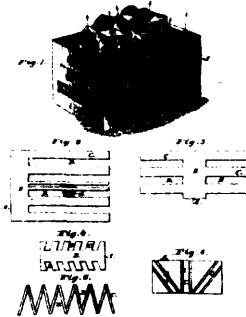

4750 Husband's Fire-kindler.

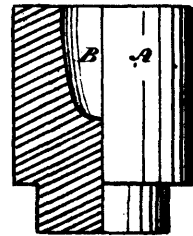

1751 Lesser's Improvement on the Manufacture of Cigars.

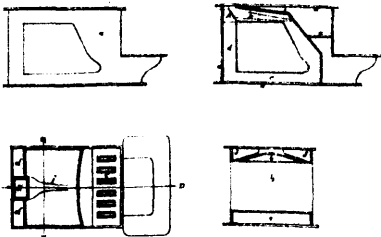

4752 Herard's Cooking-stove.

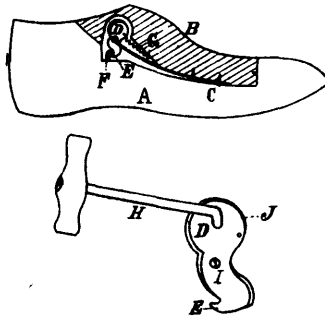

4753 Davis' Block Lock Shoe Last.

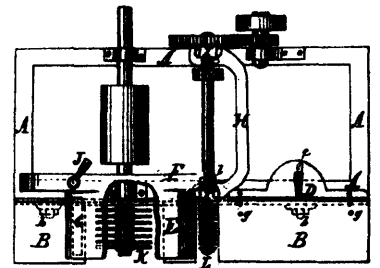

4754 Hart's Lath Machine.

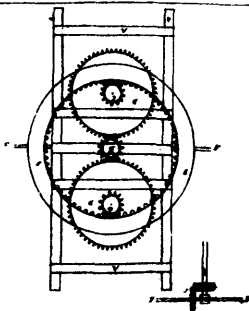

4755 Tracy's Horse-power.

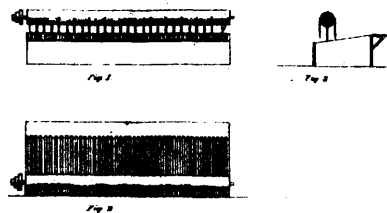

4756 Sheraton's Machine for Cleaning and Beating Carpets and other Fabrics.

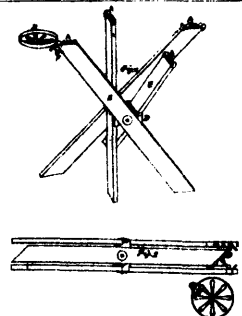

1757 Rugg's Wash Bench.

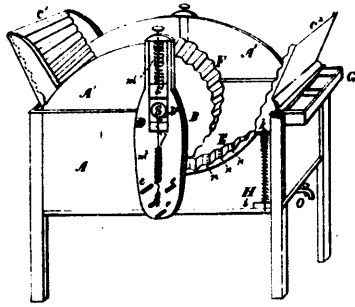

4758 Lawlor's Washing Machine.

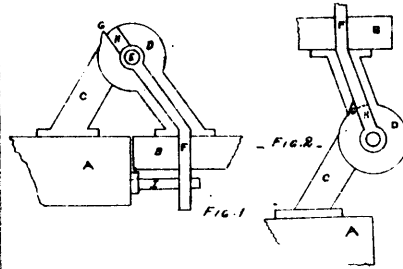

4759 Alkman's Improvements in Hinges.

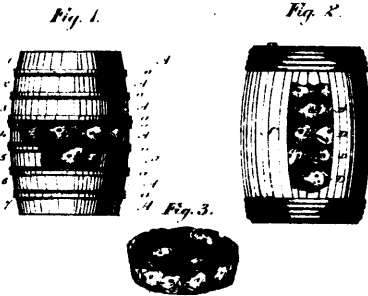

Fig. 1

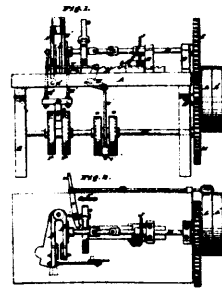

Fig. 2

4760 Lesser's Improvements on Cigars.



4761 Davis' Art of Preparing Fish for Market.



4762 Howell's Metal Creasing Machine.

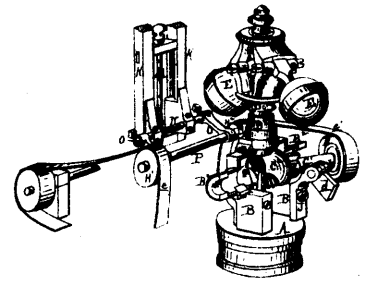

4763 Warren's Improvements on Stop Motion for Steam Engine Governors.

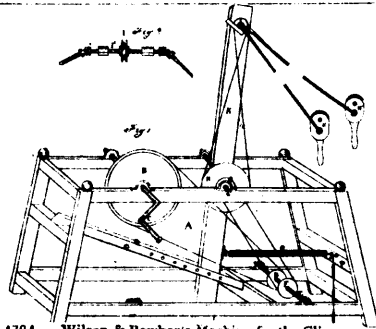

4764 Wilson & Bowker's Machine for the Clipping of Horses and Sheep.

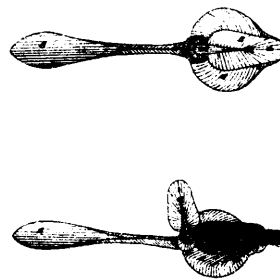

4765 Hubbell's Fire Kindler.

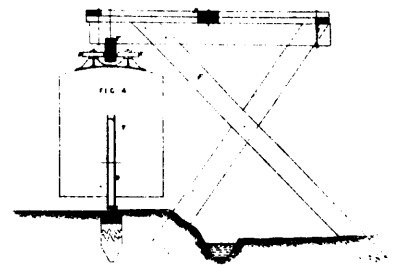

4766 Smith's Single Rail Railway.

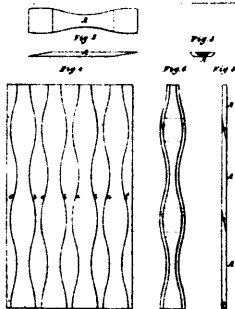

4767 Fr chettes & Cot 's Improvements on Stiffeners for Boots and Shoes.

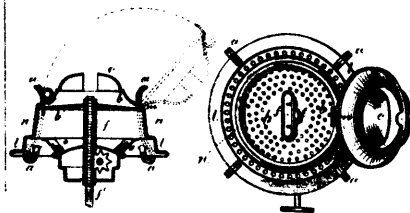

4768 Atwood's Improvements on Lamp Burners.

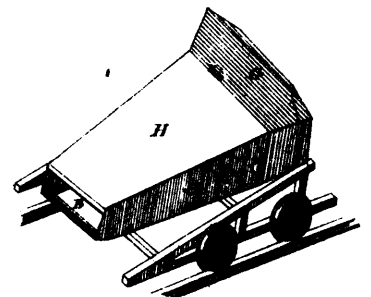

4770 Struthers' Improvements on Snow ploughs

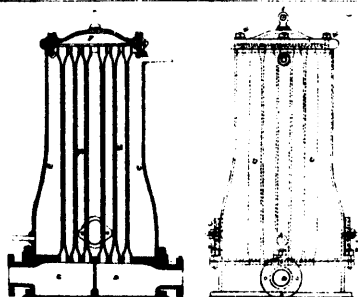

4771 Waterous' Improvements in Steam Surface Condensers and Feed Water Heaters for Steam Engines.

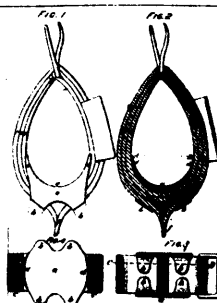

4772 Webber's Harness Lug-lining.

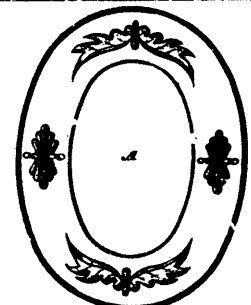

4773 Wilson's Improvements on Compounds for Picture Frames.