

Technical and Bibliographic Notes / Notes techniques et bibliographiques

The Institute has attempted to obtain the best original copy available for filming. Features of this copy which may be bibliographically unique, which may alter any of the images in the reproduction, or which may significantly change the usual method of filming, are checked below.

L'Institut a microfilmé le meilleur exemplaire qu'il lui a été possible de se procurer. Les détails de cet exemplaire qui sont peut-être uniques du point de vue bibliographique, qui peuvent modifier une image reproduite, ou qui peuvent exiger une modification dans la méthode normale de filmage sont indiqués ci-dessous.

Coloured covers/
Couverture de couleur

Covers damaged/
Couverture endommagée

Covers restored and/or laminated/
Couverture restaurée et/ou pelliculée

Cover title missing/
Le titre de couverture manque

Coloured maps/
Cartes géographiques en couleur

Coloured ink (i.e. other than blue or black)/
Encre de couleur (i.e. autre que bleue ou noire)

Coloured plates and/or illustrations/
Planches et/ou illustrations en couleur

Bound with other material/
Relié avec d'autres documents

Tight binding may cause shadows or distortion along interior margin/
La reliure serrée peut causer de l'ombre ou de la distorsion le long de la marge intérieure

Blank leaves added during restoration may appear within the text. Whenever possible, these have been omitted from filming/
Il se peut que certaines pages blanches ajoutées lors d'une restauration apparaissent dans le texte, mais, lorsque cela était possible, ces pages n'ont pas été filmées.

Additional comments:
Commentaires supplémentaires:

Coloured pages/
Pages de couleur

Pages damaged/
Pages endommagées

Pages restored and/or laminated/
Pages restaurées et/ou pelliculées

Pages discoloured, stained or foxed/
Pages décolorées, tachetées ou piquées

Pages detached/
Pages détachées

Showthrough/
Transparence

Quality of print varies/
Qualité inégale de l'impression

Continuous pagination/
Pagination continue

Includes index(es)/
Comprend un (des) index

Title on header taken from:
Le titre de l'en-tête provient:

Title page of issue/
Page de titre de la livraison

Caption of issue/
Titre de départ de la livraison

Masthead/
Générique (périodiques) de la livraison

This item is filmed at the reduction ratio checked below/
Ce document est filmé au taux de réduction indiqué ci-dessous.

10X	12X	14X	16X	18X	20X	22X	24X	26X	28X	30X	32X
<input type="checkbox"/>	<input type="checkbox"/>	<input type="checkbox"/>	<input type="checkbox"/>	<input type="checkbox"/>	<input type="checkbox"/>	<input type="checkbox"/>	<input type="checkbox"/>	<input checked="" type="checkbox"/>	<input type="checkbox"/>	<input type="checkbox"/>	<input type="checkbox"/>

The Canadian Patent Office

RECORD



Vol. IV.—No. 11.

NOVEMBER, 1876.

Price in Canada \$2.00 per An
United States - \$2.80 "

CONTENTS.

INVENTIONS PATENTED.....	171
INDEX OF INVENTIONS.....	CLXXXI
INDEX OF PATENTEES.....	CLXXXII
ILLUSTRATIONS.....	181

No. 6598. Improvement on Copy Books.

(*Perfectionnement des cahiers.*)

Eugene F. Goodman, Clinton, Iowa, U. S., 23th September, 1876, for 5 years.

Claim.—The cord B, in combination with the sliding and reversible slip A having a copy on each side capable of being used on either one of two adjacent pages of the book.

No. 6599. Horse Shoe Nail Machine.

(*Machine à clou à cheval.*)

Joseph Varney, Montreal, Que., 23th September, 1876, for 5 years.

Claim.—1st. The combination of the slide bar *l*, guide bar *i* and feeder plate *b*; 2nd. The combination of the shaft *f* carrying the gauge *a*, and bracket *d* and centre bearing *e*. 3rd. The combination of the shaft *f* carrying the gauge *a*, bracket *d* and centre bearing *e*.

No. 6600. Machine for Making Metal Screws.

(*Machine à faire des vis métalliques.*)

Albert W. Gifford, Worcester, Mass., U. S., 23th September, 1876, for 5 years.

Claim.—1st. The rotary head A, provided with sets of jaws, in combination with a series of two or more arbors E F G arranged to operate with such head, and furnished with tools to effect simultaneously the operations of milling or shanking a screw blank, and pointing or cutting a thread on another, while an attendant may be in the act of removing a finished screw from one set of the jaws of the head and substituting a blank for such screw the said arbors being provided with mechanism for operating them; 2nd. The combination of the latch *k* and the escapement *t*; 3rd. The combination of the latch *k* and escapement *t* with the lever and the feeding mechanism of the arbor E, such feeding mechanism consisting of the pulleys *so y*, band *z*, shaft *z*, screw *ax*, worm gear *b*, gear *d* and rack *e*; 4th. The combination of the sleeve *m* and the studs *p q r s* with the two pulleys *so y* and the threading arbor G.

No. 6601. Improvement on Safety-Valves.

(*Perfectionnement des soupapes de sûreté.*)

Charles H. Thomson, St. Petersburg, Pa., U. S., 23th September, 1876, for 5 years.

Claim.—The combination of valve C stem D provided with loose collar I and pulley G, lever E and fulcrum F.

No. 6602. Improvements on Wood Pavements.

(*Perfectionnements aux pavages en bois.*)

William Porter, Ottawa, Ont., 23th September, 1876, for 5 years.

Claim.—1st. A sectional block pavement composed of vertical through blocks B having dovetail tenons and intermediate bearing strips or pieces C bevelled to fit the lateral sides of the tenons, when united by nutted bolts E. 2nd. In a sectional pavement, the dovetail blocks G inserted.

No. 6603. Stove Grate.

(*Grille de calorifère.*)

George H. Stansbury, Milwaukee, Wis., Alfred S. Hubbell and Henry S. Hubbell, Buffalo, N. Y., U. S., 23th September, 1876, for 5 years.

Claim.—1st. A stove grate composed of two plates A, B, one being movable upon the other and both provided with corresponding openings *e d*, so that by adjusting the movable plate the grate can be opened or entirely closed thereby forming a tight grate which will retain all the ashes and coal

and enable a wood fire to be kept a great length of time; 2nd. A grate composed of a stationary grate plate A and swinging plate B, both provided with corresponding concentric openings *e and d*; 3rd. The combination of the stationary grate plate A and swinging plate B, both provided with concentric openings *e and d* arranged alternately in radial sets or rows, so that the openings of one set will be opposite the solid portions of the plate between the openings of the next adjacent sets.

No. 6604. Automatic Regulator Tempering Furnace.

(*Four de recuit à régulateur automatique.*)

Charles Dion, Chambly Basin, et James Baylis, Montreal, Que., 23th September, 1876, for 5 years.

Claim.—1st. The combination in the tempering chamber A, of the transverse shaft operating by means of projecting arms holding a rod from which hangs the carrying plate to dip alternately into a hot chamber and tank the article to be tempered; 2nd. In combination with the tempering furnace A, the shaft C running backward and forward by means of pinions D, working in racks E, the cover plate *z*; 3rd. The combination with the tempering chamber A of the tank L, having diaphragm *l*; 4th. In combination with the furnace chamber B and tempering chamber A, the flues B₁ B₂ and B₃ surrounding the heated chamber K; 5th. In combination with a bath or vessel containing hot air or molten metal, a tube passing through it and entering a bath of oil, water or other fluid, so that the wire drawn through such tube shall not come in contact with the external air; 6th. The combination with the wire tube of an air passage and blow *r*; 7th. The combination of the tube N and rod N₁ with groove N₂; 8th. The pyrometer contained in metal tube and indicating the temperature; 9th. The combination with a furnace chamber and a split of upper and lower blast flues communicating respectively with them, and opened and closed automatically by the rise and fall of the temperature of the furnace; 10th. The armature Z Z₁, each influenced by a set of magnets thrown alternately into circuit by the action of the pointer S on either part of the split plate T₁ on the dial; 11th. The escapement rod Y mounted on the shaft V, engaging alternately at either end with a hook and projection formed on the armature Z, according as this is influenced or not by the magnets.

No. 6605. Improvements in Harvesters.

(*Perfectionnements aux moissonneuses.*)

Christopher C. Bradley, Syracuse, N. Y. U. S., 23th September, 1876, for 5 years.

Claim.—1st. As a means of connecting the finger bar to the main frame, an inclined post E set upon the inner end of the finger bar passing through bearings in the main frame; 2nd. The lever M placed upon the main frame at a point in front and outside of the drive wheel, and in combination with the tongue by means of the link Q and crank axle N; 3rd. As a substitute for a hinge, swivel or other analogous device, as a means of connecting a finger bar to the main frame and controlling the position of the finger bar relative to the main frame, a post or slide connection between said finger bar and main frame; 4th. The post E stayed at its upper extremity by a bracing device D M set upon and springing from the cutter bar or platform; 5th. In combination with the minor axle L, which carries the driving sprocket wheel J and bevel gear X the composite ratchet; pinion Y; 6th. The combination of the chain drum R, ratchet rod Q, ratchet plate T and hand lever V, the whole forming a device for lifting the finger bar vertically; 7th. In combination with the ratchet plate T, the hand lever V and spring U; 8th. In combination with the lifting drum R, the pawl S; 9th. The combination of the pinion *f*, interior ratchet plate A keyed to the minor axle L, spring controlled duplex pawl B and key *d*, the whole forming a device for throwing in or out of gear the actuating mechanism; 10th. In combination with a bushing P serving as an axle of the main drive wheel the ratchet rod Q journalled within the same as a space-saving device; 11th. A finger bar connected with the main frame by a post E and slide *p p* upon a device upon the main frame for lifting the cutter bar.

No. 6606. Improvements on Roofs.

(*Perfectionnements aux toitures.*)

Cyrus M. Warren, Brookline, Mass., U. S., 23th September, 1876, for 5 years.

Claim.—1st. The combination of a foundation layer of two or more thicknesses of paper or felt saturated with vegetable or mineral tar or other suitable material and a water proof protecting layer of native bitumen, or a compound of native bitumen or rosin and the residuum or heavy oil of petro-

leum, or other equivalent non volatile material; 2nd. The combination of a foundation layer of two or more thicknesses of paper or felt, saturated with vegetable or mineral tar, or other suitable material, a water-proof layer of native bitumen or rosin and the residuum or heavy oil of petroleum, or other equivalent non volatile material.

No. 6607. Apparatus for Transmitting and Receiving Signals, &c.

(Appareil pour transmettre et recevoir des signaux, etc.)

John S. Gaborne, London, Eng., 28th September, 1876, for 15 years.

Claim.—1st. The novel combination of the single flexible connectors *o* or, single or double grooved pulleys *f g f g*, weights or springs *W W*, in conjunction or not with the counterweights or countersprings *C W C W*; 2nd. The novel combination of single flexible connector with a wheel or quadrant on the rubber post and with the pulley *f* and weight or spring *W* of the transmitter; 3rd. The novel combination of single flexible connector having a weight or spring at each end and eccentric or tappet on the engine shaft, a pulley or quadrant carrying the pointer of an indicating instrument and an engine counter for indicating the direction and speed of working of the engines of a steamship.

No. 6608. Process of Transferring the Grain Marks of Wood and other Configurations.

(Procédé d'imitation des fibres du bois et autres figures.)

John R. Cross, New York, U. S., 28th September, 1876 (extension of patent No. 2634), for 5 years.

No. 6609. Improvements on Sleigh Brakes.

(Perfectionnements aux freins de traîneaux.)

Robert Menary, Orangeville, Ont., 2nd October, 1876, for 5 years.

Claim.—The neck shaft *A* having radial spur brakes *B* and provided with a lever *C*, furnished with a spring catch *d* or other suitable device for fixing its position adjustably, in combination with a sleigh.

No. 6610. Panel Door Planing Machine.

(Machine à raboter les battants des portes.)

Orson G. Howes, William R. Norris, John Hall and Orson W. Sheldon, Fort-Ann. N. Y., U. S., 2nd October, 1876, for 5 years.

Claim.—1st. The combination of the rotary head and cutters *B*, stationary bed *C* and frame *A*; 2nd. The combination of the rotary head and cutters *B*, stationary bed *C*, frame *A*, pivot *a*, slot *E* and bolt *F*.

No. 6611. Improvement on Sleigh Brakes.

(Perfectionnement des freins de traîneaux.)

George Campbell and Israel Oakey, Toronto, Ont., 2nd October, 1876, for 5 years.

Claim.—The brake *E* with its two inclined slots *F*, also one connecting rod *H*, lever *I* and studs *G* supporting the brake inside of the slots to the runner; and also the slot on top of lever *K*.

No. 6612. Improvements on Valves.

(Perfectionnements aux soupapes.)

Ferdinand Behr, Frankfurt, Germ., and Eugene W. Lippert, Cincinnati, Ohio, U. S., 2nd October, 1876, for 5 years.

Claim.—1st. The regulating valve rod *f* revolvable at *e* and supplied with screw thread at the bottom, by means of which the valve surface at *s* may be increased or lessened, thereby obviating the hydraulic shock in closing the valve; 2nd. The peculiarly adjusted channels *n m n* which enable the transfer of water from *O* to *O'*; 3rd. The peculiar construction of the channel *m* and the valve *p* by means of which the equalization of pressure is attained in the supply and in the chambers *O* and *O'*; 4th. The valves *K*; *K'* which cut off the escape through channel *e* before the passage of water enters the chamber *m*, and in reverse order cut off the feed water before opening the entrance to channel *e*; 5th. The valve proper *V* in its combination and mode of operation.

No. 6613. Manufacture of Boots and Shoes.

(Fabrication des chaussures.)

Daniel A. Sutherland, Lynn, Mass., U. S., 2nd October, 1876, for 5 years.

Claim.—1st. The seam portions *e e* arranged on the outer side of the pieces *C C* and covered with the stay *S* sewed to both of said parts *C C*, said stay being provided with the grooves *g* and fillets *h i*, and the edges of the stay being folded for the reception of the seam portions *e e*, all in the manner described; 2nd. A sewing machine presser foot provided with means for folding and channeling a seam stay piece, such consisting of the fillets *e e* and of the folder composed of the tapering mouth *d*, the partition *d*, all being arranged with the guide groove *b* and needle hole *f*.

No. 6614. Stone Extractor. (Charriot épierreur.)

Joseph Filion, St. Eustache, Que., 2nd October, 1876, for 5 years.

Résumé.—1o. La combinaison de la charpente *A*, faite en comble de brisis, disposée sur quatre roues *C*, et composée des maîtres chevrons *a*, des ambes de force *b*, des leirnes *d*, des entrails *e*, des puçons *f*, des traverses *g*, avec le treuil *P*, le palan *J* et le crochet *K*; 2o. La combinaison de la plateforme *E*, portée sur la traverse *c* de l'avant-train, chevillée à l'essieu de devant *B*, avec un charriot épierreur.

Claim.—1st. The combination of the frame *A*, made in the shape of a curved roof, mounted on four wheels *C*, and composed of principal rafters *a*, cross stays *b*, rails *d*, tie-beams *e*, joggle-piece *f*, cross-piece *g* with the derrick *P*, tackle *J* and the hook *K*; 2nd. The combination of the platform *E* mounted on the cross-piece *e* of the fore-carriage, fastened to the fore-axle *B*, with a stone extracting carriage.

No. 6615. Improvements in Steam Boilers.

(Perfectionnements aux chaudières à vapeur.)

Benjamin S. Koll, Pittsburg, Pa., U. S., 2nd October, 1876, for 5 years.

Claim.—1st. The flanged, jointed, curved bearings *B* arranged in a cylinder or flue boiler; 2nd. The circulation plates *a* arranged in a cylinder or flue boiler, with a longitudinal opening between the lower adjacent edges of such plates for a downward current, to supply the upward current between the plates and the shell of the boiler; 3rd. A circulation plate *a* arranged in a cylinder or flue boiler, whereby a trough-shaped dead-water space *c* is secured above the bottom of the boiler and a little out of the line of circulation; 4th. The combination of circulation-plates *a* following the curvature of the boiler-shell and deflecting plate *d* attached to the shell; 5th. The vertical diaphragm *s* in combination with a system of circulation plates and passages on either side; 6th. The plates *a* constructed so as to form dead-water troughs *c* in combination with a blow-off pipe *P* arranged therein; 7th. The combination of blow-off pipes *P* and steam wash-pipes *e e*, relatively arranged in the dead-water troughs; 8th. A boiler having a system of water-circulation passages, wherein circulation is kept up in such passages by the fire heat or differences of temperature, the arrangement of the feed water-pipe in the line of water circulation, and discharging in the direction of the flow of the currents; 9th. The duplicate system of water-feed, water circulation and water blow-off, arranged in the opposite halves of a cylinder or flue boiler, and on opposite sides of a vertical longitudinal diaphragm.

No. 6616. Improvements on Hoes.

(Perfectionnements aux houes.)

John R. Reynolds, Essex Center, Vt., U. S., 2nd October, 1876, for 5 years.

Claim.—1st. A seeding attachment to hoes, consisting of a hopper *A*, a guide-way *D* and spring slide; 2nd. In combination with the hopper *A* and guide-way *D*, the spring slide composed of two parts *c d* adjustable relatively to each other, whereby the seed cup can be enlarged or diminished to regulate the number of kernels to be dropped simultaneously; 3rd. In combination with the slide in which the seed cup is formed, and the guide-way *D* in which the same operates, the spiral spring *I* for retracting the slide.

No. 6617. Manufacture of Peat.

(Fabrication de la tourbe.)

David Aikman, Montreal, Que., 2nd October, 1876, for 5 years.

Claim.—1st. The process of manufacturing peat fuel by delivering the pulp peat direct from the excavating machine into a number of wire moulds, and then submitting it to compression, the bricks thus formed being placed on drying stages; 2nd. The boxes *B* divided into two or more compartments, and containing moulds of wire mesh for the reception of pulped peat; 3rd. In combination with the boxes *B* carried on any suitable car, the screw or other press *M*; 4th. In combination with any machine for the excavation of peat, the track *D* laid parallel to the canal cut track *D'*, and drying stages *L* and tracks *D* connected by turntables.

No. 6618. Improvements on Stove-Pipe Ventilators.

(Perfectionnements aux ventilateurs de tuyaux de poêles.)

Johnson Briggs, Toronto, Ont., 2nd October, 1876, for 5 years.

Claim.—A ventilator connection for stove pipes, constructed of the tubular continuation *B*, having an aperture *C* enclosed by a covering *D*, forming a passage *E* furnished with a register *F* and with or without the damper *H*, whereby the foul air ascends in the passage *E* before entering the smoke flue.

No. 6619. Potato Digger. (Arrache-potatoes.)

Stephen Martin, Hars, Ont., 2nd October, 1876, for 5 years.

Claim.—1st. The combination of the parallel sides *A* having mould boards *C*, the intermediate plough point *F* and apron *G*, and the rotary blades *M* driven from the axle *B* by the band and pulley devices; 2nd. The flap valve *R* opening upwardly, pivoted to the sides *A* between the point *F* and apron *G*.

No. 6620. Refrigerator Car. (Wagon réfrigérant.)

John M. Ayer, Chicago, Ill., U. S., 2nd October, 1876, for 5 years.

Claim.—1st. The combination of an external casing, an interior lining and an intermediate sheet of India rubber, or "rubber packing"; 2nd. The combination of an external casing, an interior lining and an intermediate sheet of India rubber, or "rubber packing" arranged so as to form an air chamber between the outer casing and the rubber lining; 3rd. The combination of the outer casing, provided with openings *K*, interior lining and intermediate sheathing of India rubber, or rubber packing arranged so as to form an air chamber between the outer casing and rubber lining into which the apertures *K* open; 4th. The combination of the outer roof covering *G* and the sheathing of India rubber or rubber packing *D*; 5th. The combination of the interior roof lining and the sheathing of India rubber or rubber packing *D*; 6th. The roof boards *G H* with an air space between them, communicating by side openings *K* with the outside atmosphere in combination with the rubber sheathing *D* and supplementary roof *I*, provided with a rubber covering and forming an additional air chamber.

No. 6621. Steam Exhaust for Mill-Stone Curbs and Conveyors.

(Infractions des meules courantes et conduits.)

Benjamin Barter, Toronto, Ont., 2nd October, 1876, for 5 years.

Claim.—1st. The pipe *C* having branch pipes *E* and *F*, leading respectively to the curb stone *A* and conveyer *B*, in combination with the exhaust fan *D*; 2nd. The exhaust pipe *C*, in combination with the drip bucket *G*.

No. 6622. Improvements on Lathes.*(Perfectionnements aux tours.)*

Joseph Beaudry, Montreal, Que., 2nd October, 1876, for 5 years.

Claim.—1st. The expansible support or rest consisting of the disk *d* having the sliding arms *e* mounted thereon, and the disk *e* provided with studs which enter slots in the arms; 2nd. In combination with the rotary frame, provided with the rotary centres or arbors *c* having ratchet wheels *n* attached, one or more dogs *u* attached to the main frame, and operating to turn the blanks and present their different faces to the cutters automatically; 3rd. The knives or cutters provided with lips *p*; 4th. In combination with the main frame *A* and the rotating frame *e*, the frame *H* provided with the adjustable bar *r* and adjustable pointer *u*.

No. 6623. Portable Fence. *(Clôture portative.)*

Charles D. Swanson and John Mennie, Dawnie, Ont., 2nd October, 1876, for 5 years.

Claim.—1st. The block *a* with the gain *g* to receive one half of the bottom corner of hurdle *d*; 2nd. The wire brace *b* passing from the one end of the block *a* to the other end thereof, up and over the wedges *c*; 3rd. The wedges *c* forming the force to draw the wire braces *b* taut and forming the block.

No. 6624. One-Stave Bucket Machine.*(Machine à seau d'une douelle.)*

Israel Hogeland, Indianapolis, Ind., U. S., 2nd October, 1876, for 5 years.

Claim.—1st. The combination of the saws *L*, *L*, *L*, mandril *P*, feed-roller *F*, guides *E*, *K*, *K*; 2nd. The feed rollers *F* formed cone-shaped and provided with a rubber tube, and arranged to operate in boxes *H*, *H*, the rear box being elevated so as to allow the lower edge of the cone feed wheel *F* to lay parallel with the table; 3rd. The combination of the pressure bar *D* and roller *O* arranged and adapted to be operated in connection with the stave *A* and small roller *S*.

No. 6625. Automatic Damper.*(Registre automatique de cheminée.)*

Samuel F. Gold, Englewood, N. J., U. S., 2nd October, 1876, for 5 years.

Claim.—1st. The combination of the tank *C*, receiver *E* and pipe and lever *D*, arranged relatively to each other; 2nd. The combination of the tank *C*, pipe and lever *D*, receiver *E* and damper *B*; 3rd. The combination of the tank *C*, pipe and lever *D*, receiver *E*, damper *B* and smoke pipe *A*; 4th. The receiver *E* constructed in parts *C* having openings between them.

No. 6626. Pail and Tub Ear.*(Oreille de seau et de cuvette.)*

William Warren, Hull, Que., 2nd October, 1876, for 5 years.

Claim.—1st. The improved pail or tub ear made of wire and turned into the form of an edge as at *B*; 2nd. The wire ear of a tub or pail bent to the form of an eye in combination with upwardly oblique turned ends as at *E* and *C*, to enter the sides of the pail; also the ear and the manner of affixing it to the pail or tub.

No. 6627. Improvements in Pails and Tubs.*(Perfectionnements aux seaux et cuvettes.)*

James S. McMurray, Toronto, Ont., 2nd October, 1876, for 5 years.

Claim.—1st. The bail ear *D* provided with the downwardly projecting continuation *D* in combination with the hoop *B* and cleated staple *E*; 2nd. The bail ear *D* extended upwardly and outwardly from the pail; 3rd. The rectangular washer *F* provided with the corner spikes *f* and raised central portion; 4th. The handle *e* provided with the corrugations *e* *e* *e*.

No. 6628. Wood Pavement. *(Pavage en bois.)*

John Mather, Ottawa, Ont., 2nd October, 1876, for 5 years.

Claim.—A wood pavement composed of a flooring *A*, strips *B* nailed thereto and to block *C*, the blocks and strips alternating and constructed to be laid in sections, whereby each section can be removed independently from the roadway when desired.

No. 6629. Improvement on Gates.*(Perfectionnement des barrières.)*

Jacob Kesseler, London, Ont., 2nd October, 1876, for 5 years.

Claim.—The blocks *C*, *C*, bar *D*, slot *a*, bolt *d*, pins *f* *g* *h* and sockets *e*, *e*, in combination with gate post *A* and gate *B*.

No. 6630. Machine for Opening and Closing Blinds and Shutters.*(Machine à ouvrir et fermer les persiennes et contrevents.)*

William Jones, Oshawa, Ont., 2nd October, 1876, for 5 years.

Claim.—The combination of cog-wheels *A*, *A*, shaft *E*, handle *II*, with socket plate *F*, *F*, catch plate and pin *G*, *G* and spring *H*, *H*.

No. 6631. Process of Purifying and Deodorizing Petroleum.*(Procédé pour épurer et désinfecter le pétrole.)*

David M. Lamb, London, Ont., 2nd October, 1876, for 5 years.

Claim.—The process of treating petroleum and other oils with chlorine gas, by generating said gas within the vessel containing the oil to be deodorized and purified, by adding to the oil the salts of sodium (common salt preferable) and sulphurous acid, in about the proportions stated, with or without the addition of black oxide of manganese.

No. 6632. Art of giving Color to Photographs.*(Art de donner la couleur aux cartes photographiques.)*

Clara C. S. Franks, Toronto, Ont., 7th October, 1876, for 5 years.

Claim.—The process of painting or otherwise coloring the surface of transparent plate of glass *B*, mica or equivalent, in combination with a photographed picture stuck to a plate of glass *A*, mica or equivalent, which picture has been first rendered semi-transparent by oil or by any of the ordinary means in present use; and the attaching of the two plates *A* and *B* together, so as to give the best known effect to a photograph picture *A*.

No. 6633. Manufacture of Soap.*(Fabrication du savon.)*

Andrew J. Stewart, St. John, N. B., 7th October, 1876, (extension of Patent, No. 1175), for 5 years.

Claim.—The combination of dissolved borax, spirits of ammonia, naphtha and spirits of turpentine with ordinary soap.

No. 6634. Car Brake. *(Frein de wagon.)*

Enoch Farnsworth, Paunxutawuey, Pa., U. S., 9th October, 1876, for 5 years.

Claim.—1st. The combination with a car truck *l* of the motionial frame *4* shaft *5*, friction wheels *3* having spools *7* and intermediate band wheel *6* and band *20* having connection with the car axle *8*; 2nd. The combination with the frame *4* and its adjuncts, of the connecting rods *9*, lever *10* and lever *11* operated to give combined motionial effect to the frame, whereby the brakes are operated; 3rd. The arrangement and combination with the frame *4* and its adjuncts, of the chain *14*, lever *15* and rod *17* and *18* to operate the brakes; 4th, in combination with the frame *4* and its adjuncts of one car, the frame *4* and its adjuncts of another car, the chain *19* and rod *21*, whereby connection is formed throughout a train for braking the wheels simultaneously.

No. 6635. Weft Stop Mechanism.*(Mécanisme des touches de trame.)*

Frederick O. Tucker, Hartford, Ct., U. S., 11th October, 1876, for 5 years.

Claim.—1st. In combination with the lay, the lever *b* and operating mechanism comb *c*, locking piece *h* and dagger *g*; 2nd. The combination of the dog *d*, lever *b* and comb *c* with the cam *f*.

No. 6636. Whip Socket. *(Porte-jouet.)*

John J. Shairer, Saline, Michigan, U. S., 11th October, 1876, for 5 years.

Claim.—The bent lever *B* provided with ears *b* *b* and pivots *c* *c* made solid therewith, which turn in perforations *a* *a* of tube *A*.

No. 6637. Improvements in Harness.*(Perfectionnements dans les harnais.)*

John W. Boulden, Durham, Ont., 11th October, 1876, for 5 years.

Claim.—1st. The side pads *A* attached to the sliding plates *B*, in combination with the trees *F* and turret rings *D*; 2nd. Making a joint *G* in the centre of the bridge of a back band.

No. 6638. Milk Cooler. *(Rafraîchissoir à lait.)*

Michel Beaugard, Ely, Que., 11th October, 1876, for 5 years.

Claim.—The vat *A* and rests *B*, *B*, and the combination of the same with the ordinary milk pans *D*, *D*.

No. 6639. Process of Manufacturing Meal from Pumpkins.*(Procédé de fabrication de la farine de citrouille.)*

Theodore F. Guy, Port Dover, Ont., 11th October, 1876, for 5 years.

Claim.—The process of grinding into meal pumpkins previously dried for that purpose, so as to produce an article which can be supplied to the public in a compact and portable form at all seasons.

No. 6640. Improvements on Spittoons.*(Perfectionnements aux crachoirs.)*

Pierre C. Ste. Marie, Montreal, Que., 11th October, 1876, for 5 years.

Claim.—1st. The peculiar funnel-shaped lid *C* having the ring *F*, in combination with the cup *B* of the spittoon *A*; 2nd. In combination with a spittoon *A*, a set of three casters pivoted triangularly to the bottom of the spittoon *A* to make a self-travelling spittoon *A*.

No. 6641. Improvements on Grinding Mills.*(Perfectionnements aux moulins à blé.)*

Lewis B. McDonald, Wytheville, Va., U. S., 11th October, 1876, for 15 years.

Claim.—1st. The vertical runner having the ribbed cone, provided with a spiral eccentric horn, in combination with the fixed stone having a hollow eye, and the ribbed annulus secured therein; 2nd. The conical ribbed crusher *H* having a threaded boss, and screwed upon the end of the runner-shaft whereby it is adapted to be adjusted in the cavity of the runner; 3rd. The runner *A* provided with the ribbed cone *H*, in combination with a fixed stone having a ribbed annulus to work in contact with the cone; 4th. The stone *B* having notched plate or ears, the lateral guides *g*, the shaft *B*, arm *c* and screw rod *d* passing through said arm, and fixed in the frame of the machine.

No. 6642. Pulp Barrel Machine.*(Machine à baril en pâte.)*

George W. Laraway, Port Byron, N. Y., U. S., 11th October, 1876, for 5 years.

Claim.—1st. A die or pressure mould for compressing a pulpy material into cylindrical form consisting of an exterior shell whose segments move radially and an interior shell whose segments move spirally; 2nd. A compressing die whose segmental exterior and interior shells are movable independently to and from the position occupied by them when the cylindrical body they form is completed; 3rd. The interior shell constructed of segments hinged together; 4th. The combination of hinged segments 6 with the foot plate 54; 5th. The combination of the die or pressure mould, the pipe 27 enclosing its lower end and the ring gate 68; 6th. The combination of the gate 71 and valve 70 with the pipe 27; 7th. The combination of the segmental interior shell with the core piece; 8th. The combination of the segment supporting plates 29 with the exterior segments 31; 9th. The combination of the segment supporting plates 29, segments 31 and press rings 34 35; 10th. The combination of the exterior segmental shell with the press rings 34 35.

No. 6643. Improvements on Ploughs.*(Perfectionnements aux charrues.)*

Sidney Smith, Sr. (as Trustee for the Acton Plough Co., Assignee of William Stephenson), Acton, Ont., 11th October, 1876, for 5 years.

Claim.—1st. The beam A having clevis head P, standard C, projections D E and bifurcated handles B B integrally formed therefrom; 2nd. The beam A formed triangular in cross section rearward of the standard C and forward of the same of rectangular form, for combining lightness and strength; 3rd. The combination of land side H pivoted to the standard C near its forward end and provided with loop or keeper 1, the beam A, provided with downwardly projecting arm D and the vertical set screw J, said screw working in a socket in the lateral portion of the arm and pivoted to the keeper, and the keeper and land side adapted to slide on the arm; 4th. The beam A having curved standard C whose lower end is provided with a triangular socket formed wholly therein in combination with the share G having tapering triangular projection for attachment to the standard.

No. 6644. Improvements on Lathes for Turning Irregular Forms.*(Perfectionnements aux tours à tourner les objets de forme irrégulière.)*

Alexander Fleck, Ottawa, Ont., 11th October, 1876, for 5 years.

Claim.—1st. The disk D having yielding arms *e* projectable; 2nd. The expandible elastic or yielding support or rest consisting of the disk D having arms *e*, elastic cushions *b* and blocks *g* mounted thereon, and the disk F provided with a volute groove *g* which engage with eccentric projections *p* on the blocks *g*; 3rd. The expandible elastic or yielding support or rest having the springs *j* for retracting the arms *e*; 4th. In combination with the rotary frame provided with rotary centres or arbors I having spur wheels *m* and spring lever clutch, M, the toothed ring J and cam K attached to the main frame A and operating to turn the blanks A, and present their different faces to the cutter C automatically.

No. 6645. Manufacture of Vehicle Gearing.*(Fabrication des trains de voitures.)*

James McPhail, Mitchell, Ont., 11th October, 1876, for 5 years.

Claim.—1st. The centre bar A; 2nd. The stay rods H H H and the position and mode of attaching the stay rods to the axles' head block and centre bar by means of shackles; 3rd. The method of combination of the stay rods H H H with centre bar A, springs B B, head blocks E, king bolt F, yoke or clevis G, shackles I with axles D D.

No. 6646. Improvements on Skates.*(Perfectionnements aux patins.)*

John M. Lamb, London, Eng., 11th October, 1876, for 5 years.

Claim.—1st. Fitting the sole plate to slide forward along the runner to bring the toe clips into a position to admit the sole between them, and back again to draw the clips back until they grip the wide part of the sole; 2nd. Connecting the sole plate to the runner by slotted ear pieces or flanges bent down from the sole plate and taking into horizontal guides formed on the runner to admit of the longitudinally sliding movement of the sole plate; 3rd. In combination with the longitudinally sliding sole plate the laterally adjustable toe clips and the heel grip formed on the end of and in one with the waist portion of the sole plate; 4th. In combination with the longitudinally sliding sole plate, of the lever for sliding it back and forth pivoted to the runner; 5th. Extending the upper extremity of this lever back to form a heel grip; 6th. A skate having a sole plate sliding longitudinally and fitting the heel plate adjustably to the runner.

No. 6647. Can Opener.*(Machine à ouvrir les boîtes métalliques.)*

Alfred E. Ames, Montreal, Que., 11th October, 1876, for 5 years.

Claim.—The head *a* in combination with the projection *e* and blade *f*, whereby the invention is adapted for cutting circular openings or opening approximate to the configuration of the vessel to be opened.

No. 6648. Improvements in Coal Sifters.*(Perfectionnements aux cribles à charbon.)*

Peter W. Peckham, New York, U. S., 11th October, 1876, for 5 years.

Claim.—1st. The rim band handle D in combination with the cylindrical vessel A; 2nd. The cover H with rim *f*, slot *g* and lid J.

No. 6649. Improvements in Ash Sifters.*(Perfectionnements aux cribles à cendres.)*

Peter W. Peckham, New York, U. S., 11th October, 1876, for 5 years.

Claim.—The handle C in combination with the ash sifter B and the cylinder A.

No. 6650. Combined Coal Scuttle and Sifter.*(Panier-crible à charbon.)*

Peter W. Peckham, New York, U. S., 11th October, 1876, for 5 years.

Claim.—The circular disc C with perforations *e* and handle D with perforated centre piece *d*, in combination with the coal scuttle A with the centre rod *b*.

No. 6651. Bag Turning Machine.*(Machine à tourner les sacs.)*

Itwell S. Judson and Frank H. Van H. sten, Matteawan, N. Y., U. S., 11th October, 1876, for 5 years.

Claim.—In a machine for turning bags inside out, the combination of the cylinder B with the adjustable mouth-piece *a*, piston G with the valve *h*, crank I, shaft J, connecting rod N and adjustable table D.

No. 6652. Thill Coupling. (Ajustage de limonière.)

Callender I. Calvert, Philadelphia, Pa., U. S., 11th October 1876, for 5 years.

Claim.—1st. The plate B having a forwarded projection under the thill to retain the rubber cushion or pad C; 2nd. The pin F having a key *b*, in combination with the thill E and coupling checks D having a recess receiving the same.

No. 6653. Cow-milker. (Machine à traire le lait.)

Callender I. Calvert, Philadelphia, Pa., U. S., 11th October 1876, for 5 years.

Claim.—The thimble C having tubes D connecting with the tubes A, and provided with a plug E.

No. 6654. Apparatus for Treating Wood for the Production of Charcoal, Acetic Acid, Wood Spirits, &c.*(Appareil à traiter le bois pour la fabrication du charbon, de l'acide acétique, esprit de bois, &c.)*

Henry M. Pierce, Detroit, Mich., U. S., 11th October, 1876, for 5 years.

Claim.—1st. The combination of one or more tubes or flues having openings into the kiln with dampers shut off and outlet flue, with suitable floors properly inclined and guttered for the withdrawal of the gases and liquid products of combustion from the kiln; 2nd. In combination with a charcoal kiln having flues or tubes with dampers, valves, shut off and outlet, and with suitable floor and gutters, a recovering or separating chamber where the acetic acid is captured directly from the gases, and tubes having stop cocks or trap-connecting such kiln with such chamber and such chamber with the condenser proper, and an exhaustor for withdrawing the gases from such kiln through said chamber and condenser; 3rd. A combination of flues or tubes with dampers, stop cocks and valves with a separating chamber condenser and exhaust fan or projector for preserving the kiln and for relieving the kiln from strain, cracks, &c.

No. 6655. Combined Asphalt and Wood Pavement. (Parage mixte en asphalte et en bois.)

David Ewart, Ottawa, Ont., 11th October, 1876, for 5 years.

Claim.—The combination of the asphalt C with the wood A.

No. 6656. Door and Shutter Fastener.*(Arrête-porte et arrête-persienne.)*

Charles J. Ferguson, Philadelphia, Pa., U. S., 11th October, 1876, for 5 years.

Claim.—A pintle A to the top of which is pivoted a latch or cross piece B, in combination with an eye or socket A having one or more vertical slots *d* with which the latch automatically engages.

No. 6657. Improvements on Turbine Water Wheels.*(Perfectionnements aux roues-turbines hydrauliques.)*

Asa J. Stott and John Fletcher, Philadelphia, Pa., U. S., 11th October, 1876, for 5 years.

Claim.—1st. The combination of the cylinder *a*, wheel *i* and chute *k*; 2nd. The wheel *i* having buckets of decreasing area as they descend; 3rd. The wheel *i* having buckets of decreasing incline as they descend; 4th. The chutes formed in *k* having decreasing area as they descend.

No. 6658. Improvement on Soaps, Pomades, Cosmetics, &c.*(Perfectionnement des savons, pommades, cosmétiques, &c.)*

Frederick J. Cleaver, London, Eng., 11th October, 1876, for 5 years.

Claim.—The combining of terobene with soaps, pomades, cosmetics and the like, while such articles are in their liquid or melted condition, whereby they are rendered disinfectants or antiseptics.

No. 6659. Machine for Folding the Edges of Shoe-vamps.*(Machine à remployer les empiègues de chaussures.)*

John W. Lufkin and Richard H. Lufkin, Chelsea, Mass., U. S., 11th October, 1876, for 5 years.

Claim.—1st. In combination with the work supporting bed A the vertically reciprocating blade *b* and stationary shearing block T arranged to operate relatively to each other; 2nd. In combination with a work supporting bed A and a vertically reciprocating cutting blade, the feeding bar J and presser bar I arranged above the work and operating together and relatively to each other; 3rd. In combination with the work supporting bed A mechanism for folding and pressing the edge of the material when fed along wherein are employed the block U and presser W, or any other devices for producing the same result; 4th. In combination with the cutting blade *b* and feed bar J and presser bar I, the folding block U and fold presser W operating together and relatively to each other; 5th. An elastic or yielding fold presser consisting of block X and presser W, or any other devices. 6th. In combination with mechanism for successively feeding and folding the work a device *f* or its equivalent for applying an adhesive substance to the edge to be so folded.

No. 6660. Improvements on Handles for Pocket and other Knives.*(Perfectionnements aux manches d'outaux pliants et autres.)*

Herman Funke, New York, U. S., (Assignee of Joseph W. Gardner), 11th October, 1876, for 15 years.

Claim.—1st. A lining for the handles of pocket and other knives having the bolster *e* formed by bending a portion of the lining so as to lap over the scale. 2nd. The overlapping tip *b*.

No. 6661. Improvements on Saw Mill Dogs.*(Perfectionnements aux clameaux de scieries.)*

Joseph Van Norman, Tilsenburg, Ont., 11th October, 1876, for 5 years.

Claim.—The manner of effecting the downward and drawing motion to the teeth *c c c c*, by means of the combination of the sliding bolts *h h h* and the slides or openings B and B *b*.

No. 6662. Improvements on Wardrobe*(Perfectionnements aux crochets de garde-robes.)*

James E. Bryan, Humboldt, Kan., U. S., 11th October, 1876, for 5 years.

Claim.—The combination with the suspending bar A of the hinged spring clamp bar C, the ends of the same being curved respectively downwards and upwards.

No. 6663. Improvements on Feather Renovators.*(Perfectionnements aux machines à rafraîchir la plume.)*

Nathan P. Chaney, Potsdam, N. Y., U. S., 18th October, 1876, for 5 years.

Claim.—1st. The combination of section A provided with lugs C covered sediment chamber G, steam pipes F L, heating chamber I and shaft N having agitating arms with the section B provided with notched flanges D and door E. 2nd. The provision to the drum B of the conductors O connected to a ventilating shaft. 3rd. The provision to the drum B of the removable lining P.

No. 6664. Machine for Manufacturing Tongued and Grooved Lumber.*(Machine à fabriquer le bois bavelet.)*

Philip P. Josef, Buffalo, N. Y., U. S., 19th October, 1876, for 5 years.

Claim.—1st. The method of forming the tongues in tongued and grooved lumber by means of a series of upper and under cutters; 2nd. The divided spindles S S, in combination with the pulleys P P and the heads E E.

No. 6665. Steam Cylinder Lubricator.*(Graisseur de cylindre à vapeur.)*

Ransom C. Luce and George S. Woodruff, Grand Rapids, Mich., U. S. (Assignees of Elijah McCoy), 19th October, 1876, for 5 years.

Claim.—1st. The combination of the chamber B, the regulating tube *t* open from top to bottom and having perforations *x* and the valve *d* with stem *e* and valve seats *a b*; 2nd. The passages *m* and *n* formed in the double valve *d c*.

No. 6666. Hook for Catching Fish and Game.*(Hameçon pour le poisson et le gibier.)*

Benjamin F. Smith and William K. Bowman, Philadelphia, Pa., U. S., 19th October, 1876, for 5 years.

Claim.—1st. The shank A terminating in a disc B having passages for the hooks *d d*; 2nd. The crown D forming a base for the attachment of the hooks *d d* and affording a passage for the shank; 3rd. The latch C, dog F and bait holder G, arranged and combined for conjoint operation; 4th. The combination of shank A, disc B, crown D and spiral spring E; 5th. The combination of shank A, disc B, latch C, crown D, hooks *d d*, spring E, dog F and bait holder G.

No. 6667. Improvements on Water Engines and Pumps.*(Perfectionnements aux machines hydrauliques et aux pompes.)*

George Wells, Montreal, Que., 19th October, 1876, for 5 years.

Claim.—1st. The cylinder *g* having convex surface *h* and port *l*, in combination with concave surface *d* having ports *i* and *k*; 2nd. The cylinder *g* in combination with brackets *x* provided with adjustable bearings. 3rd. The cylinder *g*, cover *u* and port *r* combined. 4th. The combination of the casing *t*, discharge *r* and oscillating cylinder *g*; 5th. The cylinder *g* having port *l*, in combination with concave surface *d* having port *k* and vessel *p*.

No. 6668. Manufacture of Belt Pulleys.*(Fabrication des riens à courroies.)*

Augustus L. Bricknell, London, Eng., and Alexander A. Hall, Nashville, Tenn., U. S., 19th October, 1876, for 15 years.

Claim.—1st. Casting a solid rim in a mould having a voiding non-chilling core and a permanent face surface, whereby a well finished belt face and a practically circular rim is economically attained. 2nd. Separately casting the hub and the rim the former with its arms or their equivalents being cast in any suitable manner and the latter cast in a mould having a permanent face surface and a yielding non-chilling core, the two parts being concentrically arranged and united together at the joints, whereby smooth faced and practically concentric pulleys may be economically produced. 3rd. A belt pulley having a solidly cast rim and a separately cast hub with arms which are united to the rim.

No. 6669. Car-coupling.*(Attelage de wagon.)*

Joseph W. Bates, Joseph W. Bates, Jr., Minneapolis, Minn., Rudolph Borgersrode and Charles O. Borgersrode, Philadelphia, Pa., U. S., 19th October, 1876, for 5 years.

Claim.—1st. The draw-head A constructed with interior rounded jaws *a a* and side opening *bb*. 2nd. The coupling bar D constructed with central bulge *i*, and spear-shaped heads *h h* having concave shoulders *x x*; 3rd. The combination of the draw-head A provided with the interior rounded jaws *a a*, and the coupling bar D provided with the spear-shaped heads *h h* having concave shoulders *x x*. 4th. The L shaped tripper C hinged within the draw-head and operating in combination with the coupling bar D; 5th. The apron C hinged within the draw-head and operating in combination with the coupling bar D.

No. 6670. Letter File and Binder.*(Liasse groupe-lettres.)*

Newton S. Ots, New York, U. S., 19th October, 1876, for 5 years.

Claim.—1st. In combination with the binding machine B provided with the clamping bar P the pointed needles L L attached to binding bar K and flat or channelled binding strip R; 2nd. In combination with the permanent binding covers O O and the binding bar K carrying needles L, the flat or channelled binding strip R operating to permanently bind letters or papers; 3rd. In combination with the binding machine B and covers A, the clasp M pivoted to lower cover A; 4th. In combination with the sockets *g* and *i* attached respectively to the base of the binding machine B and lower cover A and the sliding clasp *h*. 5th. In combination with the binding machine B, the clamping bar P when provided with the raised handles P₁ and P₂; 6th. The strips or wings N N₁ projecting from the base and inside of the covers O O and operating as a binding device, in combination with a bar or bars armed with a series of needles or wires tapering to a point, or provided with eyes or slotted near their points, and an auxiliary binding strip or bar either channelled flat or tubular.

No. 6671. Life Raft.*(Bateau de sauvetage.)*

George Thompson, Kingston, Ont., 19th October, 1876, for 5 years.

Claim.—1st. The duplex semi-elliptic pontoons A and B hinged together. 2nd. The pontoons A and B hinged together and provided with a cork or wood casing E peripherally. 3rd. The pontoons A and B hinged together and having the casing E and the cork or wood bottom F; 4th. The pontoons A and B hinged together, provided with the following stanchions H carrying a net work I. 5th. The pontoons A and B having an automatically acting catch D; 6th. The pontoons A and B hinged together and provided with compartments G.

No. 6672. Art of Preparing and Preserving Tanning Solution.*(Art de préparer et conserver les solutions tanniques.)*

James Foley, Montreal, Que., 19th October, 1876, for 5 years.

Claim.—1st. The process of employing bisulphate of lime and sulphate of soda, separately or combined, in the preparation of tanning solutions by adding them to water to be used for leaching bark and for preparing tanning solutions from other substances and adding them to solution prepared in the ordinary way; 2nd. The process of preserving tanning solutions, preventing and arresting the decomposition of the tannic acid and its conversion into gallic acid, and of destroying the effect of the coloring matter or dye in tanning solutions, which consists in the employment of bisulphate of lime and sulphate of soda or their equivalents, either separately or combined, with tanning solutions. 3rd. The process of preparing and preserving tanning solutions by means of water impregnated with the fumes of brimstone or by adding to water previous to being used, liquid sulphurous acid. 4th. The process of preparing tanning solutions by means of moistening or impregnating bark with bisulphate of lime, sulphate of soda and liquid sulphurous acid, either separately or combined previous to the bark being saturated with water.

No. 6673. Improvements on Beehives.*(Perfectionnements aux ruches.)*

Henry Roush, Simm, Iowa, U. S., 19th October, 1876, for 5 years.

Claim.—1st. The floor of a beehive constructed with a recess, the surface of which is covered or faced with glass or analogous material. 2nd. A four-sided inclined recess *n* made in the bench *a*, the sides of which recess are covered with glass, in combination with the hole *r* and door *t*.

No. 6674. Improvements on Churn Dashers.*(Perfectionnements aux batte-beurre.)*

Albert G. Kerr, Clapham, Que., 19th October, 1876, for 5 years.

Claim.—In combination with the dasher shaft A, the revolving head B pivoted thereto by the pin C, having spirally arranged radial wings E

No. 6675. Improvements on Saw-mill Carriages. (*Perfectionnements aux charriots de scieries.*)

Florence A. Beckwith and Hiram W. Webster, (Administrators of the estate of the late Nelson F. Beckwith, Berlin, Wis., U. S., 19th October, 1876, for 5 years.

Claim.—1st. A standard or head-block for saw mill carriages through the face of which hooks L M are adapted to be simultaneously projected in opposite directions. 2nd. A standard or head block for saw mill carriages constructed with a central vertical slot in its face for the projection of the hooks; 3rd. A hook arranged in the angle of such standard and adapted to be projected upward through its face to hold a log or cant from slipping or turning upon the head-block; 4th. The combination of a reciprocating frame with a series of hooks which are adapted to be simultaneously projected in opposite directions through a vertical slot in the standard; 5th. The head block A B provided with a vertical central slot, in combination with the reciprocating frame, the downwardly curved hooks L L pivoted to said frame, the bars D F and the lever I; 6th. The head-block A B provided with a vertical central slot, in combination with the reciprocating frame, the hooks L L, connecting links G R, lever H and dog M; 7th. The combination of the upper and lower hooks with the connecting bars F I D J and the operating lever H; 8th. The combination of the supporting guide plate K with the slotted standard and the hooks and their attachments.

No. 6676. Improvements on Corsets.

(*Perfectionnements aux corsets.*)

Frederick Crompton, Chatham, Ont. 19th October 1876 for 5 years.

Claim.—1st. A corset composed of the parts 1 2 3 4 5, of the open seams between parts 2 and 3, and 4 and 5, provided with eyelet holes and furnished with a lace whereby the part of the corset fitting over the hips is held from turning out of shape, and the adjustment of the corset regulated to fit the body. 2nd. A corset having the open seams at both sides of the hips provided with a lacing, hooks and eyes, clasp or elastic web for adjusting the corset.

No. 6677. Improvements on Cigarettes.

(*Perfectionnements aux cigarettes.*)

John R. Lomas, New-Haven, Conn., U. S., 19th October, 1876 for 5 years.

Claim.—1st. A cigarette covering made from mica and provided with bands of paper on other material which hold it together, and hold over the ends for retaining the tobacco. 2nd. The combination in a cigarette of the mica covering and the wrapper of paper or other material.

No. 6678. Machine for Cancelling Postage Stamps and Post Marking Letters.

(*Machine a maculer les timbres-poste et timbrer les lettres.*)

Timothy G. Palmer, Shuteville, and Henry P. Clark, Poughkeepsie, N. Y., U. S., 19th October, 1876, for 5 years.

Claim.—1st. A pressure roller provided with a stop to be moved by the letter or paper as inserted, in combination with a continuously rotating printing roller and a coupling that is moved to contact the motor to the printing mechanism. 2nd. The combination with the impression roller *f* and printing roller *t* of the locking lever *e* and stops for arresting the movement of the impression roller, then stopping the printing roller and then liberating the impression roller. 3rd. The combination in a stamp cancelling or post marking machine of the laterally moving delivery fingers *l*, their actuating lever *v* and cam *w* with the printing and impression rollers and the stop movements of the same. 4th. The combination, in a stamp cancelling or post marking machine, of the continuously revolving motor, mutilated gears and intermediate pinion *d* with the impression roller *f* and yielding bearings *c*.

No. 6679. Machine for Crimping and Folding Leather. (*Machine a cambrer et plier le cuir.*)

John E. Wheeler, Lynn, and Frederick W. Coy, Boston, Mass., U. S., 19th October, 1876, for 5 years.

Claim.—1st. The work support A formed upon its upwardly presenting face; 2nd. The combination of the feed roll C, work support A and presser N arranged in relation to each other to crease the work as it is fed; 3rd. The cutting tool I conversely shaped upon its edge to the work support A; 4th. The combination of the cutting tool I with the work support A, feed roll C and presser N; 5th. The combination of a cutting and creasing mechanism with the following mechanism; 6th. The combination of a feed roll C, pivoted at *e* and provided with arm *ca*, with the cam D; 7th. The combination of a feed roll C pivoted at *e* and provided with arm *ca*, with the hinged rod *a* and nut *b*; 8th. The combination of an eccentrically hinged jaw F, having a bearing on shaft *e*, with lever H and cam G; 9th. The combination of the jaw F with the lever H provided with the set screw *d*, whereby the jaw is adjusted in relation to the table; 10th. The combination of two operating shafts E M, one above the work support operating by means of cam L, the vertically reciprocating cutting tool and the other below the table operating by means of cams D and G, the feed roll C and the eccentrically hinged jaw F respectively.

No. 6680. Improvements on Packages for Cigars. (*Perfectionnements dans l'emballage des cigares.*)

Charles Bundy, New York, U. S., 19th October, 1876, for 5 years.

Claim.—The flexible pouch A made with partitions *a b* to constitute compartment *d* for cigars, said pouch being closed at one end and open at the other and made shorter than the cigars which it is intended to contain.

No. 6681. Lettering Attachment for Street Lamps. (*Ajustage des inscriptions aux lanternes des rues.*)

William H. McEleheran, Hamilton, Ont., 19th October, 1876, for 5 years.

Claim.—1st. In combination with a street lamp a metallic frame composed of the pieces B C, corner irons D, the whole held together by bolts and nuts *a c* respectively for holding stamp letters for indicating the names of streets

by night as well as by day; 2nd. The construction of letters E provided with base F for support, with or without flange F and burra G G to enable them to be held between metallic plates B C or their equivalent device.

No. 6682. Preparation of Fish for Market.

(*Préparation du poisson pour le marché.*)

Charles W. Gauthier, Sandwich, Ont., 19th October, 1876, for 5 years.

Claim.—1st. The mode of preparing fish for market and transportation by freezing them in moulds singly or in parcels of two or three adapted to pack compactly in casks or boxes so that, when packed, each fish or the frozen parcel of fish is removable from said cask or box without disturbing the remainder; 2nd. A package of fish for transportation composed of fish frozen in moulds conforming to the shape of the package and packed separately or independently in parcels two or three; 3rd. The use of pans or moulds divided into curved or straight chambers A for freezing fish.

No. 6683. Steam Engine. (*Machine à vapeur.*)

Alonzo W. Eldridge, Big Rapids, Mich., U. S., 19th October 1876, for 5 years.

Claim.—The valves D D mounted upon the rock shaft C in combination with the hollow elevated valve seat B provided with the ports *a a b b*.

No. 6684. Improvements on Stoves.

(*Perfectionnements aux poêles.*)

Sherman S. Jewett, Francis H. Root and Josiah Jewett (assignees of Gaylord S. Sturard), Buffalo, N. Y., U. S., 19th October, 1876, for 5 years.

Claim.—1st. The combination with the fuel magazine E, of the surrounding downward air passage F, cylinder H and ring G, provided with recesses admitting an air current at the bottom of the magazine in an inward and downward direction. 2nd. The combination with the fuel magazine E provided with openings *m*, of the surrounding downward air passage L provided with damper *t*.

No. 6685. Machine for Pegging Boots and Shoes. (*Machine a cheviller les chaussures.*)

Oscar L. G. Noble, Chelsea, Mich., and Trent T. Prosser, Chicago, Ill., U. S., 19th October, 1876, for 5 years.

Claim.—1st. The combination of the stationary horn terminating in a solid tip or axial, and the feed for moving the boot or shoe thereon, adapted to rotation on an axis coincident with the axis of the peg driver. 2nd. The combination of the stationary horn, the pegging head, the rotary slide bar, the feed lever, connected therewith, and means for periodically reciprocating said slide bar; 3rd. The combination of the stationary horn, the pegging head, the cogged rotary slide bar, the feed lever connected therewith, the cylindrical reciprocating rack and the pinion which transmits motion from the rack to the slide bar; 4th. The combination of the cylindrical reciprocating rack and the pinion and cogged slide bar, adapted to rotate in unison around said rack constituting a mechanical movement for transmitting motion at right angles in any radial direction. 5th. A horn having a return curve. 6th. A horn pivoted at the base, so that it may be swung around to turn its axis up away from under the peg driver. 7th. The mechanism of the equivalent thereof combined with a hinged pegging head, for periodically compressing the boot or shoe bottom between said pegging head and the horn. 8th. The combination of the peg driver, the cross head thereof, the oscillating arm *N* having an annular slot *n*, the pitman connected adjustably to said arm and the bar *N*, the movements of the parts being properly timed with reference to the action of the boot or shoe bottom compressing mechanism; 9th. The combination of the wire feed rolls, the ratchet wheel and pawls for moving said feed rolls, the loose pinion carrying a ring which covers a portion of the teeth of the said ratchet wheel, the hinged pegging head supporting all the elements just enumerated, the stationary rack of the stand of the machine and the horn or an equivalent boot or shoe support. 10th. The combination of the ratchet wheel, with multiple pawls. 11th. The combination of the ratchet wheel, for moving the wire feed rolls, the loose pinion, the pawl and pawls and the open ring around the ratchet wheel adjustably secured to the pinion; 12th. The combination of the peg-driver and the slotted wire tube in the pegging head; 13th. The combination of the peg-driver, the slotted wire tube in the pegging head, and the wire feed rolls; 14th. The combination of the slotted wire tube and the reciprocating wire guide; 15th. The combination of the slotted wire tube and the reciprocating wire-indenter; 16th. The combination of the aligned slotted wire tube and peg tube with the shears and wire guide, the movements of which are timed with reference to one another. 17th. The combination of the reciprocating bar K and the indenter adjustably connected thereto; 18th. The combination of the slotted wire tube, the wire guide and the indenter; 19th. The combination with the arm of the hinged pegging head the buffer spring *C*; 20th. The combination of the hinged pegging head and the spring *O*; 21st. The combination of the hinged pegging head, the spring *O* and the weighted arm, for counterbalancing the normal stress of said spring on the pegging-head; 22nd. The combination with the driving-shaft of the machine, of the brake mechanism, adapted to always stop the machine at a point within a predetermined range.

No. 6686. Churn Power. (*Moteur de baratte.*)

Valentine H. Tisdale, Hamilton, Ont., 19th October, 1876, for 5 years.

Claim.—1st. A standard A with a slotted hook B with clutch at lower end with a bolt passing through, fastening it on one side of standard, making it adjustable to grip any height of churn in place of two permanent clutches B with a slot H at the top of standard A; 2nd. A leg or fork G with a slot I at the top; 3rd. A fly wheel D attached to centre of standard A with a stud having a slotted spoke J to which is attached one end of a connecting rod E, by means of an adjustable stud, the other end being attached to a lever or beam F working on a stud in slot H at the top of standard making it adjustable.

No. 6687. Manufacture of Boots and Shoes.

(*Fabrication des chaussures.*)

Charles E. Vaughan, St. John, N. B., 19th October, 1876, for 5 years.

Claim.—The quarter A and the shape thereof, and the method of putting the same on the vamp.

No. 6688. Water-Proof Prunella.*(Prunelle imperméable.)*

Edward D. Westgate and James G. Davie, Montreal, Que., 19th October, 1876, for 5 years.

Claim.—1st. The art of preparing or rendering prunella water-proof by treating it in a solution of alum and a solution of stearate of soda; 2nd. The art of preparing or rendering prunella water-proof by treating it with a solution of alum and a solution of soap.

No. 6689. Manufacture of White Bricks, &c.*(Fabrication des briques blanches.)*

Thomas M. Clark, Ottawa, Ont., 19th October, 1876, for 15 years.

Claim.—A composition of matter composed of from one-fourth to one-third, or thereabouts, of shell marl, and from three-fourths to two-thirds of aluminous clay or thereabouts, the proportions varying according to the quantity, more or less, of oxide of iron contained in the clay.

No. 6690. Art of, and Machine for, Making Screw Stocks.*(Art de faire les filières à coussinets et machine pour cet objet.)*

Samuel Vanstone and John W. Hoard, Providence, R. I. U. S., 19th October, 1876, for 5 years.

Claim.—1st. A machine for making a thread or threads on a continuous wire shaping rollers provided with grooves adapted to impart to the wire a form somewhat elliptical in cross section, and also longitudinal groove or their equivalent; 2nd. The shaping rollers provided with grooves having diagonal scores therein; 3rd. The combination with a pair of geared roller shafts of a hub upon one of the shafts made adjustable thereon relatively to its gear.

No. 6691. Art of Making Screw Stocks.*(Art de faire les filières à coussinets.)*

Samuel Vanstone and John W. Hoard, Providence, R. I. U. S., 19th October, 1876, for 5 years.

Claim.—1st. Rolling the metal to a somewhat oval form grooved or flattened on two opposite sides, and then passing the same between rolls each having a semi-cylindrical groove, that is obliquely scored or chased, said scores being such as to produce the spiral thread or threads; 2nd. A continuous wire or rod having throughout its length screw threads rolled thereon and projecting above the cylindrical body of the wire and adapted to be cut up into pieces of proper lengths for screws or threaded nails; 3rd. A continuous rod or wire for screws or nails rolled with raised threads thereon alternating with cylindrical or unthreaded portions; 4th. A screw or screw blank having crescent shaped eccentric threads projecting from a cylindrical stock.

No. 6692. Improvements on Hubs.*(Perfectionnements aux moyeux.)*

Levi N. Bewley, Corning, and Arthur R. Coleman, Canisteo, N. Y., U. S., 21st October, 1876, for 5 years.

Claim.—1st. The cap E having screw threaded necks *f f* in combination with the wooden hub C having screw threaded band D and the axle box B having screw threaded end C; 2nd. The caps E E' having screw threaded necks *e e f f'*, the wooden hub C having screw threaded bands D D' and the axle box B having screw threaded ends *c c*.

No. 6693. Improvements in Stoves.*(Perfectionnements dans les poêles.)*

John W. Elliot, Toronto, Ont., 21st October, 1876, for 5 years.

Claim.—1st. The combined heating and cooking chamber F provided with detachable covers J and perforated bottom, in combination with the coal feeder C, fire chamber B and exterior enclosing flue H; 2nd. The flue H passing around the exterior of the chamber F, in combination with the fire chamber B and pipes E; 3rd. The spider G in combination with feeder C, chamber F and fire pot; 4th. The hot air pipe K in combination with the combined heating and cooking chamber F, provided with the regulating inlet damper K'.

No. 6694. Device for Preventing Backlash of Machinery.*(Appareil pour empêcher les contre-coups des machines.)*

John A. Hafner, Philadelphia, Pa., U. S., 21st October, 1876, for 5 years.

Claim.—1st. The spring A composed of two or more plates or leaves of varying thickness from the inner to the outer one, and having the loop *b* and hook *a*; 2nd. The hub B having central flange *d* and a notch *e* for the hook *a* of the spring A when constructed larger on one side of said flange than on the other.

No. 6695. Process of Preserving Lobsters.*(Procédé de conservation des homards.)*

Joseph C. Ayer, Amherst, N. S., 21st October, 1876, for 5 years.

Claim.—Cooking the carcase in the shell, washing the shell with diluted acetic acid, drying the shell, coating or smearing it with oleaginous matter, freezing the carcase in the shell, the lobster to be kept in such frozen state until used.

No. 6696. Improvements on Step Ladders.*(Perfectionnements aux échelles à queue.)*

Charles H. Warren, Toronto, Ont., 21st October, 1876, for 5 years.

Claim.—The bracket A with projecting box *a* having a corrugated crown piece *c* in combination with the supporting legs C.

No. 6697. Improvements on Saw-horses.*(Perfectionnements aux chevaux de scieurs de bois.)*

Charles H. Warren, Toronto, Ont., 21st October, 1876, for 5 years.

Claim.—The legs A pivoted upon the rung B, with or without the washers C, in combination with a brace plate D or its equivalent.

No. 6698. Improvements on Steam Radiators.*(Perfectionnements aux radiateurs de vapeur.)*

William B. Snow, Brooklyn, N. Y., U. S., 21st October, 1876, for 5 years.

Claim.—The hollow sections A A united at or near their opposite ends, alternately and respectively, by means of cylindrical or approximately straight screw nipples B and tapering screw nipple C of a less diameter than the interior of the sockets which receive the nipples B.

No. 6699. Improvements on Clothes Horses.*(Perfectionnements aux sècheirs à linge.)*

Charles H. Warren, Toronto, Ont., 21st October, 1876, for 5 years.

Claim.—1st. The graduated hinged end bars B connected by the cross rails C; 2nd. The hinged stop pieces D in combination with the cross rail F.

No. 6700. Metallic Packing for Stuffing Boxes.*(Garniture métallique pour les boîtes d'étoupes.)*

Robert Bloomfield, Montreal, Que., 21st October, 1876 for 5 years.

Claim.—1st. The combination of the gland neck *e*, rings *g* and ring *k*; 2nd. The ring having recesses *k* and flats *l*; 3rd. The rings *g* and gland neck *e* having perforations *m*, in combination with space *f* and junk ring *h*.

No. 6701. Machine for Generating and Carburetting Gas.*(Machine à produire et à carburer le gaz.)*

Charles A. White, Hartford, Ct., U. S., 21st October, 1876, for 5 years.

Claim.—1st. The combination of the gasometer B, with the fixed perforated distributing cone C; 2nd. The combination with the gasometer B, of the perforated cone C and perforated diaphragm D; 3rd. The combination with the tank or reservoir A of the gasometer B provided with trap screw *d*, cone C and diaphragm D, the compound carburetter E and pipe F.

No. 6702. Machine for Shaving and Nicking Wood Screws.*(Machine à planer et fendre les vis à bois.)*

Charles D. Rogers, Providence, R. I., U. S., 21st October, 1876, for 5 years.

Claim.—1st. The plate Y operated in combination with the teeth *n* by mechanism; 2nd. In combination with the chuck shaft of a shaving and nicking machine, the gearing consisting of wheel T, cog D² and plate C, arranged and operated from the main shaft.

No. 6703. Improvements of Steam Actuated Car Brakes.*(Perfectionnements des freins à vapeur de wagons.)*

John F. Degnon, St. Louis, Mo., and Charles D. Leet, Springfield, Mass., U. S., (Assignees of Horace H. Taylor and Albert McCarnish), 21st October, 1876, for 5 years.

Claim.—1st. The combination with the cylinder of a steam or air actuated car brake of supply pipes at each end of said cylinder, and automatically operating valves, whereby decrease of pressure within the main supply pipe operates to automatically supply air from one side of the piston to the opposite side of the same, thereby equalizing the pressure upon the piston, and allowing it to return to its normal position, at a slight expense of power; 2nd. The combination of the wing valve *yu* with the hollow piston I and spiral spring L, and leather packing ring *h* and slide valve *du*.

No. 6704. Improvements on Step Ladders.*(Perfectionnements aux échelles à queue.)*

Obediah Sherwood, Jr., Sutton Flat, Que., 21st October, 1876, for 5 years.

Claim.—1st. The combination with a step ladder A, having the supporting frame B, of a sliding extension ladder section D provided with a pawl engagement E for its support; 2nd. The combination with a step ladder A, having the supporting frame B and extension section D, of the extension prop composed of two sections I G slidingly adjustable; 3rd. The combination with a step ladder A, having the supporting frame B, of the ladder section D having a pawl stop E and extension prop composed of sections I G having a pawl and ratchet engagement J K.

No. 6705. Scroll Saw.*(Scie à feeder.)*

Miller Boughner, Port Dover, Ont., 21st October, 1876, for 5 years.

Claim.—1st. The manner of constructing the eccentric N and its method of working against the friction wheel O and lever P, so that at each revolution of N the lever P and its connections Q R E and C the saw have as many down strokes communicated to them as there are sides to the eccentric N; 2nd. The combination with the eccentric N of the springs S and corals T by which the saw is sustained and lifted after each down stroke and its working secured.

No. 6706. Hydraulic Elevator.*(Elevateur hydraulique.)*

Timothy Stebins, Boston, Mass., U. S., 21st October, 1876, for 5 years.

Claim.—1st. The hollow cylinders A and E, in combination with the hollow piston D and cross head C; 2nd. The hollow cylinders A and E and hollow piston D, in combination with the piston F and cross head C; 3rd. The hollow cylinders A and E and hollow piston D, in combination with the piston F, hollow rod S, piston G, rod I and cross head C.

No. 6707. Improvements on Lamps.*(Perfectionnements aux lampes.)*

Charles T. Spencer, Rochester, N. Y., U. S., 25th October, 1876, for 5 years.

Claim.—1st. The combination with the rod A and horizontal oil reservoir, provided at each end with a burner, of the adjustable collar and its thumb nut for holding the reservoir in any desired position; 2nd. In combination with the horizontal reservoir the annular filling cup and cap, the latter adapted to slide upon the supporting rod for the purpose of removal in order to allow the lamp to be filled; 3rd. In combination with the horizontal reservoir the partitions located between the burners and perforated at the bottom dividing the reservoir into three compartments, the central of which

serves as a distributing reservoir for supplying the others with oil and preventing the oil from accumulating at either end in case the reservoir is thrown out of a horizontal position; 4th. The combination with a lamp of an annular drip chamber having an open mouth and communicating with the lamp reservoir by means of suitable apertures for collecting and returning any waste oil carried over by capillary attraction.

No. 6708. Improvements in Sewing Machines.

(*Perfectionnements aux Machines à coudre.*)

William Muir, Montreal, Que., (Assignee of David M. Smyth), 30th October, 1876, for 5 years.

Claim.—1st. In a sewing machine having the working parts below the plate, the combination therewith of a disc rotated by the ordinary driving apparatus and acting either directly or indirectly by means of projections from its face and periphery upon slides or levers giving lateral movement to the feed, and by arresting its backward motion suspending its forward movement; 2nd. The disk or variable cam G; 3rd. The screws P Q and R acting to throw out of gear the variable feed mechanism.

No. 6709. Improvements on Postage and Revenue Stamps.

(*Perfectionnements aux timbres de poste et du revenu.*)

William W. Bierce, Memphis, Tenn., and John C. Spencer, New York, U. S., 30th October, 1876, for 5 years.

Claim.—1st. In a postage stamp, a portion of the face of which is raised above the contiguous parts thereof and is surrounded with perforations or indentations; 2nd. In a postage stamp, a portion of the face of which is raised and surrounded with perforations or indentations when the corresponding portion of the back thereof is uncoated with adhesive material.

No. 6710. Improvements on Sleighs.

(*Perfectionnement aux traîneaux.*)

Benjamin F. Sweet, Fond du Lac, Wis., U. S., 30th October, 1876, for 5 years.

Claim.—The combination with the wooden knee c, gripe or clip B, beam 1, the runner and uprights a a of the metallic socket having lugs or projections on its sides and under surface, and loosely fitted to the runner and uprights to allow the play or freedom of movement.

No. 6711. Leather Shaving Tool.

(*Outil pour dorer les cuirs.*)

Jason Smith, Boston, Mass., U. S., 30th October, 1876, for 5 years.

Claim.—1st. The combination of the handle A, hinged arm B, two edged knife a and thumb screw f; 2nd. The combination of the handle A, hinged knife a, gauge b and spring c.

No. 6712. Gas Regulator and Purifier.

(*Régulateur et épurateur à gaz.*)

Charles C. Place, Somerville, Mass., U. S., 30th October, 1876, for 5 years.

Claim.—1st. The combination of the T-pipe A, provided with the cap B, and filtering box C with the lower part D of a gas regulator, for purifying the gas introduced into said regulator; 2nd. The gas regulator formed by the combination with each other of the part D provided with the shoulder d, the part L provided with the V-shaped ring flange 1 to receive the quick-silver, the cap J, the plate F, the weighted plate H h and the valve K and its adjusting rod G.

No. 6713. Improvements on Cooking Ranges.

(*Perfectionnements aux fourneaux de cuisine.*)

Toussaint Crovier, Montreal, Que., (Assignee of Louis J. Hébert), 30th October, 1876, for 5 years.

Claim.—1st. The combination of the flues 1 u and v and flue g, arranged so that the flues v enter or join together in the flue g from opposite sides, and in u position opposite to one another; 2nd. The combination of the ovens d and furnace f, having spaces s between them; 3rd. The combination of the openings c, spaces u and r and opening b; 4th. The longitudinally sliding bolt f attached by parts g and h, in combination with catch i.

No. 6714. Process for Reducing Nickel Ore.

(*Procédé pour réduire le minéral de nickel.*)

William B. Tatro, Hartford, Ct., U. S., 30th October, 1876, for 5 years.

Claim.—1st. The process of eliminating iron, copper, or other foreign matter from nickel by the combined effects of fusion and chemicals, permitting the nickel to precipitate and then pouring off the foreign matter from the top or tapping off the nickel from the bottom; 2nd. The process of eliminating iron, copper or other foreign matter from nickel by the combined effects of fusion and chemicals, permitting the nickel to precipitate and solidify and then pouring off the iron or other foreign matter in a liquid state.

No. 6715. Hand-Drum Saw. (*Scié de travaux.*)

John Givens, Shakspeare, Ont., 30th October, 1876, for 5 years.

Claim.—1st. The two double cutting teeth A A together; 2nd. The manner in which both the double cutting teeth and double drag teeth are cut, viz: the former from the termination of the cutting part c to the bottom of the tooth d, the latter being cut square from point e to bottom f.

No. 6716. Improvements on Milk Pans.

(*Perfectionnements aux boîtes à lait.*)

George Smith, Cornwall, Ont., 30th October, 1876, for 5 years.

Claim.—The perforated cream lifter A, the air vent E, the combination of these with a rectangular pan having water funnel C and water vent D.

No. 6717. Improvements on Platform Scales.

(*Perfectionnements aux balances.*)

Israel P. Magoon, St. Johnsbury, Vt., U. S., and Ora P. Patten, Montreal, Que., 30th October, 1876, for 5 years.

Claim.—1st. The combination of the pillar c of a platform scales with the level or levels d; 2nd. The combination of the a of a platform scales with the level or levels d; 3rd. The combination of the platform b, the level or levels d; 4th. A platform scales and level or levels d combined.

No. 6718. Railway Car Coupling.

(*Attelage de wagons de railroute.*)

Francis M. Andrews, Natick, Mass., U. S., 30th October, 1876, for 5 years.

Claim.—1st. The combination of the bolt retractor or bar H, slide bolt D, spring E, bolt stopper F and its actuating spring G, all being applied together and to the platform A, coupling head B and bolt case C; 2nd. The combination of the staple I, provided with the notch f and the latching catch e with the notch bolt retractor H, slide bolt D, spring E, bolt stopper F and its actuating spring G, all being applied together and to the platform A, coupling head B and bolt case C.

No. 6719. Improvements on Horse Shoe Nail Plates.

(*Perfectionnements aux carreaux à clou à cheval.*)

Joseph M. Laughlin, Boston, Mass., U. S., 30th October, 1876, for 5 years.

Claim.—1st. A nail plate provided with a series of indentures or of depressions c c c, for the formation of the levels or points of the nails punched therefrom; 2nd. A nail plate provided with a continuous groove or recess formed by removing a part of the stock, by means of milling, planing or otherwise, for the formation of the bev'els or points of the nails punched therefrom.

No. 6720. Car Coupling. (*Attelage de wagons.*)

Andrew Wald, Davenport, Iowa, U. S., 31st October, 1876, for 5 years.

Claim.—The combination of the draw-head A, weighted dog D having projections b and tooth b and coupling pin E, the several parts being designed to operate in connectio with the coupling link.

No. 6721. Improvements on Voltaic Batteries.

(*Perfectionnements aux piles voltaïques.*)

John E. Watson, Louisville, Ky., U. S., 31st October, 1876, for 5 years.

Claim.—1st. The lead tube C made conical at the bottom, perforated through the conical portion and arranged in connection with the jar A, the zinc pole and the cover B; 2nd. A battery solution formed of zinc sulphate, lead acetate and water adapted for use in connection with the sulphate of copper, metallic lead and metallic zinc; 3rd. A battery consisting of the jar A, lead funnel C, zinc G, sulphate of copper and solution of sulphate of zinc and acetate of lead combined.

No. 6722. Process and Apparatus for Converting Blood into a Fertilizer.

(*Procédé et appareil pour convertir le sang en engrais.*)

Henry O. P. Lissagary, Pautin, France, 31st October, 1876, for 5 years.

Claim.—1st. The coagulating of such blood by the mechanical action of stirring (barottage) by steam under high pressure in suitable vessels provided with, or without, other stirrers; 2nd. The spontaneous and mechanical separation of the serum water effected by the mechanical action of steam under high pressure and the subsequent filtering and compressing or drying of the coagulum; 3rd. A fertilizer consisting of blood when first coagulated by steam under high pressure, the coagulum then filtered, and when so filtered subjected to high pressure by mechanical means or desiccated; 4th. A desiccating apparatus consisting essentially of a wheel actuated by centrifugal force in combination with a furnace or other source of heat supply; 5th. The combination with the heat supply pipe F revolving wheel H and casing L, eduction pipe O, flue O and chimney D of a suction device for exhausting the heated and saturated gases from the apparatus and creating a draft; 6th. The combination of the wheel H with the casing L and inlet and outlet pipes F O arranged and constructed to permit the wheel to rotate freely in said casing; 7th. The wheel H divided into compartments having suitable doors in combination with the conical inlet funnel I and hub h when constructed to operate as set forth; 8th. The combination with the wheel and casing the inlet pipe F and outlet pipe O of the thermostats K K, the thermometer o and the atmospheric air inlet aperture e, for regulating and determining the heat in the wheel and casing.

No. 6723. Improvements on Seed Drills.

(*Perfectionnements aux semoirs traceurs.*)

Benjamin Kuhns and Charles Scholz, Dayton, Ohio, U. S., 31st October, 1876, for 5 years.

Claim.—1st. An outer and inner portion the inner part being pivoted to the outer one and provided with a feed aperture and a lip or plate for preventing the detachment therefrom of the grain conductor when in use; 2nd. The combination of the interior cup having a feed orifice and a projecting lip or plate and the conductor for guiding the grain to the hose; 3rd. The combination of the swinging cup and the perforated projections C C, upon the stationary portion A for adjusting said swinging portion so as to adapt it for the passage of grains of different sizes; 4th. The arrangement of the swinging cup with reference to the stationary one, whereby it is made to admit of the removal of the seed wheels; 5th. A seed cup for grain drills having upon it projections D D and a projecting lip or plate D D, whereby it is made to engage with the conductor E and prevent the same from being detached from the seed cup when in use; 6th. The combination and arrangement of the cup A provided with a lip or plate D D and projections D D with a grain conductor provided with hooks E for attaching it to said cup and a projecting portion E for engaging the lip or plate D D.

No. 6724. Improvements on Corsets.

(*Perfectionnements aux corsets.*)

Electa A. Waterhouse, Clunham, Ont., 31st October, 1876, for 5 years.

Claim.—The combination with a pair of corsets A of the elastic strips C

List of Patents issued up to 16th Nov., 1876, but not yet Officially published in the Patent Office Record.

- No. 6725. S. H. Moore & D. V. Moore, Chicago, Ill. U. S. A. Barn Door Roller, "31st October, 1876.
- No. 6726. F. H. Heph, London, Eng. " Fittings for Horses and Cattle," 31st October, 1876.
- No. 6727. W. S. Hutchinson Chicago Ill U S A Steam Boiler and Furnace, " 6th November, 1876.
- No. 6728. J. Brokenshire Kingston Ont Ships Pumps extension of Patent No 6431 7th November 1876
- No. 6729. J. Brokenshire, Kingston, Ont., Ship's Pumps (re-issue of Provincial Patent No. 3231), 8th November, 1876.
- No. 6730. P. W. Cattnell, Orangeville, Ont., " Liquid Cooler and Reservoir," 9th November, 1876.
- No. 6731. H. E. Fuller, Toledo, Iowa, U. S. A. " Steam Cooking Machine," 9th November, 1876.
- No. 6732. S. Vanstone & J. W. Hoard, Providence R I U S A Screw Blank Machine, " 9th November, 1876.
- No. 6733. A. Williamson, Kingston Ont " Sash Pulley and Method of Hanging Window Sashes, " 9th November 1876.
- No. 6734. G. M. Pratt Middletown Ct. U S A, Drill Chuck, " 9th November, 1876.
- No. 6735. A. Laidlaw Orangeville, Ont., " Separator and Smut Mill, " 9th November, 1876.
- No. 6736. J. M. Parent, Beauport, Que., " Cement," 9th November 1876.
- No. 6737. J. W. Waterman, Oregon, W. S. U. S. A., " Threshing Machine Tooth," 9th November, 1876.
- No. 6738. J. Elliott, Montreal, Que., " Shirt Stretcher, " 9th November, 1876.
- No. 6739. A. D. Ferris & A. N. Ferris Blakeley, Minn. U. S. A., Washing Machine, " 9th November, 1876.
- No. 6740. H. W. Moore, Olean, N. Y. U. S. A., " Compound Metal Working Machine," 9th November, 1876.
- No. 6741. O. W. Bean, Tecumseth, Mich. U S A, Hide Handles, " 9th November, 1876.
- No. 6742. A. Walrath & E. D. Bronson, Amsterdam, N. Y., U. S. A., " Broom Machines," 9th November, 1876.
- No. 6743. J. F. Gordon, Rochester, N. Y., U. S. A., " Self-binding Grain Harvester," 9th November, 1876.
- No. 6744. W. H. Maso & S. Terwilliger, Matteawan, N. Y., U. S. A., " Felling Mills," 9th November, 1876.
- No. 6745. A. J. Goodwin Brookline, Mass., U. S. A., Invalid Bedsteads, " 9th November, 1876.
- No. 6746. J. B. Minihinnick London Ont Oil Cooler Washer and Evaporator " 9th November, 1876
- No. 6747. S. Vanstone & J. W. Hoard, Providence R I U S A "Screw and Bolt Planks," 9th November, 1876.
- No. 6748. N. H. Dolson Chatham, Ont " Car Couplings " 9th November, 1876.
- No. 6749. W. Lawrence, London, Eng., " Heater and Refrigerator," 9th November, 1876.
- No. 6750. W. T. Cleaveland, Richmond Que., " Tubular Fencing," 9th November, 1876.
- No. 6751. C. T. Sleeper, C. G. Jerome & J. M. Hill Chicago Ill U S A., Stalling Box for Steam Engines, " 9th November 1876
- No. 6752. J. McHilde, Strathroy Ont " Spring Coupler and Supporter," 9th November, 1876.
- No. 6753. H. Dillaway Sandwich Mass U S A Lamp and Mould, " 9th November 1876
- No. 6754. E. Stannard, West Brook, Ct. U. S. A., Window Sash Fastener, " 10th November, 1876.
- No. 6755. R. Poole, Baltimore, Md., U. S. A., " Shaft-coupling," 10th November, 1876.
- No. 6756. M. H. Strong Brooklyn, N. Y., U. S. A., Illuminating Gas, " 14th November, 1876.
- No. 6757. F. S. Mantou, Providence, R. I., U. S. A. " Anti-friction Rudder Supporter," 14th November, 1876.
- No. 6758. A. B. Cook Erie, Pa., U. S. A. Shaft coupling, 14th November, 1876.
- No. 6759. J. Reynolds, Philadelphia, Pa., U. S. A., " Furnace Grate," 14th November, 1876.
- No. 6760. T. DeWitt, Chatham, Ont., " Spring Bed Bottom," 14th November 1876
- No. 6761. W. DeLany Cobourg Ont. Lamp Post " 14th November, 1876.
- No. 6762. A. Mephum Fayette, Ohio, U. S. A., " Saw Mill Dog," 14th November, 1876.
- No. 6763. A. B. Walker Liverpool Eng " Brewery Plant " 14th November, 1876.
- No. 6764. J. S. Robinson North East, Pa., U. S. A., Read Organ and Action, " 14th November, 1876.
- No. 6765. T. Tostem Concord Bluffs, Iowa U S A. Improved Chair and Seat, " 14th November, 1876.
- No. 6766. E. Kiss N Y U S " Table Bedstead " 14th November, 1876.
- No. 6767. O. Pickering, Needham Mass U. S. A. " Brush Cutting Implement, " 14th November, 1876.
- No. 6768. A. G. Waggener, (Assignee of A. H. Waggener), Chicago, Ill., U. S. A., " Turbine Water Wheel," 14th November, 1876.
- No. 6769. H. O. P. Lissagary Pantin, France, " Process and Apparatus for Converting Introgenous Substances into a Fertilizer," 14th November, 1876.
- No. 6770. R. D. Bradley, Preston, Md., U. S. A. Apparatus for Generating and Engine for Utilizing, a Motive Gas obtained from Water " 14th November, 1876.
- No. 6771. C. P. Weaver, Norristown Pa. U S A " Tack Machine " 14th November, 1876.
- No. 6772. D. Maxwell Paris Ont " Reaping Machine, " 14th November, 1876.
- No. 6773. L. L. Leathers, Oakland, Cal., U. S. Articial Stone, " 16th November, 1876.

INDEX OF INVENTIONS.

Acid, acetic, H. M. Pierce.....	6654	Feat, D. Alkman.....	6617
Ash sifter, P. W. Peckham.....	6619	Petroleum, D. M. Lamb.....	6631
Asphalt pavement, D. Ewart.....	6655	Photograph, C. C. S. Franks.....	6632
Backlash, preventing, J. A. Hafner.....	6694	Plough, S. Smith, Sr.....	6643
Bag turning, R. S. Judson and F. H. Van Houten.....	6651	Pomade, F. J. Cleaver.....	6658
Barrel, pulp, G. W. Laraway.....	6612	Postage stamp, T. G. Palmer and H. F. Clark.....	6678
Beehive, H. Roush.....	6673	Potato digger, S. Martin.....	6619
Blind closing, W. Jones.....	6630	Pramella, water-proof, E. D. Westgate and J. G. Davle.....	6688
Blood converting, H. O. P. Lisagaray.....	6722	Pulleys, A. L. Bricknell and A. A. Hall.....	6668
Book, E. F. Goodman.....	6598	Pump, G. Wells.....	6667
Boots and shoes, D. A. Sutherland.....	6613	Railway brake, J. F. Degnon and C. D. Leet.....	6703
" " C. E. Vaughan.....	6657	" " E. Farnsworth.....	6634
" " O. L. G. Noble and T. T. Prosser.....	6685	" " car, J. M. Ayer.....	6620
Box, stuffing, R. Bloomfield.....	6700	" " coupling, A. Wald.....	6720
Brake, car, J. F. Degnon and C. D. Leet.....	6703	" " " F. M. Andrews.....	6669
Bricks, white, T. M. Clark.....	6689	" " " J. W. Bates, J. W. Bates, Jr., R. and C. O. Burgersrode.....	6620
Bucket machine, I. Hogeland.....	6624	Refrigerator car, J. M. Ayer.....	6620
Can opener, A. E. Ames.....	6647	Roof, C. M. Warren.....	6606
Car brake, J. F. Degnon and C. D. Leet.....	6703	Saw-mill dog, J. Van Norman.....	6661
" " E. Farnsworth.....	6634	" hand, J. Gives.....	6715
" coupling, A. Wald.....	6720	" horse, C. H. Warren.....	6697
" " J. W. Bates, J. W. Bates, Jr., R. and C. O. Burgersrode.....	6669	" mill, F. A. Beckwith and W. Webster.....	6675
" " F. M. Andrews.....	6715	" scroll, M. Broughner.....	6705
" refrigerator, J. M. Ayer.....	6620	Scales, I. P. Magoon and O. P. Patten.....	6717
Churn dasher, A. G. Kerr.....	6674	Screw, A. W. Gifford.....	6600
" power, V. H. Tisdale.....	6659	" stocks, S. Vanstone and J. W. Hoard.....	6691
Cigarette, J. R. Lomas.....	6677	" wood, C. D. Rogers.....	6702
Cigar package, C. Bondy.....	6630	Scuttle, coal, P. W. Peckham.....	6650
Clothes-horse, C. H. Warren.....	6699	Seed drill, B. Kuhns and C. Scholz.....	6723
Coal sifter, P. W. Peckham.....	6650	Sewing machine, W. Mulr.....	6708
" sifter, ".....	6648	Shoe vamp, J. W. and R. H. Lusklin.....	6659
Cooking range, T. Crevier.....	6713	Shutter closing, W. Jones.....	6630
Corset, F. Crompton.....	6676	" fastener, C. J. Ferguson.....	6656
" E. A. Waterhouse.....	6724	Sifter, ash, P. W. Peckham.....	6649
Cosmetic, F. J. Cleaver.....	6658	" coal, ".....	6648
Damper, S. F. Gold.....	6625	Signal, J. S. Gisborne.....	6607
Door fastener, C. J. Ferguson.....	6656	Skate, J. M. Lamb.....	6616
Electric battery, J. E. Watson.....	6721	Sleigh, B. F. Sweet.....	6710
Elevator, hydraulic, T. Stebins.....	6706	" brake, R. Monary.....	6609
Engine, G. Wells.....	6667	" " G. Campbell and I. Oakley.....	6611
Feather renovator, N. P. Chaney.....	6663	Soap, F. J. Cleaver.....	6658
Fence, C. D. Swanson and J. Menule.....	6623	" A. J. Stewart.....	6633
Fertilizer, H. O. P. Lisagaray.....	6722	Spirits, wood, H. M. Pierce.....	6654
Fish, preparation of, C. W. Gantbler.....	6682	Spittoon, P. C. Ste. Marie.....	6640
Furnace, C. Dion and J. Baylis.....	6604	Stamp, postage, W. W. Hierce and J. C. Spencer.....	6709
Gas generating, C. A. White.....	6761	Steam boiler, B. S. Koll.....	6615
" regulator, C. C. Place.....	6712	" cylinder lubricator, R. C. Luce and G. S. Woodruff.....	6665
Gate, J. Kessler.....	6629	" engine, A. W. Eldridge.....	6683
Grate, G. H. Stansbury, A. S. and H. S. Hubbell.....	6603	" radiator, W. B. Snow.....	6698
Harness, J. W. Boulden.....	6637	Stone extractor, J. Fillico.....	6614
Harvester, C. C. Bradley.....	6605	Stove, G. H. Stansbury, A. S. and H. S. Hubbell.....	6603
Hoe, J. B. Reynolds.....	6616	" S. S. and J. Jewett and F. H. Root.....	6684
Hook, ash, B. F. Smith and W. K. Bowman.....	6666	" J. W. Elliot.....	6693
Hub, L. N. Bewley and A. R. Coleman.....	6692	" pipe, J. Briggs.....	6618
Knife handle, H. Funke.....	6660	Tanning solution, J. Foley.....	6672
Ladder, step, C. H. Warren.....	6696	Thill coupling, C. I. Calvert.....	6652
" " O. Sherwood, Jr.....	6704	Tub, J. S. McMurray.....	6627
Lamp, C. T. Spencer.....	6707	" car, W. Warren.....	6626
Lamps, street, W. H. McElcheran.....	6681	Turbine, water, A. J. Slott and J. Fletcher.....	6657
Lathe, A. Fleck.....	6644	Valve, C. H. Thomson.....	6601
" J. Beaudry.....	6622	" F. Behr and E. W. Lippert.....	6612
Leather crimping, J. E. Wheeler and F. W. Coy.....	6679	Vehicle gearing, J. McPhall.....	6645
" shaving, J. Smith.....	6711	Ventilator, J. Briggs.....	6618
Letter file, N. S. Oils.....	6670	Voltaic battery, J. E. Watson.....	6721
Life raft, G. Thompson.....	6671	Wardrobe hook, J. E. Bryan.....	6662
Lobsters, preserving, J. G. Ayer.....	6695	Water wheel, A. J. Slott and J. Fletcher.....	6657
Lubricator, R. C. Ince and G. S. Woodruff.....	6663	West stov, F. O. Tacker.....	6635
Lumber, grooved, P. P. Josef.....	6664	Whip socket, J. J. Shafer.....	6636
Machinery, backlash of, J. A. Hafner.....	6694	Wood pavement, D. Ewart.....	6655
Meal, pumpkin, T. F. Guy.....	6679	Wood, transferring the grain marks of, J. R. Cross.....	6608
Milk cooler, M. Beauregard.....	6678	Wood treating, H. M. Pierce.....	6654
Milker, C. I. Calvert.....	6653		
Milk pan, G. Smith.....	6716		
Mill, grinding, L. B. McDona d.....	6611		
" stone, B. Barter.....	6621		
Nail, horse shoe, J. M. Laughlin.....	6719		
" J. Varney.....	6599		
Nickel ore, W. R. Tatro.....	6711		
Packing, met-lic, R. Bloomfield.....	6700		
Pail, J. S. McMurray.....	6627		
" car, W. Warren.....	6626		
Pavement, W. Porter.....	6602		
" J. Mather.....	6625		
" D. Ewart.....	6653		

INDEX OF PATENTEES.

Alkman, David, feat.....	6617
Ames, Alfred E., can-opener.....	6647
Andrews, Francis M., car-coupling.....	6715
Ayer, John M., refrigerator car.....	6620
" Joseph C., preserving lobsters.....	6695
Barter, Benjamin, mill stone.....	6621
Bates, J. W. and J. W., Jr., R. and C. O. Burgersrode, car-coupling.....	6669
Bewley, L. N., and A. R. Coleman, hub.....	6692
Baylis, J., and C. Dion, furnace.....	6604

THE
CANADIAN PATENT OFFICE RECORD.

ILLUSTRATIONS.

Vol. IV.

NOVEMBER, 1876.

No. 11.

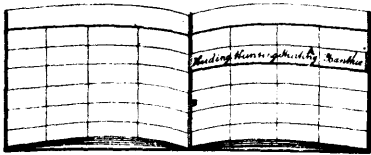

6598 Goodman's Improvement on Copy Books.

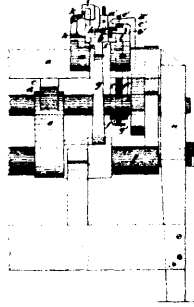

6599 Varney's Horse Shoe Nail Machine.

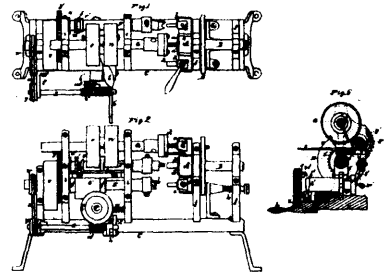

6600 Gifford's Machine for Making Metal Screws.

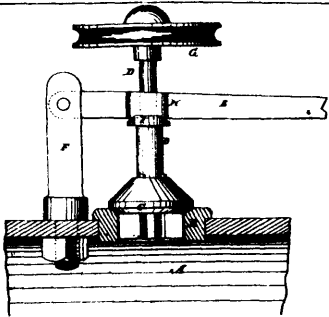

4601 Thomson's Improvement on Safety-Valves.

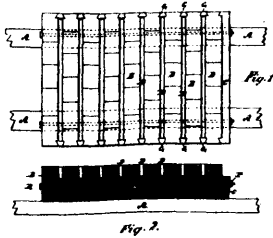

6602 Porter's Improvements on Wood Pavements.

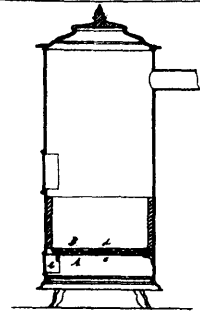

6603 Stansbury and Hubbell's Stove Grate.

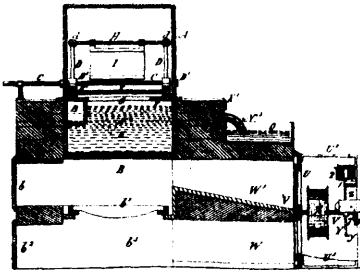

6604 Dion and Bayliss' Automatic Regulator Tempering Furnaces.

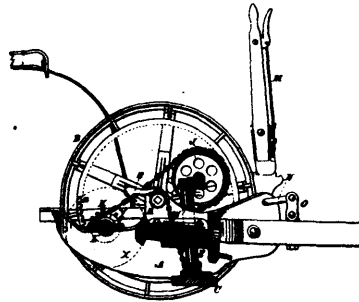

6605 Bradley's Improvements in Harvesters.

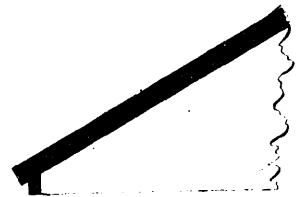

6606 Warren's Improvements on Roofs.

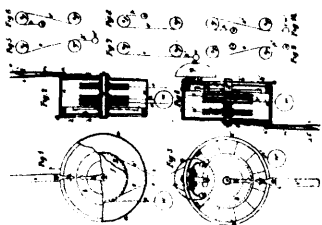

6607 Gisborne's Apparatus for Transmitting and Receiving Signals, &c.

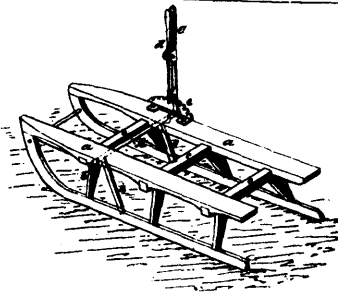

6609 Menary's Improvements on Sleigh Brakes.

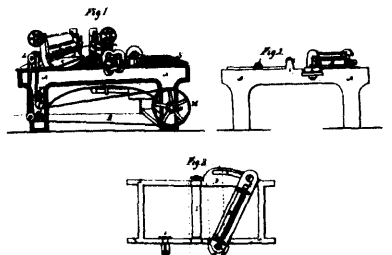

6610 Hewes, Norris, Hall and Sheldon's Door Planing Machine.

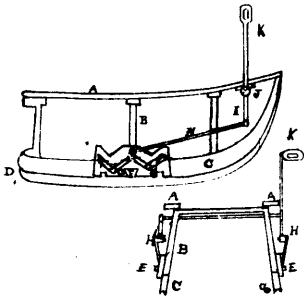

6611 Campbell and Oaker's Improvement on Sleigh Brakes.

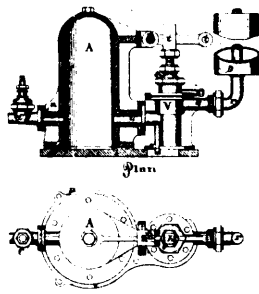

6612 Behr and Lippert's Improvements on Valves.

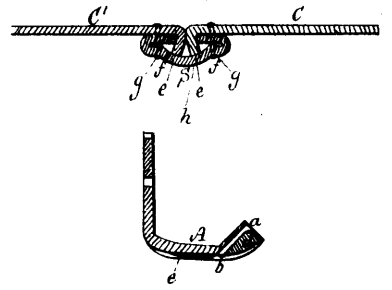

6613 Sutherland's Manufacture of Boots and Shoes

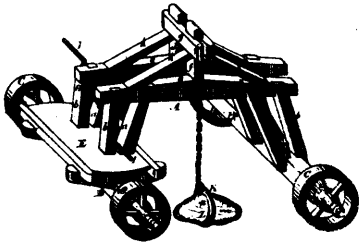

6614 Filion's Stone Extractor.

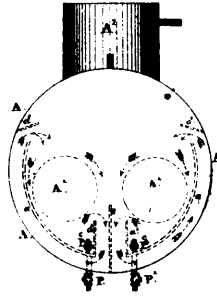

6615 Koll's Improvements in Steam Boilers.

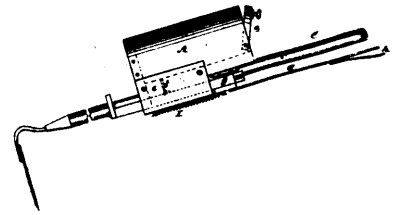

6616 Reynolds' Improvements on Hoes.

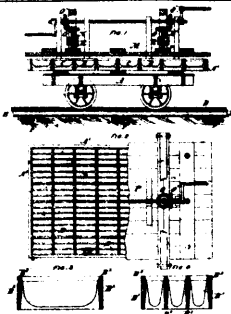

6617 Aikman's Manufacture of Peat.

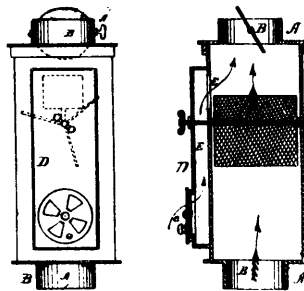

6618 Briggs' Improvements on Stove-Pipe Ventilators.

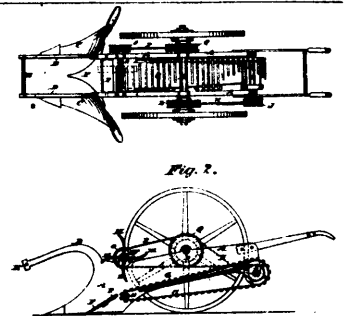

6619 Martin's Potato Digger.

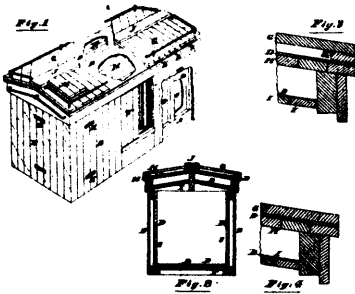

6620 Ayer's Refrigerator Car.

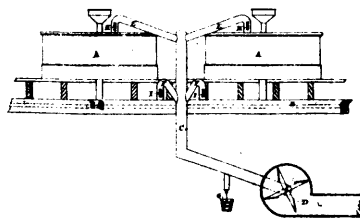

6621 Barter's Steam Exhaust for Mill-Stone Curbs and Conveyors.

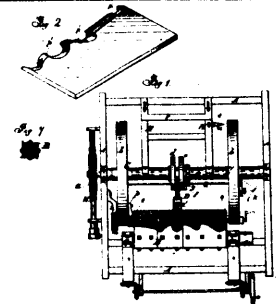

6622 Beaudry's Improvements on Lathes.

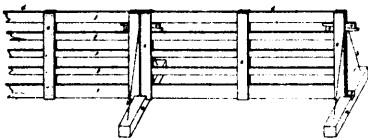

6623 Swanson and Mennie's Portable Fence.

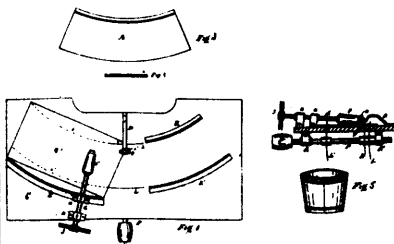

6624 Hogeland's One-Stave Bucket Machine.

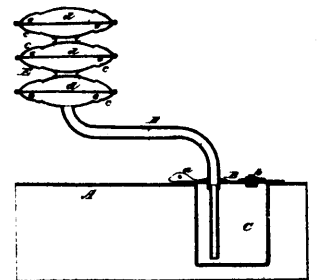

6625 Gold's Automatic Damper.

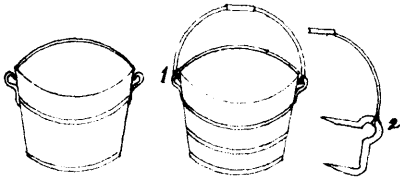

6626 Warren's Pail and Tub Ear.

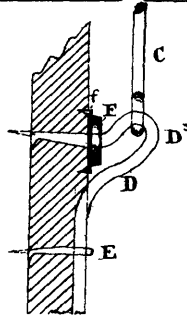

6627 McMurray's Improvements in Pails and Tubs.

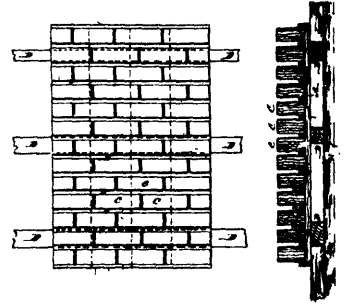

6628 Mather's Wood Pavement.

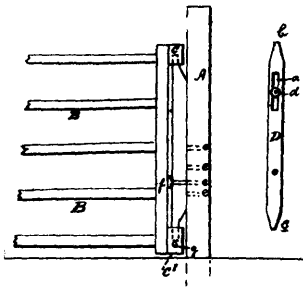

6629 Kessler's Improvement on Gates.

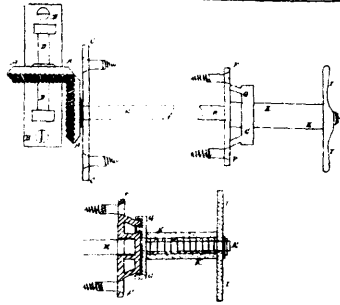

6630 Jones' Machine for Opening and Closing Blinds and Shutters.



6632 Franks' Art of giving Color to Photographs.

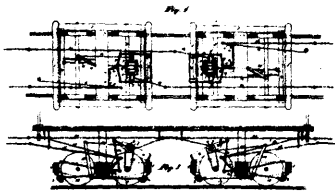

6634 Farnsworth's Car Brake.

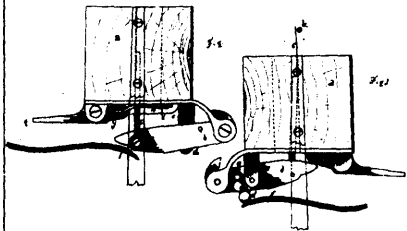

6635 Tucker's Weft Stop Mechanism.

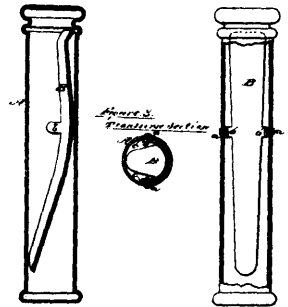

6636 Shairer's Whip Socket.

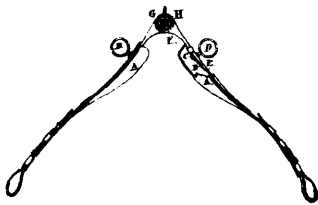

6637 Boulden's Improvements in Harness.

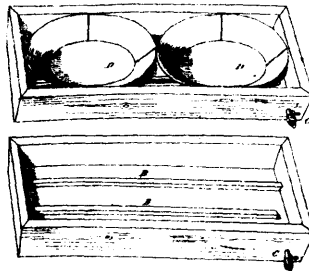

6638 Beaugard's Milk Cooler.

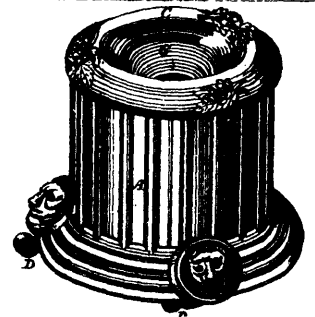

6640 Ste. Marie's Improvements on Spittoons.

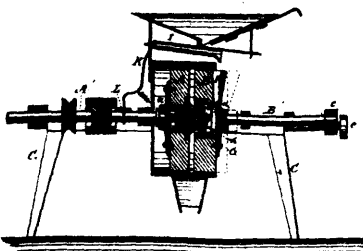

6641 McDonald's Improvements on Grinding Mills.

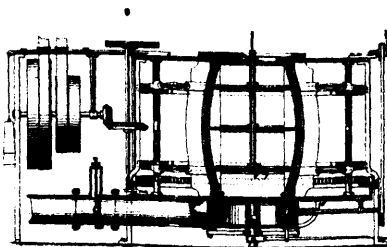

6642 Laraway's Pulp Barrel Machine.

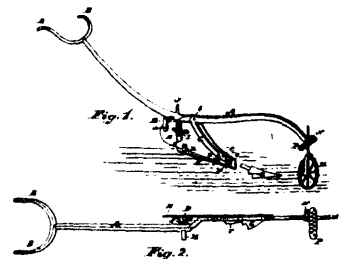

6643 Stephenson's Improvements on Ploughs.

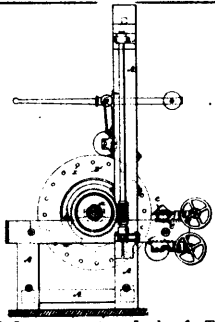

6644 Fleck's Improvements on Lathes for Turning Irregular Forms.

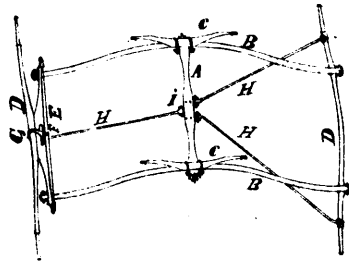

6645 McPhail's Manufacture of Vehicle Gearing.



6646 Lamb's Improvements on Skates.

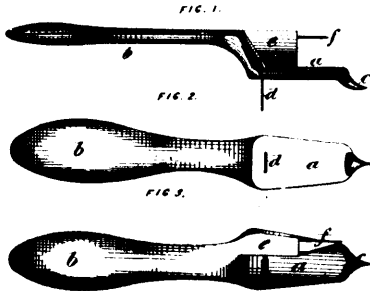

6647 Ames' Can Opener.

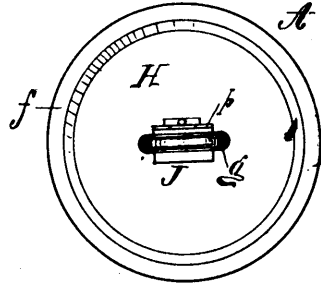

6648 Peckham's Improvements in Coal Sifters.

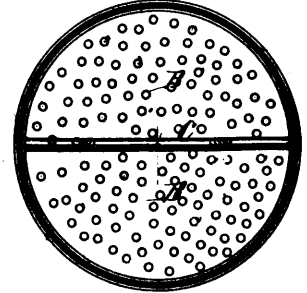

6649 Peckham's Improvements in Ash Sifters.

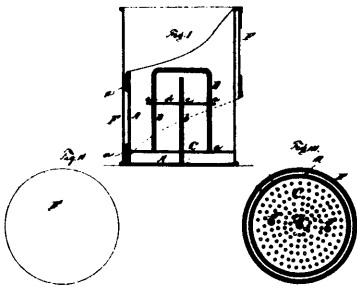

6650 Peckham's Combined Coal Scuttle and Sifter.

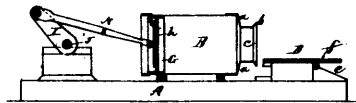

6651 Judson and Van Houten's Bag Turning Machine

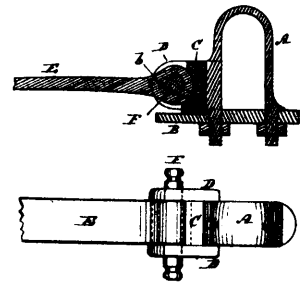

6652 Calvert's Thill Coupling.

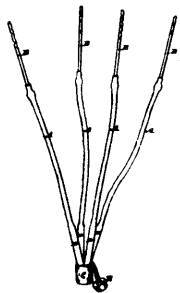

6653 Calvert's Cow-Milker.

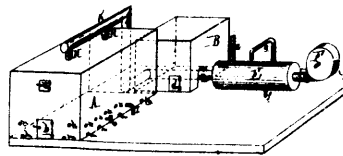

6654 Pierce's Apparatus for Treating Wood, for the Production of Charcoal, Acetic Acid, Wood Spirits, &c.

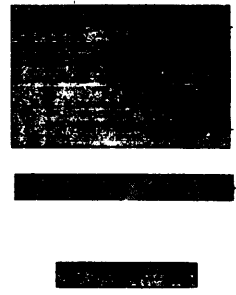

6655 Ewart's Combined Asphalt and Wood Pavement.

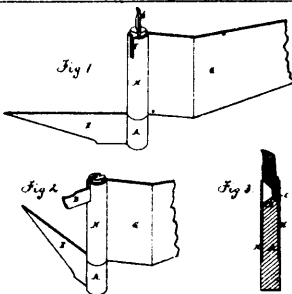

6656 Ferguson's Door and Shutter Fastener.

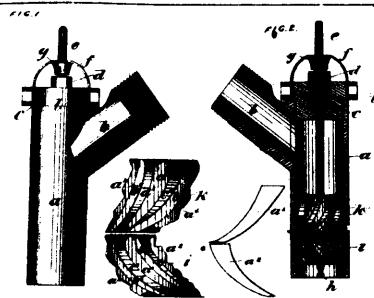

6657 Slott and Fletcher's Improvements on Turbine Water Wheels.

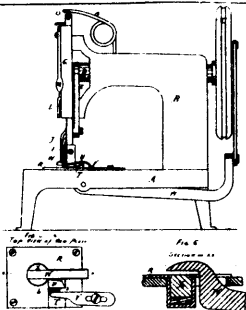

6658 Lufkin's Machine for Folding the Edges of Shoe-vamps.

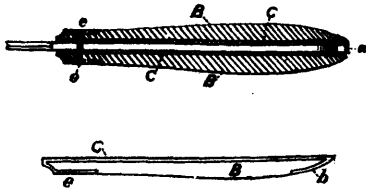

6660 Gardner's Improvements on Handles for Pocket and other Knives.

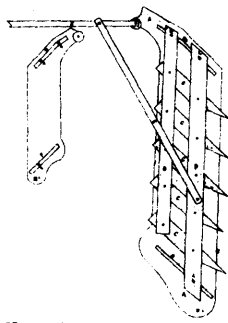

6661 Van Norman's Improvements on Saw-Mill Dogs.

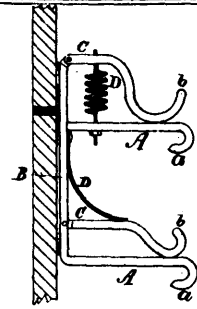

6662 Bryan's Improvements on Wardrobe Hooks.

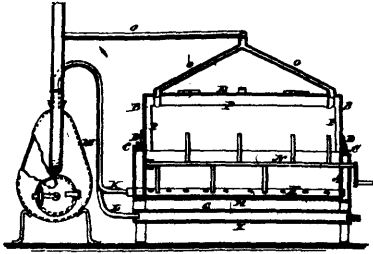

6663 Chaney's Improvements on Feather Renovators.

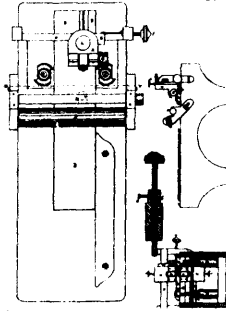

6664 Josef's Machine for Manufacturing Tongued and Grooved Lumber.

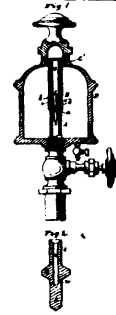

6665 McCoy's Steam Cylinder Lubricator.

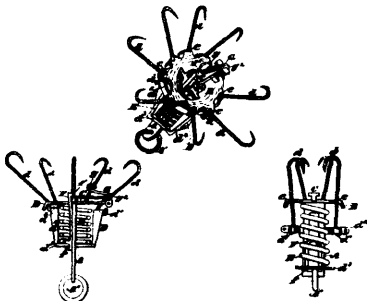

6666 Smith and Bowman's Hook for Catching Fish and Game.

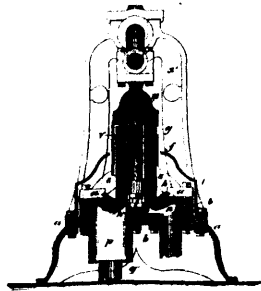

6667 Wells' Improvements on Water Engines and Pumps.

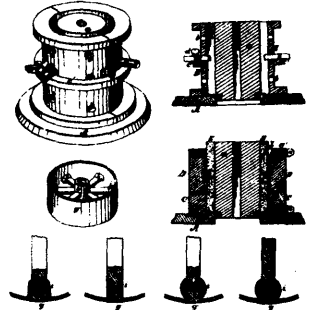

6668 Bricknell and Hall's Manufacture of Belt Pulleys.

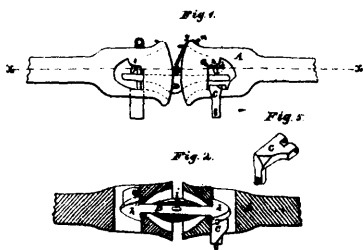

6669 Bates and Bergerode's Car-coupling.

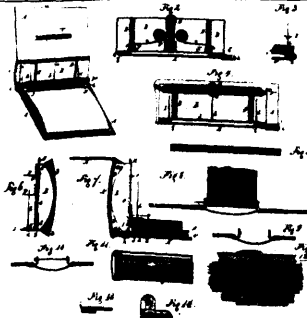

6670 Otis' Letter File and Binder.

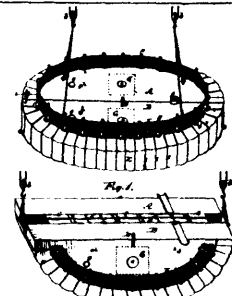

6671 Thompson's Life Raft.

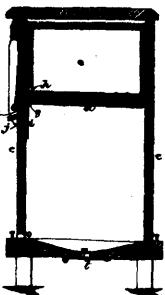

6673 Roush's Improvements on Beehives.

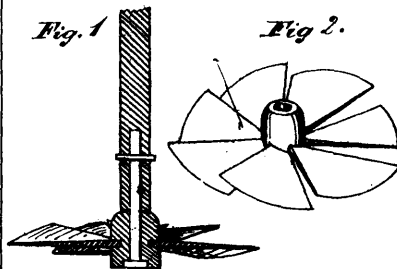

6674 Kerr's Improvements on Churn Dashers.

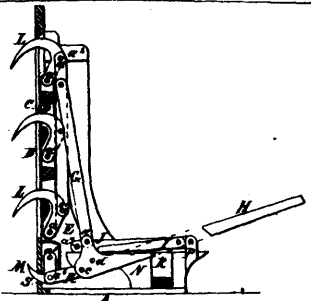

6675 Beckwith's Improvements on Saw-mill Carriages.

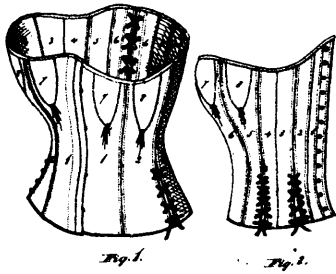

6676 Crompton's Improvements on Corsets.



6677 Lomas' Improvements on Cigarettes.

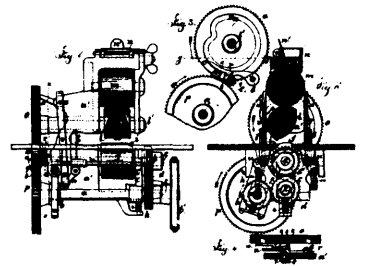

6678 Palmer and Clark's Machine for Cancelling Postage Stamps and Post Marking Letters.

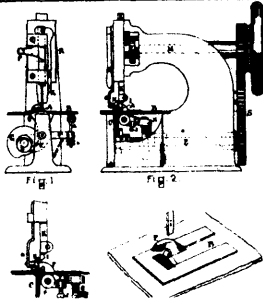

6679 Wheeler and Coy's Machine for Crimping and Folding Leather.

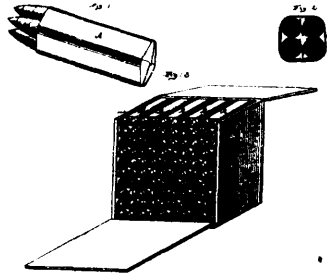

6680 Bondy's Improvements on Packages for Cigars.

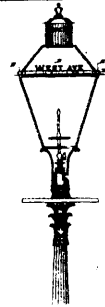

6681 McElcheran's Lettering Attachment for Street Lamps.

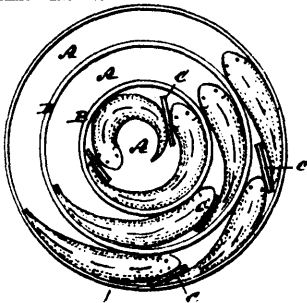

6682 Gauthier's Preparation of Fish for Market.

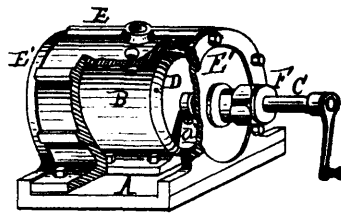

6683 Eldridge's Steam Engine.

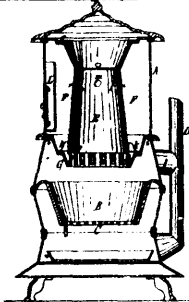

6684 Stanard's Improvements on Stoves.

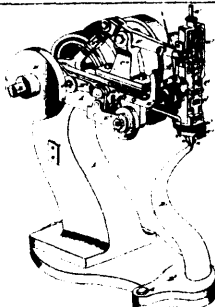

6685 Noble and Prosser's Machine for Pegging Boots and Shoes.

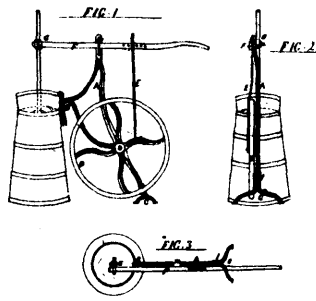

6686 Tisdale's Churn Power.

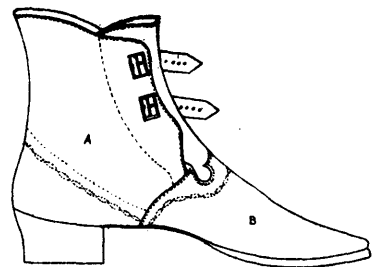

6687 Vaughan's Manufacture of Boots and Shoes.

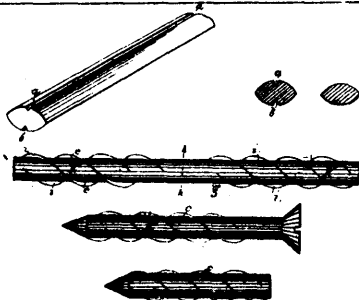

6690 Vanstone and Hoard's Art of, and Machine for, Making Screw Stocks.

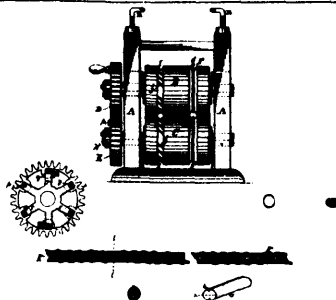

6691 Vanstone and Hoard's Art of Making Screw Stocks.

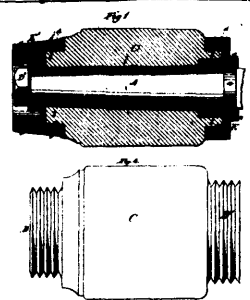

6692 Bowley and Coleman's Improvements on Hubs.

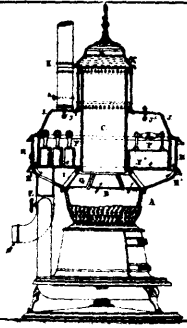

6683 Elliot's Improvements in Stoves.

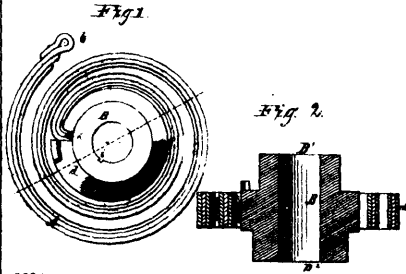

6684 Hafner's Device for Preventing Backlash of Machinery.



6696 Warren's Improvements on Step-Ladders.

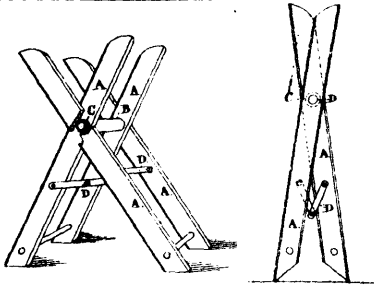

6697 Warren's Improvements on Saw-Horses.

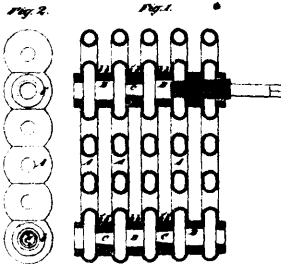

6698 Snow's Improvements on Steam Radiators.

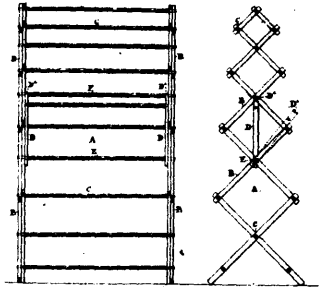

6699 Warren's Improvements on Clothes Horses.

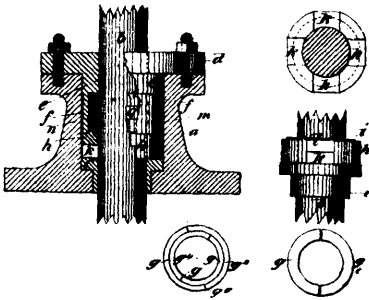

6700 Bloomfield's Metallic Packing for Stuffing Boxes.

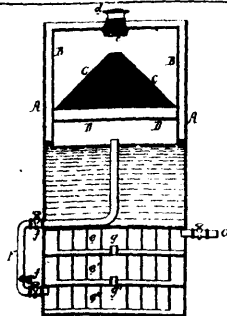

6701 White's Machine for Generating and Carburetting Gas.

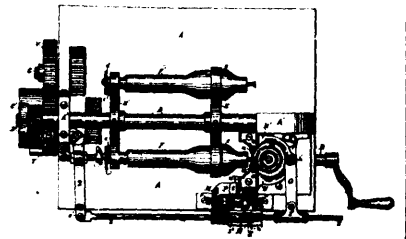

6702 Rogers' Machine for Shaving and Nicking Wood Screws.

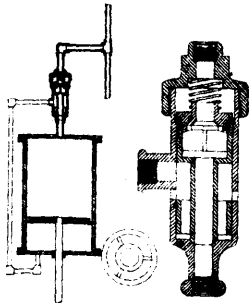

6703 Taylor and McCarnish's Improvement of Steam Actuated Car Brakes.

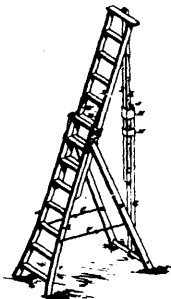

6704 Sherwood's Improvements on Step Ladders.

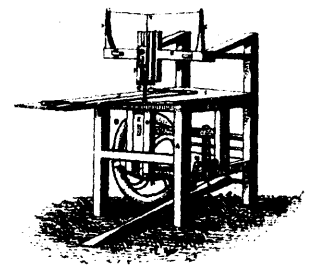

6705 Boughner's Scroll Saw.

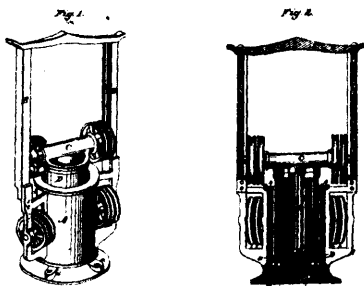

6706 Stebins' Hydraulic Elevator.

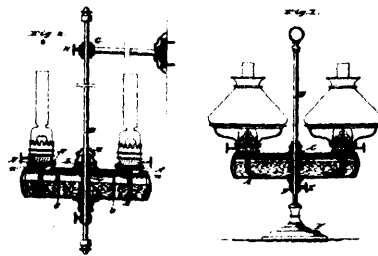

6707 Spencers' Improvements on Lamps.

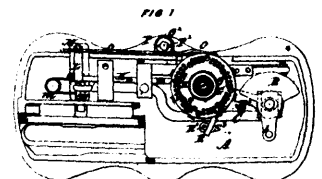

6708 Smyth's Improvements in Sewing Machines.

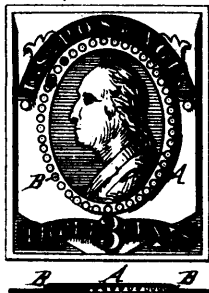

6709 Bierce and Spencer's Improvements on Postage and Revenue Stamps.

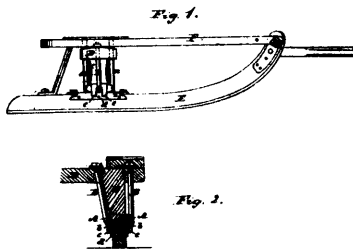

6710 Sweet's Improvements on Sleighs.

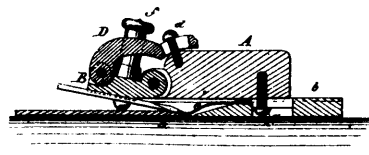

6711 Smith's Leather Shaving Tool.

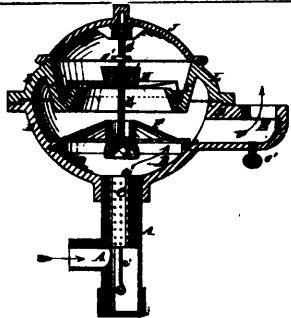

6712 Place's Gas Regulator and Purifier.

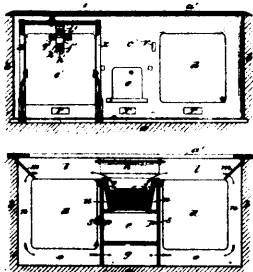

6713 Herard's Improvements on Cooking Ranges.

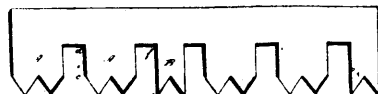

6715 Gives' Hand Drag-Saw.

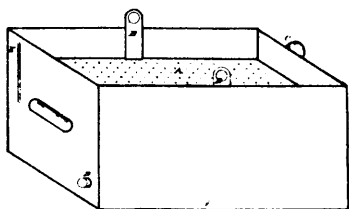

6716 Smith's Improvements on Milk Pans.

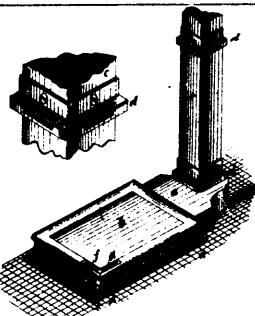

6717 Magoon's Improvements on Platform Scales.

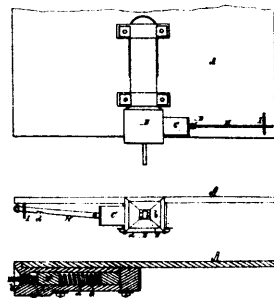

6718 Andrews' Railway Car Coupling.

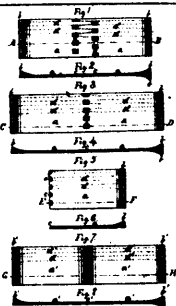

6719 Laughlin's Improvements on Horse Shoe Nail Plates.

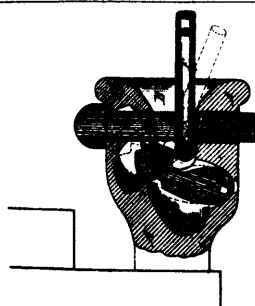

6720 Wald's Car Coupling.

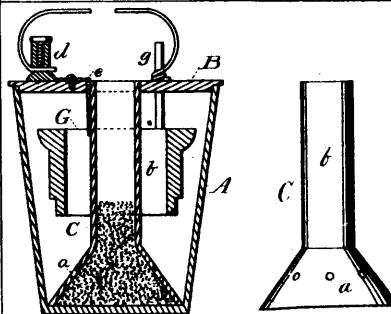

6721 Watson's Improvements on Voltaic Batteries.

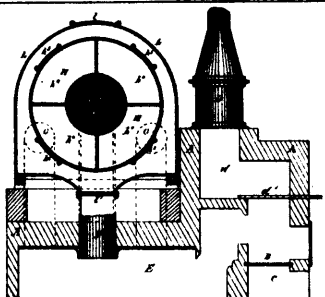

6722 Lissagaray's Process and Apparatus for Converting Blood into a Fertilizer.

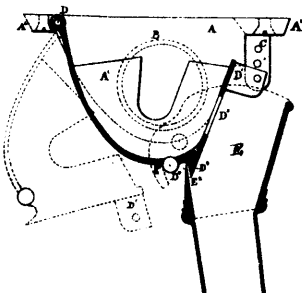

6723 Kuhns and Scholz's Improvements on Seed Drills.

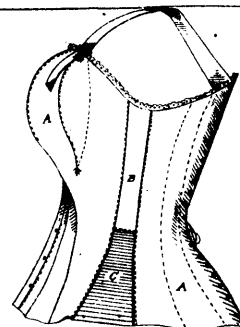

6724 Waterhouse's Improvements on Corsets.