

J. H. Griedale Feb 20, 1901  
Exp Farm, Ottawa

MANITOBA AND WESTERN EDITION

# THE FARMER'S ADVOCATE

AND HOME MAGAZINE

\* AGRICULTURE, STOCK, DAIRY, POULTRY, HORTICULTURE, VETERINARY, HOME CIRCLE.\*

REGISTERED IN ACCORDANCE WITH THE COPYRIGHT ACT OF 1875.

VOL. XXXV. LONDON, ONTARIO. APRIL 5, 1900. WINNIPEG, MANITOBA. No. 499

## Bank of Hamilton

HEAD OFFICE:  
HAMILTON, ONTARIO.

Paid-up Capital, \$1,500,000;  
Reserve, \$1,000,000;  
Total Assets, \$14,076,457.

BRANCHES IN MANITOBA:

WINNIPEG  
(CORNER MAIN AND McDERMOT STREETS;  
C. BARTLETT, AGENT).

BRANDON, MANITOBA.  
CARMAN, MORDEN,  
HAMIOTA, WINKLER,  
PLUM COULEE.

Deposits Received and Interest Allowed

GENERAL BANKING BUSINESS  
TRANSACTIONED.

Collections carefully and promptly effected at all points in Canada. Savings Banks at all Offices. Correspondence solicited.

## Pumps

A full line for farmers and stockmen. Easy to work, and cheap. Satisfaction guaranteed.

H. CATER,  
Agent Hayes Pumps, Brandon Pump Works,  
Myers Pumps, Brandon, Man.

## THE MANITOBA Fire Assurance COMPANY.

ESTABLISHED 1866.  
HEAD OFFICE, WINNIPEG.

Licensed by a full deposit with Manitoba and Territorial Governments.  
Farmers should patronize a home institution.

The Hon. H. J. MACDONALD, President.  
H. H. BECK, Vice-Pres. and Man. Director.

Reliable, Energetic Agents Wanted.

## DR. BARNARDO'S HOME.

The managers of these institutions invite applications from farmers and others for boys and youths, who are being sent out periodically, after careful training in English homes. The older boys remain for a period of one year at the Farm Home at Russell, during which time they receive practical instruction in general farm work before being placed in situations. Boys from eleven to thirteen are placed from the distributing home in Winnipeg. Applications for younger boys should be addressed to the Resident Superintendent, 115 Pacific Avenue, Winnipeg, or P. O. Box 970; and for older boys, possessing experience in farm work, to Manager, Dr. Barnardo's Farm Home, Barnardo, Man.

### CONTENTS OF THIS NUMBER.

	PAGE.
THE PICTURE AND THE PAPER	179
DAIRYING FROM A WOMAN'S POINT OF VIEW	179
PORK PACKING AND THE HOG RAISER	179
"COMMON SENSE IN CANADA"	179
COOLING WITH LIQUID AIR	179
PERMANENT LOCATION OF THE ROYAL SHOW	180
STOCK SALES BY THE GOVERNMENT	180
THE NOTED HACKNEY STALLION, GARTON DUKE OF CONNAUGHT (ILLUSTRATION)	180
THE PROPER FUNCTION OF AGRICULTURAL EXPERIMENT STATIONS	180
GOOD ROADS AND WIDE TIRES	180
REGINA STALLION SHOW	180
LIGHT SANDY SOIL AND ITS TREATMENT	181
MIXED GRAIN CROPS	181
ROADS IN THE WEST	181
ONE-DITCH ROADS	182
SWINE BREEDING	182
A PROMISING INDUSTRY FOR WOMEN	182
THE BREED OF FOWL THE FARMER WANTS	183
CONSTRUCTION OF ICE HOUSES AND COLD STORAGE FOR CREAMERIES	183
ROADMAKING	183
New "LIGOWO" OATS	183
ABORTION AMONGST COWS	184
THE HUNTER AND HACKNEY SHOWS	184
CONDITION IN HORSES AND CATTLE	184
AN UP-TO-DATE STOCK BARN (ILLUSTRATED)	184
A PLAGUE OF DOGS	184
THE SALE OF PRISON-MADE TWINE	184
FIFTEEN YEARS' EXPERIENCE IN BERKEEPIING IN MANITOBA	185
MR. R. W. STARR (ILLUSTRATION)	185
CLOVER AS A FERTILIZER	186
BUTTER - FROM THE STABLE TO THE TABLE	186
A HOUSEHOLD CONVENIENCE (ILLUSTRATED)	186
WESTERN STOCK GROWERS' ASSOCIATION	186
COMMENTS ON THE PICTURE	187
SHORTHORN BULL, TOPSMAN 17847 (ILLUSTRATION)	187
AN OHIO MAN ON THE BEEF CATTLE STANDARD	187
OUR SCOTTISH LETTER	187
ABUSE OF THE STALLION SYNDICATE SYSTEM	188
ENGLISH NOTES	188
SCALE INSECTS ON AMERICAN FRUIT IMPORTED INTO GERMANY	188
THE COWBOY	188
LONDON (ENG.) SHIRE HORSE SHOW	189
AGE TO WEAN PIGS	189
GOING INTO THE POULTRY BUSINESS	189
"SUCCESSFUL FARMING"	190
CEMENT WALLS	190
TESTIMONIALS	190
PREVENTION AND CURE OF MILK FEVER	190
MR. WM. RENNIE, SR. (ILLUSTRATION)	190
SPRING MANAGEMENT OF BEES	190
ENTOMOLOGY IN THE NORTHWEST	191
QUESTIONS AND ANSWERS: - VETERINARY: LAMINITIS; PARALYSIS IN HORSE; EPILEPSY IN PIGS; POUL EVIL; SHOULDER SLIP; PROBABLY TUBERCULOSIS; NAVICULAR DISEASE; RING-BONE ON COLT; CHRONIC INFLAMMATION OF THE LYMPHATIC GLANDS, AND INDIGESTION; LUMP JAW; ECZEMA; DISEASED SHEEP	191-92
MISCELLANEOUS: TO KILL STINKWEED; BROOME GRASS; CHART FOR CUTTING UP BEEF; CEMENT CURB IN WELL; SUBSTITUTE FOR GLASS WANTED	192
CHATTY STOCK LETTER FROM CHICAGO	192
WHAT ENGLAND IMPORTS	192
HOME MAGAZINE.	
FAMILY CIRCLE	193
UNCLE TOM'S DEPARTMENT	194
HANDEL (ILLUSTRATION)	194
THE CHILDREN'S CORNER	195
THE QUIET HOUR	195
PUZZLES	195
GOSSIP	196, 197, 199, 203, 204, 205, 206
NOTICES	196, 200
ADVERTISEMENTS	177 and 178, 196 to 208

PUBLISHED TWICE A MONTH, AT LONDON AND WINNIPEG, CAN.

## MANITOBA GARDEN SEEDS

WE HAVE AGAIN BROUGHT THE EXPERIENCE OF THE BRANDON EXPERIMENTAL FARM TO OUR AID IN SELECTING OUR LARGE STOCK OF GARDEN, FIELD AND FLOWER SEEDS. OUR STOCK WILL BE BETTER ASSORTED THAN EVER. AND WE ASK YOU TO LET US HAVE YOUR NAME, SO THAT WE MAY SEND YOU A CATALOGUE.

## FLEMING & SONS, BRANDON.

Use Fleming's Sheep Dip for lice on cattle.

**We Sell**

The genuine Anti Rheumatic Ring. The great rheumatism cure. Thousands are wearing them with the least possible result, and we have customers who would not part with their ring for \$500.00, if they could not get another. The ring should be worn on the left hand, and on the finger it fits best. The ring must be kept bright on the inside. It should be cleaned every day with a penknife or sandpaper. If you are a sufferer, don't delay a day in procuring one. Send a slip of paper the size of a finger, with 2c. and we will forward you a ring by return mail, postpaid.

D. A. REESOR, "THE JEWELER,"  
Brandon, Man.  
Issuer of Marriage Licenses.

## Seeds. Brandon Seed House.

Choice Field Seeds and Garden Seeds (in bulk).

Drop us a post card, giving your name, and we will mail you our catalogue as soon as issued.

## A. E. MCKENZIE & CO., Brandon, Man.

### Under New Management.

D. W. BEAUBIER, PROPRIETOR.  
Newly furnished throughout. All modern conveniences. Most centrally located hotel to the business part of the city.

## PALACE HOTEL.

Accommodating porter meets all trains. Open day and night. Good stabling in connection. Rates, \$1 per day. Eighth St., BRANDON, MAN., near Resistor.



# Seeds 1900

SEND TO **KEITH & CO.,**  
WINNIPEG, MAN.

Catalogues mailed on application. P. O. Box 333.

## Seeds that Will Grow.

Importers of northern-grown seeds, acknowledged to be the most suitable for Manitoba and N.-W. T. We have the largest stock of field, garden and flower seeds ever collected together in this country to select from. Our large and handsome catalogue for 1900 sent free on receipt of name and address.

**J. M. PERKINS, Seedsman,**

221 Market Street, WINNIPEG, MAN.

### IT'S A WINNER.

So is our

**Ideal Flax note-paper and envelopes**

120 sheets of paper with 100 envelopes, mailed for 60 cts.

This is only one of the many snaps we offer. We carry a full stock of office, school, municipal supplies. Write us for catalogue. Our store is "value."



**The FORD STATIONERY CO.,**  
One door north of P. O.  
P. O. Box 1273. 407 Main St., Winnipeg.

## Catalogue, Card, or any Printing

BY SKILLED WORKMEN. LATEST TYPE FACES, CUTS, DESIGNS, ORNAMENTS, AND UP-TO-DATE IDEAS.

**Appleton & Morris,**

P. O. Box 883. FRANKLIN PRESS,  
293 Market St., Winnipeg, Man.

Mail orders or estimates given prompt attention.

## The "CURE BRAND"



"Your remedy always cures," says a leading shipper—that's it in a few words.

**MITCHELL'S**

**ANTI-LUMP JAW**

Is a cure brand. It may be imitated in the label, but it can't be imitated in the cures it makes.

OUR GUARANTEE: "If it doesn't cure, your money back at once."

One bottle, \$2.00; three bottles, \$5.

Get our little book about Lump Jaw, FREE.

**W. J. MITCHELL & CO.,**  
WINNIPEG, MAN.

**R. A. BONNAR,**  
Barrister, Notary Public,  
Conveyancer, Etc.

Office 494 1/2 Main St., Winnipeg, Man.

**W. A. DUNBAR,**  
VALUER AND APPRAISER.

512 JEMIMA STREET, WINNIPEG.  
Communications attended to by TELEGRAPH.

# The Western Canadian Hail Insurance Company.

INCORPORATED BY SPECIAL ACT OF THE MANITOBA LEGISLATURE. AUTHORIZED CAPITAL **\$500,000.00** THE UNION BANK OF CANADA, BANKERS.

Head Office: Wawanesa, Man.

The only Company in Canada conducting a Hail Insurance business on recognized Insurance Principles, and offering the security of a large subscribed capital.

Stated GRADUATED Rates of Premium. Absolute Security. Prompt Settlement of Losses.

No uncertainty as to what the protection will cost, or what will be paid in the event of loss. Investigate our plan before placing your Hail Insurance. Full information furnished on application to the Secretary, or any Agent.

**JOS. CORNELL, Secretary.**

Reliable and energetic agents wanted in all districts.

# THE MACHINES THAT MADE AMERICA FAMOUS.

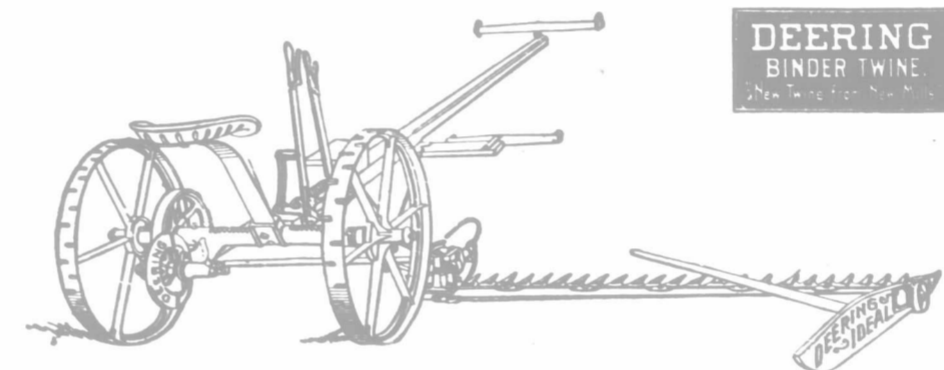

**DEERING BINDER TWINE**

IDEAL MOWER.

Starts in the heaviest, toughest grass without backing the team or bending a straw.

IT PAYS TO USE DEERING MACHINES.

# Deering Harvester Company,

Main Office and Factory :  
**CHICAGO, U. S. A.**

Canadian Branch Houses :  
**TORONTO, ONT. MONTREAL, QUE.  
LONDON, ONT. WINNIPEG, MAN.**

## Low, Wide-Tire Wheels FOR WAGONS.

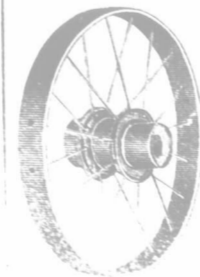

Made to fit your axles. Every farmer should have a set of these low, wide-tire, wrought-iron wheels for drawing hay, grain, corn, manure, stone, etc. They are lighter, stronger, and much cheaper than wooden wheels. Write for prices.

**Dominion Wrought Iron Wheel Co.,**  
TORONTO.

Engraving, Printing, our Specialty.

**London Engraving & Litho. Company, Ltd.,**  
LONDON, ONTARIO.

### THE "ROB ROY" MINES.

Since last issue of this paper we have received most encouraging news from our Superintendent, who tells us that our men have struck a four foot lead of ore carrying grey copper. This grey copper is the mineral which is making the Larder so famous, as it carries such immense values in silver. If you would like to invest some money in a good safe concern, we would be glad to send you full particulars, and, if feasible, show you the samples of ore sent with Superintendent's letter. We hope soon to get on in large enough quantities to warrant us in withdrawing our stock.

**THE SCOTTISH-CANADIAN MINING & DEV. CO.,**  
Limited. (Non-assessable)  
100, Queen Street, London,  
W. & A. G. & Co., Ltd.,  
10, Abchurch Lane, London, E.C. 4.

If Your Aim Is A Good Company Select The Manufacturers' Life Insurance Company, Toronto.

**J. F. JUNKIN,**  
MANAGING DIRECTOR.

## WINDMILLS



Why pay for your POWER or wear your horses out, when a

**Canadian... Steel Airmotor**

will do the work for nothing? Nature furnishes Wind, we furnish the MACHINE.

Are you a stock farmer? If so, it will pay you to get particulars of our

**Woodward Water Basins?**

Pay for yourselves in TWO YEARS !!!

**Ontario Wind Engine and Pump Co., Ltd.,**

TORONTO, ONT.

Manitoba Agents: BALFOUR IMPLEMENT COMPANY, Winnipeg, Man.

## WOODSTOCK Steel Windmills

FOR POWER AND PUMPING

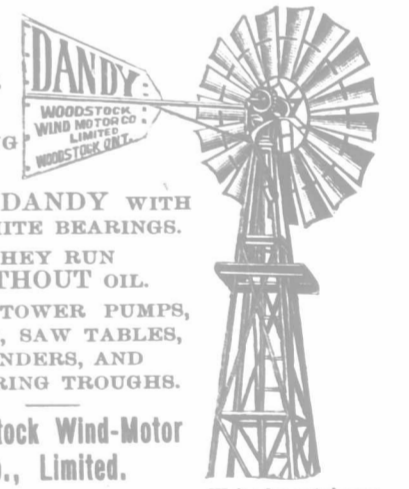

GET A DANDY WITH GRAPHITE BEARINGS. THEY RUN WITHOUT OIL. STEEL TOWER PUMPS, TANKS, SAW TABLES, GRINDERS, AND WATERING TROUGHS.

**Woodstock Wind-Motor Co., Limited.**

WOODSTOCK, ONT. Write for catalogue Agents: SYLVESTER BROS. MFG. CO Brandon, Manitoba.

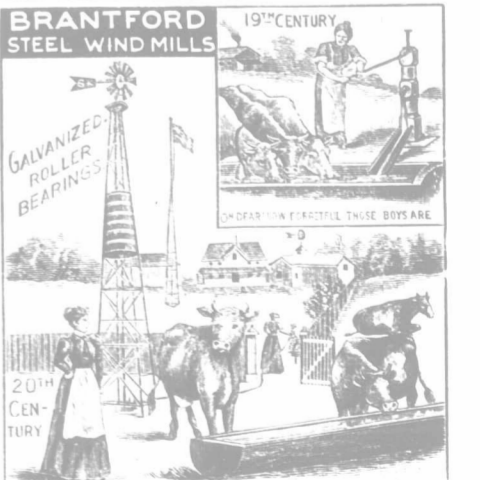

MY! WHAT A COMFORT THAT BRANTFORD MILL IS. POWER AND PUMPING MILLS. STEEL TOWERS AND FLAG STAFFS, IRON AND WOOD PUMPS, MAPLE LEAF GRAIN GRINDERS, BEE SUPPLIES.

**COCKSHUTT PLOW CO. (Limited),**  
Agents for Manitoba and N.W.T., Winnipeg



# THE FARMER'S ADVOCATE

AND HOME MAGAZINE

\* AGRICULTURE, STOCK, DAIRY, POULTRY, HORTICULTURE, VETERINARY, HOME CIRCLE.\*

REGISTERED IN ACCORDANCE WITH THE COPYRIGHT ACT OF 1875.

Vol. XXXV.

LONDON, ONT., AND WINNIPEG, MAN., APRIL 5, 1900.

No. 499

## The Picture and the Paper.

PRESTON, MINNESOTA, March 14, 1900.  
*The William Weld Co., London, Canada:*  
 GENTLEMEN,—On my arrival home from St. Paul, last night, I found your "Canada's Ideal," which was to me a great pleasure. To have the representations of such noteworthy Shorthorns represented in such high degree of art is of itself an inspiration and an incentive to strive on toward the ideal with renewed hopes and higher ambitions. The noble Shorthorn is the ideal, and the work of art and the artist seem to be at their best in representing this fine breed of cattle. I shall prize "Canada's Ideal" very highly, and shall have it framed and placed in the most conspicuous place in my office.

I am more than gratified to know that I have some animals in my herd sired by these noteworthy sires.

In conclusion, I want to say a word in behalf of the *ADVOCATE*. I have learned to anxiously watch for its coming. Truly, I can not do without it, it is so full of truths and farm benefits from beginning to end.

Very cordially yours,

JOHN C. MILLS, County Auditor.

## Dairying from a Woman's Point of View.

Our readers will appreciate, we feel sure, for their practical helpfulness and exceedingly interesting style, the series of articles by Miss Laura Rose, of the Guelph Dairy School staff, the second of which appears in this issue of the *FARMER'S ADVOCATE*. Her treatment of the subject will range, as the papers are styled, "From the Stable to the Table," where the critical consumer passes final judgment upon the finished product; in other words, she deals with each successive step in the process of dairying, particularly as it is carried on upon the farm, making altogether a fresh and valuable compendium of dairy literature. Most of her articles will prove equally serviceable to the creamery and cheese-factory patron as to the home butter-maker, and we commend their careful study. While the scientific principles underlying dairying remain the same, the art itself is progressive; hence, we must have line upon line and precept upon precept, in order to continued success. Thoroughly practical herself and a careful observer both of the best British and Canadian practice, Miss Rose has also the advantage of her experience at the Ontario Agricultural College Dairy School and in connection with Farmers' Institutes and other work of that character, coupled with a happy faculty of expressing her knowledge of the subject. In our March 5th issue the housing of dairy cattle was taken up, emphasizing the points most needful of care, and in her second contribution, which we publish on another page, the subject is "The Dairy Cow and Her Feed," the salient points of which she has very forcefully presented, giving a clear pen-picture of the former, with practical suggestions regarding the latter. In the *FARMER'S ADVOCATE* constituency Miss Rose will address what may be styled an advanced class in dairy literature, who are daily putting theory into successful practice, but the success of her previous work gives assurance that the present will be equally satisfactory, and we doubt not that with the keen perception of her sex she will bring to notice not a few points that the dairy man is prone to overlook.

Sheep are trumps in the markets just now. Think of it—lambs under a year old selling at \$7.50 per 100 lbs. in Buffalo, \$7.25 in Chicago, and \$6 in Toronto.

## Pork Packing and the Hog Raiser.

Several correspondents have written us suggesting that there is a possible danger of overdoing the establishment of pork-packing concerns, a good many of them latterly being on the co-operative plan. It seldom occurs that one loses much by deliberate consideration before embarking in any new enterprise, especially when there is a rush in that direction. The co-operative principle undoubtedly was a great help in the establishment of the Danish bacon trade, and to the co-operation of farmers in small joint stock companies the successful foundation of the Ontario cheese-factory system, with its incalculable benefits, was very largely due. At that time makers with the necessary capital and courage were not forthcoming; but by the farmers of a locality combining, the enterprise was established, and with a good salesman and board of directors to advise with the maker in factory management, etc., and the visits of the travelling instructor, all went well as a general rule. Of late years, however, the tendency is that factories are falling more and more into the hands of private parties, usually the makers, who have accumulated sufficient means to buy out the concern and pay off the stockholders, many of whom have been very willing to dispose of their interests. In other cases we find English investment-seeking capital buying up groups of factories, so as to have them under one management in order to insure a uniform and certain supply of butter and cheese for Old Country custom. Hence, the old co-operative cheese-factory system begins to show signs of passing away, but that it did great good is undeniable. Pork-packing concerns, both in the capital involved for building and management, the details of internal management, and trade relations for the disposal of bacon and other products abroad, are necessarily more serious and complicated. The present-day tendency of trade and manufacture is to centralize into large concerns, and the co-operative factory must count on competing in the sale of its products with the big packing houses in the British market, which in the main regulates the price of hogs in Canada, and the hope is that they will secure to their promoters (the stockholders), and also to their patrons, a better return than might otherwise be got, by their ability to turn out a high-class product and preserve their independence. They most assuredly have their work cut out for them.

As a general rule, the farmer finds the study, management and work of his farm sufficient to occupy the best of his energies, and his personal share in the bacon business is the breeding, management and feeding of the right type of hog at as low a cost to himself as possible. If, besides, he is disposed, after due enquiry, to invest some of his surplus in the local packing house, all well and good, providing it returns him a satisfactory dividend and he feels assured of its permanence.

The fear has been expressed that with so many factories it will be impossible to produce the necessary supply of hogs to keep them going, but with no other class of stock can the supply be so rapidly increased, and we doubt not, if the price is such as to give the farmer a decent return for his labor and feed, the animals will be forthcoming; but if the price is not right, the hogs will not be raised. Last season the price of hogs fell on the farms below four cents, and the sows were not bred. To-day the supply of hogs for the packers is abnormally low, with a strong demand in Britain, and a Toronto correspondent writes us that \$6.50 per cwt. live weight may be anticipated next summer. This will mean another rush into pig-breeding, with plentiful supplies in about a year's time.

Our conclusion is, therefore, that with the co-operative factories now projected, farmers should have a fair opportunity to judge of their success; and, instead of to-day rushing into hogs and to-mor-

row into horses, the farmer will do best to keep steadily those lines of stock that are suited to his tastes and conditions, and which have done best with him in the past—not putting all his eggs into one basket, nor flying from one extreme to another. Not so long ago, dairymen were discouraged with fifteen-cent butter and seven-cent cheese, but lately we have twelve-cent cheese and butter ranging from twenty-five to thirty-five cents per pound, and some of our readers who are now marketing one hundred pounds or more per week of gilt-edged butter, realize that their faith in the butter cow was not misplaced, and had they dropped out when the outlook was discouraging, they would have missed the golden harvest of to-day.

## "Common Sense in Canada."

Under the above heading our Old Country contemporary, *British Refrigeration*, publishes the following:

"The supreme importance, in the eyes of the British consumer, of uniformity of type and quality in all produce has been characteristically recognized by Canada, and efforts are now being concentrated in the circles of authority in the Dominion to insure its recognition by all who aspire to produce for the great market of the world. The question, as applied to cattle, is receiving most attention, as being of the greater importance, seeing that not only the beef, but also the dairy traders depend upon the type of cattle raised in the various districts. The class of animal advocated for the stock-raisers who intend their produce for the meat market is an ideal type from the point of view of the butcher as well as the consumer; and if Canada can succeed in making such a class of steer the general rule, Canadian beef will undoubtedly oust all other from top-price lists. The 'beef' steer of the ideal is short-legged, deep-bodied, and thick-fleshed, early-maturing, and possessed of robustness and vigor. The type is remarkably pronounced in all the big prizewinners of the Dominion cattle shows of the past year; and in this fact there is much reason for congratulations to the Canadian judgment. A Dominion journal, the *FARMER'S ADVOCATE*, commenting upon the matter, urges upon its readers the greater satisfaction which is to be obtained by raising good rather than inferior stock and emphasizes its argument by the indisputable assertion that 'The better the quality, and the more uniform the character of the products we send to market—whether of live stock or of any other of the fruits of the farm—the better prices we are likely to receive, and hence the better returns for our labor, and for the feed consumed by our stock.' It would be well if other communities also laid to heart the same doctrine, for then there would not be quite so much heard about the home producer being out-classed and out-sold by his foreign competitor."

## Cooling with Liquid Air.

At the time the discovery was announced last year the *FARMER'S ADVOCATE* gave a review of the discovery by Mr. Tripler, of New York, of the process of liquifying air, and a forecast of its probable uses in cold storage. The first plant of the kind on a large scale has been erected at Los Angeles, Cal., owned by the Fay Fruit Company. The machine has a capacity for producing 12 gallons of liquid air per hour. At present 11,000 refrigerator cars run out of that city with fruit, each one of which requires 10,000 pounds of ice for cooling, and which occupies  $\frac{1}{3}$  of its carrying capacity for storage. Liquid air, with its wonderful refrigeration power, will be used instead, and can be stored below the floor of the car between the wheels, so that the whole space in the car will be available for the goods shipped. More than that, the cost of the liquid air will only be one-half (so it is claimed) that of the ice. The trial of the system will be watched with great interest.



## THE FARMER'S ADVOCATE AND HOME MAGAZINE.

THE LEADING AGRICULTURAL JOURNAL IN  
THE DOMINION.

PUBLISHED BY  
THE WILLIAM WELD COMPANY (LIMITED).  
EASTERN OFFICE:  
CARLING STREET, LONDON, ONT.  
WESTERN OFFICE:  
MCINTYRE BLOCK, MAIN STREET, WINNIPEG, MAN.

LONDON, ENGLAND, OFFICE:  
W. W. CHAPMAN, Agent, Fitzalan House,  
Strand, London, W. C., England.

1. THE FARMER'S ADVOCATE is published on the fifth and twentieth of each month. It is impartial and independent of all cliques or parties, handsomely illustrated with original engravings, and furnishes the most profitable, practical, and reliable information for farmers, dairymen, gardeners, and stockmen, of any publication in Canada.
2. TERMS OF SUBSCRIPTION—\$1.00 per year in advance; \$1.25 if in arrears; sample copy free. European subscriptions, 6s., or \$1.50. New subscriptions can commence with any month.
3. ADVERTISING RATES—Single insertion, 15 cents per line. Contract rates furnished on application.
4. DISCONTINUANCES—Remember that the publisher must be notified by letter or post-card when a subscriber wishes his paper stopped. All arrears must be paid. Returning your paper will not enable us to discontinue it, as we cannot find your name on our books unless your Post Office address is given.
5. THE ADVOCATE is sent to subscribers until an explicit order is received for its discontinuance. All payments of arrears must be made as required by law.
6. THE LAW IS, that all subscribers to newspapers are held responsible until all arrears are paid and their paper ordered to be discontinued.
7. REMITTANCES should be made direct to this office, either by Registered Letter or Money Order, which will be at our risk. When made otherwise we cannot be responsible.
8. ALWAYS GIVE THE NAME of the Post Office to which your paper is sent. Your name cannot be found on our books unless this is done.
9. THE DATE ON YOUR LABEL shows to what time your subscription is paid.
10. SUBSCRIBERS failing to receive their paper promptly and regularly will confer a favor by reporting the fact at once.
11. NO ANONYMOUS communications or enquiries will receive attention.
12. LETTERS intended for publication should be written on one side of the paper only.
13. WE INVITE FARMERS to write us on any agricultural topic. We are always pleased to receive practical articles. For such as we consider valuable we will pay ten cents per inch printed matter. Criticisms of Articles, Suggestions How to Improve the Advocate, Descriptions of New Grains, Roots or Vegetables not generally known, Particulars of Experiments Tried, or Improved Methods of Cultivation, are each and all welcome. Contributions sent us must not be furnished other papers until after they have appeared in our columns. Rejected matter will be returned on receipt of postage.
14. ALL COMMUNICATIONS in reference to any matter connected with this paper should be addressed as below, and not to any individual connected with the paper.

Address—THE FARMER'S ADVOCATE, or  
THE WILLIAM WELD CO.,  
WINNIPEG, MANITOBA.

### Permanent Location of the Royal Show.

By a majority of thirty-eight to four, the Council of the Royal Agricultural Society of England, at its last meeting adopted the report of its Special Committee, appointed to consider the question of the modification or alteration of the existing show system, recommending the abandonment of the itinerant system of locating the annual show from year to year, which had been followed for sixty years, and its permanent location in some large town or city after the present rotation of districts is completed in 1902. The trend of the times is unmistakably in the direction of the permanent housing of the principal shows. The United States learned the lesson from expensive experience under the migratory system, and have settled down to a wiser plan, most of the State fairs being now permanently provided for. Ontario spent heaps of money in the forlorn hope of continuing a peripatetic Provincial fair, but found it a costly failure. The Fat Stock and Dairy Show has been "boarding around the district" and living beneath its privileges, but the prospect amounts almost to a certainty that the days of its pilgrimage are ended, and that its next exhibition will be held under cover of a permanent home. The conservative old Royal, of England, has done well to so soon get into line with the onward march of the procession, and we have not a shadow of a doubt that its future, under the proposed change of system, will be even more prosperous and glorious than the grand record it has made in its noble work of presenting high ideals to the people in magnificent products and appliances, which have exerted such uplifting influence on the agriculture of the Empire and the world.

### Stock Sales by the Government.

The Scotch combination auction sales of cattle are often referred to by the advocates of the adoption of that class of sales in Canada. At first sight, and looking only at one side of the question, the Scotch sales would seem to constitute a good argument in favor of the system; but there are two sides to this, as to most questions, and while the best prices and the average prices for the animals sold at these sales may be fairly satisfactory, yet the reports of the three leading sales this spring, namely, at Inverness, Perth, and Aberdeen, reveal the fact that of the whole number of Shorthorn cattle entered and catalogued for these sales, no fewer than 125 were left unsold, many being withdrawn for the reason that the bidding was not satisfactory to the seller, and many more failing to find buyers owing to their inferiority. In a letter recently received at this office from a prominent Canadian breeder who was present at the sales at Perth and Aberdeen in February of this year, he writes: "I was disappointed in the offerings. Anything with merit sold high, up to 240 guineas, but there were only two or three at each place that you would consider good enough to place in good company." This is quite in accord with the statement of Mr. John Isaac, in a late issue of the ADVOCATE, that the great bulk of the offerings at these sales are culls, and that in the case of those of merit, which are brought out for competition for the numerous and substantial prizes which are offered for the best, it is not unusual to withdraw them when the bidding is not satisfactory.

As a matter of business, we see no good reason why in offering stock at a sale of this character a man should not have the privilege of withdrawing

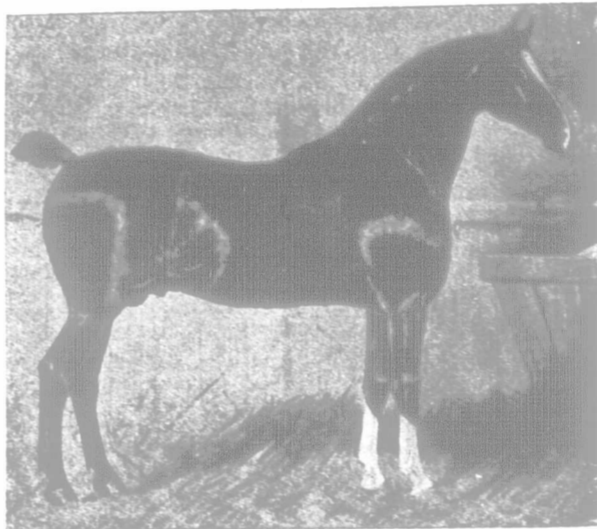

THE NOTED HACKNEY STALLION, GARTON DUKE OF CONNAUGHT.

PROPERTY OF MR. THOS. HALL, NEAR MALTON, ENGLAND.

his animals, or of placing an upset price or reserve bid on them, if he considers he is not bid fair value for them, provided this right is claimed in the announcement of the sale, and this course is certainly infinitely more honorable than the practice sometimes followed of putting up bogus bidders to protect them; yet, from observation, we feel sure that the former practice, if adopted to any considerable extent in this country, would effectually take the life out of any sale. We are assured that in the proposed government sales all these contingencies are to be provided for in a code of rules and regulations which will make everything lovely. But those who have had experience in working under the rules of exhibition and sale associations know, many of them to their cost, that too often under these rules the honest man suffers, while those untroubled by conscience or unburdened by a sense of honor get the advantage, and go off with the honors and the dollars which fairly belong to the man who is straight and who may well pray to be delivered from a list of rules and regulations which hamper him but not the other fellow.

The point we wish to make in this article is, that if in a country of limited area, where breeders are comparatively close together and within easy distance of the place of sale, where the system has been long established, and where, as the result of experience, it is reasonable to suppose the best practicable rules have been adopted, over 20 per cent. of the animals entered for the sales are left unsold at a time when the business is booming, what success can be expected with this system in a country of such magnificent distances as Canada presents, where the cash system of payment at public sales has had little trial, and where combination sales under organizations conducted by prac-

tical breeders in the past have proved miserable failures at such centers as Toronto and Guelph, even when held during the weeks in which stock shows were being held at the same place, and the advantages of reduced railway fares and the presence of stockmen attending the shows were added?

There being no present nor prospective need for the proposed sales, our farmers not having asked for them, nor the breeders either, so far as we know, till it was suggested that aid could be got for the purpose, and, as has been pointed out, with so many dubious contingencies surrounding them, the Government would be ill-advised in making such an experiment in paternalism.

### The Proper Function of Agricultural Experiment Stations.

The presidential address of Dr. H. P. Armsby, of the Pennsylvania State Agricultural College, before the last meeting of the Association of Agricultural Colleges and Experiment Stations, deals with the object and purpose of the latter, and the best means of attaining them. Judging from recent tendencies and efforts on the part of some of these institutions, those in charge have run away with the idea that they must popularize them as a means of direct instruction to the farmer. To our mind, this is a misconception that will make such inroads upon the time and attention of the staff that the great fundamental purpose for which the station exists will be completely sidetracked. That purpose is investigation, which must be thorough or scientific in the true sense of the term. The American is so impatient for immediate "results" as to grow restive under the essentially patient and deliberate procedure under which results of any permanent value are to be obtained from experimental work. The thorough-going investigator finds it difficult to resist the clamor for a "show on paper" that the institution is "doing something" that will put dollars directly in the pocket of the farmer. And when the hustling politician takes a hand in, matters are not improved, as witness the development of the wasteful Washington free-seed scandal. As Dr. Armsby points out: "The function of the experiment station is not the impossible task of giving him (the farmer) recipes suited to every possible emergency. Its business is to enlarge (through its researches) his knowledge of the natural forces which drive his farm, and how to control instead of being controlled by them." He points out that the experiment station is not designed to do the work of the agricultural college, the farmers' institute, the reading circle or the agricultural press, but rather to be a fountain from which may flow knowledge and inspiration that shall fructify and vivify the whole system. Teaching, he points out, is the business of the agricultural school and not of the experiment station. The central idea of the station is research—the discovery and promulgation of new truth.

### Good Roads and Wide Tires.

To the Editor FARMER'S ADVOCATE:

In March 5th issue of the FARMER'S ADVOCATE I had the pleasure of reading an article by Mr. Collyer, under the title of "For Good Roads." In my mind, there is nothing of such value to the farmers of Manitoba and the Northwest as good roads would be. I agree with Mr. Collyer's suggestion, and I have no hesitation in saying that it would be a long way ahead of the plan now existing. But, as to \$2.00 per quarter-section! I think \$5.00 not out of the way at all. What is \$3.00 extra compared with bad roads? Some may say \$3.00 would not help the road much from home to market (perhaps 10 miles), but he is forgetting that he would have that road's share of all his neighbors' \$3.00 along the road, and if the distance was 10 miles it would amount to at least \$50.00; so he gets \$50.00 expended on his market road for \$3.00. Surely no one will kick at that? Then, again, when clay roads get wet, and, before properly dried, are traveled by narrow-tired wagons heavily loaded, the result is that the road shows the effect of such travel for from one to two weeks, during which time it is unfit for travel by light rigs. In this municipality I have often seen it the case; therefore, I would suggest that the use of narrow tires be prohibited, either through the manufacturers or the individual users. It would be impossible to exterminate them for a while, but it may be plainly seen that clay roads will never be a success until wide tires are in general use. MAX.

Lansdowne Municipality.

### Regina Stallion Show.

Regina Spring Stallion Show will this year be held on May 3rd. Prizes will be offered for three classes, heavy draft, general purpose, and registered standard-bred.



Light Sandy Soil and Its Treatment.

Although the area of very light soil in the Province is comparatively limited, still there are in some districts thousands of acres needing very careful treatment. One of the difficulties to contend with on such land is the leachy character of the soil, which fails to retain for any length of time the natural fertility resulting from the decayed prairie vegetation of past centuries.

Retain the natural fertility of the soil, and, if possible, increase it. Owing to the light crops of straw on such lands, it is not an easy matter to keep a large herd of cattle; but this difficulty can be largely overcome by growing fodder corn; this plant delights in a warm soil.

Another important consideration is the prevention of soil drifting; this evil is rapidly increasing, and in some districts clouds of soil are seen drifting with the wind, either cutting off the young grain plants or covering them with soil.

Seed down to grass and clover every few years. Grow corn, rape, etc., and keep as large a herd of cattle as possible. Use all the farmyard manure it is possible to obtain, and spread it fresh from the stable.

Exp. Farm, Brandon, Man.

Mixed Grain Crops.

In Minnesota considerable attention has of late years been given to sowing mixed crops of grain, it being claimed that heavier yields are thus obtained. The following account of a test made at the Minnesota Experiment Station is clipped from the Farm Student's Review, and will be read with interest:

"One of the newest ideas in mixed farming is to sow flax and wheat together for a grain crop. The idea seems to be a good one so far as tried, as both the flax and the wheat seem to be benefited by the mixture. During the past two years the writer has had under his observation two or three fields of the mixed crop. In every case the wheat seemed to be benefited by the presence of what has been considered one of its worst enemies.

"The amount of each to use in the mixture is not definitely fixed as yet. The mixed crop in almost any proportion pays better than wheat alone. Flax alone is a better paying crop this year than the mixed crop, but this is on account of the unusually high price of flax as compared with wheat.

"That each reader may study the situation for himself, the following table is added.

"When one considers the fact that it costs no more to sow, harvest or thresh the mixed crop than to handle the wheat crop alone, it seems that it is the part of wisdom to gain the dollar per acre as a nice margin of profit.

Table with 7 columns: Crop, Rate sown per acre in bush., Yield of wheat per acre in bu., Yield of flax per acre in bu., Value of wheat at 60c. per bu., Value of flax at \$1.20 per bush., Total value per acre of crop, Cost of seed, Net value per acre of crop.

Tests with mixed crops have also been carried on at our Experimental Farms, and below is given the results of several tests with different mixtures from the Brandon Farm, but in these tests flax and wheat had no part. We would like to see some plots devoted to this mixture this year.

MIXED AND UNMIXED GRAIN CROP AT THE BRANDON FARM.

It is claimed by many that more grain can be grown by sowing several kinds together than from the same kinds sown separately. A very full test has been made along this line during the past season, with the result that the returns were practically the same from both methods.

Table with 6 columns: Plot, Kinds of grain sown, Variety, Ripe, Yield per acre, Avg. per acre.

Roads in the West.

Good roads, and how to obtain them, is a question here that is still under discussion. Our experience of such work is only limited, as it is but two years since any effort was put forth in the direction of roadmaking, consequently we cannot yet speak of results with any definiteness. We all realize the necessity of doing something to improve the condition of our roads, but it is what, and how to do it? Statute labor has been in force for two seasons, and while this system has some to endorse it, there are many who take an opposite view, failing to see that it is going to give us good roads.

H. CARGILL & SONS.—"Canada's Ideal" received. It is a splendid piece of work, and will do its share in making a name for Canada as well as our brave boys in South Africa."



**One-Ditch Roads.**

To the Editor FARMER'S ADVOCATE:

In building roads in a prairie country, I would advocate one-ditch roads, the ditch to be made on the side from which the water comes onto the road, leaving not more than 10 feet between fence and ditch. This will leave more prairie between grade and the other fence. It will cost no more to take 1,000 yards out of one ditch than it would cost to take 500 yards each out of two ditches. It is poor policy to make deep ditches; make them wide, thus using surface earth, which makes better roads than subsoil. Where necessary to go deep to make water fall, put the subsoil not on the grade, but on the side next the fence, if too far to take it down to the low place, which is generally near a deep cut, as the earth out of a deep cut is not needed on the grade immediately opposite. Put as few culverts in as possible; they are expensive, and will let the water loose on the other side of grade to flood the land adjoining, and be same trouble on the next road. If the water can be taken along on the high side of grade to the next cross-road, the chances are it can be got away without any damage to the road or adjoining land. The man on the low side of grade should be allowed to make a small drain close to his fence to take the water off his place. The chances are a small one will do, as there will be no flow across the road. My objection to a two-ditch road is, that when wet and muddy a teamster must stay on the grade, as there is a ditch on each side, while with a one-ditch road a teamster can leave the grade at any point. In a wet time there is no road as good as sod. If the people keep off the grade it will dry up much sooner. A one-ditch road will afford good sleighing when there is no snow on the grade. To get over the expense of keeping the weeds down on roadsides, scatter a little white clover seed, and it will soon take full possession. It is short and will not hold the snow.

Culverts and bridges should be large enough to let the water pass without confining it any; if on the small side they will wash out. There should be wings on all culverts and bridges if there is danger of washing. The top corners of stringers on culverts and bridges should be taken off, so as to leave no more than 2 inches for the plank to rest on. They will last twice as long, as the water will run off. To keep the stringers apart, put eye bolts in each end of stringers and bolt down through the two eyes through the cap washer and nut on bottom. In nailing on plank, drive the nails one-third in frame edge of plank, as the water will not have the chance of following the nail holes.

There would be more work done by collecting 50 cents per day and letting the work by contract than by statute labor. W. J. E. Portage la Prairie, Man.

**Swine Feeding.**

[By J. H. Grisdale, Agriculturist, Experimental Farm, Ottawa. Read at Live Stock Conventions.]

In no class of live stock in Canada during the last five years have such great onward strides been made, if we may judge by numbers, as in swine. As the pork-packing industry develops more and more, swine must be kept, and more and more does it become necessary that we study the conditions which surround us, the methods of feeding and the feeds best fitted to give us good returns for our investments. The feeding problem is with us of very much more importance than with our United States cousins, since ours is a more critical and fastidious class of customers, the great middle class and aristocratic Englishmen. The quality, finish, flavor and appearance of our product must be just right or he spends his money elsewhere and we are left to console ourselves as best we may. Feeding being our most serious problem, it is eminently fit that we discuss it fully to-day.

Since "swine feeding" may be expected to mean the feeding of breeding and young stock, I shall first say a few words on that part of the question. To insure good healthy litters it is essential that the sow be properly nourished. A plentiful ration of bran, shorts and oats, and roots, is well fitted to sustain both herself and the young she bears. As farrowing time approaches, and for some few days after, the ration should be decreased. Once safely past that critical period, a heavy ration of bran, shorts, crushed oats, and milk, if available, is best suited to supply the milk her offspring demand. The young pigs should be early taught to eat. This may be done by placing a small trough in the enclosure. For a few days a small supply of warm new milk might be placed in the trough; and later, skim milk warmed to blood heat. In two or three weeks, or even less, some shorts or oatmeal might be added to the milk. Great care must be taken to keep the trough scrupulously clean. It should be washed thoroughly every day. If the young are reared in winter, it is well to give them a few sods to turn up in their pen. The roots and earth appear to give the important ends of supplying vegetable and mineral matter so necessary to the health and development of young animals. By pursuing this, as some similar method of feeding the young, they will at from seven to nine weeks be weaned. Care should be taken at this time to reduce the sow's ration, especially the bran, shorts, oats, and milk,

Much of the trouble experienced in raising pigs arises from the feed and care given the sow. If these are what they should be, no sickness is likely to occur in the young. Do not feed the same mixture for long to either sow or young. Variety in feed aids digestion. Once the pigs are weaned, if we are to hope for much profit, it is essential to get them to a weight of, say 100 lbs., without much expense. If in summer, this can be best done by letting the youngsters run on pasture, feeding them a small amount of bran, shorts or oats to help them along. In winter, excellent gains may be made on a ration consisting almost exclusively of roots. If the pasture has to be on seeded land, a good crop, we have found, is oats and peas equal parts, while rape cannot be surpassed. The great aim during this first period should be to secure a good growth, rather than to put on fat. Any check suffered in growth is likely to bring disaster at a later date.

The practice of finishing pigs off on grass or pasture is one which has not met with great success where quality was the chief aim, but it is most economical.

**FEEDING PIGS ON RAPE.**

On August 2nd, 1899, two lots of six pigs each were placed on a rape plot of about one-third acre. This rape had been sown in drills on May 20th, but, owing to wet weather, had made rather poor growth, and so was only about 15 inches high at date of turning in the pigs. For some time after their introduction they failed to eat much of the crop, especially the younger lot. Very little grain was given, however, and finally both lots fed heartily upon the juicy young plants. The growing rape was pretty well eaten down by Oct. 1st, and from that date till Nov. 30th an allowance of 4 lbs. of rape per pig was fed daily from another field. The five remaining after Nov. 30th received as much mangolds as they would eat, about 4 lbs. each daily.

The following table gives the particulars as to increase and daily rate of gain:

Lot No. 1.	First weight.	Last weight.	Gain.	Days fed.	Daily rate of gain.
No. 81	59	176	117	119	.97
No. 82	69	190	121	119	1.02
No. 83	56	180	124	119	1.04
No. 84	84	190	126	119	1.06
No. 85	76	191	115	119	.97
No. 86	59	173	114	119	.96
Total	383	1100	717	119	*1.004
Lot No. 2.					
No. 87	32	165	133	148	.90
No. 88	32	190	158	148	1.07
No. 89	30	161	131	148	.89
No. 90	38	170	132	148	.90
No. 91	54	202	148	148	1.00
Total	216	923	717	148	.95

\*Average rate of gain.  
One pig in lot No. 2 died after being fed for 35 days. The pigs in lot No. 2 appeared to be too young to introduce upon rape, as they did not thrive for about a month after being confined in the lot. The dew or moisture from the plants seemed to affect them, causing their skin to crack. Lot No. 1 was not affected in the same way.

Below is a statement of cost and proceeds of 11 finished hogs:

11 pigs at \$2.00 average	\$22.00
Rent of lot	2.00
3,000 lbs. rape and roots at \$2.00 ton	3.00
4,102 lbs. meal at \$1.00 cwt.	41.02
	\$71.02
Proceeds of 1,988 lbs. pork at \$1.50 cwt.	\$89.46
Net profit	18.44

It was, of course, impossible to determine the quantity of rape grown on the lot, so a rental of \$2 is charged for the one-third acre.

Pig No.	Live wght.	Dress wght.	Per cent. dress.	Date killed.	Yard Criticism.	Quality of pork.
81	176	128	72.7	Nov. 30	Straight	Poor
82	190	136	71.6	"	"	Fair
83	180	133	73.9	"	"	Very poor
84	190	136	71.6	"	"	Very poor
85	191	144	75.4	"	"	Fair
86	173	125	72.2	"	Short	Poor
87	165	123	74.5	Dec. 29	Straight	Good
88	190	137	72.1	"	"	Very good
89	161	118	73.3	"	"	Very good
90	170	121	71.2	"	"	Very good
91	202	147	72.7	"	"	Good

The date of killing is given in each case, since, though all were treated in the same way till Nov. 30th, after that date the remaining pigs were fed roots instead of rape. It will be observed that the lot killed Dec. 29th were all firm in quality, any one of them being superior to the best in lot No. 1, killed Nov. 30th.

**PRODUCING HARD PORK.**

The problem of producing hard pork is one which is receiving much attention at present. At both Guelph and Ottawa a number of experiments have been conducted, or are in progress at present, to determine, if possible, the causes which go to induce variations in the quality of the pork.

A great amount of data has been secured, but no fixed conclusions can be said to have been reached yet. The individuality of the animal appears to have more to do with the quality of its flesh than the feed put into him, provided, of course, he is fed a fairly balanced ration. The question of hard and soft pork is one which is too often mixed with "mixed" and "straight" carcasses. The percentage of fat among "fits" seem in our experience to be less than among "straights" or "selects." From other points I have observed, I am at present inclined to think that maturity or ripe-

ness of the pig has a very great deal to do with the quality of the meat.

We have found that the animal that made a good thrifty growth from start to finish has almost invariably proven to be of superior quality; while the animal that was rushed to the required weight, or brought to it too slowly, has in many cases proven soft. We are near the completion of an extensive experiment at Ottawa to ascertain the causes of this defect in our pork, and parts of the flesh of each pig are being analyzed by our chemist, Mr. F. T. Shutt, to determine, if possible, the component parts whose absence or presence go to influence the quality of the meat. There is, however, no doubt that feed is an important factor in the character of the flesh produced, and very marked effects follow on the continued use of certain feeds.

The important point is to feed a good growing ration, strong in protein or flesh-forming materials, as well as rich in bone food.

**PREPARATION OF FOOD.**

The preparation of the food for swine is a question which is always with us. While varying conditions may somewhat modify the practice best suited for economical pork-production, still most reliable data seem to point in the same direction—that is, the feeding of all grain ground and dry or whole and soaked. This has been found to be the case in a number of experiments at Ottawa, and last spring in an experiment with 12 pigs divided into three lots of four each, we found an advantage of about five per cent. in favor of ground as compared with whole grain. Another point brought out in the same experiment was the economy of feeding a limited ration rather than an unlimited one, a saving of about eight per cent. being effected by careful feeding.

The cooking of foods has been found to neither improve nor injure foods to any great extent, save potatoes, which we have found to be of very little value unless cooked. It may pay to cook some part of the feed for the sake of the effect upon the animals under certain conditions, as, for instance, feeding warm feed when the weather is very cold.

A ration that we have found economical is composed of oats, peas and barley, equal parts, and as much corn as of the three others. This, when supplemented with skim milk and under favorable conditions for development, has never failed to give us good returns. Skim milk holds a high place as a feed for hogs, and the quality of the meat seems to be uniformly improved by the addition of this by-product of our dairying industry. It is almost essential to the proper development of our young pigs, and is a most valuable adjunct to grain feed in fattening stock. It seems to act as a stimulant as well as a food, for where small amounts were fed daily excellent results were obtained. To give an idea of what I mean, let me quote from a bulletin recently published by the Department of Agriculture at Ottawa, compiled by myself.

These facts are obtained from a large number of experiments:

No. of swine in test.	Lbs. skim milk consumed per head per day.	Lbs.
4	2	1 lb. corn, equal to 1.83 lbs. skim milk.
31	3	1 lb. mixed grain, equal to 3.23 lbs. skim milk.
4	5.4	1 lb. mixed grain, equal to 5.38 lbs. skim milk.
4	13.6	1 lb. frosted wheat, equal to 7.91 lbs. skim milk.
12	15.7	1 lb. mixed grain, equal to 7.31 lbs. skim milk.
12	17.1	1 lb. mixed grain, equal to 8.82 lbs. skim milk.
12	23.7	1 lb. mixed grain, equal to 7.76 lbs. skim milk.

Generally speaking, skim milk may be said to be worth one-sixth to one-fifth as much as an equal weight of mixed meal.

**A Promising Industry for Women.**

Farmers' wives and daughters, do you want money? If you do, here is something to lay hold of now, something both pleasant and profitable; just the thing for the women folk. It is the new industry of raising poultry for fattening. Spring will soon be here, and you should start early. In order to conduct the business on a large scale, you should have an incubator; then, instead of waiting for your hens to cluck, you could get your wooden hen ready at once and have your chickens hatched early. The eggs should be set about the 15th of March or the 1st of April. "The early bird catches the worm" is an old proverb, but in this case it is the early chickens the buyer wants to catch, and for which he will pay the highest price. In this, as in every other business, you need to have patience, perseverance, and enthusiasm, if you want to succeed. After your chickens are hatched, with what pleasure and pride you will watch the growth of your beautiful feathered family, and what a pleasant task it will be to feed and look after them. As a general rule, women are far more interested in poultry than men are—that is why they should manage it themselves. One must love the work in order to attain success. The Wyandottes are the best for fattening, as they grow so large. Now, farmers' wives, up and bedoing! Start out at once with energy and determination, tell the men you are going to manage the poultry-raising. Tell them the work is too easy for them, it would only make them lazy. When you sell your chickens, and get your returns in cash, you will be able to purchase many comforts that you cannot very well afford at the present time.

Queen's Co., P. E. I. MRS. ANNIE RODD.



### The Breed of Fowl the Farmer Wants.

To the Editor FARMER'S ADVOCATE:

There is a great deal said and written about the merits of the different breeds of fowl, each party claiming for his favorite about all the merits known. I believe each breed has more or less merit, or they would not be bred and reared as they have been. The two principal points in a fowl should be eggs and flesh. Can the two be combined in one bird? In a great many cases they are not. Certain breeds are bred for their egg production, others are bred for their flesh. But what the farmer wants is a bird that will produce a large quantity of eggs and at a time when eggs are a good price, and at the same time produce a firm, large, fleshy bird for the table. I believe we have several kinds of poultry that will answer the above. My experience in poultry-raising extends back nearly 25 years. The first pure-bred birds I bought were a pair of pure China swans. I paid \$2 for a pair two days old, and both turned out to be ganders. I was so well pleased with them that I invested in a pair the next fall. They were fine large birds, and the gander could be heard hawking nearly two miles on a clear day. They were very poor layers. A disease called black pip carried off all but the gander. He was mated with common geese with very gratifying results. As the offspring were much larger than the original, my next investment was a pair of Muscova ducks, but with many disappointing results, but I think the blame lies with the breeder more than the ducks. The third investment was in a setting of Houdan eggs, with a dozen birds as the result. The following year we had so many Houdans that we were able to kill off all common and grade birds, and to keep only the pure. The result was very unsatisfactory. Lay, lay, lay! At last, about the last of May, half a dozen did condescend to sit. We gladly availed ourselves of the offer, with the result that several stayed on the nest three days, and then were so pleased with their patience that they commenced to sing, etc. Two stayed on nest till the three weeks had nearly expired, when they considered themselves entitled to a change, and left accordingly. Not one stayed long enough to hatch; result, no chickens. Such layers! Nice large eggs. The flesh was a nice white, plump meat, such as Englishmen tell me they like in the Old Country. I love the Houdan, and as soon as I can I shall keep a few of them. The Shanghaies I did not keep very long, as they had too much leg and neck, but a very good layer and a lot of meat, but a hard keeper. I gave up poultry-breeding for several years, when I got a few common hens. Among the lot was a little buff hen—and such a layer, from November till October. Then I tried the Brahmans. They are a fine, large, fancy bird, but did not suit me; very few eggs, but plenty of meat. I have been informed that, since they have improved the breed till they have got a good egg-producer. I hope so, for there was room for improvement along that line. The next was the White Leghorn. They are a beautiful bird, and lay a good-sized egg, and plenty of them, with a fair amount of meat. Eight years ago I invested in three dozen and a half of Plymouth Rock eggs, from which I got six birds. I might say it was not the fault of the breeder from whom I got the eggs, as the eggs travelled 50 miles in a buggy, then 140 miles in cars, then 5 miles in buggy; a wonder any hatched. The cockerels were very poor specimens, but the pullets were very fine birds. I purchased a cockerel from a party in Brandon, who had some magnificent birds. I had a handsome trio. The following spring I purchased a trio of Silver Laced Wyandottes from a Winnipeg yard. The first time I had seen the Wyandottes I fell in love with them—such nice large beauties. We had the Wyandottes and Plymouth Rocks in pens side by side for several years, and noted results. We were a long time deciding which breed was best for the farmer. They weighed the same, both had a nice yellow flesh, both easy keepers, both good layers and good sitters, but the Wyandottes were harder to coax to set; both made good mothers. As we found it a difficult matter to keep both breeds, we decided to part with the Rocks and keep only the Wyandottes, which we considered had the most handsome dress. After carefully considering the matter, we believe the Rocks and Wyandottes are the best kind for the farmer; they are good layers. If well cared for and well fed, will lay all winter and make a good table fowl, and are an ornament to any farm.

A word for the Guinea fowl. When we came here we brought a pair with us. While we had them we were not troubled with hawks, wolves or foxes. But we got tired of the roving things; from early morning till late at night it was never quiet, and if any strange bird or animal appeared they made the bush ring. They were cross with the poultry, especially the little chicks, so we sold them. Alas! alack! Since disposing of them the wolves will come right up to the house and carry off the hens from under our nose. I believe the remedy is a pair of Guinea fowl. J. B. POWELL.  
East Assiniboia.

H. J. PATTERSON, Director, College Park Agricultural Experiment Station, Prince George Co., Md.—“Such a publication as ‘Canada's Ideal’ I deem highly educational, and should be in the hands of all stock-raisers in order to set before them a proper type to breed to, and have a general good influence in improving our breeds.”

### Construction of Ice Houses and Cold Storage for Creameries.

[By Dairy Superintendent C. A. Murray, at the Manitoba Dairy Convention.]

The creameries that I have visited in Manitoba have all been very poorly constructed; but I have not seen them all, and what I have seen may have been the poorer ones. The main trouble with the refrigerators in these creameries is that an attempt has been made to build a storage room, or ice box, too cheaply, or with so little lumber that they have not secured the proper insulation from outside influences. The ice houses that have come under my notice so far have one thickness of one-inch lumber, with a varied assortment of large cracks and knot holes, and paint has been conspicuous by its absence.

Before I undertake to explain the methods of building ice houses or ice boxes, I want to make a few suggestions as to the building of a creamery itself. In the first place, I recommend a foundation of stone or brick, as the custom of putting a factory upon stilts or posts is an everlasting source of grief. It forms a nest for dogs, cats, rats, and invariably breeds more bad smells than anything around a factory. Another source of trouble and extra work is found in raised floors, or the so-called “gravity system.” It causes an immense amount of unnecessary labor in lifting and carrying and climbing steps, and the water always soaks into the wood-work and rots very fast. Low ceilings are disagreeable, and a nuisance to the maker, but are quite common. To my mind, twelve feet is low enough. To have an engine in the same room where you are trying to make butter is enough to discourage the best of buttermakers.

But to stop complaining, and in so much as I cannot go into the entire details of building a factory, if anyone intends to erect a building I will readily furnish plans and specifications, and although the original cost of the building may be a little more, the comfort and the amount saved will in a short time pay the difference.

To return to the ice boxes. The size is immaterial, as I shall not go into the minor details of the framework; and it is little difference if sawdust is used to fill in between the walls, or if paper and air spaces is adopted, so long as you make them good; but this you cannot do unless you use plenty of lumber. For the most of it rough lumber will do, and shiplap is very good. I do not believe it is good practice to put on building paper unless it is put between two layers of boards, because it will break, tear and become loose when not properly supported, and nothing will support paper like a layer of boards on each side of it. Three or four layers of paper, in places two thicknesses, between boards, and five thicknesses of boards, will make a box that will hold its temperature. This seems like a great deal of lumber, but it is not so much in the long run, as there is not much surface to cover. Four thicknesses of lumber, four inches of sawdust, one-inch air space, and a layer of paper, make an excellent box. The doors in every case should be beveled, and also the casings and the doors should be properly packed and built the same as the walls. And the floors should be at least three thicknesses of lumber and two layers of tar paper, if they are up off the ground; but if they are close to the ground and filled up between the joists, two thicknesses of lumber and one layer of paper is very good. The ceiling should be covered at least four inches with sawdust. The ice in such a box should be put up overhead into a galvanized pan with a rack or wooden mat in the bottom to prevent punching holes in it, and properly supported with ceiling under the support, which would be the top of the ice box, but under the pan. Sufficient room should be left around the sides of the pan and the ceiling to admit of a free circulation of air. This pan should drain to one corner, and the waste pipe should in all cases have a trap in it.

A box of this style can be made large enough for most ordinary purposes, but if anyone cares to increase the size so as to store butter for some time and get the utmost out of their ice, follow the same lines, but make two pans, or as many as needed, and carry the drip from the ice through a series of tanks or drums (say five in number), of galvanized iron, four feet high and twelve inches in diameter, connecting a pipe from the bottom of the first one to the top of the second one, bottom of the second to the top of the third, and so on, with a trap after the last one. Other systems may be as good as this, but boxes built upon these lines will prove satisfactory, will hold the temperature, and where the tanks I speak of are used, little more can be taken out of the ice to cool the room.

I do not condemn using large drums and filling them with broken ice and salt, provided anyone has the time to devote to breaking ice and salting it; but you cannot secure a low temperature and hold it in a poorly-constructed box, and if you have a good box it is “love's labor lost” to break and salt ice. The main fault with the drums is that they are hard to clean; they catch and hold a lot of dirt, and they cost more and will not last as long as the pans I speak of.

In the building of an ice house, four thicknesses of lumber and two of paper, with good doors and sufficient sawdust to pack the ice in, will keep ice very well in this country, and if gravel or some such material, and a connection to the drain or sewer be made, it prevents the floor from becoming too wet and saves the ice. Ventilation through the roof is almost necessary. I also advise putting the

ice into the house in tiers and on edge, as it comes from the water, as it seems to be the general impression that it keeps better in this way than it does if it is laid flat.

In reference to mechanical refrigeration, I am quite sure that at the present time there is not a factory in Manitoba that would find any advantage in an ice machine, and the cost of operation would be greater than the cost of ice, and not enough benefit otherwise to pay for the cost of the machine. The cost of ice in Manitoba will, I believe, always be cheap enough to successfully compete with the ice machine; and, although a very fine grade of butter is made by using the machine, there is still a great deal of improvement for us to make before we need urge the adoption of mechanical refrigeration.

### Roadmaking.

FAVORS THE WIDE TIRE.

This is a very important and difficult subject upon which you have asked my help. The best roads we will ever have in this prairie land will be nicely-rounded grades. In this municipality we use six road machines and find they make the best of roads, finishing up smooth and wearing well. Where the road is not too low, or a high grade is needed, we make only one ditch on high side of road so as to catch flow of water, and then one can drive on or off grade. Two years ago this municipality purchased a few bushels of white clover seed, and supplied pathmasters with a small quantity to sow along grades and ditches, and it has proven a good investment, keeping down weeds and forming a sod; it will choke anything out, and is very hardy.

*Statute Labor or Contract?*—In making new roads or bridges, I believe contract is best. You get the work done by experienced men, and for less money than if done by statute labor. But, since we have most of our roads made and getting road machines, I find statute labor works all right to keep up the roads. I find that with good pathmasters, and a good man on grader, a great deal more work is done, and the farmers' boys take a delight in the work. There is quite a strife here to see who has the best and smoothest road, with straightest grade. The pathmasters, being residents, are on hand to make repairs, and should know where to put work to best advantage. Put in good men, and encourage them by building good bridges and culverts, and giving them good tools to work with; and until somebody shows me something better, I am in favor of statute labor. We use pile bridges on all running streams, and have a good pile-driver, and put in frame culverts or boxes in all small ones. We are watching the tile and iron pipes in use on the N. P. R., and will adopt some of them if they stand well. I think the only danger is frost cracking them.

All grades should be rolled down hard and smooth, and think every municipality ought to have several good heavy road rollers. After a road is made it is hard to keep it smooth where there is no sand or gravel to put on it. The first aid to good roads will be the adoption of wide-tire wagons—not less than three inches should be allowed. A wide tire rolls the road instead of cutting it into ruts to hold water and soften the grade. Narrow tires have ruined more roads than anything else, and a law should be passed taxing them heavily. By use of wide tires every wagon is turned into an effective roller, and as all that is necessary to good roads is a smooth, hard surface, wide tires as road rollers are therefore roadmakers. Experience has proved that in hauling loads on wagons with wide tires, six inches is best for farm and road wagons.

In tests it has been proven that there is a difference in draft of from 20 to 75 per cent. in favor of wide tires. High freight rates make the cost of shipping grain several cents more than it ought, but not at as great a cost per mile as the hauling to market on wagons with narrow tires.

Farmers and travellers combining in favor of good roads and wide tires will be one of the first and most important helps. Another thing that would help, and make the country assume a better appearance, is the cutting of all weeds on the roadsides; every land-owner should be compelled to cut all the road allowance adjoining his property, and in a few years the improvement in the roads of this country would be wonderful.

W. T. MUIR, Reeve.

Municipality Portage la Prairie.

### New “Ligowo” Oats.

Not having noticed anything on Improved Ligowo oats in your paper, I concluded that little or nothing was known about them by the majority of farmers. I have grown them for a couple of years, so can give you a little information as to their qualities. I first procured the seed from the Experimental Farm in 1898, and sowed it on heavy clay loam. They yielded at the rate of eighty-two bushels per acre. Last year being a poor year, they did not yield so heavily. I may say that the Improved Ligowo oats are the heaviest cropper we have ever grown, and also the heaviest in weight. I have them that weigh thirty-nine pounds per bushel. The oats are very large and long, the straw is coarse, long, and free from rust. They are also a very early oat. If you think this would be of any value to the readers of your paper, you may publish it. Wishing success to you and paper,  
Haldimand, Co. GEO. GOWN.

[ED. NOTE.—This variety of oats is now advertised in the FARMER'S ADVOCATE by the Steele, Briggs Seed Co., Toronto. Send for their catalogue.]



Abortion Amongst Cows.

CAUSES.

Abortion amongst cows may be due to a variety of causes.

Abortion arising from an accident, or any other cause, often becomes contagious. Infectious abortion has long been known in this country.

Amongst the causes of abortion are the following, viz., impure water, unsound food, frosted food, offensive smells, disease, fright, over-exertion, accident, and the use of bulls that have come into contact with the disease.

REMEDIAL MEASURES.

1. Underground drains at farm steadings should be replaced by surface drains, and these should be kept clean.

2. Liquid manure should be kept some distance from wells and streams of water.

3. The floors of byres should be frequently flushed and kept clean, a little crude carbolic acid, say 2 ozs. to a bucketful, being added to the water.

4. All aborted cows, and those showing signs of abortion, should be immediately isolated, the after-birth (generally retained by aborted cows) to be removed and destroyed.

5. The calf-bed and passages of aborted cows should be disinfected; and for this purpose, and for a continuance of this operation—applied externally as well as internally to the genitals—I recommend the commercial chloride of zinc, 1 part in 1,000 parts of water. It is less irritating, less poisonous, and much cheaper than other antiseptics or germicides. t costs from 6d. to 8d. per lb.

W. WILLIAMS, Principal, New Veterinary College, Edinburgh. March, 1900.

The Hunter and Hackney Shows.

(BY OUR OWN CORRESPONDENT.)

The 16th annual show of Hunters, Thoroughbreds, etc., was held at Islington, London, on March 13 to 16 last. The first day was entirely devoted to the awarding of the 29 premiums offered through the Royal Commission on Horse Breeding, each to the value of \$750, the horses to which these premiums are awarded being Thoroughbreds and undertaking to serve, within certain specified areas in which they are allotted, not less than fifty "half-bred" mares at the fee of \$10, with a groom's fee of 60c. For these 29 premiums there were entered 115 Thoroughbred stallions, of which some 70 were selected by the judges and sent to the vets., who rejected nine of their number, or over 12 per cent. of the number selected. The limit of age in these classes is from 4 to 20 years of age. The attendance during this day was a very limited one, and there is no doubt but that considerable difference of opinion exists as to the utility of these premiums, which, in effect, make one particular breed of English horses bounty fed, and lays it open to question whether or no the actual worth to the country at large is returned by the produce got by such premium-winners. On the second day the show was very much more largely attended, His Royal Highness the Prince of Wales being present in the afternoon, and watched a parade of the Queen's premium winners and some other classes.

Presumably you have already received full reports of the Shire Horse Show and the Hackney Show, both of which preceded the foregoing Hunter Show, each occupying a full week; therefore, there is no need to recapitulate. However, one may say that during all its existence the Shire Horse Society never had a more successful meeting. The same remark applies with equal force to the Hackney Show. In connection with this latter show it is worthy of record that its entries are one and all subjected to a stringent veterinary examination before entering the judges' ring. This year's record is indeed a remarkable one as showing the general soundness of the breed and their almost entire freedom from hereditary disease, 406 being examined by the veterinary, with the result that 386 were passed sound and 20 rejected.

Condition in Horses and Cattle.

"Condition" in a horse has a very different meaning to the same expression as applied to cattle. In the case of the latter the more heavily-fleshed the animal is the better is its "condition" reputed to be, whereas in the case of horses it is not great wealth of flesh, but great muscular development (so essential to the performance of the work expected of it) that constitutes the highest condition. A considerable wealth of flesh is of course necessary for animals which are used for draft purposes, because in such cases "weight" tells, but in the case of animals required for fast work it is sheer hard muscle rather than ponderance of flabby flesh that is specially required. Good condition can only be obtained by the use of proper foods, and for this purpose there is nothing better than a ration having for its basis good oats and sweet well-saved hay. Oats should form the "foundation" of all rations for horses.

An Up-to-Date Stock Barn.

The accompanying illustration represents the basement plan of the stock barn to be constructed on the farm of Capt. T. E. Robson, M. P., this coming summer. The barn will be 100 feet long and 62 feet wide, inside measurement, besides the cement silo, and additional space for sheep pen and root house. The sheep pen will be used largely for ewes lambing in cold weather, and for a horse box at other seasons, as another building will be erected for sheep. The plan was designed by Messrs. Isaac Usher & Son, Queenston, Ont., who write Captain Robson as follows:

"Enclosed find pencil sketch of basement for your new stock barn. We have given our best efforts to make it convenient for feeding, cleaning, and thorough ventilation. You will notice that we have left single doors behind the cattle and box stalls, but should you think best to clean out your stables with sled, cart or wagon, make double instead of single doors. You will notice that we have put three lines of ten-inch tile as inlets for pure air. You will need five foul air shafts on each side and one at each end to carry foul air up through your barn. These shafts should be light boxes about 3x10 in., inside measurement. They should be carried a little higher than the hay or grain is mowed. You will also note that we have designed two light picket gates at the upper end of each cattle passage. One gate is held by angle iron, the opposite gate being held in position by any fastening to the other gate. By this means cattle cannot get through into feed rooms. You will see by plan that we have designed ten box stalls of somewhat different sizes. We think those very necessary in your business of breeding high-class cattle. We would suggest that the partitions in box stalls should not be built higher than the separation of cattle requires, so as not to obstruct light and circulation of air, and we suggest plenty of good-sized windows.

"Now, Captain, be sure to

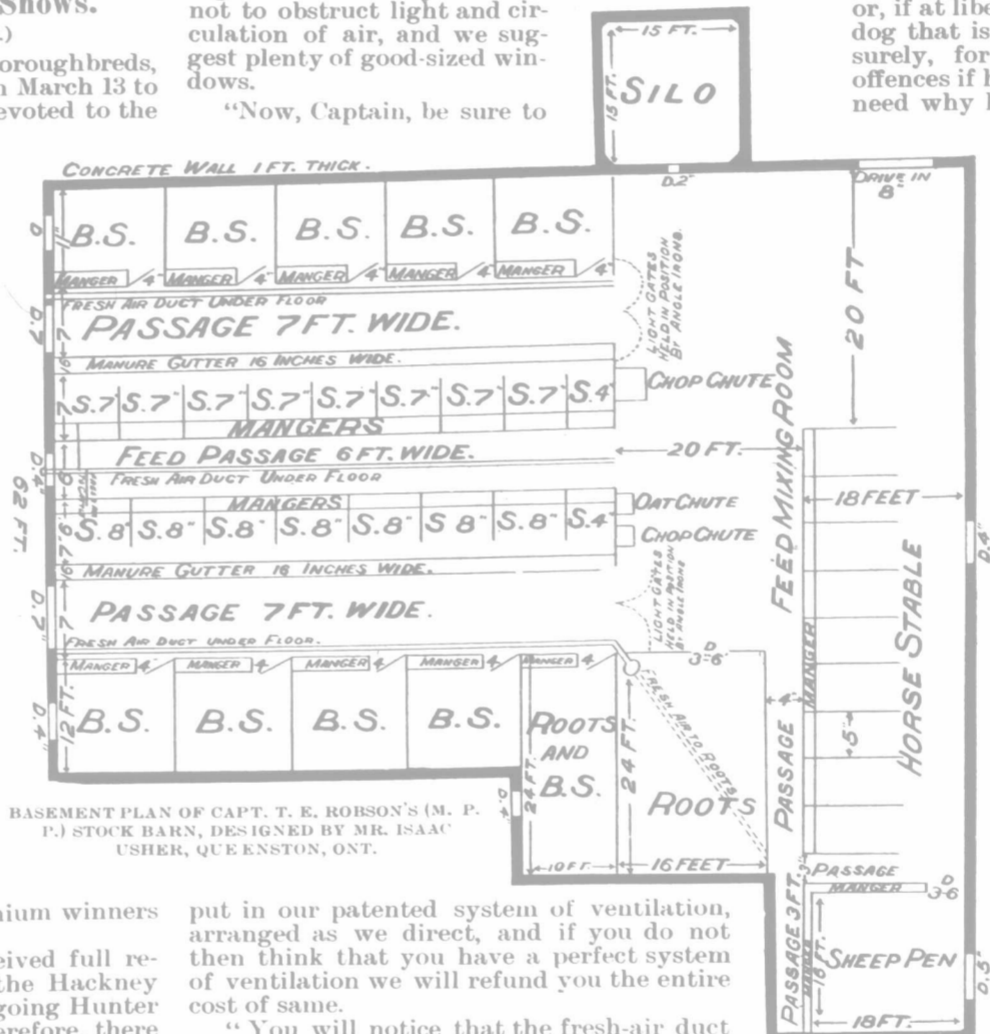

BASEMENT PLAN OF CAPT. T. E. ROBSON'S (M. P.) STOCK BARN, DESIGNED BY MR. ISAAC USHER, QUEENSTON, ONT.

put in our patented system of ventilation, arranged as we direct, and if you do not then think that you have a perfect system of ventilation we will refund you the entire cost of same.

"You will notice that the fresh-air duct running in front of box stalls on east side of your stables stops at the corner of root cellar, and is there connected to a vertical tile which brings the surplus fresh air to top of root-cellar floor. By placing two 2x6-in. scantling (which are tied with 1x2 in. pieces 4 in. apart) immediately over and diagonally across root cellar the fresh air is distributed through roots, and the foul air is removed by shafts as above mentioned. We construct the root cellar by placing, on each side of passage shown on plan, upright scantling (4x4 in.) to ceiling and imbedded in the cement floor at bottom. Then nail 1x4-in. slats, 4 in.



CROSS SECTION OF BASEMENT SHOWING ARRANGEMENT OF FLOORS, GUTTERS, PASSAGES, ELEVATED FEED PASSAGE, FRESH-AIR DUCT, ETC.

apart, on inside of scantling. With fresh air under and circulation on two sides your roots will not decay. The door on north-west corner admits driving in and out of your stables, leaving ample room to turn and stow a number of vehicles without interfering with feed-mixing room or access to your silo. We think this is more advantageous than having your vehicles and horses in separate buildings, as you can hitch and unhitch in any kind of weather without exposure. You will notice we have designed a small portion of your horse stable and your sheep pen on the north-east corner and outside main building. This we deem

necessary, as you can arrange a much cooled atmosphere than in the main part of your basement stables. If these plans do not meet approval, kindly advise us so that we can make any change that you suggest. We are building basement stables on our own farm for the accommodation of 125 head of cattle on somewhat similar plans to the draft enclosed for you, and as we have developed a plan for supporting the upper floor, we would like to meet yourself or your contractor for the woodwork and discuss the most economical way to support the barn floor above and the enormous load that it will have to carry. ISAAC USHER & SON. "Queenston, Ont., Feb. 27, 1900."

A Plague of Dogs.

At the present time the farmers in North Yorkshire are suffering severely from a plague of dogs. Their sheep are being destroyed at such a rate that the matter is becoming most serious. This can well be believed when one of our contemporaries states that "fully one hundred" sheep have been lost in this way around Thirsk. There can be small wonder that the farmers of the district have determined to petition Parliament upon the subject. Their proposals include an increased dog tax and a new regulation requiring the owner of every dog to have his name and address engraved upon its collar. These suggestions are good, but it is doubtful if they are sufficient to meet the case. The name on the collar would be useful when the animal was caught, but would not assist in the catching. Probably the best plan would be to enable the magistrates or the county council to declare a district to be infested with dangerous dogs upon receiving proof of sheep having been worried. Then when such order is in force require every owner of a dog to keep it shut up or chained from sunset to sunrise, or, if at liberty, securely muzzled. The owner of a dog that is given to committing this crime would surely, for his own protection, prevent further offences if he knew of the matter—and there is no need why he should not know. If he lives in a pastoral district, and his dog continues to thrive, and refuses to take meals at home, he may safely assume that it is causing him to run the risk of having to pay for someone's sheep.—Mark Lane Express, London, Eng.

The Sale of Prison-Made Twine.

I may say that Central Prison binder twine will be sold to farmers direct who apply for it, so long as any of the stock may remain unsold. It is expected that fully 1,000 tons of twine will be produced in time for the harvest. It is not possible at the present time to fix the price, as it will be based on the market price of hemp used, adding cost of manufacturing, and providing a margin of 1 1/2 cents per pound for profit. It will give you some idea of the trend of the market when it is stated that the price of Manila hemp has advanced from 33c. per lb. in July, 1897, to 14c. per lb. on 1st January, 1900. The general price of twine is also likely to be affected by the scarcity, owing to hemp not being obtainable for making it. The condition of the market affords a tempting opportunity for combinations and the exacting of famine prices. This is being duly guarded against, so far as the prison product can be made effective in regulating prices, but the quantity being limited, it is impossible to predict how far efforts being made will work successfully. Yours truly, JAMES NOXON, Inspector.

[EDITORIAL NOTE.—In another column Inspector Noxon, of Toronto, Ont., announces the plan whereby farmers may obtain twine for their own use from the Ontario Central Prison, for which prices are to be fixed on June 1st. Read carefully the advertisement. The Warden of Kingston Penitentiary, Mr. J. M. Platt, announces also, elsewhere in this issue, that the time for receiving orders for twine made at that institution has been extended to May 1st. Write Mr. Platt at once for further particulars. Owing to prospective high prices, binder twine is a live topic, and the question of its manufacture and sale by the Government is very fully discussed in a pamphlet lately issued by Hon. David Mills, Minister of Justice, Ottawa, and from whom, we presume, copies may be obtained.]

Have you provided a sufficient supply of well-cleaned seed grain, so as to be ready to rush the seeding when the time comes? Have the implements been repaired and sharpened, the harness mended, cleaned and oiled, and the horse collars made comfortable. Is the supply of summer firewood for the house cut, split and piled ready for use?



**Fifteen Years' Experience in Beekeeping in Manitoba.**

[By James Duncan, Dominion City. Read before the Horticultural Society.]

I claim to be one at least of those who have made a fair success of beekeeping in this country. Without any previous experience, in '84 I purchased my first swarm, merely as an experiment. Ever since, my winter losses have been from nil to four per cent., until last winter and spring it reached eight per cent. The reason I assign for this loss I will refer to under the head of Wintering. For a number of years I have carried through each winter an average of one hundred hives. At present I have over one hundred, all apparently in good condition. The time at my disposal will not permit me to enter into the details of beekeeping, so I shall only refer briefly to a few general principles, which, I think, will be found applicable in most localities and under most conditions. In the spring, when the snow is disappearing under the genial rays of the sun, and nature is stirring itself into newness of life, the beekeeper's thoughts are naturally turned to his little pets, and he is desirous that they, after their long confinement, may rejoice with nature in a joyous flight. But prudence has to be exercised. If there is not yet pollen or honey to be had, their vitality will be impaired in their fruitless search for the same and the sudden changes of temperature which often occur at this season of the year. Many would go out that would never return, which would materially effect the season's results.

I would advise an examination of the hives. If any are found noisy and restless, or short of food, carry them out on a fine day, the temperature being not less than 60°, and let them have a fly. If the snow is not all gone, to minimize the loss of bees lighting on it, scatter some straw or chaff around. They may be transferred into clean hives; if weak, which they are liable to be under such conditions, contract the hive to the number of frames the bees can cover nicely; if short of stores, feed them and return to their winter depository, care being taken that they occupy the same stands when set out for the summer. Where there are only a few hives kept, they might all be treated as above with good results, as it has a tendency to start the queens to lay.

In removing bees from their winter quarters for the summer, haste should be made slowly until the weather becomes settled and the blossoms appear. The prosperity of the hive depends very much on the treatment it receives at this particular time. There are three things indispensable, if even a fair success is to be attained: sufficiency of food, a prolific queen, and a conservation of all available heat in the hives. I think the reasonableness of this will appear when we take into consideration that the life of the bee does not so much depend on the number of days it lives as upon the amount of work performed by it. The limit of its existence in the working season is about forty days. Yet it will survive under proper conditions for over six months in confinement, come out in the spring bright and lively, and will help nurse the little babies that are soon to take its place. The bees surviving the winter will soon disappear, and the strength of the hive in the end of May will depend upon what those bees have been able to accomplish in the way of brood-raising, and this will be regulated by existing conditions. If the queen is to fully perform her functions, not only a proper temperature, but plenty of food is necessary, for, be it remembered, her majesty will never attempt to raise a family in a cold house, or where the means of support is not in evidence. To do so would be to violate the laws that govern her being; something her highness never does. The presence of unsealed food in the hive has a tendency to stimulate more active home duties and lessen the necessity of roaming in search of food, especially in unfavorable weather; and minimizes to a great extent what is known as spring dwindling. The presence in the hive of the bees helps to raise the temperature and facilitate the reproduction of the same. The man or woman who deserves the name of beekeeper will use every means they can devise in aiding those foster-mothers in raising the thousands of fatherless children under their care. For, be assured, if financial results are to be obtained, they must come from the labors of the bees who are in excess of that required to maintain the economy of the hive. Hence, a good start is half the victory.

We will now refer to the setting-out of bees for the summer. If there are a number of hives, the evening is, I think, the better time, if late enough so as they will not fly until next morning, when there will be less excitement, they mark their locations better, and are less liable to mix up, as sometimes they do, leaving some hive almost depopulated when set out during the day and allowed to fly. The entrance of each hive should be contracted to about an inch by means of entrance blocks; next day, if fine, the entrances may be enlarged by slipping back the blocks a little to facilitate the flight of the bees, and afterwards arrange them so as the bees can just get out and in nicely. The winter quilts or cloths used for the absorbing of moisture and the retaining of heat may be left on and the covers placed over them. The hives now being on their summer stands, and, we will presume, all numbered, the next thing in

order is to examine them on the first opportunity, with the temperature as already indicated. Provided with a smoker, something to loosen the frames, a clean, empty hive, and a notebook and pencil, we will proceed to hive No. 1. Remove it from its stand, upon which we will place the empty hive; then we will remove its cover quilts and propolis cloth (if necessary, give a puff of smoke), loosen the frames and proceed to transfer them, with the bees adhering, to the empty hive, they still to retain their original position in the hive. Keep a sharp lookout for the queen or any indications of her, remove all badly-moulded comb, or an excess of drone comb over three square inches—unless in hives intended for breeding purposes, which may contain a full frame of drone comb, or even more. If weak, or short of stores, contract or feed, or both, as already mentioned. Make all snug and warm and properly adjust entrance blocks. In the notebook should be recorded the number and condition of hive for future reference. The hive from which the bees were transferred should be properly cleaned, and hive No. 2 treated as No. 1, and so on to the end. All queenless colonies should at once receive a queen or be doubled-up with a hive containing one. If doubts are entertained as to the queenlessness of a hive, it may be examined a week later, and if no queen is found, or eggs present, it may be safely treated as queenless. A colony without a queen, although it may after a while start fertile workers, it is only a matter of time when it will become extinct. Hives having had proper care, lacking in neither comfort or unsealed stores, should along about the first of June be getting crowded with bees, the drones will be making their appearance, and preparations for swarming will be in progress. Entrance blocks may now be removed from all except weak colonies. Swarming may be controlled to a certain extent by giving room just at the right time, ventilation, and

given when to put on surplus cases; these rules may look very fine on paper, but I have often found them bad in practice. The matter rests with the apiarist's good judgment and his knowledge of what is required. We must not forget that the brood nest or box we usually call a hive is a workshop, where the results of the work performed is simply a reproduction of itself. In each brood nest we find: A queen that produces the eggs, which about the third day hatch out; an army of bees who nurse the larva, and another army of bees who provide the food for all. As the young bees emerge from the cells they take the place of the nurse bees, and they in their turn take the place of the field bees, who, by their incessant toil, are being worn out and fast disappearing. Hence, I think it will be quite apparent that the prosperity of the hive depends on the queen having full liberty in the exercise of her functions to the best of her ability.

With a good prolific queen in the hive (none else ought to be allowed in the apiary), the increase in the field bees will soon be greatly in excess of the decrease, and the result will be, if there is honey to be had, that the stores collected will be proportionately in excess of the colony's demand and the queen's domain will be intruded upon by the storing of it. If this state of things were allowed to go on, disaster would be the result; but nature has taught the bees to avoid this by preparing for the establishing of new homes and their leaving the old in search of it. The beekeeper who would turn the labor of his bees into cash must see to it that their energies are not expended in maintaining new homes, but in storing the nectar of the flowers for his benefit. This may be accomplished by giving storing room when the supply of honey gets in excess of the requirements of the colony. If extracted honey is the object in view, a super containing 6-inch frames, filled either with comb sheets of foundation or simply starters, should be placed in on the hive with a queen excluder under it. I might mention that the frames I use for surplus honey are only 6 inches deep, filled with comb or full sheets of foundation. I find the bees will start to work more readily in them than in deeper ones, and they are handier every way. When the box is about two-thirds full, raise it and place another one under it. The top box, which will be the first to be finished, may be extracted and exchange places with the one on the hive, which, when filled and extracted, may again take its former place, and so on until the end of the season. But in no case should honey be extracted until fully ripened, which is only in rare cases until fully sealed. Not later than the first week in September a thorough examination ought to be made of the hives, the supers taken off all hives short of winter stores, and the same receive sufficient sealed honey, or feed pure granulated-sugar syrup to raise their stores to at least 30 pounds in each hive. As the honey flow draws to a close all supers ought to be removed, and as the weather becomes colder bee quilts or several thicknesses of some material, preferably woollen, should be placed over the propolis cloths, and the entrance block adjusted as the strength of the colonies may severally require. When the season gets advanced, and the prospects of the bees getting a fly disappears, they should be placed in their winter quarters. Those quarters may be a house cellar, or any depository where the air can be kept pure and a fairly equal temperature maintained, with the entrance blocks and covers removed.

The hives should rest at least one foot from the floor, and if tiered up, inch strips should be placed one on each side of under hive for the next to rest upon, that not only a free circulation of air may be maintained, but that the moisture may escape from the under hive. The temperature should be regulated by the amount of moisture present—40° would be about right in a dry cellar, but in might be raised to 50° should dampness appear. As promised, I will mention the reasons I assign for my unusual heavy loss last spring. First—neglect in leaving the cellar door open the previous fall until the temperature went below freezing in the cellar; second—in allowing the temperature to rise gradually after shutting the door instead of raising it more rapidly by artificial means. The lowering of temperature for a short time might not materially affect the health of the bees at the moment, from the fact that under such conditions the cluster would contract, become more compact, hence would be more able to resist the cold. The after results, in my estimation, is where the injury mainly comes in. Cold air entering the hives, and coming in contact with the warm air inside, moisture is formed. Honey, even when sealed, having a strong affinity for moisture, the honey in the hive absorbs the same and renders it unfit food for the bees, who, from their long confinement without a cleansing flight, require a perfectly pure food. Honey, being pure in fact, an already digested food—fills all the requirements of the bees and is fully assimilated by them, but when eaten by them while containing an excess of moisture, it has a tendency to clog up the intestines, and results often in diarrhoea, loss of vitality, and probably, I think, one of the great causes of spring dwindling. Hence it will be apparent that the quicker a low temperature is raised the better. The winter problem may be solved thus: Plenty of good sealed stores, proper packing, pure air and right temperature.

S. E. PRATHER, Sec.-Treas. Sattley Manufacturing Co., Springfield, Ill.—"Canada's Ideal" "is a very fine picture, and I will be pleased to have it framed to hang up in my office."

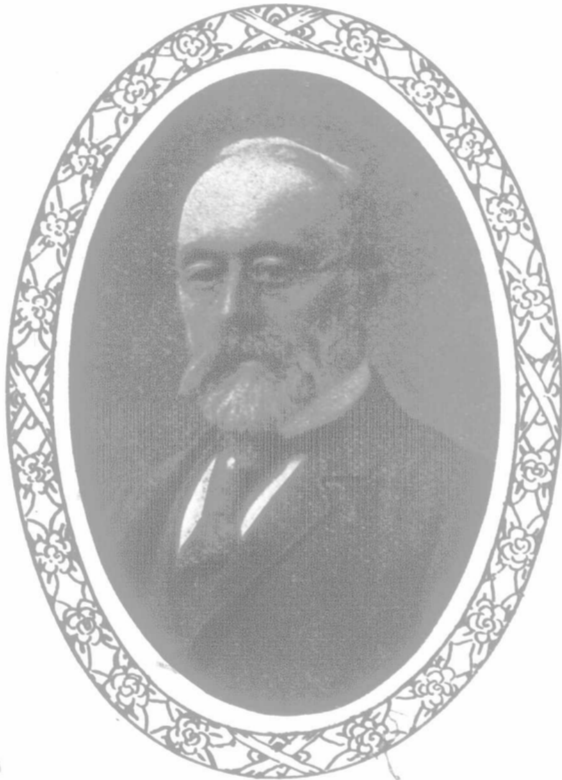

MR. R. W. STARR.

Starr's Point, near Wolfville, Nova Scotia. An enthusiastic and successful fruit-grower.

by extracting freely. But my experience leads me to believe that it is more profitable to allow all strong colonies to swarm once. The second swarms may be stopped by cutting out all queen cells but one from the parent hive; also, by removing the parent hive to a new location and placing the swarm on its stand.

By this process the young colony gets all the field bees, and so weakens the old colony that when the queens emerge from their cells there is no desire to swarm, but a battle royal, and the fittest survive. I prefer the former plan and use a number of the best cells so cut out in forming nuclei, and, by so doing, have queens to use when wanted. All young swarms, after being settled in their hives a few days, should be examined to make sure that each has got a queen, as there is a possibility that she may have been lost or injured, although it does not often occur. As all first swarms, with but few exceptions, have laying queens, eggs ought to be present. All cells left in the parent hives should receive attention, that there may be no doubt that each queen has made her appearance in due time, about 8 days from date of swarming; also, that she has safely returned from her bridal tour 3 or 4 days later. If any hives are found queenless, and no queens or queen cells at command, insert in each a comb containing eggs not more than three days old; this is important if good queens are to be reared. In about 15 days the lack will be supplied. This, of course, would not be practicable in early spring, before the drones make their appearance.

The financial results for the summer much depends upon the care exercised in giving the bees the needed room just at the right time. If young swarms and hives having swarmed are allowed to fill up and contract the swarming fever, the prospects of dollars and cents vanish. We often see, through bee journals, rules laid down and directions



### Clover as a Fertilizer.

[An address delivered before the Farmers' Institute at Portage la Prairie in February, by Frank T. Shutt, M. A., Chemist of the Experimental Farms.]

The subject that I have been asked to address you on this afternoon is the maintenance of soil fertility by the growth of clover. It is a subject that has engaged our careful attention for some years past at Ottawa, and which for the last two years has also been investigated at the branch experimental farms, so that now we can present to you a considerable amount of reliable data, all of which go to show the great value of clover as a soil improver.

In conversation with many of your best and most observant farmers, I learn that the soils of this Province that have been successively cropped with wheat for a number of years now show a marked decrease in yield. This is only to be expected, for you have annually been taking plant food from the soil and returning none. We have pursued an irrational course of farming, neglecting—entirely losing sight of the fact that soil is not inexhaustible. It is quite true that our crops take a large proportion of their nourishment from the air, but it is just as true that they also draw upon the soil for a necessary part of their food. This food must be replaced if the soil's fertility is to be maintained.

Let us briefly review a few fundamental principles. What is the nature of a plant? It is a living thing, because it can increase in size, in weight, and reproduce its kind. As a living thing it requires food; it cannot create anything. What are the sources and nature of that food? The sources are the air and the soil. From the former the plant abstracts a gas known as carbonic acid (a product of animal life), which, by means of the green coloring matter in the presence of sunlight, is converted into starch, sugar, gum, etc., in the plant's tissues. From the latter the plant takes moisture, mineral matter (such as lime, phosphoric acid, potash), and the nitrogen necessary for its existence and growth. The food taken from the soil is absorbed through the roots as a dilute solution. The nitrogen of the soil, before it can be made of use by crops, must first be converted into compounds, known to the chemist as *nitrates*. This conversion is brought about by certain germs that live in the soil, and is known as nitrification. It is assisted by warmth and a right degree of moisture. It proceeds rapidly in summer in mellow, rich, aerated soils.

We will now revert to our argument. Science and practice have demonstrated that of all the elements of plant food abstracted by crops from the soil, there are practically three which we must return if the soil's fertility is to be maintained. Of the others, there is, generally speaking, a sufficient supply. The three I refer to are: Nitrogen, phosphoric acid, and potash. Constant cropping reduces the soil's store of these. For instance, let us illustrate the truth of this statement with the case of wheat. In twenty years a crop of wheat of 15 bushels per acre will have abstracted from the soil of that area about 650 lbs. nitrogen, 200 lbs. phosphoric acid, and 300 lbs. potash. These facts explain why fields lose their productiveness unless plant food is returned.

Now, plant food may be said to exist in the soil in two conditions: the one, inert, locked up and useless (because insoluble) to plants; the other, available, assimilable (because soluble), to plants. The latter, even in the richest soils, exists only in very small quantities, but its store is becoming constantly replenished by good culture. It is the store of available food that is more particularly reduced by growing crops. This is a very important point.

We must now consider for a few moments the two great classes of constituents that make up a fertile soil. The one is the disintegrated and semi-decomposed mineral or rock matter (which furnishes the lime, potash, phosphoric acid, etc., for our crops); the other is humus or vegetable matter (furnishing the nitrogen) resulting from the decomposition of the remains of past generations of plants. Humus is a most important and valuable ingredient of soils, as well from a mechanical as from a chemical standpoint. It is present to a large extent in all fertile soils; indeed, it characterizes such. It is the natural storehouse of nitrogen. By its further decay in the soil it liberates not only nitrogen but also the small amounts of mineral matter it contains, in forms suitable for absorption by crops. The percentage of nitrogen marks chiefly the fertility of a soil, and this percentage depends upon the amount of humus present. Moreover, as the humus disappears by continuous culture, so is the nitrogen dissipated. So that in order to have a soil rich in nitrogen we must keep up and replace humus-forming materials. Further, humus has a great retentive power for moisture, and improves a soil's tilth, making it mellow. It is highly important that for our crops the soil should be moist (to supply them with the water necessary for their growth) and that it should be mellow to allow root extension, to allow air to freely permeate it (for roots, as well as leaves, require air). Under such conditions nitrification will proceed rapidly.

To sum up this brief review, we see that continuous cropping, as for example, with wheat, reduces the soil's store of nitrogen, phosphoric acid, potash and humus. Further, it tends materially to injure the mechanical condition or tilth, which latter is a property of soils that must be closely attended to if

our crops are to be well supplied with moisture and have a comfortable bed or medium in which their seeds can germinate and their roots forage for food. It will now be our business to learn how the growing of clover may improve a soil in these respects.

(TO BE CONTINUED.)

### Butter--From the Stable to the Table.

ARTICLE II.

#### THE DAIRY COW AND HER FEED.

The dairy cow is not an animal in her natural, normal condition, but one which by continuous selection, breeding and care, has been developed from an ordinary mammal into what might be called a living machine for converting coarse food into milk.

It is the habit in mammals, when their young have reached a certain maturity, for the mammary glands to cease secreting milk, but man has so developed this particular function in cows as to make the lactation period almost continuous. This fact gives us an animal whose constitution has been weakened and its nervous system greatly intensified, requiring the utmost care and intelligence in handling to give a profitable return.

There are a number of dairy breeds, each with its peculiarities and special recommendation. The *Jersey* and *Guernsey*, which may be classed together, are pre-eminently noted for giving rich, yellow milk, containing the largest fat globules. They are large and economical butter producers, and consequently are the buttermakers' cows.

The *Holstein* is the largest of the dairy breeds, consuming quantities of food and giving in return a good flow of milk of average quality. She might be termed the milk-seller's cow.

The *Ayrshire* is of medium size, giving a fair quality and quantity of milk having the smallest fat globules, which makes it difficult to cream. For this reason the milk is particularly adapted for cheesemaking, and the Ayrshire is known as the cow for the cheesemaker.

Some Shorthorns have distinguished themselves as milkers, but as a class they run more to the beef type.

A general description of the dairy cow is applicable to any of the dairy breeds.

In form she should be wedge-shaped, as viewed from the front, top and back.

Her constitution is indicated by width of chest, giving plenty of room for heart and lung action, also by a mellow, elastic skin, and fine, soft, oily hair.

A large barrel shows capacity for digesting quantities of food.

Her nerve power, so essential in milk secretion, is shown by her full, bright, intelligent eye, her broad forehead and her prominent, open-jointed spinal column.

But the main feature of the dairy cow is her ability to secrete milk. For this she must have a capacious udder, with large teats evenly placed. The veins on the udder should be numerous and prominent. The milk veins should be large, tortuous, and extending well forward before entering the abdomen.

The general appearance should be decidedly feminine, and her disposition gentle, but lively.

While much stress may be laid on the form of a cow, still the only true test of her value is in her ability to produce butter-fat. This can only be ascertained by weighing and testing her milk. Scales and a Babcock tester are indispensable in building up a paying dairy herd. Have a standard, and, after a fair trial, discard every cow which does not come up to it. Demand that each cow give you 6,000 pounds of 3.6 per cent. milk, or if the pounds be fewer the per cent. must be correspondingly higher. This is not making too high a demand when records show that some Holsteins have given as much as 30,000 pounds of milk in one year, and a noted Jersey, Signal's Lilly Flagg, 1,047 pounds of butter in a year.

Perhaps I might just explain what 3.6 per cent. milk means. A fair sample of the milk is taken and tested, and shows there is 3.6 per cent. fat in it, meaning that in every hundred pounds of that milk there would be three and six-tenths pounds of pure butter-fat, which would make four and a quarter pounds of butter.

It was impossible for the Israelites to make bricks without straw, so it is just as impossible for a cow to make milk without a liberal supply of food and water. Depend upon it, she is going to look after herself first, and if you only give her food enough to maintain the heat and wear and tear of her body, you need not look for large returns in the milk pail. It is the poorest of economy to stint a milking cow in her food.

No question is receiving so much attention in agricultural journals as balanced rations, and feeding has now become a science.

As grass is the ideal food of the cow, we should endeavor to supply succulence to the winter ration to approach as near as possible summer conditions. Silage has filled the long-felt want in this respect. No cheaper, better bulky food can be provided. It increases the flow of milk, and makes the cream easier to churn.

35 lbs. of good silage,  
10 lbs. cut clover hay,  
4 lbs. bean, "  
2 lbs. chopped oats,  
2 lbs. chopped peas.

all mixed together and given in two feeds (night and morning), with fifteen or twenty pounds of mangels fed at noon, or if you have not the mangels give a little good oat straw or hay. This makes a ration on which cows should do well. It is necessary to occasionally make a change in the ration, as it gives the cow more relish for her food. Appetites vary in cows the same as in human beings; some want more, others less. Some feeders recommend giving what will be eaten up clean in two hours.

A word with regard to the water. I fear many think so long as the water is *wet* it is good enough for the cattle. It is a sad mistake. Impure water is not only bad for the cows, but it is a means of spreading disease, and many serious outbreaks of diphtheria, typhoid fever, etc., have been traced through the milk to the water the cows have had access to. See that it is pure, then give her a liberal supply of it, for remember over 87 per cent. of her milk is composed of water.

Of all the creatures the farm can boast—  
And in my time I've seen a host—  
The most profitable one that I know now  
Is a No. 1 good dairy cow.

LAURA ROSE.

O. A. C. Dairy School, Guelph.

### A Household Convenience.

I have a good thing to suggest to those who are willing, at very little trouble and expense, to lessen the discomforts of farm life. The fact that the water closet is out of doors, and at some distance from the house, constitutes a hardship throughout the winter that the kind farmer deplores and yet does not know how to avoid. This hardship can be avoided very cheaply and in a perfect manner wherever there is a furnace under the house and a fire burning continuously night and day through the cold period of the year. Every one who has cleaned the furnace tubes knows how the air "sucks" into the opening used for cleaning. If a hole were cut in the furnace smoke pipe, just above the furnace, the air would rush into the pipe, just as the air rushes into the cleaning hole. Connect a 6-inch pipe to the smoke pipe, and continue this pipe down to the floor, and it will be found that the air is being drawn into the open end of this pipe. Let this pipe pass into a closed box. If this box is not air-tight, the air will be found rushing into it through every crevice and crack. The air passing into the box would be drawn up through the pipe into the smoke pipe. If there were anything in the box of a bad odor, such odors could not get out of the box, because the air is rushing into the box through every possible opening. The offensive odors would pass off with this air through the smoke pipe into the outer air above the house. I herewith show a sectional

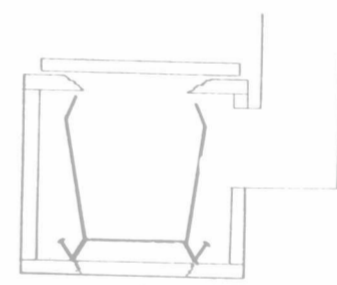

Closest Attachment to Furnace.

view of the box, properly furnished and arranged for the purpose. The pipe passing out and up at the right-hand side connects with the smoke pipe. The whole top turns up on hinges like the lid of a chest. The opening in the top is closed with a cover, as shown. It is fastened at one edge with hinges, and can be turned up out of the way when

required. When the receptacle is to be carried out, the top of the box is turned up and the cover of the receptacle put on. There is room to leave this cover inside of the box. Nails, considerably inclined, driven into the bottom, guide the receptacle to the exact place again. The box should be fairly tight, though not absolutely so, for some air should pass in to carry all offensive odors up the smoke pipe. Especially should there be some leakage around the small cover on top to allow air to carry away offensive odors from the top of the receptacle. In most furnace cellars room can be found for this arrangement, and any tinsmith can connect with furnace smoke pipe. I put one in at the beginning of the winter, and it is a great convenience and a perfect success. The difference between going into a warm cellar and going through the snow to a bitterly-cold building out of doors is very great indeed. It could be connected with a coal-stove smoke pipe, provided there were a convenient place to put the box. You need not have the slightest fear of anything offensive as long as there is a good draft up the smoke pipe with which it is connected. Of course, as soon as warm weather comes and fires are put out, the thing would not work, but then it would not be required. The box I made is 17x24 inches, and 13½ inches high, inside measurement. The bottom extends out in front 2 or 3 feet to form a little platform.

Elgin Co., Ont.

H. PETTIT.

### Western Stock Growers' Association.

The Western Stock Growers' Association will hold its annual meeting at Medicine Hat on April 12th. A deputation from the Manitoba Horse Breeders' Association is to attend to seek the co-operation of Western men in securing cavalry remount stations in the West for British army purposes. Single-fare return tickets will be available to those attending the convention.



## COMMENTS ON THE PICTURE.

## "Canada's Ideal" Before the Critics.

ALFRED J. ANDREWS, Winnipeg, Man.—"I beg to acknowledge receipt of your engraving, 'Canada's Ideal.' It certainly seems to me to be an exceptionally fine production and will be highly appreciated by your subscribers. The educational advantages of such productions cannot be overestimated."

G. F. STEPHENS & Co., Winnipeg.—"We beg to acknowledge with thanks the receipt of your picture, 'Canada's Ideal,' which is indeed a work of art, and we must congratulate you upon being able to give your subscribers such an example of the Shorthorns of Canada."

A. M. NANTON, Winnipeg.—"I beg to acknowledge receipt of the live-stock engraving designated 'Canada's Ideal,' which you kindly sent me. As a work of art, I consider it very good indeed, and agree with you that the picture will be valuable and of great interest to farmers and stockmen."

GEO. H. SHAW, Assistant General Freight Agent, C. P. R., Winnipeg, Man.—"I have received the copy of the engraving of the Shorthorns referred to in your note of the 12th inst. I am sure this will be an object lesson to the farming community."

W. MCINTYRE, Manager Canadian Pacific Ry.—"I have yours of the 12th, also a copy of the picture entitled 'Canada's Ideal,' and I have no hesitation in saying that it is a very creditable piece of art work in animal portraiture, and must have a beneficial influence on the stock-breeding interests."

EUGENE DAVENPORT, Dean and Director, College of Agriculture and Agricultural Experiment Station, Urbana, Ill.—"Canada's Ideal' will be framed and hung in our new agricultural building."

E. R. NICHOLS, Acting President, Kansas State Agricultural College, Manhattan, Kan.—"Allow me to congratulate you for your engraving, 'Canada's Ideal.' Our agricultural department will put it on exhibition."

H. F. BROWN, Minneapolis, Minn.—"The large engraving of 'Canada's Ideal' is surely very commendable. I will have same nicely framed and occupy a place at 'Browndale.'"

GEO. HARDING & SON, Waukesha, Wis.—"We appreciate the picture of prizewinning Shorthorns, and will frame it at an early date. Beg to thank you for this favor."

WM. RENNIE, Toronto, Can.—"Thank you for the beautiful engraving, 'Canada's Ideal.' The picture is certainly a work of art, and reflects great credit upon the ADVOCATE."

H. H. GOODSELL, Massachusetts Agricultural College, Amherst, Mass.—"Accept my thanks in behalf of the Agricultural Department of the Massachusetts Agricultural College for your 'Canada's Ideal.' I shall have the same framed and hung in our recitation room."

M. A. SCOVELL, Director and Chemist, Agricultural Experiment Station, State College of Kentucky.—"We are in receipt of 'Canada's Ideal,' and we are pleased to receive it. It is an excellent engraving, and does the Shorthorn justice."

A. CHRYSTAL, Marshall, Mich.—"Many thanks for the engraving, 'Canada's Ideal.' I certainly appreciate it very much. I opened it last night, and this morning it is being framed, and will be hung up in my office as soon as completed. With kind regards."

THE LEADER, Regina, Assa.—"Have received from the publishers of the FARMER'S ADVOCATE a beautiful large live-stock engraving, entitled 'Canada's Ideal,' representing the cosmopolitan Shorthorn and including a number of noteworthy individuals of that breed. The picture forms a fitting companion to the three live-stock engravings previously issued by the FARMER'S ADVOCATE, and a more instructive adornment for the farm home would be difficult to produce."

CHAS. W. PETERSON, Deputy Commissioner of Agriculture, Regina.—"I am deeply obliged for the engraving entitled 'Canada's Ideal.' The educational influence of true representations of individuals of undoubted merit ranks second only to the privilege of personal inspection. You have certainly succeeded in minimizing the disadvantage which the majority of our settlers labor under in being unable to personally inspect animals of the class portrayed, and I am sure your subscribers will appreciate your effort to move 'Mahomet to the mountain.'"

CHAS. C. NORTON, First National Bank, Corning, Iowa.—"Thanks for the beautiful engraving of Shorthorns. Shorthorns are coming to the front very rapidly over here. At the sale of Crawford & Sons, held at Newton, Iowa, March 9th, the females averaged about \$435, some being calves and some old cows."

A. P. WESTERVELT, Secretary-Treasurer, Dominion Cattle, Sheep and Swine Breeders' Associations and Ontario Provincial Winter Fair, Parliament Buildings, Toronto.—"Canada's Ideal' is an exceedingly good portrait of a number of good animals. It should be the means of fixing on the minds of all who study it what the ideals are in the line of stock breeding."

EDWARD B. VOORHEES, Director, New Jersey Agricultural Experiment Stations, New Brunswick, N. J.—"It is certainly a magnificent picture, and will be of great value to me in my work as a teacher as well as serving as an object lesson to many farmers who visit the institution. Work of this sort cannot be too highly commended, as its influence is for good all along the line, helping the man in his adoption of ideals, and thus raising the live-stock business to a higher plane."

PROF. G. E. DAY, of the Ontario Agricultural College, writes:—"I beg to acknowledge receipt of the beautiful engraving, 'Canada's Ideal,' and to thank you for the same. The study of this picture is an education in itself, and I am sure every lover of good cattle will appreciate its merits. It should be especially valuable to young stockmen as an aid to the study of beef type, as well as Shorthorn type, and your enterprise in giving to the public such a notable collection should meet with the hearty approval of our breeders."

J. H. PICKRELL, Secretary, American Shorthorn



SHORTHORN BULL, TOPSMAN = 17847 =

Winner of first prize and sweepstakes at Winnipeg, Toronto, London, and Ottawa, 1899.  
OWNED BY AND USED FOUR YEARS IN THE HERD OF J. G. BARRON, CARRERRY, MAN.

Breeders' Association, Springfield, Ill.—"The engraving, 'Canada's Ideal,' is one of the cases where Canadian Shorthorns are admitted into the United States free of duty, without custom-house certificates. So many live Shorthorns are coming that it keeps one clerk busy almost all the time making out custom-house certificates, which will admit them free of duty. This picture commends itself enough to have it nicely framed, and then it will be hung upon the walls of our new office, which we expect to occupy in a short time, so that Shorthorn breeders who visit the office can see 'Canada's Ideal.' Please accept the thanks of the American Shorthorn Breeders' Association for the same."

## An Ohio Man on the Beef Cattle Standard.

Publishers the Farmer's Advocate, London, Canada:

GENTLEMEN,—We are in receipt of a copy of your engraving, "Canada's Ideal," for which you have our thanks. The picture is certainly a very fine one, and shows a line of animals of which Canada may be proud. I have great faith in the future of meat production throughout the region surrounding the Great Lakes, and I believe that Canadian farmers have done wisely in maintaining the high standard of their beef cattle. Should any Ontario farmer have misgivings upon this point, I would suggest to him that he come over to this side of the lake and endeavor to pick up a herd of first-class feeding cattle. I think that a few days spent in this work in a State which once stood second to none in the quality of its beef cattle would show him that the rank which Canada now holds is well worth striving to maintain. There are still magnificent beef cattle in Ohio, but their number, both relative and actual, has sadly diminished during the last twenty years, and now our farmers are awakening to the realization that a golden opportunity has been neglected. Yours truly,

CHAS. E. THORNE, Director,  
Ohio Agricultural Experiment Station, Wooster,  
Ohio, March 17, 1900.

## Our Scottish Letter.

THE SPRING BULL SALES.

The bull sale season is over, and breeders have before them some data upon which to base an estimate for the coming year. An outbreak of foot-and-mouth disease in Norfolk in the beginning of February was an unlooked-for and somewhat disconcerting event. It upset one's calculations, and the disease being much dreaded, restrictions were imposed on the movements of cattle in England, while the Irish Privy Council made assurance doubly sure by shutting out all cattle from the green isle. In past years Irishmen have been splendid buyers at the bull sales, and the absence of their demand was felt at all the sales, but specially at the Galloway sale at Castle Douglas. Anticipating, as they justly were entitled to anticipate, an increased demand from Ireland, where the Congested Districts Board reports very favorably of the results of Galloway sires, breeders had prepared for a good demand by putting a larger number of bulls than usual through the sale. The sudden closing of the Irish ports, however, upset all calculations, and the Galloway breeders had to submit to low rates for everything except the top specimens. The Aberdeen-Angus "tail" was also disastrously affected, and the average for both polled breeds was down from the figures of 1899. Highlanders held their own, but the Shorthorns had a substantial advance.

The Shorthorn and Aberdeen-Angus centers are Perth, Aberdeen, and Inverness. While Mr. Moir was selling at Aberdeen on Thursday last the news arrived of the release of Ladysmith and its gallant defenders. The fact was announced by Mr. Moir from the rostrum, and the audience abandoned itself to hilarious cheering for several minutes, putting all thoughts of bull buying out of their minds. When business was resumed the first animal to enter the ring, curiously enough, was a white bull of moderate quality named Kruger. He was at once assailed with shouts of derision and contempt, and enthusiastically hissed. It was next to impossible to get anyone to bid for him, but after a bit a movement was made; he was decidedly unpopular, and some granite individual got a bargain of him at 134 gs. If the original Kruger could only be secured as easily the Transvaal troubles would soon be at an end. To return to our Shorthorns. The leading herd has been that of Lord Lovat at Beaufort Castle, Beaulieu, on the borders of Inverness and Ross. This herd is quite distinct in its characteristics. Whatever may have been the cause, the result of the breeding pursued is to produce a very strong, heavily-fleshed animal, rather *outré* in color—red with white patches like the Ayrshire order, undefined orange-roan being not uncommon, and nothing very striking in the way of breed type and character. All the same, the Lovat bulls sell, and at the spring sales they make high prices. This year they have surpassed all previous records. They were first in both classes at Perth, and first at Inverness. The first Inverness bull sold for 230 gs., to go to Buenos Ayres; the first in the younger class at Perth went at 240 gs., to the same quarter; and the first in the older class at Perth, which was rather unpopular, at 120 gs., to a home buyer. These are three splendid prices for bull calves. Lord Lovat's average for three at Inverness was £126, and his average at Perth for a like number was £150 5s., more than double the amount realized at places as averages last year. Eleven of the highest priced bulls at Perth made an average of £122 3s. 8d., and the 194 bulls sold made the respectable average of £28 9s. 9d. each, the highest yet reached at these sales for bull calves. A superior Perthshire herd of Shorthorns is that of Mr. Mastone Graham, at Redgorton. He owned the second-prize bull calf in the older class, and it was sold for nearly double the price of the first-prize one in the same class, viz., 230 gs. At Inverness 72 Shorthorn bulls made an average of £30 5s. 2d. each, and at Aberdeen 164 bulls made £21 16s. 5d. each.

The significance of these figures is best appreciated when the fact is borne in mind that the bulls offered in this way are mainly destined for crossing purposes, and their quality and breeding has a vast influence on the future not only of Shorthorns, but of the ordinary cattle of the country. The choicest animals as a rule are not sold at the spring bull sales, but those best adapted for cross-breeding purposes are invariably so, and very soon no one will dream of buying a crossing bull in any other way than this. A fleshy bull is what is wanted for this purpose, and given depth of flesh, the breeding of the bull is not so much taken into account. This is, however, a mistake, and the best results in the production of commercial cattle are got by those who act on the principle that any bull is not good enough for crossing purposes. The importance attaching to pedigree is one cause of the glaring discrepancies between the awards of the judges and the estimate placed upon an animal by competing bidders. Thus, Lord Lovat's Saturn, placed first, made 120 gs. The Redgorton Royal Chief, placed second, made 230 gs. The third in the class made 40 gs., the fourth 100 gs., the fifth 95 gs., the sixth 105 gs., the seventh 41



gs., and the eighth 43 gs. In the younger class the first, from Lovat, made 240 gs.; the second, from Barrelwell, dropped to 38 gs.; the third, from Holl, made 94 gs.; the fourth made 56 gs.; and the fifth, a Montrave bull, 100 gs. The sixth was not drawn, and the seventh made 88 gs. It will be seen from these figures that judges and buyers differ very seriously amongst Shorthorns, and the case with other breeds is not much better.

The leading price of the season has been made by an Aberdeen-Angus bull calf, bred at Ballindalloch, and sold at Perth in the preceding week for 300 gs. His buyer was Mr. W. S. Ferguson, Pictstonhill, Perth. In spite of this high figure, the averages for A.-A. cattle at these sales are not as high as for Shorthorns. This is chiefly due to there being too many of them. At Perth the average price of 297 bulls was £27 6s. 1d., and at Aberdeen 188 made £22 10s. 9d. The leading averages at Perth amongst the blackskins were made by Sir George Macpherson Grant, who got £91 9s. for eleven. Lord Strathmore got £64 3s. 1d. for ten; Mr. MacLaren, Auchnaguie, Ballinbrig, £57 15s. for five; Mr. George Bruce, Tochineal, £45 3s. for two; and Mr. Chalmers, of Aldbar, £37 5s. 6d. for five. Extraordinary advances have been made in certain herds of black cattle through the agency of one particular bull, and it is more than ever demonstrated by the results of these sales that the bull is one-half the herd. It is in fact, demonstrated that he is much more than one-half the herd, because Auchnaguie, for example, has sprung from an average of £23 2s. in 1890 to £57 15s. in 1900 by the use of the fine Aldbar bull, Delamore, for which he paid 190 gs. at the Perth bull sale in 1898. This fine bull was first at the Royal in 1893, and is one of the best animals of his breed seen for many a day, and the quality of his stock is a further vindication of the idea that a quality bull will breed better than a strong, coarse animal excellent, it may be, in some particulars.

Highlanders and Galloways mature more slowly than these finer breeds, but they have done well this year also. The highest price at Oban was made by the three-year-old bull, Calum Riabbach II. of Atholl 1325, which has been twice champion at the Highland. He made £155 in the sale-ring, his buyer being the Earl of Southesk, who, on land better adapted for Aberdeen-Angus than for Highland cattle, keeps a fold of unusual excellence. The second-prize bull, from Poltalloch, made £71, and then there was a big drop, for the third only made £33, and the fourth made £41. The first two-year-old bull made £54, and the second £52. The first three stirks made, respectively, £45, £52, and £35. The average for 24 aged bulls was £25 19s.; for 22 two-year-olds, £28 10s. 6d.; and for 19 stirks, £22 15s. 6d. The Galloways hardly had as good a sale, and chiefly because of their excessive numbers. The top price of the sale was £135, paid by the Duke of Buccleuch for the first-prize stirk bred by Sir Robert Jardine, Bart., Castlemilk. His average for 8 bulls was £36, and Mr. Wilson, Tundergarth, Mains, Lockerbie, had £38 for three. Mr. McCormick, Locherkit, had £23 8s. 6d. for six, and Mr. Thomas Graham, Beaumont, Carlisle, £29 7s. 6d. for two. Mr. Fraser, Glaisters, Kirkgrinjeon, had £28 7s. 6d. for six. Colonel Dudgeon, of Cargen, had £27 17s. 6d. for two, but a large number of herds had averages under £20. Too many cooks spoil the broth, and too many bulls spoil a sale. "SCOTLAND YET."

#### Abuse of the Stallion Syndicate System.

SIR,—Re company ownership, or syndicate plan of owning stallions, the general plan of the agent is to start out to some small village and to find out the veterinary surgeon, or someone that takes an interest in the horse business. The agent is generally a slick talker, and shows his horse to the best advantage. He now offers his man \$100, or a share for nothing, to help sell the horse. They now start out and tell the farmers how they can make money by investing in a company horse, showing how other horsemen have made money out of the business. They may sell eight or ten shares, then there is a halt, and the agent has to get another man to finish the sale. This man has to be paid for his trouble and support. When the sale is finished the men receive their pay, say \$200, for help to make the sale; the agent's expenses, \$100, and his pay takes \$300 more. Now, this is \$600 added to the price of the horse. A horse worth \$1,000 at the importer's stable will cost \$1,600 to a company, and in many cases \$2,500. After the company is formed, someone takes the horse to keep, say at \$10 per month—\$120. Now they put him on the route, which will cost \$12 per week for ten weeks, or \$120, and the groom gets \$80 for his pay. To these add shoeing it, \$10, and interest on capital, \$80; invested say \$1,600 at five per cent. Now, this makes a total of \$410. The horse is bred to say 90 mares, at \$10 per mare; he gets 60 per cent. in foal, or \$540, thus leaving the company \$130 profit. Now the sequel: The first note is now due, which is \$533—one-third the price of the horse—and there is only \$130 in the treasury to pay the note of \$533, with interest added. As a result the farmers have to go down in their pockets for the balance. The next thing is they become dissatisfied over the result and want to sell the horse, and as a rule he is put on the market and sold for what he would bring. This is the result of most of the company ownership of stallions I know of. There have been four companies around here, and the horses cost from \$2,500 to \$3,000, and when they were put on the market they did not bring \$300 apiece. JAMES HENDERSON, Middlesex Co., Ont.

#### English Notes.

FROM OUR OWN CORRESPONDENT.

There has been, during the past month, sold for exportation to Canada a considerable number of pedigreed live stock, selected from some of the best studs and herds we have.

Mr. E. R. Hogate, of Toronto, is over here selecting heavy draft horses, amongst which he has already secured some very excellent Shire stallions and some few of Yorkshire Coach horses, these being shipped at the end of February. Since this date he has been successful in securing a typical Clydesdale stallion of very great merit from Mr. A. McIntyre, Lord Mayor 10586 by name, who was bred by Mr. D. Howatt, of Bogleshole, Glasgow, he being sired by Prince of Ord 7156, a grandson of that celebrated horse, Prince of Wales; whilst his dam is equally well bred, being got by that famous horse, Darnley 222.

Cattle buyers have also been very busy. For instance, Mr. Andrews, manager of the Canadian Land and Colonization Company, has selected from the noted herds of His Grace the Duke of Buccleuch and Messrs. Biggar & Sons, eleven Galloway bulls, six from the former and five from the latter. This same buyer is also taking out a few Galloway heifers for the Company, who will, when shipment arrives, stand possessed of a grand lot of these most valuable and hardy cattle, whose merit for the production of the highest quality of beef and first-class skins for robes stands unequalled.

Mr. W. D. Flatt, Hamilton, Ont., has also been, through his agent, a large purchaser of Shorthorns of the highest breeding and pedigree, thirty-five head having been selected from the noted herd of Mr. P. L. Mills, namely, eight cows, seventeen one- and two-year-old heifers, two yearling bulls and eight heifer and bull calves; from Mr. Leopold de Rothschild's herd, one cow and calf and yearling heifer; a grand two-year-old heifer from the Queen's herd; whilst from the herd of Lord Roseberry and several other Scotch breeders several first-class animals have been selected; and then two capital young bulls by a son of the noted Willis bull, Count Lavender, have also been purchased at Holywell Manor.

The pure-bred flocks of Shropshire sheep in Canada will be materially strengthened by the shipment of a very valuable selection of thirty-two in-lamb ewes, which were selected and shipped by Messrs. Alfred Mansell & Co., from some of the most carefully-bred flocks we have in the country, to the order of Mr. Bradshaw, who is to be congratulated upon becoming possessed of so valuable a lot of typical and first-class ewes.

Some first-class Yorkshire pigs have also been selected for Canada, Mr. D. C. Flatt, Millgrove, Ont., being in this instance the purchaser. Amongst the herds from which these careful selections have been made are those of Her Majesty the Queen, Lord Roseberry, and Messrs. P. L. Mills and Daybell, all of whom are leading breeders.

One of the most notable sales of race horses ever held was undoubtedly that of the late Duke of Westminster, where nineteen horses made the enormous total value of \$355,017.00, an average of just over \$18,685, the top price being paid for Flying Fox, who last year won the Two Thousand, the Derby and the St. Ledger, 37,500 guineas, or practically \$187,500.

#### Scale Insects on American Fruit Imported into Germany.

Dr. Howard, official Entomologist of the U.S. Department of Agriculture, has recently published Mr. E. A. Schwarz's translation and abstract of an important series of "Investigations on American Fruit-Shield Lice," by Dr. L. Reh. Some of the results reached by these investigations are of much interest to the fruit-growers in our scale-infested districts.

On the fruit examined, Dr. Reh found altogether 259 specimens of Putnam's scale, 17 of Forbes', 757 of San José, 115 of the Camellia scale, 129 of the scurfy bark-louse, and 59 of the oyster-shell bark-louse. He did not find any free living larvae of any of the species; of the Camellia scale and San José, he found several mature females containing eggs or embryos. He holds that the importation of fresh fruits infested with either of these two species is liable to introduce them.

With regard to dried fruits, he says "it must be accepted as an invariable rule that no living scale has ever been found thereon." No living scales have been found on dried apple peelings. This report is encouraging to managers of fruit evaporators who have found a market in Germany for their dried apple peelings up to the time of their prohibition. He experimented with San José scale on fresh apple peelings, and found that they lived only from eight to fourteen days; on very thick peelings they lived twenty days. The wrappings, packings and boxing of infested fruit were examined, but no living scale was found on any of these. The prohibition of the importation of dried fruits, apple peelings or fruit packings is held unnecessary.

He found nine per cent. of all the San José scale killed by natural insect enemies, and 22½ per cent. infected by fungi.

EMERY COBB, Kankakee, Ill. "I commend your enterprise and thank you for the remembrance."

ANDREW SMITH, F. R. C. V. S., the Ontario Veterinary College, Toronto, says it is an excellent representation of the Shorthorns.

#### The Cowboy.

BY J. M'CAIG.

Most people have accumulated a more or less generous amount of ignorance about the West and about Western life. This store of ignorance is fantastically mixed with lurid visions of massacres, scalplings, roughriding and lariat-throwing. The human figures on the canvas are Mexican and Indian, some dead-shot Jim of the former people being generally pitted against a horde of Blackfeet or Crees and managing by most improvable and overdrawn skill to outshoot or outride his red-skinned enemies. The phase of cowboy life that the reading public have been made most conversant with is the frontier aspect of it—the conflict of the cow-man with the plains Indians at a time when the latter existed in much greater numbers than at present and had lost none of their primitive energy and ferocity. The extension of the frontier towards the west by the white settler was an eager, anxious and sometimes fatal business for him. Now the Indians are entirely different. The transforming of the Indian to a white man is frequently pointed to with pride, but the process is killing him. He cannot stand houses and fences. His constitution is becoming undermined by want of the eager life to which he is constitutionally fitted and by the change from the purely meat diet of buffalo times to a mixed diet of vegetables, meat and pastry. He is even a cowboy or haymaker himself, and will borrow a quarter from you to buy a dinner, promising to pay you when he sells his hay—just as a white man would—and is so long in coming back that you are forced to conclude the hay market must have gone all to pieces. Truly the working of the white man's leaven in him is gratifying.

The Indian and Mexican may be eliminated from both the social and industrial West. The Indian is simply a figure as of a passing horseman on the outer limits of the broad prairie horizon; the Mexican has fallen back before the vigor of the invading Saxon. An occasional Mexican cow-puncher may be seen, with the bronzed and parched face of the dry southern plateau, and the live, black, passionate eyes, mistakenly thought to be energetic; but as a race their domination has been spoiled by the cold, calculating business energy and enterprise of the American or Canadian rancher and cowboy. Nevertheless, the Mexican lives in the history of cow-punching. The saddle of the cow-puncher is Mexican in style and name; his *sombrero* is the same. His "chaps" are the older *chaparreros*; the "round-up" is an adaptation from the Spanish *rodeo*. The rawhide *lariat*, or *lasso*, have scarcely given place to the less picturesque "rope." The word *broncho* is as frequently used as "cowhorse," and the term "mustang" and "pinto" will live as long as the coloring and blood of the two species are found among the horses of the range. The term "cayuse," so commonly applied to the half-wild Western ponies, is not Mexican, but is derived from the Cayuse Indians, a tribe of western Oregon. The reason for the Mexican coloring that the cattle business bears is not far to seek, for the industry began in the south and has travelled north in a broad belt along the eastern side of the Rockies through the United States and up into Canada beyond the sixtieth parallel. With the growth of industry in the New England States and the consequent demand for food stuff, the cattle business extended into the free grass country of the western frontier. The southern fringe of United States territory merged into the Mexican range country. It was found by Mexicans that by driving their cattle farther north their beef qualities were improved by reason of the better grasses of the higher temperate climes and the improved appetites of their bony, dry-hided, big-horned beasts. Beef became a larger consideration than rawhide. The Mexicans learned the beef business from the Saxons, and the Saxon, with his ready susceptibility, learned the cow-punching from the Mexican. The two coalesced, or rather the invasion and conquest of the descendants of Hengist and Horsa was complete. English beef and English mind was too much for the lassitude of the southerner. It was a bloodless Spanish-American war. The Saxon took the Long Trail and carried it on towards the arctic circle; the Mexican quit, but his art was and is a dominating and necessary feature of the cattle business, and so cow-punching remained. The growth of the cattle business has been phenomenal during the past thirty years. It has extended east and west from Dakota to the Rockies at one time or another, but tends to narrow by the encroachment of the cultivator westwards. Its narrowing in the United States has made its growth in the Canadian Northwest extremely rapid during the past ten years, and it is scarcely necessary to say that there is no part of the range country in America better suited to the successful pursuit of the business than the prairie district of southern Alberta, with its good grass and water and comparatively mild winters. The amount of American capital already invested or seeking investment north of the line is a simple and forcible proof of this.

The cowboy's life is spent in the saddle. His country knows no furrow; his equipment has neither binder nor drill. His domain, in most cases, is not limited by fences, and his cattle may be at any place within a radius of fifty miles. Hence it is easily understood that the cowboy goes little on foot. When seen off his horse he does not seem to have been made for walking. His gait is awkward. His heels, as they say, do not track, and his knees are bent outward in bow-legged fashion, and his



shoulders are not carried too squarely. But put him on a horse and all is changed. He is a live and supple figure, rigid from the saddle downward, but all flexible above. You may see him dashing along the trail and into town with almost boyish elation in his prospect of having a good time. His horse is urged mercilessly with spur and quirt, for horse-flesh is not saved in the cow business. His cayuse's ears are set back, his body spread low, and he takes all turns and hillocks with marvellous certainty, and finally halts so short by a sudden draw on the curb that an ordinary man's neck or back would be broken; but it is impossible to disintegrate the cowboy and his horse. They are inseparable. The horse is guided not by drawing to the right or left on the bit, but by moving the hand holding the reins loosely to right or left so as to let the strap fall on the neck where the collar would rest. Drawing the reins across the neck to the right brings the cayuse to the right, and across to the left brings him to the left. Even this is sometimes unnecessary, for the movement of the body or knees serves to guide the susceptible cowhorse. A cowhorse will respond so quickly to the rein that he will stop short in the full gallop and turn directly about on his hind legs and be off in the opposite direction in a flash. The cowboy appears at his best only on his horse, and he must be studied there.

The equipment of the cow-puncher, though losing some of its picturesqueness, is characteristic and more or less striking. His hat is the sombrero, a broad-brimmed light gray felt with a narrow band. An awkward-looking piece of headgear at first it seems. But it is a protection from both sun and rain, and is held on by a strap passing backwards below the prominent back part of the head. His coat and vest are easy-fitting, as a rule. He wears a soft shirt and generally a bright-colored silk handkerchief about his neck. Over his legs and passing up to about the hips he wears what are called "chaps," a kind of leather legging. They usually have a fringe of leather streamers two or three inches long running along the outer seam. They are worn loosely, and are a protection to the legs among the brush. Sometimes the "chaps" are of goat skin tanned with the hair on, but are usually of calfskin. The boots of the cowboy are long boots of calfskin, made very tight and with light narrow soles. The heels are very high and are placed far forward under the foot like a ballet-dancer's. A cowboy jams his foot into the saddle up to the heel, but on account of the peculiar neat make of the shoe he is seldom caught with his foot stuck in the stirrup. For protection against rain the cowboy carries a "slicker," or yellow oilcloth coat, and in winter-time he has a brown canvas coat lined with woolen goods of some kind. The carrying of a gun is a thing of the past, and in this north country there is a tendency to seek comfort first in fur coats, mits, and even felt boots, instead of making parade of the traditional cow-puncher's paraphernalia.

The lawlessness of the cow-puncher is found more in books than in reality. The sport of making a tenderfoot dance by forming a ring about him and shooting into the floor at his heels is played out. Neither do cowboys ride into bars on horseback for their drinks or clean out the room with a "gun." As a matter of fact, the cow-punchers are, as a class, reserved, self-contained, and not given to license. They are generally credited with having an unrivalled opulence of sulphurous epithet. It is only volcanic in exceptional cases. When it does come it is generally picturesque and original. The cow-puncher does not repeat himself in his ornamental and elevated discourse any more than he does in common conversation. He is sometimes taciturn and reticent, and this mask not unfrequently covers an educated and thoughtful man, who has come from different conditions to feel the freedom of the plains, find a beginning in new surroundings or to forget a capricious sweetheart. The saddle is his home—and the Mexican saddle is a comfortable seat compared to the English saddle—the hard, gray, open, boundless prairie is his domain, and the free, broad western wind that sweeps bench and bottom, coulee and butte, making all sweet and clean, is his heritage. An easterner has no conception of the joys of the saddle. The horses are tough. They have good constitution and good wind, and are wonderfully sure of foot. The first mile in the morning is perhaps a bit rough. Your horse feels the exhilaration of starting out fresh. He is heady and tosses and rolls about uncomfortably. By-and-by you get closer to your saddle and more comfortable. You give him a dash for a quarter of a mile. The air is like champagne. Your lungs are filled, your whole body is in exercise. You feel the life of your cayuse and glow all over, and you rejoice in being simply an animal and in the best of working shape. "Yes," said an old-timer, "it shakes up your juices a bit and gives you a fresh start. This country ain't in a bad place."

[TO BE CONTINUED.]

The University of Edinburgh has worthily bestowed the degree of LL. D. upon Miss E. A. Ormerod, whose contributions on Agricultural Entomology have been exceedingly helpful to the farmers of Great Britain and Ireland, and to a very considerable degree to those of America as well. Miss Ormerod has devoted the best years of her life to a study of the life-history and methods of prevention of the insect pests of the farm, and her researches in this direction have enabled agriculturists in many countries to save money in checking the ravages of such pests.

### Going Into the Poultry Business.

I advise anyone intending "going into the business of raising poultry" to have comfortable quarters for the fowls. Any warm, comfortable roosting and nesting place will do until something better is provided. Be sure that plenty of dry dust for bathing is supplied at all times. It is the great remedy against lice, to which fowls are especially liable. This, with plenty of sun, pure water and regular feeding, will give success both in eggs and chickens. Do not crowd the house, and be sure the fowls have plenty of ventilation. Plenty of heat, plenty of food and water, plenty of fresh air, will bring plenty of fresh eggs in the winter and spring, when they are scarce and high. In the summer, allow the fowls to range over the farm, thus paying for themselves in destroying insects and keeping themselves healthy. Always feed regularly, as above stated, and they are sure to return at night.

**The Poultry House.**—The poultry house should face the south on one of its broadsides, and the more glass you have in this the better. One portion should be half dark for the nests, as I have shown by a plan in March 5th issue of the *ADVOCATE*. The roosting place may be in one end; the perches not more than 2 or 3 feet from the floor, especially if the breed is heavy. The perches should be quite large; 2x1 in. scantling, set on edge and nicely rounded, has been found to be all right. A scratch-room is also necessary. Keep everything about the house scrupulously clean. Whitewash at least once in three months with lime, and if lice make their appearance, fumigate the house and sprinkle Scotch snuff among the feathers of the fowls.

**Proper Foods for Fowls.**—Never give fowls sloppy food. When mixed feed is given, it should be made as stiff as possible. I prefer feeding in troughs, as I think the mash, if fed on the floor, would become stuck to the floor by the treading of the fowls while eating. Oat chop, shorts and roots, cooked together and fed pretty hot in winter, with a little black pepper, make a good food. Have broken bone, lime and gravel always before the fowls, as these help them digest their food. Give them a little meat, but not too much. Wheat (parched), oats, along with a little corn, are good egg-producers.

**Market Breeds.**—If your aim is poultry for market, I advise getting Brahmas and Plymouth Rocks. These breeds will lay sufficient eggs for table use and breeding purposes. Give them large, roomy quarters while growing, but while fattening they should be somewhat confined.

**Egg Producers.**—The Leghorn, Poland and Houdan are great layers, and their eggs are good. The Hamburgs are good layers, but their eggs are small. For a laying breed I prefer the Leghorns, because they can be depended on for eggs at all times of the year, if properly cared for.

Elgin Co., Ont.

CLAUDE BLAKE.

### Age to Wean Pigs.

There is a rather common belief that a litter of pigs, after they have attained the age of five or six weeks, can be more cheaply kept off than on the sow, or that it is more economical to wean them at that age. Indeed, we fear that, in not a few cases, in the desire to get two or three litters in the year from the same sow, the pigs are weaned at four to five weeks old, which we feel sure is unwise and far from true economy. It may seem reasonable that if the whole of the feed is fed direct to the pigs, instead of a portion of it to the sow, the pigs would receive greater benefit from it, but it should be remembered that the pigs at so tender an age are incapable of extracting as great an amount of nourishment from the food as can the sow, and in a form as suitable for the digestive organs of the little pigs, which are liable to be thrown out of health by partaking of strong, heating, or unprepared food, and may thus be rendered unthrifty for a considerable length of time if not quite knocked out of the race of life.

A series of eight experiments, carefully conducted at the Wisconsin Agricultural College, demonstrated the advisability of keeping the pigs on the sow as long as possible, consistent with the healthy and strong condition of the mother, and this, for many reasons, chief of which is that a sow and her pigs together will extract more nourishment from a given quantity of food than will the weaned pigs alone. The sows and pigs were separately weighed each week, any loss or gain of the sow was deducted from or added to the increased weight of the pigs. The pigs were allowed to remain on the sow for ten weeks, when a similar course of feeding was carried on with the pigs for a period of seven weeks. Without going into the figures closely, it will be sufficient to take the average quantity of meal and of skim milk required to produce 100 lbs. increase of live weight in the pigs when sucking the sow, and after being weaned. The sow and pigs consumed on an average 231 lbs. meal and 534 lbs. skim milk, while the weaned pigs alone disposed of 230 lbs. meal and 539 lbs. of skim milk in making a similar increase. The returns were thus practically identical. Experienced pig breeders, we are sure, will generally agree that pigs which have been allowed to remain with their

dams for eight or ten weeks, with sufficient exercise, suffer far less from the weaning than those taken from the sow at five or six weeks old, a custom which is far too common, under the mistaken notion that time is lost and extra expense incurred by leaving the pigs on the sow for a longer time, whereas the check sustained by the too early weaned pigs far outweighs the cost of keeping the sow and pigs longer together.

### London (Eng.) Shire Horse Show.

The last exhibition of this century of the Shire Horse Society has become a thing of the past. It has been a grand one in every way, the entries large, the quality good, the prices realized for animals sold record ones, and, best of all, the judging was well and expeditiously done. Very old hands were two of the judges, whilst the third was a promising colt who wisely lent himself to carrying out the views of the more experienced pair who with him occasionally formed the pair of judges by whom each class is judged. One very curious circumstance in connection with the show was that both of last year's champions again occupied their positions of last year: thus Mr. Henderson's very fine four-year-old stallion, Buscot Harold, beat all comers in the decisive struggle for supremacy amongst the male exhibits, whilst Sir Blundell Maple's extraordinary mare, Dunsmore Gloaming, had little difficulty in making good her claim for championship amongst the female Shires of all ages. Here the comparison ends, since the stallion was bred by its owner, whereas the mare was bred by our Norfolk royal farmer, His Royal Highness the Prince of Wales, K. G., at one of whose biennial sales she was sold for what at that time was considered an extravagant price. Whilst in the possession of Mr. Muntz she was dubbed with the prefix Dunsmore, which is the one for which Mr. Muntz paid 5s. to the Shire Horse Society for the sole right of using. This sale of prefixes and affixes by the Society is an amusing example of the right claimed by a few of our stock-breeding societies in defiance of law and reason. As no one has taken the trouble to upset this resumption of a right not possessed by the few societies, the anomaly continues of exhibitors and others buying animals and then dubbing them with their respective prefixes or affixes, and misleading the public by taking to themselves the credit which of right belongs to the breeder of the animal alone.

Another notable fact in connection with the recent show was the collection, in the class for mares over four years old and above 16 hands or 64 inches high, of at least four Shire Horse Show champion mares, viz.: Dunsmore Gloaming, Aldenham Dame, Aurea, and Queen of the Shires, an array of quality, size and weight unprecedented. Then to this quartette must be added still another splendid specimen of the Shire Horse breed, i.e., the mare, Miss Constance, now also owned by Sir Blundell Maple. This mare was placed third in the class; following her as fourth-prize winner came Aurea, the dam of Buscot Harold, the champion stallion; whilst Queen of the Shires, a second mare, now the property of Mr. Fred Crisp, had to be content with the reserve and highly-commended ticket. I think that in all truth it may be asserted that never has been seen six grander specimens of the draft horse at one show than these five mares and one referred to later on. Any one of them could give stones and a beating for size, substance and quality combined to the best Clydesdale mare of to-day. It is this combination which is now of the greatest value on the horse markets of these Islands. Parties interested may write, and truthfully so, of the wonderful quality of bone and well-set hind legs which the best Clydesdales possess, but these alone are useless in our large towns where heavy lorries laden with three and four tons have to be started and stayed by a pair of horses on the asphalt and wood pavements now common and bound to become general in our large commercial and shipping towns and cities.

Still another notable circumstance is the fact that the first-prize yearling stallion is sired by the same horse, Markeaton Royal Harold, as the champion stallion, and also bred by its owner, Mr. Henderson, M. P., one more of our many successful men of business who have gone in for the breeding and still more for the exhibition of pure-bred stock. This wonderful yearling colt was sold by its breeder and owner to Sir Blundell Maple, M. P., still another of our merchant princes, for the record-breaking price for yearlings of 1,500 guineas.

In connection with the reserve champion mare, Southgate Charm, one of the sextette and one of the grandest four-year-old mares ever seen, may be mentioned the fact that she was bred by her present owner, Mr. Fred Crisp, who sold her at one of his auction sales for some 350 guineas, and subsequently bought her back at another sale for 750 guineas, and now possesses one of the cheapest mares for the purpose of her breeder and present owner, who, like so many others of our notable stock exhibitors, owes his fortune to trade.

To attempt to give even an approximately full account of all the exhibits at the show, and their history and points of merit, would require pages of your valuable paper. I must therefore content myself with offering the above discursive remarks and trust that they will interest your readers.

SANDERS SPENCER.

Holywell Manor, St. Ives, Hunts, Eng.



### "Successful Farming."

The new book on "Successful Farming," or farming for profit, written by Mr. William Rennie, Sr., late Superintendent of the Ontario Agricultural College Farm at Guelph, and now on sale, is the plain and pointed teaching of a successful practical farmer, who has demonstrated by actual work in the sight of the public the undoubted success of the methods of farming and feeding which he recommends. Mr. Rennie was many years ago awarded the first-prize silver medal offered by the Ontario Agriculture and Arts Association for the cleanest and best-managed farm, and the many thousands of farmers who have visited the College farm at Guelph in the last ten years can testify to the thoroughness of cultivation and resultant good crops exemplified under his management there. The term scientific farming has been long looked upon by the average farmer as impossible, or at least impracticable, farming; but Mr. Rennie's example and teaching has shown that it simply means intelligent, sensible and successful farming, as his success has been due to the use of no expensive special fertilizers or feeds, or methods of management, but to such as are easily within the reach of the general farmer. If the man and the book had taught nothing more than the paramount value of clover as a factor in supplying humus or vegetable matter in the soil and maintaining fertility, together with the wisdom of surface manuring and thorough tillage for increasing productiveness of the soil, the destruction of weeds, and the conservation of soil moisture, they had done magnificent service to the farmers of Canada; but, in addition to this, the book treats helpfully of many other features of farm work, such as rotation of crops, under-draining, fencing, economic feeding of stock; root, corn, and rape culture; breeds of stock and farm bookkeeping, making in all a valuable book of 300 pages, profusely illustrated, well printed and bound, and conveniently classified. As a Canadian product, and the product of a man known to be reliable and practical, "Successful Farming" may well find a place in the library of every farmer disposed to be progressive.

### Cement Walls.

To the Editor FARMER'S ADVOCATE:

I notice in your issue of Feb. 5th several articles on concrete work, and I would like to say a few words along that line.

Concrete work has passed the experimental stage and has become one of the leading materials for building purposes, especially among the farmers of Ontario, and I believe if the farmers knew more about concrete for building barn basements, it would be more extensively used; for a wall built with concrete is more durable, cheaper and stronger than either brick or stone. Let me say, I know whereof I speak, for I am a practical mason and know the cost of a wall built of stone, brick or concrete. I will just refer to one building I superintended in 1898—the evaporator of J. W. VanDyke, Grimsby, Ont.—and shall give you a description of same. The size of the building is 45x160x24 feet to plate, with gables 12 feet high, making in all 36 feet high from foundation to top of gables. The first story is 13 ft. high and 12 in. thick; the second, 8 ft. high and 10 in. thick, gables, 8 in. thick; and every 14 ft. there are buttresses 1x2 ft. for the trusses to lie on. The first-story walls support the second-story walls and iron roof, and the second floor and machinery and fruit is supported by trusses. There is not a post or pillar in the first story; it is all in one room, 43x158 ft., inside measurement. The first floor is of Thorold cement concrete, and is used in the fall for evaporating purposes, and in the winter for a hockey or curling rink. Now, sir, I think that if a concrete wall of the thickness and height I have stated can support such tremendous weight, it is positive proof of its staying qualities.

Now, as to the cost of the building, Mr. VanDyke states it cost him from \$1,000 to \$1,200 less than brick or stone, according to the estimates he received for the work. NORVAL B. HAGAR, Welland Co., Ont.

### Testimonials.

C. F. SHAFFER, Proprietor, Wellman, Iowa.—"Your picture, named 'Canada's Ideal,' is a magnificent picture of animal portraiture. It fills the eye of the most critical judge."

CHAS. D. WOODS, Director, Maine Agricultural Experiment Station.—"The picture is an instructive one, and is made so it will prove to be more and more interesting as time passes. I congratulate you on bringing together in so fine a manner so many typical animals of this breed."

D. E. SALMON, Chief of Bureau of Animal Industry, Washington, D. C.—"I have the honor to acknowledge the receipt of the live-stock engraving designated 'Canada's Ideal,' for which accept my thanks. I take pleasure in stating that this picture will be preserved for reference as portraying typical individuals of the Shorthorn breed."

### Prevention and Cure of Milk Fever.

We prepare cows against milk fever by taking all roughness away from them for a week or ten days before cows are due to calve; we feed nothing but hot bran mashes twice daily and about two quarts to a feed only, the third feed we give two quarts of soaked shelled oats, a few turnips and red or sugar beets with the bran mashes; we give salts twice before calving, from  $\frac{3}{4}$  of a pound to 1 $\frac{1}{4}$  pounds, according to size of cow and condition of her bowels; to the salts we add 1 ounce of ground ginger, 1 ounce of jalap and  $\frac{1}{2}$  pint of sweet molasses (homemade preferred). If we catch cow laboring or soon after calving we give from a pint to a quart of either sweet oil or raw linseed oil, and add from one to two tablespoonfuls of turpentine; we put enough warm blankets on cow to keep her perfectly comfortable, sometimes as many as three wool blankets and pin them up close so no air strikes cow; we usually put a small Canton flannel next to her, one that does not come over her tail, then we can pin a piece of an old clean rag of any kind on to the end of that to hang over her tail so as not to soil the large blankets in pinning them around her, and when those rags become soiled we remove them, and put on another; we invariably sponge cow off after cleaning or right after calving, the tail, the vulva and her quarters, with a solution of 4 grains of bichloride of mercury to one quart of warm water, and sometimes, if afraid of fever, we flush out the womb with same solution or a little weaker, say 2 $\frac{1}{2}$  or 3 grains to the quart of water, by using a clean rubber syringe; the very first symptoms we

other medicine, adding 1 to 2 ounces of aromatic spirits of ammonia if cow becomes stupid. The main thing is to keep cow extra well bedded and well blanketed and give lots of hand rubbing over the spinal cord and around neck. Sometimes, in extreme cases, we put mustard plaster over loins. M. HILGERT.

[NOTE.—Mr. Hilgert has a valuable herd of high-producing Jersey cows, of which for years he lost numbers from among them annually with milk fever, but since he has adopted the preventive treatment above described, the cases of milk fever in his herd are by far less frequent, and of the cases that do occur he claims, by his curative treatment, to save about four out of five animals attacked.—ED. FARMER'S ADVOCATE.]

### Spring Management of Bees.

BY MORLEY PETTIT.

Much has been said and written on this subject and possibly some bees have been too much managed for their own good or their owner's profit. If bees are well wintered, a few simple rules, with a great deal of sense and experience, are the best stock-in-trade for spring management. Cellar-wintered bees are removed and placed on summer stands early in April. As the motion of carrying out and the change from absolute darkness to daylight thoroughly arouses them, it is necessary that the day chosen be sunny and warm enough for bees to fly (not below 50° F. in the shade). The apiarist should have plenty of help, and keep the cellar as dark and cool as possible during the operation, to avoid greatly disturbing the bees before they can be carried out. Practically sting-proof gloves may be made of cotton which has been used as a hive-cloth long enough to be thoroughly coated with propolis on one side. It is a good plan, where the hives are set in rows in the apiary, to carry out one row, then darken the cellar while the covers and entrance blocks are adjusted; then take out another row, and so on. Set covers on loosely to allow the cushions to air and dry, and close the entrances to about three inches. Mark, "to be fed," any hives which seem rather light.

The most convenient method of feeding in spring is to make syrup of granulated sugar dissolved in water in the proportion of 4 lbs. sugar to 1 quart of water. Fill empty combs with this and hang them in a warm room to drip. They should be quite warm when taken to the hive. After the bees have ceased flying in the evening, go to each hive needing stores and turn back the cloth far enough to remove one comb next the wall, replacing it by one filled with syrup. The entrance should be closed while the top is open, and the change made as quickly as possible to conserve the heat of the hive. Sealed combs, with cappings crushed to induce the bees to distribute the honey, are preferable; but are not so easily obtained at this time of year. I need not state that the matter of spring stores is of the utmost importance. It is equally important to guard against

### ROBBING.

As it is so ably expressed in "Langstroth on the Honeybee," under the adage, *An ounce of prevention is worth a ton of cure*: "Bees are so prone to rob each other in time of scarcity that unless great precautions are used the apiarist will often lose some of his most promising colonies. . . . As soon as they can leave their hives in the spring, they may begin to assail the weaker colonies. . . . If the marauders. . . . attack a strong and healthy colony, they are usually

glad to escape with their lives from its resolute defenders. The beekeeper, therefore, who neglects to watch his needy colonies, and to assist such as are weak or queenless, must count upon suffering heavy losses from robber bees." Experience teaches that where fifty or more hives are kept, the apiarist, during the spring months, should go through the yard at least once every hour, when bees are flying and no honey coming in, to watch for indications of robbing. These are detected by an unusual activity about the entrance, and a shrill sound peculiar to robbers. The flight of young bees which occurs from many of the hives almost every warm afternoon may be mistaken for robbing; but there can be no doubt if the bees emerging from the entrance are loaded with sweets. When it is discovered that a hive is being robbed, sprinkle quantities of flour on the bees at the entrance, and watch the other hives to find the robbers' home. Close their entrance for a time, taking care not to smother them. Put hay over the entrance of the hive robbed, and sprinkle freely with cold water. If this does not break up the robbing, remove the hive to the cellar in the evening, leaving an empty box in its place as a decoy to the robbers. Two or three days' buzzing about this box will satisfy them, and the hive may safely be replaced on its stand, *in the evening*. The time of greatest danger from robbing is when the bees are first out, and from fruit bloom to the opening of white clover.

As soon as the thermometer reaches 70° F. in the shade, on a still day the brood chambers may safely be opened for adjusting brood and stores, and clipping queens. First, find the queen and gently lift her from the comb by the wings; then grasp two or



MR. WM. RENNIE, SR.

Late Superintendent of the Ontario Agricultural College Farm. Author of "Successful Farming."

notice, say if the cow begins to tramp about with her hind legs and becomes uneasy, nose dry and ears cold, we give from one-half to a pint of No. 1 whiskey and two ounces of aromatic spirits of ammonia and give the cow a good hand rubbing every hour. Bath her udder with warm water, rub it well and strip about one-half the milk out, never milk a cow clean for four or five days, but milk often; if the cow does not revive in a couple of hours, we give  $\frac{1}{2}$  pint of whiskey, 30 grains of quinine, 1 grain of nuxvomica, mixed with 1 pint of hot tea made of camomile flowers, saffron and mace (or powdered nutmeg) every four hours, as hot as possible for cow to take, and as the cow improves we give the doses farther apart, but never forget the udder and the hand rubbing of udder, legs and body; if legs get cold rub them well with alcohol and bandage them light. If a cow gets down we never let her lie flat, but prop her up and hold her up with bales of straw or hay; if bowels do not move readily, we give 1 pint of sweet oil or raw linseed oil with 1 tablespoonful of turpentine every 8 hours in between the other doses, and we give injections of hot water, castile soap and glycerine every hour or two. If cow cannot make water, which occurs very often, we take the water from them, or put  $\frac{1}{2}$  ounce of spirits of nitre in each dose of medicine and tea we give her. This will cure any cow of milk fever, unless cow gets down bad and gets to crawling and twitching her head, neck and muscles. In that case I give 2 ounces of chloral hydrate and 1 ounce of bromide of potash, dissolved in 1 pint of boiling water with  $\frac{1}{2}$  pint of molasses (sweet, homemade preferred), divided in two doses, two hours apart. Never give more than that under any circumstances. Then go on again with the



three of her legs between the thumb and first finger of the left hand, holding her so while about half of one wing is clipped off with a small pair of pointed scissors. By experienced beekeepers, spreading brood may be practiced with advantage; but for the beginner and average beekeeper it is safest to leave this matter to the bees.

**Entomology in the Northwest.**

[An address given by Percy B. Gregson, President of the Northwest Entomological Society, Waghorn, Alberta, to the pupils and parents at Waghorn Schoolhouse, Alta., on the "Oviposition of Insects."]

(Continued from page 154.)

Turning now to the fecundity of insects, the number of eggs one female will lay is enormous. Many female moths lay 500 eggs apiece, some 1,000, and some even 1,500; but compared with the queen bee this amount sinks even into insignificance, for the queen bee lays the extraordinary number of 1,400,000 eggs in a single season. The common house fly lays 80 or more eggs at each sitting, and, as it lays three or four settings during its life, the result is something like 300 eggs per fly. These eggs hatch in a couple of days, and the life-round of the fly until the next brood being only from 10 to 14 days, the progeny of a single female fly during the entire summer is estimated at upwards of 2,000,000 flies.

The eggs of insects can withstand a great degree of cold. It has often been noticed that after a severe winter insects are, in fact, more numerous in the succeeding summer, and the reason is that while birds, animals and insects themselves perish, the degree of cold these can withstand is in a much less ratio than that which can be resisted by the eggs of insects. The eggs of many insects are productive after being exposed to a temperature of 20 degrees below zero. So also the vital principle in the larvæ of many insects is not extinguished by extreme cold.

With all the array of different insects around us, with their tremendous fecundity, and with such power in certain of their stages of resistance to the elements, the wonder is that we are not overwhelmed by such a vast multitude. But insects in all stages of their life have many enemies. They are devoured by other insects and by birds, animals, spiders, toads, etc., and destroyed by floods and droughts. There are deadly enemies on every side. There are many insects which are parasites; that is, which lay their eggs in the bodies of other insects, so that when the young larva hatches it eats the living flesh of the insect in which it is born. Every insect, large or small, is liable to be attacked by a parasite. The Hessian fly, for example, small as it is, is preyed upon by at least ten different kinds of other flies. There are many insects which lay their eggs in the bodies of caterpillars. Sometimes as many as 80 or 100 minute larvæ of parasites will live in a single caterpillar, gradually eating up his interior, but not touching a vital spot; while the wretched caterpillar will go about eating his food until at last he succumbs to the enemy within. There are even minute insects which lay their own eggs in the eggs of others, and the young larva lives and comes to maturity inside the egg—a warm shelter indeed!

But time will not allow me to say more now; and there is so much—so very much—of such interest and wonder. Upon some other evening I hope to be able to tell you about the fierce struggle for survival that is ever going on in the insect world, and to show you some friends of the farmer in that world.

**QUESTIONS AND ANSWERS.**

**Veterinary.**

**LAMINITIS.**

SUBSCRIBER, Indian Head:—"I have a mare seven years old which became stiff while standing in the stable. She stands with her fore feet forward and her hind feet spread apart. It appears to hurt her to back out of the stall. She had a colt last spring. She feeds well, and her water appears to be all right. Can you tell me what is the matter with her, and what treatment would you prescribe?"

[You have not mentioned how long your mare has been "stiffened," which, in assisting to arrive at a correct opinion of the case, would have been very useful information. It is, however, evidently a case of laminitis (inflammation of the feet), either of the subacute or chronic form, caused by the animal being compelled to stand in a constrained position on a plank floor for an unduly prolonged period. I would advise you to put the mare in a roomy box stall, deeply bedded with sawdust, chaff or short straw. Remove all superfluous horn from the soles and walls of the hoofs, and soak the feet in tepid water three hours daily for one week; then apply the following blister to the coronet of each foot: Powdered cantharides, four drams; vaseline, three ounces (mix). After three weeks have the feet carefully shod with fairly heavy ordinary-seated shoes. Do not draw the nails too tightly. Give moderate daily exercise on soft ground. Remove all mud or clay from the feet every night and stop with linseed meal poultice. Keep the bowels open by giving, every alternate night for one month, a bran mash, made by boiling a large teacupful of flaxseed in sufficient water to scald four quarts of bran. Into each mash put a large teaspoonful of nitrate of potash.]

W. A. DUNBAR, V. S., Winnipeg.]

**PARALYSIS IN HORSE.**

E. W., Oxford Co., Ont.:—"My horse has been so sick I cannot use him. He laid down in the stable and he cannot get up. He is in good fair condition. I have been working him some all along; he has had hay nearly all the time; he has worked about one day a week on the whole. He seems to have no use in his limbs, and he strikes a great deal with his front legs and some with hind legs. He lays stretched out all the time, and then he throws his head back as far as he can. I have him in a warm place, on the ground floor. I gave him about 2½ pints of raw linseed oil, 1 oz. of sweet niter, and 1 tablespoon of black pepper. His bowels move freely, and he makes water and lots of it. He will not eat anything. Do you think it is indigestion?"

[Your horse is affected with paralysis, evidently, especially of the hind limbs. From the symptoms given I do not think he will recover. He should be gotten upon his feet and supported by slings. Of course, if he has so far lost power that he cannot stand, but will throw his whole weight on the slings, he must be let down again. It does not do to raise a horse entirely off his feet. Sling are merely for the purpose of enabling an animal to rest himself without lying down when he is unable to rise again, and unless he can stand without full support they should not be used. If he cannot be placed in slings he should be turned from side to side every 6 or 8 hours and kept well bedded with clean dry straw. If his bowels become constipated give some more oil or 6 to 8 drams of aloes, with 2 drams ginger, and give 2-dram doses of nux vomica three times daily. If he does not show any improvement in a few days it would be a kindness to destroy him. Give him a little of anything he will eat, but if he will eat soft, easily-digested food, it will be better than dry grain.]

J. H. REED, V. S.]

**EPILEPSY IN PIGS.**

BACON RAISER, Brant Co., Ont.:—"I had sixteen pigs two months old, in a warm pen. About a week ago one began to have fits. When it touched food it would jump backward and lie on its side, apparently without breathing, then its limbs would twitch and it would breathe with difficulty. After a minute or so it would get up and sometimes eat, never having an attack a second time at one meal. Since then a number have had fits, and four, two of which I never saw with fits, have died. I examined the dead ones and found a quantity of blood around their throats, and a frothy substance in their windpipes. The livers were spotted and one stomach was inflamed. The pig that was first sick drinks a little milk. It is very weak, and walks about a great deal and turns in a circle, but does not have the fits very often. The feed has been principally shorts."

[Your pigs are suffering from a form of epilepsy induced by indigestion due to the nature of the food and want of exercise. If possible, allow exercise, and change the food. In all animals the brain is liable to become affected from stomach trouble. Give the pigs about 2 ozs. (for each pig) of either Epsom salts or raw linseed oil in their food once daily, until it causes purgation. If they will not eat their food with the medicine in it you will have to drench them. A pig is hard to drench, and great care must be taken in order to avoid suffocation. Cease feeding shorts, and feed small quantities of grain, with a liberal amount of either turnips or mangolds or a few boiled potatoes. In winter-time when pigs are confined they require roots or something to take the place of the green food they get at other seasons; they also suffer from want of exercise, and we should endeavor to keep them under conditions as nearly natural as possible. After you have caused purgation, I would advise a little of the following mixture (say a dessert-spoonful for each pig) given in the food once daily, viz., equal parts of Epsom salts, sulphur and powdered charcoal. It would also be well to draw a little blood from the pigs at once, which can be done by cutting a piece off the tails or ears.]

J. H. REED, V. S.]

**POLL EVIL.**

G. W., York Co., Ont.:—"We have a horse, 6 years old, that has a big lump on his head. It is about 3 weeks since we first noticed it, and it is sometimes larger than others; not very hard at present, but very tender. He will not let us rub it with anything if he can help it. We think he has bumped his head on the top of the stall. We are anxious to have him cured as quickly as possible, as he is a fine heavy draft, working every day except stormy days."

[Your horse has bruised the poll in some way, and the effect is what is called poll evil. In many cases, if properly treated in the early stages, serious results can be avoided; but if pus is formed, which in some cases occurs early, it will be a tedious case. Bathe the parts repeatedly and for a considerable time with warm water to allay the inflammation and alleviate the pain. When the inflammation has been allayed in this way, blister with the following: 1 dram each of powdered cantharides and biniodide of mercury, mixed with 1 ounce of vaseline or lard. Clip the hair off and apply the blister with smart friction: in 24 hours rub well again, and in 24 hours longer wash off and apply a little lard. Apply lard or sweet oil every day until the scale comes off; when, if there still be any enlargement, blister again. If, in the meantime, pus should form, it must be opened and all sinuses (if any be formed) dissected out. Of course, if this stage be reached, blistering must be ceased. If necessary to operate, you had better employ a veterinarian.]

J. HUGO REED, V. S.]

**SHOULDER SLIP.**

E. F., Prescott Co., Ont.:—"A valuable mare of my father's has something wrong with shoulder. She is 5 years old, large, in fine condition, lively on the road, and very boisterous in her stall, frequently climbing into her manger, which is about as high as her chest, and sometimes has difficulty to pull the last foot out. At the end of January, after having started on a two-day's trip, with a load of grain, at daylight, I noticed she was limping; she limped the whole journey till she got home; now it cannot be noticed, but about two or three weeks ago a large hollow appeared in her chest, as though the shoulder point were sprung out; last week that disappeared, but the shoulder seems to have moved forward, and just behind the bone on which the collar rests, is a hollow running from the top to the bottom, parallel with the collar, and about an inch or so deep. She shows no sign of any pain. Please advise and oblige yours truly."

[Your mare has shoulder slip, or sweeney, the result of sprain of the muscles of the shoulder, caused, in this case, no doubt, by the mare straining to get her feet out of the manger. At first there are swelling and soreness of the muscles, with sometimes lameness. The inflammation subsides, and is followed by atrophy (wasting away) of the muscles, when the animal is seldom lame, but there is usually an imperfect action; she fetches the foot forward in rather a rotatory motion. In extreme cases the shoulder slips partially out of joint at each step, hence the name "shoulder slip." Recovery is slow; it usually takes from 6 to 10 months to affect a perfect cure. The animal should have rest, but if forced to work her, she should be worked or driven on smooth and hard ground, on no account should she be used in the furrow to the plow. We sometimes insert setons, but it requires an expert to insert them, and I would advise the application of a blister about once every month until the muscles have regained their normal condition. Clip the hair off the affected parts, and use the same blister and apply the same way as is recommended in this issue for the colt with ringbone.]

J. H. REED, V. S.]

**PROBABLY TUBERCULOSIS.**

A READER, Huron Co., Ont.:—"I have a steer 3 years old that took a cough about two months ago. He seemed to breathe about a half too fast, and he went off his feed pretty much for some weeks, but by nursing him he has held his flesh pretty well. I do not think he is much thinner now than he was before he took sick. After he takes a drink he has a spell of coughing. Sometimes he seems to cough harder than others, and he seems to be breathing more regular now than a month ago. He has never got food to fatten him. He seems a lot brighter than he did six weeks ago. Is there any danger of tuberculosis? First few days he stood around, not eating. He was frothing at the mouth, but that only lasted for a few days. Now, as he continues to cough, are the other cattle safe near him? He is inside all the time since he took sick." He never seemed to run at the nose that I noticed."

[It is impossible to state positively whether your steer is affected with tuberculosis or suffering from an attack of inflammation of the lungs which has become chronic. As a rule, inflammation of the lungs will terminate either fatally or in a cure in much less time than your steer has been ill. The absence of a discharge from the nostrils and a fated breath indicate tubercle. It is probable he had tuberculosis in a latent stage, and the cold and draft excited it to activity; then the removal to warmer quarters and good care partially arrested the disease. If he is tubercular, there is a danger in keeping him with other cattle, especially in the stable; there would be little danger of affection if running out in the open air. I would advise you to have him tested with tuberculin to decide whether he is affected. He is evidently suffering from some serious affection, as he refuses to eat enough to fatten.]

J. HUGO REED, V. S.]

**NAVICULAR DISEASE.**

J. G., Wentworth Co., Ont.:—"I have a mare seven years old. I bought her last fall. She had been running the hard roads, I believe, before I had her. Her front feet are stiffened right up and her chest has drawn in. I thought with rest she would get better, but she has not. I had her out driving only a few times when the snow was soft, but then she is worse and can hardly move for awhile after it. She has not had shoes on since I've had her. Will you kindly oblige by giving me information as to what to do?"

[The symptoms given indicate navicular disease (coffin joint lameness), a well established case of which is incurable. The falling in of the muscles of the breast is a wasting of the muscular tissue due to the fact that the muscles are not performing their normal functions owing to tenderness of the feet. The symptoms may be relieved by poulticing the feet or by repeated blistering around the coronet, either of which will encourage the growth of horn and thereby relieve the contraction which is the result of inflammation in the joint. In some cases an animal will go better with bar shoes and in other cases bars appear to increase the symptoms. You might try them. It is not probable she will ever be sound, but with care you may get considerable satisfaction out of her at slow work. If she becomes practically useless, you might get a veterinarian to perform neurotomy (removing a portion of the nerves that supply the foot). This operation removes the lameness by removing sensation, but does not cure the disease. It is a last resort, as an animal



may become entirely disabled shortly after the operation; while, on the other hand, she may go practically sound for an indefinite period.

J. HUGO REED, V. S.]

**RINGBONE ON COLT.**

J. McK., Algoma:—"I have a roadster colt 10 months old, which has what appears to be ringbone coming on fetlock. Would you advise me to blister? and what would be best to use?"

"2. Where can I get a good horse book on breeding, training, and diseases of horses?"

[If the colt shows no sign of lameness, leave him alone. If lame, it would be well to blister the fetlock. In many cases in young animals blistering will affect a cure. In case it fails, you will have to get a veterinarian to fire him. Use the following blister: 2 drs. each of cantharides and biniodide of mercury mixed with 2 ozs. vaseline. Clip the hair off the enlargement all around the limb; clip a little above and below the enlargement, too. Apply a little of the ointment and rub with smart friction; then apply a little more and rub well, and so on. It takes from 20 to 30 minutes good hard work to blister a part properly, as the effects of a blister depend to a great extent upon the mode of application. It requires to be well rubbed in. Tie the colt's head, so that he can't bite the parts. In 24 hours rub well again with the blister, and in 24 hours longer wash the parts off with warm water and soap and apply a little hog's lard or sweet oil. Let his head down now, and give him a nice box stall, if possible, but don't allow him to run where he will get into water or slush. Apply a little lard or oil daily until the scale comes off, when you will tie him up again and blister as at first. If after 4 or 5 months after the second blister he is still lame, you had better have him fired.

2. If you write J. A. Carveth & Co., 413 Parliament street, Toronto, they will send you a list of veterinary books, with prices, and you can order what suits you. J. H. REED, V. S.]

**CHRONIC INFLAMMATION OF THE LYMPHATIC GLANDS, AND INDIGESTION.**

CONSTANT READER, Neepawa:—"1. I have a 3-year-old colt with one of her hind legs swoolen quite large. I noticed it first last July; then the swelling only appeared when she was standing idle for a few days. Now the swelling is quite large, and remains so even when exercised. Sometimes for a week or so the swelling is larger than at other times. About a month ago it broke out on the inside of the leg, just below the knee, and some matter came out of it, but the sore is now healed up."

"2. Have another horse 16 years old. When put to steady work, refuses to eat, but seems to have a good appetite when only worked lightly. Fed on green oats, sheaves, oat straw, and oats."

[1. The lymphatic glands of the affected portion of the limb are in an inflamed condition, and the case being of 8 months' standing, it will be somewhat difficult to treat it successfully. Prepare the animal for physic by feeding exclusively on bran-mash diet for sixteen hours, and then give the following purgative ball: Barbadoes aloes, 7 drams; powdered ginger, 2 drams; syrup or soap, sufficient to form a ball. Continue the bran-mash ration until the physic has ceased to operate. After this, give, morning and evening, in food for two weeks; iodide of potass, and nitrate of potass., of each 1 dram; powdered gentian, 2 drams. Paint the leg once daily for four days with strong tincture of iodine (iodine, 6 drams; iodide of potass., 5 drams; alcohol, 8 ozs.). Allow one week to elapse and wash the leg thoroughly with warm water and castile soap, removing all scabs and scuff from the skin, and then repeat the application of the tincture of iodine. Repeat this treatment for at least four times, strictly observing the above directions.

2. Your horse being an aged animal, I would advise you to have his teeth carefully examined, if possible, by a competent person. I would also advise you to change his fodder from oat straw to good hay. Give every night in bran mash for two weeks: nux vomica, 1 dram; powdered gentian and bicarbonate of soda, of each 2 drams.

W. A. DUNBAR, V. S., Winnipeg.]

**LUMP JAW.**

GREENHORN:—"After reading these articles in the last two numbers of the ADVOCATE, re lump jaw in cattle, I would like to know if the disease ever starts in the cheek opposite the teeth. I know of a case of lump jaw that was under treatment. There were some young cattle kept in the same field, and three of them took lumps in the cheek, on one or both sides. These lumps were not attached to the bone in any way, as they were killed and I saw one of them taken off with the skin. I asked to have it cut open, and there appeared to be a hole in the center from the skin extending in towards the mouth. There was no matter of any account, but the hole seemed rather open and running a small amount of dark, watery stuff, very dirty looking. Now, I would like to know if this is the same disease, or if there is any possibility of it being so?"

[It is very probable this case was lump jaw, but it is impossible to say with certainty. The lumps of this disease are liable to appear on either jaw or the tongue, and in many cases are not attached to the bone, especially in the early stages; later on the bone may or may not become involved. When the bone is not involved, a cure can, in most cases, be effected by carefully dissecting the tumor out. We must always look with suspicion upon lumps on cattle's jaws, unless known to be caused by a direct injury. J. HUGO REED, V. S.]

**ECZEMA.**

E. T., West Hall, Man.:—"Would you kindly tell reason why jack rabbits have large blisters, generally on the hind leg, sometimes filled with water, other times with water and matter? Is it a disease that effects the whole rabbit, making them unfit for eating? Some assert that it is dropsy."

[The ailment appears to be a peculiar disease of the skin, of an eczematous nature, but unless I had the privilege of making an autopsy of an affected rabbit I would not feel justified in giving a decided opinion as to the nature of the disease, or as to the wholesomeness of the flesh as human food. If you are much interested in this matter, please forward the newly-killed carcass of an affected rabbit by express, prepaid, to the office of the FARMER'S ADVOCATE, and we will examine it and report. W. A. DUNBAR, V. S., Winnipeg.]

**DISEASED SHEEP.**

S. P. F., Brandon:—"I have had a number of sheep take sick lately. They go off their feed and die in a day or two. Can you tell me the cause, name of disease, and cure?"

[Your description of symptoms of the disease is altogether inefficient to warrant me in giving an opinion as to the nature of the ailment. Bad feeding and bad care has very often a good deal to do with the unhealthy condition of sheep. There are several good veterinary surgeons in Brandon, and I would advise you to lose no time in consulting one of them. W. A. DUNBAR, V. S., Winnipeg.]

**Miscellaneous.**

**TO KILL STINKWEED.**

GRENFIELDAR:—"Could you kindly furnish us, next issue, with the best methods for killing the French or stink weed? A field, summer-fallowed last season, was not duly cultivated, and some of the seeds matured and will spring up in greatly increased quantity. A weeding implement was introduced last season, having a long beam (or two), with long, springy teeth to scuffle the surface, and, being rigid, will not reach every spot of ground where uneven. Is there no cheaper or better implement? What is the chain harrow? How would it do? Is there a weeder composed of quadrilateral frames of iron rod, attached to each other so as to rise and fall to inequalities, the sides being a foot or two in length? And how would it do? How would it do to make a number of two-bar harrows, rather light, sufficient in length and number to be attached to the whole length of the drawbar of ordinary harrows, and having teeth, say five inches apart, and sloping back so as not to tear up grain roots? And what would be the best shape and size of such teeth?"

[Stinkweed being an annual, very easily killed when young, as its root have but a slight hold on the soil, the easiest and most effective way of destroying it is by attacking the young plants as soon after the seeds have germinated as possible. We believe the best implement for this purpose yet introduced is the weeder. There are several makes, and some are doubtless better than others. They are light and easily operated; a large quantity of land can be covered quickly and repeatedly, with little or no injury to the grain crop; they are easily handled, and if stubble, rose bushes or other rubbish should accumulate in front of them they can readily be lifted clear. The long, springy teeth do enough kicking to kill all such weeds as stinkweed, if employed when the plants are very small, without injury to the grain, and can be repeatedly used to kill several crops of weeds, at the same time assisting to retain the soil moisture by keeping the surface from crusting over. Of course a weeder can only be used when the surface is dry, or it might injure the grain. We do not know of the chain harrow being used in this country. They would be too heavy, more likely to injure the grain, and require more labor, and could not be used as frequently. We have no knowledge of any implements answering the other descriptions being in use, but cannot see wherein they could be any improvement over the weeders.]

**BROME GRASS.**

A. E. J., Edmonton, Alta.:—"In looking over your number of February 5th I see an item on "Smooth Brome Grass." Kindly let me know the right time to sow the seed, the quantity to the acre, and if oats will do to sow the seed with, as I have about 50 acres ready for the spring, and am intending sowing oats. Any particulars you can give me will be thankfully received through your columns."

[Brome seed may be sown from early spring till end of July, but seeding during the last week in May or the first week in June will give the most satisfactory results. Ten pounds of seed per acre, if sown evenly, is the proper quantity to sow. If Mr. J.'s land on which he purposes sowing Brome seed has been fallowed, 1/2 bushel oats per acre may not injure the young grass plants, provided the season is favorable. If land has only been fall plowed and oats are sown with Brome seed, the young plants will in all probability be so weakened or entirely killed out that the grass will be a failure. It is safer to sow Brome seed alone, and keep weeds from seeding the first year by mowing. ANGUS MACKAY, Supt.]

**CHART FOR CUTTING UP BEEF.**

SUBSCRIBER, Pilot Mound:—"Would you kindly publish in your next issue of the FARMER'S ADVOCATE a chart for cutting up beef?"

[See chart and article on this subject in March 20th issue.]

**CEMENT CURB IN WELL.**

R. D. SMITH, Provencher Dist., Man.:—"I have a flowing well which I find difficult to control, as there is a wooden piping in it, and at the top a box about 3 feet square and 6 feet deep, the water rising to about 3 feet above the ground. Could a cement jacket be built around the boxing to hold the flow and stand frost? There is a good clay subsoil. If this can be done, I should like to know how to proceed."

[In reply to yours of the 15th, re inquiry of R. D. Smith: Yes, a cement jacket 18 inches thick and of the depth or height mentioned can be built on the outside of the box referred to. The work would be done as stated in your February 5th, 1900, issue, pages 67 and 69. The box referred to would require to be made tight, so as to prevent water from washing the cement concrete while in the green state or before it has set. After setting, the concrete jacket would be plastered with a covering coat of about 1/2 of an inch thick, composed of one part cement and one part fine, sharp, clean sand. D. BATTLE, Thorold, Ont.]

**SUBSTITUTE FOR GLASS WANTED.**

J. D., N. Westminster Co., B. C.:—"As I am making a hotbed, I wish to know if there is any substitute for glass, equally as good. If so, please let me know through your ADVOCATE where I could procure it?"

[So far as we are aware, no material has yet been produced to take the place of glass as covering for hotbeds. We know of a large number of green-houses in operation, and glass is the only material used to let in the light and heat and keep out the cold. If any of our readers know of a material that is more satisfactory and sufficiently cheap to warrant its use, we would gladly hear from them.]

**Chatty Stock Letter from Chicago.**

FROM OUR OWN CORRESPONDENT.

Following table shows current and comparative live stock prices:

prices:	Extreme prices now.	Top Prices		
		ago.	1899	1898
Beef cattle.				
1500 lbs. up.....	\$4 75 to 5 70	\$6 05	\$5 75	\$5 50
1350 to 1500 lbs.....	4 55 to 5 50	6 00	5 75	5 75
1200 to 1350 lbs.....	4 30 to 5 60	5 65	5 60	5 30
1050 to 1200 lbs.....	4 10 to 5 45	5 65	5 40	5 10
900 to 1050 lbs.....	3 90 to 4 90	5 10	5 15	5 00
Hogs.				
Mixed.....	4 70 to 5 20	4 95	3 95	4 02
Heavy.....	4 80 to 5 25	5 00	4 00	4 10
Light.....	4 75 to 5 15	4 90	3 90	4 10
Pigs.....	3 50 to 4 85	4 75	3 80	3 75
Sheep.				
Natives.....	4 00 to 6 00	6 00	5 00	4 75
Lambs.....	5 00 to 7 15	7 50	5 90	5 75
Colorado lambs.....	6 90 to 7 25	7 50	5 90	5 75

The fat-cattle market is pretty low just now, mainly for the reason that there are so many undesirable and underfed cattle being forced upon the market. The fine-stock market is in good shape, exceptionally good shape. The following summary of the Wallace Estill dispersion sale of Aberdeen-Angus cattle, at Dexter Park Amphitheatre, Chicago, makes a remarkable record:

58 females sold for \$33,845, averaging \$583.53.  
14 males sold for \$7,354, averaging \$561.00.  
72 head sold for \$41,639, averaging \$579.30.  
Highest priced cow, \$2,800.00.  
Highest priced bull, \$2,100.00.

Lucia Estill, a queen mother cow with a bull calf at side, sold at \$2,800, the highest price by \$750 of any Aberdeen-Angus cow ever auctioned. The average was \$120 per head higher than the previous best sale of the year, \$62 higher than the best sale of last year, \$72 higher than the famous M. H. Cochrane sale of 47 selected Angus cattle in 1883, and over \$262 per head higher than the great National Hereford Show sale last October at Kansas City.

The demand for good feeding cattle is strong. There are not a few cattle that were fed all winter that are sent back to the country. These cattle would do all right on grass, but they will not take hold and make the gain from the start that could be made from thin cattle that had been roughed through.

Hogs have been selling the highest lately since 1895. A well-known packer during a conversation recently expressed the opinion that the supply of hogs would continue light for some few weeks to come, and prices rule high. He stated that the demand from the Southern States for hog products had never been better, owing to the high prices of cotton and prosperous times. The copper and iron regions of Michigan and Wisconsin were taking a greatly increased amount, and that the consumption of hog products was simply enormous, and while a short time ago he had an entirely different opinion, he now believed in higher prices.

Sheep prices continue to rule the highest on record for many years. There were sold for S. W. Hamilton, of Winona, Minn., 339 head of 132-lb western sheep at \$6.00 per cwt. This is the highest price for western sheep since 1893. Lambs are selling very well and feeders are happy.

**What England Imports.**

Some striking figures of the value of agricultural imports into the United Kingdom from all countries are below given. They represent the values of the different descriptions of agricultural products for the years 1898 and 1899:

	1899.	1898.
Cattle for food.....	£ 8,572,114	£ 9,399,793
Sheep for food.....	942,891	984,863
Fresh beef.....	7,344,723	5,915,705
Fresh mutton.....	5,439,407	4,902,179
Bacon.....	10,400,602	10,321,674
Hams.....	4,094,500	3,894,839
Other meats.....	5,358,564	4,945,943
Poultry and game.....	785,294	657,492
Eggs.....	5,044,392	4,457,117
Cheese.....	5,515,091	4,970,242
Butter.....	17,213,516	15,961,783
Margarine.....	2,549,376	2,384,384
Lard.....	3,068,985	2,887,801
Milk.....	1,456,003	1,435,951
Wheat.....	22,282,701	26,147,256
Flour.....	10,700,990	11,545,443
Maize.....	12,967,205	11,282,310
Barley.....	4,960,352	6,791,472
Oats.....	4,190,721	4,382,857
Beans.....	573,891	670,159
Peas.....	898,951	689,769
Potatoes.....	1,577,519	1,913,912
Onions.....	845,782	792,909
Apples.....	1,186,143	1,108,056
Vegetables.....	1,744,068	1,680,756
Hops.....	899,842	1,030,140
Living animals.....	9,515,012	10,385,676
Dead meat.....	32,637,796	29,580,340
Meal or flour.....	58,088,561	62,909,264

The foreign sale of American flour is increasing enormously, from about 1,000,000 barrels in 1875 to over 40,000,000 barrels in 1885, and 15,000,000 barrels in 1899.





The Mutiny of the "Helen Gray."

BY GEORGE MANVILLE FENN.

CHAPTER I.

"No! No! Don't, pray don't! Man—man! I've a wife and child. Don't kill me. Help!"

I seemed to hear those words as I lay there in the hot darkness, wondering whether I was awake or whether I was dreaming, for I was stretched out in my bunk 'tween decks, but as soon as I had heard them, all, for a few moments, was as still as death.

"Dreaming!" I said to myself. Then, "Awake," I muttered through my teeth, for there came now the sound of scuffling, and a curious noise as if someone was trying to call out with a hand held over his mouth. Then there was a dull splash, and pat, pat, pat, naked feet running along the deck over my head.

But stop a moment. That is not a fair beginning. It's like jumping over a wall half way down a garden instead of going in at the gate. So I'll try again.

I, John Robertson, gentleman, tell you this story of peril and adventure on the sea.

No; wrong again. I, John Robertson, blackguard, tell you this tale. No, no, no; that will not do. I am going too far the other way now. I was a blackguard at one time, for I ought to have known better. The fact is I went all wrong, as many another has gone before.

I quarreled with my father; I thought I was to keep up the supplies of money that I wanted; and at last, to spite my relatives, I said that I would disgrace them all by going and enlisting. But I did not do that, for it so happened that I had done a great deal of yachting all round the Scottish and Irish coasts, and, as my tastes were marine, I went to sea instead.

My idea was to join the Royal Navy; but at the last moment I altered my mind, being scared by the thought of the strict discipline, so I did the wisest thing I ever did in my life; I got a berth before the mast on board a large barque bound for the East, saying to myself: "They'll be sorry now," hugging myself with the idea that I should soon have my father at the docks begging me to come home again for my mother's and sisters' sake, and I felt as proud and pleased as could be when, two days after I had written to say what I had done, one of my messmates shouted down into the fore-castle that there was a grey-headed old gentleman wanted to see me.

I smiled to myself as I went slowly up on deck in my tar-stained, oily, second-hand canvas suit, and sticking my tarry hands well down into my pockets, I swaggered along the deck toward where my father stood near the gangway, where half-a-dozen Malays were helping to get the cargo aboard.

I expected to see the old gentleman looking careworn and with the tears of agony in his eyes; but there he stood, handsome and florid, in his glossy black coat and well-brushed hat, his gold-mounted cane in his well-gloved hand, his gold-rimmed eye-glasses hanging on his broad breast, while I looked as much like a common sailor as the time I had been on board would allow.

No; he did not fall upon my breast as I swaggered up, but said, coolly: "Ah, Jack, my lad!" and he gave me a poke or two with his cane as he might have prodded a horse or an ox to make it move so that he could examine it well. "Humph! looks businesslike. So you are going to be a sailor, eh?"

"Yes, sir," I said. "I am going round the world."

"Right; nice long voyage for you. Do you good, Jack. Going to earn your living, eh? Well, I like your pride, my boy; and I will not insult you by offering you money. Thought I'd just drop in and see you before you sailed. I won't shake hands; my gloves are new. Goodbye. I dare say you'll make a decent sailor after a time."

He gave me a sharp, short nod and turned and walked away, leaving me more astonished than I ever had been before in my life.

That was my first lesson. That taught me, in my foolish young conceit, that I was of not so much consequence in the world as I thought, and on the top of it came another, for the big, burly first mate shouted at me from the other side of the deck:

"Now, you, sir, why aren't you at work?"

"Because it is my watch below," I said, savagely.

"Eh? What!" roared the mate. "Look here, young fellow, that kind of thing won't do with me. I know your sort pretty well; idle, loafing scamps, who have failed in everything, and then, because they know the names of a few ropes and sheets, think they're sailors. If it's your spell below, go below; but if you sauce me, confound you, you'll find you've got into the wrong box."

I thrust my hands into my pockets, after giving the mate an ugly look, which brought him close up to me, when he bent his head a little so as to look me full in the eyes before I turned off to walk to the hatch, and as I began to descend I found him close to me, still ready to look me down.

"Hold hard a moment, young fellow," he said, clapping me on the shoulder. "I daresay you think yourself a pretty big bug in your way, but you're one of the crew of the Helen Gray now, and you've got to obey."

"And if I don't?" I said, stung into speaking at last.

"I'm going to make you, boy," he cried in a loud, fierce voice. "I've tamed bigger fellows than you, and I'm going to tame you, as you shall see. Go below."

I went below. I don't think I was afraid, but he seemed to have a something about him that forced me to obey, and raging within myself I felt as if I had found my master at last.

The fore-castle of a large merchant ship, with its gloomy and stuffy atmosphere, is not, at the best, of times, an attractive place. Now it seemed the vilest hole I had ever entered, as I threw myself down in my bunk and lay staring before me, face to face with the fact that I had made a mistake.

My musings were interrupted by the descent of one of the crew, a big, heavy, elderly man, who had so far confined his intercourse with me to a rough nod or two, and borrowing my tobacco pouch, or asking for a match in one word, "Light."

But now he came close up to where I lay, squatted down and stared in my face.

"Well," I said, trying to imitate the rough manners and customs of my companions, "know me again?"

"Oh yes; I should know you again," he said, nodding his head. "No mistaking a chap like you."

"Why?"

"Why?" he said with a laugh. "It's curious, that it is. I went to the play once, and there was a chap on the stage and dressed up and making believe that he was a sailor, and he talked as if he thought he looked like one, but, bless your art, he was no more like a seaman than I am—than—"

going to be messmates. We shall sleep close alongside o' one another, and perhaps you'll be in my watch."

"Well, what of that?"

"I've been at sea five-and-thirty year, and I wanted to give you a bit of advice."

"Keep it till you're asked for it."

He gave me a grim smile, struck a match carefully, put it out after lighting his pipe, and went on smoking.

"You're rusty, mate, you want scraping and oiling."

"Don't try to do it now, I might kick."

"Won't do, lad. Now, look ye here: you're a chap as can speak well when you like. You've got book larning in you and that sort o' thing, and you know as well as I do that soldiers and sailors has to do what they're told. You've only just joined the ship, and you've begun to make things hot for you by having a row with the first mate."

"I've had a few words with a bully."

"Same thing, young 'un, but don't call names. Stow all that. It won't do here. You cut up rough with him, and he won't have it. Why the skipper has to give way to him sometimes."

"I'll let him see that he isn't going to bully me."

"Nay, not you. He isn't such a bad sort when you come to know him. Take it a bit easy: do what he tells you, and you will be all right."

"No, but you looked it. Yah! you're not made of the stuff to do that at the first rough word said to you. Stick to your work, my lad, and learn to be a regular sailor as soon as you can. You do know something about it, eh?"

"Oh, yes; I've been out in a yacht in all kinds of weather."

"Ay. But a yacht ain't a barque."

"Nor a barque is not a yacht. Here, what's your name?"

"Joe, mate—Joe Stacey."

"Then, Joe Stacey, I beg your pardon for being so rough; I was put out."

"Course you was, mate, but never mind about beggin' pardon. We don't do that sort o' thing here. Have a pipe."

I lit up and began to smoke.

"Skipper's just come aboard."

"Has he?"

"Yes, and brought his missus and their little gal along with him."

"His wife and child? What for?"

"Well, I did hear something about her having been bad, and coming a voyage to set her up again."

"Rough life for a woman."

"Oh, no. 'Sides if a man's married I don't s'pose he likes leaving his missus, and I don't s'pose his wife likes leaving he."

"Where are we going?"

"You asked that ere before signing for the voyage."

"Oh, yes. I remember; Singapore, Hong Kong, and Shanghai."

"That's so. And a nice voyage too. All warm weather."

"And what are we laden with?"

"General cargo. Lot of wine, beer, and speerits; and Manchester goods. There's a steam engine and waterworks, and a lot of fall-lads they use in smashing up the stones for getting gold put here," he said, tapping the bulkhead.

"Gold?"

"Somewhere up the country, away from Singapore; and there's a whole lot of weapons—rifles and bay'nets, and revolvers and cartridges for one of the rajah chaps there who is going to turn his people into reg'lar soldiers."

"Indian rajahs?"

"No; them Malay chaps like our six lascars."

"Won't catch me doing such a donkey's trick again," I said to myself about a quarter of an hour afterward as I leaned over the side, gazing on the distant shore. "He's a brute and a bully, and one of these days if I don't thrash him my name's not—"

"Roberts."

My name was pronounced quietly by the very man, who had come close up behind me, and as I faced round he held out his hand.

"That was very smart and plucky of you, Roberts," he said. "Thank you. Shake hands; I shan't forget it."

I gave him my hand and he grasped it hard, holding it a moment as he said, rather hurriedly:

"Wife and youngsters at home, my lad. Been rather awkward if I'd had a dig from that fellow's knife."

"Well," I said to myself directly afterwards, "if that isn't disarming a man what is! How am I to thrash him now?"

My musings were cut short by a pleasant silvery voice—

"Oh, mamma, look, look!"

I turned and saw a bright sunny-haired little thing standing on the poop-deck, holding the hand of a tall, graceful-looking woman, who was gazing in the direction pointed out by the child.

"Well," said Joe, who had come slowly up to my side "what do you think of the skipper's little un? Don't you wish you was married and had a gal like that?"

"No," I said. "A man who can't manage himself can't manage children."

"No," said Joe. "I say, though, is it true you've had another row with the mate?"

"Mr. Denson and I are the best of friends," I said, grimly.

"No! Are you though? Wasn't there a row then?"

"Yes," I said, and I told him what had taken place.

"Knocked him over. Tried to take out a knife—eh? Rather ugly; I don't like that."

"Why?"

"Because them Malay chaps have got such bad memories. Then that man will soon forget it!"

"Nay, my lad, that's t'other sort of bad memory as forgets the good that's done you. This one never forgets the ill."

"You don't think—"

"Not much, my lad. Too much trouble. Nuff to do to get through my work."

No more was said, but that incident, the conversation, and the sight of the tall, graceful woman standing by the captain with their pretty little girl seemed to be burned into my brain.

That promised to be a pleasant uneventful voyage. There were troubles on board, of course, just as there are on every merchant vessel, and I could not help seeing that the first mate, after that incident when he knocked the Malay down, seemed to be particularly severe and distant with the whole of the little party.

But they never seemed to resent it, going humbly and willingly about their work, and as soon as it was done getting together again.

"Don't seem to trust 'em, mate," Joe said to me one day. "Keeps 'em off like. Well, 'tain't no wonder when a man's drawn a knife on you. If ever I'm skipper of a ship I should like to have a crew of twenty men."

"Twenty?"

"That's the number, my lad. Five Englishmen; five Irishmen; five Scotch, and five Welsh."

"A mixture."

"Yes, and a good one. No lascars for me."

But though the Malays went quietly and obediently about their work, it was very plain to see that they were not forgiven. Captain Barton treated them roughly, and if ever there was an unpleasant job on hand Denson was sure to put it on to these men.

I did not like them, feeling full of distrust, but somehow I felt annoyed often and often, and this made me always speak civilly to them when they had, as I judged it, been put upon extra, or more roughly spoken to than they deserved. I did not want to be friends with them, but I often gave one or the other a bit of tobacco or a civil word, and it was always received with a smile and a bright look.

One day at Rio four of them had a tremendously hard job landing cargo. The heat was terrible, but they worked on without a murmur, and if I had been the chief mate I should certainly have contrived that they had the watch below that night; but they did not, and it so happened that Ismael and another man always known as Dullah were in my watch.

We had sailed at sundown, and I was forward looking out ahead into the darkness, and thinking how grand the stars were. Dullah was over on the port side, and I had spoken to him and given him a bit of tobacco some time before—half-an-hour—perhaps an hour, for I had been dreaming, as it were, about home and my people, and half-mockingly thinking to myself what a change this was, and what a fool I was to come, when I started round, and was going to speak, but, as I could just dimly see, the captain held up his hand before my face.

"Hold your tongue," he whispered, and then he went away from me round to the port side.

I don't know how it was, but something moved me to follow, and I was just in time to see the skipper give something dark under the bulwarks a tremendous kick.

A man sprang to his feet on the instant, and I ran up expecting to see a knife out, for it was Dullah, but he stood with his arms folded, patiently listening while the captain called him all the lazy, untrustworthy soundreils he could lay his tongue to.

Captain Barton went below, and I back to my place, and when all was very quiet about half-an-hour later I felt sure that the poor fellow must have gone to sleep again, and I walked softly round to find him with his arms crossed upon the bulwark, perfectly motionless.

"He's off again," I said to myself, and I laid my hand softly on his shoulder.

But there was no sudden start. The dark face was slowly turned round, and the gleaming eyes looked straight into mine.

"No sleep," he said, in a guttural whisper.

"That's right. Have a bit more 'bacco."

"Thank you, no," he said, "Sirih." He held up a brass box, and showed me that he was chewing betel nut and sirih leaf, a kind of pepper-like plant they are very fond of, and use with wet lime, chewing them for hours together.

"All right; keep awake, mate."

"Tire—much work," he said, nodding his head, and I saw his white teeth gleam as I turned away.

Now, they say that history repeats itself. It did in my adventures. For one night after we had got round the Cape and were sailing away before a gentle breeze straight for Colombo, it was my watch again, and this time there was another of the Malays instead of Dullah. He, too, had had a heavy day on deck in the hot sun, doing a lot of re-stowing and hauling at a fall, for the captain had fancied that the ship was getting a bit of a list to starboard, and took advantage of a very calm day to shift some heavy cases.

Well, just as it was on that other dark night, I was leaning over the bulwarks gazing right ahead, when I suddenly said to myself: "I'm as sleepy as sleepy. The heat, I suppose. I wonder whether that Malay chap's awake."

I turned sharply round and saw a dark figure go by the binnet to light right aft.

"The skipper," I said to myself, and I knew he was coming to give a look round.

I could hear the men buzz, buzz, buzz, in the darkness, quite a low murmur, as I stepped quietly round, thinking that if the Malay was not awake the poor fellow would be in for it.

"All right," I said to myself, as I caught sight of him through the darkness, just dimly seen, with his arms on the bulwark, gazing out to sea. But at that moment a sound fell upon my ear—a low, deep, hoarse breathing.

I sprang to the man's side and caught him by the arm to give him a shake.

He uttered a quick ejaculation, and sprang from me expecting a blow, while beyond him I could see the skipper coming through the gloom.

[TO BE CONTINUED.]



## Travelling Notes.

## AUSTRALIA.

We have talked so much of cities; and there is, after all, so much similarity in all large ones, that a few words about Adelaide is all we will indulge in. The population is 100,000, and, although in importance Adelaide is not yet the equal of Sydney and Melbourne, it is making giant strides. Many consider it the prettiest of the three, and most certainly it is the cleanest. It is surrounded by fine parks, and beyond its boundaries are lovely blue hills. Wide streets, marble pavements, and fine, substantial public and private buildings, botanical gardens filled with rarest plants, many in bloom all the year round. All these combine to make Adelaide most attractive. Truly these four cities, Sydney, Melbourne, Adelaide, and Brisbane, have much to be proud of.

One great drawback in Australia is the scarcity of water. There is so little rain in summer—and summer here is, of course, so much longer than with us at home. The rain water has to be caught during winter and stored in galvanized tanks and cisterns to supply the houses the year round. Thus all houses or other buildings (at all country railway stations there are funny linen bags hung) have at their sides a big tank. This want of rain also causes the absence of green grass—and all know what a loss this is—and the storms of sand and dust, which with the high winds sweep over the cities, are dreadful. From the beginning of April till the end of October the climate, they say, is most delightful; but in January, February and March the heat is suffocating, and what wonder, with the thermometer varying from 90° to 115° in the shade. When the north wind blows, the heat is especially trying and very dry. The flies are something appalling, and they seem to have a special fondness for the backs of men's coats. They buzz about you in that aggravating style of which flies are such accomplished exponents, and everyone has to wear veils, and even men wear nets encircling the face and neck. As for the worried horses, they have regular hats and bonnets in lieu of the nets in use. All this looks very funny, but it is absolutely necessary for any kind of comfort. Notwithstanding the great heat, the flowers flourish and grain ripens and is harvested; but farming is, of course, very different to ours. A very curious contrast is afforded as you speed along, by the green hedges all over the country and the arid and desert-like appearance of the grass; then the thousands of sheep on the ranches, which reminded us of the Northwest; the immense number of rabbits skurrying into the brush and underwood, and the infinite varieties of the Eucalyptus, or gum tree, which grow here in such profusion. Another novel sight is the queer old ox teams, often numbering 10 or 12 oxen for a heavy load, and looking so picturesque; and then the black natives, not quite so attractive. All these sights are very novel and very interesting, and fill us with wonder as we observe the striking differences in each country, and yet the similarity, especially amongst the people. Without exception, *hospitality* seems to reign equally everywhere, and the kindness and attention met with in all our travels has been never-failing.

The lovely home of relatives where we now are is about 30 miles from Adelaide, in the hills, and is indeed an ideal spot. The magnificent gum trees pervade the landscape everywhere, and the lovely river where one can go cray-fishing, or sit on its banks, or lie under those grand and shading trees, drinking in a scene of unutterable richness, with the blue hills spreading far and wide. Such a scene—and in mid-winter too! Fancy our Christmas in this weather—warmth everywhere—and nowhere warmer than in our hearty and loving welcome to the far Australian home. The dear aunt and uncle, whom to know is to love, and the warm-hearted cousins, made a Christmas which will stand out bright and clear when occasions again roll between us all. We had the regulation routine Christmas—cards and Christmas services, which seemed so strange with the temperature over 100°—and then the regular old Christmas cheer; and in spite of the heat, *didn't* we enjoy that pudding! And we thought of all the dear ones at home, and of those who have "gone before," and thousands of miles were bridged in thought, and outside in the garden

were blooming thousands of roses, and shrubs and vines in endless charm. Truly *such* a Christmas! Somehow we cannot help feeling at home in our sister colonies. *Four* now have we been in—Queensland, Victoria, New South Wales, and South Australia;—and what grand countries they are! At every turn in each continent we have now been in there is cause for thankfulness and pride;—the wonders of nature; the patience and energy of man; and that universal *brotherhood* which unites us.

## UNCLE TOM'S DEPARTMENT.

MY DEAR NEPHEWS AND NIECES,—

It would be quite the orthodox thing for Uncle Tom to discourse upon the war; but as every paper is bristling with war news, it would be superfluous to do so. All Canada is throbbing with exultation at the recent British victories, and testifying her joy in many ways; yet she has also cause to weep for the loss of those dear sons who have shed their blood in "darkest Africa." It is certainly laudable to be patriotic, to sing national songs and wave your country's flag; but is there any reason for the almost fanatical actions that have been perpetrated in the name of patriotism, such as the burning of the effigies of Cronje and Joubert, etc.? We may and do condemn them as enemies of our country, but we should also respect them as brave soldiers, none the less brave because they are our enemies and have been overpowered. The most patriotic men are not those who shout the loudest, else why have they not gone to take part in the fray and



HANDEL.

show their patriotism in action rather than in words?

Too cruel a thing is war. Let us talk of something else.

Ho there! my farmers and farmeresses in embryo, how many of you have your seeds started ready for transplanting next month? You girls who are planning to have a flower-bed should have pansies, pinks, petunias and all early-blooming plants peeping through the soil, or at least planted by this time. The beginning of May is early enough to sow ordinary asters; but if one wishes to have a succession of bloom it is not too soon to begin now. The pleasure to be derived from even one flower-bed can only be realized when one has made the experiment. Even then one cannot fully estimate it; every blossom from it gives pleasure to the recipient, and were it all summed up, we should consider ourselves guilty of a sin of omission if we allowed such an opportunity to slip by unused. We may each have a Flower Mission of our own, and not only "Scatter seeds of kindness," but at the same time "leave as our bequest an added beauty to the earth." True, no one of us is a very important part of the great universe, and yet humanity's total is made up of just such units as you and I; so, if each of us would only do our share, what a grand whole we should make!

Do you wish the world were better?  
Let me tell you what to do.  
Set a watch upon your actions,  
Always keep them straight and true,  
Bid your mind of selfish motives,  
Let your thoughts be clean and high;  
You can make a little Eden  
Of the sphere you occupy.

The pleasures of the many  
May be oft-times traced to one,  
As the hand that plants an acorn  
Shelters armies from the sun.

Your loving  
UNCLE TOM.

## Handel.

In a recent issue we had "St. Cecilia"—that fair musical saint of legendary fame. Here, however, is no legend—no saint—but that marvellous composer of the immortal "Messiah," George Frederic Handel. The story is related of how the sounds of the harpsichord were heard at midnight, weirdly sounding through the house, and how the family, on entering the room, found the small boy lost in his wonderful musical dreams, playing away, robed in his quaint little nightgown and old-fashioned cap. The artist, Margaret Dicksee, has well portrayed the amazed attitudes of the family, and the surprised, yet rapt, expression of the young musician. To look at him here and to realize the glorious genius which has ruled the realm of sacred music so long is indeed food for earnest thought. We see a little white-robed boy—who is long since gone to his rest—yet he lives, for such work as his is deathless.

## Recipes.

## DRINKS FOR THE SICK.

*Orange Whey.*—The juice of one orange to one pint of sweet milk. Heat slowly until curds form; strain and cool.

*Corn Tea.*—Parch common corn until browned through; grind and pour on water. Drink with or without milk. Excellent for nausea.

*Bran Gruel.*—Boil for half an hour one pint of wheat bran in three pints of water. Strain through a gravy strainer and add a little salt. This is a good gruel for fevers and inflammation, and makes a nice drink by thinning and adding lemon juice.

*Egg Lemonade.*—White of one egg, one tablespoon white sugar, juice of one lemon, goblet of water; beat together. Very grateful in inflammation of lungs, stomach or bowels.

*Hot Lemonade.*—Make the same way, using hot water. Good for colds and biliousness.

*Oatmeal Tea.*—Two tablespoons raw oatmeal to one quart of cold water; two hours in a cool place, then drain off as it is wanted. Nourishing in convalescence.

*Gum Arabic Water.*—One teaspoon gum arabic, one goblet cold water; stand until it dissolves. Flavor with juice of any fruit.

*Sago Milk.*—Three tablespoonfuls of sago soaked in a cupful of cold water one hour; add three cupfuls of boiling milk; sweeten and flavor to taste. Simmer slowly a half hour. Eat warm.

## BAKED SALMON.

One whole tin of salmon, two eggs, one tablespoonful of melted butter, a cup of bread crumbs, some pepper, salt, and two or three finely-minced pickled gherkins. Drain the liquor carefully off the salmon and use it for the sauce, and pick the fish to pieces, afterward working in the butter, bread crumbs, eggs and seasoning. Lastly, put the mixture into a well-buttered pudding-bowl, and cover it tightly, and put it into a pot of boiling water, boil one hour, then take out of the pot, and stand the pudding one minute in cold water to loosen the pudding from the bowl, and then turn out on a hot dish.

The sauce is made as follows: Take a cup of melted butter, and add to it the liquor from the tin, a beaten egg, pepper, salt, some minced parsley and a minced gherkin. Boil up and pour over the pudding before serving, unless you prefer it served in a sauce-boat.

## DESTRUCTION OF ROACHES.

For the instant destruction of roaches, stir into a half-pint of hot paste a dime's worth of phosphorus, adding, when cool, a quarter the bulk of grease. This should be placed where they frequent, and they will die while eating it.

Trifles should never be allowed to discourage the ambitious. When a kangaroo is on its last legs it may still be able to do some good jumping.





The Sun's Cup.

Snug in her bed little Daffodil lay,
Dreaming she thought she heard somebody say:
"Daffodil, Daffodil, aren't you awake?
Robins their nests are beginning to make."

MY DEAR CHILDREN.—

You are all fond of animals, I am sure, so I am
going to tell you about some clever ones. There
were once two cats, who lived in a barn. Each cat
had a nest of kittens of about the same age, on op-

Now I will tell you about a horse that deserved
a medal. A ship had gone ashore on the rocks, and
the poor sailors could be seen clinging to parts of
the wreck. Just then a man came riding up on a
big horse. His master knew that the horse was a
splendid swimmer, so he rode him right into the
sea.

Here is another horse story. One day a lady saw
a poor horse with a big sore place on its shoulder,
in the field next her garden. She went into the
house and got some ointment, then called the horse
to come to her.

Next day she heard a horse neighing, and, going
into the garden, found that it was her friend of yester-
day. She dressed his wounds again. The next
day he came again. The horse soon got well, but he
remembered the lady, and if he met her, would walk
up to her to be patted.

But it won't do to preach too much to you little
folks, will it? Here are some nonsense verses for
you:

- You may have noticed, little friends,
That cats don't wash their faces
Before they eat, as children do
In all good Christian places.

paws, and see whether she stops to wash before
eating it. You needn't copy her, though, for your
dinner won't run away while you are making your-
selves tidy.

Well, good-bye, chicks! You might write a letter
sometimes to—
Your old friend,
COUSIN DOROTHY.

THE QUIET HOUR.

The Triumph of Love.

"My Lord and Master, at Thy feet adoring,
I see Thee bowed beneath Thy load of woe;
For me, a sinner, is Thy life-blood pouring;
For Thee, my Saviour, scarce my tears will flow.

The love of God! Who can measure it? Who
can tell the length and breadth and depth and
height? We often doubt His love. When care,
sorrow or pain seem to take the sunshine out of
life, Satan is very ready with his lying suggestions
that God is harsh, unkind, unloving.

Love inspired our Leader to triumph on the
Cross and despise the shame. He was calm, serene
and noble, revealing the grandeur of his kingly
dignity, unruined by the tempest which raged
around. Was it any wonder that Pilate exclaimed,
"Behold your King!"

Love still inspires men to follow unshrinkingly
in the footsteps of their Master. As Pierson says,
"Follow the gospel of Christ as it marches down
the centuries, and what do you see? Hard hearts,
cruel with crime, that no human love could soften,

Love still inspires men to follow unshrinkingly
in the footsteps of their Master. As Pierson says,
"Follow the gospel of Christ as it marches down
the centuries, and what do you see? Hard hearts,
cruel with crime, that no human love could soften,

Can Christ be dead, as some would have us
believe? Could a dead man possibly inspire such
devotion in innumerable hearts? Love reaches out
to meet love. He who is the Life of the world
reaches down into the very depths of our hearts,

"Nor deem, who to that bliss aspire,
Must win their way through blood and fire.
The writhings of a wounded heart
Are fiercer than a fowler's dart.

HOPE.

Puzzles.

[The following prizes are offered every quarter, beginning
with months of April, July and October: For answers to
puzzles during each quarter—1st prize, \$1.50; 2nd, \$1.00; 3rd,
75c. For original puzzles—1st, \$1.00; 2nd, 75c.; 3rd, 50c.

This column is open to all who comply with the following
rules: Puzzles must be original—that is, must not be copied
from other papers; they must be written on one side only of
paper, and sender's name signed to each puzzle; answers must
accompany all original puzzles (preferably on separate paper).
It is not necessary to write out puzzles to which you send an-
swers—the number of puzzle and date of issue is sufficient.
Partial answers will receive credit. Work intended for first
issue of any month should reach Pakenham not later than the
15th of the month previous; that for second issue not later
than the 5th of that month. Leave envelope open, mark
"Printer's Copy" in one corner, and letter will come for one
cent. Address all work to Miss Ada Armand, Pakenham,
Ont.]

1—CONTINUED CHARADE.

1—A nickname for Edward.
2—Means to arrange for publication.
1, 2, 3 is supposed to personify knowledge. (Now add sign
of possession.)
1, 2, 3, 4 tells that 1, 2, 3 is gone away.
1, 2, 3, 4, 5 names the goal of all accepted puzzles. M. N.

2—DOUBLE ACROSTIC.

1—A boy's name.
2—Against.
3—A crony.
4—A sphere.
5—A color.
6—A planet.
7—A dale.
8—A measure.
9—A title.
Primals and finals, read downward, name two much-talked-
of places in South Africa. M. N.

3—ANACROSTIC.

Under a cruel tyrant,
But longing to be free,
After years of fighting,
Came sweet liberty.
Look on her triumphant brow,
By victory elated.
In the fight she bravely fought,
Ever the foe hated.
Ruin's there no longer now.
(The initials transposed give the answer.) ROLLY.

4—CHARADE.

Of all the lads I ever saw,
Three was the most complete.
To One his lessons was but play,
In class or at his seat.
Or if he had his wood to split,
Or mend the garden gate,
He did his Two sums cheerfully,
Though he'd to sit up late.
When Two-three on the field of life,
Whore every man is fighting,
He'll be Complete and do his best—
The wrongs of others righting. ROLLY.

5—DIAMOND.

1, In diamond; 2, the total; 3, an instrument for boring
holes; 4, a country in Africa; 5, dismal; 6, to drive away; 7, in
diamond. L. B. FORCK.

6—CURTAILINGS.

Even though the x x x x x can follow and understand the
intricate plots of the novelist, Charles x x x x x, he may yet
not be able to unravel this puzzle and x x x x this sentence.
F. L. S.

Answers to March 5th Puzzles.

- 1—s i r e n 2—n o r m a
e r e o d e o n
v r e n t e n
e k e m o t o n
r i v e r a n e n t
3— h
c o b
d o r i s
c o a s t e d
h o r s e t a i l
b i t t e r s
s e a r s
d i s
l
4—Ed-da.
5—J a P a n c a T e r
g u I s e p l U m p
g r A z e p i N e d Piano tuner.
C o N e y a m E n d
a l O n e s h R e d
6—Won a papa now.
7—Apparently.
8—Agape—gape—gap.

SOLVERS TO MARCH 5TH PUZZLES.

"Diana," "Rolly."

ADDITIONAL SOLVER TO FEB. 20TH PUZZLES.

M. R. G.

COUSINLY CHAT.

In order to comply with the request to occupy less space
with puzzles, we have been obliged to reduce the number pub-
lished, and henceforth will only use those of real merit. Our
list of solvers has dwindled somewhat of late, and yet the work
should not be above the ability of all our old friends. "Itally
round the flag," boys and girls, and, above all, come early.
ADA A.

Only a scratch! and yet a scratch has often cost
a life. A scratch should be carefully washed with
a little Castile soap and warm water. It should
never be touched by any finger nails. If there is
any appearance of inflammation, a small bread-and-
milk poultice, or the application of some medicated
clay, will be the safest and best treatment. A
sudden and decided change in the weather or a
poor condition of the blood will often favor the
scratch and develop it as an agent for serious evil.



"WHEN BUYING WHY NOT GET THE BEST?"

# Stephens' Paint

PURE  
READY  
MIXED

The Quality of the Oil  
is the Life of the Paint.

CROWN



BRAND

Made with Manitoba Pure,  
Raw or Boiled Linseed Oil.

Each succeeding year of the 15 years that STEPHENS' HOUSE PAINTS have been upon the market has added to their popularity until now they are known and asked for in every town and village between the Great Lakes and the Pacific Ocean. Being composed of selected pigments in combination with **MANITOBA LINSEED OIL**, they form a **PAINT THAT CANNOT BE EQUALLED** in covering or lasting properties by anything made in Canada. The testimony of the best painters is that there is nothing to equal Pure Linseed Oil as a medium or binder for paint. It has also been proved beyond question that Pure Carbonate of Lead, known as White Lead, has not the same lasting powers as can be obtained when it is mixed with Oxida Zinc, Oxide Lead, or even Ochres, besides which it is a deadly poison and should never be used alone for inside house painting. That STEPHENS' PAINTS have attained a high place in the public estimation is shown by the fact that the highest claim rival dealers can make is that the "As Good as Stephens'." While this may be a compliment to our Paint, it is untrue in as much as we are the only makers who use Manitoba Linseed Oil exclusively in our product. When you consider that it costs as much to apply a cheap paint as a good one, it would appear foolish for anyone, for the sake of a few cents per gallon, to buy an unreliable article made thousands of miles away, while a **FIRST-CLASS PAINT** can be had, made and warranted by a reliable house in Manitoba.

If you want the **Best Paint for the Money;** Paint that will cover; Paint that will wear; Paint for outside and inside use; Paint for Floors, Walls, Ceilings, Roofs, Houses, Barns, Stables, Elevators, Buggies, Sleighs, Agricultural Implements; All kinds of Paint for every description of work—

**Buy STEPHENS' and you will NEVER REGRET it.**

REMEMBER the oil used in "STEPHENS' PAINTS" is made from Flaxseed grown in Manitoba and Northwest Territories, and is not surpassed by anything in the world.

Sold by leading hardware dealers between Lake Superior and Pacific Ocean, but if your nearest dealer cannot supply you, write us direct, and we will send sample color cards, prices, and cost laid down at your nearest railway station, also estimate of quantity you will require for the work.

MANUFACTURED BY

**G. F. STEPHENS & CO.,**  
WINNIPEG.

#### GOSSIP.

Mr. Andrew Graham, of the Forest Home Farm, Pomeroy, Man., writes us from Cargill, Ont., that he expects to reach home about the first week in April with a carload of pure-bred stock. In the lot will be a few really good young Shorthorn bulls, ready for service, which will be disposed of at reasonable prices. Any one requiring a young bull would do well to communicate with Mr. Graham at once.

Mr. William Martin, proprietor Hope Farm, St. Jean Baptiste, Man., and breeder of Galloway cattle, changes his advertisement this issue, advertising three good yearling home-bred bulls for sale, also one imported from Ontario, to make room for some importations from Scotland. These bulls will be sold at very reasonable prices. Any parties desiring this breed of bulls had better correspond with Mr. William Martin, Winnipeg, or T. M. Campbell, Manager Hope Farm, St. Jean Baptiste, Manitoba.

Messrs. Munn, of Riverside Poultry Yards, Winnipeg, write: "We shall be breeding from Hawsons, Thompson, Bradley Bros, and Bohns, with Bantam Rocks, White Rocks, of the English strain, and S. C. W. Leghorns, of Knapp Bros, Weykoff, Cornell and Schroeder strains. We have unlimited range, shade, feed and water, and expect to have a large number of choice specimens for sale next fall from these three yards. Our

sows are all doing nicely, and we are now aving eggs for hatching. Expect to start our neobator very soon.

Mr. George Benile, of Bennie Bros, Castleberry, reports his recent importation of Clydesdales as having landed from Ontario in first-rate condition, and states that they received many compliments from neighbors upon the excellent selection they have made. The stallion, Aberdeen, gives specially good satisfaction. He also reports that their Shorthorn herd have wintered well, and on date of writing they had seven bull calves and two heifers from the Edwards-bred bull, "Knight of Lancaster." He adds that the calves are a grand lot, and he expects to have some of them at the Winnipeg Industrial in July.

In a recent letter from J. A. Kinsella, late Dairy Superintendent of Assiniboia, now holding a responsible position on the dairy staff in New Zealand, he says, the largest factory in New Zealand is at Dunedin, in the South Island. This factory is turning out 51 tons of butter daily, besides a big city milk trade, which would bring up the output to six tons per day. The company that control this factory have some 200 head of cows in all, many of the factories turning out from 2 to 3 tons of butter daily, others making 4 or 50 lbs. each and a ton of butter. It will be some time yet before the factories in this country will be turning out such immense quantities of product.

W. J. Young, Superintendent of Southside Farm, White Bear Lake, Minnesota, sends us some interesting figures regarding official tests of three of their Holsteins made by the Minnesota Experiment Station. Mr. Young says that the test was made from February 11th to 17th, inclusive, which was the coldest time of the winter. It is also worthy of notice that the heifers had been in milk some months. Mr. Young also points out that it is from just such cows as these that his company is offering for sale bull calves in their advertisement in the FARMER'S ADVOCATE. His report of the tests is as follows: Sylvia Netherland, registered No. 44119; age as last calving, 6 years 8 months 26 days. Number of days since calving, 23. Total number of pounds of milk in seven days, 139.90 lbs., containing 13.834 lbs. fat. Counting butter at 80 per cent. fat, the rule adopted by the Holstein Association, she made in the seven days, 17 lbs. 4.89 ozs. of butter. Daisy Van Beers, No. 46449; age at calving, 2 years 9 months 8 days. Number of days since calving, 72. Total pounds of milk in the seven days, 303.140, containing 10.325 lbs. fat. With butter 80 per cent. fat, she made in the seven days, 12 lbs. 11.90 ozs. of butter. Winnifred's Pride Beauty, No. 45171; age at calving, 2 years 7 months. Number of days since calving, 119. Total number of pounds of milk in seven days, 237.349, containing 7.959 lbs. fat. With butter 80 per cent. fat, she made in the seven days, 9 lbs. 15.96 ozs. of butter.

#### Horse Owners! Use



#### GOMBAULT'S Caustic Balsam

A Safe Speedy and Positive Cure  
The Safest, Best BLISTER ever used. Takes the place of all liniments for mild or severe action. Removes all Bunches or Blemishes from Horses and Cattle. SUPERSEDES ALL CAUTERY OR FIRING. Impossible to produce scur or bluish. Every bottle sold is warranted to give satisfaction. Price \$1.50 per bottle. Sold by druggists, or sent by express, charges paid, with full directions for its use. Send for descriptive circulars. THE LAWRENCE-WILLIAMS CO., TORONTO, CAN.

#### Our 1900 Baby Carriage and Wagon

Catalogue is now ready to mail. If requiring one, send us your address.

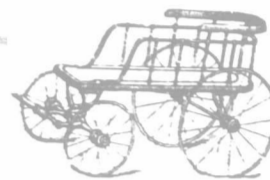

The finest line in Canada. Ask for our big furniture catalogue—it makes house-furnishing easy by mail.

#### Scott Furniture Co.,

276 Main Street, Winnipeg, Man.

Largest Dealers in Western Canada.

#### NOTICES.

Mr. Kenneth McIvor, of Roselea Stock Farm, Virden, Man., the introducer of Western or Native Rye Grass, writes: "Having obtained from the C. P. R. a reduction of 50% on ordinary rates up to April 30th next on above seed, in quantities not less than 100 lbs., on their main line from Whittemouth to Cochrane, and branch lines in Manitoba and the Territories, to and including Pincher Creek on Crow's Nest line, I will make a reduction in price up to said date from \$6 per 100 lbs. to \$5.50, or until such time as present supply is cleared out."

A Strong School.—Twelve regular teachers, with an up-to-date equipment, including sixty machines for typewriting, combine to give strength and prominence to the Central Business College, of Toronto, which is now recognized as the leading commercial school in Canada. The spring term continues from April 2nd into the summer term, which will open early in July, but members are admitted at any time into any department throughout the year. There are no vacations.

Messrs. G. F. Stephens & Co. place an advertisement of Stephens' pure, ready-mixed, Crown Brand paints in this issue, mixed with Manitoba pure raw or boiled linseed oil. Their paints are specially prepared for houses or barns, stables, elevators, buggies, sleighs, agricultural implements, etc. These paints are sold by the leading hardware dealers between Lake Superior and the Coast, but if the dealer in your district cannot supply you, write direct to G. F. Stephens & Co., Winnipeg, and you will be at once supplied with sample color cards and prices at your nearest railway station, and you will also be apprised of what quantity of paint you will require for the work you want done.

#### GOSSIP.

The famous Hereford cattle importer and breeder, Mr. T. L. Miller, of Beecher, Illinois, died March 15th, at the age of 83 years. Mr. Miller was a doughty champion of the Herefords, and did a great work in advocating and introducing them in the Western States. He was an able writer, and a man of great courage and perseverance.

We wish to draw our readers' attention to the new advertisement of Mr. Israel Groff, in which he offers the Scotch-bred bull, Golden Robe 2636. In writing, Mr. Groff states that as he has disposed of most of his females he can sell Golden Robe. A glance at his pedigree will show the value of such a sire; in fact, very few of such bulls are for sale on this continent. Golden Robe is the sire of the 1st-prize heifer calf in 1888 and the 1st-prize yearling heifer in 1899 at the Toronto Industrial Exhibition.

To head his fine herd of Shorthorns, Mr. John T. Gibson, Denfield, Ont., has purchased from Mr. J. M. Gardhouse, of Highfield, the imported Duthie-bred bull, Prime Minister 1328-63914, by Chesterfield (37049), dam Princess Lovely, by Field Marshal, granddam by Heir of Englishman. Prime Minister is a grand bull, and has proved an impressive sire, as well as a prizewinner at Toronto, and his breeding with such magnificent top-crosses is of the very best. Mr. Gibson is to be congratulated on securing so desirable a bull to use in his herd.

#### MAUD S. HAS GONE.

The world-famous mare, Maud S. (208), the former queen of the light-horse turf, fell dead in her stall at Shults-hurst, Port Chester, on March 17th, at the age of 26. Her body now lies in a little plot on the Bonner Farm at Tarrytown, New York, beside the remains of Dexter, who was in his day as great as Maud S. was in her day.







**Marchmont Stock Farm,**  
MIDDLECHURCH, MAN.

**Scotch-bred Shorthorn Cattle**

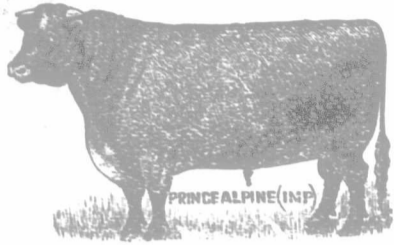

7 10  
YEARLING BULLS. BULL CALVES.

W. S. LISTER, Middlechurch, Man.

**"PRAIRIE HOME STOCK FARM."**

Bulls at head of herd:  
Judge = 23419 = and Imp. Jubilee = 28858 =.

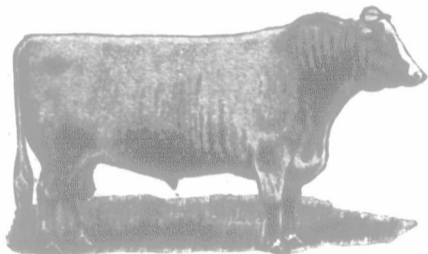

Yorkshire and Berkshire Swine,  
Clydesdale Stallions and  
Shropshire Sheep,  
Shorthorn and Ayrshire Cattle.

THOS. GREENWAY, Proprietor. m  
JAMES YULE, Manager, Crystal City.

**Shorthorns** 4 Heifers and 2 Young Bulls.  
Choice ones of Royal Sailor breeding,  
also Admiral, their stock  
bull. Also imported CLYDESDALE STALLION.  
A. & J. CHADBURN, Ralphton, Man.

**THREE BULLS**

Fit for service, the best I ever offered, for sale. Also some fine two-year-old and year-old heifers.  
GEORGE RANKIN, Hamiota, Man.

**For Sale :**

1 3-year-old Shorthorn bull, Strathallan Hero = 26857 =.  
1 yearling bull, Pioneer of Gloster = 31959 =.  
3 bull calves: Strathallan Pioneer = 31960 =, Boharm Chief = 31958 =, and another got by Duke of Gloster = 24263 = suitable for the range.  
FRED W. GREEN, MOOSE JAW, ASSA. 3-f-m

**D. FRASER & SONS,**  
EMERSON, MAN.,

Breeders and importers of Durham Cattle, Shropshire and Southdown Sheep, and Pure-bred Poland-China Pigs a specialty. Young stock for sale. 9-y-m

**THREE CHOICE SHORTHORN BULLS FOR SALE**

AT MODERATE PRICES,  
from 10 to 13 months old, with good Scotch pedigrees and individual merit. Write, or, better, call.  
J. G. Washington,  
Elysee Stock Farm,  
3-f-m NINGA, MAN.

**ELMWOOD STOCK FARM.**

**Scotch Shorthorns for Sale :**  
Three grand young bulls, all got by imported Scotch sires, and out of extra good cows, by imported bulls.  
H. O. AYEARST,  
MIDDLECHURCH, MAN.

**SHORTHORNS, YORKSHIRES AND TAMWORTHS.**

Stock of all ages and both sexes, at prices according to quality. Auction sales of farm stock undertaken. Improved farm and wild lands for sale in the Winnipeg district. Correspondence solicited.

W. G. STYLES,  
Sec. 12-13-1. West, Rosser P. O., C. P. R.

**Landazer Stock Farm.**  
Shorthorns Choice young bulls and females, Cotswolds of top quality, etc. Prices moderate. D. Hyslop & Sons,  
492, Kiltbruce, Man.

**"ALPHA BABY" SEPARATOR**

The CANADIAN DAIRY SUPPLY CO., Montreal, Branch Office, 236 King St., Winnipeg, sole agents in Canada for the DE LAVAL SEPARATORS.

The Alpha machines still lead the procession, and only have to be known to be appreciated. The agents of cheap grade machines tell you that theirs are "just as good." You never hear them compared with each other, as they know that the Alpha is the favorite. High-grade mechanism, durable, best skimmer on any market. Dairy schools prove that fact. We do not claim that the skimmed milk from the Alpha is better for calves than from other machines, that suggests a lurking suspicion that there is too much butter-fat in the milk, which is too expensive to feed, at 20c. per pound, to calves. When they get down to the .01 and .02 points with thick cream from cold milk, then something interesting can be expected. Call and examine and be convinced, and keep out of a position where you would feel sorry that you bought so soon.

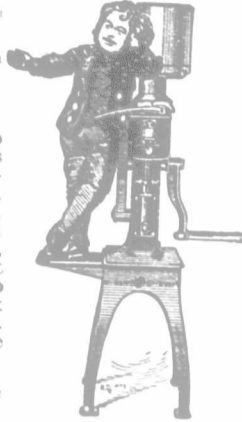

Send for circulars and particulars re prices to

**The Canadian Dairy Supply Company,**  
236 KING ST., WINNIPEG, MAN.

**Sub-Surface Packer  
and Davidson's Grain Pickler.**

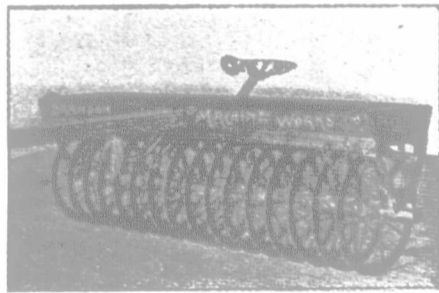

Manufactured by  
**THE BRANDON MACHINE WORKS CO.**  
BRANDON, MAN.

**Sporting Goods.**

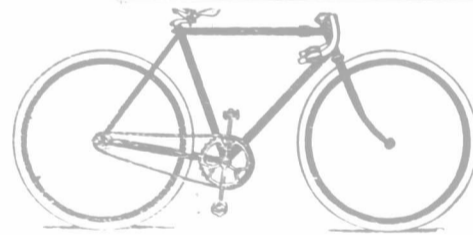

**"Rambler" Bicycles.**

FISHING TACKLE, HAMMOCKS, CAMP BENCH AND CHAIRS, FOLDING BATHS, FOOTBALLS, TRAP SHOOTERS' SUPPLIES, FISH NETS, BICYCLE SUPPLIES.

**THE HINGSTON SMITH ARMS CO., WINNIPEG, MAN.**

**Maw's Poultry Farm, Winnipeg.**

BREEDS BEST STRAINS OF UTILITY BREEDS.

Thoroughly acclimatized and best adapted to our climate. Have for sale stock and eggs of Mammoth Bronze Turkeys, Toulouse Geese, Imperial Deep-keeled Pekin Ducks, English Rouen Ducks, White Wyandottes, White Leghorns, Silver-Laced Wyandottes, Light Brahmans, Hero Strain Plymouth Rocks. Homing Pigeons from best imported Belgian stock, same as used by the army for carrying messages from beleaguered cities. Large illustrated catalogue, giving list of prizes and medals won at all leading exhibitions, with prices, description and pedigree of stock mailed free on receipt of address. I am North-west agent for the celebrated **CYPHERS INCUBATOR AND BROODER**. Mr. Cyphers is the discoverer and patentee of the diffusive principle in artificial incubation, thus saving the lives of thousands of chicks that die in the shell in ordinary incubators. It is asbestos-coated and perfectly fireproof. Supplies and regulates its own moisture, and so simple a child can operate it with success. Write for particulars.

**YOUR ATTENTION**

Our No. 1 Collection contains 33 full sized packets of the best Vegetable Seeds, sufficient to furnish vegetables throughout the year, and one packet of Wild-Garden Flower Seeds, which we will send prepaid to any address in the Dominion of Canada or United States for the extremely low price of \$1.

Our No. 2 Collection contains 16 packets of Vegetable Seeds and one packet Wild Garden Flower Seed Mixture. Prepaid for 50 cents.

Our No. 3 Collection contains 8 packets of Vegetable Seeds for 25c.

Our No. 4 Collection contains 40 packets of Flower Seeds for \$1.

Our No. 5 Collection contains 20 packets of Flower Seeds for 50c.

Our No. 6 Collection contains 10 packets of Flower Seeds for 25c.

All postpaid on receipt of price. For varieties in above collections see our Handsome Illustrated Catalogue containing other great offers. Mailed free to any address.

**R. ALSTON, Royal Greenhouse & Seed Establishment, WINNIPEG, MAN**

4 Young (Golden Royal - 24402-) **SHORTHORN BULLS.**  
Good size, grand feeders, in good growing order, and from choicely-bred dams.

J. H. KINNEAR, SOURIS, MAN.

**THORNDALE STOCK FARM,**  
MANITOU.

JOHN S. ROBSON, PROP.  
Females of all ages  
FOR SALE.  
Write for particulars.

**SHORTHORNS**

Masterpiece = 23750 =, by imp. Grand Sweep, out of an Indian Chief dam, at head of herd. Imp. Large Yorkshires for sale.  
JAMES BRAY,  
LONGBURN, MAN.

**HEREFORDS**

I keep only the best. For stock of all ages.  
Write or call. WM. SHARMAN, m  
"Ridgewood Stock Farm," SOURIS, MAN.



**POPLAR GROVE  
HEREFORDS**  
THE LARGEST HERD  
IN CANADA.

STOCK OF ALL  
AGES FOR SALE.

J. E. MARPLES,  
DELEAU, MAN.

**Hope Farm Galloways**

Three good yearlings, home-bred bulls, still for sale. Also one imported from Ontario. To make room for some importations from Scotland, these will be sold at very reasonable prices.

Apply to T. M. CAMPBELL, Manager,  
Hope Farm, St. Jean Baptiste, Manitoba



6 young bulls, by Mani-  
and Robbie O'Day, out of  
some of our best cows.  
9 Berkshire sows of  
choice quality and breeding,  
from 5 months to 3 years. The  
standard of our Yorkshire  
herd is steadily improving.  
Our stock boars, the sweep-  
stakes at last Industrial

the other recently imported from England, are grand specimens of the breed. A choice lot of sows ready for breeding. About 50 B. P. Rock Cockerels, strong, healthy birds, of great size and good markings. All at reasonable prices.  
ANDREW GRAHAM,  
Forest Home Farm, Pomeroy, Man. Rol-  
and, N. P. R.; Carman, C. P. R.

**STEEL BROS., Glenboro, Manitoba,**  
BREEDERS  
OF  
Ayrshire Cattle.

Choice young stock for sale. 24-2-y-m

**JERSEY BULLS**

2 high-class Jersey Bulls for sale.  
Also farm laugs. 1-y-m Midway, Man.

**Bulls. Bulls. Bulls.**

I WILL undertake commissions to purchase pure-bred bulls of any breed for ranchmen, and will attend to their careful shipment, on the best terms obtainable. Correspondence solicited.

WM. SHARMAN,  
RIDGWOOD FARM, SOURIS, MAN.  
References—Merchants' Bank, Farmer's Advocate,  
Nor-West Farmer, Pure-bred Cattle Breeders' Association.

**SWEEPSTAKES HERD OF  
LARGE ENGLISH BERKSHIRES**

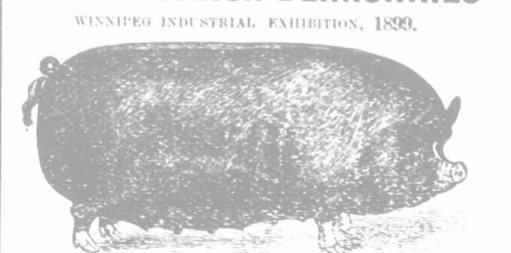

Herd headed by Perfection (1799), Proud Victor (1691), Prince (1690). A choice lot of young sows fit for breeding; a nice lot of September pigs, both sexes. Booking orders for spring pigs, boars or sows, not akin. Address or call on

R. MCKENZIE,  
Waple Lodge Stock Farm, HIGH BLUFF, MAN.  
PLEASE MENTION FARMER'S ADVOCATE.



GOSSIP.

Rock Bailey, Union, Ont.—"I have sold my entire herd of Jerseys which I advertised in the FARMER'S ADVOCATE a short time ago, except one cow. Would advise anyone having stock, etc., for sale to put an ad. in the ADVOCATE. Wishing you continued success."

GREAT SALE OF ABERDEEN-ANGUS CATTLE. At the dispersion sale of the Aberdeen-Angus herd of Wallace Estill, of Estill, Mo., at Dexter Park, Chicago, March 22nd and 23rd, 58 females averaged \$583.53, 14 bulls \$561, and the whole 72 head sold made an average of \$579.30. The highest price for a bull was \$2,100, and for a cow with a bull calf at side, \$2,800. The average at this sale was \$120 higher than that of any other sale of any breed of cattle this year up to that date.

A GOOD LIST OF SALES FROM CARGILL HERD. Messrs. H. Cargill & Son, Cargill, Ont., write: "We have the following sales of Short-horns from our herd to report: To John M. Fishbeck, Howell, Mich., bull, Loyal Member, out of Rosalind (Imp.), of which it is sufficient to say that he is a worthy son of his sire, Royal Member; and Rose of Strathallan 5th, sired by the Duthie-bred Lancaster bull, Rantin Robin (Imp.).

"To Charles Fishbeck, Howell, Mich., the imported heifer, Maisie, of the good old Mayflower family of Heatherwick, sired by a son of Scottish Archer, and in calf to the Marr-bred Golden Hope, second-prize winner at the Royal Northern in 1899; and Diamond 20th, out of the Crombie-bred cow, Diamond 18th, the highest-priced cow at the sale of D. D. Wilson, and sired by the Lancaster bull, Rantin Robin, bred by Mr. Duthie.

"To assist his present herd bull, Golden Fame, we sold Mr. W. D. Platt the low-down, level, good bull, Orange Chief (Imp.), sired by Orange Duke (Imp.).

"To R. Mitchell & Son, Burlington, Ont., the good red bull, Prince William (Imp.), sired by the Duthie-bred Reveller (71359), a grandson of the great Star of Morning (58189).

"To A. D. McGugan, of Rodney, Ont., the Wanton heifer, Dayspring (Imp.), a great, thick one with a double cross of William of Orange, and in calf to the grand bull, Count Amaranth (Imp.); also the Royal Lady heifer, Rosetta 8th (Imp.), a matron of the right sort, and in calf to the Princess Royal bull, Scottish Prince (73593).

"Mr. T. H. Canfield, of Lake Park, Minnesota, has selected the following first-class animals—not a middling one in the lot—viz: The Duthie-bred bull, Count Amaranth (Imp.) (71289), of the same family as Field Marshal, Alma and other noted animals; the Butterfly cow, Blythesome Girl (Imp. in dam), bred by Mr. Duthie and sired by Pride of Morning (64546), dam, by Gravesend (46161) and grand-dam by William of Orange (50694); the great, thick calf, Morning Perfection 2nd (Imp.), sired by Craibstone (66885), a son of William of Orange; Princess Ina (Imp.), a Princess Royal heifer, by the prizewinning bull, Prince of Pitivie (71246), and safely in calf to Prince Victor (73322); Duchess Gwynne 5th (Imp.), by Solitaire (68539), dam by Star of Morning (58139); Blooming Pride (Imp.), an Orange Blossom, by Sittytion Pride (67539), bred by Mr. Duthie, and out of prizewinning dams; Augusta 99th (Imp.), one of the famous Inverquohomery Augusta family, noted as winners at Smithfield, and sired by the Highland Society prizewinning bull, Waverly (68072).

"That really good bull and sire of good ones, Orange Duke (Imp.), we sold to Mr. W. B. Campbell, Campbellcroft, Ont.

"To Doctor Gillies, of Teeswater, a right good heifer, Rosa Bell (Imp.), a prizewinner in Scotland, and safely in calf to Scottish Victor (68557), by the famous Scottish Archer (58856).

"To David Birrell, Greenwood, the good bull, Prince Cruickshank (Imp.) (73277), by Emperor (67008), dam by Master of the Mint (57749); also the heifer calf, Blythesome Morning, out of Blythesome Girl and sired by Royal Member (Imp.).

"Royal Member (Imp.) (64711), our herd bull for a number of years, has gone to add laurels to the herd of Mr. Robert Duff, of Myrtle, Ont.

"The roan bull, Beauchamp (Imp.) was selected by Shantz Bros., Haysville, to head their herd of Short-horns. He is a low-down, thick fellow, full of Cruickshank blood, and will surely do his new owners good.

"To James Tolton, Walkerton, Ont., a choice red Sittytion Secret heifer, Sybella 5th, bred on the most fashionable lines, sired by Prince of Pitivie (71246) first-prize bull at Perth in 1898, and sold to South America at a long price. This heifer has been bred to our red bull, Golden Drop Victor, purchased at Mr. Duthie's sale of 1899 for 290 guineas, and of which Mr. Duthie says: 'He is as good a bull as I ever bred, and I have the greatest confidence that he will make a sire of good ones.'

"Geo. Harding & Son, Waukesha, Wisconsin, made us a flying visit, and purchased the following animals: Sylvia, same breeding as above, and bred in Scotland to Morning Pride (75113); Augusta 77th and heifer calf, Augusta 112th, and Augusta 88th, all of the famous Inverquohomery Augusta family, which has furnished more Smithfield winners than any other. Lady Miranda and heifer calf, Lady Miranda 2nd, by the good bull, Count Amaranth, a pair of good ones; Helen 20th and bull calf, Royal Pride, a good heifer and a grand calf, of grand quality and full of Cruickshank blood; Donside Queen, a Kinellar Claret, and bull calf, Donside Count, by Count Amaranth, another pair of good ones, with a lot of Cruickshank; Morning Maid, by the great Star of Morning, herself winner of first prize this year at Turriff and Fyvie, and her heifer calf, Scottish Maid, by Sittytion Victoria, a son of Scottish Archer, out of Sittytion Victoria, by Gondolier; Claudia 2nd, a great thick red cow, in calf to Prince of Archers, another son of the renowned Scottish Archer; Lady Bell 5th, a massive roan heifer, a Kinellar Jealousy pedigree, and in calf to Count Amaranth; Lady Ann, a heifer of great scale, a Jilt pedigree, and her heifer calf, Scottish Lady, by Scottish Prince, a Princess Royal bull; Lord of Strathbogie, a Sittytion Secret bull, thick, low-down—an all-round good one that we shall read about in the future."

LEICESTERS!

Young rams and ewes for sale. Write or call on A. D. GAMLEY, BRANDON, MANITOBA. Box 193.

CANCER CURED WITHOUT KNIFE OR PLASTER. FULL PARTICULARS FREE. F. STOTT & JURY, Bowmanville, Ont.

Roxey Stock Farm, BRANDON, MAN. J. A. S. MACMILLAN, IMPORTER AND BREEDER OF PURE-BRED

Clydesdales, Shires, Hackneys. STALLIONS AND MARES.

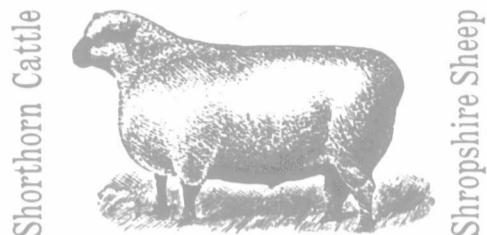

INSPECTION INVITED. CORRESPONDENCE SOLICITED. TERMS EASY. Prices Right. FULL PARTICULARS ON APPLICATION.

APPLY: P. O. BOX 403.

Now is the time to buy EGGS FOR HATCHING. Eggs from high-class G. Wyandottes, Langshans, Indian Games, Light Brahmans, P. Rocks, B. Cochins, B. Minorcas, and Silver Laced Wyandottes, at \$2.00 per setting. Also offer for sale, very cheap, 12 L. Brahmans, 10 P. Rocks, 1 trio Langshans, 10 Pekin ducks, Guinea fowl, fancy pigeons, and a few White Wyandotte cockerels. Speak quick if you want some. S. LING & CO., Fort Rouge Poultry Yards, Winnipeg, Man.

PLYMOUTH ROCKS HIGH-CLASS STOCK. WILLIAM LAUGHLAND, - Hartney, Man.

Norwood Bridge Poultry Yards, WINNIPEG, MAN. Breeder of high-class S. C. B. Minorcas, Houdans, and White Wyandottes; also Bronze turkeys, Pekin Bantams, Pekin ducks. Young stock for sale of all varieties. Write or call.

310 First Premiums AWARDED TO THE PRAIRIE STATE INCUBATOR. Guaranteed to operate in any climate. Send for catalogue. PRAIRIE STATE INCUBATOR CO. Home City, Pa.

AGENTS WANTED for the Gem Sickle and Tool Grinder, with Saw Gunning attachment. A necessity to every farmer. D. M. McMILLAN, Brandon, Man., sole agent for Manitoba and Eastern Assiniboia. 4-x-m

THE Very Best PLACE FOR THE FARMER'S SON TO SPEND THE WINTER MONTHS IS AT THE Winnipeg Business College. WRITE FOR HANDSOME CATALOGUE (FREE). G. W. DONALD, SECRETARY.

Wanted: Farmers' sons or other industrious persons of fair education, to whom \$40 a month would be an inducement. I could also engage a few ladies at their own homes. T. H. Linscott, Brantford, Ont.

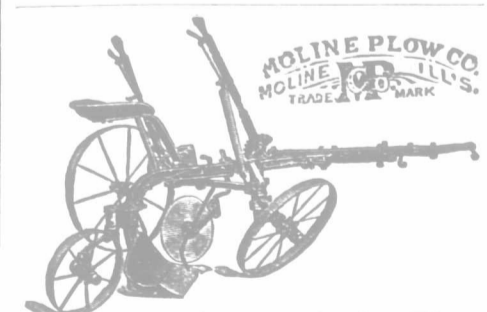

The Good Enough Sulky Plow CAN NOT BE BEAT. The Price will please you and its work will surprise you! Write for illustrated circular. It will pay you. MINNESOTA MOLINE PLOW CO. H. F. Anderson, Agent, Winnipeg, Man.

DISPERSION OF THE HILLHURST STUD OF HACKNEYS! Saturday, April 28th, 1900, AT Grand's Repository, Toronto, Ont.

The entire famous Hillhurst stud of Hackneys, the oldest-established stud of the breed in America, will be sold at auction. This offering will include the prizewinning stallion, Barthorpe Performer, one of the greatest horses of the breed in the show-yard or stud; brood mares that have won honors on the track, in harness and in the stud, and a superb lot of young show stock, fit for any competition, and including four bay stallions of very superior excellence.

Such an offering of Hackney Horses has never before been made in America. Sale to commence at 10 o'clock. For catalogue and full information address: M. H. COCHRANE, Hillhurst Farm, Hillhurst, Quebec.

DALGETY BROS., 463 King St., London, Ont.

Largest importers in Canada. Fourth consignment has just arrived in splendid condition, and includes some heavy ones. Will be on sale at Black Horse Hotel, Toronto, on and after Monday, March 19th, for ten days, and afterwards at London, Ont. Fifth consignment will arrive second week in March. Have sold more Clydes than all importers combined. A specially good lot of stallions and mares soon to arrive. No exorbitant prices asked. SMALL PROFITS AND QUICK RETURNS.

CANADIAN PACIFIC RY. UNEQUALLED ACCOMMODATION. The only line having through trains to the

EAST AND WEST SLEEPING CARS TO Montreal, Toronto, Vancouver and East, and West Kootenay.

TOURIST SLEEPING CARS. These cars are provided with every requisite, and only a nominal charge is made for a berth.

ATLIN, DAWSON CITY, CAPE NOME, AND THE ALASKAN GOLD FIELDS.

For full particulars apply to the nearest C. P. R. agent, or address: C. E. McPHERSON, GEN. PASS. AGENT. WINNIPEG.

Condensed Time Table from Winnipeg. MAIN LINE. Morris, Emerson, St. Paul, Chicago, Toronto, Montreal, Spokane, Tacoma, Victoria, San Francisco. Lv. Daily 1.45 p.m. Ar. Daily 1.05 p.m.

PORTAGE LA PRAIRIE BRANCH. Tues., Thur., Mon., Wed., Sat., Fri. 4:20 p.m. 4:20 p.m. Leaves Winnipeg. 6:25 " 5:56 " " Oakville. 7:20 " 6:30 " " Portage la Prairie. 8:25 " 7:15 " Arrives Beaver.

LAKE BRANCH. Mon. & Fri. 8:40 a.m. Leaves Portage la Prairie. 9:20 " Arrives Oakland. Mon. & Fri. 9:30 a.m. Leaves Oakland. 10:20 " Arrives Portage la Prairie.

MORRIS-BRANDON BRANCH. Morris, Roland, Miami, Baldur, Belmont, Wawanesa, Brandon. Also Souris River Branch, Belmont to Elgin. Lv. Mon., Wed. & Fri. 10.40 a.m. Ar. Tues., Thurs. & Sat. 4.40 p.m. FOR FURTHER INFORMATION APPLY TO H. SWINFORD, Depot Building, Water St., Winnipeg, Man. PLEASE MENTION FARMER'S ADVOCATE

The Veterinary Association of Manitoba.

Under the authority of Secs. 18, 19, 20, 22 and 26 of the Veterinary Association Act, 1890 (53 Vic., Chap. 60), the following persons only are entitled to practice as Veterinary Surgeons in the Province of Manitoba, or to collect fees for the service rendered as such:—

Table listing names of veterinary surgeons in Manitoba, including Atkinson, J. C., Baker, G. P., Braund, F. J., Brocken, G. E., Clark, J., Cook, W. S., Coote, H. L., Cox, S. A., Cruickshank, J. G., Damm, J., Dunbar, W. A., Fisher, J. F., Fowler, J., Graham, N., Green, E., Hatton, J., Harrison, W., Henderson, W. S., Hilliard, W. A., Hilton, G. H., Hinman, W. J., Hodgins, J., Hurl, W. N. J., Irwin, J. J., Lake, W. H., Lawley, E. H., Lawson, R., Leslie, W., Lipsett, J. H., Lipsett, R. C., Little, C., Little, M., Little, W., Livingston, A. M., McFadden, D. H., McGillivray, J., McKay, D. H., McKinnon, G. A., McLoughry, R. A., McMillan, A., Martin, W. E., Montleith, R. A., McNaught, D., Marshall, R. G., Murray, G. P., Nagle, J. W., Reid, D. S., Robinson, F. E., Roe, J. S., Rombough, M. B., Rowcroft, S. V., Rutherford, J. G., Rutledge, J. W., Shultz, W. A., Smith, W. H., Smith, H. D., Snider, J. H., Spiers, J., Stevenson, C. A., Stevenson, J. A., Swerston, W., Taylor, W. H., Thompson, S. J., Torrance, F., Waldon, J., Walker, J. E., Welch, J., Williamson, A. E., Whaley, H. E., Whimster, M., Young, J. M., Young, M.

The practice of the veterinary profession in Manitoba by any other person is in direct contravention of the statute, and renders him liable for prosecution.

F. TORRANCE, REGISTRAR, WINNIPEG.

BEEMAN GRAIN CLEANERS ARE THE BEST. "JUMBO" Our Great Succotash Machine. It separates oats, all foreign seeds, cleans flax, timothy, clover, etc. Poor imitations are dear at any price. Prices are very low. Write for circulars. BEEMAN & CO., 2902 Pleasant Ave., Minneapolis, Minn.

STAY AT HOTEL LELAND The Leading Hotel of the West. ALL MODERN CONVENIENCES. RATES, \$2 to \$4 PER DAY. BUS MEETS ALL TRAINS. W. D. DOUGLAS, Prop., Winnipeg, Man.



## NOTICES.

**The Farmers' Binder Twine Co., Limited,** Brantford, are out with their prices on binder twine for the harvest of 1900. This factory has been a real success from start to finish, and has made good profits for its many small stockholders by judiciously investing the funds of the company, and, at the same time, holding binder twine down at prices that defied competition. See their advertisement in this issue, and learn their figures before ordering twine for the coming harvest.

**Red Star Binder Twine.**—Farmers and users of twine will do well to remember that the word "Manila" in binder twine is only a commercial term and is used on mixed twines. Better buy some positively known brand that you are familiar with, and that you know the makers of. This is the best guarantee you can reach for if you want to be saved trouble in the harvest fields. The Brantford Binder Twine Company's splendid "Red Star" should now be familiar to every farmer in the Dominion.

**Champion Binders.**—In our issue of March 20th we called attention to the fact that the "Champion" binders, mowers and reapers manufactured by the Warder, Bushnell & Glessner Co., of Springfield, Ohio, were about to be introduced into Manitoba and the Northwest. We have since learned that the "Champion" binder has been manufactured for the last two or three years, under patent rights, by the Frost & Wood Co., Limited, of Smith's Falls. The large and growing sale of their binder during the last three years attests to the great popularity which it has already gained among our Canadian agriculturists. The Frost & Wood Co. have sold a large number of their binders in Manitoba and the Northwest, and they have given the most excellent satisfaction, and as a result, the many merits of the "Champion" binder have already been introduced to our Canadian farmers from the Atlantic to the Pacific.

**Caustic Balsam for Lump Jaw.**

To the Editor of the FARMER'S ADVOCATE, London and Winnipeg:  
SIR,—In looking over your copy of March 5th, 1900, page 128, I see the article headed "Lump Jaw and Compensation." I wish to direct correspondent's attention to our ad. in your paper. We advertise a cure, and append two testimonials from prominent farmers and feeders of stock:

To THE EUREKA VET. MED. CO., London, Ont.:

GENTLEMEN,—I have used the Eureka Veterinary Caustic Balsam for lump jaw in cattle and on the many different ailments among my horses for the past year or two, and I find it an excellent remedy and would not be without it in my stables. I have cured two cases of lump jaw by the use of it, and know of other cases that were cured.  
H. FARNCOMB,  
Lot 16, con. 5, London Tp., Masonville P. O.

To THE EUREKA VET. MED. CO., London, Ont.:

I have given Eureka Veterinary Caustic Balsam a fair trial in lump jaw in cattle, and in every instance it has proven effectual and given entire satisfaction. The results were far beyond my expectations.  
JOHN GEARY,  
Lot 13, con. 5, London Tp., London P. O.  
THE EUREKA VET. MED. CO., London, Ont.

## SIXTH ANNUAL . . .

## Canadian Horse Show

UNDER THE JOINT AUSPICES OF

The Canadian Horse Breeders' Ass'n

AND  
The Country and Hunt Club of Toronto,

TO BE HELD IN

### The Armouries,

TORONTO, CANADA,

ON  
THURSDAY, FRIDAY, SATURDAY,  
April 26, 27, 28, 1900.

ENTRIES CLOSE on Thursday, April 12th, 1900, and should be addressed to

HENRY WADE,  
Parliament Buildings, TORONTO, ONT.

## OAKLAWN FARM

as ever, greatly excels all other establishments in the quality and numbers of its

### PERCHERONS and FRENCH COACHERS

ON HAND:

229 STALLIONS—234 MARES

Home bred and imported, including a few

CHOICE SHIRES

At the Illinois, Iowa and Michigan State Fairs of 1899, Oaklawn's exhibits in 22 stallion classes won 18 first prizes.

Prices and terms reasonable.

### DUNHAM, FLETCHER & COLEMAN

WAYNE, DU PAGE CO., ILLINOIS.

## Cucumbers and Melons

and all vegetables are exceedingly profitable if grown for the early market. Large yields and early maturity are certain to follow the judicious use of

**Nitrate of Soda.**

For particulars and proofs write for free book to **John A. Myers, 12-R John St., New York.** Nitrate for sale by fertilizer dealers everywhere.

Write at once for List of Dealers.

## FOR SALE AT REDUCED PRICES.

1 No. 7 Alexandra Cream Separator.  
1 No. 1 Alexandra Cream Separator.  
1 Springer Cream Separator.  
2 Springer Cream Separator Bowls.  
1 Iron Cheese Press.  
1 Wooden Cheese Press.

Address: BOX 524, LONDON.

**WANTED**—By April 20th, 1900, a married man, good worker, who understands farming in all its branches, also the feeding and care of dairy cattle, and is a good milker. Must be reliable, honest and trustworthy. Salary, \$200 per year; free house, garden, firewood, and a good percentage on pure-bred Ayrshire stock sold. Permanent situation to suitable person. Must have first-class references. Address—

**JOHN A. McDONALD, Jr.,**  
Williamstown, Ont.  
Scotchman preferred.

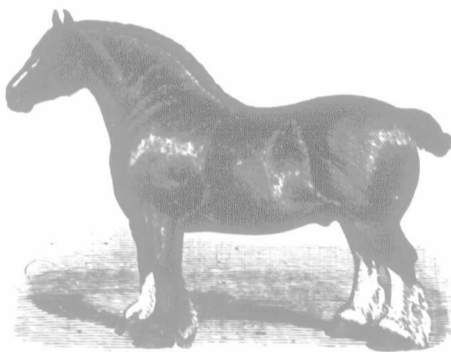

## Clydesdales FOR SALE.

The largest stud of superior imported Clydesdales in Canada; 15 stallions of different ages, warranted sure, sound, and money-makers; inspection invited. Those horses are not got up for show purposes, they are fed and exercised with a view to usefulness.

Also 1 aged Hackney Stallion.

**JOHN BELL,**

Clydesdale Farm, Amber P. O.,

E. R. York, Ont.

Agincourt Station, C. P. R. or G. T. R.  
Trains met by appointment.

## THORNCLIFFE Stock Farm

The largest stud of Clydesdales in Canada, headed by the Champion Stallion of all ages,

"LYON MACGREGOR."

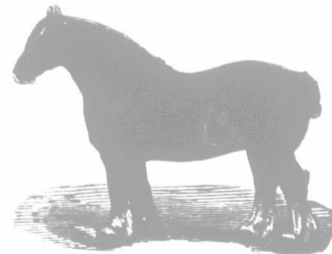

## Stallions and Colts

From the best blood in Scotland and Canada. Ayrshire bulls and heifers from imported stock. Jersey heifers and bull calves, sired by the prize-winning bull, Distinction's Golden. Best milking strains, with good teats. Terms reasonable. A visit to Thorncliffe will well repay you.

**ROBT. DAVIES,**

on Thorncliffe Stock Farm, TORONTO.

PLEASE MENTION FARMER'S ADVOCATE.

Peter C. Kellogg, Auctioneer,

has been instructed by

**MESSRS. AYER & MCKINNEY,**

of Meridale Farms, Meredith, Delaware Co., N. Y., to close out

## At Auction the entire Meridale Herd of Jersey Cattle NEARLY 200 HEAD.

WEDNESDAY and THURSDAY, APRIL 11 and 12,

at the Central New York Fair Grounds, ONEONTA, N. Y. (midway between Albany and Binghamton), on the Delaware &amp; Hudson R. R.

We invite you to the sale of a **BUTTER HERD.** As foundation cows this herd secured five pure St. Lambert tested daughters of Stoke Pogis 3rd and ten tested daughters of his equally great brother, Stoke Pogis 5th. It also purchased notable cows that were close in blood to other great butter sources, but has always made its St. Lambert and LeClair blood a central feature of its efforts. It had two half-sisters of the great LeClair cow, Matilda 4th, of marvellous merit.

Two bulls of this herd from the start were chosen offspring of the two world-famous cows, Ida of St. Lambert and Matilda 4th, regarded by the managers as the greatest two cows of the Jersey breed, considering their dairy powers as individuals, their power to transmit dairy capacity to their descendants, and the unapproached merit of the immediate families from which they sprung.

To fix the types of these great models upon the herd has ever been the aim. How well it has been accomplished is shown by the splendid butter yields of the cows hereby offered at auction (not one of which was forced), hence indicative of what cows will do year in and year out with good treatment, no effort having been made to learn what they might do under great pressure. It has also been significantly demonstrated by cows bred here that have passed into other herds, some of them prominent. In very many instances cows of Meridale breeding have made increased tests for subsequent owners, readily demonstrating their blood inheritance when called upon to act it out. The herd has recently been subjected to the tuberculin test by Dr. Francis Bridge, Veterinarian of the Pennsylvania State Board of Agriculture for eighteen years, whose certificate of health will accompany each animal sold. There is no cow in the herd that is vicious, tricky or difficult to milk, nor an aborter. For catalogues, ready March 20, address:

**PETER C. KELLOGG, 107 John Street, New York City**Parties writing to advertisers will please mention *The Farmer's Advocate.*

## 20 - Imported Scotch Shorthorns - 20

2 BULLS, 1 and 2 YEARS OLD; 14 HEIFERS, 2 YEARS OLD;  
4 YEARLING HEIFERS.

THIS importation came out of quarantine on the 12th July, and representatives of many of the leading Scotch families are amongst them, including Minna, Brawith Buds, Secreta, Mysie, Beauties, Lady Mays, Lustres, etc. The home-bred herd contains Indian Statesman—23004—, and 15 young bulls from 6 to 18 months old, and 50 cows and heifers of all ages Registered Shorthorns, yearling rams and ewes, ram lambs from imp. Flashlight. Any of the above will be sold at reasonable prices. Correspondence or a personal visit solicited. Catalogues on application.

Burlington Junction Station and Telegraph **W. G. PETTIT & SON,**  
Office, G. T. R., within half a mile of farm. FREEMAN, ONT.

## H. CARGILL & SON,

CARGILL, ONTARIO.

The largest herd of Imported Scotch Shorthorn Cattle in Canada.

## SEVENTY-SIX HEAD IMPORTED DURING 1899.

13 BULLS.

63 FEMALES.

ALL imported females of suitable age bred before leaving Scotland. Catalogue free. Correspondence or personal inspection invited. Address as above. Cargill Station half a mile from barns, on Grand Trunk Ry.; 70 miles north-west of Guelph.

## If You WANT GOOD STOCK WRITE US NOW.

BREEDERS AND IMPORTERS OF PURE-BRED

### AYRSHIRES, SHROPSHIRE, GUERNSEYS, and YORKSHIRES.

These are our Specialties.

**WANTED.** About middle April, good industrious man and wife. No family. Man must be good stock hand. Wife to manage boarding house. Good wages. References required. Address:

**ISALEIGH GRANGE FARM, Danville, Quebec.**  
J. N. GREENSHIELDS, PROP. T. D. McCALLUM, MGR.

Important to Breeders and Horsemen.

## Eureka Veterinary CAUSTIC BALSAM.

A reliable and speedy remedy for Curbs, Splints, Spavins, Sweeney, etc., etc., in Horses, and Lump Jaw in Cattle. See pamphlet which accompanies every bottle, giving scientific treatment in the various diseases. It can be used in every case of veterinary practice where stimulating applications and blisters are prescribed. It has no superior. Every bottle sold is guaranteed to give satisfaction. Price 75c. per bottle. Sold by all druggists. Guaranteed remedy for sterility in cows, with full instructions. Price, \$2. Prepared by **THE EUREKA VETERINARY MEDICINE COMPANY, London, Ont.**

**A QUICK, SHARP CUT** hurts much less than a bruise, crush or tear. Done with the **DEHORNING KEYSTONE KNIFE** is the safest. Quick, sharp cut. Cuts from four sides at once. Cannot crush, bruise or tear. Most humane method of dehorning known. Took highest award World's Fair. Write for free circulars before buying.

**KEYSTONE DEHORNING CO. Picton, Ont.**

PLEASE MENTION FARMER'S ADVOCATE.

## FOR SALE:

### Imported Clydesdale Stallion No. 9053.

Bay, with both hind feet white, and strip in face. Foaled 1889. Will weigh about 2,000 lbs. Sired by Prince of Wales 673. Dam by Darnley 222; 2nd dam by Old Times 579; 3rd dam by Sir Colin 1290, etc.

For further particulars apply to

**O. A. COATES,**  
Bothwell, Ont.

## ROSEDALE STOCK FARM.

Clyde and Shire Horses, Scotch Shorthorns, Leicester Sheep.

One Imp. Clyde stallion, rising three years old, weighs 1,875 lbs., and is as good as he is heavy; also a Canadian-bred Shire colt, 1 year old. A few choice young bulls, 11 and 12 months old. The Duth e bull, Prime Minister, heads our herd. Can furnish a carload of young bulls at reasonable figures. My motto, "The best is none too good."  
**J. M. GARDHOUSE, Highfield P. O., Malton, G. T. R.**

## FOR SALE:

The roan Scotch-bred Shorthorn bull,

### Golden Robe 20396,

By Knight of St. John (17102); dam, Golden Bud (imp.) 23015. Having sold most of my females, I can dispose of Golden Robe. He is sure and quiet.

**ISRAEL GROFF,**  
Alma, Ont.



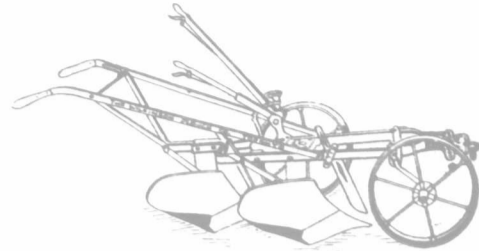
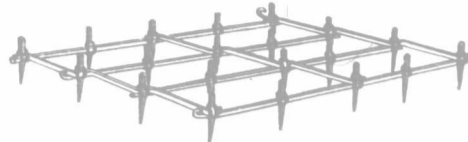
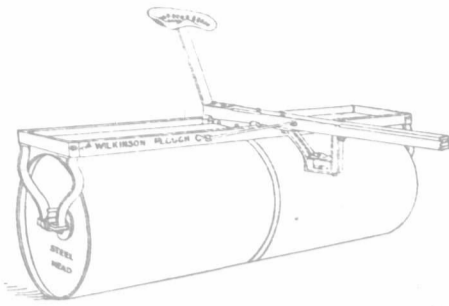
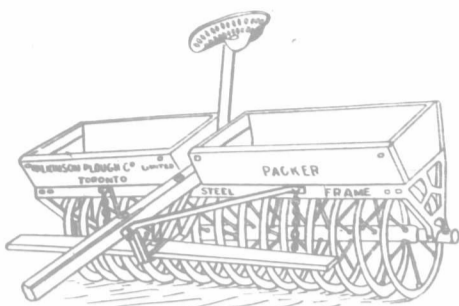

THE WILKINSON PLOUGH CO., LTD.,

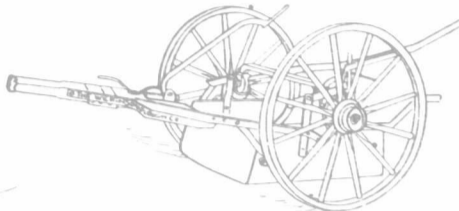
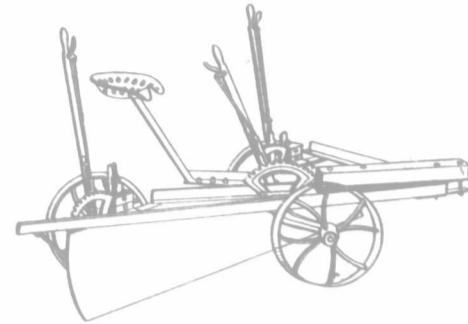

TORONTO, CANADA.

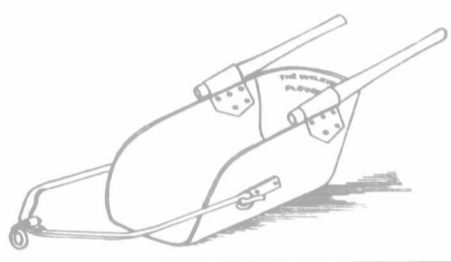
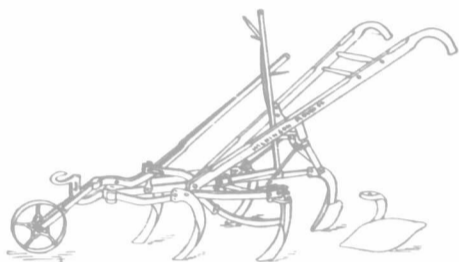
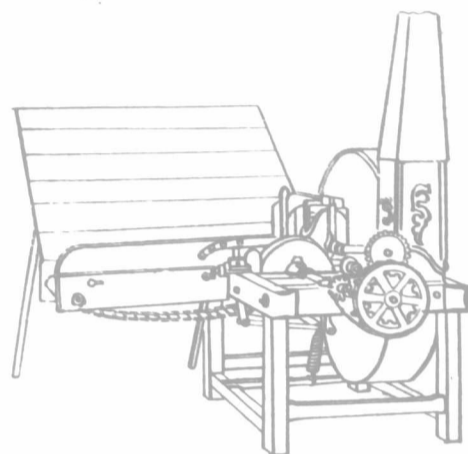

Don't Guess At Results.

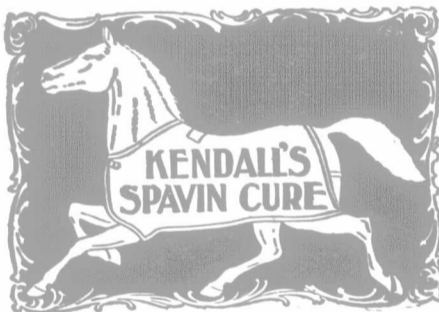

This man knows what he did and how he did it. Such endorsements as the following are a sufficient proof of its merits.

ARTHUR JOHNSTON Greenwood P. O. and Telegraph Office,



13 IMPORTED AND HOME-BRED SHORTHORN BULLS 17 imported COWS and HEIFERS 22 home-bred COWS and HEIFERS

5 SHORTHORN BULLS Of the most noted Scotch families, and choice individuals. For prices and particulars write to SHORE BROS., White Oak.

FOR SALE: TWO CHOICE SHORTHORN BULLS. GAVIN BARBOUR, Crosshill, Ont. SCOTCH SHORTHORN BULLS AND HEIFERS HERD ESTABLISHED IN 1872.

SHORTHORNS I have six young females for sale—three are in calf and three old enough to be bred. These heifers have four or more crosses of the finest Booth sires, on imported Marr and Gordon Castle foundation, a desirable and needed line of breeding.

JOHN DRYDEN, BROOKLIN, ONTARIO, BREEDER OF Scotch Shorthorns, Choice Shropshire Sheep.

W. D. FLATT, Hamilton, Ontario, Can., Importer and breeder of Shorthorn Cattle.



GOLDEN FAME (IMP.)—26056—(72610). My herd is one of the largest in America, both imported and Canadian-bred. A very choice selection of both sexes always on hand for sale.

SPRINGBANK FARM. Shorthorn Cattle, Oxford Sheep, and Bronze Turkeys. Young bulls for sale.

J. & W. B. WATT, Salem, Ont., Offer for sale the four-year-old imported Clydesdale stallion, Heather Bloom (10203), and Six Shorthorn Bulls.

John Miller & Sons, BROUGHAM P. O. and TELEGRAPH OFFICE, OFFER FOR SALE... 4 Imported Clydesdale Stallions. 10 Scotch-bred Shorthorn Bulls. ...PRICES REASONABLE. Claremont Stn., Pickering Stn., C.P.R. G.T.R.

SPRING GROVE STOCK FARM Shorthorn Cattle and Lincoln Sheep. Herd prize and sweepstake at Toronto Industrial Exhibition, 1897 and 1898. Herd headed by Topsman =17847=, champion at Winnipeg, Toronto, London and Ottawa, 1899. High-class Shorthorns of all ages for sale. Also prize-winning Lincolns. Apply T. E. ROBSON, Ilderton, Ont.

Maple Lodge Stock Farm ESTABLISHED 1854. SHORTHORNS—An excellent lot of young bulls, and a special value in young cows and heifers in calf to our imported Knuckle Duster. LEICESTERS—Imported and home bred—the best. ALEX. W. SMITH, MAPLE LODGE P. O., ONT.

HAWTHORN HERD OF DEEP-MILKING SHORTHORNS. We are offering 5 young bulls for sale, of first-class quality, and A1 breeding. Wm. Grainger & Son, - Londesboro, Ont.

SHORTHORN BULLS AND HEIFERS FOR SALE. Cruickshank and other Scotch sort, headed by (imp.) Knuckle Duster. Herd has furnished the Fat Stock Show champion three out of the last five years. Correspondence invited. Exeter Station, G. T. R., H. SMITH, half mile from farm. HAY, ONT.

SHORTHORN CATTLE AND LINCOLN SHEEP. Imp. The Baron at head of herd. Seven young bulls for sale—good ones. Also a few females. Stud rams all imported from H. Dudding, Esq.; the same blood as the 1000-guinea ram. J. T. GIBSON, DENFIELD, ONT.

Scotch Shorthorns FOR SALE. 100 head to select from; 15 grand young bulls by Valkyrie =21806=, and cows and heifers of all ages, of the most approved breeding, served by (imp.) Diamond Jubilee =28861=, now at the head of our herd. T. DOUGLAS & SONS, Strathroy Station and P. O. Farm 1 mile north of the town.

5--Shorthorn Bulls--5 From 9 to 15 months. Also a few choice yearling and 2-yr.-old heifers, among which are grand, thick-fleshed and choicely bred animals, mostly solid red colors. Speak quickly, for they will not last long. STOUFFVILLE STATION, G. A. BRODIE, G. T. R. BETHESDA, ONT.

SCOTCH SHORTHORNS and BERKSHIRES. Choice young bulls and heifers for sale. Also Berkshire pigs of the most approved breeding. Meadowvale Stn., C.P.R. Six miles from Brampton, G.T.R. S. J. PEARSON & SON, Meadowvale, Ont.

BONNIE BURN STOCK FARM Forty rods north of Stouffville Station, offers for sale (5) five grand young Shorthorn bulls, good breeding and excellent quality, at very moderate prices. Write for what you want. D. H. RUSSELL, Stouffville, Ont.

R. & S. NICHOLSON SYLVAN P. O., PARKHILL STATION. Scotch Shorthorns, imp. and home-bred. The Imp. Clipper bull, Chief of Stars, heads the herd. Eight extra good 2-year-old heifers for sale, in calf to Chief of Stars (72215). Inspection invited.

SHORTHORNS Choice bulls ready for service, by Scottish Chief =27244=, by Scottish Pride (imp.). Dam Fancy's Gem, by Guardsman (imp.). BERKSHIRES. Modern type, well-bred boars and sows, all ages. ALEXANDER LOVE, EAGLE, ELGIN CO., ONT.

Clover Leaf Lodge HERD OF Shorthorns A number of choice young bulls, heifers and cows, excellent milking strains. Correspondence invited. R. CORLEY, Belgrave P. O., Ont., and G. T. R.; Wingham, C. P. R.

2 Thorough Hereford Bulls for sale—1 and 2 years old. W. R. COLEMAN, "Oakdale Farm," Cookstown P. O., Ont.

40 HEREFORDS Bulls, Cows, and Heifers, for immediate sale. Alfred Stone, 5 Douglas St., GUELPH, ONT.



F. W. STONE ESTATE, GUELPH, ONTARIO.

The first Hereford herd established in Canada by importations in 1859 of the best prizewinners of England, followed by repeated further importations, including winners of first prize at Royal Agricultural Show. Choice young Hereford Bulls for sale. Also McDougall's Sheep Dip and Cattle Wash, fresh imported, non-poisonous and reliable; thoroughly tested by over forty years' use on farms of above estate. -om



75 HEAD High-quality, Early-maturing Herefords Prizewinners, Producers of Money-makers in the feed lot.

The blood of "Corrector," "Eureka," "Ancient Briton," and "Rupert," on an "Anxiety" foundation. Send for illustrated catalogue. -om

H. D. SMITH, COMPTON, QUE.

\$200 Do you want a Snap? \$200 Now is your Chance.

One good Jersey cow, 7 years old; one good Jersey heifer, 3 years old; and one bull, 3 years old; or, if preferred, a good yearling bull. All registered in the A. J. C. C. Both cows due to calve soon (in calf to Handsome Kloter, one of Mrs. E. M. Jones' best bulls). All for the low price of \$200 (if taken before cows drop their calves), f. o. b. cars at Chatham, or will sell singly. Also young Jersey bulls, and a few choice Jersey grade heifers at reasonable prices. -om W. W. EVERITT, Chatham, Ont.

GLEN ROUGE JERSEYS.

WILLIAM ROLPH, Markham, Ont., offers twelve Jersey Bulls and Heifers (pure St. Lamberts), out of tested cows. Grand individuals. Prices right.

BRAMPTON JERSEY HERD.

Brampton's Monarch (imported), Canada's champion bull, 1898, heads the herd, which numbers 75 head. Now for sale, high class cows and heifers in calf, heifer calves, and 6 extra choice young bulls, sired by Monarch, the best we ever saw. They are from tested show cows. A few high-grade springers. -om B. H. BULL & SON, BRAMPTON, ONT.

The Annandale Farm Holstein-Friesians.

For sale, after careful selection from my thoroughbred and grade bull calves, ages from 1 to 15 months old, from cows averaging 10,000 to 16,000 lbs. milk per year and testing 3 1/2 to 4; sired by the grand bull, COLANTHUS ABBEKERK 2nd, winner of 1st prize at Toronto, Ottawa, and London, as yearling. Prices reasonable.

E. D. TILLSON, Proprietor, Tilsonburg, Ont.

MAPLE HILL HOLSTEIN-FRIESIANS

Three Yearling Heifers, sired by Colanthus Abbeckerk 2nd, and in calf to Daisy Teake's King (brother to Daisy Meake's Queen, the great test and show cow).

Three Bull Calves, sired by De Kol 2nd's Paul De Kol Duke, the great butter-bred bull; dams, the fine show cows, Lady Akkrum 2nd, Cornelia Artis, and Madge Merton. -om G. W. CLEMONS, St. George, Ont.

3 Holstein-Friesian Yearling Bulls FOR SALE. Prices right. Apply to WILLIAM SUHRING, Sebringville, Ont.

WE WANT TO SELL A FEW Holstein Heifers, coming 2 years old

THEY are of the richest and largest producing strains, fine individuals, and bred to as good bulls as there are living. We have a few bull calves and yearling bulls also for sale. -om

HENRY STEVENS & SONS. LACONA, OSWEGO CO., N. Y.

I now offer a 2-year-old HOLSTEIN BULL. Dam Daisy Banks, winner of Toronto milk test, 1898 and 1899. She has given as high as 81 lbs. milk in one day. A fine bull in every respect, and guaranteed a sure stock getter. Also a few young bulls and heifer calves. -om GEO. RICE, Currie's Crossing, Oxford Co., Ont. BROOKBANK FINE STOCK FARM.

Maple Glen Stock Farm.

Special Offer: An Ayrshire bull, sired by Glen a rich bull, bred by President Matteson, Union N. Y. Has for dam the sweet show heifer, Glen 2nd, an unimpaired superior specimen, and a yearling bull, Ottawa and 2nd, for which 1898 was a Liverpool bull, where she was also a member of several prize herds. She gave over 50 lbs. milk per day on show grounds as a two-year-old. Also a bull two years old past; dam was half sister to our old stock and show bull. The sire of some of the best in world to-day. We still have a few females from 6 months to 6 years old for sale—on a dairy test winner of the York family. Prices reasonable for quality. -om C. J. Gilroy & Son, Glen Buell, Ont. Brockville, on C. P. R. or G. T. R.

AYRSHIRES FOR SALE.

The kind that can speak for themselves. Size, constitution, dairy and show combined. Six young bulls for sale, by Glencairn 3rd (imp.), dam Primrose (imp.). Five from Napoleon of Auchenbrain (imp.). Their dams are all Glencairn heifers. Five of their dams were shown last fall at Toronto, London, and Ottawa. Also a few good cows. No culls sold.

JAMES BODEN, TREDINNOCK FARM, -om STE. ANNE DE BELLEVUE, QUE.

Ayrshire Bull Calves of 1899

One bull 5 months and young calves 2 to 3 weeks, from some of our best imported cows. Will sell at reasonable prices. Address:

ROBT. HUNTER, Manager to W. W. Ogilvie. LACHINE RAPIDS, -om QUE.

Maple Cliff Dairy and Stock Farm

Ayrshires and Tamworths for Sale: 1 yearling and 5 fall calves, and a number of heifers. Five Tamworth boars, fit for service, and 40 fall pigs.

R. Reid & Co., - Hintonburg, Ontario.

\$11.-Registered Ayrshires-\$11.

Calves coming now in the herd of 30 high-producing registered Ayrshires (either sex): 3 days to 1 week old, \$11.00; over that age, \$1.00 per week extra. All sired by Norman McLeod -1594-. Also yearling bull from same sire and a famous dam. -om

J. A. James, Nilestown, Ontario.

KEEP THE BOYS ON THE FARM

By sending them to Meadows Farm, Carleton Place, to see J. Yuill & Sons' stock. Eighty-four Ayrshires, second to none in the world for milk production. Thirty-two Shropshire ewes and two rams which are from prizewinning stock. Fourteen Berkshires of the bacon type; and a grand flock of E. P. Rocks. Also two good Collie pups, 4 weeks old. -om J. YUILL & SONS, Props., Carleton Place.

4 AYRSHIRE BULLS 4

Sired by Beauty Style of Auchenbrain (imp.), whose dam gave 72 lbs. milk in one day, and out of high-producing dams. -om R. S. BROOKS, - Brantford, Ont. Formerly T. Brooks & Son.

Choice Ayrshires, Barred Rocks and Eggs.

4 FINE BULLS fit for service. Bull calves, and heifers. A few Barred Rock cockerels. Eggs for hatching from choice matings in Barred Rocks, at \$2 per 15; incubator eggs, \$4 per 100; Cayuga duck eggs, \$1 per 11.

JAS. McCORMACK & SON, -om ROCKTON, ONTARIO.

For Sale: Six Ayrshire bulls, ranging from 5 months to 1 year past. Also a few cows and heifers, thoroughbred fowls, and Scotch collie dogs. -om WM. STEWART & SON, MENIE, ONT.

Kicking Cows.

Stop your cows kicking, increase the flow of milk by the use of

SORE TEAT SALVE. Positively prevents chapped teats, warts, and caked bag or udder. Price, 25c., 50c., and \$1, per tin.

WM. MOLE, Veterinary Surgeon, -om 443 Bathurst St., TORONTO.

CALVERT & DWYER CO'Y, WOOL

TORONTO, CANADA. Write us before selling your wool. It will pay you. -om

Shropshire Rams and Ewes

Newly imported from the greatest English breeders. Home-bred rams and ewes of best quality. Scotch Shorthorns and Clydesdale horses for sale at moderate prices, and in large numbers, by

ROBERT MILLER, -om STOUFFVILLE, ONT.

FAIRVIEW SHROPSHIRE RAMS.

From the greatest winning flock in Canada. Excellent rams to head flocks offered. Good individuals by leading winners.

Different combinations of "Newton Lord," "Fair Star," "Mountain Dreamer," and the \$1200 "Ruddington Eclipse" blood freely found in the offering. The four most famous Shropshire rams known. Blood will tell! It pays well to have the best. -om JOHN CAMPBELL, Woodville, Ont., Can.

PLEASE MENTION FARMER'S ADVOCATE.

Summer Hill Herd

HEADQUARTERS FOR THE IDEAL BACON HOG.

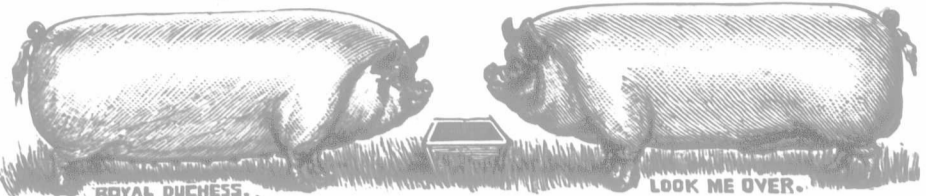

The largest herd of pedigreed Yorkshires of the large English type in Canada. Purity of breed, size, and general excellence is my motto. One hundred awards with one hundred and five exhibits at 7 shows in 1899. A choice selection of young boars and sows of all ages for sale; also boars fit for service, and pregnant sows. Fifty breeding sows, of which 25 (twenty-five) are imported; also three imported stock boars bred by such noted breeders as Sanders Spencer and Philo L. Mills. Am also using two Canadian-bred stock boars, first prize at Toronto in 1898-99. Express charges prepaid. All stock carefully shipped and guaranteed as described. Telephone, Millgrove, Ont. Telegraph 254 Bay St. S., Hamilton, Ont. -om D. C. FLATT, MILLGROVE, ONT.

EUROPEAN ADVERTISEMENTS.

KENT OR ROMNEY MARSH Sheep.

ANNUAL RAM SALE

The annual show and sale of registered Kent or Romney Marsh Rams, consisting of selected specimens from leading flocks of the breed, will be held at ASHFORD, KENT, ENGLAND, On Friday, September 28th, 1900.

Catalogues and full information from

W. W. CHAPMAN, Secretary Kent or Romney Marsh Sheep Breeders' Association, Fitzalan House, Arundel Street, Strand, -om LONDON, ENGLAND.

W. W. Chapman,

Secretary of the National Sheep Breeders' Association, Secretary of the Kent or Romney Marsh Sheep Breeders' Association, and late Secretary of the Southdown Sheep Society.

Pedigree Live Stock Agent, Exporter and shipper. All kinds of registered stock personally selected and exported on commission; quotations given, and all enquiries answered.

Address: FITZALAN HOUSE, ARUNDEL ST., STRAND, LONDON W. W. Cables—Sheepote, London. -om

SNELGROVE BERKSHIRES AND COTSWOLDS.

We have several young boars fit for service, of choice quality. We have a grand lot of sows to farrow in April or May, and will be prepared to supply pairs or trios not akin. Now is the time to order. Our Cotswolds are of the highest class. Can supply yearling rams and yearling ewes. Write for prices. -om SNELL & LYONS, SNELGROVE, ONT.

We lead, others follow.

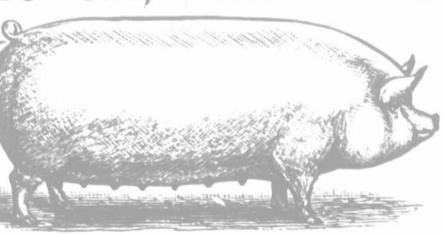

Oak Lodge Yorkshires have a special type bred on foot and are acknowledged to be the highest class of bacon hogs. Grand sweepstakes over all other breeds on foot and for dressed carcasses at Provincial Winter Show. Won all herd prizes offered at the largest Canadian exhibitions.

Improve the quality of your pigs by securing some of Oak Lodge blood. Quality! quality! our motto. All stock fully guaranteed. -om

Brethour & Saunders, Barford, Ont., Can.

April Offering: Yorkshires, Shorthorns

A number of Improved Yorkshire boars ready for service, of the bacon type; also sows ready to breed, not akin. A number of spring pigs ready for immediate shipment, the get of an imported boar, and from show sows. Pairs supplied not akin. Also four choice Shorthorn bulls of Scotch breeding, of the fleshy, early-maturing sort. Address:

H. J. DAVIS, -om BOX 290, WOODSTOCK, ONT.

Springridge Poland-Chinas

Now offering the 2-year-old sire, Blackmoore, and a few of his young females, and booking orders for young stock from the royally-bred Goldbug, lately added to the herd.

WM. J. DUCK, MORPETH, ONT.

DUROC-JERSEY SWINE.

We have a fine lot First-Class Stock of all ages and either sex. Address, -om TAPE BROS., Ridgetown, Ont.

EGGS FOR HATCHING—Barred P. Rocks and Golden Wyandottes, \$1.00 per setting. A few choice cockerels left. -om James Rowe, Avon, Ont.

BARRED PLYMOUTH ROCKS.

\$50 silver cup and gold medal winners at the "Ontario," Peterboro, 1900. More prizes than any four breeders at Toronto, London and Ottawa Fairs, 1899. Blood will tell.

EGGS \$2.00 and \$3.00 per 15.

ASKIN POULTRY YARDS, London. GEO. W. MILLER, PROP.

KNAPP STRAIN S. C. WHITE LEGHORNS. The greatest egg producers. Eggs from a fine pen, headed by a first-prize cockerel treated with prize females, at \$1.00 per setting. -om W. O. BURGESS, Queenston, Ontario.

DES MOINES INCUBATOR Co

The BEST and the CHEAPEST.

95 Per Cent. Hatches are often reported by those who use these Incubators.

One reason for this record is absolute uniformity of temperature in egg chamber; correct instructions for operating; has fireproof lamp. A great mistake it would be to purchase an Incubator or Brooder without first getting a copy of our 148-page catalogue. Send 3 cents for illustrated catalogue of Incubator, Brooder, Poultry and Poultry Supplies. -om THE POULTRY GUIDE (new edition) 15 cents by mail.

O. ROLLAND,

373 St. Paul St., MONTREAL.

Sole Agent for the Dominion. -om



FLEMING'S LUMP JAW CURE. QUICKLY CURED.

Fleming's Lump Jaw Cure

The only radical cure known. Is endorsed by the most prominent ranchers and shippers of the continent. Easy to use. Is applied externally. One to three applications cure. Leaves jaw sound and smooth. Cannot harm in any way. One bottle usually cures two or three ordinary or one severe case. Price \$2.00. Sold by druggists. Can be sent anywhere by mail.

Money cheerfully refunded if the remedy ever fails. FREE!—Some important reports and an illustrated treatise on Lump Jaw. Write for them.

FLEMING BROS., Chemists, St. George, Ont.

PLEASE MENTION FARMER'S ADVOCATE.



**GOSSIP.**

A VALUABLE SHIPMENT OF SCOTCH SHORT-HORNS.

Mr. W. D. Flatt, Trout Creek Farm, Hamilton, Ontario, has, says the Aberdeen Free Press, just concluded, through his Scotch agent, Mr. George Campbell, Harthill, formerly of Kinellar, the purchase of a very choice lot of Scotch Shorthorns, which will compare favorably with any consignment which has yet left our shores for the Dominion. Canadian breeders have for many years been loyal supporters of the thick-fleshed, robust cattle bred in the north of Scotland, which have been found to fit in with the economical and climatic conditions of the Dominion, and as the production of the highest class of commercial bullocks has of late been a profitable branch of the business of the Canadian farmers, the demand for the best class of Scotch Shorthorns is very active. Mr. Campbell, in executing Mr. Flatt's commission, has not been hampered with regard to the price, and, having a close acquaintance with the best strains of Scotch Shorthorns, he has secured for his shipment a lot of 54 Shorthorns from the most celebrated herds in the country, which puts into possession of his principal a remarkably fine representation of the best things which this country can produce.

No fewer than 35 head, consisting of 8 cows, 17 one- and two-year-old heifers, 2 yearling bulls, and 8 heifer and bull calves, were purchased from the great "Cruickshank" herd established by Mr. Philo L. Mills, Ruddington Hall, Nottingham—a loyal worshipper, as he himself has confessed, at the shrine of "St. Duthie." A large proportion of the Ruddington Hall draft consists of some of the very best things Mr. Mills purchased at the recent notable sales in the north of Scotland, and the others are chiefly from Mr. Mills' own Scotch families, dashed with a cross of the celebrated Royal champion, bull Marengo. Among the cows, Glad Princess, a very good four-year-old roan, with a promising bull calf at foot by Best of Archers, inherits the blood of Mr. Gordon's (of Newton) Star of Morning, the sire of the Highland Society champion bull, Pride of Morning, stock bull at Collynie. The breeding of Proud Amaranth, a five-year-old roan, by Pride of Morning, which is accompanied by a nine-month-old heifer calf, Amaranthish, by Royal Chamberlain (a son of the champion bull, Chamberlain), runs into the most potent strains of the old Cruickshank herd—a strain which among other notable things produced Mr. Duthie's famous stock and exhibition bull, Field Marshal. Roan Bess will be remembered as the "plum" of the Newton offering, by Star of Morning, and out of Bessie by Prince of Fashion, which cost Mr. Mills 110 guineas as a yearling. She has proved herself to be a grand breeding cow, having at foot a bull calf by Solferino (by the champion Marengo), which goes to Canada with his dam, and which is certain to have a great showyard career before him. He is regarded by good judges on this side as quite an exceptional calf, having a very sweet head, well laid shoulders, great width over his back and loin, rare under line, and his wonderful symmetry is set off to advantage by his beautiful covering of hair. Rosalind, a three-year-old with a double cross of Star of Morning, is a thick-fleshed three-year-old bred at Newton with a Best of Archers bull calf at foot. Ruby of Douglass III., a very useful breeding cow with a heavy flow of milk, traces down her pedigree to the good old herd at Auchnagathie, as she is descended from Mr. Mitchell's Gems of the Vale, and has thus a cross of the great show bull, Duke of Chamberburgh, while she herself was got by Chamberlain. A thick-fleshed, low-standing three-year-old will be found in the beautifully bred cow, Naomi's Ruth, a daughter of Touchstone (the sire of the National champion, Cornerstone), and descended from the great Sittyton Clipper tribe, which produced so many of the late Mr. Amos Cruickshank's notable sires. As she is in calf to Best of Archers, she is quite good enough to be classed among the most choicely bred animals in Mr. Campbell's selection. Among the two-year-old heifers is included Cornelia, a very pretty red heifer bred at Newton, by the Edinburgh champion bull, Cornerstone, her dam being by Mario II. (by the Royal English champion Mario). Cornelia was one of the gems of Mr. Gordon's sale last year; she is in calf to Marengo, and is quite a class female, inheriting the most potent of Scotch breeding. Lady Percy, a two-year-old in calf to Best of Archers, and by Marengo, and her dam, Lady Mary, by Eastern Star, is descended from a great show family brought to the front by Mr. M'William, Stonytown, which has taken champion prizes at the leading shows in the north of Scotland.

The yearling heifers include such grandly bred lots as Collynie Missie, a very thick-fleshed, blocky roan of beautiful breed type. She is by Nonpareil Victor, and her dam, Dalmony Missie CXXXII., by Lord Lavender, and goes back to a whole bunch of notable sires—William of Orange, Athabasca, and Heir of Englishman—so that this youngster is justly reckoned one of the attractions of Mr. Flatt's great collection. Crescendo's Charity, by Mr. John Wilson's Crescendo, dam Star of Charity, is a well-bred yearling with a fine chest and bosom, and Marengo Cambridge Gwynne, bred by Marengo, represents an English strain. Belle of Archers, by Lordly Archer (a half-brother of the champion Marengo) and from Lady Belle (by Chamberlain), is a remarkably attractive heifer of excellent breed type. Her dam was a first-prize winner at the Nottingham Show, was first for the best milking Shorthorn, and was sold at a long figure to go to the Cape. Of the calves which have been selected, note may be made of Marengo's Ruddington Star, a Cruickshank Clipper, by Mr. Mills' great champion, which shows extra promise, and Marengo's Sunshine, which traces back to the old Heatherwick Mayflowers, which are closely bred to the old Sittyton blood.

In the herd of Mr. Leopold de Rothschild, the great show four-year-old cow, Mayflower IV., bred by Mr. Robert Turner, and full of Collynie breeding, was obtained. She has had a notable career in the showyard, being first at Buckingham as a yearling, first at Exeter and reserve champion, first at the Royal English, first at Bedford, and first at Suffolk as a two-year-old, while she won at Oxford, Bedford and the Royal as a three-year-old shown in the cow class. She is looking very fresh, and should have further honors at her call. She is accompanied by a heifer calf by

a son of Count Lavender (Mr. Willis' great stock and show bull) which looks like doing credit to her dam, and by Mayflower VI., a red yearling heifer, an animal of extraordinary substance and wealth of cover.

In the herd of Her Majesty the Queen there was secured May Blossom, a beautifully-bred two-year-old white heifer, by Monarch, dam Maid of Honor (by Gael, the sire of the Prince of Wales' 1000 guineas bull), which will be exported to Canada to prove to the breeders there that as good whites may be bred as come from the all-reds.

From the famous herd at Dalmeny belonging to Lord Roseberry, Mr. Campbell obtained several exceptionally well-bred Shorthorns, including the Auchnagathie-bred cow, Gladys, full of the Cruickshank blood; Dalmony Nonpareil V., by Sittyton Seal, out of a "Gravesend" dam, and going straight back to one of the favorite Kinellar strains; and the yearling bull, Dalmeny Primate, whose sire was Scottish Sailor and his dam Vain Princess, is from one of the best breeding families in the Collynie herd. Dalmeny Primate is a wide, massive red, with great thighs, and shows a dash of character and breeding.

Mr. Campbell, Harthill, parted with several very good things to Mr. Flatt. One of these is the Gordon-Castle-bred heifer, Lily of the Valley XVII., by the Uppermill-bred bull, Musgrave, a stylish female of nice character and breeding, and another is the seven-year-old cow, Golden Drop X., by Sittyton Sort, dam Gold Drop IX. (by Gravesend), which represents one of the most valued and rarest of the fine old Kinellar tribes. She is a cow of great wealth, scale, and quality, and will be a favorite with Mr. Flatt, as he has one of her sons as stock bull in his herd. Another of the Harthill purchases is Glastonia V., by Masterpiece (bred at Collynie), dam Glastonia—a strain which goes back to the same foundation as the great show heifer, Maid of Promise. She is a big milker, and has a pretty bull calf at foot. Mr. Campbell, Deystone, supplied a very well-bred heifer in Nonpareil XXXV., by Kintore Hero, and from Nonpareil Gem by First Counsel. From Mr. Watson, Auchronie, Aberdeenshire, two heifers and a bull calf were purchased—Queen Mary, a three-year-old, by the valuable breeding Cruickshank sire, Clan Alpine, and her red bull calf by Clifton, and a one-year-old roan bull by Lord Banff, out of Kinellar Roan Bessie—a very wide bull of great wealth of cover and substance, with a beautiful head and character, got by the Iverquhomery-bred sire, Cap-a-Pie. In the herd of Mr. Spencer, Holywell Manor, two nice red bulls from deep-milking strains and by Valiant (a son of Count Lavender) were obtained, and these complete as fine a collection of cattle as ever left this country.

You can't do it.

YOU CAN'T MAKE GOOD BUTTER OR CHEESE WITH COMMON, IMPURE SALT. IT PAYS TO USE THE BEST, AND THE BEST IS

**Windsor Salt . . .**

THE USE OF WHICH IMPROVES FLAVOR AND KEEPING QUALITY.

THE **Windsor Salt Co. (LIMITED),** WINDSOR, ONT.

I would call special attention to the ad. of the SCOTTISH-Canadian Mining Co. this week. They have made a big strike on their property, and it is a first-class stock to buy now. Their ad. is on page 178. Write for particulars, if you are looking for a good investment. **A. E. WELCH, Mines & Mining, London, Ont.**

ADDRESS **Belleville Business College.** BELLEVILLE, ONTARIO.

FOUR WELL-EQUIPPED DEPARTMENTS.

**SPRING TERM**

Begins Monday, April 2nd. **Central Business College, Toronto.**

Twelve regular teachers. Sixty typewriting machines. Splendid equipment. Costs no more for a course here than in a small, half-equipped school. No vacations. Work runs right along through July and August. Write for catalogue. **W. H. SHAW, PRINCIPAL.**

SPRING TERM OPENS APRIL 2nd.

**CENTRAL Business College** STRATFORD, ONTARIO.

A school that enjoys a large patronage, has large staff of expert teachers, gives superior training, and produces best results. Write for our prospectus. **W. J. ELLIOTT, Principal.**

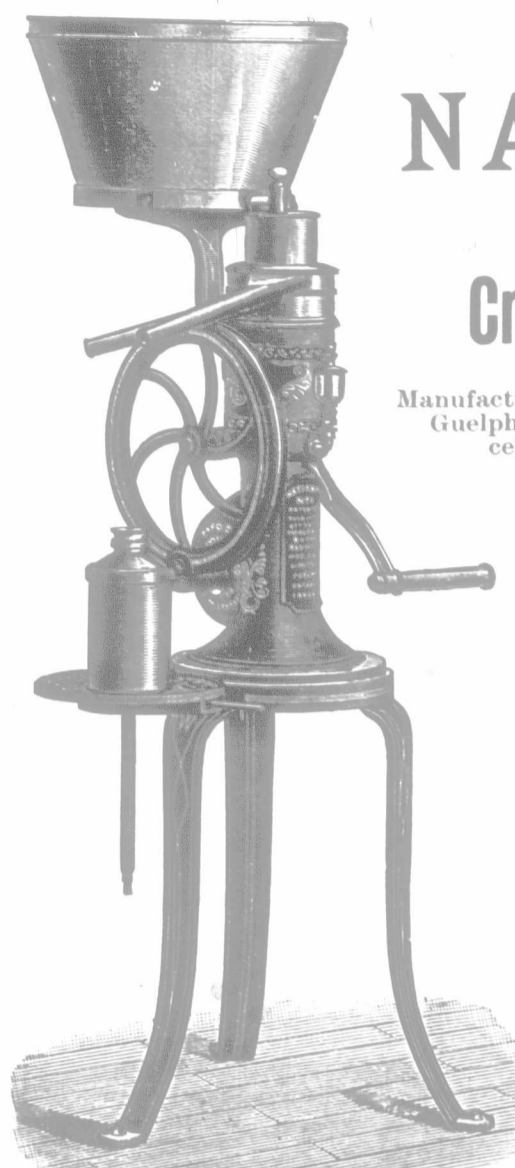

THE **NATIONAL** FARM Cream Separator

Manufactured by the Raymond Mfg. Co. of Guelph, Limited, manufacturers of the celebrated Raymond Sewing Machines.

THE National is an up-to-date machine, leading all others in separating cream by centrifugal force. It is the farmers' choice, because it runs easy, skims fast and clean, and makes a perfect cream, containing any per cent. of butter-fat desired. It is also easier to clean than any other. The National is built of the very best material suitable for the construction of a high-speed machine, and with proper care should last a lifetime. The bearings are interchangeable and easily adjusted. Every machine is guaranteed to do good work, and a trial of the "National" is solicited before purchasing any other. The already large sale of the "National," and the growing demand for it, shows how much the Canadian farmers appreciate a Canadian-made machine that does its work so easily and well, and at the same time returns such a large profit on the small investment. Ask for the "National"; try it and buy it.

THE CREAMERY SUPPLY CO., GUELPH, ONT., General agents for Ontario.

MESSRS. CAMPBELL & GLENN, 381 TALBOT ST., LONDON, ONT., Agents for the Counties of Middlesex and West.

"NATIONAL" NO. 1 HAND POWER. Capacity, 330 to 350 lbs. per hour. **The Raymond Mfg. Co'y of Guelph, Ltd. GUELPH, ONT.**

THIS IS A **GEMENT SILO** BUILT ON THE FARM OF **John Louve, Harpley, Ont.**

It is hexagonal—that is, 6 corners—and is 10 feet across each way, inside measurement, and is 30 feet high.



READ WHAT MR. JOHN LOUVE SAYS ABOUT THOROLD CEMENT: GRANDBEND, ONT., NOV. 14, 1899.

ESTATE OF JOHN BATTLE, THOROLD, ONT.: DEAR SIR,—I have this summer built a silo 30 feet high by 10 feet across inside—six corners. It was built under the instructions of A. E. Hodgert, your travelling agent and instructor, who understands his business thoroughly. I have filled it with corn, and it is a grand success so far as I can see yet. I also built a large arch root-cellar in the approach to the barn. It was built by your A. E. Hodgert. The arch is 12 x 30 feet. The wall is 12 inches at the side by 14 inches at the top. The root-house and silo are getting as hard as stone, and I would advise those who intend building either one to build them of cement. My silo is here for inspection, and also arch root-house. **JOHN LOUVE, Harpley.**

**Estate of John Battle, Thorold, Ontario.**



GOSSIP.

In the footlines accompanying the illustration, in our issue of March 20th, page 161, of the Holstein cow, Belle Korndyke, a typographical error made the date of the official test in which she won first prize, as 1889, whereas it should read 1898-9.

At the London Shire Horse Show sale, the highest price, 450 guineas, was paid by Mr. Towgood for Catherpe Brenda, Mr. H. P. Taunton's 5th-prize winner in the two-year-old class, sired by Harold. The next highest figure was 300 guineas for the three-year-old mare, Real Gem, by Stroxtou Tom. The highest price for a stallion was 230 guineas for the two-year-old Birdsal Calament. The three-year-old stallion, Holker Viking, by Stalmine Premier, also sold for 230 guineas. Yearling colts sold at 20 guineas to 150 guineas. Two- and three-year-olds from 40 guineas up.

THE BIRRELL SALE OF SHORTHORNS.

The auction sale of Shorthorns at Mosboro, Ont., estate of the late Mr. John E. Birrell, March 14th, was very successful, the attendance of stockmen and farmers being very large. The cattle, as a rule, were of an excellent type, the younger things especially being well fleshed and well haired, and, with few exceptions, the animals were in excellent condition. The management of the sale on the part of those responsible for the ring display and the bringing out of the cattle was execrable, and presented an object lesson which should serve as a warning to those contemplating the holding of public sales of stock. Had it not been for the fact that judicious advertising had brought together a very large company of enterprising men eager to buy cattle, and but for the commendable tact, skill and good temper of the capable and well-qualified auctioneer, Mr. Thos. Ingram, of Guelph, what resulted in an exceptionally good sale might easily have turned out a disastrous failure. Owing to the neglect to provide a roped-off ring, not more than a quarter of those present could get a glimpse of the animals when brought out for sale, and this defect was sought to be remedied by the introduction of a heavy draft horse at intervals parading around the inside of the apology for a ring, to the peril of the life and limbs of the company, and in innumerable instances, when the auctioneer had located a bidder, the charge of the heavy horse scattered the crowd so that the salesman would need the eye of an eagle to pick out his bidders again. Then the delay in bringing out the animals in succession and the hesitancy in answering questions as to dates of service, etc., tended to dampen the ardor of buyers, but the men were there for business, and were evidently disposed to make allowances, considering all the circumstances, but while all's well that ends well, it is not wise to presume too much on the good-nature of the public. The sale was notable for the uniformity of good prices, everything selling well up to its value, without any fancy prices being paid. The highest price for a female was \$260, paid by Mr. James Cowan, of Seaford, for Crimson Gem 4th, a red 3-year-old by Imp. Clan Campbell. Mr. Flatt, of Hamilton, took the excellent roan heifer, Starlight 2nd, at \$250, and Mr. W. G. Pettit, of Freeman, the yearling Crimson Fuchsia 16th, at \$225, and the 3-year-old Aggie Ury 3rd, by War Eagle, at \$230. The roan 2-year-old bull, Prince Cruick shank, imported last year by Messrs. Cargill, a bull of fine type and excellent quality, was also taken by Mr. Pettit at \$500, and is good value for the price. Five capital yearling bulls sold at prices ranging from \$155 to \$205 each, and were cheap at the price. The 32 head sold (several calves catalogued going with their dams) averaged \$193 each, most of the buyers being farmers and small breeders. The farm of 170 acres, with first-class buildings, was sold at auction to Mr. Wm. Woodley, of Fullarton, for \$10,300, and is good value for the money, being one of the most desirable farms in the Province.

We append a list of the animals sold, with the address of the buyers:

Cows and Heifers	Price
Crimson Fuchsia 9th, 4 years; Edwin Battly, Gore Bay	\$225
Crimson Fuchsia 14th, 2 years; C. Kearns, Port Huron	200
Crimson Fuchsia 16th, 15 months; W. G. Pettit, Freeman	235
Crimson Gem 4th, 4 years; Jas. Cowan, Seaford	260
Crimson Gem 7th, 3 years; R. Miller, Pickering	130
Crimson Gem 8th, 1 year; Jas. Cowan	185
Crimson Gem 9th, 9 months; Geo. Johnston, Balsam	115
Crimson Fuchsia 18th, 8 months; R. E. Johnston, Pickering	160
Crimson Fuchsia 17th, 2 years; R. E. Johnston	160
Crimson Fuchsia 15th, 16 months; C. Kearns	205
Minnie Warrior 3rd, 4 years; C. Kearns	220
Minnie Warrior 6th, 3 years; M. Shantz, Breslau	140
Minnie April 2nd, 2 years; Robert Harvey, Guelph	230
Starlight 2nd, 2 years; J. I. Flatt, Hamilton	250
Minnie Moss 2nd, 1 year; Edwin Battly	110
Minnie Moss 3rd, 1 year; John Davidson, Ashburn	185
Minnie March 3rd, 1 year; Geo. Johnston	120
Minnie Benson, 1 year; J. I. Flatt, Hamilton	170
Minnie Warrior 7th, 10 months; C. Kearns	140
Aggie Ury 3rd, 3 years; W. G. Pettit	230
Starlight 9 years; John Bradley	140
Mayflower Maid 4th, 4 years; Robt. Miller	195
Starlight 3rd, 1 year; Geo. Johnston	170
<b>Bulls</b>	
Prince Cruickshank 6527th, 6, 9, 1 year, 10 months; W. G. Pettit	500
Ben Mychree, 1 year; Wm. Hay, Tara	180
Montgomery, 18 months; E. R. Cook, Glenwilliams	135
Buckingham, 17 months; S. Macdonald, Berke	160
King Kenney, 17 months; Wm. Wise & Son, Clinton	205
Royal Gloster, 15 months; E. R. Cook	195
Colbert King, 15 months; John McGowan, Wellesley	155
Clan Alpine, 13 months; John Hill, Baden	180
Maniacamp, 13 months; James Cowan, Seaford	175

PLEASE MENTION FARMER'S ADVOCATE.

SEEDS for 25c.

Any 12 Varieties—Regular 5 cent Packages—Money Refunded if not Satisfactory.

- |  |                                  |                                 |
|--|----------------------------------|---------------------------------|
| <b>VEGETABLES.</b><br>(Order by Number.) | 12—Herbs, Marjoram.              | 22—Squash, Hubbard.             |
| 1—Beet, Eclipse, Round.                  | 13—Lettuce, Nonpareil (Cabbage). | 23—Tomato, Extra Early Atlantic |
| 2—Beet, Egyptian, Flat-round.            | 14—Lettuce, Denver Market        | 24—Tomato, Dwarf Champion.      |
| 3—Cabbage, Winningstadt.                 | (Curled).                        |                                 |
| 4—Cabbage, Fottler's Brunswick.          | 15—Musk Melon, Extra Early.      |                                 |
| 5—Carrot, Half-long, Scarlet.            | 16—Water Melon, Early Canada.    |                                 |
| 6—Carrot, Oxheart, or Guerande.          | 17—Onion, Large Red, Wethers-    |                                 |
| 7—Cucumber, Chicago Pickling.            | field.                           |                                 |
| 8—Cucumber, Long Green.                  | 18—Onion, Yellow Globe, Danvers. |                                 |
| 9—Celery, Golden Self-Blanching.         | 19—Parsnip, Hollow Crown.        |                                 |
| 10—Herbs, Sage.                          | 20—Radish, French Breakfast.     |                                 |
| 11—Herbs, Savory.                        | 21—Radish, Rosy Gem, White       |                                 |
|  | Tipped.                          |                                 |
|  |                                  | <b>FLOWERS.</b>                 |
|  |                                  | 25—Asters, Mixed.               |
|  |                                  | 26—Mignonette, Sweet.           |
|  |                                  | 27—Pansy, Mixed.                |
|  |                                  | 28—Petunia, Mixed.              |
|  |                                  | 29—Nasturtiums, Tall Mixed.     |
|  |                                  | 30—Sweet Peas, Fine Mixed.      |
|  |                                  | 31—Wild Flower, Garden Mixed.   |

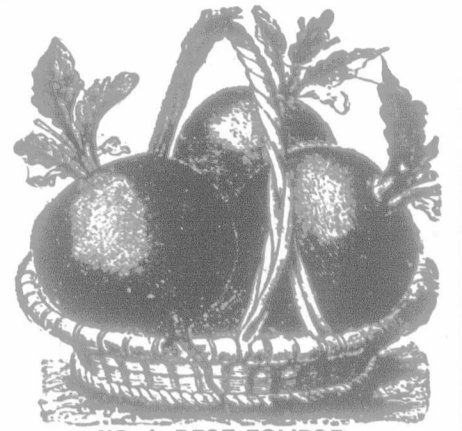

FREE Providing this coupon is CUT OUT and sent to us with an order for 12 packets, we will include 1 packet New Giant Yellow Sweet Sultan—Price 25c—FREE OF CHARGE TO "ADVOCATE" READERS.

WM. RENNIE, TORONTO. BY MAIL, POSTPAID. ORDER TO-DAY.

Persianic Sheep Dip and Animal Wash.

A NON-POISONOUS LIQUID "DIP."  
Kills Ticks. Kills Red Lice. Heals Wounds.  
Greatly Improves quality of WOOL.  
For Horses, Cattle, and Pigs.  
Removes all insects. Thoroughly cleanses the skin.  
Leading "STOCKMEN" endorse it as the CHEAPEST and most EFFECTIVE "Dip" on the market.  
SOLD BY ALL DRUGGISTS, 50 cents PER QT. CAN.  
Special rates in larger quantities.  
MADE ONLY BY  
The Pickhardt Renfrew Co.  
LIMITED,  
STOUFFVILLE, ONT.

A Grand New Oat

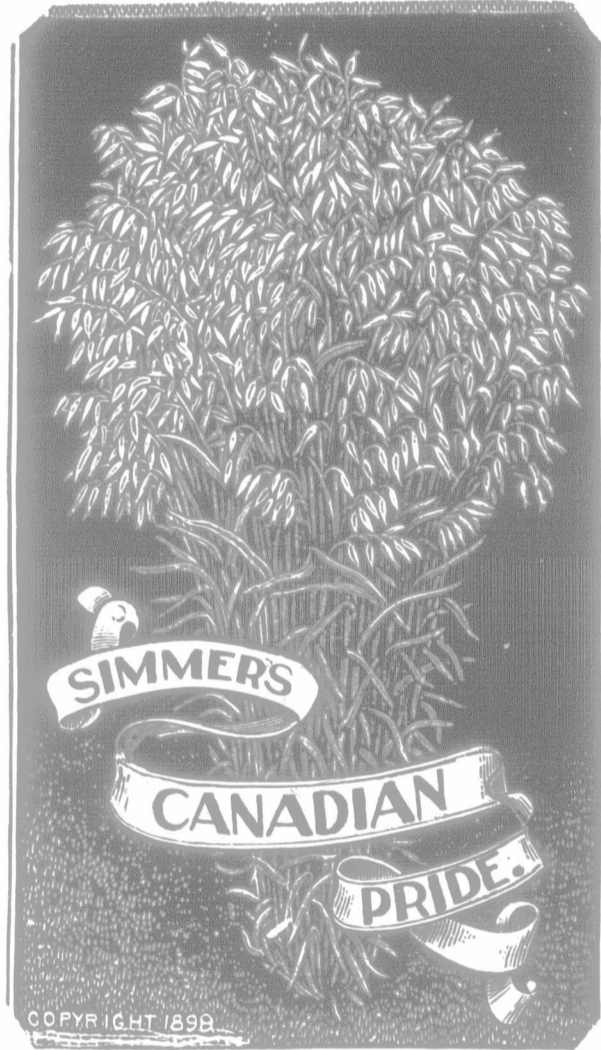

SIMMERS' CANADIAN PRIDE. NOTE.—We have had grown for us only a limited stock of this variety. We would therefore request customers desirous of securing seed to order early.

Simm's Canadian Pride OAT is without a blemish—and we predict for it the most wonderful run that any oat has ever had. Now, we know that this is a strong statement, but we know also that this oat will back up anything and everything that we can say in its favor. To our mind it is the only absolutely perfect oat of to-day—perfect in all respects—perfect in growth, in vigor, in yield, and quality. This is certainly the greatest oat we have ever seen, and we think the many years that we have spent in originating and producing farm seeds entitle us to this opinion. Canadian Pride Oat is a very plump, heavy variety, but at the same time having thin hulls. All the heavy varieties that we have heretofore seen have had such thick, hard hulls as to be almost valueless for feeding purposes. We are glad, therefore, to be able to offer this "Canadian Pride" Oat, which combines hardness, vigor and productiveness with heavy grain and the best of feeding qualities. The oats are white, and have good large kernels. They weigh forty pounds to the measured bushel. It is a branching variety, with very stiff straw of vigorous growth, free from smut and rust. The stooking qualities of the oats are remarkable. It should not be sown too thick, using but 1 1/2 measured bushels per acre. PRICE—Lb., 20c.; 3lb., 50c., postpaid; by express or freight—peck, 40c.; bush., \$1.20; two bush., \$2.30; five bush., \$5.50; ten bush., \$10.50. Cotton bags included.

ADDRESS ALL ORDERS: J. A. SIMMERS, Seeds, Bulbs and Plants. TORONTO, ONTARIO.

Provan's Patent Reversible Carriers, Fork and Slings

HAVE now become a Standard of Excellence with the Farmers of Canada and the United States. At the World's Fair, Chicago, 1893, the only Medal and Diploma given on Hay Carriers, Forks and Slings was awarded to us on these implements.

Following is a copy of the Judges' Award: AWARD. "For open trip hook to receive the sling; automatic clutch, adjustable for size of load desired; ingenious design of stop block, which enables perfect control of carriage; no springs required for locking car, which has motion in all directions; compact form of fork, which can be tripped in any position; the car is reversible and of double action; for novelty, ingenuity, and usefulness. Excellence of material and construction."

Correspondence solicited. Special discount for cash. Manufactured by James W. Provan, OSHAWA, ONT., CANADA. Agents for Province of Quebec: Massey-Harris Co., Ltd., Montreal.

FARMERS, ATTENTION! Cement Stables, Walls, Floors, ETC.,

Built on short notice by an expert cement mechanic. Work done anywhere in Ontario or Manitoba. Address: ROBERT TAGGART, Box 616, on Woodstock, Ont. LIVE STOCK AUCTIONEER. The undersigned is prepared to conduct pure-bred auction sales. 20 years' experience. References: John I. Hobson and Alfred Stone, Guelph; Jas. Hunter, Alma, and Mossom Boyd, Bobcaygeon. Thos. Ingram, Care Mercury Office, Guelph, Ont.

**TORONTO ENGRAVING CO.**  
92 BAY ST  
CUTS BY ALL PROCESSES  
LIVE STOCK A SPECIALITY.

PLEASE MENTION FARMER'S ADVOCATE.

ANTISEPTIC FIBREWARE



BUTTER, HONEY, JAM, ETC.,

The E. B. EDDY CO. (LIMITED), HULL, P. Q.

THE GLOBE FURNITURE COMPANY, LIMITED, WALKERVILLE, ONTARIO.  
CHURCH BENCHES, PULPITS, ALTARS, BARRA, SCHOOL DESKS, ETC.  
WRITE FOR PRICES



ESTABLISHED 1866.  
**GEORGE KEITH**  
 for sure-growing  
**SEEDS**  
 Finest Quality. Send for Catalogue.  
 124 KING STREET E., TORONTO.

**BINDER TWINE**

The man that don't realize the importance of sustaining this co-operative twine movement with his patronage and influence is little better than a

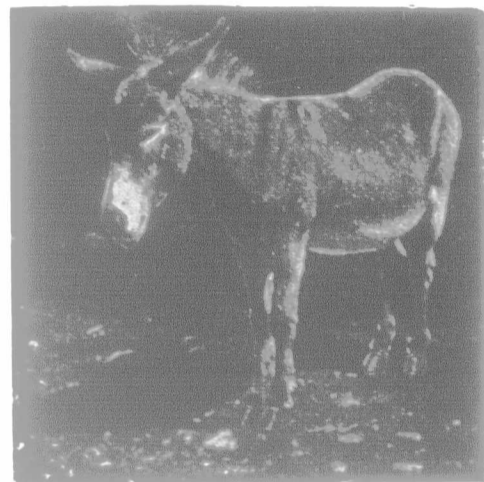

**FARMERS' CO-OPERATIVE BINDER TWINE COMPANY, Limited, Brantford.** with its thousands of stockholders, is again ahead in the great Binder Twine race for the harvest of 1900. Competition defied. Red Star (magnificent), 12jc.; Blue Star, 11jc.; Standard, 10jc. Mill running full tilt. Raw material bought right. See our farmer agents at once. Farmers, you would have paid 16c. to 20c. a pound this coming season for twine had it not been for the existence of this Co-operative Company. Opposition—"Buy us you can't. Lease us you cannot. Crush us if you can. We hold you at defiance so long as the farmers are loyal to their trust." Order early, this is your last warning.

**JOSEPH STRATFORD,**  
 GENERAL MANAGER.



**BINDER TWINE.**—The time for receiving orders from farmers for Binder Twine manufactured at Kingston Penitentiary has been extended to 1st May next. Further particulars on application to J. M. PLATT, Warden of Penitentiary, Kingston.

**BUCHANAN'S**  
 (Malleable Improved)  
**PITCHING MACHINE**  
 For unloading hay and all kinds of loose grain.

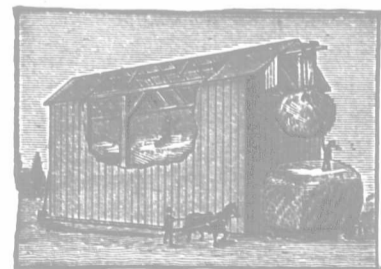

Unloads on either side of barn floor without changing car. No climbing necessary. Malleable Iron Cars. Steel Forks. Knot Passing Pulleys. Will work on stacks as well as in barns. Satisfaction guaranteed.

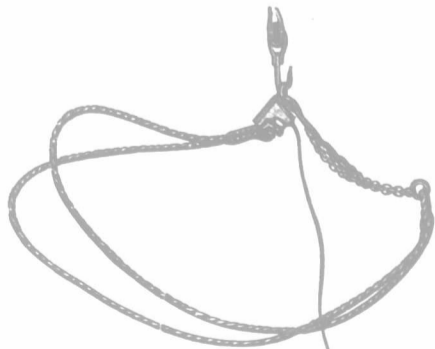

**The Common-Sense Sheaf-Lifter**  
 Works in connection with Pitching Machine, and is the most complete apparatus ever offered to the public for pitching sheaves. Sheaves left in the mow just as they come from the load.

**RESPONSIBLE AGENTS WANTED**  
 Circulars, Prices and Terms on application to  
**M. T. BUCHANAN & CO., Ingersoll, Can.**

**"Canada's Greatest Seed House"**



**NEW SEED OATS**

THAT WILL MAKE  
**THE FARM PAY.**

NEW IMPROVED

**"LIGOWO" OAT**

THE HEAVIEST CROPPER KNOWN  
 Yielded 100 bush. 20 lbs. per acre at Brandon Experimental Farm in 1899.

The Improved "Ligowo" Oat is a large, plump, white variety, with a branching head and stiff straw, a vigorous grower, very prolific, and exceedingly early. It has been grown and tested at all the Experimental Farms, and has given as a result of four years' trial an average crop of 64 BUSH., 6 LBS. PER ACRE. With such favorable results as above reported by the Dominion Experimental Farms, we were induced to procure a supply of seed stock from the original source in France, and now offer for the first time the Improved Ligowo Oats grown from imported stock. Price per lb., 25c.; 5 lbs. for \$1 (post-paid); 1/4 bush., \$1.25; bush., \$2.00; 5 bush. lots and over, \$1.90 per bush.; bags, 20c. each extra.

**NEW "SENSATION" OAT**

Very large Grain, Best Quality, Strong Straw

It is impossible to over-estimate the good qualities of this New White Branching Oat. It has been grown in this vicinity the past year with extraordinary results. The grain is of good size, the hulls are thin, and the kernel is the largest in proportion to the size of the oat we have yet seen,

making it the best variety grown for feeding and milling purposes. The Sensation stools out well, and the straw is very strong, and does not lodge, even when others with a less weight of head go down. It is a very vigorous grower, quite noticeably so when seen growing beside other varieties. It is bound to take a leading place, and will, no doubt, become a very popular variety. Price per lb., 15c.; 4 lbs., 50c. (post-paid); bush., \$1; 5 bush. lots, 90c. per bush.; 10 bush. lots and over, 90c. per bush.; bags, 20c. each extra.

**IMPROVED "AMERICAN" OAT**

This splendid oat has already proved itself to be entitled to rank among the very first and best varieties. It is a heavy growing strong strawed variety, and is of such vigorous constitution as to be almost proof against rust and other diseases. The grain is large, white, thin hulled, and in every respect first-class. Price per bush., 75c.; 5 bush. lots and over, 70c. per bush.; 10 bush. lots and over, 65c.; bags, 20c. each extra.

**SELECTED "BLACK TARTARIAN" OAT**

It is extremely hardy, grows with vigor and rapidity, stands well, and adapts itself to almost any soil. Grain very black, large and plump. Our seed is grown from imported stock. Price per bush., 70c.; 5 bush. lots, 65c. per bush.; 10 bush. lots and over, 60c. per bush.; bags, 20c. each extra.

**STOCKS** of these new and improved oats are limited; order early and avoid disappointment. The bushel prices are for shipment from Toronto.

You can get Steele, Briggs' Famous Garden and Flower Seeds from your Resident Merchant, or send for them direct. **THE BEST SEEDS THAT GROW.**

A Handsome Illustrated 112 Page Catalogue Free, send for one to-day.

**The Steele, Briggs Seed Co., LIMITED**  
 TORONTO, Ont.

**GOSSIP.**

In writing to advertisers, mention the "Farmer's Advocate"

**ALEX. HUME & CO.'S AYRSHIRES.**

With each succeeding generation of Ayrshire cattle in the hands of Mr. Alex. Hume, near Menie, Ont., may be found greater uniformity and increasing quality, which can only follow judicious mating and careful development. When we called at the farm early in January, we found a long string of matrons doing service (30 in all), and while they are a splendid lot, we feel that we cannot pass without making a few remarks regarding some individuals: Eva of Barcheskie 2565, by Craigs of Kyle and out of Eva 2nd of Orchardton, was bred by Mr. W. P. Gilmore in Scotland, and is a cow of which any owner may well feel proud, as she carries in her veins the blood of many of Scotland's best families. Three of her daughters are now in the herd, and carry sufficient dairying indications in their make-up

to justify high hopes for their future. We also saw about a dozen three- and four-year-old daughters of White Chief of St. Annes, which are due to calve in the spring, and upwards of 20 head of youngsters by the same sire, all showing the best Ayrshire characteristics, with their beautiful glossy and well-marked skins of finest texture, indicating superior quality and vigorous digestive and assimilating qualities. Much careful study has been given the subject of judicious mating and the selection of proper sires. White Chief of St. Annes has done much valuable service in this herd, and one cannot but be impressed by the uniformity of his progeny, which, no doubt, traces to his strength of breeding. His dam, White Floss, was one of the highest Canadian producers, winning wherever shown from her babyhood, from the World's Fair, Chicago, until the present, and we understand she is considered one of the greatest show cows in the United States at the present day, depending, no doubt, largely upon her wonderful constitution—a feature so strongly sought in the Ayrshire cow in the herd of her breeder. Glencairn 3rd

(Imp.) also proved himself one of the best sires, and did much valuable service to the breed in this country. We also saw the young bull, Caspian of St. Annes (Imp.), and in him we feel that Mr. Hume has an impressive sire, having sufficient size and a robust constitution, with strong masculine characteristics. Mr. Hume informed us that he has found a ready demand for all salable stock. A few choice fall calves were on hand when we called, and his advertisement in this issue mentions some nice ones of younger age. Parties requiring really choice and well-bred Ayrshires will do well to watch his offerings and act quickly, for they are not the kind that hang long in the market. In Yorkshires, Mr. Hume has shown rare judgment in making his foundation selections from the noted Haskett family, and as three or four brood sows are kept on hand, he is seldom without young stuff to fill orders. When we called we saw some choice young boars and sows ready for shipment, in which no mistake can be made in their purchase. Watch Mr. Hume's offerings.



**GOSSIP.**

**SHORTHORNS SELL HIGH IN IOWA.**

At the dispersion sale of the Shorthorn herd of J. R. Crawford & Sons, Newton, Ia., March 8th, some high prices were made, the light roan six-year-old cow, Gwendoline 5th, by Knight of the Thistle, topping the sale at \$1,100. F. A. Edwards, Webster, Ia., was the buyer. Glen Nonpareil, a red six-year-old cow, sold for \$920; Bashful 4th, a red three-year-old, for \$915, and a dozen other females brought from \$300 to \$825 each. The red three-year-old bull, Victor Baron, by Baron Cruickshank, brought \$925, and went to H. D. Parsons, Newton, Ia. Secret Valentine, a roan yearling bull by St. Valentine, went to Riley & Greenwood, Albion, Nebraska, at \$855. Thirteen bulls brought an average of \$282, 42 females an average of \$434, and the 55 head sold averaged \$398.63.

On March 6th and 7th, C. S. Barclay sold 97 head of Shorthorns at West Liberty, Iowa. In this offering were 20 head which were a part of the herd of A. & G. Davidson, Monticello, Ia., sons of Mr. Jas. H. Davidson, Balsam, Ont., recently purchased by Mr. Barclay. These were superior animals and in the good condition which the Davidsons always keep their stock, and they made the grand average price of \$363.80, the two cows, Duchesses of Gloster 23th and 31st, bringing \$550 and \$600, respectively, and Golden Bud 2nd, a red two-year-old bred by Hon. John Dryden, sired by Revenue, topped the sale at \$625. The highest price for a bull at this sale was \$390, for the red Grand Baron, but five others sold at prices ranging from \$300 to \$335. The 97 head sold at this sale brought an average of \$199.55.

**A NOTABLE IMPORTATION OF YORKSHIRES.**

From the Aberdeen Free Press of recent date we quote: "Mr. D. C. Flatt, of Summer Hill Stock Farm, Millgrove, Ontario, Canada, whose famous herd of Yorkshire swine is the largest in that country, has been on a tour through England and Scotland in search of the choicest specimens of Large Yorkshires he could obtain. He purchased a number of the prize 'Royal' winners of 1899, and several which were in training for the forthcoming 'Royal' Show at York; in fact, he bought nothing but strictly first-class stock, which will form a valuable addition to his famous herd at Summer Hill. His purchases were drawn from the stocks of Mr. Philo L. Mills; Mr. Daybell, Nottingham; the Queen, and the Earl of Roseberry, and include several notably fine specimens of both boars and sows, which only a high price could have tempted the owners to part with. This important consignment of high-class stock, which will leave Glasgow Feb. 3rd, per the Donaldson liner, Concordia, for St. John, testifies to the great business enterprise of Mr. Flatt, and will be a valuable acquisition to the stock of pigs of bacon type in Canada." Mr. Flatt writes us that he confidently believes this selection of Yorkshires is the most valuable importation ever made to Canada, among the number being a young boar from the herd of Mr. D. R. Daybell, which cost \$200, his sire being a very noted getter, being the sire of over 40 first-prize winners in Britain last year. There are also in the lot some very choice sows, bred to the best boars in England, and due to farrow in April. Such an importation, added to the already large and strong herd at Summer Hill, will place Mr. Flatt in a good position to supply the great demand which is sure to be experienced this spring in sympathy with the rapidly-rising prices for hogs of bacon type in the market at all points in Canada. Mr. Flatt also selected and imported for Mr. Thos. Teasdale, Concord, Ont., a fine Berkshire sow from the herd of Her Majesty the Queen at the Windsor Shaw Farm.

**Awards.**

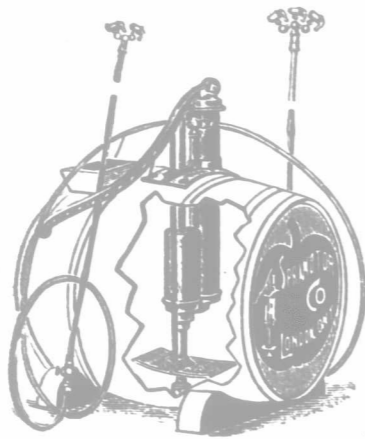

and St. Petersburg, Russia, when no such contests took place. The only contest ever held was under the auspices of the Board of Control of the Fruit Experimental Stations of Ontario, which was held at Grimsby, April 1st and 2nd, 1897, at which the Spramotor was awarded first place against the best America could produce.

**THE SPRAMOTOR CO.** will forfeit \$100 to the Red Cross Fund if a superior award has been granted to any spraying machine other than the Spramotor, anywhere in the world where the Spramotor was exhibited.

Over 100 medals and first awards have been granted the Spramotor since 1876.  
Used by the San Jose Scale Commission, Ontario Government, during the winter of 1899 and 1900.

**Certificate of Official Award.**

This is to certify that at the contest of Spraying Apparatus held at Grimsby under the auspices of the Board of Control of the Fruit Experimental Stations of Ontario, in which there were eleven contestants, the Spramotor, made by the Spramotor Co., of London, Ont., was awarded first place.

*H. J. Hall*  
Judges.  
*W. H. Hall*

Send for our 82 page copyrighted treatise and catalogue for 1900, which is free. We pay the postage. Agents wanted. Address  
**Spramotor Co., 68-70 King St., London, Can.**  
Mention this publication.

**We want YOUR name. YOU want our new catalogue. YOU also want our Threshing Machinery. WE want YOUR trade.**

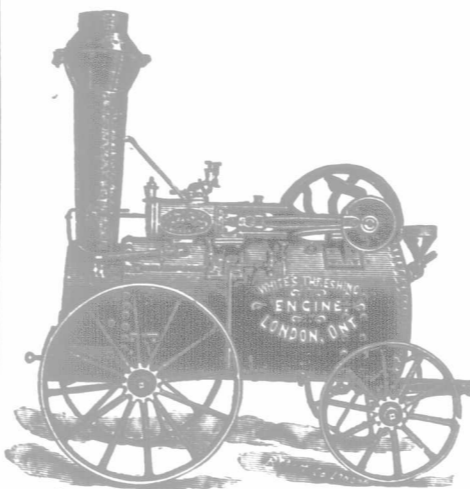
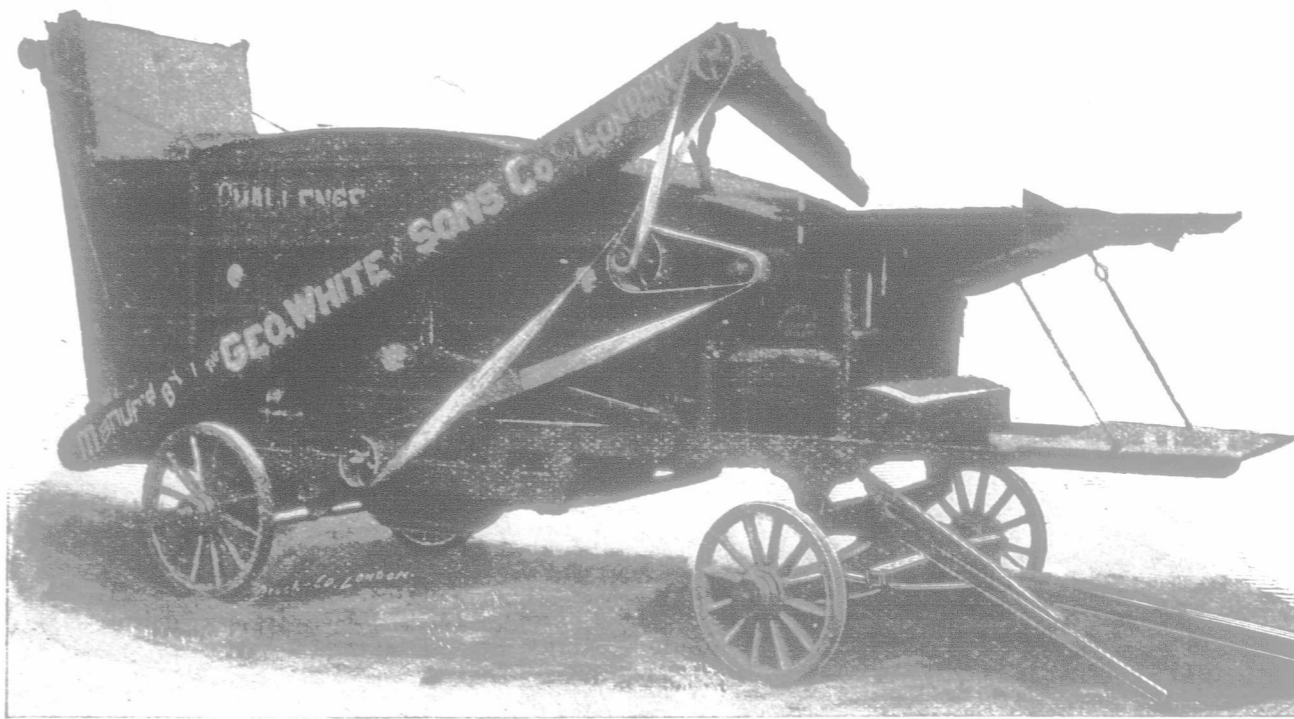

In this age of progress be up-to-date.

**HOW?**

BY USING

**THE WHITE** New Challenge Thresher and New high-speed Portable and Traction Engines

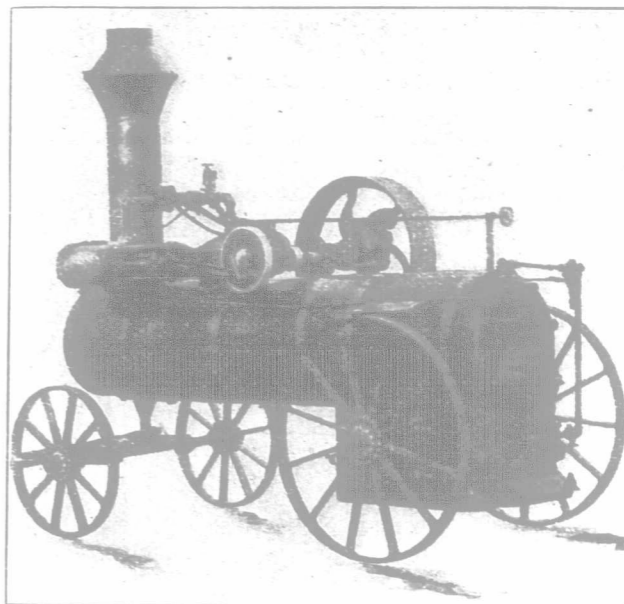

To see our 1900 improvements is to appreciate them. If you cannot come to see us, write, and we will have a practical traveller call to see you.

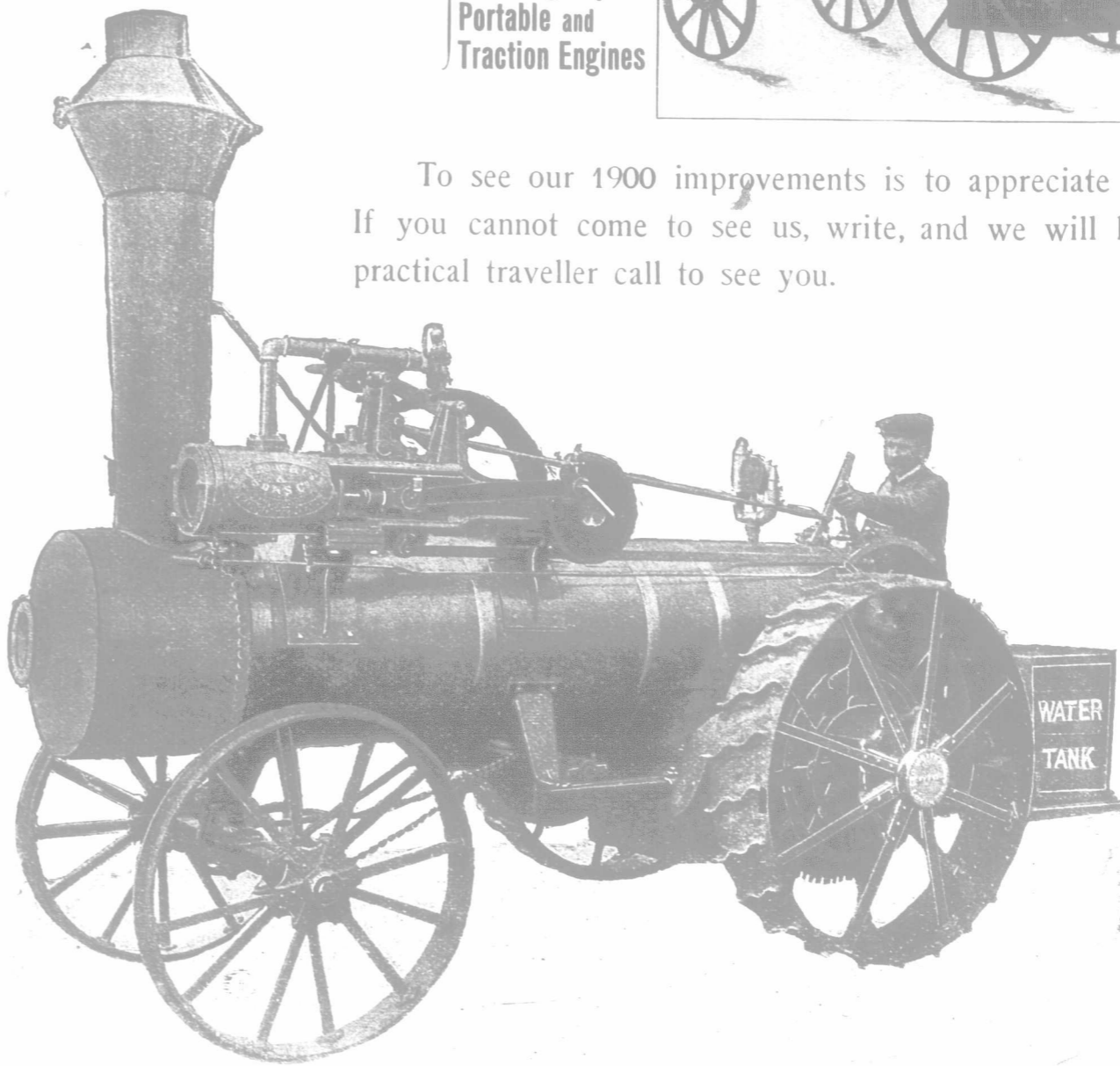

**THE GEO. WHITE & SONS CO., Limited, LONDON, ONT.**



# —Paints—

House,  
Barn,  
Roof,  
Bridge,  
Wagon,  
Implement,  
Coach

Paints  
Ready  
for  
Use.

## Varnishes

for Carriages, Implements, Wagons. Interior and Exterior Finish.

WHEN PURCHASING PAINTS OR VARNISHES, SEE THAT THE PACKAGES BEAR THE NAME OF

**The Canada Paint Co., Ltd.,** MONTREAL AND TORONTO.

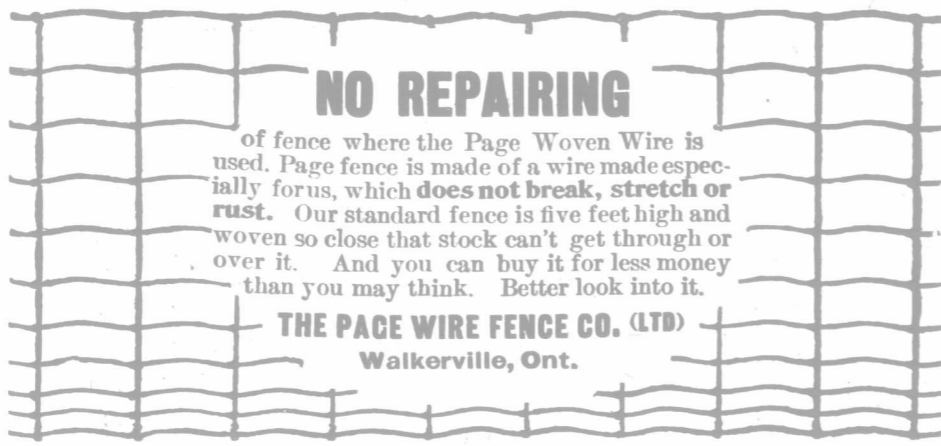

**NO REPAIRING**  
of fence where the Page Woven Wire is used. Page fence is made of a wire made especially for us, which **does not break, stretch or rust.** Our standard fence is five feet high and woven so close that stock can't get through or over it. And you can buy it for less money than you may think. Better look into it.

**THE PAGE WIRE FENCE CO. (LTD)**  
Walkerville, Ont.

Strathy's "HINGE" Stay Field Fence and SINGLE POLE Gates  
"THE 20TH CENTURY FENCE."

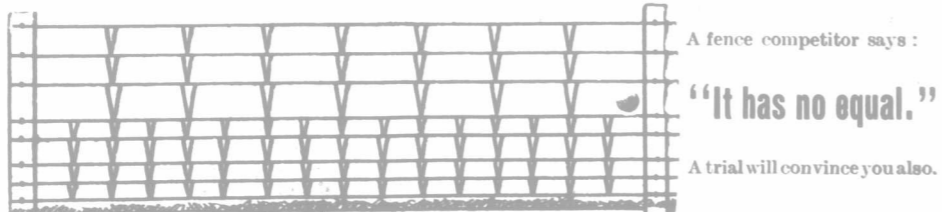

A fence competitor says:  
"It has no equal."  
A trial will convince you also.

The product of years of practical experience, careful study and experiment under the hardest climatic conditions of heavy snow and severe frost in winter and high temperature in summer, with a variation of 150 degrees. Our Spring Post meets perfectly the requirements and overcomes all the difficulties of contraction and expansion, under a variation of 180 degrees of temperature, and has besides a reserve capacity of as much more to provide for great strain and to automatically take up the stretch in the wires. Our "Hinge" Stays so act, when under pressure of snow or other weight, that when the weight is removed the fence springs back to place, with Stays unbent and fence uninjured. A system all our own and unlike any other. We use heavy wires—high-carbon spring-steel wire of highest quality—but our system is cheaper and the completed cost less than any other fence. Write for full particulars, and state fully your requirements.

**STRATHY & CO.,** WELLAND, ONT.  
Agents of ability wanted in every part of Canada.



**"SAFE LOCK" METAL SHINGLES**  
THE KIND THAT ARE WEATHERPROOF  
COST LITTLE MORE THAN WOOD SHINGLES  
AND ARE LIGHTNING AND FIRE PROOF  
ASK FOR FREE SAMPLES

METAL SHINGLE & SIDING CO.  
PRESTON, ONT.

### LIVE STOCK AUCTION SALES

Conducted in all parts of the country. Pedigree stock a specialty. Write for terms. References: J. C. Snell, Edmonton; John I. Hobson, Guelph; Hon. M. H. Cochrane, Compton, P. Q.; or this office.

JOHN SMITH, BRAMPTON.

### SHEEP BREEDERS' ASSOCIATIONS.

American Shropshire Registry Association, the largest live stock organization in the world. Hon. John Dryden, President, Toronto, Canada. Address correspondence to MORTIMER LEVERING, Secretary, Lafayette, Indiana.

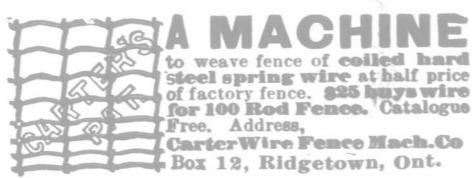

**A MACHINE**  
to weave fence of coiled hard steel spring wire at half price of factory fence. \$25 buys wire for 100 Rod Fence. Catalogue Free. Address, Carter Wire Fence Mach. Co. Box 12, Ridgeway, Ont.



**FENCE MACHINE**  
The GEM still holds the record—120 rods 10-wire fence in 10 hours. Price, \$5.00. Coiled Spring and other wire for sale in any quantity. Write—  
McGregor, Banwell Co., WINDSOR, - ONT.



**FAMILY KNITTER!**  
Will do all knitting required in a family, homespun or factory yarn. SIMPLEST KNITTER ON THE MARKET.  
We guarantee every machine to do good work. Agents wanted. Write for particulars.  
PRICE, \$5.00.  
**DUNDAS KNITTING MACHINE CO.,**  
DUNDAS, ONTARIO.

# Handsome Is that Handsome Does.

NO OTHER MOWER LOOKS QUITE SO NICE.



NO OTHER MOWER WORKS QUITE SO WELL.

### OUR NO. 8.

We are a loyal people—  
None more so:—the motto we teach:  
Then why not be consistent,  
And practice what we preach?

Our soldier boys have courage,  
Our workingmen have skill:  
Why, then, buy foreign-made machines,  
And our own men help to kill.

Perhaps, for the want of thought,  
Some for the moment may have strayed;  
But who is there among us  
For experience has not paid?

But now, with spring returning,  
The fields will soon be green;  
Then buy from us our Number Eight,  
For she's the meadow's "queen."

*THE Frost & Wood Company*  
LIMITED.

Toronto.  
London.  
Winnipeg.  
Montreal.  
Quebec.  
St. John.

HOME OFFICE AND WORKS:  
Smith's Falls, Ont.

# BINDER

# FARMER'S TWINE

PURE MANILA, 650 FEET,  
SPECIAL MANILA,  
TIGER,  
STANDARD.

Farmers! Don't be taken in. There is none "just as good." These twines will not bunch at the knottor, and a Binder will run all day without stoppage, thus saving time, annoyance and a "lot o' cussin'."

We pack our twine in bags of the size of ordinary grain bags, and we are not ashamed to put our name upon it. Don't take any other.

# CONSUMERS' CORDAGE CO.

Limited.

MONTREAL.





## SHOPPING BY MAIL

Is made easy on application to

# The Hudson's Bay Stores.

Made in Canada by Expert Canadian Workmen.

On the Dowagiac Pattern, but with parts strengthened and improved.

## The STEVENS MFG. CO.'S SHOE DRILL

Undoubtedly the best grain seeder made. Specially adapted for use in Canadian Northwest.

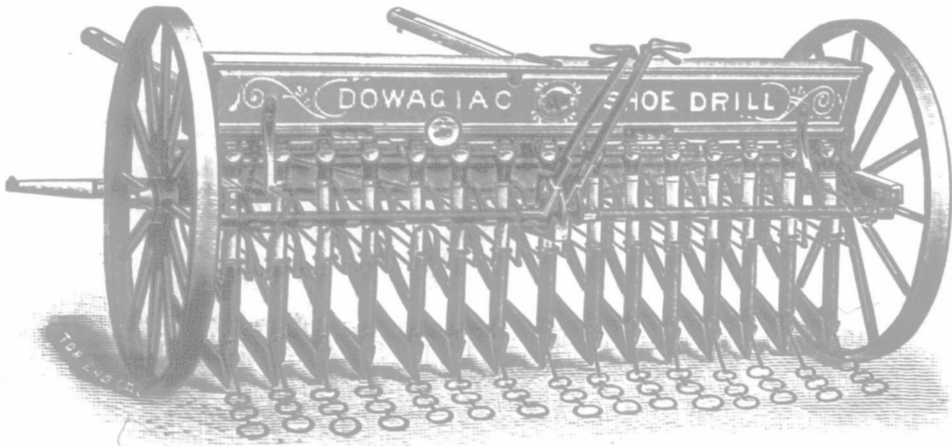

### WHAT IT DOES :

Works perfectly in wet as well as dry ground.  
Presses down stubble and trash and passes over.  
Makes furrows to any desired depth.  
Cuts sod or prairie ground better than any other device.  
Seed deposited at bottom of furrow—cannot be blown away.  
Makes furrows close together, utilizing all ground.

### WHAT IT IS MADE OF :

The best material in every respect.  
The best plow-share steel for shoes.  
Best tempered steel for springs.  
Malleable iron for all light castings.  
Main frame of angle iron, trussed and braced, and practically unbreakable.  
Poles and all other parts of wood made of thoroughly-seasoned stuff.  
Wheels with solid hub, hickory spokes, ash rims and three-inch tires.  
In workmanship and material cannot be surpassed.

## The STEVENS MANUFACTURING CO., WINNIPEG, MAN.

HEAD OFFICE : LONDON, ONT.

Mention this paper.

*You don't know how delicious  
Tea can be unless you have  
tried Blue Ribbon Ceylon.*

**METAL EAR LABELS**  
Used by all Live Stock Record Associations.

Sheep size, per 100.....	\$1.50
Hog size, per 100.....	1.50
Cattle size, per 100.....	2.00

Punch and Pliers for attaching labels to ear, each \$1.00.  
Name on one side and any numbers wanted on reverse side. F. S. BURCH & CO.

178 Michigan St., Chicago, Ill.

**THE ONTARIO VETERINARY COLLEGE**  
(LIMITED),  
TEMPERANCE ST., TORONTO, CANADA  
Affiliated with the University of Toronto.

Patrons: Governor-General of Canada, and Lieut. Governor of Ontario. Fee, \$25.00 per session. Apply to ANDREW SMITH, F.R.C.V.S., Principal, 18-23 St.

**Are You Thinking  
of Building?**

IF SO, TO YOUR ADVANTAGE TO WRITE

**Dick, Banning & Co.,**

WINNIPEG, MAN.

No Instrument is more popular in Canada to-day than the

## Bell Piano

And there is no better to be had.

THE orchestral attachment renders possible the effect of sixteen different stringed instruments. It is used only in the "BELL." Send for free booklet, No. 40, it tells all about it.

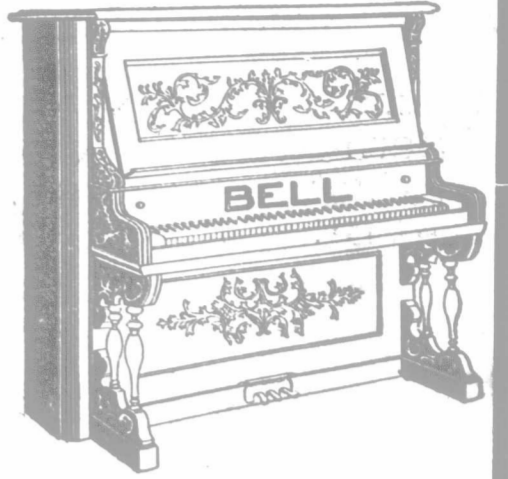

Built to last a lifetime.

The BELL ORGAN & PIANO CO., Limited, GUELPH, ONTARIO.  
Or J. L. MEIKLE & CO., Agents, WINNIPEG, MAN.

WORLD'S HIGHEST HONORS

# MASSEY-HARRIS

CULTIVATING, SEEDING

HAY MAKING HARVESTING

## MACHINES

## Government Analysis.

LABORATORY OF INLAND REVENUE,  
OFFICE OF OFFICIAL ANALYST,  
Montreal, April 8, 1895.

"I hereby certify that I have drawn, by my own hand, ten samples of the

## St. Lawrence Sugar Refining Co.'s

EXTRA STANDARD GRANULATED SUGAR, indiscriminately taken from ten lots of about 150 barrels each. I have analyzed same and find them uniformly to contain:

99 <sup>99</sup>/<sub>100</sub> TO 100 per cent. of pure Cane Sugar, with no impurities whatever."

(Signed) JOHN BAKER EDWARDS, Ph. D., D.C.L.,  
Prof. of Chemistry and Public Analyst, Montreal.

Please Mention the Farmer's Advocate.