

INDEX TO ADVERTISEMENTS

ADAMANT WALL PLASTER.	Page
Adamant Mfg. Co.	11, vi
National Association	x
ARCHITECTS.	111
Directory	111
ARCHITECTURAL SCULPTORS AND CARVERS.	
Canovsky, B. H.	vii
Gullet, F. B.	vii
Hicks, W. Stevens.	vii
Hotbrook & Mollington.	vii
Johnson & Son, Wm.	vii
Mowbray, Thos.	vii
Turner Frederic	vii
Wagner, Zeidler & Co.	142
Young & Collins.	142
ARCHITECTURAL IRON WORK.	
Barnum Wire & Iron Works.	1
B. Greening Wire Co.	1V
Dennis, R.	xiii
Ives & Co., H. R.	1V
Whitfield, John.	1V
ART FURNITURE.	
Scott & Son, W.	vii
Wright & Co.	142
ART WOODWORK.	
Wagner, Zeidler & Co.	142
BENT GLASS MANUFACTURERS.	
Polito, T.	143
Price, S. I.	143
BUILDERS' HARDWARE.	
Aikenshead & Crombie.	v
Rice Lewis & Son.	1V
Vokes, M. & J. L.	143
BRICKS (PRESSED).	
Hynes Terra Cotta & Brick Co.	vi
Morrison & Co., T. A.	1V
Savage, R. D.	1V
Toronto Pressed Brick & Terra Cotta Co.	1V
The Ontario Terra Cotta, Brick & Sewer Pipe Co.	xi
BUILDERS' SUPPLIES.	
Adamant Mfg. Co.	11, vi
Adamson, Joseph.	1
Morrison & Co., T. A.	1V
Maguire, William.	144
McNally & Co.	144
Rathbun Co.	vi
Vokes, M. & J. L.	143
BUILDING STONE DEALERS.	
Britnell & Co.	11
Bristow Bros.	11
Gillespie & Brooks.	11
Lynn, Peter.	x
Morrison & Co., T. A.	1V
Rathbun Co.	vi
Savage, R. D.	viii
Vokes Malcolm Stone Co.	11
CHURCH AND SCHOOL FURNITURE.	
Bennet Furnishing Co.	1V
Canadian Office & School Furniture Co.	vii
Office Specialty Co.	vii
Pennington & Baker.	x
CHIMNEY TOPPING.	
Hanson, Hamd M.	ix

CEMENTS.	
Adamant Mfg. Co.	vi
McNally & Co., Wm.	144
Maguire, William.	1V
McRae & Co.	1V
Morrison & Co., T. A.	1V
Rathbun Co.	vi
Savage, R. D.	viii
Terry, Edward.	vii
Vokes, M. & J. L.	143
Wright & Sons, C. B.	144
CONSULTING ENGINEER.	
Barty, A. B.	141
CONTRACTORS AND BUILDERS.	
Andrews, Francis.	11
Davidson & Kelly.	11
Davis, H.	11
Davie, George.	11
Dearing, Geo.	11
Hood & Co., H. T.	11
Grant & Goddard.	11
Hancock, Thomas.	11
Hannah Bros.	11
Humphrey, T. R.	11
Lynn, Peter.	x
Marshall, John.	11
Mortimore, Geo. T.	11
Moss, Wm.	11
Pudfin, Wm.	11
Redmond, Joseph.	11
Stevens, Chas. H.	11
Thomas & Howell.	11
Webb, John E.	11
CUT STONE CONTRACTORS.	
Bristow Bros.	111
Hibbard, H. & T.	111
Isaac Brothers.	111
Johnson & Son, Wm.	111
Oakley & Holmes.	111
ELECTRIC LIGHTING.	
Royson & Co., A. T.	141
London Electric Co.	1
The Keegan-Milne Co.	141
ELEVATORS.	
Ives & Co., H. R.	14V
Leach & Turnbull.	1
Miller Bros. & Toms.	xi
ENGRAVERS.	
Canadian Photo-Eng Bureau	144
Kramer, W. J.	143
Leidrow, A. B.	144
Toronto Engraving Co.	144
Wickman, James L.	144
GALVANIZED IRON WORKS.	
Douglas Bros.	v
Doug & Haines.	v
Douglas & Co., John.	v
Hedges & Lanik.	xii
Ormsby, A. B.	xii
Tucker & Dillon.	v
GRATES AND TILES.	
Earl & Co., Edward.	ix
Hotbrook & Mollington.	ix
Rice Lewis & Son.	1V
Scott & Son, Wm.	vii
Vokes, M. & J. L.	143
IRON PIPE.	
Ives & Co., H. R.	14V

HEATING.	
Burrow, Stewart & Milne.	x
Clare Bros. & Co.	v
Howard Furnace Co.	viii
King & Son, Warden.	xii
Laidlaw Mfg. Co.	141
McClary Mfg. Co.	143
Ormsby, A. B.	xii
Sellers & Co.	xii
Toronto Furnace Co.	viii
Toronto Radiator Mfg Co.	111
Waterous Engine Works.	xii
LEGAL.	
Denon & Dods.	v
METALLIC LATH.	
Clare Bros. & Co.	1V
Cockburn, I. B.	143
MINERAL WOOL.	
Gast & Atchison.	vi
Savage, R. D.	viii
MANTELS AND OVERMANTELS.	
Earl & Co., Edward.	ix
Wright & Co.	ix
Scott & Son, Wm.	vii
MONIAR COLOIDS.	
Vokes, M. & J. L.	143
ORNAMENTAL PLASTERERS.	
Baker, J. D.	ii
Hynes Terra Cotta & Brick Co.	vi
Littleford & Thorne.	ii
Whetter, Henry R.	ii
Wright, Jas.	ii
PAINTERS.	
Dill & O'Henra.	111
Dunham, Frank T.	111
Gilmor & Casey.	111
Hatch, W. J.	111
Polito, T.	143
Taylor, W. J.	111
PAINTS, VARNISHES, &C.	
Cottingham, Walter H.	1V
Muirhead, Andrew.	143
PAVING.	
Excelsior Pavement Co.	143
Forsyth, Robert.	143
Gardner & Co., A.	1V
The Colman-Hamilton Co.	143
PLASTERERS.	
Dayton, William H.	11
Fox, R. B.	11
Hynes, W. J.	11
Littleford & Thorne.	11
Mngill, E. T.	11
Watson Bros.	11
PLATE GLASS.	
Lyon, N. T.	111
McCaushind & Son.	v
Toronto Plate Glass Importing Co.	xi
PLUMBERS.	
Bennett & Wright.	141
PLUMBING SUPPLIES.	
Booth & Son.	ii
Hignano, O.	v
Malcolm, W. B.	ii
St. Johns Stone Chinaware Co.	xii
ROOFING MATERIALS.	
Canada Galvanizing & Steel Roofing Co.	143
Merchant & Co.	143
Metallic Roofing Co.	1V

TO ARCHITECTS, PLUMBERS, AND ALL PERSONS WHO HAVE PLUMBING WORK.

MALCOLM'S PATENT DEMAREST VALVE.

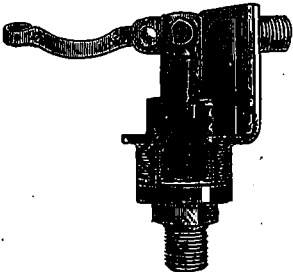

The accompanying cut represents a PATENT RUBBER SEATED VALVE, or BALL COCK. All plumbers, and quite a large proportion of the public, know that the ordinary Tank Ball Cock will leak and give trouble in a comparatively short space of time, and will require repairing. Therefore, to save expense and trouble, use MALCOLM'S PATENT RUBBER SEATED VALVE BALL COCK. Over three thousand (3,000) of them now in use, and THEY ARE GIVING UNIVERSAL SATISFACTION. It is safe to say that it will wear at least three times longer than any other Ball Cock in the Market; IN FACT, IT DOES NOT REQUIRE ANY REPAIRS.

ASK YOUR PLUMBERS FOR THEM.

A COMPLETE ASSORTMENT OF PLUMBERS' SUPPLIES ALWAYS ON HAND.

FOR PRICES AND TERMS APPLY TO

W. B. MALCOLM,

(Manufacturer and Patentee)

89 and 91 Church Street,

TORONTO.

ROOFERS.

Duthie & Sons, G. II
 Forbes, Duncan. II
 Hutson, W. D. IV
 Metallic Roofing Co. IV
 Ormsby, A. B. xii
 Rennie & Son, R. II
 Sautler, Wm. II
 Shales, John H. II
 Stewart, W. T. II
 The Furnace Roofing & Paving Co. II
 Toronto Roofing Co. II
 Williams & Co., H. II

SANITARY APPLIANCES.

Booth & Son. ii
 Earl & Co., Edward. ix
 Elliott, O. v
 Ives & Co., H. R. IV
 Malcolm, W. B. i
 St. Johns Stone Chinaware Co. xii

SEWER PIPE.

Hamilton and Toronto Sewer Pipe Co. iv
 McNally & Co., W. 144
 Maguire, William iv
 McRae & Co. iv
 Terry, Edward. iv
 The Ontario Terra Cotta Pressed Brick & Sewer Pipe Co. xi
 The Colman, Hamilton Co. 142
 Vokes, M. & J. L. 143

SINGLE STAINS.

Cabot, Samuel. x

SLIDING BLINDS.

Clatworthy, Geo. xi
 Savage, R. D. xvii

STAINED AND DECORATIVE GLASS.

Castle & Son. v
 Dominion Stained Glass Co. iv
 W. C. Barnes, Son & Gilson. iv

Elliott & Son. I
 Grimson, G. & J. E. iv
 Longhurst & Co., H. III
 Lyon, M. T. v
 McCausland & Son. iv
 Spence & Son, J. C. iv
 The Bell Art Stained Glass Works. iv

TERRA COTTA.

Morrison & Co., T. A. iii
 The Hynes Terra Cotta & Brick Co. ii
 Toronto Pressed Brick & Terra Cotta Co. ii
 The Ontario Terra Cotta, Brick & Sewer Pipe Co. xi

TERRA COTTA FIREPROOFING.

Rathbun Co. vi

WALL PAPER AND CEILING DECORATIONS.

Elliott & Son. II
 Murphy, John. 141

Ornamental Plasterers.

J. D. BAKER

Plaster and Cement,

Architectural Ornaments,

Centre Flowers, etc.

RESIDENCE: SHOP:
 38 CATHCART ST. REAR 22 UNIVERSITY ST.
 MONTREAL:



JAMES WRIGHT,
 Manufacturer of
Ornamental Plaster Work
In Queen Anne, Romanesque and other designs.
Flowers, Bosses, Enrichments, Capitals, &c.

Show Rooms and Residence:
 by Victoria Street, TORONTO.

HENRY R. WHETTER,

Manufacturer of

ORNAMENTAL PLASTER WORK

In all Architectural Styles.

FLOWERS, BOSSES, ENRICHMENTS, etc.

Show Rooms and Residence:

91 Queen Street West, TORONTO.



205 King St. West
Holbrook & Moulton
 TORONTO.

**ARCHITECTURAL SCULPTORS,
 MODELLERS, ETC.**

— DEALERS IN —

English Grates & Tiles

BOOTH & SON, Manufacturers of Plumbers' Copper & Brass Work,

155 TO 157 YORK STREET, TORONTO.

Booth's Patent Combined Bath and Wash Basin.

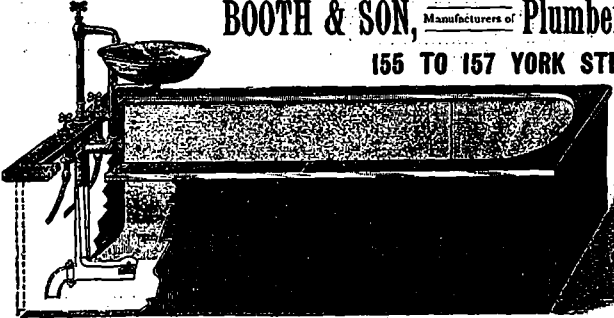

In many houses, for want of space in both room, a wash basin cannot be used. By our improvements this desideratum is supplied, fitted with hot and cold water, waste and overflow.

Some of our Specialties:
 COPPER BATH BOILERS.
 GALVANIZED IRON BOILERS.
 PLANISHED COPPER BATH TUBS.
 EARTHENWARE PLUMBERS' BRASS WORK.
 SANITARY EARTHENWARE.
 SEND FOR PRICES.

TORONTO PRESSED BRICK & TERRA COTTA CO.,

MANUFACTURERS OF

Red and Brown Plain, Moulded and Ornamental

FINE PRESSED BRICK

Large Stock always on hand.

ALL KINDS OF

ROOF TILE, RIDGING, FINIALS, &c.

RED AND BLACK MORTAR COLORS FOR SALE.

OFFICE:

62 Adelaide Street East, TORONTO.

WORKS AT MILTON, ONT.

R. C. DANCY, Managing-Director.

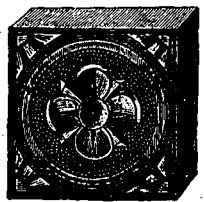
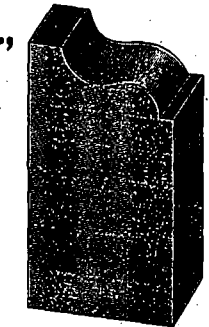
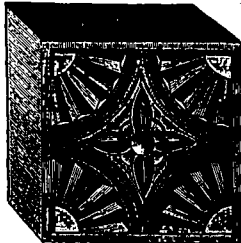

SAFFORD'S PATENT RADIATOR

FOR
HOT WATER AND STEAM HEATING.

Patented 1887.

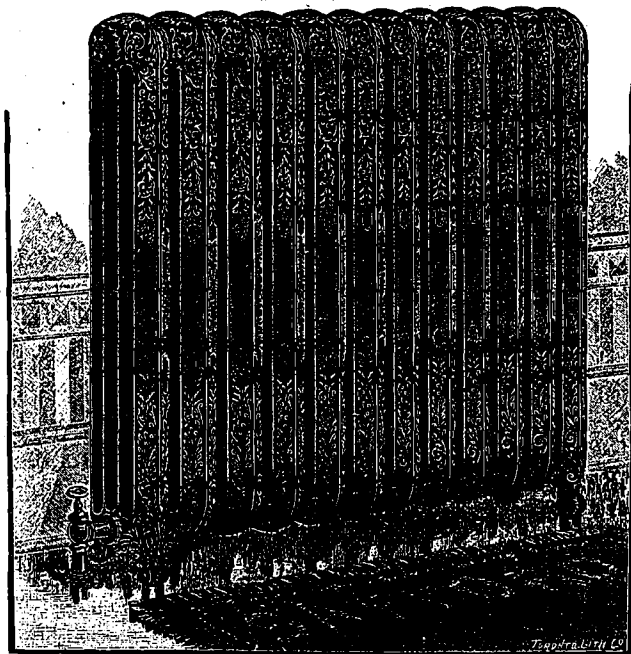

The **ONLY** Radiator in the Market
Built **WITHOUT** Bolts and Washers.

The **MOST EFFECTIVE** ever invented.

The **FIRST ORNAMENTAL** Radiator
manufactured in Canada.

No Cumbersome Base, No Bolts,
No Packed Joints.

Free, Unobstructed Circulation,
Even Castings, Nipple Connections,
Absolutely Tight and Per-
manent Joints.

OVER HALF MILLION SQUARE FEET
NOW IN USE.

BEWARE

OF

SPURIOUS IMITATIONS.

Improved Pattern—without top.



**EXAMINE FORM
OF
CONNECTION CAREFULLY**

Sizes made are :

42½, 38½, 32½, 26½, and 21½ in. high.

Send for price list and catalogue.

MANUFACTURED BY

THE TORONTO RADIATOR MFG. CO.
(LIMITED)

366 to 376 Dufferin St.,

TORONTO.

BRANCH WAREHOUSES:

80 St. Francois Xavier St., - Montreal.



*Sectional View of Hot Water Radiator Showing
Form of Connection.*

*Sectional View of Steam Radiator Showing
Form of Connection.*

HAMILTON, WINNIPEG, AND VICTORIA, B. C.

Maguire's Sewer Gas Preventive,
Flushing and Self-Cleaning Trap.

SEWER PIPE,

Chimney Tops,
Fire Brick,
Fire Clay.

PORTLAND

AND

NATIVE CEMENTS

always on hand.

LOWEST PRICES.

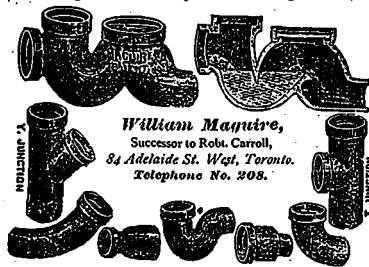

William Maguire,
Successor to Robt. Carroll,
84 Adelaide St. West, Toronto.
Telephone No. 208.

NOTICE.

Particular attention is directed to the formation and construction of the MAGUIRE TRAP. Sanitary experts, engineers, architects, plumbers and builders, after subjecting it to the severest tests, have declared it to be worthy of their unqualified approval. Leading physicians also declare that where it is used, typhoid fever, diphtheria, and other infectious diseases are much less prevalent. In the city of Toronto there is a very large and constantly increasing number of these traps being used, and in every instance they are giving perfect satisfaction.

EDWARD TERRY

DEALER IN

Portland and Queenston Cements.

PLASTER PARIS, GREY AND
WHITE LIME,

Fire Brick and Clay, Sewer Pipe, Hair,
American and Canadian Lime,
Plaster, Salt.

23 and 25 GEORGE ST.,

Telephone 164.

TORONTO.



PORTLAND CEMENT, FIRE BRICKS,

FIRE CLAY, SEWER PIPES, SEWER INVERTS.

LOWEST PRICES.

McRAE & CO.,

98 Esplanade St.,

TORONTO.

OTTAWA OFFICE: 16 METCALFE ST.

A. E. CARPENTER, Pres.

J. H. NEW, Vice-Pres.

HENRY NEW, Sec.-Treas.



THE HAMILTON AND TORONTO SEWER PIPE CO. (LIMITED)

HAMILTON, CANADA,

Successors to THE CAMPBELL SEWER PIPE CO. and the HAMILTON
SEWER PIPE CO.

— MANUFACTURERS OR —

Steam Pressed, Salt-Glazed, Vitrified

SEWER PIPE

Flue Pipes, Chimney Tops and Smoke Preventives.

ESTABLISHED 1860. We have contracts to supply the cities of Toronto, London and Hamilton.
Toronto Office and Yard: Corner Front and York Streets.

T. A. MORRISON & CO

185 St. James Street, MONTREAL.

AGENTS FOR

CONTRACTORS' SUPPLIES.

Building Brick (Ormsston, Sherbrooke, e.c.)
Pressed Brick & Terra Cotta (Ontario T. C. B.
Co.'s, Toronto),

Sewer Brick (Squa-ended Bevelled),
Calcedin Plaster, Cements, Stone, etc., etc.

CORRESPONDENCE SOLICITED.

DOMINION STAINED GLASS COMPANY

77 Richmond St. W., Toronto.

MEMORIAL WINDOWS

And every description of Church and Domestic Glass.

Designs and Estimates on application.

W. WAKEFIELD. J. HARRISON.

Telephone 1470.

HAMILTON ART STAINED GLASS WORKS

MANUFACTURERS OF

Church and Domestic Stained Glass.

LEAD GLAZING AND SAND CUT A SPECIALTY.

H. LONGHURST & CO.,

16 JOHN STREET N. HAMILTON.

G. & J. E. GRIMSON,

39 UNIVERSITY ST., MONTREAL.

STAINED, PAINTED & DECORATIVE

EMBOSSED GLASS

For Church and Domestic Purposes.

Estimates given for all work at low prices,
according to design and finish.

J. C. SPENCE & SONS,

ARTISTS IN STAINED GLASS,

ECCLESIASTICAL AND DOMESTIC.

Mural Decorations, Art Tiles, Brasses,

Church Furniture, etc.

BLEURY STREET, - MONTREAL.

Dominion Stained Glass Works

60 KING WILLIAM ST., - HAMILTON.

STAINED AND PAINTED

WINDOW GLASS

For churches, public buildings & private residences.

W. C. BARNES, SON & GILSON.

THE BELL ART STAINED GLASS WORKS

MANUFACTURERS OF

Ecclesiastic and Domestic

ART GLASS

Of Every Description.

LEAD GLAZING AND SAND CUT

A SPECIALTY.

110 RICHMOND ST. WEST,

TORONTO, ONT.

D. BELL, MANAGER.

STAINED GLASS



Memorials

Church Decorations

CASTLE & SON

40 Bloor Street, Montreal, Can., and New York.

CHARLES EVANS & CO.,
(London, Eng.)

AGENTS FOR Stained Glass, Brass Tablets, Ceramic and Venetian Glass, Mosaics, Painted Tiles.



TUCKER & DILLON,
Galvanized Iron Cornice Works.

87 Bay St., Toronto.

Valleys, Eave Troughs, Patent Expansion-conductor Pipes, Improved Draught Proof Skylights, and other Sheet-Metal Trimmings for buildings made to any Architectural Design. Furnace Work and Jobbing attended to.

HEDGES & LANKIN,

Trimmers and Galvanized Iron Cornice Workers.

GALVANIZED IRON SKYLIGHTS.

Furnaces and Registers supplied and put up on the shortest notice.
21, 23 & 25 Garden Ave., TORONTO, ONT.

Toronto Galvanized Iron Cornice Works

DOUGLAS BROS.



121 Adelaide St. West, TORONTO.
Manufacturers of Galvanized Iron Cornices. Window Caps of every description.

OTTAWA GALVANIZED IRON WORKS,

Douglas & Haines

Manufacturers of Galvanized Iron and Copper Cornices, Window Caps, Skylights, and other sheet and metal trimmings for buildings.

234 WELLINGTON STREET, OTTAWA.

JOHN DOUGLAS & CO.,

Manufacturers of

Galvanized Iron & Copper Cornices & Skylights

Window Caps of every description and all other Sheet Metal Trimmings for buildings.

395 SPADINA AVE. TORONTO.

Telephone 140.

Legal.

ANDREW DODS, Residence: 194 Dovercourt Rd.
FRANK DENTON, B. C. L., Residence: 59 Borden St.

DENTON & DODS,

Barristers, Solicitors, Notaries, etc.

10 1/2 Adelaide St. East, TORONTO.
Money to loan on buildings in course of erection.

Builders' Hardware.

SPECIALTIES:

*Hopkins and Dickinson's
Yale & Towne Mfg. Co.'s
Chicago Spring Co.'s
B. G. Tisdale's*

**BRONZE HARDWARE.
"BOWER-BARFF" GOODS.
DOUBLE ACTION SPRING HINGES.
IRON STABLE FITTINGS.**

Write for full particulars of above goods.

**AIKENHEAD & CROMBIE,
- TORONTO**

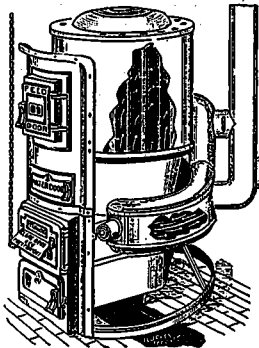

GLARE BROS. & CO.,
PRESTON, ONTARIO,

MANUFACTURERS OF

Coal and Wood

**HOT AIR FURNACES
AND REGISTERS.**

10 STYLES. 35 SIZES.

Write for Illustrated and Descriptive Catalogue of the largest variety and best Hot Air Furnaces manufactured in Canada.

HAWKE & EMES, 1290 Queen St. West,
Telephone 5043,
Sole Agents for Toronto.

MENTION THIS PAPER.

THE SANITAS WASH BASIN

Offers the following advantages:

Through it waste water is completely and rapidly removed, a quick discharge, as from a small flush-tank, effected, filling the pipes full bore, and the trap and waste pipes are thoroughly scoured. It provides

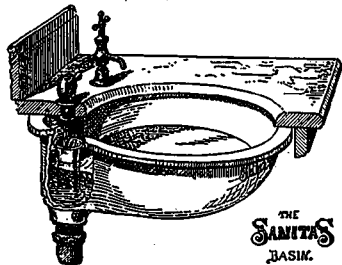

**THE
SANITAS
BASIN.**

for an overflow without requiring a special pipe or valve for this purpose; it has no brass-work in the bottom of the bowl in the way of hands when washing, and no chain and plug.

**IT IS A SIMPLE, DURABLE AND WELL-CONSTRUCTED
SANITARY PLUMBING FIXTURE.**



The Sanitas Water Closet.

SOLD BY ALL DEALERS IN PLUMBING APPLIANCES.

Manufactured by

SANITAS MANUFACTURING CO.

117 Bank Street,

OTTAWA, ONTARIO.

TELEPHONE 1035.

WORKS AND OFFICE :

Esplanade, foot of Jarvis Street, - **TORONTO.**

In Stock : TERRA COTTA BELTS, STRINGS, DIAPERS,
TERRA COTTA ROOF TILES, PANELS,
TERRA COTTA CHIMNEY POTS.

Soapstone Finish for Plastering, Plaster
Paris Centers, Plaster Paris
Brackets, Mortar
Colors, etc.

The Hynes Terra Cotta & Brick Co.

We make from details and instructions in the shortest possible time, and submit work before burning for approval or alteration, giving the architects just what they want.

CHEAPER THAN STONE.
MORE DURABLE THAN GRANITE OR METAL.

M. J. HYNES, Manager and Director.
Montreal Agents : **W. McNally & Co.**
Hamilton Agent : **W. A. Freeman.**

HAVE YOU SEEN OUR NEW

Terra Cotta Tile

For Towers, Gables and Mansards?

METALLIC ROOFING CO. OF CANADA, Ltd.

Rear 84 to 90 Yonge Street,

- **TORONTO.**

Telephone 1457.

MANUFACTURERS OF

Eastlake Metallic Shingles

- AND -

SHEET STEEL BRICK SIDING PLATES.

MINERAL WOOL

Indestructible, Fire-Proof, Sound-Proof, Frost-Proof, Vermin-Proof, Odorless

For deadening fire-proofing insulation of heat and cold in buildings,

Prevention of frost in water and gas pipes.

ALSO

FIRE-PROOF SECTIONAL COVERING (Lankin's Patent) FOR STEAM PIPES AND BOILERS

Best Non-Conductor for all surfaces, steam or fire heat; will not char, crack or burn.
Easily applied and removed by any one and endorsed by insurance companies.

For full information and samples free, address

GAST & ATCHISON,

80 Adelaide Street West.

TORONTO, ONT.

ADAMANT

is the perfection of Wall Plaster.
is not affected by frost.
is hard and will not crack.

OFFICE AND FACTORY :

100 ESPLANADE EAST,

- **TORONTO, CAN.**

Telephone 2180.

THE RATHBUN COMPANY

DESERONTO, - ONTARIO.

Manufacturers of

Porous Terra Cotta

FOR FIREPROOFING AND BUILDING PURPOSES,

*Flat and Segment Arches, Iron Girders and Column Protection,
Partitions, Roofing, Furring, &c.*

PERFECT NON-CONDUCTOR OF HEAT, COLD, NOISE.

Used in the following buildings :

- St. Lawrence Sugar Refinery, Montreal.*
- Canadian Pacific Station, " (in part).*
- Napanee, Tamworth & Quebec Station, Newburgh.*
- Barrington's Trunk Factory, Montreal.*
- Hon. G. A. Drummond's Dwelling, Montreal.*
- Bank of Commerce Building, Toronto.*

- New Post Office, Napanee.*
- Royal Insurance Co.'s Building, Montreal.*
- Imperial Fire Insurance Co.'s Building, Montreal*
- Canada Life Building, Toronto.*
- Board of Trade Building, Toronto.*

Manufacturers of all sizes and kinds of

LUMBER, LATH, SHINGLES AND TIMBER, DOORS, SASH, BLINDS, STAIRS, COUNTERS,
And all descriptions of Wooden House Building Materials.

THE NAPANEE CEMENT WORKS, (Limited.)

Napanee Mills, - Ontario,

MANUFACTURERS OF

HYDRAULIC CEMENT,

Guaranteed equal to any native Cement.

ROACH LIME, BUILDING STONE, Etc.

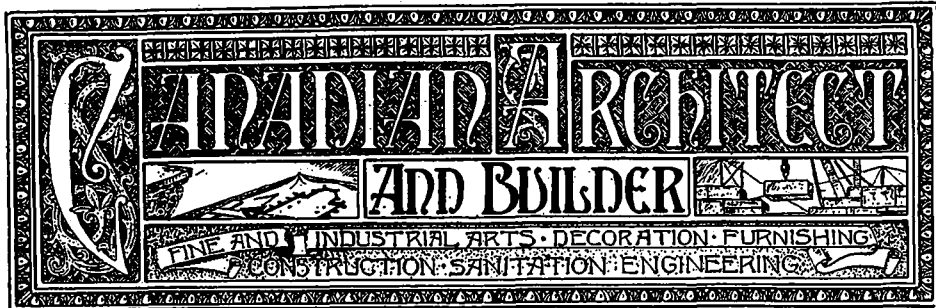

VOL. III.—No. XII. TORONTO AND MONTREAL, CANADA, DECEMBER, 1890.

(PRICE 20 CENTS
\$2.00 PER YEAR.)

—THE—
CANADIAN ARCHITECT AND BUILDER,

A Monthly Journal of Modern Constructive Methods,

(With a Weekly Intermediary Edition—The CANADIAN CONTRACT RECORD),

PUBLISHED ON THE THIRD SATURDAY IN EACH MONTH IN THE INTEREST OF ARCHITECTS, CIVIL AND SANITARY ENGINEERS, PLUMBERS, DECORATORS, BUILDERS, CONTRACTORS, AND MANUFACTURERS OF AND DEALERS IN BUILDING MATERIALS AND APPLIANCES.

C. H. MORTIMER, Publisher,

14 King Street West, - TORONTO, CANADA.
TEMPLE BUILDING, MONTREAL.

SUBSCRIPTIONS.

The CANADIAN ARCHITECT AND BUILDER will be mailed to any address in Canada or the United States for \$2.00 per year. The price to subscribers in foreign countries, is \$2.50. Subscriptions are payable in advance. The paper will be discontinued at expiration of term paid for, if so stipulated by the subscriber; but where no such understanding exists, it will be continued until instructions to discontinue are received and all arrears paid.

ADVERTISEMENTS.

Prices for advertising sent promptly on application. Orders for advertising should reach the office of publication not later than the 15th day of the month, and changes of advertisements not later than the 5th day of the month.

EDITOR'S ANNOUNCEMENTS.

Contributions of technical value to the persons in whose interests this journal is published, are cordially invited. Subscribers are also requested to forward newspaper clippings or written items of interest from their respective localities.

The "Canadian Architect and Builder" is the official paper of the Architectural Associations of Ontario and Quebec.

The publisher desires to ensure the regular and prompt delivery of this Journal to every subscriber, and requests that any cause of complaint in this particular be reported at once to the office of publication. Subscribers who may change their address should also give prompt notice of same, and in doing so, should give both the old and new address.

CLOSE OF VOL. III.

WITH the present number the CANADIAN ARCHITECT AND BUILDER completes its third yearly volume. To mark the occasion we have sought to make this number one of more than ordinary interest. The year which is about closing has been, so far as this journal is concerned, one of steady progress. The weekly intermediate edition for contractors commenced in February last, has been well received, and has been the means of substantially increasing the number of subscribers and advertisers, thus becoming one of the most important factors in the journal's success.

Our thanks are due to those architects, engineers, and others who have made it their medium of communication with contractors, and by doing so have assisted in making the paper valuable. It will take time to make this edition all that we desire it to be, but every week progress is being made, and the facilities for obtaining advance information improved. Contractors may therefore expect each issue for the new year to prove increasingly valuable.

It is the purpose to increase the number of illustrations and in other particulars to further improve the regular edition. In the short period of three years the number of illustrations has been doubled. The rate of improvement in the future must depend, as in the past, on the measure of support accorded the efforts of the publisher. Friends of the paper are requested not to lose sight of the fact that by exerting an active influence on its behalf, they can materially assist it to attain to a higher standard of excellence and value. There are various ways in which this assistance may be given, one of which is by referring to our advertising pages when requiring materials of any kind. These pages now form the most complete reference list obtainable of materials entering into architectural and engineering works, and as a rule, we believe the advertisers to be reli-

able. We have heard of an instance or two where an architect spent hours of valuable time and physical exertion in seeking to find where he might purchase certain articles which reference to the advertising department of this journal would have rendered unnecessary. We simply mention the fact in order to prevent its recurrence. Advertisers naturally desire to know that benefit has accrued to them from their advertisements. The publisher is also a partaker in this desire, since upon its fulfilment depends largely the extent of his advertising patronage. We therefore ask friends of this journal not only to make use of the advertisements appearing in it, but also in their correspondence with advertisers to mention it as the source of their information.

We fully appreciate the liberal use made of the advertising department of the paper. Commencing the new year with nearly double the number of subscribers appearing on our books at the close of 1889, we can offer advertisers in 1891 a wide and constantly widening constituency, with the benefits accruing therefrom.

We hope that increased use will be made of the columns of the CANADIAN ARCHITECT AND BUILDER for the expression of opinions on subjects coming legitimately within its scope. Finally we extend to every reader the wish for a "Merry Christmas and Happy New Year."

THE plumbing regulations of Toronto are continually being tampered with. One of the latest fads is the adoption for business premises of the New York method of placing the opening of the fresh air inlet in the sidewalk, the orifice being protected by a cast iron grating set flush with the pavement. During a recent visit to that city we examined the condition of these gratings, and found the majority of them either practically or entirely closed by accumulations of dust. Even supposing these gratings to be kept free, the constant dropping of dirt into the pipe beneath would result in the eventual stoppage at the bend, which in 99 out of 100 cases is found necessary in carrying the pipe to the connection behind the main trap. In some cases a sort of small iron sink is placed beneath the grating with the connecting pipe entering the side a couple of inches above the bottom. Even this device would soon choke up with sweepings, and in winter with snow, which, freezing, would completely block the orifice. We would a thousand times prefer the omission of the main trap than be compelled to use this unreliable device.

THE amended building ordinance of the city of Hamilton is, on the whole, a step in the right direction. The clause requiring the lodgment of plans with the Building Inspector will be the cause of considerable labor to the architect and expense to the client, if such plans, or copies thereof, are to be retained by the Inspector. The regulations limiting the proportion of the width of street which may be occupied, are good, as is also the stipulation that permission must be obtained from the occupant of adjoining premises before any material may be deposited in front of his property. The provision relating to the keeping of lights on all piles of building materials as well as excavations for drains, etc., is almost too sweeping in its nature, and, yet, considering the careless manner in which heaps of building material and rubbish are left by the workmen, it is really a necessity. The fencing in of all building operations is also a necessity. It is simply abominable to have to run the gauntlet of splashing lime, swaying lumber and dropping bricks, which is so often the experience of passers by. It would be of interest to know what are the requirements referred to as Sec. 7, Chap. 41, regarding the erection and character of the buildings. These requirements are, in most of our cities, of a very low grade and far behind the times. We were surprised the other day to find that the Toronto by-laws had been amended to prohibit wooden breast-summers at shop fronts, requiring the substitution of rolled iron. Was there ever a more stupid regulation? In the case of a serious fire the un-

protected iron beam would give way long before one of wood—in fact before the latter would have charred to the depth of half an inch. It is high time for Toronto architects to rise in a body and insist upon the enactment of sensible by-laws based on modern experience and in line with the best practice in other places.

WE would bespeak on the part of architects and students a careful perusal of the report of the late meeting of the Council of the Ontario Association of Architects, which will be found in this issue. It foreshadows a great advance in regard to the education of our future architects, and we hope every principal will loyally second the efforts of the Council, by putting before his pupils the necessity of vigorously preparing the work set before them. It is high time for architects to awake to the fact that their profession does not stand on a par with that of medicine and law in the minds of the public, and that they have no one to blame but themselves. Now is the time to go forward and repair the mistakes of the past. Education is the first need of the day, and the profession in the older countries has begun to realize the necessities of the case. Canada must not be behind, and looks to Ontario, her richest province, to lead in this matter. Students must sturdily face the fact that unless they are prepared to work and study with assiduity, to spend their five years in an earnest struggle to fit themselves for their life-work, they had better enter a bank or go behind the merchants' counter.

The Council rightly decided to recommend that the members of the Association abstain from competing for the Montreal Board of Trade. That corporation has shown, by its replies to the protests of both the Quebec and Ontario Associations, that it has little desire to secure designs from Canadian architects. These organizations represent a very large percentage of the architects of any repute in both provinces, and had the Board honestly desired to be, even in a small degree, patriotic, they would have evinced some willingness to accede to the requests of these Associations. The building cannot be erected for double the amount stated in the conditions; this amount, (\$275,000), plus 10%, has been arbitrarily fixed, and any design exceeding it in estimated cost will be strictly ruled out if the printed conditions are honestly adhered to. This, of course, would rule out all competitors, who would have had all their trouble and expense for naught, and then the Board will be open to treat with some favored "dark horse," who will be unhampered by any limitations in regard to expenditure. No one but a novice, and no one with honest intentions will enter this competition expecting to produce a design worthy of the institution for the amount named. The inference might be therefore drawn that the competitors will be composed of two classes—fools and knaves. The members of the Toronto Architectural Guild at their monthly dinner on the 11th inst., decided to act in concert with the Associations in the matter.

COMPETITION FOR CHURCH DESIGNS.

THE Presbyterian Church in Canada has determined upon making an effort to improve the architecture of its churches and with that object proposes to issue a pamphlet containing approved designs with letterpress explaining the same and also treating the question of church architecture from different points of view.

It is proposed to have a competition of designs for churches as per the list of requirements given hereafter, and to publish those designs which may meet with the approval of the experts. The plans and perspective only, with possibly one elevation will be illustrated, as it is not desirable to give sufficient drawings to allow of the design being made use of except through the author. The intention of the Committee of the Presbyterian Church which has this matter in hand is, that the author of a design which may be approved of by any congregation proposing to build shall be employed at the usual commission.

The following prizes, viz, \$75, \$50, and \$25 will be given to the three best designs in order of merit, irrespective of the class under which they may be sent in.

The excellence of a plan will consist in the closeness with which the conditions have been fulfilled, the quality of the design and the inexpensiveness of erecting the building. No limit has been made as to cost in any class, as it is desirable that the designers should not be hampered except in so far that he must bear in mind that a good design which is inexpensive is superior to an equally good or even better design which will cost more money.

The experts, three in number, will be chosen by the Council of the Ontario Association of Architects and their report will be final in the matter.

The three designs which will be awarded the prizes will be chosen from among those standing first and second in the different classes. The experts will be instructed to favour the designs for the small and inexpensive buildings in preference to those for the large and costly ones.

The drawings are to be prepared in black and white to a scale

of 8 feet to the inch. The plans and elevation in line only with windows blocked in or not as may be preferred by the designer. The perspective should be a thoroughly good drawing, and may be rendered as thought fit; but a large amount of extraneous matter should not be put in. The perspectives to be set up from a plan drawn four feet to an inch.

Bad or inferior drawings will not be illustrated, no matter how good the design may be, but an opportunity will be afforded the author to prepare or have prepared, suitable drawings.

Each competitor is requested to send in a short description of his design and to state clearly the material which he would use in its erection, together with a statement of cost. The experts will have the right to correct the estimated cost placed on any design as may appear to them just. The above statement is to be printed in the pamphlet along with the selected design together with the name of the author and his business address.

The following is a statement of the classes of buildings which are required to meet the wants of the average congregations in each of the classes in which it has been thought well to divide church buildings.

1st. Country church to seat from 150 to 200 persons, with one room to be used as vestry and library. Church to be heated with stoves.

2nd. Village church, capacity 250 to 300 persons; with one room to be used as vestry and library. Church to be heated with stoves.

3rd. Large village church, seating 350 to 400, with vestry and library. To be furnace heated.

4th. Small town church, seating 350 to 400 persons, with vestry or school room.

5th. Large town church, with seating capacity of from 500 to 600, with vestry, library, school room and kitchen.

6th. City church, seating from 600 to 1,000, with vestry, library, school room and kitchen.

7th. Large city church, seating from 1,000 to 1,300, with vestry, library, school rooms and kitchen.

In the last four clauses the designer will himself settle the method of heating and arrange same.

All designs to be sent in on or before the 14th day of March, 1891, addressed to the Registrar of the Ontario Association of Architects, Toronto.

THE QUEBEC CITY HALL.

THE largely advertised competition for the Quebec city hall culminated in the sending in of only six sets of designs—three from Quebec, and one each from Ottawa, Woodstock, and Buffalo.

This result might easily have been predicted. The conditions imposed an enormous and useless amount of labor—eighth scale plans from sub-basement to roof, the latter to show "projections of eaves, skylights, scuttles, cresting, etc., in full;" sections of every separate portion of the buildings; isometrical elevations; isometrical or aerial perspectives; complete specifications; heating apparatus, size of mains, number and area of radiators.

Fatherly advice is given upon the minutest points, even to the blind nailing of the flooring boards; and then to crown all, this complicated mass of bricks and mortar, aggregating more than 2,000,000 cubic feet, is to be built for \$200,000—less than ten cents a cubic foot—a sum insufficient for anything but the simplest commercial or residential building. We feel safe in affirming that twenty cents per foot will be found too small an allowance for the erection of a building of the character stipulated. No wonder the hundred eager applicants for copies of the conditions dwindled down to a corporal's guard.

The manner of adjudicating upon the designs is worthy of note. The designs were sent in under motto, of course, but oh, ye guileless architects, they were to be exhibited according to the conditions to the public for a week or more before the committee of adjudication began their work as assessors. The Mayor the Chairman of the Road Committee, and the City Engineer selected the jury, appointing Mr. E. Tache, of Quebec, "artist architect"; Deputy Minister Crown Lands; Mr. Victor Roy, of Montreal, "practical architect"; and Mr. H. Stavelay, architect.

The first prize was awarded Mr. Charest, Quebec; second, Porter & Son, Buffalo; and third, Mr. Peachy, Quebec. According to the newspaper report, the first prize was awarded because it seemed "to have enlisted the sympathy of the jury by coming nearest to the mark in point of probable cost," although "popular suffrage seemed to point" to another design which the jury could not go on account of the probable cost.

Here, then, is another lesson for architects. When will the members of the profession learn to have sufficient respect to ignore all invitations to compete which are not drawn up in a proper manner? The labor imposed by the conditions in this case was excessive—practically preparing drawings sufficient for reception of tenders, the value, (even reckoning on a cost of only \$200,000), being quite \$5,000—while the other two prize designs were to be retained, the premiums only being paid for them.

The result also proves how utterly useless it is to fix a limit of cost which is absurdly below what the work can be done for. In this case the jury selected the design which most nearly approx-



S. H. TOWNSEND, Secretary, Toronto.



D. B. DICK, Treasurer, Toronto.



D. EWART, OTTAWA.



JAS. BALFOUR, A.R.C.A., 3rd Vice-President, Hamilton.



Geo. DURAND, 1st Vice-President, London.



W. G. STORM, R.C.A., President, Toronto.



E. K. ARNOLD, 2nd Vice-President, Ottawa.



S. G. CURRY, Toronto.



EDMUND BURKE, Toronto.



J. E. BELCHER, Peterborough.



JOSEPH POWNE, Kingston.

ORIGINAL EXECUTIVE OFFICERS OF

ONTARIO ASSOCIATION OF ARCHITECTS.

inated the sum announced. If the jury had not been practical men, the probability is that "popular suffrage" would have selected the most showy design regardless of cost.

It is to be hoped that the establishment of Quebec's new Association of Architects will engender such an *esprit du corps* that corporations in the future will be compelled to formulate proper conditions of competition or be minus designs from competent and self-respecting architects in that province.

OUR ILLUSTRATIONS.

PROPOSED ATHLETIC CLUB HOUSE, TORONTO.—E. J. LENOX, ARCHITECT.

ROYAL VICTORIA HOSPITAL, MONTREAL.—H. SAXON SNELL & SON, ARCHITECTS, LONDON, ENG.

SEMI-DETACHED HOUSE IN NORTH STREET, TORONTO, THE PROPERTY OF MR. S. G. CURRY.—MESSRS. DARLING & CURRY, ARCHITECTS.

TORONTO ARCHITECTURAL SKETCH CLUB COMPETITION FOR "A COTTAGE BY THE SEA"—DESIGNS BY "BRINY" (MR. T. R. JOHNSON), AND "PIETRO" (MR. ERNEST WILBY), AWARDED FIRST AND SECOND POSITION RESPECTIVELY.

ONTARIO ASSOCIATION OF ARCHITECTS.

A MEETING of the Council was held in the rooms of the Toronto Architectural Sketch Club on Wednesday and Thursday, December 3rd and 4th. Present: Messrs. Arnoldi and Ewart, of Ottawa; Rastrick and Edwards, of Hamilton; Blackwell, of Peterboro', and D. B. Dick, Curry and Burke, Toronto, and the Registrar, Mr. S. H. Townsend. The President, Mr. Storm, was unavoidably absent, much to his regret, through pressure of business engagements. In his absence the Vice-President, Mr. Arnoldi, took the chair.

A large amount of important business was transacted. The Toronto members who had been appointed at the August meeting to act as a Committee on By-laws, presented a draft report. Messrs. Arnoldi and Ewart, the Committee on Education, presented a draft report of a comprehensive course of subjects to be required of students in the various examinations.

The Registrar reported that he had received 140 applications for registration, embracing almost every known person in practice in the province. After a scrutiny of the names the list was approved.

The draft by-laws of the Association were adopted after the insertion of several amendments and additions, and will be submitted to the Association for ratification or revision at the Convention to be held in February next.

The draft by-laws governing the Council of the Association were then carefully considered, and after various additions and amendments, adopted. These by-laws defined the duties of the various officers and the examiners.

The annual fee was fixed at \$15 for resident members, (that is, resident in the County of York, and City of Toronto), and \$10 for non-resident members, payable on or before the 1st of July of each year. If not paid until after this date, the fee to be \$20 and \$15 respectively. Student fees.—Upon admission as a student, \$5; filing indentures, \$1; each examination, \$1.

It was also resolved that no member of the Association shall retain in his office, any student unless he is properly registered and in good standing in the books of the Registrar.

The Registrar reported that many students had not yet registered, and stated that the probable reason was through a misunderstanding as to the date up to which applications would be received, owing to the lapse of time between the passing of the Act and the appointment of the Council. It was therefore, on motion, resolved, that students be allowed to register up to the date of the first annual convention in February; and that notice be sent to all registered architects requesting them to draw the attention of their students to such extension of time.

Mr. Curry presented a proposition made by representatives of the Presbyterian Church with regard to the issue of a publication having in view the improvement of the design of Presbyterian church edifices. It was resolved "That having heard with much pleasure this proposition, a competition, or series of competitions, be instituted under the auspices of this Association, the Council hereby approving of the object desired to be attained, and that we consent to appoint a judge or judges for these competitions.

The arrangements for the forthcoming Convention were then discussed. It was decided to omit the holding of an exhibition of drawings, with the hope that a thoroughly representative one may be held in 1892.

Messrs. Storm, Dick and Curry were appointed a Committee on Programme and Arrangements for the Convention.

Messrs. Arnoldi, Burke, Blackwell and Edwards were appointed a Committee on papers to be presented, Mr. Arnoldi being Chairman, with instructions to report to the Registrar not later than Jan. 15th.

Mr. Curry read a communication from the Secretary of the

Quebec Association regarding the proposed competition for the Board of Trade offices in that city.

The following letter to the Secretary of the Montreal Board of Trade was drafted and ordered to be sent forthwith:

GEORGE HADRIILL, ESQ., SECRETARY BOARD OF TRADE, MONTREAL.

DEAR SIR,—The Council of the Ontario Association of Architects has had under consideration the conditions of competition for the proposed Board of Trade Building in Montreal, and has decided to recommend all members of the Association to refrain from competing for the following reasons:

1st. That the board has selected six architects resident in the United States and agreed to pay them \$300 each to send in competitive designs, and has not seen fit to select six Canadian architects in like manner, but has decided to award \$300 each to the authors of the six Canadian designs placed highest in order of merit by the expert. Under such an invidious distinction the most capable architects will not compete as the competition really resolves itself into a contest for the paltry sum of \$300 and the slight possibility of obtaining the commission to erect the building. If your board had selected six Canadian architects of the highest standing, the competition would have been one between six representative architects resident in the United States, and six resident in Canada, and would have been likely to meet with a hearty response from Canadians, but under the conditions advertised the most capable architects in Canada will not compete, and the competition will really be between six firms of architects in the United States—some of them of the highest standing—and such men in Canada as are prepared to compete for the \$300, knowing that the best men in the profession in Canada are not competing.

2nd. That the amount appropriated is utterly inadequate for the erection of the building, and that any design which could be carried out for any sum near the amount named would be absolutely certain of rejection.

Very truly yours,

S. H. TOWNSEND, Registrar.

The report of the Committee on Education was taken up clause by clause, and finally adopted as follows:

Preliminary Examinations.—Candidates for admission as pupils or students in the office of a registered architect, must have passed the examination of the second form of a High School or Collegiate Institute; or, as an alternative, the entrance examination to a High School or Collegiate Institute, and an examination in mathematics and either French or German equivalent to the second form as above.

Intermediate and Final Examinations.—In addition to the preliminary examination, every student shall be required to pass three other examinations, two of which shall be intermediate and one final. The first intermediate shall be taken not less than one, and not more than two years from the time of passing the preliminary; and the second intermediate not less than one nor more than two years after passing the first intermediate. The final examination, admitting to registration as an architect may be taken at the expiration of the term of the student's indenture, or any time thereafter as he may elect.

First Intermediate.—Each candidate shall at least one month prior to the date fixed for the first intermediate examination, send to the Registrar the following drawings which must be certified as his own work:

Two sheets of the Orders of Architecture; two sheets of the Early English, Decorated and Perpendicular Periods; two examples of each period, such as a door, window or arcade—shown by plan, section and elevation; one sheet of Mouldings and Ornament, embodying examples of each of the above Periods.

The topics only of the examinations were decided upon, viz.:—Elements of Construction, History of Architecture, Mathematics, Technical Subjects, Applied Mechanics.

Second Intermediate.—Drawings under the same conditions as first intermediate;—one sheet of drawings of Ornament, freehand, from the round in outline; three sheets of drawings, measured from existing examples; one sheet Detail Construction of Roof-truss, with joints and iron work drawn to a large scale; one sheet showing construction of wooden floors, wood and iron, and iron and terra cotta; two sheets, Stone, Brick and Iron Details; two sheets, Details of Joiners' Work.

History of Architecture; Characteristics of Styles; Strength of Materials; Graphic Statics; Structural Iron Work; Mathematics; Electricity.

Final.—Set of Drawings, Details and Specifications of Building of Character to be designated, (worked out at time of examination); Nature and Properties of Materials—Limes, Cements, Stone, Brick, Timber; Foundations; Practical Knowledge of Building Trades; Heating and Ventilation; Applied Mathematics; Sanitary Science; Architectural Jurisprudence.

Honor Course (optional).—Levelling; Bills of Quantities; Acoustics; Modelling.

The members of the Council resident in Toronto were appointed a Committee to compile a list of text books required for preparation for the above examinations, and to define and add to the list of subjects as may be thought advisable.

It was decided that students may go up for the two intermediate examinations to such localities as may be designated by the Council from time to time, as may be required. The final examinations, however, to be held in all cases in Toronto. The examinations to be held in April of each year, all candidates giving one month's notice to the Registrar of their intention of presenting themselves—the fee in all cases to accompany the notice.

The Council then adjourned.

ANNUAL DINNER OF THE TORONTO ARCHITECTURAL SKETCH CLUB.

THE first annual dinner of the Toronto Architectural Sketch Club was held on Thursday evening, December 18th, in Webb's restaurant. The affair passed off very pleasantly. The chair was occupied by the President, Mr. S. C. Curry. Seated around the table were the following gentlemen: Messrs. S. H. Townsend, Frank Darling, Edmund Burke, W. S. Thomson, J. P. Murray, Samuel Jones, John Gemmill, C. H. Mortimer, A. H. Gregg, C. H. Acton Bond, A. Clarence Barrett, Harry Simpson, Herbert E. Matthews, Ernest Witby, Murray A. White, Bert Westwood, C. J. Gibson, A. F. Cuernier, R. Wilson, G. Clapperton, G. Moir, Joseph Yorke, G. Seif, J. A. Radford, Edgar B. Jarvis, F. S. Baker, J. W. Siddell, J. A. Pearson, Alf. Broadhurst, A. C. Ansell, C. J. Esad, H. Robertson, J. J. Woolnough, J. Worsley, J. G. S. Russell, T. R. Johnson, C. F. Wickson, C. J. Lennon, Henry Sprout, D. W. Kinghorn, J. J. N. Gander, Fred Armstrong, Arthur Dennis, John Ritchie, J. J. F. Brown, Geo. W. Gounilock and C. J. Gibson.

The discussion of the excellent menu engaged the full attention of the company for upwards of an hour, when the toast list was entered upon, the health of Her Majesty the Queen being followed by the singing of the National Anthem.

Mr. Curry in proposing the toast of "Canada," said he was glad to know that this toast was taking its proper place at our social gatherings. It was a right thing that they should remember always to be true to Canadians. (Applause.) He was pleased to see a great number of a great people, they must think well of themselves. There was a too prevalent idea on the part of some of our citizens to look upon Canada as an inferior place. If those people thought this a poor country, why did they stay here? Unfortunately this question had become in some respects a political one. There were to-day in Canada two parties, both of which claimed to be loyal to the country. Possibly they were. But it must be admitted that there was on the part of one or two a win for power and less for the good of our country. That should be discontinued by every true Canadian. Country should be put before party every time. He was sorry to observe that Sir Richard Cartwright spoke recently of Canada as a breeding ground to furnish men for the United States, and that he said that one million Canadians were citizens of the United States. Of course Sir Richard claimed that the National Policy was to blame for this, though that was a question not to be raised on this occasion. He believed that fewer of our people would leave Canada if they were given the opportunities they should receive. It was well enough for Sir Richard Cartwright to say that Canadians can win high positions on the other side, but it was a strange thing that if that was so they could not succeed at home. It was the old story of a prophet not without honour save in his own country. As Canadians, we should stick up for our own country. Even if there were a barren land we should be proud of it, but such a few of our people are so proud of their countries could not do this. He did not think there was a people that stood more by their country than the Scotch, and yet there were many finer lands. Who ever saw a Scotchman sneer at his country? The Scotchman loves the highlands—especially the Highlander. (Applause and laughter.) As Canadians we should be always Canadian. We should never think it a clever thing to run down our country. It might be true that we are not so progressive as some other people in some ways, and we are not so enterprising. (Applause.) Canada had shown a remarkable amount of progress. We have the best canal system in the world and the best railway system. Notwithstanding that some parties said the C. P. Railway would never earn sufficient to pay for the axle grease, the company was able to pay a dividend upon the enormous capital required to build the road. We must try to develop a national spirit. We must develop our resources. It will never do for us to be simply producers of crude material for export to other countries. We must become wealthy, but we would never become an independent people. To develop national life, we should encourage art, for the love of the beautiful had much to do with the formation of character. We should strive to be just as cultured as any people. Canada had no reason to be ashamed of her men of letters, although at one time it was declared that we could never have a national literature, and the time must come when we will occupy a high place. He asked the company to drink to the "Prosperity of Canada."

The toast was drunk with great enthusiasm, and was followed by the singing of "The Maple Leaf."

The Chairman announced that the next toast was that of the "Ontario Association of Architects." He coupled with this the name of the Secretary, Mr. S. H. Townsend. He regretted that Mr. Storm was unable to attend. He read the following reply which had been received to the invitation to the President:

"Mr. Storm regrets exceedingly that an important engagement made some days ago will deprive him of the pleasure of attending the Toronto Architectural Sketch Club supper. He desires at the same time to express his appreciation of the honour done him by the kind invitation, and to convey his best wishes for the success of the Club and the prosperity of the individual members thereof."

Mr. Townsend, replying to the toast, which had been very heartily received, thanked the company for the way they had honoured the toast and regretted that Mr. Storm was unable to be present to reply. It had been well said by Mr. Curry that as Canadians we should be proud of our country. After having seen a great deal of the world he was of opinion that Canada had reason to be proud of her architects. The best buildings in the country were the work of Canadians. (Applause.) There was a feeling among a certain class of the community that Canada could not produce architects. The buildings which this country could show were a sufficient refutation of that statement. Canadians could point to Toronto University as the work of a native which could compare favorably with anything on the continent. Many of our other buildings of less import were not inferior in architectural beauty and utility to any that could be pointed out on this continent.

Mr. Samuel Jones.—The Bank of Montreal is a Darling. (Laughter.) Mr. Townsend was glad to be able to say that Canada had the first country to recognize the architect legally and give him a standing. The Act of Incorporation did not give the architects all they desired, but enough to make a good start upon. He had no doubt that in the future they would be able to get additional legislation which would place the profession in the position it should occupy. With this in view it became the members of the profession to strive to elevate their ideas of professional honor and to train themselves for the high position they were destined to occupy. (Applause.)

The Chairman, in proposing the next toast—"Sister Societies"—welcomed the representatives of the Students' Art League who were present. He would ask Mr. Thomson, president of the League, and Mr. Jones, the secretary, to respond. The League deserved a considerable amount of praise. They were a society composed of young men who had banded

themselves together for the object of studying art and learning how to draw. This Art League was largely the outcome of Toronto's lack of an Art School. If Toronto had an Art School the Art League would never have come into existence. Fortunately, we had such a League, and it was doing a good work. It was to be regretted, however, that Toronto would soon have an efficient Art School. In the past the Art School had done more rather than good, and it was a matter of congratulation that the state of the present organization was such that it was practically dead. He wished the Art League every success.

Mr. Thomson, in responding, recognized in the Sketch Club co-workers with the Art League. They were both part of the art training system which the young men of Toronto were building up. The Sketch Club was the outcome of an idea, that was generated in the mind of a young man, and the two organizations would work together harmoniously and for their mutual benefit. The development of national feeling, as had been pointed out by the President, was a great want in this country. If it was true that Canada was supplying men to the United States it was a high compliment to this country. But why did such a state of things exist? There was very little here to keep the young men in the country. The Government did not encourage art, but gave a paltry grant of money a year to this important branch of education. To illustrate the way Canadians were appreciated abroad he mentioned the fact that a young Canadian had been sent to Europe by the architects of the World's Fair, Chicago, for the purpose of selecting the best ideas for the construction of the necessary buildings. It was a mistake for the Government not to educate the people to appreciate art. Let them do this and encourage national feeling and the young men would not be compelled to go abroad.

Mr. Samuel Jones said that if the Architectural Sketch Club sprang from the Art Students' League the babe had become bigger than its father. This was another example of the national vitality of the Canadian character and of its ability to "get there." There was in this country a better element to work upon than in the United States or the old land. He was sorry that politicians were more inclined to copy the evils of the old world than to copy the good. He was glad to see a young man who was so proud of the future that was in store for art. Out of evil comes good, and out of the want of an Art School had sprung these two organizations. It should not be long before they should join their forces and see that there is established in this city a Government Art School worthy of the name. In the coming contest with the authorities to re-establish the school upon a proper basis lovers of art look with confidence for the assistance of the Architectural Sketch Club. The students of the school should be given the good material to work upon, it is necessary to success that we should obey the economic laws. There was no use breeding architects or painters if the public taste for their work was not cultivated. It was a lasting disgrace that in a civilized community like this art was at so low an ebb. A young man would not stop in Canada even from patriotic motives when by going abroad his work was better appreciated and he received better pay for it. There must be a change in the mind of our students. They must be inspired to go out as missionaries among the plutocratic aristocrats and to see that Here in Toronto the best pictures were sold at too low a figure. The highest class of pictures were sold at a much less profit than the worst class. The people pretended to want art—they simply wanted art pretence. They would rather pay three-quarters of a dollar for veneer than one dollar for solid mahogany. He was more than shocked at what was called the civilization of our country. He was sure that in the future the men of letters were spending in a fevered haste in trying to scrape into their own pockets some few dollars. He was glad to know that the women were taking an interest in art, and warned the architects that they would have to look to their laurels as the other sex would be invading their sphere. (Applause.)

The Chairman then invited the company to fill their glasses and drink to the "Building Interests."

Mr. Jones, in responding assured those present that the builders were not so bad a set as some people would make them out to be. They were feeling entertained by a few that the builders were little better than rogues, and that they must be well looked after all the time. He thought that was not quite true.

A voice.—The builders are bricks.

Mr. Moir had found from an experience of 20 years that when a builder did right he would be sure to meet with the architects. He was glad to be able to say that nearly all the finer structures in the city were the work of native builders. Contractors were glad to do good work when the architects supplied good designs, which the architects, of course, always did. The Builders' Society had tried to secure the adoption of a new form of tender, but they had not succeeded very well so far. Some firms would agree to the proposal, but others would not. He hoped that eventually they would arrive at an agreement. From the intellectual faces he saw around him he was sure that the architects of the future would not be inferior to those of the present.

Mr. John Ritchie also replied by singing "Jack's Yarn." Mr. Joseph York said that the labour question often gave the builders a great deal of trouble. Sometimes a hibernian difficulty often led to great pecuniary loss. He would like to see an uniform tender adopted that would be satisfactory to all. The buildings of Toronto were very favorably with those he had seen anywhere else. He hoped that as time went on Canadians would have more money to expend on buildings.

The Chairman said that as to the quality of buildings in Toronto he believed it was superior to that of any city on the continent. The average building in Toronto was a great deal better than the average building in any city in the United States. Look at the Auditorium in Chicago and you will find it a crooked old croaker. The buildings of New York across a ten acre field. Even in the Library at Boston there were defects. It was astonishing that expensive buildings in the United States were finished in such a rough and ready way. The builders of Toronto were deserving of a great deal of credit, and the responsible builders were desirous of giving full return for every cent they received. They were not all like this. He met one builder who told him that it was the architect's business to see that you builded and he worked, and the builder's business to see that he did not. (Laughter.) He did not believe in that. If the architect was to be turned into a detective, it would make the work very expensive. The contractor in the present state of the labor market had a difficult task. It was well enough to say when workmen were dissatisfied, "get others," but that simply meant to get others just as bad.

The Chairman then proposed the toast of "Our Guests," and called upon Mr. P. Murray to reply.

Mr. Murray said he was glad that the architects were taking an interest in art. The object of the present gathering was that they might do some interior decoration. (Laughter.) He had been glad to hear the patriotic remarks of the Chairman. He was proud of being a Canadian—an Irish Canadian and a British Canadian. He thought architects would do well to see that sky windows were made so that they could be more easily handled



W. A. EDWARDS, Hamilton, Ont.



F. J. RASTICK, Hamilton, Ont.



WM. BLACKWELL, Peterborough, Ont.

MEMBERS OF COUNCIL OF THE ONTARIO ASSOCIATION OF ARCHITECTS,
APPOINTED BY THE PROVINCIAL GOVERNMENT.



C. Clift, Secretary, Montreal.



A. T. Taylor, F.R.I.B.A., R.C.A., Montreal.



J. F. Peachy, Quebec.



W. E. Doran, Treasurer, Montreal.



F. X. Berlinguet, 1st Vice-President, Montreal.



J. W. Hopkins, R.C.A., President, Montreal.



Victor Roy, 2nd Vice-President, Montreal.



A. C. Hutchinson, R.C.A., Montreal.



M. Perrault, Montreal.



A. F. Dunlop, R.C.A., Montreal.



ALPH. RAZA, Montreal.

ORIGINAL EXECUTIVE OFFICERS OF THE PROVINCE OF QUEBEC ASSOCIATION OF ARCHITECTS.

for ventilation purposes. The placing of windows was an important matter. Looking at the Board of Trade buildings he noticed that some of the windows had been placed in such a way as to detract from the utility of the building. Another important matter he desired to draw attention to was the building of stairways. So narrow had the stairs of the Bank of Commerce been made that the other day a portly customer was unable to ascend them and the manager had to be called down to see him. (Laughter).

The Chairman proposed the toast of "The Ladies," and called upon Mr. A. Clarence Barrett. Mr. Barrett in a few well chosen remarks passed an eulogium on the fair sex which drew forth much applause. The Chairman said the next toast was that of the CANADIAN ARCHITECT AND BUILDER. This paper was a benefit that few could properly estimate. In the past it had done exceedingly well considering the field that is open for it in Canada. Of course there were people who said the paper should be this, or should be that, but these people who were freest with advice gave it the least substantial assistance. THE CANADIAN ARCHITECT AND BUILDER compared very favorably with the architectural papers of England and the United States when they were of similar age, and the time would come when it would rank with any publication of the kind in the world.

The toast was drunk with enthusiasm, the company singing "For it's a jolly good journal" to the tune of "He's a jolly good fellow."

Mr. C. H. Mortimer in replying thanked those present for the kind and hearty manner in which the CANADIAN ARCHITECT AND BUILDER had been referred to.

The toast to "The Press" was responded to by Mr. J. A. Radford. The company dispersed after singing "Auld Lang Syne."

During the evening an excellent musical programme was rendered. Mr. J. J. Woolnough presided at the piano. The programme was as follows: Instrumental duet, "The Last Chord"—Messrs. J. Worsley and J. J. Woolnough; Song, "The Gray Hussar"—Mr. Herbert E. Matthews; Song, "Our Architectural World"—Messrs. W. H. B. E. and J. A. Radford; Recitation, "The Street Minstrel"—Mr. J. A. Pearson; Song, "The Fishing Excursion"—Mr. J. Worsley; Song, "In Sweet September"—Mr. E. B. Lucas; Song, "He's in the Asylum Now"—Mr. J. J. Woolnough; Song, "She Was"—Mr. H. Simpson; Song, "A Freshening Breeze"—Mr. George Self.

INCEPTION AND PROGRESS OF THE ONTARIO ASSOCIATION OF ARCHITECTS.

ON the third day of October, 1887, nine architects of the City of Toronto met in Mr. W. G. Storm's office and determined to form a society with the object of advancing the interests of architecture, and to bring about a better feeling between the members of the profession. The attempt had been made before with some degree of success, but owing to a number of causes the society then formed died a natural death in its infancy, leaving behind little or nothing to keep its memory green—except a few debts which were liquidated by the officers without any assistance from the members. But the society formed on the third of Oct., 1887, has had a very different course, as it is in a most active condition at the present date, after an existence of more than three years. In proof that it is in active working order, we may say that it has twenty-four members in good standing and a cash balance of nearly \$750.

It is not, however, of the Toronto Architectural Guild that we desire to speak, but of the formation and existence of the Ontario Association of Architects. On the 8th of Nov., 1888, the members of the Toronto Architectural Guild made their first move to form a permanent Association by appointing the following committee, viz.: Messrs. D. B. Dick, Strickland, Burke, Lennox, Storm, Townsend, Langton, Darling, Langley, Gordon and the Secretary (Curry), to prepare and submit a scheme to the Guild.

As the result of the Guild's efforts, the Ontario Association of Architects was formed on March 21st, 1889, at the Queen's Hotel, Toronto. About sixty members of the profession attended from all parts of the province, who, with but one or two exceptions, became active members of the Association.

After the meeting had been properly organized, it took into consideration the By-laws which had been prepared by a special committee, and passed them with some slight changes. The next business was the election of officers, who were as follows: W. G. Storm, Toronto, President; Geo. Durand, London, first Vice-President; E. King Arnoldi, Ottawa, second Vice-President; and Jas. Balfour, Hamilton, third Vice-President. S. H. Townsend, Toronto, was elected Secretary, and D. B. Dick, Toronto, Treasurer. The following members were elected to the Council: Edmund Burke, Toronto; J. Belcher, Peterborough; Jos. Power, Kingston; Mulligan, Hamilton, and S. G. Curry, Toronto.

In the evening the visitors were entertained at dinner at the Queen's by the members of the Toronto Architectural Guild, and there was formed an Association of Architects which in the short period of one year was to become the first incorporated Association of Architects in the world.

During the summer months of 1889 the membership of the Association increased to ninety members. In Nov. of that year the first annual convention was held in the Canadian Institute building, Toronto. The convention was in every way a success, the exhibition of drawings being very much superior to what was expected. At this meeting it was determined to apply to the Legislative Assembly of Ontario for an Act of Incorporation. A draft of the proposed Act was submitted and adopted, and nothing more could be done until the meeting of the Ontario Legislature. On the evening of the last day of the convention the visiting members were entertained at dinner by the Toronto members at Harry Webb's restaurant. One of the toasts of the

evening was "Success to the proposed Act of Incorporation," but while many drank to the toast, by far the greater number looked upon the attempt to secure incorporation as a forlorn hope. The Act was submitted to the Ontario Legislature at its last session and became law, but only after many changes had been made in the wording. The Government had deemed the measure of such public importance that it had made it a Government Bill. Some opposition was made to the Bill by members of the profession who were afraid that it might injure them in some undefinable manner. To what extent this opposition affected the Bill it is hard to say, as the Committee were not aware at the time that there was any opposition to the passing of an Act of such great advantage to the profession in its desire for advancement. After some delay on the part of the Government the Council was gazetted. The members are Messrs. W. G. Storm, F. J. Rastrick and D. B. Dick for three years; King Arnoldi, W. A. Edwards and David Ewart for two years; and Edmund Burke, Wm. Blackwell and S. G. Curry for one year. The names of the old Council which had been elected by the Association were given to the Government from which to select the new Council, but of the number they only appointed six, selecting the balance of three from among the members of the Association. The Council met and organized according to the proclamation, and did such business as was possible on the occasion of their first meeting. A second meeting was held by the Council on December 30 and 31st. At this meeting draft by-laws for the Association and Council were considered. The qualifications necessary for enrollment as a student were also settled, as well as the examinations which he would be required to pass before he can become a properly qualified member of the Association. Another meeting of the Council will be necessary before the annual meeting in February to give the final touches to the above measures.

The first annual meeting of the incorporated society will take place on the third Tuesday in February, when a very full attendance of the members is expected. The success of the Association is assured if ordinary care is observed in electing suitable men on the Council. Let us hope that the members of the Association will have its interests sufficiently at heart to select capable and energetic men to this position.

"CANADIAN ARCHITECT AND BUILDER" COMPETITION FOR A CITY HOUSE.

THE publisher of the CANADIAN ARCHITECT AND BUILDER invites competitive designs for a city house to cost not more than \$4,000. The house is to be erected by a young architect having an income of about \$2,000 per annum and a family of three young children. The house is to be placed on the south side of the street. The lot is 30 feet wide and the houses on either side are built up to within 2½ feet of the dividing line. They are at a uniform distance of 15 feet from the street line, and 55 feet deep including wing, and of the same class as the one in competition.

In judging the designs the disposition of the various rooms with regard to convenience and especially direct sunlight will be taken into consideration. Good lighting will receive higher marks than good elevations, i.e., a good plan having poor elevations, compared with a good elevation set up from a poor plan.

The city by-laws will not permit of wooden construction below level of first floor, while above that it must be either plastered or tiled.

The heating will be by hot air and position of registers should be indicated.

Each competitor will be required to give a concise description of his design, stating the materials he proposes should be used in its construction. The first premium will be \$15; second \$5; third one year's subscription to CANADIAN ARCHITECT AND BUILDER. A premium of \$5 will also be given for the best perspective seen in.

Drawings must be made on sheets of heavy white paper or bristol board 14 x 20 inches in size, and must be drawn sufficiently coarse to allow of their being enlarged to twice the size. No color or wash work will be allowed. Each drawing must be marked with the *nom de plume* of its author, and the author's name, *nom de plume* and full address, enclosed in sealed envelope, must accompany each drawing sent in.

Drawings must reach the office of the CANADIAN ARCHITECT AND BUILDER, 14 King street west, Toronto, not later than the 5th day of February next.

The right is reserved of publishing any design sent in. All designs will be returned to their authors within a reasonable time after the competition is decided.

The decision as to the respective merits of the designs submitted will be made by a committee appointed by the Architectural Guild of Toronto.

All architects practicing in cities are debarred from this competition.

We regret to announce the death in England of Mr. A. D. Steele, late of Hutchinson & Steele, architects, Montreal. Mr. Steele gave up business in Canada a short time since under the orders of his doctor and started for England, hoping to regain his health. Mr. Steele was very highly thought of in Montreal, being a quiet unassuming gentleman, and his many friends will regret to hear of his sudden demise.

Fireproofing having become a necessity it is very gratifying to note Canadian enterprises of the kind in the industries of the Dominion. Co. of the province, Ont. We refer particularly to their porous terra cotta fireproofing and hollow tile. This industry has been in existence about two years, and we learn that besides many others the following prominent buildings have used their fireproofing: Bank of Commerce, Toronto; Board of Trade, Toronto; Canada Life Building, Toronto; The Biological Library, Toronto; The Printing Bureau, Ottawa; The Royal Insurance Building, Montreal; The Sun Insurance Building, Montreal; The Canadian Pacific Window Street Station, Montreal, (in part); The St. Lawrence Sugar Refinery, Montreal; The Telephone Building, Montreal; The Kingston, Napanee & Western Railroad Stations; G. A. Drummond's Residence, Montreal, (in part); Napanee Post Office, Ontario; The Nickel Wing of the Kingston Hospital.

CANADIAN BUILDING STONES.

THE following report prepared by a Committee of the Quebec Association of Architects on the nature of the building stones in what is known as the Lake St. John District, will no doubt prove of interest and value to Canadian architects and builders :

To the "Province of Quebec Association of Architects," and all whom it may concern :

The undersigned, at the instance of the Quebec Local Association of Architects, have the honor to make the following report on the quarries now open on the Quebec and Lake St. John Railway line; the said quarries having been visited at the invitation of the Railway Company, on the 13th and 14th inst., in company with other architects, stone cutters and others.

1. The first quarry visited and called "Bourg-Louis" quarry, is situated at half mile distance on this side of the station of that name, and thirty miles and a half from Quebec. It was opened last summer by M. Ignace Bilodeau, who is also the proprietor. A number of bridge piers and culverts have been constructed in its neighborhood with stone extracted from it. All the stone paving of Damourges hill in this city has been drawn from there since. Although opened for a comparatively short time, the appearance at present are that this quarry will furnish a very fine building stone. The predominating colors in it are the red, blue and light grey, which blending together, produce sometimes a good effect.

2. The second quarry is situated at a distance of one mile from the Riviere a Pierre station, which is itself at 58 miles distance from Quebec. It is on the slopes of a mountain and a few arpents only from the main road. It was opened by M. Frs. Parent during the course of last summer, but it is owned by M. Voyer. We find there some layers of stone of above three feet in thickness and very regular, which could furnish material for smooth columns and other stones of large dimensions. The stone is coarse grained, of a grayish color admixed with red, and presents a brilliant surface owing to the feldspath which it contains; the effect is very fine.

3. About one-third of a mile further from this quarry, and on the same mountain slope, we find the quarry owned by M. Frs. Parent, which was opened by him only a few weeks ago. The stone from this quarry has all the qualities which characterize its neighbors. It is being employed at present in the construction of a house for the Hon. Chas. Langelier at the corner of Grande-Allee and Conroy streets. The string courses dividing the stories will probably be polished, as the stone gives every indication of lending itself well to the process. Stone from this quarry and the previous one has been used in the facings of Chevalier Baillarge's house on St. Louis street (on the site of the old Montgomery house) and the adjoining one owned by M. Hoop, nevertheless the eye cannot detect any difference in the appearance of the two stones, a fact which proves their identity. As the quarry is situated at a certain distance from the railway line, the company will construct a siding to facilitate transport.

4. At half a mile distance from Miquick river station, and at 74 1/2 miles from Quebec, we find M. Bolanger's quarry, which is being worked for a couple of years past. We can obtain here stones of very large dimensions, which the proprietor uses in the construction of monuments and constructions of all kinds; it can be easily polished and cut in any form. The Carrier

Beaucourt monument erected on the shore of Lairet river in 1889 is from that quarry, also the heavy copings and pillars around the Court House in this city. This stone is spotted with black and bluish-gray, and has a very fine appearance.

5. Further on, and at a distance of 178 1/2 miles from Quebec and 11 miles from Chambord station, on the littoral of Lake St. John on the Chicoutimi and St. Alphonse embankment we arrive at the quarry owned by M. H. J. Boemer, the constructor of the Quebec and Lake St. John railway line. As in the case of the Bourg-Louis and Miquick quarries, this one is close to the railway line, and can consequently be easily and cheaply worked. The stone is calcareous and is stratified, as are all sedimentary stones; the thickness of the beds varies from one to two feet. As this stone can be extracted in large blocks, it is found very advantageous for the construction of bridge piers and other similar works, when stones of large dimensions are required. Its color is of a bluish gray, with a very fine grain and a texture better suited to rock work than to finely cut faces. The masonry work of the bridges on the St. Charles river at Lorette and that of Riviere des Merces is from this quarry; a fact which proves the superiority of the

stone in construction of that kind, since the contractors have gone to such a great distance to obtain it.

6. At Roberval, at a distance of 120 miles from Quebec, and also near the shore of Lake St. John, we find there other quarries of a calcareous nature, similar to the Chambord quarry, but of a finer and more homogeneous grain, which renders this stone more fitted to finely cut work than the others. One of these quarries is at a distance of about 4 miles on this side of Roberval station and is owned by a M. Ouellet. The stone cornices and window and door trimmings of the Ursulines Church are from this quarry. The other two quarries are at a few arpents distance only from Roberval station and near the railway station; one of these belongs to M. Ephrem Brassard and the other to M. Membrin. All the stone which was employed in the construction of the Ursulines Convent at Roberval comes from these two quarries.

7. A fine quarry of granite (gneiss) of a reddish color is seen at about 4 miles distance of Roberval in a cut made for the passage of the railway; this quarry is not worked, but by the appearance of the stone we cannot but think that it would furnish a

fine building stone. At many other points on the railway line, where cuts have been made for the passage, can be seen further indications of a good stone for constructing purposes and street paving. With the exception of M. Boemer's quarry at Chambord, and those of Roberval, which are all of a calcareous nature, the other quarries mentioned are of granite (gneiss) formed by the agglomeration of three minerals: feldspath, mica and quartz.

As already referred to, the granite show varied tints, but the proportion of the three minerals not being the same in each, it follows that the stone in some quarries is much harder than that of the others, according to the greater or less proportion of quartz contained in each kind. Notwithstanding this fact, all these granites can be cut with ease and give a fine polish. Their great durability renders their adoption most advantageous, in spite of their being a little more expensive to cut than lime stones, and as the means of extracting and transporting them are not costly it is clear that we should prefer them to lime stone; they also possess a greater variety and richness of colors.

The calcareous quarries of Chambord and Roberval furnish a stone of an earthy texture, coarse grained and of a rough surface when broken. The

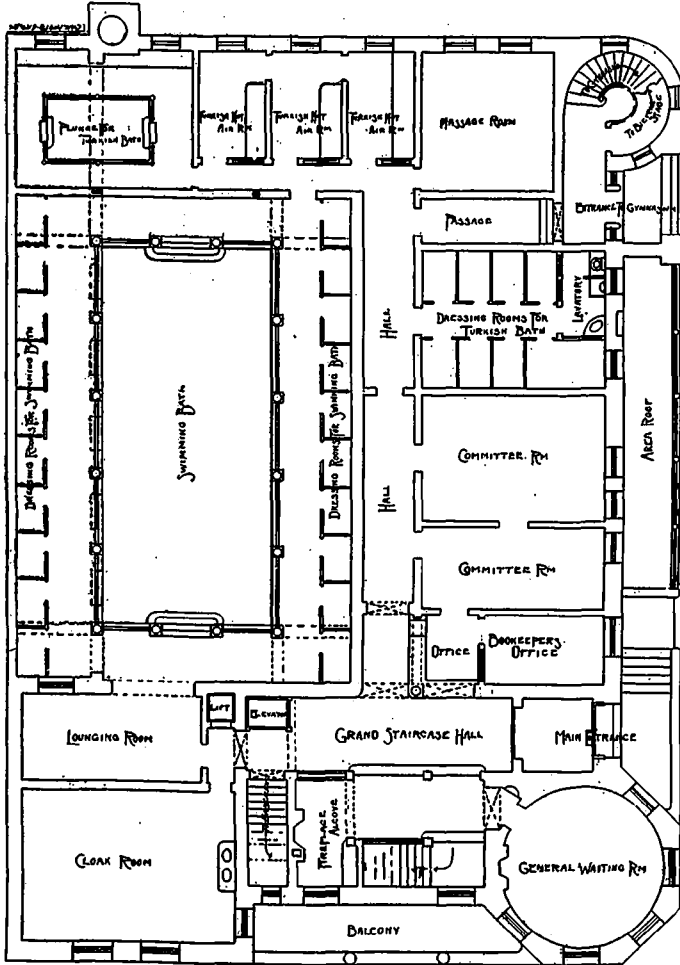

PLAN OF PROPOSED ATHLETIC CLUB BUILDING, TORONTO.

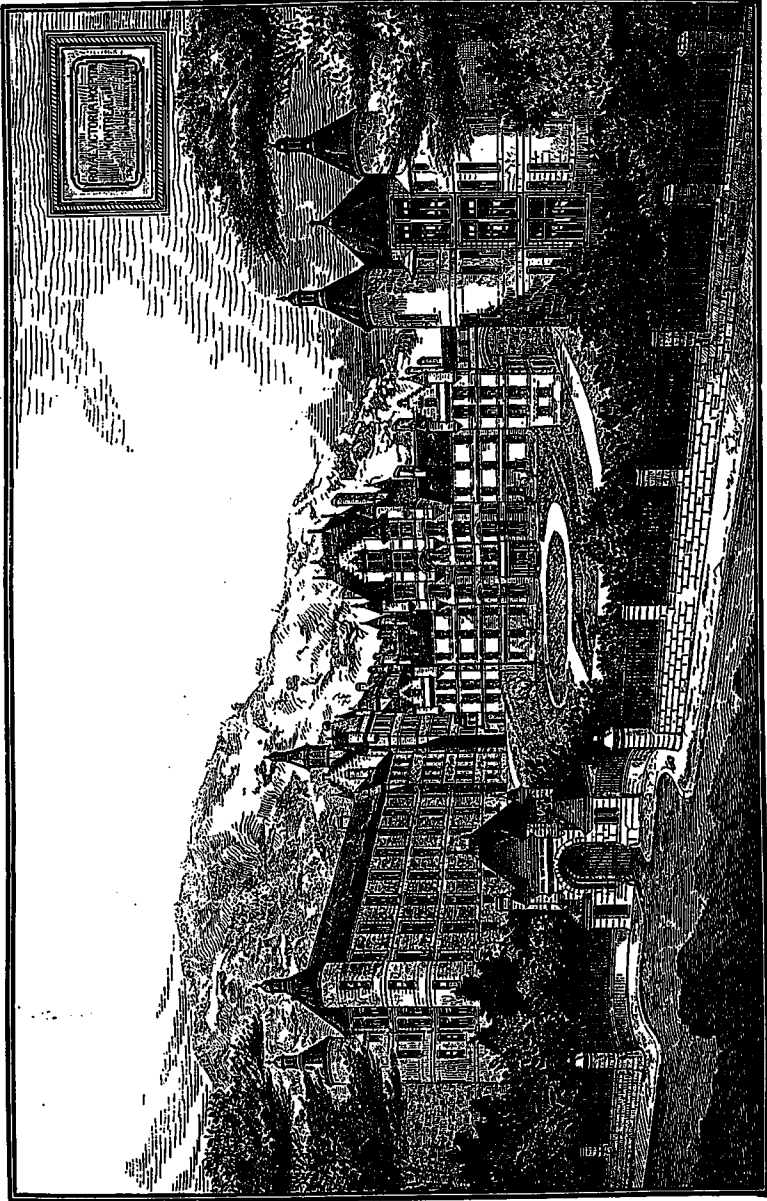

ROYAL VICTORIA HOSPITAL, MONTREAL.
H. SAXON, SNELL & SON, ARCHITECTS, LONDON, ENG.

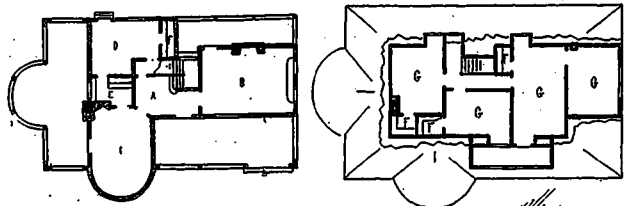

- A. Hall
- B. Sitting Room
- C. Dining Room
- D. Kitchen
- E. Pantry
- F. Cops & Clo
- G. Bed Rooms

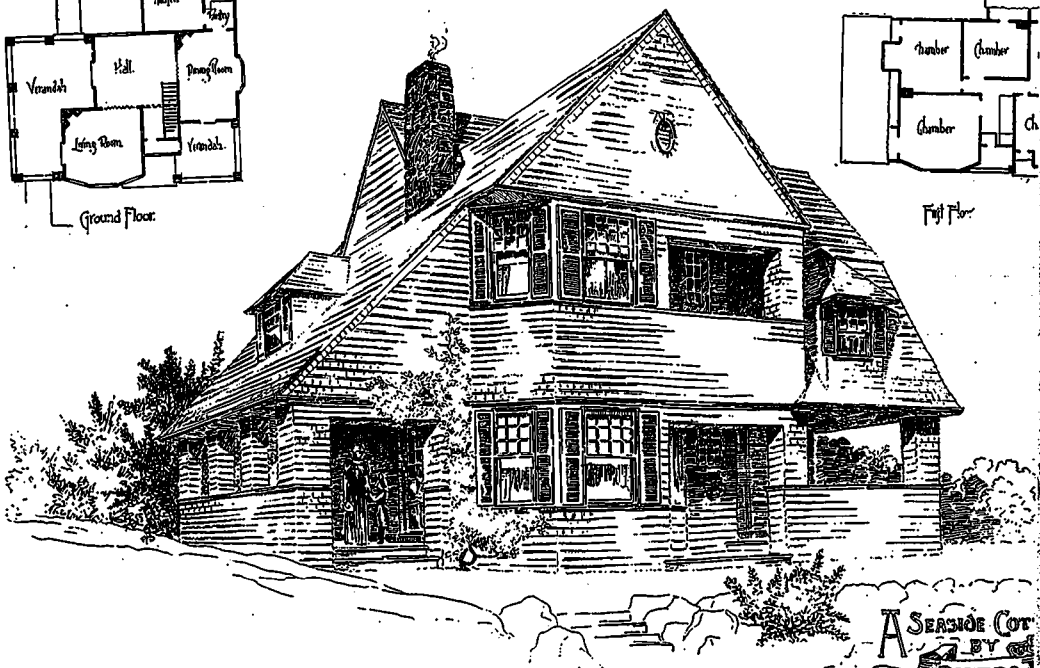
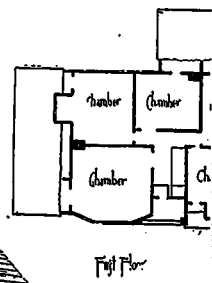
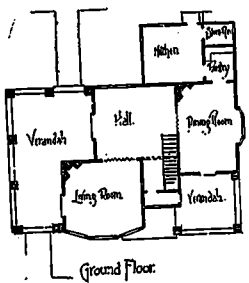

A SEASIDE COTTAGE
BY
PIETRO

TORONTO ARCHITECTURAL SKETCH CLUB COMPETITION FOR
"A COTTAGE BY THE SEA."

DESIGNS BY "BRINY" (MR. T. R. JOHNSON), AND "PIETRO" (MR. ERNEST WILBY), AWARDED FIRST AND SECOND POSITION RESPECTIVELY.

color of the stone varies from a blue to a deep gray; that of Chambord specially unites many qualities of a good free stone.

In concluding this report, we would suggest to the Province of Quebec Association of Architects the formation of a collection of stones not only from Lake St. John region, but also from the quarries of the Maritime Provinces and the Dominion in general.

Signed,

CHS. BAILLARGE.
F. H. BERLINOUEY.
D. OUKLEET.

ST. GEORGE'S PATENT VITRIFIED TILE SECTIONAL SEWER.

THE following particulars relate to inventions of Mr. St. George, City Surveyor of Montreal, to be used on the construction of sewers; and for which patents have recently been granted in the United States and Canada:

The invention has for its object to produce a sewer which shall be more

this another section of the same depth flat at the top to receive the open mounted gully, which is made from any depth from nine inches upwards to suit the depth of the watercourse, forming a part of the sidewalk. A manhole cover is formed in it, which is keyed to prevent its being tampered with. Through this manhole cover men can descend to clean out the cess-pit, or it can be cleaned by means of scoops. The whole gully is four feet six inches deep from the watercourse level to the bottom of the cess-pit. The advantages over a brick gully are that the material is imperishable and is easily built and handled.

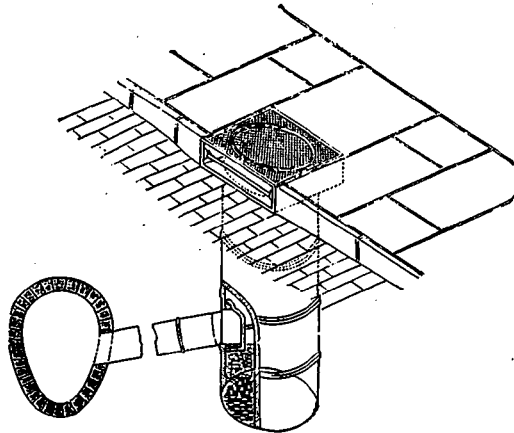

The following tables of comparative cost will be of interest:

Portland cement, 2 bbls., at \$3.00	\$6.00
Labor, 7 days, at \$1.25	8.75
Carter, 2 days, at \$2.00	4.00
Bricklayer, 2 days, at \$3.50	7.00
Bricks, bevelled, 750, at \$11.00 per 1,000	8.62
Bricks, squares, 250, at \$10.00 per 1,000	2.50
Sand, 1 cartload	.75
Bottom stone for foundation, 20 ft. at 2 cents	4.00
Grate stone	3.60
Iron grating	7.00
Cast iron Shedd's trap	1.50
Total cost	\$53.72

Cast iron pipe in sections, 1,100 lbs., at 2 cents per lb.	\$22.00
Labor in setting and digging, 6 days at \$1.25	7.50
Carter, 1 day, at \$2.00	2.00
Cast iron Shedd's trap	1.50
Royalty	5.00
Total cost	\$38.00

Or a difference in cost of say \$14.00 in favor of the iron gully. It is presumed that the cast iron will last for at least twenty years as against the four or five years service of the brick, added to which is its improved appearance and the fact of its being perfectly watertight.

The following cities have them in use: Montreal, Quebec, Toronto, Ottawa, St. Henry, St. Cunegonde, Cote St. Louis, Cote St. Antoine, Owen Sound, Peterboro'.

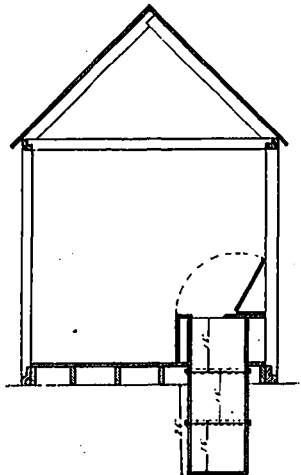

This gully can also be used for cess-pools, as shown in cut.

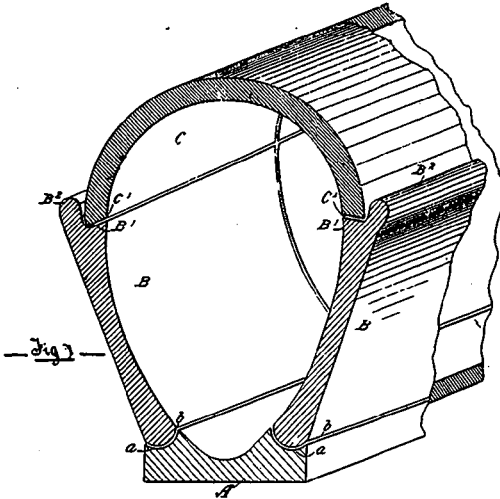

easily constructed and more durable than those now built up in brickwork, and have its constituent parts more easily handled and set in place than lengths of complete cross sections of such conduits, and be strongest at the points at which most resistance must be offered to the pressure of the earth.

The sewer is composed of oval cross sections of four pieces, viz., the invert, the two curved sides and the top—all these breaking joint at their longitudinal junctions. The invert is flat at the bottom, and has the screw-backs formed by its upper edges followed for the reception of the curved edges of the sections forming the sides, which at their junction with the invert are given such increased strength and thickness as will prevent the pressure of the earth from breaking them in. These sides have their top edges slightly sloping outward, and affording with a flange formed on each side section and projecting outward and above them, a continuous socket joint to receive the top arch, the edges of which correspond to the tops of the side sections, thereby protecting the branch or springing of the arch, i. e., the point at which it is weakest, and especially so against external pressure. When any connection is to be made, such as a house drain with the sewer, one of the side sections (having formed in it an opening, which will serve either for a right or left junction, and a rim formed round it by the thickening of the substance of which the sewer is composed), may be substituted for a side piece of the ordinary type.

The vitrified tile will be from 2 to 2½ inches thick, and will cost about from \$4.50 to \$5 per lineal yard.

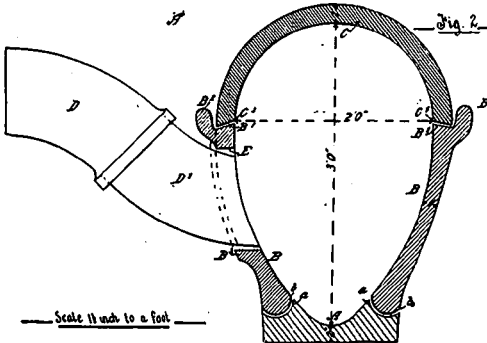

St. George's patent cast iron street gully is made of cast iron, circular in form, twenty-four inches in diameter and upwards, the bottom section having a fin bottom, eighteen inches deep. Upon this is another section flanged with the sewer connection cast in it, also the same depth, and upon

QUERIES AND ANSWERS.

DEC. 6, 1890.

Editor CANADIAN ARCHITECT AND BUILDER.

SIR,—Will you allow me to ask you a question about house planning? The November issue of your journal contains a view with plan attached of a villa at St. Hyacinthe, P.Q. Do you think it is a good thing to have a toilet room with a water closet and bath in it placed in the centre of the house, opening only out of the reception room—apparently one of the best rooms in the house. The architects do not show how this closet and bath are to be lighted or ventilated. It can hardly be from the roof, as the roof over it is the highest part of the building. There is a borrowed light from the kitchen, but I should think it was not advisable to ventilate a water closet only into a kitchen.

One other point strikes me. The bath is so enclosed behind the w. c. partition that a bather can get in only at one-half of the bath, and this bathroom is lighted by a borrowed light into the reception room. There are many students who would like to know more about this plan than is shown here. Perhaps the architects would give us some particulars?

Yours, etc.,

"JUNIOR."

TORONTO ARCHITECTURAL SKETCH CLUB.

A WELL-ATTENDED meeting of this club took place on Tuesday evening, Nov. 25th, when an instructive paper on "Mouldings" was read by Mr. R. W. Gambier-Bousfield, A.R.I.B.A. To make his paper more consistent, Mr. Bousfield had prepared a number of diagrams showing the formation and tracing the development of mouldings in the various styles. At the close of the paper a hearty vote of thanks was tendered the lecturer for the amount of time and labor he had given the subject.

Mr. Frank Darling then criticized the competitive drawings for "A Cottage by the Sea," pointing out the merits and defects of each design in such a way that many useful points were obtained by those present. He thinks that a verandah, instead of running narrowly round the greater part of a building, should be of less length and wider; it would then give more room for persons to sit in groups without impeding traffic, would be useful for open air meals, and in every way more suitable for a summer cottage. The desirability of keeping the kitchen as separate as possible from the main building was emphasized, also the need of having some access to the kitchen otherwise than

through dining-room. This is one of the most successful competitions the club has had, twenty very creditable designs being sent in. The authors of the three best designs are as follows: First place, T. R. Johnson; second, Ernest Wilby; third, Chas. Lennox. A noticeable feature in the competition was a design sent in by an amateur member of the Club.

The subject of the next competition is "A Window in Some Distinctive Style"; size of openings 9 ft. x 12 ft.; drawings to be sent in by Jan. 24, 1891.

On Tuesday, the 9th inst., the Club met at the Public Library, and by the courtesy of Mr. Bain, examined the architectural and other art books contained in the reference department.

The reading class, conducted by Mr. S. G. Curry, which meets every Monday evening, has started with a very good attendance. Clark's Building Superintendence is the first book taken up, and it is proposed to work conjointly therewith on D. C. Berg's "Safe Building."

PUBLICATIONS.

Canada's illustrated paper, the Dominion Illustrated, is greatly improved under its new management. The Christmas Number, kindly sent us by the publishers, is of a high character in point of letterpress and illustration, and as a purely Canadian production, does credit to the country as well as to the enterprise of the publishers.

The Christmas edition of the Cosmopolitan Magazine is one hundred thousand copies. The order, as originally given to the printers, was for 85,000 copies, but while on the press it was thought advisable to increase the number to 100,000. It contains a feature never attempted before by any magazine, consisting of 123 cartoons from the brush of Dan Beard, the now famous artist, who did such wonderful illustrations in Mark Twain's book, "The Yankee at the Court of King Arthur."

To Mr. James Acton, the publisher of the Canadian Shoe and Leather Journal, is due the credit of having produced the largest and handsomest special number of a trade journal ever published in Canada. In addition to upwards of 200 pages of letter press and engravings of the principal Canadian cities, leading leather manufactures, wholesale and retail shoe stores, etc., it contains more than one hundred portraits of representative men in the trade throughout Canada. The typography throughout, as well as the many-colored lithographed covers in which it is enclosed, is of a high order. The extensive advertising patronage bestowed upon this number speaks well for the enterprise of the Canadian shoe and leather trades, who evidently have discovered that in judicious advertising is to be found one of the most important secrets of business success.

Mr. Jos. R. Kilburn, architect, Stratford, Ont., a member of the Ontario Association of Architects, died on December 7th of pleurisy after two days' illness.

FOR SALE.

TILES, SCAFFOLD POLES, TIES, TELEGRAPH POLES AND BILL TIMBER. Will contract now and deliver on opening of navigation.

KIRKWOOD & MCKINNON,
Sedbury, Ontario.

BOOKS ON BUILDING

AND THE ALLIED ARTS.

LATEST PUBLICATIONS:

Palliser's Court Houses, City Halls, Jails, &c.,

Palliser's Common Sense School Architecture,

Specifications and Contract Blanks, Etc.

Full Descriptive Lists mailed on application; also of all American and Foreign Building Journals with club rates.

PALLISER, PALLISER & CO.,

24 East 42nd St.,

NEW YORK.

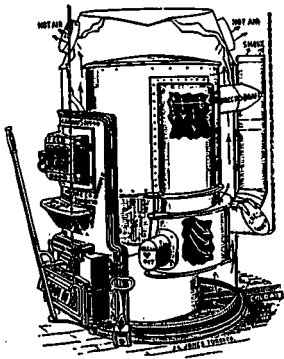

Hot Air Furnaces

Coal or Wood; Cast Iron or Steel Domes.

56 VARIETIES.

Quick, Powerful and Economical;
Full guarantee of Construction, Detail and Operation.

Examine our Steel Dome Low Radiator (shown in cut) for price and capability before closing contracts—it will pay.

Write for prices and catalogue.

McCLARY MFG. CO.

London, Toronto, Montreal, Winnipeg.

OFFICE SPECIALTY MANUFACTURING CO.

118 BAY STREET, TORONTO,

— DEAL IN —

Superior Office Desks

And School Desks

— AND —

FURNITURE.

INTERIOR VAULT FITTINGS IN METAL

METAL ROLLER BOOK SHELVES.

SHANNON LETTER AND BILL FILES - DOCUMENT FILES
BEED CASES - CABINETS OF FILES - ROLLER
COPIERS - SCHLICHT INDEXES, ETC.

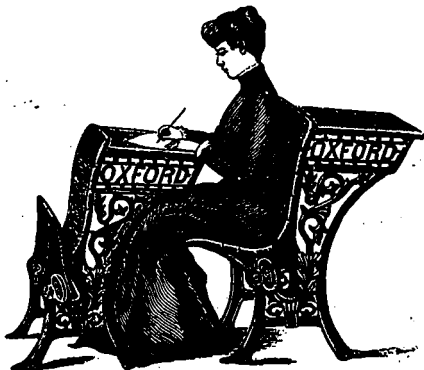

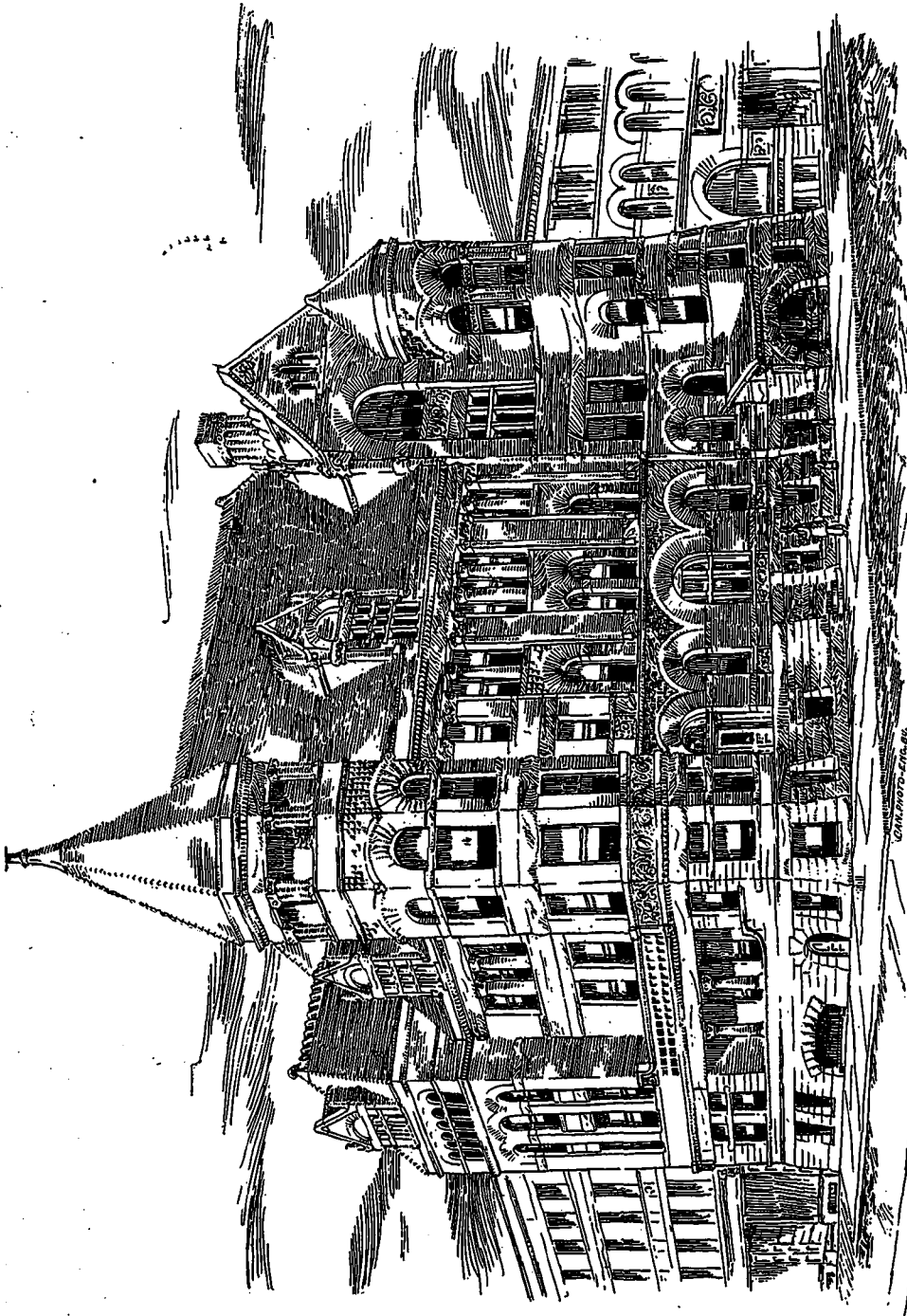

PROPOSED ATHLETIC CLUB HOUSE, TORONTO
E. J. LENOX, ARCHITECT.

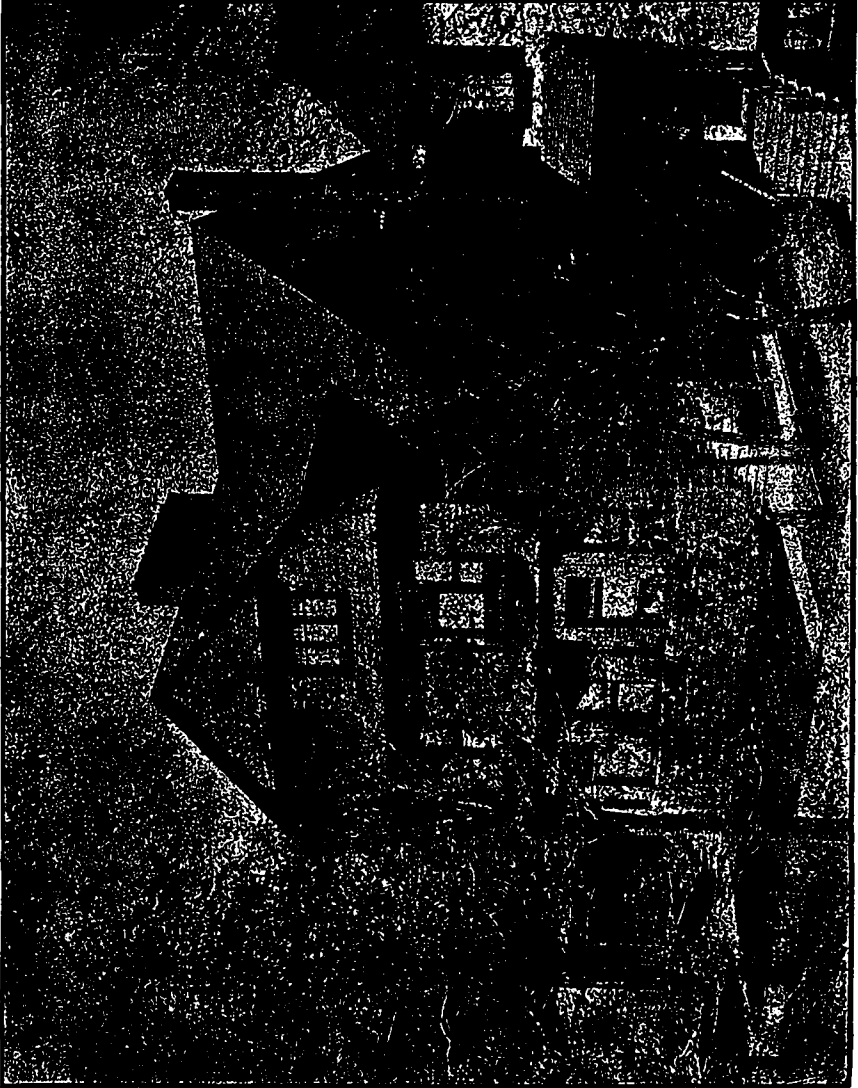

SEMI-DETACHED DOUBLE HOUSE IN NORTH STREET, TORONTO, THE PROPERTY OF MR. S. G. CURRY.
MESSRS. DARLING & CURRY, ARCHITECTS.

QUEBEC ARCHITECTS.

J. W. Hopkins, R.C.A. E. C. Hopkins.
J. W. & E. C. HOPKINS,
Architects and Valuators,
 145 St. James Street, MONTREAL.
 Bell Telephone 959. Federal Telephone 375.

F. X. BERLINQUET,
Architect and Valuator,
 201 St. John Street, QUEBEC.

Victor Roy. L. Z. Gauthier.
ROY & GAUTHIER,
Architects and Valuators,
 180 St. James Street, MONTREAL.
 Bell Telephone 2758.

CHRIS. CLIFF,
Architect and Valuator,
 180 St. James Street, MONTREAL.
 Bell Telephone 1956.

W. E. DORAN,
Architect and Valuator,
 85 St. James Street, MONTREAL.
 Bell Telephone 1799. Federal Telephone 157.

A. C. HUTCHISON, R.C.A.,
Architect and Valuator,
 181 St. James Street, MONTREAL.
 Bell Telephone 898.

A. F. DUNLOP, R.C.A.,
Architect and Valuator,
 162 St. James Street, MONTREAL.
 Federal Telephone 904.

A. RAZA,
Architect and Valuator,
 3 Place D'Armes Hill, MONTREAL.
 Bell Telephone 961.

M. Perrault. A. Mesnard.
PERRAULT & MESNARD,
ARCHITECTS
 11 & 17 Place D'Armes Hill, MONTREAL.
 Bell Telephone 696. Federal Telephone 138.

A. T. Taylor, F.R.I.B.A. R.C.A. C. H. Gordon, London.
TAYLOR & GORDON,
ARCHITECTS
 Union Buildings, 43 ST. FRANCOIS XAVIER ST.
 Bell Telephone 2817.

J. F. PEACHY,
Architect and Valuator,
 444 St. John Street, QUEBEC.

J. NELSON, A.R.C.A.,
Architect and Valuator,
 1724 Notre Dame Street, MONTREAL.
 Federal Telephone 380.

JOHN JAMES BROWNE,
Architect and Valuator,
 207 St. James Street, MONTREAL.

J. B. RESTHER & SON,
ARCHITECTS
Offices: Imperial Building, MONTREAL.
 107 St. James St., Telephone 1800.

WM. T. THOMAS,
ARCHITECT
 204 St. James Street, MONTREAL.

A. G. Fowler. J. H. Bowe.
FOWLER & BOWE,
Architects and Valuators,
 198 St. James Street, MONTREAL.
 Bell Telephone 2654.

Theo. Daoust. Arthur Gendron.
DAOUST & GENDRON,
ARCHITECTS
 99 St. James Street, MONTREAL.
 Bell Telephone 2540.

ROBERT FINDLAY,
Architect and Valuator,
 New York Life Bldg, 11 Place d'Armes, MONTREAL.
 Bell Telephone 2557.

J. H. BERNARD,
Architect and Valuator,
 Imperial Building, St. James Street, MONTREAL.
 Bell Telephone 2788.

W. H. HODSON,
Architect and Valuator,
 45 1/2 St. Antoine Street, MONTREAL.

WRIGHT & SON,
ARCHITECTS
 Mechanics' Institute Building, (Room 23) MONTREAL.

G. de G. Languedoc. J. Haynes.
LANGUEDOC & HAYNES,
Architects and Civil Engineers,
 Offices: 162 St. James Street, MONTREAL.
 Bell Telephone No. 1793.

J. A. P. BULMAN,
Architect and Valuator,
 156 St. James Street, MONTREAL.

SIMON LESAGE,
Architect and Civil Engineer,
 17 Place d'Armes Hill, MONTREAL.
 Bell Telephone 1869.

J. A. Chausse. E. Mesnard.
CHAUSSE & MESNARD,
ARCHITECTS
 77 ST. JAMES STREET, MONTREAL.
 Bell Telephone 2545.

H. STAVELEY,
ARCHITECT
 113 St. Peter Street, QUEBEC.

E. COLONNA,
ARCHITECT
 246 1/2 St. Catherine St., MONTREAL.

The following letter speaks for itself:
 Office of W. A. Freeman,
 HAMPTON, ONT., Nov. 5th, 1890.

ADAMANT MFG. CO., Toronto, Ont.
 GENTLEMEN,—I have much pleasure in giving my views of the Adamant Wall Plaster, which I used lately in my office and show room. It is far superior to the ordinary lime and sand mortar that has been formerly used:
 1st. That the building can be plastered and completed without the men leaving the job on account of drying.
 2nd. The carpenters can go in next day and finish their work as they did in this case.
 3rd. On account of its strength to adhere to any substance. My ceiling is a long span; put machinery on floor over ceiling three days after it was put on, which jars the whole building. It has been running now for some time, and up to the present there is no appearance of cracks or imperfection whatever—in fact, I would not have the old style mortar put on my building if it was put on for nothing.
 Yours truly,
 W. A. FREEMAN.

WALL PAPERS
 FROM
THE BEST MAKERS IN AMERICA, ENGLAND AND FRANCE.
 A large variety, most carefully selected, for sale by
JOHN MURPHY,
 2301 ST. CATHERINE ST., MONTREAL.

JOBBERS IN ALL KINDS OF ROOFING MATERIALS.

CANADA GALVANIZING & STEEL ROOFING CO.
 MANUFACTURERS OF
CORRUGATED IRON ROOFING,
SIDING, CEILING ETC.
 OFFICE AND WORKS 22 LAOUR ST., MONTREAL, QUE.

ELEVATOR AND BRICK SHINGLES.

M. & J. L. VOKES
 Vitrified, Salt Glazed SEWER PIPE
 Portland & Native CEMENTS · DRAIN TILES
 MORTAR COLORS · BUILDERS SUPPLIES ·
 ALL SHADES A SPECIALTY
 HARDWARE MERCHANTS
 TORONTO
 111 YONGE ST. CORNER ADELAIDE ST.

THE CROMPTON SYSTEM

INCANDESCENT AND ARC ELECTRIC LIGHTING, OF ENGLAND.

This system is acknowledged by all the impartial experts to be the best in the world. For isolated Plants or Central Stations there are none superior. Cost is very low.

General Agents in Canada:

THE KEEGANS-MILNE CO., MONTREAL.

INTERIOR WIRING A SPECIALTY. WRITE FOR ESTIMATES.

WARDEN KING & SON

Craig Street Foundry, MONTREAL,

32 Front Street West, TORONTO,

Manufacturers of

SPENCE PATENT HOT WATER BOILER



THE "DAISY,"

The Leading Hot Water Boiler of this continent. 5,000 in use. Send for testimonials and prices.

Manufacturers and Sole Agents in Canada for

THE NEW YORK Safety Dumb Waiter (STORM'S PATENT)

This Waiter is very favorably known in the United States; it is the most complete thing of the kind, being also cheap, substantial and durable. No house should be without one. Descriptive pamphlet sent on application.

MANUFACTURERS ALSO OF
Soil and Greenhouse Pipes and Fittings,
Steam and Hot Water Fittings,

Stable Fittings,
Plumbers' Wares,

Columns, Girders,
Circular and Straight Iron Stairs,
And all kinds of House and Machinery Castings.

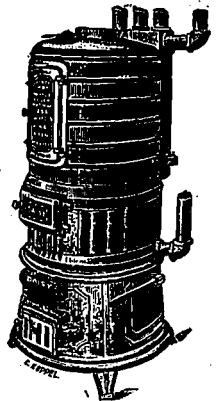

The "Daisy"

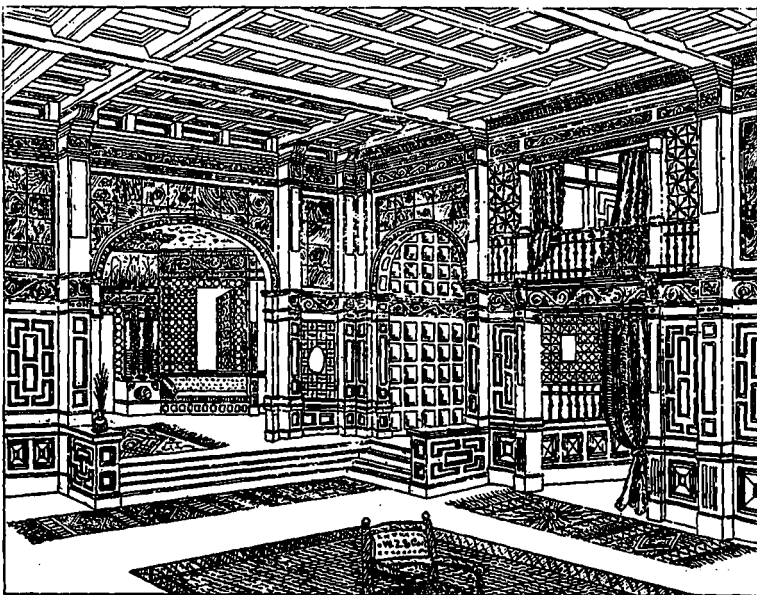

Dominion Emporium

FOR

INTERIOR

ART

WOODWORK

AND

ARCHITECTURAL

WOOD-CARVING.

Wagner,

Zeidler

& Co.,

West Toronto Junction.

Estimates given for Constructive Carpentry where Interior Woodwork and Carpentry are let together.



Importer and Dealer in
**Paints, Dry Colors, Varnishes, Chamolis
Skins, Glues, Bronze Powders
and General Manufac-
turers' Supplies.**

Agent for Samuel Cabot, Boston, U. S., Interior
and Exterior Creosote Stains and Mosaic Colors; and
for Lewis Berger & Sons' (Ltd.) Celebrated Carriage
and House Painters' Varnishes, London, Eng.

ANDREW MUIRHEAD,
82 BAY STREET TORONTO, ONT.

T. B. COCKBURN,
PATENT FLAT WIRE LATHING
64 Canada Street, Hamilton, Ont.

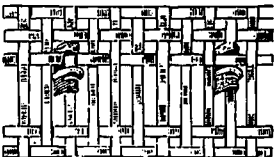

ARCHITECTS AND CONTRACTORS:
Gentlemen: I take this opportunity of bringing to your
notice my Flat Wire Lathing, for which patents have
been issued in the United States and Canada. The ob-
ject of the patent is to provide a light, yet substantial
Fire-proof Lathing, which offers a smooth, unbroken
surface for the reception of plaster, and on which the
plaster will key securely. Being made of flat wire, it
offers the best plastering surface of any wire lathing.
The key is an absolute certainty and is obtained by the
plaster turning over the edge of the wire; this will be
found invaluable in the plastering of ceilings. Its many
advantages over Round Wire Lathing are apparent.
An adjustable foot made of sheet metal, having two
hooks, is attached to the lathing and takes the place of
furring. By means of these feet the lathing can be
fixed in position at one-half the cost of lathing requiring
furring. After the cloth is woven the feet may be at-
tached in any position required. The cloth may be used
in either plain or with the adjustable foot as shown in
cut.

The Canadian Office & School Furniture Co., (Ltd.)

PRESTON, - - - - - ONTARIO.

(Successors to W. Stahlsehmidt & Co.)

MANUFACTURERS OF

Office, School, Church and Lodge

FURNITURE

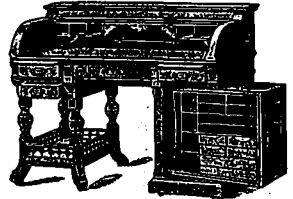

OFFICE DESK No. 54.

SEND FOR CATALOGUE.

THE "PERFECT AUTOMATIC" SCHOOL DESK.

GEO. F. BOSTWICK, REPRESENTATIVE

24 West Front Street.

TORONTO.

ROYAL UNION RADIATOR

Steam or Hot Water.

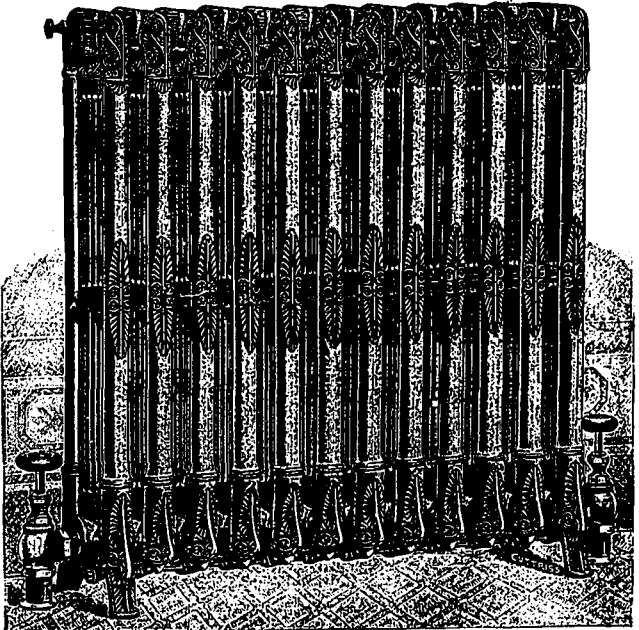

The only Radiator without SCREW nipples and packed joints.

The neatest and most artistic. The best circulating.

The only Radiator that has nipple connections without gaskets or other decaying material, and NOT OVER RATED in measurement.

LIDLAW MANUFACTURING CO., LIMITED,
HAMILTON, ONT.

If you are BUILDING

Write us for a copy of our book on
"A TIN ROOF,"

AND OUR

FORMULÆ,

Containing full information about this roofing; showing how to cover, lay and paint; and how to specify for a tin roof in order to obtain best results.

Either or both Pamphlets sent free of cost.

If your building needs ventilation, or you are troubled from downward draughts in your chimney, write us for information relative to our

STAR * VENTILATOR

MERCHANT & CO.

Philadelphia, New York, Chicago, London.



PHOTO-ENGRAVING

By the Latest Methods.

HALF-TONE

Direct from Photos a Specialty.

CUTS

For Newspapers, Magazines, Books, Catalogues, and all advertising purposes, made with promptness and despatch.

REPRODUCTIONS

Guaranteed as good as copy.

Samples and prices on application.

The Canadian Photo Engraving Bureau

203 YONGE ST., - TORONTO.

MOORE & ALEXANDER, Proprietors. TELEPHONE 2158.

At The Half-Tone Portraits accompanying this issue of the ARCHITECT AND BUILDER are a sample of our work.

PHOTO ENGRAVING
PROCESS WORK
 REPRESENTING
 PHOTO ENGRAVINGS, WOOD CUTS,
 STIPPLE LITHO, LITHOGRAPH &
 STEEL ENGRAVINGS, MANUSCRIPT
 PLANS & MAPS, FINE BOOK WORK
 & NEWS-PAPER ILLUSTRATIONS,
 BY

J. J. LISIENAN,
 DESIGNER &
 WOOD ENGRAVER
 156
 ST. JAMES ST.
 MONTREAL.

A. D. BARRY,
Consulting, Civil and Mechanical Engineer,
 22 LEXTER LANE, TORONTO.

I beg leave to inform you that I am prepared to supply Plans and Estimates for all descriptions of Structural Iron and Steel Work, Engines and Boilers, Girders, Roofs, Bridges, &c.; and also to inspect same during or after erection. Having had long practical experience both in the manufacture, erection, and inspection of this class of work, I trust to be favored with your confidence. Masters in arbitration, valuation of machinery and plant, and adjustment of fire losses, will receive special attention.

Please mention the CANADIAN ARCHITECT AND BUILDER when corresponding with advertisers.

PLATES BY EVERY PROCESS SUITABLE FOR ILLUSTRATIVE PURPOSES
 REDUCED REPRODUCTIONS OF CUTS FOR
 BOOKS, CATALOGUES, FACSIMILES FROM
 DESIGN SKETCHES, DIAGRAMS, &c.

TORONTO ENGRAVING CO.
 DESIGNERS & ENGRAVERS
 53 KING ST. WEST @ TORONTO
 CORN. KING & BAY STS.

R. LAIDLAW
 ENGRAVER,
 68 KING ST. WEST, HAMILTON, ONT.
Photo Engraving in Line and Half Tone.

A. T. ANDERSON & CO.,
 CONTRACTORS FOR ALL KINDS OF
ELECTRICAL and GENERAL MACHINERY
 Electric Light, Electric Motors, Telephone, Telegraph Plants, etc.
 FIRST-RATE WORK GUARANTEED.
Write for estimates. Agents undertaken.
 OFFICES: ELGIN CHAMBERS,
 75 Adelaide St. East, TORONTO.
 P. O. Box 388.

Toronto,
 Peterboro',
 Montreal.

JOHN WHITFIELD,

174 and 176 Front Street East,

SUPPLIES ALL KINDS OF

IRON AND STEEL WORK

FOR BUILDERS, &c.

Telephone No. 2009.

Architectural Sculptors and Carvers.

W. STIVENS HICKS,

Architectural Sculptor and Modeller,

13 RICHMOND ST. EAST, TORONTO.

All kinds of Stone and Wood Carving.

YOUNG & COLLINS,

Architectural Carvers and Modellers.

SHOP:

154 Richmond Street West, TORONTO.

Residence: 102 Manning Avenue.

**F. B. GULLETT,
SCULPTOR,**

112 Church Street, TORONTO.

Estimates given for GRANITE COLUMNS, PILASTERS,
MONUMENTS AND VAULTS, polished and hammered.
ALL KINDS OF BUILDING WORK.

B. H. CARNOFSKY,

Interior Cabinet Decorations

And all kinds of Furniture made to order.

CHURCH WORK A SPECIALTY.

128 & 130 ONTARIO ST., KINGSTON.

FREDERICK TURNER,

—) Architectural (—

STONE CARVER AND MODELLER.

WOOD CARVER.

10 Rebecca St. (near James), HAMILTON.

WM. R. JOHNSTON & SON,

Architectural

Stone Carvers and Modellers.

Wood Carvers.

161 Borden Street, TORONTO.

**THOS. MOWBRAY,
ARCHITECTURAL SCULPTOR**

In Stone and Wood,



SUCH AS

Altars, Fonts, ♦

♦ Reredos, Pulpits,

Together with general architectural work for public and private buildings.

Christian Art

A SPECIALTY.

ADDRESS:

YONGE ST. ARCADE, TORONTO.

J. WRIGHT

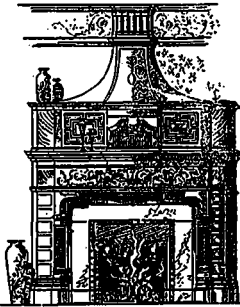

F. WRIGHT.

J. SYCAMORE.

WRIGHT & CO.

Designers, Carvers,

—) AND (—

**Art Furniture
MANUFACTURERS.**

*Mantel Pieces and Eclectic Furniture
a specialty*

DESIGNS AND ESTIMATES SUPPLIED.

64, 66 and 68 Grange Ave.,
TORONTO.

A large stock always on hand.

HARDWOOD MANTELPieces.

W. SCOTT & SONS,

MONTREAL.

— MANUFACTURERS OF —

MANTELPieces & FINE FURNITURE

A large stock of English Grates and Tiles, Open Fireplaces, etc.

FINE ART DEALERS AND GILDERS.

1739 NOTRE DAME ST.,

MONTREAL.



21 MELINDA ST. TORONTO-ONT.

TORONTO FURNACE CO.

8 & 10 Queen St. East, TORONTO.

TELEPHONE, 1907.

Manufacturers of

"The Celebrated Novelty"

HOT WATER & AIR COMBINATION

AND

STEEL PLATE HOT AIR FURNACES

Steel Ranges. Hot Air Registers.

NEWEST! CHEAPEST! BEST

Write for Catalogue and Estimates.

Headquarters for Construction, Building and
Jobbing Castings. Column Gratings,
Sash-weights, etc., etc.

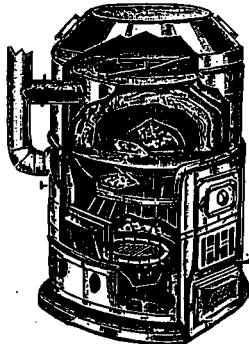

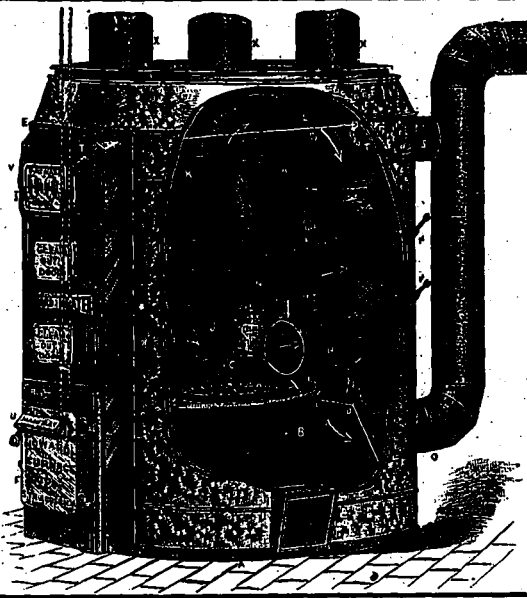

THE CELEBRATED Howard Furnaces

Successful beyond all precedent. Every heater fully guaranteed. Dealers protected in the sale of "Howard Furnaces."

DEALERS:

Here is the Furnace you want. Low down, all Cast Iron, simple in parts and thoroughly original. Easy to "set up" and a good seller.

WRITE FOR TERMS, PRICE LIST AND CATALOGUE.

Telling points of superiority. Scientific Construction. Entire Utilization of Fuel. Correct Material. Actual Economy.

THE HOWARD FURNACE CO. OF BERLIN,
(Ltd.)

BERLIN, ONT.

AND SYRACUSE, N. Y.

EXCELSIOR PAVEMENT CO.

Sidewalks, Carriage Drives, Corridors, Landings, Steps,

MALT, CELLAR & STABLE FLOORS, VASES.

Estimates given promptly on application.

Office, 299 College Street, TORONTO.

TELEPHONE 1199.

T. J. WHITTARD, Superintendent.

J. WATSON, Manager.

STUART'S

Patent Granolithic

SIDEWALKS, FLOORS, STEPS, LANDINGS, CORRIDORS, AREAS AND STABLES.
No building perfect without Granolithic Footpaths. It has stood the test of years and climates.

IMPERIAL STONEWARE LAUNDRY TUBS
Are without parallel the finest and most complete in the market. Guaranteed perfect.
Building Granite, Granite Facing, Blocks, Polished Granite of every kind, Monumental Work. Marble for Interiors, Plumbings, Furniture, Cemetery, or any purpose, and of all kinds of Marble in the market.

Send for Estimates. **ROBERT FORSYTH,**
MONTREAL: 130 Bleury St. TORONTO: 14 Toronto Arcade.

Builders' and Contractors' Supplies

PORTLAND CEMENTS,
ROMAN CEMENTS,
KEENE'S CEMENT,
(Coarse, Parian and Superfine.)
CALCINED PLASTER,
NAVY BARROWS,
STEEL RAILWAY AND ROAD
SCRAPERS,
FIRE BRICKS,
FIRE CLAY,
FLUE COVERS,

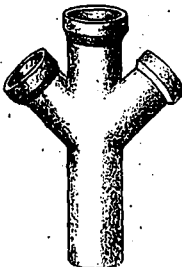

COACH HOUSE BRICKS,
CHIMNEY LININGS,
CHIMNEY TOPS, Ornamental
FLOOR TILES,
ART TILES,
SEWER PIPES, Scotch, English
and American.
ENGLISH AND SCOTCH
SANDSTONE,
SCOTCH STEAM AND HAND
DERRICKS.

A LARGE STOCK AT LOWEST PRICES.

W. McNALLY & CO.,

MONTREAL.

BENNETT & WRIGHT,
Steam and Hot Water Heating,
Sanitary Plumbing, Gas Fixtures.
72 Queen St. East TORONTO.
Telephone No. 42.

T. POLITO,
GLASS BENDING WORKS,
39 UNIVERSITY STREET, MONTREAL.

Glass Bending in all its branches.
PAINTER AND DECORATOR.

Hell Telephone 468. Federal Telephone 1544.

To Architects and Builders.
GLASS BENDING
IN ALL ITS BRANCHES.

BY
S. J. PRICE,
6 HERMINE STREET, MONTREAL.
Bell Telephone 2005.

Hull Cement and Lime Works.
ESTABLISHED 1837.
C. B. Wright & Sons,
PROPRIETORS.

HULL, P. Q.
Manufacturers, Importers and Dealers in
Portland and Foreign Cements,
Hull Cement or Water Lime,
Scotch Fire Brick and Clay,
Common and Pressed Building Brick,
Plaster of Paris,
Drain Pipes,
Tiles,
Dimension and Rubble Limestone.

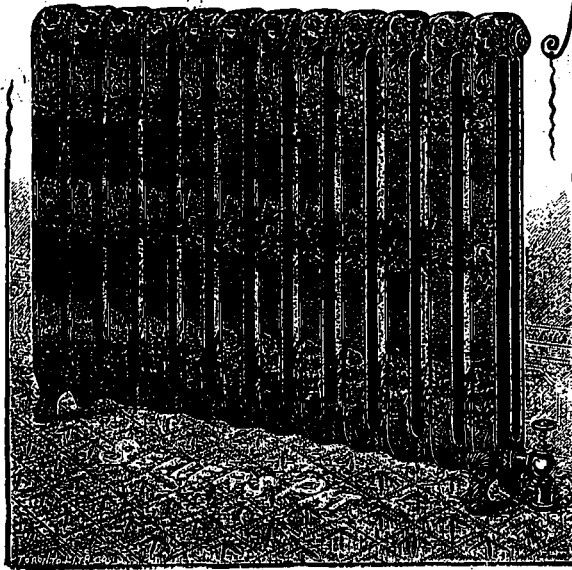

C. SELLERS & CO.

MANUFACTURERS OF

**EXTENSION
RADIATORS**

For Steam and Hot Water,

— AND —

**HOT WATER BOILERS,
TORONTO, ONT.**

Free Circulation, Even Castings,

Absolutely Tight and Permanent Joints,

Simple, Economical, Effective.

Guaranteed to be INFERIOR TO NONE IN EFFECT-
IVENESS AND ECONOMY OF OPERATION, and

MUCH LOWER IN PRICE.

Write for full particulars,

C. SELLERS & CO.,

146 to 160 Niagara Street, - TORONTO.

EDWARD EARL & CO.

Embossed, Encaustic, Enamelled and Plain

GLAZED TILES

For Bathrooms, Hearths and Vestibules.

69 BLEURY STREET, - MONTREAL.

THE HANSEN

Salt-Glazed Terra-Cotta Weather-Protecting Chimney-Topping.

Patented in the United States and Canada.

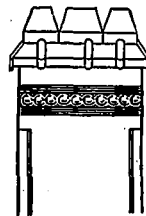
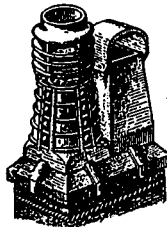
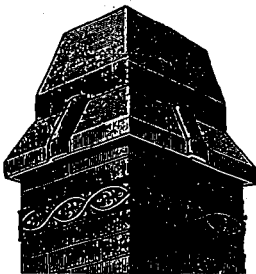

Indorsed by Architects throughout the country; are mainly designed to replace the common corbelled chimney top, for the PROPER PROTECTION of chimney masonry from the usual EARLY DESTRUCTION of same by the action of rain and frost. These toppings are manufactured by steam press and dies, same as first-class salt-glazed sewer pipe, for keeping in stock in same manner, and as made in pieces (see diagrams) present the CHEAPEST, MOST PRACTICAL ever READY and LASTING material for bricklayers' use in topping out chimneys. Deducing value of mason's material and time saved when using these toppings, their COST PER FLUE does not exceed 50 to 60 cents (th of common brick tops, which secures absolutely PERMANENT chimney masonry, and saves annoyance and REPAIR EXPENSES, the usual and too frequent experience of owners.

HARALD M. HANSEN, Patentee,

88 La Salle Street, Chicago, Ill.

THESE CHIMNEY TOPPINGS ARE MANUFACTURED AND SOLD UNDER LICENSE BY

THE STANDARD DRAIN PIPE CO.,

St. Johns, P. Q.,

SOLE MANUFACTURERS FOR CANADA.

Responsible Agents to carry stock and handle these goods wanted. Write manufacturers for sample and terms. Correspondence solicited.

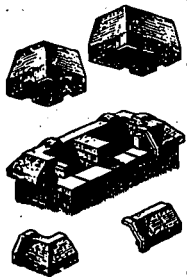

Adamant

is the Modern Wall Plaster, while old style mortar is a relic of the dark ages, and has been tolerated for centuries for the want of a better substitute.

Adamant dries within three days; lime mortar is soft and damp for weeks.

Adamant only requires heat for ten hours after application in the coldest weather; lime mortar requires heat and constant care for at least a month in such weather.

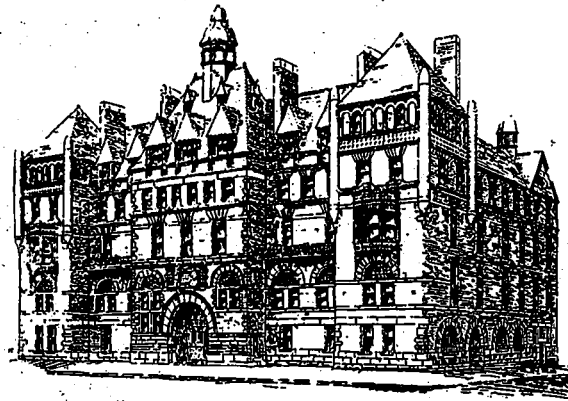

HOSPITAL FOR SICK CHILDREN, TORONTO, CAN.—PLASTERED WITH ADAMANT.

fire or water, and cannot be broken or marred by furniture. Crumbling walls, falling ceilings and defaced decorations are unknown where Adamant is used. It is mixed with water, and applied by any mason, in the ordinary manner. It has been used all over this country and abroad for the last four years, and is endorsed by architects, engineers, and scientific men.

Write to any of the undersigned for information:

- The Adamant Manufacturing Co., Syracuse, N. Y.
- Adamant Manufacturing Co., Bennett Building, N. Y.
- The Keystone Plaster Co., Philadelphia, Pa.
- The Keystone Plaster Co., Pittsburgh, Pa.
- The N. W. Adamant Co., Minneapolis, Minn.
- The N. W. Adamant Co., West Superior, Wis.
- The N. W. Adamant Co., Milwaukee, Wis.
- The Michigan Adamant Co., Detroit, Mich.
- The Michigan Adamant Co., Grand Rapids, Mich.
- The New Jersey Adamant Co., Harrison, N. J.
- The Chicago Adamant Co., Chicago, Ill.

- The United Adamant Co., Baltimore, Md.
- The St. Louis Adamant Co., St. Louis, Mo.
- The New England Adamant Co., Boston, Mass.
- The Ohio Adamant Plaster Co., Columbus, Ohio.
- The Ohio Plaster Co., Cleveland, Ohio.
- The Nebraska Adamant Co., Omaha, Neb.
- The Adamant Plaster Co., Indianapolis, Ind.
- The Connecticut Adamant Co., New Haven, Conn.
- The South-Eastern Adamant Co., Savannah, Georgia.
- Adamant Plaster Mfg. Co., Tacoma, W. T.
- The Adamant Mfg. Co., Toronto, Can.

PETER LYALL, BUILDER,

— AGENT FOR —

CORNGOCKLE RED SANDSTONE,

From Dumfriesshire, Scotland.

ALSO FOR JOHN GRAHAM & CO.'S, (OF SCOTLAND,)

STEAM AND HAND POWER CRANES.

For samples and price list address

6 DONEGANI STREET, MONTREAL.

"SUPERIOR JEWEL" HOT AIR FURNACE

THE FINEST

STEEL

FURNACE EVER MADE.

Uses Less Fuel

— THAN —

Any other Furnace

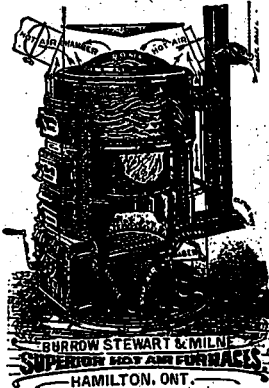

BURROW STEWART & MILNE
SUPERIOR HOT AIR FURNACES
HAMILTON, ONT.

Write for Circulare with List of References.

BURROW, STEWART & MILNE, Manufacturers, HAMILTON.

Has given satisfaction in every case;
Not a single failure;
Every person using them will give highest
recommendation.



PENNINGTON, BAKER & CO.

Church, School
and Lodge

FURNITURE

Hamilton, Ont.



CABOT'S

CREOSOTE SHINGLE STAINS

Give the soft velvety coloring effect so desirable for exteriors. The only exterior coloring that does not blacken. Houses all over the country have been treated with this Stain in the last ten years.

For samples on wood, with book of creosoted houses, apply to

SAMUEL CABOT,

Sole Manufacturer,

70 Kilby Street, BOSTON, MASS.

ANDREW MUIRHEAD, 82 Bay Street, Toronto,
Agent for Ontario.

TORONTO

Telephone No. 1599.

Cable address, "PLATE."

IMPORTING CO.

IMPORTERS OF
Every kind Rolled
Plates, and Plain,
Colored and Orna-
mental Window
Glass.

**BRITISH
ROUGH-CAST
MIRROR**

PLATE GLASS

55 and 57 Victoria St.,
TORONTO.

Plate Glass shipped to and Fixed at any point in the Dominion.

PILKINGTON'S WINDOW AND PICTURE GLASS, PLAIN AND ORNAMENTAL.

The Ontario Terra Cotta Brick & Sewer Pipe Co.

(LIMITED)

— MANUFACTURERS OF —

HIGH GRADE PRESSED BRICK

(By semi-dry and plastic processes)

In Plain and Ornamental Designs.

We desire to call special attention to our

TERRA COTTA AND ROOFING TILES

IN A VARIETY OF PATTERNS.

Samples and prices will be furnished at the Company's office,

LIVINGSTON BUILDING, 34 YONGE STREET,
(Opposite new Board of Trade Building)

TORONTO.

WORKS AT CAMPBELLVILLE, ONT.

L. M. LIVINGSTON, President.

MONTREAL AGENTS:
T. A. MORRISON & CO.
73 Temple Buildings.

C. C. WITCHALL, Managing-Director.

WILLER'S SLIDING BLINDS

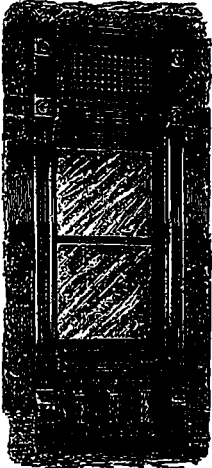

THE STANDARD
Sliding
Blinds

Of the Country.
They are used in pre-
ference to any
other by the
Leading Architects.

THE ONLY
Sliding
Blinds

GIVING
UNIVERSAL
SATISFACTION.

For full partic-
ulars, send for
our new catalogue
No. 8, Architects
and Builders' edi-
tion.

WM. WILLER

Sole Manfr.,
Fourth and Cedar Sts.,
MILWAUKEE, Wis.

Agents Wanted everywhere. State your
business when writing for catalogue or agency.

GEO. CLATWORTHY

AGENT

60 ADELAIDE ST. WEST, - TORONTO.

Telephone 1740.

Send for Catalogue.



No. 1 DUMB WAITER.

MILLER BROS & TOMS

SUCCESSORS TO MILLER BROS & MITCHELL
MACHINISTS,
MILLWRIGHTS, &
ENGINEERS.

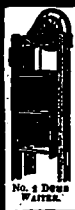

No. 2 DUMB WAITER.

MANUFACTURERS OF
SAFETY HOISTING APPARATUS OF EVERY KIND.

Passenger Elevators
FOR HOTELS, STORES,
PUBLIC BUILDINGS, &c.

FREIGHT HOISTS
FOR WAREHOUSES, ETC.
HAND POWER, STEAM,
AND HYDRAULIC.

Safety Dumb Waiters
NEW DESIGN.



PASSENGER ELEV.

HOISTING ENGINES

FOR MINES, QUARRIES
EYE SIMPLY, COMPACT
AND DURABLE.

Hand & Steam Derrick.

2, 3, 4 & 6 TONS
FOR QUARRIES, & FOR
BUILDERS' USE.



DUMB WAITER PLATFORM.

GENERAL MACHINE WORK

OFFICE: 122 KING STREET.
WORKS: 110 TO 120 KING ST

Montreal.



HAND HOIST.

"CANADA FOR CANADIANS."

CLOSETS, BASINS, URINALS, ETC.

In White and Decorated.



EMBOSSED "ENGLISH" CLOSET,
Same as Imported "Unitas" Closet.

Made from best quality of Imported English Clays and manufactured on the English plan. We guarantee satisfaction in every way equal to imported goods.

Our lines include the leading English and American patterns, and are in the hands of jobbers from Halifax to Victoria.

The attention of Architects and Plumbers throughout the Dominion is invited to our goods.



"CLAW-FOOT" CLOSET, PLAIN WHITE,
A favorite American Pattern.

SEND FOR CATALOGUES.

ST. JOHNS STONE CHINA WARE Co.

ST. JOHNS, P. Q.

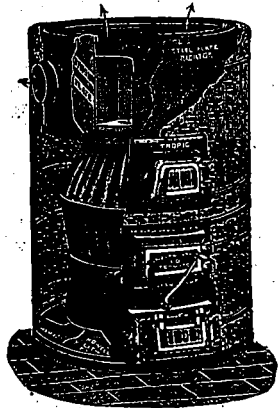

WARRANTED SMOKE, DUST AND GAS TIGHT.

LIDLAW'S NEW TROPIC HOT AIR FURNACE

Latest and Best Steel Plate Furnace in the Market.

IMPROVED GIANT FURNACES, BOYNTON FURNACES.

The largest and best assortment of Cast and Steel Furnaces ever made. Be sure and get an estimate. Every furnace guaranteed to give perfect satisfaction.

A. B. ORMSBY,

126 QUEEN STREET EAST,
Agent for Toronto.

Telephone 1725.

Ontario Galvanized Iron &

Copper Cornice Works.

CORNICES,

WINDOW CAPS,

METALLIC ROOFING,

and all other Metal Trimmings for Buildings, all made of Crimped Iron and Copper. Iron Crimped to the trade.

Iron Skylights.

Over 18,500 in use.

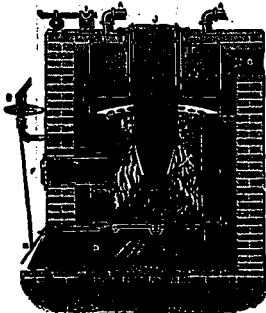

THE DUNNING - BOILER, Patent Steam and Hot Water Heater

Made entirely of Wrought Iron or Steel, with Self-Feeding Coal Magazine or Surface Heater; is the oldest and best for Low Pressure Steam and Hot Water Heating, and insures a warm home day and night.

MADE AS FOLLOWS: As a Magazine Boiler, which requires attention but once in twenty-four hours; as a Surface Boiler, to burn hard or soft coal, wood or coke; as a Hot Water Boiler, for greenhouse and hot water heating; as a Portable Boiler, to be set without brick work. Also in Two Sections to pass through any door where a larger one cannot be used. Made in six patterns, fifty-one sizes. Send for Illustrated Catalogue, with full description and price list.

STEAM KEPT UP CONSTANTLY

Manufactured and supplied to the trade by

WATEROUS ENGINE WORKS CO., LTD.

BRANTFORD, CANADA.

SEND FOR CATALOGUE.

Crestin

Iron Columns,

Finials and Vanes,

Stable Fittings,

Architectural and Artistic Iron Work

Wire Work of all kinds.

Illustrated Catalogue on application.

Estimates and Designs submitted.

R. DENNIS,

LONDON,

ONTARIO.