

Technical and Bibliographic Notes / Notes techniques et bibliographiques

The Institute has attempted to obtain the best original copy available for filming. Features of this copy which may be bibliographically unique, which may alter any of the images in the reproduction, or which may significantly change the usual method of filming, are checked below.

L'Institut a microfilmé le meilleur exemplaire qu'il lui a été possible de se procurer. Les détails de cet exemplaire qui sont peut-être uniques du point de vue bibliographique, qui peuvent modifier une image reproduite, ou qui peuvent exiger une modification dans la méthode normale de filmage sont indiqués ci-dessous.

Coloured covers/
Couverture de couleur

Coloured pages/
Pages de couleur

Covers damaged/
Couverture endommagée

Pages damaged/
Pages endommagées

Covers restored and/or laminated/
Couverture restaurée et/ou pelliculée

Pages restored and/or laminated/
Pages restaurées et/ou pelliculées

Cover title missing/
Le titre de couverture manque

Pages discoloured, stained or foxed/
Pages décolorées, tachetées ou piquées

Coloured maps/
Cartes géographiques en couleur

Pages detached/
Pages détachées

Coloured ink (i.e. other than blue or black)/
Encre de couleur (i.e. autre que bleue ou noire)

Showthrough/
Transparence

Coloured plates and/or illustrations/
Planches et/ou illustrations en couleur

Quality of print varies/
Qualité inégale de l'impression

Bound with other material/
Relié avec d'autres documents

Continuous pagination/
Pagination continue

Tight binding may cause shadows or distortion along interior margin/
La reliure serrée peut causer de l'ombre ou de la distorsion le long de la marge intérieure

Includes index(es)/
Comprend un (des) index

Title on header taken from: /
Le titre de l'en-tête provient:

Blank leaves added during restoration may appear within the text. Whenever possible, these have been omitted from filming/
Il se peut que certaines pages blanches ajoutées lors d'une restauration apparaissent dans le texte, mais, lorsque cela était possible, ces pages n'ont pas été filmées.

Title page of issue/
Page de titre de la livraison

Caption of issue/
Titre de départ de la livraison

Masthead/
Générique (périodiques) de la livraison

Additional comments: /
Commentaires supplémentaires:

This item is filmed at the reduction ratio checked below/
Ce document est filmé au taux de réduction indiqué ci-dessous.

10X	12X	14X	16X	18X	20X	22X	24X	26X	28X	30X	32X
<input type="checkbox"/>	<input type="checkbox"/>	<input type="checkbox"/>	<input type="checkbox"/>	<input type="checkbox"/>	<input type="checkbox"/>	<input type="checkbox"/>	<input type="checkbox"/>	<input type="checkbox"/>	<input checked="" type="checkbox"/>	<input type="checkbox"/>	<input type="checkbox"/>

ROYAL OIL CO. TORONTO
...and...
MONTREAL

CYLINDER
DYNAMO
ENGINE.....

OILS

CANADIAN MANUFACTURER
AND INDUSTRIAL WORLD.
DEVOTED TO THE MANUFACTURING INTEREST OF THE DOMINION.

Vol. 37.

TORONTO, AUGUST 19, 1898.

No. 4.

**THE INVOICE
Tag Envelope**

Should be used on all Express Parcels. The saving in postage pays for the Envelope ten times over.

Manufactured by
The Barber & Ellis Co., Limited.
Nos. 43, 45, 47, 49 BAY STREET, TORONTO.

Write for Samples.

ANILINE LIZARINES
DOMINION DYEWOOD & CHEMICAL CO.
SOLE AGENTS FOR CANADA TORONTO.

CHARLES F. CLARK, Pres. JAMES CRITCHFIELD, Treas.
ESTABLISHED 1849.

**THE BRADSTREET
MERCANTILE AGENCY**

THE BRADSTREET COMPANY, Proprietors
346 & 348 Broadway, NEW YORK.
Offices in the principal cities of the United States, Canada, the European Continent, Australia, and in London, England.

The Bradstreet Company is the oldest, and financially the strongest organization of its kind—working in one interest and under one management—with wider ramifications, with more capital invested in the business, and it expends more money every year for the collection and dissemination of information than any similar institution in the world.

TORONTO OFFICES:
McKinnon Bldg., Cor. Jordan & Melinda Sts.
THOS. C. IRVING Superintendent.

Estimates for
**LEATHER
RUBBER "THISTLE"
and GANDY
BELTING**
will be found favorable

We are the only
Manufacturers in
Canada making
**GENUINE
OAK TANNED
BELTING**
in "Extra," "Standard"
and "Dynamo."

We Manufacture
CARD CLOTHING
set in
**OAK LEATHER,
FLEXIFORT
and
RUBBER**

**HEDDLES,
LOOM REEDS,
PICKERS,
RUB. APRONS,
Etc.**

MONTREAL * THE J. C. McLAREN BELTING CO. * TORONTO

**Fensom's
Elevators**

ELECTRIC
HYDRAULIC
STEAM
HAND-POWER

All made of the best material and finest workmanship.

The Fensom Elevator Works...
52, 54, 56
Duke Street,
Toronto, Ont.

RUBBER GOODS OF ALL KINDS.

THE CUTAPERCHA & RUBBER CO.
TORONTO

61 and 63 FRONT ST. WEST, TORONTO.

THE...
**Walkerville
Malleable Iron
Co., (Limited)**

Manufacturers of...
**REFINED AIR FURNACE
Malleable Castings**

ALSO LIGHT GREY IRON CASTINGS.

WALKERVILLE, ONTARIO.

Manufacturers of
HAMILTON Facing Mill Co., LIMITED
Foundry Facings, Ceylon Plumbago,
Core Compound and Foundry Supplies
HAMILTON, ONT.

MISSISSAUGA
A. D. JACQUES & CO.
PUBLISHER, ONT.
SEND FOR CATALOGUE.
MAGNETISTS TAPS

RIDOUT & MAYBEE
Foreign members of the...
CHARTERED INSTITUTE OF
PATENT AGENTS, ENGLAND

SOLICITORS OF AND EXPERTS IN
PAMPHLET ON PATENTS SENT FREE
103 Bay Street, Toronto

Patents

The Royal Electric Co'y

MONTREAL, QUE.

Western Office.... TORONTO, ONT.

S.K.C. Two-Phase Alternators

Incandescent Light, Arc Light and Power from same Dynamo and Circuit.

Highest Efficiency

Best Regulation

Slow Speed

Least Attention



No Collector

No Moving Wire

No Exposed Parts

No Compounding

S.K.C. 50 Kilowatt Two-Phase Generator

DIAMOND BRAND



Manufactured by.... **The HAMILTON AND TORONTO SEWER PIPE CO.**
HAMILTON, ONTARIO.



THE STANDARD DRAIN PIPE COMPANY, ST. JOHN'S, P.Q.

Manufacturers of Salt Glazed Vitrified Sewer Pipes, Double Strength Railway Culvert Pipes, Inverts, Vents, and all kinds of Fire Clay Goods.

The Standard Drain Pipe Co. of St. John's, P.Q., Ltd. *W. C. TROTTER President.*

REGISTERED..... BRAND

The Sampson Brand IS A HIGH GRADE OF

Portland Cement.

..UNIFORM.. ..FINELY GROUND.. ..RELIABLE..

Quality equal to the best English and German Brands. Manufactured by the

Owen Sound Portland Cement Co., LIMITED
SHALLOW LAKE, - ONTARIO.

The City of Toronto have contracted with us to supply our Sampson Brand Portland Cement for the requirements of the whole City for 1897 and 1898.

For Prices and further information address the Manager at Works, Shallow Lake, Ont., or

JOHN LUCAS, 377 Spadina Ave., Toronto, Ont.
Correspondence Solicited.

FIRE PROTECTION.

INDICATOR VALVES. CHECK VALVES.

INDICATOR POSTS.

FIRE HYDRANTS. CAST IRON PIPE.

For the modern equipment of your Mill with Automatic "Sprinkling System," write us.

We manufacture a full line of these goods.

ST. LAWRENCE FOUNDRY CO.

OF TORONTO (Limited),

TORONTO, - CANADA.

The Goldie & McCulloch Co., (Limited)

GALT, - - - ONT.

MANUFACTURERS OF

STEAM ENGINES, BOILERS, WATER WHEELS

Flouring and Saw Mill Machinery, Wood Working Machinery, Wool Machinery.
Fire and Burglar Proof Safes, Vault Doors. Wood Rim Split Pulleys,
Friction Pulleys, Friction Clutch, Couplings, etc.

"Dumfries Foundry," - - Galt, Ontario, Canada.

THE Defiance Machine Works,

DEFIANCE, OHIO, U.S.A.

Established 1850

INVENTORS AND BUILDERS OF UP-TO-DATE
NINETEENTH CENTURY

AUTOMATIC Wood-Working Machinery

For Making

WAGON AND CARRIAGE WHEELS, HUBS, SPOKES, RIMS
FELLOES, SHAFTS, POLES, NECK-YOKES, SINGLE-
TREES, BARREL HOOPS, Etc., Etc.

Send for 300-Page Catalogue—FREE
GENERAL CANADIAN AGENTS

ESTATE OF T. T. COLEMAN
SEAFORTH, ONTARIO, CANADA

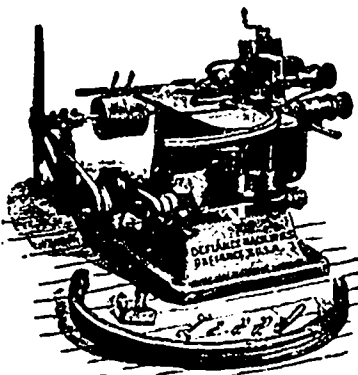

RIM PLANING MACHINE.

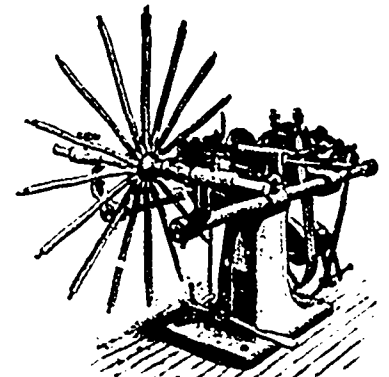

WHEEL TENONING MACHINE

JOHN BERTRAM & SONS,

DUNDAS, - - - ONTARIO.

We have a number of

Second-Hand Tools

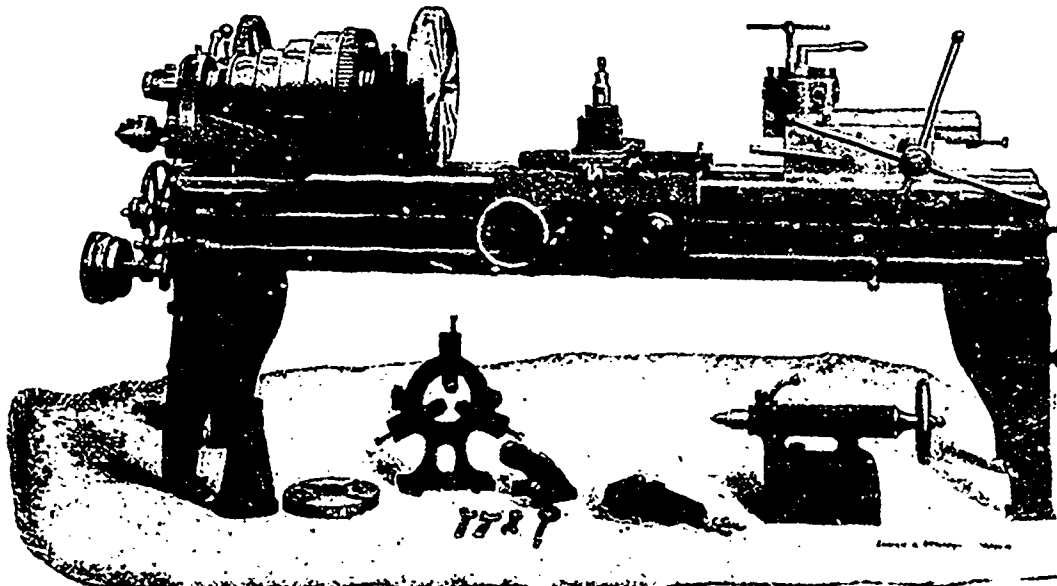

ENGINE LATHE WITH TURRET ATTACHMENT.

Which being in
Good Order are
offered at

**Very
Low
Prices**

To clear out,
Stock quickly.



PLEASE
WRITE IF
INTERESTED



THE NOVA SCOTIA STEEL CO., LIMITED

MANUFACTURERS OF

BRIGHT COMPRESSED STEEL SHAFTING

FROM 1/2 TO 6 INCHES IN DIAMETER. GUARANTEED STRAIGHT AND TRUE TO WITHIN 1/32 OF AN INCH.

Spring, Reeled Machinery, Tire, Toe Caulk, Sleigh Shoe, Angles, Special Sections and all Merchant Bar Steel. Sheet Steel up to 48 inches wide.

RAILWAY AND ELECTRIC RAILWAY CAR AXLES

FISH PLATES, SPIKES AND TRACK BOLTS

Tee Rails, 12, 18, 24 and 28 lbs. per yard

HEAVY FORGINGS a SPECIALTY.

"FERRONA" PIG IRON, For Foundry Use.

Works—NEW GLASGOW, N.S., and FERRONA, N.S.

Head Office—NEW GLASGOW, NOVA SCOTIA

GALT Machine Knife Works

PETER HAY,

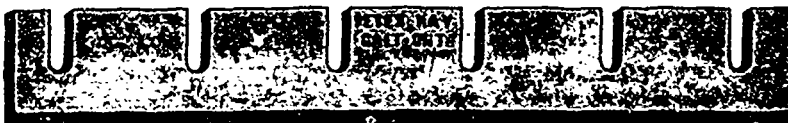

GALT, ONT.

Manufacturers of Every Description of.....

KNIVES, For Wood-Working, Paper Cutting and Leather-Splitting Machines

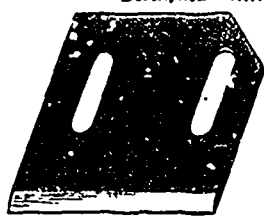

BARK KNIVES
PULP KNIVES
RAG KNIVES
Etc., Etc.



Shear Blades,
Straw Knives,
Paper Knives,
Etc., Etc.



Quality Guaranteed. Special Knives Made to Order. Send for Price List

DOMINION BRIDGE CO., Limited,



MONTREAL AND
LACHINE LOCKS, P.Q.

Steel Bridges for Railways and Highways,
Steel Piers and Trestles, Steel Water Towers and Tanks,
Steel Roofs, Girders, Beams, Columns for Buildings.

A large Stock of ROLLED STEEL BEAMS, JOISTS, GIRDERS, CHANNELS, ANGLES, TEES, Z BARS and PLATES

Tables, giving Sizes and Strength of Rolled Beams on application.

ALWAYS ON HAND IN LENGTHS TO THIRTY-FIVE FEET.

Post Office Address,
MONTREAL.

GEORGE E. EVANS, Agent, 38 Canada Life Building,
TORONTO, ONT.



WINN & HOLLAND,
MONTREAL,
SOLE AGENTS FOR CANADA.

BRUNNER MOND & CO.'S

Pure Alkali,
Bleaching Powder,
Caustic Soda, ALL STRENGTHS.
Bicarbonate of Soda,
Concentrated Sal Soda,
Soda Crystals.

Wm. J. MATHESON & CO., LIMITED

NEW YORK
BOSTON
PHILADELPHIA
PROVIDENCE
CHARLOTTE, N.C.
MONTREAL, CANADA

DYE... STUFFS

The Polson Iron Works, TORONTO CANADA.

THE BEST EQUIPPED BOILER AND ENGINE WORKS IN CANADA.

We Manufacture—

STEEL BOILERS

The BROWN AUTOMATIC ENGINE, MARINE ENGINES (SINGLE, COMPOUND AND TRIPLE), Hoisting and Mining Engines
STEEL STEAM VESSELS OF EVERY DESCRIPTION. STEAM YACHTS AND LAUNCHES.

GET OUR PRICES BEFORE ORDERING.

ESPLANADE EAST, Foot of Sherbourne St., - - Toronto, Canada

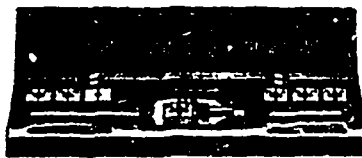
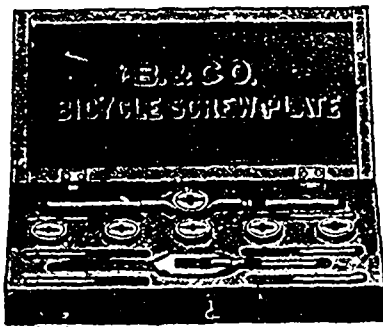

Bicycle Screw Plates, Reece Screw Plates, Derby Screw Plates, Blacksmiths' Stocks and Dies, Blacksmiths' Improved Screw Plates, Hand Taps, Machine Taps, Pipe Taps, every kind of Taps and Dies are manufactured by

BUTTERFIELD & CO., Rock Island, P.Q.

**ALBERT
MANUFACTURING CO.**

Manufacturers of the
well-known

"HAMMER BRAND"

**Calcined
PLASTER**

—AND—

Patent Rock Wall Plaster

HILLSBOROUGH, N.B.,
CANADA.

GET THE BEST

And at Same Time the **CHEAPEST**
HEARLE'S ANTI-SCALE POWDER
The unequalled Boiler Purge.

Send for Circulars with Testimonials.
C. C. HEARLE,
623 LaSalle Street, Montreal, P. Q.

WM. BARBER & BROS.

Georgetown, Ont.

Manufacturers **Book and Fine Papers.**

of.....

THE TORONTO PAPER MFG. CO., Cornwall, Ont.,

Manufacturers of Engine Sized Superior
Papers, White and Tinted Book Papers, Blue
and Cream Laid and Wave Foolscaps, Account,
Envelope and Lithographic Papers, etc.

KEMP MFG. CO.

TORONTO.

Galvanizing

DONE FOR THE TRADE.

GET OUR PRICES.

WELLAND VALE MANUFACTURING CO.

Limited, ST. CATHARINES ONT.

Manufacturers of.....

**Axes, Edge Tools, Saws,
Farming Implements
and Bicycles.**

F. W. Hore's Sons, HAMILTON,
ONT.

Manufacturers of

Wheels, Wheel Materials, Shafts, etc.

W. H. Storey & Son, ACTON, ONT.,

Manufacturers of..... **FINE GLOVES AND MITTS**

In every variety and style. **Moccasins.**

CANADIAN OFFICE & SCHOOL FURNITURE CO. LIMITED
PRESTON ONT.
FINE BANK OFFICE, COURT HOUSE & DRUG STORE FITTINGS.
OFFICE, SCHOOL, CHURCH & LODGE FURNITURE.
SEND FOR CATALOGUE

THOUSANDS IN USE.

THE WEBSTER FEED-WATER HEATER AND PURIFIER.

Points of Advantage.

- 1—All back pressure from engines dispensed with.
- 2—Simple in construction, and most durable.
- 3—All condensation from heating coils, machines, etc., can be returned to the Webster Heater.
- 4—The only heater in the market that the condensation from coils, etc., can be returned to.
- 5—Guaranteed temperature of feed water from 208 to 212 degrees, utilizing the waste exhaust steam.
- 6—We have Webster Heaters in operation for eight years that have never cost one cent for repairs.

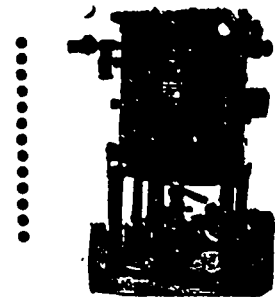

116 PAGE CATALOGUE MAILED ON APPLICATION.

DARLING BROS., Queen and Ottawa Sts., MONTREAL

FRANK DARLING, Agent, NELSON, B.C.

J. HERBERT LARWORTH, B.A. Sc., Agent, CENTRAL CHAMBERS, OTTAWA, ONT.

The **Packard Electric Co.,** Limited.

MAKERS OF

**Lamps and
Transformers**

Sole Agents for SCHEEFFER RECORDING WATT METERS

ST. CATHARINES, ONT.

Mumford's Improved Boiler.

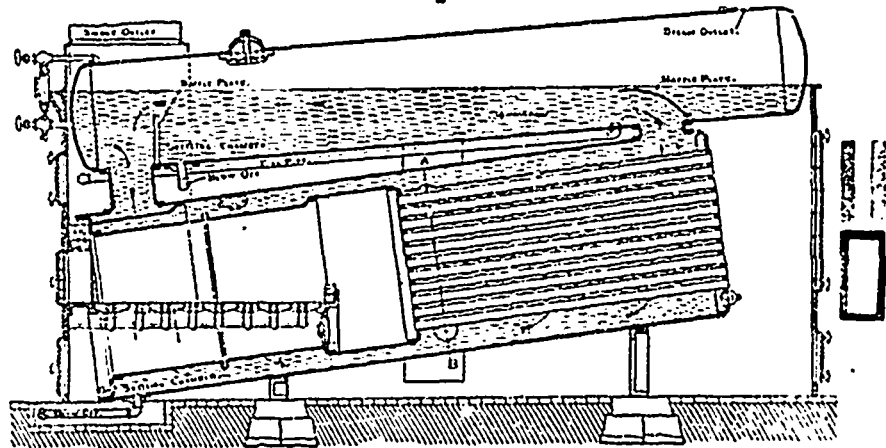

LARGE HEATING SURFACE.

Adapted to Forced Draft...

INCREASING HORSE POWER WITHOUT
FOAMING OR PRIMING.

Specially arranged for using **Bad Water**—with little
or no scale formation.

ROBB ENGINEERING CO., LIMITED, AMHERST, N.S.

Wm. McKay, Traveller, - Seaforth, Ont.

DO YOU REQUIRE Rubber Belting?

IF SO, BUY THE BRANDS MADE BY

The CANADIAN RUBBER COMPANY of MONTREAL

CAPITAL \$2,000,000.

Manufacturers of all Kinds of Rubber Goods

ONTARIO BRANCH—Cor. Front and Yonge Streets, TORONTO.

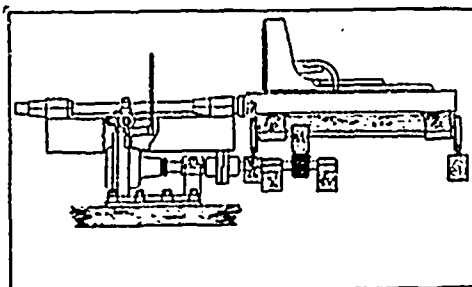
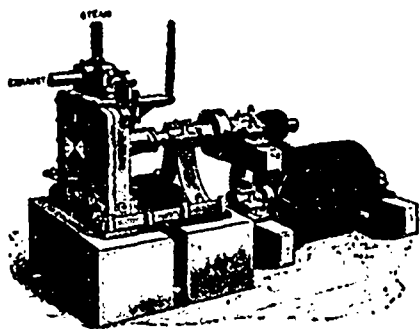

THE DAKE STEAM FEED

EMBODIES THE FOLLOWING
ADVANTAGES :

- Simplicity of Construction.
- Small Space Occupied.
- Economical Use of Steam.

Easy Adaptation to either New Mills or those now in use.
Positive and Easy Control. Cheapness.

The movement of the engine in either direction is under the absolute control of the sawyer, thus accommodating the speed of the feed to the size of the logs.

Mill men, who have used other makes of Steam Feeds, comment favorably on the economical use of steam of our Feed over others.

Write for Catalogue and full particulars.

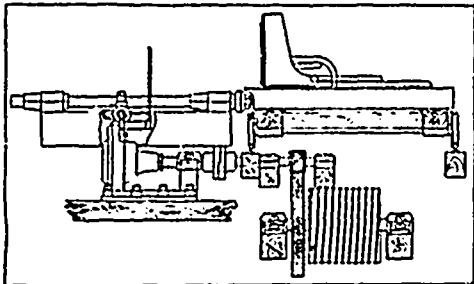

**THE JENCKES MACHINE CO.,
SHERBROOKE, QUE.**

Succeeding the Phelps Machine Co., Eastman, Que.

The KAY Electrical Manufacturing Co.

HAMILTON, ONT.

Begs to announce that in future it will conduct its business under the name of

The T. & H. Electric Co.

HAMILTON, ONT.,
255-257 James St. 'Phone 953.

TORONTO, ONT.,
'Phone 1211. 58 Adelaide St. W.

The WEBBER Patent Straitway Valve

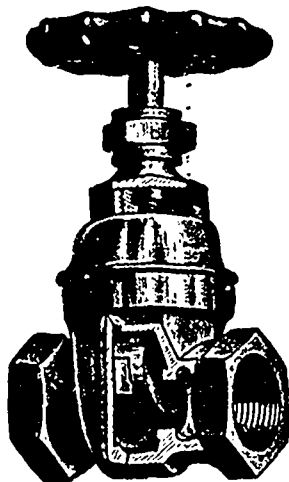

FOR.....
Steam,
Water
or
Gas...

EVERY
VALVE
TESTED.

The KEEP Engine Co., (Limited),
WALKERVILLE, ONT.

Sole Manufacturers for Canada. Send for Price List.

TORONTO ELECTRIC MOTOR CO.

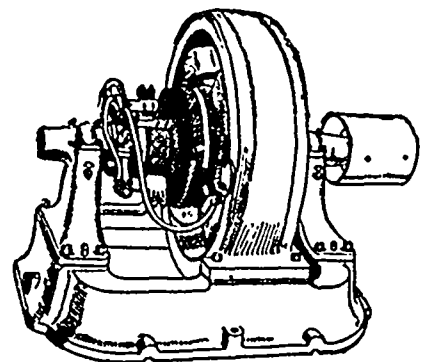

From 8 to 100 K. W.

103 105, 107, 109 Adelaide Street West, Toronto
or to

R. E. T. PRINGLE,
216 St. James Street, Montreal.

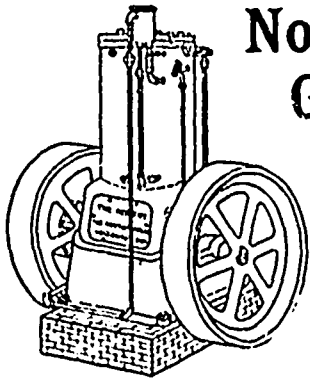

**Northey
Gas and
Gasoline
Engine**



OUR BOOKLET TELLS
ALL ABOUT IT.
WRITE FOR IT.

"BUILT FOR HARD WORK."

Steam and Power

Pumps
"FOR ALL DUTIES"

ALL KINDS FOR ALL PURPOSES.

Estimates and Plans Furnished.

Correspondence Invited.

**Northey Mnfg. Co., Limited, 1000 King St. W.
Toronto.**

MICA BOILER AND STEAM PIPE COVERING.

THE CHEAPEST IN THE MARKET. DURABLE, FLEXIBLE, AND A MAGNIFICENT NON-CONDUCTOR OF HEAT.

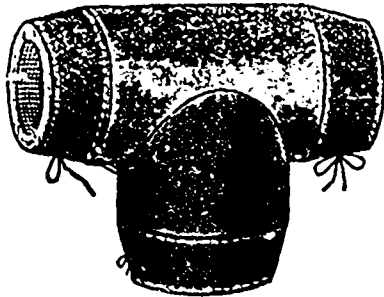

TEE

Made in Sections to fit all sizes of Pipes, and can be removed and replaced as often as desired.

Adjustable Mica Coverings for all kinds of fittings.

Mica Covering cannot be affected by vibration, and will not shift or sag.

Write for reports of trials, testimonials, etc., to

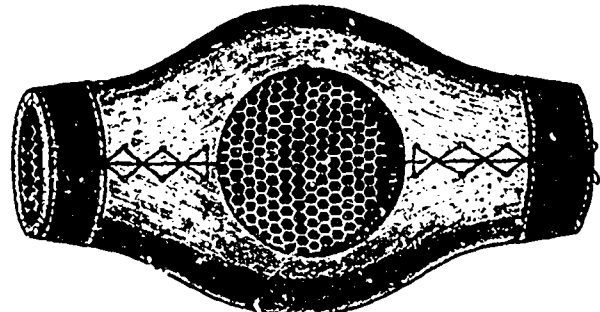

GLOBE VALVE.

THE MICA BOILER COVERING COMPANY, Limited
9 JORDAN STREET, TORONTO.

FETHERSTONHAUGH & CO.

PATENT BARRISTERS AND SOLICITORS

ELECTRICAL AND MECHANICAL EXPERTS AND DRAUGHTSMEN

Head Office: Canadian Bank of Commerce Bldg., Toronto, Ont.

Patents Procured in Canada and all Foreign Countries.

Offices in Montreal, Que., Ottawa, Ont., and Washington, D.C.

Upton Midget Enclosed Arc.

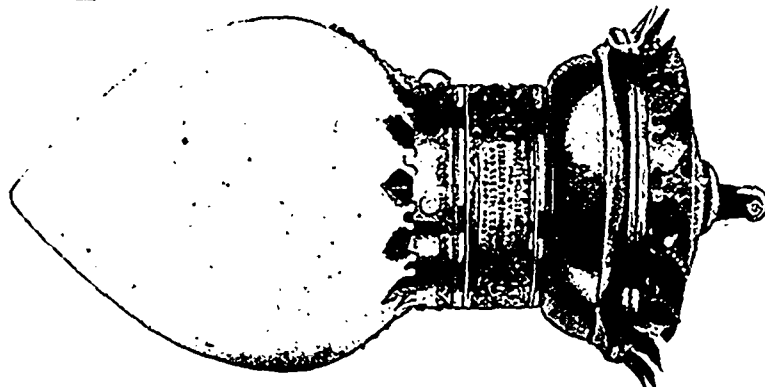

THIS LAMP BURNS 150 to 200 HOURS WITH ONE SET OF CARBONS. SIMPLE, RELIABLE AND EFFECTIVE.

600 to 300 C.P. WITH 5 AMPERES AT 100 VOLT ALTERNATING OR STRAIGHT.

Write for Full Particulars.

JOHN FORMAN

ELECTRICAL SUPPLIES,

HARDTMUTH CARBONS.

644 CRAIG STREET, - MONTREAL.



ESTABLISHED IN 1890.

PUBLISHED ON THE FIRST AND THIRD FRIDAYS OF EACH MONTH

Official Organ of the Canadian Manufacturers' Association.

Subscription, \$1.00 per year.

ADVERTISING RATES:

\$12.00 Per Column inch per year; Thirty inches to Page.

The Canadian Manufacturer Publishing Co., Limited.

McKinnon Building, Cor. Melinda and Jordan Sts., Toronto.

J. J. CASSIDY, Editor.

J. C. GARDNER, Business Manager.

G. A. G. BROWNE, 145 Fleet St., London, E.C., Eng., Sole Agent in Great Britain.

OUR FOREIGN TRADE.

It is somewhat unfortunate that our Trade and Navigation returns for the year ended June 30, 1898, have not been issued, so that reliable information could be obtained as to the effects of the operation of the tariff of 1897, with its reciprocity conditions. With this information in hand, public opinion might be intelligently expressed as to the changes, if any, in the trade relations between Canada and the United States, which ought to be proposed by our Commissioners at the International Conference which is soon to be held in Quebec. Still a retrospect of the commerce during the past two or three years may aid in arriving at some useful conclusions.

According to the returns for the year ending June 30, 1897, the imports into Canada, entered for consumption, amounted to \$111,294,021, of which \$91,061,229, or about 82 per cent. of the whole, were from Great Britain and the United States, the proportions being,

FROM GREAT BRITAIN.	
Dutiable.....	\$20,217,422
Free of duty.....	9,194,766
	\$29,412,188
FROM UNITED STATES.	
Dutiable.....	\$30,482,509
Free of duty.....	31,166,532
	\$61,649,041

Of the imports, the value of manufactured goods were, from Great Britain, \$26,092,421, United States, \$32,355,835.

For the first time in the history of our commerce, Canada purchased a greater value in manufactured goods from the United States than it did from Great Britain; the excess being \$5,263,414. Two years ago, the excess in favor of Great Britain, under the same classification, was \$4,164,339. Although for a little over two months of the year, the latter country was obtaining a rebate of 12½ per cent. on tariff rates, the average rate of duties collected on all manufactures, free and dutiable, was, on imports from Great Britain 27.06 per cent; from the United States, 29.15 per cent. This arose from the fact that under the tariff of 1897, the average

rate of duty on dry goods, which are mainly imported from Great Britain, was increased from 29.07 per cent. to 32.87 per cent., while on metals and general hardware, which principally come from the United States, the average rate of duty was reduced from 26.71 per cent. to 23.80 per cent. The average rate of duty on all manufactured goods, dutiable and free, such as were imported from Great Britain in 1895-96 was increased from 24.68 per cent. to 26.165 per cent.; and on such manufactured goods as we imported from the United States was only increased from 20.55 per cent. to 21.36 per cent. On all such dutiable manufactured goods as were imported from both Great Britain and the United States, the tariff of 1897 levied about \$230,000 more duty than was imposed under the old tariff. The pretended reduction of duties was a myth, so also to a great extent was, and is, the so-called preferential treatment accorded to Great Britain.

This journal has time and again pointed to the fact that the five millions of Canadians have for years been purchasing from the seventy millions of Americans 50 per cent. more goods than they sold to them, and that we, not they, are best entitled to dictate the terms on which our future trade is to be conducted. We believe that the less our Canadian representatives meddle with the question of this trade, the better it will be for the country. It might be well for both countries to put all agricultural products, minerals and fish on the free list, and for the United States to admit lumber, wood pulp and nickel free, on consideration that Canada refrains from imposing export duties on logs, pulp wood and nickel ore and matte.

PROTECTION THE ONLY MEDICINE.

At a recent meeting of the Leeds, England, Chamber of Commerce, an interesting discussion took place on a resolution moved by Mr. Zossenheim which set out that, as the existing commercial treaties between Great Britain and Germany were about to expire, it was desirable that the Government should seek from Chambers of Commerce information as to the duties which pressed most heavily upon the industries of their particular district with a view of amending them. The resolution opened up the whole question of the terms upon which British manufacturers are bound to fight their battle. Discussing the question The Manchester Textile Recorder says that the action of the Canadian Government was a great shock to Britain's Continental neighbors, who have so long been accustomed to an open market in exchange for a closed one, that a partial closure appeared to them to be intolerable. But they cannot be surprised, says our contemporary, if the policy they follow is at any time adopted by others. It is a moot question whether, if a duty much more moderate than that imposed by Germany, was put on goods from that country entering England, whether many of them could enter. Mr. Zossenheim pointed out that middle and lower class Yorkshire woollens were by reason of the tariff practically shut out from Germany, while that very class of goods found its great outlet in Great Britain. It may very well happen that an extension of this principle would lead, in the event of federation, to a reconsideration of the whole question. The Recorder does not believe it would be wise for Britain to change her policy, but if it did happen, the loss to Germany would be enormous. It can be well understood that German statesmen feel uneasy at

the action of Canada, which may easily be followed by other colonies. While it is not likely that for many years there will be an effective Federation of the Empire, the thing is inevitable and only wants crystallizing by some great and serious event. "We know," says the Recorder, "that our colonial kinsmen do not share the views of the mother country on tariff matters, and something in the shape of a Zollverein may be in the future. It is possible to so arrange it as to leave the power of competition in neutral markets unaffected, and if this happened we believe that only our own kinsmen would be serious competitors."

The Textile Recorder has the following to say by way of explanation and comment.

As a concrete instance Mr. Zossenheim showed that the German duties on woollen goods weighing more than 200 grammes per square metro was equal to 7½d. per pound; on those weighing less than that, one shilling per pound, ready-made clothing, 1s 4d. per pound; and manufactured goods often 100 per cent. of their value. For all these the German manufacturer finds in England a free and willing market, to the undoubted advantage of the purchaser on this side, because, being compelled to sell here in the face of open competition, he must needs abandon the benefit of his tariff. In Germany the price to the consumer is regulated only by internal competition, and a margin is left which enables him to keep his works going by taking orders at lower prices from abroad than he will accept from his own countrymen. Still the shoe does pinch makers in this country, and while recognizing the many advantages arising from our free fiscal system it is well to remember that our own countrymen settled in the colonies have not the same faith in it, and that when they enter, as they will, the councils of the Empire, the present view may be modified. While we in this country might complain of such a course, German makers could not, for it is merely meting out to them their own measure. It may, therefore, be prudent on their part to seize this opportunity of bringing their tariffs into nearer consonance with the true fiscal policy. They would probably not suffer in the long run, but, on the other hand, would show greater expansion, a thing which has always happened whenever the experiment has been tried. France becoming more rigidly protectionist year by year, is less and less a prosperous trading country, and compares very unfavorably with many of its neighbors. Germany has now an opportunity of taking a step in the right direction, and the duty of our Government to help it to do so by obtaining all the guidance possible from the trained commercial intelligence of the country is plain.

The obtuseness and conservatism that so generally characterizes the ideas of our British friends when considering their fiscal policy is exceedingly apparent in the conclusions of our contemporary. It assumes that Imperial unity will, in the not far distant future, be an accomplished fact, and that when that time comes, and the Colonies are represented in the councils of the Empire, changes will be made that will include the existence of a tariff which will discriminate in favor of British countries, and that when that time arrives Germany will be sorry, although unable to help herself. There are many things that must be brought about before this German grief will assume an acute form, and the advice that The Recorder offers to the country will not, in our opinion, be soon accepted. Under free trade Great Britain is not in a position to retaliate against Germany's unfriendly tariff, and there is no likelihood that that country will modify its fiscal policy merely because British interests are unfavorably affected by it. Why should Germany, who now holds the whip handle in the matter, modify its tariff, and bring its fiscal policy into

nearer consonance with the British free trade idea? How could it be possible that German trade would show greater expansion under free trade than now? France, our contemporary tells us, while becoming more rigidly protectionist, year by year, is less and less a prosperous trading country, but in our opinion that fact has no weight when we consider that Germany, and the United States also, while becoming more rigidly protectionist, year by year, are becoming more and more prosperous trading countries, while Great Britain after a half century of free trade, finds itself in a dilemma from which there is no hope of relief except a return to protection.

It may be a bitter pill for British free traders to swallow, but they will be forced to gulp down the medicine.

ARE OUR MANUFACTURERS PREPARED?

Now that there is a cessation of hostilities between the United States and Spain, leaving Cuba and Porto Rico virtually in possession of the Americans, and open to the world to supply the wants of the people of those islands, Canadian manufacturers, particularly of farm machinery, should ask themselves if they are prepared to share in that heavy and remunerative trade. Cuba and Porto Rico will need farm machinery and the demand is sure to come. In Cuba, the long struggle between the Spaniards and the Cubans has resulted in great destruction of property that must be made good, and our manufacturers should be prepared to step in and obtain their share of the desirable and profitable markets thus opened.

An intelligent writer in an American contemporary sizes up the situation as follows:—

"If it is safe to venture any predictions at all these days, I feel justified in proclaiming that the prospective market in Cuba and Porto Rico for agricultural implements is superb. I have two good reasons upon which to base such a belief. In the first place, we must remember the war of devastation which has been desolating Cuba during the past several years. We must readily understand, in view of such conditions, that the great bulk of all agricultural implements has fallen victim to the martial tread of blood and fire. The war between Spain and the insurgents has been one of property destruction, and the burden of the ruin has fallen on the agricultural interests. That means that Cuba's stock of implements, utensils and machinery is materially reduced. It means that the hand of the sword has hurt the hand of the plough; it means that in the Cuban struggle against Spanish control Scriptural prophecy has been reversed, and the ploughshare has been lengthened into a bloody spear.

"We all anticipate a great revolution in conditions in Cuba so soon as American influence becomes supreme. We look forward to the day, and an early one at that, in which a transplanted branch from the tree of American enterprise will flourish on Cuban soil to the great prosperity of her people. We are already calculating upon a revival thereof of all the varied lines of agricultural activities, such as will soon make 'the gem of the Antilles' blossom with the wealth of an exuberant growth. In fact, we felicitate ourselves on the splendid development possible to that country as soon as American energy and enterprise shall have begun their work.

"All is prospective expansion, improvement and development of agriculture will demand an immense supply of

machinery and implements successfully to execute the work. American energy, with American ingenuity, which latter is typified in our mechanical devices, is certain, in the course of a very short time, to transform Cuba into a paradise of prosperity. That being true, a tremendous demand for agricultural implements will be excited at the beginning, which will be well sustained for many years to come.

"Cuba is naturally an agricultural center. She is just so constituted that she is sure to become a rich and opulent garden of luscious and marketable products. Her soil is adapted to the cultivation of both luxuries and necessities, and both are certain to flourish under American guidance and patronage. That of itself is conclusive testimony as to the outlook for an implement market. With the rehabilitation of enterprise down there, almost the entire field of agricultural needs will have to be supplied anew. The crushing ruin of war has swept the old tools of industry into destruction.

"America has no rival in the manufacture of agricultural implements and machinery. Our people stand supreme in every market. We can beat competitors on this side of the Atlantic; we can beat them in Africa, South America or wherever we meet them. Naturally, we will establish our pre-eminence in the West Indian markets now looming up anew."

What is said of American energy, skill and ingenuity in the production of agricultural machinery, and the excellence of it, may with equal truth be said of Canadian manufacturers and their products.

WEST INDIA TRADE.

With peace there will come a very rapid expansion of our trade with Cuba and Porto Rico. Though just now the people are greatly impoverished by the war, yet with peace in the islands it will take but little time to force from the soil crops of many kinds that we can take in exchange for goods of all kinds that will be in great demand, and, in a little time the big staples of sugar and tobacco will be flourishing. Meantime, iron ores, copper, fine hard woods and other products they have, are in demand at our coast cities and will find a ready market with institutions now suffering for lack of them. Best of all, our trade of all kinds will be direct, instead of roundabout through Spain, and, with lessened cost on both sides, the volume of trade both ways will be larger and more profitable than ever before. The great natural wealth of both islands will be rapidly developed by American enterprise and capital, and result in a great trade with our Atlantic coast cities and mainly with New York. Naturally, the West India trade belongs almost wholly to the United States, and henceforth will come here.—New York Financial News.

What our contemporary says of the great natural wealth of Cuba and Porto Rico may with equal propriety be said of the British West India Islands. Those possessions have been for years in better political condition than the other islands under Spanish rule, and in that respect, at least, have that much of a start of Cuba and Porto Rico in the race for material greatness. All these islands produce almost identically the same things. In many of these things Spain has heretofore supplied her wants largely from her West India possessions, the surplus finding their chief and almost only market in the United States, in return for which many of their wants have been supplied, in a more or less roundabout manner it is true, from their American neighbors. This is

true to a great extent of the British islands, the imports into the United States from both the Spanish and British Islands being subject to identical rates of duty.

But a change of flag in Cuba and Porto Rico will work a great change in the Status as between them and their British neighbors, and while these latter will continue to be liable to the commercial restrictions imposed by the United States, there will undoubtedly be modifications in them that will give the former advantages that the latter cannot hope to obtain. Cuba and Porto Rico will be to all intents and purposes, parts of the American Republic, while the British possessions will remain as they are. That is to say, they will remain as they are, integral parts of the British Empire, unless from force of circumstances they find it to their advantage to make a change. Will the fealty of Jamaicans hold them to the idle observance of the fact that their late Spanish neighbors have a very decided tariff preference shown their products in American markets of which they are deprived, or will they demand an equivalent from the British Government? It is not in the power of the Canadian Government to solve this question, nor is it proper that it should attempt to do so. It can be solved, and that quite easily, by the abandonment by Great Britain of Cobdenism, and the adoption of a system of preferential tariff in favor of the products of all British possessions and against all other countries.

STEAM VS. ELECTRICITY.

In calling attention to the inroads being made by trolley railways upon the local passenger business of the steam railroads, The Western Electrician says:

Steam railroad managers are reminded of the growing importance of the electric trolley lines by the marked falling off in suburban traffic in all the large cities of the country at this season of the year. The steam roads running out of Chicago, which have heretofore enjoyed a profitable suburban business, complain that their cars are deserted for the trolley lines since the hot weather set in. Open cars are run on the electric roads and passengers are not annoyed by smoke and flying cinders. An additional inducement of considerable importance is found in the comparatively low fare charged by the electric railway companies.

In the ten years up to, and including 1893, the number of passengers carried on the steam railroads in Massachusetts increased at the rate of 5,825,000 a year. The next four they decreased at the rate of 4,766,000 a year. The decrease in passenger journeys from 1893 to 1897 was more than 19,000,000 or 15.65 per cent. While the number of journeys fell off 15.65 per cent., the passenger miles fell off only 6.66 per cent., showing that the average journey grew in length nearly twelve per cent. There are six steam railways entering Boston. These lost 12.2 per cent. of their passengers into and out of Boston from 1893 to 1897. There are five electric street railroads that enter Boston, and these gained in the same four years 31.2 per cent. in the number of passengers carried. This is the most significant feature of the report.

In all the reports thus far submitted it is evident that the greatest falling off has been in short trip passengers. The Lake Shore's decrease in this class was 227,539 persons. The Michigan Central carried last year in local travel 2,385,519 showing a falling off of 107,798 passengers. The experience

of other companies confirms the impression gained from these statistics. An executive officer of a Chicago road is reported to have suggested that perhaps the best policy for the railroads to pursue would be to build a few miles of trolley lines at various points along their own line and bring in the passengers from the surrounding country. These lines would be connected with their own tracks, and the road could carry the passengers between the neighboring towns either over their own rails or on a separate track along their right-of-way.

THE METALLIFEROUS WEALTH OF ONTARIO.

Mr. Archibald Blue, Director of the Ontario Bureau of Mines, in Part II. of the Seventh Annual Report of his Bureau, gives the statistics of the metalliferous mines and works of the Province for the three months of the current year ending March 31, together with the statistics of the year 1897 as follows:

	1898	1897
	3 mos.	12 mos.
GOLD:		
Ore treated.....net tons	13,939	27,589
Gold product..... oz.	5,288	11,412
Value of gold.....	\$86,175	\$190,244
SILVER:		
Ore treated.....net tons	35	
Silver product..... oz.	9,750	none.
Value of silver.....	\$5,287	
NICKEL AND COPPER:		
Ore smelted.....net tons	28,008½	96,094
Matte product..... "	5,236	14,034
Nickel in matte..... "	652	1,999
Copper in matte..... "	1,202	2,750
Value of nickel.....	\$119,910	\$359,651
Value of copper.....	\$75,369	\$200,067
Iron ore.....net tons	5,203½	2,763
Value at mines.....	\$9,488	\$4,689
Pig Iron:		
Ontario ores.....net tons	4,298	2,770
Foreign ores..... "	15,814	34,722
Mill cinder, etc..... "	2,157	5,350
Pig iron product..... "	12,927	24,011
Value of pig iron.....	\$155,126	\$288,128
Summarized by values, the statistics of the first three months of the current year and of the twelve months of last year are as follows:		
Gold.....	\$86,175	\$190,244
Silver.....	5,287	
Nickel.....	119,910	359,651
Copper.....	75,369	200,067
Iron ore.....	9,488	4,689
Pig iron.....	155,126	288,128
Totals.....	\$451,355	\$1,042,779

Comparing the production by percentages, it is found that the value of the gold product in the three months of 1898 is 50½ per cent. of the 12 months product of 1897; of nickel, 33½ per cent.; of copper, 37¾ per cent.; of iron ore, 202½ per cent.; of pig iron, 54 per cent.; and of all metals and ores, 43 per cent. These rates if maintained throughout 1898 should result in nearly doubling the values of 1897.

GERMANY'S BLOW AT CANADA.

Germany has not been slow to hit back at Canada for her practical attempt to begin the commercial federation of the British Empire. The Dominion, it will be remembered, signalized the year of Jubilee by offering English goods coming to her ports a reduction on the tariff which was imposed on foreign goods. This measure, as was well known at the time, was a contravention of the commercial treaties with Belgium

and Germany, under which England had disgracefully bound her colonies not to give easier admittance to English goods than to those of Belgium and Germany.

Regarding which the London Daily Mail says:

It was to force the hand of Downing-street that Canada took her action. In view of that action England had either churlishly to refuse her daughter's gift, or to take her courage in her hands and denounce the treaties. She adopted the latter course, and on the 31st of July the treaties will expire, and Canada will give British and Colonial imports a twenty-five per cent. preference over those from foreign countries.

But new treaties to supersede those denounced have not yet been concluded, and pending their drawing up and ratification, Germany has decided to continue to give England and her colonies the most-favored-nation treatment, but to exclude Canada.

So we are brought to Act the Second in the commercial federation drama. Germany, in a way, is perfectly within her rights in refusing favorable terms to the temerarious colony which has spoiled her game of spoiling England. But England also is bound to stand up for her colony. She cannot in decency take benefits from Canada and see Canada suffering in the slightest degree for conferring those benefits. So she must see Canada through. And how? Simply by hurrying on that Customs Union of the Empire which all the colonies have been urging for years past, which Mr. Chamberlain has already foreshadowed in England, which every Englishman, save a few belated cranks, is ready now to welcome.

When all the daughter States give to the mother country what Canada is giving, and when the mother country reciprocates the gift, we shall hear very little about Germany's refusal of most-favored-nation treatment.

EDITORIAL NOTES.

Canadian manufacturers and protectionists are yet to be heard from in regard to a reciprocity arrangement which proposes to make Canada practically a free market for our manufacturers.—Home Market Bulletin.

The employes of every factory which is working under the old N.P. tariff are enjoying prosperity and good wages. The shirt and collar makers, working under the new Fielding tariff, are enjoying a cut in wages.—Hamilton Spectator.

Speaking of the conditions that are now shedding such a halo of prosperity over Canada, The Toronto Globe says:—June concludes a banner year in Canadian trade, our exports aggregating \$158,726,801 and our imports entered for consumption \$130,630,195, a total of \$289,356,996. This total is \$44,059,852 greater than the figures for the previous year, the increase in exports being \$24,723,678 and in imports \$19,336,174. The aggregate trade is a round \$50,000,000 greater than in 1896, and is the greatest record for any year in our history. The large exports from the Dominion during the past two years are a feature of the trade situation. With but a few exceptions the yearly imports have exceeded the exports, the average since Confederation up to 1897 being \$16,766,000. In 1897 the value of our exports exceeded the imports by \$18,732,000, and in 1898 by \$27,006,000. The increase of aggregate trade for the past year has been about double that of any year in the history of the Dominion, and the excess of exports is an indication that Canadians are paying off their debts owed abroad. The total exports and imports are generally but a small fraction of the trade of a nation,

and are valuable as guides in the commercial situation so far as they indicate and are the reflection of a healthy expansion of internal commerce. Every merchant and every manufacturer has already felt the sweeping change for the better now indicated by the trade returns, and the harmony between official statistics and the feeling of the business community shows that the expansion has been even, regular and natural.

There is a splendid opportunity for some enterprising individual to start a fruit canning factory in Toronto. One might think that the centre of the fruit district would be the best location for an industry of this kind. Such, however, is not the case. The shipping centre to which the fruit naturally gravitates is the best place for establishing a canning factory. Fruit can generally be bought cheaper in Toronto than in the district where it is grown. It not unfrequently happens that large consignments have to be shipped from Toronto back to where it was grown, there to be canned by the local factories. On Saturday last, for instance, 500 packages were re-shipped across the lake to a canning factory in the fruit country. A factory located in Toronto could take advantage of the glut that frequently characterizes the market, being thereby enabled to put up fruit cheaper than factories situated in the fruit districts. The city of Toronto is, we believe, superior to any other point in Ontario for the canning industry. Some two or three years ago it was proposed to start a factory in the old Jaques & Hays property, but the project never materialized. We believe there is good money in the business for anyone who will start a factory here. A high-class pickle factory is also needed in Ontario, and no better place can be selected than Toronto for its location. It seems ridiculous that we should import so many pickles from the United States and Great Britain, when we grow as good pickling vegetables as any country in the world. There is surely no patent or trade secret in connection with the putting up of pickles.—Toronto World.

We do not import much wood pulp, nowadays, excepting such as we bring over from Canada. Last May our total imports were 4,144 tons, and all but about 600 tons came from British North America. During the eleven months ended with May, 21,295 tons out of a total of 25,893 tons imported came from the Dominion. We are not so very unfriendly to the Canadian pulp industry, after all, since we spend in Canada more than 80 per cent. of all the money we invest in foreign pulp. The Canadians are wise in side-tracking that matter of an export duty on wood pulp.—The Paper Mill.

The New York Commercial, speaking of the undervaluation of goods entering the United States, says:—

"The total amount of St. Gall goods involved in the present discussion approximates \$6,000,000 per year, of which probably two-thirds is consigned by the St. Gall houses to their agents and branch houses here. If the goods are undervalued 50 or even 30 per cent. it means a loss to the Government of millions in revenue. For instance, if the merchandise is undervalued to the extent of one-third of the above amount, the \$2,000,000 is dutiable at about 60 per cent ad valorem, or a loss in revenue approximately of \$1,200,000 annually. But where some goods are undervalued 138 per cent, one can readily understand how much greater the loss would be if the abuse were not stopped.

Undervaluation is undoubtedly a bad thing, not only for the revenue but also for the honest importer, but the system comes to be absolutely unbearable when goods are undervalued to the extent of 138 per cent. One would naturally conclude that when 100 per cent. had been deducted from the value of an article it ceased to be of use as a means of raising revenue, but to rate it as being worth 38 per cent. less than nothing, indicates that the importation of such goods should be prohibited. But perhaps the Commercial is a little off in its figures.

Speaking of the forthcoming International Conference at Quebec, at which the question of commercial reciprocity between Canada and the United States will be discussed, The Buffalo Courier says:—

"Buffalo, like all of the frontier cities, is interested in several of these questions. The alien labor laws of this country have been a constant source of friction between our people and our Canadian neighbors. The transportation of merchandise in bond vitally affects some of the railways terminating here. The fishing privileges in the great lakes, and the question of maintaining naval vessels on the lakes are matters of local interest. But of far greater importance than any of these to Buffalonians is the formulation of equitable regulations relating to reciprocity of trade. While a few local industries may receive benefits as a result of the high protective wall erected between Canada and the United States by the Dingley law, it does not admit to question that Buffalo as a whole would profit by enlarged trade relations with Canada. Under the new order of things, Buffalo might become both a market town and a trading point for a much larger section of Ontario than heretofore.

No doubt about the benefits that Buffalo, and the United States generally, would receive, but the "trading point" for Canada should undoubtedly be in Canada.

Speaking of the recently discovered corundum deposits of Ontario The Toronto Globe says:—

We are rich in everything necessary to greatness except coal, and fortunately our lack in this respect is largely overcome by the magnificent water powers that will ere long give electric power for the processes of mining and reduction of our minerals. The discovery of corundum deposits gives Ontario another source of wealth scarcely less important than our unrivalled nickel fields. Corundum is the best known abrasive, and owing to its scarcity, emery, a much less satisfactory material, is used for grinding down and polishing metals in most of the world's machine shops. Of late an artificial substitute, carb. run. am, produced from carboniferous material by intense electrical heat, has been extensively introduced, and great works for its manufacture are now in operation at Niagara Falls, but Mr. Blue, Director of Mines, strongly believes that the natural product can more than hold its own in the market. The production of aluminium from the corundum deposits is an industry of huge possibilities, for if aluminium can be produced as cheaply as Mr. Blue evidently anticipates it will very largely displace tin in all industrial processes.

The following letter was written by the Hon. William Mulock, Postmaster-General of Canada, to Mr. C. Freeman Murray, the Secretary of the British Empire League,

OFFICE OF THE HIGH COMMISSIONER FOR CANADA,
17 VICTORIA STREET, LONDON, S.W.
July 13, 1898.

DEAR MR. MURRAY,—You will probably have learned from this morning's papers that our Postal Conference has had a most satisfactory termination, and I now avail myself of the

freedom, that I felt was not mine during the Conference, to speak my mind more freely.

I am satisfied that the work of the British Empire League, both in Canada and here, has been a powerful educational force in removing prejudices and brushing away difficulties in the way of the adoption of penny post within the Empire. I trust that the happy result of this Conference will serve as a further incentive to the League to continue their good work. The unanimity with which this morning's London Press speaks approvingly of the work of the Conference, shows that here, as in Canada, the unity of the Empire is now part of the national creed.

It would seem that the federation movement, like the development of the British Constitution, will go on steadily, perhaps at times almost imperceptibly, but yet always making safe progress.—Yours sincerely, (Signed), W. MULLOCK.

The Science and Art of Mining, a mining paper published in connection with the Wigan School of Mines, says: "Street car axles are being made at Krupp's works with seven to eight per cent. of nickel, as also hollow driving axles for locomotives. For fire-box steel as much as twenty-five per cent. of nickel is used." Less than seven per cent. of nickel does not seem to be thought of any value in the construction of locomotive axles. The growing use of nickel is another piece of good fortune that is falling to investors in Canadian mines.—Toronto Globe.

Yes, it is a piece of exceedingly good fortune to the Americans who have bought Canadian nickel mines, and who, notwithstanding their agreement made with the Dominion Government to refine the ore in Canada—are permitted to do the refining in the United States. It is a very great piece of fortune for the American capitalists, the American workmen who do the refining, and the American shipbuilders and other manufacturers who use nickel steel, and the men who do the work for the manufacturers. They get work and wages and profits, while the Canadians get nothing but the privilege of examining the hole in the ground where their nickel ore once was. It is simply abominable that the Laurier government should allow this state of affairs to continue when it is in its power to give Canada and Canadians the full benefit of the mining, the refining and the manufacturing of nickel and nickel steel, and the manufacturing, work, wages and profits incident to all manufactures in which nickel or nickel steel is used. Yes, to the shame of the Grit government and of the Grit party which supports it, the growing use of nickel is another piece of good fortune not shared by the Canadians, in whose hands the whole business should be.—Hamilton Spectator.

Mr. Pittar, the head of the statistical department of the Customs House, has just completed his annual volume on British trade. It appears that the total of British, foreign and Colonial trade has risen from £681,826,448 in 1893 to £745,203,078 in 1897. It is true that our export trade was less in 1897 than in 1896, but British exports have risen from £277,138,270 in 1893 to £294,174,118 in 1897. It is also noteworthy that whilst during the same five years our exports to foreign countries have increased $4\frac{1}{2}$ per cent., the increase to British possessions is nine per cent.—British Trade Journal.

Messrs. Pickford & Black, managing owners of the West India Steamship Lines out of St. John, N.B., and Halifax, N.S., will now have a steamer sailing from Halifax, N.S., about the first of every month for Cape Hayti, Kingston, Ja., Santiago and Guantanamo, and any other ports on the south

side of Cuba that may be open for business. And so soon as Havana is again open for trade they will have a direct steamer from Halifax to that port, as before the war. This is important information for merchants and others desiring to increase trade with the West Indies and Cuba.

As a result of the new Tariff arrangement between England and Canada, several Sheffield firms have opened branches in the Dominion, where many had agencies before, and it is hoped that the volume of business will be increased.—Hardware, Metals and Machinery, London.

We don't hear of any new agencies being opened by foreign manufacturer in the United States. Under the "new Tariff arrangement," in our country, foreign manufacturers are compelled to invest their money in the establishment of costly plants if they want to share in the benefits of the American market. It is different in Canada.—American Economist.

The British Parliamentary Committee appointed to inquire into the question of national wheat stores, recommends the appointment of a royal commission to deal with the matter, as the committee is impressed with the immense importance of Government wheat stores, as an essential item for national defense.

Discussing the operation of the Fielding tariff on the shirt and collar industry, The Galt Reporter says:—

"The Berlin factory employs over 450 hands. Its establishment twenty years ago was one of the direct results of the National Policy, from which the town has benefitted immensely in other respects. The impulse given the commercial interests of Berlin by the erection of the Williams, Greene and Rome factory, and its subsequent expansion into a mammoth industry, can scarcely be estimated by outsiders. Its establishment tended towards the creation in the town of kindred industries, as well as a sentiment inclining towards an aggressive factory policy. In all these things we find the secret of Berlin's growth."

The "Little Englander" is extinct in English politics. If you want evidence of the fact you can find it at every bye-election. In the recent contest at Gravesend, for example, the placards of the opposing candidates disclosed a welcome rivalry in devotion to the principle of a united Empire. Conservatives were adjured to

"Vote for Ryder and Federation with our Colonies; vote for Ryder, Empire and world-wide markets." On the other side the appeal was to "vote for Runciman and British trade, a strong Navy, Unity and Empire."

There may not be much to choose from here. But we can, at any rate, regard Mr. Ryder's return as ensuring the presence of another strong Imperialist in the House of Commons.—Canadian Gazette, London.

Several cities in the consular district of Cognac, which at present have no effective fire department, anticipate purchasing steam fire-engines. Cognac already has a fund for this purpose. Manufacturers should address M. E. Jouard, No. 1, rue Louise de Savoie, Cognac, Charente, France.

The importation of cycles into Straits Settlements would appear to be profitable under certain conditions. Last year Great Britain sold about \$70,000 worth of cycles there. High-class cycles would alone have any chance of success.

CANADIAN MANUFACTURERS' ASSOCIATION.

<p>President: J. F. ELLIS.</p> <p>First Vice-President: JAMES KENDRY, M.P.</p> <p>Second Vice-President: P. W. ELLIS.</p> <p>Treasurer: GEORGE BOOTH.</p> <p>Chairman Executive Committee: R. W. ELLIOT.</p> <p>Chairman Tariff Committee: W. K. McNAUGHT.</p> <p><i>The Executive Committee meet on the Second Tuesday of each month.</i></p>	<p>OFFICES</p> <p>McKinnon Building,</p> <p>TORONTO.</p> <p>Tel. 1274.</p> <hr/> <p>J. J. CASSIDEY, - SECRETARY.</p> <hr/> <p>THE OBJECTS OF THIS ASSOCIATION ARE:</p> <p>To secure by all legitimate means the aid of both Public Opinion and Governmental Policy in favor of the development of home industry and the promotion of Canadian manufacturing enterprises.</p> <p>To enable those in all branches of manufacturing enterprises to act in concert, as a united body, whenever action in behalf of any particular industry, or of the whole body, is necessary.</p> <p>To maintain Canada for Canadians.</p> <p>Any person directly interested in any Canadian manufacturing industry is eligible for membership.</p>	<p>CANADIAN INDUSTRIAL LEAGUE, <i>President,</i> JAB. KENDRY, M.P.</p> <p>WOOLL MANUFACTURERS' ASSOCIATION, <i>President,</i> BENNETT ROSAMOND, M.P.</p> <p>KNIT GOODS MANUFACTURERS' ASSOCIATION, <i>President,</i> JOHN PENMAN.</p> <p>CARPET MANUFACTURERS' ASSOCIATION, <i>President,</i> J. P. MURRAY.</p> <p>GLOVE MANUFACTURERS' ASSOCIATION, <i>President,</i> A. R. CLAIRK.</p> <p>REPRESENTATIVES TO TORONTO INDUSTRIAL EXHIBITION ASSOCIATION.</p> <p>R. W. ELLIOT. GEORGE BOOTH. W. K. McNAUGHT. A. F. KEMP. J. J. CASSIDEY.</p>
--	---	---

WHAT THE ASSOCIATION ADVOCATES.

The following resolutions were passed at the Twenty-Third Annual Meeting of the Canadian Manufacturers' Association held in Toronto, April 12, 1898.

THE NATIONAL POLICY.

Whereas, from its geographical position and commercial environment the prosperity of the Dominion of Canada depends largely upon the maintenance of a fiscal policy which will foster our agricultural, mining, commercial and industrial enterprises, and which will make the interests of Canadians paramount to those of foreigners; by preventing this from being made a slaughter market for the surplus products of foreign countries; and whereas, the observance of such policy gives confidence and stability to capital and enables our artisans to obtain wages far in excess of those which prevail in European countries, and which keeps them in the country by the payment of wages which enable them to live in comfort; and which provides a home market for many lines of agricultural products, which cannot be exported; a policy which also attracts foreign capital and inaugurates industries by inducing those who desire to participate in the benefits of our market to manufacture their products here; a policy which encourages and develops inter-provincial trade, and produces amongst the people a feeling of security, of national pride, and commercial and industrial independence, highly conducive to the welfare of the whole people, without which we can never attain to the emera of national prosperity; and whereas, the revival of the mining industry in this country has given an impetus, not only to agricultural, but to many other industrial enterprises, as nearly everything used or consumed in the mining regions has to be brought from outside sources;

Therefore, be it resolved, that this Association desire to again place itself upon record, that in its opinion the prosperity of this country imperatively demands the continuance of a fixed and definite policy of protection, from the general principle of which there shall be no deviation, in order that our agricultural, mining, commercial and other industrial enterprises may participate in its general prosperity.

PREFERENTIAL TRADE.

While heartily commending the Dominion Government for their desire to confine the scope of the Preferential Tariff exclusively to the Mother Country and the British Colonies, this Association is strongly of the opinion:—

- That our Preferential Tariff should not be extended to any colony, unless such colony accords to us a tariff preference in their market, equivalent to the discrimination allowed by us in its favor.
- Where our minimum Preferential Tariff is applied, the minimum rate of duty thereunder should be high enough to protect existing Canadian industries from the competition of countries having lower priced labor, cheaper raw materials and capital, and whose long-established industries give them great advantages over those of Canada.
- That although the minimum Preferential Tariff has already been extended to Great Britain without any corresponding preference to Canada, we would strongly impress upon the Dominion Government the necessity of obtaining reciprocal concessions from the Mother Country as speedily as possible.

CANADA'S COMMERCIAL AGENTS.

Following is the correct official list of Canada's Commercial Agents in Great Britain, British Possessions and foreign countries.

- J. S. Larke,** Sydney, N.S.W., agent for Australasia.
- G. Eustace Burk,** Kingston, Jamaica, agent for Jamaica.
- Robert Bryson,** St. John, Antigua, agent for Antigua, Montserrat and Dominica.
- S. L. Horsford,** St. Kitts, agent for St. Kitts, Nevis and Virgin Islands.
- Edgar Tripp,** Port of Spain, Trinidad, agent for Trinidad and Tobago.
- C. E. Sontum,** Christiania, Norway, agent for Sweden and Denmark.
- D. M. Rennie,** Buenos Ayres, Argentine Republic, agent for Argentine Republic and Uruguay.

In addition to their other duties, the undermentioned will answer inquiries relative to trade matters, and their services are available in furthering the interests of Canadian traders.

- J. G. Colmer,** 17 Victoria Street, London, S.W., England.
- Thomas Moffat,** 16 Church Street; Cape Town, South Africa.
- G. H. Mitchell,** 15 Water Street, Liverpool, England.
- H. M. Murray,** 40 St. Enoch Square, Glasgow, Scotland.
- Harrison Watson,** Curator Imperial Institute, London, England.

Following are some of the items of information given in the August "Bulletin" of the Canadian Manufacturers' Association:

CANADIAN MANUFACTURING INDUSTRIES.

"The nation that manufactures for itself prospers."

During the fiscal year ending June 30, 1897, the exports of Canadian manufactured products were valued at \$34,715,480, which was twenty-seven per cent. of the value of all exports of Canadian products for that year.

The destination of these manufactured products was as follows:—

Great Britain.....	\$15,295,087
United States.....	14,998,722
Franco.....	223,265
Germany.....	149,174
Other Foreign Countries.....	3,210,410
Newfoundland.....	566,464
British West Indies.....	272,358
Total.....	\$34,715,480

CANADIAN EXPORTS OF MANUFACTURES.

The manufactured articles exported from Canada in 1897 and their respective values were as follows:—

Articles.	Value.
Agricultural Implements.....	\$761,842
Books.....	80,549
Bread and Biscuits.....	16,530
Carriages, Carts, Wagons and parts of.....	44,723
Bicycles, and parts of.....	312,805
Cottons.....	915,327
Clothing, Hats and Caps.....	43,934
Cordage, Junk and Oakum.....	125,701
Furs.....	12,560
Glass.....	7,208
Gypsum and Lime.....	75,430
Extract of Hemlock Bark.....	97,483
Explosives, etc.....	76,578
Household Effects.....	945,855
Iron, Scrap.....	5,030
Iron and Hardware.....	336,736
Leather.....	1,414,584
Boots and Shoes.....	97,148

Machinery	166,868
Musical Instruments.....	399,715
Oil-Cake.....	195,039
Rags.....	78,564
Sewing Machines.....	14,354
Stone, Wrought.....	4,983
Salt.....	1,168
Soap.....	15,114
Sugar.....	76,235
Tow.....	84,728
Tobacco, Snuff and Cigars.....	68,602
Woolens.....	47,884
Wood, Manufactures of.....	26,844,461
Ale and Beer.....	6,832
Whiskey and other Spirits.....	450,702
Ships sold to other countries.....	105,164
Other articles.....	755,034
Total.....	\$34,715,480

WHAT ARE MANUFACTURED PRODUCTS?

The classification of "Manufactures" given in the preceding table is that prepared by Mr. George Johnson, Dominion Statistician, which, it is proposed, shall be adopted by the Canadian Government in publishing official returns in the Trade and Navigation Returns and other Blue Books. The list includes quite a number of articles that have never before been classified as "Manufactures," and while the change is undoubtedly in the right direction, there are many who think that it has not gone far enough. Under this classification in the item "Wood, Manufactures of," is included blinds, doors and sashes, matches, mouldings, pails, tubs and churns, spools, wood pulp, etc., that had previously been classified as "Products of the Forest." The change is obviously a proper one, but there are other changes that might have been made with equal propriety, and which should be made. Thus "The Mine" is credited with pig or ingot copper, and with pig lead, which are not taken from the earth, although the ores from which they are smelted are; and the same may be said of nickel matte and also refined oil. Such articles should be credited to "Manufactures" but are not. So also regarding "The Fisheries" under which is credited canned fish and lobster, fish oil, and the furs of marine animals. Under the old classification "Animals and their Products," which it is not proposed to change, are enumerated butter, cheese, dressed furs, grease, lard, meats, canned meats, lard oil and tallow, while under the classification "Agricultural Products," are enumerated balsam, bran, cider, flax, dried and canned fruits and vegetables, malt, maple sugar, flour of wheat, buckwheat, oatmeal, etc. All of these articles were subjected to manufacturing processes, and many of them fully prepared for final consumption, and yet they are located in classes that indicate the expenditure of the smallest possible amount of unskilled labor. Many of these articles represent the investment of large capital in factories and the employment of highly skilled labor, and should be classed as "Manufactures."

THE CANADIAN MARKET.

The Canadian market is the best that Canadian manufacturers have access to; and that the possibilities of it have not been exhausted is demonstrated by the fact that every year Canada purchases from other countries many million dollars worth of merchandise that could with good advantage have been made at home.

It is one of the objects of the Canadian Manufacturers' Association to direct attention in this direction, and to show from the official returns, the many different articles imported into the country, the value of them, the sources from whence they come, and the reasons why such articles could be produced in Canada by Canadian manufacturers employing Canadian labor. Some of these facts will be of a surprising character. There are many articles that the Canadian people

require for their comfort and convenience that cannot under any possible circumstances be produced at home, and of course these must be imported from whatever country they can be procured to best advantage. There are many other articles, however, that are imported, the production of which gives employment to both capital and labor in other countries, that could to good advantage have been produced at home, giving employment to Canadian capital and labor. Some of such articles are not now produced in Canada at all, and it is an object of the Association to point out the circumstances under which such articles can be produced at home to good advantage. There are other articles that are produced in Canada of quite as good quality and style, and at as low cost, as similar imported articles, yet which are not produced in sufficient quantity and variety to fill all the demands of the home market; and it is an object of the Association to direct attention to these more or less unnecessary imports, and the extent and value of them, and to show how Canadian manufacturers might more fully occupy the market with their products.

Every manufacturer in Canada is personally interested in this matter of supplying the home market.

THE FOREIGN MARKET.

The development of some of our Canadian industrial enterprises has reached a point where they successfully compete in the markets of the world, and this is emphasized in the fact that the value of the exports of Canadian manufactured products is more than twenty-seven per cent. of the value of all the exports of the whole Dominion.

By reference to a tabulated statement, shown in another page, it may be learned just what lines of manufactures were exported in 1897, and the table does not include such articles as pig copper, and pig lead, gold and silver bullion, canned fish, lobsters, and oysters, butter, cheese, lard, canned meats, pork, bacon, sausage, lard oil and tallow, flax, dried and canned fruits and vegetables, malt, etc., all of which might with propriety have been included in the list.

A question that is presented for the close attention of every Canadian manufacturer and producer is: "Can I engage in this export business, and to what extent?" It is an object of the Canadian Manufacturers' Association to give reliable information in this direction; and the bulletins issued by the Association contain the gist of the reports made to their several governments by the commercial and consular agents of Canada, Great Britain and the United States, and from other sources. Canada maintains agents in Australia, Jamaica, Antigua, St. Kitts, Trinidad and Buenos Ayres, who make frequent reports to the Department of Trade and Commerce concerning the conditions of trade in those countries, and with whom any of our manufacturers can correspond at any time. Both the British and the United States Governments maintain consular and commercial agents in about every important commercial city in the world, and their reports are published regularly and frequently, and are sent to this Association as soon as published. These reports contain information of as much value to Canadian manufacturers as to those of Great Britain and the United States, where they relate to conditions of trade and in showing the opening for business in lines in which our manufacturers desire to participate.

CANADIAN IMPORTS FROM THE UNITED STATES.

Figures giving the total imports into Canada from the United States for the fiscal year ending with June 30, 1898, are not yet available, but the following table, compiled by the United States Department of State, includes all the leading exports from that country into Canada except iron and steel, and gold and silver. It covers the ten months ending April 1, 1897 and 1898 respectively. In 1897 the exports to Canada, of gold and silver and manufactures thereof, aggregated

\$5,267,576, and of iron and steel and manufactures thereof \$6,441,681.

Articles.	1897.	1898.
Agricultural implements.....	\$291,107	\$542,364
Animals.....	566,432	1,806,479
Books.....	517,078	596,629
Breadstuffs.....	7,229,653	11,015,263
Carriages and vehicles.....	100,668	142,523
Bicycles.....	528,515	418,025
Clocks.....	307,900	266,649
Coke and coal.....	7,433,275	7,746,990
Cotton.....	2,792,895	3,771,132
Manufactures of.....	2,752,798	1,944,842
Copper.....	32,500	100,618
Fertilizers.....	80,192	89,652
Fruits and nuts.....	614,675	898,653
Furs and skins.....	228,602	350,014
Hides and skins.....	805,361	414,077
Instruments (scientific).....	235,793	256,935
Hardware.....	438,556	581,345
Sewing machines.....	76,392	117,695
Typewriters.....	26,417	43,288
Leather and manufactures of..	757,531	807,240
Naval stores.....	106,486	80,590
Oil cake.....	91,704	152,579
Oils.....	635,194	663,249
Paper.....	51,243	84,902
Provisions.....	311,089	162,697
Hog products.....	1,329,166	2,047,710
Dairy products.....	217,925	501,347
Seeds.....	624,669	467,495
Tobacco.....	1,421,177	611,674
Manufactures of.....	55,357	52,664
Wood and manufactures of....	1,677,904	2,029,729
Wool.....	276,071	16,461
Total.....	\$32,614,325	\$38,801,410

It will be noticed that twenty-three out of the thirty-two articles enumerated show an increase, some quite marked, and the total is nearly a twenty per cent. advance over the same period of 1897, although that was the banner year in exports from the United States to Canada, there being an increase from \$44,858,039 in 1886 to \$64,334,800 in 1897.

British exports to Canada of iron and steel aggregated \$3,157,384 in 1897; the United States in this line, \$6,441,681. But makers of iron and steel in the United States have recently demonstrated their ability to undersell Great Britain in her own markets, so the bulk of the Canadian trade can probably be counted upon to be drawn from the United States.

In cotton and manufactures thereof, Great Britain sold Canada in 1897 to the value of \$3,551,560, while the United States sold \$5,545,693. But Canada is now manufacturing her own cottons, and as will be noticed from the table given, the imports of raw cotton from the United States this year show quite an increase, while the imports of manufactures of cotton show a marked decrease.

In breadstuffs, coke and coal, hog products, dairy products, seeds, tobacco and lumber, England does not compete with the United States. The total imports under this head from the United States for ten months of 1898 reached the enormous sum of \$24,472,872, while Great Britain's entire exports to Canada in 1897 only amounted to \$33,157,234.

Canadian manufacturers would do well to study this trend of trade. In ten of the items enumerated the value of the imports was less in 1898 than in 1897, to wit, bicycles, clocks, manufactures of cotton, hides and skins, typewriters, naval stores, provisions, seeds, tobacco, manufactures of tobacco and wool. The decrease in the imports of hides and skins was not due to a falling off in the demand, but rather because it was supplied from other sources. The decrease in imports of naval stores is only some \$26,000, and in manufactures of tobacco \$2,700, but the decreases in imports of bicycles, \$110,490; manufactures of cotton, \$1,807,956; provisions, \$148,392 and seeds, \$157,174, show that in these articles the production in Canada is fast catching up with the demand. It is noticeable that in less than one year Canada should have almost ceased from purchasing wool in the United States.

The other items in the table show where Canadian manufacturers have much to do to supply all the demands of the country for agricultural implements, breadstuffs, carriages, copper, fertilizers, fruits, furs, hardware, sewing machines, typewriters, leather and manufactures of leather, paper, hog and dairy products, etc.

CANADA'S TRADE WITH THE UNITED STATES.

According to the returns of the United States Bureau of Statistics the trade interchanged between Canada and that country in the fiscal years named was as follows :

	From Canada to United States.	From United States to Canada.
1893.....	\$37,777,463	\$46,794,331
1894.....	36,790,916	56,664,094
1895.....	36,574,327	52,854,769
1896.....	40,787,565	59,687,921
1897.....	40,309,371	64,928,821

This shows that last year Canada bought goods of the United States valued at \$13 per head of our population, while the goods that we sold there was valued at only \$8 per head. A large portion of Canada's purchases from the United States consisted of articles that we might have made at home, while our sales were of articles that that country was obliged to have.

CANADIAN FRUIT PULP.

Mr. Harrison Watson, Curator of the Imperial Institute, London, England, whose services are always available in furthering the interests of Canadian exporters, has forwarded a communication from an importing house in that city to the Ontario Department of Agriculture in which is discussed the opportunities for supplying the British market with fruit pulp—that is, fruit that has been subjected to partial cooking and put up in tins without the addition of sugar. Speaking of raspberry pulp the letter says:—

"This is an article in very large consumption here and this is a particular season in which we think your friends (if large quantities are grown in Canada) would do well to make a trial shipment. We have had considerable quantities from Australia. Some three years ago we had several tons, but since then, owing to the dry weather, their crops have not been large enough to enable them to ship. The form in which this is put up in Australia is either in cases, each containing two 45-lb. square tins, or ten 11-lb. square tins, gross weight. The Australians have generally packed in the square tin, as it makes a little difference in the freight in consequence of tins taking up more room, but the bulk of the pulp which we receive from the Continent, which is mainly apricot, is generally shipped in the round tins, and these, we think, are more suitable for carrying, as the square tins are apt to crack at the edges and corners, which creates leakage. We cannot tell you how long the raspberry is cooked in the process, but no water must be used, the fruit only being put into the tins and only sufficiently cooked or heated to create the necessary vacuum. A great object with this article is good color and firmness of fruit, and you will understand that no sugar must be added, but only the fruit itself packed. We should estimate that the value to-day would be roughly about £30 per ton, gross, in tin, ex-wharf, London. As it is now getting late in the year there is not much chance of your friends packing any this season as they would probably not have the tins ready for use, but if any of them would like to pack a small quantity, say a few cases, and send them forward simply as a trial, we would very soon advise them as to whether the article was of the right nature, and then matters would be ready for another season. In a year like the present, when a rather short crop is expected here, and that following an exceptionally short crop here last year, we would probably very easily dispose of four or five hundred tons. Last year the crop was so light that in January and February if we had had any pulp here we might have obtained £50 to £60 per ton for it."

Mr. Watson also speaks of enquiries he has received from merchants in Hamburg, Germany, relative to the possibilities of Canadian trade in dried and evaporated fruits with that country. They say in their communication to him:—"Of late years evaporated apples, apricots, pears, etc., have become largely consumed in the country (Germany), and of these the former take the first place. We are thoroughly convinced that your country might get a large share of this trade if properly taken in hand. We cannot impress upon you too strongly that apples be dried only in wooden trays, and not in zinc ones; for all apples, according to our laws, must be analysed here by sworn chemists on arrival, and should a trace of zinc be found, which could only be the case were they dried on zinc trays, then buyers are free to cancel their contracts, for they are not allowed to be consumed here. The evaporated apples imported here are packed in boxes of fifty pounds, English, and barrels of 200 pounds, English, and ninety per cent. of them are of the prime grade. Shipments are also made of choice and fancy packings."

The Canadian Manufacturers' Association will take pleasure in obtaining further information regarding these openings for export trade for any of our manufacturers who will express a desire for it.

BARLEY MALT IN SOUTH AFRICA.

All of the barley malt used in South Africa is purchased through commercial houses in London, England. It is shipped both in bags and tanks. The bags are made of double thickness of heavy sacking. The tanks are of sheet iron of about No. 24 gauge. The weight of the malt contained in either sacks or tanks is 200 pounds net. Much of the barley used in London for the manufacture of malt is grown in the United States, that from California being highly esteemed. The value of the imports of barley malt into South Africa during 1897, amounted to \$178,848, of which 80 per cent. was from Great Britain and 20 per cent. from Germany. Canadian barley malt should find a good market in South Africa, but the quality in demand and other conditions of the market should be known before any shipments are made.

BELGIAN EXPORT ASSOCIATION.

An association has recently been formed in Belgium to encourage the exportation of the products of that country. The organizing members represent Belgium's greatest industries. The object of the association is to establish a permanent office for the purpose of collecting in foreign countries, either directly or through the intervention of diplomatic and consular agents, such information as creating markets for Belgian products, grants for railways, tramways, lighting, private and public works in general, and contracts of all kinds; transmitting such information as may be of interest to members; also to establish a sample exhibition where goods manufactured by members in view of exportation will be admitted on payment of space rent. A special bureau annexed to this exposition will furnish all necessary explanations to foreign visitors, and put them in touch with interested manufacturers. There will be organized a bureau giving information as to means of transportation, freight, exchange, custom duties, commercial usages of importing countries, as well as all other trade information. It is also designed to create agencies—commercial and financial branch houses in foreign countries.

The headquarters are at Brussels. Any person engaged in industry or manufacture in Belgium may become a member. The association is subdivided into fourteen groups, according to the nature of the various manufactures. Members may be enrolled in one or more groups, but pay an additional fee for each registration.

The annual fee is \$19.30 for individual members and \$38.60 for corporations. Admission to membership implies

the obligation to remain a member for the first five years and subsequently for terms of three years.

CANADA'S PREFERENTIAL TARIFF.

By the terms of the preferential tariff of 1897 a reduction of 12½ per cent. took place on April 23rd of that year, and of an additional 12½ per cent. on July 1, 1898, making the full 25 per cent. on all goods entitled to the lower rate of duty, either by reason of their British origin, of reciprocal tariffs or of favored-nation clauses. In addition to British goods the following countries were admitted by the reciprocal character of their tariffs:—New South Wales, British India, the Netherlands and Japan. The goods of Germany and Belgium were admitted under the treaties of those countries with Great Britain, and the goods of almost twenty other foreign countries came in under favored-nation clauses. Imports from France, Algeria and the French colonies were admitted under the French treaty, which had received the sanction of the Canadian Parliament, but all others came in under British treaty stipulations in the acceptance of which Canada never had any say. With the determination of the Belgian and German treaties the claims of other foreign nations under most-favored-nation clauses to preferential treatment ceased, and nothing stands in the way of the restriction of the preference to Great Britain and the British colonies. During the month of July the 25 per cent. reduction was applicable to the goods of Great Britain and also to all the favored nations above referred to.

The British preferential tariff, which went into effect on August 1st, applies to the United Kingdom of Great Britain and Ireland, Bermuda, the British West Indies, British Guiana and any other British colony or possession the customs tariff of which, on the whole, is as favorable to Canada as the British preferential tariff is to such colony or possession. Under this clause the goods of British India, Ceylon, the Straits Settlements and New South Wales are entitled to the preference. The tariffs of the British West Indies, while in no sense protective in their character, are not such as to entitle those islands to rank under the preferential tariff, but Canada, in view of the depressed condition of those colonies, has made an exception in their case and has accorded them, without exacting any reciprocal concession, the benefit of the reciprocal tariff. Canada's principal importations from the West Indies are sugar and fruit, and as we receive those commodities we may be expected to send back food products in large quantities, such as they have formerly been in the habit of purchasing from the United States, particularly flour. A change has been made in the sugar duties which it is hoped will result in benefit to the West Indies. The old flat specific duty operated against low grade sugars such as come from the West Indies, but by the adoption of another system the importation of sugar from those islands will be facilitated. On 92 degree sugar, which is the average test of raw sugar imported from the West Indies, the duty is 62½ cents per 100 pounds, as against 50 cents under the old tariff, but the 25 per cent. reduction under the preferential tariff will make the duty on West Indian sugar 49½ cents, as against 62½ cents coming from foreign countries. Sugar refined in countries entitled to the benefit of the preferential rate will not be admitted unless it is grown within the British possessions. Canada's consumption of sugar is 300,000,000 pounds per year, of which she received, under the old tariff conditions, 25,000,000 pounds from the British West Indies and British Guiana. A large increase in this importation may now be looked for. The preferential rate on sugar will also apply to New Zealand, Fiji and Mauritius for the special benefit of the western refiners. Manufactured articles to be admitted under the preferential tariff shall be bona fide the manufactures of countries entitled to the benefits of such tariff, and such benefits will not extend to the importation of articles into the production of which there has not entered at least 25 per cent. of the labor of such countries. The final value of goods

admitted from Great Britain must represent at least 25 per cent. of British labor.

Preferential tariff regulations and general regulations as to invoices and entries of goods have been issued to collectors of customs. The following refer to entries under the preferential clause:

An invoice duly certified as prescribed by the regulations must be produced and delivered to the collector before the entry of any importation under the British preferential tariff shall be allowed; provided, however, that certificates endorsed on postal packages not exceeding \$25 in value, the contents of which are not merchandise for sale, may be accepted as evidence of the origin thereof.

A separate invoice must be furnished for goods entitled to entry under the preferential tariff, and the certificates required must be written, printed or stamped on the invoice.

The preferential tariff does not apply to any of the following articles, viz.: Wines, malt liquors, spirits, spirituous liquors, liquid medicines and articles containing alcohol, tobacco, cigars and cigarettes.

Goods entered under the preferential tariff must be imported direct from some one of the countries entitled to preference.

Goods passing in transit from one country through an intermediate country to Canada may be deemed to be imported direct when the goods have been originally destined for Canada from the first mentioned country, subject to production of bills of lading and other documents.

All invoices of sugars for entry under the preferential tariff are required to have marked thereon distinctly in writing that the sugars are raw or refined in each case, as the facts may be.

Any article entered at a reduced rate of duty under the "French treaty act, 1894," shall not be entitled to a further reduction of duty under the provisions of the British preferential tariff of Canada.

There will be an enforcement of section 35 of the customs act, which applies to all importations into Canada, including importations from the United States. It is as follows:—

"Every invoice of goods imported into Canada shall be certified in writing as correct by the person, firm or corporation selling or consigning the goods, and shall truly show the whole and actual value of the goods in the currency of the country whence the goods have been exported directly to Canada, and the quantity and description of such goods, and the marks and numbers on the packages, in such a manner as to indicate truly the quantities and values of the articles comprised in each exportation package, all of which packages shall be legibly marked and numbered on the outside when of such a character as to enable such marks and numbers to be placed thereon."

Postal packages and small importations of goods not exceeding \$25 in dutiable value may be entered on the special entry form for "Small collections" or "postal parcels" upon the declaration of the importer or his agent.

THE RUSSIAN TARIFF.

The British Board of Trade has received a copy of a despatch from Her Majesty's Ambassador at St. Petersburg intimating that certain changes have recently been made in the Russian Customs tariff with respect to the import duties leviable on agricultural machinery and implements. The alterations are as follows:—Portable engines with threshers of a complicated system to pay fifty copecks gold per pood (1s. 11d. per cwt.) instead of one rouble twenty copecks as hitherto; sheaf-binding reapers, steam threshers with drums not less than four and one-half feet in width and with joints not less than forty inches in width, hay scatterers, horse rakes, sorters with spiral wire cylinders, potato sorters, machines for scattering manure in powdered state, crushers, centrifugal cream separators with their parts, and all newly-invented and improved agricultural machines and implements

intended for experimental stations and museums to be admitted free of duty. Parts of the foregoing machines and implements are also to be admitted free. Parts of all other agricultural machines and implements to pay fifty copecks gold per pood.

FREE CATALOGUES.

Collectors of Customs throughout the Dominion have been notified by the Customs Department that bona fide catalogues and price lists of goods for wholesale in any country beyond the limits of Canada, not exceeding three to one address, may be admitted through the mails free of duty, provided that the catalogue and price list shall not be held to include almanacs, and advertising periodicals, or printed matter, designed to advertise the sale of goods by any firm in Canada. They have also been notified that the products of Belgium and Germany are not to be entered under the provision of the French Treaty Act, on and after August 1st.

BICYCLES IN SPAIN.

The bicycle trade is, comparatively speaking, in its infancy in Spain, but the demand for machines is yearly increasing. It is estimated that about 20,000 machines were sold in Spain during the last twelve months, of which about one-third were of British origin, the rest coming from France, Germany and United States. There is a demand for very light machines. It would appear that the Continental makers do all they can to push the sale of their machines by establishing branch houses, advertising extensively, and by arranging for professional riders to appear at races on machines made by their employers. British firms, on the other hand, will only deal with their agents as merchants, that is to say, the agents must buy the machines out and out, and bear all the expense of advertising, etc. Very few machines are made in Spain.

Before Building . . .

everyone should know the economical advantages offered by using our

METALLIC CORNICES

SHEET METAL FRONTS

ETC.

They give durable, fireproof satisfaction. Make old buildings look like new at slight expense, and are invaluable for use in all new up-to-date structures.

Send for our new Catalogue for interesting information.

We make any Pattern, Shape or Size desired.

METALLIC ROOFING CO., Limited,
1181 KING STREET W., TORONTO.

AXES IN GUATEMALA.

The British Consul at Guatemala writes:—Axes are supplied from the United States. Prices and samples of these might be had for manufacturers to work to. I am seriously informed that one of the chief reasons why American axes are preferred to British is because the former are made with round holes or eyes for the handle, while those of British make have their eyes or holes oval-shaped. The Indian when he breaks the handle of his axe, chops off a branch of a tree, fixes it in the axe head, and goes on with his work, whereas if the hole be oval a certain amount of paring and trimming is required to shape the stick to the hole into which it must be fixed. This is a very small matter, and it might surely be worth the while of manufacturers to look to and remedy.

ELECTRIC LIGHTING AT SPEZIA, ITALY.

The municipality of Spezia has under consideration a project for lighting the principal streets of the town by electricity, and for laying down the requisite plant. The naval dockyard, its buildings, and establishments are lighted by electricity, and so are a few private houses in the immediate vicinity of two private stations fitted with "Otto" gas engines, but the town itself is lighted by gas.

CUTLERY IN THE PHILIPPINE ISLANDS.

All, or nearly all, the cutlery sold in Manila comes from Germany and England. German goods, introduced there under English marks, have nearly controlled the market of late years, thanks to their cheapness, if not to their quality. The principal firms selling cutlery there are as follows:

Bazar Filipino, Messrs. Warlomont Freres; La Puerta del Sol, J. F. Ramirez; Bazar Vilasco, Calle Nueva; Estrella del Norte, Levy Hermanos; Ullmann Freres, Calle de la Escolta; Greilsammer Freres, Calle de la Escolta; Pierre Blanc, Calle de la Escolta.

GRINDING MILLS IN GUATEMALA.

There is a demand in Guatemala for small cattle mills used by the natives on small plantations. These are of very light construction (thus ensuring low duties), and are very cheap. The mill most used there of this description is made at Buffalo, N.Y. A small mill is also used for grinding corn and for making tortillas, made in the United States, and costs about \$10 gold.

PNEUMATIC TYRES AND BICYCLES IN RUSSIA.

Pneumatic tires are classified in the Russian Customs Returns under "manufactures of rubber," so that it is not possible to say exactly what the imports into the Empire really are. The annual imports of rubber goods amount to about 2,000 poods, representing a value of from 90,000 to 95,000 roubles. The principal countries of origin are Germany and England. German pneumatics cost wholesale in St. Petersburg from 20 to 24 roubles per pair, according to quality, air chamber included. In any case pneumatics adhering to the rim would not suit the country, where roads are bad and accidents frequent. The Customs authorities have made a special rubric for bicycles which show that the imports amounted to 10,000 cycles, value 1,248,000 roubles. Most business is done in March and April. The sales are increasing every year.

E. A. WALLBERG, C.E.,

Bell Telephone Building, - MONTREAL, QUE.

HEAD CANADIAN OFFICE FOR

KINGSLEY WATER TUBE BOILERS

*Manufactured in Montreal,
Ottawa and Toronto.*

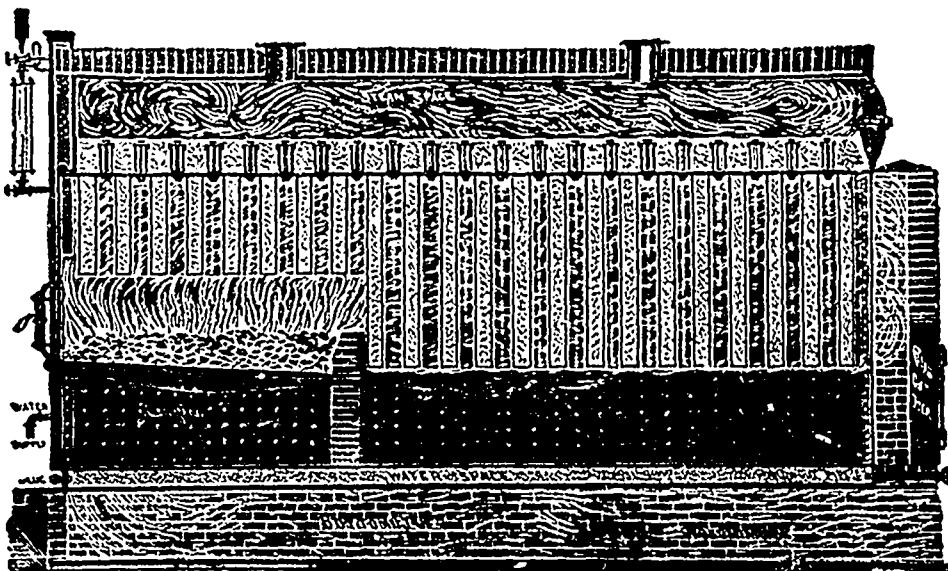

*For Steam, Power
and Hot Water
Installations...*

*The Most Economical Boiler,
and the Cheapest, when
based on Evaporat-
ing Capacity.*

Can be installed in any Basement,
requiring only 6½ feet in height.

GUARANTEED: A Saving in Fuel of 20 per cent. over Return Tubular Boilers.
A Saving in Fuel of 50 per cent. over any Cast Iron Heater.

...Catalogue Free.

CAPTAINS OF INDUSTRY.

The following items of information, which are classified under the title "Captains of Industry," relate to matters that are of special interest to every advertiser on these pages, and to every concern in Canada interested in any manufacturing industry whatever, this interest extending to supply houses also.

If a new manufacturing enterprise of any kind is being started, or an electric lighting plant instituted, or an electric railroad, or a telephono, or a telegraph line is being constructed; or a saw mill, a woolen, cotton, or knitting mill; or if any industrial establishment has been destroyed by fire with a probability of its being rebuilt, our friends should understand that possibly there may be something in the event for them. Do you catch on to the idea?

The starting of any such concern means a demand for some sort of machines, machinery, or supplies, such as steam engines and boilers, shafting, pulleys, belt-ing, lubricants, machinery supplies, wood or iron working machinery, ventilating and drying apparatus; pumps, valves, packing, dynamos, motors, wire, arc and incandescent lamps, and an infinite variety of electrical supplies, chemicals, acids, alkalies, etc. It is well worth the while of every reader of the Canadian Manufacturer to closely inspect all items under the head of Captains of Industry.

George E. Tuckett & Sons Co., Hamilton, Ont., will erect a new factory adjoining their present premises. The building will be of brick, 76x52 feet, three stories high.

The Crow's Nest Pass Coal Co., Coal Creek, B.C., have placed an order through their manager, Mr. Wm. Blakemore, with the James Cooper Mfg. Co., Limited, Montreal, for two miles of 6 inch pipe line, and a boiler, engine and mill plant.

Mr. Johnston's sawmill near Dumbarton Station, N.B., was destroyed by fire a few days ago.

Mr. Tegart will erect a sawmill near Golden, B.C.

R. E. L. Brown has purchased the Bell sawmill property and timber rights at Kalso, B.C.

The Ottawa Mining and Milling Co's sawmill at North Bend, B.C., was recently destroyed by fire.

Black & Co., Fergus, Ont., are building a new planing mill.

A vote will be taken on a by-law at Stratford, Ont., regarding the erection of a new city hall, which will cost \$28,000.

The Chatham Oil Company are punching down another hole west and south of their gusher on the Herbert farm. Their gusher is now doing about 40 barrels per day, pumped with a gas pump. The company also has two other small producers on the same property.

Tenders will be received for the identical reconstruction of the Clifton House, recently destroyed by fire at Niagara Falls, Ont.

Gotfrid Monpetits' sash and door factory at Coteau Station, Que., was destroyed by fire July 27th. N. Bray's carriage factory at the same place was also burned.

Gilmour's lumber mills near Campbellford were destroyed by fire a few days ago.

James Robson & Sons, Oshawa, Ont., have purchased the Cedarvale works and will convert it into a tannery. The finer kinds of colored leathers will be manufactured and over 100 men employed the year round. It is probable the Oshawa Electric Railway will extend their tracks to the works.

The London, Eng., correspondent of The Paper Mill says:—Some time ago there was quite a spurt in the exportation of Canadian paper to this country, and it was predicted that a regular trade would be established. As a matter of fact, very little paper is received at British ports from Canada, although with the extra production that will shortly be on the market there is no doubt but that the British market will be more energetically cultivated in the near future. Last year the total value of all classes of papers supplied to this market by Canada was only £11,831. There is an improvement, however, compared with the previous year, when the value was £8,360. The annual value of the exportation of British paper to Canada is between £40,000 and £45,000.

Messrs. Robson & Co., Brantford, Ont., have secured an option on the old brewery at that place and will convert it into a roller flour mill. The mill will have a capacity of 500 or 600 barrels a day. This will mean an outlay in machinery of not less than \$20,000.

The Centaur Mfg. Co., Chicago, appreciate the fact that all manufacturers, as also all other business concerns, require the use of horses in their business, and knowing that humanity to these faithful servants requires that their comfort shall be well looked after, are manufacturing a number of indispensable articles including in which are Centaur ventilating collar pads, Centaur spring curry combs, horse felt goods of all descriptions and other harness and hardware specialties. A merciful man is merciful to his beast.

The Ashcroft Water, Light and Power Co., Ashcroft, B.C., will erect a power house on the Bearpaw River and install an electric light and power plant.

The Royal Electric Co., Montreal, will install electricity into the works of the Dominion Cotton Co., Montreal. The contract calls for 1,500 horse power with the option of increasing it to 3,000.

The ratepayers of Prescott, Ont., will vote on a by-law to authorize the Town Council to put in a waterworks system.

The Liberty Mining Co., with headquarters at Rosland, B.C., have installed an Ingersoll-Sergeant piston inlet compressor with full complement of drills, etc., having purchased this through the Rosland branch of the James Cooper Mfg. Co., Limited.

The extension to Messrs. Wm. Paterson & Co's biscuit factory at Brantford has been completed. The building is 70x52 feet, three stories high. Special machinery has been received from England, including an oven 50 feet long by 10 feet wide. The new department will be in operation by September, and will engage 40 more hands. Total cost about \$16,000.

Mr. Joseph Boyden, Ottawa, will build a hotel at that place. The building will be six stories high and have all the latest improvements.

The Safety Light and Heat Company manufacturers of the Cliff-Wardlaw Acetylene Gas Generators, Dundas, Ont., write us as follows:—Dear Sirs, we have had several enquiries from our ad. in the CANADIAN MANUFACTURER, and if the orders materialize as we anticipate, we will be more than pleased at the result of our decision to advertise with you. We are to-day installing a twenty-five light plant for Mr. C. W. Papst, at Seaforth, Ont., next week a large machine in a Hamilton suburban residence, and so it goes on. There is no doubt that we have the machine that is wanted by the people, clean, safe and the only really automatic machine in the market.

INGERSOLL-SERGEANT Rock Drills

FOR MINES, TUNNELS AND QUARRIES

PISTON INLET Air Compressors

STRAIGHT LINE
DUPLEX and
COMPOUND.

FOR ALL DUTIES.

... COMPLETE MINE EQUIPMENT ...

JAMES COOPER MANUF'G CO., Limited, - 299 St. James St., Montreal.

Other Offices - - - ROSSLAND, B.C. RAT PORTAGE, ONT. HALIFAX, N.S.

Application has been made by C. S. Drummond, representative of the British Traction Co., London, Eng., to the City Council at Nelson, B.C., for a thirty year charter to run an electric street railway in the Kootenays. The city to have the privilege of purchasing the line under certain specific conditions. Instructions were given to the City Clerk to notify Mr. Drummond that the Council was favorably disposed towards the plan and that the franchise requested would be granted as soon as terms could be agreed upon. The British Electric Traction Company is said to be a strong corporation and amply able to carry out any undertaking it may enter into.

The Crystal City Flour Mill, Crystal City, Man., will build a new grain elevator in connection with the mill.

The Thompson Valley Power Co., Kamloops, B.C., has been incorporated with a capital stock of \$25,000 to utilize the water-power of the North Thompson River, B.C.

Amidst all the fluctuations and changes which time brings in trade and manufactures, the Cobourg Matting Factory has unwaveringly continued active operations since it came into the hands of William Mitchell, whose carefulness and diligent application to business has continued to advance the capacity and importance of this manufactory. And at the present time the products of the Cobourg Matting Works rank with the best on this continent. Not only in workmanship and faultless finish, but in texture and beauty of design as well. In the sample room may be found almost exhaustless piles of new and old designs in endless variety, for mats, matting and carpets, in hemp, jute, cocoa, and all wool, as well as of mixed material. In

the shipping rooms large consignments were being packed and prepared for shipment. Mr. Mitchell has lately imported at large expense a very fine loom, with all modern improvements, from Dundee, Scotland, which enables him now to turn out some of the best and most sought for articles. From year to year, as demand increased, the machinery and capacity of this flourishing manufactory has been added to, until it now stands unrivalled as one of its kind on this continent. Owing to the Spanish-American war having had a disturbing effect in the markets upon the material used in the Matting Works, Mr. Mitchell has made much larger purchases this year than usual, and we found the spacious store rooms packed to overflowing, so that if there should be an appreciable rise in the fibre used, this factory will not be affected for some time. This concern gives employment to a large number of operatives. *Cobourg Sentinel Star.*

The Miller Bros. Co., Montreal, have applied for incorporation with a capital stock of \$300,000 to manufacture paper, wood and straw pulp, etc.

A rather unusual whaling venture has been started in Newfoundland, under the management of Mr. Neilson, late Superintendent of fisheries at St. Johns. The company is called the Cabot Whaling Company. A small steamer was built in Norway, manned with experienced Norwegian whalers, and fitted up with all the modern improvements for whaling. It arrived at St. Johns a short time ago, and after landing some cargo and coaling, began operations about the mouth of Conception and Trinity, not far from St. Johns. Although the whaling business in most waters seems to

have died out, in a week or ten days she had brought in no less than seven whales ranging from sixty to 100 feet in length, of the fin-back and sulphur-bottom species. This extraordinary success has made quite a sensation, and it seems to have been proven that there are immense numbers of whales around the coast, and that the Norwegians know how to capture them. These whales are not nearly so valuable as the Greenland or "right" whales, because the bone in their mouths is an inferior article, though of considerable commercial value. The oil is excellent. The correct estimate of the value of one of these whales is \$700 to \$1,000. The Cabot Company has erected a factory for the manufacture of the oil at Snook's Arm, Notre Dame Bay. The "Cabot" carries a gun in her bows from which is fired a harpoon. On striking a whale a bomb explodes, killing the whale instantaneously and developing a gas which prevents it from sinking. The loss of a whale by this method is very rare.

The large new lighthouse at Port Dalhousie, Ont., was struck by lightning and completely destroyed by fire August 12th.

The Magnetawan Tanning and Electric Co., Burk's Falls, Ont., will extend their plant and building.

The Noble Five Mining Co., Sandon, B.C. has just installed a new seven-drill Compressor Plant supplied by the James Cooper Mfg. Co., Limited, Montreal, together with one and a-half miles of pipe line and necessary accessories for plant.

The Electric Co. of Windsor, N.S., has ordered a 100 horse power Robb-Armstrong engine from the Robb Engineering Co.

The New "Bell" Automatic Engine.

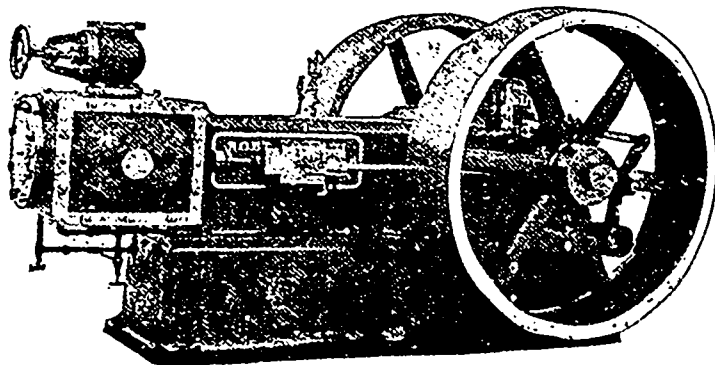

....FOR...
**Electric Lighting,
 Electric Railways,
 Manufactories, Mills.**

UNSURPASSED FOR
 Economy, Perfect Balance, Absolute Regulation, Smooth Running.

Manufactured only by **SEND FOR CATALOGUE**

ROBT. BELL, Jr., Hensall Engine and Machine Works, **HENSALL, Ont., Canada.**



Emery

WRITE FOR LATEST CATALOGUES AND SAMPLES TO

THE LONDON EMERY WORKS CO., 10/12 VINE ST., CLERKENWELL, **LONDON, E.C.**
AGENTS WANTED....

CLOTH AND PAPER.
 GLASS & FLINT PAPER.
 "Atlas Brand"

"FLORA" Knife Polish
 in 3d. Gd. & 1/ Tins.

Ground, Washed & Flour

WHEELS of highest
 quality for general
 & special purposes.

Grinding Machinery.



Messrs. Mackenzie & Mann, who have acquired the franchise of the Rainy River Railway, have let to Mr. E. F. Farquhar, of Toronto, the first 35 miles of work. It is expected that the line will leave the Port Arthur, Duluth and Western Railway at Stanley station cross the Kaminitiqua at Kakabeka Falls, follow the south bank of the river until its junction with the Mattawan, then along the Mattawan valley, running through the Mattawan iron range and south of Lake Shabendowan.

The James Cooper Mfg. Co., Limited, Montreal, have received an order from the North Brookfield Mining Co. for two more hoisting engines, one to increase their present plant, and one for new property they are opening up.

Work on the development of the Grand Falls, N.B., water power has commenced. A building about 300x80 feet will be erected and nearly a mile of railway built to connect with the C.P.R.

The Ontario Telephone and Switch-Board Construction Co., London, Ont., has been incorporated with a capital stock of \$75,000 to manufacture telephones, switch-boards, etc.

The fire, which occurred at Waterville, Que., recently, destroyed Swanson's furniture factory, Adams' hames factory and Galt's sawmill.

Cherry Bros.' flour mill, Galt, Ont., has been purchased by David Spiers.

The B. A. Corporation of Rossland, B.C., report that they have both Compressors that were installed by the James Cooper Manufacturing Co., Limited,—of 12 drill and 5 drill capacity respectively—now running, and development work will be proceeded with, with great vigor. This Company in the Great Western, Nickel Plate, West Le-Roi, and Josie are operating nineteen Ingersoll Sergeant Drills.

The D. W. Karn Co., Woodstock, Ont., has been incorporated with a capital stock of \$500,000 to manufacture organs, pianos, etc.

The Rat Portage Cold Storage and Produce Co. has been incorporated with a capital stock of \$50,000.

The town of Hawkesbury, Ont., has voted to raise \$7,500 to bonus the Riordan paper mills to establish a branch in Hawkesbury.

A mining company, represented by B. F. Pearson, Halifax, N.S., are having a stamp mill, of considerable dimensions, built at New Glasgow, N.S.

The Dominion Elevator Co., Winnipeg, Man., will build an elevator at St. Jean, Man.

The Robb Engineering Co. are building two 100 horse power boilers for the electric station of the city of New Westminster, B.C.

The works of the Montreal Linotype Co., Montreal, was destroyed by fire July 29th. Loss about \$30,000.

M. J. Hogan, of Section 12, Soulanges Canal, has placed an order with the James Cooper Manufacturing Co., Limited, of Montreal, for three of their latest type Sergeant Drills.

The Lachute, Que., Water Works Company are putting water pipes in all the streets of that town, and will shortly put in fifty hydrants for fire protection.

The Canada Food Supply Co., Montreal, will establish a canning factory at Vankleok Hill, Ont., where they will can all kinds of fruits and vegetables.

J. & B. Grier's sawmill at Montreal was destroyed by fire recently.

Building permits have been issued to the Massey-Harris Co., Toronto, for a three-story and basement brick and stone factory to cost \$8,000.

The Bertram Engine Works Co., Toronto, have completed a large barge for the Prescott Elevator Co. It is 180 feet long and fourteen feet deep, and 30-foot beam. It is built entirely of steel, and is planked with five-inch rock elm as a protection against rocks in the canal.

Plans are being prepared for a new bank and office building at Grimsby, Ont., the work upon which will be commenced immediately.

Messrs. Rogers Bros. will build another elevator in connection with their flour mill at McGregor, Man.

THE CANADIAN RAND DRILL CO. have moved their General Sales Office, controlling Canadian Territory, to 18 Victoria Square, Montreal, in order to facilitate their business, which has been rapidly increasing during the last two years. They have established an office at 88 York St., Toronto, one in Halifax, one in Rat Portage in charge of Mr. George J. Ross, and one in Rossland in charge of Mr. Mendenhall. They are as usual manufacturing largely along the lines of duplex construction which they have advocated from the first. A duplex compressor costs a little more in the first place than a straight line machine, but the difference in economy of the two offsets the difference in price. Their Toronto office has lately contracted with the Canadian Copper Co., the largest nickel producers of Canada, for a very large mining plant. The Canadian Gold Fields of Marmora, they have also just equipped with a large Corlias Compressor.

Through the Halifax office the Intercolonial Coal Mining Co., of Westville, are also installing one of their high class machines for pumping. Duplex construction permits of an economical arrangement of cylinders in proper ratio to the steam pressure at hand, and to the air pressure required.

The Rat Portage office last year installed from start to finish a large plant at the Sultana mine, a large plant at the Foley mine, and also a large plant at the Mikado. They are now putting in machinery at the Cameron Islands mine, and also a large plant for the Boulder Gold Mining Co., which is controlled by Mr. Leclair and other American capitalists.

The Rossland branch has rather the advantage of the others in that it has a large warehouse at its back and is able to fill orders from stock. They have lately contracted with the Knob Hill mine for a large power plant and two mining plants, the object being for the second mining plant being supplied with power from the one Compressor located at Knob Hill.

Pure
Chemicals

Phosphorous,
Sal. Ammoniac,
Muriate Ammonia,
Sal. Soda,
Bicarb. Soda,
Epsom Salts.

FINEST QUALITY.

Manufacturers Prices and Terms.

**Arthur P. Tippet & Co.,
MONTREAL.**

Canadian Agents.

B. GREENING WIRE CO.
(LIMITED)
WIRE MANUFACTURERS
& METAL PERFORATORS
**HAMILTON
& MONTREAL.**

Wire Screens for Every Class of Material.

Perforated Metal of Steel, Copper, Brass, Zinc for all purposes.

Special Attention given to Minor's Requirements.

In a paper read before the convention of the Canadian Electrical Association, entitled "The Unconscious Ownership of an Important Key," Mr. W. T. Bonner described a novel method of handling farm produce and other highway freight by suburban and interurban electric roads. It was pointed out that the cost on ordinary highways is enormous compared with that on railways, so that a large amount of land quite near the large centres of population is handicapped in reaching the market in comparison with land situated perhaps thousands of miles away, but requiring a shorter wagon haul. On the other hand, the extensive terminal facilities required with standard railroad system run up the cost of short-haul business on railroads to a high figure per mile

compared with the long-haul traffic. A method of providing freight haulage to districts near the large centres of population at a low cost has been worked out by the Bonner Rail Wagon Company by means of trailer trucks fitted for the ready reception of ordinary wagons. By this means milk, market produce, express, baggage, and, in fact, any traffic that is now hauled at great expense from centres of population to the outlying districts by horses, or, in case this becomes too expensive, is sent by rail, freight or express with the attendant transshipment and terminal charges at both ends, may be carried in wagons directly from the place of shipment to destination without transshipment and without long and expensive animal haulage. The wagon is not ma-

terially different from those of standard construction, but is simply fitted with devices for its ready attachment to the truck over which it rides in loading. The truck is also practically the same as that in general use upon electric railways. The actual time required for shipping or unshipping the wagon from the truck is said to be not more than that required for coupling cars. It is obvious that this same principle can be made use of without any special devices other than flat cars and platforms by which ordinary wagons may be run on to the cars, to which they can be blocked and chained. The additional freight traffic secured in this way would in many cases increase materially the income of suburban roads with light service, with a comparatively small increase in the total expenses.



WATER WHEELS

For Heads of 3 Feet to 2000 Feet.

ADAPTED TO MILLING AND ALL POWER PURPOSES.

Recent tests at Holyoke enable us to guarantee:

The Largest Power ever obtained from a wheel of the same diameter. The highest speed ever obtained for the same power. The highest mean efficiency ever obtained when running from half to full gate. We guarantee also: A runner of the greatest possible strength. A gate unequalled in quickness and ease of opening and closing.
Write for pamphlet, stating your head.

JAMES LEFFEL & CO., Springfield, Ohio, U.S.A.

A large tow boat with thirty-one canal barges in tow, arrived at Three Rivers, Que., a few days ago, to load paper pulp for the International Paper Co's mills at Whitehall, N.Y.

Among the probabilities of the near future is a very large pulp mill at Baie, St. Paul, a very desirable location about midway between the city of Quebec and the mouth of the Saguenay river.

THE TORONTO PATENT AGENCY, (LIMITED) . . .

TORONTO, CAN.

Head Office, 79, 80, 81 Confederation Life Building.

CAPITAL, \$25,000.00.

Patents obtained. Patents sold on commission. Provincial rights sold. Most active sales. Best results. Quickest work. Honest Treatment. Oldest company. Reliable references. All patent business promptly attended to. Valuation and prospects of any patent furnished on application.

Pipe and Boiler Coverings, Engine Packings,

LUBRICATING OILS, GREASES, AND BOILER COMPOUND, COTTON WASTE, ETC.

EUREKA MINERAL WOOL and ASBESTOS CO., 136 Bay Street, - Toronto.

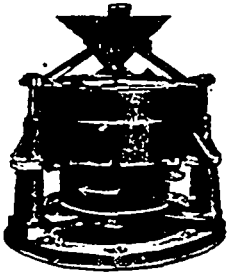

ROCK

CRUSHERS

EMERY

MILLS

AND

MILLSTONES.

FRENCH BUHR AND ESOPUS STONES. *Send for Circular.*

STURTEVANT MILL CO.

BOSTON, MASS.

THE

Crocker Patent Turbine



This Wheel is to be found in representative plants in nearly all parts of the Dominion. It possesses among its leading features

LARGE POWER FOR THE DIAMETER.

SUPERIOR STRENGTH AND DURABILITY.

GREAT EFFICIENCY AT ALL DEGREES OF GATE OPENING.

Designs prepared for complete plants and the best development of power possible under the peculiar circumstances of head, etc., in any locality.

CIRCULARS AND PRICES ON APPLICATION.

5-inch Crocker Wheel Plant at the works of the Boston Rubber Co., St. Jerome, Que.

The JENCKES MACHINE CO.,

28 LANSDOWNE STREET

(SHERBROOKE, QUE.)

It is said that Messrs. James Ross, of Montreal, and George Gooderham and Geo. A. Cox, of Toronto, are associated with a syndicate of English capitalists in the scheme to build a very large and palatial hotel in this city in which \$1,500,000 will be invested.

A company is being promoted for the establishment of a meat packing factory at Weston, a suburb of Toronto, to be called the Canadian Meat Market Company, who will prepare all kinds of meats for both foreign and domestic consumption. It is proposed to utilize the old woolen mill and site at Weston for the business.

The following building permits have been issued by the Toronto city authorities:—To A. B. Ormsby, to erect a two-storey brick addition to the workshop at 126 Queen street east, at a cost of \$1,150; M. S. Robinson, for a four storey brick addition in the rear of the Bijou theatre, to cost \$26,000; trustees of the House of Industry, to erect two brick additions of two storeys each to the House of Industry on Elm street, to

cost \$15,000; M. Stanton & Co., for enlargement of their wall paper factory, 946 Yonge street, to cost \$2,500; Charles S. Miller, to build a one-storey brick addition to the Kirby House, corner of Queen and William streets, to cost \$400; Geo. H. Hees & Co., for three-storey brick factory, on the south side of Pears avenue, near Avenue Road, to cost \$9,000; Geo. H. Hees, for a three-storey brick warehouse, alongside the factory, to cost \$7,000; the city of Toronto will build a one-storey brick addition to the Yonge street firehall for an engine-house, at a cost of \$600.

A. C. NEFF, Chartered Accountant. JAMES WOOD, Late Sec. The T. Eaton Co., Ltd. **NEFF & WOOD** PUBLIC ACCOUNTANTS, AUDITORS ASSIGNEES, ETC. Room 500 McKinnon Bldg., Toronto

GEORGE WHITE-FRASER.

Member Can. Soc. C.E. Member Am. Inst. Elec. Eng. **CONSULTING and Electrical Engineer.** CONSTRUCTING Railways, Lighting, Power Transmissions, Factory Plants, Reports, Specifications, Tests. 18 Imperial Loan Building, TORONTO.

H. F. STRICKLAND, Electrical Contractor.

77 ADELAIDE ST. E., TORONTO. Telephone 1838. SPECIALTY:—Electric Wiring, by skilled men. All work done according to latest methods, at lowest possible prices. Complete Isolated Plants.

To WOOLEN CLOTH Manufacturers and Wool Dealers.

SYKES, HOLT & CO. Wool Brokers, SYDNEY, N.S.W.

We undertake the buying of Washed and Greasy Wools in all the Australian markets on the lowest terms. Orders executed strictly to instructions. Samples and all information will be forwarded on application. BANKERS—The Union Bank of Australia, Limited, Sydney. REFERENCES—J. S. Larke, Esq., Agent Govt. of Canada in Australia.

ROBT. A. ROSS, E.E., Consultant to Canadian Pacific Ry., and Boiler Inspection Co.

CONSULTING ENGINEER. Specifications, plans, advice upon Steam and Electric Plants, Power transmission and distribution. Special machines designed. 17 St. John Street, MONTREAL.

SPORTSMEN NOTE

The ABBEY IMPROVED CHILLED SHOT NEWCASTLE-ON-TYNE, ENGLAND. Is made by a New Process, and is highly spoken of by Sporting Partners and Sportsmen. Kills at greater distance than Soft Shot. Send to your Gunmaker for Samples.

JOHN J. GARTSHORE, 13 Front St. West, Toronto. RAILWAY, TRAMWAY, and **Contractors' Supplies** METALS and SCRAP IRON Bought and Sold.

ALBERT BELL ENGINE WORKS

DUNNVILLE, ONT. Makers of YACHT ENGINES, 1 H.P. to 50 H.P. Safety Water Tube BOILERS PROPELLER WHEELS Stationary Engines and Boilers

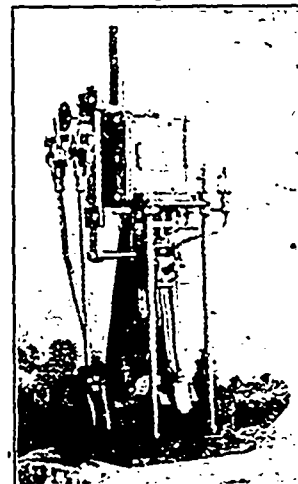

WRITE FOR CIRCULARS

FLEMING & CHAPIN, 229-231 Church St., PHILADELPHIA. **TAPES** Common Superfine Extra Superfine

CARBONIZER A neutral substance, harmless to animal fibre or tissue, while it destroys burrs, etc., as efficiently as acid. It leaves the wool in fine condition. Manufactured by the Merrimac Chemical Co., 13 PEARL ST. BOSTON.

BOILERS. YOU WANT THEM. WE MAKE THEM. WRITE FOR PRICES. **BANNERMAN & FINDLATER,** Boiler Makers, OTTAWA, ONT.

WANTED Mechanics, Engineers and Firemen to enclose 20 cents in stamps for Working Model of Valve for Steam Engines. Address, H. F. LOWE, M.E., Patent Solicitor, Confederation Life Bldg., Toronto, Canada.

PATENT FOR SALE. Canadian Patent No. 33178, relating to apparatus for rapidly discharging cargo from vessels, whereby the necessity of shovelling grain, coal, etc., in small quantities is avoided. Apply to **JOHN W. GLAHOLOM,** Nanaimo, B.C.

J. ALEX. CULVERWELL, Electrical and Mechanical **BROKER,** Special Agent Royal Victoria Life, 5 King Street West, - - TORONTO.

SOUTH AFRICAN EXHIBITION

A gentleman who has been in South Africa, would attend the Exhibition to be held at Grahamstown, South Africa, during December, 1898, and January, 1899, in the interests of two or three Canadian Manufacturing firms. The object being to minimize the cost of representation to each firm.

Only one in each line will be taken. Address, "SOUTH AFRICA," CARE CANADIAN MANUFACTURER, Toronto.

Canadian Goods for New Zealand To CANADIAN MANUFACTURERS

Our Mr. YEREX—a Canadian—but for the last 10 years a resident of New Zealand, will arrive at Vancouver by the "Aorangi" on August 11th, and will proceed eastward, touching at the leading towns en route. He leaves the same port again by the same steamer on November 17th, and while in Canada would like to make arrangements to represent any firm or firms who wish to have their goods introduced to the New Zealand public.

We have had 8 years experience in importing American Manufactures, and we think we understand the New Zealand market. REFERENCES: The Union Bank of Australia, Limited, Wellington; J. S. Larke, Esq., Agent for the Government of Canada, Sydney, N.S.W.

The YEREX & JONES CO. HEAD OFFICE—Wellington, New Zealand. BRANCHES—Dunedin, Christchurch, Wanganui and Napier, New Zealand. Agencies throughout the Colony. Address at once GEO. M. YEREX, care of THE CANADIAN MANUFACTURER, Toronto, up till October 1st.

TORONTO MACHINE SCREW CO.

Manufacturers of Hexagon and Square Head Cap Screws. Steel and Iron Set Screws. Hanger and Plumber Bolts, Studs, etc. Send for Price List and Discount. 109 1/2 Adelaide St. W., - TORONTO.

The Canadian Rubber Co., of Montreal, have sent us a circular in which they say: "Crude rubber still continuing to advance without any prospects at the present time of any break or decline, it makes it compulsory upon us to advance the prices of our products in mechanical goods. We are therefore compelled to withdraw all quotations and our new prices will be the lowest

that we can afford, and we will guarantee that our goods will, as in the past, be found of full value and the most satisfactory and economical of any offered in the market."

Samuel May, Henry S. May and Charles F. Wheaton, and associates, of Toronto, have obtained incorporation under the name of "The Dodge Manufacturing Company, of Toronto, Limited," for the following pur-

poses:—To manufacture, build, operate, deal in, and buy and sell engines, boilers, machinery, motors, castings, pulleys of all kinds, ironware, and other productions of metals or wood, or other materials, and to carry on a general foundry, engineering, and machinist's business, and to manufacture and deal in all kinds of power transmission appliances, with power to acquire the business now carried on at the said city of Toronto by Samuel May, under the firm name of the Dodge Wood Split Pulley Company, and to assume the liabilities connected with such business. The amount of capital stock is to be \$190,000.

The Harriston Pork Packing Co. Harriston, Ont., is being incorporated with a capital stock of \$100,000 to carry on the business indicated by its name. Among the incorporators are Robert Fallis and Richard Dowling.

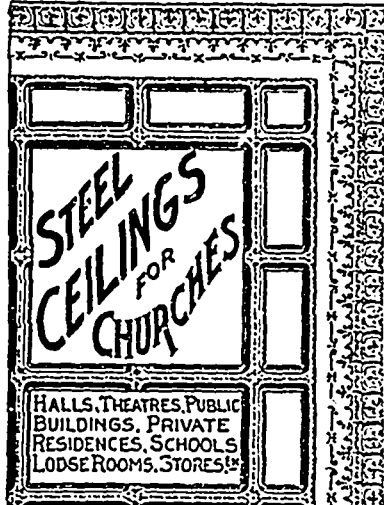

STEEL CEILINGS FOR CHURCHES

HALLS, THEATRES, PUBLIC BUILDINGS, PRIVATE RESIDENCES, SCHOOLS, LODGE ROOMS, STORES

Not a Substitute

but superior to lath and plaster, will not crack and fall off, absolutely fire-proof, handsome in appearance. Send for our beautiful catalogues showing three hundred designs: free for the asking. Estimates furnished on receipt of plans.

The ...
PEDLAR METAL ROOFING CO.
Oshawa, Ont.

MALCOLM MILLS CO.

Manufacturers of
Fancy Twist Yarns, in Worsted, Silk
Cotton, etc. Polished Threads.
Silk Nolls Yarns.
Metal Threads and Tinsels.
MILLS—Frankford, Pa.
OFFICE—229 Chestnut Street, Philadelphia

PROGRESSIVE MANUFACTURERS

USE THE
BLACKWELL UP-TO-DATE VARNISHES
For Finishing Pianos, Carriages, and
Railway Coaches.
BLACKWELL & CO., TORONTO.

Dominion Oil Cloth Co.

Manufacturers of....
OIL-CLOTHS of Every Description
Floor Oil-Cloth, Table Oil-Cloth,
Carriage Oil-Cloth,
Enamelled Oil-Cloth,
Stair Oil-Cloth, etc.
Office and Works
Cor. St. Catharino and Parthonsais Sts.,
MONTREAL, Que.

WOOLEN MACHINERY

...FOR SALE...

24 Hutehison & Hollingworth Dob-
cross Looms.

20 Harness. 3 Box, 9/4.

9 Leeming's, of Bradford, England,
"Dandy" Looms.

6 Harness. 1 Box, 10/4.

1 Hand Loom, Complete, with
Shuttles, etc.

32 Harness. 4 Box.

1 Waste Shaker.

2 ft. 8 in. wide, 24 in. diameter.

1 Iron Doffer.

36 in. diam., 60 in. wide, with
2 1/2 in. shaft.

1 Knowles Pump—Steam.

4 1/2 in. x 3 1/2 in. Water Cylinder

1 Horizontal Engine.

Six Horse Power.

All of the above can be seen run-
ning at the Factory, ST. GABRIEL
LOCKS, MONTREAL.

We are prepared to entertain any
reasonable offer for above.

Further Particulars on application.

Montreal Woolen Mill Co.
MONTREAL.

Felts for Pulp Mills

20 years in the business
—the first to make Felts
in Canada; capacity 1,000
lbs. per day. All our
Felts are woven endless, without a splice. Our Felts will last longer and make
drier Pulp. All up-to-date mills use our Felts. New mills, when in need, write
for samples and prices.

HAMELIN & AYERS, Lachute Mills, P.Q.

ELECTRIC REPAIR & CONTRACTING CO.

GEO. E. MATTHEWS, Manager. 621 LaGauchetiere St., MONTREAL. TEL. 2177.

COMPLETE ELECTRIC PLANTS INSTALLED.

ELECTRIC APPARATUS OF ALL KINDS REPAIRED ON THE SHORTEST NOTICE.

Armatures Rewound for all Systems. Commutators Refilled.
Write us, our Prices are reasonable and work good.



**The Diamond
Machine & Tool Co.**
TORONTO, ONT.
Manufacturers of....
Machine Screws
OF EVERY DESCRIPTION.

SEND FOR
CATALOGUE
and
PRICE LIST.

The Thomas Organ and Piano Co., Woodstock, Ont., inform us that they have just forwarded a very large organ built by them for the new English Church, to be called the Cathedral, at Christchurch, New Zealand. As this company have sent quite a number of their instruments to Australia, they think, with good reason, that if proper means are employed, Canadian manufacturers ought to obtain a good share of the trade in that line in competition with other countries.

The Thomas Organ and Piano Co., Woodstock, Ont., have just added to the equipment of their works a new double planer, made for them by Major Harper, Whitby, Ont., and several other machines, and have added another lumber drying kiln. The company inform us that their factory is being worked to its fullest capacity to meet the demand for Thomas organs.

Messrs. Edward Jefferson & Bro., 28 Strawberry street, Philadelphia, have sent us a catalogue having reference to the second-hand woolen and worsted machinery which they are offering for sale. Included in the list is one complete worsted spinning mill, one complete mill for making clay worsteds, etc., one for making men's wear, one for making fancy curtains, and one complete Brussels carpet plant, consisting of 112 looms and accessory machinery. The catalogue describes this machinery in detail, and also makes reference to a great deal of other similar machinery, full particulars of which will be sent on application.

The Fairbanks Company, Montreal, have sent us a circular having reference to the Chatillon Balances manufactured by them, and which have just been admitted to veri-

fication in Canada by the Department of Inland Revenue. It is claimed for these balances that they are the best of this description made, and that they are the only ones of this class admitted into Canada. The Government requirement is that no balance of any capacity, whatever shall have an error exceeding one ounce of its maximum capacity. The Chatillon balance has successfully passed the ordeal of the severe tests required, and are to be placed upon the Canadian market by the Fairbanks Company of Montreal, who already have a large number of orders for the article. Agents are wanted for the sale of it.

The Fairbanks Company, Montreal, have sent us samples of the vulcabeston sheet packing, vulcabeston braided round packing, and vulcabeston pressed rope gaskets, which they are offering to Canadian steam users. Vulcabeston is asbestos in combination with waterproofing and vulcanizing material. It is furnished in sheets, in round braided packing, in pressed rope gaskets, and in moulded gaskets, and is used for valve stem packing, steam joint packing, handhole and manhole gaskets. Vulcabeston sheet packing is a superior steam joint packing on account of its permanent resistance to heat. It is not liable to injury by acids, gases, etc.; it will not shrink or absorb moisture, and is invaluable for a number of purposes. Vulcabeston braided round packing is a flexible round packing composed of strong twisted strands of pure asbestos, braided, and combined with waterproofing material, vulcanized and coated with plumbago. It is an excellent packing for high pressure steam, hot water, oil, acid and ammonia; also for locomotives, stationary and marine engine throttle valves. It is

self lubricating, and will not shrink, pulp or blow out. Vulcabeston pressed rope gaskets are made from vulcabeston round packing. For use on handhole and manhole plates, flanged steam joints, etc. For further information and samples enquire of the Fairbanks Company.

The Bannockburn Mine have just placed an order with the James Cooper Mfg. Co., Limited, for a hoisting and pumping plant consisting of a thirty h.p. Lidgerwood hoisting engine with necessary boiler, pump, etc.

The Hall Mines, Limited, Nelson, B.C., are re-equipping their tramway line with a complete new set of buckets, and have placed order with James D. Sword, of the James Cooper Mfg. Co., Limited, for \$10 buckets. Delivery is to be made within eight weeks.

The Waterous Engine Works Co., Brantford, Ont., through their Winnipeg, Manitoba branch, has furnished Peter McArthur with the machinery for his mill at Lake Winnipegosis, Man.

Mr. David Richard's sawmill and lumber yard at Campbellton, N.B., was burned July 18th. Loss about \$18,000.

A shingle mill is being built at Sackville, N.B., by Senator Poirier.

John Whitesides is erecting a shingle mill at Huntsville, Ont.

The new iron tank erected at Cardinal, Ont., by the Edwardsburg Starch Co., is nearing completion. It is 40 feet high and is mounted on four iron legs 65 feet long and strongly braced. It has a capacity of 90,000 gallons and will contain the water supply of the town.

Adam Beck, London, Ont., has started a cigar-box factory at Montreal.



The Whitelaw-Shepherd
...ENGINE...
SIMPLICITY, COMPACTNESS,
PERFECT REGULATION,
ECONOMY,
AUTOMATIC LUBRICATION.



For Electric Lighting Mills, Factories,
and other purposes where Economy,
close regulation and enduring service
is required.

Manufactured by..... **R. WHITELAW, Woodstock, Ont.**

The ELECTRICAL CONSTRUCTION CO.
OF LONDON (Limited).
MULTIPOLAR MOTORS and DYNAMOS
— AND —
DIRECT CONNECTED PLANTS FOR
ISOLATED LIGHTING.
Repair Work a Specialty.

HEAD OFFICE AND FACTORY:
No. 90 YORK STREET, LONDON, CANADA.
760 Main Street, WINNIPEG. 42 York Street. TORONTO.

Our Products are the Standard of Quality.

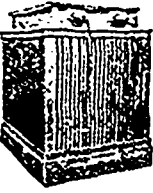
 <p>Direct Current Dust Proof Motor. Same General Design as Westinghouse Multipolar Motors.</p>	 <p>Our Direct-Connected Generators Are Adopted by all Requiring the BEST</p>	 <p>Tesla Poly-phase Induction Motors. Type "C." The Only Motors Supplying Niagara Power in Buffalo.</p>	 <p>Self-Cooling Transformers. 10,000 H.P. in Buffalo and Tonawanda Alone Employed in the Utilization of Niagara Power.</p>
--	--	--	--

Westinghouse Electric & Mfg. Co. Pittsburgh, Pa.
New York, Atlanta, Austin, Boston, Buffalo, Chicago, Cincinnati, Philadelphia, St. Louis, San Francisco, Syracuse, Tacoma, Denver, Mountain Electric Co. Canada, Ahearn & Super, Ottawa, Mexico, G. & O. Brantiff & Co., City of Mexico, Westinghouse Electric Co., Limited, 22 Victoria Street, London.

Peck, Benny & Co's rolling mills, Montreal, were destroyed by fire August 3rd. Loss about \$100,000.

W. W. Doherty will rebuild his flour mill at Campbelltown, N.B., which was recently destroyed by fire.

The flour mill of Wray & Hawshaw, Lucan, Ont., which was burned recently, will be rebuilt.

An order has been placed with the James Cooper Manufacturing Co., Limited, Montreal, by the Canadian Construction Co., Farran's Point, for two of the "Lidgerwood" type double cylinder double drum Hoisting Engines, complete with boilers.

The Heinz Pickle Co., Pittsburg, Pa., will probably establish a branch of their works in Toronto.

The ratepayers of Campbellford, Ont., have voted on to raise \$8,000 for the construction of a new incandescent light system to replace the one now in use.

M. A. Cleveland, contractor, of North Channel, found that he has considerable more rock work than anticipated, and has put in three more Ingersoll-Sergeant Drills.

An elevator with capacity of about 65,000 bushels will be built by the Manitoba Grain Co., in connection with its Alberta Roller Mill at Calgary, N.W.T.

THE NEW SCHEEFER WATT-METER.

The Packard Electric Company, St. Catharines, Ont., have the following to say regarding the advantages of using the Scheefer Watt-Meter:—

It has been found by experience that a central electric lighting station can supply thirty per cent. more customers on the "meter" than on the "flat" rate. This thirty per cent. really represents wastefulness, which is inherent in the nature of the average customer, and the "flat" rate. The investment in meters, and their proper care, makes the plant equivalent to one thirty per cent. larger.

A central station which is in the electric lighting business for the profits on its investment can easily realize the great advantage in the use of meters. That many small villages and cities make but a small profit, or the income only sufficient to pay actual running expenses, is not surprising, in view of the waste and extravagance of the "flat" rate. These same stations may, by proper and economical use of meters, be made profitable.

It is not necessary to point out the evils of the "flat" rate; but it is self-evident that many customers never take the trouble to turn out all or part of their lamps, and in places where the plant gives all-night service the lamps are left burning all night. A fallacy in "flat" rates is the basing of charges on fifty Watt lamps. A fifty Watt sixteen c.p. lamp is somewhat of a rarity in the market, sixty Watt being about an average, and many lamps are used taking more even—seventy or eighty Watts. In most small stations the voltage is kept above what the lamps were made for; even in the case of a fifty Watt lamp the consumption will be higher. We have found that most small stations, if they use fifty volts, keep the voltage at fifty-five or sixty. These wastes are impossible to avoid in the "flat" rate.

A meter measures the actual consumption of current. The central station gets paid for actual service given the customer, and it behooves the consumer to use his lights in the best and most economical way.

The new Scheefer Watt-Meter for alternating current has been devised to correct various faults which were in the Scheefer meter, which has given such good results.

The meter is round and has a rubber band placed around the circumference, over which

KERR Water Motors

1/8 to 20 HORSE POWER.

Noiseless Running, Require No Attention, operated with water at a pressure of 30 pounds and upwards.

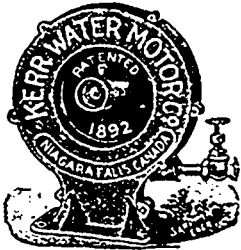

Reliable intending purchasers can have our Motors on trial by writing us, stating water pressure, a valve, power, required and class of work to be done.

Our Motors are sold on their merits. Our prices are low. Enquiries solicited and cheerfully answered.

...WRITE US ..

KERR WATER MOTOR CO.,
NIAGARA FALLS, CANADA.

Jones & Moore Electric Company

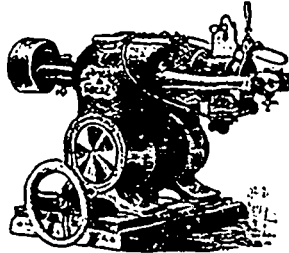

ELECTRIC LIGHT
...AND...
POWER PLANTS

Multipolar Machines
25 to 100 K. W.

16 Light Arc Plant for sale cheap. Good as New.

22 Adelaide Street West, - Toronto.

Keep your Belts from Slipping and Preserve them by using

STICK FAST FELT DRESSING.



REGISTERED.

Guaranteed to keep any Belt from slipping the moment it is applied; also to keep Belts from cracking.

This Dressing will save you power and money.

Give it a trial order. Hundreds of testimonials from users.

H. R. RIDOUT & CO.,

Railway, Mill, Foundry and Engineers' Supplies,

22 ST. JOHN STREET, MONTREAL.

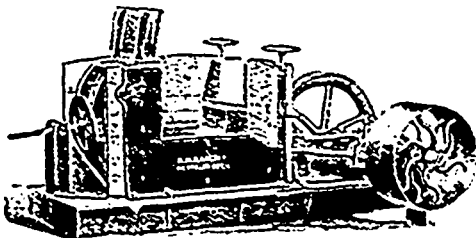

H. W. KARCH

HESPELER, ONT.

IRON FOUNDER and MACHINIST

Manufacturer of

WOOLEN MACHINERY,

Rotary Fulling Mills, Kicker Fulling Mills, Soaping Machines,
Cloth Washers, Wool and Waste Dusters, Rag Dusters, Drum Spool Winders,
Reels, Spooling and Doubling Machines, Ring Twisters, Card Creels,
Dead Spindle Spooler for Warp or Dresser Spools,
Patent Double-Acting Gig Dyeing Machines.

Engineers' Supplies

OF ALL DESCRIPTIONS

THE HEINTZ STEAM SAVER

Will increase your productive power and decrease your fuel account.

Write us for Booklet C.

'Twill interest you.

The **JAMES MORRISON**

BRASS MFG. CO. Limited,

TORONTO

is placed the other case. This rubber band should always be used, as it makes the meter perfectly dust and bug proof. It has been found that meters with cases of ordinary fitting are hampered with dust and dirt; and with such cases it is impossible to keep meters correct, necessitating frequent overhauling and cleaning. The Scheefer meter, if the case is properly put on with the rubber band, is perfectly air-tight and gives an assurance of its permanency. The binding posts will be seen to be insulated in a thorough manner, ordinary holes not being depended upon. The holes in the binding part are closed on end and insulated by hard rubber, making it impossible that anything can get through the post; and also making it unnecessary to tape or plug any holes. The moving parts are extremely light—at the same time not too delicate.

The iron circuit in the magnetic system is practically a closed one, preventing stray lines of force from acting on other parts of the meter, and is therefore, unaffected by outside influences. This closed circuit gives the maximum effect with the minimum energy possible in construction, the shunt winding taking about $\frac{1}{2}$ to $\frac{1}{4}$ Watt, on 15,000 alternations, and not exceeding $\frac{1}{2}$ to $\frac{3}{4}$ Watt on 7,200 alternations.

This meter is correct on inductive loads, and therefore can be used on fan motors, or induction motors, arc lamps, etc.

Stations adopting the meter system in all

or part, must take the proper care and precaution in their use. This requires some familiarity with meters, which is generally obtained by experience and care in following the instructions. That some people get better results with meters than others is due to the more intelligent care taken. A meter by nature is of a delicate construction. They are carefully calibrated by standard instruments and packed with considerable care. In order that they should remain correct it is necessary that they be handled so that nothing changes. The friction is reduced to the lowest point, and any rough handling will strain or change some part, which will immediately add friction, and then the meter ceases to be reliable.

Every station which uses meters should fit up a place to overhaul and keep meters; a place that can be locked up or kept so that the meters may remain untampered. A wood rack or base on which meters can be conveniently placed and leveled for testing, inspected and calibrated, should be secured—one with brass levelling screws would be preferred; also a board with key wall sockets, having lamps for testing, and all connections made in workmanlike manner, so that meters can be tested in a convenient and rapid manner.

The first and greatest trouble with meters having ordinary cases, is that of dirt getting into them, as it is impossible with ordinary joints to prevent this. Bugs seeking warmth

and darkness always enter meters. Meters of this class should be taken down at least once a year, tested and thoroughly cleaned. A bellows and brush may in some cases suffice. In other cases it will be necessary to take the meter apart and thoroughly clean.

The jewels should be inspected, as they wear rough or may be cracked. By screwing out the jewel screw from the bottom, and taking a pin or needle and running it over the surface of the jewel, any imperfection or roughness can be detected. If the least roughness is detected a new jewel screw should be used. Also the pivot on end of shaft should be inspected. As a rule, a rough jewel will make a rough pivot. If the pivot is replaceable, as in the new Scheefer Meter, a new pivot can be placed in. If the pivot is not replaceable, a new shaft should be used.

The top guiding pin on the shaft should be inspected to see that it is not bent, as it is quite thin and may be bent in taking the armature in or out of the meter, or in packing. In the new Scheefer Meter, this can be replaced by a new pin. If the pin is bent it will be quite likely that the meter will not run properly.

See that no dirt is between the magnets. Carefully pass clean paper between them to dislodge any particles. See that all the screws are tight about the meter.

THE WM. HAMILTON MFG. CO., LIMITED,
 Engineers and Builders

MODERN MINING and MILLING MACHINERY

“Gyrating Vanner”

SHAKES LIKE A PAN—SEND FOR SPECIAL CIRCULAR



Department “E”



Contractors for the Design and Construction of Complete Stamp Mills, Concentration, Chlorination, Cyanide, and Smelter Equipments....



PETERBOROUGH, ONT., or VANCOUVER, B.C.

FORMULAS FOR DYEING.

Messrs. W. J. Matheson & Co., New York, have sent us a color card in which is shown six dyeings on worsted yarn dyed with colors made by the company. These colors show the depth of color produced by each dye with percentage given. The colors shown are also a good line for fancy dress goods, piece-dyed dress goods and knitting yarns. The method of preparing the bath for dyeing, is to fill the dye tub quarter full of water, get to boil, then put in dyes and Glauber's salts: boil until dissolved, then fill with cold water to within six inches of

the top of the tub. Put in oil of vitriol and thoroughly stir; have the yarn thoroughly wet, enter into dye liquor quickly, give two or three turns; then put on steam and heat to boil in about half to three-quarters of an hour. Manipulate according to formula.

No. 1.—Bright green.—100 pounds worsted yarn. Prepare a bath and dye with two pounds acid green, extra concentrated, fifteen pounds Glauber's salts, four pounds oil of vitriol. Enter yarn into bath at 120 degrees F. Work well while heating to boil, work at boil one hour, lift, cool, wash and dry.

No. 2.—Bright red.—100 pounds worsted yarn. Prepare a bath and dye with three pounds naphthol red C, fifteen pounds Glauber's salts, four pounds oil of vitriol. Enter yarn into dye bath at 120 degrees F. Work well while heating to boil, work at boil one hour, lift, cool and wash and dry.

No. 3.—Violet.—100 pounds worsted yarn. Prepare a bath and dye with two pounds formyle violet 10B, fifteen pounds Glauber's salts, four pounds oil of vitriol. Enter yarn into dye bath at 100 degrees F. Work well while heating to boil, work at boil one hour, lift, cool, wash and dry.

No. 4.—Orange.—100 pounds worsted yarn. Prepare a bath and dye with one pound orange GG, ten pounds Glauber's salts, four pounds oil of vitriol. Enter yarn into dye bath at 10 degrees F. Work well while heating to boil, work at boil one hour, lift, cool, wash and dry.

No. 5.—Cochineal red.—100 pounds worsted yarn. Prepare a bath and dye with three pounds brilliant cochineal 4R, fifteen pounds Glauber's salts, four pounds oil of vitriol. Enter yarn into dye bath at 120 degrees F. Work well while heating to boil, work at boil one hour, lift, cool, wash and dry.

No. 6.—Bright blue.—100 pounds worsted yarn. Prepare a bath and dye with two pounds indigo blue N, fifteen pounds Glauber's salts, four pounds oil of vitriol. Enter yarn into dye bath at 120 degrees F. Work well while heating to boil, work at boil one hour, lift, cool, wash and dry.

Warrell & Howard's planing mill at Powassan, Ont., was burned July 26th.

Cole & Gable will build a flour mill at Dauphin, Man., having a capacity of ninety barrels daily.

H. B. Hunt will build a new flour mill near Beeton, Ont.

CHEMICAL
COMPOUND
COMPANY

CORRECTLY
COMPILED
CHEMICAL
COMPOUNDS

CIVILITY
CAREFULNESS
COMPLETENESS
CONTINUITY

DO YOU KNOW

That you are paying for Boiler Compound all the time whether you use it or not?

IF YOU DO NOT BUY

You will pay your coal dealer more than its cost in the extra Coal you burn.

Zinkolene Saves Money

THE CHEMICAL COMPOUND CO., 311 Temple Building, Toronto.

THE OTTAWA PORCELAIN AND CARBON CO., Limited, OTTAWA, ONT. . . .

MANUFACTURERS OF

CARBON POINTS for all kinds of Arc Lamps, including Cored and Solid Carbon for Incandescent Circuits.

..... ALSO.....

MOTOR BRUSHES and Specialties in Carbon for Telegraph, Telephone and Electric Light Supplies.

PORCELAIN INSULATORS, Cleats, Door Knobs, and all kinds of Pressed Porcelain for Electrical and Hardware Lines.

ALL GOODS GUARANTEED TO GIVE SATISFACTION.

A Saving.

The first cost is not the test of an actual saving. The truly Economical Manufacturer knows this to be true. For instance, the cheap, trappy Pulley, by its inferior working qualities, is a source of loss to the user the moment it is put in operation, and this loss continues all the time the Pulley is working. You do not get the full or proper results from your power plant. Higher price, though, is not always a sign of better quality, for instance—you may or may not have to pay more for

"THE REEVES" PATENT WOOD SPLIT PULLEY

but in either case you are getting the best value on the market. Because with THE REEVES the saving is continual, in Power, in Time, in Shafting, in Belting, and last but not least, and as a result of all the other savings, a saving in Money. CAN YOU AFFORD TO BE WITHOUT "THE REEVES"? Is the best too good for you? WRITE TO-DAY FOR OUR CATALOGUE AND GET OUR PRICES.

Also COLUMBUS, IND.

REEVES PULLEY CO., Toronto, Ont.

CORUNDUM LANDS OF ONTARIO.

In his well-known work on the geology of Canada, published thirty-five years ago, Logan notes an occurrence of corundum in the Township of Burgess, in Lanark County, being on the second lot in the ninth range. There, in contact with crystalline limestone, is a rock made up of folspar, quartz, calcite, silvery white mica and sphene and disseminated through it were found small grains of a mineral whose color varied from light rose-red to sapphire-blue, while a hardness of greater than topaz showed it to be corundum. Small crystals of light blue corundum were also found in the limestone of the vicinity. But so little interest did the discovery awaken that for many years the place of occurrence was forgotten and unknown, and it was only the circumstance of a much greater and far more valuable find of the same mineral in Carlow Township, Hastings County, that led as a matter of curiosity to the re-discovery of the Burgess corundum a few months ago.

Speaking of the discovery of this valuable deposit, Mr. Archibald Blue, Director of Mines of the Ontario Government, says:—

More than twenty years ago a little girl and her father were sitting on the rocks to rest after a walk through the woods at their home in North Hastings, and an oddly shaped stone which she picked up suggested to her mind the form of the glass stopper of a cruet-stand bottle. It was a crystal of corundum which had been weathered out of its matrix, but neither the child nor her father had then a suspicion of its name, nor that it had any relation, near or remote, to sapphire or ruby.

Still later, other discoveries of the mineral were made in the same region, and it was mistaken for apatite or the phosphate of lime. The nearest guess to its identity was made by a man who had studied mineralogy, and he thought it was emery.

Finally it happened that a lot of rocks was sent to the Geological Survey by some collector in Carlow, and, having lain for several years in a storehouse, they were turned over by Mr. Ferrier, the lithologist of the Survey, who discovered in one of the specimens a

crystal which he identified as corundum. This was two years ago, and it was the beginning of the end of the romance. Mr. Ferrier proceeded from Ottawa to Carlow Township, under the instructions of his chief, Dr. George M. Dawson, and with Nesbitt Armstrong, of the New Carlow Mills, for guide, he succeeded in finding the corundum.

A few days later information of the discovery was communicated by Dr. Dawson to the Bureau of Mines at Toronto, and in view of its importance and the possibilities of other deposits in the district, the mining rights in the lands were withdrawn from sale pending the carrying out of well-planned exploration.

This was late in 1896, and the work could not be undertaken until the following year, when it was placed in the hands of Prof. Willet G. Miller, of the Kingston School of Mining. The tracing of the mineral became an easy matter, and by the middle of October Prof. Miller had located occurrences throughout seven different townships and over an area of about 100 square miles. These townships are Carlow, Raglan, Bangor

GEO. REID & CO.,

Dealers in

Textile Machinery and Supplies,
TORONTO, ONT.,

Have bought and are offering for sale at great **Bargains** the entire machinery of the Campbellford Woolen Mill (which they are now taking out), also

A 4-Set Mill (Running), A 2-Set Mill (Running), and Three 1-Set Mills (Running).

✉ Write at once for Prices and particulars.

ADVERTISE IN THE CANADIAN MANUFACTURER.

.. ORDER ..

“Capitol”



THIS IS THE
STANDARD GRADE

CYLINDER

‘Renown’ ‘Atlantic’

ENGINE

RED OIL

NO BETTER OILS MADE

THE QUEEN CITY OIL CO., LIMITED

SAMUEL ROGERS, PRESIDENT

TORONTO, Canada

BELTING

**E
L
L
I
N
G**

**Leather Belting,
Lancashire Hair,
English
Card Clothing,**

D. K. McLAREN

Head Office and Factory—
VICTORIA SQUARE, - MONTREAL
Stock Depots—Ottawa, Galt.

OAK

**E
N
D
I
N
E**

WESTERN TRADE:—

Our Mr. R. M. W. McLaren, in charge of Galt Branch, will be pleased to give quotations as well as receive orders.

STORAGE BATTERIES

THE LIGHTEST. THE STRONGEST. THE BEST.

If you use Electricity wo Batteries Repaired and Recharged
can save you Money. at Reasonable Rates.

The Croftan Storage Battery Co.

W. M. H. NELLES. CANADIAN BRANCH. REIN WADSWORTH.
22 Sheppard Street, Toronto, Ont.

SHUTTLES



**BOBBINS
SPOOLS
PICKER
STICKS
CLOTH
ROLLS, Etc.**

JOHN HOPE & CO., - - LACHUTE, QUE.

THOMPSON & CO., Manufacturers of

BOBBINS and SPOOLS

FROM SELECTED STOCK.

Correspondence Solicited
Orders Promptly Filled

• **SHERBROOKE, P. Q.**

and Radcliffe, in Hastings, and Brudenell, Lynedoch and Sebastopol, in Renfrow.

The length of the corundum belt from east to west is about thirty miles and its average breadth is about three and a-half miles. It embraces over 60,000 acres, in all but a few thousands of which the mineral rights are held by the Crown. Another area has been partially explored in the Township of Methuen, in Peterborough County, where corundum of fine quality has been discovered, but the extent of it has not yet been determined.

Under arrangements made by the Ontario Crown Lands Department, several tons of ore were mined in November of last year and taken to the Kingston School of Mining for a mill test, designed to show not merely the proportion of corundum in the dike rock from which it was mined and the quality of it, but also the methods by which the ore could be most successfully treated to separate the mineral from its gangue and prepared for placing it upon the market.

There seems now to be no doubt that operations can be economically carried out upon a commercial scale, and assurances are equally satisfactory as regards the quality of the corundum. The tests made at Kingston show that the rock carries fifteen per cent. of corundum, and the proportion might be considerably increased with careful cobbing at the mines if this was desirable. If treated on a large scale the cost of milling the rock ought not to exceed \$1 per ton, and under careful management it might be reduced to sixty cents per ton of rock, or say of 300 pounds corundum, with an average of fifteen per cent. ore. What gives assurance of cheap production is the existence of abundant water power in the heart of the corundum

belt, on the Madawaska River and its tributaries, which may be electrically developed with a moderate investment of capital.

At present one of the chief uses of corundum is as an abrasive, yet, owing to its scarcity and cost no great quantity is available. The best known deposits are in Georgia and North Carolina, but these are limited in extent and are practically controlled by a combine. Emery has accordingly been the chief natural material used as an abrasive, being found in several countries in large abundance. In recent years, too, an artificial product known as carborundum has grown into favor, and the manufacturers of it are inspired with confidence that they can supply the market to the exclusion of every other kind of abrasive. But experiments recently made, go to show that for the best lines of work corundum is much superior to carborundum, and with the prospect of the opening up of large deposits in the Ontario fields corundum should have nothing to fear in the competition. Corundum certainly possesses one great advantage over its rivals in that it may be put to other uses.

As an ore of aluminium it has a great future if some present difficulties, which appear to be only of a trifling character, are surmounted. Pure corundum, which is alumina, is composed of 46.8 per cent. of oxygen and 53.2 per cent. aluminium, and in the treatment of ore at the Kingston School of Mining corundum has been produced 99.5 per cent. fine. The obnoxious elements consist of silica, sulphur and iron, all three not exceeding the half of one per cent., and means can no doubt be found to separate these from the corundum. At the present time cryolite and bauxite, are the principal ores of aluminium, the former carrying about

thirteen and the latter about twenty-six per cent. of the metal, or say one-quarter and one-half respectively of the metallic aluminium in pure corundum. Three analyses of the Hastings corundum made by Dr. Goodwin gave an average of 96.82 alumina, and the average of corundum concentrates obtained by Prof. DeKalb from a treatment of 1,200 pounds of rock was over ninety per cent. pure. And besides the corundum there is recovered from the rock in the process of treatment about five per cent. of magnetite, containing sixty-nine per cent. metallic iron suitable for the manufacture of the finest steel, or a quantity sufficient to pay the whole cost of milling.

It is the policy of the Ontario Government in dealing with the lands in the corundum belt, to encourage the founding of an industry which will bring the greatest good to the Province, and to that end the proper regulations have been framed and adopted.

WESTINGHOUSE ENTERPRISE.

In our last issue it was stated that this journal had received an invitation from the Westinghouse Machine Co., and the Westinghouse Electric and Manufacturing Co., to be present on July 30th at their works at Pittsburgh, Penn., primarily to inspect some remarkable new engines and electric apparatus which are about to be shipped to England, and incidentally to view the great establishments which are regarded as the model workshops of the United States. The visitors on that occasion saw three 2,500 horse power electrical generators, direct connected to three 2,500 horse power engines, which were constructed for the

CANADA IRON FURNACE CO., LIMITED
Montreal, Radnor and Three Rivers

Manufacturers of the well-known

"C.I.F." Three Rivers Charcoal Pig Iron

Suitable for Car Wheels, Cylinders and Fine Castings, where the utmost strength is required.

UNSURPASSED IN STRENGTH BY SWEDISH, RUSSIAN OR AMERICAN CHARCOAL IRON.

Offices: *Canada Life Insurance Bldg., Montreal.*

CANADA CHEMICAL MANUFACTURING CO.

— MANUFACTURERS OF —

Sulphuric, Nitric, and Muriatic Acids—Commercial and Chemically Pure.

Mixed Acids for Explosives.

Liquid Ammonia, Glauber Salts, Copperas, Muriate Tin, Tin Crystals, Acetic Acid, Nitrate Iron, Bisulphite Soda, Acid Phosphate for Baking Powders and General Chemicals, Fertilizers, etc.

LONDON, - ONTARIO.

MONTREAL PIPE FOUNDRY CO...

SUCCESSORS TO (Limited)

DRUMMOND-McCALL PIPE FOUNDRY CO.

Manufacturers of



"Specials," Hydrants, Valves, Etc.

Offices: - - - **Canada Life Building, MONTREAL**

DEPARTMENT

MILL and FIRE

Hose

SUPPLIES

W. A. FLEMING

Metropolitan Electric Supply Company, of London.

It is no new circumstance that England sends to America for electrical apparatus, but it is a new circumstance that England sends to America for large steam engines.

Neither the generators nor the engines which drive them are, in the present instance, "the largest ever built," but they are the largest of their type ever constructed, and they embody many new and interesting features in design and construction.

The Metropolitan Electric Supply Company is the greatest electric lighting company in Europe, and their present contract with the Westinghouse interests calls for "three compound two-phase steam alternators," each consisting of an enclosed vertical compound engine with the armature of the generator coupled direct to the engine crank-shaft, the engine and generator being mounted on separate bed plates.

The engines and generators are so designed that the full out-put can be obtained at any speed from 116 to 145 revolutions per minute, this range of speed being necessary in order to provide a variation in the frequency of the alternations, and thus enabling a supply to be given to existing transformers in London. They are of the enclosed vertical compound marine type.

The electrical apparatus built by the Westinghouse Electric and Manufacturing Company, accompanying these engines, consists of three direct connected alternating current generators, each having a nominal output of 2,000 horse power and delivering two-phase currents at a pressure of 500 volts. The armature, or the revolving element, of each generator, as before mentioned, is mounted directly on the engine shaft.

There is one direct current multipolar exciter to each generator, which is arranged for direct connection to the engine shaft.

This plant is to supply primarily arc and incandescent lighting to London, but a portion of the power is to be used for operating rotary transformers, which in turn supply current to direct current motors, and for charging storage batteries by the three-wire D. C. system.

The present contract which the London company has with the Westinghouse people has a further significance for American industry. The Metropolitan Electric Supply Company, of London, is planning now central stations, and newly equipping old ones, and it is likely that the Westinghouse Companies will be called upon to supply many additional engines and generators, of thousands of horse power capacity, before the work now begun is completed.

Apart from the machines contracted for by the Metropolitan Electric Supply Company, the gas engines and the steam turbines at the Westinghouse Machine Co's works are particularly noteworthy.

The Gas Engine Department is doing a large business turning out engines from ten to 200 brake horse power and shipping them all over the country. These engines are without a rival in the electric lighting business, combining as they do the features of

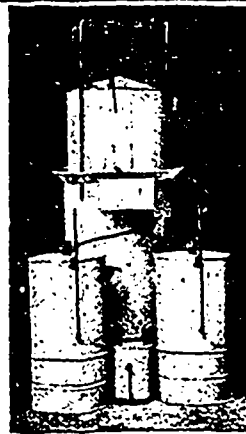

The "SAFETY" ACETYLENE GAS MACHINE

THE MOST SIMPLE AND THE SAFEST MACHINE MADE. It does what other machines cannot do. It generates Gas Cool. It washes and purifies the Gas twice. Automatically removes the Ash from the Carbide. Leaves the Ash perfectly dry and thoroughly exhausted.

Manufactured by..... **EVERY MACHINE GUARANTEED.**

THE SAFETY LIGHT & HEAT CO., Dundas, Ont.

Proprietors and Sole Manufacturers for the Dominion of the celebrated **CLIFF-WARDLAW GENERATORS.**

HAMILTON COTTON CO.

HAMILTON, ONTARIO.

YARN MANUFACTURERS, DYERS, AND BLEACHERS,

Warp Yarns of all descriptions, in Skein, Chain, or on Beams.
Hosiery Yarns in Single or Double; in Cop, Skein or Cone.
Yarns of all kinds for Manufacturers' use.

Twines, Lampwicks, Webbing, Etc.

Dyeing of all colors, including **GENUINE FAST BLACK.**

ALEX. GARTSHORE, President. J. G. ALLAN, Sec.-Treas. JAS. THOMSON, Vice-Pres. and Gen. Mngr.

THE GARTSHORE-THOMSON PIPE & FOUNDRY CO.

Limited

CAST IRON PIPE

3 in. to 60 in. diameter.

For Water, Gas, Culverts and Sewers

Special Castings and all kinds of
WATER WORKS SUPPLIES

FLEXIBLE AND FLANGE PIPE.

HAMILTON, ONT.

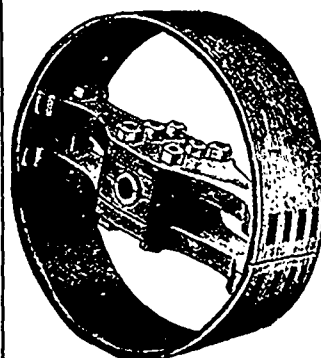

BENT WOOD SPLIT PULLEYS, RIM...

(REID'S PATENT).

The Strongest, Lightest and Best Belt Surface in the World

No Glue, no Nails in Rim like Segment Rim Pulleys, to be affected by Steam, Dampness or Moist Temperature.

EVERY PULLEY GUARANTEED.

The Reid Bros. Manufacturing Co., of Toronto,
257 King St. West, Toronto.

THE CANADIAN COLORED COTTON MILLS COMPANY.

**Cottonades, Tickings, Denims,
Awnings, Shirtings,
Flannelettes, Gingham,
Zephyrs, Skirtings,
Dress Goods, Lawns,
Cotton Blankets,
Angolas, Yarns, etc.**

Only Wholesale Trade Supplied.

D. MORRICE, SONS & CO.

AGENTS

MONTREAL and TORONTO.

The London Machine Tool Co., LONDON, ONT.

MANUFACTURERS OF GENERAL MACHINERY....

Having recently sold our patterns and plant to the A. R. Williams Co., of Toronto, retaining only such machines as are useful in our business, we beg to say that we are rapidly putting in New Machinery, from new and improved designs, and are now in a position to receive orders for all Standard Tools for Metal Working in all branches. It will be our aim, by personal supervision of the product of works, with expert men of large experience at the head of each department, to turn out nothing but first-class work at moderate prices. And as we intend to deal directly with the manufacturers, they will be enabled to get their machinery at first cost.

As we shall not be able to personally visit each manufacturer, it is for this purpose that we publish this advertisement. This is our agent who is going about to solicit a share of your patronage. We are thankful for the patronage extended to us in the past, and hope that we may secure an extension of the favors for the future.

All correspondence relating to the following Tools will be promptly answered, viz:

LATHES—Engine, Gap, Break, Turret, Fox, Spinning, Etc.
PLANES—Standard, Crank, Plato, Etc.
DRILLS—Standard, Sensitive, Multiple, Radial, Etc.
MILLING MACHINES—Lincoln, Plain, Universal, Etc.

SHAPING MACHINES—Whitworth, G. & E., Rack-Driven, Etc.
HAMMERS—Steam, Sandage Drop, Stiles Drop.
BULL-DOZERS for all purposes.
PUNCHES AND SHEARS for Plato, Anglos, Channels, Gauges, Etc.

And we would call special attention to our **PRESSES** for Cutting, Stamping, Drawing Wiring, Riveting, Etc. We shall also esteem it a pleasure to give quotations on Special and General Machinery in our line.

LONDON MACHINE TOOL CO.

JOHN J. KELLER & CO.

104 and 106 MURRAY ST.
NEW YORK

220 Church St., Philadelphia.

135 Pearl Street, Boston.

**Aniline Colors,
Dyewood Extracts,
Sumac and
Nutmeg Extracts.**

FAST COLORS for Wool Dyeing,
One Dip Cotton Colors, Novelties
and Specialties for Calico
Printing.

MANUFACTURED BY

JOHN R. GEIGY & CO.
BASLE, SWITZERLAND

**LIGHT YOUR
FACTORY WITH**

LUXFER PRISMS

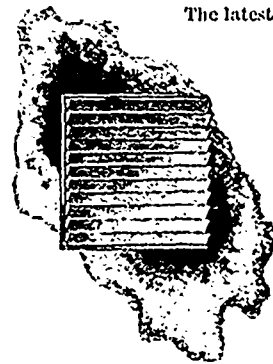

The latest device for

LIGHTING

dark rooms and
offices

By Daylight

For catalogue
and estimates
write to

**Luxfer Prism
Co'y, Limited.**

58 Yonge Street, - TORONTO.

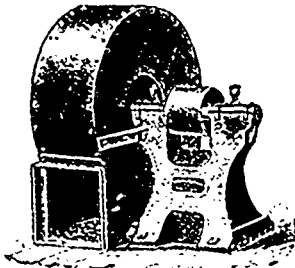

**Ventilating Steel-Plate
Fans, Blowers and
Exhausters.**

WE have on hand Fans of the Best American Makes, ranging from 15 inch to 72 inch. Also Second-hand Coil Heaters, with Fans to suit, from 1,000 feet to 5,000 feet of inch pipe capacity.

THE ABOVE ARE FOR SALE CHEAP.

Write for Prices and Send for Catalogue.

**McEachren Heating and
Ventilating Co., GALT, ONT.**

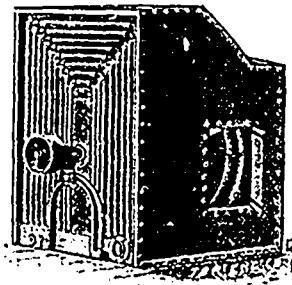

absolutely steady running, solidity of construction, and a minimum of floor space. The principle on which they run is a modification of the well-known Beau do Rochas cycle. This consists of compressing the charge into the head of the cylinder before igniting it. These engines differ from the ordinary "hit and miss" type in that the governor acts by controlling the quantity of explosive mixture which is taken into the cylinder. This results in an adjustment of the power of each explosion to the amount of work being done; hence the engine runs with the steadiness and regularity of a first-class steam engine. The regulation is so perfect that the Company has built many direct connected rigs where the dynamo is mounted rigidly on the end of the engine shaft. Even under this most severe test the lights are perfectly steady.

Not content with confining itself to the well-beaten path, the Westinghouse Machine Company have been reaching forward in the realm of things not previously done and have successfully built a 650 brake horse power gas engine. This engine has three cylinders, each twenty-five inches in diameter, and a thirty inch stroke, and runs at 145 revolutions per minute. Its economy is very marked, resulting in the production of a brake horse power for eleven cubic feet of natural gas. This is the largest gas engine in the world, and it operates with complete success.

A Parsons steam turbine driving a 200 h.p. alternating current generator was particularly interesting to the visitors. This turbine is a somewhat new form of steam engine, although extremely old in principle. It makes use of the high velocity attained by steam in passing through an orifice from a higher pressure to a lower, and acts much in the same manner as a water turbine. The Westinghouse Machine Co. have spent much time and money experimenting on this subject, and are now in a position to build Parsons turbines which give phenomenal results as compared with ordinary steam engines.

The Parsons turbine is a similar type of engine to that fitted on a little boat named the "Turbinia," which has lately been creating such a sensation in England by its remarkable performances. The engine consists essentially of—

(1) A barrel, in the internal bore of which are fitted numerous rows of turbine blades.

(2) A shaft, which revolves within the above barrel, having complementary blades fitted to the periphery. (3) Bearings.

(4) Lubricating and governing devices. The barrel and shaft together form a series of hundreds of complete turbines. The steam passing from one to the other expands itself and does work in each set until it arrives at the exhaust end, when it is entirely devoid of energy, and by this means utilizing the steam to its utmost limit, and producing remarkably economical results.

The turbine on exhibition runs at 4,700 revolutions per minute without any perceptible vibration. This speed, however, is not limited in any way. It may be either higher or lower. The bearings, which are a special feature, admit of any rotative speed that might be desired.

The visit to the Westinghouse works was one of uninterrupted pleasure and instruction.

A shipment of 4,000 tons of paper pulp was made a few days ago from Port Medway, N.S., to Cardiff, Wales.

**NEW DISCHARGE FOR COTTON
PLUSHES DYED WITH DIAMINE
COLORS.**

We take pleasure in presenting the following discharge method for producing white and colored effects upon cotton plush dyed with Diamine Colors.

There are many difficulties incident to discharging cotton plushes with a tin salt discharge on account of the tendency of the acid to discolor the edges of the discharge print and of the additional labor necessary in washing the goods after discharging. The application of the following discharge meets with none of these difficulties, as no acid is used in the process. Cotton goods need not be washed after discharging, but after steaming and drying are simply brushed in order to free them from the adhering zinc dust.

White discharge paste. 96 parts zinc dust, 60 parts dextrine solution 1:1, 30 parts water, 2 parts glycerine. Boil and mix thoroughly, and when cool add 50 parts Sodium bisulphite.

Yellow discharge paste. a. $\frac{2}{3}$ parts Thioflavine T, Pat., $\frac{1}{3}$ parts new Phosphine G, Pat., dissolved in 13 parts Acetic acid No. 8. Boil thoroughly and cool.

b. 6 parts tannic acid, $\frac{1}{2}$ parts tartaric acid, dissolved and boiled in 20 parts acetic acid No. 8, and allowed to cool.

Solution A is then mixed with solution B and these two added to the White Discharge paste given above. The Thioflavine T and New Phosphine G may be substituted by other basic colors that are not discharged with zinc dust. —Dye Stuffs.

**THE CANADIAN PEAT FUEL
COMPANY.**

One of the latest discoveries is that peat bogs may be turned into money, by using the peat as fuel. It is well known that in Ireland, Wales, Holland and Bavaria, peat has long been the sole fuel used by the very poor; but recently machinery has been invented by means of which vast areas of hitherto unused bogs can be converted into marketable peat, which as a fuel is said to rival coal itself.

The origin of peat bogs is well understood. They occur in low situations, or where some natural or artificial obstacle impedes the



**Mills,
Factories,
Warehouses**

Are best protected
against fire by being
equipped with

**Eddy's Indurated Fibreware
FIRE PAILS**

We are the only manufacturers in Canada
of this celebrated ware.

The E. B. EDDY CO., Limited.

Hull, Montreal, Toronto

**The Pulsometer
STEAM PUMP**

OFTEN IMITATED BUT
NEVER EQUALLED . . .

The handiest simplest and most efficient steam pump for general Mining, Quarrying and Contractors' purposes.

Muddy or Gritty Liquids
Handled without
wear.

Descriptive Catalogue
with prices, furnished
on application.

**PULSOMETER
Steam Pump Co.**
New York, U.S.A.

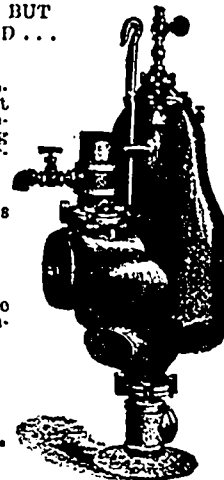

A. R. Williams Machinery Co.

Toronto and Montreal,
Selling Agent for Canada.



THE STURTEVANT SYSTEM

OF

Heating and Ventilating

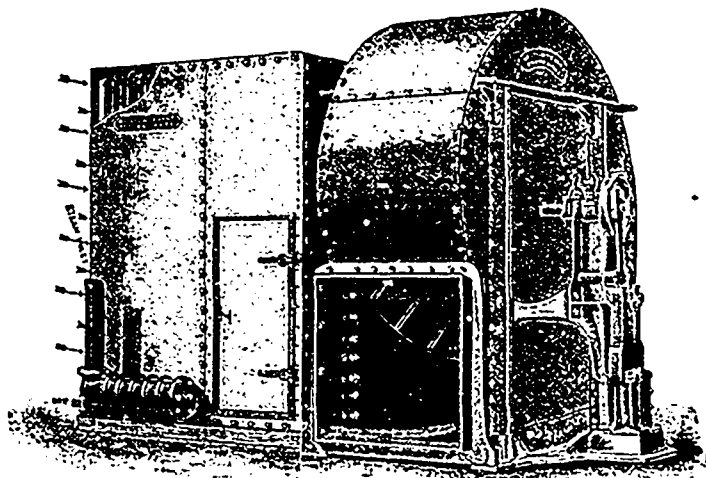

The Sturtevant Steam Heating and Drying Apparatus

APPLICABLE TO ALL CLASSES OF BUILDINGS

Has had a THOROUGH TEST in the Dominion
AND THE
Northern Portion of the United States.

Over 300 Plants in Successful Operation in
this Cold Climate.

Send for Catalogue No. 84, Describing this System
and No. 86, Showing 2,500 Representative
Buildings Heated and Ventilated.

B. F. STURTEVANT CO.
BOSTON, MASS., U.S.A.

**For
Drying**

This Apparatus is unexcelled for Lumber, Cotton, Wool, Hair, Brick, Pottery, Glue, Soap, Cloth and all Textile Goods.

A. R. WILLIAMS MACHINERY CO., LIMITED
General Canadian Agents
Toronto, Brantford, Montreal

ADVERTISEMENTS
RECEIVED
FOR
ALL
PAPERS.

AD

C. E. Browne,
Advertising Agent.
 145 Fleet Street
 LONDON E.C. Eng.

FOR
SALE OR LEASE
 For term of years,
LARGE
FACTORY PREMISES

AT KING ST. SUBWAY, TORONTO.

Ground Floor Area, 36,000 feet.
 Railway sidings and other City facilities.
 LIBERAL TERMS.
 LAND SECURITY COMPANY,
 44 Victoria St., Toronto.

R. C. Jamieson. A. T. Higginson.
R. C. JAMIESON & CO.
 Manufacturers of
Varnishes and Japans.

Importers of Oils, Paints, Colors, Turpentine,
Methylated Spirits, Shellacs, Rosins,
 Glues, Gold Leaf, Bronze, etc.

OFFICE—13 ST. JOHN STREET.
 FACTORY AND WAREHOUSE—23 to 29 ST.
 THOMAS STREET.
 MONTREAL.

Sun Lighting Machine.
 ACETYLENE GAS.

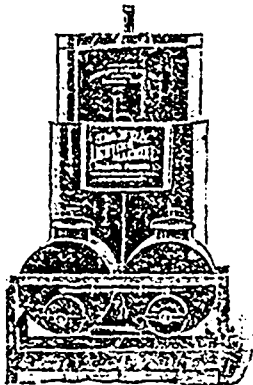

The
Acme
of
Perfection
in
Lighting.

At the Mini-
 mum of Cost.

Suitable for any place where Artificial Light
 is required. Dwellings, Stores, Churches,
 Factories, Hotels, Street Lighting, etc.

Write for Catalogue.

THE
Acetylene Lighting Co.
 (LIMITED).
 LONDON, ONTARIO.

drainage. Abundant moisture favors the growth of a low order of plants, such as the sphagnum mosses. This plant is noted for its absorption and storing of water. Its whole structure is that of an aggregation of reservoirs in successive layers, which are kept filled by capillary attraction, even when the plant itself is above water level. These same properties of the moss tend also to its decay. It requires a constant supply of moisture, yet it is continually pumping up to the surface of its tufts the water in which it stands, thus promoting evaporation, while at the same time, by regularly decaying at the roots, it deposits the detritus which adds to the solid contents of the bog. This process goes on till the bog is raised above the level of the surface waters, when sphagnum vegetation ceases. Thus bogs of considerable depth are made.

The peat bogs in Canada, and particularly in Ontario, are of a vast extent, and by virtue of their immense stores of carbon, constitute a potential source of fuel supply. In the Townships of Wainfleet and Humberstone, in Welland County, about five miles from Welland, lies a peat bog of some 5,000 acres, owned by the Canadian Peat Fuel Company of Toronto. While in the County of Essex, on the lake shore, just south of the town of Leamington, thousands of acres of bog have been purchased by a local company for fuel purposes. The dark, decomposed peat, which underlies the layer of moss, suitable for litter, is being manufactured into fuel. The depth of this peaty section varies from a foot or two at the edge of the bog to twenty feet in the centre. The peat is cut and air-dried, after which it is pulverized by being passed through a picker



Centaur Ventilating Spring Back.
 Flexible and Self-Adjusting.

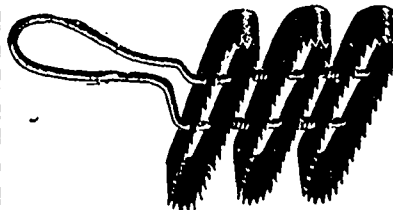

Centaur Spring Curry Comb.

CENTAUR VENTILATING
COLLAR PADS. FULLY
WARRANTED.

Will Positively Cure and Prevent any Horse's
Sore Neck.

PRICES, PER DOZEN, TO DEALERS, JULY 1, 1898 :

Original Centaur Pads, No. 1.....	\$4 00
" " " " No. 2.....	4 25
" " " " No. 3.....	4 50
Centaur Zinc Pads.....	3 50
Centaur Swing Back Pads, No. 1.....	4 25
" " " " No. 2.....	4 50
" " " " No. 3.....	4 75
Centaur Zinc Swing Back Pads.....	4 00

The Centaur Mfg. Co.,

EXCLUSIVE MANUFACTURERS
HARNESS and HARDWARE SPECIALTIES

HORSE FELT GOODS of all Descriptions.

FELT SWEATS. 'DEER SKIN COLLAR AND BACK PADS.

—SEND FOR PRICE LIST—

201-203 Lake Street, - - CHICAGO, U.S.A.

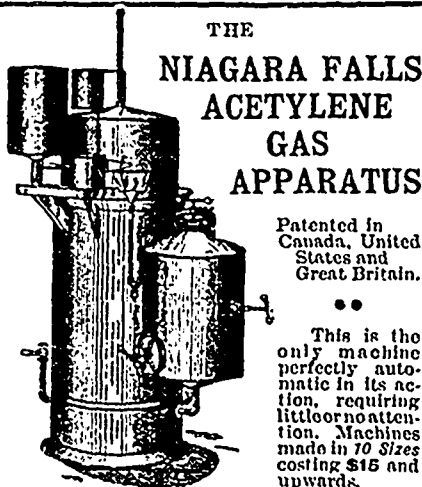

THE
NIAGARA FALLS
ACETYLENE
GAS
APPARATUS

Patented in
 Canada, United
 States and
 Great Britain.

This is the
 only machine
 perfectly auto-
 matic in its ac-
 tion, requiring
 little or no atten-
 tion. Machines
 made in 10 sizes
 costing \$15 and
 upwards.

Acetylene Gas the Coming Light.
CHEAPER THAN ELECTRIC LIGHT
COAL GAS OR COAL OIL

For Private Dwellings, Business Houses
 Churches, Public Halls and Offices.

For particulars write to the
NIAGARA FALLS ACETYLENE GAS MACHINE CO.
 NIAGARA FALLS, ONT. LIMITED.

Hamilton
Acetylene
Gas
Machine.

SIMPLE, ECONOMICAL, DURABLE
AND SAFE.

Adapted for Private Houses, Offices, Stores,
 Churches, or any building where a clear,
 bright and steady light is required.

300 in Use in the Dominion of Canada.
 Address Communications to

Hamilton Acetylene Gas
Machine Co., Limited,

71 York Street, HAMILTON.

and automatically deposited in a hopper, which feeds a steel tube about two inches in diameter and fifteen inches long. The pulverized peat is forced through this tube by pressure and formed into cylindrical blocks, about three inches in length, and almost equal in density to anthracite coal.

This novel article is manufactured in the form of a hard, dense block, containing all of the fibrous, carbonaceous, volatile and other materials and elements which are originally embodied in the raw peat, and an amount of moisture only corresponding approximately with that in the surrounding atmosphere.

The fuel is non-friable and weather proof

by reason of its solidity, and the external glaze imparted to it by frictional contact with the forming dies. The inherent moisture of the peat is reduced to twelve per cent. of the mass. In weight it stands thus with coal, eighty-three pounds per cubic foot of peat, equal seventy-three pounds bituminous of ninety-three pounds of anthracite

In a great measure this fuel solves the problem of furnishing a cheap, clean, uniform and reliable fuel for all domestic purposes, as it is equally serviceable for grates, stoves, cooking ranges and furnaces, giving a long, bright flame and intense heat almost from the moment of ignition, and its durability compares favorably with that of coal

in consumption, as the density and hardness of the blocks ensure the retention of their original form until the last atom of the inherent carbon and gas has been consumed.

This fuel has already been used in locomotive firing with excellent results. In steam-raising the pressed peat has been found to be equal to good anthracite coal. It has been shown that the thermal value of 100 lbs. of peat is equal to 91.15 lbs. of coal.

This fuel can be put on the cars ready for shipment for sixty cents a ton. At a slight advance on this it can be placed upon the market, and is bound to become a god-send to thousands of the struggling poor.

TO MANUFACTURERS...

Bar Iron, Steel, Boiler Plate,
Rivets, Tube Expanders,
Hammers, Metallic Letters
and
Figures for Patterns.

RICE LEWIS & SON

(LIMITED)

COR. KING AND VICTORIA STREETS, TORONTO.

ADVERTISE IN THE CANADIAN MANUFACTURER.

SEND FOR RATES.

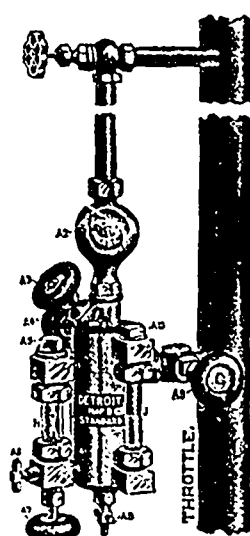

THE BEST JUDGES OF ENGINES

THOSE WHO BUILD HIGH-GRADE ENGINES,
ALL USE

The Detroit, Sight-Feed Lubricators

This is equally true of Canadian as of American engine builders. They know that the valve friction must be overcome if their engines are to work at their best. They know from experience that the Detroit Lubricators do this, and where so much is at stake they want only the best. It should be the same with all engine owners. The saving our Lubricators effect will pay for themselves very soon.

Send for Catalogue and Prices.

Detroit Lubricator Co.,
DETROIT, MICH.

RETURN OF PROSPERITY

The Wise Will Take Advantage of it.

MANUFACTURERS

Who would increase their output—
Retain their present customers—
and secure new ones, will
not fail to exhibit at....



CANADA'S GREAT INDUSTRIAL EXPOSITION TORONTO AUGUST 29th to SEPTEMBER 10, 1898.

GREAT
DEMAND
FOR SPACE.

Applications should
be made at once.

Entries Close August 6th.

For Prize Lists, Entry Forms and all Information
address the Manager.

JOHN J. WITHROW, President.

H. J. HILL, Manager, Toronto.

The Attendance of Visitors this Year will be Greater than ever.

THE "ROBB" HOT WATER HEATER.

The heater here illustrated was designed and patented by Mr. D. W. Robb, and is manufactured by the Robb Engineering Co., of Amherst, N.S. A number have been placed in buildings in different parts of the Maritime Provinces during the past two years, and have given highly satisfactory results.

It consists of a number of upright cast iron sections of the general shape of a horseshoe, with circulating pipes on each side of the crown. The height is much less than in most other types, permitting of its use in very low cellars, and as it may be shipped in sections it is easily taken into any building through the doors or windows. It is provided with rocking grates extending about half the length of the heater, which are easily operated by a lever. The hot gases are directed upwards by a fire bridge at the rear of the grate, and then downwards by a shield which prevents them escaping too quickly out through the smoke pipe. The part of the outer rim of each section that is exposed to the fire is curved, increasing the heating surface very largely.

On account of the shape of the heating surfaces and their direct exposure to the flames, soot cannot collect. This allows of the use of soft coal as well as hard without cleaning out, and keeps the heater always at

its highest efficiency. The flame being in one large body admits of more perfect combustion, or greater heat than is obtained where it is divided into thin sheets before the gases are fully ignited.

The water circulates from the return headers at the bottom to the flow header at the top in an almost vertical direction. The movement is therefore very rapid, giving much quicker heating than is usually secured

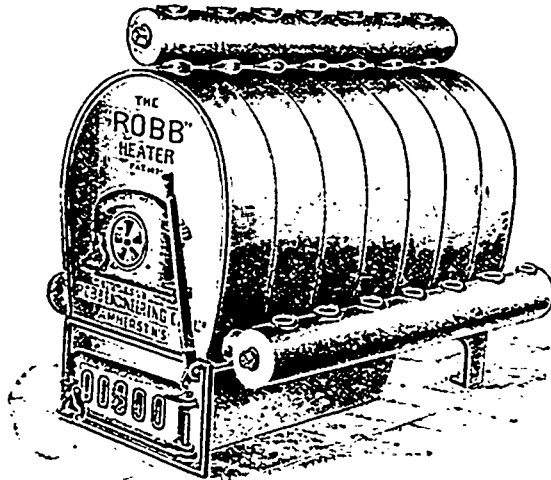

The Robb Heater.

with hot water. This rapid circulation also assists largely in the economy shown by this heater, as it is necessary for the best results that the water should escape as fast as heated, allowing colder water to take its place.

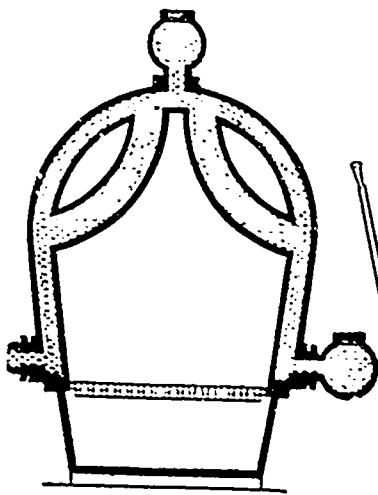

Sectional View, Cross-wise.

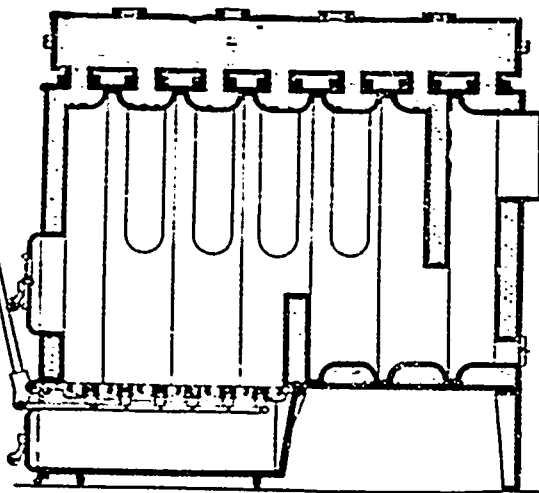

Sectional View, Lengthwise.

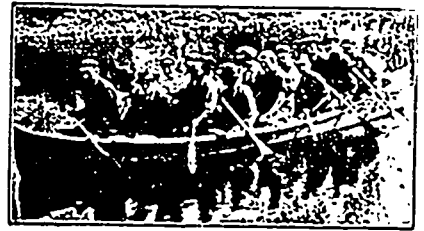

Canoes for Alaska and Gold Regions

This cut is one of our 19 foot, No. 68x Canoes, and shows carrying capacity. Write for our catalogue and discounts.

Peterborough Canoe Co., Limited, Peterborough



For IRON FENCING, BANK and OFFICE RAILINGS and all kinds of IRONWORK

Address:

Toronto Fence & Ornamental Iron Works
73 Adelaide St. West, Toronto.

LEITCH & TURNBULL. Canada Elevator Works, Queen and Peter St., HAMILTON, ONT. Patent Safety Hydraulic, Hand and Power ELEVATORS. Telephone Connection.

BROWN & CO.



Manufacturers of Square and Hexagon HOT PRESSED NUTS.

PARIS, - ONT.

THE PARIS ELECTRO-PLATING CO.

Manufacturers of Stove Trimmings, Organ and Piano Trimmings, also all kinds of Brass and Nickel Plating Done Paris Station, - - Ontario

FIRSTBROOK BROS.

Dovetail and Packing Boxes Top-Pins, Side Blocks and Cross Arms. Wood Printers, Etc. Cigar Boxes, Shipping Cases. TORONTO, - - ONTARIO Write for Prices.

Smith Wool-Stock Co., 219 Front St. E., Toronto. Makers of WOOL STOCK, SHODDIES, Etc. All lines of Graded Woolen Bags, Carbonizing and Neutralizing, Buyers of Wool Pickings, All lines of Hard and Soft Waste.

Advertise in the Canadian Manufacturer.

The Wellington Mills, LONDON, ENGLAND

GENUINE EMERY

Oakey's Flexible Twilled Emery Cloth. Oakey's Flint Paper and Glass Paper. Oakey's Emery Paper, Black Lead, Etc. Prize Medal and Highest Award Philadelphia, 1876, for Superiority of Quality, Skillful Manufacture, Sharpness, Durability, and Uniformity of Grain.

Manufacturers.... **JOHN OAKEY & SONS, Ltd.,** Wellington Mills, Westminster Bridge Road, London, Eng.

Inquiries should be addressed to

JOHN FORMAN, 650 CRAIG ST., MONTREAL.

A. KLIPSTEIN & CO.

122 PEARL STREET, NEW YORK.

Anilines, Dyestuffs and Chemicals.

DELIVERY MADE AT NEW YORK, MONTREAL OR HAMILTON.

WRIGHT & DALLYN, AGENTS,

HAMILTON, ONTARIO.

Ford, Ruthven & Co.,
 21177 STREET, SYDNEY,
 AUSTRALIA.
WOOL BUYERS on Commission

Letters of Credit must accompany orders.
 Bankers:—Bank of Australasia, Sydney.

GEO. PATTINSON & CO.
 PRESTON, - ONTARIO.
 Manufacturers of

FINE AND MEDIUM TWEEDS

Guelph Woolen Mill Co.,
 GUELPH, ONT.
 Manufacturers of

Underwear, Hosiery, Whoslin,
 Fingering and Worsted Yarn,
 Elderdown Flannel, Etc.

Selling Agents—Dobbs Fraser, Montreal,
 Z. H. Wade & Co., Toronto.

PENMAN MANUFACTURING CO.
 PARIS, ONT.
 Manufacturers of

Hosiery, Shirts, Drawers,
 Glove Linings and Yarns.

Selling Agents—H. Morrison, Paris & Co.,
 Montreal and Toronto.

ROSAMOND WOOLEN CO.
 ALMONTA, ONT.

Fine Tweeds, Cassimeres,
 and Fancy Worsted
 Suitings and Trouserings.

JOHN HALLAM
 TORONTO

REPRODUCERS OF
 and **Wools**
 Special Preparation for

Reproductions made for Eight
 Dents per Square Inch.

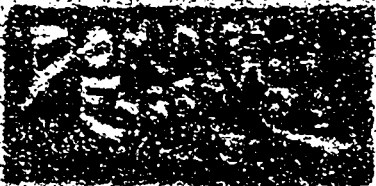

Half Faces Made Direct from
 Flax.

It Loads Them All.

THE OLDEST,
 THE LARGEST,
 THE SAFEST,
 THE CHEAPEST,

CANADIAN LIFE INSURANCE COMPANY LTD

THE CANADA LIFE ASSURANCE COMPANY.

CAPITAL AND FUNDS OVER \$13,000,000.

Write for Prospectus.

A. G. RAMSAY,
 President.

GEO. A. & E. W. COX,
 Managers for Toronto
 and Eastern Ontario.

WOOL.

A. T. PATERSON & CO.,

...Merchants...

85 FRANCOIS XAVIER STREET,

MONTREAL.

Represented by
MR. DAVID GUTHRIE.

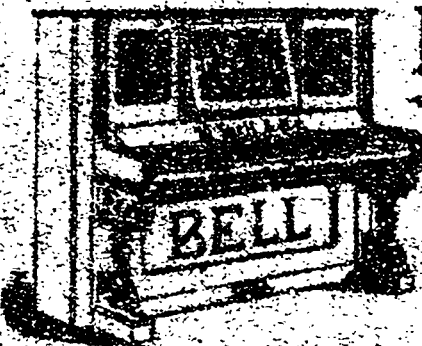

BELL

HIGH CLASS

INSTRUMENTS

USED AND RECOMMENDED
 BY

LEADING MUSICIANS.

Send for Catalogue.

THE BELL ORGAN AND PIANO CO

(LIMITED)

GUELPH, - ONTARIO.



CROSBY STEAM GAGE AND VALVE CO.

Sole Proprietors and Manufacturers of

Crosby High Pressure Valves for all kinds of Boilers, Water Relief Valves including
 the Underwriter which is fully approved by the London and Lancashire
 Insurance Companies; Crosby Steam Gages, Ringing Piston Valves, with
 and without Electrical Attachments; Crosby Engineering Steam
 Gages, Recording Gages and Patent Gage Testers.
 Original Office: 251 Broadway, New York.

STANDARD PAINTS PIPE VALVES
 CLARK'S LIGHT PIPE NOSE AND ADJUSTABLE COUPLINGS

All kinds of Pressure and Vacuum Gages used in the various Arts

Gold Medal Fair, Exposition, 1883

Two Highest Awards, Centennial Exposition, 1889

Patent Office and Works

BOSTON, MASS., U.S.A.

Branch Office at New York, Chicago, and London, Eng.

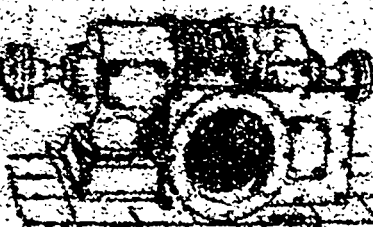

**"LITTLE GIANT"
 TURBINE**

FOR ALL PURPOSES.

HORIZONTAL AND VERTICAL

BUILT IN 44 SIZES.

We guarantee a higher percentage of power from
 water and less wear and tear than any other wheel on the market.

Water Wheel, Governors, Water Turbine, Francis, Pelton, Blodgett and Parsons,
 Turbines and other machinery for applications.

J. C. WILSON & CO., - - GLENORA, ONT.

LANGWELL'S BABBITT, MONTREAL.

AN EXCELLENT ANTI-FRICTION METAL.

G. LANGWELL & SON, MONTREAL

THE DOMINION FOUNDRY SUPPLY CO.
 22-24 St. George Street, MONTREAL.
 FOUNDRY FACINGS and SUPPLIES,
 CRUCIBLES, PLUMBAGO, Etc.

BELLHOUSE, DILLON & CO.

SOLE AGENTS FOR THE UNITED STATES AND CANADA.

The West Indies Chemical Works LIMITED, JAMAICA.

MAKERS OF THE FINEST QUALITY OF EXTRACTS OF LOGWOOD.

28 Colborne St., TORONTO.
 30 St. Francois Xavier St., MONTREAL.
 20 Cedar St., NEW YORK.



The Ontario . . . Malleable Iron Co.

(Limited)

....Manufacturers of....

MALLEABLE IRON Coatings to Order for all kinds of

AGRICULTURAL IMPLEMENTS

.....AND.....

Miscellaneous Purposes

OSHAWA, - - ONT.

FOR LIGHT and HEAVY WORK.

MOULDING SANDS

Albany and South Amboy



Manufacturers of

FINE VARNISHES

Japans—Asphaltums—Shellacs

Maple Leaf Brand Coach Varnishes

J. H. FARR & CO.

Armature Insulating Compound

Insulating Compound for Weather-Proof Wire, Tube Compound, Mica Paste, etc., etc.

8 to 16 MORSE STREET TORONTO



THE CANADA SWITCH & SPRING CO., LIMITED.

Manufacturers of
SPECIALTIES FOR.....

Steam and Electric Railways,

SPRINGS, STEEL CASTINGS, FROGS, FORGINGS, TRUCKS FOR ELECTRIC RAILWAYS, ETC.

INTERLOCKING SWITCH and SIGNAL PLANTS,

(Under patents of Messrs. Saxby & Farmer, Limited, of London, Eng.)

CANAL BANK, POINT ST. CHARLES, MONTREAL.

BRISTOL'S Recording Instruments

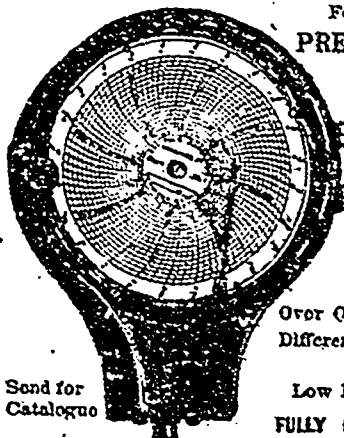

For..... PRESSURE

Temperature AND

Electricity

Over One Hundred Different Varieties.

Low Prices and FULLY GUARANTEED

THE BRISTOL CO. WATERBURY, CONN., U.S.A.

Send for Catalogue

SMITH'S FALLS

Malleable Iron Works

00000

CAPACITY 2,000 TONS.

00000

WILLIAM H. FROST

PROPRIETOR,

SMITH'S FALLS,

ONTARIO, CANADA.

CARRIER, LAINE & CO. | Dredges,

SAW MILL MACHINERY,

Montreal Branch.... 147 St. James St.

Quebec Branch....