

Technical and Bibliographic Notes / Notes techniques et bibliographiques

The Institute has attempted to obtain the best original copy available for filming. Features of this copy which may be bibliographically unique, which may alter any of the images in the reproduction, or which may significantly change the usual method of filming, are checked below.

L'Institut a microfilmé le meilleur exemplaire qu'il lui a été possible de se procurer. Les détails de cet exemplaire qui sont peut-être uniques du point de vue bibliographique, qui peuvent modifier une image reproduite, ou qui peuvent exiger une modification dans la méthode normale de filmage sont indiqués ci-dessous.

- Coloured covers/
Couverture de couleur
- Covers damaged/
Couverture endommagée
- Covers restored and/or laminated/
Couverture restaurée et/ou pelliculée
- Cover title missing/
Le titre de couverture manque
- Coloured maps/
Cartes géographiques en couleur
- Coloured ink (i.e. other than blue or black)/
Encre de couleur (i.e. autre que bleue ou noire)
- Coloured plates and/or illustrations/
Planches et/ou illustrations en couleur
- Bound with other material/
Relié avec d'autres documents
- Tight binding may cause shadows or distortion along interior margin/
La reliure serrée peut causer de l'ombre ou de la distorsion le long de la marge intérieure
- Blank leaves added during restoration may appear within the text. Whenever possible, these have been omitted from filming/
Il se peut que certaines pages blanches ajoutées lors d'une restauration apparaissent dans le texte, mais, lorsque cela était possible, ces pages n'ont pas été filmées.

- Coloured pages/
Pages de couleur
- Pages damaged/
Pages endommagées
- Pages restored and/or laminated/
Pages restaurées et/ou pelliculées
- Pages discoloured, stained or foxed/
Pages décolorées, tachetées ou piquées
- Pages detached/
Pages détachées
- Showthrough/
Transparence
- Quality of print varies/
Qualité inégale de l'impression
- Continuous pagination/
Pagination continue
- Includes index(es)/
Comprend un (des) index

Title on header taken from: /
Le titre de l'en-tête provient:

- Title page of issue/
Page de titre de la livraison
- Caption of issue/
Titre de départ de la livraison
- Masthead/
Générique (périodiques) de la livraison

Additional comments: /
Commentaires supplémentaires:

This item is filmed at the reduction ratio checked below /
Ce document est filmé au taux de réduction indiqué ci-dessous.

10X	12X	14X	16X	18X	20X	22X	24X	26X	28X	30X	32X
								✓			



Vol. II.—No. 1.

APRIL, 1874.

Price in Canada \$1.50 per An
United States - \$2.00 "

CONTENTS.

INVENTIONS PATENTED, 1
 INDEX OF INVENTIONS, 10
 INDEX OF PATENTEES, 11
 ILLUSTRATIONS, 13

INVENTIONS PATENTED.

No. 3244. RICHARD SMITH, Sherbrooke, Que., 27th March, 1874, for 5 years: "Improvements on Hot Air Furnaces." (Perfectionnements aux calorifères à air chaud.)

Claim.—1st. The application of the lining H, H, suspended in the interior of the heater and drum in such a manner as to leave a space between the lining and the outer shell of each.

No. 3245. FREDERICK TARRANT and JOHN P. CONKLING, Saratoga Springs, N. Y., U. S., 27th March, 1874, for 15 years: "Improvements on Stove-pipe Thimbles." (Perfectionnements aux douilles des tuyaux de poêles.)

Claim.—A telescopic stove-pipe thimble, the tubes A, and B, of which are provided at their outer ends with flanges A1, and B1, and have interlocking spiral beads a, and b.

No. 3246. JAMES H. THORP, Chicago, Ill., U. S., (Assignee of J. P. THORP), 27th March, 1874, for 5 years: "Improvements on Thill Couplings." (Perfectionnements dans l'accouplement des limonnières.)

Claim.—The hook F, applied to the thill-coupling, and passing through a hole in the thill wire to operate in the manner set forth.

No. 3247. ALBERT UNGERER, Simmering, Austria, 27th March, 1874, for 5 years: "Process and Apparatus for Preparing Paper Pulp, &c." (Procédé et appareil pour préparer la pâte à papier, &c.)

Claim.—1st. A new and peculiar process for isolating the cells of plants without injuring their integrity and for freeing them completely from the substances known as incrustating substances, whereby they are also decoloured to a great extent; 2nd. The arrangement of an apparatus specially adapted for the aforesaid purpose and especially applicable for the manufacture of paper pulp from wood, as specified and described.

No. 3248. MATHEW GLEN and WILLIAM H. LYNCH, Shipton, Que., 27th March, 1874, for 5 years: "Machine for Grinding, Polishing and Finishing Slate." (Machine à dégrossir, polir et parfaire l'ardoise.)

Claim.—The machine with the moveable metal plate B, B, worked between a number of rollers c, c, c, c, and x, x, x, x, by a connecting rod d, attached to a crank and balance wheel combined, moved by steam or water power.

No. 3249. LOUIS A. COLTEAU, Léonville, France, 27th March, 1874, for 5 years: "Potato Sowing Machine." (Semoir à patates.)

Claim.—1st. The novel combination of the moveable recipient p, the cloth r, the inclined plane u, the rotating shaft with wings c, the rotating shaft with eccentrics z, the rotating discs a1, and the funnel d1, with intermittent opening, all working together in the manner described; 2nd. The moveable recipient p, with the cloth r, constructed as described in combination with the inclined plane u, the rotating winged shaft x, the rotating shaft with eccentrics z, the rotating shaft b1, with discs a1, and the funnel d1, constructed, arranged and operating as set forth; 3rd. The ploughshare d, in combination with the bar e, the upright f, the shaft g, the lever h, the cross piece i, the segments j, and the ploughshares k, the bars l, the segments o, as described.

No. 3250. SAMUEL P. WILLEBY, Philadelphia, Penn., U. S., 27th March, 1874, for 5 years: "Improvements on Keels of Vessels." (Perfectionnements aux quilles de vaisseaux.)

Claim.—1st. The concave supplementary bilge keels; 2nd. The arched or rounded centre or true keel; 3rd. In combination with a vessel's hull the concave supplementary bilge keels, and the arched or rounded centre or true keel as described.

No. 3251. THOMAS A. DAVIES, New York, U. S., 27th March, 1874, for 5 years: "Signal Hand Lantern." (Lanterne de signal à main.)

Claim.—A signal hand lantern having a coloured shade or coloured conical cylinder J, attached to the oil cup A, by the parts described and covered from the lantern with the oil cup A, arranged to be moved vertically whereby the white light is changed to a coloured light and the coloured to a white light for making signals as described.

No. 3252. GEORGE H. DAVIS, Boston, Mass., U. S., 27th March, 1874, for 5 years: "Improvement on Upright Piano-fortes." (Perfectionnement des pianos droits.)

Claim.—Upright piano metallic frame A, made or provided with the shelf a, and the flange C, arranged as specified; the combination of the shelf a, and the flange C, with the metallic frame A, the wooden straining pin bar B, and the back frame D, all arranged and applied together as set forth, series of wooden plugs d, or harmonic connections with the perforated flange C, the metallic frame A, the straining pin bar B, and the back frame D, all connected and arranged as specified.

No. 3253. RICHARD SMITH, Sherbrooke, Que., 27th March, 1874, for 5 years: "Process for Reducing Wood into Pulp." (Procédé pour convertir le bois en pâte.)

Claim.—The process of manufacturing fibrous pulp by the application of superheated steam to the wood or other kindred substances, while chemically undergoing the process of reduction into pulp.

No. 3254. WILLIAM C. HOBBS, London, Ont., 27th March, 1874, for 5 years: "Folding Pipe Bedstead." (Couchette en tube pliante.)

Claim.—Connecting the head and foot frame, H, H, to the side rails B, B, so that said frames may be turned so as to lie in the same plane with and between the side rails.

No. 3255. THOMAS H. CARROLL, Erie, Penn., U. S., 27th March, 1874, for 5 years: "Machine for Sawing Lumber into Strips." (Machine à scier le bois en tringles.)

Claim.—1st. The sliding sleeve and collar C, having grooves I, I, in combination with the box c, ctt, having the lining of metal C¹, when constructed to operate in the manner described; 2nd. The revolving and sliding sleeve and collar C, carrying saw E, box c, ctt, having arm c¹ and eye D, and hand lever E, with the guide rod D¹; 3rd. The pivoted and slotted sliding sleeve f, having arm f¹ and gauge rod E, in combination with the transverse guide rod g; 4th. A machine for sawing planks or boards into strips, the sliding saw C, the fixed saw U, the horizontally adjustable gauge F, and single carrying rollers G, when constructed and arranged with relation to each other, and operating in the manner described.

No. 3256. THOMAS ALEXANDER, Glenwilliams, Ont., 27th March, 1874, for 5 years: "Improvements on Waggon's." (Perfectionnements aux voitures.)

Claim.—1st. Making of waggon seats with the metal corner clasps a, a, a, of approved shape, screwed or bolted to the wood work, and binding together the back and sides of the seat; 2nd. The metal standard b, b, for single or double panels of waggon boxes being checked at the top c, or at the top and centre c, d, as may be required and finished at the bottom with a flange or spur e, and fastened to the sill as described.

No. 3257. JAMES H. THORP, Chicago, Ill., U. S., 27th March, 1874, for 5 years: "Brick Machine." (Machine à brique.)

Claim.—1st. A brick machine, the endless chain of moulds H, stretched by drums F, F, and operating under rollers D, D, forcing the clay into moulds. 2nd. The combination of an endless chain of moulds H, each having a moveable bottom c, provided with an annular rib k, and web l, and drums F, F, having raised bands G, for driving out the moulded bricks in the manner set forth; 3rd. Providing the moveable journal boxes C, C, with an elastic rubber packing P, P, as set forth.

No. 3258. GUSTAVE H. E. DUBELLE, Montréal, Que., 31st March, 1874, for 5 years: "Process for the Manufacture of Butter." (Procédé de fabrication du beurre.)

Claim.—The manufacture of butter from the semi-fluid, oleo-margarine, as described.

No. 3259. THOMAS S. SEABURY, St. James, N. Y., U. S., 31st March, 1874, for 5 years: "Improvements in Waggon Jacks" (Perfectionnements aux crics à voitures.)

Claim.—A waggon Jack, consisting of the two legs A, and B, lever C, catch D, and bar or pin E.

No. 3260. FRANCIS NICHOLS, New London, Ct., U. S., 31st March, 1874, for 5 years: "Acid Pump and Syphon." (Pompe et siphon pour les acides.)

Claim.—1st. An acid pump consisting of the chambered bulb A, valves G, collapsible elastic bulb K, and pipe connections B, F, arranged and combined as specified; 2nd. The tube L, provided with the hole O, to operate with the bulb K; 3rd. Angle band Q, provided with a lip R, and applied to the parts A, and E¹, for connecting the same; 4th. The nozzle E, F, projecting downward into the enlarged chamber of the bulb A, below the suction pipe L, and provided with a downwardly seated valve as described; 5th. Flexible joint composed of the socketed head B¹, the tubular part G¹, their flanges a¹, b¹, and elastic belt or band D¹, all arranged as specified.

No. 3261. DARIUS DAVISON, New York, U. S., 21st March, 1874, for 5 years: "Improvements on the construction, setting and operation of retorts for the manufacture of coal gas." (Perfectionnements dans la construction, l'ajustage et le fonctionnement des cornues pour la fabrication du gaz de charbon.)

Claim.—1st. The retorts formed with about their back halves or position wider on their bottom than about their front halves thereof to give bottom surface and room in the back parts of the retorts in a bench for the whole charge of coal, said retorts being gradually reduced in width at or near the centre of their lengths; 2nd. The transverse outer ribs B, made in connection with and as an integral part of the retort irrespective of the form of the latter; 3rd. The supporting block C, in combination with the outer transverse ribs

B, of the retorts; 4th. The damper F, in combination with the furnace D, and retorts A, of different widths as described; 5th. The process as described, and irrespective of any particular form or construction of retorts to accomplish the results herein specified of distilling the whole charge of coal in or about the back halves of the retorts, leaving the bottom of about the front halves or any portion thereof more than is the usual practice free from coal.

No. 3262. DARIUS DAVISON, New York, U. S., 31st March 1874, for 5 years: "Manufacture of illuminating gas." (Fabrication du gaz d'éclairage.)

Claim.—The process described of manufacturing illuminating gas from coal or other substances by withdrawing the residual coke or material of one charge from the retort or retorts when all the good illuminating gas desired or beneficial to obtain for the use has been distilled therefrom, and while the residual coke in the retort or retorts is at a comparatively low temperature, and the non-luminous gas has not been distilled therefrom, then temporarily closing and reheating the retort or retorts while empty to the necessary degree properly to distill the succeeding charge and then recharging the retort or retorts in time and manner described as a regular systematic continuous mode of operation for the purpose set forth.

No. 3263. GEORGE SWEET, Dansville, N. Y., U. S., 31st March 1874, for 5 years: "Improvement on Wheelwright Machines." (Perfectionnement des machines de charronnerie.)

Claim.—1st. The combination with the arms c, c, of the slide a, provided with the lugs i, i, and operated by the cam lever E, or equivalent in the manner specified; 2nd. The elbow lever j, with tooth v, and spring f, operating in combination with the notched disc B; 3rd. The combination with the disc B, arms c, c, segment D, and slides a, of the sliding saws and auger carriages G, G, all mounted upon the frame A, and operating as set forth; 4th. The combination with the stationary spindle K, of the saw P, sliding carriage G 2, carrying the hollow auger R, and of the rest R, all arranged to operate in the manner specified.

No. 3264. GEORGE SWEET, Dansville, N. Y., U. S., 31st March, 1874, for 5 years: "Horse Rake." (Râteau à cheval.)

Claim.—1st. The combination with the axle A, and wheels B, B, of the shaft I, cranks p, p, or equivalent, connecting rods n, n, and brakes L, L, arranged to operate in the manner specified; 2nd. The combination with the axle A, and thills c, c, of the toggle arms M, M, arranged to operate in the manner specified; 3rd. The combination with the toggle arms M, M, and lever P, of the trip H, so arranged as to throw up or break the joint of the toggle arms before the axle begins to turn as described; 4th. The combination with the toggle arms M, M, and trip H, of the adjustable gauge c. 5th. The combination with the axle A, and shaft I, of the notched rib O, and lever P, provided with the pawl v; 6th. The combination with the toggle arms M, M, of the pivot piece N, for lengthening or shortening said toggle arms; and 7th. The combination with the axle A, and rake teeth D, D, of the rock arms H, H, arranged to operate in the manner specified.

No. 3265. GEORGE SWEET, Dansville, N. Y., U. S., 31st March, 1874, for 5 years: "Plaster Sower." (Semoir à plâtre.)

Claim.—1st. The combination of the hopper G, slide K, and agitator H, when attached directly to the axle and under as described, and operated by the engaging and disengaging gears p, r, s, and lever u; 2nd. The combination with the gears p, r, s, and lever u, of the slide v, and way w; 3rd. The combination in a plaster sower, with the thills and axle of a stiff stay bar D, and joint piece E.

No. 3266. SALEM T. LAMB, New Albany, Md., and BENJAMIN F. AVERY, Louisville, Ky., U. S., 4th April, 1874, for 5 years: "Self-acting Car Coupler." (Atelage de wagon automatique.)

Claim.—1st. The vibrating and reciprocating trip B, C, pivoted beneath the coupling pin passage O, so that when it forward its upper end is protected by the support d, and when it back will guide the link into an approaching draw-head; 2nd. The draw-head A, having the recess extending from the back of the coupling-pin through the back of the chamber and forward in front of the coupling-pin through the base of the draw-head in combination with the trip B, C; 3rd. The coupling pin with the depressed edge of its overhang cap isolated from the draw-head; 4th. The draw-head with an upper front stop d, and a lower back supporting stop i, in combination with the trip B, C, which slide backwards and forwards on its axial pin; 5th. The draw-head with the strengthening and supporting casing below its base; 6th. The trip with a passage between its lower end and its counterbalance whereby the weight is thrown forward of the coupling-pin and room for said pin and for dirt to pass downward provided as described; 7th. The combination of a vertically suspended coupling pin with the counterbalance vibrating and reciprocating under hung trip; 8th. The offset n, on the coupling-pin D, in combination with the shoulder p, of the draw-head; and 9th. The jointed self-locking bar E, E¹, in combination with a coupling-pin for the purpose set forth.

No. 3267. DANIEL E. FLETCHER, Lindsay, Ont., 4th April, 1874, 5 years: "Machine for churning." (Machine à baratter.)

Claim.—The application of the horizontal screw dash C, as set forth.

No. 3268. WILLIAM A. LEWIS, Springfield, Vt., U. S., 4th April, 1874, for 10 years: "Improvement on Churn Powers." (Perfectionnement des mécanismes des barattes.)

Claim.—1st. The clutch M, or its equivalent, in combination with the gear wheel, when the said wheels are employed as described; 2nd. The groove F; 3rd. the combination and arrangement of the changeable wheels E, and I, arbour C, stud N, clutch M, grooves F, and K, and pins G, and L, as described.

No. 3269. THOMAS MATHIAS, and JOHN A. COONS, New Berlin, Ill., U. S., 4th April, 1874, for 5 years: "Improvements in churns." (Perfectionnements dans les barattes.)

Claim.—A churn with double milk receivers A, and B, and double dashers I, and J, in combination with the double dasher rods H, H, lever L, and standard K.

No. 3270. OREN F. COOK, Grand Island, Cal., U. S. 4th April, 1874, for 5 years: "Process of preparing Grain for the Manufacture of Flour." (Procédé pour préparer le grain pour la fabrication de la farine.)

Claim.—The process of removing from grain its outer husk or bran as described, to wit: first, subjecting the grain after the ordinary cleaning to the action of water or steam to soften the husk, then passing it between two vertical bran-covered metallic surfaces, one revolving within the other as set forth.

No. 3271. WILLIAM R. MACAULAY, Hamilton, Ont., 4th April, 1874, for 5 years: "Self-acting Car-coupler." (Attelage de wagon automatique.)

Claim.—The combination and arrangement of the several parts, namely: the arrow headed coupler arms B, for connecting the cars together in connection with the buffer and spring C, the bolt D, and the saddle E, in connection with the rods F, and H, and the lever G, for uncoupling the cars, all operating as set forth.

No. 3272. FRANCIS GREEN, Montreal, Que., (Assignee of T. HOLLAND), 4th April, 1874, for 5 years: "Combination Steam, Water and Gauge Cock." (Robinet à vapeur, à eau et de regard combiné.)

Claim.—The combination gauge cock composed of the column A, connected with the boiler and provided with two or more gauge cocks with the pressure gauge H, and water gauge I, as described.

No. 3273. SAMUEL RODGERS, Toronto, Ont., 4th April, 1874, for 5 years: "Improvements in Tobacco Cutters." (Perfectionnements aux hache-tabac.)

Claim.—The combination and arrangement with each other of the various parts of the device, namely: the stand A, the table B, with fence L, the frame C, with guide c, the handle D, the knife E, with stud e, the gauge bar F, with regulating screw J, and spring N. The whole as specified.

No. 3274. JOHN O'BRIEN, Quebec, 4th April, 1874, for 5 years: "Papyrus Photograph Card." (Carte photographique en papyrus.)

Claim.—The preparation of card board for the production of pictures by photographic process, by first coating the surface with a japan composed of a warmer's gold size, spirits of turpentine and carrier's vegetable black, and secondly, with one or more coats of varnish composed of copal varnish, Prussian blue, corrosive sublimate, linseed oil, and spirits of turpentine, in about the proportions specified.

No. 3275. DANIEL LARER, and SAMUEL E. GRISCOM, Pottsville, Penn., U. S., 4th April, 1874, for 15 years: "Diamond Mill-stone Dressing Machine" (Machine à diamant pour rhabiller les meules.)

Claim.—The combination of the bed-plate A, longitudinally sliding frame B, transversely sliding diamond carrier D, feed-screw J, ratchet L, ricker M, pawl N, latches V, W, and set-screw T.

No. 3276 RICHARD SMITH, Sherbrooke Que., 4th April, 1874, for 5 years: "Apparatus for Navigation." (Appareil de Navigation.)

Claim.—The construction of the floats T (drawing No. 2) of thin cedar staves *a*, (drawing No. 2) or other light material secured to ash knees or ribs *b*, (drawing No. 2) in such manner as to give the desired form and covered with cloth or canvas thoroughly cemented upon the float *a* so as to be perfectly air tight and water tight; 2nd. a seat E, constructed in such manner as to be adjustable and capable of being either elevated or depressed, and so as to be movable either forward or backward; 3rd. Paddle wheels so constructed by means of the paddles W, (drawing No. 2) flukes V, (drawing No. 2) with their studs and thumb nuts *e*, (drawing No. 2) as to be readily taken to pieces; 4th. The fasteners X, Q, & S, with their connections as described; 5th. The construction of a navigable apparatus with detachable frame B, B, b, b, and gear so that the frame and gear can be taken apart and stowed away in the floats for convenience in transportation, and 6th. Floats A, A, so constructed as that a part or the whole of the frame work and gear can be packed away in them, the whole as described.

No. 3277. SIMEON MILLS, Madison, Wis., U. S., 4th April, 1874, for 15 years: "Toilet Tabouret." (Tabouret-toilette.)

Claim.—1st. A tabouret having an upper compartment for the reception of a night vessel, placed at a convenient height for use and provided with a room or seat and elastic fitting cover all constructed as specified; 2nd. A tabouret provided with the two compartments B, and C, the lower one serving as a chest for waste paper and other articles, and the upper one to receive, conceal, and carry an ordinary chamber or night vessel, all in the manner set forth.

No. 3278. ROBERT J. CAMPBELL, Toronto, Ont., 4th April, 1874, for 5 years: "Curtain Ring and Hook." (Anneau et crochet de rideau.)

Claim.—1st. The curtain rings B, and double hook *b*, fastened from a single piece of wire as described. 2nd. The curtain support B₂, fashioned with hook head and spike from a single piece of wire as described.

No. 3279. JOHN HORTON, Philadelphia, Penn., U. S., 4th April, 1874, for 5 years: "Process for massing granulated iron ore into lumps." (Procédé pour agglomérer le minéral de fer.)

Claim.—Combining or massing the granulations or particles of iron ore by mixing with the said ore, clay, mortar, or othersuitable substance, and water, for the purpose described.

No. 3280. BENJAMIN G. MARTIN, New York, U. S., 8th April, 1874, for 5 years: "Improvements on Presses." (Perfectionnements aux Presses.)

For pressing cotton and other articles.
Claim.—1st. The combination of swivel braces H, with a disc G, and a slide E, and with the head-block, and follower of a press, in the manner described; 2nd. The combination of working pawls K, K, and stop pawls L, L, with the swivel braces H, disc G, slide E, head-block A, and follower D, as set forth; 3rd. The releasing levers M, M, in combination with the stop pawls K, K, L, L, swivel braces H, slide E, follower D, and head-block A, in the manner described.

No. 3281. HENRY COBLEY, Toronto, Ont., 8th April, 1874, for 5 years: "Improvements on Boots and Shoes." (Perfectionnements dans les chaussures.)

Claim.—1st. The application of a sole of india-rubber *a*, or its equivalent, to the inner sole of leather, or cloth boots or shoes; 2nd. The enclosing of a portion of the uppers of leather or cloth boots or shoes with rubber-cloth C, or the piecing of said uppers with rubber-cloth; 3rd. The combination of the india-rubber sole *a*, or its equivalent, and the partial covering or piecing of the uppers of boots and shoes with rubber-cloth C.

No. 3282. EDWARD BEANES, Toronto, Ont., 10th April, 1874; (Extension of Patent No. 265, N. B.): "Improvements on Brewing." (Perfectionnements dans la fabrication de la bière.)

Claim.—In the process of brewing, the treating the brewing materials with sulphurous acid, or the salts of sulphurous acid hereinbefore mentioned, before their entrance into the wash-tun during the process of mashing or during the process of boiling the wort with the hops, and consequently before the fermentation of the liquor has taken place and the production thereby of an improved quality of beer, substantially in the manner described, and this is granted subject to the provisions and conditions in the said Patent hereunto annexed, mentioned and contained.

No. 3283. DAVID N. B. COFFIN, Jr., THOMAS H. JOHNSON and BENJAMIN WOODWARD, Boston, Mass., U. S., 8th April, 1874, (Extension of Patent No. 236, N. B.): "Improvements in Capstans and Windlasses." (Perfectionnements aux cabestans et aux guindeaux.)

Claim.--1st. The conical or taper gears *a, b, f, c*, and the angular shafts *j*, in combination with the barrel of a capstan; 2nd. Connecting the fulcrum gear *e*, to the bed-plate, automatically by furnishing each with series of inclined faced lugs; 3rd. Duplicating the inclined faces of the lugs *i*, on the fulcrum gear, and the bed-plate in reverse order so as to operate both ways; 4th. The inclined or wedge-shaped lifter *o*, made moveable separately from the parts to be locked together, in combination with the sliding bolts of a capstan; 5th. The arrangement of one or more series of inclined or wedge-shaped lifters upon a ring or circular connection *p*, so as to operate simultaneously on several bolts in the locking mechanism of a capstan; 6th. Casting the lower journal part of the spindle or shaft of a capstan on and as a part of a bed-plate; 7th. Casting the lower journal part of a spindle or shaft of a capstan hollow in combination with its formation on and as a part of the bed-plate irrespective of the construction of the upper portion; 8th. Compounding the spindle or shaft of a capstan, by forming the lower journal part on and as a part of the bed-plate, and inserting the comparatively lighter wrought part to form the upper portion; 9th. The employment of the shaft *b*, extended from the capstan in combination with the shafts *d*, or *e*, with suitable gears as *u, f, s*, and *t*; 10th. Locking the fulcrum gear of a capstan to the bed-plate, by means of bolts moveable upward from beneath into contact therewith; 11th. The employment of a series of inclines moveable in a circle and so applied in combination with the fulcrum gear of a capstan as to lift said gear from its position of inaction to the proper position to be acted on by gears playing into it; 12th. Fastening the cover of a capstan by means of lugs *v*, in combination with the sockets or grooves in the hub *13th*. The arrangement of the cover fastenings in relation to the locking mechanism of the capstan, so that when the cover is rotated to a stop in one direction, the bolts will be adjusted for the simple power and the cover fastened, and when rotated in the opposite direction to a stop, the cover will also be fastened and the bolts adjusted for the multiplied power, while in an intermediate position the cover is unfastened and may be removed; 14th. Suspending the fulcrum gear to the rotating body of the capstan; 15th. The arrangement of the gears *A, Z*, pawl wheel *F*, barrel *I*, friction *L*, and chain wheel *P*, and the points of disconnecting, whereby both barrel *I*, and chain wheel *P*, are brought under control of the friction mechanism and yet used separately for winding, heaving in, &c.; 16th. The windlass shaft *N*, in combination with the friction band and barrel of a windlass; 17th. The partly circular heads and sockets, in combination with the pawls of a windlass; 18th. A groove formed under the projecting part of a capstan's base; 19th. The application of pawls to a capstan by means of a cast joint or hinge, in any manner so as to allow the pawl to operate in both directions; 20th. The employment of a side opening *g*, in combination with the enclosed bolt, in the construction of a capstan; 21st. The arrangement of inclined lifters, made moveable, in combination with the lock notches or spaces *h*, so as to be used both to slide the bolts out of connection automatically and also at the pleasure of the operator; 22nd. The arrangement of inclined lifters *u, i*, in duplicate and in reverse order in combination with lock notches or lugs and sliding bolts; 23rd. The arrangement of an elevated flat-part, *z*, between two inclines arranged in reverse order; 24th. Radially-sliding keys or bolts in combination with a retaining socket in one part, and a locking space or shoulder in another, of the two parts of a capstan or windlass to be connected or disconnected; 25th. A roller or sheave, arranged with its axis obliquely to the windlass and its axis; 26th. The employment of conical or cylindrical rollers, arranged in combination with the spindle or barrel of a capstan or windlass to relieve the friction incident to the side or transverse thrust; 27th. The arrangement of rollers longitudinally, between the shoulder of a barrel and that of the spindle or bed plate to sustain and support the barrel end-wise; 28th. The arrangement of sliding bolts in sockets on the fulcrum gear; 29th. The lifting and sustaining ring *v*, in combination with the bolts or locking mechanism of a capstan and inclined lifter, arranged either on it or an auxiliary part *x*; 30th. The employment of an elastic or spring element interposed between the part bearing the pawl pockets and the fixed portion of the bed-plate; 31st. The inclines *X*, for automatically lifting the fulcrum gear; 32nd. Locking or clutching the centre or first moving gear, of the capstan to the lever-head automatically by interlocking lugs formed on each; 33rd. The arrangement of a concentric circular or annular flange or rim, or flanges or ribs *N*, between the spindle or hub and the rim or periphery of the bed plate of a capstan or windlass; 34th. The arrangement of a friction wheel between the two barrels of a capstan or windlass with provision for connecting and disconnecting it to or from one or both at pleasure; 35th. The application of the differential windlass to the friction mechanism of a capstan or windlass; 36th. The employment of the combined bearing and brake or friction shoe in the friction mechanism of a capstan or windlass; 37th. The employment of chain-lugs spanning the groove in the chain-wheel and made adjustable radially in sockets at the bottom and extending up the sides of the groove between the two cheeks of the chain-wheel; 38th. The employment of keys back of said lugs, with or without the circular form; 39th. The arrangement of a ratchet or toothed rim directly in connection with the central or first actuating gear of a capstan above the main barrel bearings and in combination with a non-traversing or local jointed pawl or pawls connected to the lever-head; 40th. Constructing the ratchet-plate and central or first actuating gear of a capstan in one piece; 41st. Seating the hub of those rotating parts of a capstan which have a vertical or approximately vertical axis directly within an oil or other lubricating receptacle or rim as shown.

No. 3284. ADAM PRITZ, Dayton, Ohio, U. S., 10th April, 1874, for 10 years: "Automatic Car-coupling." (Attelage de wagon automatique.)

Claim.--1st. The coupling pin *D*, constructed as shown and provided with a central opening *D*₁, which has the general form of a triangle with round corners and concave sides, in combination with the draw-head *A*; 2nd. In combination with the coupling pin *D*, provided with the central opening *D*₁, and connected to or with the draw-head *A*, the pin *L*, passing horizontally through said head and engaging with said coupling pin.

No. 3285. JAMES INGLIS, Montreal, Que., 10th April, 1874, for 5 years: "Process for Sensitizing Glass or other Plates." (Procédé pour sensibiliser les plaques de verre ou autres.)

Claim.--The frame *a*, comprising the handle *b*, the notches *c, c*, the supports *d, d*, the pin *e*, with the manner of using it as represented in Fig. 3.

No. 3286. JAMES A. TUPPER and ABNER R. GILES, Ottawa, Ont., 10th April, 1874, for 5 years: "Machine for Washing Clothes." (Machine à laver le linge.)

Claim.--The round bar, its fixture in the straight position forming its own shoulders in the box or tub and admitting of one-eighth of an inch more or less between the lower part of the bar and the zinc on the bottom of the box or tub.

No. 3287. DANIEL B. WAGGENER and JOHN H. BREED, Philadelphia, Pen., U. S., 10th April, 1874, for 15 years: "Fire Extinguisher." (Extincteur d'incendie.)

Claim.--1st. In a fire extinguisher, the combination of an acid chamber *A*, an alkaline chamber *B*, and a generating chamber *C*, to which they are connected by curved water-ways *A*₁ and *B*₁, open throughout their entire length and each giving vent into the generating chamber above its bottom line; 2nd. In a fire extinguisher, the combination with the generating chamber *C*, of the strainer *F*, secured to its periphery, and perforated at all points except on its upper surface between the periphery of the generating chamber and the discharge pipe *E*, 3rd. The combination with a fire extinguisher of a spring or springs *G*, for holding a wrench.

No. 3288. WILLIAM P. HALE, Brockport, N. Y., U. S., 10th April, 1874, for 5 years: "Circular Saw." (Scie ronde.)

Claim.--1st. A circular saw, having both sides concave from circumference to circumference, diametrically as set forth; 2nd. A circular saw having a plain circumference between the teeth on a true circle of uniform radius, and teeth formed by notching; 3rd. Swaging or bending the teeth outwardly beyond the circumferential line to form projecting cutting edges.

No. 3289. WILLIAM P. HALE, Brockport, N. Y., U. S., 10th April, 1874, for 5 years: "Circular Gang Sawing Machine." (Machine à scies circulaires multiples.)

Claim.--1st. The cylinder *I*, secured to the shaft *G*, or head *H*, by radial screws *J*, or other means whereby an air space intervenes between the cylinder and shaft; 2nd. Securing the saws on the cylinder *I*, by intervening rings *K*, and outer rings *K*₁, screwing on the cylinder as described; 3rd. The combination with a gang of operating circular saws of upper and lower series of guides *L*, arranged above and below the out of the saws, 4th. The guides *L*, having channels *a*, hung upon a tubular shaft *M*, for conveying lubricating oil to the saws, 5th. The employment of the worm gears *P*, arranged as set forth, for operating the feed and delivery rollers *C, D*, as described.

No. 3290. ISAAC NEWTON, Cleveland, Ohio, U. S., 10th April, 1874, for 5 years: "Carriage bolt." (Boulon de voiture.)

Claim.--The described bolt having projections or feathers *a*, on the sides thereof directly under the head.

No. 3291. CHARLES H. THURSTON, Marlborough, N. H., U. S., 10th April, 1874, for 5 years: "Wooden Knob and Closet Pin." (Bouton de porte et patène en bois.)

Claim.--1st. A knob attachment consisting of a screw as represented having gimlet point *s* at its opposite ends and a groove arranged with and in the thread; 2nd. In a knob closet pin, a handle composed of a head or body *B*, a grooved screw *A*, and the key *C*, all constructed and arranged as set forth.

No. 3292. ROBERT SMALLWOOD, Charlottetown, P. E. I., 10th April, 1874, for 5 years: "Lever Feed for Shingle Sawing Machines." (Lever alimentateur pour les machines à scier le bardeau.)

Claim.—The combination of the wheel A, frame D, lever E, roller G, and pitman H, for operating the block carriage of a shingle sawing machine.

No. 3293. THOMAS H. MARSH, Toronto, Ont., 10th April, 1874, for 5 years: "Agitator for Bird Shooting from the Trap." (Agitateur pour le tir des oiseaux au sortir des trappes.)

Claim.—An agitator consisting of the frame B, with or without the side stays B', and connected by spiral springs D, or their equivalent, to the stationary staples a, and manipulated by the string C, arranged and operating as described.

No. 3294. JAMES H. THORP, Chicago, Ill., U. S., 15th April, 1874, for 5 years: "Portable Burglar Alarm." (Délateur de voleur portatif.)

Claim.—1st. A portable burglar alarm having a revolving bell B, actuated by clock mechanism; 2nd. Maintaining the thread J, in an adjusted letting off position by the spring K, applied and operating as described; 3rd. The thread J, having a spring match holding aperture K', the adjustable friction plate L, and the taper holder M, arranged and operating as set forth.

No. 3295. THOMAS K. KNAPP, Dansville, N. Y., U. S., 15th April, 1874, for 5 years: "Knife and Scissors Sharpener." (Remouleur de couteaux et de ciseaux.)

Claim.—1st. The combination of the revolving steel cutter D, provided with three angular bevelled edges more or less and grooves c, c, around its periphery with the case A, constructed in the manner specified; 2nd. The centre slot a, of the sharpener case A, in combination with the lips a, a, and slots a', a', and disc D, for sharpening scissors as specified.

No. 3296. THOMAS K. KNAPP, Dansville, N. Y., 15th April 1874, for 5 years: "Improvements in Mops." (Perfectionnements aux balais à laver.)

Claim.—1st. The semi-hexagonal heads a, a, for holding the cloth k, adjusted by the thumb screws e, e, in the octagon rods c, c; 2nd. The arrangement of the thimble o, on the handle a, provided with projections containing semi-octagonal slots at each end to retain the octagonal rods c, c, as specified; 3rd. The arrangement of the spring f, fastened to handle a, by a pin j, constructed to pass under the thimble b, and ferrule m, and provided with projections n, o, to catch in the notches of the thimble and ferrule as specified; and 4th. The octagonal shaped rods c, c, secured to the thimble as shown by pins i, i, riveted to the upper hexagonal plate g, provided with thumb screws e, e, and the lower portions of the rods running parallel with each other and the upper portions bent outwards as specified.

No. 3297. THOMAS PIPER, Hamilton, Ont., 16th April, 1874, for 5 years: "Clutching Device for Driving Sewing Machines." (Appareil à griffe pour faire mouvoir les machines à coudre.)

Claim.—1st. The combined screw and clutch box H, M, driven by the nut I, which is driven by the belts J, J, and treadles A, K, in combination with the fly or drive wheel G, for operating sewing machines; 2nd. The arrangement of the screw clutch H, recessed on the outside as shown in Fig. 3, having rollers C, and springs c, when combined with the hollow hub f, and solid hub h, of the fly or drive wheel G; 3rd. The arrangement of the hubs g, g, attached to the fly wheel G, in combination with the clutch springs i, i, and screw and clutch H, as shown in Fig. 3; 4th. The combination of the clutch springs i, i, with the pulleys N, N, and operated by the straps or rods J, J, and 5th. The fly wheel G, constructed with a recessed solid hub h, on one side and a hollow hub f, on the other as shown in Fig. 2.

No. 3298. RYERSON PORTER, Bothwell, Ont., 16th April, 1874, for 5 years: "Auger for Boring Pump and other Tubes." (Tarière à percer les tuyaux de pompes et autres.)

Claim.—1st. The application of the tube for the purposes set forth 2nd. The combination of the cutter d, d, with the tube a, a, and the collar f, f; 3rd. The combination or attachment of the coil or worm c, c, to the tube a, a, for the purposes set forth.

No. 3299. BURDETT L. ROWLEY, New Britain, Ct., U. S., 16th April, 1874, for 5 years: "Bridle Bit." (Mors de bride.)

Claim.—A bridle-bit having the portion A, which is contained within the mouth of a horse, covered with leather C that is arranged with the edge of its grain to the wear upon said part.

No. 3300. THOMAS T. PEARSON and CHARLES A. McLANE, Hopewell Corner, N. B., 16th April, 1874, for 5 years: "Steam Generator." (Générateur de vapeur.)

Claim.—Admitting water slowly into the steam chamber B, B, B, so that it may be in sufficient supply to generate the necessary steam and without being in quantity sufficient to check the operation in the cold water chamber attached to the steam generator together with the vent V, as shown in drawing.

No. 3301. HECTOR MACKINNON, Toronto, Ont., 16th April, 1874 for 5 years: "Coal Oil Cooking Stove." (Poele de cuisine à pétrole.)

Claim.—1st. Forming an air chamber between the top deck E and bottom deck H, with partitions or guards h, arranged thereon around which the air must pass in a zig-zag direction before reaching the flames; 2nd. The application to a coal oil lamp of an open water font B, placed above the wick pinions; 3rd. The wick tubes b, c, e, in combination with the open water font B, and air chamber z, having guards or partitions h, arranged therein; 4th. The peculiar shape of the chimneys F, F, contracting towards and expanding at the flame; 5th. The peculiarly shaped chimneys F, F, in combination with the perforated plate D, and wick tubes c, c, 6th. The hot water reservoir I through which the oblong flues G, G, pass in combination with the chimneys F, F, and bolt g; 7th. The steam pipes n, passing within the space between the outer and inner side of the oven L, in combination with the reservoir; 8th. The steamers N, N, and oven L, with flange ring K, supported by the tripod K, in combination with the reservoir I; 9th. The flat iron heater P, in combination with the chimneys F, F; 10th. The detachable cover Q, fitting on the heater P, and guided into its place by the guide bar q, as specified.

No. 3302. JOHN BIRKS and JOSEPH C. JOUFFRAY, Montreal, Que., 16th April, 1874, for 5 years: "Ginger Porter." (Bière de gingembre forte.)

Claim.—A compound to be called indifferently ginger porter and ginger stout and ginger port composed of effervescing water, simple syrup, tartaric acid, alcohol, essence of ginger, and burnt sugar with flavouring substances, added according to circumstances in the proportions set forth.

No. 3303. THOMAS ROBERTSON, Toronto, Ont., 16th April 1874, for 5 years: "Machine for Shaping Lozenges." (Machine à tailler les pastilles.)

Claim.—1st. Fashioning the ordinary lozenge of commerce when hard, with oval or moulded faces, or with chamfered edges; 2nd. Shaping the faces of lozenges, by the action of revolving cutters C; 3rd. The revolving reciprocating outer shafts, C, C, with cutter heads E', driven by belts, or their equivalent in combination with the revolving shaft B, arranged and operating as described; 4th. The revolving shaft D, wheels E, with eccentric channels e, e, and e', in combination with the levers F, F', arranged and operating as described; 5th. The revolving shaft D, wheel E, with cam c, in combination with the lever G, arranged and operating as described; 6th. The revolving shaft D, wheel D', and wheel D'', with inflected channel d, cut in hub, in combination with the rods H, and sliding frames I, arranged and operating as specified; 7th. The levers F, and F', with spring guard f, in combination with the lozenge holder E', arranged and operating as described; 8th. The levers F, F', with spring guard f, in combination with the feed tube K, with or without the detachable tubes K', arranged as specified; 9th. The lever F', and holder F'', in combination with the revolving outer C', arranged and operating as described; 10th. The spring guard f, in combination with the pin f', arranged as specified; 11th. Feeding lozenges to any required shape by abrasion; 12th. Feeding the lozenges to the cutters through passages which allow of but one row of lozenges as described.

No. 3304. CLARK R. SHELTON, New Haven, Ct., U. S., 16th April, 1874, for 10 years: "Driving Whip." (Fouet de voiture.)

Claim.—1st. In combination with the stock B, the socket C, and tip A, when the socket is constructed with the covering thimble f, at its upper end or a, at its lower end, or both, and threaded upon its inside to receive the tip; 2nd. In combination with the stock B, tip A, and internally threaded socket C, the ferrule a, upon the lower end of the tip as specified.

No. 3305. ROBERT G. LITTLE, Halifax, N. S., 16th April, 1874, for 5 years: "Improvements in Churns." (Perfectionnements aux barattes.)

Claim.—1st. The combination of the churn A, with the extension B, having a lid a when constructed as specified, 2nd. The combination of the dashers c, and f, with the jointed lever d, constructed and arranged as described, 3rd. The combination with churn A, of the fly wheels G, and D, crank shaft b, jointed lever d, and dashers c, and f, as set forth.

No. 3306. ALEXANDER THOMPSON, Hamilton, Ont., 16th April, 1874, for 5 years: "Improvements in the Draught Power of Agricultural Implements." (Perfectionnements dans la tire des instruments aratoires.)

Claim.—The combination and arrangement of the several parts namely, the extension swivel pipe A, connecting ring B, in connection with clevis L, rod hook D, in connection with recoil spring E, in the tube, all operating as set forth.

No. 3307. G. BOUCHER de Boucherville, Quebec, 16th April, 1874, for 5 years: "Fire-escape Hook." (Crochet d'appareil de sauvetage.)

Résumé.—L'arrangement et la position relative du crochet A, et du gond, clou, ou support B, ou du crochet A', et du gond B', sur la fenêtre, la manière de passer la gâche E, de la corde D, sur le gond B, et de la contourner sur la courbe F, et la dépression C, du crochet A, tenu horizontalement en dehors de la fenêtre, le tout tel que décrit.

No. 3308. DAVID B. TENNANT, Yonge, Ont., 16th April, 1874, for 5 years: "Hand Sower." (Semoir à bras.)

Claim.—The combination of the oblong seed containing box A, having suitable carrying handles L, and perforated bottom B, longitudinal shaft D, having strips J, secured thereto, and gear wheels E, F, the whole operating as set forth.

No. 3309. DEWITT C. McDONALD and ISAAC B. GORDON, Rushford, N. Y., U. S., 16th April, 1874, for 5 years: "Horse Fork." (Fourche à cheval.)

Claim.—1st. In combination with the outside tines A₁, A₂, of a horse hay fork, the step b, constructed and attached as specified; 2nd. The horse hay fork, constructed with the 3 or more tines A₁, A₂, the shanks of each fastened together making one shank B, the shank or shanks elongated for the brace-bar D, to swing on, also having the upright stud or eye c, which the draft-bar D, swings on, all arranged as described; 3rd. Combination with the draft-bar D, eccentric trip-lever E, or its equivalent, arranged to operate in the manner described; 4th. The horse hay-fork formed of the tines A₁, A₂, and shank B, bolted together at a, the draft-bar c, pivoted to the central tine, or tines A, and having the notch e, the pivoted brace-bar D, the eccentric trip lever E, pivoted to the brace-bar D, the chain K, and trip cord g, all constructed, arranged and combined to operate in the manner specified.

No. 3310. ELBRIDGE MARSHALL, Iola, Ks., U. S., 16th April, 1874, for 5 years: "Washing Machine." (Machine à laver.)

Claim.—1st. The horizontally reciprocating beater H, having the round bar a, on top combined with the hinge-horizontal rubber C; 2nd. The arrangement of the forked lever G, hinged to the box B, by rod i, and eye-bolts h, and levers G, pivoted or hinged to beater H, in combination with the vertical rod F; 3rd. Providing the box B, with tapering strips e, applied inside on the bottom; and 4th. The adjustable connection of the rod F, and lever E, as set forth.

No. 3311. ALLEN STRAIN, Greenfield, Ohio, U. S., 16th April, 1874, for 5 years: "Car-coupling." (Attelage de wagon.)

Claim.—1st. The triangular plate P, with extension arm K, pivoted at A, in connection with pin i, rope E, and lever C, applied to draw bar A, to raise and lock the same; 2nd. The triangular gravity-plate B, arranged to press with its base upon lever C, in a slotted draw-bar A.

No. 3312. JOSEPH HANRAHAN, Ottawa, Ont., 16th April, 1874, for 5 years: "Rock Drill." (Drille de mine.)

Claim.—1st. A rock drill having a cruciform bit and either or both of the radial wings C, and D, bevelled unequally on opposite sides so as to throw the cutting edge out of a radial line; 2nd. Recessing the cutting edge A, centrally as set forth.

No. 3313. JOHN G. COOEY, St. John, N. B., 16th April, 1874, for 5 years: "Lamp Stove." (Poêle à lampe.)

Claim.—1st. The wick tubes D, D, D, arranged in pairs having intermediately an air space E, for conveying air for combustion to the burners; 2nd. Lamp-stoves, the water tank H, elevated above the oil tank A, and having an intermediately air space E; 3rd. The perforated hood-plate J, supporting the chimneys N, and perforated casing L, surrounding burners for the induction and passage of air; 4th. The shafts G, provided with wick elevating ratchet wheels having their bearings in the plates H, and held removably in place by vertical wedge shaped slides I, fitting in guides O; 5th. The arrangement of the shaft G, operating in the intermediately space between the oil and water tanks; 6th. The combination and arrangement of the chimneys N, and conical jacket M, having a perforated top.

No. 3314. CHARLES B. PETTENGILL, Hebron, Me., U. S., 16th April, 1874, for 15 years: "Kitchen Implement." (Outil de cuisine.)

To be used as a sad-iron holder; pie fork; for lifting basins, bowls and kettles; for shifting dampers, grates in stoves; lifting covers, &c.

Claim.—The combination of the arms b, c, frames e, f, rod i, prongs o, p, spiral spring j, and the leather or cloth covering n, arranged to operate in the manner set forth.

No. 3315. WILLIAM A. WHITE, (Assignee of J. F. Ross), Toronto, Ont., 16th April, 1874, for 5 years: "Clothes Bracket." (Séchoir à linge.)

Claim.—1st. A bracket clothes drier consisting of the brackets A, with stationary or hinged arms A₁, connected by the clothes rail D; 2nd. The bracket A, having the double hooks e, c, with slots between and tops C, in combination with the bracket arm A₁ having the trunnions B, and elongated end B₁, arranged as described.

No. 3316. EDWIN A. SMITH and EDWARD H. ROBERTS, Toronto, Ont., 16th April, 1874, for 5 years: "Burglar Proof Lock Attachment." (Disposition de serrure à l'épreuve des voleurs.)

Claim.—Arresting the operating of the bolt of a lock by the insertion of a pin B, or its equivalent, through the frame and any of the working parts of the lock as described.

No. 3317. JEAN B. CAMYRE, Montreal, Que., 16th April, 1874, for 5 years: "Boiler for Washing Clothes." (Chaudière de buanderie.)

Claim.—1st. The inner vessel of a double boiler for steam washing, the combination of the conduit pipe C; 2nd. The combination of an inner vessel B, having a conduit pipe C, with an outer boiler provided with an outlet or top D, as described.

No. 3318. JOHN GRAY and HENRY F. TEETER, Teeterville, Ont., 16th April, 1874, for 5 years: "Spring for all kind of Vehicles." (Ressort propre aux voitures de toutes sortes.)

Claim.—The straight inside leaf B, with the prongs or slips C, two or more on each side of the inside leaf B, to receive the leaves of which the spring A, is composed.

No. 3319. CHARLES PARKER, (Assignee of George Geer), Meriden, Ct., U. S., 16th April, 1874, for 15 years: "Boot Jack." (Tire-botte.)

Claim.—A boot-jack consisting of the two parts A, B, with their respective horns D, the said two parts pivoted together and overlapping each other at a point distant from the pivot and secured in any desired position as described.

No. 3320. CHRISTOPHER LOCKMAN, JAMES M. DAVIES and ANDREW HAMMOND, Hamilton, Ont., 16th April, 1874, for 5 years: "Device for Uniting Rags for Carpets." (Appareil à joindre les guenilles à tapis.)

Claim.—The flat plate a, provided with a point d, hook c, and eye e, for uniting the ends of rags, slips of cloth, selvage, &c., as specified.

No. 3321. NATHAN F. BURNHAM, York, Penn., U.S., 16th April, 1874, for 15 years: "Turbine Water Wheel." (Turbine hydraulique.)

Claim.—1st. The hub A, constructed with an upward flare and with its lower portion A', extended below the periphery of the wheel in combination with bushings a, constructed as described having their lower edges sloped downwardly from the periphery to the hub; these members operating in combination as set forth; 2nd. The combination in a flume wheel, the casing B, the wheel hub F, interposed between the bearing box and casing, and the water wheel shaft B, passing through the stuffing-box and elevated bearing; these members being constructed and operating in combination as set forth; 3rd. The combination with a turbine water wheel of a cam or eccentric J, and a yoke or strap H, to operate the gate or gates; 4th. The combination of the casing D, the gate E, the flange c, on the gate overlapping the casing; the cover K, the flange f, on the cover overlapping the flange on the gate and the shoulder n, on the cover abutting against the inner edge of the casing; these members being constructed and operating as set forth, whereby a tight joint is formed between the gate and casing.

No. 3322. ADAM WYNNE, Indiana, Penn., U.S., 16th April, 1874, for 5 years: "Fire Grate." (Grille à feu.)

Claim.—1st. The corrugated plate A, provided near its base with perforations x, and the interior air pipe E. 2nd. The hinged plate A, having perforators x, and interior air-pipe E, in combination with the part B, having partitions a, inlet c, and outlet d, constructed and arranged as set forth.

No. 3323. ALEXANDER SMEATON, Quebec, Que., 16th April, 1874, for 5 years: "Tailor's Square." (Equerre de tailleur.)

Claim.—An oblong tailor's square having subdivision tables or scales Nos. 1, 2, 3, 4, 5, and 6, marked thereon, for the purpose of drafting a correct fitting body of garment by taking a single tape measurement at the breast as set forth.

No. 3324. MATTHIAS DAY, Jr., Mansfield, Ohio, U.S., 16th April, 1874, for 5 years: "Improvements in Electric Lights." (Perfectionnements dans les lumières électriques.)

Claim.—1st. In an electric light, the combination with each electrode holder and one electrical circuit, of two or more electrodes; 2nd. The combination with the magnet R, of the carbon-supporting rod L, arranged to act as the armature of the magnet; 3rd. The combination with the armature or guide-rod of the electro-magnet M, arranged upon the top thereof, in the manner set forth; 4th. The combination with the motive power of an electric light and the carbon-electrode; thereof, of a connecting-rod and gears imparting simultaneous motion to both electrodes; 5th. The combination with the motive power of an electric light, of a constant and regularly acting clock movement.

No. 3325. JOSEPH H. BEAN, and WILLIAM H. FISHER, Cincinnati, Ohio, U.S., 17th April, 1874, for 5 years: "Hemmer Attachments for Sewing Machines." (Disposition des machines à coudre pour ourler.)

Claim.—1st. A new article of manufacture in a hemmer composed of only one piece of metal and making various widths of hem; 2nd. A hemmer composed of only one piece of metal, the scroll or scrolls of which are cut out of and are a part of the upper bent arm of the same and are on that portion of the hemmer which is next to the needle of the sewing machine when in operation on the same; 3rd. A hemmer the scroll or scrolls of which have the peculiar configuration and configuration set forth; 4th. The peculiar form of the opening a, b, c, in a hemmer attachment as set forth.

No. 3326. RICHARD MACKENZIE, Montreal, Que., 17th April, 1874, for 5 years: "Machine for making Spiral Springs." (Machine à faire les ressorts spiraux.)

Claim.—1st. The screw-shaft B, operating in a nut C, and provided with a collar D, having a feed aperture E, in combination with the shaft F, having a mandril G, and shaft H, having a crank I, all operating as set forth; 2nd. The shaft H, bearing in movable journal boxes P, adjustable by set screws M; 3rd. The interchangeable gears J, K, for regulating the pitch of the spring by the relative speed of the shafts B, and F, as set forth.

No. 3327. JOSEPH N. WILDERS, Croxton, Kerrial, Eng., 17th April, 1874, for 5 years: "Improvements on Thrashing Machines." (Perfectionnements aux machines à battre.)

Claim.—1st. The toothed carrier boxes C, operated by the joint action of the crank shaft D, and the pivotal coupling arms H, to give a greater vertical movement to the delivery than the receiving end of said boxes; 2nd. The combination in a thrashing machine of an automatically feeding-platform of notched vibrating bars C, F,

with an adjustable vibrating regulator I, J, and a thrashing cylinder; 3rd. The hinge guide-board N, in combination with the vibrating feeder C, and thrashing cylinder; 4th. An automatic grain-feeder for thrashing machines having a grain feeding platform of vibrating notched bars C, F, an adjustable vibrating regulator and vibrator I, J, an operating crank shaft D, and hinged guide-board N, the several parts being constructed and arranged for joint operation as described.

No. 3328. RUFUS H. BROWN, JAMES M. CALLER, WILLIAM A. PERKINS, Salem, JOHN A. ENOS, Peabody, U.S., and OLIVER C. SMITH, Ipsville, Mass., U.S., 17th April, 1874, for 5 years: "Improvements on Leather Dressing Machines." (Perfectionnements aux machines à apprêter les cuirs.)

Claim.—1st. In a leather dressing machine a tool having in addition to a traversing movement in contact with the work and a return movement out of contact therewith, a positive rotation in a retrograde direction, by means as described; 2nd. In combination with the traversing tool-stock the system of shafts and pulleys as described by which the rotating tool is driven; 3rd. The leather dressing tool provided with parallel spiral blades arranged and constructed as described; 4th. A tool formed with removable spiral blades, secured as shown; 5th. In combination with the cylindrical tool having the spiral blades, a traversing grinder-roll as described; 6th. In combination with the guide-rods or rails c, and slides reciprocating thereon, a tool-stock carrying a rotary tool to which reciprocating movements over and clear from the bed in one direction and in contact with the bed in the opposite direction are imparted; 7th. In combination with the guide rods or rails c, and slides reciprocating thereon, a tool stock jointed to said slides and carrying a working tool or cylinder to which positive rotative movements are imparted; 8th. The tool stock e, pulleys a, belts r, shaft v, pulleys s, belt w, pulley u, shaft A, pulleys x, z, shaft m, pulleys z, belt y, pulleys n, combined and arranged to impart rotative movements to the tool; 9th. The crank-wheels t, k, shafts l, m, link o, in combination with and for operating the tool-stock and its rotary tool reciprocatively; 10th. The counter-balance weighted crank-wheels in combination with the reciprocating tool-stock and rotary tool c, and 11th. The bed f, supported as described.

No. 3329. ROBERT BARCLAY, Paris, Ont., 17th April, 1874, for 5 years: "Clock and Watch Escapement." (Echappement d'horlogerie.)

Claim.—The two pallets E, E', set horizontally parallel on the spindle C, each having a V notch with a straight inclined face F, F', in combination with the vertical escape wheel D, operating as set forth.

No. 3330. WILLIAM PERRY, jr., Montreal, Que., 17th April, 1874, for 5 years: "Combined Chemical and Water Fire Engine." (Pompe à feu hydro-chimique.)

Claim.—1st. Two chemical tanks E, H, in combination with the pumps B, B, chamber D, and air cylinder A, operating as described; 2nd. The suction-box J, and chamber D, provided with valves i, j, k, in combination with the chambers E, H, and cylinder A, for receiving water by suction; 3rd. The pipes F, F', and cocks G, G', connecting the chambers E, H, and pumps B, B, for cutting off connection as described; and 4th. The employment of the syringe M, fitted to the cylinder A, for charging the same as set forth.

No. 3331. JOHN C. TALLMAN, Montreal, Que., 18th April, 1874, for 5 years: "Milk and Beer Refrigerator." (Réfrigérant pour le lait et la bière.)

Claim.—1st. In a machine for cooling milk or other liquids, the combination of a vessel A, and coil pipes B, arranged circumferentially and internally, and employed as set forth; 2nd. The spiral coil-pipe C, applied and used within a beer containing vessel, for the passage of a refrigerating medium; 3rd. The circumferential pans D, arranged externally of the vessel A and as set forth.

No. 3332. JOHN C. TALLMAN, Montreal, Que., 18th April, 1874, for 5 years: "A Churn." (Une haratte.)

Claim.—1st. The barrel B, rotating longitudinally and horizontally in a frame A, in combination with a central shaft C, rotating in an opposite direction simultaneously as set forth; 2nd. In combination with the frame A, and barrel B, the gears F, G, H, adjusted to operate as described; 3rd. The axial pin D, and transverse axial pins L, arranged and applied as set forth.

No. 3333. JOHN C. TALLMAN, Montreal, Que., 18th April, 1874, for 5 years: "A Milk Safe." (Un garde lait.)

Claim.—The combination of the hub F, and arms F, rotating around the shaft B, and the series of shelves D, rotating with the said shaft B, as set forth.

No. 3334. CYRUS E. GRANDY and ZIBA B. GRANDY, Stafford Springs, Ct., U. S., 24th April, 1874, for 5 years: "Improvements on Saw Sets." (Perfectionnements aux rainettes.)

Claim.—The die-plate A, notched bed-die B, movable die-bar C, movable die D, cam lever E, and adjustable yoke F, combined and arranged to bend the tooth between two bearings on the bed-plate, the combination of the die-plate A, bed-die C, movable die D, cam lever E, adjustable yoke F, and gauge-bar M, arranged to bend the tooth over the bed-die.

No. 3335. THOMAS HOULDING, Ipswich, Mass., U. S., 24th April, 1874, for 5 years: "Combined Hay Rake and Spreader." (Rateau-faneur à foin.)

Claim.—The revolving axle N, and block P, with arms Q, Q, having the forks W, W, and r, at their ends, held stationary when used for a Hay Rake by aid of the sliding-bar D, and ratchet wheel C, and made to revolve when used as a spreader, by aid of cog-wheels d, e, k, and m, the arm j, and pin t, in combination with B, B, frames A, and O.

No. 3336. ROBERT H. THURSTON, Hoboken, N. J., U. S., 24th April, 1874, for 5 years: "Autographic Testing Machine." (Machine à essai autographique.)

Claim.—1st. The "Automatic Recording Attachment" to a machine for testing the strength of materials, said attachment consisting of a table G, carrying the card or paper upon which the record is made, the pencil and holder I, the guide-curve F, or their several mechanical equivalents, when combined in such a manner as to be capable of describing a diagram or curve of which the co-ordinates are proportional, one to the four producing distortion or rupture, and the other to the degree of such distortion of the piece tested, the area of the said curve is also an indication of the resiliency of the test piece; 2nd. An automatically produced strain diagram in which the abscissas or the ordinates as the case may be are greater than, and are proportional to the actual extension or change of form of the specimen producing it; 3rd. The combination of an automatic recording apparatus, of the kind described, with a machine for testing strength of materials; 4th. The machine for testing strength of materials consisting of the suspended levers B, C, or equivalent E, Fig. 2, and the frame A, A, sustaining said levers with their axis in the same line.

No. 3337. JAMES KIRKPATRICK, Hamilton, Ont., (Assignee of Alfred Paraf), 24th April, 1874, for 5 years: "Improvement in Purifying and Separating Fats." (Perfectionnement dans la purification et la séparation des corps gras.)

Claim.—The process or processes for the improvement in the manufacture of products from fresh fat, as set forth.

No. 3338. NICHOLAS A. ASSELSTINE, Ernestown, Ont., 24th April, 1874, for 5 years: "Portable Fence." (Clôture portative.)

Claim.—1st. A fence panel composed of two upper rails A, A, and two lower rails B, B, and pickets C, the rails A, A, inclining to admit of adjustment; 2nd. A fence panel constructed to admit the end pickets of the adjoining sections to pass intermediately through the lap-joint rails A, A, and the lower rails B, B, to overlap laterally; 3rd. A fence trestle having the fixed post D, at the apex and entering between the rails A, A, for securing the fence; 4th. The application of an adjustable straddle-bar E, notched to receive the rails B, B, and secured to the legs of the trestle in mortises by a pin and wedge as described.

No. 3339. GEORGE PAYZANT, Chicago, Ill., U. S., 24th April, 1874, for 5 years: "Table-leaf Support." (Pied de pliant de table.)

Claim.—A table-leaf support, consisting of the supporting arm D, and of the brace or bearing C, provided with the laterally-inclined arm C', for the purpose of folding the arm D, when the leaf is folded as specified.

No. 3340. GEORGE A. MARTIN, Bolton Centre, Que., 24th April, 1874, for 5 years: "Veneer Cutting Machine." (Machine à tailler les bois de placage.)

Claim.—The frame d, in combination with dogs k; 2nd. The saddle e, set obliquely; 3rd. The combination of the dogs k, arranged to hold the material obliquely in combination with the oblique cutter f.

No. 3341. PERCY KEEN, and JOHN DENCE, London, Eng., 24th April, 1874, for 5 years: "Apparatus for Elevating Corn, Mineral Coal, &c.,

Applicable for Discharging or Loading Vessels, Dredging, Pumping, &c." (Appareil à élever le blé, la houille, &c., propre à charger ou décharger les vaisseaux, à draguer, pomper, &c.)

Claim.—1st. The combination of the column a, or its equivalent, and the carriage b, with jib c, and trunk d. 2nd. The combination of gears and wheels e, e₁, e₂, e₃, e₄, e₅, e₆, e₇, with shafts e, and c. 3rd. The shaft e, and wheel e₁, in combination with the column a, and carriage b; 4th. The carriage b, in combination with the counter-balance f; 5th. The jib c, and trunk d, in combination with counter-balance g; 6th. The trunk d, spout j, and carriage b, combined and working together as described; and 7th. The column a, in combination with carriage b, pipes h, h₁, and i, together with motive mechanism attached to head of trunk d, as described.

No. 3342. JOHN A. BLAKE, New Haven, Ct., U. S., 24th April, 1874, for 5 years: "Improvements in Stone Crushers." (Perfectionnements dans les broyeurs de pierre.)

Claim.—1st. The jaw plates of a stone crusher constructed with wrought metal bars imbedded upon the surface; 2nd. In combination with the jaw-plate Fig. 2, the back or base, Fig. 3, independent of the frame of the machine and forming the bearing surface for the jaw-plate; 3rd. The jaw-plate or plates of a stone crusher, and the back or base for the jaw-plate, the one constructed with a projection or projections D, and the other with a corresponding recess or recesses upon their meeting surfaces as specified.

No. 3343. JOHN A. BLAKE, and SAMUEL L. MARSDEN, New Haven, Ct., U. S., 24th April, 1874, for 5 years: "Improvements on Blake's Stone Crusher." (Perfectionnements au broyeur de pierre dit de Blake.)

Claim.—The pitman F, for a stone crusher formed with seats a, a, and having combined therewith the passages d, d, leading from the upper end of the pitman down to the seats as described.

No. 3344. DANIEL A. JOHNSON, Boston, Mass., U. S., 24th April, 1874, for 5 years: "Device for Preventing Horses from Straying." (Appareil pour empêcher les chevaux d'errer.)

Claim.—The T-shaped yoke A with or without the depressor i, operating in the manner set forth.

No. 3345. JEROME C. DIETRICH, Galt, Ont., 27th April, 1874, for 5 years: "Improvements on Saw Handles." (Perfectionnements aux manches de scies.)

Claim.—A double saw handle constructed as described.

No. 3346. ALFRED BINGHAM, Hamilton, Ont., 28th April, 1874, for 5 years: "Improvements in Machines for Cutting Circular Metal Pieces." (Perfectionnements aux machines à couper les pièces de métal circulaires.)

Claim.—The combination and arrangement of the several parts, namely: the circular pointed chisel A, in connection with the screw rod C, and the bars B, on which the centre point D, works by means of the lever or handle E, at end of machine, also the scale plate E, attached to the frame in connection with the centre point D, to regulate the diameter of the cut to be made, all operating as set forth.

No. 3347. CAMPBELL B. LECKIE, Hamilton, Ont., 28th April, 1874, for 5 years: "Composition for Washing." (Composition pour le lavage.)

Claim.—Mixing together sal-soda, common soap, pearl ash, liquid pot ash, sulphate of soda, palm oil, Fuller's Earth, Oxalic Acid, and soda ash, then put them into a vessel and bring them to a boil, then put them into a cooler and agitate them till the crystals form.

No. 3348. FREDRIC DE CEE, Houghton, Ont., 27th April, 1874, for 5 years: "Machine for Washing Clothes." (Machine à laver le linge.)

Claim.—A suction washing machine for washing soiled clothing composed of the drum or cylinder e, its head d, and handle a, as shown in Figure 1, the two inside cylinders g, and A, the centre tube i, and the four stays e, e, e, e, in Figure 2, all constructed arranged and operated as described.

No. 3349. WILLIAM WADE, Morpeth, Ont., 27th April, 1874, for 5 years: "Improvement on Self Car-Couplers." (Perfectionnement des attelages automatiques de wagons.)

Claim.—The application of latch C, combined with lifter B; 2nd. The inner arrangement and chambers E, F, G, as set forth.

No. 3350. FRANKLIN LEONARD, Cleveland, Ohio, U. S., 27th April, 1874, for 5 years: "Machine for Making Railway Car-Coupling Pins." (Machine à faire les chevilles d'attelage de voitures des chemin de fer.)

Claim.—1st. The slides B, and C, arranged to operate conjointly in relation to each other and in combination with the slides B', and C', for upsetting and gathering up the stock in a bar for forming thereon the heads and collars of railway coupling pins in the manner described; 2nd. The dies N, O, having thereon the prints c, c, and d, d, for forming the heads and collars of railway coupling pins, in couples in the manner described; 3rd. The slides B, and C, arranged to operate in combination with each other and to co operate with the slides B', C', and in relation to the dies N, O, in the manner described; 4th. Combination of the arms H, G, slides B, C, flange or lip E, pin a, guide-rod F, and pin B, connecting rod I, and eccentric K; 5th. The cog wheel A, having a break or space m, in the face thereof in combination with the pinion D, pin g, and arm J; 6th. The wheel E, spring j, and pin o, in combination with the pinion D, cog-wheel A, and arm J; 7th. Making from a single bar of heated iron two coupling-pins with solid heads and collars thereon at one continuous operation by upsetting the metal by means of the slides B, C, and B', C', operating laterally on each side of the dies N, O, and then by compressing or swaging to form the heads and collars between said dies as set forth.

No. 3351. WILLIAM HESTON and JOSEPH W. SABIN, Akren, Ohio, U. S., 27th April, 1874, for 5 years: "Rubber Packing for Piston Rods, &c." (Garniture en caoutchouc pour les tiges de pistons, &c.)

Claim.—The packing described as a new article of manufacture constructed as described.

No. 3352. EGERTON R. SHOREY and RUFUS A. SHOREY, Napanee, Ont., (Assignees of Abiel O'Dell), 27th April, 1874, for 5 years: "Improvements on Washing Machines." (Perfectionnements aux machines à laver.)

Claim.—1st. The combination of the adjustable sliding clamp B, and spring E, with the tub or vat O; 2nd. The clamp G, and clasp H, applied as set forth for securing the washer to the tub by the facings B; 3rd. The employment of rollers J, corrugated circumferentially in combination with a corrugated roller I; 4th. The facing B, having slots C, for receiving the ends of the clamp B, and a suitable opening to prevent clothes entering the ends of the rollers; 5th. The concave bottom M, applied as set forth.

No. 3353. THOMAS B. WARRELL, Philadelphia, Penn., U. S., 27th April, 1874, for 5 years: "Improvements on Bank Locks." (Perfectionnements aux serrures de banques.)

Claim.—1st. A series of racks carrying locking bolts and moving in four different directions when operated by the same spindle as described; 2nd. The dog L, in combination with the driving rack K, and combination wheels G; 3rd. The moving of the dog L, and locking bolts simultaneously as described; 4th. The construction of the dog in two pieces, held together by means of the screw bolt or its equivalent when by the separation of the lower from the upper piece, the dog is separated from the actuating rack K, and thus its connection with the locking bolts is severed; 5th. The enlargement on the front end of the dog L, to prevent its being forced inwards by a burglar; 6th. The supplementary dog L', in combination with the gear wheel P, and dog L, to prevent a burglar feeling the combination by means of the principal dog at each revolution of the dial; 7th. The dog L, and wheel P, or any other device which will keep the principal dog out of connection with the combination wheel for two or more revolutions of the dial; 8th. One or more idler wheels R, driven by the same spindle as the combination wheels; 9th. The annular head or projection a, on the outer corner of the dial to intercept the view of the figures on the periphery of the latter; 10th. The construction of the dial B, in two pieces for facilitating the removal of that part containing the figures; 11th. The tappets H, constructed as represented when their projecting ends are about the same width as the divisions b, on the peripheries of the combination wheels G; 12th. The construction of the dial spindle C, with a double cone enlargement p, having a cap q.

No. 3354. JOHN B. FARR, Woodbridge, Ont., 27th April, 1874, for 5 years: "Improvements on the 'Raymond Sewing Machine.'" (Perfectionnements à la machine à coudre dite "de Raymond.")

Claim.—The combination of the straight motion D, take up lever E, needle bar F, clot G, and check spring H.

No. 3355. WILLIAM T. BUNNELL, Ottawa, Ont., 27th April, 1874, for 5 years: "Improvements on Washing Machines." (Perfectionnements aux machines à laver.)

Claim.—1st. A removable bottom or wash-board for washing machine; 2nd. In combination with washing machines having a semi-circular frame or tub A, the removable bottom or wash-board C, having bars, ribs, corrugations or rollers H, as described.

No. 3356. JOHN A. McMARTIN, Montreal, Que., 27th April, 1874, for 5 years: "Apparatus for Elevating Water, Earth, Ores, &c." (Appareil pour élever l'eau, la terre, les minerais, etc.)

Claim.—The toggles D, actuated by lever H, provided with brace I, pivoted to piece A, and provided with roller F, working in oblique slot G, as set forth.

No. 3357. CHARLES PARKER and DEXTER W. PARKER, Meriden, Ct., U. S., 27th April, 1874, for 15 years: "Improvements on Claw-hammers." (Perfectionnements aux marteaux brettelés.)

Claim.—1st. A cast metal hammer having the head formed from wrought metal and united in the process of casting, as specified; 2nd. A cast metal hammer with wrought metal face a, attached to the claw by the process of casting as specified.

No. 3358. JOSEPH W. STRANGE, Bangor, Me., U. S., 27th April, 1874, for 5 years: "Improvements on Churns." (Perfectionnements aux barattes.)

Claim.—1st. In combination with a rotary dasher a train or series of differential gears, or their equivalents, and in combination agents whereby the dasher is driven with a greater or less degree of speed; 2nd. Turning the hubs of the gears of a uniform size to receive the crank and orienting upon each a notch or its substitute for confining the crank to it; 3rd. The crank provided with the spring latch K, to operate in connection with the notches f, and be interchangeable with each gear hub.

No. 3359. HAMBILTON S. DAVIES, Camden, N. J., U. S., and SAMUEL PANCOST, Hamilton, Ont., 27th April, 1874, for 5 years: "Improved Guard for Interfering Horses." (Entretien perfectionné pour les chevaux qui s'entretailent.)

Claim.—The elastic-pad A, having inner and outer flanges a, b, and adapted to the shoe, as set forth.

No. 3360. JAMES GOOD, Toronto, Ont., 27th April, 1874, for 5 years: "Improvements in Street Culverts and Waste Water Drains." (Perfectionnements aux égouts de rues et fossés d'écoulement.)

Claim.—1st. The peculiarly shaped foot B, in combination with the angled trap D; 2nd. The weighted valve B, pivoted within the leg L, of the culvert in combination with the ledge b, cast upon two sides of the culvert leg B, as described.

No. 3361. JACOB W. DAVIS, San Francisco, Cal., U. S., 27th April, 1874, for 5 years: "Fastening for Seams." (Arrête-couture.)

Claim.—The rivet, eyellet or equivalent metal stud b, for fastening the commencement or termination of seams in sewing as described.

No. 3362. JOHN DESMOND and ARCHIBALD L. McMILLAN, Chatham, Ont., 27th April, 1874, for 5 years: "Steam Engine Piston." (Piston de machine à vapeur.)

Claim.—The combination of sliding blocks B, clamps C, screw D, lock nut G, catch H, and spring I, in connection with pins F, and springs A, for the purpose of adjusting the rings in a steam engine piston.

No. 3363. WILLIAM ELLIOT, Sullivan, Ont., 27th April, 1874, for 15 years: "Millstone Running Gear." (Engrenage de meule courante.)

Claim.—1st. The bed stone A, held adjustable in the frame A¹ by the screws B¹; 2nd. The combination of the driving shaft B, spindle C, and coupling D, for driving the running stone C¹; 3rd. The tempering rod K, provided with a nut P, swivel L, and clutch J, in combination with the spindle C, and band I, all operating as set forth, for suspending the stone C¹, from a beam M, for effecting the raising or lowering of the running stone in the manner described.

No. 3364. HENRY P. MANLEY, Potsdam, N. Y., U. S., 27th April, 1874, for 5 years: "Feather Renovator." (Rafraichisseur à plume.)

Claim.—1st. The combination of the steaming cylinder B, and drying cylinder D, vertically arranged in the frame A, and connected by steam pipes as set forth; 2nd. The drying cylinder D, having an internal steam tight casing E; 3rd. The casing E having a perforated bottom, and lower casing F, to receive a drawer or drawers G; 4th. Providing the drying cylinder with a shaft H, having radial arms for agitating the feathers; 5th. The hinged sides of the cylinders B, and D, admitting of a vertical adjustment to form a connecting channel as described.

No. 3365. DANIEL H. ISEMINGER, Heyworth, Ill, U. S., 27th April, 1874, for 5 years: "Saw Sharpening Machine." (Machine à affuter les scies.)

Claim.—The combination with the hinged file-rod and connecting rod U, of spring top V, connected to the file-rod, so as to release the gauge-plate S, by lifting the file out of the teeth as specified.

No. 3366. GEORGE F. SIMONDS and JAMES A. FERSON, Fitchburg, Mass., U. S., 27th April, 1874, for 5 years: "Improvements on Tempering Saws." (Perfectionnements dans le trempage des scies.)

Claim.—1st. The improved method of tempering saws, &c., between compression plates a, h; 2nd. The improved tempering oven, having the plates for clamping and compressing the work as described.

No. 3367. ELIJAH J. DEVENS and HENRY M. JONES, Coldwater, Mich., U. S., 27th April, 1874, for 5 years: "Grain-cradle." (Ja-velier.)

Claim.—1st. The combination of the clasps b, with the adjusting-nuts d, and screw-rod a, fastened to the blade and extending across all of the fingers of the cradle. 2nd. The wedge c, applied as set forth in combination with the rod a, and clasps b, for fastening the fingers as described.

No. 3368. HENRY CARTER and DANIEL STEWART, Aylmer, Ont., 27th April, 1874, for 5 years: "Fly Trap." (Gobe-mouche.)

Claim.—The arrangement and combination of the bait chamber D, formed within the cage and having open thimbles f, and perforated covering plate, with a rectangular cage A, having wire cloth sides b, b, and opaque ends c, c, provided with wire gauze openings B, B, for admitting light to the bait chamber as set forth.

INDEX OF INVENTIONS.

Acid pump and syphon, T. Nichols	3260
Agricultural implements, improvement on draught power of, A. Thompson.....	3306
Auger for boring pumps, and other tubes, R. Porter	3298
Bedstead, folding pipe, W. C. Hobbs.....	3254
Beer and milk refrigerator, J. C. Tallman	3331
Bird shooting from the trap, agitator for, T. D. Marsh	3293
Boot Jack, C. Parker	3319
Boots and shoes, H. Cobley.....	3281
Brewing, E. Beanes.....	3282
Brick machine, J. H. Thorp	3257
Bridle Bit, B. L. Rowley.....	3299
Burglar alarm, portable, J. H. Thorp.....	3294
Burglar proof lock attachment, E. A. Smith, and E. H. Roberts	3316
Rutter, process for manufacture of, G. H. E. Dabelle	3253
Capstans and windlasses, D. N. B. Coffin, Jr., T. H. Johnston, and B. Woodward	3233
Car coupler, A. Strain.....	3311
" automatic, A. Pritz.....	3284
Car coupler, self acting, S. T. Lamb, and B. T. Avery.....	3268
" self, W. Wade	3249
" self-acting, W. R. Macaulay.....	3271
Carpets, device for unrolling rags for, C. Lockman, J. M. Davies and A. Hammond.....	3323
Carriage bolt, Isaac Newton.....	3290
Churn, R. G. Little.....	3305
Churns, T. Mathias and J. A. Coons	3269
Churn, J. C. Tallman.....	3332
Churns, J. W. Strange	3333
Churning machine, D. E. Fletcher.....	3267
Churn powers, W. A. Lewis.....	3268
Clock and watch escapement, R. Barclay.....	3329
Clothes bracket, W. A. White.....	3315
Cock, steam, water, and gauge combined, F. Greene.....	3272
Cooking stove, coal oil, H. Mackinnon.....	3301
Culverts, street and waste water drains, J. Good	3360
Curtain ring and hook, R. J. Campbell.....	3278
Drains, waste water, and street culverts, J. Good.....	3366
Dredging, &c., apparatus for, P. Keen and J. Dence.....	3341
Drill rock, J. Hanrahan.....	3312
Electric lights, M. Day	3321
Elevating corn, coal, &c., applicable for discharging or loading vessels, dredging, pumping, &c., apparatus for, P. Keen and J. Deico	3341
Elevating water, earth, ores, &c., apparatus for, J. A. McMartin	3356
Fats, purifying and separating, J. Kirkpatrick.....	3337
Feather renovator, H. P. Manley	3361
Fence, portable, N. A. Asselstine.....	3333
Fire engines, combined chemical and water, W. Perry, Jr.....	3330
Fire escape hook, G. Boucher de Boucherville	3207
Fire extinguisher, D. B. Wuggener and J. H. Breed	3287
Fire grate, A. Wynne.....	3322
Flour, preparing grain for the manufacture of, O. F. Cook.....	3270
Fly trap, H. Carter and D. Stewart	3363
Furnaces, hot air, Richard Smith	3214
Gas, coal, construction, setting and operation of retorts for the manufacture of, D. Davison	3261
Gas, illuminating, manufacture of, D. Davison.....	3262
Ginger porter, John Birks and J. C. Jonffray	3302
Grain cradle, E. J. Devens and H. M. Jones.....	3367
Hammer, claw, C. Parker and D. W. Parker	3357
Hay rake and spreader combined, T. Houlding	3335
Horses, device for preventing from straying, D. A. Johnson	3344
Horse fork, DeWitt C. McDonald and I. B. Gordon	3309

Horses, guard for interfering, H. S. Davis and S. Pancost	335
Horse rake, G. Sweet	3264
Iron ore, granulated, process for massing into lumps, T. Horton	3279
Keels of vessels, S. P. Willeby	3250
Kitchen implement, C. B. Pettengill	3314
Knife and scissors sharpener, D. K. Knapp	3205
Knob and closet pin, wooden, C. H. Thurston	3291
Lamp stove, J. G. Cooley	3313
Leather dressing machines, R. H. Brown, J. M. Caller, W. A. Perkins, J. A. Enos and O. C. Smith	3328
Locks, bank, T. B. Worrell	3353
Lozenges, machine for shaping, T. Robertson	3303
Metal, machine for cutting circular pieces, A. Bingham	3346
Milk and beer refrigerator, J. C. Tallman	3331
Milk safe, J. C. Tallman	3333
Millstone dressing machine, diamond, D. Larer and S. E. Griscom	3275
Millstone running gear, W. Elliot	3363
Mops, T. K. Knapp	3296
Navigation, apparatus for, R. Smith	3276
Paper pulp, process and apparatus for preparing, Albert Ungerer	3247
Planofortes, upright, G. H. Davis	3252
Piston rods, rubber packing for, W. Heston and J. W. Sabin	3351
Photograph, card, papyrus, John O'Brien	3274
Plaster sower, G. Sweet	3265
Potato sowing machine, L. A. Couteau	3249
Presses, B. G. Martin	3250
Pulp, reducing wood into, R. Smith	3253
Pumping, &c., apparatus for, P. Keen and J. Dence	3341
Railway car-coupling pins, machine for making, Franklin Leonard	3350
Refrigerator, milk and beer, J. C. Tallman	3331
Saw, circular, W. P. Hale	3288
Saw handles, J. C. Dietrich	3345
Sawing lumber into strips, machine for, T. H. Carroll	3255
Sawing machine, circular gang, W. P. Hale	3289
Saw set, C. E. Grandy and Z. B. Grandy	3334
Saw sharpening machine, D. H. Iseminger	3365
Saws, tempering, G. F. Simonds and J. A. Ferson	3366
Seams, fastening for, J. W. Davis	3361
Sensitizing glass or other plates, J. Inglis	3285
Sewing machine, J. B. Farr	3354
Sewing machines, clutching device for driving, T. Piper	3297
Sewing machine, hemmer attachment for, J. H. Bean and W. H. Fisher	3325
Single sawing machine, lever feed for, R. Smallwood	3292
Signal, hand lantern, T. A. Davies	3251
Slate, machine for grinding, polishing and finishing, W. Glen and W. H. Lynch	3248
Sower, hand, D. D. Tennant	3308
Spring for vehicles, J. Gray and H. F. Teeter	3318
Springs, spiral, machine for making, R. Mackenzie	3326
Steam engine piston, J. Desmond and A. L. McMillan	3362
Steam generator, T. T. Pearson and C. A. McLane	3300
Stone crushers, J. A. Blake	3342
" J. A. Blake, and S. L. Marsden	3343
Stove pipe thimbles, T. Tarrant and J. P. Conkling	3245
Table leaf support, G. Payzant	3339
Tailor's square, A. Smeaton	3323
Testing machine, autographic, R. H. Thurston	3336
Thill couplings, J. H. Thorp	3246
Thrashing machines, J. M. Wilders	3327
Tobacco cutters, S. Rodgers	3273
Toilet tabouret, S. Mills	3277
Turbine water wheel, N. F. Burnham	3321
Veneer cutting machine, G. A. Martin	3340
Waggons, T. Alexander	3256
" jacks, T. S. Seabury	3259

Washing boiler, J. B. Camyré	3317
" composition, C. B. Leckie	3317
" machine, J. A. Tupper and A. R. Giles	3286
" " E. Marshall	3310
" " T. De Ceu	3348
" " R. Egerton and R. A. Shorey	3352
" " W. B. Bunnell	3355
Watch and clock escapement, R. Barclay	3329
Wheelwright machines, G. Sweet	3263
Whip, driving, C. R. Shelton	3304
Windlasses and capstans, D. N. B. Coffin, Jr., Thomas H. Johnston and B. Woodward	3283

INDEX OF PATENTEEES.

Alexander, Thomas, waggons	3256
Asselstine, Nicholas A., portable fence	3338
Avery, Benjamin F., and Salem T. Lamb, self-acting car-coupler	3266
Barclay, Robert, clock and watch escapement	3329
Bean, Joseph H., and W. H. Fisher, hemmer attachment for sewing machines	3325
Beanes, Edward, brewing	3282
Bingham, Alfred, machine for cutting circular metal pieces	3346
Birks, John, and J. C. Jouffray, ginger porter	3302
Blake, John A., stone crushers	3342
Blake, John A., and S. L. Marsden, stone crusher	3343
Boucher de Boucherville, G., fire escape hook	3307
Breed, John H., and Daniel B. Waggener, fire extinguisher	3287
Brown, Rufus H., J. M. Caller, W. A. Perkins, J. A. Enos, and O. C. Smith, leather dressing machine	3328
Bunnell, William T., washing machines	3355
Burubam, Nathan F., turbine water wheel	3321
Caller, James M., R. H. Brown, W. A. Perkins, J. A. Enos, and O. C. Smith, leather dressing machine	3328
Campbell, Robert J., curtain ring and hook	3278
Camyré, Jean B., washing boiler	3317
Carroll, Thomas H., machine for sawing lumber into strips	3255
Carter, Henry, and D. Stewart, fly trap	3368
Cobley, Henry, boots and shoes	3281
Coffin, David N. B. Jr., T. H. Johnston and B. Woodward, capstans and windlasses	3283
Conkling, John P., and F. Tarrant, stove pipe thimbles	3245
Cooley, John G., lamp stove	3313
Cook, Oren F., preparing grain for the manufacture of flour	3270
Coons, John A., and T. Mathias, churns	3269
Couteau, Louis A., potato sowing machine	3249
Davies, James M., C. Lockman, and A. Hammond, device for uniting rags for carpets	3320
Davies, Thomas A., signal hand lantern	3251
Davis, George H., upright piano-fortes	3252
Davis, Hamblinton S., and S. Pancost, guard for interfering horses	3359
Davis, Jacob W., fastening for seams	3361
Davison, Darlus, construction, setting and operation of retorts for manufacture of coal gas	3261
Davison, Darlus, manufacture of illuminating gas	3262
Day, Mathias, electric light	3324
DeCeU, Fredric, washing machine	3348
Dence, John, and P. Keen, apparatus for elevating corn, coal, &c., applicable for discharging or loading vessels, dredging, pumping, &c	3341
Desmond, John, and A. L. McMillan, steam engine piston	3362
Devens, Elijah J., and H. M. Jones, grain cradle	3367
Dietrich, Jerome C., saw handles	3345
Dubelle, Gustave H. E., process for manufacture of butter	3258
Elliot, William, millstone running gear	3363

THE

CANADIAN PATENT OFFICE RECORD

ILLUSTRATIONS

Vol. II.

APRIL, 1874.

No. 1.

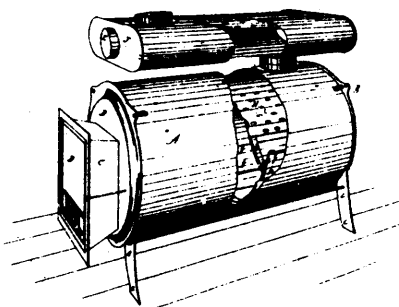

3244 Smith's Improvements on Hot Air Furnaces.

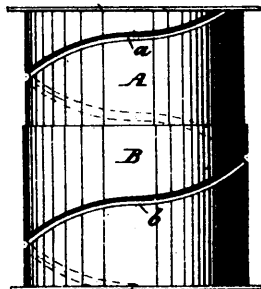

3245 Tarrant & Conkling's Improvements on Stove-pipe Thimbles.

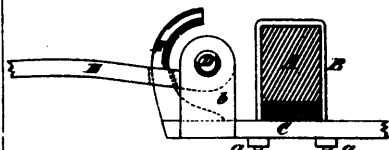

3246 Thorp's Improvements on Thill Couplings.

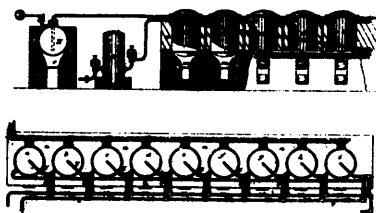

3247 Ungerer's Process and Apparatus for Preparing Paper Pulp, &c.

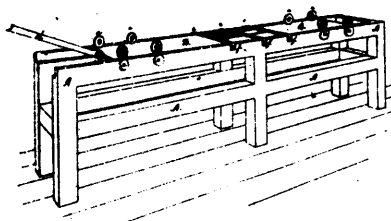

3248 Glen & Lynch's Machine for Grinding, Polishing and Finishing Slats.

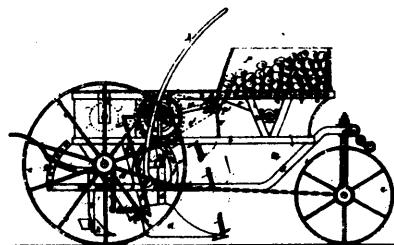

3249 Coussau's Potato Sowing Machine.

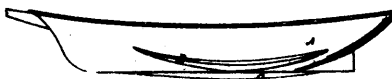

3250 Willeby's Improvements on Keels of Vessels.

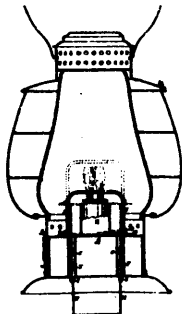

3251 Davies' Signal Hand Lantern.

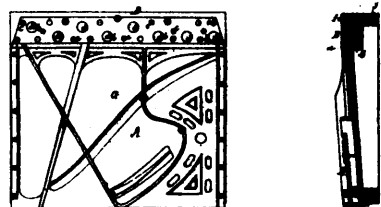

3252 Davis' Improvements on Upright Piano-fortes.

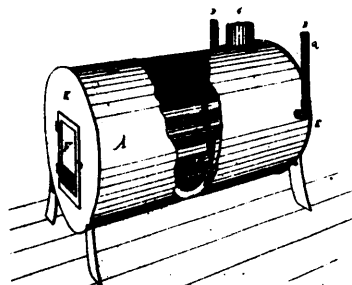

3253 Smith's Process for Reducing Wood into Pulp.

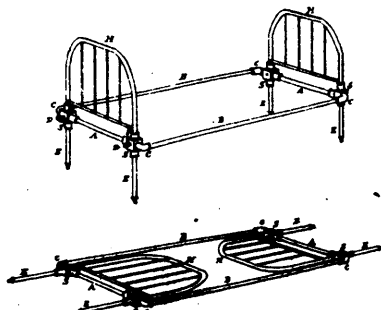

3254 Hobs' Folding Pipe Bedstead.

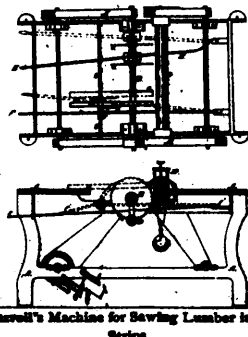

3255 Carvell's Machine for Sawing Lumber into Strips.

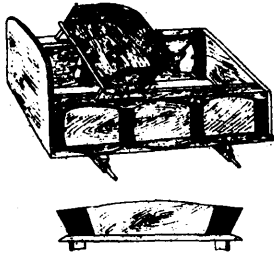

3256 Alexander's Improvements on Waggons.

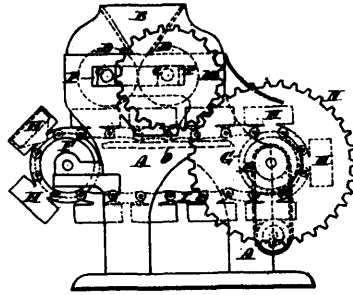

3257 Thorp's Brick Machine.

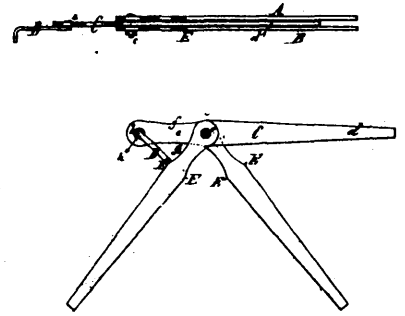

3259 Seabury's Improvements in Waggon Jacks.

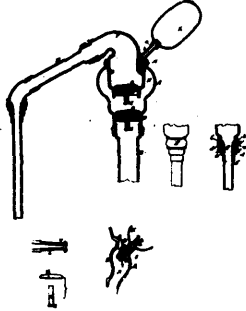

3260 Nichols' Acid Pump and Syphon.

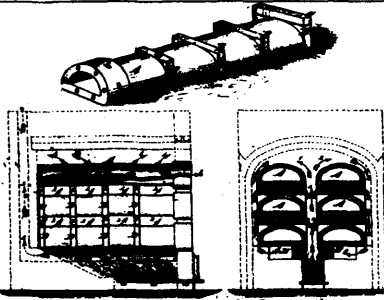

3261 Davidson's Improvements on the Construction, Setting and Operation of Retorts for the Manufacture of Coal Gas.

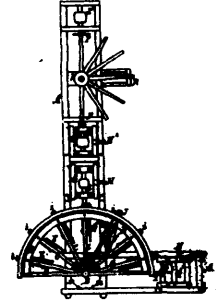

3263 Sweet's Improvement on Wheelwright Machines.

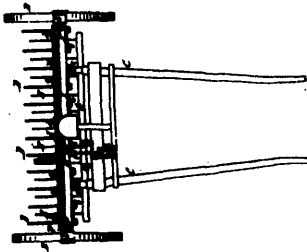

3264 Sweet's Horse Rake.

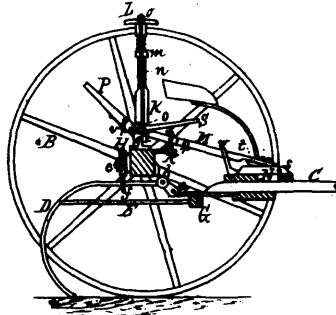

3265 Sweet's Plaster Sower.

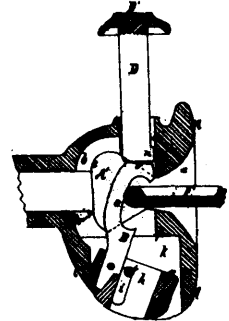

3266 Lamb & Avery's Self-acting Car-coupler.

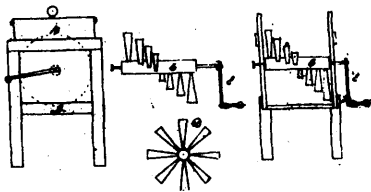

3267 Fletcher's Mashing for Churning.

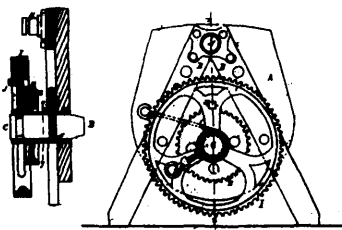

3268 Lewis' Improvement on Churn Powers.

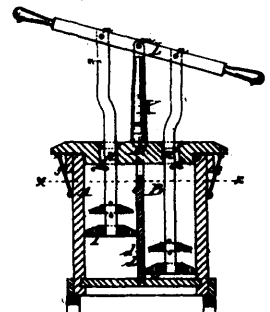

3269 Mathias & Coos' Improvements in Churns.

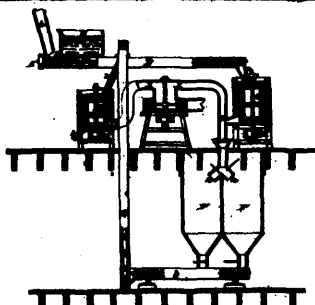

3270 Cook's Process of Preparing Grain for the Manufacture of Flour.

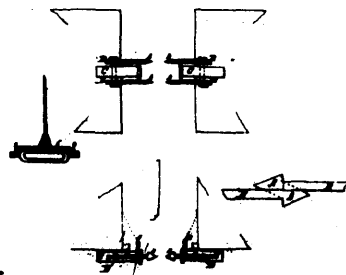

3271 Macanley's Self-acting Car-coupler.

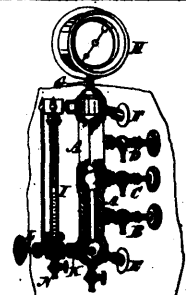

3272 Holland's Combination Steam, Water and Gauge Cock.

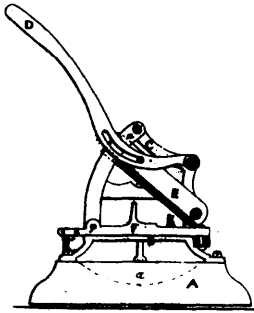

3273 Rodgers' Improvements in Tobacco Cutters.

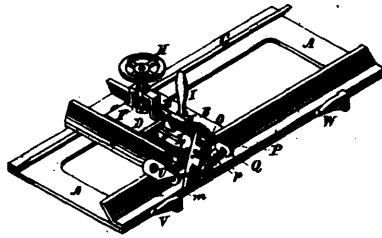

3275 Larer & Griscom's Diamond Mill-stone Dressing Machine.

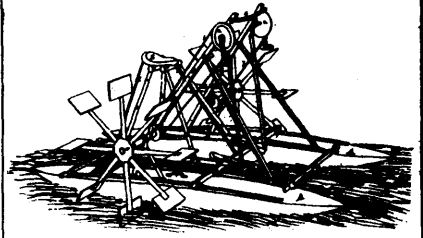

3276 Smith's Apparatus for Navigation.



3277 Mills' Toilet Tabouret.

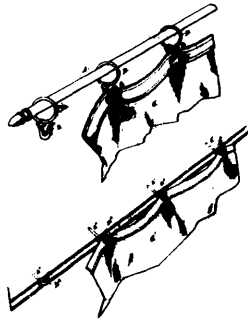

3278 Campbell's Curtain Ring and Hook.

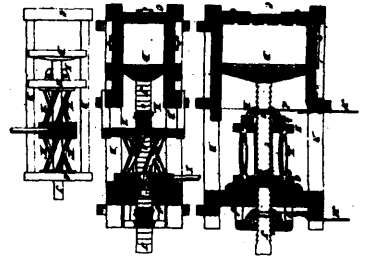

3280 Martin's Improvements on Presses.



3281 Cobley's Improvements on Boots and Shoes.

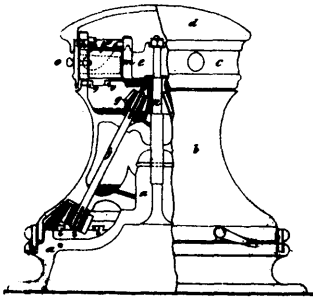

3283 Coffin, Johnston & Woodward's Improvements in Capstans and Windlasses.

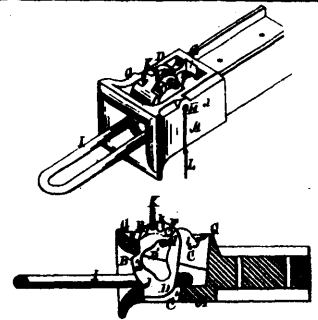

3284 Fritz's Automatic Car-coupling.

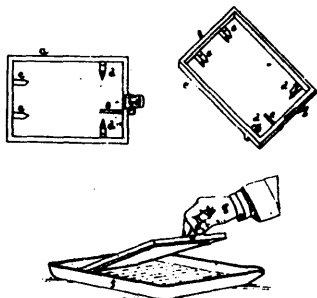

3285 Inglis' Process for Sensitizing Glass or other Plates.

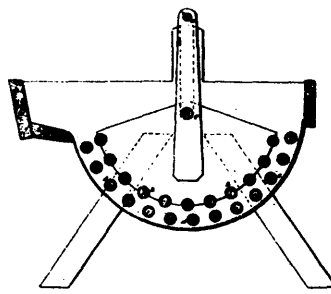

3286 Tupper & Giles' Machine for Washing Clothes.

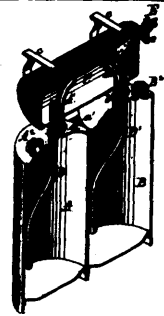

3287 Waggoner & Breed's Fire Extinguisher.

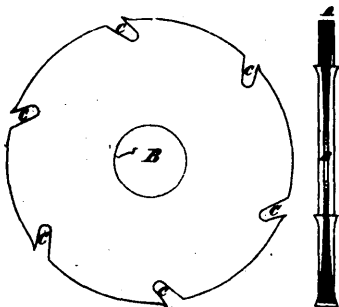

3288 Hale's Circular Saw.

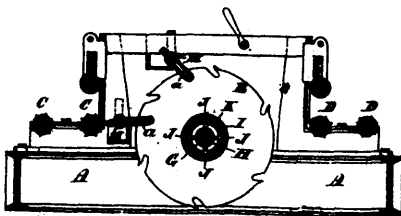

3289 Hale's Circular Gang Sawing Machine.



3290 Newton's Carriage Bolt.

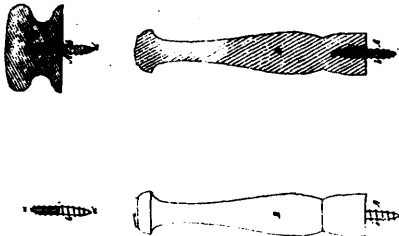

3291 Thurston's Wooden Knob and Closet Pin.

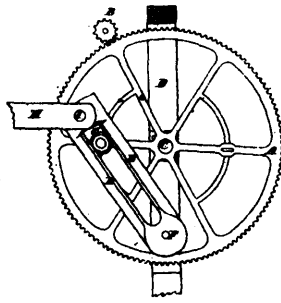

3292 Smallwood's Lever Feed for Shingle Sawing Machines.

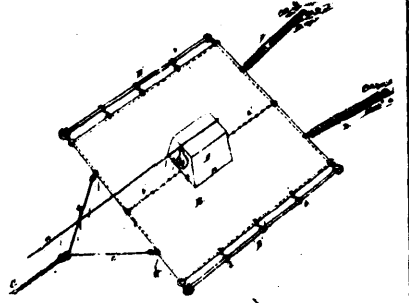

3293 Marsh's Agitator for Bird Shooting from the Trap.

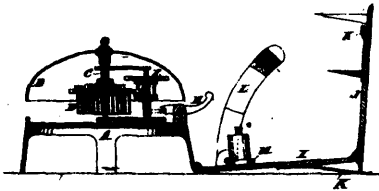

3294 Thorp's Portable Burglar Alarm.

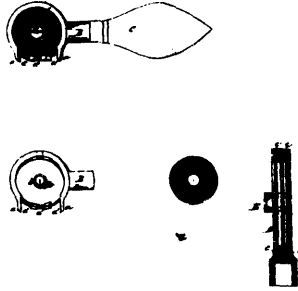

3295 Knapp's Knife and Scissors Sharpener.

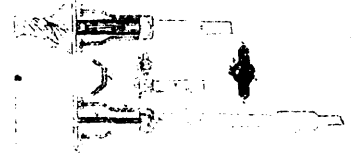

3296 Knapp's Improvements in Mops.

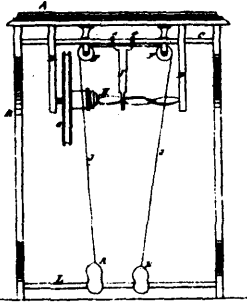

3297 Piper's Clutching Device for Driving Sewing Machines.

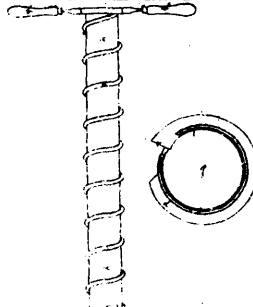

3298 Porter's Auger for Boring Pump and other Tubes.

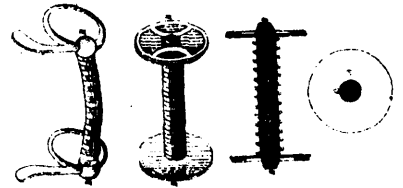

3299 Rowley's Bridle Bit.

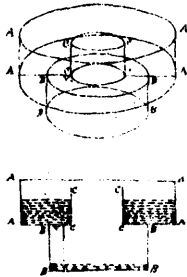

3300 Pearson & McLane's Steam Generator.

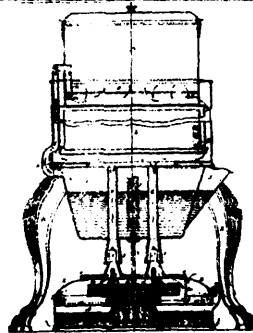

3301 MacKinnon's Coal Oil Cooking Stove.

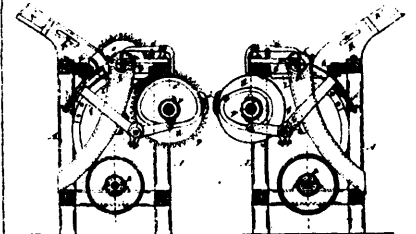

3303 Robertson's Machine for Shaping Lozenges.



3304 Shelton's Driving Whip.

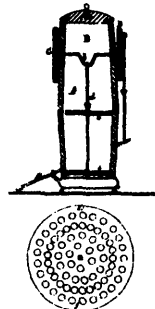

3305 Little's Improvements in Churns.

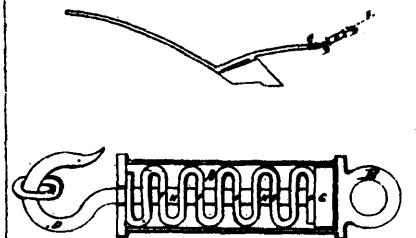

3306 Thompson's Improvements in the Draught Power of Agricultural Implements.

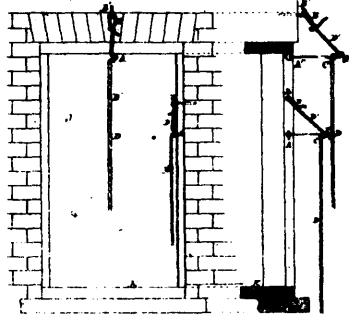

3307 De Boucherville's Fire-escape Hook.



3308 Tennant's Hand Sower.

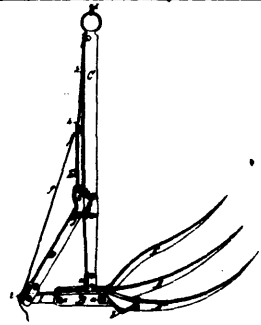

3309 McDonald & Gordon's Horse Fork.

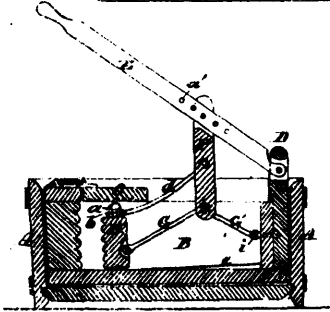

3310 Marshall's Washing Machine.

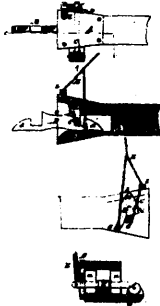

3311 Strain's Car-coupling.

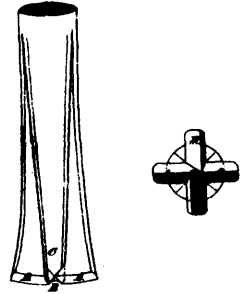

3312 Hanrahan's Rock Drill.



3313 Cooy's Lamp Stove.

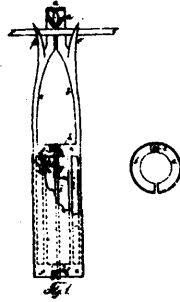

3314 Pettengill's Kitchen Implement.

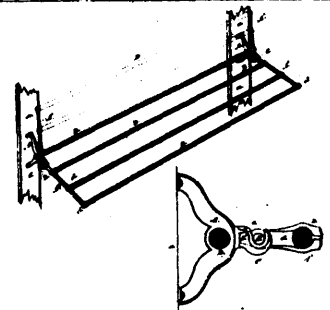

3315 Ross' Clothes Bracket.

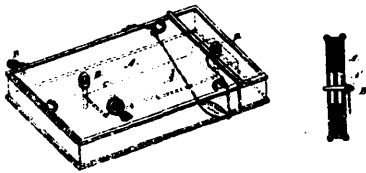

3316 Smith & Roberts' Burglar Proof Lock Attachment.

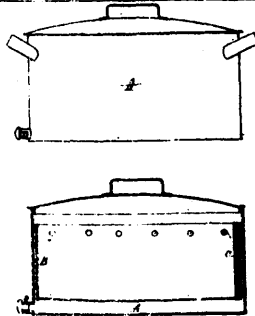

3317 Camyre's Boiler for Washing Clothes.

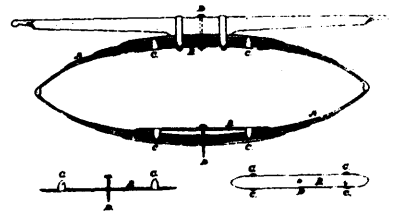

3318 Gray & Teeter's Spring for all Kind of Vehicles.

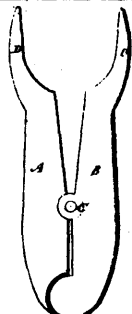

3319 Parker's Boot Jack.

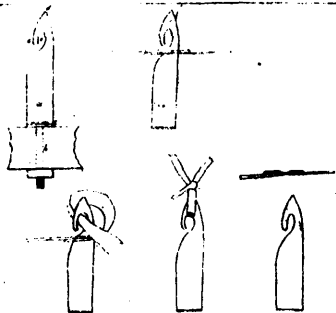

3320 Lockman, Davis & Hammond's Device for Untying Rags for Carpets.

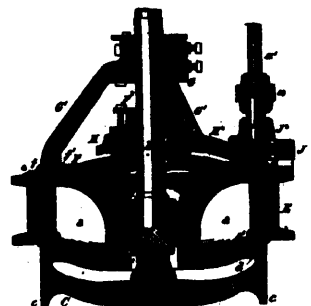

3321 Burnham's Turbine Water Wheel.

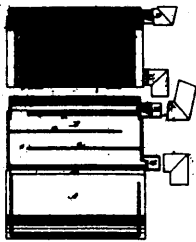

3322 Wynne's Fire Grate.

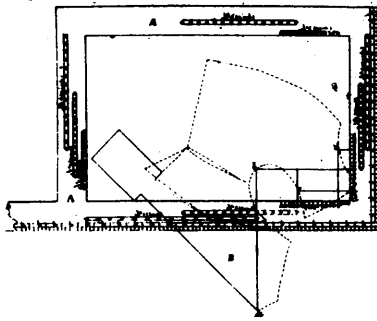

3323 Smeaton's Tailor's Square.

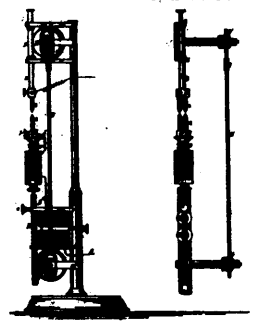

3324 Day's Improvements in Electric Lights.

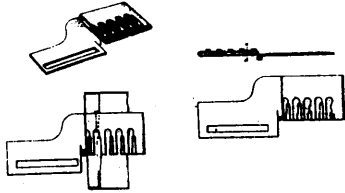

3325 Beas & Fisher's Hammer Attachments for Sewing Machines.

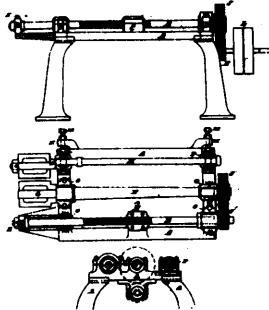

3328 Mackenzie's Machine for Making Spiral Springs.

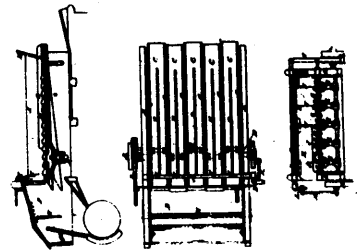

3327 Wilders' Improvements on Threshing Machines.

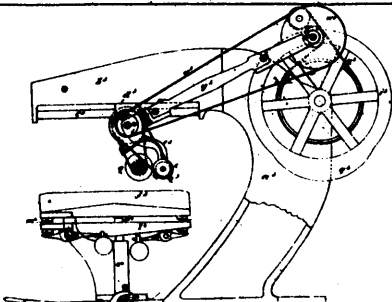

3328 Brown, Callier, Perkins, Enos & Smith's Improvements on Leather Dressing Machines.

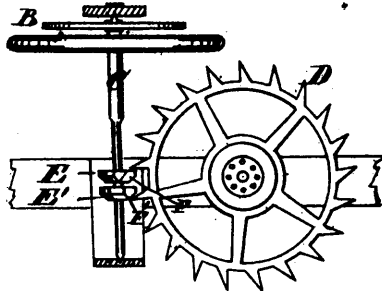

3329 Barclay's Clock and Watch Escapement.

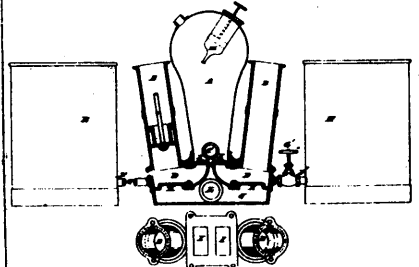

3330 Ferry's Combined Chemical and Water Fire Engine.

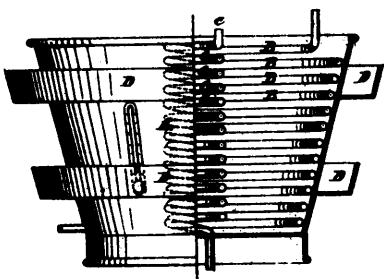

3331 Tallman's Milk and Beer Refrigerator.

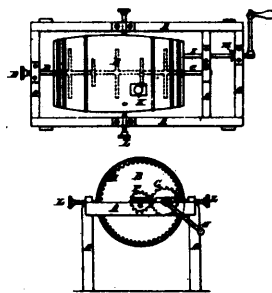

3332 Tallman's Churn.

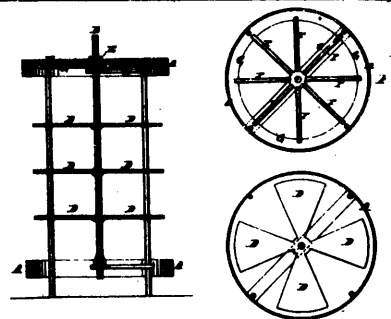

3333 Tallman's Milk Safe.

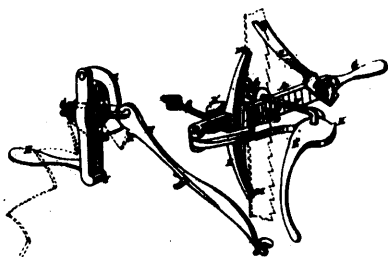

3334 Grady's Improvements on Saw Sets.

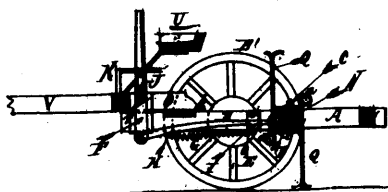

3335 Houlding's Combined Hay Rake and Spreader.

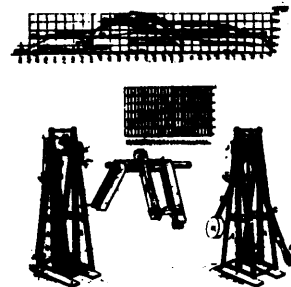

3336 Thurston's Autographic Testing Machine.

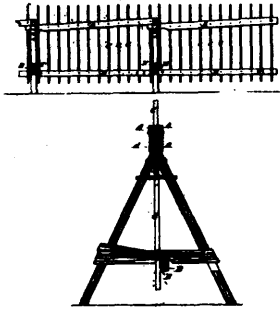

3338 Assestine's Portable Fence.

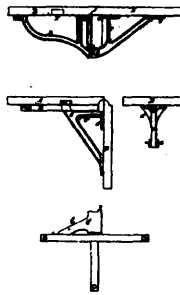

3339 Payzant's Table-leaf Support.

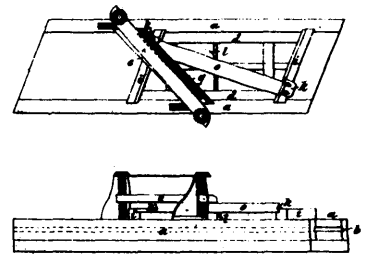

3340 Martin's Veneer Cutting Machine.

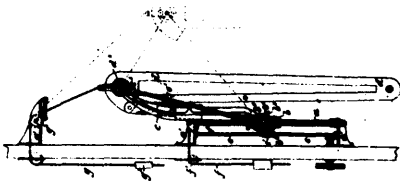

3341 Keen & Dence's Apparatus for Elevating Corn, Mineral Coal, &c., Applicable for Discharging or Loading Vessels, Dredging, Pumping, &c.

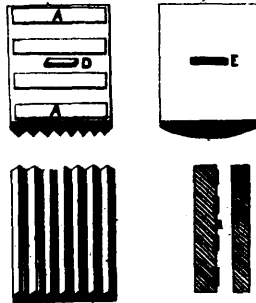

3342 Blake's Improvements in Stone Crushers.

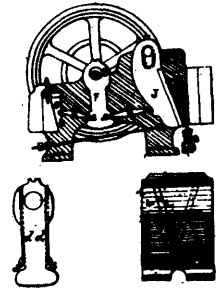

3343 Blake & Marsden's Improvements on Blake's Stone Crusher.

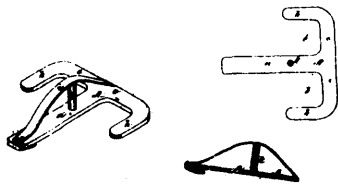

3344 Johnson's Device for Preventing Horses from Straying.

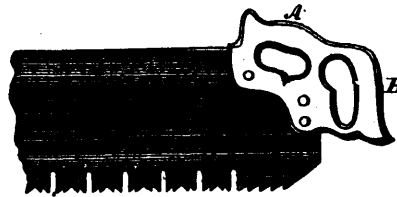

3345 Dietrich's Improvements on Saw Handles.

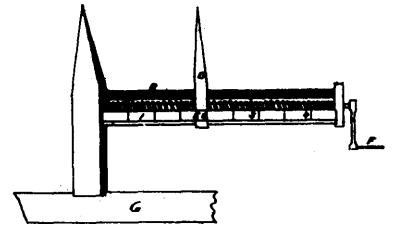

3346 Bingham's Improvements in Machines for Cutting Circular Metal Pieces.

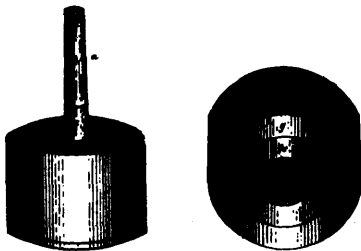

3348 De Ceu's Machine for Washing Clothes.

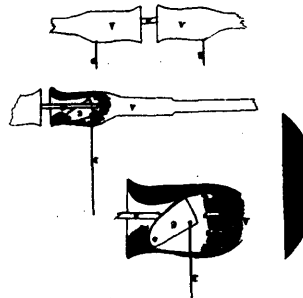

3349 Wade's Improvement on Self-car Couplers.

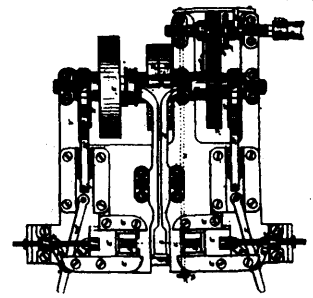

3350 Leopard's Machine for Making Railway Car-coupling Pins.

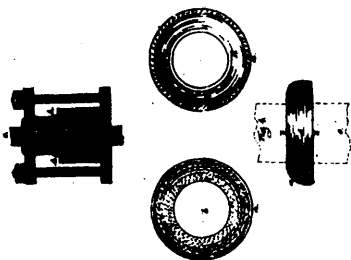

3351 Heston & Sabin's Rubber Packing for Piston Rods, &c.

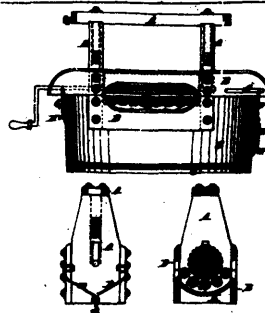

3352 O'Dell's Improvements on Washing Machines.

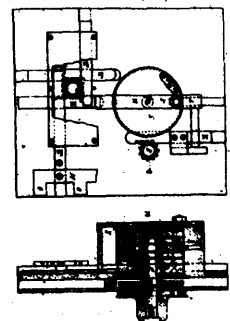

3353 Worell's Improvements on Bank Locks.

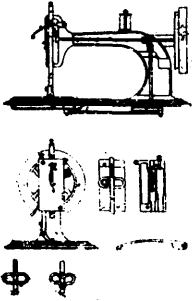

3354 Farr's Improvements on the "Raymond Sewing Machine."

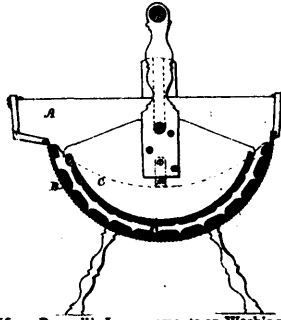

3355 Bunnell's Improvements on Washing Machines.

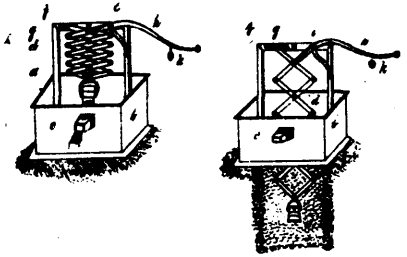

3356 McMartin's Apparatus for Elevating Water, Earth, Ores, &c.

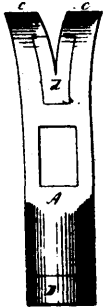

3357 Parker's Improvements on Claw-hammers.

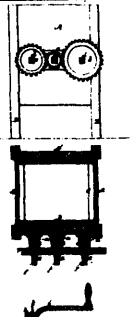

3358 Strange's Improvements on Churn.

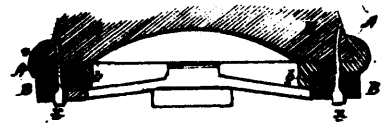

3359 Davis & Pencoast's Improved Guard for Interfering Horses.

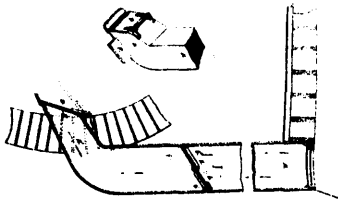

3360 Good's Improvements in Street Culverts and Waste Water Drains.



3361 Davis' Fastening for Seams.

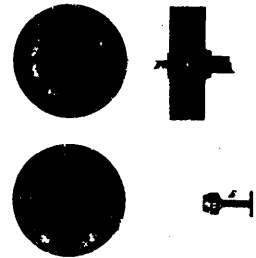

3362 Desmond & McMillan's Steam Engine Piston.

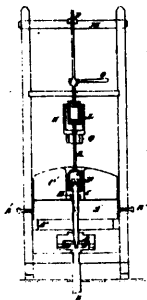

3363 Elliot's Millstone Running Gear.

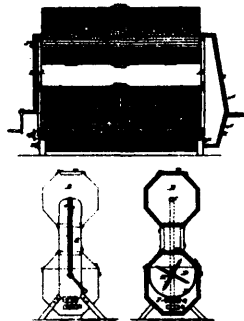

3364 Manley's Feather Remover.

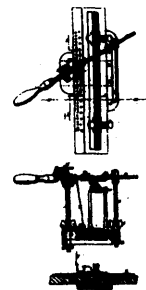

3365 Iseninger's Saw Sharpening Machine.

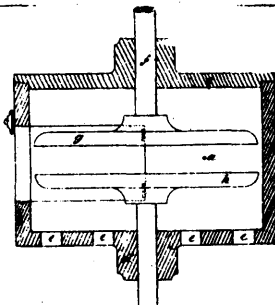

3366 Simonds & Person's Improvement on Tempering Saws.

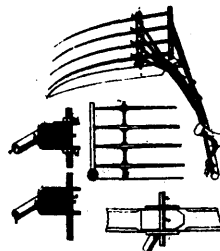

3367 Devins & Jones' Grain-cradle.

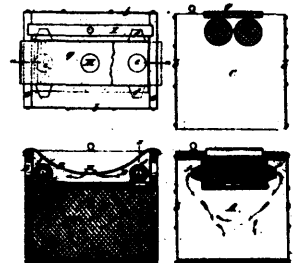

3368 Carter & Stewart's Fly Trap.