

The **CANADIAN** THRESHERMAN AND **FARMER**

WINNIPEG CANADA

AUGUST

NINETEEN FOURTEEN

BETTER FARMING — BIGGER CROPS — BETTER PRICES



"THE FAIREST OF THE FAIR"

Published Monthly by **E. H. HEATH CO. LIMITED** — *Our Twelfth Year*
Ransom Eng. Co. Ltd

The Gearless Russell With Sharpe Grain Saving Feature

Is not a dream but a reality.

It is made to store the grain, AND DOES IT. By actual use, we find that every separator needs it, so say the threshermen who are using this stacker and the farmer who has had his grain threshed with a separator that has a SHARPE GRAIN SAVING STACKER ATTACHED.

The GEARLESS RUSSELL with the SHARPE GRAIN SAVING FEATURE, costs you nothing extra. We furnish all belts and pulleys and we paint stacker to match the separator to which it is to be attached.

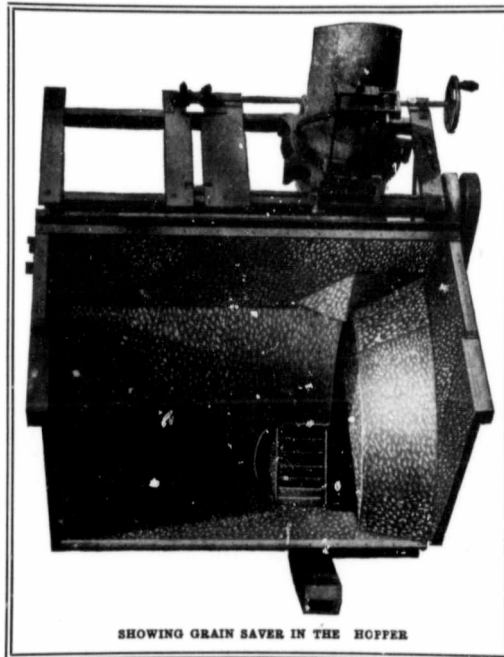

SHOWING GRAIN SAVER IN THE HOPPER

The GRAIN SAVING FEATURE is the same to the wind stacker, as the tailing auger is to the separator. We build this stacker for any make or size of separator, new or old, wood or steel.

This stacker has no back-lash.
It will increase your business by satisfying your customers.
They can see the grain go into the grates in the hopper.

Write us and we will convince you that this stacker is what you need. It is not an expenditure, but an investment.

The Russell Wind Stacker Co.
Indianapolis, Ind.

(
m
th
fu
yic
O

yo
jus
ple
ha
ho

for
on
of
low
pr
kin

cos

de:
ple
fro
pro

far:
for
ma
eve
of

30
161

BIGGER CROP YIELDS

FOLLOW DEEP, SEASONABLE PLOWING

COAXING Nature to open up her vast store houses of soil wealth, is largely a matter of deep, seasonable plowing. Just below the shallow depth of the average horse turned furrows is a bountiful supply of crop fertility—that yields to the persuasion of a Hart-Parr Power Outfit. With a

HART-PARR -OIL TRACTOR-

AND SELF AND HAND LIFT PLOW

you can easily plow 6 to 8 inches deep and do it just when conditions are right. This power plowing outfit is ready when you are ready, and it hangs to the job from start to finish, working long hours and overtime, if necessary, without rest.

After plowing, you can use this same tractor for every kind of field and belt work and do it all on CHEAPEST KEROSENE. It cuts the cost of all farm work requiring reliable power, to the lowest notch. Dollar for dollar, it returns a bigger profit on the money invested in it than any other kind of power, animal or mechanical.

The initial cost is comparatively small, and the cost for up-keep and repairs is remarkably low.

The Hart-Parr Power Plow, too, has many desirable features found in no other. It saves the plowman's wages and board. You operate it right from the engine platform and pocket an additional profit.

Our catalog and literature on Hart-Parr power farming machinery contain a lot of profitable ideas for the farmer who is making money but wants to make more, or the farmer who is barely breaking even and wants to show a profit on the credit side of his ledger. Write for this literature to-day.

HART-PARR CO.

30 Main St., Portage la Prairie, Man.
1616 8th Ave., Regina, Sask.

The Chapin Co., 325 8th Ave. West, Calgary, Alta.

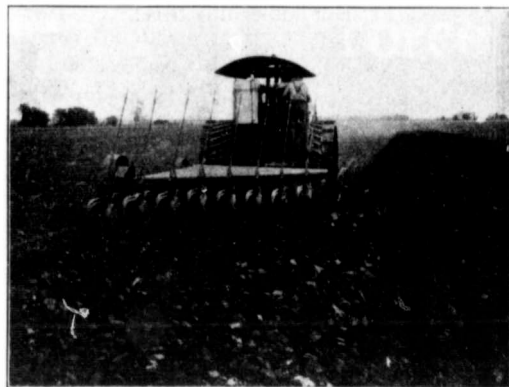

Turning even, uniform furrows with a Hart-Parr "60" and 8 furrow self and hand lift plow

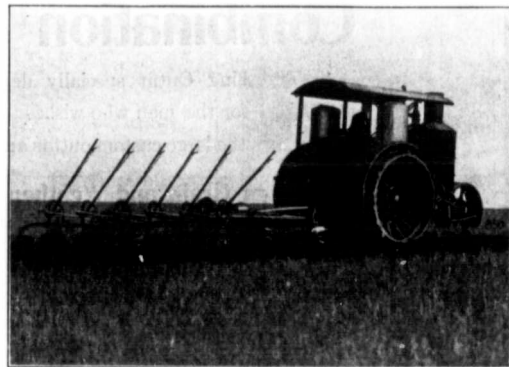

Hart-Parr "40" making the second round in stubble with a Hart-Parr 6 furrow self and hand lift plow.



Doing a deep, even job of stubble plowing with a Hart-Parr "27" and 4 furrow self and hand lift plow.

Here is a Practical, Paying Proposition!

Buy a Threshing Outfit of your own this year! Possibly you have never dreamed of such a thing because the cost of an ordinary outfit was too much for your own needs and you had no intention of threshing for others. But look into this:

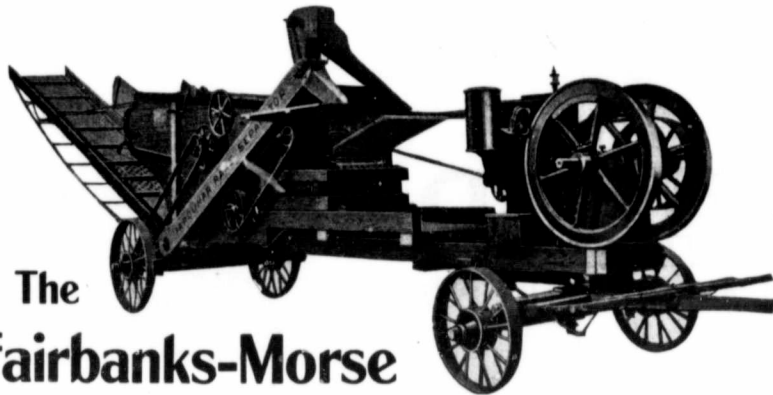

The Fairbanks-Morse Combination Threshing Machine

is a Threshing Outfit specially designed for the farmer who wants to do his own threshing—for the man who wishes to be independent—free of delays which so frequently accompany the large custom outfits and able to thresh his crop when conditions are right.

**When Grain and Weather are Ready so is
The Fairbanks-Morse Combination Thresher**

The outfit consists of a Fairbanks-Morse 8 H.P. Oil Engine and a Farquhar Rake Separator. These machines will thresh from 400 to 500 bushels of wheat a day, depending on general conditions. They get all the grain out of the straw, and clean it perfectly, ready for market.

You know the Fairbanks-Morse Engine—a World's Standard for 35 years!

We need only say that the Farquhar Separator is fit to bear it company, and, with the Engine, carries the Fairbanks-Morse Guarantee. The Farquhar machine is mechanically designed from the ground up—strong, substantially built in every particular and made on scientific mechanical principles. It is backed by years of experience.

This Combination Outfit is Remarkably Reasonable in Price

and when your threshing is over you have an 8 h.p. Fairbanks-Morse Engine at your command for all the odd jobs about your farm. Figure what this will mean to you!

Let us send you Particulars and Terms To-day.

We Manufacture:

Fairbanks-Morse Oil Tractors, 15-30, 20-40 and 30-60 H.P.; Oil Engines, Portable and Stationary, 1 to 500 H.P. for all purposes; Marine Engines, 2 and 4 Cycle, 3/4 to 100 H.P.; Binder Engines, adapted to all makes of Binders; Hand and Power Pumps for every purpose; Truck and Pitless Scales, specially designed for farm use; Electric Lighting Plants, suitable for country residences.

The Canadian Fairbanks-Morse Co., Limited

Winnipeg Montreal St. John Regina Ottawa Toronto Saskatoon Vancouver Victoria Calgary

You saw this advertisement in this magazine. Don't forget to say so when writing.

Mac
Th
MacD

Barr
Reg

No
Hi

1
Mac
Fra

General Sol
Thresher M
General M
Collectors'
General Sol
and Implem
Six Thresh
Saskatoon

Pac
&

II

WR
Pace,

Genera



Fight!
C

WE DO NO
into fe
WE DO NO
for adv
and 3r
WE DO NO
our co
WE DO B
SQUAR

Write for p
ing the qua
the pu

The Great
76-80 Lon

Distributing
Messrs. R
Messrs. R

BIG J
C

An excell
lot on one o
l streets—
Avenue and
at a

DE
Owner (a la
at a very l
payment. E
practically
decorated im
in the pink
purchaser m
A splendid
any family c
country to
care of Box

**Mackenzie, Brown,
Thom, McMorran,
MacDonald, Bastedo &
Jackson**

Barristers, Solicitors, &c.
Regina, Sask., Canada

Norman MacKenzie, K.C.
Hon. George W. Brown
Douglas J. Thom
T. Sydney McMorran
Hector Y. MacDonald, K.C.
Frank L. Bastedo, LL. B.
Edwin Jackson
General Solicitors in Canada for the National
Thresher Manufacturers' Association of America
General Solicitors in Canada for the American
Collectors' Association.
General Solicitors in Canada for eight Thresher
and Implement Companies, and in addition for
six Thresher and Implement Companies in
Saskatchewan.

**Pace, Harrison
& Millar, Ltd.**

Winnipeg
INSURANCE

LIVE STOCK
Fire
Accident
Sickness
Automobile
Plate Glass
Liability
Bonds
Tornado

WRITE FOR AGENCY

**Pace, Harrison & Millar
Ltd.**
General Agents, Winnipeg

GREAT WEST WOVEN WIRE FENCING



**Fighting for Honest
Competition**

WE DO NOT buy old wire and make it
into fencing.
WE DO NOT spend thousands of dollars
for advertising trying to push 2nd
and 3rd class fence.
WE DO NOT believe in blackmailing
our competitors.
WE DO BELIEVE IN A FAIR AND
SQUARE DEAL FOR EVERYBODY.

Write for prices and catalog mention-
ing the quantity of fence required and
the purpose it is needed for

The Great West Wire Fence Co., Ltd.
76-80 Lombard Street, WINNIPEG, Man.

Distributing Offices:
Messrs. Reynolds & Jackson, Calgary, Alta.
Messrs. Race, Hunt & Giddy, Edmonton, Alt.

**BIG BARGAIN IN A
CITY HOME**

An excellent seven-roomed house and
lot on one of Winnipeg's favorite residen-
tial streets—within a few yards of Portage
Avenue and all cars—can be purchased
at a

DECIDED BARGAIN.

Owner (a lady) must sell and will sacrifice
at a very low figure for reasonable cash
payment. House has fine basement and
practically new furnace. Just been
decorated inside and out and altogether is
in the pink of condition. No agents—
purchaser may deal direct with owner.

A splendid investment. Ideal home for
any family contemplating moving from the
country to Winnipeg. Address, M. L.,
Care of Box 3164, Winnipeg.

ABOUT OURSELVES

PRACTICALLY every mail that we open
contains some flattering testimony to the
value of the contents matter of this
magazine to its readers. We get lots of boosting,
but rarely a "kick"—except on the subject of
mailing. It seems that our best efforts are futile in
all attempts to maintain a perfect mailing system.

In this connection we wish to express our intense
anxiety to satisfy our friends. We will stop at
nothing to cover any disappointment and to replace
anything that may go astray after leaving our hands.
If any subscription remittance should go astray, we
are perfectly willing to take our correspondent's
word that he has mailed it, and we do not think
anyone is mean enough to take advantage of this to
obtain a free service of the paper. We would,
however, in such a case expect the subscriber's
co-operation in endeavouring to trace the matter.

But we are very desirous of having some legiti-
mate kicks or criticism as to any feature of our actual
performances in these pages. We will gratefully
appreciate any suggestions from the minds of our
readers who are following us in the educational work
as well as the recreative element in our magazine.

The most watchful and the most versatile brain
(and we can lay claim to neither) will sometimes
shoot wide of the mark and sometimes miss fire
altogether. Our best friends are those who do not
hesitate to speak their mind. They see things from
another point of view than that on which the man
at the wheel has in his eye. *He* may sometimes go
to sleep, but having paid the price, *they* are on the
look for "the goods" all the time.

We ask particularly that the present issue may
be taken as a starting point for criticism or comment.
Will you, kind reader, peruse it carefully and send us
your thoughts, briefly or voluminously, as it may
appear to you. * We have fresh plans in our vision
all the time. We may wear out but it is certainly
not our intention to rust out. No one can help us
so effectively as you can. You are paying for the
music and you have a right to choose the tune.



Write to the CUDAHY PACKING CO.,
TORONTO, Canada, for our booklet
"HINTS TO HOUSEWIVES"



THE PREMIER COMPANY

THE PREMIER GOODS

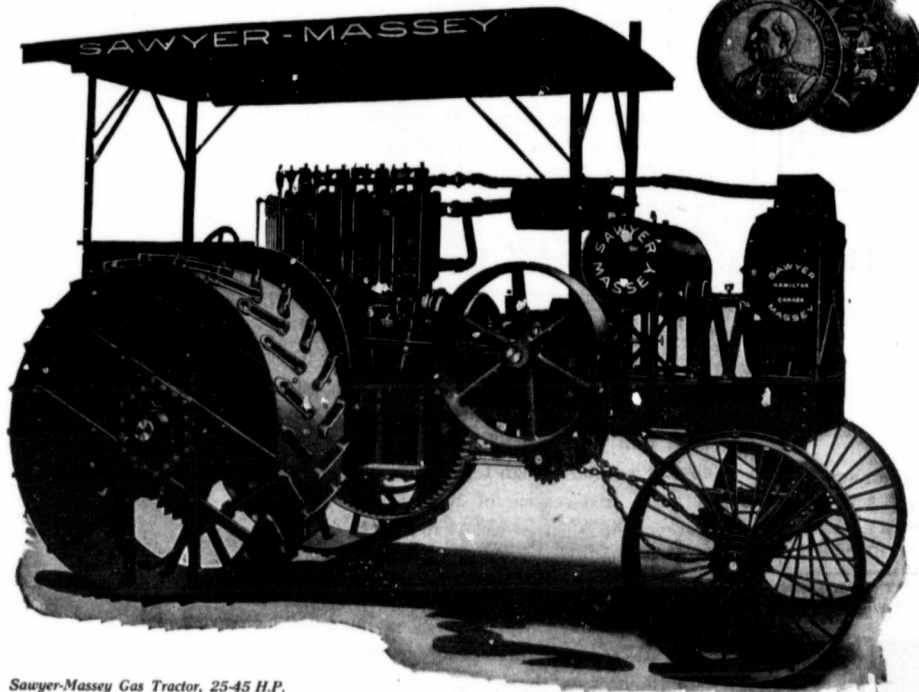

Sawyer-Massey Gas Tractor, 25-45 H.P.

THE BUSINESS OF FARMING

Farming is as much a business as any other industry, and just like any other business, it needs efficient and up-to-date methods. Modern labor saving machinery has so reduced the price of grain that the farmer who still uses the old methods has seen his profits shrink to nothing, while the progressive man who makes farming a real business has made greater profits than ever before.

SAWYER-MASSEY Tractors will increase your earnings and make profits for you. The 25-45 horse power Gas Tractor was proven the best in Canada at the Winnipeg Contest last summer, winning the Gold Medal and outpointing all competitors. SAWYER-MASSEY Steam Tractors are built in many sizes and styles to fit the needs of every farm, and have won an excellent reputation through many years of hard service.

Write for our Illustrated Catalogue and a copy of the "Sawyer-Massey Chronicle." You ought to learn more about these machines.

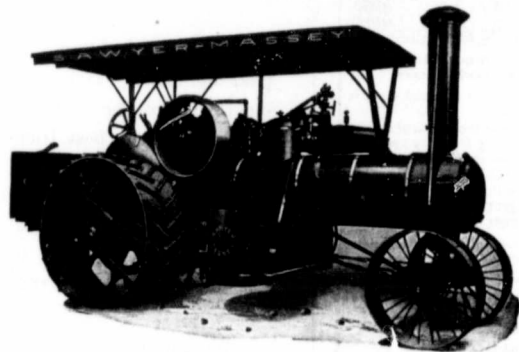

SAWYER-MASSEY COMPANY, Limited

Builders of Steam and Gas Tractors, Threshers, and Road-making Machinery

Head Office and Factory

HAMILTON, CANADA

Branches and Warehouses: WINNIPEG, Manitoba; REGINA, Saskatchewan;

CALGARY, Alberta; Agency, BUENOS AIRES, Argentina.

SAWYER-MASSEY

You saw this advertisement in this magazine. Don't forget to say so when writing.

A u
M
Vol.
1. The Cor
A BC
far
in
And yet
farmer
"bug" i
one of
enemies
country
noxious
The g
long be
farmers
acquaint
loss dir
"Cut-w
describe
to be se
every fa
moment
feature
the gre
ground
as to be
disclose
(from w
on the
and you
As we
port cor
Woodst
onsalug
made on
the "Ar
County,
in thous
billions
day mar
laying b
wide an
tent of
estimate
farmer h
tire crop
fields h
though
live stoc
with litt
becomin
present s
In Ma
market g



Vol. XIX.

WINNIPEG, CANADA, AUGUST, 1914.

No. 8.



1. The Common Cut-Worm—*Peridroma suavis*.

A New Light on the
 Scourge of the "Army" and
 "Cut"-Worm

Specially written for the Canadian Thresherman and Farmer by J.D.D.



2. The Army Worm—*Heliothia unipuncta*. (Forewings Ocher shaded with white centre spot)

ABOUT the last thing a farmer will interest himself in is the subject of bugs. And yet what the North American farmer has come to regard as a "bug" is quickly developing into one of the most destructive enemies of his grain crop the country has yet had to face—noxious weeds not excepted.

The growing season of 1914 will long be remembered by certain farmers and truck growers of our acquaintance as a record year of loss directly attributable to the "Cut-worm." We need not describe its operations—they are to be seen in every garden, on every farm and homestead at this moment. The most annoying feature of it is the fact that for the greater part it feeds underground or so near to the surface as to be lost to view, but it soon discloses its "cutting" process (from which it derives its name) on the stems of our vegetables and young grain.

As we write (July 18th), a report comes to the West from Woodstock, Ont., of a tremendous onslaught which is now being made on part of that province by the "Army-worm." "In Brant County, near Burford, not merely in thousands or millions, but in billions the 'Army-worm' is today marching through the county laying bare a path several miles wide and doing damage the extent of which it is difficult to estimate. Already more than one farmer has lost practically his entire crop for the season. Pasture fields have been stripped as though swept by a prairie fire live stock is suffering as a result with little prospect of conditions becoming any better during the present season."

In Manitoba quite a number of market gardeners have been com-

pelled to sow or plant their vegetable crop twice, and not infrequently three times, because of the voracity and numbers of "Cut-worms" on the land.

Now all this is sorry reading, but "the worst is yet to come" if we are going to let things take their course and expect "the balance of Nature" to adjust things.

upon it as a "Providential visitation" when a cloud of insects swooped down upon some defined locality or an army of caterpillars crept up noiselessly in the dark from nowhere to clear the land of every green blade.

The idea was that some flagrant act of godlessness in that locality had called down this particular

We have been getting after the cut-worm and the army-worm after they have done the damage. Why not make a dead set on the parent, which eats nothing but lays from two or three hundred to twelve or fourteen hundred eggs that hatch out into caterpillars whose whole life's business is to feed at the rate of something like thirty thousand times their original weight in a fortnight? When she is caring for the household clothes and furs in their summer quarters, the careful housewife does not look for the worm that eats but she swats the creature of wings that produces the feeder. And the housewife is right.

Nature is very kind, but, like all womankind, she resents any foolish interference with her plans quite as much as that polar frost of neglect that freezes the life out of the most long-suffering.

The worm pest has grown, like so much of our weeds, by criminal neglect on the one hand, and by idiotic interference on the other with the lives of those other little creatures (birds and beetles to wit) that find their natural sustenance in those very "bugs" and worms which at times breed far in excess of what no doubt is their legitimate place in the economy of living things.

There is no bungling in Nature. It is when the ignorance of the human elements runs riot among the works of Nature that we find things showing up in lop-sided fashion. The day has passed long ago when men solemnly looked

punishment, the fact being, however, that somewhere either through the continued neglect of the human agency to "keep the place clean" or the same bungling hand being lifted to destroy the bird, beast or insect that was needful to maintain that fine and invariable balance of Nature this little thing or a few days' life was suffered to get out of hand.

"All is love, but all is law," and there is a potentiality of comfort in that to those who are disposed to respect the law and the right of every creature to its existence.

"Big fleas have little fleas
Upon their backs to bite 'em;
Little fleas have lesser fleas,
And so *ad infinitum*."

Bulletins on "The Cut-worm" have been published at an odd time by the Department of Agriculture. We have a half-dozen of these before us published

in Canada as well as in the United States. They give a mass of detail largely of scientific and somewhat elaborate descriptions of the various members of the "Cut-worm" family, and are fairly unanimous in the advice they offer as to the means of dealing with the scourge. Indeed they all seem to have copied from one prototype. If they have failed (and we think they have) to "take hold" upon the popular mind in so far as to excite it to effective action, it is because they smack too much of the academic. We found out long ago that a treatise prepared by one who is essentially a "bugologist" for a class of students is a hopeless document to offer to the average layman.

Now the uniform advice of these pamphlets is to go after the worm by means of poisoned bait, by herding them into furrows or ditches, by setting poultry to work on infected parts, by spraying, etc., then as preventive measures, clean cultivation and protective bands of tin or paper around the plants are suggested. These or any other measures, even to hard picking, are all right in their place, but when aggregated and working with a consuming enthusiasm they will only prove partially effective and (under favorable conditions to the insects) be found as hopeless to deal with the overwhelming crowd as Mrs. Partington found it to sweep back the ocean with a kitchen broom.

Possibly every reader of this magazine has a rough idea of the life history and habits of any one of our numerous representative "Cut-worms." The different species have their own seasons of emerging from the pupa or chrysalis in which they have spent a portion (generally the winter) of their lives, and some forty years' observation and collecting satisfies us that—with trifling



Euzoa octogaster

variations due to climatic conditions—they observe these "dates" with wonderful regularity. The "bugs" or perfect insects of the more injurious species are on the wing from late in April to end of August.

Almost the first business of the females after coming out of their "swaddling clothes" is to mate and then proceed to lay eggs on their chosen food plant, which may be leaves of trees, shrubs, grasses or weeds. Some of them, however, are not fastidious and are so strangely awanting in the parental instinct that they will deposit their eggs on a window, fence post, or practically any bit of hard substance or soft goods, leaving the youngsters when they burst the shell to crawl, it may be, many yards in search of food. These eggs are laid in clusters and are therefore not difficult to locate.

What seems remarkable to the writer (who has observed and collected in entomology for over forty years) is the absence in these books of any reference to the idea of getting after the parent insects by means of the sugaring process or the moth traps commonly used by collectors.

A single female of the "Cut-worm" species will lay anything from two or three hundred to over 1,000 eggs, which will hatch in from ten days to a fortnight, sometimes in less time. These diminutive caterpillars begin to feed at a terrific pace, and many of them are full fed, have gone through their chrysalis stage and emerged as the perfect insect before the end of summer, depositing in their turn a big contribution of eggs. The caterpillars from these starting life late in the summer or fall will feed up to a certain point only, until the first breath of winter warns them that it is time to "cease firing." They will then find themselves cosy winter quarters a few inches underground among the roots of stubble and practically any description of plant; there they will curl up and go to sleep, or "hibernate," much as the squirrels and their kindred do throughout the winter.



Agrotis ypsilon
(The sworn foe of the market gardener)

As soon as the voice of spring is heard, these voracious worms will uncurl, wake up, and after their long fast attack everything in sight that their jaws can tackle, and do their business of eating in a style that astonishes observers who have long been accustomed to witness their voracity. Some wonderful stories have gone abroad as to what a caterpillar will eat in a given time. In one of the books published by a well-known authority in the early '0's it was gravely announced that the caterpillar of say the common cabbage butterfly will eat 30,000 times its original weight in a fortnight!

But the books on entomology even at this date are far from being reliable or even moderately comprehensive as to their useful facts, and in common with many other Nature lovers, the writer has gained far more from observation and practice in the field than from all the books he possesses

Every succeeding year proves that the practice of hunting the caterpillar with "Paris Green" and other poisons introduced into suitable bait is not effectively meeting the case. The cut-worm pest is more deep-seated today than it ever was and it cannot be fought successfully by simply going after the worms. The root of the trouble is the perfect insect or moth that breeds these worms, and something very definite can be done at little cost of time or money to destroy this source of all the mischief. This article suggests a plan which the writer has practised for many years with invariable success.

on the subject—with one brilliant exception, viz., that of "The Butterfly Farmer," published monthly by a very observant young lady—Miss Ximena McGlashan, of Truckee, Cal. And the wonderful assemblage of facts compiled by this young lady is the fruit of incessant labor and painstaking care in the actual work of watching and recording the habits of these gay citizens of the Sunlight and Moonbeams. Her practical information and unpretentious monthly will turn the scale against most of the "standard" works on entomology to be found on the bookshelves to-day.

The purpose of this article is to seriously advise our farmers and market gardener friends. While neglecting nothing that the authorities advise in dealing with the caterpillar, they should also turn their attention to the root of the evil, viz.: the parent insect that will bequeath a family of probably a thousand rapacious mouths, busy every one of them for at least six weeks from the hour of their birth, eating and eating—and still eating. And the horror of the situation is that they do it out of sight, for "on deck" they are night feeders and disappear

underground or among the surface roots during the day.

This practice of trapping the insects by means of nectar or artificial light is a very old one. Indeed no collector can get to know what is living around him in insect life unless he follows it. Now if "bug-hunters" have trapped their quarry with the uniform success which the writer has met with, why not extend it from this circumscribed field of the naturalist pure and simple, and make it of practical service to the farmer or truck-farmer?

Suppose some farmer who is suffering from a hoard of "Cut" or "Army" worms goes out or sends out some of his young folks to an infested spot with some "mixture" containing Paris green or to hand pick all the robbers they can lay their hands upon: if they return with a pail containing a few hundreds, or even a few thousands—is not this considered a most gratifying result, and does it not encourage the he to to



Manestra tenebrosa

some hundreds of yards of any one of the trees or fence posts which have been painted.

With the above (costing at the outside 20 cents) 50 or 60 trees or fence posts can be effectively "doctored," and these may be at a distance of 30 yards or more from each other. It is quite unnecessary to "paint" the posts with anything beyond a couple of strokes of a moderate sized painter's brush—near the top of the post, or breast high if on a tree, as the liquid will naturally trickle down and the little rivulets formed become ideal "drinking saloons" for these confirmed tipplers. On a favorable night, that is to say almost any night that is not wet or unusually cold or stormy, many thousands of "Cut-worms" and their kindred will settle at these "open bars." They become so drunk or so completely overcome by the stuff that they can be approached with a strong lantern and swatted as they sit, not in tens or hundreds, but often in thousands, depending upon the strength of their forces in that particular neighborhood.

This painting job should be done just after sunset. Half-an-hour will suffice to cover the trail suggested by the above and to dispense this small quantity of liquid evenly on the trees or fence posts. Time should then be allowed for the creatures to settle and become thoroughly "incapable." At the date of writing (15th July) eight o'clock would be about right to start out with the paint pot and say 10.30 to follow it up with the lantern.

Then there are the "moth traps" which are made of nothing more than an ordinary oil lamp allowed to burn all night at some strategic point in the open. This lamp is fixed in a box into which are fitted sheets of glass so arranged that the moths will find their way into the lamp, but cannot get out again. Under the lamp there is a receptacle—it may be an ordinary bucket—in the bottom of which a few lumps of cyanide of potassium have been placed. Should the moths find their way into the lamp in such numbers as to choke up the space around it, the cyanide overcomes them, they drop into the bucket, and are dead in a few seconds.

On this page we illustrate one of these moth traps made by one of the leading entomological supply houses. It is rather an expensive affair for the purpose if

The M

carried (the princ a home-t any man at a cost half for t send par reader. for his h Manitob; pails unc packed m dead mo which we About th bottom c fourth m few straj sively th; berhood the "seat ing was t the little

It is n grey ha suggestio how any quarter-s 640-acre f of this kin dozen co incredulit spread" an seriousne; any exper at least s The st quite a fe them to c They are are not la evening w on say a there is a available neighbor ganized c the year i hands can seeding a insects are

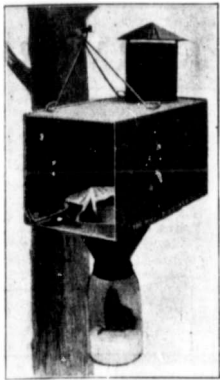

The Moth Trap used with oil lamp to burn all night.

carried out on a large scale, but the principle can be followed and a home-made trap constructed by any man or boy around the farm at a cost of about a dollar and a half for the entire outfit. We will send particulars to any interested reader. A friend made a couple for his home garden in Southern Manitoba. The first night the pails underneath his lamp were packed nearly three parts full with dead moths, many thousands of which were females big with eggs. The second night they were only about three inches deep in the bottom of the pails, and on the fourth night there were only a few stragglers, showing conclusively that the immediate neighborhood had been so denuded of the "seat of the trouble" that nothing was to be apprehended from the little that was left.

It is not unlikely that a few grey heads will smile at these suggestions and want to know how any one is to deal with a quarter-section, not to mention a 640-acre farm, with a performance of this kind. There are at least a dozen complete answers to this incredulity. First of all, the widespread and constantly increasing seriousness of the trouble justifies any experiment that will deal with at least some portion of it.

The suggestions given have quite a few things to commend them to everyone involved. (1) They are inexpensive. (2) They are not laborious; two boys each evening will do all that is needful on say a ten-acre patch. (3) If there is a desire to engage every available hand on the farm or neighborhood on a thoroughly organized campaign, the season of the year is just the time when hands can be spared — between seeding and harvest — when the insects are most of all in evidence.



Peltis ducei.

Again, it will afford one of the most interesting, instructive, not to say exciting, bits of sport the young folks can be lined up in. It is essentially a job for the boys and girls. If the writer might offer a suggestion it is that as a practical — intensely practical — part of their educational syllabus the schools right through the country should be harnessed to this work of "swatting the bug." The matter opens up a field of untold wonders in recreative as well as big paying employment which cannot be exhausted in one short article. We have set the ball rolling and will continue to push it, if for no other reason than that we have "been at it" for years, and have had the satisfaction of clearing more than one neighborhood in which the caterpillars of those moths were threatening to become a nuisance.

Many of our moths (that is the perfect or winged insect) are deprived of the mouth organ or feeding tube and are unable to feed.

Paris Green or any other poisonous substance used in combination with sufficient strength to kill insect life is an exceedingly dangerous thing to have lying around any farm. It is a constant menace both to animal and to human life, but the very practical proposal offered in this article will kill nothing except the insects it is intended to kill. These suggestions are not the sudden, untried "idea" of an odd moment but on a small scale they have been followed out by thousands of entomologists as well as some painstaking farmers in different parts of the world. There's no doubt as to the result if one will but take the pains.

These live only for a short time (eight to fourteen days), and having done their part in perpetuating the species, they die off. They are not attracted by the nectar, but they fly to lights. On the other hand the "Cut-worm" crowd swarm both to nectar and lights, and therefore the treacle pot and the all-night lamp come in for an equal share in the business of luring them to their doom. The distinctive merit of the "trap" is that having been set, it is working all night, roping in its victims by the thousands while its owner sleeps.

The most prolific breeding grounds are around places where cultivation or an attempt at cultivation has been made. Weeds or summer-fallow offer the most tempting inducements to the female moth seeking for a "sure thing" for her brood. So that in making a start with this propaganda it should preferably be made in the neighborhood of a cultivated spot or where it is intended to cultivate. The edge of a poplar, oak or other bluff adjoining summer-fallow or where it is intended to raise a crop of grain, roots or vegetables is a good place to make a fair trial.

On no account "let up" on any efforts that are being made

along the lines suggested by the Department bulletins. It is needful in the last degree to have every iron in the fire because this evil is growing apace. Witness the sudden developments in Ontario already referred to and the universal complaint from market gardeners, especially in the prairie provinces. The newspaper says "they know not whence they came," but the most elementary knowledge of the beast will tell them that they have been allowed to breed in some neglected spot — possibly more than one — where the weed inspector has "joined the majority," or has not been able to make his weight felt.

These spots could not have been many miles away. A cultivated observation would at sometime or other have seen the beginnings of this great army on the march, in time at least to have decimated it or prevent its reaching the awful proportions it has assumed. The bulletins for the greater part give very fair reproductions of the



Noctua fennica.

house of the "bed-bug," the little red-brown blood sucker that is as familiar and on no less affectionate terms with the members of the household as the domestic pup.

The cut-worms and the army-worms belong to a far more aristocratic family than the bugs. They have a more complex organization and go through exactly the same wonderful metamorphoses that those great insects of many colors perform in course of their career. They are very dainty in their methods and easily killed off if you know their weaknesses and their life-habits which at times enable us to get after them without chasing every feisty individual on the wing.

The bugologist who runs after his quarry only with a green gauze net is wasting an awful lot of time and far more precious energy. The net has its uses but its function doesn't come into the programme we must follow out to get after the multitude.

Those warm evenings—best of all after a thunderstorm when things have quieted down—is the psychological moment for making a big kill, just as a few succeeding dry hot days is the ideal condition under which to put the cultivator or a "Cyclone Weed-Killer" over a well established weed crop on summer fallow.

There's a time for everything in dealing with things that live, grow and perpetuate their species and generally time enough to deal with them successfully (either in killing or curing) if we will take the opportunity. But "Opportunity" it is said, has only one little lock above her forehead. She is bald behind and if you don't seize her by the forehead, there's nothing to catch hold of once she has gone by.

NOTE.—The foregoing article has not been written merely to provide amusement to our readers. The purpose behind it is a very serious one, viz.: to call attention to a very grave condition of things which has not yet been sufficiently "brought home" to those who are most vitally concerned. The writer of it will be glad to reply by return mail to any interested inquirer.—Ed.

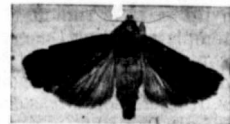

Hadena denotatrix (The Destroying Hadena)

The real bug is not the creature that is doing the mischief. A bug is a wingless insect and is fairly represented by the prehistoric

THE CANADIAN THRESHERMAN AND FARMER

CANADA'S LEADING AGRICULTURAL MAGAZINE

E. H. HEATH,
PRESIDENT

E. W. HAMILTON,
MANAGING DIRECTOR

F. C. BRAY, TREASURER



E. H. HEATH COMPANY, Limited,
WINNIPEG, CANADA



(MEMBERS WESTERN CANADA PRESS ASSOCIATION)

PUBLISHED MONTHLY BY

J. D. DUTHIE, EDITOR

C. B. FULLER,
FIELD REP.

U.S. Representatives—
JAS. A. BUCHANAN
CHAS. M. BEER
1313 MARQUETTE BLDG.
CHICAGO, ILL.

AUTHORIZED BY THE POSTMASTER GENERAL, OTTAWA, CANADA, FOR TRANSMISSION AS SECOND CLASS MATTER

AUG.

"The Job-less and the Loafer"

1914

OUR GUARANTEE

No advertisement is allowed in our columns until we are satisfied that the advertiser is absolutely reliable and that any subscriber can safely do business with him. If any subscriber is defrauded E. H. Heath Co., Ltd., will make good the loss resulting therefrom, if the event takes place within 30 days of date advertisement appeared, and complaint be made to us in writing with proofs, not later than ten days after its occurring, and provided, also, the subscriber in writing to the advertiser, stated that his advertisement was seen in "The Canadian Thresherman and Farmer." Be careful when writing an advertiser to say that you saw the advertisement in "The Canadian Thresherman and Farmer."

WHAT IS TO BE DONE that has not been done to solve the problem of the unemployed? Some few years ago when things were humming like an all night threshing outfit, hustling citizens stuck their thumbs into their waistcoat armholes and declared with great satisfaction: "There is work for all; this is no country for the loafer!" Canada certainly has no reservations for loafers but why has she got such an army of these on her hands at the present moment? Why are there so many jobless men and women on the market in the face of the fact that there are so many menless jobs going abegging? These are questions that cannot fail to intrude themselves on everyone's notice in these days. In all the western cities we observe out-of-works sitting around on the verandah of almost every boarding house, in the hotel rotundas or taking a long nap under the shade trees of the city parks.

TRADE CONDITIONS ARE BLAMED in a loose general way, and we have suffered no doubt from a lassitude in business but nothing more than what overtakes the commercial life of every community at recurring periods. It comes and goes in spite of all sorts of economic theories that profess to account for them. The "theories" neither find the cause nor provide the remedy, and as we have seen again and again, the stagnation comes and it goes, inexplicably, whether we are at war with our neighbors or at peace with all people. No genius has yet arisen who seems to have the wisdom and the administrative capacity to regulate things at these times. There are features in them that seem to be beyond the reach of man, but surely this matter of the unemployed is something that we can take a hand in to some purpose.

"NO MAN WILLING TO WORK need be without a job," we have been assured by men who toil incessantly themselves and who are also employers of labor. We used to discount that assurance but have come to feel that it has a big backing of fact. At Winnipeg Exhibition the other day it was astonishing to hear the number of visiting farmers complain of the difficulty they found in obtaining farm help while there is an army of able-bodied men in Winnipeg alone, following Micawber's profession of "waiting for something to turn up." It is rumoured that the Dominion Government contemplate putting the gag on the immigration in so far as, for some time, to block the entry into the country of all candidates who are not going on the land. If this can be done, it offers some reasonable prospects of helping to level things up, but what of the crowd now in the cities walking the streets or dawdling away the time until an opening occurs in their own line? There are vast numbers of these "own line" workless ones, too.

THE WORDS IN ITALICS are significant. They mean, in fact that the greater portion of those workless folks will rather kill months in idleness than work at anything that is not in the line they have been accustomed to, or that is out of the city. Those of them who cling to the city like limpets to their rock, have been born and reared in a city, probably London or one of the densely populated provincial towns of England. They abhor a farmer and the farming business so heartily that they "cannot stick it at any price," to quote their own expression. What a mistake it has been to encourage people of that type to come in! To deal with them as vagrants unless they consent to go on the land would not be kind to the farmer on whom they were foisted, were he looking for help that did not require another man to watch it all the time.

WE KNOW THE FARMER IS DISTRUSTED to a very great extent by numbers of those people. There is probably some justification for this because there have occurred instances in which the farmer has made a poor shape in fulfilling his side of the contract. But we know a very respectable number of farmers on whose fidelity we can bank as on the best security on earth, who are looking for help and in whose employ any earnest man cannot fail to be enriched in experience. If the farmer cannot afford, if the nature of the unskilled labor doesn't warrant a "handsome" salary, it is a decent wage and with the very best of feeding, domestic comfort and the living force of a good example, it has a standard of value all its own. It is not to be compared with any cold-blooded weekly emolument doled out by city corporations or government departments.

"I'D WILLINGLY HAVE PAID FOR IT could I have afforded it," said one, who recently came into the city after having put in a winter and early spring with one of Manitoba's representative stock-breeders. "I was broke, but Bruce Walker put me right on the track, and from the night I reached the farm I was in clover all the time." That young Englishman had been "raised" as a furniture and carpet salesman, but when he landed in Winnipeg with a few dollars in his pocket he found there were too many salesmen looking for jobs. So he decided to make his first experiment in farming. It was not a disappointment on either side and it is a pleasant tribute to the farming race to hear a man say he would willingly have paid for the treatment he had received and the experience gained. It seems to us that something simple is wanted in the nature of a guarantee of good faith as between farmer and hired man. Most of all to protect decent and capable men from being exploited and hounded by unscrupulous farmers.

SUBSCRIPTION RATES

Postage prepaid,
Canada and Great
Britain,
\$1.00 Per Year.
Single copies 15 cents.
Postage prepaid,
United States and
Foreign Countries,
\$1.50 Per Year.

Failing to receive paper, you should notify the office at once, when mistakes, if any, will be corrected immediately.

All Subscriptions must be paid for in advance and no subscription will be accepted for a shorter period than six months.

Advertising copy in order to secure good position should be in our hands not later than the 15th of the month preceding date of issue.

Advertising rates furnished on application.

Au

Th
Pr
3

Here
gives
Such
that
to fe
its fu
in a
loose
wet
way
separ
and c
of fe
tured
work



The Ruth —The Self-Feeder with No “Wear-Out” to It!

This Guarantee Protects You for 3 Years--Read It!

Here is the strongest guarantee ever given with any self-feeder.

Such faith have we in the Ruth Feeder, that we guarantee every Ruth Feeder to feed any make or size of separator to its full capacity, with any kind of grain in any condition whatsoever, bound, loose, straight, tangled, stack burned, wet or dry, piled on the carrier any way you please, without slugging the separator cylinder or loosening a spike, and do a faster, cleaner and better job of feeding than any feeder manufactured by any other company in the world.

The records for astonishing durability being piled up by Ruth Feeders all over America have never before been duplicated in the history of self-feeders.

Despite the fact they are getting the hardest, most constant, most trying use, Ruth Feeders are demonstrating almost every day that there is practically no wear-out to them.

Famous for the Fact that it can never Slug a Cylinder or Bend or Break any of the Teeth

We give a signed guarantee to this effect with every Ruth Feeder. It stands up under your work—under the heaviest work. Buy a Ruth and you can rest assured that you will not meet with any of the delays or time and money losses due to cylinder troubles or bending or breaking of teeth.

There are, as you know, some self-feeders that shake themselves to pieces in one season's work alone — and because there are self-feeders so poorly made that they have a habit of frequently slugging the cylinder, it will pay you to be careful when buying your self-feeder.

See how and why the RUTH does more work and better work—how it accurately regulates the flow of the grain,

the throat may be contracted or expanded so that the right amount of grain is always fed—how the retarder and feeding cylinder are controlled by the Pickering Governor that operates a trip lever that stops the riddle until the feeding cylinder has disposed of the grain, maintaining an even flow of grain constantly, rendering clogging impossible at any and all times.

Get All the Facts about the RUTH FEEDER and you will have No Other.

YOU CAN SECURE RUTH FEEDERS WITH OR WITHOUT SWINGING ELEVATORS

Regardless of price or any other condition whatever, the

Maytag Power Washer

With Swinging Wringer
IS THE BEST

WRITE FOR PARTICULARS

The Merchants' Hardware
Specialties, Ltd. at Calgary
are Sole Agents for Alberta.



Do not put off ordering your feeder until the last minute—GET READY.

If you live in Alberta, write direct to The W. S. COOPER CO., Calgary. They are our Alberta Agents and have all sizes on hand as well as a complete stock of repairs.

Threshers' Supplies? Yes, Everything

THE MAYTAG CO. LIMITED, WINNIPEG



MIXED FARMING

MANITOBA - SASKATCHEWAN - ALBERTA

BY W.C.M. KILLICAN B.S.A.



No. 6 ALFALFA

LAST month I described the crops in general and men-good qualities of leguminous tioned that so far as Western Canada was concerned the most important of these crops is alfalfa. I proved that leguminous crops are very beneficial in their effect on the land and very valuable as plant food. Alfalfa possesses these strong points in a marked degree. In addition it is a most abundant yielder. The average yield of the experimental plots of alfalfa at the Experimental Farm at Brandon for the years 1912 and 1913 was 5 tons 260 lbs. per acre. The plots of timothy under the same conditions averaged 1 ton 1,940 lbs. for the same years. This proportion will usually be found to hold, i.e., the alfalfa will always yield more than twice as much as timothy under the same conditions.

Alfalfa a Success

The success of alfalfa has been thoroughly demonstrated in most parts of Western Canada. Perhaps in some districts it may still be in the experimental stage, but certainly in all parts of Manitoba it is a proven success. Through the use of hardy varieties and the best means of inoculation and cultivation its use should be spread even into the most unfavorable localities.

Varieties

Grimm's is probably the hardest variety, but the price of genuine Grimm seed is prohibitive. Baltic and Turkestan are also hardy varieties, and in many localities, common alfalfa, if the seed has been grown in a northern locality, will do very well. At Brandon we find all kinds to be hardy.

Preparation of Land

The first consideration in the growing of alfalfa is the preparation of the land. Alfalfa does best on a deep, rich, well-drained soil. It takes a plentiful supply of moisture, but cannot stand to have a stagnant flooded condition of the land. In fact, the average Manitoba farm provides soil conditions admirably suited to the growing of alfalfa. The land should be clean before alfalfa is sown. Alfalfa is hardy after it becomes established, but during the first year it needs every chance. It should therefore be sown where the land is reason-

ably free from weeds, and where the native grasses have been killed out. Following a crop of corn or roots, that has been kept clean, is an ideal place for alfalfa. After a summer-fallow is the best possible place, but as that means two years lost, it makes it rather an expensive crop to start. It can be sown following a grain crop, if the land is clean and in good fertility. In any case, the land should be well worked so that there is a fine firm seed bed into which to put the alfalfa seed.

tained in limited quantities from the experimental farms by paying the expenses for shipping.

Inoculating soil should not be exposed to the light more than is absolutely necessary, and should not be dried out. Either of these conditions kills the bacteria. It should be spread very thinly and evenly over the field and immediately harrowed in.

Seeding

The last week in May or the first week in June is considered the best time to sow. The spring

grains of wheat, and then the mixture sown at the rate of one bushel per acre. The wheat is broken in an ordinary grain crusher set so open that it only breaks it enough to prevent it from growing. The broken seeds are found better than chop of bran or any other material tried as they flow more evenly and smoothly. The flour particles are screened out. The drill should be set to place the seeds about an inch apart.

First Year

No crop is to be expected from alfalfa the year it is sown. It is engaged in the work of establishing itself. During the first year it is growing down into the earth and establishing its roots rather than making a crop of hay. It should be clipped off once during the season. Clip when any weeds begin to come in flower, so as to prevent their seeding. The clippings may be left on the ground as a mulch. Alfalfa should not be pastured the first year, as animals are likely to injure it by biting off the crowns and by tramping. Neither should it be clipped late in the season, but should go into winter with six or eight inches of its own growth to hold the snow.

Harvesting

Alfalfa should be cut in early bloom. It rapidly becomes more woody and less digestible as it approaches maturity.

A better indication than the stage of blossoms is the starting of the new growth from the root. As soon as fresh young branches are seen sprouting from the crown, it is time to cut, as the new growth then is ready to come on. If the new growth is allowed to get high enough to be cut back it gets a set-back and the second crop will be lessened or at least delayed.

Alfalfa is rather hard to cure and requires considerable attention after cutting. The things that make it hard to cure are: (1) It grows a heavy crop of a very succulent green character and is thus hard to dry; (2) it is rather open and thus suffers easily from rain; (3) the leaves are the most valuable part, but if the crop is dried too much, or handled too much, they fall off and are lost. The method found most satisfactory at the Experimental Farm is as follows: The

Continued on page 25



A good prospect in alfalfa.

Inoculation

On most of the land in Western Canada it is found advisable to inoculate. In some of the scrub districts, where the wild pea vine is plentiful, inoculation does not seem to be required, but in most of the open prairie districts, decided benefits are obtained. The land that has never grown alfalfa seems to lack the bacteria that associate themselves with it. Inoculation will often gradually take place by itself, but in the meantime there is a loss of time for the crop and of money for its owner. By artificial inoculation it may be put on a productive basis from the start. There are two ways of inoculating, viz., by means of a bacteria culture, which may be obtained from some of the agricultural colleges, and by using soil from a field that is already growing alfalfa successfully. The latter means is most commonly used in Manitoba. Most farmers have now got a neighbor within driving distance who has an alfalfa patch from which they can get inoculating soil. Such soil may also be ob-

rains have started by that time, and the soil is in a moist, warm condition, suitable for the germination of small seeds. The earlier part of the season may be used in killing weeds on the land, so as to give the alfalfa a better chance. In countries farther south later sowing is the rule, but that is not advisable here, because a strong vigorous growth is needed to prepare for winter. Twenty pounds of seed per acre is required. It seems a large quantity, but one must remember that alfalfa never thickens up like other forage crops.

It should always be sown without any nurse crop. There is not enough moisture in the average season to grow a crop of grain and, at the same time, to give the alfalfa sown with it the moisture it requires. One cannot expect a good catch of alfalfa unless it has the field to itself.

There are several good ways of applying the seed. The method used on the Experimental Farm is to sow it in the ordinary grain drill. The seed is mixed with twice its quantity of broken

atio
you
fall
are

three
sprit
sprit
Ault
big 1

oper
work
every
claim

all th
duct

TI

B

A
G
O
O
D
T
R
A
C
T
O
R
A
T

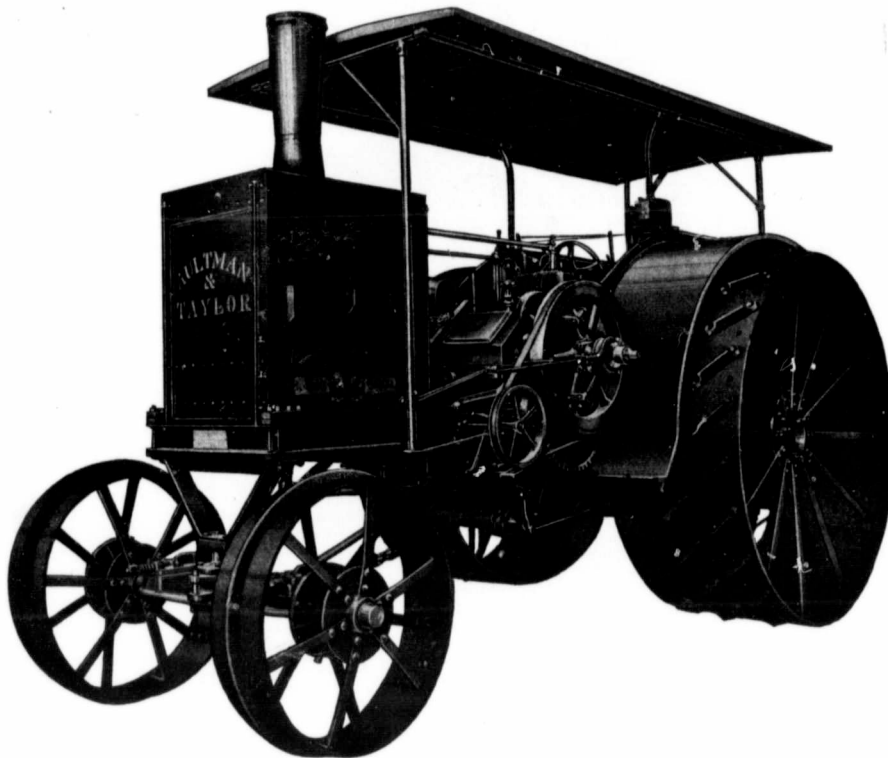

A
R
E
A
S
O
N
A
B
L
E
P
R
I
C
E

Big Power for Deep Fall Plowing

Possibly no other one operation on the farm is more important than deep, early fall plowing. It's the laying of the very foundation of your next year's crop. You must have a perfect seed bed to obtain the best crop results. To make this perfect seed bed, you must plow deep. This requires power, and lots of it—power that's steady and dependable. It's useless to undertake to do fall plowing with horses. It tires them out and proves a costly operation, and then the work is not properly done. Best results are secured by doing this work with an old reliable

AULTMAN-TAYLOR 30-60 GAS TRACTOR

Place your order now for an Aultman-Taylor 30-60 Gas Tractor and save time, labor and money. Do your harvesting and threshing with this big powerful machine and then follow up this work by deep, thorough fall plowing. Then when the rush spring work comes on, your plowing is done. With your plowing done, you need not worry about weather conditions in the spring. You can take this tractor and do your seeding, getting your seed in early, thereby giving it an excellent start. With an Aultman-Taylor 30-60 at your service, you can always get your crops in on record and make every acre of your land yield you big profits.

The Aultman-Taylor 30-60 is not only a good tractor for fall plowing, but it is just as efficient for numerous other power operations on the farm. For belt work, such as silo filling, saw milling, corn shelling, threshing, etc., it can't be beat. For road work, such as pulling graders, levelers and hauling road building material, it leads all others. It's the tractor that makes good everywhere, at any kind of work. Let us prove to you what it will do for you right on your own farm. We can prove every claim made for this tractor of tractors. All we ask is an opportunity to show you.

WRITE US TO-DAY. It takes only a few minutes. Use the Coupon below or send us a post card. We want you to get all the information about this big sturdy tractor. Every farmer interested in raising bigger and better crops and reducing production cost should communicate with us. Act now.

THE AULTMAN & TAYLOR Machinery Company

LOCK BOX No. 64. MANSFIELD, OHIO

Branches:—Minneapolis, Minn.; Great Falls, Mont.;
Calgary, Alta.; Regina, Sask., Canada

COUPON

Please send me full information concerning the Aultman-Taylor Gas Tractor

Name.....

P.O.....

Prov.....

A MAN'S TALK TO MEN

By
REV. DR. J. L. GORE



Straight Goods

It is a happy moment in a man's life when the world finds him to be straight. Somebody has doubted his word—somebody has questioned his character—somebody has impeached his speech—somebody has impuned his motive—then there comes the indication and the world discovers that the man is straight. Righteousness will out. Sincerity comes to the surface. Rectitude reveals itself. O man, be straight! It pays to live right. Dr. T. De Wit Talmage once said:

"I should like, as a minister, when I am dying, to be able truthfully to say what a captain of the English army, fallen at the head of his column and dying on the Egyptian battle-field, said to General Wolseley, who came to condole with him: 'I led them straight; didn't I lead them straight, general?'"

Aim High

AIM high! If you would live to be eighty-five, aim at one hundred. If you would like to be worth \$50,000, put your mark at \$100,000. Aim high. Leave a large margin for the possibility of failure. Remember that the unexpected always happens. A sudden death will remove your best backer. A conflagration will burn the heart out of your best laid plan. A friend's failure in business will compel you to rearrange all your personal affairs. A cyclone may put a new face on the geographical aspect of affairs. Henry W. Longfellow once said:

"If you hit the mark, you must aim a little above it; every arrow that flies feels the attraction of the earth."

God's Plan For You

I WOULD be in deep despair if I did not believe that I had a place in God's plan. I believe that I am a significant character and not a cypher in the chain of destiny. This gives me strength in the hour of struggle and strong hope in the hour of defeat. No evil thing can happen to a child of the King. All things work together, for good to them who are working for the general good of all. Therefore I will merge my plan in the divine plan and glory in the will of God.

Even in the dark days of the Middle Ages the voice of Peter the Hermit was lifted, and the Crusades commenced. That was the missionary movement of the twelfth century, and it had for its watchword the sublime sentence: Deus vult—"It is the will of God!"

The Secret of Success

SUCCESS is a thing which can be bought and paid for. The main question is are you willing to pay the price. The price must be paid in the currency of crucifixion—blood, tears and agony. The article is lying on the centre table of Chance and Circumstance. Have you got the coin? Are you willing to pay the purchase price. Everything in this world has its price; fame, reputation, character, success, popularity and power. Pay your money and take your choice. A single sentence from one of Lord Campbell's letters to his father, excusing himself for not coming to Scotland on a visit, will sufficiently illustrate the way in which these men climbed into the Temple of Honor: "To have any chance of success I must be more steady than other men; I must be in chambers when they are at the theatre; I must study when they are asleep; I must, above all, remain in town when they are in the country."

The Self Centered

CERTAIN people always figure on every proposition from their own individual standpoint. They ask: "What is there in this for me?"—"Where do I come in in this transaction?" "Is there any gain, benefit or profit to come my way?" Every plan, scheme, proposal and program is viewed from the standpoint of self-interest. They begin with themselves and end where they begin. All interests which do not centre inward are cut out. The author of "Sixty Years in Public Life," says, concerning Commodore Vanderbilt once in a conversation Mr. Conkling said: "Mr. Vanderbilt, why did you sell Maud S.?"

Mr. Vanderbilt proceeded to give reasons. He had received letters from strangers inquiring about her pedigree, care, age, treatment, etc., which he could not answer without more labor than he was willing to perform. As a final reason, he said: "When I drive up Broadway, people do not say, 'There goes Vanderbilt,' but they say, 'There goes Maud S.'"

Sudden Inspirations

EVERY man has his inspirations, therefore every man ought to have a book of inspirations. When a good thought comes to you write it down. Write it down the moment you receive it in the exact language in which it was mentally expressed to you. It is remarkable how fresh and invigorating these mental lighting flashes are. Great writers have prized the mood, the thought and the phrase. Keep a note book of your own and put down immediately every happy thought which comes to you.

Among Lord Bacon's Remains, we find a paper entitled, "Sudden Thoughts, set down for Profit." At all hours, by the side of Voltaire's bed, or on his table, stood his pen and ink with slips of paper. The margins of his books were covered with his "sudden thoughts."

Don't Sneer

DON'T laugh at another man's religion. Any religion, almost, is better than no religion at all. You have no right, even, to criticise a man's religion unless you can offer him something better. Remember that a man's religious convictions are the most sacred possessions of his soul. Without churches, creeds and Catechisms the world would be swept by a universal wave of anarchy. Therefore cultivate religion in yourself and encourage it in others. Charles Kingsley says, in one of his letters, "there is no more unloving, heartless man-murderer, than the man who goes about trying, for the display of his own 'talents,' to shake people in their belief, even when that belief is not sound. Better believe in ghosts 'with no heads and jackboots on,' like my Eversley people, than believe in nothing but self! Therefore Maurice's loving, Christian rule is, 'Never take away from a man even the shadow of a spiritual truth, unless you can give him substance in return.'"

Condensation

THE secret of success in speaking, writing is condensation. Put your "introduction" and eliminate your "application" and make your point. The world is ever looking for the man who thinks for it. It is not even interested in the process of thought—what the world wants for is the mental result. Put it in a sentence. Express it in a line. Study the art of condensation. Be brief.

There is a story told of a newspaper correspondent who telegraphed his editor as follows: "Have column story on so-and-so. Shall I send it?" The editor, mindful of the value of space, wired back: "Send six hundred words." In a few hours he received another message from the anxious correspondent, reading: "Can't be told in less than twelve hundred." The editor promptly telegraphed back: "Story of creation of world told in six hundred. Try it."

Practical Religion

THE practical religion of the world today is expressed in that word—"Christian." The sayings and doings of Jesus have set up a universal standard of morality. Therefore when we would appeal to a man's best nature we ask him to be like a Christian." The world has accepted the Christian standard of morality. It still has its doubts about "miracles," dogmas and creeds, but it has no questions to ask concerning the Sermon on the Mount. Nations and individuals are to be judged by the ethics and teachings of Jesus.

Matthew Arnold once said that nations that follow what he called "the line of Jesus" will win in life's struggle, while those that do not follow "the line of Jesus" will perish.

Popularity

THE highest type of popularity begins upon its face the stamp of conscientiousness. It's a great thing to be popular with yourself. The best kind of respect is self-respect. It is a great thing to be happy when you are alone—when the din of business has died out and the music of the social world has faded away in the distance to hear the voice of an approving conscience—this is great. Ever seek to be popular with your God, your conscience and yourself.

At a time of some public exhibition in Rochester, there was a great crowd of people struggling to get through the train-gate but one of the officials stood quietly with his back to the gate, and so restrained the crowd. Someone laughingly said, "You are not a very popular man to-night," and he answered, "O yes I am; I'm popular with the management."

Three Important Things

THERE are three important things in life which will bring you peace: your home, your business and your church. Your business will provide you with an occupation, your home will provide you with the master motive of love and provide you with a circle of friends for whom you would lay down your life. Your church will bring you in contact and keep you in touch with the best elements in human nature and crown your life with the golden light of an immortal hope. Remember the trinity of business, church and home. John Richard Green wrote just before his death: "What seems to me to grow fairer as life goes by is the love and tenderness of home, the laughter of little children, and the simple talk by the fire-side."

Every Arrow Points to a Reason for Advance Success

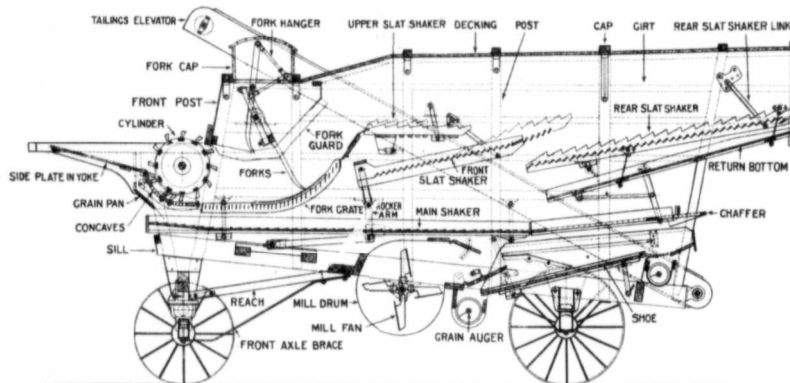

Sectional View of Advance Standard 3 Shaker Separator.

THERE are Advance Separator features of which we are especially proud—features such as the forks back of the cylinder which insure a large amount of separation at the cylinder and prevent back-lashing of the cylinder; the extra large shakers; the “no choke” chaffer that make possible the cleanest work; the famous Advance windstacker; and many other Advance features that are well known to practically every thresherman.

But the success of the Advance has not been based on a few good features. It is the result of the careful design and construction maintained throughout the entire machine. Each part has received as much attention as though it were the most important part of the separator. Each detail is a good reason why thousands of threshermen rely on the Advance.

In the Advance you get a strong, simple machine that for many years has been demonstrating its ability to stand up under the hardest usage; you get a machine that is known from one end of the world to the other as a fast, clean, efficient separator; and you get a separator that operates with minimum power. These facts go unchallenged wherever the Advance is used. What more could you ask in a Separator? The Advance is built in the Standard Shaker sizes—28 x 44, 30 x 48, 32 x 56, 36 x 60, 40 x 64, and in two Junior sizes—22 x 36 and 24 x 40.

We will gladly send you a copy of the Advance Line Catalog, completely describing Advance Separators and Steamers. It is a good book for threshermen to read. Send for it.

Rumely Lines of Power-Farming Machinery

KEROSENE TRACTORS
GASOLINE TRACTORS
STEAM TRACTORS
KEROSENE ENGINES
GASOLINE ENGINES
STEAM ENGINES

GRAIN SEPARATORS
CLOVER HULLERS
ALFALFA HULLERS
BALING PRESSES
ROAD MACHINES

ENGINE GANG PLOWS
TRACTION DISC PLOWS
FEED MILLS
GRAIN GRADERS
SAW MILLS

SAW RIGS
POWER PUMPS
POWER HOISTS
GRAIN ELEVATORS
FUEL TANKS
ELECTRIC LIGHT PLANTS

Catalogs on request.

Rumely Products Company

(Incorporated)

Power-Farming Machinery

Chicago

Illinois

AD 983

PRACTICAL TALKS TO THRESHERMEN Talk No. LXXXII.

Conducted By PROFESSOR P. S. ROSE

Note.—The term "gas engine" in these lessons will be used indiscriminately in speaking about all internal combustion engines.

THERE are five principal methods whereby power the motor to the drive wheels of a tractor. They may be classified roughly as follows:

- 1. By a combination of bevel and spur gears from a motor whose crank shaft is parallel to the engine frame.
2. By a combination of spur gears from the motor placed crosswise of the tractor frame.

of Coventry, England, designed a tractor with worm drive two or three years ago but in this country only one concern, the Morton Truck and Tractor Company, has adopted the idea.

This machine differs so much from most other tractors on the market that we have decided to give a brief description of its principal features. Figure 178 represents a longitudinal, sectional view of the entire tractor

mitted through the steering post G, to the drum beneath the transmission case and from thence to both axles. This arrangement makes it easy for the operator, while turning both axles makes it possible to turn very close corners.

Power for the drivers is transmitted through shaft E, to the worms above each axle which are shown greatly exaggerated in Figure 179.

are more minutely set forth in Figure 181.

The worm, worm wheel and differential are all enclosed in a perfectly tight casing and run in a bath of oil. The change speed gears in the transmission case are also enclosed and it seems impossible for dust or grit to enter any of the working parts. This is perhaps the nearest dust proof construction in tractors that has yet been devised. All the gears are cut from cast steel. The worms are made of nickel steel and the worm wheel of phosphor bronze. A 4 1/4 x 6 inch, four cylinder, four cycle motor constitutes the power plant. The weight of the complete tractor is about eight thousand sand pounds. This is one of the new light weight machines intended for farmers in the older settled portions of the country. In passing, it may be well to mention that the wheels are so designed that rubber tires can be fitted, thus transforming the tractor into a road machine. There are one or two other light weight machines equipped in like manner for road service but up to the present we have no reports as to how well this feature works in practice.

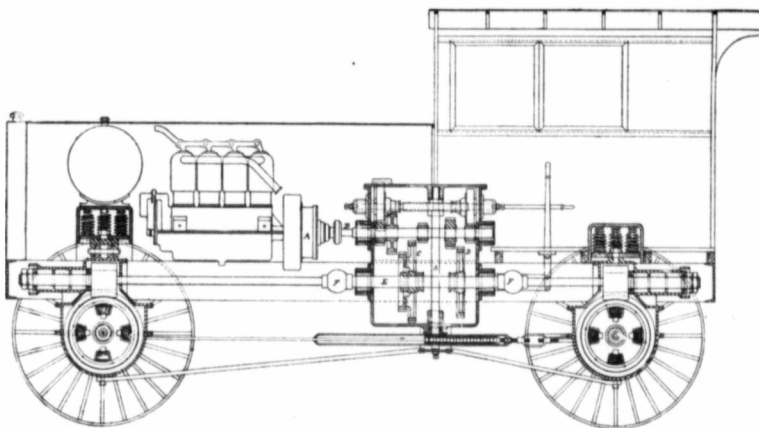

Fig. 178. Sectional view of Morton Worm Drive Tractor showing transmission.

3. By a combination of spur gears and sprocket chains to the rear axle—the motor crosswise of the frame.

4. By the use of a combination of spur gears and worm gears with the motor parallel to the frame.

5. By the use of friction wheels in combination with spur gears or chains.

The first two methods are most commonly used and examples have been shown in the last two or three lessons. While these two methods are used in the majority of tractors it does not necessarily follow that they are the best, for designers and manufacturers are more inclined to follow established custom than to branch out along new lines. The fact remains that most motor trucks, even those of the heaviest type, are using the chain drive and a few are using worm drive. The latter has been in use only a very few years for truck or automobile service but in that short time reports seem to agree that it has considerable merit. The worm drive was first used in Europe where it attracted so much favorable attention that several auto truck firms have adopted it in this country. The Daimler Company

showing the arrangement of the gears in the transmission case, the worm, worm gear, differential and the heavy springs over each axle that carry the motor frame and transmission mechanism.

The transmission, or speed changing gears, are of the heavy selective type with three speeds forward and a reverse. The forward speeds are one and one-half, three, and five miles an hour respectively while the reverse is one and three-quarter miles.

Gears C and D slide freely on the square shaft E. When C is moved forward until the front gear of the pair meshes with its corresponding gear on shaft B, the tractor is in high gear; moving it backward gives the slow speed and intermediate speed is obtained by shifting gear D. The means by which all these changes are made is not clearly shown in the drawing, neither is the exact method of reversing, but all this can readily be supplied by the reader.

The machine is steered with the power of the motor which is controlled at the will of the operator by means of a hand steering wheel, not shown, in the cab which engages and disengages the proper gears. Power is trans-

mitted through the steering post G, to the drum beneath the transmission case and from thence to both axles. This arrangement makes it easy for the operator, while turning both axles makes it possible to turn very close corners. Power for the drivers is transmitted through shaft E, to the worms above each axle which are shown greatly exaggerated in Figure 179.

It will be noticed that this shaft is provided with two universal joints F, one on each side of the gear case, to prevent any twisting or misalignment of the worm due to distortion of the frame in passing over rough ground. There is also another universal joint in each worm, details of which can be studied in Figure 180. This

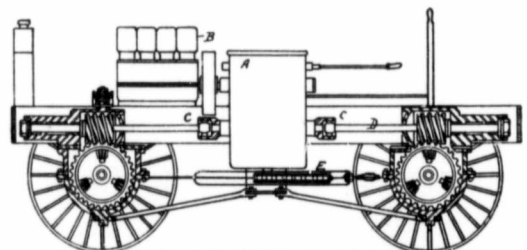

Fig. 179. Sectional view showing worm and worm wheel—worm greatly exaggerated.

figure shows the details of the axle and differential. The former is of the semi-floating type used widely in motor trucks and automobiles. Both front and rear axles are identical. The differential is of the bevel gear, bevel pinion type commonly used except that the outer rim is a worm gear instead of a spr gear as in more familiar types. The details of both worm and worm wheel

out for heavy traction service nor how it will compare with spur gear transmission as to wearing qualities. These are questions that can be answered only after long work in the field.

The high cost of horses and their high cost of maintenance have combined to turn the attention not only of threshermen but of farmers generally to mechan-



Ahead of the Procession

If you could look over Western Canada you could see, dotting the country, International Harvester oil tractors at work in the fields of many farmers, furnishing them with an abundance of economical power, pulling plows and other field machines, threshing, hauling, hulling, road-making. There are many hundreds of them, even now in the early years of the efficient I H C tractor. The men who own these tractors are the biggest money

makers. They are always on the alert for the most profitable methods. They are leading the others. They are "ahead of the procession."

The public is just awakening to the possibilities of tractor over horse use, and yet experts see that the oil tractor is coming into common use on the farm as surely as they once saw the binder come.

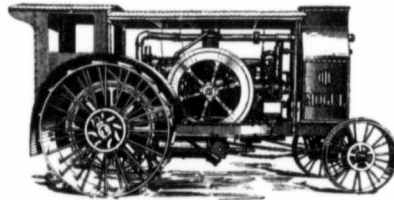

International Harvester Oil Tractors Mogul and Titan

are made in 6-12 to 30-60 horse power sizes, operating on low or high grade fuel oils, easy to operate, simple and powerful in engine and transmission—and they have International Harvester standards to back them.

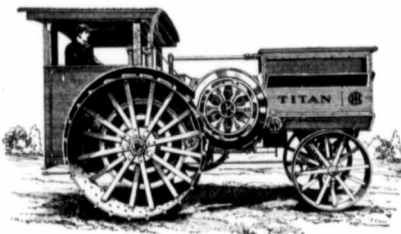

It is a safe guess that an International Harvester tractor would mean more money and greater farming satisfaction for you. This is a matter that cannot be passed by without a serious investigation if you are farming seriously. Write to the nearest branch house for facts and full information. Learn where you may see I H C tractors demonstrated.

International Harvester Company of Canada, Limited

WESTERN BRANCH HOUSES AT:

Brandon, Man.; Calgary, Alta.; Edmonton, Alta.; Estevan, Sask.;
Lethbridge, Alta.; North Battleford, Sask.; Regina, Sask.;
Saskatoon, Sask.; Winnipeg, Man.; Yorkton, Sask.



The Price of Wheat

There is a matter which every farmer who expects to have wheat to sell should take up immediately, and that is the financing of his crop. Our neighbors to the south have an enormous crop of winter wheat, and while their crop of spring wheat is apparently damaged to some extent by black rust, the outlook at the present time is for a crop of something like nine hundred millions. Russia will probably have eight hundred and fifty millions, or possibly even more, and many of the Continental countries have good crops. The enormous American crop and the fact that already a very large amount of it has been sold for export, makes the outlook for anything like profitable wheat prices very gloomy at the present time. Before a bushel of Canadian western wheat can move the chances are that every market in Great Britain and Europe will be filled with American wheat. Already prices are very low for our October, running from 14 cents to 15 cents below the October price at the same date last year. The Agricultural Commission figured the average price of wheat to the farmer in Saskatchewan last year at 67 cents. If present indications prove correct, the prices this year will be not more than 57 cents, in which there is absolutely no money, if there is not a direct loss.

The suggestion I wish to make is that every farmer who can possibly arrange to do so hold his wheat until January or February. There is much truth in the old saying "Beware of the tail end of a big crop, because it has no tail," and it is quite possible that the American crop may prove considerably less than estimated. Again, there is a good deal of talk, and apparently with some basis for it, of the winter wheat being of poor milling quality. It will take the British and Continental millers some time to find this out. If there is serious black rust in their spring wheat crop, its milling quality will also be affected, and by the time January and February come round, there is a reasonable hope for a fairly active demand for our wheat at materially improved prices. These higher prices should go into the pockets of the farmers, and not into the pockets of the dealers.

Banks are well supplied with money, and if approached carefully and well in advance of requirements, there should not be very much difficulty for the man who requires money as soon as his crop is harvested in securing it at a reasonable rate, to warrant his holding his crop rather than selling it. This is a matter which farmers should take up immediately.

Another matter which should be dealt with before harvest actually begins is the question of storage. Many farms are actually without storage, and, of course,



A man who can make a price in wheat. Seager Wheeler and his crop.

some men are so placed that they cannot afford to buy lumber to put up granaries, or buy the metal granaries all ready to put up. These men, of course, will have to sell as soon as they thresh, but with care and the expenditure of a good deal of work and a small amount of money it is surprising how much storage can be provided on the farms. There is no time to be lost, however, and the farmer who does not wish to take 57 or 60 cents a bushel for his wheat should immediately get busy, see his banker and arrange for a line of credit, and concentrate all his energies on providing storage for his crop.

Public Abattoirs

Last month something was said about the heavy increase in hog shipments and the need of looking out for the future in the way of packing houses and abattoirs. In Saskatchewan, where co-operation is already well under

way, the co-operative packing house seems the most reasonable solution of the difficulty. In Manitoba, there should be a movement on foot for co-operative packing plants at some of the centres other than Winnipeg, but in Winnipeg the Government is pledged to a public abattoir and packing plant, and has the ground for the erection of such buildings in connection with the Union Stock Yards. It is four years since the Act was passed and the public abattoir promised, but so far nothing has been done towards its erection. The Govern-

ment farmers in their own interest should get busy.

The Live Stock Contract

The Railway Commission is once more considering the live stock shippers' contract, which has been hanging fire for considerably over two years. It is understood that they have asked the railway companies for proof of the value of the average animal shipped, in order to decide on a minimum and maximum value for animals killed. Those who have been negotiating for the live stock shippers have wanted the minimum fixed at not less than eighty dollars. The railways are anxious for a contract with a maximum of not more than sixty dollars, and will bring every possible influence to bear on the Railway Commission to fix the maximum as low as possible. Not only the actual men who are shipping live stock, but every farmer who is raising a steer for sale is interested in this matter, and it would be a very wise move for the farmers of any given district which ships, say a train-load a week during the season, to get together and bombard the Railway Commission with facts and figures relative to the value of the cattle shipped from their district. There cannot be too much of this kind of information sent to the Commission. It would be a very excellent thing if statements of this kind went through the local grain growers' associations. The Railway Commission has come to associate the grain growers' organizations with the idea of farmers who mean business, and any information sent in through an organized body, such as the local association, has just that much more chance of consideration. The matter is a very important one, because after the long delay, when the live stock shippers' contract is decided on now, it will be likely to remain law for a long time without change. It is unfortunate that the Railway Commission have taken it up again just at a time when farmers are so busy with their crops, but the shipment of live stock is really relatively more important to the western farmer than the shipment of his wheat; in fact, the great bulk of the grain he raises on his farm should be shipped in the

Continued on page 26

Do Right By The Farmer

"The Man Behind the Gun"

Only in the Red River Special.

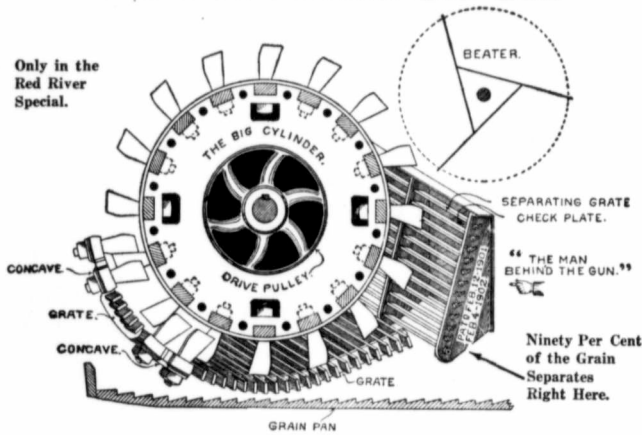

Patented in the United States and Canada.

Flaxcombe, Saskatchewan, October 17, 1913.
I don't think my new 44 x 64 Red River Special separator can be beat. I got on more days than any other machine in this district in the same time, and threshed two days while three other outfits were idle on account of rain. When we were in flax it was the talk of the district. My machine is in as good shape to-day as the day it left Regina, having run 21 full days.
A. F. WADE.

Carroll, Manitoba, March 19, 1914.
Last fall I purchased one of your Red River Special separators. This machine gave me entire satisfaction. For fast threshing and good work in all conditions of grain I recommend the Red River Special separator to anyone in need of a machine.
JAS. I. MOFFATT.

He is going to hire you to do his threshing.
He wants a good job.
He wants his grain saved.
He knows you can do it with a Red River Special.
He knows the reason why. He knows it BEATS OUT THE GRAIN.
He knows others do not. He knows it has that wonderful command Check Plate, the Beating Shakers, and the Graduated Cylinder, the "Man Behind the Gun," the Separating Grate and Check Plate, the Beating Shakers, and the Graduated Adjustable Chaffer.
He is looking and longing for you to come down the road with a Red River Special.
DO RIGHT BY HIM.

We have thousands of testimonials like the following:

Fisher, Minnesota, October 19, 1913.
This fall Mr. Olaf Larson, of Fisher, Minn., threshed our grain with a 36 x 56 Red River Special and attachments. It saved our grain and it saved our time. It ran steadily and all the time. We believe the Red River Special is as near to a perfect grain saver as it is possible to build. From its construction and its method of handling the grain and straw after it leaves the cylinder it does not seem possible that even a single kernel can escape with the straw. We want a Red River Special to do our work next year.

JOSEF M. HEGGE,
HENRY SVENUNGSON,
HANS HELGESON,
MARTIN BERG,
JOHN STALENN,
OLE KNUFSON,
HALVOR PETERSON,
CHR. PETERSON.

Amanda, North Dakota, October 17, 1913.
The 32 x 52 Red River Special separator we bought of you in 1912 works fine. It is the best cleaner and grain saver we ever saw.
We believe the reason your separator saves the grain better than other makes of machines is that it separates the grain from the straw by force.
We have more threshing than we can do. The farmers come for miles around and insist that we shall do their threshing. If we were in the market for twenty machines, they would all be Red River Specials.

CHRIST L. OLSON,
MIKE IRMEN,
LUDWIG ENGELSTAD.

NOTE CAREFULLY THE FOLLOWING ILLUSTRATIONS:

THE MAN BEHIND THE GUN PATENTED IN U.S. FEB. 11 - 1901
PATENTED IN CANADA OCT. 23 - 1901



This is the way to Separate by hand with a pitchfork

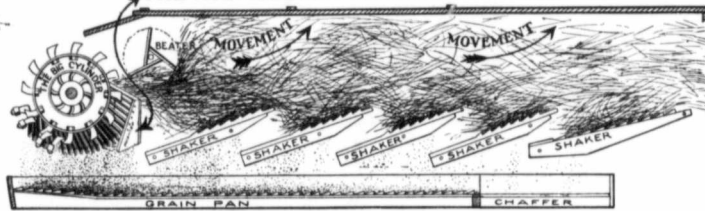

This is the way the RED RIVER SPECIAL Separates
IT BEATS IT OUT - like you do with a pitchfork



This is the way the Lazy Man tries to Separate with a pitchfork

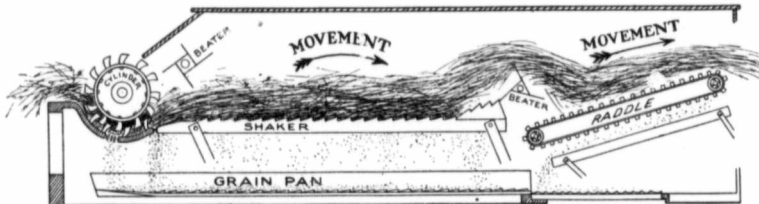

This is the way OTHER KINDS try to separate
THEY DON'T BEAT OUT THE GRAIN

Send for free Catalog and Thresher Facts.

NICHOLS & SHEPARD COMPANY, Battle Creek, Michigan

In continuous business since 1848

Builders of the Red River Special Threshers, Traction Steam Engines, Oil-Gas Tractors, Stackers, Feeders, etc.
Branch Houses with Repairs and Stocks of Machinery at WINNIPEG, MAN., and REGINA, SASK.

You saw this advertisement in this magazine. Don't forget to say so when writing.

Birds And Their Relation To Agriculture

By HOPKINS MOORHOUSE

THERE is one crop in Manitoba which is not included in the government statistics. In fact it is very doubtful if the average farmer is aware of it at all, even though his farm is producing tons of it. No less than 1,974 million pounds or 987,000 tons of it are harvested every summer.

This crop is about the meanest that could be imagined—a concentrated agricultural menace. It consists of bugs and slugs; caterpillars in the egg as well as on the leg; weed seeds that are noxious and obnoxious; gnats and rats, mice and lice and some gophers. The harvesting of it

more, they are based on the area of Manitoba before the boundaries of the province were extended. Forty-seven million acres about covers it and it is generally conceded that an average of three is a low estimate, double that being more nearly correct. Each bird uses at least one and a half ounces of food per day, equaling for the season over fourteen pounds per bird.

It is an amazing thing that the place which our birds hold in the general scheme of things is not more generally appreciated by our farmers. To the average man birds are just birds; they have wings and fly about and twitter or chirp or sing or screech; some of them are pretty to look at and he likes to have them around. They are a part of his outdoors—a part which he accepts in the same large way that he accepts

nigh impossible. The importance of this being thoroughly understood rests on the fact that once the birds have been driven from any locality they never return to it.

The reason for this is that in their migration birds fly at night and about two miles high. Consequently they do not alight to look up new homes. This is illustrated by the swallow, the humming bird, the king bird, etc. Or perhaps it is a robin which you remember used to return each year to the vicinity of your home—the same robins.

The migration of the birds takes place from about the first of August till the end of September. It is a wonderful flight they take and while the flock is assembling just prior to the long winging southward it is frequently possible to see them congregating.

The answer is that the percentage of increase is lost in migration and that without the natural increase during the season the death-toll of the migration periods would soon exterminate the little travellers.

For the migration trip is indeed a hazardous one. Most of the



Flicker. A bird to which an ant-hill is a picnic ground.

Manitoba birds came into the country by way of the Atlantic



Barn swallow. A valuable bird now finding a home in Manitoba in increasing numbers.

In Manitoba, no less than 987,000 tons of "trouble crop", viz: bugs and slugs; caterpillars in the egg as well as on the leg; weed seeds, rats, mice, lice, gophers, etc. are assimilated in the stomachs of these friends of the farmer every Summer. These figures are not mere guesses but careful estimates by experts and very conservative estimates at that. No sensible farmer will kill a bird till he knows whether it is a friend or a foe.

extends over a period of 150 days and the whole 987,000 tons of it is cleaned up by a huge army of happy and industrious workers—the birds. There are in Manitoba during the summer season over 141 million birds.

Think of it! Nearly a million tons of trouble crop assimilated every season in the stomachs of these friends of the farmer.

And to all this must be added the good work of the forty-three varieties of birds which remain with us when the cold weather sets in or migrate from farther north to spend the winter with us; for these winter birds live almost continuously on weed seeds, of which they consume an unbelievable quantity.

The figures above given are not mere guesses, but careful estimates by experts, very conservative estimates at that. Further-

the earth and the sky, sunshine, wind and rain. Talk pigs, sheep, cattle, horses, poultry, fodder and grain crops and the conversation will fairly clink with money values; but mention birds and the average man will at once classify you as some kind of an "ologist," a bug-hunter, a collector of specimens, and fidget to drive on.

Yet if there is one subject which deserves serious consideration from the standpoint of dollars and cents loss and gain, it is the subject of birds and their protection. For here we have a finger on the factor that keeps Nature in balance. Scarcity of bird life means insect epidemics—outbreaks of worm, fly, caterpillar and gopher. Without the protection afforded the farmer by the vigilant army of birds that is constantly working in his behalf, profitable farming would be well

Some day when you go outdoors to find the fields or woodlands literally alive with birds you will know that they are gathering for the trip. It is a long journey and one fraught with many dangers to the travellers, many of whom are destined never to reach the journey's end.

In these dangers of the far-flung air passages we find the answer to the very natural query: If there are 141 million birds in Manitoba and the seventy pairs of them produce from six to twelve of a family during the season, why will there not be a great increase in the number of birds returning to us next year?

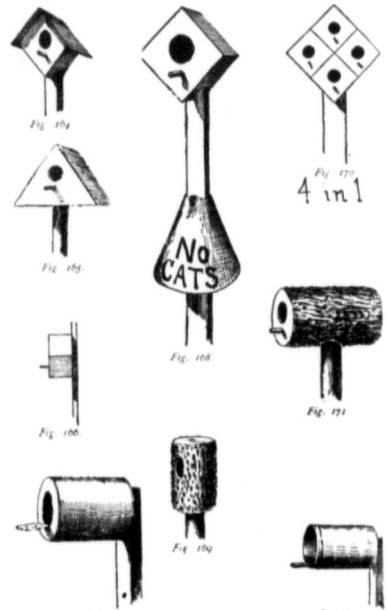

Protect the Birds

coast and in leaving the country they return by the same route. The clouds of the tiny creatures, two miles in the air, are often struck by severe storms along the coast line which they follow. It must be remembered that these little fellows who are not in the habit of oiling their wings like the wild ducks and geese and who have not the strength of these larger birds—these little chaos are in dire distress when they are

T
1.
2.
more
3.
fertili
4.
feedin
hance
ity is
tural
prosp
prosp
5.
nor la
witho
of liv
6.
farm
mone;
7.
dense
walk
point;
marke
realiz
any o
8.
mand;
slaugh
9.
now
prices
first a
the gr
herds

What You Have Waited For and Wanted—

THE STRITE TRACTOR

The all purpose farm tractor has been announced on several occasions, but when it appeared it did not fill the bill. The STRITE TRACTOR, however, after many years of trial and experiment comes to the farmer as a rare all purpose farm tractor, meeting every farm power requirement.

The STRITE TRACTOR can be operated more conveniently and economically than a team of horses. It weighs only 3700 lbs., and does the work of ten or twelve good draft horses. The STRITE TRACTOR will pull three 14-in. stubble plows, 6 to 10 inches deep, depending on the condition of the soil; also binders, mowing machines, grain drills, corn cultivators and manure spreaders, and will also handle small threshing machines and ensilage cutters on the belt.

The STRITE TRACTOR is the most simplified, accessible tractor designed, with all parts standardized and interchangeable. Has three speed selective type, sliding gear transmission, with steel machine cut, bone hardened gears running into a continuous oil bath. All bearings in the



STRITE TRACTOR are of the Hyatt high duty type roller bearings, and bantam anti-thrust bearings, eliminating every ounce of skin friction possible—a construction not to be

found in any other tractor. A tractor without a soft metal bearing. A high duty, low speed motor, with governor enclosed. High tension magneto and circulating pump driven

from same shaft, with cylinders cast in pairs. Equipped with gasoline-kerosene carburetor. One wheel drive, eliminating excessive weight and troublesome differentials. Adjustable spring mounted front axle, which can be adjusted to various conditions, for plowing, handling binders, road work, pulling direct in a line of center draft.

Why You Should Buy a STRITE TRACTOR!

You get more for your money. It plows more ground with less fuel than any other tractor built. Costs less to own, less to operate and maintain. Turns as short as horses and plows. Can be shipped as local freight in box car. You can use your sulky and triple gang plows, and all your standard farm tools. No special equipment to buy. Does not pack the soil. Does all the work of the stationary engine on the belt. Handles the ensilage cutter, silo filler, small threshing machine, etc. Expense is stopped when you pull the switch.

For further information write

BURRIDGE COOPER CO. LIMITED

WINNIPEG and REGINA

You saw this advertisement in this magazine. Don't forget to say so when writing.

Twelve Reasons for More Live Stock

1. Because it will pay.
2. Because the country needs more meat.
3. Because the soil needs more fertilizer.
4. Because the raising and feeding of live stock on farms enhances soil fertility. Soil fertility is the foundation of agricultural prosperity, and agricultural prosperity is the basis of general prosperity.
5. Because neither corn prices nor land values can be maintained without the raising and feeding of live stock on farms.
6. Because live stock utilizes farm waste and turns it into money.
7. Because live stock condenses values on the farm; can walk to the market or shipping point; can be transported and marketed at less expense; and realizes greater net returns than any other farm products.
8. Because the market demands younger animals for slaughter.
9. Because pure bred stock is now selling at relatively low prices, and those who stock up first and stay in longest will reap the greatest rewards in improved herds and more profitable returns.

10. Because association with domestic animals on the farm is essential to the right development of the character and practical knowledge and ability of children.

11. Because the presence of live stock inspires a love for the farm, and tends to prevent desertion of the farm for the city.

12. Because it is every farmer's sacred duty to leave his farm in at least as good condition as when he found it, for use by future generations.

Cow Testing Pays

There can be no question as to the bright light shed by dairy records on the actual performance of herds and of individual cows. They are useful alike in proving the superiority of certain cows as well as the effect of good dairy practice.

The value of a pure bred dairy sire is also revealed when comparing herds. One herd of 14 cows gave 306 pounds of fat in a month. In an adjoining herd of 14, where cow testing has been carried on for four years and where the sire is pure bred, the yield was 556 pounds of fat, in other words the income was seventy-five dollars more for that one month.

Be sure you take up cow testing this year, because it pays well.

MOGUL ENGINE PLOWS

4-5-6-8
10 and 12
FURROW

403

When you get ready to buy Engine Plows don't forget that the Mogul has the following features: Individual levers for controlling the bottoms. Cone bearings in head blocks to take up all looseness due to wear. Large gauge wheels that will not clog. Pin break. Close and easy adjustment of suction, alignment, etc. Spacing blocks between beams to insure even furrows. Strong rigid frame. Large platform. And, most important of all for efficient work, perfect bottoms made in our own factory for our own plows, under the most rigid inspection.

We also build the Mogul Power Lift Engine Plow in 4, 5 and 6-furrow sizes. Write for catalog describing the most complete line of Engine Plows on the market.

Made by
PARLIN & ORENDORFF CO., Canton, Ill., U.S.A.

INTERNATIONAL HARVESTER CO. OF CANADA,
LIMITED, SALES AGENTS FOR CANADA

Winnipeg Brandon Regina	Saskatoon Yorkton North Battleford Estevan	Calgary Edmonton Lethbridge
-------------------------------	-----------------------------------------------------	-----------------------------------

You saw this advertisement in this magazine. Don't forget to say so when writing.

buffeted and tossed on the gusts of a bad storm. Their feathers quickly become wet and tangled and down they go like a stone into the ocean—thousands, millions of them. Sometimes even the larger water birds are overcome and on the Pacific coast after a bad storm, so many coots (commonly called mud-hens) have been killed that their battered remains, washed in by the tides, literally strew the shore.

The necessity, therefore, of every effort being made to protect and assist our birds must be apparent, if we would have them continue with us from year to year in satisfactory numbers.

The species of birds found in Manitoba are about the same as in Ontario. While there are a few Ontario birds not found here, Manitoba in turn possesses some which do not frequent the province to the East. Many fine songsters might be mentioned, such as the rose-breasted grosbeak, the catbird, the thrushes, robins, Baltimore orioles, the vireos, bobolink, etc. It is from the standpoint of their economic value, however, that they deserve the serious consideration of farmer and urban dweller alike.

Many birds will eat twice the equivalent of their own weight per day. A young robin, almost fully fledged will weigh about three ounces, but will eat 165 cut-worms, weighing 5½ ounces. One reason birds are such great feeders is that they maintain a higher temperature than any other creature. While the temperature of animals will run from eighty-eight to one hundred, that of birds will run to 112. Cold blooded animals such as snakes and turtles have a temperature as low as forty. The reason for the higher temperature of the birds is not only the energy required for flight, but the heat necessary to incubate their eggs. The requisite heat can only be maintained by the consumption of much food.

The rose-breasted grosbeak has been known to nest convenient to a quarter-acre plot of potatoes in order to live on potato bugs. Professor Frobisher, the well-known investigator of bird life, tells of one family which he watched line up on the fence—the young of one nest. A few days afterwards the entire crop of bugs had been fed by the old birds to the young gluttons on the fence. Bobolinks are found nesting near clover fields in order that they may be handy to a supply of the caterpillar which is the product of the clover-leaf moth.

Most birds will take over one hundred insects per day to feed their young. Chickadees will eat from 200 to 500 insects per day. The black-billed cuckoo is

very fond of caterpillars, so much so, that the hairs of the caterpillar perforate the bird's stomach till the stomach has the appearance of being covered with hair on the outside. This does not seem to interfere with digestion, however, or to rob the titbit of its savor.

Chester A. Reed gives the startling figure of 21,000 bushels of insects consumed per day in the small state of Massachusetts. Manitoba's figure on the same basis would be five times this quantity or 105,000 bushels per day. The following data is given by the Biology Department of the Manitoba Agricultural College:

Insectivorous Birds

Robins—Worms and caterpillars, 5 ozs. per day.

Meadowlarks — Cutworms, ground beetles and grasshoppers.

Oriole—Tree insects, leaf insects, click beetles.

Swallows—Flies, moths, mosquitoes. Flicker — Ants, grasshoppers, beetles. Its weight per day, 1,000 inch bugs found in one stomach.

Nighthawk and Whip-poor-Will — Insect eggs, May beetles, leaf beetles and night-moths.

Fly Catchers, Phoebe and Pewee—Flies, grain and clover weevils, vine curculions. Chickadee—Insect eggs. 1,028 in crops of 4 chickadees.

Mice and Gopher Catchers

Thousands of stomachs have been examined by Fisher, King & Beal in New York State with the following results:

Red-Shoulder Hawks—Of 220 stomachs examined, less than 2 per cent contained poultry.

Broad-Winged Hawks—Of 65 examined, no trace of poultry.

Sparrow Hawks—Of 320 examined, no trace of poultry; but 101 mice, 244 insects, 52 birds, 12 reptiles.

Marsh Hawks—Of 124 examined, only 7 contained poultry, and 79 contained mice.

It would thus appear that the general idea that hawks and owls are wholesale poultry eaters is a fallacy. The great-horned owl, or cat owl, is the only one which attacks poultry, all others being great destroyers of rodents during their nightly prowlings. Of the hawks, only the sharp-skinned, cooper's, pigeon and goshawk attack poultry. Small nibbling animals such as mice, rats, ground squirrels, gophers, etc., would increase very rapidly were they not kept in check by the hawks by day and the owls by night.

Trees are protected from wood ants, bark borers and leaf-eating insects by the woodpeckers, vireos and other tree birds. These birds attack the cocoons of the insects, hidden under crevices of the bark. The yellow-bellied sap-sucker is the only woodpecker who can be said to harm trees. Down in Ontario the elms of some districts have been entirely destroyed by the forest tent caterpillar. Why? Because of sparrow-shooting contests in those districts. With the birds killed off or frightened away from the neighborhood, the trees soon succumbed to the unopposed attack of the caterpillars.

THRESHERS' SUPPLIES. Make \$1 do the work of \$2.

We save you money on high grade threshers' supplies, as our Prices are based on the actual manufacturing cost, every article guaranteed to be first class.

ENDLESS STITCHED BELTS

T 10. Our "Reliable" Belts are the heaviest and most durable offered. They are made on full weight 32-oz. duck. They are filled with pure linseed oil, pressed with the new and improved hydraulic machine process, making the belt exceptionally pliable and durable. They are impervious to heat, cold, steam, gas or acid fumes. All belts will stretch some. The "Reliable" will stretch but little. It is made on a special weave of duck of proper width for each size belt, giving a proper salvage and even strain on both edges. You will find our "Reliable" Drive Belts the best and most durable and pliable you ever used.



100 ft., 7 in. x 4-ply ...	\$26.00	120 ft., 7 in. x 5-ply ...	29.50	150 ft., 7 in. x 4-ply ...	39.50
100 ft., 7 in. x 5-ply ...	32.00	120 ft., 7 in. x 5-ply ...	37.50	150 ft., 7 in. x 5-ply ...	45.50
100 ft., 8 in. x 4-ply ...	30.00	120 ft., 8 in. x 4-ply ...	35.00	150 ft., 8 in. x 4-ply ...	43.00
100 ft., 8 in. x 5-ply ...	38.00	120 ft., 8 in. x 5-ply ...	42.50	150 ft., 8 in. x 5-ply ...	49.50

TANK PUMPS AND OUTFITS

No other style low-down pump has stood the tests of time like this one. It has the greatest strength. Is the SIMPLEST, and handles more water with less labor than any other low-down pump. Can be successfully used for filling threshing tanks, washing out boilers, for use in shallow stock wells, draining cellars or irrigation purposes.

T 31.—Price complete as shown in cut and including 2-in. round self-fastening strainer, nozzle and hose band. Weight 95 lbs. Price \$5.50

T 40—20-FT. "STANDARD" OUTFIT Consisting of Low-Down Tank Pump, T 31, complete, with hose bands and strainer. 20 ft. 2-in wire-lined "Standard" Suction Hose, 10 ft. 1-in. 3-ply "Queen" Discharge Hose. Complete outfit (Weight 140 lbs.) Price \$12.65

T 41—25-FT. "STANDARD" OUTFIT Consisting of Low-Down Tank Pump, T 31, complete, with hose bands and strainer. 25 ft. 2-in. wire-lined "Standard" Suction Hose, 10 ft. 1-in. 3-ply Discharge Hose. Complete outfit (Weight 150 lbs.) Price \$13.40

T 42—20-FT. "YELLOW JACKET" OUTFIT Consisting of Low-Down Tank Pump, T 31, complete, with hose bands and strainer. 25 ft. 2-in. "Yellow Jacket" Suction Hose, 10 ft. 1-in. 4-ply Discharge Hose. Complete Outfit (Weight 160 lbs.) Price \$17.00

T 43—15-FT. "YELLOW JACKET" OUTFIT Consisting of Low-Down Tank Pump, T 31, complete, with hose bands and strainer. 15 ft. 2-in. "Yellow Jacket" Suction Hose, 15 ft. 1-in. 4-ply Discharge Hose. Complete Outfit. Price \$20.00



OILS, LUBRICANTS AND AXLE GREASE

Threshermen and Farmers desiring high-grade lubricating oils will profit by sending us a trial order. We make a specialty of this line and are handling the very best oils that can be compounded at the lowest known prices; cylinder oil, castor machine oil, harvester oil, gasoline engine oil, thresher hard oil. Get our prices on steel barrels and all other lines of threshers' supplies. Catalog free on request.

C. S. JUDSON Co. LTD.

181 Market Street, Winnipeg, Man.

"FLOUR CITY" TRACTORS

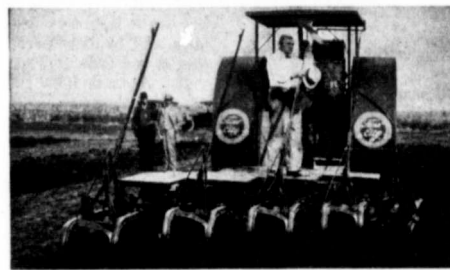

A Successful Tractor

The two essentials in a successful farm tractor are staunch construction and plenty of power. One without the other will result in failure. Combine these with a design that eliminates superfluous weight without sacrificing strength and you have the main features that are embodied in the design of the "FLOUR CITY."

Add to this our even balanced four cylinder motor and simplified bevel gear transmission, and you have the main points which have contributed to the success of the "FLOUR CITY" and made it the most popular tractor in the field to-day.

The "FLOUR CITY" is manufactured in small as well as large types, 15, 20, 30 and 40 H.P. represents respectively the draw bar power of the four sizes we manufacture. Our new Booklet of Testimonials will be sent on request. It is the best evidence you can get.

Canadian Branch: 828 44th Ave. N., Saskatoon, Sask.

KINNARD-HAINES CO. MINNEAPOLIS, MINN.

It
mann
vided
balan
divid
each s
to the
which
woodj
for di
grubs
snowt
cos, i
grosb
short,
crunch
main
birds
seeds,
differ
the co
untold
The
fore of
tural
mated
State
of we
includ
white-
the w
which
gether
same f
weed s
of a si
other.
birds t
1,500 v
It will
that th

COCKSHUTT

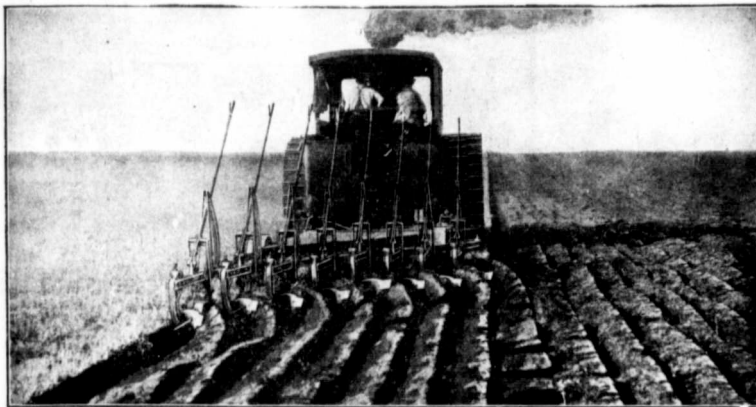

ENGINE GANG PLOWS

Scrub Breaker, Mould-board, or Disc Types

The Cockshutt factory designed and produced the first successful Tractor Plow. We set the pace and have always maintained our lead—largely because the experience gained in long years of experimental work enables us to build plows that meet every plowing condition. In buying a Cockshutt you buy an equipment that is suited to your land—one that will do YOUR work just as you want it done.

Cockshutt Mouldboard Plows are built in two styles, a Hand-Lever style like illustration, and an automatic Power-Lift style. The former

comes in sizes of 5 to 12 furrows, the latter in 5, 6, 8 and 10 furrow sizes. Both can be equipped with either Breaker or Stubble bottoms. We have lately perfected a new Engine Disc Plow and also a heavy Scrub Breaker. Illustrations and description of any style will be cheerfully mailed you upon request. If you are interested in Power Farming you should read our booklet entitled "Horseless Plowing." Send for a copy to-day.

COCKSHUTT PLOW CO. LIMITED

WINNIPEG

REGINA

CALGARY

SASKATOON

DISTRIBUTING WAREHOUSES:

BRANDON

PORTAGE LA PRAIRIE

RED DEER

LETHBRIDGE

EDMONTON

You saw this advertisement in this magazine. Don't forget to say so when writing.

It is interesting to note the manner in which Nature has provided for everything to work in balance. Each bird has his individual habits and tastes, and each species is equipped according to their haunts and the food on which they subsist. Thus the woodpecker has a long sharp bill for digging out the burrowing grubs, while the sparrows, the snowbirds, the buntings and juncos, the red polls and finches, grosbecks and waxwings have short, stout bills in which to crunch the seeds forming their main article of diet. Our winter birds live principally on weed seeds, and there are forty-three different varieties with us during the cold weather. They destroy untold quantities of weeds.

The weed-seed eaters are therefore of great value to any agricultural country. It has been estimated that the sparrows of the State of Iowa consume 875 tons of weed seeds each winter; this includes the tree sparrow, the white-throat, the song sparrow and the white-crown sparrow, all of which are found in Manitoba, together with fourteen others of the same family. No less than 7,500 weed seeds were found in the crop of a single dove and 4,016 in another. The crops of the snowbirds usually contain from 500 to 1,500 weed seeds when examined. It will be seen at once, therefore, that these birds are entitled to the

friendship and protection of every farmer.

In fact, there are very few birds indeed which should not be looked upon kindly. Perhaps the most outstanding exception is the cow bird, or cow blackbird. We have the little swashbuckler right here in Manitoba. She is that little gray bird that follows cattle in flocks of from three to seven, alighting on their horns or their backs or snooping about in the grass around them while the cattle are feeding. The bird will hang around horses in the same manner. Professor McCoon, on one of his geological surveys for the Dominion Government, found that a pair of these birds took up with the party in the neighborhood of Manitou, Manitoba, and accompanied them all the way to Edmonton, Alberta. They followed the horses all day, sleeping on the animal's back each night. They used the flies around the horses for their food.

Beyond being useful where the horn fly is a nuisance, however, the cow bird is an enemy. The "female of the species is more deadly than the male," though it is hard to say whether hubby is responsible or not for the shabby trick she plays on the other birds. At any rate, the female Cow Bird is a deserter, a shirker of responsibilities. She lays her eggs on other birds' doorsteps and never comes back to take any interest in the

fate of the baby cow birds.

It is this habit of depositing her eggs in other birds' nests that renders the cow bird a menace. Many of the kind, industrious and decent-living birds bring forth several families during a season when they are not handicapped by the cow bird intruder; in the latter case it keeps them busy, long after their own offspring are earning a living for themselves, feeding the never-satisfied young founding that has been foisted upon them. So busy are they kept that further families for that season are out of the question. In short, to raise one cow bird costs the lives of from six to twelve of our most useful birds.

It may be suggested that the birds ought to have enough sense to discard the intruding egg and refuse to be imposed upon. Sometimes this is exactly what happens. Mr. J. J. Golden relates the experience of a friend of his in Ontario in this connection. In a shrub close to this friend's house a pair of summer yellow warblers had built their nest, and one morning he awoke to a great uproar. The birds were very uneasy, he noted, flying away from the nest, then back to it, then away again; so he went outside to see what was the matter. A cow bird's egg in the nest was the cause of the rumpus. He decided to leave the egg where it was and see what would happen.



The Right Lads for Farm Life

are being sent out by the Bisco Farm and Shaftesbury Homes in the county of Surrey, England, and the Twickenham Home, Middlesex.

Their Majesties the King and Queen

are patrons and the Earl of Jersey, G.C.M.G., is president of the Society of which he above named homes are units specially equipped for the training of lads for farm life.

The work of the Society is an imperial one and for many years it has been supplying lads of excellent character and physique to the farms of the Dominion. About 1,000 are now settled at various points in Canada.

Mr. H. G. Copeland, the Secretary, who has recently been on a tour through Canada, will be glad to receive donations towards the Society's work at the headquarters, 164 Shaftesbury Avenue, London, England, or they may be sent to the editor of this paper.

You cannot interest yourself in a more worthy institution.

Paint Your Engines with CARBON BLACK ELASTIC PAINT

It is a Weatherproof
Bright Glossy Black
80c. per Gallon

Buy direct from
SHINGLE STAINS & SPECIALTIES
LIMITED
66 KING ST. WINNIPEG

The little birds continued their display of annoyance for some time and finally covered the nest by building another one on top of it. No sooner was this second nest complete than along came the cow bird again and repeated the trick. Nothing daunted, the birds started to work and actually built a third nest on top of the second, again covering the offensive egg from sight. In this third nest they reared their own family.

In Ontario the cow bird has grown so numerous that many of the most useful small birds have become practically extinct, a situation bound to prove of grave injury.

A movement is on foot in the East for the better protection of birds, and in October last the Canadian Society for the Protection of Birds was formed in Toronto under the patronage of the provincial departments of Education, Agriculture and Game and Fisheries, and the Faculty of Forestry at Toronto University. The first endeavor of this organization was to interest the Boy Scouts and the result has been that the youth of the province are taking a new interest in bird life. The society delivers lectures free of charge in any community where a fair attendance can be promised. The pledge that is signed by all members and associate members reads as follows:

"We, whose names are hereunder subscribed, having become Members or Associate Members of the Canadian Society for the Protection of Birds, hereby pledge ourselves to refrain from injuring or destroying any wild birds, their eggs or nests, and to prevent, as far as possible, others doing so, and to encourage the study of birds and of nature.

"Provided always that nothing in this pledge shall apply to shooting or taking of game birds, or wild fowl by legitimate means."

There is already in Manitoba a Game and Bird Protective Association whose members take a keen interest in bird protection. The subject also comes in for the careful attention of the Extension Department of the Manitoba Agricultural College in the annual demonstration train programmes and the nature studies of the Normal classes.

Ornithology has come in for close study by several enthusiasts in Manitoba, among whom might be mentioned Mr. Norman Criddle, of Treesbank, Manitoba; Dr. Speechly, of Manitou; Principal Hales, of the Normal School at Brandon; Mr. Jackson, Lecturer, Biology Department, Manitoba Agricultural College, and Mr. J. J. Golden, Supt. of Immigration for Manitoba. The latter gentleman is conceded to be an authority on Manitoba botany and has devoted considerable attention to bird study. He has given many interesting talks on birds at schools of all kinds throughout the pro-

vince and at many agricultural society meetings.

Discussing the subject of bird protection with the writer, Mr. Golden suggested that the surest method of getting the younger generation to value and protect the birds would be the setting apart of field days during the summer, the school teachers taking the children into the fields and woodlands to see the birds in their haunts, to learn their names, habits and usefulness. Mr. Golden thinks that those who know the birds will never see them harmed, but rather will provide means for them to nest; for the study of bird activities affords the keenest pleasure. If a system of questions could be adopted whereby the pupils asked the teacher formal questions regarding the life and habits of the birds, the teachers would be compelled to familiarize themselves with the subject. This, Mr. Golden believes, would prove a great incentive, and the knowledge of bird life would reach through the teacher to the children and through the children to their parents.

Certainly it is very important that a more general effort be made by the farmers to assist the birds and conserve their usefulness. Much can be done in the matter of affording nesting places. The greatest of all such, of course, is the shrub or tree, and in opening up a farm it is easy to leave clumps of trees where they may be found or even to set out wind-breaks and shelter belts to do double duty. It is also a simple matter to build a few bird houses; a can, box or hollow log nailed to a tall post will look like home to a family of birds. (See Figs. 167, 169, 172, 171, etc.)

Also it would be well to keep an eye on Pussy! Rambling cats are the greatest destroyers of bird life we have. Professor Frohisher says that in the State of Massachusetts alone cats destroy over two million birds annually. (Note the tin funnel inverted in Fig. 168—a cheap but effective method of preventing cats from climbing to the nest.) Protection against cats is becoming more necessary in Manitoba because the tamer birds are beginning to favor us with their presence in increasing numbers. No new country usually has the variety of birds which come in following settlement; there are many birds which like human companionship. The red headed woodpecker is a great chap for hanging around where people are. The barn swallow is another useful bird which is beginning to arrive in Manitoba, and the pretty bluebird is still another which might be mentioned as a settlement bird.

The destruction of birds is no

Here are EIGHT REASONS why the New Steel "HUMMING BIRD" is the

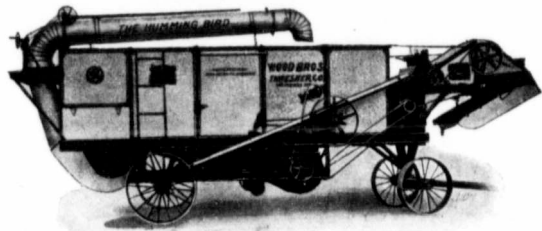

GLENER AMONG ALL THRESHERS

1. Steel construction means strength and rigidity
2. More perfect design and modern construction
3. Wind stacker is built on the frame of the machine
4. Absolute simplicity and no weak parts
5. Runs smooth and makes no noise
6. Does not throw the grain over
7. Cleans anything and everything thoroughly
8. Earns bigger profits and is a money maker every way

This is evolution in all things. The days of the old-fashioned wood-bult separator are fast fleeing. The "Humming Bird" is the outcome of more than a quarter of a century's experience in threshing machinery building. It is the work of the famous Wood Bros., of Des Moines, Iowa, and in every respect represents the very summit of construction known to modern methods of farming. Not until 1913 did the first "Humming Bird" make its appearance. Careful and severe tests proved this new creation to be the best ever. Its success was instantaneous. United States and Canadian threshermen are loud in their praises of the "Humming Bird" the GLENER AMONG ALL THRESHERS.

Threshermen should lose no time in becoming better acquainted with this wonderful separator. Write us to-day for further information. It will be gladly forwarded.

Not an Hour Lost with this Outfit in the Field
Write To-day for Free Illustrated Catalogue. Live Agents Wanted

The North American Machinery Co., Limited
WINNIPEG MAN.

You saw this advertisement in this magazine. Don't forget to say so when writing.

Make this Windmill Pump for You

Our Airmotor solves the farm pumping problem. It costs nothing for power, and only needs oiling once a month. Use it to pump water into one of our high tanks or steel pressure tanks. From the tank, run a set of water pipes to your house, carriage shed, stable and garden. In your stable, fit each stall with our Woodward Water Basin, so every cow, steer or horse will have lots of water. This means more milk, quicker fattening, or better condition of your team, and no work or loss of time for watering. Have handy hose attachments to wash carriages, stable floors, hog pens, etc., at the barn, also pipes to water lawn and garden. You produce more truck, yet save labor.

Write us for our Airmotor Catalogue—We sell everything you need. Get Airmotor, pumps, pipe fittings, water basins and stalls. You save wages, and do more and better work with these city conveniences at hand.

Ask us for Our Catalogue No. W.P.

Ontario Wind Engine & Pump Co., Ltd.
398 ATLANTIC AVENUE, TORONTO
Branches: Montreal, Winnipeg, Calgary

You saw this advertisement in this magazine. Don't forget to say so when writing.



THIS FIRE PUMP operated by our Airmotor, gives a steady stream for a hose to water your garden, or fills your elevated tank, or your Toronto Underground Pressure Tank. Pipe water all over your barn and house. Save work, time and trouble. We have many other kinds of pumps—also pipe, fittings, house and barn water specialties, all for farm use.

This Water Basin in each stall in your barn, always gives your animals water. They thrive better, and give you more profit.

less w
thought
friend I
body pi
harm is
to him
would
family t
potato c
worms i
—this o
killed.
you any
working
half all
creature
accordin
or shint
would t
calls, to
and see
to enter
and tra
entertain
lives. T
of it you
stead of
would b
of your

mowing
soon as t
ing, and
the mid
tender is
and a ha
mowing

The Old Way

Of Delivering the Sheaves from the Stook to the Feeder

6 stook teams @ \$5	\$30.00
4 pitchers @ \$3	12.00
Board of 10 men @ 50c	5.00
Board of 12 horses @ 25c	3.00
Trouble and expense in getting gang and keeping the same	5.00
Loss through not being able to keep machine fully supplied with sheaves	20.00
Total	\$75.00

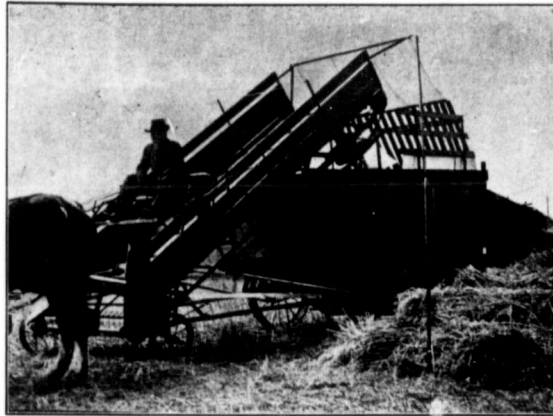

This shows machine delivering load, end door open and bottom released

This shows a load delivered

Jackson Combination Way

Of Delivering the Sheaves from the Stook to the Feeder

1 machine, 1 man and 4 horses	\$ 7.00
2 pitchers	6.00
Board for 4 horses @ 25c	1.00
Board for 3 men @ 50c	1.50
Total	\$16.50
A saving of \$59.50 per day.		
We also guarantee to save \$60 per day in grain, or a total of \$120 per day.		

NO STOOK TEAMS AND WAGONS REQUIRED. NO ARMY OF MEN AND TEAMS TO BOARD

The Jackson Combination is warranted to save more grain and do the work cheaper and better than can be done in any other known way, and will save the farmers'

threshing bill. This machine has solved the threshers' and farmers' labor troubles, and is a real blessing to the farmers' wives of Western Canada. If you are interested write to

The Jackson Combination Sheaf Loader and Carrier

BRANDON - - MANITOBA

You saw this advertisement in this magazine. Don't forget to say so when writing.

less wanton because due to thoughtlessness. After the little friend lies dead, his soft little body pitifully inert and warm, the harm is done and the work allotted to him unfinished. Perhaps he would have brought forth a family that would have saved the potato crop or eliminated the cut-worms from the vegetable garden—this one little bird that you have killed. Not only has he not done you any harm, but he has been working energetically in your behalf all the time—a friendly little creature, joyously living his best according to Nature's plan, rain or shine. How much better it would be to learn his song, his calls, to go with him to the nest and see mother and the children, to enter into the little comedies and tragedies that make up the entertaining story of the family's lives. The mystery and wonder of it would so absorb you that instead of being "only a bird" he would become an interesting part of your life.

Mixed Farming

Continued from page 12

mowing machine is started as soon as the dew is off in the morning, and kept going till noon or in the middle of the afternoon. The tedder is started about an hour and a half or two hours after the mowing machine; it shakes up the

swarth, opening it to the air and turning up the lower side. This operation may be done by the side delivery rake nearly as well as by the tedder, and it saves labor by making later raking unnecessary. If a heavy crop of alfalfa is left in the swarth without turning, the top will dry until the leaves fall off before the bottom has even wilted. If a man has only a small area, it can be turned by hand, but if growing it extensively it will pay to have either a side delivery rake or else a tedder. If the weather is hot and dry, everything cut in the morning should be raked and coiled the same afternoon. If the weather is cloudy or cool the raking may be deferred until the next day. The coils should be made small so that the air will circulate through and dry the hay. This method makes ideal hay when the weather is favorable and greatly lessens the loss from bleaching and washing if the weather is wet.

Alfalfa is not good stacking material as it is coarse and open. It is best to store it under a roof. However, it can be stacked successfully. The centre of the stack should be kept firm and high so that the layers slope out. The top of the stack should be finished off with wild hay or some good shedding material.

Awful

Henry Clews, at a dinner in Newport, said of American traveling:

"It is delightful to travel in America, but I think that American porters handle our luggage a little too roughly.

"Once, at a certain station, I was amazed and pleased to hear a uniformed official shout to a burly porter:

"Hi, what are you knockin' them trunks about like that for?"

"The porter had been lifting great trunks above his head and hurling them down onto the floor

furiously; but now he stood stock still in astonishment.

"What's that, boss?" he said.

"What do you mean by knockin' trunks about like that?" repeated the official. "Look at the floor, man. Look at the dents you're makin' in the concrete. Don't you know you'll lose your job if you damage the company's property?"



A true friendship is as sweet as a pool of refreshing silence in the desert of demoralizing din.—Thomas Dreier.

SMOKE FOREST & STREAM TOBACCO

It is exceptionally mild

10c Per Tin 10c

Practical Talks to Threshermen

Continued from page 16

ical power and the result is that a determined effort is being made to satisfy the demand for a light weight tractor at a moderate price and one that will stand up to its work without requiring many

In this series of lessons we shall endeavor to show not only the leading machines that are on the market and their construction, but all the different ideas of consequence that have been devised covering the subject of farm tractors.

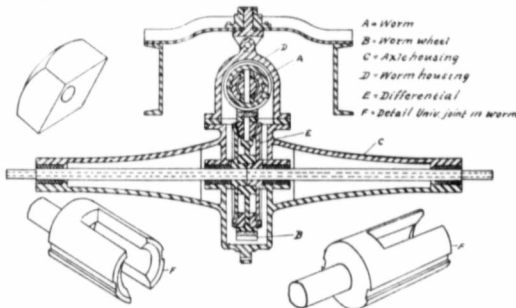

Fig. 180. Detail of axle showing differential gear, worm and worm wheel.

repairs through a long period of years. Up to the present, perhaps the greatest trouble with tractors is that of length of service before repair bills become excessive. General farming is wearing on

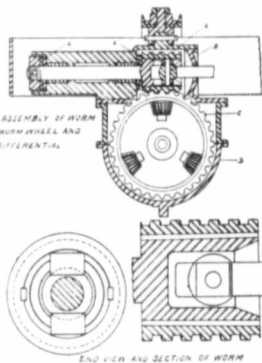

Fig. 181. Detail of worm, worm wheel and Universal coupling.

machinery at best and, fortunately for the manufacturers of farm power machinery, the farmers have always been used to paying high prices for their power and must continue to pay high prices if they depend upon animals. This makes the farm power field seem attractive to inventors and manufacturers alike for they are convinced that if a tractor can be produced that will not require heavy upkeep charges it can be sold literally by the hundreds of thousands. There are undoubtedly many machines on the market in which this element of rough, heavy service has not been given enough consideration. Some of the machines do not stand up to their task as well as they should and yet the improvement, even in this particular, has been greater than any but close students of the industry realize within the last two or three years.

Farm Problems

Continued from page 18

form of beef, mutton or pork, and no matter how busy farmers should be, they should take time to see that this contract is made in their interests and not in that of the railways. The farmers may rest assured that the Railway Commission are taking time to see that their interests are absolutely safeguarded.

Keeping up with Jones

There are a lot of people who are governed by the things they own, or rather, the things that own them. When your house is too daintily furnished for everyday use and is always dressed up for company, it ceases to be home and becomes a hotel. There is many a man who spends his evenings in the drawing-room, rigged out in a dress suit, who would prefer to spend them in the kitchen with his feet in the oven. By wearing a dress suit he isn't pleasing himself, but is trying to please Jones or, more likely, Mrs. Jones. He furnishes his house and buys expensive things just to keep up with Jones, when he ought to know that Jones has acquired all his things in order to keep up with Brown, and Brown to keep up with Robinson.

A learned man writes of "the isolation of fine manners," but it may well be questioned whether manners that do isolate really are fine. The perfection of breeding creates an atmosphere which brings out the best that is in others, and which helps all well-meaning people to feel comfortable and at ease. We admire the grandeur and glitter of a glacier, but it holds no homelike suggestion.

Safety for the Golden Grain

Proof against fire, vermin, lightning

Diameter 14 feet
Wall 8 feet high
Raise of roof 3 1-2 feet

Capacity 1050 Bushels

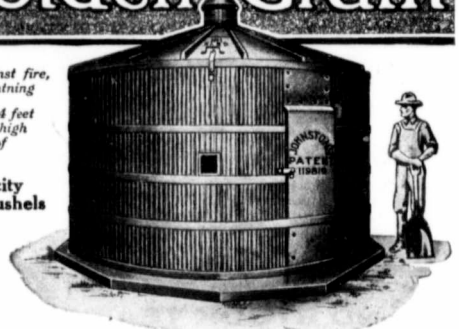

ANOTHER problem settled beyond doubt! Safe storage for grain. Proof against vermin—proof against fire and lightning—and protected absolutely from wind, weather and water. There you have the Johnston Granary. You have been looking for a granary that could not bulge. A granary with a large door—a granary with a sturdy frame. The Johnston Granary ends your search. Here we offer you a perfect safety for your grain, and at the same time a fireproof storage building for many other uses throughout the year. Sturdy as it is the Johnston Granary is not a fixture. It can be set anywhere and moved with ease to any part of the farm.

Johnston's Granary

(Patented in Canada and United States)

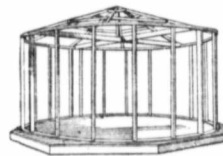

This cut shows the strong framework construction that makes the Johnston granary so rigid and durable. This frame which we supply is covered with heavy galvanized corrugated iron sheets which are locked together, nailed to the frame, and further supported by wide bands that positively prevent bulging. There is a large double door, the inside being in movable sections, to hold the grain at any height and the outside of iron, fireproof, equipped for secure locking. The roof has a rise of 3 1/2 feet and is made of sections of galvanized iron, which lock tight at the seams. The Johnston granary is filled through the opening in the roof direct from the spout. A 14-inch ventilator provides ample ventilation.

The Dinnen Grain Unloader

This portable loader and unloader can be used anywhere on the farm. It is attached quickly wherever needed—so that one will be enough for most farms. Send the coupon for prices and particulars.

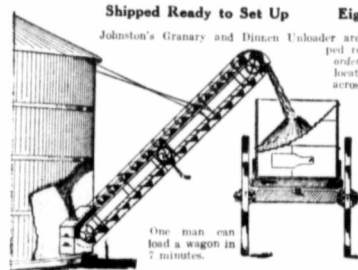

One man can load a wagon in 7 minutes.

The Metal Shingle & Siding Co. WINNIPEG, MAN. Limited

Associated with A. B. Ormsby & Co., Limited

Consolidated factories at
Preston Toronto Montreal
Winnipeg Calgary Edmonton
Saskatoon Regina

Shipped Ready to Set Up

Eight Factories in Canada

Johnston's Granary and Dinnen Unloader are fitted at the factory—shipped ready to put together the day order is received. Factories are located at eight farming centres across Canada, to fill orders for all metal building materials and farm equipment. Catalogues or special information cheerfully given. Use the coupon.

The Metal Shingle & Siding Co., Limited, Winnipeg
Send information about Johnston Granary and Dinnen Unloader direct to C.T.

AT engine ing pov amount livered. more th matter i some tir relation: work. but a co energy. In me: a subst: must be instance unit of of length ments. is the ur intensity amount British t variably B.T.U. of heat r perature

THE ORIGINAL FARMERS' COMPANY
BIGGER AND BETTER THAN EVER!

The Canadian Stover Gasoline Engine Company have always given Best Quality

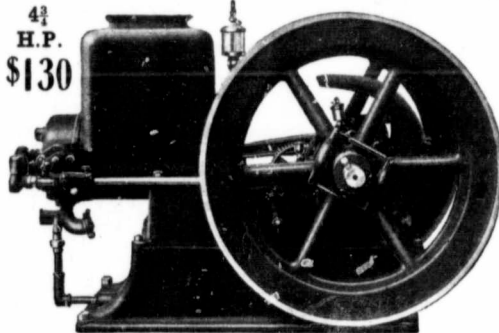

4 1/2
 H.P.
 \$130

Every Engine fitted with Self-Cleaning Igniter. Gasoline Tank in Base.

Note Our Latest Offers:

Our Exclusive Safety Device

- 1 1/2 H.P. Engines, complete with pulley 42.50
- 3 H.P. Engines, complete with pulley, self-contained 85.50
- 4 1/2 H.P. Engines, complete with pulley, self-contained 130.00
- 7 1/2 H.P. Engines, complete with pulley, self-contained 195.00

Power Washer, reversible wringer, enameled drain board, drains from the bottom, both washer and wringer controlled by small lever. Complete with 22.00

Every Engine is guaranteed perfect in workmanship and material and to develop much more than the advertised Horse-Power.

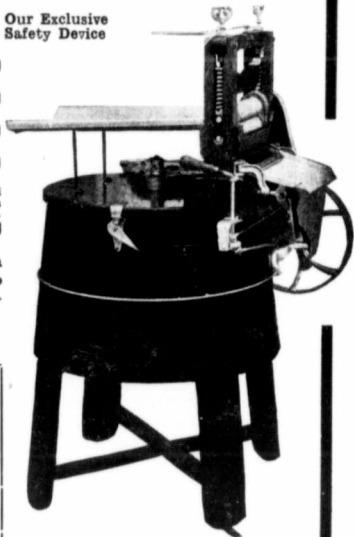

Compare Our Goods with the Best on the Market
 WRITE FOR CATALOGUE

Tool Grinder No. 310

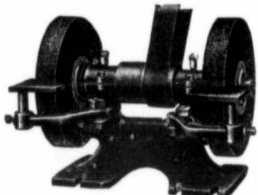

Price \$11.00
 Complete with sickle-grinder attachment

Plow Shares

Cheap Plow Shares kill horses. These fitted Plow Shares are absolutely guaranteed first class in every respect. They are standard in Make and Quality. Stubble, Breaking or Engine Plow Shares same price.

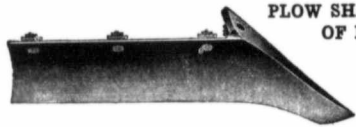

PLOW SHARES OF EVERY MAKE

PRICE LIST

	Each
12-in. Shares	\$2.00
14-in. Shares	2.25
16-in. Shares	2.50

Write for Catalogue

The Canadian Stover Gasoline Engine Co. Ltd., Brandon, Man.

Gas Engine Troubles

By A. C. CAMPBELL

Article Number 4

AT the close of our last article we were discussing the question of running an engine too cold and thereby losing power or using an excessive amount of fuel for the power delivered. To enable our readers to more thoroughly understand this matter it will be well to devote some time to the discussion of the relationship between heat and work. Heat is not a substance but a condition. It is a form of energy.

In measuring anything, whether a substance or a condition, we must have a definite unit. For instance, one pound is the unit of weight, one foot the unit of length and so on in all measurements. A degree of temperature is the unit used in measuring the intensity of heat but not the amount of heat. The unit of the amount of heat is called the British thermal unit and is invariably expressed by the letters B.T.U. A B.T.U. is the amount of heat required to raise the temperature of one pound of water,

one degree F when the temperature of the water is 62 degrees F.

There is a definite relationship between heat and work, that is to say, if we have a certain amount of heat in a fuel it is equivalent to a certain amount of energy or work.

Careful experiments have gone to prove that the mechanical energy of one B.T.U. is 778 foot-pounds. A pound of fuel contains a definite number of B.T.U. and therefore the greater number of heat units transformed into work by the engine, the more efficient is the engine. A pound of gasoline contains from 18,000 to 20,000 B.T.U. and a pound of kerosene contains from 22,000 to 24,000 B.T.U. If we conducted a test with a gasoline engine and found that of the 20,000 B.T.U. in a pound of gasoline, 5,000 were delivered in the form of work then the efficiency of the engine would be 25 per cent. That is to say, 25 per cent of the B.T.U. have been transformed into work. It should now be plain to the reader that if



When you think Thresher Tank, think

"Saska"

and ask any Implement Dealer in Western Canada, or write us for Special Delivered Price.

"SASKA" MANUFACTURING CO.
 LIMITED
 SASKATOON SASKATCHEWAN

the cooling medium in the jacket be kept at a low temperature it will absorb more B.T.U. than if kept at a high temperature thereby leaving a less percentage of the available B.T.U. to be delivered in the form of work, resulting in less efficiency.

In other words, we get either less power out of the fuel or more fuel consumed for a given amount of power delivered.

Other causes for that symptom of trouble "excessive fuel consumption" are: engine running too fast at light loads, fuel of poor quality, engine parts heating or binding, valves or ignition out of time.

The sixth symptom of trouble on our list is "back firing." This, as previously explained, is due to delayed burning of previous charge. A slow burning charge will continue to burn throughout the exhaust stroke and the incoming charge will be ignited by the burning gas still in the cylinder. Too weak a mixture or too late ignition will cause this trouble. Glowing points, either carbon or metal in the compression chamber will give the same result.

Our seventh symptom of trouble is "heavy explosions at the exhaust pipe," and this is always caused by the misfiring of the previous charge. Misfiring in turn can generally be traced to defective ignition, or incorrect mixture although there are many other causes which have already been discussed.

Smoke is also a symptom of trouble. There should be no smoke visible around an internal combustion engine when it is running properly whether it be burning gasoline or kerosene. The presence of smoke indicates that something is wrong and the engine will not be delivering its maximum power. Black smoke indicates too rich a mixture, blue smoke excessive lubrication, and in the case of a kerosene engine white clouds of steam, too much water in the mixture. Smoke at the open end of the cylinder shows that either the piston rings are leaking, compression or else there is a sand hole in the piston.

We have now gone over all of the eight symptoms of trouble mentioned in the first of these series and in dealing with them we have discussed practically all of the troubles met with in gas engines by the operator. The writer will now try to relate some of the experiences which he has met with, both as an operator and as an expert and later we may take up some plowing and threshing problems. It was these actual field experiences which enabled him to classify gas engine troubles under the eight headings which we call symptoms of trouble.

In relating these experiences,

we will take them in the same general order that we have followed in discussing the symptoms of trouble. During the writer's earlier experiences as an operator he met with lots of trouble just as most other young operators do and difficult starting seemed to be one of the principle troubles. Sometimes the cause was very simple. On one occasion he was running a small gasoline tractor and one evening had to stop to adjust the plows. Before trying to start again he took out the ignitor and cleaned the points, then replacing it tried to start. The engine refused to go and every time the piston came in on the compression stroke, a hissing sound of escaping gas could be heard. It being necessary to crank the engine from the ground he could not locate the leak and came to the conclusion that the piston rings were leaking and not knowing overmuch about an engine he telephoned to the city for a complete set of new rings. In the morning he got the farmer, for whom he was plowing, to come out to the engine and crank it for him while he tried to locate the leak. The ignitor gasket was found to be leaking and on being replaced with a new one the engine started off and run as well as before. Three days later the piston rings came and the following day an expert arrived, the former were never used, but from the latter the writer got a lot of good advice and information. One point here worth noticing is that when an expert visits your machine you should always make it a point to learn all you can from him.

On another occasion the writer was running a large two cylinder kerosene engine and had been meeting with splendid success until one very hot day in July. The outfit was running beautifully when sometime during the afternoon the clutch started slipping. He stopped and adjusted the clutch and then attempted to start but the engine remained dead. Every adjustment on the engine was inspected and found to be correct, the carbureter was taken apart and cleaned, the same was done with the ignitors but still the engine refused to go. The temperature was about 110 degrees in the shade that day and the writer was just about played out cranking the engine. However he stayed with it and finally along towards evening the outfit started and run as though nothing had ever happened. The engine had been started but the problem of why it did not start at first had not been solved yet, but after remaining awake nearly all night thinking about it, the problem became clear. The writer figured it out this way: The en-

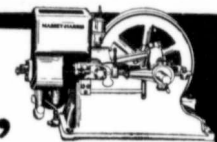

"Farm Power"

A good Gasoline Engine does much to solve the problem of farm help.

Our free booklet "Farm Power" tells of the many jobs which it will do at small cost as compared with hand labor.

And perhaps the most interesting part of it is that an Engine costs nothing in "wages" or "keep" when not running.

Massey - Harris Gasoline Engines

Are Famous for Efficiency and Economy

Their high efficiency, coupled with their economy of operation make them the ideal Farm Engine.

1 1/2 to 20 Horse Power, Stationary or Mounted.

Hopper Jacket or Closed Jacket.

Direct-Connected Pump, Spray Outfits, Saw Outfits, Pump Jacks, Etc.

Massey-Harris Co., Limited.

Winnipeg,	Regina,	Saskatoon,
Swift Current,	Calgary,	Yorkton,
	Edmonton.	

===== Agencies Everywhere =====

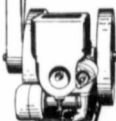



TWO HORSES

with this
4 cycle
4 h. p.
Farm
**Cushman
Engine**

**on your binder
are better than
4 horses without
the engine.**

Saves a Team

Horses merely draw machine. Engine does all operating. Runs reel and sickle, elevates, binds and delivers grain. Sickle continues to run when bull wheel skids or in turning. Does away with loose sheaves. Cuts heaviest grain—tangled grain. Binder won't choke. Easily attached to any binder. Has patented clutch pulley with sprocket for chain drive to double sprocket on binder. Throttling governor with Schebler carburetor prevents jerk on engine or binder. No waste fuel.

Original Binder Engine For all grains in any section. Weighs only 167 lbs. Tested and proved by 7,000 farmers on soft, sandy, hard and rough ground.

This Same Engine is also an All-Purpose Engine

Best for running the grindstone, pump, corn sheller, wood saw, feed grinder, washer, separator, etc. Runs at any speed. Change speed at any time without stopping. We also build 2-cylinder engines, 6 to 20 h. p., for silo filling, operating large balers, etc. See your dealer. Tell us your needs. Start the binder engine matter today. Catalog free.

CUSHMAN MOTOR WORKS OF CANADA, Ltd.
286 PRINCESS STREET, WINNIPEG.

gi
an
ve
da
us
we
so
pis
the
wa
oil
cyl
wa
cor
eng
app
tio
wa
san
thi
abc
sta
cyl
wit
eng
mal
wel
eng
and
rule
tryi

Th
miss
Agri
peric
Aug
It co
the
ing
men
Th
three
ing,
spect
divid
rende
est at
other
pure
Re
great
Cana
"O
tested
proba
dozen
while
total
seeds
produ
maind
ern a
most
tana
Alfalf
consin
tically
Canad
Refr
frost o
that t
milk
ruin o
the he
heavy

gine had been pulling a big load and was naturally running very hot, added to this the day was much hotter than usual. When the engine was stopped the cylinder oil was so thin that it simply ran off the piston and rings to the bottom of the cylinder. When the engine was cranked there was no film of oil between the piston rings and cylinder walls and therefore there was practically no suction and no compression, yet the fact that the engine turned over hard made it appear that there was both suction and compression.

The following day the engine was stopped under practically the same conditions, the sole reason this time being to prove out the above theory. Before trying to start this time the writer squirted cylinder oil into the cylinders with an oil gun and turned the engine over three or four times to make sure that the pistons were well lubricated. After this the engine started with perfect ease and ever after that it became a rule to lubricate the piston before trying to start a very hot engine.

Report of the Seed Commissioner

The report of the Seed Commissioner of the Department of Agriculture for Canada for the period from March, 1911, to August 31, 1913, has been printed. It concludes at this date because the annual routine of seed testing and seed inspection commences on the first of September.

The report is divided under the three main heads of Seed Growing, Seed Testing and Seed Inspection and these are again subdivided in such a manner as to render the report of great interest and value to seed growers and others interested in good and pure seed.

Referring to Alfalfa—a crop of great and growing importance in Canada—the report says:

"Of the 353 samples of seed tested at Ottawa last season, probably not more than half a dozen were of Canadian origin, while more than one-third of the total number contained weed seeds which occur only in Alfalfa produced in Europe. The remainder originated in the western and middle western states, most of them probably in Montana and Utah. Very little Alfalfa seed is produced in Wisconsin and Minnesota and practically none of it is to be had in Canada."

Referring to the influence of frost on immature oats it is stated that two degrees when in the milk stage will, in most cases, ruin oats for seed even though the heads may fill and give off a heavy bushel weight.

Busy Belts for Busy Threshers



See the picture shown above? Imagine what would happen if the thresher belt went wrong and there was none to replace it. It would mean that twenty men and the teams would stop working.

But wages would still be going on.

The boss of the thresher equipment would lose good money, and what is more, he would lose prestige, because the next man on the schedule would be kept waiting and would make no allowance for poor equipment.

And every man knows how vital it is to keep the thresher busy at threshing season. Even such a small thing as a belt may wreck the whole season's profits.

What Men Know

That is why more and more threshermen are specifying Goodyear belts.

They know that in these belts they get service. Their money buys maximum service—more than just so much rubber and fabric put together to meet a price.

They know that a Goodyear belt will stand up under hardest work, heaviest weather and roughest handling. They know that it delivers all the power all the time to the thresher and that a Goodyear belt can be depended upon day in and day out, season in and season out.



No Slipping

And they know that Goodyear belts have a minimum "slippage," hug the pulleys, delivering maximum power while minimizing resistance.

"Black Diamond"

This is a belt made from a specially selected cotton duck and the exact rubber friction for the purpose. The different layers are vulcanized into one impervious powerful unit. It is a splendid thresher belt. It is also used for saw-mills. It "delivers" always and everywhere.

"Reliable"

A fine belt for ordinary work. Not as high grade a belt as Black Diamond, yet far superior to belts made simply to meet a price. Remember that every Goodyear belt is tested at every process in its manufacture. It must prove itself before you can buy it.

Agricultural Hose

Made for heavy work around threshing time—no break-downs, no money lost. Adds to the efficiency of the thresher equipment.

Let Goodyear experts tell you of Goodyear service. Remember that Goodyear quality rules in this line as in automobile tires. Asking questions costs nothing. No obligation is involved.

The Goodyear Tire & Rubber Company of Canada, Ltd.

Head Office, TORONTO, ONT. Factory, BOWMANVILLE, ONT.,
Branches at Victoria, Vancouver, Edmonton, Calgary, Regina, Winnipeg, Hamilton,
Ottawa, Montreal, St. John, N.B.

This report, which constitutes a concise summary of the work of the Seed Branch for the period indicated, is available to all who apply for it to the Publications Branch of the Department of Agriculture at Ottawa.



He—"Will you be my partner—"

She—"Oh, George, this is so sudden! Give me a little time—"

He (continuing)—"for the next dance?"

She (continuing)—"to catch my breath. I haven't recovered from the last Boston yet."

"SIMPLE AND STRONG NOTHING TO GO WRONG."

The more simple any piece of machinery is constructed, the better, if it will do its work right.

The Practical Force-Feed Oil Pump

is the most simple lubricator ever produced—just two pieces do the pumping, and made adjustable for wear—entire pump can be taken apart and put together again in a few minutes—no ratchet wheel, pawls, etc. to wear and cause trouble.

Pumps any grade of oil no matter how heavy or light—the weather never gets too cold or too hot for this simple lubricator to do its work right.

For seven years it has stood the test—thousands of them in daily use.

You can't afford to waste time and money fooling with a lubricator or common ratchet pump when you can get a "Practical" at the price they are now selling at.

Write for Catalogue and full information.

McCullough Mfg. Co., Minneapolis, Minn., U.S.A.

Crane & Ordway Co., Winnipeg, Man.

Distributing Agents for Western Canada.

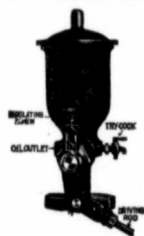

The Thresherman's Question Drawer.

ANSWERS TO CORRESPONDENTS

Q. C.W.S. 1. Which has the more power, a double or a single cylinder engine, both made by the same company and rated at the same horse power?

2. In setting the valves of a cross compound engine does the large or low pressure valve require more lead than the high pressure valve?

3. Is lye a good substance to put into a boiler with the feed water to prevent or remove scale?

4. Are there any other reverse gears besides the Case that are set to give equal cut-off and not equal lead?

5. Will not all engines run satisfactorily if set with equal lead without reference to cut-off?

6. What are the usual speeds required of separator cylinders for different kinds of grain?

A. 1. If there are two engines, one having a single cylinder and the other two cylinders made by the same company and rated at the same horse power, we should think they would develop practically the same power. There might be some slight variation with different engine, but we should hardly think the designers would deliberately make one more powerful than the other.

2. The amount of lead which the valve of any engine is given depends upon the design of the engine. There is no general rule to follow and so it is impossible to answer your question with any degree of definiteness. In practically all of the tandem compound engines used for threshing, both the high pressure and low pressure valves are given the same lead.

3. Lye is a strong alkali and if used in a boiler having a scale deposited by alkali it would not improve conditions in the least. If used in boilers having a heavy line scale with no alkali it might give favorable results. Ordinarily we do not recommend the use of lye.

4. All of the Woolf valve gears are usually set with slightly unequal lead and if you will look over your thresher catalogs you will see that there are a number of manufacturers beside the Case Company that have adopted the Woolf valve gear.

5. An engine whose valve is set with equal lead will always run well though if you desire the greatest fuel economy under

heavy load it is found advisable with many kinds of valve gears to set the valve for equal cut-off.

6. The twelve bar cylinder is supposed to run at from eleven to twelve hundred revolutions for all of the different varieties of grain while the twenty bar cylinder runs at from seven hundred and fifty to eight hundred and twenty-five revolutions. You will notice there is about the same percentage of variation in speed allowed in either case to provide for heavy straw and damp grain.

Q. G.A. I have some trouble with the governor of a steam engine and a man told me that the engine was to run at the same speed with a load as when it runs idle. Does an engine set at two hundred and fifty revolutions per minute while running idle run at the same speed with a load?

A. The object of a governor on any engine is to hold the speed the same no matter whether the load be heavy or light. If the governor is working all right and the engine is not loaded beyond its capacity, it will run at practically the same speed when running light or when pulling a load. Stationary engines used for mill work or electric lighting should not show more than one or two per cent variation in speed under any conditions. A somewhat greater variation may be permitted in traction engines, but not to exceed five per cent.

Q. F.M.S. How should I proceed to measure the flow of a small stream? How is an indicator applied to an engine to obtain the actual work performed in the cylinder? How can I obtain a list of the questions given in an engineer's examination for license in any locality?

A. The following directions from Kent's Pocket Book on the measurement of an open stream by velocity and cross section will, we believe, answer your question. Kent says:

"Measure the depth of the water at from six to twelve points across the stream at equal distances between, add all the depths in feet together and divide by the number of measurements made. This will be the average depth of the stream. Multiplying by its width will give its area or cross section. Multiply this by the velocity of the stream in feet per



"I put it up, myself"

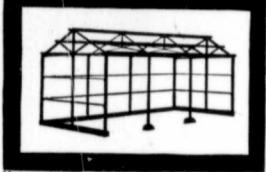

Ready-made Farm Buildings

(Patents applied for)

Ready Made Buildings are just the kind you want for storage, carriage houses, implement sheds.

You can put them up quickly—and once built you have rigid buildings that will stand any wind pressure or roof strain without sagging. You have buildings that are fire-proof and lightning proof—buildings that will never cost a cent for paint or repairs.

Send for full information and free catalogue Tear out the coupon and mail it to-day

The Metal Shingle & Siding Co., Limited

WINNIPEG, MAN.

Associated with A. B. Ormsby & Co., Ltd.

Consolidated factories at: PRESTON WINNIPEG TORONTO SASKATOON REGINA MONTREAL CALGARY EDMONTON

Coupon

Send full information about Ready Made Buildings.

The Metal Shingle & Siding Co., Ltd. Winnipeg, Man.

C.T.F.

You saw this advertisement in this magazine. Don't forget to say so when writing.

The Eagle Scrub Cutter

WILL CLEAN UP YOUR SCRUB LAND IN A FRACTION OF THE TIME THAT AN ARMY OF MEN AND HORSES WOULD DO IT. It does it positively at a

SAVING OF 75 PER CENT

It costs a remarkably small sum and is of special interest to OWNERS OF TRACTORS IN SCRUB LAND, who can positively and easily make a big source of revenue with this machine. It is simple, strongly built and easily handled. It will cut anything from an inch sapling to trees of 8 or 10 inches clean by the soil.

Write for complete details to

The International Harvester Co. Winnipeg

or THE EAGLE MANUFACTURING CO., Dauphin, Man.

You saw this advertisement in this magazine. Don't forget to say so when writing.

mini
disc
min
stre
off
and
mid
pass
a n
aver
tanc
velo
top
than
aver
eigh
face
conv
of o
hund
Th
ngly
and
not
ment
An
cylin
attac
a per
dicat
of the
and v
the 1
pistor
exert
indica
to me
in prest
engin
the in
placed
ries a
rotate
with
the ei
figure
the in
piston
which
that a
pencil
definit
height
sure i
points
length
stroke
figure,
ured l
the sc
of the
reveal
der an
the ex
other
of the
dition
can be
gas en
steam
ranged
one v
anoth
end of
corded
Q.
which
most
gine, a

minute and the result will be the discharge in cubic feet per minute. The velocity of the stream can be found by laying off one hundred feet of the bank and throwing a float into the middle, noting the time taken in passing the hundred feet. Do this a number of times and take the average; then dividing this distance by the time gives the velocity at the surface. As the top of the stream flows faster than the bottom and sides, the average velocity being about eighty-three per cent of the surface velocity at the middle, it is convenient to measure a distance of one hundred and twenty feet for the float and reckon it as one hundred feet."

The above method is exceedingly crude but is the simplest and is satisfactory where you do not care for an exact measurement.

An indicator consists of a small cylinder with the piston rod attached to a lever which carries a pencil. The cylinder of the indicator is attached to the cylinder of the engine by means of a pipe and valves in such a manner that the pressure which moves the piston of the engine will also be exerted upon the piston of the indicator. This causes the latter to move up or down in its cylinder in accordance with the steam pressure in the cylinder of the engine. The pencil arm which the indicator piston actuates is placed against a drum which carries a piece of paper. This drum rotates exactly in synchronism with the motion of the piston of the engine. The pencil traces a figure on the paper which is called the indicator card. The indicator piston works against a spring which is carefully calibrated so that an inch of movement of the pencil arm will represent a known definite pressure. The vertical heights of the card represent pressure in the cylinder at various points of the stroke while the length of the card represents the stroke of the engine piston. The figure, therefore, must be measured by two scales, one which is the scale of the spring, the other of the stroke. The indicator card reveals the pressure in the cylinder and the total work done. To the experienced eye it shows many other things, such as the setting of the valves and the general condition of the engine. An indicator can be used upon either steam or gas engine. When used on a steam engine the piping is arranged so that by the opening of one valve and the closing of another the pressure from either end of the cylinder can be recorded by the indicator.

Q. T.H.C. Please tell me at which speed you would get the most power out of a steam engine, at 400 revolutions per min-

ute, or 225 with steam tractor the same in both cases.

A. The power of a steam engine is directly proportional to its speed. All other things being equal, doubling the speed will double the horse power.

Q. F.A.R. It is very difficult to hold steam with any boiler here on account of bad straw. Do you think it advisable to run the water pipe from the injector or pump through the smoke box, making several turns and then lead it out to the boiler?

A. Your plan of using a coil in the smoke box through which to circulate the feed water would work successfully if you could arrange for a constant circulation of water, but without a constant circulation the water would become very hot and turn into steam at high pressure. Of course, it would escape through the outlet into the boiler, but pockets would form in the coils in which there would be no water. If any of the coils became dry they would burn out in a short time and anyone near the front or back of the machine at such a time might be dangerously scalded. You might be able to put in a coil, with connections at both top and bottom to the boiler if care were taken that each length of pipe pitched upward at about the same angle. You could then arrange a tee in the lower section of pipe through which the water could be pumped, but even if this were done there is no assurance that the water would not flow into the boiler instead of being forced through the coil. There is another thing also to consider and that is the obstruction of the draft in the smoke box by a coil of pipe. Economizers are used in connection with sanitary steam plants built along the lines you suggest which have improved the economy of such plants anywhere from 10 per cent to 15 per cent. It is comparatively easy in a large installation to arrange a set of pipes and also arrange to keep them cleaned, which, by the way, is very essential to their perfect operation.

In a small installation like a traction engine boiler, we believe the idea would be pretty difficult to work out satisfactorily.

❧ ❧ ❧

ERROR.

In the advertisement of the J. I. Case Threshing Machine Co. in our issue of July, the statement was made that ninety per cent of the grain is "Threshed" at the cylinder.

This typographical error will be obvious at once to our readers who will no doubt themselves have corrected it to read "SEPARATED" at the cylinder. We regret the error which is solely due to carelessness in proof-reading.

International Harvester OIL AND GAS ENGINES PROVEN TO BE MOST ECONOMICAL

The following extracts are taken from a report by Prof. L. J. Smith on the Stationary Farm Gas Engine Demonstration, held in connection with the Winnipeg Industrial Exhibition, July 10-18, 1914:—

"Another test was made that was not very spectacular, but nevertheless it was important as it told how much it cost to run the engine itself. Each engine was run 15 minutes on no load, and the fuel consumption and the variation of speed was recorded. The best engine on fuel economy in this test was the I.H.C. 6 horse power gasoline. It showed that it could run all day (10 hours) on less than a gallon of gasoline and at a cost of a little less than 18 cents. The test at least showed that it hardly paid to stop the engine in extremely cold weather when going to dinner."
"Entry No. 4, an I.H.C. engine, made a remarkable showing when the tachometer readings were taken. Its uniformity of speed left nothing more to be desired so far as designing for speed regulation is concerned."
"The results of the tests in general showed that the gas engines entered were, in nearly every stage of the game, capable of doing what was claimed for them. Special credit must be given the Entry No. 4 for its ability to do the same amount of work on a pound of kerosene as the best entry in the gasoline class could do on a pound of gasoline."

Read on page 40 of this issue, the full report of this demonstration as written by Prof. L. J. Smith, Department of Agricultural Engineering, Manitoba Agricultural College, who had charge of it.

If interested write to branch house for catalog describing all sizes of gasoline and kerosene burning engines

Canadian Branch Houses:

International Harvester Company of Canada Ltd.

At Brandon, Calgary, Edmonton, Estevan, Hamilton, Lethbridge, London, Montreal, N. Battleford, Ottawa, Quebec, Regina, Saskatoon, St. John, Winnipeg, Yorkton.

You saw this advertisement in this magazine. Don't forget to say so when writing.

English Made Threshing Machinery for Canada

The question is often asked; why do not English manufacturers of Threshing Machinery cater for the markets of North America generally and Canada in particular? In every other wheat growing country of the world English machines are used in large numbers, but in Canada which is fast becoming one of the leading wheat producing countries, English machines are never seen.

a world-famed firm of steam plow makers. Thrashers and engines made by Ransomes were the first to replace animals for thrashing in almost every country in the world and the amount of pioneer work that has been done by them in the last 80 years is enormous. Their plows and implements are used in tens of thousands in Europe, Asia, Australia, Africa and South America, whilst thou-

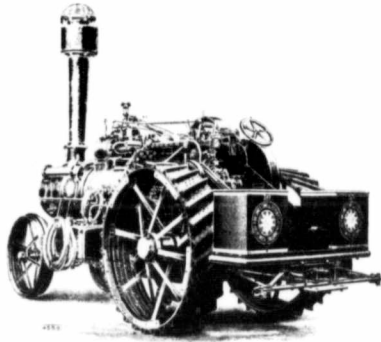

What is the explanation? Some will reply that the design of the English Separator is not suitable for Canada conditions, but English Manufacturers who cater for export trade have had to meet in other countries, conditions both more stringent and widely different from home conditions than are to be found in Canada.

The name of Ransomes, Sims & Jeffries will be familiar to all farmers in Western Canada who are of old country origin and everybody who is acquainted with the name and fame of this old-established British firm will be interested to know that they have entered the Canadian Market for the supply of thrashing outfits,

sands of their thrashing outfits are at work helping the crops of the world on their way from the field to the consumer. From a small shop employing a handful of men the business has developed into one employing over 3,000 hands, the main premises extending over 80 acres whilst the plow, implement and lawn mower works are entirely separate and self contained. The Canadian British Engineering Co. Ltd., of 85 Lombard Street, Winnipeg, are the sole agents for Ransomes Sims & Jeffries and during the exhibition had an outfit under demonstration. We reproduce cuts of this machinery. As will be seen from our illustration in

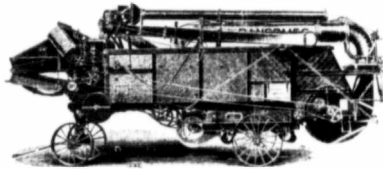

some examples of which are already in Winnipeg. The history of the firm dates back to the year 1789 when Robert Ransome started his foundry in Ipswich, England and commenced to manufacture plows.

Ransomes made the first plow ever used with a steam engine, this being constructed to the designs of a gentleman who afterwards became the founder of

general appearance the thrasher is along lines familiar to users in Canada, this is understandable when one learns that it has been designed by experts who have for some time been studying, on the ground, the requirements of Canadian thrashermen and farmers. The machines has all the features such as Feeder, High Weigher and Loader, Windstacker, etc., which are familiar to our readers

The "California of Canada" The O.K. Okanagan

King of the Fruit Districts

TRUE EDUCATION CONSISTS IN BEING ON GOOD TERMS WITH MOTHER EARTH AND WITH ALL THE WONDERFUL THINGS THAT CREEP, CRAWL, RUN, CLIMB, SWIM AND FLY. How can you receive such an education better than owning a first class Orchard in the SUNNY OKANAGAN. There is comfort, beauty and profit in the occupation of an Orchardist.

We Prepare This Business For You

We Plant and Care for your Orchard for 5 Years

WE GIVE YOU 55 MONTHS FOR THE PAYMENT WITH NO INTEREST AND NO TAXES. If death occurs while you are paying for your Orchard, we return the money. WE SELL FROM ONE ACRE UP.

We will care for your Orchard when in bearing if desired, so that you can have all your time to yourself. WE TAKE NO SALARY, ONLY 20 PER CENT OF THE PRODUCT, PAYING YOU 80 PER CENT.

We plant in large areas and only a few varieties, that we may meet Market Conditions. OUR EXPENSE IS 75 PER CENT LESS THAN THE LITTLE FELLOW.

Come in and see us, or write us for information.

Western Okanagan Orchards Co. Ltd.

Per Okanagan Selling Agency.

205 CONFEDERATION LIFE BLDG.

WINNIPEG.

You saw this advertisement in this magazine. Don't forget to say so when writing.

DENTISTRY

We Can End Your Teeth Troubles

If the public knew the quality of Dentistry we are doing for the price, the clean sanitary methods we have adopted, the new city hall would not accommodate us for office room. But the public are learning gradually from their friends that we do exactly as we advertise.

Tired Paying Big Dental Bills?

Note Our Prices

BIG SAVING ON FINE DENTISTRY



BRIDGE WORK

\$5.00 Per Tooth Best 22k. Gold

\$5.00

22k. Gold Crowns

OUR PRICES ALWAYS REMAIN THE SAME

Hundreds of others are taking advantage of our popular prices. Why not you? Do your false teeth fit? Or do they constantly drop in your mouth. If so, call and see the dentists who know how to fit your mouth with Perfect Plates.

We now operate our own Mechanical Department. Have finally reached the perfection mark in our Gold Plates.

Emergency Department means that you break your artificial plate and send it to us; we return by next mail. Or if you need work of any description done at once our Emergency department, which is now in perfect equipment, is at your service.

\$8.00 WHALEBONE OPEN EVENINGS

Whalebone



Personal Attention

Take advantage of our fifteen years' experience as specialists in making teeth.

Address all Correspondence, "Emergency Department."

McGreavy Block 258 1/2 Portage Ave.

DR. PARSONS Telephone M. 699 Over GTP Ticket Office

WINNIPEG

Bring Us Your Belt Worries We will Carry Them All

This is a sporting offer but we make it because we know when you have seen us that all trouble from belt service will become a thing of the past in your experience. The only real safeguard against slippage and leakage in a hustling season of threshing is to employ a real belt—a belt that is made by men who know from life long experience on the job what is really necessary in a belt that will not disappoint you in the slightest particular when you are banking on it. This is the



Lion Brand

Rubber Belt

OR THE

Maple Leaf

Endless Thresher Belt



You can get them from any thresher company doing business in Canada. They cost a little more than other fabrics that are a big risk from the day they are used in any power transmission, but we guarantee our goods against all disappointments from slippage or breaking. They are the 'guards' that will never betray their trust under any pressure—at threshing time or at any time.

Gutta Percha and Rubber Limited, WINNIPEG CALGARY

NOT IN ANY TRUST OR COMBINE

and in addition the makers claim the following points of superiority.

1. First class British workmanship and material.
2. Superior design, construction and finish.
3. Clean and perfect threshing and separation.
4. Superior cleaning.
5. Easy access to all parts and every possible convenience for adjustment.

The steam tractor is provided with a single cylinder engine it is evident that every care has been taken to make the tractor simple and easy

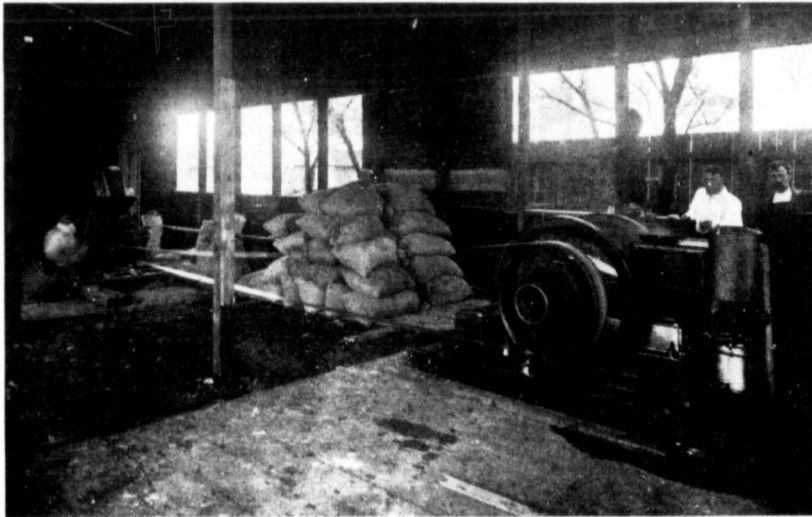

Stationary Farm Gas Engine Contest at Winnipeg Exhibition

to handle. The boiler is a fine example of high class boiler making and the design has been passed by the Province of Alberta for the highest pressure allowable by that authority. The sets stocked in Winnipeg are of sizes that will appeal to the large and medium farmer rather than thresherman. A full line of spare parts is carried by the Canadian British Engineering Co. at their warehouse 85 Lombard Street, Winnipeg, and this firm will have pleasure in supplying catalogues and information.



Increase Your Profits for 1914

The expense of operation and up-keep of an engine cuts a large hole in the profits of each season's run. The direct cause of part of this expense is the Common D Slide Valve. Replace it with a Gould Balance Valve and you will increase the capacity of your engine, save fuel, water and lubricating oil. Eliminate the expensive wear in the valve gear. For further information, write for our tenth Annual Catalog

HOW TO SET A SLIDE VALVE

is explained fully and is easy to understand. This Catalog No. 10 will be sent postpaid. Address:

Gould Balance Valve Company, Manufacturers, Kellogg, Iowa

CASE Machinery for Autumn Work



THE SIGN
OF
MECHANICAL
EXCELLENCE
THE
WORLD OVER



Case "06" Oil Tractor, Operating Case Baler



Case Machines Owned at Columbus, Wis.



Shelling Outfit

CASE BALING PRESSES BELT AND POWER

CASE Baling Presses of any size are bound to please you for two simple reasons. First, because of the excellent work that they do; and second, because of their honest, conscientious construction, they last a long time with a minimum cost for repairs. We have just issued a new catalog of our Baling Presses, which describes those features that have called forth such letters as this one from Colorado:

"It is not a question of how much this baler will handle, but how much we can get to it and take away from it. The Case Engine and Baler are entirely satisfactory."

CASE HUSKER-SHREDDER

Aside from the fact of the efficiency, the CASE Husker-Shredder, as evidenced by the word of a user from South Dakota (whose name we will give you on request), whose work with a CASE machine consisted largely of FINISHING THE JOBS THAT OTHERS HAD GIVEN UP, is designed for absolute safety. The feeder's position is fully five feet away from the snapping rolls. It is impossible for him to get caught in the rolls from the footboard. As to their design, construction and efficiency, let us send you our catalog on Husker-Shredders if you are interested.

CASE CORN SHELLERS

If you are going to add a corn sheller to your equipment this fall, now is the time to buy your CASE sheller; that is, if you want fast, consistent work, with a machine whose repair bills are almost unknown. If you want a rapid, worthy machine, that will put money into your bank account, let it be a CASE Sheller. Applications for catalogs will be promptly acknowledged.

J. I. Case Threshing Machine Co.
INC.

741-791 STATE ST., RACINE, WIS., U. S. A.

CANADIAN BRANCHES: Toronto, Winnipeg, Saskatoon, Regina and Calgary

THE SIGN
OF
MECHANICAL
EXCELLENCE
THE
WORLD OVER



CASE

The Standard by Which Others Are Judged

TRACTOR GANG PLOWS

This is August. You can now forecast, almost certainly, what profit your crop will yield you. You, therefore, know how much of your earnings you are going to put back into increased equipment in the way of new machinery. Are you going to increase your efficiency by joining the class of power plowmen?

If you are, here is some preliminary information that will guide you right in the safe purchase of a plowing outfit for use this fall.

CASE-RACINE TRACTOR GANG PLOWS

These machines contain all the vital elements of design and efficiency that are found elsewhere, and in addition those exclusive features that have made them conspicuous for good work in almost every section of the country. Some of the worthy features we describe briefly here. Our catalog gives you the facts in detail. You can't afford not to be well posted on the information contained in this book, which is yours for the asking. Here are some of the features of CASE-RACINE TRACTOR GANG PLOWS:

1. They bear our trade mark—the Case Eagle, which is your guarantee for the genuineness of the machine.
2. The Spring Hitch—Each plow is drawn by a powerful spring attached to the rigid frame. When the point of the share comes in contact with a stone, or obstruction, the spring yields and absorbs the shock, which otherwise might injure the bottom or spring the beam.
3. The Automatic Dodge—This device enables the bottom to rise over and to the side of the obstacle encountered, as illustrated. Note that the arrow points to the two face plows, which have been forced widely apart by the side pressure on the bottom. This Automatic Dodge allows the bottom to dodge to the side of the obstacle. The moment it has passed the bottom falls right back into the furrow.
4. Side Tension Spring—This spring releases all side strains on the beam. When the bottom strikes the obstruction a glancing blow on the side, the spring releases sufficiently to allow the bottom to be forced to one side without injury.

Do not these features appeal to you? Add to them the cast brake pin construction, the beam hitch, the automatic lift. Surely you can't do without a CASE-RACINE TRACTOR GANG PLOW.

CASE TRACTORS—Steam and Gas

For power for all kinds of work, you know that there is none that can touch CASE Engines for steam or gas power. They still maintain their superiority. They are the standards, like all CASE machinery, by which others are judged. Catalogs on any and all lines immediately sent on request.

J. I. Case Threshing Machine Co.
INC.

741-791 STATE ST., RACINE, WIS., U. S. A.

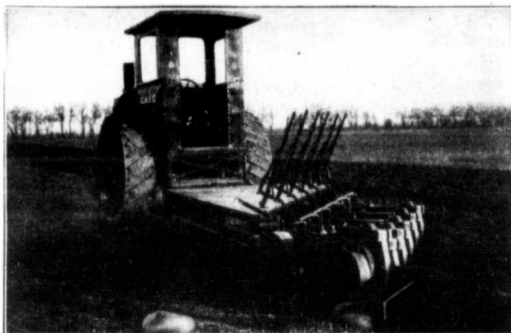

Scene Showing Action referred to in "3"



Case 80 H. P. Steam Engine and Case-Racine Tractor Gang Plow



Plowing Outfit, Havana, N. D.

CANADIAN BRANCHES: Toronto, Winnipeg, Saskatoon, Regina and Calgary



STEER FEEDING EXPERIMENT

Brandon Experimental Farm

AN experiment was conducted this season in which corn ensilage was compared with dry corn fodder which stood in the stooks until required. The corn for both lots was grown in the same way, and except for the different method of storage was the same in every way. In order to feed the proper quantities for a fair test, the ensilage and the corn fodder were analysed. The ensilage was found to contain 22.16 per cent dry matter and the corn fodder 51.49 per cent dry matter. They were fed in such quantities that the cattle got the same amount of dry matter of each feed. The corn stalks were cut up and mixed with straw so as to be fed under the same con-

care so that the difference in weight between the two lots averaged only 2½ lbs. per steer. Both lots were dehorned and were fed in large box stalls in the stable formerly used as a horse stable. The steers fed on ensilage received 30 lbs. per day during most of the period, and the other lot received 13 lbs. per day dry corn fodder. They started on 2 lbs. of grain per steer per day, gradually increased to 8 lbs., at which rate they remained most of the winter. At the finish their grain ration was gradually increased to 14 lbs. per steer per day.

The gains made by each steer for each month were as follows:

The steers were sold at \$7.60 per cwt. to be weighed at the farm and 5 per cent allowed for shrinkage. They were delivered on June 2nd, but as the supply of corn stalks gave out on May 15th and both lots were fed ensilage after that date, the results are

Lot 1. Fed Dry Corn Fodder.

No. of steer.	Weight at start.	Weight after 1 month.	Weight after 2 months.	Weight after 3 months.	Weight after 4 months.	Weight after 5 months.	Weight after 6 months.	Gain in 6 months.
1	1,015	1,060	1,095	1,125	1,155	1,190	1,195	180
2	935	1,000	1,030	1,085	1,180	1,195	1,240	305
3	1,025	1,055	1,080	1,100	1,180	1,260	1,280	255
4	1,040	1,120	1,130	1,165	1,215	1,260	1,270	230
5	1,105	1,180	1,270	1,290	1,355	1,425	1,430	325
6	1,030	1,065	1,085	1,145	1,220	1,250	1,320	290
7	1,015	1,015	1,090	1,130	1,165	1,220	1,255	240
8	940	1,005	1,050	1,090	1,120	1,185	1,210	270
9	1,110	1,150	1,200	1,250	1,290	1,330	1,390	280
10	1,050	1,105	1,110	1,145	1,215	1,245	1,275	225
Average	1,026½	1,075½	1,114	1,158½	1,209½	1,256½	1,286½	260
Av. gain in month		49	38½	44½	51	46½	30	

Lot 2. Fed Corn Ensilage.

No. of steer.	Weight at start.	Weight after 1 month.	Weight after 2 months.	Weight after 3 months.	Weight after 4 months.	Weight after 5 months.	Weight after 6 months.	Gain in 6 months.
1	1,010	1,080	1,100	1,195	1,230	1,270	1,315	305
2	1,000	1,080	1,110	1,225	1,282	1,340	1,400	400
3	1,225	1,280	1,310	1,410	1,405	1,480	1,545	320
4	965	1,015	1,080	1,185	1,200	1,270	1,325	360
5	1,055	1,175	1,230	1,320	1,380	1,460	1,500	445
6	975	1,030	1,090	1,155	1,200	1,215	1,285	310
7	1,000	1,050	1,100	1,185	1,210	1,260	1,295	295
8	1,025	1,080	1,125	1,200	1,230	1,280	1,315	290
9*	920	905	1,000	1,095	1,125	1,190	1,280	360
10	1,065	1,120	1,135	1,230	1,275	1,320	1,385	320
Av. per steer	1,024	1,081½	1,128	1,220	1,253½	1,308½	1,364½	340½
Av. gain in mth.		57½	46½	92	33½	55	56	

*Bled badly when dehorned.

ditions as the ensilage. Both lots of cattle received straw and grain in equal quantities, and when alfalfa was fed near the end of the experiment they received equal quantities of it.

The steers used for this experiment were purchased in Winnipeg stockyards at 6c. per lb. Commission, feed, freight and shrinkage brought their cost up to \$6.40 per cwt. when landed in Brandon, fed and watered. They were divided into two lots with unusually great

computed on the basis of May 15th weights. While the margin between buying and selling prices was small, only \$1.20 per cwt., the good gains made by the steers made it possible to show a profit. The results of the experiment are as follows:

This experiment is a strong argument for the building of silos. The results show that the steers made decidedly better gains when fed with ensilage. The work of bringing in the stook corn and

THE WEARING RECORD OF THE "MAGNET" Cream Separator

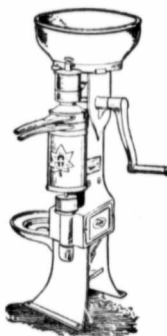

has been established by over ONE HUNDRED THOUSAND Canadian Dairymen and Farmers who have used it during the past 16 years. This record of WEARING QUALITY is unsurpassed by any other make of Cream Separator the world over, probably unequalled by any machine on the market.

THE REASON

Because it is built with the only correct running gear, the reliable and double Square Gear.

Its perfect skimming is because in its one-piece skimmer the cones are set so that the centrifugal force that breaks the connection between the butter-fat and milk, in order to make perfect separation, has free action. Beware of cones that are placed close together, as is the case with all worn gear separators, as they introduce Frictional separation which prevents the full action of the centrifugal force and therefore, irregular separation, and then besides the insertion of many extra pieces which are really Mechanical obstructions and are also very troublesome to clean.

We will easily prove what we say by showing you the MAGNET in your own dairy. The design and construction of the machine is what has compelled us to double the output of our factory this year.

The Petrie Mfg. Co. Ltd.

Head Office and Factory: HAMILTON, ONT.

Winnipeg, Calgary, Regina, Vancouver, Montreal, St. John, Edmonton.

You saw this advertisement in this magazine. Don't forget to say so when writing.

When you think Belt Guide think

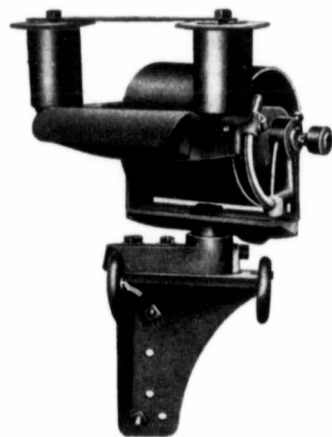

"Saska"

and ask any Implement Dealer in Western Canada, or write us for Special Delivered Price

"SASKA" MANUFACTURING CO. LIMITED
SASKATOON SASKATCHEWAN

You saw this advertisement in this magazine. Don't forget to say so when writing.

No. of steers
First weigh
Finished weight
Finished weight
Total gain
Average gain
First cost
Total cost
Receipts from
shrinkage
Total profit
Average cost
Average cost
Average selling price
Average cost

14,080 lbs. of
12,866 lbs. of
2,464 lbs. of
23,929 lbs. of

Average cost

14,680 lbs. of
13,276 lbs. of
2,464 lbs. of
26,830 lbs. of

Average cost

cutting it greater a than the v silage. If bunch of averaged s the incret would cert of a silo. While b

T And to the

Each succ new reso needs. As others are places. W adequate a; and gas we shall fail m source of h already lea; power of st In like n that when longer avai silo is brou serve forag; waste. ing value of in the stov field, or ev dry, but a feeding val cases of crop fodder dries its feeding the farmer i big crops a its poor on The silo

	fodder. Dry corn Lot 1. lbs.	Lot 2. corn ensilage. lbs.
No. of steers in each lot	10	10
First weight, gross No. 15th, 1913	10,265	10,240
First weight, averages	1,026½	1,024
Finished weight, gross, May 15th, 1914	12,865	13,645
Finished weight, average	1,286½	1,364½
Total gain in six months	2,600	3,405
Average gain per steer in six months	260	340½
Average gain per steer per day	1.43	1.87
First cost of steers at \$6.40 per cwt.	\$656.96	\$655.36
Total cost of feed	218.98	218.45
Total cost	875.94	873.81
Receipts from sale at \$7.60 per cwt., 5 per cent off for shrinkage	928.87	995.19
Total profit	52.93	121.38
Average cost per steer	65.70	65.54
Average cost of feed per steer	21.90	21.84
Average selling price per steer	92.89	99.52
Average profit per steer	5.29	12.14
Average cost of 100 lbs. gain	8.42	6.44

Cost of Feed.

Lot 1.		
14,680 lbs. of oats and barley at ¾c. per lb.		\$110.10
12,806 lbs. of straw at \$2.00 per ton		12.87
22,464 lbs. of alfalfa at \$12.00 per ton		14.78
23,920 lbs. of corn fodder at \$6.75 per ton		81.23
		\$218.98
Average cost per steer per day		.12
Lot 2.		
14,680 lbs. of oats and barley at ¾c. per lb.		\$110.10
12,276 lbs. of straw at \$2.00 per ton		13.28
22,464 lbs. of alfalfa at \$12.00 per ton		14.78
23,830 lbs. of corn ensilage at \$3.00 per ton		80.29
		\$218.45
Average cost per steer per day		.12

cutting it up was considerably greater and more inconvenient than the work of storing the ensilage. If in addition to such a bunch of steers, a man had an averaged sized herd of dairy cattle the increased economy of feed would certainly pay for the cost of a silo.

actually sold at the same rate, expert cattle buyers who examined them all agreed in saying that those fed ensilage were better finished and more valuable cattle. The difference in value between the two lots was placed at from ¼c. to ½c. per lb. by the various buyers who saw them.

While both lots of steers were

The Silo---100 Years Old

And What It is Doing. Born in Germany, Transplanted to the United States Years Ago, but New in the West.

Each succeeding generation finds new resources to supply its needs. As certain products fail others are found to take their places. When timber became inadequate as a fuel supply, coal, oil and gas were found. When these shall fail man will find some other source of heat and power. He is already learning to use the direct power of sunlight.

In like manner it comes about that when the vast plains are no longer available for pasture, the silo is brought into use to conserve forage which formerly went to waste. Two-fifths of the feeding value of a good corn crop lies in the stover. When left in the field, or even when cut and fed dry, but a small per cent of this feeding value is available. In cases of crop failure the immature fodder dries up and loses much of its feeding value. With the silo the farmer is able to store up his big crops and make the most of his poor ones.

many about one hundred years ago. It has for many years been used in the eastern portion of the United States, but only in recent years in the west. The rapid multiplication of silos in Kansas and other states proves their utility. The farmer who builds a silo one year is apt to build another one the next year, his neighbors build, and so all over the country we see silos springing up as by magic.

These silos are of three kinds as to the materials of which they are built — the wooden silo, the metal silo, and the concrete silo. There are also many varieties of each of these three kinds. Each kind has its advocates. There are also three kinds of silos in respect to elevation; the above-ground-silo, the bank silo and the pit-silo. Where drainage allows the pit-silo excels all others in cheapness and has some advantages along with a few disadvantages. Occasionally a stock-raiser may be so fortunate as to have a precipitous hill or draw where he may build

Alpha Gas Engines Are Farm Burden Bearers



The "Alpha" is a good engine for any purpose, but because there is no "mystery" in either its construction or operation it is ideal for farm use.

It isn't built of rough castings and put together like a stove. It's built more like a high grade watch.

It starts and runs on a slow speed magneto. That means you have no batteries to fuss with or to exhaust themselves.

You just give it a supply of gasoline or kerosene, oil it up, give it a pull and away it goes and saws your wood, cuts your fodder, grinds your feed, pumps your water, runs your cream separator or your washing machine, or anything else you want it to do. No worry, no bother, no tinkering — just plugs along like a steady well-broken horse.

Every farmer ought to have an "Alpha." Send for new catalog.

You Could Buy an IDEAL GREEN FEED SILO



every year and still be money ahead.

If you keep cows or raise stock you are losing money every year you try to get along without a silo.

Get our Silo Book and learn how to make more money with silage.

DE LAVAL DAIRY SUPPLY CO., Ltd.
LARGEST MANUFACTURERS OF DAIRY SUPPLIES IN CANADA
MONTREAL PETERBORO WINNIPEG VANCOUVER

You saw this advertisement in this magazine. Don't forget to say so when writing.



Dr. Thomas' Eclectric Oil

Relieves all Pain in Man or Beast

25 Cent Bottles at all Dealers

You saw this advertisement in this magazine. Don't forget to say so when writing.

It will pay you to write for our New Catalogue

WRITE FOR CATALOGUE

Gas, Automobile and Traction Engineering

Best Quality Well Made **\$3.50 UP** ANY MAKE

BINDER CANVASSES ABSOLUTELY GUARANTEED **\$3.50**

Set of Five Wrenches 60c. **\$1.85 UP**

PLOW SHARES \$1.85 UP

H. R. HAWKEY & CO.
HARDWARE MAIL ORDER SPECIALISTS
WINNIPEG

Name this magazine when writing advertisers

a bank silo having all the advantages of both the above-ground and the pit-silo. The essential features of silos are that they shall be air-tight, and shall keep the silage from freezing and moulding. The walls should be smooth, as nearly circular as possible, and should be vertical. The diameter of a silo should be gauged according to the amount of stock to be fed, so that several inches of the whole exposed surface may be removed at each feeding.

A good height, or depth, is a desirable quality of a silo so that the silage may furnish its own pressure. Cost and durability are also factors which may rightly enter into the question of what kind to build. It is not the purpose of this article to give specific directions for the building of silos. These may be had from many sources.

Our agricultural papers are full of this subject. I would urge the reader to get full information and lay plans after a careful study of the subject. The following ten reasons why every farmer who keeps live stock should have a silo, formulated by Professor J. H. Skinner, of Purdue University, deserve careful consideration:

1—The silo preserves the palatability and succulence of the green corn plant for winter feeding.

2—It helps to make use of the entire corn plant.

3—The silo increases the live stock capacity of the farm.

4—Silage is a good summer feed when pastures are short.

5—Because of the small amount of ground space required by the silo it is an economical means of storing forage.

6—The silo prevents waste of corn stalks, leaves and husks, which contain about two-fifths of the feeding value of the corn plant.

7—The silo located near the feed manger is an assurance of having feed near at hand in stormy as well as fair weather.

8—The silo assists in reducing the cost of gains in fattening cattle and sheep.

9—Silage greatly increases the milk flow during the winter season and decreases the cost of production.

10—There are no stalks to

bother in the manure when corn is put into silo.

All should understand that silage is not a complete or balanced ration. It is a succulent food and should be supplemented with some balancing dry feed. Good corn silage and alfalfa hay make a good ration. What I mean by good corn silage is silage made from well matured corn and including the ear as well as the stalk and leaves. The feeding value of silage depends very directly upon the character of the material put into the silo. Silage devoid of grain needs more of a grain ration to balance it.

What does the silo mean to agriculture? It means the bringing back of the live stock industry which has been slipping away from us in the past few decades.

It means that the farmer on a moderate-sized farm can raise his own calves and produce beef for the market at a good profit. It means more intensive farming, better breeding of stock, and the establishing of more and better homes. The thousands of cattle on a hill owned by a ranchman become the cattle on a thousand hills owned by happy and contented farmers.

It means, it is to be hoped, an actual increase in the live stock business till beef and mutton and pork may find their way to the poor man's table.

It means the feeding of home-grown crops at home and the maintenance of the fertility of the farm.

It means better social and economic conditions, and while it is not a panacea for all the ills to which humanity is subject, it may help to right some conditions.

MANITOBA BOYS' AND GIRLS' CLUB

Agricultural Instruction in Manitoba

MANITOBA boys and girls sides to study and practise are being encouraged on all agriculture, and the Department of Agriculture is being ably supported by the Department of Education in this direction.

Eight branches of the Manitoba Boys' and Girls' Club, formed last May, have each held a most successful Club Fair at which the chickens, potatoes and corn produced by the boys and girls were on exhibition. At Roland were shown 263 live chickens, 63 bushels of hand-selected potatoes and 66 sheaves of fodder corn, and the district raised \$127 in prize money. This will give some idea of the interest that is being taken in the Boys' and Girls' Club movement.

After the fairs the members took their pure-bred chickens

The DESMOND MODEL "U" Is Your Injector

The One Injector that will give perfect service under all conditions



No need to bother with so-called "Special Connections," "Rights and Lefts," "Fronts and Backs." The one Model "U" will fit all connections. The two-piece body connected with a Union Nut does the trick. Loosen the nut, turn the connections to meet your piping at whatever angle is most convenient. No need to wait until your dealer can secure an injector to fit your piping—if he has but one Model "U" in stock, it will be the right one for your needs.

Model "U" is FLEXIBLE and will meet every demand that can be made on an injector. Starts low at 20 to 25 lbs. and works high to 175 lbs.

Special high pressure injectors with a range from 60 to 335 lbs. can be furnished when desired. The Model "U" lifts water 25 feet; handles water at 130 degrees and delivers to the boiler at almost 212 degrees.

Every injector is thoroughly tested before leaving our hands and carries an unqualified guarantee to do perfect work under any test. If your dealer cannot supply you write us direct and give us his name. We will see you are supplied.

DESMOND STEPHAN MANUFACTURING CO., Urbana, Ohio

Steam or Gas Tractors

Equipped with

PICKERING THE GOVERNOR WITHOUT JOINTS PICKERING

give greatest efficiency

FITTED TO EVERY BUILD OF ENGINE

Patent Ball Ranger Speed Changer Supplied on all Genuine Pickering Governors. Will increase speed 50% or more.

The Pickering Governor Co.

PORTLAND CONN., U.S.A.

<p>GLARE ACETYLENE HEADLIGHT</p>  <p>"GLARE" spells satisfaction. Operating expenses 1c. per hour. Rents on a pivot and is controlled from the foot board of engine.</p>	<p>GULLICK SPARK ARRESTER</p>  <p>Fits any engine. Screens adapted to fuel. Does not clog and interfere with the draft.</p>
<p>POPE ADJUSTABLE FLUE CUTTER</p>  <p>When in need of a flue cutter try the "POPE." Superior to anything on the market of its kind. Cuts the flue without burring the end.</p>	<p>GREGORY AUTOMATIC BELT GUIDE</p>  <p>Works strictly automatically. Makes the belt run square on the cylinder and saves wear on edge of belt.</p>

POPE WHELOCK MFG. CO.,
Successors to E. M. POPE, Watertown, S.D.
Write for prices and special information to

THE MAYTAG CO. LIMITED Winnipeg, Man.

THE BEST Anti-Friction BABBITT On the Market is

The Frost King

The "Frost King" is the product of our long years of experience and is without doubt the most reliable Anti-Friction Babbitt made to-day. It is specially designed for Threshing Engines, Separators and Machinery of all kinds. If your dealer does not stock this metal, write us for a 30-pound box at 37c. per pound, or a 60-pound box at 35c. per pound. These are delivered prices. Please send money order to avoid delay.

Hoyt Metal Co. Eastern Ave. and Lewis St. TORONTO

FACTORIES—London, Eng.; Toronto, New York, and St. Louis

DR. WARNOCK'S ULCERKURE

The wound healing wonder. Heals without leaving a scar or the usual aftergrowth of white hairs. Ulcerkure is the surest and safest of all antiseptics.

Sold in bottles, 50 cents and \$1.00
Western Veterinary Co.
Sole Proprietors
P.O. Box 2132. Winnipeg, Canada

Name this magazine when writing advertisers

Aug
home to
farm, fl
seed, et
At th
Sho
bers of
made er
Agricul
Many c
fit, sec
The tot
turkeys,
chickens
The m
of the C
and girl
and 16
complete
or not.
school
similar o
tribute
Club Fa
ber from
of chag
best ob
hens.
families
lbs. of p
grains o
of fodder
ber also
with th
number.
Husband

I Do
as m
of c
sever

I Sto
every
from

I Pre
a hea
in th

I Sha
myse
waste

I Sha
always
featu

I Am
HE
These
about

CLARI

Name this ma

home to keep for foundations of farm flocks, their potatoes for seed, etc.

At the Brandon Dressed Poultry Show this year several members of the Boys' and Girls' Club made entries, the Department of Agriculture financing the exhibit. Many of these entries captured first, second, third or fourth prizes. The total exhibits consisted of 32 turkeys, 28 ducks, 28 geese, 62 chickens and 108 eggs.

The method of forming a branch of the Club is simple. All boys and girls between the ages of 10 and 16 (inclusive) are invited to compete, whether attending school or not. The municipal council, school board, board of trade or similar organization agrees to contribute sufficient funds for the Club Fair in the fall. One member from each family is given free of charge one dozen eggs from the best obtainable pure-bred-to-lay hens. Every member of the families represented is given 10 lbs. of pure-bred potatoes and 150 grains of each of three varieties of fodder corn. Each Club member also receives a Club button with the member's individual number. The Poultry and Field Husbandry Departments of the

Agricultural College issued a circular of rules and regulations with information and instructions regarding each of the contests planned, and these were really the text books for the Club members. Each member received a circular and a notebook free of charge and these were put to splendid use.

In future the girls will have separate work with contests probably in canning, preserving, bread-making, butter-making and plain sewing. The boys will need to know the proper crops for their land, what feeds produce growth and fatten live stock, how to market their products economically, how to co-operate among themselves, etc.

The Boys' and Girls' Club work will be enlarged upon this season. The branches at present formed are located at Roland, Manitou, Darlingford, Warren, Starbuck, Stonewall, Neepawa, and Oak Lake.

The results obtained certainly justify the efforts of the Department in the above work. The boys and girls have in turn interested their parents as is evidenced by the many enquiries received.

One girl at Neepawa raised 10 chickens from one setting of eggs and sold five cockerels at \$2.50 each. Other members had equally high offers, but would not sell. One boy at Darlingford (a nephew of Prof. Bedford) grew 472 pounds of potatoes from 10 pounds of seed. This is a record, so far as we know, for potato production under field conditions in Manitoba. Many members grew as much as 400 pounds from their 10 pounds of seed.



The Spendthrift Cow

Farmer A. (in auto), "Good morning, neighbor! Fine day this!"

Farmer B. (in wagon), "Yes, tolerably. Going to quit milking?"

A. "No, not entirely. I'm just going to quit milking for fun."

B. "Well, how's that?"

A. "These cows are eating their heads off."

B. "They are, eh? But how do you know?"

A. "I just weigh and test the milk from the herd and keep a record. Each cow gets credit for the milk she produces, also for the calf and the manure, then she is charged for the cost of maintenance."

B. "But isn't that an awful lot of work?"

A. "Well, it does take a few minutes a day, but I believe I get a dollar (\$1.00) an hour for this work. You see it makes all the other work count. Before I kept records, I spent hours of labor on

You Will Need Some of These
"QUALITY FIRST" PRODUCTS

for the Threshing Season

LILY WHITE ENGINE KEROSENE		REX MOTOR SPIRIT
	WHITE ROSE MOTOR GASOLINE	
NATIONAL CARBONLESS MOTOR OIL		NATIONAL GAS ENGINE OIL
	NATIONAL HARVESTER OIL	
STERLING TRANS- MISSION GREASE		STERLING FRICTIONLESS COMPOUND
	BLACK BEAUTY AXLE GREASE	

MAKE EVERY MOMENT COUNT by using Oils and Greases that you can depend upon.

If your Dealer cannot supply you write for prices and literature to:

Canadian Oil Companies Limited

REGINA WINNIPEG CALGARY

We make Prompt Shipments Try Us.

THRESHING MACHINE OWNERS

Do you know that all threshing machines MUST be equipped with a verified scale of not less than 100 lbs. capacity? Do you know that the absence of such scale will subject you to the penalties named in section 65 of Weights and Measures Act? If you do not know these amendments send us for a copy of the same.

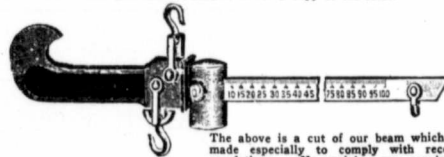

The above is a cut of our beam which is made especially to comply with recent regulations. No weights are required. Price, express prepaid, including government stamp, \$5.00

Wm. N. Courtenay & Co. Box 3613 Winnipeg, Man.

You saw this advertisement in this magazine. Don't forget to say so when writing.

these cows and they didn't even pay for their feed. The labor was all wasted. It alone amounts to about \$20.00 per year for each cow to say nothing of the feed she consumes."

B. "What is the matter with

that brindle? She looks like a good one."

A. "Yes, she made a profit of \$5.00, but what is the use of keeping such a cow when you can just as well have one that nets \$20.00 or more.

I Do

as much for you with six tons of coal as others do with seven.

I Stop

every particle of dust or gas from escaping into the house

I Preserve

a healthful amount of moisture in the air of every room.

I Shake

myself thoroughly without waste, or a poker.

I Shall

always do this because of features I alone possess.

I Am The



These people will tell more about me:

CLARE & BROCKEST LIMITED WINNIPEG

Name this magazine when writing advertisers

The Motor Contest is evidently a thing of the past in so far as the Winnipeg Exhibition is concerned. This does not mean that the gas engine has ceased to be a source of farm power, neither does it mean that the tractor is a back number. The Motor Contest was put on for a purpose. It served that purpose and after having done so each succeeding contest was more or less a repetition of the last.

It entailed considerable expense on the part of the exhibition people as well as upon the manufacturers. It was, therefore, decided to cut it out entirely. The gas engine, however, as a source of farm power has come to stay. There is scarcely a farmer in Western Canada to-day of any size who does not have one of these little machines chug, chugging away, pumping water, grinding feed, churning, and in a great many cases lighting the farm home.

The Winnipeg Industrial Exhibition, therefore, decided that it would be a good thing to give a demonstration of this gas engine, and had it not been for the financial stringency and the curtailed trade a great many more engines would undoubtedly have been entered. As it was eight machines representing four companies were placed upon the belt. It was not a contest, but merely a demonstration, and, after all, demonstrations are the things that bring out the real merit. In a contest everybody gets a medal and every man gets a first prize

Stationary Farm Gas Engine Demonstration

At Canadian Industrial Exhibition

somewhere. In a demonstration, however, it is wholly and solely a matter of points, and each contestant can award himself just as many medals as he chooses.

In order that the thing might be more practical a feed grinding demonstration was also put on. The directors used a feed grinder, feeling that the gas engine is used for this purpose more than for any other, and at the same time shows more results. The contest included a two hours' test to demonstrate chiefly the engine's ability to develop power at its

most economical load. The score card was arranged in such a way as to encourage the engines to make the load as near as possible their rated horse power. They were tested for half an hour for their maximum horse power. In this contest the engines were scored partly on fuel economy, but chiefly on their ability to handle an overload for a short time. A 30 per cent overload was taken as a standard, and it was decided by the judges to give the engine a perfect score of 30 points if they could develop a 30 per cent

overload. One engine very near showed this amount of power and made a score of 26 points on the particular part of the contest. In the brake tests the engines were belted to a small rope friction brake which was almost a copy part of the large brakes used in the motor contest. This style of brake has been found to be very efficient, and is much more adaptable to a contest than the large brake, as it can be applied to practically any speed of engine and size of pulley.

After all, a contest of this kind viewed from the standpoint of the farmer is of benefit in that it shows whether or not the engine is developing its rate of horse power. In the case of the engines entered, they showed up well with their catalogued ratings. One engine that was interesting to watch was entry No. 7, which was a two cycle engine. The distillate engine is something new in Western Canada viewed from the standpoint of the farmer, and will doubtless be watched with interest by the farmers of Western Canada during the next few years.

We would advise our readers to send for catalogues of the various engines entered and then go over the score cards and compare the catalogues rating in the catalogues with the work actually done. It will be a valuable lesson on the farm gas engine, and at the same time will place you in a position to analyze the talk of

TABLE 1—DATA SHEET

Entry Number	Maker's or Agent's Name	Type: vertical or horizontal	Rated horse power	Weight of Engine	Smallest rectangular floor space entire machine occupies	Retail Price, F.O.B., Winnipeg
Gasoline—						
1	International Harvester Co.	hor.	1900	3-6x7-0	\$300	187.50
2	C. S. Judson & Co.	hor.	1900	3-2x4-0	415	
3	Cookshutt Flow Co.	hor.	2200	3-1x5-4	415	
4	R. A. Lister & Co.	vert.	720	3-3x4	275	
5	Cushman Motor Works	vert.	4	280	1-4x2-0	195
Kerosene or Distillate—						
6	International Harvester Co., kerosene	hor.	1960	3-6x7-0	300	
7	Judson, 2 cycle, distillate	hor.	6		400	

*Engine runs on crude oil also.

TABLE 2—RESULTS OF TESTS.

Entry Number	MAKER'S OR AGENT'S NAME	ECONOMY BRAKE OR BELT HORSE POWER										MAXIMUM BRAKE H. P. TEST					FEED GRINDER TEST				NO. LOAD TEST								
		Total Time of Test, Minutes	Time Lost Due to Engine	Actual Length of Test	Average Number of revolutions, engine	Average Horse Power Developed	Lbs. Fuel Used	Lbs. Water Used	Number of Horse Power per Gallon Fuel	Cost of Fuel per 10 hr. run, developed by engine	Total Length of Test, Minutes	Time Lost, Due to Engine	Actual Length of Test	Average No. of revolutions per min. of Engine	Lbs. Fuel Used	Lbs. Water Used	Average Brake H. P. developed	Cost of Fuel per Brake H. P. hour	Actual Length of Test, Minutes	Lbs. Fuel Used	Lbs. of Barley Ground	Cost of Fuel per 100 Lbs. of Feed	Bushels of Barley Ground per hour	Average No. R. P. M. of Engine	Lbs. Fuel Used per hour	Cost of Running Engine 10 hr. per rated	Variation of Speed per 100 revs. of engine		
																												R.P.M.	cts.
Fuel costs in bulk, Winnipeg, July 16, 1914.																													
Grinder used—																													
Vesnot & Co.'s 8-inch for all save Cushman, which was tested with a 6-inch Vesnot with counter shaft.																													

TABLE 3—SCORE SHEET—500 POINTS

Entry Number	MAKER'S OR AGENT'S NAME	ECONOMY BRAKE TEST				MAXIMUM BRAKE TEST				FEED GRINDING	DESIGN AND CONSTRUCTION										Final Score								
		Fuel Economy	Water Economy	% of Rated H. P.	Uniformity of Speed	Fuel Economy	Water Economy	% of Max. H. P. above Rated H. P.	Uniformity of Speed		Cost of Grinding Feed	Feed Ground per Rated H. P. per hour	Fuel Economy on no load	Durability	Accessibility	Protection of Working Parts	Governor Action	Lubrication	General Finish	Cost of Repairs		Ignition	Condition of Engine after Tests	Ease in Getting Repairs	Cost per H. P., F. O. B., Wkg.	Score, of 100 points	Deductions		
a. 5 points deducted for being more than 5% above speed on brake tests.																													
b. 15 points deducted for stops.																													
c. 5 points to be deducted from score on account of feed ground being coarser than other tests.																													
* Certain data not being available, a final score for this engine was not worked out.																													

by
bu
C
gas eng
telligent
The co
trol of P
of Agri
Manitob
Prof. H
Agricul
Shanks
Mechani
million
berta.
It is to
test will
per year,
changes
the score
the conte
haustive,

So Good You Can Write Your Own Guarantee

The Judson 7-H.P. at \$197⁵⁰ Won the Gasoline Engine Contest at Winnipeg Exhibition over Engines Costing TWICE AS MUCH

Grinding over $\frac{1}{2}$ ton of barley in 1 hour on $\frac{2}{3}$ of a gallon of gasoline, or at cost of $1\frac{1}{3}$ cents per 100 lbs. Economy on Brake Test was greatest, and showing a Brake H.P. of over $7\frac{3}{4}$, or 10 per cent. above rated H.P.

We not only Save You Money on the Cost of an Engine but Save You Money on Fuel when using our Engines

Simple
Durable
Economical

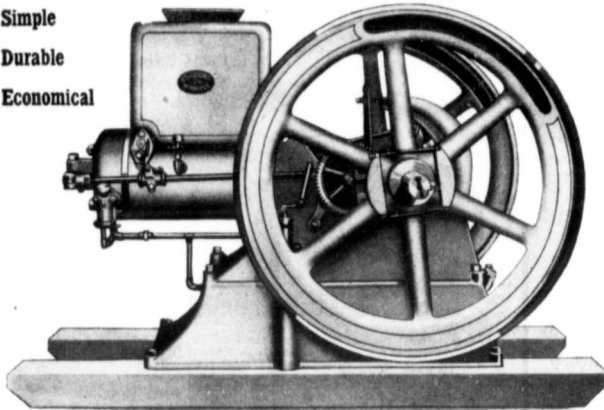

The Only High-Grade Gasoline Engine Sold Direct to Farmer

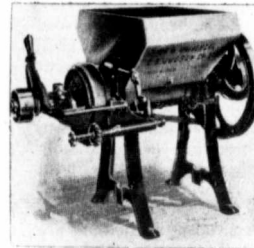

- 1 1/2 H.P. \$ 42.50
- 3 H.P. 87.50
- 5 H.P. 135.00
- 7 H.P. 197.50
- 9 H.P. 295.00
- 12 H.P. 350.00
- 22 H.P. Portable. 875.00
- 30 H.P. 1150.00

Built in magnets, \$15.00 extra.

Universal No. 4 Gas Engine Grinder, Self-sharpening burrs. Have you ever tried to saw wood without a fly-wheel on a buzz-saw? You have exactly the same trouble when running a grinder of the old type made for steam engines. That's why we guarantee this grinder to do finer and faster work with less h.p. than any other mill sold in Canada. 6 1/2 in. plate, h.p. 3 to 5, price **\$23.50** 8 in. " " 4 to 10 " **\$29.50**

From Judge's Report on Gasoline Engine Contest at Winnipeg Fair, July 15, 1914.

Make of Engine	Rated H.P.	H.P. on Brake Test	Economic Brake Test		Feed Grinding Test			Price of Engine at Winnipeg	Total No. of Points scored
			Lbs. of fuel used per 2 H.R.'s	Cost of fuel per 10-hour day for each H.P.	Length of Test	Lbs. of Barley ground	Cost of fuel per 100 lbs. feed		
Judson.....	7	7.75	9.1	21.6 cts.	1 hour	1,010	1.33 cts.	\$197.50	411.9
Lister.....	5	5.5	6.7	24.6 "	1 "	720	1.72 "	275.00	406.5
International Harvester Co.....	6	6.5	10.9	26.6 "	1 "	723	1.65 "	300.00	385.3
Cockshutt.....	8	8.00	12.3	25.6 "	1 "	380	5.18 "	415.00	332.5
Cushman.....	4	3.95	5.25	22.4 "	1 "	441	1.70 "	185.00	383.9

To prove the simplicity of our engine it was operated during this test by a boy who never worked in a gas engine factory, while all other engines were operated by experts.

This proves that the Judson Engine was built to compete with High Grade Standard Engines like the above, and not built for a price proposition like other mail order engines whose only object is price, not quality.

When you want the Right Engine at the Right Price buy a Judson, and test it on your own farm for 30 days free.

You can buy engines cheaper, but you cannot buy a better engine than the Judson at any price

Send to-day for free catalog of Gasoline Engines, Grinders, Wood Saws and farm supplies. We help you solve your labor problem. **SOLD ONLY FROM FACTORY TO FARM (no agents).**

C. S. JUDSON CO. LTD., 181 Market St., WINNIPEG, Canada

gas engine salesman more intelligently.

The contest was under the control of Prof. L. J. Smith, Professor of Agricultural Engineering at Manitoba Agricultural College, Prof. H. J. Gilmore, Manitoba Agricultural College, and G. L. Shanks in charge of the Farm Mechanics' Department, Vermilion School of Agriculture, Alberta.

It is to be hoped that this contest will be continued from year to year, and while there are some changes that might be made in the score cards that would make the contest more efficient and exhaustive, yet each succeeding



Farm Engine Contest at Winnipeg Exhibition

contest makes the rules more complete.

❧ ❧ ❧

"Do you believe that money makes the mare go?" asked Dubbleigh.

"Sure," said Wiggley. "As soon as a man gets money he buys an automobile, and the mare goes for what she's worth."

Of all the work that produces results nine-tenths must be drudgery. There is no work, from the highest to the lowest, that can be done well by any man who is unwilling to make that sacrifice.



Winnipeg, Aug. 3, 1914.

Wheat

War overshadows all other features in the market just now. The end of last month saw October wheat selling at 80½¢, really much too low, but a slow reaction to higher figures ensued until the middle of July since which time the intense drought has brought a more rapid advance. On July 27th, the fear of widespread war induced shorts to cover, resulting in remarkably nervous panicky markets until August 1st when the volume of trade in futures had become so small that violent fluctuations are unlikely. To-day there was a decided tendency on the part of the best houses to discourage any trading in futures pending more complete war news.

For the last three days the demand for cash wheat has been very jerky and uncertain, exporters almost withdrawing from the market on account of the heavy war-risk insurance rates, making the transaction of business impossible. Many feel that Europe wants our wheat and will pay a big price for it, in the event of the British fleet defeating or bottling up the German fleet. Evidently this feeling found expression today in the strength in Winnipeg, despite weakness in American markets. On the other hand a disaster to the British fleet might greatly retard the free movement of our wheat, allow stock to pile up at terminals and perhaps bring on a money panic resulting in lower prices for a short time. Or Great Britain might conserve our present stocks and new wheat crop and move same under convoy for purposes of the Empire only. So uncertain are conditions that a prediction of the outcome is only a wild guess. Meantime Russia, Germany and France have forbidden the export of all farinaceous products, while France has also removed the duty on wheat. Assuredly should peace come soon, this wheat should advance.

Western crop conditions are most unsatisfactory. Estimates carefully collected by leading grain houses indicate a crop from 60 per cent to 70 per cent of an average, subject to a still greater reduction unless some moisture or cool weather comes

in the next week. Wheat cutting is quite general in Manitoba and will be in Saskatchewan by August 5th. It is generally agreed that the grade has been lowered by the recent intense heat.

Excessive rains have reduced wheat acreage sown in the Argentine. American winter wheat threshing shows very satisfactory returns and it is carefully estimated that their winter wheat crops will still aggregate 920,000,000 bushels. World's shipments last week were large showing that the winter wheat is urgently wanted by Europe. Foreign crop prospects indicate yields well below last year's figures. Russia leading with a loss of 152,000,000 bushels. reports poor yields with too much rain. Germany and Italy fair to good crops. India has had good rains but Australia has been too dry. Great Britain has a fair crop of about 55,000,000 bushels. The American spring wheat crop is slightly below the average.

A word as to marketing. Western Canada sees this crop starting off at a figure now about six to eight cents higher than a year

GEISER and PEERLESS WINNERS

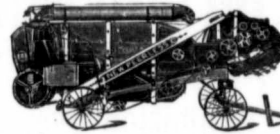

Peerless Separators

Have made the great reputation they enjoy by their light running and grain saving qualities. The "Peerless" is a separator without riddle and with many valuable features not found in any other make of machine.

We do not pretend to say that these Separators will save absolutely ALL the grain, but we do assert that they will save 98 per cent of that which is ordinarily wasted by the best machine now in the field, when it is crowded as it must be for big work; that at least 95 per cent of all the grain is separated from the straw by the time it leaves the big drum; after this we have more separating capacity than any other machine on the market. We can supply with these Separators, Wind Stackers or Straw Carriers, Self Feeders and Band Cutters, Automatic Weighers or Wagon Loaders, Flax and Timothy Attachments.

Geiser Separators Nos. 4 & 5

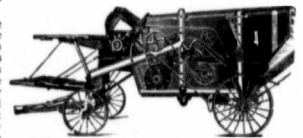

Geiser 4 Cylinder, 4 Cycle Engine

Power, Durability and Strength are all bodied in this amazingly popular tractor — the Geiser, 4-cylinder and 4-cycle type. Forward speeds 1 1/2 and 2 1/2 miles, and reverse 1 1/2 miles per hour. The crank case is exceedingly strong where bolted to other parts. Gearing is of the best open hearth steel. Vertical cylinders with cylinder head, valve box and water jacket all in one casting. Connecting rod made from a steel forging and is extra large and strong. Crank shaft is forged from one large steel; you can't beat it.

There are no riddles in this machine hence there are none to clog and give endless trouble. No time wasted in making changes for the different kinds of grain. Adjustments all made on the outside and can be done while the machine is being operated. Cylinder contains nine bars of exceptional strength and is perfectly balanced. It will positively pay you to investigate other exclusive features of this fine machine.

The exceptional results secured by users of our Diamond 40-70 Gas Tractor and the large demand for a smaller gas tractor embodying the same practical features has induced us to place the Junior Model, as herewith illustrated, on the market. Two forward speeds of 2 1/2 and 4 miles per hour; reverse speed 2 miles per hour. All controlled by one lever. Burns distillate, kerosene or gasoline. Gasoline consumption averages 8-10 pints per h.p. per hour with a slight increase when kerosene or distillate are used. Will handle five 14-inch breaking plows in average soil or six 14-inch stubble bottoms.

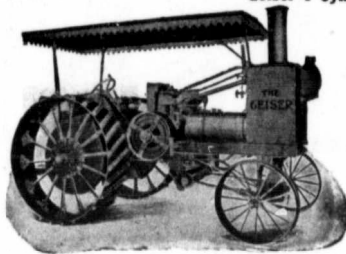

Diamond Junior Gas Tractor

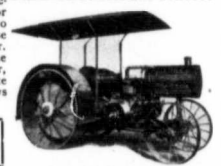

We are offering very attractive prices and terms—good until August 1st, but cannot guarantee them after that date.

Burridge-Cooper Co. Ltd., Winnipeg Man., and Regina, Sask.
Address all inquiries to Winnipeg Office.

You saw this advertisement in this magazine. Don't forget to say so when writing.

This is the sort of Letter that proves our claim for

The *Manitoba* as an Engine of strictly high grade construction, and representing all that is best in simplicity and effective service:

"Manitoba Engines Limited, Saskatoon, Sask.

"Dear Sirs:—We unhesitatingly recommend the Manitoba Engines to give perfect and entire satisfaction and to be just as represented. We have a 10-h.p. drive an Eclipse Sawyer-Mansley Separator, and although the threshing was often very tough last fall, we had always power to spare, used about 8 gals. of gasoline per 10-hour day, and had no trouble with lubrication. Our Engine was equipped with a Bosch magneto, and on cold mornings all that was necessary to start up without any trouble was to see that all connections were clear and use a couple of quarts of hot water on the carburetor.

"The simplicity of the Engine is one of its chief attractions. Gasoline engines so frequently prove disappointing that it is a real pleasure to have one like the Manitoba, and we will gladly answer personally any inquiries about this type of an engine. Wishing you every success, we are, sincerely yours, BAILLIE BROS & PUNN (per A. A. BAILLIE)."

Get our Catalogue to learn how many things the Manitoba will do and why it will do them better.

Manitoba Windmills

In all Sizes, for Power or Pumping

Made with all-steel towers, and in sizes from 6 to 14 feet. Manitoba Windmills have demonstrated by their merit that they are, beyond all, the windmills for the West. They embody many special features not found in any other mill. Our illustrated Windmill Catalogue is free for the asking.

"Made in the West for Western Needs."

We Manufacture Gasoline Engines, 1 1/2 to 25 H.P. Wood and Iron Pumps. Grain Grinders, 6 to 12 inch. Wood Saws, all sizes. Pumping and Power Windmills, 8 to 14 feet



MANITOBA ENGINES, LIMITED
Calgary, Alta. BRANDON, Man. Saskatoon, Sask.

You saw this advertisement in this magazine. Don't forget to say so when writing.

ago
tions
Farn
Auto
whea
main
in th
Arge
whea
and t
can l
price:

Str
weat
shipr
comb
past
crop
distrib
the a
Michi
likely
yet.
that o
oats a
316, a
Rus
from
pects
that c
demar
the lin

Barl
are E
bushel
crop E
of all
be the
mand
panic
prove.
hurry
brings

A be
last tw
sharply
business
panic a
oil. Ye
have fo
recently
the U.S.
ally liq
business
worth !
though
artificia
tion inf
Review
grain, fr
Autumn
a much
two yea
the volu
below fr



Name this

ago though the world's conditions are much more bullish. Farmers would likely do well this Autumn to exchange their cash wheat for May wheat, thus remaining in the market until later in the season, when, unless the Argentine crop is very large, wheat should reach better prices and the more leisurely our crop can be marketed, the better will prices rule.

Coarse Grains

Strength in wheat, unfavorable weather in the corn belt and light shipments from the Argentine, all combined to help our oats the past fortnight and with a poor crop of oats in even the best districts and great damage from the army worm in Ontario and Michigan, our October oats will likely advance five to ten cents yet. Corn visible is about half that of a year ago. Our stocks of oats at Fort William are 1,093,316, against 3,685,071 a year ago.

Russia reports great damage from the excessive heat and expects a crop 270,000,000 under that of last year. The eastern demand is good on both sides of the line.

Barley

Barley stocks at Fort William are 193,087, against 646,023 bushels a year ago. The barley crop has suffered perhaps most of all from the drought and will be the lightest in years. The demand is fair and unless money panic ensues, prices should improve. Farmers should be in no hurry to ship till September brings the malting demand.

Flax

A bear raid in this grain in the last two days carried prices down sharply. Timid holders feared business stagnation and financial panic and destroy the demand for oil. Yet many American crushers have found a good demand for oil recently. The flax crop in both the U.S.A. and Canada is unusually light. Based on normal business conditions, flax is well worth \$1.50 per bushel in store though financial conditions may artificially depress it or speculation inflate it.

Reviewing the market in all grain, farmers will likely find this Autumn, barring continued war, a much brisker market than for two years past, with little fear of the volume depressing the prices below fair levels.



¶ Four years ago we began to pay transportation charges on all our mail order business. Since then this business has increased five-fold.

¶ In emulation of this success, the whole mail order business of Canada is gradually measuring up to our prepayment methods.

But Our Clean-cut Policy

of paying all charges on everything in catalogue

is Still Unapproached

¶ In this last six months we have installed a complete new plant for handling our mail order business. It occupies four times the floor space of our former one and is one of the most complete and most modern equipments on this continent. This has enabled us to give all our Mail Order customers a one-day service, that is,

We Now Ship Your Order Within One Day Of Its Arrival

¶ This new speed service is now inaugurated because we are determined to deserve still greater business from our customers. It will give them a far more efficient service than has been possible in the past.

¶ Our new Fall and Winter catalogue, the most beautiful catalogue we have ever published, full of fine colored prints that show the actual appearance of the goods, is now ready. When you get your copy peruse it carefully. If you have not received a copy, your name and address on a post card will bring one by return mail.

Remembering These Four Points!

1. Every article in a Simpson catalogue is prepaid to your post-office or nearest express office.
2. Every order for goods from a Simpson catalogue is despatched within one day of the time we receive it.
3. Every customer gets the benefit of Toronto styles and prices just as if the Simpson store was in your home town.
4. Every order goes to our customers by fast train. We no longer make any freight shipments.

The **SIMPSON** Company
Robert Limited
TORONTO

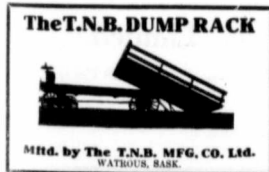

Name this magazine when writing advertisers

A Breakdown
"So, you broke your engagement with Miss Spenser?"
"No; I didn't break it."

"Oh! she broke it?"
"No; she didn't break it."
"But it is broken?"
"Yes; she told me what her

clothes cost, and I told her what my income was; then our engagement sagged in the middle and dissolved."

XXXXXXXXXXXXXXXXXXXXXXXXXXXXXXXXXXXXXXXXXXXX

XXXXXXXXXXXXXXXXXXXXXXXXXXXXXXXXXXXXXXXXXXXX

The Christie Grant Mailing House

XXXXXXXXXXXXXXXXXXXXXXXXXXXXXXXXXXXXXXXXXXXX

XXXXXXXXXXXXXXXXXXXXXXXXXXXXXXXXXXXXXXXXXXXX

It is an education to visit successful business establishments. During the past month it has been my privilege to be shown through a western mail order house that is one of the most systematic in its business arrangement of any on this continent.

Every department impresses the visitor as a high type of excellence in efficiency, system and promptness. Only experienced help is employed and this adds a dignity to the establishment that is most unusual. This class of help is enabled to make a comfortable salary and the usual careworn inexperienced underpaid employees are missing. The absence of the latter class of employees impressed me, as it is the first establishment I have visited where the poorly nourished half-hearted type has not made a silent appeal for my sympathy. Such an efficient class of employees make the visitor see harmonious co-operation throughout the entire mail order house.

The Christie Grant Co. realize that a large selection of employees makes it possible for them to sell better goods cheaper, and their customers are thus able to realize the benefit of the values made possible by superior business management. The useless complex methods used in so many mail order houses that pile up a cost of two dollars to carry out a two cent transaction are dispensed with. This is another item that makes it possible for the Christie Grant Co. to offer a superior quality of goods cheaper to the customer. In the first place the system is so perfect that errors are scarcely possible and in the second place the energy and time given to useless complex methods are utilized to prompt attention and careful selection of goods for the customer.

The accomplishment of their present attainment is convincing proof of their superior business management — an illustration of genuine Western progressiveness that astonishes the commercial world.

On Good Friday The Christie Grant Company was organized. To-day their warehouse is complete in its arrangements. The departments are filled with a high class quality of goods, many of them bearing their own stamp; the catalogues have been sent throughout the West and the employees are busy attending to a rush of orders that come in with every mail. All this has been accomplished in three months. Another feature of their work that is highly commendable is their respect for merchants in country towns. They will not antagonize them because they handle goods that are not sold in small towns.

Their catalogues contain the very latest styles in dresses, suits, millinery and lingerie. In the coat department I saw the best value in rat coats that I have seen in Canada. Ladies southern muskrat coats made of fine skins and with linings guaranteed for two seasons' wear are catalogued for \$42.50. The quality was superior to a small child's southern rat coat that I purchased last year for \$35.00 in a department store. Another most unusual value is a northern muskrat coat similarly lined for \$52.50. They carry a complete stock of smart coats at prices astonishingly low.

The smart new dresses and suits, all carefully arranged, free from handling by careless shoppers, are fresh and clean from the manufacturers for mail order customers. A silk dress for \$7.50, an all-wool panama skirt for \$4.50, a stylish fine quality blue serge suit for \$9.95 are all values that fascinate any woman who likes to dress well. These departments have solved the high-cost-of-dressing problem.

Neat house dresses nicely trimmed at \$1.00, a maternity gown of all-wool cashmere for \$5.25, serge waists for \$1.59 and children's sweater coats to fifty cents are other tempting values to the city shopper who wishes she might live in the country long enough to take advantage of the Christie Grant Catalogue House.

Hosiery, cutlery, watches, household linen, blankets, boots, laces, fancy neckwear, corsets and underwear are systematically arranged in their separate departments where the clerks may quickly gather together the goods ready for shipment.

I was especially interested in the children's clothing. It is made of good wearing quality and the ready-made garments are so reasonable that a busy mother cannot afford to make them—a real help to tired Western mothers.

Several times I have asked for infants' outfits in the stores as mothers have written me asking about them. In the outfits I have examined there were many useless articles. A complete infant's outfit at a reasonable price has been a growing demand from Western wives for a long time. Being familiar with Western needs, The Christie Grant Company have put up in neat boxes a complete infants' outfit for \$11.00.

The up-to-date millinery for fall is smart, pleasing and excellent value. One hat that is especially pretty is made with corded silk crown and trimmed with ostrich plumes and flowers about the brim with an ostrich mount. It would retail at \$15.00, but is marked \$7.95. A pretty hat with velvet brim with an ostrich

Farmers! Local Grain Buyers! Bankers!

Consign your grain to MONARCH GRAIN COMPANY, 635 Grain Exchange, Winnipeg, or, if you prefer to sell on track, wire or phone for our prices.

PHONE MAIN 7644

We are always open to buy cars of grain on track, or in store Fort William or Port Arthur. Option orders handled with care and despatch. Write for our daily price card, and our weather thermometer.

LICENSED AND BONDED

Reference: BANK OF MONTREAL

You saw this advertisement in this magazine. Don't forget to say so when writing.

The Self-Steering Device

Has earned and received more gratitude from plowmen and plowing experts than anything that has been invented for the dual purpose of saving time and labor and making absolutely perfect work.

Can be fitted to any Tractor now on the Market

It is the only patented steering device now in general use on tractors. Inures to all traction engine operators the most perfect self-steering arrangement, regardless of what make of tractor they are using. Extends only five feet in front of tractor axle to truck axle, and takes very little if any more head-land. Unanimously endorsed by prominent engine experts who acknowledge it to be a direct and simple solution of all engine steering troubles. Used all over the world on all tractors. Four successful seasons in Canada. Any man can attach it to any engine. Price is reasonable, backed by a Positive Guarantee that it will fulfill its purpose.

Write for Complete Details to

Cushman Motor Works of Canada Ltd.
Light Weight Gas Engine Builders
290 Princess Street, Winnipeg



Let the Cuddy do the Work

You saw this advertisement in this magazine. Don't forget to say so when writing.



Massey-Harris Binder

A Simple and Reliable Binder which is Easy to Handle and Easy on the Horses—The most Convenient and Lightest-Running Binder on the Market to-day.

- | | |
|-------------------------------------------------------------------------------------------|-------------------------------------------------------------------------|
| Strong Steel Frame thoroughly braced and Trussed. | Easily Adjusted Reel — one Lever does it all,—70 adjustments. |
| The Double Truss Main Frame keeps Drive Wheel true. | Elevator Chain runs outside of all Sprockets—reduces friction and wear. |
| Drive Wheel is very strong and equipped with Traction Lugs. | Effective Divider—Folds for Transport. |
| Steel Grain Wheel; substantial and strong, protected by Divider, does not run down grain. | Convenient Operating Levers within easy reach of driver. |
| The Cutting Mechanism is effective under all conditions. | Perfect Knotter; always ties and always ties tight. |
| Floating Elevator, front and rear; handles any volume of Grain. | Three Discharge Arms ensure positive discharge of the sheaf. |

Massey-Harris Co., Limited.

Winnipeg, Regina, Saskatoon, Swift Current,
Calgary, Yorkton, Edmonton.

— Agencies Everywhere —

You saw this advertisement in this magazine. Don't forget to say so when writing.

mount
marked
Compar
the cat
charges
At t
women'
one qui
with a
sells for
threw
pense
e apor
axon y
partner
attention
myself I
Grant I
similar;
tain of
landed I
Courtes
in this h
The b
a kind of
please tl
big shoe

XXXXXXXXXXXX

A

During
ternal co
been pre
There ha
on the p
to meet t
as much
mands of
have ch
owing to
experienc
certain tl
the part
were no
main ide;
something
One o

Canada is
it looks
machine ir
It weighs
is built to
twelve go
manufactu
pull three
six to 10 i
on the con
power is
that it will
machines,
spreaders,
threshing n

mount and corded silk crown is marked \$2.75. The Christie Grant Company prepays all charges, so the catalogue prices include all charges.

At the first department of women's clothing I picked up a fine quality of chambray apron with an embroidered front. It sells for 59 cents. Unconsciously I threw it over my arm, and in my intense interest in the department of aprons I walked away with the apron when the head of the department courteously called my attention to it. I congratulated myself that I was in the Christie Grant Mail Order House, for a similar act of forgetfulness in certain other places would have landed me in the police station. Courtesy is another strong pillar in this house.

The boot department has in it a kind of children's shoe that must please the parent discouraged by big shoe bills. The Christie Grant

shoe challenges any little boy or girl to wear it out before any other brand made.

The department for men's clothing contain a stock as complete as those for women. Hand-tailored suits of quality cut in the latest models, overcoats waria and in the latest style, wear-resisting garments — coats, shirts, underwear and furs all are purchases that please. A fur-lined coat, lined with pieced coon skins, dyed dark brown, with Persian lamb is catalogued to be delivered at the nearest express office for \$15.00. Caps, mittens, collars and suspenders are listed at equally low prices.

I could see no trace of disorder about — every department sanitary and sunny — all employees bright and ambitious and happy in their work, the atmosphere of the entire establishment seemed charged with optimism.

P.R.H.

Sporting Goods

THAT ARE

Fit for Sport

EVERYTHING FOR THE SPORTSMAN AND ATHLETE
BASEBALL UNIFORMS
 OUR BIG SPECIALITY



Get our prices before placing your order, as we certainly have the finest in Western Canada. Also

Baseball Supplies of all descriptions, Football Goods, Lally's Lacrosse Sticks, Tennis Goods, High Grade Cricket Bats, Kams Golf Clubs, Sweaters, Pennants, Shirts, Cycle Tires, Baseball Shoes, Waterman Canoe Engines. **GET THEM AT THE**

Sportsmen's Headquarters

P. J. Cantwell Co. Limited

346 Portage Avenue, Winnipeg, Man.

Dept. C.T.

You saw this advertisement in this magazine. Don't forget to say so when writing.

A New Tractor for Western Canada

During the past few years internal combustion tractors have been produced without number. There has been an attempt made on the part of the manufacturers to meet the demand of the farmer as much as possible. These demands on the part of the farmer have changed almost annually, owing to the fact that his field experiences have shown him that certain things were demanded on the part of the farm tractor that were not always meant. The main idea seems to be to supply something that is "all purpose."

One of the latest arrivals in

etc. It is well built, being made of the very best material, and constructed along the lines of the best engineering practice.

Some time ago we had the pleasure of a conference with Mr. Bierman who is the prime mover in the Strite Mfg. Co. in Minneapolis, and a more enthusiastic gentleman for any machine we have yet to meet. Mr. Bierman bases his enthusiasm upon what the Strite tractor has been doing across the line for the past three or four years. The company has not forced its machine upon the market, but on the other hand has

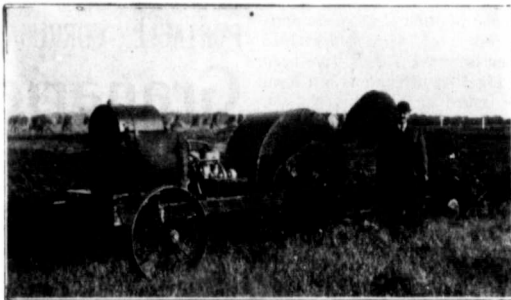

Canada is the Strite Tractor, and it looks good. It is a small machine in size, but big in power. It weighs only 3,700 pounds, but is built to do the work of ten or twelve good draft horses. The manufacturers claim that it will pull three 14 inch double plows six to 10 inches deep, depending on the condition of the soil. Its power is sufficiently flexible so that it will pull binders, mowing machines, grain drills, manure spreaders, and will drive small threshing machines, feed grinders,

gone very slowly. If they found that a change was necessary in their design or construction they have tested out this change in every particular before placing their stamp of approval upon it. The result is that the machine is comparatively free from imperfections.

This machine is handled by the Burridge Cooper Co. Ltd., of Winnipeg, and anyone in need of a small tractor will do well to get into touch with this concern.

There are many good reasons why the use of

DUNLOP Thresher Belting

is quite general throughout every threshing community.

Threshermen are beginning to realize that rubber Belting surpasses any other kind of Belting for the work they have to do, and

That Dunlop Thresher Rubber Belting embodies all the good qualities of an Ideal Rubber Belt.

Dunlop Thresher Belting is made in the finest, the largest, and the best equipped Rubber Factory in all Canada.

**BY EXPERT WORKMEN
 IN A UNIFORM WAY
 FROM THE BEST
 MATERIALS**

Wherein lies the secret of
**SERVICE, QUALITY
 AND SATISFACTION**

Ask our nearest Branch for a sample of the Belt.

Dunlop Tire & Rubber Goods Co. Limited
 Head Office and factories: Toronto

BRANCHES—Victoria, Vancouver, Edmonton, Calgary, Saskatoon, Regina, Winnipeg, London, Hamilton, Toronto, Ottawa, Montreal, St. John, N.B.

You saw this advertisement in this magazine. Don't forget to say so when writing.

La Compagnie Desjardins Famous Small Threshing Machines
"THE CALL OF THE WEST" Sold by

A. STANLEY JONES : : : North Battleford, Saskatchewan

General Sales Agent for Saskatchewan and Manitoba and British Columbia

Head Offices: "The Industrial Spur East" Phone 223 and 220

Suitable for 4, 6, and 8 H.P. Engines

Prices from \$284.00 to \$317.00 including high loader, chaff return, straw carrier and all separator belts and also the freight paid to any point in Sask. or Manitoba. (Time terms also; write for them.) Capacity from 350 of wheat to 600 or 700, and of oats 600 to 1500 according to size taken, your threshing bill will be more than your payment. These machines have been made since 1864. I introduced them to the West 4 years ago and we are the original ones and want you to remember this owing to the many imitations. Do not buy any sort of machine without getting my catalog. The prices mentioned above are for separators by themselves and they will work well with any engine of good power, such as Fairbanks Morse, Stickney, Galloway, I.H.C., Judson, Gilson, Starite, Armstrong, Cushman, Eaton, Gould, Shapley and Muir. If you have any one of these engines now is the time for you to order your separator so that this year you will not have to wait for any thresher. Your stooks will not be left in the field but will be threshed at the right time, and you will get your fall plowing done. Immediate shipment and freight prepaid!

If you want engine and separator, we have them and can quote you \$383 to \$612 for engine and separator freight paid anywhere in Saskatchewan and many points in Manitoba. The \$612.00 consists of 28" separator, high loader chaff return, straw carrier, all belts including main belt and an 8 H.P. engine. Time Terms also. WRITE FOR FREE CATALOG.

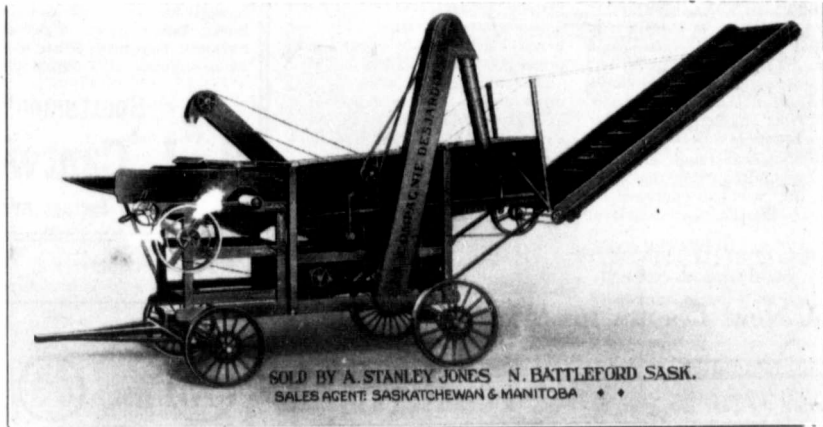

SOLD BY A. STANLEY JONES N. BATTLEFORD SASK.
SALES AGENT SASKATCHEWAN & MANITOBA

You saw this advertisement in this magazine. Don't forget to say so when writing.

How to Tell the Age of Hens and Pigeons

There has been a great development of late years in the Canadian poultry industry. This development has been brought about by many factors, chief among which are the untiring and highly successful efforts of breeders; the experimental work carried on at the various poultry plants of the Dominion and provincial experimental farms and agricultural colleges; the information given out by these institutions; the poultry exhibits in which the people of Canada are now taking a great interest; and, last, but not least, the profits of the industry—little thought of it in the past—but now well recognized and appreciated.

Production is increasing at an extraordinary rate while the quality of the product shows wonderful improvement. The value of the flock depends upon the production of the birds selected, but the productiveness of any bird decreases after a certain age is reached. It is very important, therefore, that the breeder be able to tell with some degree of certainty the age of the fowls which he desires to retain or purchase for breeding purposes, otherwise he will be exposed to the risk of hav-

ing individuals that are past their prime and that do not pay for their keep.

Record books have been established for horses, cattle and many other animals where information pertaining to pedigree, age, etc., is kept for reference, but it has remained to Victor Fortier, Assistant Dominion Poultry Husbandman, Central Experimental Farm, Ottawa, after much personal observation and study, to publish a method whereby the age of hens can be accurately estimated. This information, which is meant especially for the breeder and the judge, has been published under the direction of the Hon. Martin Burrell, in a profusely illustrated bulletin, which is No. 16, Second Series, of the Central Experimental Farm. Copies will be mailed to those who apply for them to the Publications Branch, Department of Agriculture, Ottawa.

Varieties of Grain Crops to Grow

For twenty-six years the Dominion Experimental Farms have been experimenting with grain crops at the various Farms and Stations distributed over Canada trying to learn which var-

ieties give best results in the different provinces. Not only have the best known sorts produced at other places been grown side by side but at the Central Farm at Ottawa new varieties have been bred, and when found desirable, perpetuated and distributed to growers.

For the information of the Canadian farmer the more important results of the season of 1913 at the different Farms have been put together in summarized form and issued in Bulletin No. 74. There are included in this some recommendations as to varieties to grow and methods of production to follow that should prove of great service to growers in all parts of Canada.

Referring to "Marquis" wheat which was bred at Ottawa the bulletin says, "Marquis produces very large crops, has usually good straw and is more resistant to rust than most of the common varieties." A large edition of this bulletin has been printed so that all who desire copies may secure them by applying to the Publications Branch, Department of Agriculture at Ottawa.

Moike—Pat, phwat is diplomacy?
Pat—Diplomacy is when yez wants to call me a liar, but does it over the telephone.

By December First—

You will have made and saved enough in using our

PORTABLE CORRUGATED Granaries

to pay for them.



This is the only Granary on the market that has passed the experimental stage. It is cheap, durable, permanent. Fire and Vermin Proof.

Write today for full particulars of our remarkable offer.

Winnipeg Ceiling & Roofing Company, Limited

P.O. Box 3006 CT, Winnipeg, Man.

Splic
5. Dr
right by
rope firr
ing each
the othe
are 32.
6. Spl
the rop
with the
as show
mainder
finishing
making
are 34 s
complete
the finis

The sq
ropes
will draw
with sma
knot for
gether.
dyed bla
illustrati
may be ti
illustrati



1. Cross
proper one
in Figure
2. Move
the arrow i

Knots for Tying Ropes Together

Continued from page 39 June Issue

Spliced Crown (Continued)

5. Draw the three strands down tight by holding the end of the rope firmly in one hand and pulling each strand alternately with the other hand, as shown in Figure 32.

6. Splice the three strands into the rope, starting each strand with the aid of a marline spike, as shown in Figure 33. The remainder of the splicing and the finishing is done exactly as in making the short splice. Figure 34 shows the splicing partly completed, and Figure 35 shows the finished work.

Figure Eight Knot

The figure eight knot is used for preventing the strands from untwisting, and for forming a knob or hand hold at the end of a rope or at any point between the ends. In making it form a bight as shown in Figure 36, then move the end as shown by the arrow in Figure 36 until it is in the position shown in Figure 37 and draw it up tight.

Overhand Knot

The overhand knot is used for the same purpose as the figure eight knot, and is made by forming a bight through which the end of the rope is passed. The loose knot is shown in Figure 38.

Fig. 36



Fig. 37



Fig. 38



Knots for Tying Ropes Together

Square Knot

The square knot is used for tying ropes securely together, but will draw rather tight especially with small ropes. It is a good knot for tying binder twine together. One rope has been dyed black in order to make the illustrations clearer. The knot may be tied by consulting the illustrations and directions.

in the position shown in Figure 40.



Fig. 40

3. Move ends A and B as shown by the arrows in Figure 40 until they are in the position shown in Figure 41. Be sure the proper end is nearest you at the point of crossing in the right hand.

4. Move end B as shown by the arrow in Figure 41 until it is in the position shown in Figure 42 and draw up tight as shown

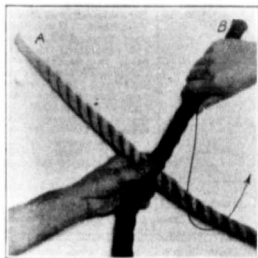

Fig. 39

1. Cross the ropes with the proper one nearest you as shown in Figure 39.
2. Move end B as shown by the arrow in Figure 39 until it is

ASK FOR FIVE ROSES FLOUR

The World's Best



Send for Five Roses Cook Book—

COUPON
Write Name and Address plainly. Don't forget to enclose Ten Cents in stamps.

NAME: _____
ADDRESS: _____
NAME OF DEALER: _____

BEING A MANUAL OF GOOD RECIPES carefully chosen from the contributions of over two thousand successful users of Five Roses Flour throughout Canada. Also Useful Notes on the various classes of good things to eat, all of which have been carefully checked and re-checked by competent authority.

Address your Envelope to LAKE OF THE WOODS MILLING CO. LIMITED, WINNIPEG

If unable to secure Five Roses Flour from your local dealer, write the Lake Of The Woods Milling Co. Limited, Winnipeg.

You saw this advertisement in this magazine. Don't forget to say so when writing.

OXY-ACETYLENE WELDING

Mr. THRESHERMAN:

If anything breaks or is worn out on your threshing machine or traction engine have it welded. Your time is valuable and we are at your service. Tell us your troubles. Send the broken parts to us or ask us to come to your place. No waste of time and no trouble to us. We are the pioneers of the process. We are experts and guarantee our work. Lowest prices.

L'AIR LIQUIDE SOCIETY, 325 William Ave., Winnipeg, Man.

Largest manufacturers of Oxygen and Welding Plants

Ask for information and newest catalogue.

You saw this advertisement in this magazine. Don't forget to say so when writing.

CAST IRON WELDING

also CAST STEEL, BRONZE, MALLEABLE IRON, STEEL, COPPER AND ALUMINUM, under a positive guarantee.

Do not hesitate to send us your broken cylinders, cylinder heads, connecting rods, crank cases, engine beds, bull pinions, etc., and we will return them as good as new and stronger where mended at a great saving.

We do not attempt to repair certain castings on which a saving cannot be made in which case we sell it for scrap and return the proceeds to the customer, which helps to pay the freight.

Entrust the work to us, we have the oldest and largest Oxy-Acetylene welding works in the West.

Inquiries cheerfully answered.

MANITOBA WELDING & MFG. CO.

62½ PRINCESS STREET

WINNIPEG, MAN.

Established in 1911.

You saw this advertisement in this magazine. Don't forget to say so when writing.

Be sure To Renew Your Subscription Before It's Too Late

in Figure 34. Both parts of one rope should be in front of or be-



Fig. 41

hind the other, as shown at points C and D in Figure 42 and



Fig. 43

not as shown at points E and F of the granny knot in Figure 44.



Fig. 45



Fig. 45

Granny Knot

The granny knot, shown in Figure 44, is of very little use



Fig. 44

and tends to slip under a pull. It is only tied by those who do not know the difference between it and the square knot.

Bread-Box Knot

The bread-box knot, shown in Figure 45, looks very much like the square knot, but it is very apt to slip. The difference in the finished knot is in the positions of the ends A and B, as you will see in comparing Figures 42 and 45.

To be continued

Duro Violins
Victoria Mandolins and Guitars
Stewart Banjos
Have a World-wide Reputation.
Instalment Payments Accepted. Get Particulars
ROYAL MUSIC COMPANY
460 Spadina Ave. Toronto

Name this magazine when writing advertisers

Has it Ever Happened

that you were short of help at threshing time, or that your expenses were too heavy? You can guard against this

The Answer is—

Hart-Brown Wing Carriers

ATTACHES
TO ANY
SEPARATOR
WITH ANY
FEEDER,
OLD OR NEW



Mr. Hart B. Carrier will prove the best hired man you ever had. The carrier attaches to the main sills and main frame of separator, putting no weight on feeder. It delivers the bundles to the band knives straighter, more evenly and uniform than is done by hand. It facilitates rapid and steady threshing. The troughs swing about as is most convenient, and the carriers will save the services of from two to four pitchers, and if used with the Hart Universal Thresher Racks will

SAVE EIGHT TO TEN MEN AND TEAMS

The Hart Universal Thresher Rack fits on any wagon or truck gear, has no derricks or other complicated parts for unloading—only a simple pull-off gate that holds the load while the rack is withdrawn from beneath it.

No waits at the machine for an opportunity to unload. No time wasted in pitching off.

One rack and driver will do as much work as two ordinary racks, two drivers and one field pitcher.

Racks may be purchased complete, or you can **Build Racks Yourself**. We will furnish plans, specifications and license.

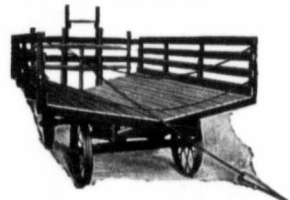

Sold by Canadian Avery Company

WINNIPEG, Man. - and - REGINA, Sask

Manufactured by **HART GRAIN WEIGHER CO., PEORIA, ILL.**

You saw this advertisement in this magazine. Don't forget to say so when writing.

"\$612.00 Complete Threshing Outfit."

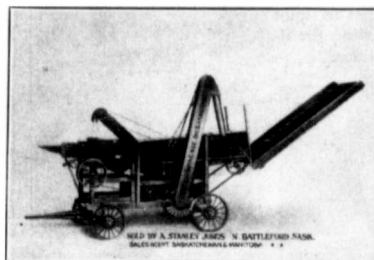

8 H.P. Engine, Carrier, High Loader, Chaff Return. All belts, can be mounted on one platform on any wagon. Capacity four hundred to one thousand bushels according to grain. Large stocks at North Battleford. Smaller sizes from \$383, engine and separator. Carriage paid in Saskatchewan. Cut shows separator at \$284 and \$317, freight paid in Saskatchewan. Cut shows separator at special \$65 truck. Extensible to 16 feet to carry whole outfit. WRITE FOR FREE CATALOGUE and time terms also.

A. STANLEY JONES, North Battleford

General Agent for Saskatchewan and Manitoba, La Compagnie Des Jardins. Established 1860.

You saw this advertisement in this magazine. Don't forget to say so when writing.

Halt!

Two Irishmen were among a class that was being drilled in marching tactics. One was new at the business, and turning to his companion, asked him the mean-

ing of the command, "Halt!" "Why," said Mike, "when he says 'Halt,' you just bring the foot that's on the ground to the side by the foot that's in the air, and remain motionless."

Moist

Moist factors North limiting portion yield is by the during cumulat other o for consists ture car 1913, th snow fa the spr The am rainfall ance. T moisture now or a certain that is that ha carried o fall.

The r vestigati Demons brought moisture from the large fa year's cr ations w the Den last fall. have sho of the fa ture as (is slightl age of th ing to th of availa sidering t section of moisture average.

The Perfection Granary

Built on the One Correct Plan---Heavy Angle Iron Framework with Sheet Metal Covering

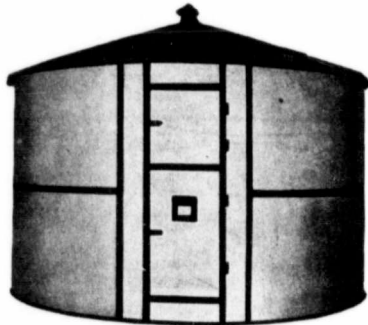

Patent Applied For
CAPACITY 1000 BUSHELS
Diameter 14 ft., Height 8 ft., Shipping Weight 1100 lbs.

The "Perfection" Granary is the result of a determination to build a Granary that is perfect in every respect. About a score of Granaries were built and discarded because faulty in some way or other. Finally we discarded as impractical any system of construction by bolting sheet metal to sheet metal. We now weld on each four sides of each body sheet heavy Angle Iron. Bolts fasten Angle Iron to Angle Iron. There is no bolting of metal sheet to metal sheet, as this is wrong, as wind lugging on such bolts eventually tears them through the metal. We have developed this use of Angle Iron into what every one admits is a perfect Granary. At least 500 farmers have inspected this Granary and not one could find a single fault. Hence the name "Perfection."

No wind can blow this Granary down; no weight of grain can collapse it. It is simplicity itself to bolt the sections together. It took us six years to build this Granary.

Write us for Circular giving Full Particulars, Prices and Terms.

OUR GUARANTEE: Money back if you are not satisfied and we will pay Freight both ways.

This Guarantee could not be given with any other Granary.

Winnipeg Steel Granary and Culvert Co., Limited
Winnipeg, Man.
P.O. Box 3054 C.

You saw this advertisement in this magazine. Don't forget to say so when writing.

Moisture and Crop Production

Moisture is one of the essential factors in crop production. In North Dakota it is also one of the limiting factors. Through many portions of the state the crop yield is determined more largely by the rainfall and its timeliness during the season and the accumulated moisture than by any other one factor. The moisture for producing this year's crop consists of the accumulated moisture carried over in the soil from 1913, the absorbed portion of the snow fall from this winter, and the spring and summer rains. The amount and timeliness of the rainfall are also of much importance. There is only one of these moisture factors that is known now or that can be controlled to a certain extent by the farmer; that is the amount of moisture that has been accumulated or carried over in the soil from last fall.

The results of five year's investigations on the North Dakota Demonstration Farms have brought out the fact that the moisture carried over in the soil from the fall before is one of the large factors in producing next year's crop. Moisture determinations were made on the fields of the Demonstration Farms late last fall. These determinations have shown that considering all of the farms, the amount of moisture as contained in the subsoil is slightly over that of the average of the last five years, amounting to the equal of 1914 barrels of available moisture. In considering the farms in the western section of the state, the available moisture is somewhat below the average. These facts are of im-

portance, for it has been found that when the soil is well supplied with moisture in the fall, a fair crop is generally secured the next year. However, when the soil contains but little accumulated moisture, the succeeding year's crop is light unless carried through the spring and summer by timely and abundant rains.

In the fall of 1912, the first three feet of the soil averaged 2,311 barrels of available water per acre. The crop of 1913 on the Demonstration Farms averaged 17½ bushels, in spite of the dry May and June. The crop was carried through these months by the accumulated moisture in the soil. The farmer should consider moisture conditions in planning his crops for the year. This is especially true where one does not practice a form of rotation which results in the accumulation of soil water from year to year. The soil moisture on any farm may be determined to a considerable extent by examining and noting the depth to which the moisture goes, and determining approximately how moist the soil is. Under conditions of a dry soil with a comparatively small amount of accumulated moisture, few chances should be taken in the sowing of large acreages of small grain crops. Instead, a larger proportion of the land should be summer tilled or planted to a cultivated crop, thus allowing the accumulation of moisture for succeeding years. In this connection, it is important to remember that the cultivated corn or potato fields have invariably shown a high moisture content, and that these fields are the ones that we must depend upon for the production of the paying crops in light rainfall seasons.

HARROW WHILE YOU PLOW

Showing method of attaching Christiansen Engine Plow Harrow. This harrow is flexible and is built of steel.

Don't go over your land twice when once will do. The ground is always easiest to level when it is just plowed.

The CHRISTIANSEN LINE OF PLOW ATTACHMENTS is the most complete to be found anywhere. Made to fit any style or make of plow, moldboard or disc.

THE CHRISTIANSEN ENGINE PLOW HARROW

is the only harrow on the market today that can be used successfully after an engine gang. It can be adjusted to any angle, and does not interfere in the least with turning at the ends. Adjustable to same angle for all sizes of plows.

Can be changed to a horse-harrow in a few minutes
NO DRAW BAR REQUIRED

Don't begin your Spring work until you have investigated our line of harrow attachments. They have no equal. More of them in use than all other makes combined.

PRICES FOR ENGINE PLOW HARROWS

6-bottom, 2 sections	\$18.00
8-bottom, 3 sections	24.00
10-bottom, 4 sections	30.00
Gang Plow, 36-in.	10.00
Triple Plow, 48-in.	11.00

If your dealer cannot supply you remit us direct. Money refunded if not satisfactory after a fair trial. Dealers wanted in Manitoba, Saskatchewan and Alberta.

NO SIDE DRAFT

Saves \$2 per day for every plow and man.

The Christiansen Harrow Co.
351 Austin Street, WINNIPEG, Man.

You saw this advertisement in this magazine. Don't forget to say so when writing.

OUR YOUNG FOLK CONDUCTED BY Cousin Doris.

Girls' Cozy Corner

Waiting

By Fannie Stearns Davis
Your little room beneath the eaves
Is sweet and cool and white,
The window's dim with lilac leaves
That break the hot noon light.

The muslin curtains sweep the sill;
I made them fresh for you,
And gathered daisies up the hill,
Sweet fern and meadow rue.

A thin white gown for you to wear
Hangs on the closet hooks,
And on the little table there
Stand all your poetry books.

O little girl who grew so tall,
And went away so soon,
Are you not coming back at all
By nightfall or by noon?

Are you not coming back to see
Your garden, running wild?
Are you not coming back to me,
Who am your mother, child?

Your little room can wait for you,
A score of Junes, maybe,
Can bring you ferns and meadow rue
And curtains quaint to see:

Your poetry books can wait, but I,
I cannot always wait,
O child, I would not have you cry
At coming back too late!

The Brave Little Girl

By Tudor Jenks.
A brave little girl (perhaps 'twas you)
Once thought she met a bugaboo—
As large as any ever seen,
Quite as cross, and twice as green!
It seemed to be just—standing there,
With something between a grin and a glare.

But this little girl said to the bugaboo,
"Oh, pooh! I don't believe in you!
There is no need for you to stay,
So—scat! You'd better run away!"
And just as sure as sure can be,
That bugaboo changed to the stump of a tree!

Then the brave little girl just nodded
her head:
"I see it's true as Mamma said—
That the bugaboo isn't even an elf:
It's only a 'when-you-scare-yourself.'
If you just keep cool and say, 'Oh, pooh!'
It puts an end to the bugaboo!"

Prize Poem

The prize is awarded this month to Frances Margaret Eleanor Whitehead, who wrote the following poem. She is a little girl, only eight years old, and Cousin Doris thinks it is a wonderful composition for such a little girl.

A Song of the Seasons

(1)
Oh what does it mean when the robin comes,
And builds his nest with a sweet, sweet song,
And the crows fly caw, caw over head,
These are the signs that spring has come.

(2)
Yes what does it mean when the fruits are ripe,
And the birds with their little ones fly,
Oh this is the sign that summer is nigh,
And that spring hath floated by.

(3)
And what does it mean when the colored leaves fall,
And the birds fly away to the south,
Come, these are the signs that autumn is here,
And footsteps cold lingering near.

(4)
Now what does it mean when the cold blizzards blow,
And love goes around through the house,
Oh this is the sign that winter has come,
With Jack Frost to nip and jolly good fun.

(5)
But the warm summer days are more to my taste,
When I can take part in a bare footed race,
But which of these four do I love best?
I will leave it to you and to all to guess.
—Frances Margaret Eleanor Whitehead, Silton, Sask.

"Country Boys' Creed"

We suggest that this "Creed" should be printed in bold face type and hung up in a conspicuous place in every rural school room in Western Canada.—(Ed.)

"I believe that the country which God made is more beautiful than the city which man made; that life out of doors and in touch with the earth is the natural life of man. I believe that work with nature is more inspiring than work with the most intricate machinery. I believe that the dignity of labor depends not on what you do, but how you do it; that opportunity comes to a boy on the farm as often as to a boy in the city; that life is larger and freer and happier on the farm than in the town; that my success depends not upon my location, but upon myself; not upon my dreams, but upon what I actually do; not upon luck, but upon pluck. I believe in working when you work and in playing when you play, and in giving and demanding a square deal in every act of life."

Webb, Sask., June 25.

Dear Cousin Doris:—May I enter your club? I like to read the girls' and boys' stories. Some of them are very interesting, so I thought I would write. I live with my grandpa and grandma. Their names are Mr. and Mrs. Echer. My name is Huldah Hoover. I am 10 years old, and I live on a farm in summer and in town in winter. I would rather live on the farm, but I have to go to school in winter, so we move in town. I will close with a recipe for brown bread:— 2 cups sweet milk, 1 cup of sour, 2 cups corn meal, 1 cup of flour, 2 table-spoonfuls molasses, 1 teaspoon soda.

I remain, wishing the club every success. Hoping to see my letter in print.
Huldah Josephine Hoover.
Thank you for your recipe, Huldah.

What a Beautiful Flower Garden You Must Have, Jeans.

Dundee, Man., May 26, 1914.

Dear Cousin Doris:—This is the first letter I ever wrote to your charming club. And when mail day comes I always turn to the children's page first.

I am fourteen years old, and am in the seventh grade at school. My favorite studies are reading and composition. Yesterday we had a holiday. It was Victoria Day. But it rained nearly all day, Friday before we kept Empire Day in

the usual way. This spring, on the 27th of March I fell at school and cut my knee open on some ice. I did not get to school for 37 days, so I was not anxious for a holiday. This spring I put up two tin pails, also an old tea pot and crock-birds are building in them. In one there are four eggs, and she is not done laying. Her nest is made from wool, grass, strings, hair, paper and lined with straw. Her eggs are green with black dots. I stand on a chair to peep in. I would not destroy them, as I love birds.

Yesterday I set a hen, and if she has chicks I will sell them to get money. How many cousins have chicks of their own? Last year we had over eighty, and the rats ate them all but one. This year I made a funny scarecrow to frighten them away.

My flowers are not up yet. I planted dahlias, sweet peas, asters, pansies, petunia, mignonette, balsam, nasturtium, sweet William. The wild flowers are beautiful. I have found crocus, buttercup, violet, primrose, marigold. This morn-

With the lift of his chin, and a bit of grin,
Without any doubting or quidding,
He started to sing as he tackled the thing
That couldn't be done—and he did it.

There are thousands to tell you it can't not be done;
There are thousands to prophesy failure;
There are thousands to point out to you one by one.

The dangers that wait to assail you
But just buckle in with a bit of a grin,
Then take off your coat and go to it,
Just start to sing as you tackle the thing
That "cannot be done." and you'll do it.

—Anonymous.

Your capital is time—given to you in twenty-four hour lots each day. Don't squander your capital. Make it an asset that will yield you a goodly rate of interest the rest of your life. The street car companies get rich on five-cent fares. The prudent man acquires knowledge by turning to profit the odd moments of the day. No matter how busy you are, you have a few spare minutes each day. Put that into a systematic effort to master some one thing. At the end of the year you will know more and get paid more. Get a strangle hold on the habit of success.

The borrower runs in his own debt. Has a man gained anything who has received a hundred favors and rendered none?—Emerson.

The things you'll be remembered by are those things which you do differently from others.—Glen Buck.

No letters ever go into the waste paper basket. Sometimes they are lost on the way.

Deer Lodge, Sask., June 15th, 1914.

Dear Campers:—This is my second letter to your club, but the last one landed in the W.P.B. I am sixteen years old, but hope I am not past the age limit. I only go to school in the winter time, but am in Grade VI. I see most of the members have had adventures to write about, but I have had none worth while. We take "The Canadian Thresherman" and like it real well. My father has a "Big Four" engine, and is away breaking. I do all the work at home, such as doing the chores and milking.

Well I think I will close now, as it is getting late. Will write later on if this one is printed.

Yours sincerely,

Theodore Grimes.

P.S.—If any of the members care to write to me I will answer them with pleasure.—T.G.

Baldon, Sask.

Dear Campers:—This is my first letter I have sent to your club, and I hope you receive it. I would like to see in print. I like to kill gophers and cut their tails off, and get money for them. I have got 200 now. I shot at a goose and I thought I hit it, but it got up and flew away.

We had a prairie fire, and it got a long way before we put it out, but it

ing my cousin and I went in a creek to get marigolds, and she lost one of her rubbers and did not know it till she reached school. But we got some huge bunches of flowers anyway.

I hope my letter will not be judged till the W.P.B. has dined.

Wishing the paper every success, I remain,
Jean Edie.

Canadian Boys' Camp

A Boy's Will

Somebody said that it couldn't be done,
But he, with a chuckle, replied:
That "maybe it couldn't," but he would be one.

Who didn't say so till he tried,
So he buckled right in, with the trace of a grin

On his face—if he worried, he hid it.
He started to sing as he tackled the thing
That couldn't be done—and he did it.

Somebody scoffed, "Oh, you'll never do that;
At least, no one ever has done it."
But he took off his coat and he took off his hat,
And the first thing we knew he'd begun it;

did no
and har
We lu
two cow
ginger
a fine c
of his f
one bro
Vera. Y
name is
I go to
grade.
had two
dance
and
it is n
white n
bye and
Dear C
ter to y
My b
Thresh
I am t
am in g
dron in
El
Dear C
letter to
short on
I came
myself.
brothers
they will
later.
I am i
the comm
I think
One of
Life
Glen M
Winch
e-need.
ple ab
and salu

Shooters at the Traps and in the Field Unite in Praising

BALLISTITE DENSE AND New BULK Empire Smokeless Powders

Uniform under all conditions, high velocity, close pattern, light recoil. These famous powders can be had in any shell loaded in Canada. Your dealer can supply you. **INSIST!**



You saw this advertisement in this magazine. Don't forget to say so when writing.

did no damage, and it was very hot and hard to fight.

We have 45 hens and 17 horses, and two cows and four calves. We have a ginger cat. He catches gophers; he is a fine cat. We call him Ginger, because of his fur. I have three sisters and one brother. My sisters' names are Vera, Yvette and Louise; my brother's name is Harold. I am 11 years old. I go to school, and I am in the fourth grade. I like to read your letters. We had two dogs, and we took them to a dance and lost them, so we have no dogs now. This is the 28th of April, and it is snowing. The ground is almost white now. I think I will close, so good bye and good luck to the campers.
Teddy Smeeton.

Ste. Anne, Man., May 5, 1914.

Dear Campers:—This is my first letter to your club.

My brother takes "The Canadian Thresherman and Farmer."

I am 6 years old. It is raining. I am going to school. There are 20 children in school.

Dick Toews.

Elfrs (Box 1), May 31st, 1914.

Dear Campers:—As this is my first letter to your club I will only write a short one.

I came from England last spring by myself, leaving both my parents, six brothers and two sisters, but I think they will all come out here sooner or later.

I am fifteen, and was through with the common school.

I think this country is a grand one.

One of the most excitable days of my life was when King George and Queen Mary came to visit the people of Winchester just after they had been crowned. There were just millions of people along the roads to see them pass and salute them.

He was in a fine carriage drawn by some fine cream colored horses, and a man sat on each of the horses' backs



Looking Wise but saying little.

Well, now, I must close, as this is not a very short letter.

Wishing the club every success.

Charley Mould.
I would like some of the campers to correspond with me. I will answer all letters.

A Blessed Blunder

There is in the State of Georgia a man with no less than three academic de-

grees, whose first desire for an education was brought about in a singular way. When this man was seventeen years old, his father let him leave school and go to work on a piece of land of his own.

In the fall, after the young man's little crop of corn, cowpeas, and pumpkins was "laid by," the young people of the village began to have "moonlight parties." There was one pretty, brown-eyed girl at home from college for her first vacation, whom the young farmer particularly admired. One day he timidly addressed to her the following note:

"There is going to be a party up at Mrs. Hall's this evening. Will you except my company?"

The girl, following a careless neighborhood custom, replied at the foot of the sheet on which the young man had written. Her reply was brief. "Certainly," was the only word she wrote except her name.

The young man was elated. He spent two or three hours in dressing for the occasion, and planning the things he should say to his fair companion. When he reached the young lady's home, he was much surprised to meet her coming out with another boy.

"What does this mean?" he inquired, with considerable spirit.

"It means," responded the girl with equal spirit, "that I have done exactly what you asked me to."

Dumbfounded, the young man turned and started home. On the way he purposely stepped into a mud puddle, and spattered his shoes and trousers. Feeling as if he were choking, he tore off his first standing collar with so much force that he broke the bone collar button he had borrowed from his father.

When he got home he stole up into his own room, and there, alone, read over and over the note he had written to the

girl, which she had returned with her reply. It seemed all right to him. He read it a score of times, and at each reading he got more angry.

Finally he exclaimed, "She's a fool! Going to college has turned her head!"

His mother, in the next room, heard him, and hurried in to see what was the matter.

Struggling bravely to keep his voice from quivering, he told her what had happened. She asked to see the note. The moment she had read it she saw what was wrong.

She handed her son a small dictionary that lay on a side table, kissed him, and said "Good night, my boy. It is really your fault; but I am afraid Lula thinks a little too well of herself, too. Perhaps she thought you were making fun of her in some way."

His mother had not been out of the room ten minutes when he discovered his mistake and made five resolutions: first, to tell Lula, politely, that he had meant no disrespect; second, to let Lula alone; third, to get an education; fourth, to get an education; fifth, to get an education.



A promising Craftsman and his last achievement

OUR WOMEN FOLK

CONDUCTED BY
PEARL RICHMOND HAMILTON

Special to the Home Economics Societies

This department publishes every report received and as received. Recently a request from the Agricultural College has been sent to the societies asking the reports to be forwarded to Miss Gowseil, and she will have them published in the Canadian Home Journal.

If the purpose of this request is to have these reports and correspondence edited, we would take the opportunity to point out that we have never "edited" a single line of any H.E.S. matter that has passed through our hands in so far as to suppress or change the import of what was written. We have always felt that the ladies of the "Home Economics" in Manitoba were thoroughly capable of putting their thoughts into good understandable Anglo-Saxon. Our uniform experience has been that their news contributions have been sent in exceptionally good form, showing remarkable journalistic merit in more than one case, and that their essays or comments on matters of the moment have been marked by sound common sense and real womanly instinct. Anyhow we have tacitly acknowledged their liberty to think without restriction, and have seen to it that the freedom of their expressions was not to be tampered with in these columns.

This department is a forum for the free expression of our women folk. Editorially we have said nothing regarding the friction between the Agricultural College and the H.E.S. On the other hand, for the past two years we have upheld the college in every possible way.

The women of Manitoba are intelligent women—many of them are better educated, and have had a far wider experience of the theory and practice of household economy than some of us who have gone to lecture to them. There are times when we resent the attitude of these hired educators—sometimes extremely youthful and notoriously inexperienced ones, who come from points where conditions of life are wholly different in many particulars—to tell us how to do things, especially when we have been DOING the things for ten, twenty years — and successfully too. Recognizing this fact we repeat that we are pleased to have our department open for the free discussion of any subject that concerns our women folks.

We are a Western publication, and we strive to publish that which applies to Western conditions. We trust we may continue to have the reports from the H.E.S., because it is a Western society. We shall give the H.E.S. reports and papers prompt attention in publication, and trust the women of the province will continue to send us the intensely interesting and wholly instructive reading they have honored us with in the past. Knowing personally most of the H.E.S. presidents, we feel that a bond of sympathy exists that cannot be severed by what may be nothing more than the unthinking strictures of some subordinate official. Freedom of expression is encouraged in our department as we have said because we recognize the intelligence and the right of those women.

The women of the H.E.S. of Manitoba are united in one great aim, viz, the improvement of their homes, their community and their country in every possible way.

In this great ambition they are too big minded to be influenced by any whim on the part of what is so much, after all, a matter of "here to-day and gone tomorrow." The women of Manitoba are here all the time. They cannot afford to sacrifice the interests of their community. In this great ambition H.E.S. women we are with you.
Pearl Richmond Hamilton.

Watch the Corners

If you wake up in the morning of a chill and cheerless day
And feel inclined to grumble, pout or frown,
Just glance into your mirror and you will quickly see
It's just because the corners of your mouth turn down.
Then take this simple rhyme,
Remember it in time,
It's always dreary weather in country-side or town
When you wake and find the corners of your mouth turned down.

If you wake up in the morning full of bright and happy thoughts
And begin to count the blessings in your cup,
Then glance into your mirror and you will quickly see
It's all because the corners of your mouth turn up.
Then take this little rhyme,
Remember all the time
There's joy a plenty in this world to fill life's cup
If you'll only keep the corners of your mouth turned up.
—Sunshine Corner.

Brave Angels of Mercy PEARL RICHMOND HAMILTON

For some time I have wanted to bring before our women readers a few facts concerning an institution that shelters girls from Manitoba and Saskatchewan rural places, as well as cities. Last year forty girls came from Saskatchewan

rural places, and forty more from country places in Manitoba—besides a large number from the city.

About a year ago a young motherless girl in Saskatchewan appealed to me when she had no friend on earth. She was ready to take her life. Helpless—deserted by the one who betrayed her—she pleaded for mercy. She knew me only as contributor to a girl's page. I immediately called up the matron of Grace Hospital—Staff-Captain Payne—and explained to her this girl in her distress.

"We will shelter her, Mrs. Hamilton," she said in her sweet gentle Christian voice, and I sent for her. She came without money and alone, and to-day she is a lovely Christian girl, facing the world with a determination to be a good woman. About three months ago I became interested in a girl whom I visited in her cell at the police station. She was only eighteen years old, yet had sunk to the very depths of sin. After her trial I visited her again in her clean sunny room in Grace Hospital. To-day she is a changed girl—the dazed, indifferent girl in the cell is bright and clean and happy in the atmosphere made so sweetly peaceful by the women of the Salvation Army, who are angels of mercy to this fallen girlhood. These are the women who compose the staff of Grace Hospital. They reach out a helpful hand to save weak and stumbling girls—and through prayer and hard work create an atmosphere so full of love and sympathy that these girls turn into ways of right thinking and living, and go into the world strengthened in spirit and will, ready to take up life's burdens with a determination to be good women. Here they are trained to be home-makers. They learn to cook and to do all kinds of house work.

I have felt many times that an appeal to our women of the West would bring helpful response, as they do not realize that a little help would mean so much to these women who are giving their lives for the rescue work of unfortunate girls. There are three ways that assistance might be given. First—these girls make good house-help. Farmers' wives need help. The offer of a home for the girl and her babe, with a wage that would clothe herself and her

little one, would greatly assist the women of these women.

Second—Clothing is acceptable, as many of them have little clothing, and infants' clothing is greatly needed.

And last, but by no means least, financial help is wanted. Girls are sheltered in the hospital from six to nine months, and often a year, and most of them can never pay a cent.

For this reason I appeal to the Home Economics Societies, the Home-makers Clubs, and our other women readers as well. A missionary society in Manitoba sent their monthly collection last month. Church societies and other organizations that could send in a collection would help more than they realize. This is home-missionary work, because it is assisting in the uplift of girlhood. Over in Grace hospital are sixty girls who mourn the loss of a friend who has brought into their hearts the peace of the Christ love. In every corner of our city, out on your prairie, in little houses dotted here and there about our great Dominion of Canada, are Christian girls and wives who first saw the light of salvation from the dark abyss of sin, through the efforts and love of that noble woman, Adjutant Beekstead of Grace hospital. She was one of the number who embarked for Eternity on the Empress of Ireland, and to-day there are hundreds of girls and women in Canada who remember her love and helpfulness that encouraged them to reform and become useful young women and godly wives and mothers.

Only the week before she passed on to her heavenly home she led me to the clean white bedside of a girl whom she rescued from the depths of sin. As I listened to her sweet, beautiful tender words of love to this suffering girl I thought "Dear Miss Beekstead, you are near, very near the Christ—a genuine sister of mercy." I have been with this beautiful woman from the corner of suffering girlhood to the places where help is employed in this hospital, and I have watched every face brighten as she passed. The nine-months' old babe of a crippled mother reached out his hands as soon as she entered the room. I remarked about it "Yes," she replied, "he always wants to come to me when he sees me." She knew every babe, every girl, every one who is employed in Grace hospital, and every one there was blessed by her personal ality. Her great work on earth is finished and a memorial to her memory. I am sure must appeal to all who honor ideal Womanhood. Over in Grace hospital Miss Beekstead could never turn a girl from the door, and this year Winnipeg and the West have sent more than usual down the dark and for these good women at Grace hospital to care for. Miss Beekstead was Mrs. Payne's assistant, and during the long months of Mrs. Payne's recent illness (caused from over work) Adjutant Beekstead superintended the work most successfully, because her heart and soul were in the work. I have on my desk letters from girls who say they feel as if they have lost a mother. It is the desire of every one in the hospital to have a memorial in memory of Adjutant Beekstead. Staff-Captain Payne, who is broken hearted over the loss of her companion-worker, says that a ward for sick children would be a memorial that would be most fitting, for Adjutant Beekstead loved the little sick babes, and regretted that the hospital had no separate ward for them. There is a beautiful room in the hospital that is large enough for ten little cots. This ward

During Harvest-time the Accuracy of Your Watch or Clock is Most Important

Why not have it inspected now, and then, if repairs are necessary, have them finished before the busy "rush season" starts?

It will cost you nothing to have your watch examined thoroughly by our watch department. We will let you know immediately whether any repairs are necessary and what they will cost, when you can tell us whether to go ahead or not, just as you wish.

Why not, then, send your watch to us and get immediate attention? If you haven't a suitable box to mail it in, write us, and we will send you one.

D. R. DINGWALL, Limited

JEWELLERS AND
WATCHMAKERS

PORTAGE AVENUE
WINNIPEG

ornished with cots and a suitable tablet to her memory would be a memorial that would long bless the memory of that noble woman who gave her life for others.

For the sake of some mother's girl, will you lend a helping hand?

Send all contributions to Mrs. Payne, Matron of Grace hospital, Preston and Arlington Streets, Winnipeg.

"Down below their burdens falling
For a little bit of love,
Many souls in pain are calling
For a little bit of love.
If they die in grief and shame,
Someone surely is to blame,
For not going in God's name
With a little bit love.

While the souls of girls are dying
For a little bit of love,
While their heavy hearts are crying
For a little bit of love.
Stand no longer idly by,
You can help them if you try
Go, then, saying "Here am I
With a little bit of love."

Mothers' Corner

We Mothers
(By A Mother).

There's all of pleasure and all of peace
For mothers;
Many the troubles that find release
To mothers.

It's in the kiss of the poor bumped head,
It's in the counseling word that's said,
Why, the world is made, and the march
is led
By mothers!

A song to sing or a cross to share
Has mother;
A grief to bear—but a smile to wear—
Has mother.

A road to walk and a goal to win,
An inglenook to find comfort in,
The gladdest hours that we know begin
As mothers.

A little laughter, perhaps some tears,
Has mother;
The days, the weeks, the months and
years,
As mother.

Are a mock at age and a jeer at time,
A vale to cross and a hill to climb,
But the prose of life takes the lilt of
rhyme
If a mother.

The mother-soul and the mother-heart
Of mother,
Help us to drift from the world apart
With mother;

For come days happy or come days sad,
We count no hours but the ones made
glad,
By the dear good times we have ever
had
With mother.

In all the world who are loved the most,
"We mothers!"
May our children always have cause to
boast
Of their mothers.

And if we can keep a smiling face,
No matter how hopeless seems the race,
Then Heaven will surely have a place
For mothers!

—Esther Hall Dixon.

A Fourth Month Formula

Mrs. M. H. N. C.: A fourth month formula which agrees with many children consists of sixteen ounces whole milk, and sixteen or seventeen ounces of barley or oatmeal gruel, a pinch of soda, and nine level teaspoonfuls of sugar of milk. Give five ounces at a feeding. By the time she is six months old, the formula may be strengthened, if it agrees with her, to twenty ounces of whole milk and eighteen ounces of gruel, giving six ounces at a feeding.

Will the mothers of this corner read the paper entitled Mutual Sympathy by Mrs. Begshaw? I have left some out of this corner to give room for its publication.

Fruitative Tablet Poisons B.b.e

One of our readers has appealed to me to use my influence for having re-

moved the guarantee on the boxes containing fruitative tablets.

She is a mother in Saskatchewan. Her one-year-old babe as one, and within two hours died in convulsions. The doctor examined the tablets, and said that there is enough strychnine in half of one to kill a child. I give this to warn other mothers. I am sure our readers sympathize with the mother who has lost her bright healthy babe in this way

P. R. H.

Home Economics

Loyalty to Mrs. Dayton

Mrs. Pearl Richmond Hamilton.
Dear Madam:—I saw a letter in "The Thresherman" from Mrs. Dayton referring to unjust and untrue statements being circulated regarding her. I would like to tell you how we—the H.E.S. of Swan River dealt with this. The re-

ports were circulated in a meeting of our society by some one who came here much to the distress of those of us who would not be party to that sort of thing.

I asked our president if we might discuss it at our next meeting very fully, which she most kindly allowed us to do.

In the meantime we wrote to Mrs. Dayton for true information, and she sent us a prompt reply.

The president appointed a committee of three ladies (after the discussion had revealed the strong sympathy of the meeting towards Mrs. Dayton) to draw up a resolution of confidence in her, to be submitted to a meeting of the society. This was done, and carried unanimously. I may say that Mrs. Dayton greatly appreciated our order, as she expressed so in a most kind letter.

Yours sincerely,
Gertrude Richardson,
Swan River H.E.S.

Wanted—Threads of Sympathy.

Dear Mrs. Hamilton:—I have read with much interest the report from Benito in the June "Thresherman," but it is evident that there are certain points which are not quite clear to our sisters in Benito.

(1) The society there is a comparatively new one. The secretary could find no mention in the handbook of a Provincial President, nor of a Provincial Executive either. And yet in Feb., 1913, a Provincial Executive was elected by the members of the H.E.S. at the Annual Convention Mr. Black was in charge of the programme on that occasion also, and by his "direction" the women elected a Provincial Executive, with Mrs. Dayton as president. That is why the article in the April issue alluded to the Provincial President. The women were "directed" to elect a Provincial Executive in spite of the fact that an Act of Incorporation had been passed in the previous autumn (1912) which in its clause 22 made the ap-

The
Bake-Day
Smile
of
Perfect
Satisfaction



PURITY FLOUR
More Bread and Better Bread

WESTERN CANADA FLOUR MILLS COMPANY, LIMITED
MILLERS TO THE PEOPLE

You saw this advertisement in this magazine. Don't forget to say so when writing.

pointment of women officers unnecessary and indeed contrary to law. The act was just as much in operation in Feb., 1913, as it is to-day. Further, it has never been satisfactorily explained why the Provincial Executive of 1912 knew nothing of the details of an act which concerned them so closely, and had apparently been in existence for some time before Feb., 1913.

(2) The secretary of the Benito Society mentions that the programme for the conference of Feb. 18th, 1914, had been previously prepared, and that common courtesy demanded that it should be carried out as arranged. But surely the H.E. Societies are subject to the same rules as govern the W.C.T.U., Ladies' Aids, lodges and all other assemblies of men and women. The order of a programme may be changed if the majority in an assembly wish it. It is the privilege of any member to ask permission (courteously, of course), to lay an important matter before the meeting. It is the duty of a chairman (courteously, also), to find out the will of the majority, and the will of the majority is law. Let me recommend to the Benito Society an excellent manual, "Rules of Order," by Robert. (Price 85c.).

(3) And yet one more point. The Benito report goes on to comment on the hospitality offered and refused by the majority of the presidents. I was one of the minority who arrived in the college on the evening before, was shown to a comfortable room, and had breakfast next morning with the students. After vain attempts to find someone whom I might address as hostess both on Tuesday night and again on Wednesday morning, I left to attend a meeting convened by the Provincial Vice-President in a room at the Industrial Bureau, where I found several H.E.S. friends, both old and new.

In conclusion let me heartily endorse the idea that the H.E. Societies need a centre that should be educational, stable and worthy of the people who support it, and this centre should be the M.A.C. The M.A.C. needs the mothers of Manitoba, whose influence on the future students may be a tower of strength to the M.A.C. The work of the H.E. Societies may be likened to that wondrous thing in Nature, a spider's web. It needs a centre from which threads of sympathy and learning may radiate everywhere. And yet the centre by itself is not enough to make the web strong and beautiful. Its form is incomplete without the threads which wind in circles round and round, without the strands of sympathy and encouragement which bind hearts near with hearts far away, and give strength and symmetry to the whole.

Such an ideal can only be approached in a spirit of harmony and co-operation between the M.A.C. and the women of Manitoba, who by their wits, stout hearts and strong sense of duty, have done their share in the upbuilding of this province.

The eighty members of our H.E.S. greatly appreciate your paper.

With their thanks and my own, I am,
Yours sincerely,
Mary Speechly,
Pilot Mound.

Mrs. Armstrong Replies.

Manitou, July 6, 1914.

Dear Mrs. Hamilton:—Having written the article which your editor called "The Missing Link Between the Department of Agriculture and the H.E. Societies" I was very much interested in the Benito report of your June issue. While the secretary of the Benito H.E. Society does not contradict any statement in my report, she questions one—"The Provincial President was calmly ignored." No better corroboration of the statement could be asked than the fact that one present at the conference did not realize we had a Provincial President. Of course neither she nor the Advisory Board is mentioned in the Handbook or in the Act of Incorporation. That is just why we wish the act amended. Each district elected representatives to that board, and consequently had a right to see that those representatives were recognized. There is still another place that our Advisory Board is not

mentioned—in the official report of the convention at which they were elected. That report publishes a paper by Mrs. Lipsett Skinner, which was not given, but makes no mention of the Advisory Board, which was elected.

The secretary of Benito implies that the fifteen representatives who met at the Industrial Bureau ought not to have done so. To me it seems the only business-like thing to have done, and did not in any way show a lack of courtesy. Our invitations gave us the option of staying either at the college or in the city, so that any president was quite justified in going from the city to the conference if she wished. And allow me to point out just here that Mr. Black is not the superintendent of H.E. Societies, nor was there anything in the invitation to indicate that he called the meeting. Mrs. Salisbury, who is superintendent, invited us, and through her the Minister of Agriculture guaranteed our expenses. I for one wrote accepting the invitation to attend the opening of the college, and arrived in good time, although I had not the pleasure of meeting any of the staff. That night and the next I occupied one of the beds "prepared at considerable expense," and ate four meals with the resident students. But I feel under no compulsion to the staff for this comfortable accommodation, for I realize that neither they nor the honorable

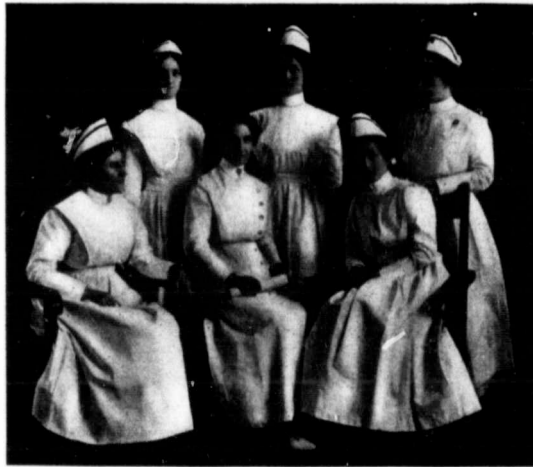

Staff of Grace (Salvation Army) Hospital, Winnipeg. Centre figure is Mrs. Payne, Matron. Sitting on her right is Adjutant Beckford, who went down with her noble companions in the "Empress of Ireland."

minister himself is out of pocket because of it. The Provincial Treasury to which we all contribute supplies the money for these things. Of course one appreciates any little acts of courtesy on the part of those in charge.

As to giving publicity to this matter, is it not a public matter, and as such entitled to publicity? Let me add that none of the presidents aimed at separation from the college. The chairman professed to interpret our resolution that way, in spite of our assurances to the contrary. The women of the province feel they have a right to any help the Department of Agriculture can give them through the college. The fact that they wish representation on a provincial executive of their own societies is no excuse for saying they do not appreciate any assistance given by the department. And whether they get that representation or not is not of so much importance, so long as we realize our right to it, and stand by our principles. If nothing further is accomplished the Provincial President, Mrs. Dayton, has done a great deal for the women of the province in standing by them in spite of the discourtesy she received, till they get an opportunity of making their views known.

In conclusion, let me say I am glad the correspondent from Benito calls our meeting a "conference." I have heard it called something else.

Yours sincerely,
Madge E. Armstrong,
Pres. of Manitou H.E.S.

Home Economics

Valley River

Dear Mrs. Hamilton — Although not reported, our society has held a number of interesting meetings during 1914. The loss our society has sustained, owing to our efficient secretary, Miss Taylor, leaving the community, has been keenly felt by all. Acting as secretary ever since the society was organized, her work in its behalf, and the influence of her cheerful personality, all tended to make her departure most regrettable. As a token of appreciation of her helpfulness the members presented Miss Taylor with a handsome case of toilet articles. Mrs. Macdonald gave an interesting talk on the care of milk at the January meeting. The advantages of the butter-worker also as a labor-saving device were described by the members who use them. The subject of February's meeting, "First Aid to the Injured," with demonstrations on bandaging, was taken up by the president, Mrs. Jones, whose address was most instructive.

Owing to the president being unable to attend the Conference at the Agricultural College held in February, Miss Taylor represented our society.

Much credit is due to the president

the Home," in which she proved that the home properly understood and properly governed, is the best Empire builder. Too many people, boys and girls, specially, look upon the home merely as a place in which to eat and sleep. Home influence is essential in forming the mind and character of the future citizen, yet the opportunities for exercising this influence were too few and too short. Inducements for spending the evenings at home might be found in congenial companionship, music reading aloud, interesting occupations and—a plea which will be warmly endorsed by every Old Countrywoman—the open fireplace. We regret that lack of space will not allow us to reproduce the paper in extenso, it was so true and so eminently practical.

Miss Gordon read various excerpts explaining the Empire Movement, of which the two most important branches are the "Overseas Club" and the "Hands Across the Sea," both of which have for their aim the welding together of the white races into one immense Empire, one great power for good. Willie Simpson and Kenneth Couch sang as a duet "The Red, White and Blue," with true patriotic fervour, and were well and deservedly applauded. The Cor. Sec. was directed to write to the Agricultural College and ask the Librarian to send out two books for the use of the June committee, and the meeting closed with the singing of the National Anthem and the serving of lunch.

Birtle

Owing to disagreeable weather our June meeting was very small but we enjoyed very much the program prepared. Our clubroom is being carried on very successfully and I thought that this would be a good time to tell you about it.

The club was formed under the auspices of the Birtle Home Economic Society—of which Mrs. David Watt is the capable president—and is controlled by a committee appointed by them. A vacant store was secured and transformed into very comfortable premises and a personal canvas was made for subscriptions which amounted to \$145. With this fund as a nucleus furniture was purchased. Sundry necessities were obtained, and the rooms were opened in February last. From the date of opening the project has been entirely successful. The rooms are open each day from 9 a.m. until 8.30 p.m. and the services of a lady member have been obtained, who attends every afternoon from 3 to 6 o'clock. For the first three months the gross revenue was \$229.65. This amount was made up of subscriptions, and income derived from teas held on Saturday afternoons. From a financial point of view the result has been eminently satisfactory, and the committee feel that they are justified in expecting to be able to clear the whole cost that may be incurred in the running of the rest room by the income derived from Saturday afternoon teas. Every Saturday of the month, with the exception of one which is given monthly to any church organization, wishing to serve tea, three ladies of the society undertake to supply the teas, and this brings in a goodly sum. On home economic meeting days quite a large amount is taken, as nearly all who attend take their 10 cent tea at the club room.

Apart from finance the room has been a decided success. The ladies from the country appreciate it highly, and the remark of one lady, that it was just fine to be able to sit down after shopping and have a cup of tea expresses the general feelings. I enclose our program for the second half of 1914.

July—Instrumental (the Misses Wheatley); "Maternal Sympathy," Mrs. Bagshaw; reading, "A Restful Way," Mrs. Wheatley; "The Value of Higher Education," Miss H. Mainwaring; vocal duet, Mrs. Patterson and Mrs. Mitchell; "Preserving fruits and packing butter," Mrs. T. Haney.

August—Picnic at Hoopers Lake.

September—Humorous reading, Mrs. Cartwright; "Why Women Shouldn't have the Franchise," Mrs. F. Mainwaring; solo, Miss Wilson; "Why Women shouldn't have the Franchise," Mrs. Wallis; instrumental, Mrs. B. Shaw.

October—Instrumental, Miss Wickware; "The Relation of Home to School,"

Mrs. I
Wife's
inson;
Novi
vocal
Maggi
Care o
Miss
Cartwi
Dece
Wallis
Gifts,
duet,
'Ideas'
Arthur
(1)
In cl

Write for Our Fall and Winter Catalogue

We want you to have a copy of it because we know that you will be pleased with it. In it you will find artistically illustrated and truthfully described the newest and most popular styles being worn this Fall in the leading centres of fashion. The values in it are the very best obtainable, because it is costing us a whole lot less to do business than others.

In the first place, our warehouse is centrally situated in the wholesale district where property is not as valuable as in the leading retail streets. In the second place, our warehouse is of modern construction and in consequence our insurance rate is very low.

In the third place, we have our own private railway siding, which means a very considerable saving in the handling of freight from and to the railway freight sheds.

In the fourth place, we have dispensed with all the unnecessary red tape that has developed in established catalogue houses, and have installed the simplest and most complete system in existence for handling orders received by post.

In these various ways we are saving sufficient not only to prepay the charges to your nearest express or post office but also to quote prices that represent very material savings.

This is an Unqualified Offer

Every price quoted in our catalogue means the price to your nearest express or post office. We make this offer without evasion or equivocation of any kind, so that our customers may know just exactly what their goods are going to cost them.

If you have not already had a copy of our catalogue, drop us a post card and by return mail we shall be pleased to send you one.

If at any time you may happen to be in Winnipeg come to see us as we are exceedingly anxious to make the personal acquaintance of as many of our customers as we possibly can, because a personal acquaintance goes a long way in enabling us to give the sort of service that you shall expect, and that we intend to give.



CHRISTIE GRANT CO. LIMITED
WINNIPEG
CANADA

AT YOUR SERVICE

**Smoke Our
 Clan Grant
 Scotch
 Mixture**

You saw this advertisement in this magazine. Don't forget to say so when writing.

Mrs. Porter; solo, Miss Graham; "The Wife's Share of the Income," Mrs. Dickinson; recitation, Mrs. Easson.

November—Reading, Mrs. Malcolm; vocal duet, Miss Louise Wilson and Miss Maggie Wickware; "Demonstration of Care of a Bed Patient in the Home," Miss Patterson; instrumental, Mrs. Cartwright.

December—humorous reading, Mrs. Wallis; "Fancy Work for Christmas Gifts," Mrs. Armstrong; instrumental duet, Mrs. Malcolm and Miss Seale; "Ideas for Christmas presents," Mrs. Arthur Doig; solo, Miss Yeand.e.

(Miss) Elizabeth R. McCurdy,
 Secy.-Treas.
 H.E. Society.

"Maternal Sympathy."

By Elsie Bagshawe.

(Read at the Birle Society.)

In choosing the subject of "Maternal

Sympathy" I hope I am not in any way turning aside out of the beaten track of Instructive Ethics, followed in the society of "Domestic Economics," for is it not true that in all things appertaining to the home the mother lives and moves in a wide area of administrative power? Do we not call her the "Home Ruler!" in careful love is she not to some of the children the "Home Secretary," and if she gets the vote will she not aspire to that coveted position. All wives would like to be "Domestic Chancellor of the Exchequer."

As she caters to the bodily wants of her household, no one can deny that she is in full command of the "Department of the Interior," and so on, is vested in her the duty of keeping the wheels of the domestic machinery well oiled.

After relegating to the mistress of the home all the honors coming to her, we

will just glance at a picture which I think in this age is becoming all too common, the great evidence of the lack of good fellowship between parents and their children, fast approaching the youthful stage when our young people think they know everything, and when environment tends to keep on that mistake.

About a year ago, I was for a few days the guest in a house which of itself left nothing to desire, that is, for those who value externals, beautifully equipped, well ordered, everything up to date.

At the table where one meets always every member of the family, I thought to myself, "now I shall notice if the home life matches the surroundings, a more uncomfortable experience for the visitor could not be well imagined. The husband, a bluff good-natured man, not on very good terms with his H's, one,

who as they say, had made his pile."

The sons were rather impossible young men, no manners, kept contradicting each other, and also their parents. The daughters might have been nice girls if they had been trained, but they looked bored all the time and dissatisfied, as if this dear old world was not a place good enough for them to live in. The mother was immaculate in her dress, money spread all over her, a rather, god-hearted person, empty-minded, but perhaps sincere as far as she went, but her thoughts were not on those around her, there no loving motherly sympathy disturbed her or interfered with her social duties—so called—and I thought how is it that one sees so many people putting so much energy into fleeting things; why do they wear their lives out polishing floors and furniture, and all the

Minnedosa

The April meeting of the H. E. S. of Minnedosa was unusually large and interesting. After the usual business had been transacted, a committee of four ladies was elected to revise the prize list for the summer fair, and also to do some collecting for prizes.

Miss Gowsell, the extension lecturer, then gave an address on the high cost of living, and way to overcome it. Suggesting that canning of peas, corn and beans and preserving hubarb would be much more economical than buying the fresh supplies in early spring.

Miss Gowsell also emphasized the importance of housekeepers studying the value of foods, so a well balanced meal might be prepared, and instructed the members on how the "food" lessons should be taken up.

Mrs. Woodcock moved a vote of thanks to Miss Gowsell, which was replied to in a few words, bringing a very pleasant meeting to a close.

Anne G. Lomant, Sec.

Oak Lake

The regular monthly meeting of May was held on Saturday, 18th, in the "Rest Room."

Mrs. Shirley gave a most interesting paper on "The Nature Studies of our Poets," pointing out how very expressive literature was of life, dwelling particularly upon Wordsworth.

Miss Kearns also read a paper on "Short Steps in House Cleaning," which was full of wit and humor.

A recitation by Miss Mary Anderson showed much dramatic ability.

The Misses Parsons and Carey in a duet both sang very sweetly, and a solo from Miss McAindle was greatly appreciated.

The regular monthly meeting of June was held on Saturday, 20th. Miss Annie Taylor opened the programme with a selection on the violin, very sweetly rendered.

Mrs. Cameron, who always sings delightfully, also contributed to the afternoon's entertainment. Mrs. Carter and Miss Connor sang for the first time, pleasing everyone very much.

Mr. Hanna, of Rogerson, gave an instructive address on "The Relation of the Community to the Empire," bringing out the importance of home influence in connection with the training in the school as factors in the building up of character in the young, preparing them for a place in the community and the empire.

In order that more books may be added to our library, it was decided to serve refreshments in the Rest Room on July 15 in aid of that fund.

Homemakers' Clubs

We have an excellent paper entitled "Dress versus Fashion" from one of the Homemakers' Clubs, but unfortunately the name of the writer and the name of the society has been lost. Will the society kindly send us the names, and we shall publish it in our September number.

Kindly send all reports to my private address to insure prompt attention.

Pearl Richmond Hamilton,
983 Grosvenor Ave., Winnipeg.

Hanley

"A Woman's Duty to Herself"

By Mrs. E. Bushby,
(Read at the Hanley, Sask., Homemakers' Club).

Without a doubt the word woman is one which should, and for the most part does, appeal to the right thinking person, for more than the much used and abused term "Lady." Woman is such a wholesome, reliable expression that it should never be misunderstood, or taken as anything but a compliment. In these days women occupies a position which was unthinkable one hundred years ago. In science, arts, literature, business and even in politics she is in the foremost rank, and holds a position from an intellectual point almost, if not equal, to that held by man. The woman of to-day has great responsibility placed upon her, which she can use not only for her own family, but the world at large. It has been said woman's influence is the greatest force in the world, and if it is—and who will deny it what magnificent opportunities are hers to use as she wills. It is a wo-

man's duty to cultivate a deepness of sympathy, and true charity. I do not mean charity of the purse, but charity of mind, thought and speech. Good manners are most beautifying to one's personality; they express inner refinement, gentleness and charm. I would most forcibly say that good manners can be taught by the golden rule, "Do unto others as you would that they should do to you." It is as refreshing as it is rare to hear a number of women conversing in quiet tones. The cultivation of the voice should be part of the education of every woman. I believe it is the duty of every woman to herself to appear at her best whether in privacy of her own home, or under the observation at the home of some one else. I think it the duty of a woman to herself to be as well dressed as her means will permit, with her face, hands and entire body in fact, evidencing painstaking care. Women owe it to themselves to care about their appearance. It is not a woman's duty to care for every one in the household to the neglect of herself. With regard to health, it is a woman's duty to know herself physically, as far as lies in his power, so that she may not only discharge those duties which make her a useful member of the family and society. Just as truly as she loves her family, she must love herself well enough to take good care of her health and mind. What she gives herself in the way of reasonable and helpful reading she can give out again in interest with her children in their school work and social progress in her attractiveness to them and to others whose esteem they value. It is also a woman's duty to herself to secure rest and conserve strength. Woman should take special care of herself as the foundation of her well being. It is due to every woman on earth one hour lying at full length on a sofa every day it will refresh both mind and body. Work and rest should be equalized if possible. Remember work diligently while you work and rest faithfully when you rest. It is a woman's duty to be helpful, there is no sensation so gratifying as that of having done something helpful. Remember each should be willing to do her share in the world's entertainment, so try and use the talents you possess. The woods would be very silent if no birds sang there, but those that sang their best. The sympathetic woman can make the home life brighter, and the husband stronger to do battle with the world. It is hers to stimulate, encourage and uplift. Surely these are duties of the highest order. It is a woman's duty to regard life as a sacred trust, and make the utmost that is possible of themselves and finally to do good by example and positive effort.

They talk about a woman's sphere. As though it had a limit. There's not a place in earth or heaven. Not a task to mankind given. Not a blessing or a woe, Not a whisper, "Yes or no." Not a life, or death or birth, That has a feather's weight of worth. Without a woman in it.

Theodore and District Homemakers' Club

The club held their regular monthly meeting in the rest room on the afternoon of June the 18th. The meeting opened in the usual way by singing The Maple Leaf. Minutes of last meeting were read and adopted with President Mrs. Burnard in the chair. Arrangements were then made to rent our rest room. During the summer months we will hold our next meeting in the Methodist church July 15th. The roll call for next meeting to be answered by our favorite flowers. During the month of June we had quite a successful sewing afternoon for a family of small children who have recently lost their mother who was a member of our club. The club joins in sending their sympathy to the father and children. The church and homemakers gave a very pleasant social evening to Rev. Mr. Eriven, who was leaving for Ontario; also presented him with a very handsome club bag. We hoped he may long be spared to use it. We might here thank Mrs. Tracey who so kindly gave the use of her house and beautiful grounds for the social, which I am sure was appreciated by all present. She also did her utmost to

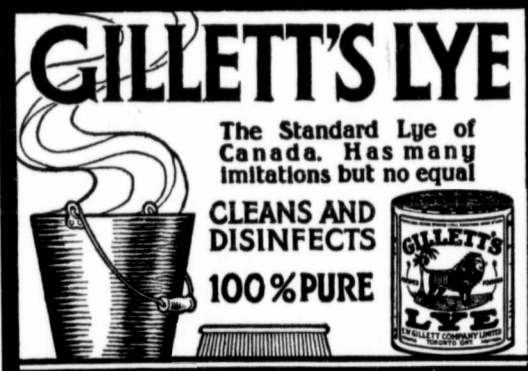

GILLETT'S LYE

The Standard Lye of Canada. Has many imitations but no equal

CLEANS AND DISINFECTS

100% PURE

You saw this advertisement in this magazine. Don't forget to say so when writing.



Ford
THE UNIVERSAL CAR

If you want the safest car—you want the Ford. Its Vanadium steel construction—its design and perfect balance make it the strongest and lightest car on the market. Its planetary transmission makes it the safest and easiest to control. The Ford is the "Safety First" car.

\$600 for the runabout; \$650 for the touring car and \$900 for the town car—f. o. b. Ford, Ontario, complete with equipment. Get catalog and particulars from any branch or from Ford Motor Co., Ltd., Ford, Ontario.

You saw this advertisement in this magazine. Don't forget to say so when writing.



BABBITTS Buy Direct from the Manufacturers and Save Money

THE OWL METAL CO. LTD.
OWL BABBITT METAL
WINNIPEG, MAN.

OWL BABBITT METAL For Threshing Machines, Small Gas and Steam Engines. Cash with order price 36¢ per lb. Scientifically alloyed Babbitt metals made in Winnipeg by

OWL TRACTION METAL For Gas and Steam Tractors will stand heaviest work. Worth \$1.00. Cash with order price 65¢ per lb.

The Owl Metal Co., Ltd.
Metallurgical Experts
151 Notre Dame Ave. WINNIPEG

You saw this advertisement in this magazine. Don't forget to say so when writing.

Remember to renew your Subscription

make every one feel comfortable and at home.
Our meeting was then closed by the National Anthem.

Candiac, Sask.

Written by Paul Wiklund, read by Mrs. Pretty

Food Values

(This paper was read before the Candiac Homemakers' Club)

All human activity, whether mental or physical, requires not only a strong, healthy bodily organism, but it requires also power or energy to enable it to perform its duties. In doing manual labor, for example, a man's muscles and other tissues are gradually wasted or worn out by exertion, while at the same time this work is the result of a mysterious power possessed by the muscles. These wasted muscles must be constantly repaired, and this energy constantly maintained in order that he may be able to continue this work. In fact, the mere functioning of the bodily organs wastes both tissue and energy constantly, which must be as constantly replaced.

To this end we take food. And as food serves mainly two purposes, to build up the body and to supply it with heat and energy, so there are, roughly speaking, two classes of nutrients, those that form tissues and those that are used as fuel, combining with the air breathed in by the lungs. The former, proteins, are found in the fibers of lean meat, in cheese, in egg, gluten of grain, and so on. The latter are fat, sugar and starch.

Out of every hundred pounds of food consumed by a person there should be about three pound of protein or tissue-building ingredient, three pounds of fat, which may be either butter, or lard or oil. Nine pounds of sugar and starch, and eighty-five pounds, or eight and one-half gallons of water. Starch, it may be said, is identical with sugar, though in a different chemical state.

Two of these nutriment, protein and fat, are found in meat. Lean beef is about 75 per cent water, the rest being solid substance, of which the greater part is protein, and the remainder fat and waste material. It is the most valuable of all the lean meats, though mutton and fowl are not much inferior. The food value of fish is not nearly so great. Ham contains a great proportion of fat, while the chief value of pork is in the fat, which makes up more than ninety per cent of its weight. Eggs and cheese, both animal substances, are to all practical purposes identical with meat, and eggs particularly, being easy of digestion, are even preferable to the former.

But not in meat alone do we find those proteins so necessary for building up and maintaining the health and strength of the body. As we said before, there is in grain a substance called gluten, which gives to dough its sticky consistency. This gluten, like the fibers of meat, etc., is a substance which is useful in forming muscle and sinew, as any animal substance, perhaps more so. A pound of oatmeal, for example, is nearly as rich in protein as a pound of beef, and wheat bread, though deprived of much of its value by being robbed of its bran, is not much inferior. Hence whole wheat or Graham bread, is far more valuable in every way than white bread. But these grains contain in addition from five to ten times as much starch as gluten, and this is considerably more than is required, so that meat or other animal foods become necessary. However, it can be shown theoretically, and it has certainly been proved in actual practice, that oatmeal and whole wheat bread, supplemented by milk and butter, not only satisfies the wants of the body, but is a far more healthful and beneficial diet, since it contains the necessary nutriment while it is free from harmful substances, than one in which meat occupies a prominent part.

Potatoes and other garden vegetables are chiefly starch and sugar, and when these are used, meat or cheese must of course be added. Beans might to some extent take the place of meat, but that they are difficult to digest. The great value of green vegetables and roots however lies in the phosphate and other salts which they contain, and which are so very useful in promoting nervous growth and power, as well as in stimula-

ting and assisting the organs of the body. Phosphoric acid is a substance without which organic life would be impossible, and this acid, in the form of phosphate salts, is found in considerable quantities in most green garden vegetables, such as cabbage, onion, radish, turnip. Turnips, beets, and carrots are also very rich in sugar.

Fruit is also a very valuable food, being much the same as vegetables in nature, except that they are far richer in sugar. They also have certain acids which are a great aid to digestion, though fruits that are too sour are not to be preferred. Apples are beyond all comparison most helpful and nutritious of the common fruits, and are held by many to have, in addition, considerable medicinal value.

Thus we see that beef and fowl are meats that are more valuable than ham, pork or fish, though these have some value also, while cheese and eggs are equal in value with the former. Yet, under ordinary circumstances meat and other animal substances are not very necessary articles of diet, since grain, vegetables and fruit, especially when helped out with milk, cream and butter, supply all the wants of the body, both for making of tissue and for fuel. Of course, a man who works hard physically will require more solid food than one of sedentary habits, and a growing child will require a different diet from the mature adult. Yet in the main, a diet in which cereals, fruit and vegetables predominate will be found to be best for old and young, and when fresh fruit and vegetables are plentifully employed there will be little need for doctor or medicine.

Care and Cooking of Fish.

(Mrs. J. S. Quimby.)

Before dressing fish, care should be taken that it is well washed, but not water-soaked, as the flavor is thereby diminished. Fresh water fish, however, may have a muddy smell and taste. This can only be remedied by dry and dress it.

To fry fish, after it is well washed roll up in a cloth to thoroughly dry. Dip in egg and bread crumbs. It will be much improved by being dipped twice.

Have the pan ready with plenty of smoking hot drippings or lard. Let the fish fry until it is well browned. If fried in oil, it has a much finer color. Never use butter, as it makes the fish a bad color. Garnish.

In broiling fish be careful your grid-iron is clean; place it on the fire and when hot rub it over with suet to keep the fish from sticking. The fish must be floured and seasoned before broiling. It should be boiled over a clear fire only, and great care taken that it does not burn or become smoky. But it must be well done.

For baked shad make a dressing of fine bread crumbs and cold ham minced. Moisten with a little sweet milk, and the yolk of an egg; season to taste. Fill the inside of the fish with the dressing. After having rubbed over the shad with the beaten yolk of an egg, lay it in a deep pan, put a little water in the bottom to which a piece of butter has been added. Dredge with a little flour. A large shad should be baked an hour. Fish can be too well cooked. Pour the gravy over it and garnish with slices of onion and sprigs of parsley or celery or lettuce leaves.

Recipes

Graham Cake.—This cake requires two cupsful of buttermilk; one beaten egg; two cupsful of brown sugar; two table-spoonfuls of melted butter; two rounded teaspoonfuls of soda; one teaspoonful each of salt, cinnamon, cloves and nutmeg, one cupful of chopped raisins, one cupful of sifted white flour; and enough Graham flour to make a stiff batter. This will make two loaves.

CARROT PUDDING

1 cup grated carrots, 1 cup grated potatoes, 1 cup chopped suet, 1 cup sugar, 1 cup raisins, 1 cup currants, 2 cups flour, some lemon peel, 1 teaspoonful baking-soda, a little spice to suit taste. Steam good for three hours. Serve with sauce. (This is good.)—Mrs. Connolly, Arkona, Ont., Mail Route, Theford, Ont., R. R. No. 4.

The Long Looked For Has Come!

It is here! Cheap Power for the Farm

The "INGECO" Throttling Governor Kerosene Engine

IT APPEALED TO US, IT WILL APPEAL TO YOU

If you really want the best engine value in this Country, this engine will surely appeal to you.

This is not a Gasoline Engine with a Kerosene Attachment, it is a Kerosene Engine, designed to burn Kerosene, operates with Kerosene and is economical on Kerosene.

We guarantee consumption of Kerosene with "INGECO" ENGINES not to exceed in quantity what it takes of Gasoline to operate a Gasoline Engine. Think of the saving in dollars in one year.

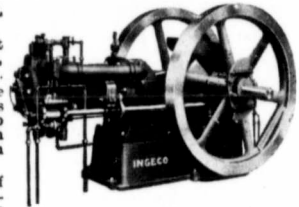

An "INGECO" Engine will deliver 100 per cent service. It will come up to your fullest expectation as to power, reliability and durability.

Besides its operating costs very low, which is an important item at the present cost of fuel, its simplicity of construction and accessibility make it easy to take care of.

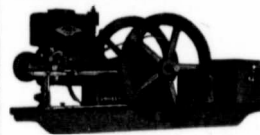

All parts are made from jigs and replacement is readily made.

The "INGECO" Engine is designed and constructed to give satisfactory service under all conditions and always delivers its full rating with an abundance of power to spare.

We have such a range in sizes and styles, that space does not permit us to quote prices. If interested, write us for circulars fully describing. Made in sizes 1 1/2 to 7000 H. P., Tank Cooled, Hopper Cooled, Air Cooled, Horizontal and Vertical, Portable and Stationary.

Canadian Distributors

Burridge-Cooper Co., Ltd., Winnipeg, Man., and Regina, Sask.

Address enquiries to Winnipeg Office.

You saw this advertisement in this magazine. Don't forget to say so when writing.



FAIR WINNERS

have often been produced by the help of

ABSORBINE

as it strengthens the muscles and ligaments, keeps out soreness, prevents fatigue, stops pain, reduces swelling and inflammation. It is a positive ANTISEPTIC AND GERMICIDE and therefore especially effective in healing cuts, sores, galls, bruises, etc.

Used by successful exhibitors and trainers because ABSORBINE does not blister, stain or remove the hair, and horse can be worked.

KILLS PAIN AND STOPS LAMENESS QUICKLY

It is economical, as only a few drops full strength are required at an application. A bottle of ABSORBINE, diluted as per formula on label, makes three gallons of efficient liniment at a cost of 50 cents a gallon. You will find it a money maker for you in getting all your horses in better shape for regular work or sale and you might also make a prize winner by removing some blemish from them with ABSORBINE.

Frank Briscoe, Osceola, Ont., writes May 1st, 1912.

"Absorbine has cured a big mare that was completely used up with contraction of the muscles. I bought her for \$500.00 and wouldn't take less than \$400.00 now. I owe many thanks to ABSORBINE."

USE ABSORBINE to remove Bursal Enlargements, Bog Spavins, Throats, Inflamed Parts, Thickened Tissues, Rheumatic Deposits, Enlarged Veins, Painful Swellings and Affections to cure any strain or lameness; to repair strained, ruptured tendons, ligaments or muscles; to strengthen any part that needs it. You can buy Absorbine at regular dealers, price \$2.00 per bottle or sent to you, express prepaid with full instructions. Write me about any special case on which you would like advice. Horse book free. Manufactured only by

W. F. YOUNG, P.D.F., 112 LYMAN'S BLDG., MONTREAL, Can.

You saw this advertisement in this magazine. Don't forget to say so when writing.

Success Business College

\$50 Pays for 4 Months Course

Insure success by a business training. Get it in the best Business College the College that has made the greatest success of its business. This is the Success Business College, with schools at Winnipeg, Regina, Moose Jaw, Weyburn, Calgary, Lethbridge and Vancouver. We use 309 typewriters. Send to the nearest school for free prospectus, beautifully illustrated. Don't put it off.

FG GARBUTT, PRINCIPAL

You saw this advertisement in this magazine. Don't forget to say so when writing.

A NOVELTY IN MYSTERY STORIES
THE SECRET OF LONESOME COVE

By
SAMUEL HOPKINS ADAMS
 AUTHOR OF AVERAGE JONES ETC

Copyright, 1913, The Bobbs-Merrill Company.

Continued from page 73 July

The Star-master spun it with a practised hand. Slowly and more slowly it turned, until, as it came to a stop, a ray of light, mysteriously appearing focussed on a constellation.

"Yonder is your star," declared the astrologist. "See how the aural light seeks it."

"Oh I say!" murmured he of the monocle. "Weird, you know! Quite gets on one's nerves. Quite!"

"Sh-h-h-h!" reproved Preston Jax. "Silence is the fitting medium of the higher mysteries. Madam, your life is a pathway between happiness and grief. Loss, like a speeding comet, has crossed it here. Happiness, like the soft moon glow, has beamed upon it, and will again beam, in fuller effulgence."

With beautifully modulated intonations he proceeded, while one of his visitors regarded him with awe-struck reverence, and the other waited with patience—but unimpressed, so the orator felt, by his gifts. His voice sank, by deep-toned gradations into silence. The ray winked out. Then the woman spoke.

"Is it possible for your stars to guide me to an object which I have lost?"

"Nothing is hidden from the stars," declared their master. "Their radiance shines not alone upon the broad expanses of existence, but also into the smallest crevices of life. You seek jewels, madam?" (Kent had let this much out, as if by accident, in the morning's conversation.)

"Yes."

"Your birth stone is the blood-stone. Unhappy, indeed, would be the omen if you lost one of those gems." (He was fishing and came forward toward her, almost brushing Kent.)

"But I say," cried Kent in apparently uncontrollable agitation; "did your stars tell you that she had lost some jewelry? Tell me, is that how you knew?"

In his eagerness he caught at the astrologer's arm, the right one, and his long fingers, gathering in the ample folds of the gown, pressed nervously upon the wrist. Preston Jax winced away. All the excited vapidly passed from Kent's speech at once.

"The jewels which this lady has lost," he said very quietly, "are a set of unique rose-topazes I thought—in fact, I felt that you could, with or without the aid of your stars, help her to recover them."

Blackness, instant and impenetrable, was the answer to this. There was a subdued flowing sound of drapery, as if some one were brushing along the wall. Kent raised his voice the merest trifle.

"Unless you wish to be arrested, I advise you not to leave this place. Not by either exit."

"Arrested on what charge?" came half-chokingly out of the darkness.

"Theft."

"I didn't take them."

"Murder, then."

"My God!" So abject was the terror and misery in the cry that Kent felt sorry for the wretch. Then, with a certain dogged bitterness: "I don't care what you know; I didn't kill her."

"That is very likely true," replied Kent soothingly. "But it is what I must know in detail. Find your foot lever and turn on the light."

The two visitors could hear him grope heavily. As the light flashed on, they saw, with a shock, that he was on all fours. It was as if Kent's word had felled him. Instantly he was up, however, and faced around upon Marjorie Blair.

"Who was she?" he demanded. "Your sister?"

Mrs. Blair was very pale, but her eyes were steady and her voice under control as she answered:

"I do not know."

"You must know! Don't torture me! I'm a rat in a trap."

"I'm sorry," she said gently, "that I can't help you. But I do not know."

"You, then." The Star-master turned upon Kent. "What am I up against? How did you find me?"

Thrusting his hand in his pocket the scientist brought out a little patch of black cloth, with a single star skillfully embroidered on it.

"Wild blackberry has long thorns and sharp," he said. "You left this tatter on Hawkhill Cliffs."

You don't have to lean over hot cooking top and steaming pots to work damper on

McClary's
Sask-alta
Range Patented Direct Draft Damper is operated from the front. Ask the McClary dealer to show you.

424

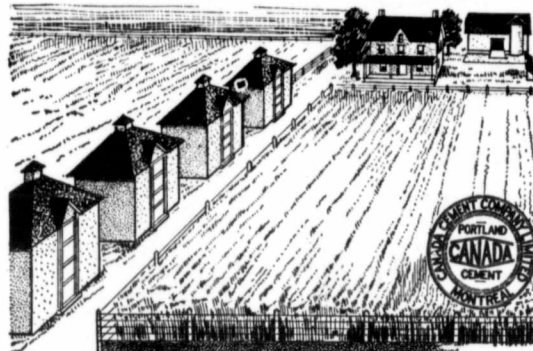

Granaries That Increase Profits

are the ones that are right on your own farm. They are the kind that enable you to hold your grain, without storage charges or waste from rats or other rodents, until you can obtain the best prices. They are the kind that need no repairs and last a lifetime. They are the kind that

Are Built of Concrete

Concrete never wears out. It's the farmer's best grain insurance against loss from fire, rodents or any other cause.

"What the Farmer can do with Concrete" is the title of a free book that shows how you can build better buildings on the farm with concrete, and save money by the operation. Write for it today.

Farmer's Information Bureau
 Canada Cement Company Limited
 783 Herald Building, Montreal



Family Group Photos a Specialty

AT

STEELE & CO., LTD.

MAIN ST. AND BANNATYNE AVE.

WINNIPEG

Acetylene Headlights for Traction Engines

Complete in one apparatus. The best on the market. Indispensable for plowing at night or moving over rough fields, and bad roads. Attachments for all makes of engines. Projects a light 400 feet. Will not jar out. Runs ten hours with one charge. Write for catalog. Agents wanted.

AMERICAN ACETYLENE STOVE CO.
 612 Masonic Temple, Minneapolis, Minn.

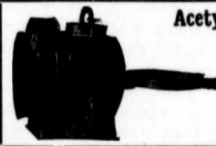



All "ARLINGTON COLLARS" are good, but our CHALLENGE BRAND is the best



\$35
DOMINION BICYCLES
FOR
\$25



These famous Bicycles now sold at little more than the cost of manufacture. The Dominion retails at \$35 in Winnipeg, but you can buy it by mail for \$25. Equipped with mud guards, wood or steel Dunlop rims, roller chain, New Departure Coaster, rubber pedals, pump and tools.

Sundries and Tires at wholesale prices to everyone. Send for our illustrated free catalog.

Dominion Cycle Company

224-6 LOGAN AVE.
WINNIPEG, CANADA

Don't Take Chances on a Poor Grindstone

Don't spoil your knives, axes, hoes or cutter-bar blades on some soft-softened, lapped, cheap stone. That's not economy!

Here's a good stone—the **CLEVELAND "STERLING"**. Guaranteed to wear evenly, grind quickly and put a keen edge on. Made of the only Berea rock, exactly the right grit for farm use. Ball-bearing, well-made steel frame. Works like a bicycle—and just as easy. Every stone personally selected by our expert judges.

CLEVELAND Grindstones

We are the biggest producers of grindstones in the world. We own and operate the only Berea quarry, the standard by which all grindstones are compared. We have 17 other quarries. We've made grindstones for 60 years. 9 out of every 10 agricultural implement makers use our stones in their own shops. They know what's best. We treat our customers fairly. Money back if anything goes wrong. Write for booklet, "The Grit that Grinds," and name of dealer who will supply you. Insist on this trade mark.

THE CLEVELAND STONE CO.
1125 LEADER NEWS BLDG., CLEVELAND, OHIO

SALESMEN

Get Larger Salaries Than Any Other Class of Men

We will teach you to be a high grade salesman. In eight weeks we will send you definite propositions from a large number of leading firms who will offer you appointments to some of the best places in the country. No further experience required. Write today for our booklet, list of hundreds of good openings and full particulars. Booklet and application form sent free. **NATIONAL SALESMEN'S TRAINING ACADEMY**, Kansas City, New York, San Francisco.

At the name, the man's chin muscle throbbed with his effort to hold his teeth steady against chattering.

"At first I suspected an army officer. When I found that the cloth was below grade, the only other starred profession I could think of was astrology. As the highest class astrologer now advertising, you seemed likely to be the man. When I found, first, that you were out of town on July 5th, and, just now, by a somewhat rough experiment, that you had suffered a wound of the right wrist, I was certain."

"What do you want?"
"A fair exchange. My name is Chester Kent."

The Star-master's chin worked convulsively. "The Kent that broke up the Coordinated Spiritism Circle?"
"Yes."

"It's ill bargaining with the devil," observed Preston Jax grimly. "What's the exchange?"

"I do not believe that you are guilty of murder. Tell me the whole story, plainly and straight, and I'll clear you in so far as I can believe you innocent."

For the first time the seer's chin was at peace.

"You want me to begin with this lady's necklace?"

"Why, yes. But after that, begin at the beginning."

"The topazes are caged under a rock near the cliff. I couldn't direct you, but I could show you."

"In time you shall. One moment. As you realize, you are under presumption of murder. Do you know the identity of the victim?"

"Of Astræa? That's all I know about her. I don't even know her last name."

"Why Astræa?"

"That's the way she signed herself. She seemed to think I knew all about her, without being told."

"And you played up to that belief?"

"Well—of course I did."

"Yes, you naturally would. But if you had no name to write to, how could you answer the letters?"

"Through personal advertisements. She had made out a code. She was a smart one in some ways, I can tell you."

"Have you any of the letters here?"

"Only the last one."

"Bring it to me."

Obediently as an intimidated child, the astrologer left the room, presently returning with a plain sheet of paper with handwriting on one side. Kent, who almost never made a mistake, had forgotten in his absorption in the matter of the document, the presence, even the existence, of Marjorie Blair. He was recalled to himself, with a shock, as he felt

GRAND TRUNK PACIFIC

Excursions

Via "Great Lakes"

To London, Hamilton, Toronto, Stratford, Niagara Falls, Montreal, Quebec, Halifax, New York, and all points in Eastern Canada.

STEAMERS
"NORONIC" "HAMONIC" "HURONIC"

The Quickest Route to Eastern Canada with Longest Sail in Finest Steamers.

Double Daily Service

To Winnipeg, Regina, Saskatoon, Edmonton.
New Route to Battleford and Calgary.

Arrange Your Trip NOW!!!

Travel in Grand Trunk Pacific fan-cooled, electric lighted sleepers. Get the best dining car service. Enjoy real comfort and have pleasant trip. See our Agents for full information.

W. J. QUINLAN,
District Passenger Agent
260 Portage Avenue, Winnipeg

You saw this advertisement in this magazine. Don't forget to say so when writing.

STANDARD Gas Engine Oil

Recommended by leading builders for all types of internal combustion engines, both tractor and stationary—gasoline and kerosene. Keeps its body at high temperature, leaves practically no carbon deposit. Equally good for external bearings.

PRAIRIE Harvester Oil

The most durable oil for farm machinery. Stays on the bearings; will not gum or corrode; not affected by weather.

Eldorado Castor Oil
Thresher Hard Oil
Arctic Cup Grease

Imperial Oil Co. service puts these products within the reach of anyone in the Dominion.

Write any agency.

THE IMPERIAL OIL COMPANY, Limited

Toronto	Montreal	Winnipeg	Vancouver
Ottawa	Quebec	Calgary	Edmonton
Halifax	St. John	Regina	Saskatoon

You saw this advertisement in this magazine. Don't forget to say so when writing.

Don't Fail to Renew Your Subscription Before it is Too Late.



ALL WEATHER CONDITIONS ARE ALIKE TO GABOT'S CREOSOTE STAINS

IT WITHSTANDS THEM ALL
It soaks into the wood, preserving it, and prevents wet or dry rot, and injury by insects or worms.

Easy to Apply
Any one can apply this stain, all that is required is an ordinary paint brush.

Economical!
The cost of applying this wood preserving stain is so low that you should use it on all your farm buildings.

Write for our Illustrated Booklet. It will be of valuable interest to you

BRAID & McCURDY
301 TRIBUNE BUILDING
WINNIPEG : MAN.

Name this magazine when writing advertisers



Columbia's the Heart of the Engine

Costs no more—lasts longer

Hitch a Columbia battery to your engine and watch her go—sure fire, low cost, long life, steady work. Say Columbia for batteries and get the quarter century guaranty of the largest battery works on earth. Every cell signed by the makers.

Buy them anywhere—but insist on Columbia.

Canadian National Carbon Co. Limited
99 Paton Road, Toronto, Ont.
Convenient Fahnestock spring clip Binding Posts without extra charge.

Name this magazine when writing advertisers

her shoulder touch his. Involuntarily he whirled the sheet behind him.

"Let me see the rest of it please," she said calmly enough.

Kent nodded. With drooping head, and chin atwilt, the Master of Stars stood studying them, while they read the letter together. It was in two hand-writings, the date, address and body of the letter being in a clear running character, while the signature, "Astræa," was in very fine, minute, detached lettering. The note read:

"All is now ready. You have but to carry out our arrangements implicitly. The place is known to you. There can be no difficulty in your finding it. At two hours after sundown of July the fifth we shall be there. Our ship will be in waiting. All will be as before. Fail me not. Your reward shall be greater than you dream.

Astræa."

Kent looked askance at Mrs. Blair. She was very white, and her sensitive lips quivered a little, but she contrived, with an effort of courage which he marked with a flashing access of admiration, to smile reassuringly.

"Don't fear for me," she said. "We Dorrances are of firm fiber."

"So I see," he said warmly. He folded and pocketed the letter.

"Had you ever been to this place before?" Kent asked of Jax.

"No."

"Then how did you expect to find it?"

"She sent me a map. I lost it—that night."

"What about the ship?"

"I wish you'd tell me. There wasn't any ship that I could see."

"And the reference to all being as it was before?"

"You've got me again, there."

In most every letter there was something about things I didn't understand. She seemed to think we used to know each other. Maybe we did. Hundreds of 'em come to me. I can't remember 'em all. Sometimes she called me Hermann. My name ain't Hermann. Right up to the time I saw her on the Heights I was afraid she was taking me for somebody else and that the whole game would be queered as soon as we came face to face."

"It seems quite probable," said Kent with a faint smile, "that you were taken for some one else. Your personal appearance would hardly betray the error, however."

"Well, if I was taken for another man," said the puzzled astrologist, "why didn't she say so when she saw me?"

"What did she say when she saw you?"

"Why, she seemed just as tickled to set eyes on me as if I were her Hermann twice over."

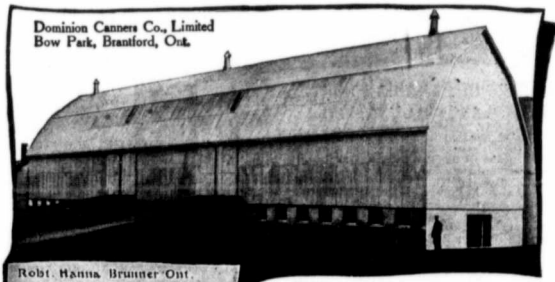

Dominion Canners Co., Limited
Bow Park, Brantford, Ont.



Robt. Hanna Brunner Ont.



Nicholas Roth
Shakespeare Ont.



Burley Miller
Port Rowan Ont.



Wm Reid Princeton Ont.

These Steel Trusses of Double-Angle Steel make the most rigid barn construction known to man



Steel Truss Barns

(Patented in Canada and the United States)

These barns are built complete in our factories. We send you a whole barn. There is nothing for you to provide, because we ship everything complete—Steel Trusses, corrugated iron covering, and all the lumber, and there's not a piece of wood in the whole job that one man cannot handle. The Steel Trusses come ready to put in place. Doors are fitted with all the hardware, and are ready to hang. Bird-proof track is supplied. Windows are of metal and wired-glass, and are built into the sheets of corrugated iron. They are as easy to put in place as any other sheet of iron.

The Steel Truss Barns have large, circular ventilators of galvanized iron—and the best hayfork outfit money can buy. Cornices, ridge and eaves, roof and sides are all the best grade of galvanized iron.

To land a barn on your farm in such shape as this is going to save you many a dollar in labor, and an endless amount of time and trouble. And, remember, no wood shows anywhere on this barn. Once a Steel Truss Barn is built, there is no cost for repairs—no paint bills, no rotting sills or shingles. Figure that saving when you think about your new barn.

Eight factories are ready to send you one of these barns any size you want—and the very day your order reaches us. We know that men will want to know a lot about this great new barn idea, and we are ready to answer questions and send out full information explaining the whole thing clearly. Do not hesitate to write us about it. Tear out the coupon and mail it to-day.

The Metal Shingle & Siding Company, Limited

WINNIPEG, MAN.

Head Office: PRESTON, ONTARIO

Associated with A. B. ORMSBY & Co., Limited.

Consolidated Factories at
Preston Toronto Montreal Winnipeg
Saskatoon Regina Calgary Edmonton

COUPON

Send me full information about Steel Truss Barns advertised in Canadian Thresherman & Farmer

To The Metal Shingle & Siding Co., Ltd.
WINNIPEG, MAN.



SYNOPSIS OF CANADIAN NORTH-WEST LAND REGULATIONS

THE sole head of a family, or any male over 18 years old, may homestead a quarter-section of available Dominion land in Manitoba, Saskatchewan or Alberta. The applicant must appear in person at the Dominion Lands Agency or Sub-Agency for the District. Entry by proxy may be made at the office of any Local Agent of Dominion Lands (not sub-agent), on certain conditions.

Duties—Six months' residence upon and cultivation of the land in each of three years. A homesteader may live within nine miles of his homestead on a farm of at least 80 acres, on certain conditions. A habitable house is required in every case, except when residence is performed in the vicinity.

In certain districts a homesteader in good standing may pre-empt a quarter-section alongside his homestead. Price \$3 per acre. **Duties**—Six months' residence in each of six years from date of homestead entry (including the time required to earn homestead patent) and 50 acres extra cultivation. The area of cultivation is subject to reduction in case of rough, scrubby or stony land after report by Homestead Inspector on application for patent.

A homesteader who has exhausted his homestead right and cannot obtain a pre-emption may take a purchased homestead in certain districts. Price, \$3 per acre. **Duties**—Must reside six months in each of three years, cultivate 50 acres and erect a house worth \$300.

W. W. CORY,
Deputy of the Minister of the Interior.
N.B.—Unauthorized publication of this advertisement will not be paid for.—37085.

1877-1914

Thirty-six years' experience in brewing

Drewry's Redwood Lager

tells the story of its popularity

TRY IT

Name this magazine when writing advertisers

A Wealth of Water

Write Today For FREE Book

The 1914 demand is for a wealth of water! Tentimes more work than drillers to do it! Never before was there such a tremendous opportunity to make immense profits. Tens of thousands of farmers calling for deep wells. The terrible 1913 drought taught them a terrible lesson. Epidemics, Typhoid, Malaria—other diseases due to impure water—have created a crying need everywhere for deep-drilled, pure water wells. Farmers—engineers—threshermen—farm hands—live men in all lines—are making big money drilling wells! "I dig \$10 a day above expenses, right along."—Thos. Kelley.

Wealth In Drilling Wells

Men Who Never Before Had Any Well Drilling Experience Are Making \$20.00 to \$50.00 per Day with **ARMSTRONG Well Drills!**

Either Traction or Portable style. Will drill faster and at lower cost per foot than any other well drill in existence! Easiest to operate. Three right hand levers complete every operation. Furnish with our special engine—made just for drilling metal Runs quietly. Simple. Pays for itself in part cost and time payment plan. Write for complete plan and price.

ARMSTRONG MFG. CO.
354 Drake Bldg. No. 2 Saskatoon, Sask.
Home Office and Factory, Waterloo, Iowa.

"Exactly," replied Kent with satisfaction.

"Well, how do you account for that?"

Passing over the query, the other proceeded: "Now, as I understand it, you put yourself in my hands undeservedly."

"What else can I do?" cried Preston Jax.

"Nothing that would be so wise. So do not try. I shall want you to come to Martindale Center on call. Pack up and be ready."

"But the police!" quavered Jax. "You said the place was guarded, and I'd be pinched if I tried to get out."

"Oh, no," retorted Kent, with a smile. "That wouldn't have been true, and I never lie. You inferred that, and wrongly, from my little ruse to keep you from running away. That you would be arrested eventually, if you attempted escape was true. It still is true."

"I believe it," replied Preston Jax fervently, "with you on my trail."

"Come, Mrs. Blair," said Kent. "Remember, Jax: fair play, and we shall pull you through yet."

In the taxi, Marjorie Blair turned to Kent. "You are a very wonderful person," she said—Kent shook his head—"and, I think, a very kind one." Kent shook his head again. "Be kind to me, and leave me to go home alone."

Kent stopped the cab, stepped out and raised his hat. She leaned toward him.

"Just a moment," she said. "Perhaps I ought not to ask; but it is too strong for me. Will you tell me who the woman was?"

Kent fell back a step, his eyes widening.

"You don't see it yet?" he asked.

"Not a glimmer of light. Unless she was some—some unacknowledged member of the family."

"No. Not that."

"And you can't tell me who she was?"

"Yes; but not just now. Try to be patient for a little, Mrs. Blair."

"Very well. Your judgment is best, doubtless. Of course you know whose hand wrote the body of that letter?"

"Yes; try not to think of it," advised Kent. "It isn't nearly so ugly as it seems."

She looked at him with her straight, fearless, wistful glance.

"He had left me nothing to love," she said sadly; "but to find disgrace and shame even to the end of his life! That is hard. That it should have been my husband who gave the thing most precious to me to another woman! But why did he write the letter to Preston Jax for her to sign?"

Chester Kent shook his head.

NOTE.—We have no connection with any employment agency of similar name.

Harvesting and Thresher Help!

We supply Engineers, Separators, Firemen, Tankmen, Cooks, and all other help required for Harvesting and Threshing on short notice. Telephone orders not being legal it is absolutely necessary that you write or wire us stating wages and nature of work.

Hall's Red River Employment Bureau
188 LOGAN AVENUE
Joseph Hall, Proprietor

You saw this advertisement in this magazine. Don't forget to say so when writing.

Announcing The New Typewriter OLIVER No. 7

WE ANNOUNCE AN AMAZING MODEL, the OLIVER No. 7—a typewriter of *superexcellence*, with automatic devices and refinements that mark the zenith of typewriter progress. A marvel of beauty, speed and easy action. Typewriting efficiency raised to the nth power.

The OLIVER No. 7 embodies all previous Oliver innovations and new self-acting devices never before seen on any typewriter. A leap in advance which places The Oliver ten years ahead of its time. So smooth in action, so light to the touch, so easy to run, that experts are amazed. A model that means to the typist delightful ease of operation.

A model that means a higher standard of typewriting, longer and better service.

The No. 7 is now on exhibit and sale at all Oliver Branches and Agencies

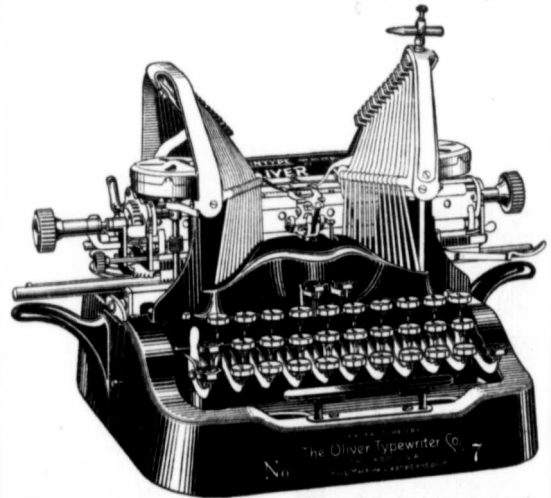

The new model has more improvements, refinements and new uses than we can even enumerate here.

The "cushioned keyboard" with "anchor keys" and the new automatic features mean less work for the hands, less strain on the eyes, less manual and mental effort.

With all of these masterly mechanical improvements we have made the machine more beautiful and symmetrical. From every standpoint The OLIVER No. 7 attains superlative excellence.

Nothing you could wish for has been omitted. The new devices, refinements, improvements and conveniences found on the No. 7 represent an enormous outlay and vastly increase its value—the price has not been advanced one penny. We shall

even continue in force our popular 17-Cents-a-Day purchase plan, the same as on previous Oliver models.

The OLIVER No. 7, equipped with the famous Printype, if desired, without extra charge.

You owe it to yourself to see the new machine before you buy any typewriter at any price. Note its beauty, speed and easy action, its wonderful automatic devices. Try it on any work that is ever done on typewriters. Try it on many kinds of work that no other typewriter will do.

It is a significant fact that the typewriter that introduced such epoch-making innovations as visible writing, visible reading, Printype, etc should be the first to introduce automatic methods of operation.

The OLIVER Typewriter Co.
Oliver Typewriter Building
CHICAGO

High-Priced Pork while
waiting their own Feed.



**AGENTS
WANTED**
in Every Town
and District

Shipments made
from Galt, Ont. and
Winnipeg, Man.

Address to Head
Office

Canadian Hog Motor Co. Ltd.
92 Alexander Ave. East Winnipeg, Man.

Name this magazine when writing advertisers

Well Drilling Machines

Over 70 sizes and styles for drilling either deep or shallow wells in any kind of soil on wheels or on glass or horse sills. With engines, simple, durable. ANY mechanic can operate them. Send for catalogue.

WILLIAMS BROS.
ITHACA, N. Y.

Name this magazine when writing advertisers

Imperial Bank

OF CANADA
Established 1878

Capital Authorized \$10,000,000
Capital Paid Up 7,000,000
Reserve and Undivided Profits 7,000,000
Total Assets 78,000,000

BRANCHES IN WESTERN CANADA

Province of Manitoba
Brandon Portage la Prairie Winnipeg
Province of Saskatchewan
Balgonie Broadview North Rattleford
Northern Fort Qu'Appelle Prince Albert
Saskatoon Moose Jaw Regina
Wilkie Hague Wynyard

Province of Alberta

Ashabaska Landing Edmonton Strathcona
Banff Lethbridge Wainwright
Calgary Red Deer Redcliff
Rocky Mountain Hse. Medicine Hat Millet

SAVINGS DEPARTMENTS AT ALL BRANCHES

Interest allowed at Current Rates
Drafts and Letters of Credit issued available in
all parts of the world.

Winnipeg Branch
N. G. LESLIE,
Manager.

Name this magazine when writing advertisers

The Pump That Pumps **SPRAY PUMPS** Double-acting, L.H.L. Tank and Spray PUMPS
MYERS SHAY TOOLS
Store Ladders, Etc.
of all kinds. Write for descriptive circular and prices. Exclusive agency given to right party who will buy in quantities.
Myers Shayon Flexible Door Hangers with steel roller bearings, easy to push and to pull, cannot be thrown off the track—hence its name—“Shayon.” Write for descriptive circular and prices. Exclusive agency given to right party who will buy in quantities.
W. F. MYERS & CO., CHICAGO, ILL.

Name this magazine when writing advertisers

THE ORIGINAL PECH Boring Machine
THE OLD RELIABLE Easiest to operate Borens Faster Most Durable
Improved Up-to-date Drilling Machines
DESCRIPTIVE CATALOGUE FREE
Cherokee Mfg. Co., Dept. A, Cherokee, Iowa.

Name this magazine when writing advertisers

CHAPTER XIX

The Strange Tryst

Midnight found Kent in the throes of literary effort. He was striving to compose a letter to Sedgwick, that should, in turn, compose the recipient's perturbed feelings. It concluded, with some acerbity:

"You've made a pretty complete idiot of yourself once. Don't try to eclipse your own record."

By which he purposed to convey to the artist the fact that his presence in Boston was neither desirable nor advisable. As he was about to affix his signature, a knock brought him to the door of his hotel room.

"Letter for you," announced the messenger boy.

Kent signed the book and received a broad thin envelope sealed in golden hued wax with the imprint of a star, and addressed in typewriting to his own name.

"Confound all fools who sign their letters on the outside!" said Kent, scowling at the seal. "What has that planetary lunatic got to say that won't keep?"

What Preston Jax had to say was, first, in the form of a very brief note; secondly, in the shape of a formidable-looking document. The note began "Esteemed sir," concluded "Yours remorsefully," and set forth, in somewhat exotic language, that the writer, fearing a lapse of courage that might confuse his narrative when he should come to give it, had "taken pen in hand" to commit it to writing, and would the recipient "kindly pardon haste?" Therewith, twenty-one typed pages.

"Haste!" cried Chester Kent grievously. "Why, he's written me the story of his life!"

Indeed, at a cursory glance, it appeared so. The initial paragraph opened, "I was born of poor but honest parents." Chester Kent groaned. A little farther down the page the phrase, "Oh, that those innocent days of my happy childhood might return!" rose and smote him in the eyes. Chester Kent snorted. A desperate leap landed him in the midst of page five, where he encountered this gem, "With these fateful words the kind old minister laid a faltering hand upon my head. But enough!"

"Quite enough!" agreed Chester Kent, and kicked the Star-master's document into a corner.

It fell in a crumpled heap with one sheet, curving in upward protuberance, conspicuous to the eye. On this sheet there was handwriting, and the handwriting was the same as that of the note Marjorie Blair had identified. Kent retrieved the paper, laid it on his desk, selected a likely spot

Blue Ribbon TEA
RED LABEL
WON GRAND PRIZE FOR QUALITY
WORLDS FAIR SEATTLE 1909

Try me - I wont disappoint you!

You saw this advertisement in this magazine. Don't forget to say so when writing.

Mason & Risch Pianos

"FROM FACTORY TO HOME"
17 WESTERN BRANCH STORES

The Mason & Risch Piano is an instrument which embodies in surpassing measure all of those qualities which make the possession of a high-grade Piano desirable. "To Own a Mason & Risch Piano is to Possess The Best Piano Built." It is a compliment to your good judgment, and a dividend to your pocketbook, for it is sold to you at the LOWEST price it CAN be sold, direct "from Factory to Home."

WRITE FOR CATALOGUE TO-DAY!

MASON & RISCH LIMITED

WINNIPEG, MAN.

"Not only Life Insurance, but adequate Life Insurance, in the form most nearly taking the place of the household provider when his supporting care is removed."

That is to say—take MONTHLY INCOME INSURANCE, the ideal of protection.

Safe — regular — dependable — permanent — automatic — there are a hundred arguments for MONTHLY INCOME INSURANCE.

The Great-West Life issues this Plan on most attractive terms. Send for a fully descriptive pamphlet just off the Press. Observe the rates, the comprehensive provisions and the liberal arrangement whereby beneficiaries are given the advantage of the Company's high profit-earnings.

The Great-West Life Assurance Company

Head Office - Winnipeg, Man.

You saw this advertisement in this magazine. Don't forget to say so when writing.

E. V. Chaplin J. R. Young, C.A.
T. Anderson, C.A.
CHAPLIN, YOUNG & ANDERSON
Accountants and Auditors
545 Somerset Building
WINNIPEG, Man. Phone MAIN 2153

Ring-Bone
There is no name so old and bad that we will not guarantee
Fleming's Spavin and Ringbone Paste
to remove the lameness and make the horse go sound. Money refunded if it ever fails. Easy to use and goes to three 46-minute applications cure. Works just as well on Ringbone and Bone Spavin. Before ordering or buying any kind of a remedy for any kind of a blemish, write for a free copy of Fleming's Vest-Pocket
Veterinary Adviser
Illustrated pages of veterinary information, with special attention to the treatment of lameness. Turbly book. Indexed and illustrated. Make a right beginning by seeing for this book.
FLEMING BROS., Chemists,
45 Church Street, Toronto, Ont.

Name this magazine when writing advertisers

GRAND TRUNK RAILWAY SYSTEM
Double Track Route
TO
Detroit, London, Hamilton, Toronto, Montreal and New York via Niagara Falls
Smooth road-bed, polite employees, unexcelled dining-car service, and latest standard equipment
AGENTS, COOK'S TOURS AND ALL STEAMSHIP LINES
Rates, reservations and all particulars at Ticket Office
Phone Main 7098 260 Portage
WINNIPEG

Dealers Increase Your Sales!
Take a Look at the
Strite Governor Pulley
It's the original and the only thing for driving cream separators with gasoline engines. One trial, always satisfied. TRY ONE. More in use than all others combined. Costs no more than imitations. Also, ask about our other popular pulleys.
STRITE GOVERNOR PULLEY CO. 310 S. 3RD ST., MINNEAPOLIS
Name this magazine when writing advertisers

PATENTS
LLOYD BLACKMORE & CO. LTD.
Hope Bldg., 63 Sparks St., Ottawa, Ont.
Write for Free Book of Information.

Capital and Reserve
\$3,000,000
Money to Loan
We have money to loan on improved Farm and City Property.
Our financial strength and expert staff enable us to capably manage estates. We are a permanent institution and will survive the longest trusts.
We act as Trustee, Executor, Administrator, Guardian, Liquidator, Assignee, and Financial Agent.
National Trust COMPANY LIMITED
D. H. Cooper, Manager.
C. Y. Stainer Secretary.
323 Main Street
WINNIPEG.

Name this magazine when writing advertisers

for one more plunge, and dived into the turbid flood of words. And behold! as he turned, so to speak the corner of the narrative, the current became suddenly clear. The muddled eloquence fell away; and the style crystallized into the tense quick testimony of the prime actor in a drama, intensely and shudderingly felt.

The reader ran through it with increasing absorption. Then, pencil in hand, he attacked the first part of the precious screed and emerged from a scene of literary carnage with one brief paragraph in hand and the slaughtered bodies of many eloquent pages strewn the floor. That one paragraph stated that Preston Jax, whose real name was John Preston, had, after a rebellious boyhood, run away to sea, lived two years before the mast, picked up a smattering of education, been assistant and capper for a magnetic healer, and had finally formulated a system of astrological prophecy that won him a slow but increasing renown. The gist of the system was to assign some particular and often imaginary star to every subject, and, by a natural aptitude for worming out secrets from the credulous, lead them along the celestial paths of mysticism to a point where he could reach their pocketbooks. He had been specially successful with women. One bit of his philosophy Kent had preserved unaltered.

"They bite slower than men; but when they do take hold, they swallow the hook so deep that you're lucky to get it back at all."
An hour's work with a pencil that should have been blue resolved the document, under Kent's skillful and remorseless editorship, into its salient elements. Obviously it was impossible to put it into alien hands for copying. Kent ordered up a typewriter and copied it himself. The duplicate he enclosed in his letter to Sedgwick. The original he put aside to sleep upon. Thus it ran:

"This Astrea affair looked good from the first," so began Preston Jax's confession, as beheaded and stripped down by its editor. "It looked like one of the best. You could smell money in it with half a nose. She bit first on one of the occult ads—the number four of the old series, a double-column with display in heavy-faced Italics and leaded out strong. That ad always was a good woman-fetcher. Her first letter came in on Monday, I recollect. It was a big mail. There were a lot of Curiositys and a couple of Suspiciouses, and this was one of half a dozen in the True Believers' pile. Irene, my assistant, had put the red pencil on it, when

UNION BANK OF CANADA

Established 1868



Head Office Winnipeg
Paid-up Capital..... \$6,000,000
Reserve..... 2,400,000
Total Assets, over..... \$8,000,000
HON. PRESIDENT WM. PRICE, Esq.
PRESIDENT - JOHN GALT, Esq.
VICE-PRESIDENTS
R. T. RILEY, Esq. G. H. THOMPSON, Esq.
DIRECTORS
W. R. ALLAN, Esq.
Hon. S. BARKER, P.C., M.P.
M. BULL, Esq.
L. L. COLBY, Esq.
B. B. CRONYN, Esq.
E. L. DREWRY, Esq.
E. E. A. DU VERNET, Esq., K.C.
S. HAAS, Esq.
F. W. HEURACH, Esq.
F. E. KENASTON, Esq.
WM. SHAW, Esq.
G. H. BALFOUR, General Manager.
H. B. SHAW, Assistant General Manager.
F. W. S. CRISP, Superintendent of Branches

London, Eng., Branches—11 Threadneedle St., E. C., and West End Branch, Haymarket, S.W.
This Bank, having over 310 branches in Canada, extending from Halifax to Prince Rupert, offers excellent facilities for the transaction of every description of banking business. It has correspondents in all cities of importance throughout Canada, the United States, the Continent of Europe, and the British Empire.
Collections made in all parts of the Dominion, and returns promptly remitted at lowest rates of exchange.

Head Office, Winnipeg.
Two Central Offices in Winnipeg—Main St. & William Ave. J. D. M. Neeve, Manager. Portage Ave., Cor. Garry St. (adjoining Post Office), F. J. Boulton, Manager.
Other Branches in Winnipeg as follows: Corydon Ave., Logan Ave., North End, Sargent Ave., Portage Ave., and Arlington St., Sargent Ave., and Arlington St., 490 Portage Ave.
Branches and Agencies West of the Great Lakes.
Manitoba—Baldur, Birse, Boisverain, Brandon, Garberry, Carman, Carroll, Clearwater, Crystal City, Cypress River, Dauphin, Deloraine, Glenboro, Hamiota, Hartney, Holland, Killarney, Manitoba, McCreary, Melita, Minnedosa, Minto, Morden, Neepawa, Newdale, Niags, Rapid City, Roblin, Roland, Russell, Shoal Lake, Somerset, Souris, Strasbair, The Pas, Virden, Waskada, Wawanosa, Wellwood, Winnipeg.
Saskatchewan—Abbeey, Adano, Alask, Aroon, Asquith, Assiniboia, Bounty, Buchanan, Cahrs, Canon, Carlyle, Craik, Capar, Cut Knife, Diamond, Drummer, Eastend, Esterhazy, Estevan, Eyebrow, Filmore, Gravelbourg, Gurnsey, Gull Lake, Herbert, Hughson, Humboldt, Indian Head, Jansen, Keisaid, Kelvinshurst, Kerrobert, Kinslerley, Landis, Lang, Leisgan, Lemberg, Lovrina, Lundan, Lussland, Macklin, Maple Creek, Mayfield, Macross, Melfort, Milestone, Moose Jaw, Moosemin, Morse, Netherhill, Neudorf, Ogema, Outlook, Ostrow, Pease, Perdue, Pispot, Plenty, Prince Albert, Qu'Appelle, Regina, Rosenville, Roseton, Saskatchewan, Scott, Scepter, Shaunavon, Simpson, Simons, Southey, Strassburg, Swift Current, Towner, Theodora, Togo, Tompkins, Vancouver, Verdigy, Viceroy, Wapella, Wawota, Watrous, Webb, Weyburn, Wilkie, Windthorst, Wolseley, Yorkton, Zealandia.
Alberta—Airdrie, Airds, Barons, Bashaw, Bassano, Bellevue, Blackie, Blairmore, Bowden, Bow Island, Brooks, Calgary, Carbon, Cardston, Carstairs, Crowsnest, Crowsnest Park, Grande Prairie, Grassy Lake, Hanna, High River, Hillcrest, Innisfail, Irvine, Laconbe, Langdon, Lethbridge, Macleod, Medicine Hat, Okotoks, Peaceburg, Pelly, Pelly Creek, Seven Persons, Standard, Strathmore, Swallow, Three Hills, Wainwright, Wainwright.
British Columbia—Enderby, Glacier, Hazelton, Lillooet, Nanaimo, New Hazelton, Newport, New Westminster, Prince Rupert, Smithers, Telkwa, Vancouver, Vernon, Victoria.

You saw this advertisement in this magazine. Don't forget to say so when writing.

The World's Best Eveners Help to Stop Your Farm Leaks
Heider 2, 4, 5, and 6-horse eveners on the market 12 years. Often imitated but not equalled. The Heider 4-horse plow evener works 4 bushes on a front on gang, sulky or disc plow, one horse in furrow, three on unplowed ground. Heider 6-horse wagon evener for wagon, manure spreader, grain drill or other implements with pole.
HEIDER EVENERS are the means of many short-cuts in farming. They save time, labor and horses, consequently they are more and more manufactured in the largest evener factory in the world and is no experiment. They are made right by expert workmen, of best materials, and fully guaranteed. Why take chances with the ordinary kind when you can get the best? Ask YOUR DEALER for Heider Eveners. If he has none in stock, write us for free circular showing entire line and we will tell you where to get them. Address: **Heider Mfg. Co., 79F Main St., Carroll, Iowa.**
Write for Free Circular Showing Full Line

You saw this advertisement in this magazine. Don't forget to say so when writing.

REMINGTON UMC METALLIC CARTRIDGES
For All Standard Firearms
IT must be a satisfaction to the individual rifle, pistol or revolver user to know that his preference for Remington-UMC Metallics is shared alike by professional experts, crack shots and sportsmen in all parts of the world.
So in ever increasing quantities Remington-UMC Metallics are made for every standard make and for every calibre in use — rifle, pistol and revolver.
Get them from the dealer who shows the Red Ball Mark of Remington-UMC—the Sign of the Sportsman's Headquarters.
To keep your gun cleaned and lubricated right, use Rem Oil, the new powder solvent, rust preventative, and gun lubricant.
Remington Arms-Union Metallic Cartridge Co.
Windsor, Ontario

You saw this advertisement in this magazine. Don't forget to say so when writing.

HE...
Ca...
For...
the...
Hun...
Bod...
We...
who...
buy...
and...
the...
new...
brand...
is...
clear...
ing...
many...
I...
col...
used...
in...
require...
to...
a...
full...
perfect...
REMOVE...
any...
that...
con...
Price...
is...
the...
LAW...
Name this...
PA...
Write f...
FED...
36-37 C...
Name this...
\$1500...
have...
been...
oper...
ing...
Mach...
to...
regul...
output...
of...
factur...
make...
MACHI...
Made...
of...
earth...
and...
min...
eral...
s...
ped...
with...
g...
c...
page...
C...
THE...
AM...
WEL...
General...
Office...
and...
Works...
AURORA...
U.S.A...
Chicago...
Office...
First...
Nat...
B...
Name this...
ERZ...
Leads...
to...
J...
Phon...
Name this...

THE BEST LINIMENT
ON PAIN KILLER FOR THE HUMAN BODY

**Gombault's
Caustic Balsam**
IT HAS NO EQUAL

FOR — It is penetrating, soothing and cooling, and for all kinds of Burns, Bruises, or Wounds, Pain, Insect Bites, Boils, Corns and Bunions. **HUMAN BODY** — Caustic Balsam has no equal as a Liniment.

We would say to all who buy it that it does not contain a particle of poisonous substance and therefore no harm can result from its external use. Persistent, thorough use will cure every old or chronic ailment and it can be used on any case that requires an outward application with perfect safety.

Perfectly Safe and Reliable Remedy for
Sore Throat
Chest Cold
Backache
Neuralgia
Sprains
Strains
Lumbago
Diphtheria
Sore Lungs
Rheumatism
and all Stiff Joints

REMOVES THE BORENESS—STRENGTHENS MUSCLES
Dorville, Tex.—"One bottle Caustic Balsam did my rheumatism more good than \$12.00 paid in doctor's bills."
OTTO A. BEYER
Price \$1.00 per bottle. Sold by druggists, or sent by express. Write for booklet 8.
The LAWRENCE-WILLIAMS COMPANY, Toronto, Can.

Name this magazine when writing advertisers

PATENTS TRADE MARKS AND DESIGNS

Write for booklet, circulars, terms, etc.
FETHERSTONHAUGH & CO.
FRED. B. FETHERSTONHAUGH, F. C. M. E.
GERALD S. ROXBURGH, E. A. Sc.
36-37 Canada Life Bldg. WINNIPEG

Name this magazine when writing advertisers



\$1500 to \$5000 Per Year

have been made by hundreds of people operating the "American" Drilling Machines. 40 years' experience, 80 regular styles and sizes and the output of the world's largest manufacturers of this kind of machinery make

"AMERICAN" MACHINES STANDARD

Made in types for every kind of earth and rock drilling or mineral prospecting, equipped with any power, or operated with your traction engine. Our new 1914 page Catalog Free.

THE AMERICAN WELL WORKS

General Office and Works:
AURORA
ILL., U.S.A.
Chicago Office:
First Nat. Bk. Bldg.

Name this magazine when writing advertisers

ERZINGER'S No. 2 CUT PLUG

Leads them all. It's the Best Dollar Tobacco sold anywhere.

JOHN ERZINGER
Montyre Bldg. - 293 Portage Ave.
Phone 69 Phone 2677

Name this magazine when writing advertisers

she sorted out the mail, to show it was something special. But don't get her into this, Professor Kent. If you do, it's all off, jewels and all. Irene has always been for the straight star business and forecast game, and no extras or side lines. Besides, we were married last week.

"What attracted Irene's red pencil, and caught me right away, was the style of the thing. The handwriting was classy. The paper was elegant. There was something rich about it all. This was no Bidly, pinching out the missis' stationery to make a play with. She quoted poetry, swell poetry. First off she signed herself 'An Adept'. I gave her the Personal, No. 3, and followed it up with the Special Friendly, No. 5. Irene never liked that No. 5. She says it's spoony. Just the same, it fetches them. But not this one. She began to get personal and warm-hearted, all right, and answered up with the kind-red-soul racket. But come to Boston? Not a move! Said she couldn't. There were reasons. It looked like the old game—flitter-headed wife and jealous husband. Nothing in that game, unless you go in for the straight holdup. And blackmail was always too strong for my taste. So I did the natural thing; gave her special readings and doubled on the price. She paid like a lamb.

"Then, blame if it didn't slip out she wasn't married at all! I lost that letter. It was kind of endearing. Irene put up a howl. It was getting too personal for her taste. I told her I would cut it out. Then I gave my swell lady another address and wrote her for a picture. Nothing doing. But she began to hint around at a meeting. One day a letter came with a hundred-dollar bill in it. Loose, too, just like you or me might send a two-cent stamp. 'For expenses', she wrote, and I was to come at once. Our souls had returned to recognize and join each other, she said. Here is the only part of the letter I could dig up from the waste basket."

Here the specimen of handwriting that had caught Kent's eye was pasted upon the document.

"You have pointed out to me that our stars, swinging in mighty circles, are rushing on to a joint climax. Together we may force open the doors to the past, and sway the world as we sought to do in bygone days."

(To be continued)

In Answering Advertisements in this Magazine be sure and mention where you saw the advt. Remember we guarantee the reliability of all our advertisers.

The Occidental Fire Insurance Co.

Head Office: WAWANESA, MAN.
A. NAISMITH, President R. M. MATHESON, Vice-President
A. F. KEMPTON, Sec. and Mgr. C. D. KERR, Treasurer
Subscribed Capital \$500,000.00
Security to Policy-holders 640,817.29

Full Deposit with Dominion Government
Agents wanted in unrepresented districts

S.H. Henderson, Pres. E. H. Dewart, Vice-Pres. C. D. Kerr, Treasurer

The WAWANESA MUTUAL INSURANCE COMPANY

HEAD OFFICE: WAWANESA, MAN.
A. F. KEMPTON, Secretary-Manager
Amount of Insurance in force Dec. 31st, 1913 \$38,242,194.00
Assets over Liabilities 662,467.96

THE NUMBER OF FARMERS INSURED, 31st. DEC. 1913, 25,495
The Largest Farmers Mutual Fire Insurance Company in Canada. Agents wanted in unrepresented districts

JOSEPH RODGERS & SONS, Limited
SHEFFIELD, ENG.

REGISTERED TRADE MARK
* * * * *
GRANTED 1882
Avoid imitations of our CUTLERY by Seeing that This EXACT MARK is on Each Blade.
SOLE AGENTS FOR CANADA

JAMES HUTTON & CO., MONTREAL.

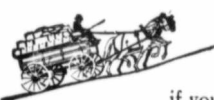

No Need of a Tow

if you grease your wheels with
Mica Axle Grease

It lightens the load and saves wear and tear.

"There's Mica in it, that's why."

THE IMPERIAL OIL CO., Limited
Winnipeg Toronto St. John
Vancouver Montreal Halifax



There Is No String To This Pipe

It is absolutely FREE to subscribers who take advantage of this offer

The Weekly Free Press and Prairie Farmer,

Winnipeg

The Canadian Thresherman and Farmer

Both including Pipe for the nominal sum of **\$1.25**

The lowest price at which these two papers will be offered this year is \$1.25. It makes no difference whether you take the pipe or not, the price is the same. While the supply of these pipes lasts they will be given away free to all who subscribe. Better get your order in early and be sure of a good smoke.

Weekly Free Press and Prairie Farmer. 1914
Winnipeg, Man.

Find enclosed \$1.25, for which send the "Weekly Free Press and Prairie Farmer" one year, and the "Canadian Thresherman and Farmer," one year, together with pipe to the following address:

Name

Town

Province P.O. Box



Conducted for the benefit of Dealers, Threshermen and Farmers who have anything to sell or exchange. Five cents a word for each insertion.

FREE FOR SIX MONTHS—My special offer to introduce my magazine "Investing For Profit." It is worth \$10 a copy to anyone who has been getting poorer while the rich, richer. It demonstrates the real earning power of money and shows how anyone no matter how poor, can acquire riches. "Investing for Profit" is the only progressive financial journal published. It shows how \$100 grows to \$2,000. Write now and I'll send it six months free. H. L. Barber, 496-20 W. Jackson Blvd., Chicago.

FARMS WANTED. We have direct buyers. Don't pay commissions. Write describing property, naming lowest price. We help buyers locate desirable property free. American Investment Association 15 Palace Bldg., Minneapolis, Minn.

OXY-ACETYLENE WELDING—Save your cracked or broken castings from the scrap heap. We weld cylinders, crank shafts, gears, levers, etc., retain original form and strength at a small cost. Metal added to worn-out parts. All metals welded. Write for particulars. The Welding & Manufacturing Co., 624 Princess Street, Winnipeg.

FOR SALE.

We have on hand at present a very full line of Rebuilt and Second-hand Engines and Separators, which we are offering at attractive prices. Write us fully what you are thinking of buying, when we shall be pleased to tell you what we have and quote prices. All our rebuilt goods are sold under same guarantee as new ones and of course are carefully repainted and look exactly like new. If you write us at once we are sure to have the size you almost want.

SAWYER-MASSEY COMPANY, LIMITED, Winnipeg, Man.

BARGAINS.

- 1 30 H.P. double undermounted Avery engine, with Alberta and Saskatchewan Boiler. This engine has been repaired and fixed up in first class shape.
 - 1 30 H.P. undermounted Avery engine, with regular boiler, repaired and fixed up in first class shape—this would make a dandy threshing engine.
 - 1 20-35 Avery gas engine—has been out two seasons and is in first class shape.
 - 1 20-35 Avery gas engine—has been out seven days in 1913, is practically as good as new.
 - 1 18 H.P. double undermounted Avery engine, coil burner, is in first class shape.
 - 1 3-ton Avery farm truck, has been repaired and over-hauled and is in first class shape.
 - 1 36 x 60 Avery separator, complete with feeder, weigher, wind stacker; has only been out 30 days. Has been repaired and repainted, looks like new.
 - 1 32 x 54 Avery separator, only been out 20 days, and is in first class shape.
 - 1 42 x 70 Avery separator, has run 50 days, has been repaired, repainted and over-hauled and is in first class shape.
- If you are interested in second hand goods and none of the above suit you, let us hear from you, stating just what you want, and we feel sure we can fix you out all right. We feel sure we can fix you out alright.
- CANADIAN AVERY COMPANY, LTD.** Winnipeg and Regina.

BUYERS, ATTENTION!

HE GEORGE WHITH & SONS COMPANY LIMITED, BRANDON, MAN.

- ENGINES**
- 2-25 H.P. White tractors thoroughly rebuilt and in good shape. Each... \$ 160.00
 - Second Hand
 - 1-16 H.P. American Advance traction... \$ 700.00
 - 1-18 H.P. Minneapolis traction... \$ 600.00
 - 1-20 H.P. Brandon Cornell, Portable... \$4000.00
 - 1-20 H.P. White tractor... \$1200.00
- SEPARATORS—Second Hand**
- Aultman & Taylor, 28x50, all attachments... \$ 400.00
 - 1-40x62 Waterloo separator, all attachments... \$ 400.00
 - 1-30x60 Goddard separator, all attachments... \$ 300.00
 - 1-30x60 American Abell, all attachments... \$ 325.00
 - 30x56 Felburn separator, all attachments... \$ 300.00
 - 2-32x56 Great West separator, all attachments... \$ 200.00
 - 1-30x56 Great West separator, all attachments... \$ 200.00
 - 2-White Challenger separator, all attachments, Each... \$ 900.00
- Write us re new goods—We have the best.

WANTED—Improved farms and wild lands. Best system for quick results. Full particulars and magazine free. Don't pay big commissions. Western Sales Agency, Minneapolis, Minn.

REBUILT ENGINES and separators bought and sold. Do you want a good rebuilt automobile? Experts sent out to all parts of Sask. Agents for Geo. White engines and separators. Rumely, Gear Scott, and Advance lines. The G. M. Graves Machine and Motor Co., Sutherland, Sask.

FOR SALE.

- No. 15 Horse Case Simple Portable Engine.....20540
 - 15 Horse Case Simple Portable Engine.....18833
 - 15 Horse Compound Portable Engine.....13428
 - 18 Horse Simple Traction Waterloo.....323
 - 16 Horse Portable Sawyer-Massey.....8299
 - 20 Horse Portable Sawyer-Massey.....1419
 - 20 Horse Simple Traction Sawyer-Massey.....1116
 - 30 Horse Compound Traction Engine, Case 7988
 - 20 Horse Simple Traction Engine, Case.....1721
 - 20 Horse Simple Traction Engine, Case.....16912
 - 32 Horse Simple Traction Engine, Case.....19119
- J. I. CASE, THRESHING MACHINE COMPANY, Winnipeg, Canada.**

FOR SALE—1 110 H.P. simple traction J. I. Case engine, 1 80 H.P. simple traction J. I. Case engine, 1 75 H.P. simple traction J. I. Case engine, 2 25 H.P. simple traction J. I. Case engines, 1 60 H.P. simple traction J. I. Case engine, 1 45 H.P. simple traction J. I. Case engine, 1 45 H.P. simple portable J. I. Case engine, 1 30-60 oil tractor J. I. Case engine, 2 40-62 separators, J. I. Case, 2 36-58 separators, J. I. Case, 1 32-54 separator, J. I. Case, 1 28-50 separator, J. I. Case, 1 24-42 separator, J. I. Case. The above separators are all equipped with feeders, windstackers, and automatic grain handlers. The 110, 80 and 75 H.P. engines are equipped with contractor's fuel bunkers. We also have for sale two second-hand J. I. Case 30 H.P. automobiles, which will be sold at reasonable prices. 1. Case Threshing Machine Co., Regina, Sask.

LAND—30 miles from Winnipeg. A1 mixed farming lands. Good transportation, from 1/2 mile to 3 miles from railway. Water at 15 feet. Garden City Land Company, 318 McIntyre Block, Winnipeg. Phone M 4799.

WANTED to hear of good farm or unimproved land for sale. Send description and price. Northwestern Business Agency, Minneapolis, Minn.

STEWART SHEAF LOADER—Good as new. Will be sold cheap. Apply R. A. Brodie, Pierson, Man.

FOR SALE—4 H.P. Waterloo Boy Gasoline Engine, practically new. Has been used for demonstrating purposes only. In first class shape. Price \$125, a real snap. Maytag Co., Limited, Winnipeg, Canada.

HALL'S RED RIVER EMPLOYMENT OFFICE, 152 Logan Ave., East, is connected to old established Red River Employment Office. Farm hands, engineers, steam and gasoline plowmen and all other farm help. Phone Main 7298.

"HEAVEN AND HELL" and the world of spirits. Swedenborg's great work on the life after death. 400 pages. Only 25c. post-paid. W. H. Law, 486-G, Euclid Ave., Toronto, Ont.

CASH FOR YOUR FARM OR BUSINESS—I bring buyers and sellers together. No matter where located, if you want to buy, sell or exchange any kind of farm, business or machinery anywhere, at any price, write me. Established 1881. Frank P. Cleveland, 1881 Adams Express Building, Chicago, Illinois.

WANTED—Separator man for fall's run, at least 10 years experience in Manitoba or Dakotas; a real hustler, able to handle men and alive to his finger tips, a man we will never have to wait on, to work on an outfit he will never be sorry for or ashamed of. References required and given. Wheat, oats, barley and flax. Apply Bourne, Box 414, Kinsley, Wis.

FOR SALE—1 Hart-Parr 30-60 H.P. Kerosene Engine, 1 32-inch cylinder Red River Special Separator, 1 7-furrow, 8 furrowed frame Cockshutt Plow. A Snap for cash. Cole, Grasmere Farm, Wapella, Sask.

FOR SALE, CHEAP—25 H.P. Winnipig Gas Tractor and Gang Plow. For particulars apply to W. Rehill, Sunbeam, Alberta.

\$1,800 BUYS COMPLETE OUTFIT—25 H.P. new Huber Engine (plow gear), 41 x 66 Pitts Separator, all complete. No. 1 running order. Aukes, Wimbledon, North Dakota

AGENTS WANTED—Having the sole agency for the Dominion of Canada to handle The Richmond Automatic Fire Extinguisher we are willing to pay big commissions to agents to represent us. Just a few more agents wanted. Write immediately. The Hobart Mfg. Co., 210 Enderston Bldg. Winnipeg. 8-1

CANADIAN GOVERNMENT EXAMINATIONS for railway mail clerks everywhere soon. Citizens over 15 eligible. Big pay life job. Yearly vacation with full pay. Common education sufficient. Write immediately for free sample questions and list of examination places. Franklin Institute, Dept. G 180 Rochester, N.Y.

FOR SALE—640 acres 2 1/2 miles from Lanigan, 310 acres 3 miles from Moose Jaw, 1,280 acres near Gainsborough, 160 acres improved near Carievale, 1,280 acres near Borden, 320 acres near McNutt, 640 acres improved near Paynton, 160 acres improved near Rama. These lands are offered at right prices on the following terms: 1-10 cash, balance 9 yearly payments at 6 per cent. For list and maps write Canada Lands, Limited, 406 Northern Crown Bank Bldg., Winnipeg, Canada.

ENGINEER—Wishes position running gas tractor. Fairbanks or Rumely preferred. Apply C. J. Surprenant, Otterburne, Man.

"STUDEBAKER"

Electric Started

Electric Lighted

Four Cylinder \$1,375.00
Six Cylinder \$1,975.00

Complete Stock of Spare Parts Carried for all Models from 1911 to date. Trade discount to legitimate dealers.

Breen Motor Co. Ltd., 704 Broadway, WINNIPEG

You saw this advertisement in this magazine. Don't forget to say so when writing.

THE STORY OF TWO FARMS AND ONE FLASH

PROTECTION POSITIVELY GUARANTEED

caused by lightning to any structure and its contents if said structure has been rodded by our ninety-nine p.c. pure copper cable. We give an absolute guarantee to this effect, and we know we are taking no risk in doing so.

IN OUR TEN YEARS' BUSINESS AS ELECTRICIANS'

No building which has been protected by the "TOWNSLEY" system has ever been damaged by lightning storm, while others in the immediate vicinity have gone up in smoke.

IT CANNOT HAPPEN

and our protecting cover (which is the least expensive insurance you ever paid) not only guarantees you against loss of property, but the inconvenience arising from such destruction, and the double loss in being put out of business till it has been replaced.

Write us at once for full particulars. Agents wanted in Western Canada

335 9th Street

Brandon
O. W. TOWNSLEY, Manager

RUINED BY SIMPLE NEGLIGENCE OF THE ROLLY-BEING UNPROTECTED

99 CANADIAN LIGHTNING ARRESTER 99
CAND ELECTRICAL CO. LTD. BRANDON PURE COPPER

SAVED BY TOWNSLEY AND TAKING NO CHANCES

You saw this advertisement in this magazine. Don't forget to say so when writing.



20 HORSE POWER STEAM ENGINE.

HUBER POWER

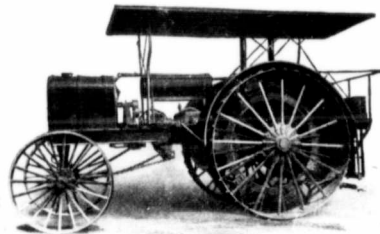

30-60 GAS TRACTOR

If you are going to need a power outfit for the general work of the farm, or for threshing, you will do well to get full information regarding the Huber line.

Should your preference be for a Gas Tractor, we can supply you with one of three sizes: the 15-30 and the 20-40 are of the two-cylinder opposed type; the 30-60 is four-cylinder. They are all regularly equipped to use both kerosene and gasoline for fuel. They are noted for the amount of effective power produced per gallon of fuel used. The cost of operation, compared with the amount of actual work accomplished, proves that a Huber Tractor is an economical and satisfactory power.

Others prefer the steam engine; and that we can furnish you in five different sizes, from 16 to 30 horse power. Each is mounted on the Huber Return Flue Boiler, which burns coal, wood, or straw, and delivers most steam for the quantity of fuel consumed. Heat must pass twice through the water the length of boiler before it can reach smoke stack. Most of it is thus utilized to produce steam. Huber steam engines have great surplus power over all ordinary requirements. The construction throughout is such that the outfit will easily withstand the hardest pulling strains and roughest usage. All Huber steam tractors can be equipped with the power guide, one of the most valuable improvements made on a traction engine. With this, it guides itself by steam power. Operator controls the direction of travel by slight movement of a straight lever. This feature alone makes it to your interest to own a Huber.

Our complete line includes threshing outfits of various sizes, and for all kinds of small grains. Every labor saving device is furnished with the Huber. They are noted for cleaning the grain perfectly, and saving it. We solicit an opportunity to figure with you on your requirements in the way of farm power or threshing machinery.



Twenty - Forty HUBER TRACTOR PLOWING

The HUBER MANUFACTURING CO.

Makers of STEAM ENGINES, GAS TRACTORS, THRESHING MACHINERY

CANADA OFFICE, WINNIPEG: Corner Logan and Arlington

Factory, MARION, OHIO, U.S.A.



HUBER STEAM ENGINE RUNNING THRESHING OUTFIT.

CASE BALING PRESSES

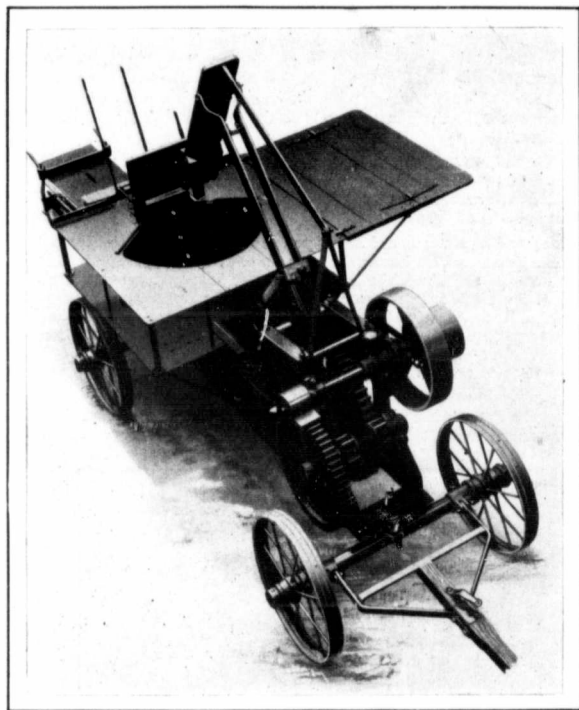

Who's getting the baling business in your vicinity?

There must be a good deal. Farmers now almost generally demand that their hay be baled because, being easy to handle, it commands higher prices. The business is there for someone—why not for you?

When anyone thinks of a baling press, he immediately thinks of a CASE Baler, because—

No. 1 Its large feed opening permits of easy, fast feeding.

No. 2 Its condenser compresses the hay right under the feeder, so that the whole forkful goes into the baler at one time.

No. 3 The CASE Baler is equipped with a friction clutch, which lets the flywheel get up to speed before the baler is started; there is slight possibility of throwing the belt.

No. 4 It is built in two sizes, 14 x 18 inches and 17 x 22 inches. The former will bale from three and a half to five tons per hour; the latter from four to six.

If you have no use for a power baler, our horse power machine has been found by many farmers to meet their needs to a T. Its size is 14 x 18 inches, with a capacity of one and a half to two tons per hour.

Will you have our new catalog on Case Baling Presses? It shows you how CASE builds these machines, and what they will do; it also tells you what they have done for others. Better profit by their experiences. A card will bring it to you.

J. I. CASE THRESHING MACHINE CO.

INCORPORATED IN THE STATE OF WISCONSIN RACINE, WIS., U. S. A.

CANADIAN BRANCHES: TORONTO, WINNIPEG, SASKATOON, REGINA & CALGARY