

**CIHM  
Microfiche  
Series  
(Monographs)**

**ICMH  
Collection de  
microfiches  
(monographies)**



**Canadian Institute for Historical Microreproductions / Institut canadien de microreproductions historiques**

**© 1994**

Technical and Bibliographic Notes / Notes techniques et bibliographiques

The Institute has attempted to obtain the best original copy available for filming. Features of this copy which may be bibliographically unique, which may alter any of the images in the reproduction, or which may significantly change the usual method of filming, are checked below.

L'Institut a microfilmé le meilleur exemplaire qu'il lui a été possible de se procurer. Les détails de cet exemplaire qui sont peut-être uniques du point de vue bibliographique, qui peuvent modifier une image reproduite, ou qui peuvent exiger une modification dans la méthode normale de filmage sont indiqués ci-dessous.

Coloured covers/  
Couverture de couleur

Covers damaged/  
Couverture endommagée

Covers restored and/or laminated/  
Couverture restaurée et/ou pelliculée

Cover title missing/  
Le titre de couverture manque

Coloured maps/  
Cartes géographiques en couleur

Coloured ink (i.e. other than blue or black)/  
Encre de couleur (i.e. autre que bleue ou noire)

Coloured plates and/or illustrations/  
Planches et/ou illustrations en couleur

Bound with other material/  
Relié avec d'autres documents

Tight binding may cause shadows or distortion  
along interior margin/  
La reliure serrée peut causer de l'ombre ou de la  
distorsion le long de la marge intérieure

Blank leaves added during restoration may appear  
within the text. Whenever possible, these have  
been omitted from filming/  
Il se peut que certaines pages blanches ajoutées  
lors d'une restauration apparaissent dans le texte,  
mais, lorsque cela était possible, ces pages n'ont  
pas été filmées.

Additional comments: /  
Commentaires supplémentaires:

Coloured pages/  
Pages de couleur

Pages damaged/  
Pages endommagées

Pages restored and/or laminated/  
Pages restaurées et/ou pelliculées

Pages discoloured, stained or foxed/  
Pages décolorées, tachetées ou piquées

Pages detached/  
Pages détachées

Showthrough/  
Transparence

Quality of print varies/  
Qualité inégale de l'impression

Continuous pagination/  
Pagination continue

Includes index(es)/  
Comprend un (des) index

Title on header taken from: /  
Le titre de l'en-tête provient:

Title page of issue/  
Page de titre de la livraison

Caption of issue/  
Titre de départ de la livraison

Masthead/  
Générique (périodiques) de la livraison

This item is filmed at the reduction ratio checked below/  
Ce document est filmé au taux de réduction indiqué ci-dessous.

10X	12X	14X	16X	18X	20X	22X	24X	26X	28X	30X	32X
					✓						

The copy filmed here has been reproduced thanks to the generosity of:

National Gallery of Canada,  
Library.

The images appearing here are the best quality possible considering the condition and legibility of the original copy and in keeping with the filming contract specifications.

Original copies in printed paper covers are filmed beginning with the front cover and ending on the last page with a printed or illustrated impression, or the back cover when appropriate. All other original copies are filmed beginning on the first page with a printed or illustrated impression, and ending on the last page with a printed or illustrated impression.

The last recorded frame on each microfiche shall contain the symbol  $\rightarrow$  (meaning "CONTINUED"), or the symbol  $\nabla$  (meaning "END"), whichever applies.

Maps, plates, charts, etc., may be filmed at different reduction ratios. Those too large to be entirely included in one exposure are filmed beginning in the upper left hand corner, left to right and top to bottom, as many frames as required. The following diagrams illustrate the method:

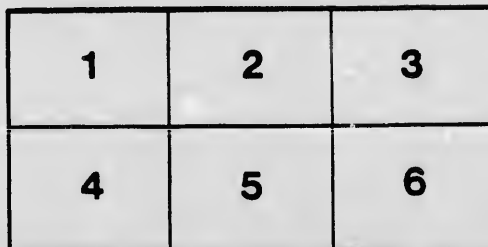
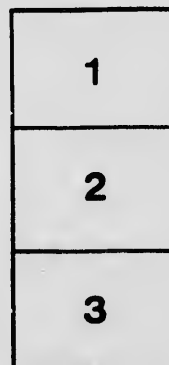
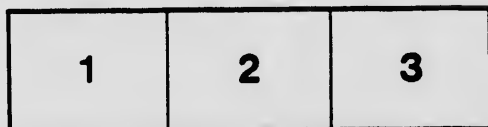

L'exemplaire filmé fut reproduit grâce à la générosité de:

Musée des Beaux-Arts du Canada,  
Bibliothèque.

Les images suivantes ont été reproduites avec le plus grand soin, compte tenu de la condition et de la netteté de l'exemplaire filmé, et en conformité avec les conditions du contrat de filmage.

Les exemplaires originaux dont la couverture en papier est imprimée sont filmés en commençant par le premier plat et en terminant soit par la dernière page qui comporte une empreinte d'impression ou d'illustration, soit par le second plat, selon le cas. Tous les autres exemplaires originaux sont filmés en commençant par la première page qui comporte une empreinte d'impression ou d'illustration et en terminant par la dernière page qui comporte une telle empreinte.

Un des symboles suivants apparaîtra sur la dernière image de chaque microfiche, selon le cas: le symbole  $\rightarrow$  signifie "A SUIVRE", le symbole  $\nabla$  signifie "FIN".

Les cartes, planches, tableaux, etc., peuvent être filmés à des taux de réduction différents. Lorsque le document est trop grand pour être reproduit en un seul cliché, il est filmé à partir de l'angle supérieur gauche, de gauche à droite, et de haut en bas, en prenant le nombre d'images nécessaire. Les diagrammes suivants illustrent la méthode.

# MICROCOPY RESOLUTION TEST CHART

(ANSI and ISO TEST CHART No. 2)



APPLIED IMAGE Inc

1653 East Main Street 14609 USA  
Rochester, New York  
(716) 482 - 0300 - Phone  
(716) 288 - 5989 - Fax

Authorized by the Minister of Education

102

BOOK 3.



# THE CANADIAN DRAWING COURSE

BY  
I. R. O'BRIEN,  
PRESIDENT, ROYAL CANADIAN ACADEMY.

J. H. McFAUL,  
TEACHER OF DRAWING, NORMAL SCHOOL.

W. M. REVELL,  
VICE PRESIDENT, ONTARIO SOCIETY OF ARTISTS.

ELEMENTARY  
FREEHAND,  
OBJECT,  
CONSTRUCTIVE  
AND PERSPECTIVE  
DRAWING.



PRICE 10 CENTS

Public School Course  
complete in 5 Books.

## CANADA PUBLISHING CO. (LIMITED) TORONTO.



Name .....



Entered according to Act of Parliament of Canada, in the year 1885, by the Canada Publishing Company (Limited) in the Office of the Minister of Agriculture.



C  
NC630  
.013  
V.3  
Rare

## GENERAL DIRECTIONS.

---

The pupils should be taught to rely solely upon the judgment of the eye in estimating form, distance and proportion; guide-lines and points are given, which afford sufficient aid for copying the examples; and an intelligent use of the exercises suggested will rapidly develop the pupils' perception, accuracy, and memory.

It is essential, however, that the teacher should have the means of testing the correctness of the drawings and of proving to his pupils the justice of his criticism: a pair of compasses, and a rule divided into inches and fractional parts will suffice for the purpose, and these should always be at hand.

The book should not be turned while the pupils are drawing, and they ought to sit upright, facing the desk.

A tolerably soft pencil should be used (HB is the best), cut to a long, sharp point. It is impossible to make a good clear drawing with a blunt pencil.

The left side of a figure should usually be drawn first so that the lines may not be covered, nor rubbed by the hand. Begin by placing the main construction lines, then sketch with a light, free sweep of the pencil the whole body of the figure, omitting the detail, observe and correct first the main proportions of height and width, then the relation of parts to each other and to the whole, then add the detail, still in faint line, and perfect the sweep of the curves. Make all corrections and erasures upon the sketch. Finish by tracing in the whole with a firm, clear line, distinct and expressive, but not too black, and avoid pressing the point of the pencil too heavily upon the paper.

Hold the pencil loosely and easily, not too near the point. In the light sketching of curves it may be held two or three inches from the point. A pencil less than two inches long should be discarded, or used only with a holder.

The teacher will, of course, forbid the pupils to wet the point of the pencil.

# CANADIAN DRAWING COURSE.

---

## SYNOPSIS.

---

The special subject of **Book No. 1** is Elementary Freehand Drawing. It contains exercises in the drawing of straight lines, combinations of lines in rectilinear figures, circles and simple ornaments. In practising these, the pupil should acquire some skill in the use of the pencil, in the judgment of distances and proportion, as well as a knowledge of simple forms and of the terms which describe them.

**Book No. 2** continues the exercises in Elementary Freehand, and gives examples of simple ornaments. Its special subject, however, is the introduction of **drawing from the round model**.

**Book No. 3** continues previous subjects upon a larger scale, and takes up **Constructive Drawing**.

**Book No. 4** has a new and special subject, the cultivation of rapid and accurate perception by the drawing

from memory of objects which, having been observed, are removed from view.

**Book No. 5** introduces Elementary Freehand Perspective in the drawing of models and familiar objects.

Progressive studies of ornament are continued throughout the course, the examples being derived chiefly from natural forms or from the antique.

As Public School teachers are being trained in proper methods of teaching, it is not considered necessary to do more than make occasional suggestions in regard to the selection of examples for blackboard and dictation lessons, or for memory and review exercises, adapted to this particular subject.

It is presumed that in each class the teacher will see that the exercises are neatly and accurately drawn, and that the subject is made clear to the comprehension of the pupils.

## BOOK NO. 3.

In this number of the series the subjects of Freehand and Model Drawing are continued, the exercises being on a larger scale and leading the pupils onward in the acquirement of that knowledge of fundamental form which is the basis of good design.

To these subjects is now added another, of immediate practical utility,—**Freehand Constructive Drawing.**

The execution of every piece of work, however simple it may be, is made more easy and certain by having a pattern to work from. This pattern is usually a drawing which shows accurately the forms and dimensions of every part, and is called a **working drawing**. Thus an ordinary dress pattern is a working drawing by means of which the material for the garment is cut to the proper shape. It may also be called a **plan**.

The term **plan** is usually applied to a drawing of a place, building, or object, as if seen from a point directly over it, as in a map.

A map, or **plan**, may be made of a garden, showing the walks, borders, grass and flower-beds. If it were required to have a similar garden made in another place such a drawing would show the gardener how to lay out the ground; that is, he would use the plan as a **working drawing**.

A **plan** of the school room would show the size and shape of the room, and the position of the doors, windows, and desks.

A **plan** of a house is a drawing which enables us to judge of the size and arrangement of the different rooms, passages, stairs, doors, windows and fire places. Other drawings of the house are required to show the height of the walls, gables and chimneys, and its outside appearance. Drawings of the latter kind are called **elevations**. Others still, showing the thickness of walls and the structure of roofs and floors, are called **sections**.

One drawing, or **plan**, is sufficient to show the size and shape of the top of a table, but another drawing is required to show the height of the table and the form of its legs—this second drawing would be called an **elevation**. If the end of the table differs from the side, a drawing of that is also required. This is called an **end elevation**.

In the first lessons it will be well to explain and use only the technical term **plan**. The use and application of the terms **elevation** and **section** should be left until the idea of representing an object by plan, side and end view, is perfectly grasped.

A **working drawing** intended for a mechanic or builder to work from would be accurately drawn to a scale or a unit of measurement. As the exercises that follow are to be drawn by freehand and without rule or measurement, they chiefly serve to illustrate the principle upon which working drawings are made, and to give practice in clearly expressing the form and construction of objects or structures by suitable views. When the pupil has fully realized the idea of expressing form by means of outline, and has attained to an accurate perception of relative size and proportion, the mechanical use of instruments in plan-drawing is easily acquired.



After drawing from each copy in the book, let the pupils make drawing from similar objects at hand, or from objects they may see at home—in the latter case they may be drawn from memory after being carefully observed. For instance, ask them to observe and draw a book, a box, or a table, shewing top, or plan, with side and end views. Each pupil should bring some small object and draw the views required to represent it, connecting the views by dotted lines as in the examples given.

Side and end views of a tool chest, strengthened by iron clamps, are given, to be copied below, enlarged as indicated. See that the height is in proportion to the width.

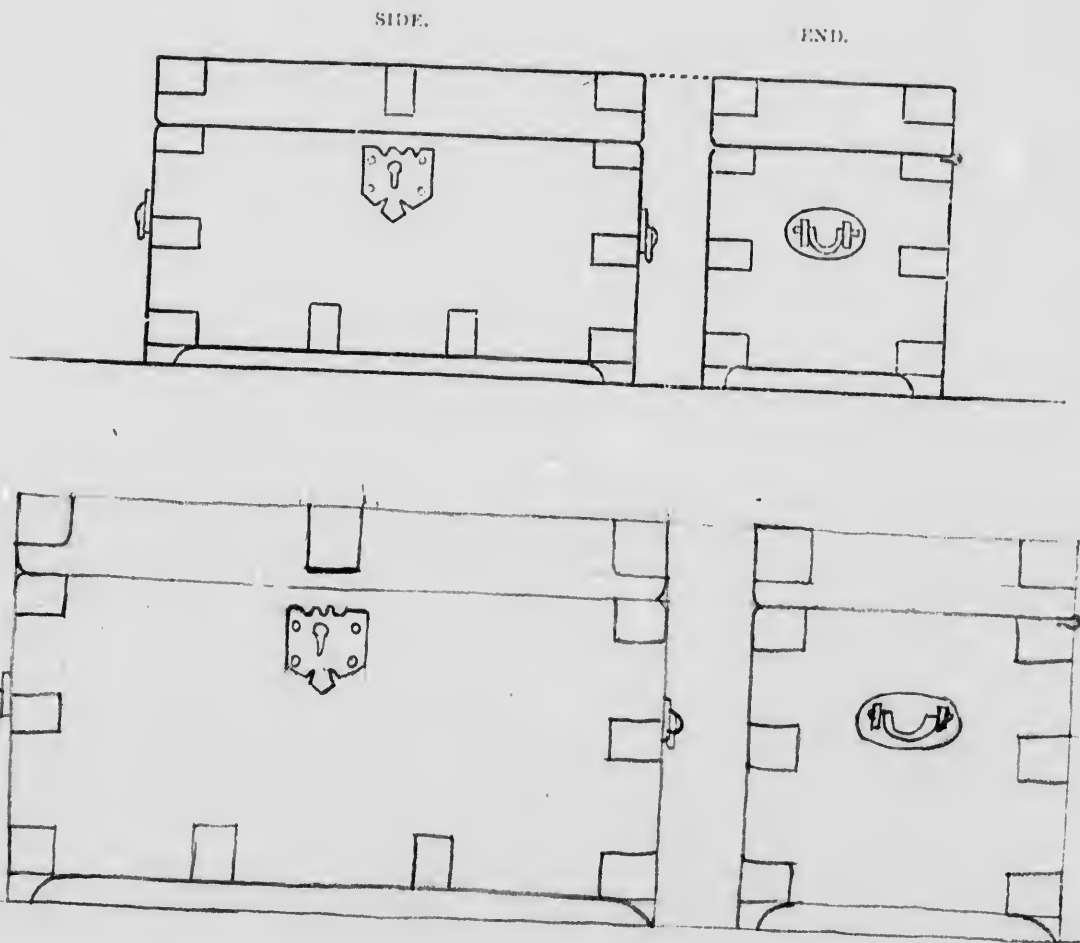

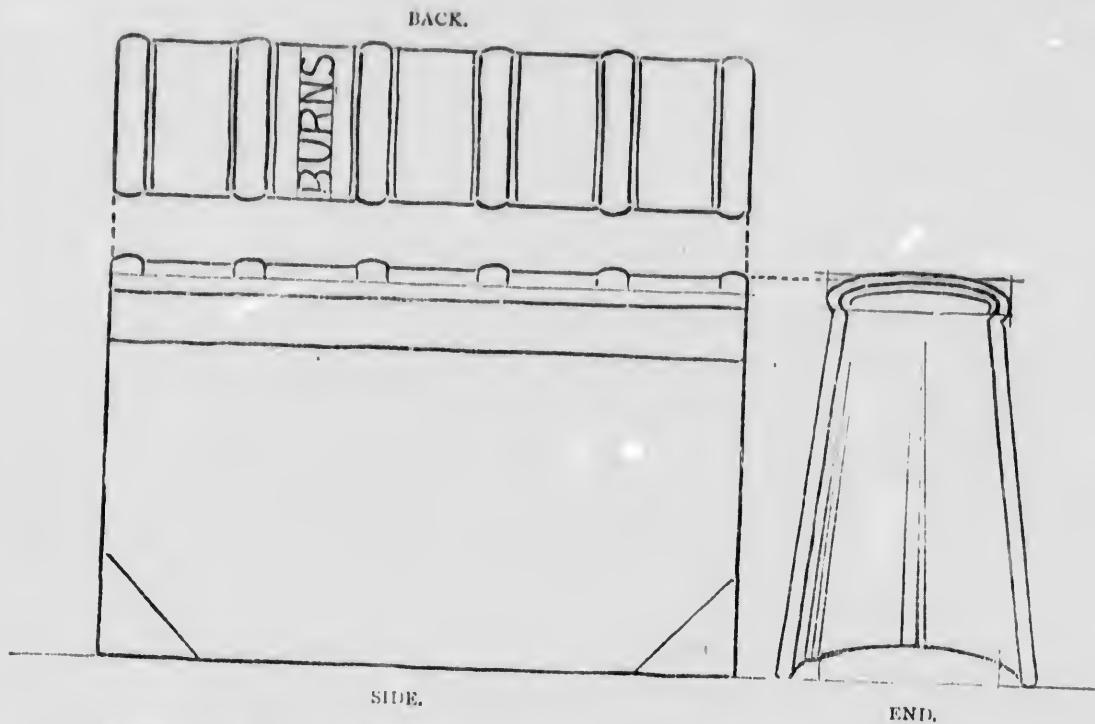

To represent clearly the shape of a book, the side, back, and end require to be shown. Take a book for a model and draw these views of it on opposite page.

A B C D E F G H I J K L M N  
 O P Q R S T U V W X Y Z

"Skeleton Alphabet" of capital letters. The spaces occupied by all the letters except I, J, M. and W, may be made equal. Draw the letters first with a faint clear line, as shown on the following page.

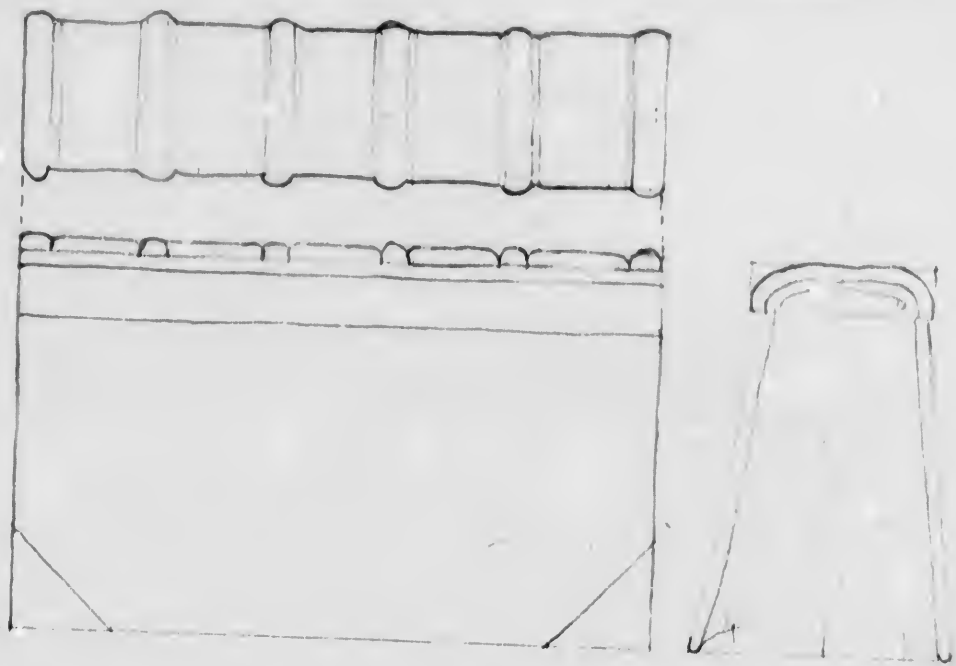

A B C D E F G H I J K L M

Copy the alphabet, enlarged. Begin by completing the faint horizontal lines, which are used as guides ; then mark the spaces the letters are to occupy.

After completing the construction lines, sketch the curves lightly with a free sweep of the hand. When the faint sketch is correct, draw the whole with a firm clear line.

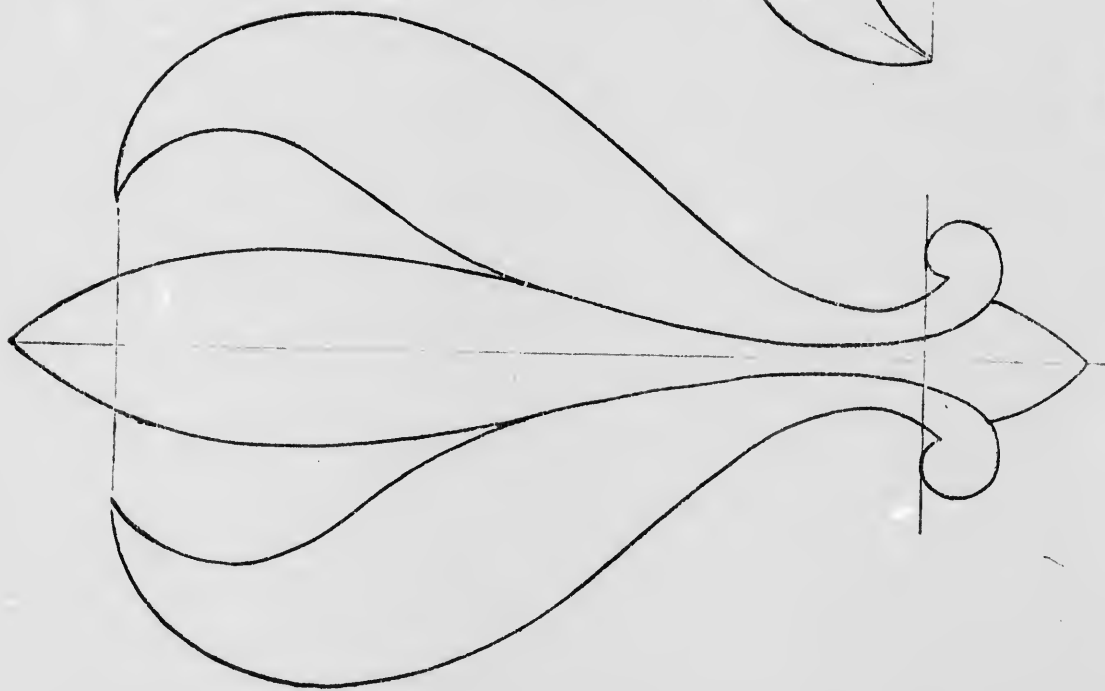

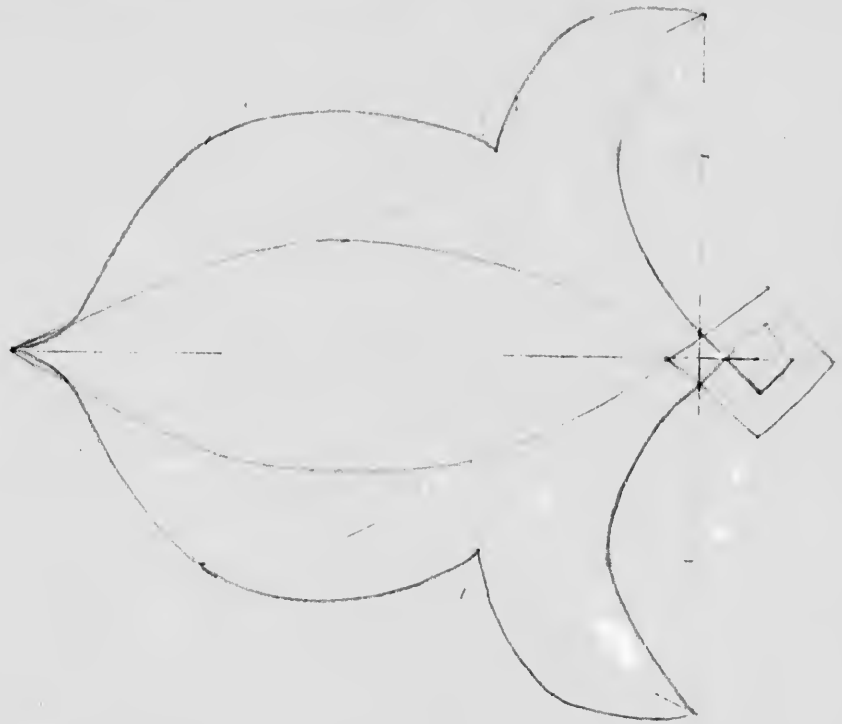

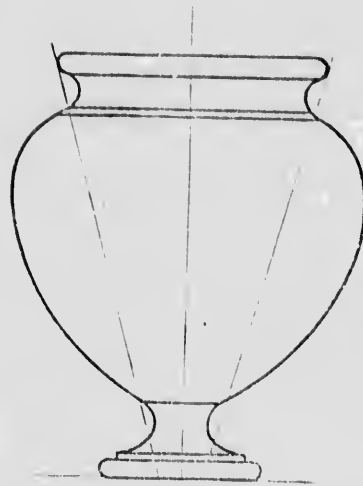

Place vase, Model No. 1, before the class. The outline of side is a reverse curve, each part being an arc of a circle. Draw from the model on opposite page of size indicated.

Trisect vertical line and bisect upper part. Observe and use construction lines suggested in sketch of one side given above.

An outline is given of a Terra Cotta Vase, to be drawn enlarged.

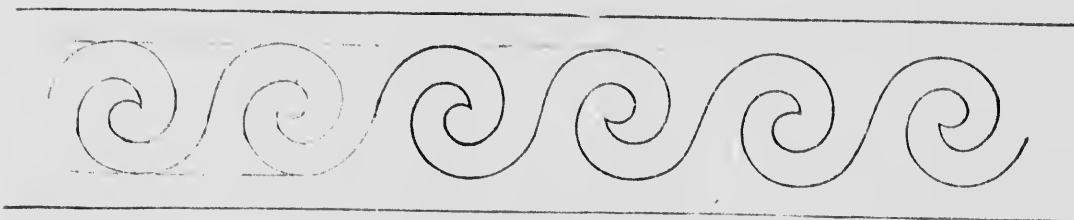
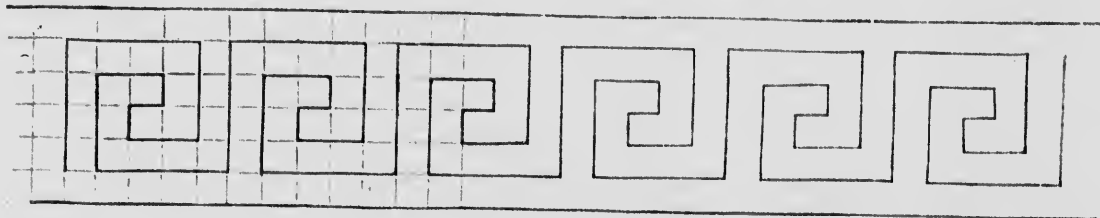

Two examples are given of the "Greek Fret," one of the fundamental forms of antique ornament. Copy, enlarged, on opposite page. Study the construction lines.



MODEL NO. 1.



TERRA COTTA VASE.

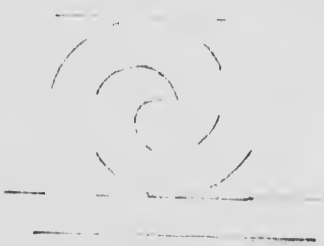
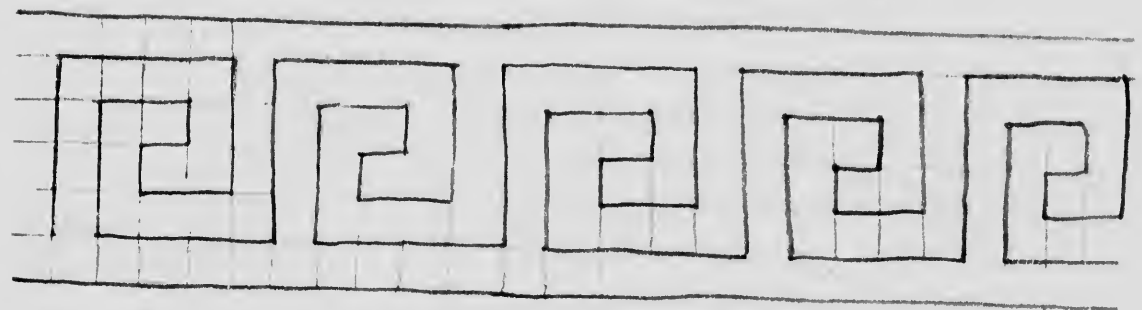

TOP, OR PLAN.

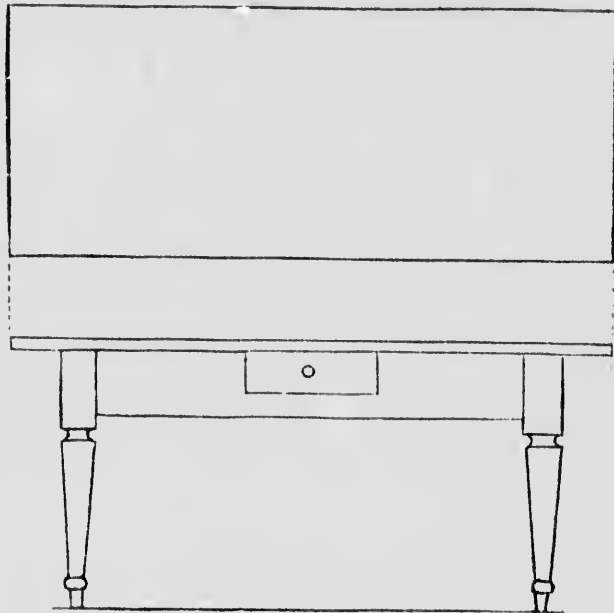

SIDE VIEW, OR ELEVATION.

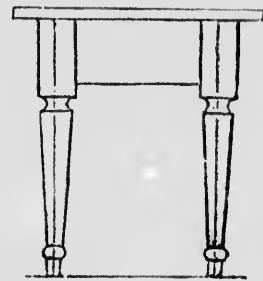

END VIEW.

Three views of a table are given. Copy these, enlarged; and make similar drawings of some other table.

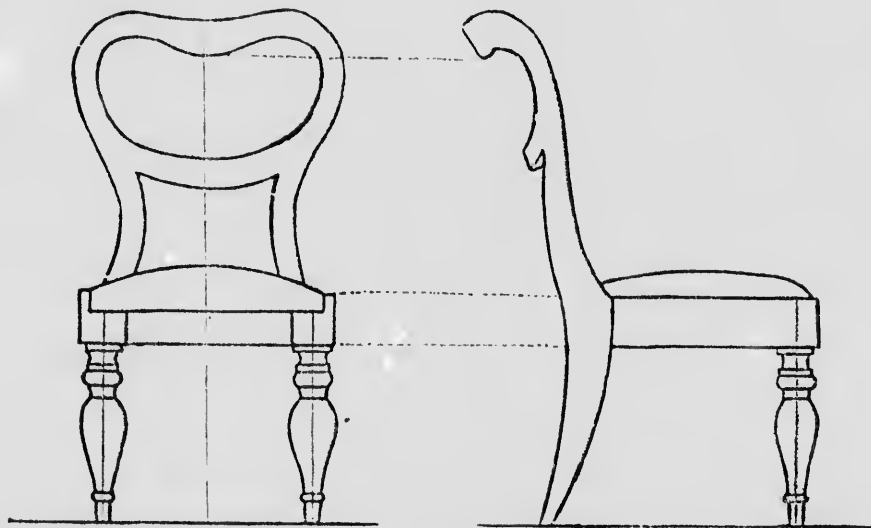

Front and side view of chair—to be copied same size.



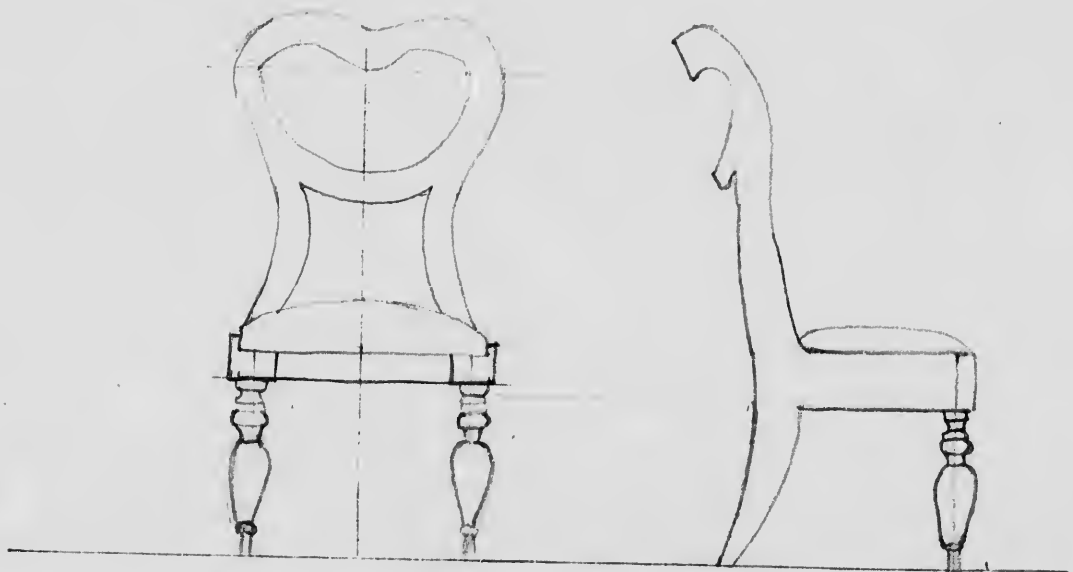
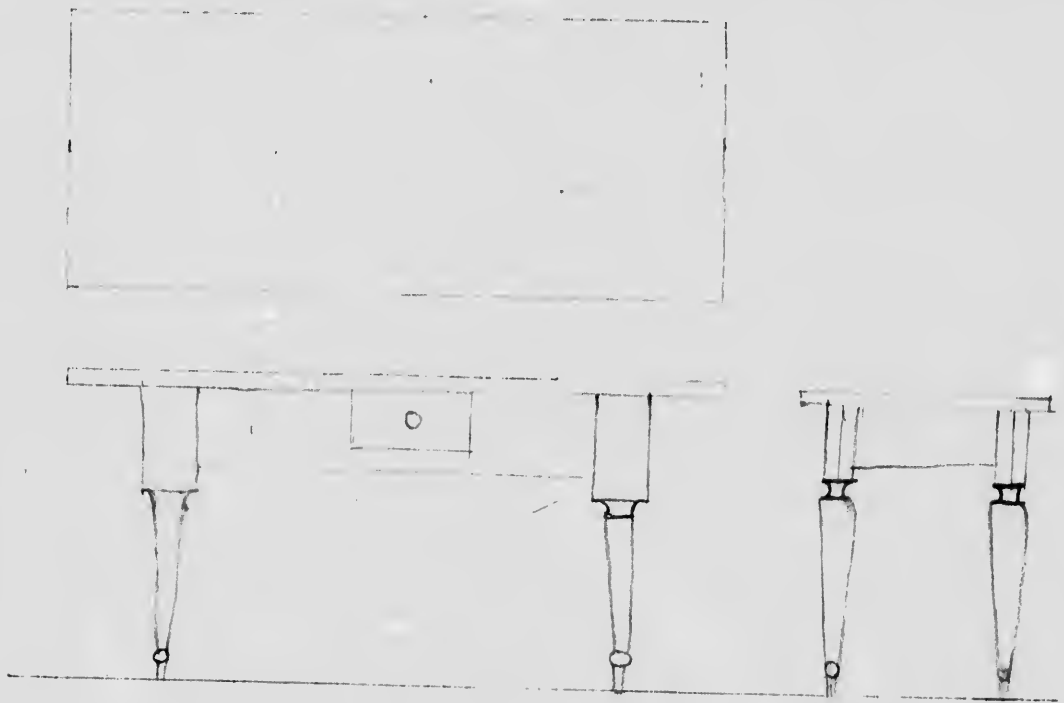

a chair

Hexagonal rosette--to be enlarged. In the incomplete figure the construction lines are shown. Finish this drawing, then draw the whole on guide-circle given, first placing the construction lines.

Make a finished drawing of the border. The construction lines required and the order in which the parts should be drawn, are indicated in the example.

In drawing the conventional leaves, notice the construction lines, and place them correctly before sketching the outline.

A "conventional" leaf is a leaf drawn symmetrically and so simplified in form by omission of detail as to adapt it for use in ornament and decoration.

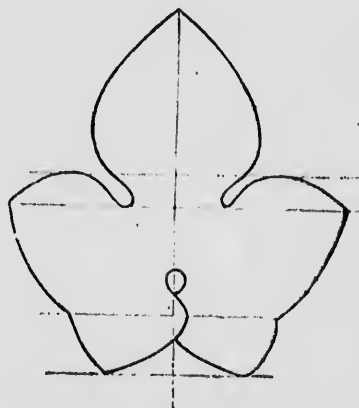
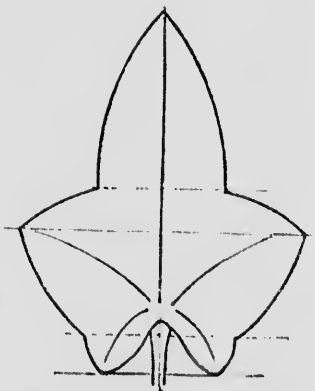
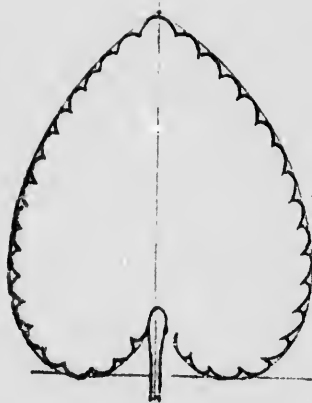
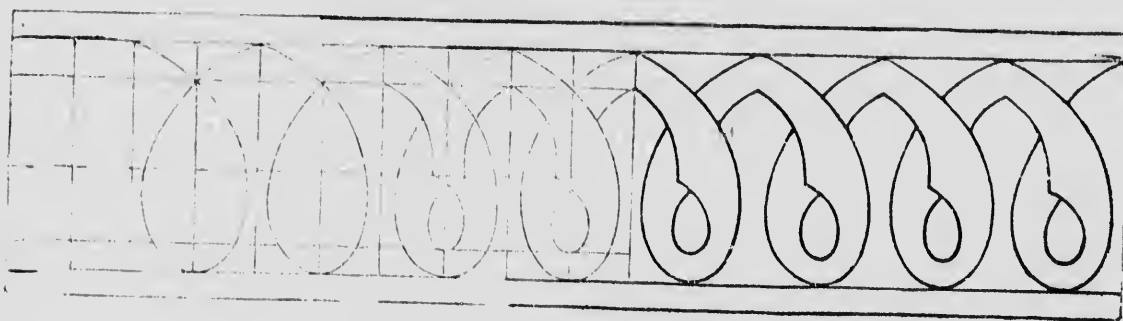
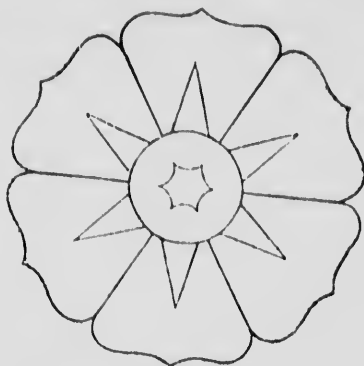

sion

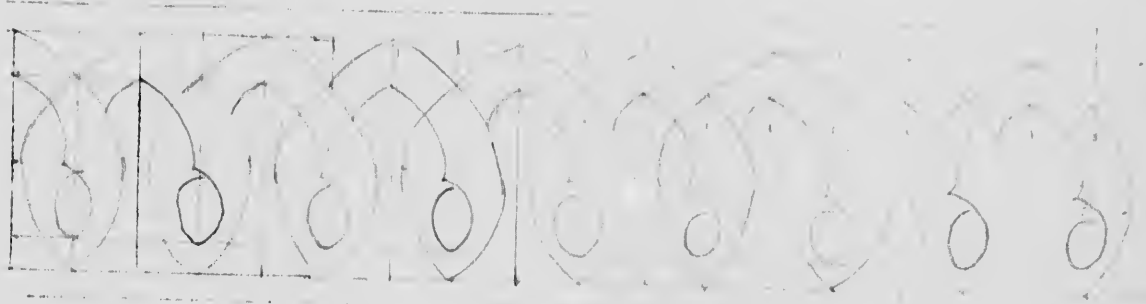
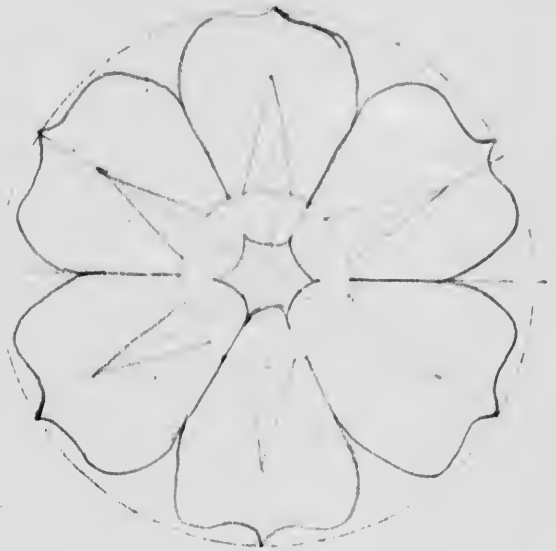
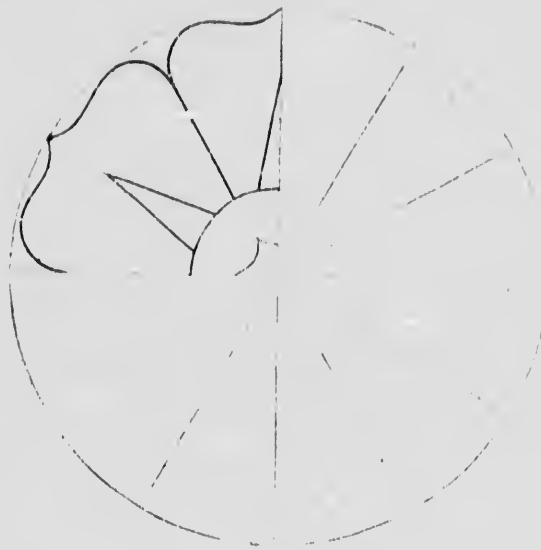

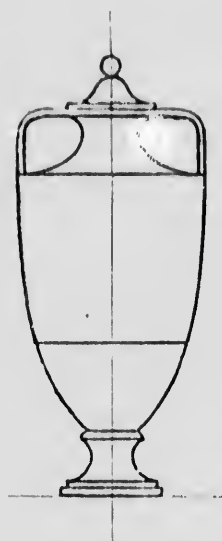
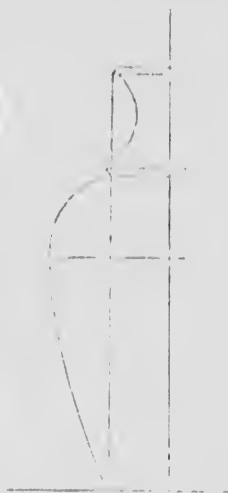

Place Model No. 2 before the class and compare with its sketch outline of one side, given above. Observe that the upper curve, or neck, is one-fourth of the whole height, that the lower curve is oval, and that its point of altitude is just above the middle of the height of the vase.

In drawing from the model, the centre line being given, bisect it and bisect again the upper part—by the aid of the points of bisection place the horizontal construction lines. Sketch lightly the whole outline and place vertical construction lines at proper width to aid in drawing the sides. Correct sketch and finish the drawing in firm line.

The outline of a Roman Covered Vase is also given, to be enlarged.

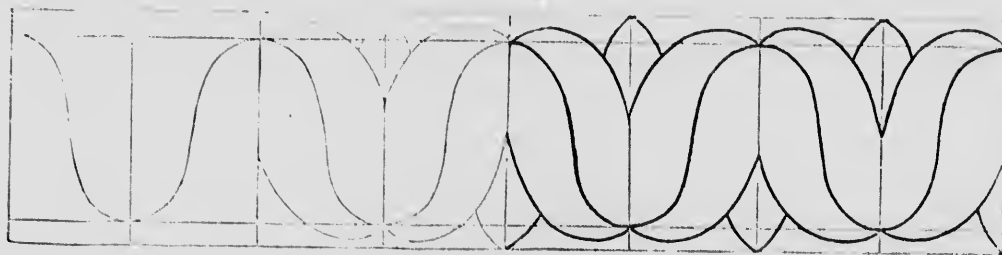

Border composed of reversed curves, founded upon a conventionalized flower form. The progressive steps to be pursued in making the enlarged copy are indicated in the example. Note the governing curved line.

iven  
ower  
  
pper  
ghtly  
des.

MODEL NO. 2.



The  
ote

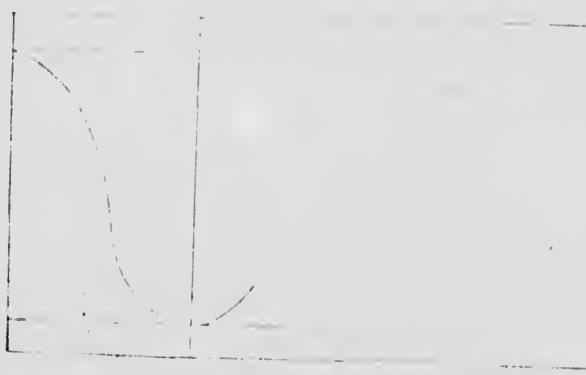

A front and side view of a padlock, and end and side views of a spool, screw-bolt and nut, and of a wood screw, are given as examples to be copied.

If possible, similar articles should be procured for the pupils to draw from.

Any object the form of which can be expressed by two views, may be drawn from memory.

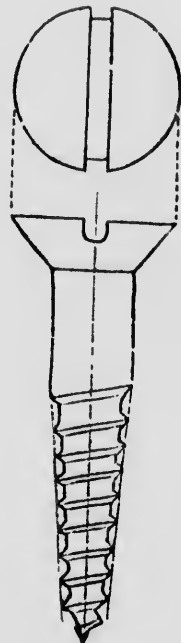
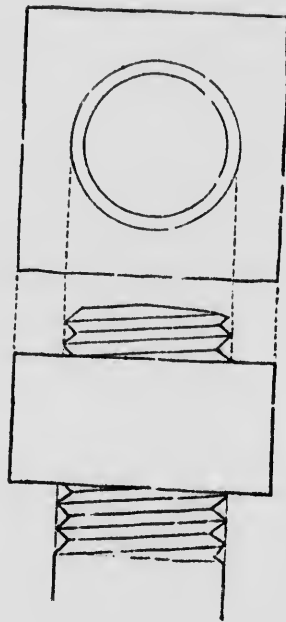
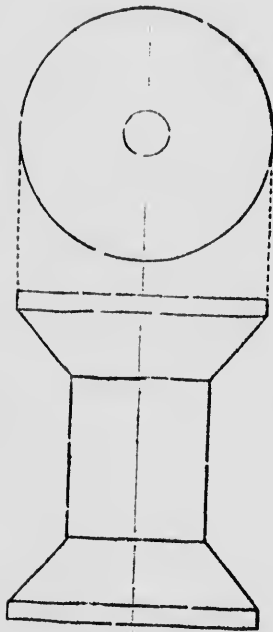
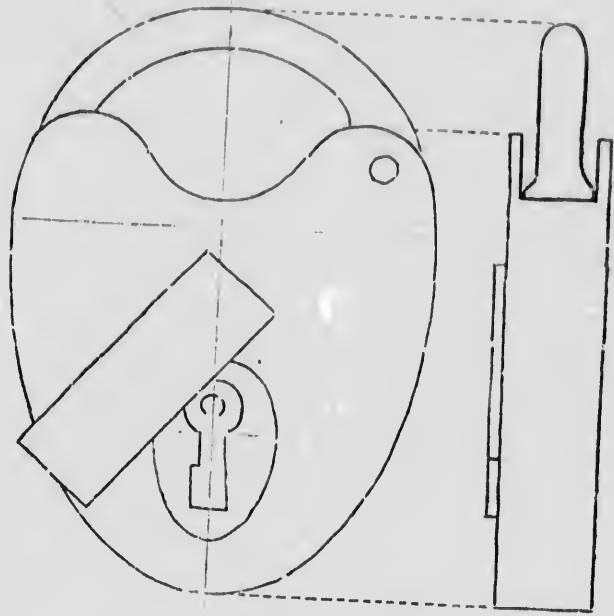

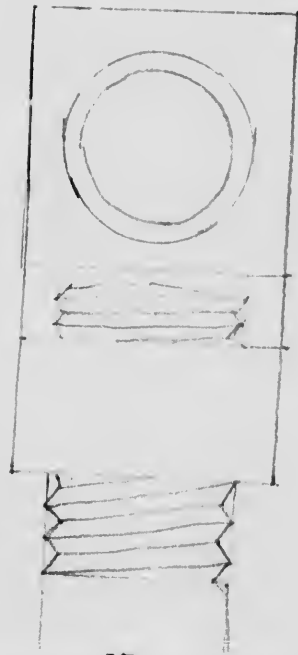
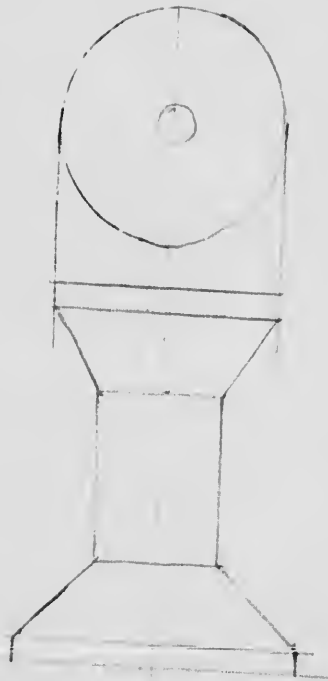
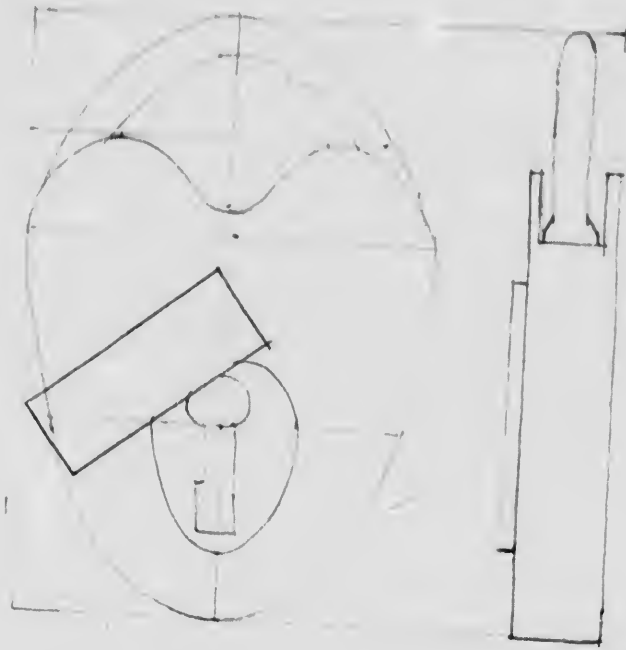

17

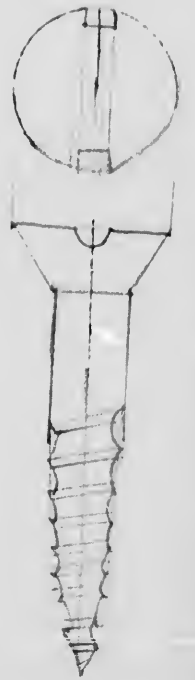

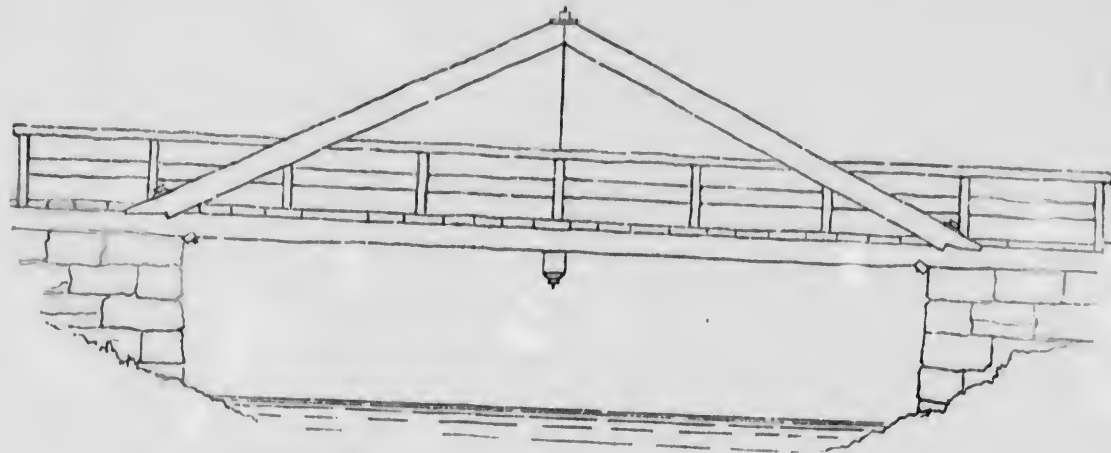

Side elevation of bridge, supported by a "king post truss." In copying this drawing, mark first the "span" or space between abutments, then draw centre line, which is an iron rod with head and nut, the floor line of the bridge, and then the sloping timbers which support the centre.

Part of alphabet of block letters to be copied, enlarged. Begin by drawing horizontal construction lines. Observe that the space is divided horizontally into five equal parts, and note the space occupied by each letter.

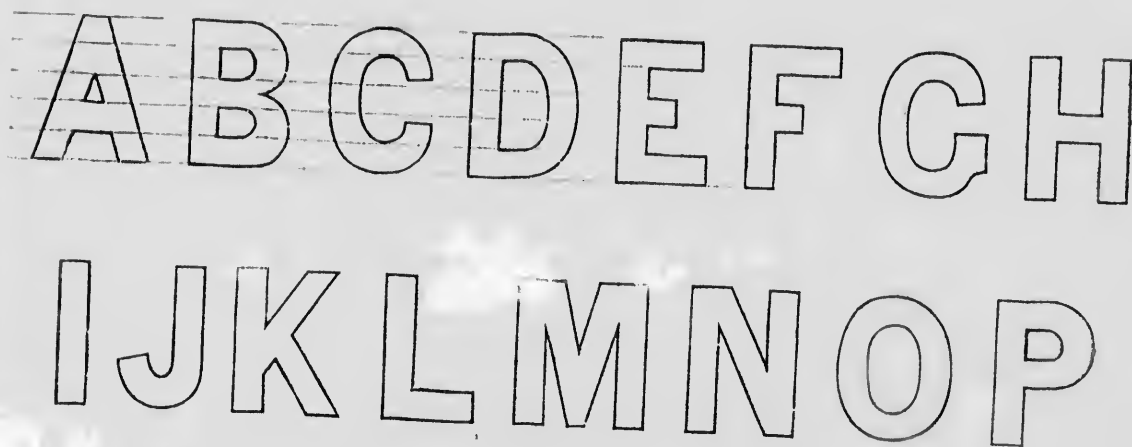





mark  
with  
tre.

in-  
the



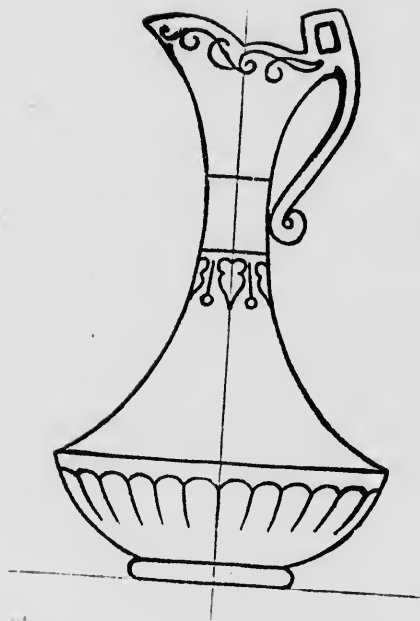
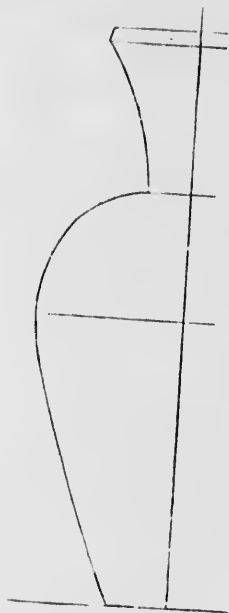

Place Model No. 3 before the class and compare with it sketch outline of one side given above. Observe that the horizontal moulding marks exactly half the height, and that the neck, or upper part, occupies more than a fourth of the whole height. Draw from the model of size indicated.

An outline of a silver pitcher is given as an example, to be enlarged. Sketch lightly the main outline before definitely fixing position of horizontal lines. Draw handle and detail of ornament last.

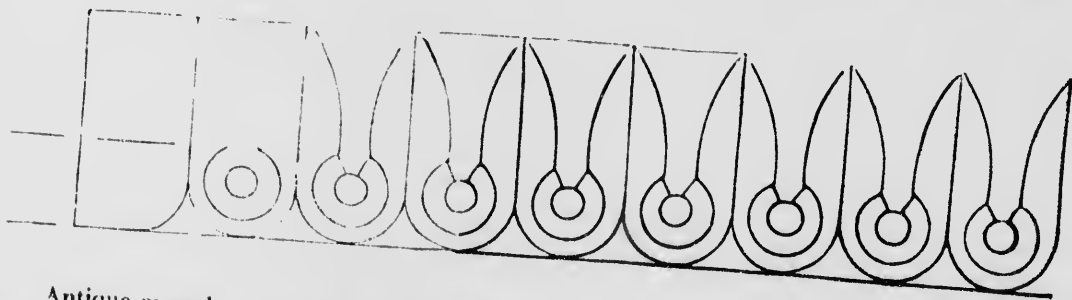

Antique carved moulding—to be drawn enlarged. Begin by completing the horizontal construction lines. The progressive steps are suggested in the example.

de given  
neck, or  
l of size

he main  
rnament



con.



MODEL NO. 3.

SILVER PITCHER.

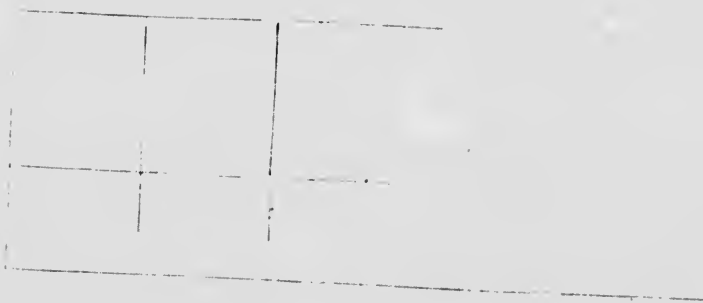

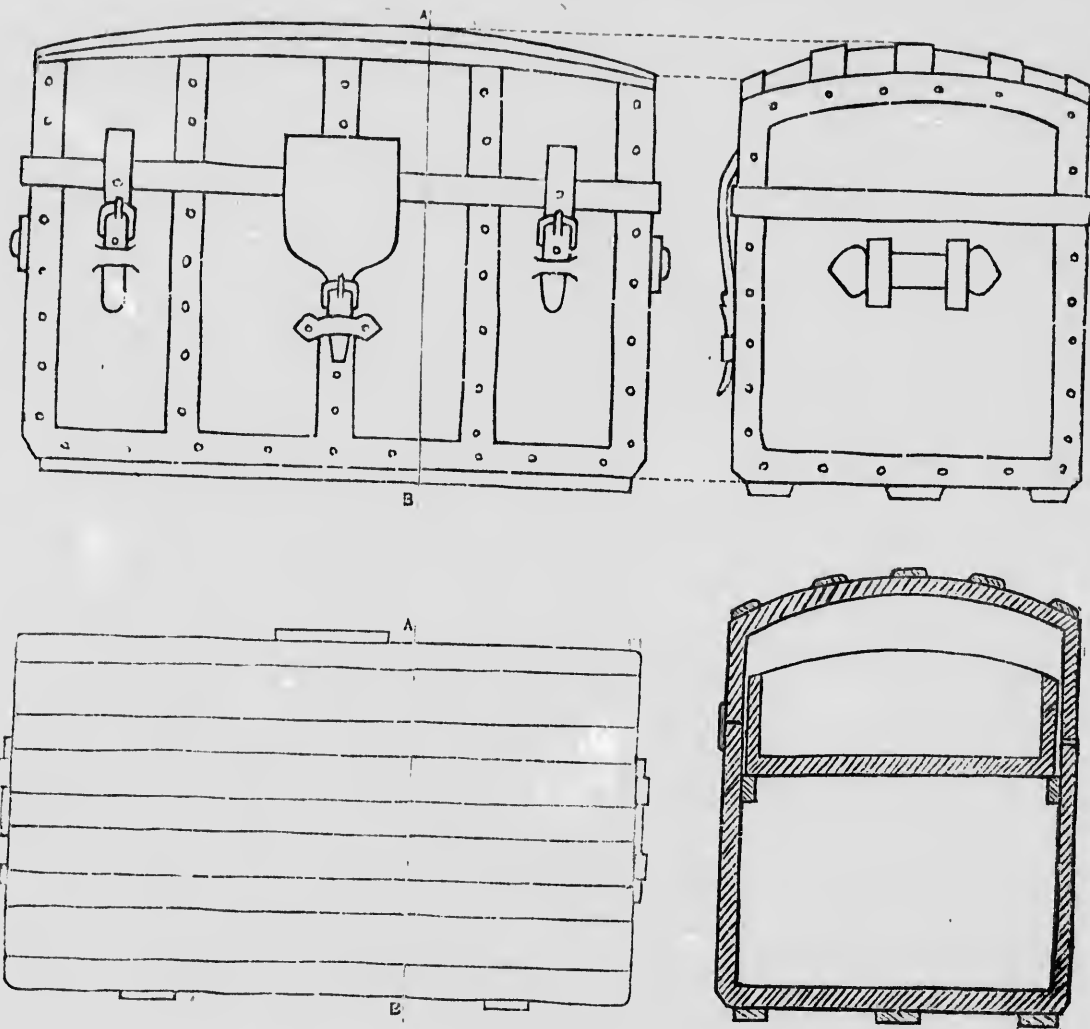

It is often necessary to show the interior of a structure,—for this purpose a “section” is given. Suppose the trunk be sawn in two at the line A B; the end view of one of the portions thus cut off is called a “section.” It shows the thickness of the sides, top and bottom of the trunk, the tray inside and its supports.

Copy these drawings, and make plan, elevations and section from some other trunk.

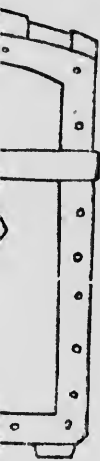

given.  
cut off  
the tray

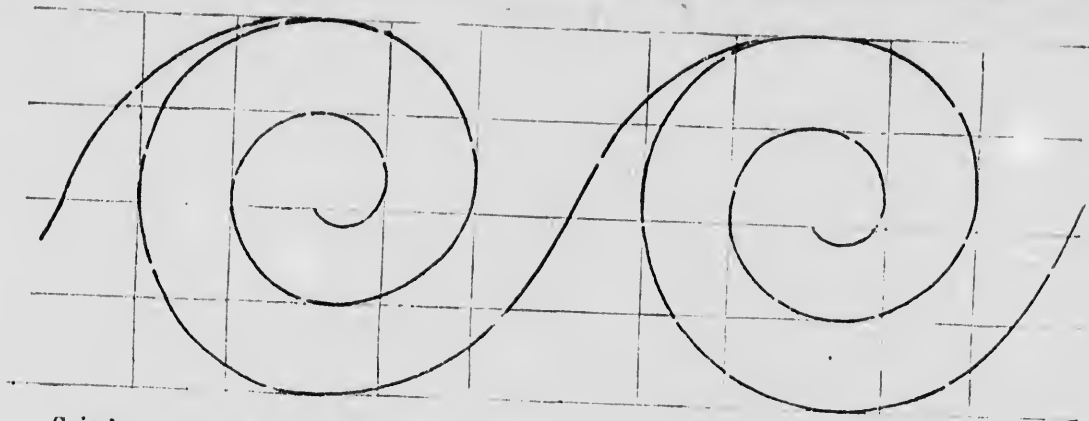

Spiral curves—draw these with great care.

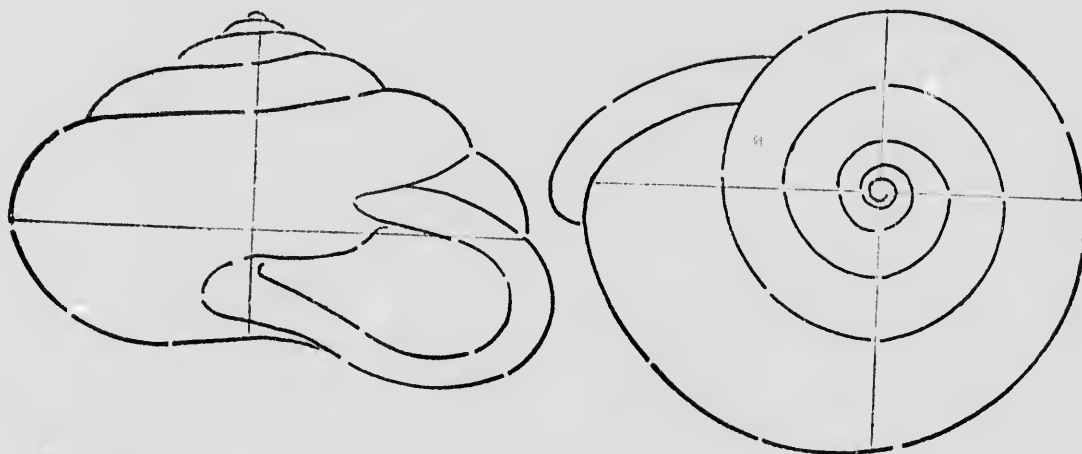

Natural spirals exemplified in snail shell

Ornament founded upon spiral curves.

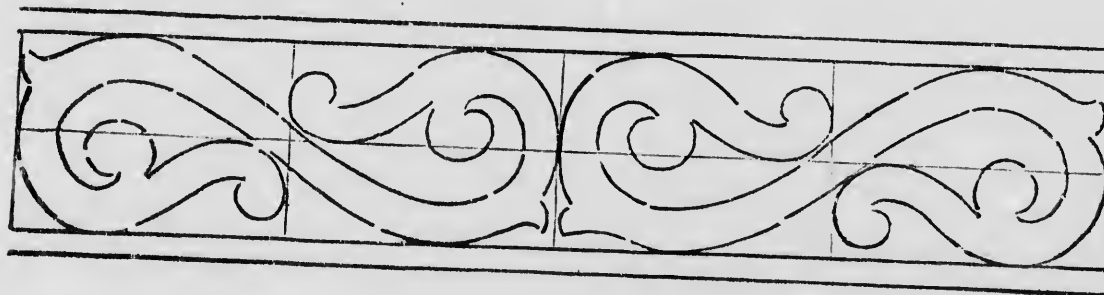

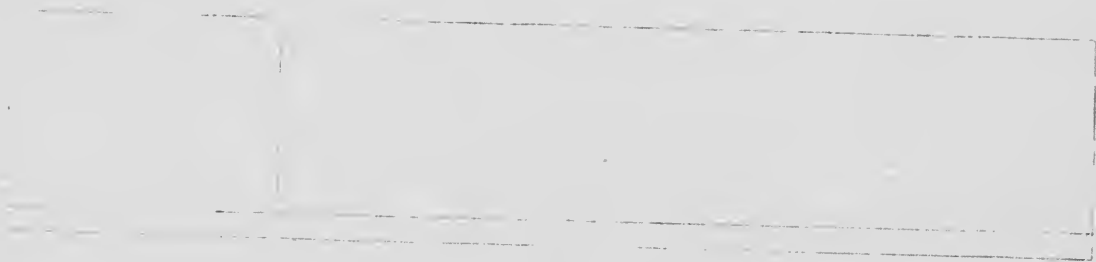



An example is given of a design founded upon the ivy leaf and berries. This may be used as a border, or placed horizontally as a frieze.

After placing the construction lines, sketch, first, the curve of the stem, then the stem and mid-rib of each leaf, expressing the sway and outspringing of the plant.

Place Model No. 4 (water-bottle) before the class, and draw it, of size indicated.

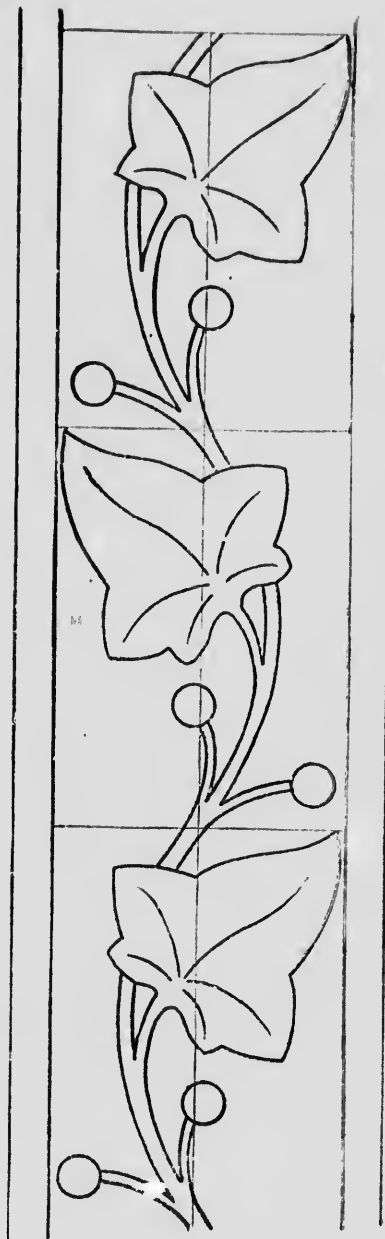





MODEL NO. 4.

Place Model No. 4 (the water bottle) before the class, and proceed, as in previous lessons, from the model.

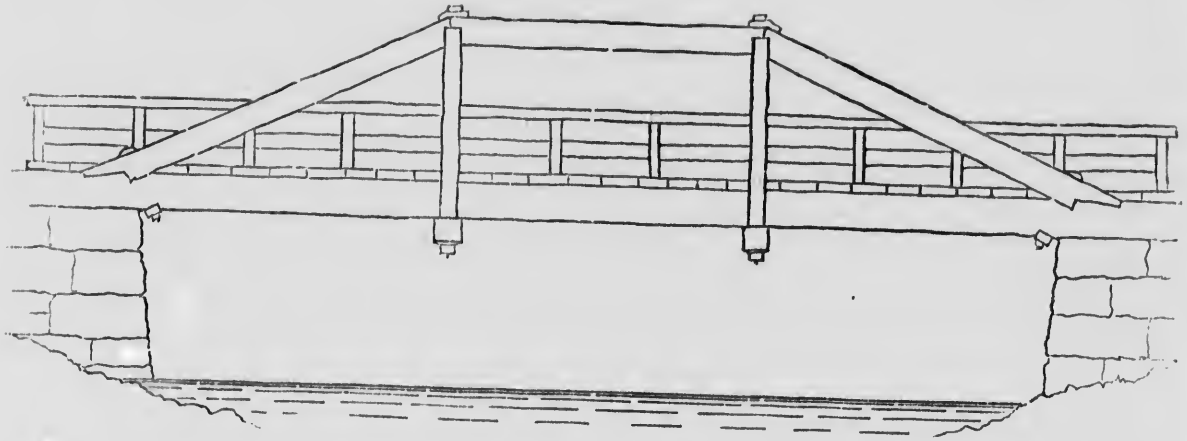

Elevation of a bridge supported by a "queen post truss." The supporting rods divide the span into three equal parts.

Completion of alphabet of block letters, and figures to correspond. See directions on p. 18.

Q R S T U V W

X Y Z . 1 2 3 4 ,



vide the

p. 18.



Handwriting practice lines consisting of solid top and bottom lines with a dashed middle line, repeated across the page.

Enlarge the examples to size indicated by construction lines. The right hand figure is founded on the flower of the Diaetra.

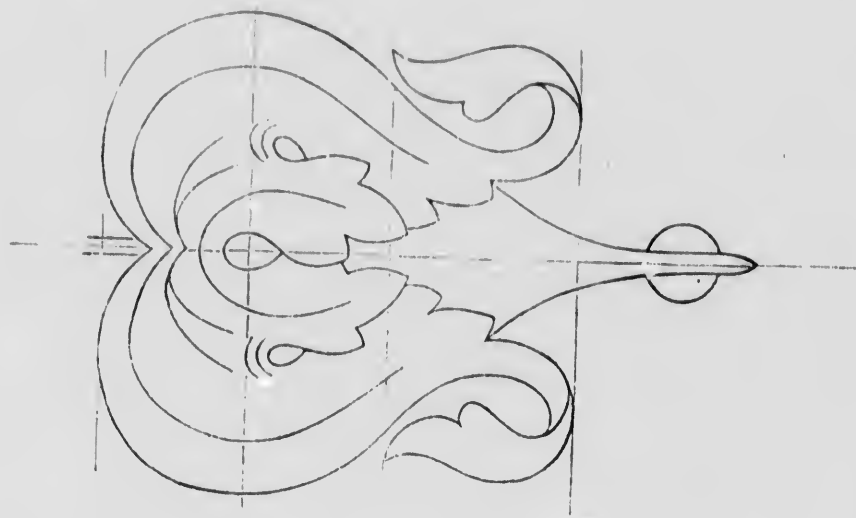
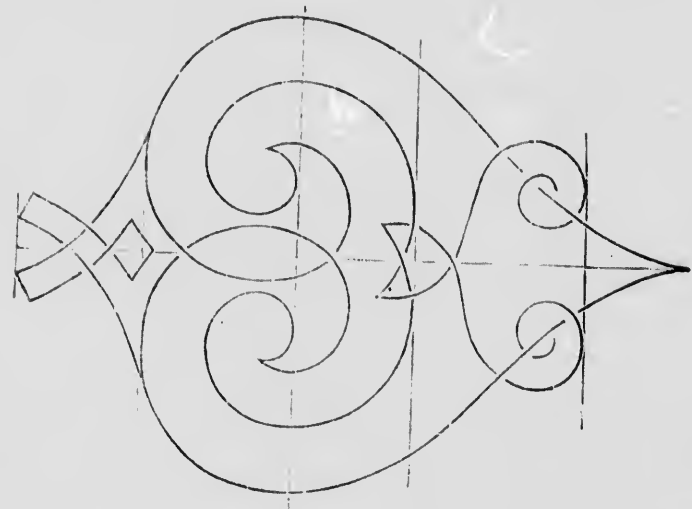

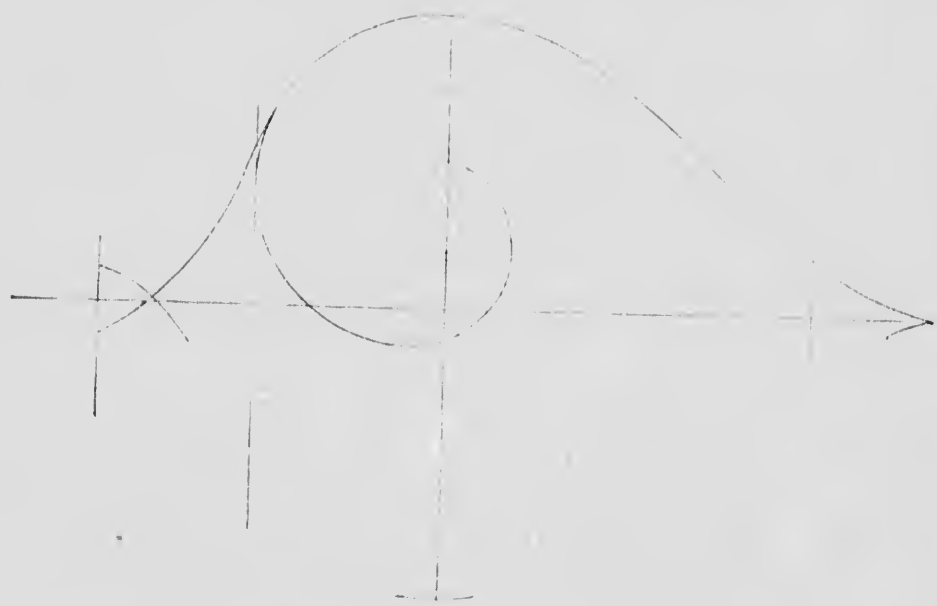

## EXAMINATION AND REVIEW.

---

The drawings of the pupils during the term will afford the best general test of their progress.

It is desirable, however, that from time to time, and particularly at the end of the term, all the subjects that have been taught should be carefully reviewed, more especially with a view to the thorough comprehension of the principles of geometric or constructive drawing and of the technical terms which have been used.

Drawing from memory is the best possible test of clear and accurate perception as well as of the power of recollection.

The following problems will suggest some of the points upon which it may be desirable to test the comprehension and attainments of the pupils :

1. Draw the side and end view of some object so as to show clearly its form and construction.
2. Draw the top, side and end view of some object requiring these three views to represent it properly.
3. An object being given, draw such views of it as are required to show clearly its form and construction.
4. What is meant by the terms **plan**, **elevation** and **section** ?
5. Draw the plan, elevation and section of a box, or other object that may be presented.
6. Draw, within a given time, from an example, any one or more of the ornamental forms or models that may be designated. The object of such an exercise is to secure rapid execution as well as accuracy.
7. Draw from memory :—  
The frets on page 8.  
The hexagonal rosette on page 12.  
Any other of the ornamental forms that have been drawn often enough to be impressed upon the memory.  
One or more of the models.

In drawing from memory the example should be shown to the pupils, so as to be clearly identified, and then put out of sight.

Blank exercise books, somewhat similar in size to the drawing books, should be used for memory drawing and drawing from objects.

## THE CANADIAN DRAWING COURSE.

---

The books comprised in this Drawing Course have been specially designed to meet the requirements of the Public Schools of Canada. The series will be found also well adapted for use in private classes. The laying of a good foundation for more advanced art training has constantly been kept in view.

Experience shows that a large proportion of the pupils leave the Public Schools before the course of instruction is completed. Most of them will have, in after life, to earn their living by some kind of handicraft, and not a few must begin to do so at an early age. The exercises in these books will be found to be of such a character as to prove of practical utility to pupils leaving school at any stage before completing the course.

In the pursuit of almost every mechanical calling, and of many others, Drawing provides a means of expressing form better than can be done by the mere use of words. It is with this application of it, in elementary education, that we are chiefly concerned.

The limited time that can be given to Drawing in the schools makes it imperative

that out of its boundless field of study such portions should be selected as will be most useful to the majority of the pupils.

The following objects are deemed of primary importance :—

1. To train the eye to the accurate perception of form, size and proportion, and to exactness in the measurement of distances and angles.
2. To train the hand to freedom and rapidity of execution, and to readiness of expression.
3. To train the memory to accurate recollection of the forms and arrangements of objects.
4. To cultivate and refine the taste by the study, delineation, and recollection of beautiful forms.

These objects are sought to be attained by instruction in :—

1. **Freehand drawing of lines, and figures from the flat.**
2. **Freehand drawing of solid objects.**
3. **Constructive drawing.**
4. **Memory drawing.**
5. **Elementary perspective.**

MANUFACTURED BY  
**THE CANADA PUBLISHING CO. (Limited).**  
**26 FRONT STREET, TORONTO.**

## **BLANK DRAWING BOOKS.**

Designed to accompany the **CANADIAN DRAWING COURSE**, made of proper size to suit the different books of the series, from very fine Drawing Paper and

**CONTAINING 24 PAGES. PRICE 5 CENTS EACH.**

---

## **DRAWING MODELS,**

Adapted for use with the

## **CANADIAN DRAWING COURSE.**

The full set of Models consist of

6 14-inch Vases ; 1 14-inch Cylinder ; 2 14-inch Hoops ; 1 14-inch Hoop, iron ; 1 2-ft. Skeleton Cube hinged for folding.

All painted and packed in a strong box, with slide-lid.

**PRICE FOR THE FULL SET, \$8.75.**

---

## **CANADIAN DRAWING COURSE.**

**A Practical Public School Course of Drawing, Complete in Five Numbers.**

**Book No. 1.**—Elementary Freehand Drawing contains exercises in the drawing of straight lines, combinations of lines in rectilinear figures, circles and simple ornaments. The exercises give skill in the use of the pencil, in the judgment of distances and proportion, as well as a knowledge of simple forms and of the terms which describe them.

**Book No. 2** continues exercises in Elementary Freehand, and gives examples of simple ornaments. Its special subject, however, is the introduction of drawing from the round model.

**Book No. 3** continues previous subjects

upon a larger scale, and takes up **Constructive Drawing and Working Plans.**

**Book No. 4** has a new and special subject, the cultivation of rapid and accurate perception by the drawing from memory of objects which, having been observed, are removed from view.

**Book No. 5** introduces Elementary Freehand Perspective in the drawing of models and familiar objects.

Progressive studies of ornament are continued throughout the course, the examples being derived chiefly from natural forms or from the antique.

---

**CANADA PUBLISHING CO. (Limited),**  
**EDUCATIONAL PUBLISHERS,**  
**26 FRONT STREET, TORONTO.**



