

**Please read and send in as full
discussion as possible at earliest date**

The Canadian Society of Civil Engineers

INCORPORATED 1887.

ADVANCE PROOF—(*Subject to revision*)

N.B.—This Society, as a body, does not hold itself responsible for the statements and opinions advanced in any of its publications.

THE DISTRIBUTION OF STRESS IN CERTAIN TENSION MEMBERS.

By C. BATHO, A. M. Can. Soc. C. E.

It is becoming generally recognized among engineers that a correct knowledge of the strength of structural members cannot be obtained by breaking tests alone. This is more especially the case with built up members in which it is probable that, as soon as some part reaches the elastic limit, the distribution of the load may change, so that the breaking load and the appearance of the specimen at fracture may not give any true guide to the action of the parts under working loads.

The most satisfactory way of obtaining a knowledge of the latter is by measuring the actual strain distribution under working loads, or, at any rate, at loads within the elastic limit of the parts, by means of some form of extensometer. Unfortunately, most forms of extensometers are open to many objections for this kind of work; some are inaccurate, others only measure the average strain over a long length, and nearly all are more or less complicated, take up a great deal of space and cannot be used in positions which are difficult of access, such as the interior of a built up column or between two angles. The writer knows of only one form of extensometer which, when proper precautions are taken, may be said to approach the ideal for this purpose. This is the Martens Extensometer, invented by Professor Martens, director of the Königliche Material Prüfungs Anstalt at Grosse Lichtefelde West, Berlin. This instrument is extremely simple in construction, easy to calibrate, and may be used in the most confined positions. (See Fig. 4.) It does not appear to have received the attention it deserves, possibly because of its simplicity, or because of inaccurate results obtained by lack of certain necessary precautions in its use. Under the conditions of the experiments described later, it was found to be capable of accurately

estimating the strain over a length of 4" to $\frac{1}{100,000}$ ". The

Martens' Extensometer was first used in the Testing Laboratory of McGill University, in 1906, for such work as is here described, but, owing to the fire of 1907, research work was considerably delayed, and has only lately been resumed.

The present paper gives an account of experiments made at McGill University to determine, by means of strain measurements with the Martens Extensometer, the distribution of stress in single and double angles with riveted end-plates loaded in tension, and to compare it with the theoretical distribution under different assumptions. Experiments are still in progress on similar members in compression and on built up members, and it is hoped that the present paper may be only a first contribution on the subject,

The experiments on built up members indicate that these do not, in general, act as one solid piece, but that the separate parts must be considered as eccentrically loaded members subject to constraints. From this it appears that the only way to build up a satisfactory theory of the action of such members is to commence with the problem, which is important in itself, of a uniform piece subjected to an eccentric load, and to work up gradually to more complicated members. This preliminary problem, with its application to the simplest form of compound member made from two angles placed back to back, is the subject of the present discussion.

Theoretical Considerations.

The method of finding the distribution of stress in a piece of uniform cross section, subjected to a load which is eccentrically applied, but which lies in an axis of symmetry of the cross-section, is well known and need not be considered in detail here. In this case the resultant stress at any point of the cross-section, the lateral deflection due to eccentricity being neglected, is given by the formula

$$f = \frac{N}{A} \pm \frac{Ncy}{I} \dots\dots\dots 1$$

Where *N* is the normal load, *A* the area of cross-section, *I* the moment of inertia of the cross-section about an axis in its plane through its centre of gravity and perpendicular to the line of symmetry on which the load axis lies, *y* the perpendicular distance of the given point from this axis, and *e* the eccentricity of the load, i. e. the distance of its point of application from the centre of gravity of the section. The + sign must be taken for points on that side of the centre of gravity on which the loading axis lies, and the - sign for points on the other side of the centre of gravity.

The equally, if not more important case of a load applied eccentrically, and not in a line of symmetry of the cross-section

(which includes, for example, the case of a single angle under tension riveted by one leg, and probably, as will be seen later, many cases of built up members where the load is apparently in a plane of symmetry) seems to be little known in this country, although it has been investigated thoroughly by many German writers. The only complete account in English, known to the writer, is in a paper by L. J. Johnson, *Trans. Am. Soc. Civil Eng.*, Vol. 56, 1906*. The full development of the formulæ is considered in Appendix I, and only an outline of the method and the details of actual calculation will be given here.

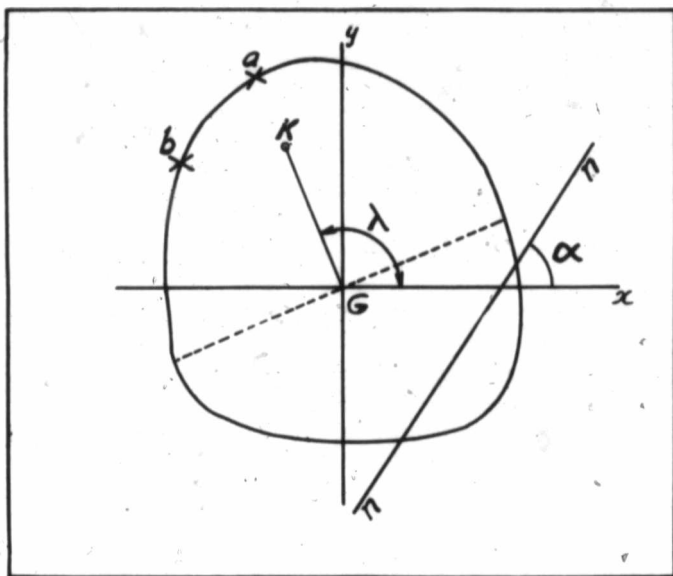

Fig. 1.

Consider a straight bar of uniform cross-section subjected to a load N , parallel to the axis of the bar, but which does not pass through the centre of gravity of the section. Let K (Fig. 1) be the loading point and G the centre of gravity of the cross-section. If KG is an axis of symmetry of the cross-section, the case will be that considered above, bending will take place about an axis in the plane perpendicular to KG and the maximum stress will be at a . If, however, K does not lie on an axis of symmetry, the neutral axis

*See Appendix I.

will be in some other direction such as nn , and the maximum stress will occur at b . Choose any convenient rectangular axes Gx, Gy through the centre of gravity (if the section is a standard one of which the moments of inertia are tabulated in the hand books, Gx and Gy should be the axes of the given moments of inertia) and indicate the angle KGx by λ . Then the inclination, α , of the neutral axis to the axis Gx is given by the equation

$$\tan \alpha = \frac{I_x - J \tan \lambda}{J - I_y \tan \lambda} \dots\dots\dots 2$$

Where I_x is the moment of inertia of the cross-section about Gx , I_y the moment of inertia about Gy and J , the product of inertia about Gx, Gy . The only assumption made in deducing this is that the distribution of stress follows a linear law. Expressing this symbolically, and forming three equations expressing that the total normal internal force across the section is equal to N , and that the sums of the moments of the internal forces about Gx and Gy are equal to the moments of N about Gx and Gy respectively, equation (2) may be deduced. (See page 23.) In a similar way the equations

$$f = N \left[\frac{I}{A} + \frac{y-x \tan \alpha}{J - I_y \tan \alpha} x_k \right] \dots\dots\dots 3$$

$$f = N \left[\frac{I}{A} + \frac{y-x \tan \alpha}{I_x - J \tan \alpha} y_k \right] \dots\dots\dots 4$$

giving the stress, f , at any point (x, y) of the cross-section, may be found. In these equations A is the area of the cross-section and x_k and y_k are the co-ordinates of the load point K . In order to find the maximum stress, all that is necessary is to substitute for x and y in (3) or (4) the co-ordinates of the point b furthest away from the neutral axis. This may usually be determined readily by inspection. If f be made zero, either (3) or (4) will give the equations of the neutral axis and thus its position may be found.

The above equations become much simpler if Gx and Gy happen to be the principal axes of inertia of the cross-section, for in this case J is equal to zero. The moments of inertia given in the hand books for standard angle sections, etc., are not taken about the principal axes. For this and other reasons, it is better to take the axes for such sections parallel to the legs of the angle and to calculate J , which is

$$\iint xy \, dx \, dy$$

taken over the section. This is usually easy to evaluate, as will be seen from the example considered later.

A few points in the application of this theory to long members subjected to tension or compression must now be considered. In

deducing the above equations it is, of course, assumed that the piece is free to bend in any direction. If it does so, the point X will be differently situated relatively to the cross-section at different sections, and this must be taken into account if correct values are to be obtained for the stresses, especially when near to the central section of a long member. In practice this will usually be a needless refinement, but in attempting to verify the theory by experiment, it must be considered. If the ends of the piece are constrained in any way, say for example, by the grips of the testing machine or the end connecting plate, or by riveted connections in actual structures, a constraining couple will be introduced, and this will have the effect of altering the position of the resultant force X . One of the deductions made from the experiments to be described is that the connecting plate in the case of riveted single angles does not introduce any considerable fixing couple, except in the plane of the plate, but, in attempting to build up a correct theory for the double angle, this constraint must be considered.

As an example of the method of calculation of the position of the neutral axis and the maximum stress in the cross-section, the case of a single angle $3'' \times 3'' \times \frac{1}{4}''$ in cross-section, loaded at the middle point of one of its external faces, will now be worked out in full. This was the section of the angles used in experiments, and the results obtained from calculation will be necessary in the discussion of the experimental results.

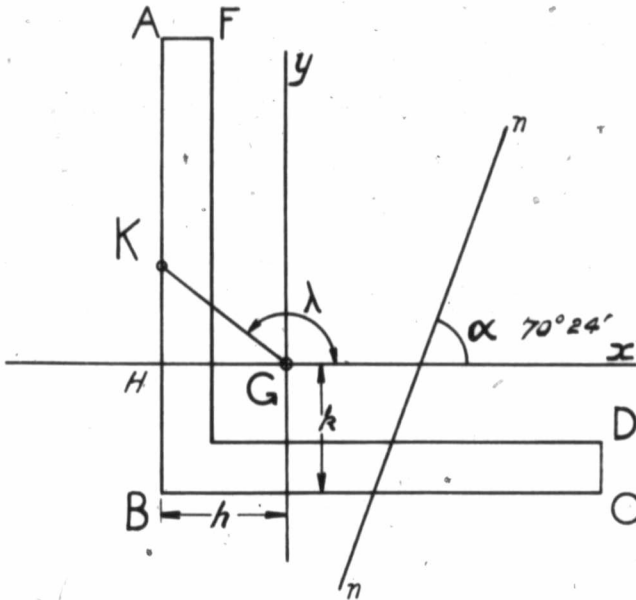

Fig. 2.

Figure 2 shows the cross-section. The axes Gx and Gy are taken parallel to the two legs of the angle. The following data are obtained from the Cambria Steel Handbook.

$$A = 1.44 \text{ square inches.}$$

$$I_x = I_y = 1.24 \text{ (inch)}^4 \text{ units.}$$

Distance of G from the back of the leg = 0.84". It is not very convenient to calculate J for the axes Gx and Gy , but as the calculation is very easy for the axes BC , BA , it will be made for these axes first, and then found for the axes through Gx , Gy by means of the formula

$$J_B = J_G + A h k$$

where J_B is the product of inertia about BC , BA .

J_G is the product of inertia about Gx , Gy and (h, k) are the coordinates of G referred to BC , BA . Now, using x' y' for coordinates referred to BC , BA ,

$$\begin{aligned} J_B &= \int \int x' y' dx' dy' \\ &= \int_0^3 \int_0^3 x' y' dx' dy' - \int_{0.25}^3 \int_{0.25}^3 x' y' dx' dy' \end{aligned}$$

$$= 0.28 \text{ (inch)}^4 \text{ units,}$$

the angle being considered as the difference between two squares. Hence

$$J_G = 0.28 - 1.44 \times (0.84)^2$$

$$= -0.74 \text{ (inch)}^4 \text{ units.}$$

This is correct to the second place of decimals, neglecting the rounding of the corners of the angles, etc., which is close enough for most purposes. It would save a great deal of calculation if the quantity J were tabulated in the handbooks on steel.

The angle is supposed to be loaded at the point K . Thus $\tan \lambda$ is in this case equal to $-\frac{KH}{HG} = -\frac{1.5 - 0.84}{0.84} = -0.786$

and the inclination of the neutral axis to the axis Gx is, from equation (2), given by

$$\begin{aligned} \tan a &= \frac{1.24 - 0.74 \times 0.786}{-0.74 + 1.24 \times 0.786} \\ &= 2.81 \end{aligned}$$

Therefore $a = 70^\circ 24'$.

The maximum stress obviously occurs at A and may be obtained

from equation (3) or (4). From 3, substituting $y = 2.16$, $x = -0.84$,

$$f_A = N \left[0.69 + \frac{2.16 + 0.84 \times 2.81}{-0.74 - 1.24 \times 2.81} \times (-0.84) \right]$$

$$= 1.59 N$$

The ratio of the maximum to the mean stress is, therefore, $1.59 \times 1.44 = 2.29$, and thus the stress estimated on the not unusual assumption that the load is uniformly distributed is approximately 130% too small.

The equation of the neutral axis may be obtained by giving f the value zero in equation (3) page 4.

$$0 = 0.69 + \frac{0.84}{4.71} (y - x \times 2.81)$$

$$\text{or } y = 2.81x - 3.87.$$

It cuts Gx at the point $x = 1.22$ and is shown by the line nn in the figure.

It will be seen from the above that the calculation, using the correct theory, is simpler than that assuming bending perpendicular to KG and equation (1) for the stress distribution, because the latter would involve the calculation of the moment of inertia of the cross-section about an axis perpendicular to KG . If bending were incorrectly assumed to take place about Gy the eccentricity of the load would be 0.84" and the stress at A would be, from equation (1)

$$= \left[\frac{0.84 \times 0.84}{1.24} + 0.69 \right] N$$

$$= 1.26 N,$$

which is about 20% too small, whilst if it were assumed to take place about Gx the eccentricity would be 0.66" and the stress A would be

$$= \left[\frac{0.64 \times 2.16}{1.24} + 0.69 \right] N$$

$$= 1.84 N,$$

which is approximately 16% too great, so that the correct value in the case of the given angle is approximately the mean of the values assuming bending about Gx and Gy respectively.

The Experiments.

All the experiments to be described were made in tension on specimens consisting of 3" x 3" x $\frac{1}{4}$ " angles having different forms of end connections. In the first experiments a simple angle was used, one leg being cut off shorter than the other, so that the specimens could be gripped in the machine by the other leg. It was tested

tension under different conditions, with the object of verifying the theory described above. It was found, however, that although the distribution of stress was linear, the positions of the line of pull varied with each placing in the machine, and the results are not thought sufficiently interesting to be published. Experiments were then made on the two single angle members shown in Fig. 3. The angles were $4' 7\frac{1}{2}"$ long and $3" \times 3" \times \frac{1}{4}"$ cross section, and were riveted by means of four $\frac{3}{4}"$ rivets having a pitch of $2\frac{1}{2}"$ to end plates $\frac{3}{4}"$ and $\frac{1}{4}"$ thick respectively, different thicknesses of end plate being used with the object of determining the effect of the restraint to bending offered by end connections of different stiffnesses. The results of the test are given in Tables I, II, and IV. The remaining experiments were made on the double angle member shown in Fig. 3. This consisted of two angles placed back to back and connected at the ends to a loading plate $\frac{3}{4}"$ thick, by four $\frac{3}{4}"$ rivets of $2\frac{1}{2}"$ pitch. The results of the tests on this angle are given in Tables III and IV. The machine used was the Emery testing machine in the McGill University Testing Laboratory. This machine is of the vertical type and has a capacity of 150,000 lbs. The length of the specimens was governed by the limits of the machine. The Emery type is eminently adapted to this kind of work, because the line of pull is constant, the load may be very accurately estimated, and there is an entire absence of vibrations which would make the reading of the extensometer difficult.

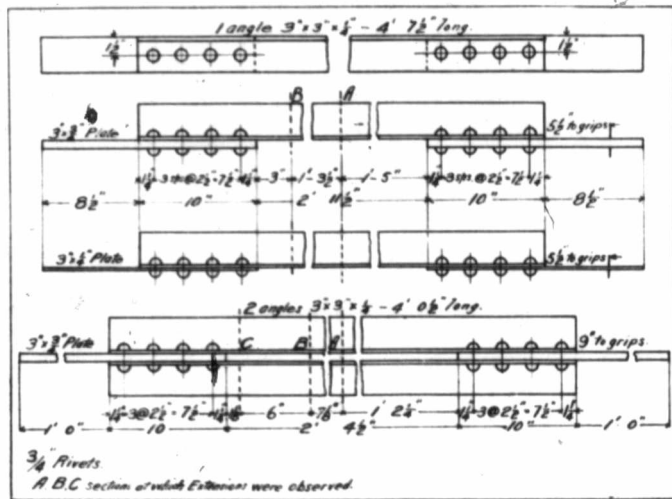

Fig. 3.

The Extensometers.

The extensometers used were a simplified form of the Martens' type, designed and constructed in the McGill Testing Laboratory, where they have been in use since 1906, and have been proved capable of giving very accurate results. Figure 4 shows the prin-

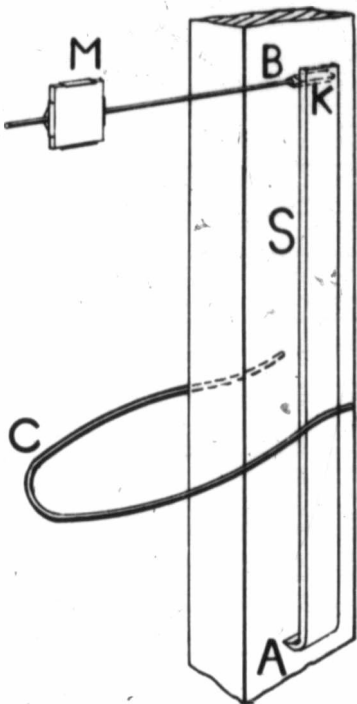

Fig. 4.

ciple of the instrument, and Figs. 5 and 6 show it in actual use on the specimens. It consists essentially of a double knife-edge, *K*, which fits between the specimen under test and a V groove in one end of a steel strip *S*, which is in contact with the specimen at *A*, and is pressed against it by means of a clip *C*. A change in the length of *AB* causes the knife edge to tilt and the tilt is measured by means of a telescope and scale, the scale being reflected in a mirror *M* attached to the knife edge. In the actual instrument the steel strip is $\frac{3}{8}$ " wide, $\frac{1}{8}$ " thick, and the length *AB* is 4".

The end A is turned at right angles and brought to a sharp edge so that it may not slip on the specimen. The knife edge is of hardened steel about 0.18" by 0.12" by 0.45", and the mirror is attached by means of a piece of steel knitting needle. The mirror is held in a clip of thin sheet steel which is arranged so that it can slide and rotate on the needle, a thin copper strip protecting its back from injury. This clip permits of a small amount of lateral adjustment. The mirror is about $\frac{1}{4}$ " square and must be as truly plane as possible, as otherwise there will be an error introduced when the image of the scale moves to a different part of its surface, as it must do if the specimen deflects at all during test. In the original form of Martens' Extensometer there was a device for adjusting the mirror and also a balance weight at the opposite side of the knife-edge, but these refinements are not only unnecessary but cumbersome, and make the instrument less adapted to use in restricted positions.

The extensometer is calibrated in a Whitworth Measuring Machine and a calibrating rod is prepared for each instrument, giving the distance from the scale to the mirror, so that a definite distance on the scale may correspond to a given extension or compression on the specimen. In the case of the experiments described below, $\frac{1}{2}$ " on the scale subdivided into ten equal divisions, corresponded to 1", so that the change of length of the specimens was

$$\frac{1000}{100,000}$$

easily read to 1". The length of the rod was about 4', varying

$$\frac{100,000}{100,000}$$

with different instruments. The angle turned by the mirror in any test is so small that there is no appreciable error in using a straight scale for the readings. This is verified by turning the mirror in the Whitworth measuring machine through much greater angles than those through which it turns in the tests. It was also found that different strips (S) did not affect the calibration, so that a knife-edge could be used with different lengths of strip without re-calibration. It is estimated that, under the conditions of test, the instrument reads accurately to 1".

$$\frac{100,000}{100,000}$$

The kind of telescope used affects greatly the facility with which readings may be taken. The McGill Testing Laboratory telescopes were made at Charlottenburg, and are adjustable vertically and horizontally, besides moving bodily about a vertical axis (See Fig. 5). The extensometer must be carefully used in order to give correct results. The mirror should be, in its mean position, parallel to the scale and the telescope should be opposite to the mirror. The clip must be arranged so that the knife edge is held quite firmly, otherwise it will not tilt correctly. The best forms of clips are made from pieces of copper wire.

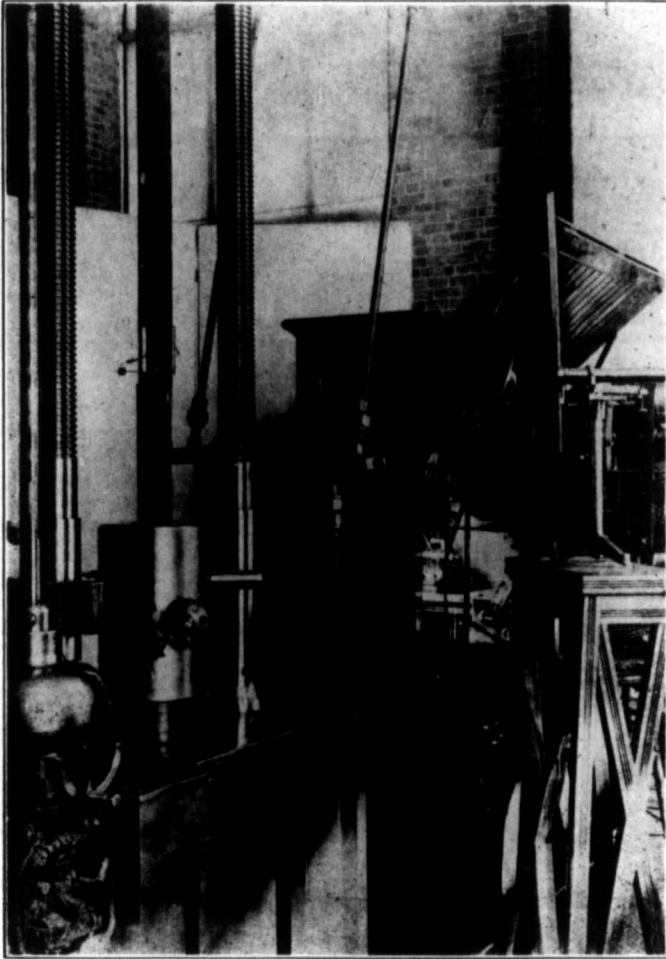

Fig. 5.

If the direction of $A B$ remains unchanged during test, the difference of the scale reading between two loads will be an accurate measure of the strain of $A B$ for the given load difference, but if $A B$ alters in direction this will not be the case. If, however, two readings are taken, one with the extensometer in the position shown, and the other with the knife-edge at A and the sharp edge of the

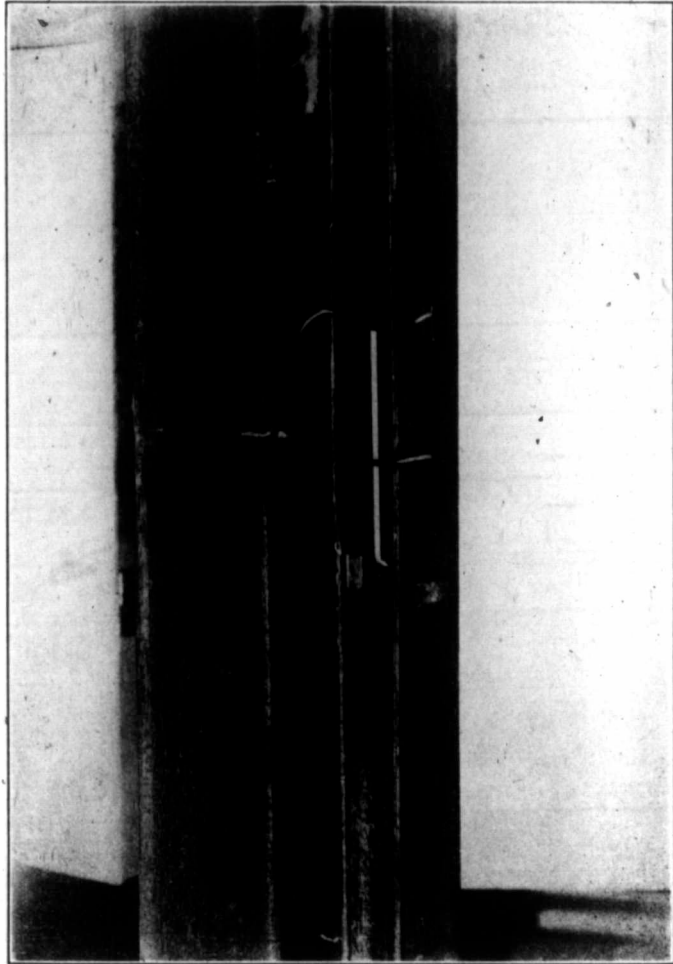

Fig. 6.

strip at *B*, the mean of the two will be correct. When any doubt exists it is always better to do this so as to eliminate possible error.

In the opinion of all who have used these instruments at McGill University, they are the most simple, practicable, and accurate extensometers in use. It will be seen that they may be readily used

in
an
(F
ta:
T/
so:
ov
mu
mi
err
be
ext
use
is
poi
str
duc

in the most restricted positions, as, for instance, between the two angles of the double angle members, where the width is only $\frac{3}{4}$ ". (Fig. 6.) The photograph shows two extensometers in use simultaneously between the angles.

The Tests.

All the tests, with one exception, were made with 4" extensometers, and, therefore the stresses tabulated are mean stresses over lengths of 4". In the case of the central sections, these stresses must be very close indeed to the actual intensities of stress at the middle points of the 4". For the end sections there may be some error introduced by considering them as such, but it is not likely to be large. It is only when the stress varies considerably over the extensometer range, as at the rivets, that the readings cannot be used to obtain values very close to the actual stresses at any point.

It will be understood then, wherever the reading at a given point is spoken of, that it was actually taken over 4" range having the point as centre. The extensometers were always arranged with the strip parallel to the axis of pull, and, therefore the stresses deduced from them give the distribution of normal stress over the

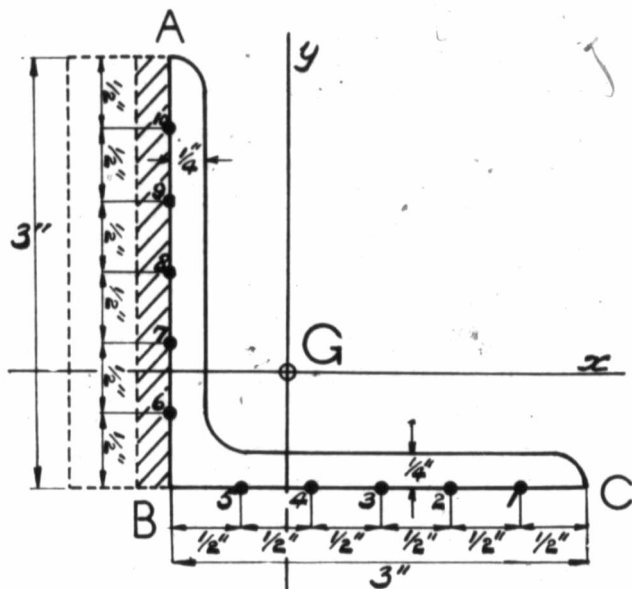

Fig. 7.

cross-section. All the stresses tabulated are for points on the outside faces of the angles. In the case of the single angles, the readings were taken at the central section and at a section 3" from the loading plate. The readings were taken across each section at intervals of $\frac{1}{8}$ " (See Fig. 7). For the double angle, 10 readings with the mirror at the lower end of the extensometer, and 10 with the mirror at the upper end were taken at the same intervals across each angle at the central section, and at two other sections, one *B*, 7 $\frac{1}{8}$ ", and the other *C*, 1 $\frac{1}{8}$ " from the loading plate (See Table III). Other readings were taken at the rivets, but are not, at present, thought sufficiently interesting for publication, as they do not give a measure of the actual stress at the rivets.

The procedure of the tests was as follows. The specimen being placed between the grips of the machine, an initial load of 100 lbs. was applied. When two extensometers had been adjusted in position, and convenient zeros taken, the load was increased to the full amount, brought back to 100 lbs. and then again increased, readings being taken in the case of the single angles at 5,000, 10,000, 15,000, and 20,000 lbs., and in the case of the double angle at 10,000, 15,000, 20,000, 25,000, and 30,000 lbs. The load was then decreased and the zero checked. Usually the extensometers returned to zero and no readings were allowed to pass in which they failed to do so. All the readings were repeated at least once before the extensometers were moved to other points. It was determined early in the course of the experiments that the readings for all the riveted pieces did not alter when the piece was taken out of the machine and replaced, and so this was done whenever the machine was required for other purposes. Three complete sets of experiments were made at the sections tabulated, but there was very little variation in the results, and the Tables are compiled from one complete set. The value of *E* (Young's Modulus) for each specimen was found by cutting pieces from different parts of the actual sections and testing them in tension. The mean value of *E*, which did not differ greatly for the different specimens, was 28.6×10^6 lbs. per square inch, and this has been used in reducing all the results.

Careful measurements were also made of the lateral bending of the specimens at different points along them, by means of small scales graduated in $\frac{1}{16}$ ", and read through telescopes.

100

The scales were arranged so that the deflections of the points *A* and *B* (Fig. 7) at each cross-section, were obtained in the directions *x* and *y*, and thus the actual twist of *AB* was found. Table IV gives the principal results of these tests, which are used in determining the exact position of the load axis, as will be described later. Only the mean of the deflections at *A* and *B* is given in the table, as

these were the values used in the reduction of the experimental results.

The Results.

In Tables I-III the stresses at the given points of the various cross-sections calculated from the actual extensometer readings are given. These were obtained by dividing the mean of the extensometer readings (with the mirror at upper end and with it at the lower end respectively) by 4", and multiplying by the mean modulus of elasticity for the piece, this being obtained by experiment, as described above. In Figures 8-13 the actual mean extensometer readings are plotted, the mean straight lines being continued so as to give the maximum strain occurring at each section. The stresses corresponding to these estimated maximum strains are tabulated in Tables VI and VII, together with the ratio they bear to the average stresses over the sections.

It will be noticed, on examining Figs. 8-13, how very closely the assumption of a linear distribution of stress over the cross-section is borne out by the experimental results. This is especially remarkable as the specimens were not elaborately prepared, but were ordinary shop products. The greater deviations from the mean occur in Figs. 9 and 11, which are for the unconnected limbs of the two single angle specimens at sections 3" from the loading plate. In these cases the deviations seem to follow definite curves, which are not only similar for the same piece at different loads, but for the two different pieces. It is, therefore, probable that they are due to a real deviation from the linear law caused by the proximity of the sections to the rivets. This view is borne out by the results of experiments made with the object of determining the stress distribution near the rivets. Figs 10 and 12 also show rather large deviations, but these must be set down to irregularities of cross-section. The largest of these, in Fig. 10, (for specimen with $\frac{1}{2}$ " plate), is at point 8, for the 20,000 lb. load, and amounts to about 6.6%, whilst the largest in Fig 12, for the left side of the double angle, is about 4.5%. In the other figures there is scarcely any deviation from the straight line. The stresses for the corner of the angle, obtained by producing the curves for the points 6-10, downwards, and those for 1-5 upwards, also agree in a very striking manner, as will be noticed from the figures, where the points surrounded by circles on the curves for 1-5 correspond with those found by producing 6-10.

These results show that the greatest confidence may be placed in the extensometers used, and that the assumption of a linear law for the stress distribution is justifiable.

The truth of this law having been established, the position of the neutral axis may be found for each load on a given section, and also the position of the load axis, according to the theory described above (page 4).

As the method of reduction is similar for all the experiments, one example will suffice to explain it. Consider the central section of the single angle member with $\frac{3}{4}$ " end plate, for which the stresses are given in Table 1, and the strains are plotted in Fig. 8. The constants of the cross-section are given in Table I. The line of stress for the points 1-5, at the 20,000 lb. load, intersects the base line at a point distant 1.88" from the corner of the angle. This is, therefore, the point where the neutral axis cuts the leg BC of the angle for this load. Its distance from B is called b (See Table V). If the line of stress for the points 6-10 be produced until it reaches the base-line, as shown to a different scale by the small figure (Fig. 8), another point of zero stress may be found. Its distance from B is 7.5", and is called a (Table V). The ratio of a to b gives the tangent of the angle of slope of the neutral axis to the axis Gx , which is called α in the analysis given above (page 4). In this case it is equal to 3.99 corresponding to an angle $\alpha = 75^\circ 5'$. The neutral axis is thus determined and the loading point (x_k, y_k) may be found from equations 3 and 4, the axes being taken through the centre of gravity parallel to the legs. In order to simplify the calculations, the point of zero stress on the leg BC is taken. Thus f in equations 3 and 4 is equal to zero, whilst the co-ordinates (x, y) are $x = 1.88 - 0.85 = 1.03$, and $y = -0.85$, the distance of the centre of gravity from the back of the angle. (This is a little different from the distance for the standard angle, because the section was slightly heavy. See Table 1.) The values x_k and y_k , found in this way, are $x = -0.80$, $y = 0.59$. These are the co-ordinates of the point of action of the resultant load at these sections referred to axes through the centre of gravity of the section. In Table IV the deflections of this specimen at different cross-sections for different loads are given. Considering the central section, taking the mean of the deflections at these points A and B for a load of 20,000 lbs., and subtracting from these the deflections similarly taken at the middle of the riveting, a correction may be found for x_k, y_k , and, if this is applied, it will be found that the point of loading referred to the co-ordinates through the centre of gravity of the section, midway between the extreme rivets at the ends, is $x_k = -0.89$, $y_k = 0.63$. In a similar manner all the other figures in Table V have been obtained.

Discussion of the Results—Single Angles.

Consider Figs. 8-11. If the point of application of the resultant force remained unchanged relatively to the section during loading,

the stress lines in each of the figures would intersect at one point for all loads, *i. e.*, the distances a and b would be the same for different loads on the same section. This is not quite the case, as will be seen on inspection of the figures and tables. For example, at the central section of the angle with the $\frac{3}{4}$ " plate, the point of application varies from $(-0.90, 0.65)$ at 5,000 lbs. load to $(-0.80, 0.59)$ at the 20,000 lb. load. This is largely due to the lateral bending of the members, and may be corrected from Table V. In order to obtain a proper basis for comparison, the load point should be referred to the sections at which the load enters the angle. There is, of course, some uncertainty as to the exact position of this cross-section. It must be somewhere between the end of the angle and the end of the loading-plate, and it seems most correct to take it at the mean section of the rivets, *i. e.*, between the two middle rivets. This has been done in the tables and the results must be close to the correct positions of the loads. It will be seen that this position is practically constant for the central section of the angle with the $\frac{3}{4}$ " plate, and its mean is a point having co-ordinates $(-0.91, 0.64)$ (referred to the axes through the centre of gravity) which is $\frac{1}{100}$ away from the centre of the connected

limbs, and .06" within the load plate. For the angle with the $\frac{1}{2}$ " plate the results are slightly more variable, their mean being a point having co-ordinates $(0.91, 0.67)$ (referred to the axes through the centre of gravity) which is 0.02" from the centre of the connected leg, and 0.06" within the load plate. The mean angle of inclination of the neutral axis to the unconnected leg, for the angle with the $\frac{3}{4}$ " plate, is 76° , and for the other angle $76^\circ 50'$. It appears from these results that there is a remarkable agreement between the action of the two angles, notwithstanding the great difference in the stiffness of their end connections. The results for the sections near to the ends give for the load points $(-1.01, 0.67)$ and $(1.04, 0.71)$ for the specimens with the $\frac{3}{4}$ " plate and $\frac{1}{2}$ " plate respectively. These points are 0.16" and 0.20" respectively within the plate, and are .03" and .07" respectively from the centre of the connected leg. Here also the two different angles behave alike. The reason for the change in position of the load axis at this position is probably that some moment is caused here by proximity to the riveted joint.

Additional evidence that the heavy end plate does not appreciably restrain the bending of the angle is afforded by the deflections given in Table IV. It will be seen from these that the mean deflection of the central section of the connected leg in the direction of x , measured from the end of the angle, is 0.14" in the case of the $\frac{3}{4}$ " end plate, and 0.15" in the case of the $\frac{1}{2}$ " end plate, whilst in the

direction of y , the values are 0.04" and 0.06" respectively. The difference between these values for the plates is small, especially considering that the first angle is slightly heavier than the other. In Appendix II a formula is developed for the central deflection of a piece subjected to an eccentric tensile force. It is shown that, when applied to a single angle of the dimensions of the specimens, the deflection of the centre of gravity arrived at is 0.15". This is in a direction perpendicular to the neutral axis and assumes the load axis to be at the middle of the outside face of the connected leg. When this displacement is resolved parallel to Gx it gives 0.145", and parallel to Gy 0.05", which are close to the experimental values.

Now the constraint offered to bending by the $\frac{3}{4}$ " end plates is probably greater than that due to any end connections used in practice. Thus it will be evident, from the above, that in very few practical cases can the end of a single angle structural member be said to be fixed.

Careful measurements were made of the deflections of the plate and the angle near to the rivets, which showed that both bent together. The want of end rigidity must, therefore, be due to the stiffness of the angle being much greater than the stiffness of the plate, and not to any yielding of the rivets.

The next question which must be considered, is the position of the load axis. Evidently, from the above, it will not depend very much on the stiffness of the end connections. In Table V the actual maximum stresses from measurements are given, together with those obtained from the theory, assuming the load axis as worked out from the experimental results. It will be seen that the agreement between the two is very close for the angle with the $\frac{3}{4}$ " plate. For the other angle, the calculated results are all 3% or 4% higher than the extensometer results, but a small variation in E would obviously bring them into agreement, and in any case the difference is small.

The truth of the theory may thus be said to be verified by the experimental values, and the stresses given in the second column of Table VI must be very close indeed to the actual maximum stresses. Considering the ratios of maximum to mean stress over the section, given in the last column of Table VI, it will be seen again that the two different angles behave very similarly, the ratio falling at the central sections from 2.23, at the lowest load, to about 2.10, at the highest. This change is, of course, due to the bending of the specimens. In the first column of Table VIII the stresses calculated from the mean position of the load axis, allowing for bending, are given, the ratio of maximum to mean stress being 2.16 for each angle. This may be taken as the mean experimental ratio for both of the sections. In this table the theoretical maximum stresses for different assumptions of the load axis, neglecting bending, are also

given. It will be seen that the assumption which best fits the actual case is that the load axis is 1" from the centre of gravity, corresponding to a point 0.15" and 0.16" respectively, within the load plate. (The values of a do not, of course, correspond exactly, because the deflection has not been considered.) The stresses at the ends of the piece are somewhat higher and correspond more closely to a load-axis at the junction of the plate and the angle, and it would seem that the best practical rule for obtaining the maximum stress of such a member would be to take the load-axis as along the line of rivets, and at the junction of the plate and angle, neglecting deflection. This would give results slightly on the safe side.

The Double Angle.

In figuring a section consisting of two angles placed back to back, connected by a plate to which the load is applied and riveted together at intervals, it is usually assumed that the section acts as one piece, *i. e.*, as a T section, thus bending about a neutral axis parallel to the unconnected legs of the angles. The load is thus assumed to act in an axis of symmetry of the cross-section, and the maximum stress in any given case may be easily calculated from equation 1 above. Applied to the experimental section, this method would give the ratio of maximum to mean stress as 2.65. A glance at Table VII will show how very far such calculated results are from the actual experimental values. In the actual specimen, the two angles did not take equal portions of the load, the angle L taking more than the angle R , but the greatest of the maximum stresses is only 2.28N at the lowest load, falling to 2.15N at the highest. The reason for this will be evident from Fig. 12, where the distribution of strain across the central cross-section is plotted for different loads in exactly the same way as in the case of the single angles. It will be seen from these figures that the two angles of the member bend each about its own neutral axis, and that they thus act like separate angles constrained at their ends. The results were, therefore, reduced to find the point of loading and the angle of inclination of the neutral axis, in the same way as for the single angles, and the results of the analysis are given in Table V. It will be seen from these that the angle of inclination is $20^{\circ} 18'$ for the right hand angle, and $18^{\circ} 48'$ for the left hand angle. The load axis for the right hand angle has a mean position $(-0.36, 0.46)$, and for the left hand $(-0.43, 0.55)$, and is constant for all the loads, except the lowest (10,000 lbs.). The results were not corrected for lateral bending, although deflections were measured (See Table IV), because the deflections were small, and it was recognized that these results could not, by reason of the unequal distribution of the load between the two angles, be so closely analysed as the results for a

single angle. Assuming that the angles, if acting separately and unconstrained at the ends, behaved as in the experiments described above, the effect of the end constraint, caused by the riveting of the angles back to back, may be found from the shift of the axis of loading. This may be assumed at the centre of the connected leg for separate action, *i. e.*, at the point $(-0.84, 0.66)$. It has, therefore, shifted in the case of the angle R through a distance equal to $\sqrt{[(0.84 - 0.36)^2 + (0.66 - 0.46)^2]} = 0.52''$, and in the case of the left hand angle through a distance of $0.42''$. This means that a restraining couple of moment $0.52 N$ inch lbs. acts on the right hand angle and a couple of $0.42 N$ inch lbs. on the left hand angle. Consider the adjoined figure (Fig. 14), which represents the two

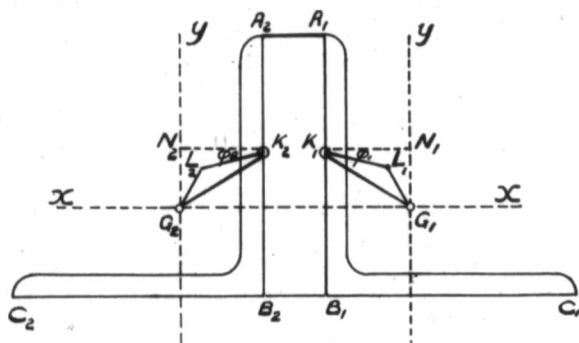

Fig. 14.

angles, G_1 being the centre of gravity of the right hand angle, G_2 that of the left hand angle. K_1 and K_2 represent the loading points for separate action, and L_1 and L_2 represent the actual axes of load found as above. The bending moment on the sections acting separately would be $N_1 \times K_1 G_1$, and $N_2 \times K_2 G_2$ respectively, where N_1 and N_2 are the loads carried by the angles. The actual moment for the right hand angle is $L_1 G_1 \times N_1$, and thus the constraining moment is $K_1 L_1 \times N_1 = 0.52 N$, about an axis perpendicular to $K_1 L_1$. This may be resolved into moments

$$N_1 \times K_1 L_1 \cos \phi_1 = N_1 \times 0.52 \cos \phi_1,$$

$$N_1 \times K_1 L_1 \sin \phi_1 = N_1 \times 0.52 \sin \phi_1,$$

parallel to $G_1 y$ and $G_1 x$ respectively.

$$\text{Now, } \tan \phi_1 = \frac{0.66 - 0.46}{0.84 - 0.36} = 0.417,$$

and the constraining moments are thus $0.48 N_1$, about an axis parallel to G_1y and $0.20 N_1$, about an axis parallel to G_1x . Similar analysis for the left hand angle leads to the values $\tan \phi_2 = 0.27$, moment parallel to $G_2y = 0.41 N_2$ and parallel to $G_2x = 0.11 N_2$.

It is thus clear that the experimental angle is subject to imperfect constraints in directions parallel to the legs of the angles, the constraint parallel to the unconnected legs being roughly 50% of that required for perfect fixing, and the corresponding figure for the connected legs being 20%. If the load had been applied through pins in the end plates, the latter restraint would probably have been almost zero, since it is due to the stiffness of the end connections. In any actual members, however, there must be a certain fixing moment in this direction, which is probably never very much greater than the above experimental value. The length of unconnected angles in this case was 28.5", which is not greater than that frequently used in practice, so that the restraining moment parallel to the connected leg is probably of the same order as that obtained in practice. It is hoped that other members with different lengths of unconnected angles, etc., may be tested in this way. With perfect constraint in both directions the stress would, of course, be uniformly distributed over the section, because the fixing moment would entirely counteract the eccentricity. With perfect fixing about the axis parallel to the connected leg and perfect freedom in a direction at right angles to it, the ordinary theory would be correct, because the line of pull would then be on G_1y at a distance $G_1 N_1$ (Fig. 14). If, on the other hand, there were no constraint in either direction, the action would be like that of the single angle. In most practical cases there is probably imperfect restraint in both directions, as in the experimental member. It must not be assumed, however, that the greater the restraint the lower the maximum stress will be, because if, for example, the angles in a member of the section considered above acted separately, the ratio of maximum to mean stress would be 2.29, whilst with perfect constraint against bending of the unconnected limb, the ideal usually aimed at, it would be 2.65, about 16% higher. (See page 14.) With perfect constraint in the direction at right angles, the ratio would be only 1.82, and with the actual imperfect restraints in both directions it is 2.15. From these results it will be seen that, for a member consisting of equal angles placed back to back, it is not desirable to stiffen the member so as to make it act as one single piece, and there must be many other cases of built up members in practice where extra stiffness given by distance pieces, diaphragms, etc., is a doubtful advantage. It must be remembered that the above figures only hold good for angles having equal legs. In the case of unequal legged angles connected by the longer legs, the stresses may be much greater if they act separately,

whilst if they are connected by the shorter legs, the reverse will be the case.

Remarks on Built Up Members.

A built up tension or compression member is one which is made of two or more simple sections, such as angles or channels, fastened together by rivets and by tie plates, lattice bars, or other connections, as in the case of a large column. Probably the simplest form is the double angle considered above. Such a built up member is usually considered as acting like one piece, and the forces in the tie plate or lattice connections are found on the assumption that, if any bending takes place, the whole member bends like a beam. The above experiments show that this is not true for the specimens tested, and it would probably be more correct to consider such a member as an assemblage of simple members each trying to bend about its own neutral axis, but more or less constrained by the subsidiary latticing, etc. In the opinion of the writer, the only way to arrive at a correct theory of the action of such structures is to consider the simplest cases first and to approach gradually the more complex cases by introducing one constraint after the other, and finding their effect by experiment and analysis. This opens the way to a large field of research, to which it is hoped that the present paper may form a first contribution. An example will make this point clear. Consider a column in the form of a rectangle, built up of four angles, connected by tie-plates or lattice bars, and loaded through two loading plates riveted to the angles at the ends. The ordinary theory would assume that the whole member behaves like one piece, the tie-plates or lattice bars simply taking up the stress like the web of a girder. According to the theory advanced here, the four angles would be regarded as trying to bend about their own neutral axes in the way a single angle has been shown to behave above, and the tie-plates would constrain them against twisting, and so would themselves be under bending stresses, the whole action being, of course, somewhat complicated. It may be stated here that actual extensometer experiments on such a column, carried out under the direction of Professor H. M. Mackay, at McGill University, entirely bear out this view, the stresses in the tie-plates being found to be tensile on one side and compressive on the other. It is hoped that these results will be published shortly. The writer hopes to investigate the theory of this type of member by considering first the relatively simple case of two angles connected by tie-plates.

Su

her
ves
dou
con
mer

(1)

(2)

(3)

(4)

(5)

(6)

I
(at
Bro
thel
McG
thro
to tl

Summary and Conclusion.

As stated in the introduction, experiments of the kind described here are still in progress at McGill University. It is hoped to investigate in a similar manner single angle members in compression, double angle members with equal and unequal legs in tension and compression, as well as various forms of built up members. Experiments on some of these are in progress.

The chief conclusions to which the present paper leads are:

- (1) That the form of extensometer described is very accurate and simple in operation, and that it is possible by its means to obtain very closely the distribution of stress in a piece of material under load;
- (2) That experiments made with these extensometers on tension specimens of uniform cross-section subjected to eccentric axial loads not in an axis of symmetry of the cross-section, bear out very closely the general theory for such a case;
- (3) That the point of application of the load for a single angle member loaded through a plate riveted to one of its legs may be taken as in the line of rivets and at the common face of the plate and angles;
- (4) That the end plate, under ordinary conditions, offers no appreciable restraint to the bending of such a member;
- (5) That a member consisting of two angles riveted together through a connecting plate does not act as one piece, but that each angle bends about its own neutral axis, and that it is not *always* an advantage to attempt to make it act as one piece by further constraints;
- (6) That a built up member should not be regarded as a single piece bending as a beam, but as several pieces each trying to bend about its own neutral axis, but restrained from doing so by the subsidiary members, such as the tie-plates, or latticing.

In conclusion, the writer wishes to thank Professor H. M. Mackay (at whose suggestion the work was commenced), Professor E. Brown, and Mr. F. P. Shearwood, of the Dominion Bridge Co., for their personal interest and advice; and Mr. S. D. Macnab, of the McGill University Testing Laboratory, who was associated with him throughout in the experimental parts of the work. He is indebted to the Dominion Bridge Co. for the specimens used in the tests.

APPENDIX I.

Theory of the Distribution of Stress in a Uniform Bar subjected to an eccentric force parallel to its axis, which does not lie in an axis of symmetry of the Cross-section.

This theory is to be found in the German text-books on Strength of Materials, but does not seem to be considered in any of those written in English*. It was developed in one form by Mohr (See "Technische Mechanik," Otto Mohr, Berlin, 1906, P. 241). This form, however, although elegant, is not adapted to practical computations. C. Bach, in his work "Elasticität und Festigkeit" (p. 223, 4th edition) gives the results referred to the principal axes of inertia of the cross-section, and L. J. Johnson in Proc. Am. Soc. C. E., Vol. 56, 1906, works out the results in the form given here, which is that best suited for calculation.

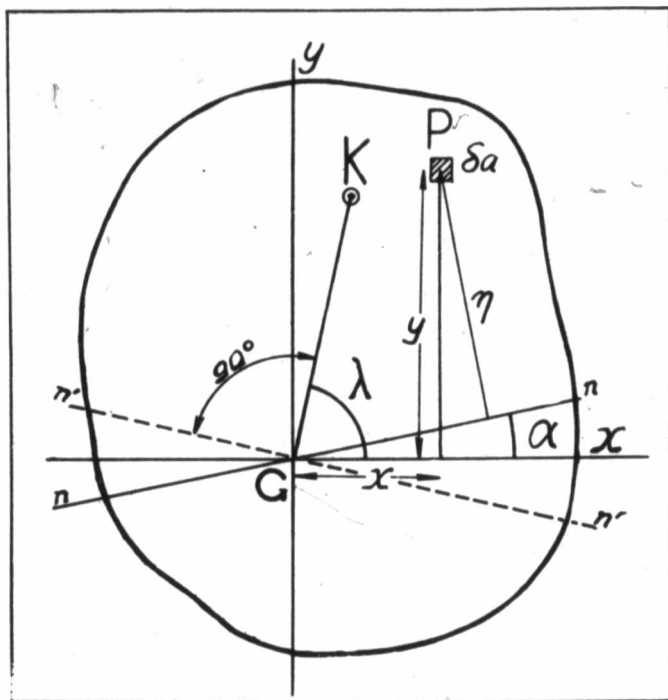

Fig. 15.

* Since writing this, a brief account of the theory has been published in the second edition of Morley's "Strength of Materials" (Longman's).

Let G (Fig. 15) be the centre of gravity of the cross-section, K the point of application of the normal load N , and Gx and Gy any rectangular axes through G . If the point K coincides with G , the stress over the cross-section will everywhere have the intensity $\frac{N}{A}$

where A is the area of the section. If K does not coincide with G , there will be in addition to this stress bending stresses caused by the moment $M = N.KG$, which has the axis GB perpendicular to GK . Consider the effect of this moment acting alone. It would cause the bar to bend about some neutral axis nn inclined at an angle α to the x -axis. Let η be the perpendicular distance of any element δa of the cross-section from nn and let (x, y) be its co-ordinates. By the ordinary laws of bending

$$\frac{f}{E\eta} = \frac{1}{R} \dots\dots\dots 1$$

where E is Young's Modulus, R the radius of curvature of the cross-section, and f the intensity of stress over δa . For equilibrium the sum of the moments of the stresses about Gx and Gy must be equal to the components of the bending moments about these axes,

Therefore $M \sin \lambda = \Sigma f y \delta a \dots\dots\dots 2$
 $M \cos \lambda = \Sigma f x \delta a \dots\dots\dots 3$

But $f = \frac{E\eta}{R} = (y \cos \alpha - x \sin \alpha)$

Therefore $\frac{R}{E} M \sin \lambda = \Sigma y^2 \delta a \cos \alpha - \Sigma x y \delta a \sin \alpha$
 $= I_x \cos \alpha - J \sin \alpha \dots\dots\dots 4$

and $\frac{R}{E} M \cos \lambda = \Sigma x y \delta a \cos \alpha - \Sigma x^2 \delta a \sin \alpha$
 $= J \cos \alpha - I_y \sin \alpha \dots\dots\dots 5$

Where I_x and I_y are the moments of inertia of the section about Gy and Gx respectively, and J is the product of inertia about (Gx, Gy) Divide 4 by 5 and obtain

$$\tan \lambda = \frac{I_x \cos \alpha - J \sin \alpha}{J \cos \alpha - I_y \sin \alpha}$$

and on rearranging the terms

$$\tan \alpha = \frac{I_x - J \tan \lambda}{J - I_y \tan \lambda}$$

which gives the angle of inclination of the neutral axis to Gx . (The effect of the direct stress $\frac{N}{A}$ will be to shift this axis parallel to itself to a position determined later).

From (1)
$$f = \frac{E\eta}{R}$$

$$= \frac{M \sin \lambda (y \cos \alpha - x \sin \alpha)}{I_x \cos \alpha - J \sin \alpha}$$

$$= \frac{N y_k (y - x \tan \alpha)}{I_x - J \tan \alpha} \dots \dots \dots 7$$

and similarly from 1 and 5

$$f = \frac{N x_k (y - x \tan \alpha)}{J - I_y \tan \alpha} \dots \dots \dots 8$$

Thus the actual stress at any point (xy) will be

$$f = \frac{N}{A} + \frac{N x_k (y - x \tan \alpha)}{J - I_y \tan \alpha} \dots \dots \dots 9$$

the positive sign being taken because η was taken positive on the side of nn on which the point K lies. Putting $f=0$ in equation 9, the equation of the neutral axis may be obtained. Various graphical and semi-graphical methods have been devised by Mohr and others, but they do not appear to the writer to have any advantages over the above.

Note on the Calculation of J.

Let J be the product of inertia about any rectangular axes, and J_G that about parallel axes through the centre of gravity of the section. Then, if (x, y) are the co-ordinates of any point of the cross-section referred to the former axes, (x', y') those referred to the parallel axes through the centre of gravity, and (\bar{x}, \bar{y}) the co-ordinates of the centre of gravity referred to the first axes

$$J = \sum xy \delta a \quad \text{over the section}$$
or
$$J = \sum (x' + \bar{x})(y' + \bar{y}) \delta a$$

$$= \sum x' y' \delta a + \sum x' y \delta a + \sum x y' \delta a + \sum y x' \delta a$$

$$= J_G + A \bar{x} \bar{y}$$
because $\sum y' \delta a = A \bar{y}' = 0$
and $\sum x' \delta a = A \bar{x}' = 0$

T
fo
cr

L
appli

A

If
bendi

but si
be us

No
point
Th
y be
end o

In
practi

Thus

APPENDIX II.

The lateral deflection of a uniform bar under an eccentric tensile force parallel to the axis, but not in an axis of symmetry of the cross-section.

Let OA (figure 16) represent the axis of the bar and let N be the applied force of eccentricity d.

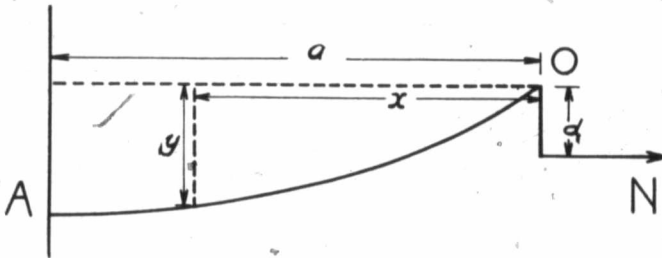

Fig. 16.

If the load were applied in an axis of symmetry the equation for bending would be

$$E I \frac{d^2 y}{dx^2} = N (y - d)$$

but since this is not the case, equations 4 and 5 of Appendix I must be used. Squaring and adding, these give—

$$\frac{d^2 y}{dx^2} = \frac{1}{R} = \frac{M}{E} \frac{1}{\sqrt{[(I_x \cos a - J \sin a)^2 + (J \cos a - I_y \sin a)^2]}}$$

Now, at any section $M = N$ multiplied by the distance of the load point from the centre of gravity.

The bending will be perpendicular to the neutral axis, and thus if y be the distance of the centre of gravity from its position at the end o, the eccentricity of any section

$$= \sqrt{[d^2 + y^2 - 2 dy \cos\{90^\circ - (\lambda + a)\}]}$$

In many cases, including the angle section, the last term is practically equal to 2dy, and the eccentricity then becomes.

$$(d - y)$$

Thus the differential equation of the axis is

$$\frac{d^2 y}{dx^2} = k^2 (y - d) \dots\dots\dots 10$$

where

$$k^2 = \frac{N}{E} \frac{1}{\sqrt{(I_x \cos \alpha - J \sin \alpha)^2 + (J \cos \alpha - I_y \sin \alpha)^2}}$$

or for the equal legged angle, since $I_x = I_y = I$

$$k^2 = \frac{N}{E} \sqrt{1^2 + J^2 - 4 J I \sin \alpha \cos \alpha} \tag{10}$$

$$y = d + A e^{kx} + B e^{-kx}$$

where A and B are constants.

Now, when $x=0, y=0$ and when $x=a, \frac{dy}{dx} = 0$

Therefore $-d = A + B$

and $0 = A e^{ka} - B e^{-ka}$

and (12) becomes

$$y = d \left[1 - \frac{e^{-ka}}{e^{ka} + e^{-ka}} e^{kx} - \frac{e^{ka}}{e^{ka} + e^{-ka}} e^{-kx} \right]$$

and the central deflection is given by

$$y = d \left[1 - \frac{2}{e^{ka} + e^{-ka}} \right] \tag{13}$$

This result will now be applied to the 3" x 3" x 1/4" angle loaded at the ends at the mid-point of one of its sides as in the case considered above, (page 5). In order that the results may apply to the experiments, α has been taken 28.25", which is the half length of the experimental angles, and $N=20,000$ lbs.

The value of d is $\sqrt{(0.84)^2 + (0.66)^2} = 1.07$ "

$$k^2 = \frac{N}{E} \sqrt{I^2 + J^2 - 4 J I \sin \alpha \cos \alpha}$$

$$k = \sqrt{\frac{20,000}{28.5 \times 10^6 \times 1.8}} = 0.02$$

The deflection at the middle is, therefore, from equation 13

$$y = 1.07 \left[1 - \frac{2}{e^{0.666} + e^{-0.666}} \right] = 0.15$$

In the experiments, deflections were measured parallel to the legs of the angle. The components of the above in these directions are

$$0.15 \cos \alpha = 0.15 \times 0.942 = 0.14$$

$$0.15 \sin \alpha = 0.15 \times 0.336 = 0.05$$

which agree very closely with the experimental values. (See page (17)).

20,000
9,650
4,080
3,500
8,930
14,980
23,200
23,950
25,000
25,900
26,500

TABLE 1.—Stresses corresponding to the mean extensometer readings for 3" x 3" x 1/4" angle with 1/2" end-plate.

LOAD N LBS.	Area of cross-section 1.52 in ²										
	1	2	3	4	5	6	7	8	9	10	
CENTRAL SECTION	5,000	- 2,360	- 780	710	2,290	3,570	5,710	6,000	6,360	6,790	7,150
	10,000	- 4,000	- 1,140	1,720	4,650	7,290	11,100	11,790	12,430	13,150	13,880
	15,000	- 5,360	- 1,140	2,790	7,000	11,000	16,400	17,500	18,200	19,300	20,450
	20,000	- 6,360	- 1,070	4,140	9,360	14,370	21,400	23,200	23,880	25,400	26,950
	5,000	- 2,860	- 1,220	640	2,070	3,640	6,080	6,290	6,650	6,800	7,080
SECTION 3" FROM END-PLATE	10,000	- 5,290	- 2,430	1,500	4,290	7,360	11,900	12,300	12,950	13,300	13,880
	15,000	- 7,650	- 3,290	2,500	6,650	10,930	17,600	18,380	18,730	19,720	20,400
	20,000	- 9,660	- 4,080	3,500	8,930	14,980	23,200	23,950	25,000	25,900	26,500

Distance from e. g. to back of angle 0.85"
 $I = 1.31 \text{ (in)}^4$ units. $J = -.77 \text{ (in)}^4$ units.
 $E = 28.6 \times 10^6 \text{ lbs per in}^2$
 Stresses in lbs per in² Tension +
 Compression -

11
 13
 loaded at
 considered
 the experi-
 h of the
 13
 to the legs
 ons are
 (See

TABLE II.—Stresses corresponding to the mean extensometer readings for 3" x 3" x 1" angle with 1" end-plate.

Area of cross-section 1.44 in²
 Distance from e.g. to back of angle 0.85"
 $I = 1.24 \text{ (in)}^4 \text{ units. } J = .74 \text{ (in)}^4 \text{ units.}$
 $E = 28,6 \times 10^6 \text{ lbs. per in.}^2$

SECTION FROM END-PLATE	LOAD N (lbs.)	STRESSES IN LBS. PER IN ² —TENSION + COMPRESSION—									
		1	2	3	4	5	6	7	8	9	10
CENTRAL SECTION	5,000	2,430	720	640	-2,290	3,500	5,790	6,080	6,430	6,790	7,510
	10,000	4,360	-1,280	1,500	5,220	7,150	11,400	12,090	12,430	13,300	13,940
	15,000	6,000	-1,280	2,500	7,430	10,670	16,680	17,800	17,630	19,600	20,600
	20,000	7,000	930	3,790	10,000	14,000	21,700	23,300	23,450	25,690	27,100
SECTION FROM END-PLATE	5,000	3,280	-1,360	640	2,430	4,000	6,210	6,430	6,790	7,150	7,440
	10,000	5,930	-2,500	1,430	4,860	7,720	12,160	12,500	13,150	13,720	14,380
	15,000	8,290	-3,360	2,430	7,440	11,430	17,930	18,500	19,300	20,350	21,300
	20,000	10,300	-4,000	3,430	9,930	15,000	23,500	24,400	25,420	26,900	27,900

TABLE III.—Stresses corresponding to the mean extensometer readings for 2-3" x 3" x 4" angles with 45° end-plate.

Constants for each angle are the same as in table No. II.

SECTION	LOAD N (LBS.)	STRESSES IN LBS. PER $\frac{1}{4}$ "																			
		1		2		3		4		5		6		7		8		9		10	
		Right	Left	Right	Left	Right	Left	Right	Left	Right	Left	Right	Left	Right	Left	Right	Left	Right	Left	Right	Left
CENTRAL	10,000	930	1,070	1,360	1,720	2,070	3,360	4,080	5,070	6,000	7,000										
	15,000	1,280	1,720	2,150	2,640	3,230	5,150	6,150	7,580	8,860	10,380										
	20,000	1,790	2,290	2,860	3,570	4,360	7,000	8,290	10,000	11,800	13,920										
	25,000	2,220	2,930	3,860	4,570	5,650	8,790	10,380	12,500	14,650	17,420										
	30,000	2,780	3,720	4,580	5,430	6,710	10,430	12,430	14,930	17,500	20,740										
	10,000	1,290	1,430	1,570	2,000	2,220	3,290	4,080	5,140	5,710	6,710										
	15,000	1,860	2,220	2,720	2,930	3,430	5,210	6,150	7,500	8,500	9,650										
	20,000	2,360	3,000	3,500	4,130	4,650	6,860	8,210	9,900	11,430	12,880										
	25,000	3,070	3,790	4,360	5,070	5,710	8,510	10,380	12,360	14,000	16,320										
	30,000	3,720	4,710	5,290	6,290	7,080	10,200	12,430	14,910	16,800	18,920										
Cx 31 $\frac{1}{2}$ " from end	Right	20,000	2,220	2,790	3,220	4,000	4,500	6,860	8,150	9,500	10,720	12,220									
	Left	20,000	3,140	3,140	3,720	4,140	4,290	6,430	7,720	8,720	10,140	11,300									
B 7 $\frac{1}{2}$ " from end	Right	20,000	3,220	3,500	3,930	4,430	4,710	6,720	8,090	9,440	10,720	12,160									
	Left	20,000	3,140	3,140	3,720	4,140	4,290	6,430	7,720	8,720	10,140	11,300									
Right	20,000	3,720	3,290	4,140	4,430	4,860	6,570	7,870	9,290	10,300	11,330										
	20,000	3,720	3,290	4,140	4,430	4,860	6,570	7,870	9,290	10,300	11,330										

x For this section, a 2" extensometer was used.

TABLE IV: Mean lateral deflection of the specimens.

SPECIMEN	SECTION	N LOAD (LBS.)	MEAN DEFLECTION OF A B			
			With respect to middle of rivets		With respect to end of angle	
			X	Y	X	Y
ALL MEASURED IN INCHES						
Single Angle with $\frac{3}{4}$ " end-plate	Central	5,000	0.03	0.01	0.04	0.01
		10,000	0.06	0.02	0.08	0.02
		15,000	0.08	0.03	0.11	0.03
		20,000	0.10	0.04	0.14	0.04
	3" from end-plate	5,000	0.02	0.01	0.03	0.01
		10,000	0.04	0.01	0.05	0.01
		15,000	0.05	0.01	0.08	0.02
		20,000	0.07	0.02	0.11	0.02
Single Angle with $\frac{1}{2}$ " end-plate	Central	5,000	0.03	0.02	0.05	0.02
		10,000	0.06	0.03	0.08	0.03
		15,000	0.08	0.04	0.13	0.04
		20,000	0.10	0.05	0.15	0.06
	3" from end-plate	5,000	0.02	0.00	0.04	0.00
		10,000	0.03	0.01	0.07	0.01
		15,000	0.05	0.01	0.09	0.02
		20,000	0.08	0.03	0.12	0.03 ^b
Double Angle	Central Left	10,000	0.00	0.01	0.00	0.02
		20,000	0.01	0.02	0.01	0.03
		30,000	0.02	0.04	0.02	0.04
	Central Right	10,000	0.00	0.01	0.00	0.02
		20,000	0.01	0.02	0.01	0.03
		30,000	0.02	0.04	0.02	0.04

N.B.—All the deflections in the direction x are negative. The values given are the mean of readings taken at A and B.

TABLE

SPECIM

Single Angle with $\frac{3}{4}$ "
end-plate

Single Angle with $\frac{1}{2}$ "
end-plate

Double Angle

TABLE V.—Reduction of experimental results to find load axis.

SPECIMEN	SECTION	LOAD (LBS)	Position of Neutral Line		Inclination of Neutral Line	Point of Zero Stress		Estimated loading axis referred to axes thro' e g of section		Estimated loading axis referred to axes thro' e g of mid rivet section		
			a	b	$\tan a$	x	y	x_k	y_k	x_k	y_k	
			INCHES		ALL MEASURED IN INCHES							
Single Angle with 3° end-plate	Central	5,000	6.80	1.75	3.88	0.90	0.85	0.90	0.65	0.93	0.66	
		10,000	7.40	1.80	4.11	0.95	0.85	0.86	0.63	0.91	0.65	
		15,000	7.50	1.85	4.06	1.00	0.85	0.82	0.60	0.90	0.63	
		20,000	7.50	1.88	3.99	1.03	0.85	0.80	0.59	0.89	0.63	
		Mean values			4.01	$a=76^\circ$			0.84	0.62	0.91	0.64
	3" from end-plate	5,000	9.07	1.66	5.46	0.81	0.85	0.99	0.69	1.01	0.70	
		10,000	11.86	1.70	6.98	0.85	0.85	0.96	0.65	1.00	0.66	
		15,000	12.07	1.70	7.09	0.85	0.85	0.96	0.65	1.01	0.66	
		20,000	12.45	1.73	7.20	0.88	0.85	0.94	0.66	1.01	0.68	
		Mean values			6.68	$a=81^\circ 30'$			0.96	0.66	1.01	0.67
Single Angle with 4° end-plate	Central	5,000	6.00	1.70	3.53	0.86	0.84	0.84	0.64	0.87	0.66	
		10,000	8.55	1.74	4.91	0.90	0.84	0.90	0.64	0.96	0.67	
		15,000	8.10	1.80	4.50	0.96	0.84	0.85	0.62	0.93	0.66	
		20,000	7.87	1.89	4.15	1.05	0.84	0.79	0.66	0.89	0.71	
		Mean values			4.27	$a=76^\circ 50'$			0.84	0.64	0.91	0.67
	3" from end-plate	5,000	9.67	1.60	6.04	0.76	0.84	1.05	0.73	1.07	0.73	
		10,000	9.00	1.63	5.52	0.79	0.84	1.01	0.71	1.04	0.72	
		15,000	9.67	1.67	5.79	0.83	0.84	0.97	0.68	1.02	0.70	
		20,000	9.67	1.71	5.65	0.87	0.84	0.95	0.66	1.03	0.69	
		Mean values			5.75	$a=80^\circ 10'$			0.99	0.69	1.04	0.71
Double Angle	Central Right	10,000	1.48	4.77	0.31	3.93	0.84					
		15,000	1.77	4.77	0.37	3.93	0.84					
		20,000	1.77	4.77	0.37	3.93	0.84					
		25,000	1.77	4.77	0.37	3.93	0.84					
		30,000	1.77	4.77	0.37	3.93	0.84					
		Mean values			0.37	$a=20^\circ 18'$			0.36	0.46		
	Central Left	10,000	1.47	3.97	0.37	3.13	0.84					
		15,000	1.42	3.87	0.37	3.03	0.84					
		20,000	1.41	3.87	0.37	3.03	0.84					
		25,000	1.24	3.87	0.32	3.03	0.84					
		30,000	1.15	3.87	0.30	3.03	0.84					
		Mean values			0.34	$a=18^\circ 48'$			0.43	0.55		
	7/8" from end-plate	Right	20,000	2.35	7.13	0.35	6.29	0.84	0.24	0.31		
		Left	20,000	2.46	4.95	0.49	4.11	0.84	0.33	0.39		
3/8" from end-plate	Right	20,000	2.70	8.95	0.30	8.11	0.84	0.24	0.31			
	Left	20,000	2.62	8.65	0.30	7.81	0.84	0.24	0.32			

TABLE VI.—Maximum Stresses. Single Angles.

SPECIMEN	SECTION	LOAD (LBS)	Max. Stress over section from extenso- meter readings	RATIO		
				Max. Mean	Max. Stress from calcu- lated load axis Max. Mean	
Single Angle with $\frac{3}{4}$ " end-plate	Central	5,000	7,500	2.28	7,350	2.23
		10,000	14,420	2.20	14,500	2.20
		15,000	21,400	2.17	21,200	2.15
		20,000	28,000	2.13	28,000	2.13
	3" from end-plate	5,000	7,500	2.28	7,500	2.28
		10,000	14,300	2.18	14,400	2.20
		15,000	21,100	2.14	21,600	2.19
		20,000	27,600	2.10	29,400	2.23
Single Angle with $\frac{1}{2}$ " end-plate	Central	5,000	7,850	2.26	7,710	2.22
		10,000	14,500	2.09	15,200	2.19
		15,000	21,500	2.07	22,350	2.15
		20,000	28,300	2.04	29,000	2.09
	3" from end-plate	5,000	7,730	2.23	8,100	2.33
		10,000	15,000	2.16	15,900	2.29
		15,000	22,150	2.13	23,200	2.23
		20,000	29,000	2.09	30,600	2.21

N.B.—All stresses are measured in lbs per \square ".
 $E = 28.6 \times 10^6$ lbs. per \square ".

TABLE VII.—Maximum stresses. Double Angle.
 $E = 28.6 \times 10^6$ lbs. per \square ".

SECTION	LOAD (LBS)	Maximum stress from extensometer readings*		RATIO Max. Mean	
		Left	Right	Left	Right
Central	10,000	7,930	6,720	2.28	1.94
	15,000	11,650	9,600	2.24	1.84
	20,000	15,300	12,880	2.21	1.85
	25,000	18,930	15,900	2.18	1.83
	30,000	22,450	18,930	2.15	1.82
$7\frac{1}{8}$ " from end-plate	20,000	13,580	13,500	1.95	1.94
$3\frac{3}{8}$ " from end-plate	20,000	12,500	12,600	1.80	1.81

TABLE VIII.—Maximum Stresses for different positions of Load Axis.

(a) ANGLE WITH ϕ° END-PLATE

LOAD (LBS)	Maximum Stress calculated from mean experimental load axis allowing for bending (-81, .60)	MAXIMUM STRESSES (THEORETICAL) NEGLECTING BENDING					
		Load axis having co-ordinates (-1.00, .65)	Load axis at outside face of plate (-1.60, .65)	Load axis at middle of plate (-1.23, .65)	Load axis at junction of plate & angle (-0.85, .65)	Load axis at middle of angle (-0.72, .65)	Load axis at inner face of angle (-0.58, .65)
-5,000	7,100	7,100	5,610	6,540	7,480	7,800	8,140
10,000	14,200	14,200	11,220	13,080	14,970	15,600	16,280
15,000	21,600	21,600	16,830	19,630	22,450	23,400	24,430
20,000	28,400	28,400	22,440	26,180	29,940	31,200	32,580
Max-Mean ^a	2.16	2.16	1.70	1.99	2.28	2.37	2.48
^a	74° 55'	84° 36'	76° 12'	84° 54'	72° 25'	56° 24'	32° 36'

(b) ANGLE WITH ϕ° END-PLATE

LOAD (LBS)	Maximum Stress calculated from mean experimental load axis allowing for bending (-81, .62)	MAXIMUM STRESSES (THEORETICAL) NEGLECTING BENDING					
		Load axis having co-ordinates (-1.00, .66)	Load axis at outside face of plate (-1.09, .66)	Load axis at middle of plate (-.96, .66)	Load axis at junction of plate & angle (-0.84, .66)	Load axis at middle of angle (-0.72, .66)	Load axis at inner face of angle (-0.59, .66)
5,000	7,490	7,490	7,250	7,600	7,950	8,300	8,650
10,000	14,980	14,980	14,500	15,200	15,900	16,600	17,300
15,000	22,470	22,470	21,750	22,800	23,850	24,900	25,950
20,000	29,960	29,960	29,000	30,400	31,800	33,200	34,600
Max-Mean ^a	2.16	2.16	2.09	2.19	2.29	2.39	2.49
^a	75° 10'	72° 42'	89° 16'	81° 18'	70° 24'	54° 48'	32° 21'

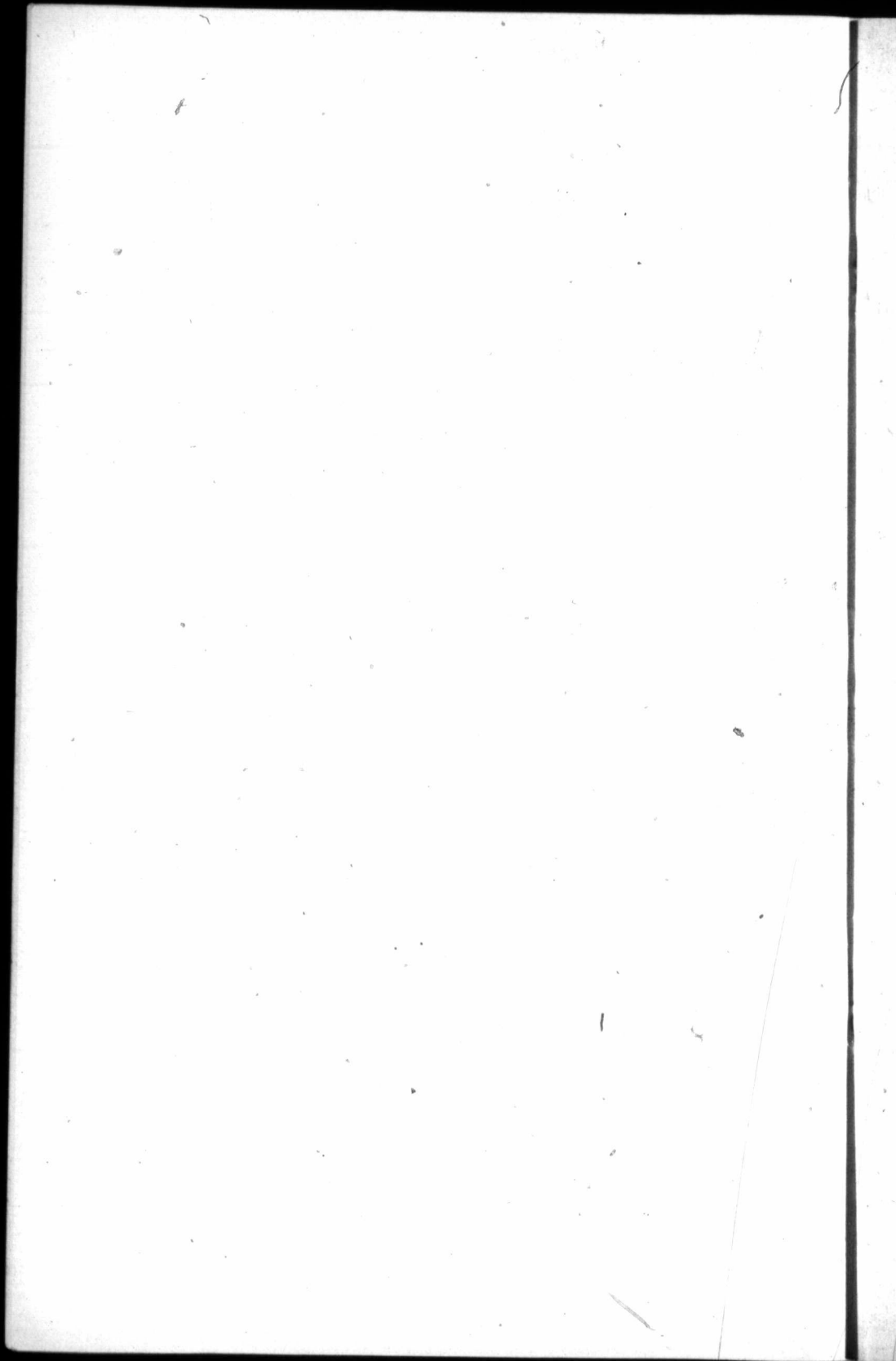

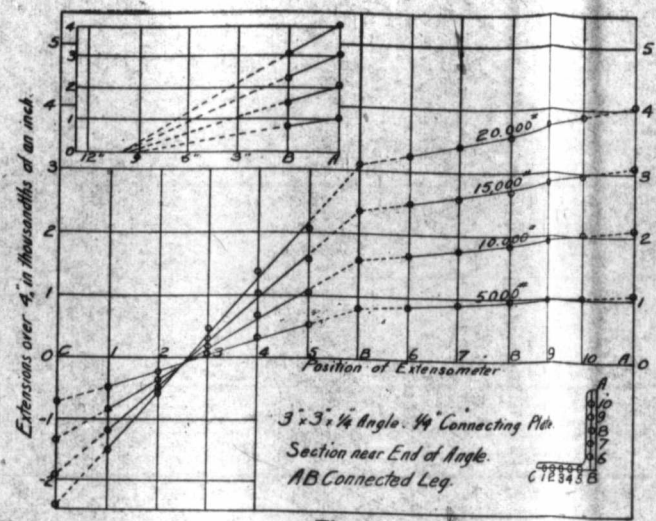

Fig. 8.

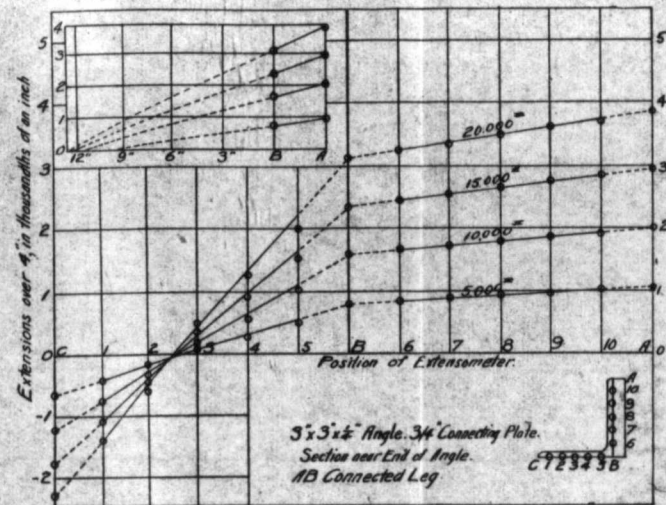

Fig. 10.

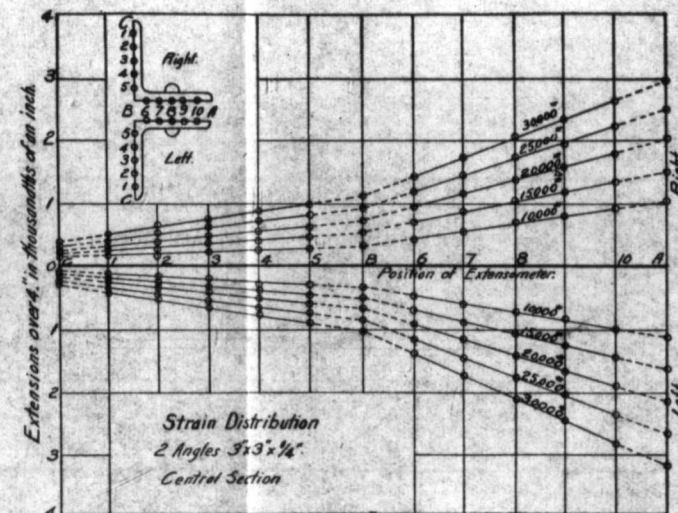

Fig. 12.

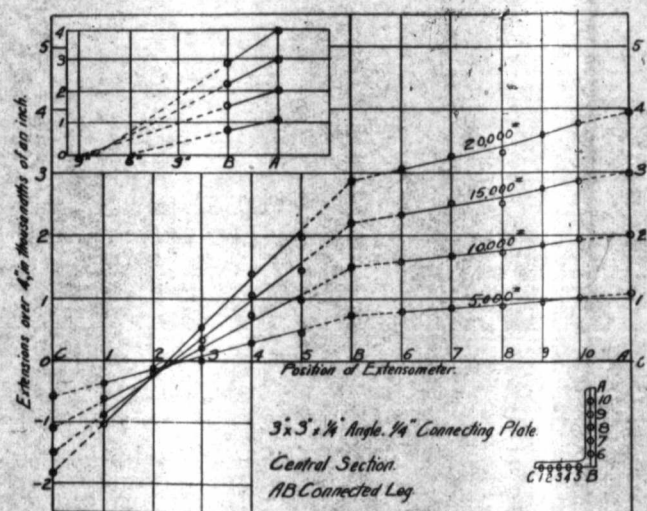

Fig. 9.

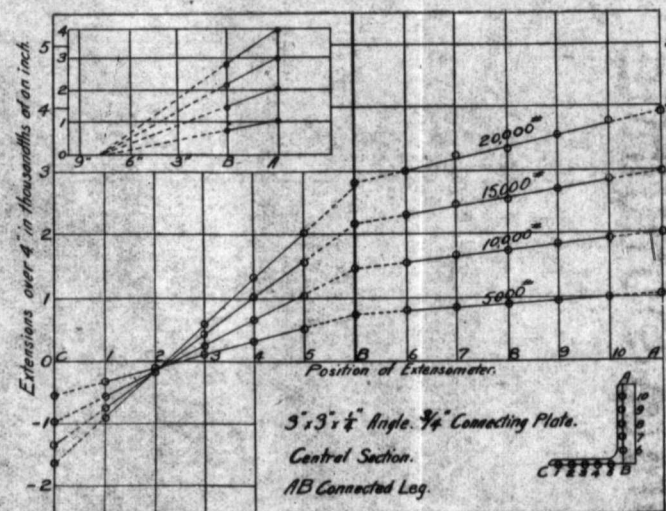

Fig. 11.

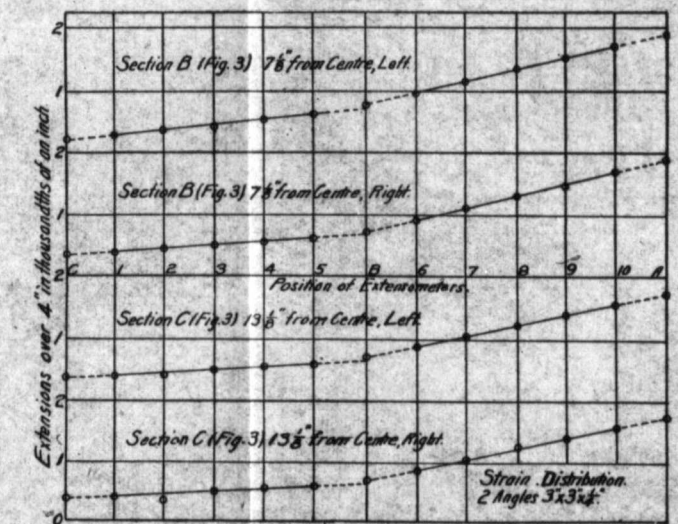

Fig. 13.