

Technical and Bibliographic Notes / Notes techniques et bibliographiques

The Institute has attempted to obtain the best original copy available for scanning. Features of this copy which may be bibliographically unique, which may alter any of the images in the reproduction, or which may significantly change the usual method of scanning are checked below.

L'Institut a numérisé le meilleur exemplaire qu'il lui a été possible de se procurer. Les détails de cet exemplaire qui sont peut-être uniques du point de vue bibliographique, qui peuvent modifier une image reproduite, ou qui peuvent exiger une modification dans la méthode normale de numérisation sont indiqués ci-dessous.

- Coloured covers /
Couverture de couleur
- Covers damaged /
Couverture endommagée
- Covers restored and/or laminated /
Couverture restaurée et/ou pelliculée
- Cover title missing /
Le titre de couverture manque
- Coloured maps /
Cartes géographiques en couleur
- Coloured ink (i.e. other than blue or black) /
Encre de couleur (i.e. autre que bleue ou noire)
- Coloured plates and/or illustrations /
Planches et/ou illustrations en couleur
- Bound with other material /
Relié avec d'autres documents
- Only edition available /
Seule édition disponible
- Tight binding may cause shadows or distortion
along interior margin / La reliure serrée peut
causer de l'ombre ou de la distorsion le long de la
marge intérieure.
- Additional comments /
Commentaires supplémentaires:

Continuous pagination.

- Coloured pages / Pages de couleur
- Pages damaged / Pages endommagées
- Pages restored and/or laminated /
Pages restaurées et/ou pelliculées
- Pages discoloured, stained or foxed/
Pages décolorées, tachetées ou piquées
- Pages detached / Pages détachées
- Showthrough / Transparence
- Quality of print varies /
Qualité inégale de l'impression
- Includes supplementary materials /
Comprend du matériel supplémentaire
- Blank leaves added during restorations may
appear within the text. Whenever possible, these
have been omitted from scanning / Il se peut que
certaines pages blanches ajoutées lors d'une
restauration apparaissent dans le texte, mais,
lorsque cela était possible, ces pages n'ont pas
été numérisées.

The Canadian Patent Office

RECORD

Vol. IX.—No. 9.

SEPTEMBER, 1881

{ Price in Canada \$2.00 per An.
United States - \$2.50 "

CONTENTS.

INVENTIONS PATENTED.....	187
INDEX OF INVENTIONS.....	CCIX
INDEX OF PATENTEES.....	CCX
ILLUSTRATIONS.....	215

INVENTIONS PATENTED.

No. 13,078. Improvements on Egg Beaters.

(*Perfectionnements aux verges de cuisine.*)

Alexander Luttrell, Kincardine, Ont., 9th July 1881; for 5 years.

Claim.—1st. The combination of the handle A of beater B with the motive power at K. 2nd. The attaching of handle A of beater B to the upright L.

No. 13,079. Improvements on Traction Engines. (*Perfectionnements aux machines de traction.*)

Walter S. Fletcher, St. Catharines, Ont., 9th July, 1881; for 5 years.

Claim.—1st. The improved intermediate equalizing gearing consisting of cog wheels I, bevelled cog wheels 1 and 2, intermediate disk 3, carrying bevelled pinions or friction wheels 4 and having a bevelled cog-faced periphery C, meshing with driving pinion G on diagonal shaft F, in combination with intermediate shaft H having cog wheel I, said wheels I J, meshing with cog wheels K L and traction wheels N, journalled on axle M. 2nd. The intermediate shaft H mounted in adjustable bearings, on brackets having slotted faces, and diagonal shaft F having a universal joint connection with a bracket carrying cog-wheel E, whereby the shaft H with the differential gear can be moved from disengagement with the traction wheels N.

No. 13,080. Improvements on Railway Wheels. (*Perfectionnements aux roues des railroutes.*)

The Atwood Railway Wheel Company, New York. (Assignee of Anson Atwood, Brooklyn.) N. Y., U. S., 9th July, 1881; (Extension of Patent No. 6,263.)

No. 13,081. Horse Power Link. (*Chaînon de manège.*)

Barnard L. Olds, St. Albans, Vt., U. S., 9th July 1881; (Extension of Patent No. 6,288.)

No. 13,082. Improvements on Eave Trough Formers. (*Perfectionnements aux moules à gouttières.*)

James Dunn, Port Hope, Ont., 9th July, 1881; (Extension of Patent No. 12,622.)

No. 13,083. Improvements on Eave Trough Formers. (*Perfectionnements aux moules à gouttières.*)

James Dunn, Port Hope, Ont., 11th July, 1881; (Extension of Patent No. 12,622.)

No. 13,084. Barn Door Hanger. (*Pature de porte d'étable.*)

Samuel H. Moore and Edward Y. Moore, Chicago, Ill., U. S., 11th July 1881; (Extension of Patent No. 6,295.)

No. 13,085. Improvements in Lubricators. (*Perfectionnements dans les graisseurs.*)

Luther B. Bailey, London, Ont., 11 July, 1881; for 5 years.
Claim.—The combination of the valve chamber V and gauge glass G with reservoir R.

No. 13,086. Improvements on Machines for Perforating Paper for Telegraphic Purposes. (*Perfectionnements aux machines à percer le papier pour l'usage télégraphique.*)

Frank Anderson, Peekskill, and Theodore M. Foote, Brooklyn, N. Y., U. S., 12th July, 1881; for 5 years.

Claim.—In a telegraphic perforator, a movable punch head actuated by suitable mechanism, to operate in conjunction with a series of punches to perforate the paper. 2nd. The combination of the key, levers and supplementary levers, for operating the punch selecting bars. 3rd. In combination with the key levers, a series of punch selecting bars and mechanism for alternating the same, to select the punches in the punch head or carrier. 4th. The combination of a reciprocating punch head carrying a series of movable punches, and a die with a series of separately and independently adjustable punch selectors, adapted to be brought into the paths of the said punches and hold them while the die is forced against them, and mechanism for operating said punch head, and punch selectors respectively. 5th. The combination of the key levers, the supplementary levers actuated by said key levers, devices for giving said supplementary levers a lateral motion, the notched punch selecting bars and the reciprocating punch head, carrying the series of movable punches and die. 6th. In combination with the key levers and the punch head, mechanisms for operating the punch head or carrier at each depression of a key. 7th. In combination with the series of separately movable key levers, punch selectors and punch head carrying a series of punches mechanism for operating the punch head and punch selectors at each depression of a key. 8th. In combination with the key levers of a perforating apparatus, a movable punch head, a rotating shaft and loosely fitting sleeve, and mechanism for connecting the sleeve to the shaft at the depression of the key lever to operate the punch head. 9th. In combination with a series of key levers, a series of punch selectors operated by said levers and a reciprocating punch head carrying a series of movable punches, a rotating shaft carrying a loosely mounted sleeve adapted to operate the punch head through intermediate connections, and mechanism for locking the sleeve to the shaft simultaneously with the depression of each key lever. 10th. In combination with the key levers and mechanism for actuating the feed, the auxiliary bars for regulating the motion of the paper feed to correspond with the length of the perforations forming each character. 11th. In combination with the key levers, punch selecting bars, and punches of the paper feeding devices and the auxiliary bars Y adapted for operation by the key levers to regulate the feed, to correspond with the punch selected bars operated at the same time. 12th. In combination with the key levers and the supplementary levers, mechanism for operating punch head, and a drum for moving the paper and its operating mechanism, so arranged in relation to each other that the punches will be operated in advance of the paper feed devices. 13th. In combination with the paper drum and its rotating devices, the arm V connected to said rotating devices, the rotary shaft A and devices communicating positive motion in one direction therefrom to said arm, a spring for retracting said arms, and the bars Y having shoulders or stops z at different distances from their free ends, and the key levers for operating said bars. 14th. In combination with the rotating shaft and loosely fitting sleeve carrying the cams, for operating the punch and feed devices, the ratchet on said shaft, and pawl on the sleeve, and the angle lever and mechanism for tripping the same. 15th. The combination with the key levers and the several punch selecting bars, of intermediate mechanism through which said bars are operated by the key levers in alternating or non-alternating order, according to the character of the respective levers. 16th. The combination, with the angle lever a for tripping the pawl c on the sleeve, of the rotating shaft stop lever e for retaining said angle lever in its normal position, and the latch bar G actuated by each of the keys and engaging with the lever pawl e, and operating to trip the latter. 17th. In combination with the key levers and supplementary levers, the oscillating frame R, rod r, arm q, and pawl and ratchet, by means of which the cam Q is rotated to impart a reciprocating motion to the rack bar, and alternate the lifting of the punch selecting bars. 18th. In combination with the paper drum and its ratchet wheel, the arm b and its pawl connected to the levers V, and the auxiliary bars adapted to abut against said arm when elevated, and serve to limit its movement and the movement of the feed devices. 19th. In combination with the punch head and punches, the bar v extending through the slots or recesses in the punches, and adapted to withdraw the punches

after piercing the paper. 20th. In combination with the key levers and supplementary levers, the transverse piece arranged successively nearer the ends of the levers as they recede from the fulcrum of the punch selecting bars, for the purpose of elevating them equally. 21st. The combination of a series of movable punches arranged in two rows, a series of key levers, some of which are adapted to operate bars for selecting punches to form an even number of characters, and others to operate bars for selecting punches to form an uneven number of characters, and mechanism for causing the bar selecting punches, to form uneven numbers of characters to alternately assume reversed positions with respect to the rows of punches as said bars are successively operated, thereby causing alternately reversed positions of the perforations composing uneven groups of characters in the paper. 22nd. In combination with the key levers, the oscillating frames adapted to be operated by the same, to actuate the punch selecting bars without alternating said bars, or to alternate the same as desired. 23rd. A fillet of paper so perforated that the component parts of the integral perforations representing the characters will alternate. 24th. A fillet of paper having a series of perforations between the integral perforations representing the characters, in the space usually left blank between said perforations. 25th. A telegraphic perforated transmitting fillet in which the perforations are in two rows, and the integral perforations representing the characters alternately in opposite rows having between each two characters, and an extra perforation or series of extra perforations serving to define and separate the letters. 26th. The combination with the punches, of alternating punch mover, and suitable mechanism for operating the same. 27th. The combination, with the punching and paper fillet feeding devices of a telegraphic perforator, of mechanism for varying the extent of unperforated space, between the perforations. 28th. The combination of the key levers, paper feed regulating cylinder, and suitable mechanism for operating and stopping the same. 29th. The combination, with the punches of a telegraphic perforating machine organized to perforate a fillet in two rows, of feeding mechanism for varying and regulating the spaces between perforations representing letters in connection with said spaces, and devices for controlling the operation of the punches, so as to reverse the successive perforation as regards their respective rows. 30th. The combination with the key levers and the shaft carrying the paper feed roller, of the stop bars O the friction cylinder mounted on said shaft and having the projections for operating said bars, the stop bars limiting the movement of said bars and of the cylinder, and motive devices connected with said cylinder and controlled by the key levers. 31st. The combination, with the key levers, of the top bars O, the cylinder having projections for operating said bars, the stops for limiting the movement of the same, and the cylinder and mechanism connecting said cylinder with the paper feeding devices. 32nd. The combination, with the continuously rotary shaft A, loose pulleys C, and clutch for engaging said pulley with said shaft, of the rotary shaft F, friction drum G having projections ρ , in intermediate connections between said pulley and drum, the stop bars O and the key levers for operating the same. 33rd. The combination of the key levers, the main rotary shaft A carrying the ratchet B, the loose pulley C on said shaft carrying the clutch b, the intermediate mechanism between the key levers and the said clutch, the paper feed mechanism and devices connecting the same with the loose pulley, and the punching devices also connected with and operated by said pulley. 34th. The continuously revolving shaft, and ratchet and the loose pulley and clutch, in combination with the revolving paper feed regulating cylinder and connecting belt or suitable gearing. 35th. In combination with the key levers and feed cylinder, the stop bars arranged to have not only a vertical movement, but also a lateral movement. 36th. In combination with the paper feed rollers, the winding reel and paper delivery reel, the yielding roller and automatic friction brake for preventing the rupture of the paper and undue delivery of the same, as it is drawn from said reel. 37th. The combination, with the paper feed rollers, the winding reel and paper delivery reel, of the friction brake for preventing the rupture of the paper as it is drawn from said delivery reel. 38th. In combination with the feed rollers and the winding reel, the friction brake for preventing rupture of the paper as it is wound upon the reel. 39th. In combination with the winding reel, a rotating movable flanged guide roller having an oscillating motion, to rotate the paper and hold it in place while it is being wound on the reel. 40th. The winding reel provided with a series of pins arranged in circular form for catching the paper, and supporting it while being wound. 41st. In combination with the key levers, a series of stop bars loosely connected therewith, and a series of stop pins or projections suitably arranged on the feed regulating cylinder. 42nd. In combination with the paper feed rollers and intermittently acting punches, the winding reel and paper delivery reel, the yielding roller η and automatic friction brake arm W for preventing the rupture of the paper and undue delivery of the same as it is drawn from said reel, and the yielding roller Z and automatic brake lever Z for regulating the movement of the winding reel.

No. 13,087. Improvements on Valves. (*Perfectionnements aux soupapes*)

The Hancock Inspirator Company, (Assignee of John T. Hancock,) Boston, Mass. U. S., 12th July, 1881; for 5 years.

Claim.—1st. The combination of two or more separate valves united together and arranged in relation to the orifices which they open and close, so that one orifice shall be opened or closed in advanced of the other or others. 2nd. The valves G H connected by a stem E, in combination with the passages B C.

No. 13,088. Improvements on Metal cans. (*Perfectionnements aux boîtes métalliques.*)

Thomas McDonald, (Assignee of Richard Austin,) Toronto, Ont., 12th July, 1881; for 5 years.

Claim.—A cylindrical sheet metal case or can constructed with a lid D having a double flange D1 and notched and deflected in the under side of flange D1, and corresponding with other notched and deflected portions of the flange C, so that by placing the notch in the flange D1 over the notch in the flange C, and turning the lid by hand, it will be thoroughly secured thereby, and by turning the lid in the contrary direction it will be slackened and taken off when so required.

No. 13,089. Improvements on Machines for Pointing and Lapping Loops. (*Perfectionnements aux machines à effiler et plier les cercles.*)

James Naylor, jr., Rochester, N. Y., U. S., 12th July, 1881; for 5 years.

Claim.—1st. In a machine for the combined purpose of pointing thinning points, and lapping barrel hoop blanks, the combination of the wheel C' having an inclined face with the wheel C having a like inclination to form the V, and the straight faced part extending beyond the periphery of the cutting extremities of the knives in the wheel C. 2nd. The wheel C carrying two distinct sets of knives, the wheel C' carrying but one set, in combination with the rests. 3rd. The combination of the wheel C, with the lapping rest E, when placed outside the periphery of the V formed by the wheels C C'. 4th. The combination of the rests F G, for pointing and thinning with the wheels C C', so that operations are done by keeping the blank in the same line. 5th. The thinning rests F, so placed in relation to the straight faced part of the wheel C as to admit the passage of the blank, after the operation between it and the face of the wheel, in combination with the pointing rest G, when the motion of the wheels is from the thinning rest to the pointing rest. 6th. The combination of the wheels with their different diameters and faces, the lapping thinning rest, located outside the V, the pointing rest within the V and the two distinct sets of knives.

No. 13,090. Improvements on the Method of Finishing the Heads of Tacks, Nails and Rivets. (*Perfectionnements dans la méthode de finir les têtes des broquettes, clous et rivets.*)

The Abington Tack and Machine Association, (Assignee of John Hyslop, jr., Abington, Mass., U. S., 12th July, 1881; for 5 years.

Claim.—Forcing the tacks, nails and rivets, point foremost, through a die of the desired shape.

No. 13,091. Improvements in Pipe Moulds. (*Perfectionnements aux moules des tuyaux.*)

Robert J. Wilson, Ridgetown, Ont., (Assignee of Ezra M. Hamilton, Los Angeles, Cal., U. S.,) 12th July, 1881; for 5 years.

Claim.—The cylinder A and sliding clamps C, connected together by a rod F and having oblique slots F F, which receive the studs or screws G G from the cylinder.

No. 13,092. Improvements on Apparatus for Laying Railway Tracks. (*Perfectionnements aux appareils à poser les voies de fer.*)

Theodore Adams, Philadelphia, Pa., 12th July, 1881; for 15 years.

Claim.—1st. A railway car provided with a roller tramway centrally located, or thereabout, upon the platform of the car and extending throughout its entire length, in combination with a chute to transfer rails, ties, etc., from the car to the road bed. 2nd. A chute or supplemental roller tramway mounted near its longitudinal centre upon a truck, and constructed and arranged to be connected to the platform of a railway car. 3rd. In combination with the railway car A, a chute or supplemental roller tramway mounted near its longitudinal centre upon a car N and adjustable thereon, for the purpose of allowing the forward end of such chute to conform to the centre of a curved road bed. 4th. In combination with a railway car A, provided with a roller tramway centrally located, or thereabout, upon its platform, a chute or supplemental roller tramway mounted near its longitudinal centre upon a car N, and adjustable thereon. 5th. A plate ρ attached near the end of the chute G, in combination with a clevis σ on the car A, the parts being constructed and arranged to permit the lateral adjustment of the forward end of the chute. 6th. The combination of the uprights I I of the truss frame, with the end K of the car N, as a means of propelling such car, and of permitting the lateral adjustment of the chute G. 7th. In a railway car, the combination, with a roller tramway, of pieces $c c c$, &c., raised up from the platform of the car to facilitate the loading of the rails upon the tramway.

No. 13,093. Improvements on Car Couplings. (*Perfectionnements aux attelages des chars.*)

Charles H. Shippee, Wickford, R. I., U. S., 12th July, 1881; for 5 years.

Claim.—1st. The combination of a horizontal swinging and sliding bar C, pivoted as desired, with a hook δ pivoted to turn vertically on its end, and having its junction with a bar supported by a hanger b . 2nd. The apertured coupling and draw-bar C, the block e having lugs e and pin e , and the spring f combined with the king bolt a . 3rd. In combination, with the draw-bar C, the jointed coupling hooks h formed with a tapering end and fitted with the inclined lugs h . 4th. In combination with the draw-bar C and jointed hook h having the slide slot k , the hanger b fitted with the turning rod G, and pin r . 5th. The tubular bearing f fitted in the bolster of the truck and the cross timbers of the car, combined with the king bolt a , block e and slotted draw-bar C. 6th. The hook h , hung on the swinging draw-bar C and formed with an inclined shoulder h , that is under cut on its face. 7th. In combination with the swing draw bar C, and its coupling hook h , the slide rod α , and hook or stirrup η fitted for retaining the draw bar in place. 8th. In combination with the slotted buffer d , the block o , plates p , spring q and pin q .

No. 13,094. Improvements on Washing Machines. (*Perfectionnements aux machines à laver.*)

Daniel F. Babb, and Martin J. Wigle, Kingsville, Ont., 12th July, 1881; for 5 years.

Claim.—1st. The application and use of corrugated and indented zinc, or other metal, as a rubbing surface, both for the washboard E and rubber I. 2nd. The combination, with the corrugated and indented zinc or other metal rubbing surface, of the cast iron guards F F.

No. 13,095. Process for the Manufacture of Caps. (*Procédé pour la confection des casquettes.*)

Deville W. Northrup, Utica, N. Y., U. S., 13th July, 1881; for 5 years.

Claim.—1st. As a new article of manufacture, a cap composed of felt, woven or knitted fabric. 2nd. A cap constructed from a section of tubular woven or knitted fabric by pointing one edge thereof, and sewing the points together to form the cap crown by fulling the fabric to the required size and texture, and by blocking, lining, binding and trimming the article after fulling. 3rd. A cap constructed from a section of tubular woven or knitted fabric, by pointing one edge thereof, and sewing the points together to form the cap crown, by fashioning one edge to adapt it to cover the visor, by fulling the fabric to the required size, and by blocking and finishing the article after fulling. 4th. A process of making caps from woven or knitted fabric consisting in fashioning the fabric to the required shape in fulling it, to consolidate the mesh and obliterate the seams, and in blocking and brimming the fulling article.

No. 13,096. Improvements on Spring Washers. (*Perfectionnements aux rondelles a ressort.*)

Daniel R. Pratt, New York, N. Y., U. S., 13th July, 1881; for 5 years.

Claim.—1st. A spring or tension device to be used with nuts and bolts, consisting of a spring formed of drawn or rolled steel wire, bent to the shape of an open annulus or polygon and corrugated, the free ends of the wire being in the same plane.

No. 13,097. Broom Corn Sizing Machine. (*Machine à assortir la houque.*)

George W. Bronson, Adelaide Bronson, Amsterdam, N. Y., U. S., and Valancy E. Fuller, Hamilton, Ont., (representatives of Alphonso Wabrath, Fort Plain, N. Y., U. S.) 13th July, 1881; (Extension of Patent No. 6321).

No. 13,098. Improvements on Coffee Percolators. (*Perfectionnements aux cafetières.*)

Wentworth G. Petry, Quebec, Que., 13th July, 1881; (Extension of Patent No. 10,962.)

No. 13,099. Improvements on Coffee Percolators. (*Perfectionnements aux cafetières.*)

Wentworth G. Petry, Quebec, Que., 14th July, 1881; (Extension of Patent No. 10,962.)

No. 13,100. Improvements on Fences. (*Perfectionnements aux clôtures.*)

Jesse Kinney, London, Ont., 14th July, 1881; (Extension of Patent No. 6,396.)

No. 13,101. Improvements in Implements for Saturating Felt Roofing. (*Perfectionnements aux appareils pour saturer les toitures en feutre.*)

John W. Paterson, Montreal, Que., 16th July, 1881; for 5 years.

Claim.—1st. The pillow blocks E, with their standards d, lugs e, and set screws f, and the reels D. 2nd. The arrangement and combination of the vat with the spindles, rollers, reels, pillow blocks and bearings.

No. 13,102. Improvement on Measuring Faucets. (*Perfectionnement aux robinets-competeurs.*)

Daniel Drawbaugh, Eberly's Mills, Pa., U. S., 16th July, 1881; for 15 years.

Claim.—1st. In a circular chamber provided with inlet and outlet ports, a cylindrical piston rotating eccentrically within such chamber, with its periphery in sliding contact with a circumferential wall thereof, and a fixed position cut off, located between the inlet and outlet ports of the chamber and extending into a recess or slot in the rotating piston, for preventing the exit of the liquid until measured and regularly delivered by the rotating piston. 2nd. A rotating piston mounted upon the wrist of a crank, or crank disk, on an actuating shaft. 3rd. The combination of an actuating shaft, the crank disk and its wrist, with the cylindrical piston, and the chamber having the recess in its side wall, for the accommodation of the crank disk.

No. 13,103. Improvements on Cockle Mills. (*Perfectionnements aux moulins à vraiei.*)

James M. King, Walnut Station, Min., U. S., 16th July, 1881; for 5 years.

Claim.—The adjustably inclined step-formed screen D provided with the checking and spreading boards G, arranged just below the edge of each step and perpendicular thereto, so as to intercept and spread the material before passing to the next section.

No. 13,104. Improvements in Cigarette Machines. (*Perfectionnements aux machines à cigarettes.*)

James A. Bonsack, Bonsack's, Va., U. S., 16th July, 1881; for 5 years.

Claim.—1st. In a cigarette machine, the combination, with a toothed distributing roller and a concave, of a roller located at the entering side of the concave and having teeth upon its periphery which cooperate with the concave for feeding the stock to the distributing cylinder and preventing it from piling upon the outside. 2nd. The combi-

nation, with the endless spreading belt C and its reciprocating frame or carriage, of a rotary brush C₅ located at the delivery end of said belt, and mounted upon its carrying frame so as to reciprocate with it. 3rd. The combination, with the distributing toothed roller E₂, the concave E₁ and roller E, of the toothed belt D passing around the roller E between the same and the concave. 4th. The combination, with the concave E₁, the roller E and the toothed belt D passing around roller E, of a presser roller C₁₀ for forcing the tobacco down between the teeth of the belt, before passing beneath the concave. 5th. A device for forming a continuous cigarette filler consisting of three endless metal belts arranged to form a trough, and a pressing surface acting in the open side of the trough. 6th. The combination, with the three endless metal belts forming a trough as described, of backing strips for guiding said belts and forming resistance as against internal pressure. 7th. The combination, with the endless metal belt F₃, of the two belts F₁ F₂ arranged at right angles to F₃, and the pulleys F₄ F₅ F₆ F₇ having flanges at their upper edges to hold these belts down closely upon F₃. 8th. The combination with the three endless metal belts arranged as described, of three pulleys located at one end of the belts and three other pulleys located at the other end of the belts, one of said sets of pulleys being connected together by level gears for the equal and uniform travel of the belts. 9th. The combination, with a rotary cutting disk, of an adjustable holder for the cigarette roll, and mechanism connecting with said holder for projecting said cigarette roll against the cutting disk, instead of the disk against the cigarette roll. 10th. The combination, with a cigarette machine which makes a continuous cigarette, of a cutting device having, when in cutting action, a secondary movement in the same direction with the cigarette, as it emerges from the machine.

No. 13,105. Improvements in Pantalon Suspenders. (*Perfectionnements aux bretelles.*)

Henry Turner, Montreal, Que., 16th July, 1881; for 5 years.

Claim.—1st. The combination of the eye M provided with bevels N and distance piece P, with the clasp H having points and eye L, and with the loop consisting of the parts D C B forming the button hole E, 2nd. A loop for a pantalon suspender having a cross bar B, ends C D, all formed in one continuous piece of material and forming a button hole E. 3rd. A flat clasp H having points L and eye L. 4th. A shoulder strap eye M provided with bevels N and distance piece P.

No. 13,106. Force Pump. (*Pompe foulante.*)

Mott B. Brooks, Brockville, Ont., 16th July, 1881; for 5 years.

Claim.—1st. The base A and water chamber B. 2nd. The combination of the plunger barrel D and escape pipe F being contained within the water and air chamber E. 3rd. The movable foot brace G.

No. 13,107. Improvements on Steam Piston Packing. (*Perfectionnements aux garnitures des pistons.*)

Abram N. Matthews, John M. Winslow and Thomas C. Clary, Norwood, Mass., U. S., 16th July, 1881; for 5 years.

Claim.—1st. In a piston packing composed of two divided rings fitted one within the other, the inner ring being provided with a projection B fitting within a corresponding recess a a in the outer ring. 2nd. The packing ring A having a joint or division b, at right angles to the plane of its diameter, and arranged centrally to the recess a a. 3rd. In a piston packing, the projection B attached to, or forming a part of ring C.

No. 13,108. Improvements in Cooking Stoves. (*Perfectionnements aux poêles de cuisine.*)

The N. S. Vedder Pattern Works, Bascom, Galbraith & Co., (Assignees of Robert Galbraith,) Troy, N. Y., U. S., 16th July, 1881; for 5 years.

Claim.—1st. The combination, with a stove having the rear top hole plate B and a heating flue immediately under that plate, of the water reservoir fitting upon that plate and over the pot holes therein, and movable thereon, and hinged at one front corner part of the reservoir to one side part of the stove. 2nd. The combination, with a stove having the rear pot hole plate, and removable reservoir fitting upon said plate, of the two pairs of half hinges c c d d fast on the two front corners of the reservoir and on the two side parts of the stove, respectively, and adapted to be connected by removable pins. 3rd. The combination, with a stove, the movable water reservoir hinged at one front corner to one side part of the stove, of the removable extension piece F detachably secured to the stove and helping to support the reservoir, when the latter is turned off from over the pot holes on to said extension piece. 4th. The combination, with a stove having a rear pot hole plate B over a heating flue space C, of a water reservoir consisting of the inner vessel D, and the outer casing E containing said vessel and supporting its bottom and fitting, and movable to and fro on said pot hole plate, with a space G between the walls of said vessel and its casing, and the bottom of the casing being open for the passage of heated air or gas from the space C into the space G. 5th. The combination, with a stove having a rear pot hole plate B over a heating flue C, of the movable casing E fitting on said plates over the pot holes therein, hinged at one front corner to one side of the stove and having walls k on all sides, a top opening through which a water vessel D can be inserted and removed, and a bottom l with opening m for supporting the bottom of the water vessel and permitting contact therewith of heated air or gas from the stove. 6th. The combination, with a stove having a rear pot hole plate B and the removable casing E fitting upon said plate and formed to receive, contain and support a removable vessel, of the two pairs of half hinges c c d d fast on the two front corners of said casing and on the two side parts of the stove, respectively, and adapted to be connected by removable pivot pins.

No. 13,109. Improvements on Waterproof Compounds. (*Perfectionnements aux composés hydrofuges.*)

Paul Crippen, Bronson, Mich., U. S., 16th July, 1881; for 5 years.

Claim.—A water proof compound composed of coal tar, sulphur and alum mixed and boiled.

No. 13,110. Improvements on Fire Pots for soldering Irons. (*Perfectionnements aux pots à feu pour les fers à souder.*)

John B. Robertson, Toronto Ont., 16th July, 1881; for 5 years.

Claim.—A fire pot when constructed with an annular flue F provided with a perforated bottom D, damper H and fire box A.

No. 13,111. Refrigerating Room. (*Chambre frigorifique.*)

Moses Kimball, Montreal, Que., 16th July, 1881; (Extension of Patent No. 6,373.)

No. 13,112. Sub-aqueous Drilling Apparatus. (*Appareil de forage sous-marin.*)

Ebenezer E. Gilbert Montreal, Que., 16th July, 1881; (Extension of Patent No. 6,395.)

No. 13,113. Improvements on Skates. (*Perfectionnements aux patins.*)

Charles Brewster, Montreal, Que., 16th July, 1881; (Extension of Patent No. 6,327.)

No. 13,114. Improvements in Reaping Machines. (*Perfectionnements aux moissonneuses.*)

Isaac Mills, Hamilton, Ont., 16th July, 1881; (Extension of Patent No. 6,314.)

No. 13,115. Improvements on Dynamo-Electric Machines. (*Perfectionnements aux machines electro-dynamiques.*)

Hiram S. Maxim, Brooklyn, N. Y., U. S., 18th July, 1881; for 15 years.

Claim.—1st. The combination of a dynamo-electric machine and a similar auxiliary machine used for exciting the main field magnets, with commutator brushes mounted so as to turn freely and revolving automatically relatively to the points of maximum and minimum current on the commutator of the auxiliary machine, in response to variations of tensions in the main current. 2nd. A dynamo-electric machine having its field magnets excited by a similar auxiliary machine, in combination with mechanism for revolving the commutator brushes of the auxiliary machine, to and from the neutral points of its commutator, and an electro-magnet for controlling the direction of such revolution, which magnet is thrown into and out of an electrical circuit by a shunt operated by an electro-magnet in the main circuit or a branch thereof. 3rd. The sector J carrying the brushes H H, in combination with the pinion K, the movable disks L L, and the friction wheel N, the said wheel N revolving continuously in the same direction. 4th. The combination of the electro-magnet *h* with the electro magnet T, the said magnet *h* being of high resistance and placed in a branch of the main circuit, and its armature lever controlling the admission of an electrical current to the magnet T, and the said magnet T being of low resistance, and operating mechanism for increasing and diminishing the amount of electricity generated by the main dynamo-electric machine. 5th. The combination, in a dynamo-electric machine, of the electro-magnet *h* and adjustable spring *a*, or equivalent device, for regulating the normal tension of the current with commutator brushes revolved automatically to and from the maximum current on the commutator by mechanism controlled by said electro-magnet.

No. 13,116. Improvements on Armatures for Dynamo-Electric Machines. (*Perfectionnements aux armatures des machines electro-dynamiques.*)

Hiram S. Maxim, Brooklyn, N. Y., U. S., 18th July, 1881; for 15 years.

Claim.—1st. An armature, for a dynamo-magneto-electric machine, composed of a series of annular plates separated by air passages from each other, and from the armature shaft, the said plates having outer and inner projections, so constructed as to keep the coils separated from each other, and leave air passages between them. 2nd. An armature, for a dynamo-magneto-electric machine, composed of a series of thin annular plates separated by air passages from each other and from the armature shaft, a part of said plates being of the form shown at A, and the remainder being of the form shown at B. 3rd. An armature, for a dynamo-magneto-electric machine, composed of annular plates with air passages between them, projections upon both the outer and inner circumferences of such plates, so constructed as to keep the coils separated from each other, and leave air passages between them. 4th. The combination of one or more of the coils C with an armature composed of a series of annular plates, separated by air passages from each other and from the armature shaft, the said plates, or a part of them, having outer and inner projections so constructed as to keep the said coils separated from each other, and leave air passages between them. 5th. In an armature composed of disks or annular plates, the combination, with such plates, of two or more similarly shaped plates of insulating material so constructed as to project slightly beyond said metallic parts, and support the coils free from contact therewith. 6th. The combination, in an armature, of two or more annular plates open about the armature shaft, and having inner and outer projections, to keep the coils separated from each other, with the rods H H and washer on said rods, interposed between the plates.

No. 13,117. Improvements on Electric Lamps. (*Perfectionnements aux lampes électriques.*)

Hiram S. Maxim, Brooklyn, N. Y., U. S., 18th July, 1881; for 15 years.

Claim.—1st. An electric lamp having its light giving part inclosed in a sealed globe, a hydro-carbon vacuum or highly rarified hydro-carbon vapour. 2nd. In an electric lamp, a continuous conductor of carbon ad-

apted to be rendered incandescent by the passage of a current of electricity, in combination with a sealed globe enclosing such conductor, in a hydro-carbon vacuum or highly rarified hydro-carbon vapor. 3rd. The process of producing a vacuum in the globe of an electric lamp, which consists in displacing the air contained in it with a liquid hydro-carbon, expelling a portion of such hydro-carbon by heat, and exhausting the remainder. 4th. The combination, in an electric lamp, of the plug R, the base V, the globe M and the cock Q with the wax or pitch S T.

No. 13,118. Improvements on Electric Lamps. (*Perfectionnements aux lampes électriques.*)

Hiram S. Maxim, Brooklyn, N. Y., U. S., 18th July, 1881; for 15 years.

Claim.—1st. The combination, in an electric lamp, of a continuous carbon conductor, metallic electrical connections for the same, and one or more washers of soft carbon interposed between said conductor, and each metallic connection. 2nd. The combination of the carbon conductor B, the support C having the flattened end *l*, the washers *m m k* and the pin *o*, and nut *t*.

No. 13,119. Improvements on Electric Lamps. (*Perfectionnements aux lampes électriques.*)

Hiram S. Maxim, Brooklyn, N. Y., U. S., 18th July, 1881; for 15 years.

Claim.—The combination of the globe A with the platinum connections C C, and the capillary spaces *a* filled with gum or wax. 2nd. The combination, with the globe of an incandescent electric lamp, of glass tubes extending up into said globe and surrounding the supporting conductors of the incandescent part of the lamp, the spaces in the said tubes being packed with a solid sealing substance. 3rd. The combination of the base E carrying the plug K with sub-base I and the ring R. 4th. In an electric lamp, the combination on a continuous incandescent conductor mounted upon electrical connections of platinum, with a globe of glass inclosing such conductor and sealed directly to said electrical connections, and wax or gum applied to said globe, where the electrical connections pass through it.

No. 13,120. Process of Manufacturing Carbon Conductors for Electric Lamps. (*Procédé pour faire des conducteurs de carbone pour les lampes électriques.*)

Hiram S. Maxim, Brooklyn, N. Y., U. S., 18th July, 1881; for 15 years.

Claim.—1st. The process of carbonizing carbonaceous substances by exposing them to a high temperature, while surrounded by hydro-carbon gas or vapour. 2nd. The process of making carbon conductors for electric lamps, by carbonizing forms of carbonaceous material in a vessel heated to a high temperature, and supplied with hydro-carbon gas or vapour.

No. 13,121. Process of Removing Atmospheric Oxygen from the Globes of Electric Lamps. (*Procédé pour enlever l'oxygène atmosphérique des globes de lampes électriques.*)

Hiram S. Maxim, Brooklyn, N. Y., U. S., 18th July, 1881; for 15 years.

Claim.—First, exhausting or otherwise removing the greater part of the air contained in such globe and, then, admitting thereto and exhausting therefrom a hydro-carbon vapour or gas.

No. 13,122. Improvements on Devices for Equalizing the Arcs of Electric Lamps. (*Perfectionnements aux appareils pour égaliser les arcs des lampes électriques.*)

Edward Weston, Newark, N. J., U. S., 18th July, 1881; for 15 years.

Claim.—1st. An electric circuit including one or more electric lamps and a circuit breaker, in combination with a resistance circuit, the ends of which are respectively connected with the main circuit, on opposite sides of the circuit breaker, whereby the resistance circuit affords a path for the current, parallel with the path afforded by that part of the main circuit which includes the circuit breaker. 2nd. The combination, in an electric circuit, of one or more electric lamps having magnetic regulators, with a continuously operating periodic circuit breaker. 3rd. The combination, in an electric circuit, of one or more electric lamps having magnetic regulators, with a circuit breaker consisting of the metallic cylinder F having the gap *f* in its periphery, and being electrically connected with one end of a break in the main circuit, and the revolving brush D₂ electrically connected with the other end of the break in the main circuit. 4th. In a circuit breaker, the adjustable cylinder F in combination with the revolving brush D₂ deriving its support from the counter shaft D and whereby it is free to hang downward, under the influence of its own gravity, except when lifted by the rotation of the stud *e* on the ratchet wheel *e*.

No. 13,123. Improvements on Electric Lamps. (*Perfectionnements aux lampes électriques.*)

Edward Weston, Newark, N. J., U. S., 18th July, 1881; for 15 years.

Claim.—1st. An electro-magnet and an armature, the opposed parts of which are respectively in the form of a cone and of a hollow cylinder, the armature having a range of motion permitting the cone to enter the hollow cylinder when the armature yields to the attraction of the magnet. 2nd. An electro-magnet having a longitudinally hollow core, in combination with a conically pointed movable armature having a range of motion permitting its conical point to enter the tubular pole of the magnet. 3rd. In combination with an electro-magnet provided with a hollow core, and a conically pointed movable armature and adjusting device, by means of which the range of movement of the lever to which the armature is attached may be adjusted. 4th. The combination of a main circuit of small resistance, which includes the carbons and the principal coil surrounding the electric magnet with a

derived circuit of large resistance, which includes a coil wound differentially upon the electro-magnet, and a circuit closer adapted to close the derived circuit, whenever the resistance in the main circuit is increased to a prescribed amount by the too great separation of the carbons. 5th. The combination of the carbons with a differential magnet, the too oppositely wound coils of which are respectively included in the main circuit which includes the carbons and in a derived circuit, whereby the distribution of the current in the two circuits is automatically dependent upon the progress of the combustion of the carbons. 6th. In an electric lamp in which the force of gravity tends to diminish the distance between the points of the carbons, a lever to which at one end a movable carbon is suspended and upon which at the other end an armature is affixed, in combination with an electro-magnet, the opposed parts of the armature and magnet being respectively conical and tubular, whereby the armature has a prescribed range of movement in the magnetic field, during the whole of which there is no material variation in the amount of attractive force exerted upon it by the magnet. 7th. The clamp *k* composed of the pivoted clamping jaws *k k* respectively linked to the forked end of the rocking armature lever, in combination with the vertical sliding rod *d*. 8th. The clamp *k* composed of the pivoted jaws *k k*, the armature lever and links connecting the same, in combination with a stop adapted to disengage the jaws *k k* from the movable carbon holder when the same has been dropped to the desired point. 9th. The combination of the vertical sliding carbon holder *d*, the clamp *k*, the forked armature lever *g* to which the clamp is linked, and an electro-magnet, the coils of which are included in the circuit which supplies the lamp. 10th. The armature lever *g* and the upper carbon holder and clamp, in combination with the pawl *g* for holding up the end of the lever carrying the clamps.

No. 13,124. Improvements on Dynamo-Electric Machines. (*Perfectionnements aux machines électro-dynamiques.*)

Edward Weston, Newark, N. J., U. S., 18th July, 1881; for 15 years.

Claim.—1st. In a dynamo-electric machine, brushes for collecting currents of electricity from a rotating commutator deriving their support from a disk mounted upon an axis coinciding with the axis of the commutator and having a range of adjustment limited to the width of one of the commutator strips, and adapted to vary the position of the brushes upon the commutator relatively to the magnetic field from the minimum point of magnetic induction to the maximum point. 2nd. The cylinder head *a* supporting the brushes *F F* provided with the concentric slots *e* of the same length in degrees of the circle as the arc described by one of the strips of the commutator, for the purpose of limiting the range of adjustment of the brushes to the distance between the minimum and maximum points of magnetic induction. 3rd. The brushes *F F* composed of silver-plated copper sheets. 4th. The rotating disk *k* operated by mechanical connection with a dynamo-electric machine, or with the driving power thereof, and provided with the radial slots *k₂*, each containing a sliding block *k₃* and an adjustable spiral spring *k₄*, in combination with the insulated hub *k*, the brush *i* and the standard *i*, the whole being arranged in circuit with the dynamo-electric machine. 5th. The main or operative circuit of a dynamo-electric machine, in combination with a bridge containing an automatic switch or circuit closer and breaker and derived circuit or shunt around said switch containing a resistance coil. 6th. The combination, with stationary electric magnets and an armature, of a water chamber and means for establishing and maintaining a circulation of water through the same. 7th. An armature and stationary electro-magnets coated with paraffine or some other insulating material, in combination with a water chamber.

No. 13,125. Improvements on Rotating Armatures for Dynamo-Electric Machines. (*Perfectionnements aux armatures rotatoires pour les machines électro-dynamiques.*)

Edward Weston, Newark, N. J., U. S., 18th July, 1881; for 15 years.

Claim.—1st. In a dynamo-electric machine, a rotary armature, the coils of which are wound upon a hollow core provided with openings in its ends and in its periphery. 2nd. A rotating armature consisting of a series of coils wound upon the hollow carrier or shell *A* which is provided with openings *c* in its ends, and openings *c* in its periphery.

No. 13,126. Improvements on Horse Rakes. (*Perfectionnements aux râteliers à cheval.*)

John Larsen and Thomas Galloway, Oshawa, Ont., 18th July, 1881; for 5 years.

Claim.—1st. A combined steadying and cleaner bar pivoted upon an arm extending below the shaft. 2nd. An arm *F* fastened to the shaft *a* and extending below it, in combination with the bar *H* pivoted to the arm *F*, at a point near the centre of the teeth *I* and supporting the bar *J*. 3rd. The bar *J* supported from a point near the centre of the teeth *I*, in combination with the push bar *K* connected to the lever *L*. 4th. The bar *J* supported from a point near the centre of the teeth *I* and connected to the lever *L* by the bar *K*, in combination with the link *M*, bracket *N* and axle *A*. 5th. The bar *J*, supported from a point near the centre of the teeth *I* and provided with a push bar *K* having holes in its opposite ends, to receive a fastening pin, in combination with the lever *L* having corresponding holes pierced in it. 6th. In a friction strap *D* passing around the hub *C* and connected at one end to the lever *G*, in combination with a bolt *a* passing through a clip on the other end of the strap *D* and a slot or elongated hole in the bracket *E*. 7th. A spiral friction band *D* attached at one end to a bracket on the axle *A* and passing two or more times around the hub *C*, in combination with the lever *G* pivoted to the axle and pivotally connected to the other end of the spiral band, and constructed and arranged to hold and draw the strap spirally around the hub.

No. 13,127. Improvements on Safe-Guards for Berths for Railway Cars and Steamships. (*Perfectionnements aux garde-corps pour les lits des chars de chemin de fer et des navires à vapeur.*)

Eleanor A. McMann, Cleveland, Ohio, U. S., 19th July, 1881; for 5 years.

Claim.—The combination, with a sleeping berth of railway cars or steamships, of the safeguard *C* hinged to sliding blocks *D D* playing on the permanent rods *d d*, or hinged to the top edge of the front *A* with a double hinge *E*, whereby the said guard may be turned down and slid into a pocket *a* or downward for stowing away, or turned upward and secured by latching to adjustable posts *B B*, said posts capable also of being turned down, having slots *b* and connected by slotted plate *C* to front *A*.

No. 13,128. Improvements on Lamps. (*Perfectionnements aux lampes.*)

Edward S. Piper, Toronto, Ont., 19th July, 1881; for 5 years.

Claim.—1st. In combination with a tail lamp in which the leg, which fits into the supporting bracket, is made hollow, but closed at both ends, perforations made in the leg near its base for the purpose of admitting cold air, with similar perforations near the top end of the leg for the purpose of permitting air in the leg to escape into a specially formed chamber below the base of the lamp, by which the burner is supplied with fresh air at the same time it is protected from sudden gusts of wind. 2nd. A double lamp case having an air space between the two skins and a chamber formed on its top, the sides of the said chamber being perforated and provided with inwardly flaring corrugated guards *k* extending across the said chamber in front of the perforations, in combination with a funnel situated above the chamber, and provided with a cone-shaped bottom having a hole in its apex. 3rd. A signal lamp having lenses on opposite sides of the burner, in combination with conically shaped reflectors behind each lens and having a tube in their centre to prevent the length of the burner to be seen through them while each acts as a reflector for the lens opposite, protecting it also from the colour of the lens behind which the reflector is placed. 4th. In combination with a lamp provided with an ordinary burner, an aperture for the admission of oil having a cone-shaped stopper, with a vent hole through its centre.

No. 13,129. Improvements on Car Couplings. (*Perfectionnements aux accouplages des chars.*)

Archie G. Hohenstein, New Haven, Ct., U. S., 19th July, 1881; for 5 years.

Claim.—1st. The combination of the two arms *C* which are united by the coupling rod *D*, the hook *G* and rod *J* having the cam *I* on its lower end, whereby the hooks can be operated from the top of the car. 2nd. The combination of the spring coupling hook with the cam, on the lower end of the operating rod *J*, an arm or lever connected to the rod, a coupling link and a horizontally moving rod *Q*.

No. 13,130. Improvements on Churn Powers. (*Perfectionnements aux moteurs des barattes.*)

Joseph A. Mumford, Avondale, N. S., 19th July, 1881; for 5 years.

Claim.—1st. A churn power adapted to be attached to a shaft *B*, or other projection from a wall *c*, consisting of the bar *A* provided with a thumb screw *a* or other means for fastening the same, carrying a driving wheel *D*, slotted lever *G* operated by a friction roller *H* within the slot mounted on a crank shaft *I* journaled to a spoke of the driving wheel *D*. 2nd. The combination of the driving wheel *D*, roller *H*, slotted lever *G* mounted on a bar *A* or other supporting frame. 3rd. The combination, with the driving wheel *D* operating, by roller *H*, a slotted lever *G*, of the belt *P*, pulley *F* and balance wheel *E*, the whole mounted on a bar *A* or other supporting frame.

No. 13,131. Improvements on Coulters. (*Perfectionnements aux coutres.*)

John Clayton, Brainerd, Min., U. S., 19th July, 1881; for 5 years.

Claim.—1st. The combination, with the rotating coulters *A* and sections *B*, the latter having the annular projections *d*, of the fixed tapered non-rotating journals *F* and the fixed non-rotating washers *G* whose inner ends abut the vertical shoulders of said journals and sections. 2nd. In a rotary plough coulters, the combination of the washers *G* with the journals *F* having tapered outer ends, on which the washers are fitted, and the hub sections *B B* having projecting flanges *d d*, said washers being arranged to break joints with the other parts.

No. 13,132. Improvements on Match Safes. (*Perfectionnements aux porte-allumettes.*)

Francis S. Dangerfield, Auburn, N. Y., U. S., 19th July, 1881; for 5 years.

Claim.—1st. The combination of the box *A*, guide plate *b* depressed at *b*, and match elevating foot *c* made conical, or tapering at its upper end. The combination of the box *A* slotted at *a*, a match elevating foot having an arm projecting through said slot, and a slide *D* having corrugations. 3rd. The combination of the box *A*, sheet metal clamp *f* provided with lugs *f₂*, *f₃*, and a spring striker *e* provided with fan-shaped serrations. 4th. The combination of the box *A*, cover *G*, groove *g* in the edge thereof, and internal shield and cover strap *h*. 5th. The combination of the box *A*, cover *G* cut away at *g₂* and pivoted to box, perforations *g₁* and screws *g₃* passing through the edge of the cover. 6th. The combination of a match box cover spring *l*, clamp *k* provided with a transverse pin *k₁*, and bent arm *I* having indentions *i* and *i₁*. 7th. The combination of the box *A*, cover *G*, cover strap *h*, clamp *k* having bent extremity *k₂*, pivot pin *k₁*, spring *l* and bent arm *I*.

No. 13,133. Improvements on Printers' Side Sticks. (*Perfectionnements aux bois des garnitures d'imprimerie.*)

James A. Burke, Robert Buckingham, Charles T. Blakeley and Charles T. Tuerck, Chicago, Ill., U. S., 19th July, 1881; for 5 years.

Claim.—1st. In a printer's side stick, the combination, with a suitable bar, of a head rigidly secured to said bar and adapted to fit over the top of the galley, and an attachment upon the opposite end of said

bar adapted to hook over the edge of the bottom of said galley. 2nd. The combination of the bar C, mechanism for securing the said bar to the galley at each end, foot H sliding upon the said bar, and mechanism for clamping the said foot to the bar at any desired point. 3rd. The combination of the bar C, head D rigidly secured thereto, and adapted to fit over the end of the galley and provided with the set screw *p*, attachment G adapted to hook over the edge of the bottom, at the opposite end of the galley foot H sliding upon the bar C, and mechanism for clamping the said foot to the bar at any desired point. 4th. In combination with the bar C and mechanism for attaching the lower end of the same to the galley, the head D, clamping screw *r* and sliding guard E. 5th. In combination with the angle bar C and with mechanism for attaching the same to the galley at each end, the sliding foot H comprising the plate *g* having the parallel flanges *f* and *f* said flanges *f* lying upon the top of said bar C and curving around into the angle thereof, and said flanges *f* resting against the flat face of said bar, and the eccentric clamp *e* pivoted between the said flanges. 6th. In combination with the bar C and mechanism for securing it at its upper end to the galley, the device G for securing said bar to the galley at its opposite end, said device comprising the plate *m* secured to the bar C and having the L-shaped projection *i* provided with the notch *h*. 7th. In combination with the bar C and mechanism for securing it at its upper end to the galley, the device G for securing said bar to the galley at its opposite end, and made adjustable by means of the slot *k* in said bar, and screw *l*.

No. 12,134. Improvements on Stovepipe Damper. (*Perfectionnements aux clés des tuyaux de poêles.*)

William F. Green, (Assignee of John H. Goodfellow,) Troy, N.Y., U.S., 19th July, 1881; for 5 years.

Claim.—1st. A stove pipe damper provided with a spring conforming to, or circumscribing a portion of the periphery of such damper. 2nd. A stove pipe damper, provided with springs B B', each conforming to, or circumscribing a portion of the periphery of such damper. 3rd. A stove pipe damper provided with a spring having a pivot of the damper of such spring. 4th. A stove pipe damper provided with springs B B' having thereon the pivots D D'. 5th. A stove pipe damper provided with supporting pivots, and a spring or springs shaped and arranged as described, all made of the same material and in one piece.

No. 13,135. Improvements on Carriage Bodies. (*Perfectionnements aux caisses des voitures.*)

Hazard W. Titus and Aurelius O. Revenaugh, Jackson, Mich., U.S., 19th July, 1881; for 5 years.

Claim.—1st. In a vehicle body, a sill having the seat portion B, the bottom C, and the connecting parts D formed from a continuously grained piece of work bent into the shape shown. 2nd. In a vehicle body, a sill having the seat support B, the bottom part C, and the connecting part D formed by bending a continuous piece of wood, and the bracket *a* bent from a continuously grained piece of wood, and secured to the sills at the points of curvature. 3rd. The combination, with the seat, of the brace M M.

No. 13,136. Improvements on Steam Pumps. (*Perfectionnements aux pompes à vapeur.*)

Rush J. Pettibone and John H. Elward, Stillwater, Min., U.S., 19th July, 1881; for 5 years.

Claim.—1st. The combination, with the crank wheel of a steam piston rod, water plunger and slotted link, the latter arranged diagonally to the piston rod and water plunger. 2nd. The combination, with the crank, of a steam piston rod, water plunger and slotted link, the latter arranged diagonally to the piston rod and water plunger, and the link, piston rod and plunger made in a single piece.

No. 13,137. Improvements on Electric Lamps. (*Perfectionnements aux lampes électriques.*)

The European Electric Company, (Assignee of Charles A. Hussey,) New York, U.S., 19th July, 1881; for 5 years.

Claim.—1st. In an electric lamp, the combination, with a body capable of being rotated or turned, containing within it two or more independent carbons, of means whereby, when said body is rotated or turned, the ends of the carbons, or holders receiving the same, are shifted to bring the carbons successively into the electric circuit. 2nd. The combination, with an electric lamp, of a stationary contact piece, and a number of resistance devices arranged upon a common support which may be rotated to bring said resistance devices with the circuit of the lamp, to vary or extinguish the light. 3rd. The combination, with an electric lamp, of a rotary spool furnished with coils of fine wire and means connected with the circuit of the lamp whereby, on the rotation of the spool by a hand piece, more or less of its coils may be thrown into the lamp circuit, and the resistance in the circuit varied.

No. 13,138. Improvements in Pumps. (*Perfectionnements dans les pompes.*)

Charles Powell, Toronto, Ont., 19th July, 1881; (Re-issue of Patent No. 11,018.)

Claim.—1st. A pump head constructed in sections, which are coupled together by a tubular core connecting with the spout. 2nd. A wooden pump head formed in sections, which are coupled together by an enlarged water chamber B provided with a tubular core, composed of two tubes projecting in opposite directions from the centre of the upper and lower faces of the water chamber, each of said tubes being driven into a section of the pump head. 3rd. A wooden pump head formed in sections, which are coupled together by a water chamber provided with a spout and a tubular core, composed of two opposite transverse tubes, each of the latter being driven into a section of the pump head. 4th. A pump head consisting of two sections *a* *a*' coupled together by a water chamber B having the transverse tubes B₁ and spout B₂, the coupling and spout being cast in one piece. 5th. A pump head constructed in sections, which are coupled together by a tubular core having a water connection with the spout or an air vessel. 6th. The water

chamber B having the transverse tubes B₁ B₁, spout B₂ and an air vessel B₃, all cast in one piece. 7th. The combination, with the handle and pump rod of a pump, of the swinging crane E, said crane being pivoted in connection with the pump head in any suitable manner, and adapted to move to permit the self-adjustment of the fulcrum of the handle. 8th. The combination of the handle pump rod, swinging crane and the air vessel, said crane being pivoted to the air vessel. 9th. In a pump in which the piston is operated by a rod passing through the pump head, the combination of packing or packing box containing packing arranged to constitute, between the pump head and moving rod, a connection to form a force pump, which connection can be broken without disturbing or tearing asunder the material composing the packing within the said packing box, when it is desired to change the pump from a force into an ordinary lifting pump, without friction between the moving rod and packing. 10th. In a pump in which the piston is operated by a rod passing through the pump head, a packing made to fit the rod tightly, in combination with a clamping bar or fork, by which the packing may be held tightly against the pump head when the pump is required as a force pump or released therefrom when required merely as a lift pump. 11th. The combination, with a flanged packing box F and the pump rod C, of the T-shaped projecting *n* on the pump head and clamping bar G. 12th. The packing box F provided with the flange F' and a recess in the bottom face, in combination with the pump rod C, circular collar F₂ fitting in the bore of the pump head, and the packing *f*. 13th. In a pump in which the piston is operated by a rod passing through the pump head, the combination of a packing or a packing box containing packing arranged to constitute for the moving piston rod the required joint to form a force pump, which joint can be broken without disturbing or tearing asunder the material composing the packing, when it is desired to change the pump from a force pump into an ordinary lifting pump, to work without appreciable friction on the moving rod. 14th. The combination of a flexible band H', the ends of which are secured a short distance apart to the lever H, for the purpose of forming a hose coupling.

No. 13,139. Gear Trip for Harvesters. (*Engrenage des moissonneurs.*)

Robert Thomson and Alfred R. Williams, Stratford, Ont., (Assignees of Orville Cooley, Brockport, N. Y., U.S.) 20th July, 1881; (Extension of Patent No. 6,329.)

No. 13,140. Pitman Connection for Mowing and other Machines. (*Bielle de raccordement pour machines à faucher et autres.*)

Robert Thomson and Alfred R. Williams, Stratford, Ont., (Assignees of Orville Cooley, Brockport, N. Y., U.S.) 20th July, 1881; (Extension of Patent No. 6,330.)

No. 13,141. Stripper, Tightener and Guide for Belts and Endless Chains. (*Appareil pour tendre, engrener et guider les courroies et les chaînes sans fin.*)

Robert Thomson and Alfred R. Williams, Stratford, Ont., (Assignees of Orville Cooley, Brockport, N. Y., U.S.) 20th July, 1881; (Extension of Patent No. 6,331.)

No. 13,142. Improvements in Harvesting Machines. (*Perfectionnements dans les moissonneuses.*)

Robert Thomson and Alfred R. Williams, Stratford, Ont., (Assignees of Orville Cooley, Brockport, N. Y., U.S.) 20th July, 1881; (Extension of Patent No. 6,332.)

No. 13,143. Improvement in Reapers and Harvestors. (*Perfectionnements dans les faucheuses-moissonneuses.*)

Robert Thomson, and Alfred R. Williams, Stratford, Ont., (Assignees of Orville Cooley, Brockport, N. Y., U.S.), 20th July, 1881; (Extension of Patent No. 6,333.)

No. 13,144. Improvements in Reaping and Harvesting Machines. (*Perfectionnements aux machines pour faucher et moissonner.*)

Robert Thomson, and Alfred R. Williams, Stratford, Ont., (Assignees of Orville Cooley, Brockport, N. Y., U.S.), 20th July, 1881; (Extension of Patent No. 6,334.)

No. 13,145. Improvements on Machines for Buffing Soles. (*Perfectionnements aux machines à polir les semelles.*)

George H. P. Flagg, (Assignee of Frederick W. Coy,) Boston, Mass., U.S., 21st July, 1881; for 15 years.

Claim.—1st. The combination of roll *a*, pulley *d* and mechanism for mowing pulley *d* towards and from roll *a* and for adjusting the axis of the pulley with relation to the axis of the roll. 2nd. The spring *d*' with reference to roll *a* and pulley *d*, whereby the strain on belt *f* depends upon the tensions of spring *d*'. 3rd. The improved shank wheel having the slit *b* in its rim *b*, and mechanism for springing the rim *b* and thereby clamping the ends of the abrasive strip between the walls of slit *b*. 4th. In a shank wheel, the slit *b* in the rim *b*, the slit *b* being inclined and adapted to hold one end of the abrasive strip, because of the acute angle the slit *b* forms with the periphery of the wheel and the corresponding short bend in the abrasive strip.

No. 13,146. Improvements on Grain Drill Distributors. (*Perfectionnements aux distributeurs des semoirs traceurs.*)

James Noxon, Ingersoll, Ont., 21st July, 1881; for 5 years.

Claim.—1st. The combination, with a scalloped rotary feed-wheel, of a sliding sleeve C provided with wings A B, one wing being arranged above, and the other in or near a horizontal plane passing through the axis of said sleeve. 2nd. A grain drill distributor having a peripheral sleeve wheel, a sliding sleeve C provided wings A B located above or near the centre of the peripheral seed wheel, and also provided with a division plate F.

No. 13,147. Improvements on Grain Binders. (*Perfectionnements aux lieuses à grain.*)

Alexander Kay, Ayr, Ont., 21st July, 1881: for 5 years.

Claim.—1st. The combination, with platform 1 having segmental slot 13, of the arms 7 9 secured to pivoted post 8, both arms moving laterally and vertical to each other, the arm 7 pivotally connected to head of the post 8 and operated vertically by latching cams 6 in posts 5 secured to the platform, said arm 7 carrying the binding wire 7 and the arm 9, the twister wheel 23 and the chisel cut-off 25. 2nd. The combination, with arm 9 of pivot post 8, arm 7 and spool 16, with the spring arm 20 for feeding and taking up the wire 17. 3rd. The chisel cut-off 25, operated by cam 26, in combination with the twister wheel 23 in the head of arm 9 for cutting the wire subsequent to the shears. 4th. The combination of presser arm 29, rod 30 and rods 31 32, and eccentric 33 for operating the same co-equally with the arm 7 for pressing the gavel. 5th. The spring presser 34 in combination with the presser arm 29, for directing the lay of the gavel. 6th. The combination of the spring shears 27 holding the end of the wire, the chisel cut-off 25 and twister wheel 23 in the head of arm 9, for cutting off the excess of twisted wire.

No. 13,148. Improvements on Churns. (*Perfectionnements aux barattes.*)

Frank M. Wright, Palmyra, N. Y., U. S., 21st July, 1881: for 5 years.

Claim.—1st. In combination with churn body A provided with corner shoulders B, the base or connecting bar C of the standards D, and the rear standards F forming a frame E, the said standards, at their lower extremities, being detachably secured to the churn body by means of the cams K. 2nd. In combination with the ends of the churn body and the projecting sides of the same, the standards D F recessed at L, and the cams K adapted to bear in said recesses. 3rd. In combination with the frame E, the cross M forming bearing for the driving shaft and provided with the lugs O having, pivoted between them, the boxes P slotted at their free ends and adapted to be secured over the shaft. 4th. In combination with the driving shaft and the fly wheels secured thereto, the adjustable wrist pins S secured to the wheels respectively, diametrically opposite each other. 5th. In combination with adjustable wrist pins S, the pitman T, dasher rods A slotted and embracing the crank shaft, and the divided top Bt provided with openings for the passage of the dasher rods. 6th. In combination with the driving wheel the adjustable wrist pin projecting beyond the pitman and provided with a winch or crank.

No. 13,149. Improvements on Devices for Carrying Fruit. (*Perfectionnements aux appareils à transporter les fruits.*)

George A. Cochrane, Liverpool, Eng., 21st July, 1881: for 5 years.

Claim.—1st. The packing, keeping or carrying of fruit in cases, arranged so that each piece of fruit shall be separated from the others, and be only obliged to support its own weight. 2nd. The packing, keeping, or carrying of fruit in cases arranged so that there shall be a thorough ventilation throughout the case. 3rd. As a new article of manufacture, a packing case with knobs A arranged so as to prevent another case coming right up to it, but so that there shall be a vacant space on every side of it, in combinations with slits or ventilating holes all over the case. 4th. As a new article of manufacture, a perforated packing case fitted with perforated shelves or trays with partitions to separate the various specimens of fruit from each other. 5th. The combination, with a case for holding fruit, of perforated trays C for carrying each layer independently of the others, and the notched or perforated partitions D for separating the fruits from each other. 6th. The combination, with a case for holding fruit, of the trays C for carrying each layer of fruit independently of the others, with the distance pieces E. 7th. As a new article of manufacture, the perforated trays glazed on their surface, so that they shall absorb as little moisture as possible from the fruit, while admitting through ventilation and separating the fruits one from the other. 8th. The method of carrying or stowing fruit on shipboard, or in warehouses, consisting in isolating each fruit from the other, in ventilating cases and placing these ventilating cases on perforated disks or floors above a vacant space from which the deleterious vapours can be removed. 9th. As a new article of manufacture, the strips of glazed perforated cardboard, millboard, or paper, for winding in and out among the fruit to form a partition. 10th. As a new article of manufacture, a packing case with double perforated sides, with one of the layers of the side free to slide on the other, so as to close the perforations to any reasonable extent.

No. 13,150. Improvements on Bark Cutting Machines. (*Perfectionnements aux machines à couper l'écorce.*)

Samuel R. Thompson, Brookline, and Samuel W. Johnson, West Medford, Mass., U. S., 21st July, 1881: for 5 years.

Claim.—1st. A rotary cutter having alternating long and short teeth, arranged in longitudinal rows, the alternating long and short teeth of said rows being respectively alternated with the short and long teeth of each adjacent row. 2nd. In combination with a rotary cutter having independent teeth and a chute or passage leading from such cutter, a rotary shaft D located in the chute, having a series of collars F and intervening pockets G, the diameter of said collar being about equal to the width of the chute, so that they arrest all fragments too small to enter the pockets, the latter carrying away the properly reduced particles. 3rd. The rotary shaft D having collars F, intervening pockets G and teeth I in said collars, combined with the fixed block having a grooved shoulder J. 4th. In combination with the chute or passage C and the shaft D, having collars F and pockets G, the sliding frame E supporting the shaft D and enabling said shaft to be removed from the machine. 5th. The combination of a frame or base B supporting a

cutter at its top, the hopper frame having the feed roll U, inclined bed plate Q and lugs P pivoted to the frame B, so as to permit the hopper frame and feed roll to be turned back.

No. 13,151. Improvements on Bee Hives. (*Perfectionnements aux ruches.*)

William S. Blaisdell, Randolph, Vt., U. S., 21st July, 1881: for 5 years.

Claim.—A bee hive constructed with the broad frames arranged in a circular form around a central standard, or common centre. 2nd. The combination of a circular series of broad comb frames with a central hollow standard. 3rd. A circular series of comb frames, the use of alternate wide and narrow frames allowing the circular arrangement of frames. 4th. The combination, with a circular series of comb frames, of removable separating bars. 5th. The combination of a circular series of broad comb frames, with a series of surplus honey boxes also arranged in a circular form and having plates J attached to the sides of each set. 6th. The combination, with the base and top of the line, of a binding rod. 7th. The combination, with the binding rod, of a cylindrical cup. 8th. The combination, of the hollow standard, of the circular series of broad comb frames, of the removable separating bars of the series of surplus honey boxes, and of the surrounding cylinder.

No. 13,152. Process of, and Apparatus for the Treatment of Ores. (*Procédé de traitement des minerais et appareil pour cet objet.*)

Thomas G. Walker, Morristown, N. J., U. S., 21st July, 1881: (Extension of Patent No. 13,061.)

No. 13,153. Process of, and Apparatus for the Treatment of Ores. (*Procédé de traitement des minerais et appareil pour cet objet.*)

Thomas G. Walker, Morristown, N. J., U. S., 22nd July, 1881: (Extension of Patent No. 13,061.)

No. 13,154. Improvements on Hydro-Carbon Gas Generators. (*Perfectionnements aux générateurs à gaz d'hydrocarbone.*)

Peter J. Fitzgerald, Sharon Hill, Penn., U. S., 25th July, 1881: for 5 years.

Claim.—1st. In a hydrocarbon gas generator, the combination, with a closed hydrocarbon reservoir provided with an air supply pipe, and a coil or fixing retort arranged for continuous operations, of a pipe leading from within and near the bottom of said reservoir, to and connecting with said coil or retort, whereby when air is forced into said reservoir above the level of a liquid hydrocarbon therein, practically the entire quantity of said hydrocarbon will be forced through said pipe to said coil or retort in continuous supply. 2nd. The combination, with the pipe connecting a hydrocarbon reservoir with a fixed gas holder, of a coil or fixing retort comprised of a coil intermediately connected with said connecting pipe, and arranged for the vapours to pass through it, and suitable means for heating said coil. 3rd. The combination, with the coil or retort E and the burner below it, of the deflecting disk arranged immediately above said coil. 4th. The combination, with the continuously operating coil or retort and the gas holder, of a vertical pipe connecting said holder with a pipe leading from said retort, and terminating within and near the bottom of said holder. 5th. The combination, with the continuously operating coil or retort, and the gas holder, of the vertical pipe H connected with said retort terminating within and near the bottom of the holder and provided with the needle-point valve, the air passages and the injector cone arranged within said pipe below said air passages. 6th. The combination with the conical externally threaded sleeve embracing the shank of needle-point valve L, of the disk M having the central conical threaded aperture in its hub. 7th. The combination, with the hydrocarbon reservoir, and a pipe Q leading from its top to a service pipe, of the centrally perforated disk arranged horizontally over the entrance to a chamber arranged in said pipe Q, and somewhat smaller in diameter than said chamber. 8th. The combination, with the pipe H connected with the retort, and the top of the gas holder, of a valve to admit gas to the top of said pipe, the injector cone arranged below said valve, and the air supply tubes T connected to the said pipe between the valve and injector cone.

No. 13,155. Improvements on Mittens. (*Perfectionnements aux mitaines.*)

Henry W. Price, Rockford, Ill., U. S., 25th July, 1881: for 5 years.

Claim.—In a mitten, the back and wrist portions formed of knitted or looped fabric, and made in a single piece of L-shape, and the palm, thumb side and tip overlapping portions made of leather. 2nd. In a mitten, the back and wrist portions formed of knitted or looped fabric and made in a single piece of L-shape, and provided with edge and top overlaps, of a palm joined thereto, having a welt inserted in the seam connections. 3rd. In an article of manufacture, the described mitten having a back and wrist of knitted, looped or other equivalent fabric, a palm having an upper edge overlapping portions, a lower edge overlapping portion, an overlapping tip, and a lined palm and thumb.

No. 13,156. Improvements in Plaiting Machines. (*Perfectionnements aux machines à plisser.*)

George W. Hendall, St. Albans, Vt., U. S., 25th July, 1881: for 5 years.

Claim.—1st. The combination of the perforated yoke C carrying the plaiting knife hinged thereto, and operating the roller G the cylinder F and endless belt E. 2nd. The drum of cylinder F supported against the upper roller by means of the endless belt. 3rd. In combination with the rotary cylinder, the lamps arranged to extend through the cylinder, carried on shelf secured to the frame and moved in and out. 4th. The herein described arrangement of rotary-heating cylinder, endless belt, upper feed roll, vibratory knife and stops.

No. 13,157. Improvements in Furniture Casters. (*Perfectionnements aux roulettes des meubles.*)

John Toler, Newark, N. J., U. S., 25th July, 1881; for 5 years.

Claim.—1st. As an improved article of manufacture, in a caster sleeve, of longitudinal section B provided with cap *b* interior flange *c* and outward ribs *f f* K and section C provided with outward spur *l*. 2nd. A caster sleeve provided with two ribs set in rear of a third one, whereby the furrow formed by the latter in the sleeve socket is closed. 3rd. The combination, with the caster E having a spindle D provided with shoulder *d*, of the caster sleeve A provided with cap *b*, inward flange *c*, ribs *f f* K and spur *l*.

No. 13,158. Improvements in Telephones. (*Perfectionnements aux téléphones.*)

The Canadian Telephone Company, Montreal, Que., (Assignee of George L. Anders, Boston, Mass., U. S.) 25th July, 1881; for 5 years.

Claim.—1st. In a district telephone system, a switch adapted for use at an intermediate station and forming a support for a telephone, thereby caused to connect line in with line out, and when the telephone is removed from its support, acting automatically when in its normal position, to always connect the telephone to line in and the central office. 2nd. A switch operating by the weight of the telephone, and normally acting on the removal of the telephone from its support to connect the telephone to line in and the central office, in combination with an auxiliary switch which can be moved at will, to change the circuit, so that the removal of the telephone from its support will connect the telephone to line out and which automatically returns to its normal position on the replacement of the telephone on its support. 3rd. The combination of the lever E having a support for a telephone attached thereto and acting, when the telephone is placed on its support, to establish a connection between line in and line out, and when the telephone is removed from its support, to connect the telephone to the line of the contacts L L' connected respectively to line in and line out and the sliding bar I in its normal position, in connection with the contact L and capable of being moved so as to disconnect from contact L and connect with contact L' held in said position by the depressed lever E and automatically returning to its normal position, when the end of the lever E is elevated. 4th. The combination of the pivoted lever E having a support for a telephone attached thereto, and provided on its under side with a projection *a* the retracting spring F spring G connected to line out springs H H' a telephone connected by one pole to said springs H H' and by the other to earth, spring L connected to line in spring L' connected to line out, sliding bar I provided with notches *b c* and with the insulating spaces *d* and the spring K.

No. 13,159. Improvements in Telegraphy. (*Perfectionnements dans la télégraphie.*)

Thomas J. Mayall, Reading, Mass., 25th July, 1881; for 5 years.

Claim.—1st. The improvement in the art of constructing telegraph lines, consisting in enclosing and insulating a gang of wires in a strap or belt of india rubber compound or other suitable material extending the same the whole length of the line, and laying one or more straps or belts containing a gang of wires in a continuous box extending the whole length of the line. 2nd. As a new article of manufacture in a strap or belt of rubber compound, or other plastic flexible insulating material, containing a gang of wires in the middle of it. 3rd. In the construction of a line of telegraph, the use of an insulating box to contain the wire, extending the whole length of the line. 4th. The method of insulating telegraph wires, consisting in coating the wire with a compound of rubber and graphite, and vulcanizing the coating. 5th. As a new article of manufacture, a box to contain a line of telegraph wire or wires extending along the line its whole length, or any part thereof, made of vulcanized rubber and graphite compound. 6th. A box to contain a line of telegraph wire or wires, extending along the line its whole length, or any part thereof, made of non-electric conducting material. 7th. In machine for enclosing telegraph wires, a band of insulating material, consisting of a supporting frame, driving pulley, shaft and gears, pressure rolls, spools, guide bar and guide rolls for the wire trimming roll, and cutters box for powdered talc, conducting rolls with levers, weights, arms and automatic arrangements for stopping the movement. 8th. In a machine for enclosing telegraph wires, a band of insulating compound material comprising, in combination, the spools *e⁶ e³ e⁴*, the rollers *a³ a⁴ a⁹ E E⁵* and the cutters *a⁶*. 9th. A pneumatic despatch tube, made of a vulcanized compound of rubber and graphite.

No. 13,160. Improvements on Oil Stoves. (*Perfectionnements aux poêles à pétrole.*)

Thomas C. Collins, Toronto, Ont., 25th July, 1881; for 5 years.

Claim.—1st. The vertical tubes leading from the burners to a heating chamber formed below the oven, the bottom of which constitutes the top of the chamber, in combination with bent or corrugated flues leading from the heating chamber to a chamber formed on the top of the oven, for the purpose of utilizing to the fullest extent the caloric produced by the coal oil or gas burners. 2nd. A heating chamber situated above the burners, and provided with corrugated or bent flues for carrying off the products of combustion, in combination with an aperture in the top of the chamber, for the purpose of obtaining the direct effect of the heat within the heating chamber. 3rd. A heating chamber situated above the burner and provided with corrugated or bent flues, for carrying off the products of combustion, in combination with an oven provided with suitable doors, and having for its bottom the top plate of the heating chamber and its top, the bottom of the top chamber, the flues connecting the two chambers passing through the oven. 4th. The vertical tubes leading from the gas burner to a chamber situated above them, in combination with a hinged bracket situated on the outside of the stove casing, above and close to holes provided with a suitable damper, and leading from the heating chamber below the hinged bracket.

No. 13,161. Improvements on Ploughs. (*Perfectionnements aux charrues.*)

Samuel Seegmiller, Goderich, Ont., 25th July, 1881; for 5 years.

Claim.—1st.—As a means of securing a vertical and lateral adjustment to a plough beam, the brace iron F, eye bolt *s* and extension *l* of the beam. 2nd. As a means of adjustment for a plough beam, the semi-spherical head *d* of the standard, the cap B and bolt *n*. 3rd. The draft rods *f f* and the truss rods *g*, in combination with the bridge ID. 4th. A trussed rod beam for a plough having a vertical and lateral adjustment upon the standard.

No. 13,162. Improvements in Butter Cans. (*Perfectionnements aux tinettes métalliques.*)

Thomas G. F. Dolby, Dulwich, Eng., 25th July, 1881; for 5 years.

Claim.—1st.—The combination of the can body having an aperture equal in diameter to the internal diameter of the body and provided with a rim arranged wholly beyond the wall of the can, and having a wax channel formed therein, and a device for engaging with said outer rim, and holding the cover in place. 2nd. The combination of the can body A, rim B containing wax channel C filled with plastic putty like wax composed. 3rd. A butter tin having formed in its lid, or cover, an aperture.

No. 13,163. Improvements in Repairing and Lining "Bessemer" Converters and Furnaces. (*Perfectionnements dans la manière de réparer et recréter les fourneaux et convertisseurs dits "de Bessemer."*)

Sidney G. Thomas, London, and Percy C. Gilchrist, Redcar, Eng., 25th July, 1881; for 15 years.

Claim.—1st. The method of repairing and making basic linings for Bessemer converters and other metallurgical furnaces by means of a liquid or semi-liquid mixture of lime and tar without ramming. 2nd. The method of manufacturing hard, shrunken lime for lining Bessemer converters and other metallurgical furnaces, by burning dolomite, or limestone, in a basic lined cupola at an intense white heat.

No. 13,164. Improvements in Dynamo or Magneto Electric Generators. (*Perfectionnements aux générateurs dynamo ou magneto-électriques.*)

Charles E. Ball, Philadelphia, Pa., U. S., 25th July, 1881; for 5 years.

Claim.—1st. In combination with two or more field magnets on opposite sides respectively, of an axial line, and with the opposing poles facing each other respectively of two or more coiled armatures arranged to revolve on said axial line each between the unlike and opposing poles of two separate magnets. 2nd. The combination of two or more revolving coiled armatures, and two or more field magnets on opposite sides of, and parallel with the axis of the armature, each of said armatures being within the inductive field or influence of the unlike poles of two or more magnets, so that, when the armatures are revolved they will operate in identical magnetic spheres, and generate identical currents. 3rd. In combination with two or more field magnets arranged respectively on opposite sides of an axial line, so that the north pole of one shall oppose, or force the south pole of the other, and vice versa, of two or more armatures arranged between the opposing poles of the two magnets respectively, and provided with suitable means for rotating in opposite directions simultaneously, so as to generate current of like polarity and energy. 4th. In a dynamo or magneto electric machine, in which two or more armatures rotate within the inductive influence of two or more field magnets whose unlike poles oppose each other respectively, the combination and arrangement of circuits and commutators, whereby the currents generated in the two armatures will both follow the same path. 5th. The combination of two or more field magnets, formed of a bar having three or more coils of wire placed thereon, of two or more armatures rotating within the inductive influence of said field magnets and circuits, or connections between said magnets and armatures, whereby said magnets may be charged by the currents induced in the armatures.

No. 13,165. Improvements on Insulating Electrical Conductors. (*Perfectionnements dans la manière d'isoler les conducteurs électriques.*)

Adolphus A. Knudson and Frederick L. Kane, Brooklyn, N. Y., U. S., 25th July, 1881; for 10 years.

Claim.—1st. An electrical conductor insulated by a covering of fibrous material which is coated or saturated or both, with waterproof flexible adhesive compound of Trinidad, or other natural asphaltum, mixed with paraffine oil, petroleum residuum, candle tar, or other non-drying and softening material. 2nd. An insulating compound for coating telegraphic conductors consisting of native bitumen or asphaltum, mixed with paraffine oil, petroleum residuum or candle tar.

No. 13,166. Improvement in Mariners' Compasses. (*Perfectionnement des boussoles marines.*)

Frederick A. Brown and John Lewis, Boston, Mass., U. S., 25th July, 1881; for 5 years.

Claim.—1st. The combination of the float and its magnetic needle, and sets of U-magnets, arranged below or against the bottom of such float, with the auxiliary magnetic needle above the float, or applied to the upper part or top thereof. 2nd. The combination of the open compass card, the float, the main and auxiliary magnetic needles, and the sets of U-magnets. 3rd. The combination of the float, and its central tubular standard, with the main and auxiliary magnetic needles, and the sets U-magnets; arranged with such float and standard. 4th. The

combination of the float, the tubular standard, the open compass card, the main and auxiliary magnetic needles, and the sets of U-magnets.

No. 13,167. Trough and Gutter Former.
(*Moule à auge et gouttière.*)

David Johns, Exeter, Ont., 25th July, 1881; for 5 years:

Claim.—1st. The combination of the frame pieces A B, and hinges C C. 2nd. The combination of the frame piece B, slotted arms G G and tubular bar H.

No. 13,168. Abrasive Belt. (*Courroie rubéfiante.*)

George H. P. Flagg, (Co-inventor with William Gordon.) Boston, Mass., U. S., 25th July, 1881; for 15 years.

Claim.—A sand paper belt, consisting of a strip of sand paper, the ends of which are joined together, the end *a* being derinded of sand, and the end *a'* skived and lapped over, and connected to the end *a*, thereby bringing the outer surfaces of the abrasive coating on a line at the joint.

No. 13,169. Improvements in the Manufacture of Head Coverings. (*Perfectionnements dans la confection des coiffures.*)

Robert Cream and George H. Hastings, Toronto, Ont., 25th July, 1881; for 5 years.

Claim.—A head covering or other article composed of two continuous bands sewn together, so that the whole of the outer band is exposed, while the inner band may be seen between the edges of the outer one.

No. 13,170. Improvements on Generators for Hydro Carbon Engines. (*Perfectionnements aux générateurs pour les machines à hydrocarbures.*)

Israel R. Blumenberg, Washington, D. C., U. S., 25th July, 1881; for 5 years.

Claim.—A combined apparatus for vaporizing bisulphide of carbon, or other hydrocarbon liquid, consisting of a bottom firing chamber or fire box, arranged under a heating chamber containing water or other suitable liquid and a space for steam, and a system of pendant tubes closed below, dipping into the water and open to an upper chamber, in which the bisulphide of carbon is supplied in a spray form to the pendant tubes, and the vapour is carried off by an outlet. 2nd. A cylindrical vessel divided into an upper vaporizing compartment, an intermediate heating compartment, containing a system of pipes dipped into water or other suitable liquid, and a lower fire box heating said liquid. 3rd. The construction of the heating chamber with the pendant tubes. 4th. The revolving spreader or nose as applied to the supply of hydrocarbon liquid to a system of pipes.

No. 13,171. Improvements on the Art of Cleaning and Opening of Spinners' Staple. (*Perfectionnements dans l'art de nettoyer et ouvrir la matière première des filateurs.*)

Chester A. Dresser, Southbrige, Mass., (Assignee of Samuel D. Keene, Providence R. I.) U. S., 25th July, 1881; for 5 years.

Claim.—1st. A separator grill provided with the adjustable bars K K K, in combination with suitable adjusting levers, whereby a rotary adjustment of the bars upon their axes is affected, and the grill as a whole is adjusted toward or from the beater. 2nd. The combination, with separator grill provided with independent adjustable bars K K K, of mechanism for adjusting said grill, both vertically, or nearly so, and laterally, as well as the several bars thereof upon their axes. 3rd. The combination, with the separator grill having bars K K K and the deflector L, of mechanism for adjusting the said grill bolt, vertically or nearly so, and laterally as well as the several bars thereof upon their axes. 4th. The combination, with a separator grill provided with independently pivoted bars K K K, of the form in cross section of right angled triangles with the longest side hollowed out of mechanism for adjusting the said grill, both vertically or nearly so, and laterally, and also the several bars thereof upon their axes. 5th. The above method of treating staple, namely, first forming it into a thick mass on a yielding roll, then allowing the beater to draw it, so as to form an apron which is cleaned by an air current, and finally detaching the staple from this apron by the continued action of the beater.

No. 13,172. Improvements on Churns. (*Perfectionnements aux barattes.*)

Jonah R. Hollis, Acadia Mines, N. S., 25th July, 1881; for 5 years.

Claim.—1st. The combination with a cream chamber A, having two dasher shafts I, of the shaft C, cranked at both ends, pitmans L, and slides F, working in guides G, secured to opposite sides of the churn, and connected by cross heads H to the dasher shafts, whereby the dashers are operated reciprocally. 2nd. The disk J, in combination with the handle K and crank or shaft C, for protecting the hand of the operator. 3rd. The churn cover *a*, provided with an opening covered by slide B.

No. 13,173. Improvements in Means of Supporting and Protecting Wires for Electrical Purposes. (*Perfectionnements dans les moyens de supporter et protéger les fils électriques.*)

The European Electric Company, (Assignee of Charles A. Hussey, New York, U. S., 25th July, 1881; for 5 years.

Claim.—1st. The combination, with a side walk curb, of wires or electrical conductors, and a conduit receiving the wires or electrical conductors, and affixed to the curb. 2nd. The combination, with a side walk curb, of wires or electrical conductors, and a conduit receiving

the wires or conductors affixed to the curb, and having a flat back bearing on the curb, and a convex front. 3rd. The combination, with a side walk curb, of wires or electrical conductors, a conduit receiving the wires or conductors, and affixed to, or in the curb, and branch conduits extending through the curb, and under the side walk to houses or other buildings. 4th. The combination with a side walk curb, of wires or electrical conductors, the conduits H, branch conduits H' and caps H².

No. 13,174. Improvements on Churns. (*Perfectionnements aux barattes.*)

John Campbell, Almonte, Ont., 27th July, 1881; (re-issue of Patent No. 4,177.)

Claim.—1st. A churn consisting of a chamber swung or oscillated so as to direct the flow of the cream to and fro in the form of a figure eight. 2nd. A swinging or oscillating churn to the chamber A having its end contracted to, or nearly to a point. 3rd. In an oscillating swinging or pendulously operating churn, the air openings or ducts D E. 4th. In combination with the chamber A, the cream braker F. 5th. In combination with the chamber A, and cream braker F, the knife G. 6th. In combination with the chamber A and air opening D E, the paddle wheel or fan H. 7th. The chamber A, suspended and swung in a plane horizontal to, or parallel with the points of suspension.

No. 13,175. Improvement on Manual Powers.
(*Perfectionnements aux machines à bras.*)

Jasper Bates, Thornbury, Ont., 25th July, 1881; (Extension of Patent No. 11,181.)

No. 13,176. Improvements on Steam Engines.
(*Perfectionnements aux machines à vapeur.*)

William Monk, Henry Monk, Hadlow Cove, and Charles W. Carrier, Levis, Que., 26th July, 1881; for 5 years.

Claim.—1st. In a steam engine having a second cylinder, for the purpose of utilizing the exhaust steam from a first cylinder, a valve L having two openings, in combination with five steam ports *a b c d e*, two of which connect with the first cylinder, two with the second cylinder and the fifth for the exhaust steam. 2nd. A valve L having the openings, in combination with five steam ports *a b c d e*, two of which connect with the first cylinder, two with the second cylinder, and the fifth of which is for the exhaust. 3rd. In two cylinders of different dimensions, the steam ports, steam ways and slide valve, which are arranged in such a manner that the steam, in the inoperative end of the second and larger cylinder, is conveyed to the operative end of the second and larger cylinder, for the purpose of increasing the power of the engine.

No. 13,177. Improvements on Soldering Machines. (*Perfectionnements aux machines à souder.*)

Charles R. Merriam and Lafayette Smith, Dover, Del., U. S., 26th July, 1881; for 5 years.

Claim.—1st. The combination of the following elements, to wit: a receptacle for holding the molten solder, a horizontal plate placed over said receptacle, and having an opening through which the angular edge of the can may dip to the solder, and a plate standard for steadying at the required angle to the solder. 2nd. The combination of the following parts, viz: a receptacle for holding the molten solder, a plate placed over the said receptacle, and having an opening through which the angular edge of the can may be passed, shoulders for steadying the can against lateral movement, and a plate or standard for steadying the can at the requisite angle to the solder. 3rd. The combination of the following elements, namely: the body A having the central flue *a*, a melting pot having a plate or cover, formed with a crescent-shaped opening *e*, and the products of combustion around, or in contact with the exterior of the melting pot. 4th. The combination of a melting pot, composed of the two parts *c c*, connected by a passage *a*, the flue *a* and package *f*. 5th. The combination of the adjustable hinged plate C, with the melting pot B having the crescent-shaped opening *e* in its top, whereby the angle of the can, with reference to the said opening and to the contents of the melting pots, may be regulated. 6th. The combination of the following elements, to wit: a heating or combustion chamber having an inlet or inlets for the admission of air to support combustion, and an outlet for the escape of the gaseous products of combustion, a melting pan composed of a casting constructed with a receptacle for holding the molten solder, and placed over the heating or combustion chamber, and an inclined plate C, for holding the can at the requisite angle with regard to the receptacle, for holding the molten solder. 7th. The combination of a burner, a heating or combustion chamber having inlets and outlets, a melting pot composed of a casting having a receptacle to hold the molten solder, and an inclined plate C, for holding the can in the requisite relation with the said receptacle. 8th. The combination of a heating or combustion chamber, having the air inlets *b* and *a* and the outlet B, a melting pot composed of a casting, having the receptacle *e* and the downwardly extending circumferential walls *c*, the inclined plate C and a burner. 9th. The combination of the adjustable inclined plate C, the set screw *n*, slotted slide E_u, set screw *u*, and a melting pot composed of a casting constructed with a receptacle for holding the molten solder. 10th. The device consisting of a block of copper, or other suitable heat retaining material having a recess *e*.

No. 13,178. Improvements on Machines for Breaking and Crushing Stones.
(*Perfectionnements aux machines à casser et écraser les pierres.*)

Philetus W. Gates, Chicago, Ill., U. S., 26th July, 1881; for 5 years.

Claim.—1st. A machine for breaking stone, crushing metal ore, or other like substances providing the shaft which carries the crushing head with a ball and a socket fulcrum bearing the interior wearing surface of which is chilled. 2nd. The revolving eccentric bearing box

of the crusher shaft provided with a top supporting flange. 3rd. The combination of the ball, and the chilled socket fulcrum bearing with the revolving eccentric bearing box. 4th. The combination of the crusher shaft having a ball, a chilled socket bearing, a crusher head, crushing concave and a revolving eccentric bearing box. 5th. The combination, with the crusher head provided with grooves and with the crusher shaft also provided with grooves, of rings for fastening the head upon its shaft, said rings being formed by flowing molten metal into the said grooves. 6th. A crusher shaft provided with a bearing box having an interior chilled surface approximating closely the form of hollow sphere, and a cylindrical exterior surface, not chilled, which bears directly upon the surface of a box formed in an arched cross bar or cap of the frame of the machine. 7th. A stone breaker, ore crusher, or reducing machine, having a crusher shaft provided with a chilled ball and socket bearing at its top, and a suspended revolving eccentric bearing box around the lower end. 8th. The combination of the shaft having a hard metal ball at its upper end, a segmental bearing box having an interior chilled surface, corresponding to the form of the bearing surface of the ball, a chilled metal crusher head of tapering form, a flaring crushing concave lined with chilled metal plates, a tubular metal frame having an oil step well at its lower end and openings at its sides and also having an inclined diaphragm with a flanged central passage through it, a loose collar between the crushing head and the flange of the diaphragm, and gearing for revolving the eccentric bearing box. 9th. The oil well forming an oil chamber and having a step block, and provided with a channel and passages in its walls, in combination with a flanged eccentric bearing box. 10th. The perforated or valved conical collar placed around the circular shaft and overhanging the top of the oil well, in combination with a grating shaft. 11th. The overhanging conical guard attached to the top of the gear wheel which revolves the eccentric bearing box. 12th. The guard at the upper outer edge of the oil chamber and outside of the channelled ledge thereof. 13th. The combination of the indication pipe, with the oil well having a channel and passages in its wall, an eccentric revolving bearing box and its shaft carrying a crusher head. 14th. The combination, with the stone breaking or ore crushing machine, of the keyed collar provided with a leverage arm on one side of its edge, a safety pin unsupported between its ends, and a toothed gear wheel or driving pulley. 15th. The combination of devices for making the casting of the hollow segmental bearing with temporary uniting webs and dividing splits, consisting of the winged pattern, the chilling ball having centering stem and sockets, parting plates, and a sand mould. 16th. The hollow casting for the segmental bearing provided with babbitt metal at its ends and in its splits, and with centering sockets whereby it is sustained and can be centered in a lathe and turned off on its cylindrical surface. 17th. The lead tool with inn metal stem for polishing the concave of the segments. 18th. The segmental bearing box for stone breaking and ore crushing machines, having an interior surface which is nearly in form of a hollow sphere and chilled.

No. 13,179. Adjustable Plough Point. (*Soc de charrue mobile.*)

Romulus R. Decker, Consecun, Ont., (Assignee of Jonathan L. Dawes, Bergin, N. Y., U. S.), 28th July, 1881; (Extension of Patent No. 6,366.)

No. 13,180. Improvements on Atomizers for Hydro-Carbons. (*Perfectionnements aux pulvérisateurs des hydro-carbures.*)

William W. Thomas, Jersey, N.J., U.S., 28th July, 1881; for 5 years.

Claim.—1st. The combination, with steam and liquid chambers and a nozzle tube extending from the liquid chamber, of a steam tube carrying a valve fitting to a seat at the rear of said nozzle tube, and extending beyond the valve so as to form between the two tubes, in front of the valve, a channel of annular transverse section. 2nd. The combination of the chambers B C, the nozzle tube D having the sharp-edged construction C and the stem tube E carrying the valve H and having the extension E'.

No. 13,181. Improvements on Corsets. (*Perfectionnements aux corsets.*)

Ira D. Warner and John C. Tallman, Bridgeport, Ct., U. S., 28th July, 1881; for 5 years.

Claim.—1st. The improvement in corset stiffeners, and in the manufacture thereof. 2nd. A protecting blade of tannic fibre adapted for attachment to a corset behind the busks. 3rd. Boring the sections, pressing the latter between heated plates while detached, then sewing the sections together. 4th. Introducing the stiffener laterally between the sheets forming the sections, then sewing the sheets close together, close to the edges of the bones. 5th. The combination of the sheets *b c* and intermediate bones extending to the edge of a binding *e* sewed through the bones.

No. 13,182. Improvements on Rowlocks.

(*Perfectionnements aux toltières.*)

Robert Kirkpatrick, Oshawa, Ont., 28th July, 1881; for 5 years.

Claim.—1st. The ribbed ferule G and the recessed ring D. 2nd. The combination of the ribbed ferule G and the recessed ring D with the stem A, fork B, pivots C bearing *b* and socket J.

No. 13,183. Improvements on Gloves. (*Perfectionnements aux gants.*)

Henry Urwick, St. John's Hill, Eng., 28th July, 1881; for 15 years.

Claim.—1st. The manufacture of kid and other gloves with the slit for the wrist band, and the slit where the thumb piece is to be seen in all as one continuous slit, and with the strip which forms the thumb piece prolonged to the welt at the extremity of the wrist band, and sewn at its side edges to the edges of the slit. 2nd. The attachment of elastic bands of vulcanized india rubber, or other elastic springs, across such strip at the wrist band.

No. 13,184. Improvements on Dumping Cars.

(*Perfectionnements aux chars à bascule.*)

Matthew Van Wormer, Dayton, Ohio, Simeon Brownell and Frank Brownell, Boston, Mass., U.S., 28th July, 1881; for 5 years.

Claim.—1st. The car bed as made with the cross sills and headers 11 extending from the longitudinal sills 2 5, and framed or fastened thereon, and with the shorter longitudinal sills 3 4, framed into the headers 11 and with the out side sills 6 7, the construction affording space at the ends of the car for the worm and gear or machinery, which operates the dumping mechanism, and ample clear space at the sides for dumping, and all without weakening the car bed. 2nd. The transom 8 applied above the frame of the car, in combination with the transome or braces a beneath the same and connected thereto, and secured under the inside sills 2 5, and the outside sills 6 7. 3rd. The rockers 9 constructed with central boss *b* and series of cogs *c c*, in combination with the convex bed 10 constructed with central socket *c'* and the sockets *c' c'*, for the purpose of dumping the car and causing it to right itself up again. 4th. In combination with the trucks and with the car bed or body of a tilting or dump car, the bar 11 for connecting these parts together and preventing their separation when the car is in motion. 5th. The dumping shaft or shaft 12, extending nearly the length of the car, in combination with a pulley thereon, and with the chain and series of pulleys or devices for actuating the same, and for connection with a hand lever or wheel and a connecting worm and gear, whereby such shaft may be operated. 6th. The combination, with the ends of the truck timbers, of the straps *i i* and their interposed guide pulley *h*, these straps being constructed and applied to each other and the truck timbers so as not to interfere with the proper action of the car springs. 7th. In combination with the swing doors, the bar or rod 15, one or more dogs or levers *k*, one or more slide latches *l* and their guides, the combination and arrangement being such that the inner ends of the dogs *k* may serve automatically to fasten or unfasten the doors. 8th. The swing doors, mortised in timbers or iron supports O at each end strengthened by truss rods *r r* and by metal cross bars or straps *p* having bevelled lower ends for engagements with the fastening latches, and provided with one or more straps or projections *q*. 9th. In combination with the car bed, the end posts 17 resting on the outside sills, and extending downward and secured to the outside of the same and extending high enough to permit the swing doors to be attached thereto, said posts being grooved or recessed at their inner corners to receive the end board *t* of the car flush with the inside of the posts, the posts and the board being held together by a connecting rod and braced by braces *u*. 10th. The centre posts 18 made and applied to the car bed, and assisting to support the swing doors, and strengthened by an inside metal plate *v'* and by a tightening rod *v* beneath the floor connecting the opposite posts. 11th. In combination with the car, the movable side bearing 19 provided at their point of suspension with a slot or keyway, whereby, whilst holding the car in position during transit and adapted to be swung up for dumping, they also prevent undue friction when the car is in motion around curves. 12th. In combination with the draw-box by the rocker 20 secured upon its under side. 13th. The brake mechanism consisting of the combination of the bar 21, arm 22 on the truck timber, arm 23, brake bar *f' g'*, rod or bar *i'*, lever *j'*, links *K'* and straps *l'*, and appropriate means for actuating the same from the car platform. 14th. The loose V-pulley *e'* made with deep sockets *3'* and the narrow-deeper grooves connecting such sockets, and whereby the chain may be held therein by its imbedded links without slipping when the pulley is revolved. 15th. The combination, with the pulley shaft, of the loose chain pulley *e'* and having V-teeth and an annular groove, of the V-tooth pulley *e* fixed to the shaft, and an appropriate mechanism for disengaging these pulleys, and to allow the car bed to dump its load suddenly or slowly. 16th. The combination of the pulley shaft and the loose and fast V-pulleys *e e'*, the shifting lever 24, rod *u'* and a hand lever. 17th. In combination with the linked chain *f* attached to both sides of the car bed, the guide pulleys *g'* made with the flat surfaces *ac* adapted for the links, and with the peripheral groove *e'*. 18th. In combination with the pulley shaft and with mechanism for operating the same, the pulleys *e e'* and chain, the guide pulleys *g g'* and guide pulleys *h h'*, the ends of the chain being fastened to the outside car cells or floor.

No. 13,185. Improvements on Sleeping Cars.

(*Perfectionnements aux chars dortoirs.*)

Adélar F. Martel and Charles A. Martel, Montreal, Que., 28th July, 1881; for 5 years.

Claim.—In a car or apartment, a berth suspended from above and provided with elevating mechanism, whereby the berth may be raised above the heads of persons occupying the apartment. 2nd. In a car or other apartment, a berth suspended from above and adapted to be raised bodily above the heads of occupants of such apartments. 3rd. A berth suspended by bands at its several corners, and a windlass adapted to wind up said bands and thereby elevate the berth. 4th. In combination with one or more berths, jointed end boards or partitions adapted and arranged to sustain the weight of the berths when lowered, and to fold inward above the berth or berths when elevated. 5th. In combination with a berth adapted to be raised or lowered, a sustaining end board or partition jointed to the berth frame and to an overhead support, and adapted to fold inward over the berth at an intermediate point. 6th. A folding partition provided at its points with means for throwing said joint out of line. 7th. A berth adapted to be raised or lowered, provided with locking bolts to engage with fixed portions of the car or apartment, and secure it firmly in both its elevated and depressed positions. 8th. A berth provided with folding end boards or partitions and suspended by flexible bands and means as shown for winding up the bands. 9th. In combination with a suspended berth, a fixed support connected with the floor of the apartment, and locking devices adapted to secure the berth to said supports. 10th. In combination with a fixed base provided with notched lugs, a suspended berth perforated to receive said lugs, and provided with locking bolts to engage therewith. 11th. A car seat having its seat portion hinged to its base and adapted to fold over. 12th. In a car seat, a seat frame provided with arc-shaped ribs, and mounted in a second frame provided with grooves of corresponding form, whereby the inclination of the seat may be varied. 13th. In a sleeping car or other apartment, a seat having the upper portion

hinged to its base, and adapted to fold down, whereby the base is adapted to receive and support a berth. 14th. The described seat consisting of the base provided with lugs on its upper face, and the upper frame hinged to said base and provided with locking bolts to engage with the lugs, whereby the seat may be turned down or turned up, and held in position for use. 15th. In a seat for use in sleeping cars and like apartments, a seat frame provided with arc-shaped ribs and mounted in grooves of corresponding form in a second frame, and locking devices adapted to hold the inner frame in its adjusted position. 16th. In a car or like apartment, a table adapted to fold within the wall of the apartment and form a flush surface therewith. 17th. In a car or like apartment having a recessed wall, a table consisting of the jointed leaf hinged at its inner edge to the wall of the car, and the brace jointed and adapted to fold upward and inward, whereby the table and its brace may be folded into the wall and made flush therewith. 18th. In combination with the folding table, a brace for supporting the same, jointed at its middle and a slide adapted to cross said joint and prevent its folding.

No. 13,186. Improvements in the Manufacture of Alumina. (*Perfectionnements dans la fabrication de l'alumine.*)

John Harrison, George L. Harrison and Thomas S. Harrison. (Assignees of Conrad Semper), Philadelphia, Pa., U. S., 28th July, 1881; for 5 years.

Claim.—1st. The process of manufacturing sulphate of alumina free from iron from ferruginous aluminous material, which consists in the addition to a solution of ferruginous sulphate of alumina, of prussiate of potash or other soluble prussiate and sulphate of copper or other soluble salt of a metal. 2nd. The addition to a solution of ferruginous sulphate of alumina of prussiate of potash or other soluble prussiate and sulphate of copper, or other soluble salt of a metal, and in the separation of the clear sulphate of alumina solution from the precipitates by suitable means, and in the concentration of said aluminous solution.

No. 13,187. Improvements in the Manufacture of Hollow Articles. (*Perfectionnements dans la fabrication des objets creux.*)

Frederick Walton, London, Eng., 28th July, 1881; for 15 years.

Claim.—1st. Moulding a composition of oxidized or solidified oil, and other ingredients upon forms of paper, thin sheet metal, or other material, by pressure in dies or moulds. 2nd. Moulding a composition of oxidized or solidified oil, and other ingredients upon a form, by pressure in dies or moulds, and then japanning upon the moulded surface.

No. 13,188. Improvements on Hoop Cutting Machines. (*Perfectionnements aux machines à tailler les cercles.*)

John Greenwood, Rochester, N.Y., U.S., 29th July, 1881; for 5 years.

Claim.—1st. The vertically acting knife and a vertically acting set of gauges, the gauges serving as stops to the plank, conforming to the edge of the same in all positions, and receding or withdrawing in line with the edge of the plank as the knife commences to cut, thereby supporting the timber and preventing splitting and shaking of the loop. 2nd. The combination, with the knife, of a rocking shaft and gauges located below the knife, the rocking shaft serving as the bed upon which the knife cuts, and to tilt the gauges, and the gauges serving as stops to the edge of the plank. 3rd. The combination of the rocking shaft F and the gauges I, the gauges extending through the rocking shaft, and moving up and down alternately with the rocking motion of the shaft by means of the crank arms *o o*. 4th. In combination with the shaft F and gauges I, the plate *g* set on one side of the gauges, and the coiled spring *r* on the other side, in the shaft. 5th. The combination of the rocking shaft F forming the bed upon which the knife cuts, and the tilting arms H H forming the table to receive the plank, the arms being pivoted to the shaft, and operated at the outer ends by the rods *m m*. 6th. The combination of the rocking shaft F, forming the bed upon which the knife cuts the tilting arms H H for holding the plank. 7th. The combination of the rocking shaft F forming the bed upon which the knife cuts the fingers H H attached to the shaft and rocking with it, and the apex L below the fingers for assorting the hoops. 8th. The combination, with the knife frame C, of the pitmans rock lever *t* provided with the segment gear *e*, the connecting rod *o 2* and the crank *o 2* for operating the shafts G P and the tilting arms H. 9th. The slot *g 2* in the bottom of the knife frame, for receiving the knife, and the set screws *h* for clamping the knife in place in the slot.

No. 31,189. Improvements on Ploughs.

(*Perfectionnements aux charrues.*)

Alonzo W. Hazelton, Brantford, Ont., 29th July, 1881; for 5 years.

Claim.—The combination of bar B attached to conical spindle C by keys or wedges.

No. 13,190. Improvements on Gang Ploughs.

(*Perfectionnements aux charrues à socs multiples.*)

Reuben Holgate, Neponsett, Ill., U. S., 29th July, 1881; for 5 years.

Claim.—1st. The combination with a telescopic axle A A² and plows, a telescopic bar A³ adapted to be raised and lowered to allow the plows to rise and lower and to adjust their depth of plowing. 2nd. In combination with telescopic bars A¹ A² and the plows, the bar A⁴ adjustably secured to the bars A¹ A² by yoke H and sliding plate *c*. 3rd. In combination with the bars A¹ A² and adjustable bar A³, the hollow shaft E having pinions *f f*, and *c'* of the bar A¹ having pinion *f*. 4th. The clutched sleeve I and cord *d*, in combination with the clutched end *a'* of the bar A¹ and with pinion *f*, and shaft E having pinion *f f*, and shaft *d* having pinion F. 5th. In combination with

the hinged bars P P *p p*, fixed block *p*, and plows L and O, the links P¹. 6th. In combination with a plate *k* hinged to the shaft K, the yoke K¹ and beam *b* connected as specified. 7th. In combination with the shaft K, yoke K¹, beam *b* and plate *k*, the standard *k* and cord *k* for adjusting depth of plowing. 8th. The lever *m*, bolt *m* and cord *m* in combination with the bar A¹, block J and shaft K to which the plow L is attached. 9th. The lever M and pawl *m*, in combination with the sleeve N having notched disk *n*, and with the shaft K. 10th. The detent *n* in combination with the sleeve *n*, notched disk *n*, pawl lever M, block *p*, link P¹, bars P P *p p* and plow O. 11th. The draft bars S¹ S² hinged to the block J and plow beam O¹ respectively, in combination with plows L O, bars R and equalizer bar S. 12th. The rods Q, in combination with plow beam O¹ and adjustable bar A¹ of a gang plow. 13th. In a gang plow, oscillating draft bars S¹ S², in combination with a draft bar S and with a plow L fixed to the wheel frame, and a plow O connected with the plow L. 14th. In a gang plow, a plow L hinged to the axle or wheel frame, and a plow O connected with the plow L by hinged connections P P *p p*, so as to permit the plows to approach each other in turning at the ends of furrows.

No. 13,191. Improvements on Printing Characters and in Composing Devices Therefor. (*Perfectionnements dans les caractères d'imprimerie et dans les appareils à composer.*)

Arthur H. Rogers, Springfield, Mass., U. S., 29th July, 1881; for 5 years.

Claim.—1st. The within described printing character *a* having one or more transverse perforations. 2nd. In combination, the slotted composing tube *b* and one or more of the transversely perforated printing characters *a*. 3rd. In combination, the composing bar *d* having sides of differential areas, and the printing character *a* perforated transversely to permit of passing said bar *d* therethrough. 4th. In combination, the solid composing-rod *i* and one or more of the transversely perforated printing characters *a*. 5th. In combination, the oscillating platen *e* of the self-inking stamp B, the series of transversely perforated printing characters *a*, the composing rod *i* and appliances for securing said rods upon said platen. 6th. The stamp *h* having the vertical ends *i* perforated to receive the composing rods *i*, in combination with said rods, and the series of transversely perforated printing characters *a*.

No. 13,192. Improvements on Paper Pressers for Type Writing Machines. (*Perfectionnements aux presses à papiers pour les machines à écrire en caractère.*)

John H. Pratt, Allentown, N. J., U. S., 29th July, 1881; for 5 years.

Claim.—1st. In a paper carrier for type writing machines, the combination with the printing cylinder B of the presser roller F, springs for pressing it toward the cylinder, a shaft on which said roller is mounted, and spring pressed paper bearing pieces. The combination, with the shaft A and roller F, of the springs C which are coiled to form loops to receive said shaft, and the shaft of the presser roller.

No. 13,193. Combined Car Brake and Coupler. (*Frein et accoupleur de chars combinés.*)

Simon Fairman, Baltimore, Md., U. S., 29th July, 1881; for 5 years.

Claim.—1st. A combined car brake and coupler having the following essential elements in combination, that is to say: a pair of brake shoes, consisting of shells conforming some what in shape to the edge of the car wheels, suspended by means of flexible bars to a plate adapted to have a sliding movement longitudinally of the car, and a coupler having a movable jaw which is depressed or opened to discharge the coupling-link upon the falling of the said brake shoes and the movement of the said plate consequent thereupon. 2nd. In combination with a pair of brake shoes D D suspended and provided with the connecting bar *a*, the swinging bar F and brake rod *b*, the said brake rod being fitted with suitable locking mechanism, whereby the said brake shoes may be sustained from contact with the wheels of the car. 3rd. In combination with the brake rods *b* having the projections *f*, the levers *e*, whereby the said brake rods may be locked and the brake shoes sustained in an elevated position. 4th. The brake rods *b* made extensible and compressible by means of the yielding blocks *b* or their equivalent. 5th. The car coupler G having, in combination, the fixed bumper *g*, vibrating jaw *h* and curved plate *n* forming a part of said jaw, whereby the said plate when the jaw is depressed, falls on the head of the links. 6th. The sliding plate C, roller *m*, weighted lever *k*, vibrating jaw *h* and fixed bumper *g*. 7th. A car brake consisting of a system of brake shoes adapted to be carried to, between the wheels of the car and the rails of the track levers, for sustaining the said shoes, and suitable mechanism for effecting the movement of the said shoes to and from the said wheels. 8th. In a car brake, a suspended shoe adapted to be thrown to beneath a car wheel, a car wheel combined with a weight which may be changed in its position and reference to the said suspended shoe and thereby influence the movement of the same towards or from the said wheel. 9th. As a means for operating an ordinary brake shoe of a car, a lever, one arm of which is connected to the said ordinary shoe, and the other arm thereof attached to a device adapted to fall to beneath a wheel of the car or between the said wheel and a rail of the track.

No. 13,194. Improvements in Apparatus for Purifying Feed Water for Steam Generators. (*Perfectionnements aux appareils à clarifier l'eau d'alimentation des générateurs de vapeur.*)

James H. Dane, San Francisco, Cal., U. S., 29th July, 1881; for 5 years.

Claim.—1st. An apparatus consisting of a chamber having its interior supplied with stones or other suitable substances, adapted to receive, distribute and purify a spray of water from above, which meets

and partially condenses a column of steam as it rises through the perforated bottom of the chamber, while the condensed and purified water is received into a reservoir below. 2nd. A apparatus adapted to receive and distribute a spray of water which, passing downward, meets a jet of upwardly moving steam within a chamber, the distributing and purifying material, consisting of cobble or other stones, pebbles or other substances, having a capacity to receive, retain and regulate the head of the stream, and receive and hold or retain the impurities with which they become coated.

No. 13,195. Improvements on Type and Space Holders. (*Perfectionnements aux porte caractères et blancs.*)

Louis K. Johnson, New York, U. S., 29th July, 1881; for 15 years.

Claim.—1st. A channel for containing a column of type or spaces, slotted transversely at its lower end and having its lower front edges cut away below the slot sufficiently to allow a prescribed number of types or spaces to be grasped and withdrawn laterally at any oblique angle. 2nd. A channel B for containing a column of types or spaces formed with the transverse slot *d* in the lower end of its right wall, the auxiliary slot *d'* formed in the lower rear portion of the left wall, both slots *d* and *d'* being in the same plane. 3rd. In a device for holding and presenting type and spaces in a prescribed manner such as described, a series of recesses and seats for the reception and support of the several channels for containing the types and spaces, arranged consecutively in advance of, and one above another. 4th. The standard A having a series of recesses *a* and seats *a'* formed in its upper portion in such manner that, when the channels B are placed in position therein, the respective ends of said channels will be supported relatively one above the other and successively in advance of each other, from the lowest to the highest. 5th. A channel B, for holding a column of type or spaces, constructed with one of its sides of less width than that of the slug or follower employed to retain and follow the types or spaces which may be contained within said channel. 6th. In combination with a channel B having one of its sides constructed of less width than the slug or follower employed within it, the combined slug and follower *g* having the spring *g* secured to the extreme edge of one of its sides.

No. 13,196. Improvements on Faucet Bushings and Faucets Combined. (*Perfectionnements aux dayots des robinets et aux robinets combinés.*)

Hiram F. Gaines, Rouses' Point, N. Y., U. S., 1st August, 1881; for 5 years.

Claim.—1st. A bushing for a faucet or pipe connection consisting of an exterior and interior screw-threaded bushing A and flange headed hollow screw plug B, provided with holes E and notches F. 2nd. A faucet H provided with notches G, screw portion K and collar I. 3rd. The combination of bushing A, perforated screw plug B, faucet H and coupling connection L. 4th. The combination of bushing A, perforated screw plug B and faucet H.

No. 13,197. Improvements on Musical Reed Instruments. (*Perfectionnements aux instruments de musique à anches.*)

Moses O. Nichols, Clyde, Ellis J. Mundy and George Butt, Norwalk, Ohio, U. S., 1st August, 1881; for 5 years.

Claim.—1st. In a musical reed instrument, the combination, with an exhaust bellows provided with main springs, of a supplemental spring or springs adapted to be brought into operation after the main springs have been partially compressed. 2nd. The combination, with an exhaust bellows provided with main springs, of a supplemental spring or springs having their upper extremities secured to the stationary bellows-board, and their opposite extremities, adapted to have free lateral bearing against the lower portion of the movable bellows board. 3rd. The combination with an exhaust bellows, provided with main springs, of a check spring connected with the movable bellows board and adapted, to resist the tendency of said main springs to press the movable bellows board outwardly. 4th. The combination with an exhaust bellows provided with main springs, of a check spring having its upper extremity connected to the stationary bellows board, and its opposite extremity attached by a flexible connecting device to the lower portion of the movable bellows. 5th. The combination, with an exhaust bellows provided with main springs, and a supplemental spring or springs, of a check spring connected with the movable bellows board and adapted to operate in resisting the tendency of the main springs, to press the said bellows board outwardly after the supplemental spring or springs have ceased to operate. 6th. The combination, with a reed chamber provided with a perforated wall, of a perforated registering disk, and a cord or band passing over a pulley formed rigid with the disk and means for moving said cord or band. 7th. The combination, with a reed chamber provided with a perforated wall and a perforated registering disk, of a cord passing over a pulley formed rigid with the disk, one extremity of said cord being weighted, and the opposite extremity being wound about a rotary shaft. 8th. The combination, with two reed chambers inclosing sets of different tone reeds, and tremolo devices attached to said chambers, of a knee lever and means which connect the latter to said tremolo devices. 9th. The combination, with two reed chambers respectively provided with tremolo devices and a rotary shaft, of flexible connections which extend from said tremolo devices to the shaft, and a flexible connection extending from the knee lever to the same shaft. 10th. The combination, with a set of reeds and a tone chamber in which the reeds vibrate, of an independent air passage formed of less sectional area than the tone chamber and communicating with its opening, and a stop valve governing the outer opening of said air passage. 11th. The combination, with a set of reeds and a tone chamber in which the reeds vibrate, of an independent air passage formed of less sectional area than the tone chamber and communicating with its opening, and a stop valve governing the outer opening of the passage, said passage inclining diagonally upward from its point of connection with the tone chamber. 12th. The combination, with a set of reeds and a tone chamber in which the reeds vibrate,

of an independent air passage formed of less sectional area than the tone chamber, and communicating with its opening, and a stop valve governing the outer opening of the passage, said passage at its point of connection with the tone chamber being formed of smaller size than at other points. 13th. The combination, with a set of reeds and a tone chamber in which they vibrate, of an independent air passage formed of less sectional area than the tone chamber, and communicating with its opening, and a stop valve governing the outer opening of the air passage, said passage being of smaller area at its point of connection with the tone chamber, and extending diagonally upward therefrom. 14th. The combination, with a set of reeds and a tone chamber in which the reeds vibrate, of an independent air passage formed of less sectional area than the tone chamber, and communicating with its opening, and a stop valve governing the outer opening of the air passage, said reeds having their stems secured to that portion of the tone chamber nearest its connections with the air passage, and having their free extremities located in that portion of the chamber which is of greatest height. 15th. The combination, with a set of reeds, of a tone chamber having its cross section similar to the longitudinal outline of an egg, the free extremities of the reeds being located in line with the greatest vertical dimension of the chamber, and their stems being secured in that portion of the chamber having contracted vertical dimension. 16th. The combination, with a set of reeds and a wind chest, of a tone chamber having a form, the cross section of which resembles the longitudinal outline of an egg, and an air passage, the front wall of which inclines upwardly and forwardly from the connection of said passage and chamber. 17th. The combination, with a set of reeds, a wind chest, and a tone chamber having a form, the cross section of which resembles the longitudinal outline of an egg, of a passage which connects the chamber with the open air, and a sounding wall adapted to receive the air vibrations which issue from the passage, said wall being formed longitudinally concave. 18th. The combination, with a set of reeds and a wind chest, of a tone chamber having the form shown, the cross section of which is practically triangular, and a passage which connects said chamber with the open air. 19th. The combination, with a set of reeds and a wind chest, and a tone chamber the cross section of which is triangular, of a passage connecting the chamber with the open air, and a sounding wall adapted to receive the impact of the air vibrations from the passage, said wall being formed with upper and lower longitudinal portions inclined relatively to each other. 20th. The combination, with a set of reeds, a wind chest and a tone chamber, the cross section of which is triangular, of a passage connecting the chamber with the open air and a sounding wall against which the air vibrations from the passage have impact, said wall being formed with upper and lower longitudinal portions, the lower portion including from the air passage, while the upper portion is of less width than the lower portion and inclines in an opposite direction. 21st. The combination, with a set of reeds which extend downward from the level F through the sub-bass register on the double diapason pitch, of a set of bugle reeds which also are voiced to a double diapason pitch, said sets of reeds being respectively located in different transverse portions of the instrument. 22nd. The combination, with a set of reeds, of a tone chamber having the forward portion of its roof inclining diagonally upward and rearward, and the rear portion thereof formed horizontal. 23rd. The combination, with a set of reeds, and a tone chamber having the forward portion of its roof inclining diagonally upward and rearward, of an air passage provided with a stop valve and communicating by a smaller intermediate passage with the forward portion of the tone chamber. 24th. The combination, with a set of reeds and a tone chamber, of one or more air compartments located in order, above the tone chamber, and provided with air connections, said tone chamber being formed closed, with the exception of its reed opening and its air opening into the chamber above. 25th. The combination with a set of reeds and a tone chamber of two air compartments located in order, above the tone chamber, and having alternate end connecting openings. 26th. The combination with a set of reeds and a tone chamber, of two air compartments located in order above the tone chamber, said two compartments being adapted to have independent communication with the open air. 27th. The combination, with a set of reeds, a wind chest and a tone chamber, of one or more air compartments located in order above the tone chamber, and having alternate end connecting passages, the upper chamber being provided with one or more small passages communicating constantly with the open air. 28th. The combination, with a front and rear row of reeds located in the same transverse plane, of a set of reed valves respectively formed in two transverse sections, the function points of the sections of the several valves being formed forward or backward of a given line according as each valve operates a reed of a front or rear row of reeds. 29th. The combination, with two longitudinal rows of sub-bass reeds, the reeds in one row of a set reed valves, each formed in one row being respectively located opposite the interspaces of the reeds in the other row, of a set of reed valves, each formed in two transverse sections, the junction point of the sections of the different valves alternating with each other forward and backward of an intermediate line. 30th. The combination, with a front and a rear row of reeds located in the same transverse plane, of a set of transversely sectional reed valves, said rear row of reeds having their valve openings formed longer than the valve openings of the front row of reeds. 31st. The combination, with a wind chest and an air passage, of a valve governing the latter, and bellows communicating with the wind chest and adapted to automatically close said valve. 32nd. The combination, with a wind chest, an air passage connecting therewith, and a valve controlling the passage, of a bellows communicating with the wind chest, a tappet formed on the movable board of the bellows, and a pin which is operated by said tappet to close the valve. 33rd. The combination, with a wind chest, air passage connecting therewith, and a valve governing the passage, of a bellows communicating with the wind chest, a spring which tends to maintain the bellows open, and a sliding pin adapted to be operated by the movable bellows board to close the valve. 34th. The combination, with a wind chest, an air passage connecting therewith, a valve governing the passage, and a spring tending to maintain the valve open, of a bellows communicating with the wind chest, a spring tending to maintain the bellows open, a sliding pin, and a tappet formed on the movable bellows board.

No 13,198. Improvements on Printing Telegraphs. (*Perfectionnements aux télégraphes imprimants.*)

The American Union Telegraph Company, New York, (Assignee of Henry Van Hovenbergh, Elizabeth, N.J.), U. S., 1st August, 1881; for 15 years.)

Claim.—The combination of a series of pins or stops mounted upon a revolving cylinder, a series of keys corresponding with said pins, each one of which, when depressed, engages with its corresponding pin and thereby arrests the motion of said cylinder at a determinate point in its revolution, a commutator or pole changer actuated by the shaft upon which said cylinder is mounted, a continuously revolving shaft which is normally coupled to the cylinder shaft by virtue of the attraction between an electro-magnet mounted upon one of said shafts, and its armature mounted upon the other, and a circuit breaker, which is brought into action by the engagement of any one of the keys with its corresponding pin upon the cylinder, to demagnetize said electro magnet, and disconnect the commutator shaft from its motor. 2nd. The combination of a series of keys, an intermittently revolving cylinder and its shaft, the movements of which are controlled by said keys, two wheels having an equal number of wave-shaped projections and recesses upon their peripherys and so mounted that the projections of one wheel are opposite to the recesses of the other, mechanism for preserving a constant relation between the revolution of said wheels and that of the said shaft, a commutator or pole changer, and a pin for actuating said commutator, which is caused to oscillate by the joint action of the wave-shaped peripheries of said wheels. 3rd. The combination of a series of keys, an intermittently revolving shaft, the movements of which are controlled by said keys, a rock shaft which performs a determinate number of oscillations during each revolution of said shaft, and two or more commutators for actuating separate circuits upon said rock shaft. 4th. The combination of a series of pins or stops mounted upon a revolving cylinder, a series of keys corresponding with said pins, each one of which, when depressed, engages with its corresponding pin and thereby arrests the motion of said cylinder and its shaft at a determinate point in its revolution, a circuit changer which is actuated by the cylinder each time that its motion is arrested by any one of said keys at its proper point and an auxiliary battery for increasing the normal strength of current in the main line which is put in action by said circuit changer. 5th. The combination of a series of keys, an intermittently revolving cylinder the movements of which are controlled by said keys, and a circuit changer which is automatically actuated by said cylinder to momentarily augment the normal strength of current in the main line, at one and the same determinate point in each and every revolution of the cylinder. 6th. The combination of a series of pins or stops mounted upon a revolving cylinder, a series of keys corresponding with said pins each one of which, when depressed, engages with its corresponding pin and thereby arrests the motion of said cylinder, a yielding mechanical connection between said cylinder and its driving axis, a ratchet wheel and click for preventing a retrograde motion of the driving axis. 7th. The combination of an intermittently revolving cylinder, a key which, when depressed, arrests said cylinder at a determinate point in its revolution, a cam which acts to maintain said key in a position to arrest the cylinder, and a spring which automatically throws said cam out of position and releases said key, when the latter is depressed by the operator. 8th. The combination of a non-polarized armature common to two electro-magnets, each of which electro-magnets has its two cores polarized oppositely to each other by a permanent magnet, and which electro-magnets are arranged with poles respectively facing each other upon opposite sides of said armature, with coils or helices upon the cores of said electro-magnets connected together in the same circuit in such a manner that a positive current traversing them tends to neutralize the normal or permanent magnetism of the electro-magnet on one side of the armature, and to increase that of the electro-magnet on the opposite side thereof, while a negative current will tend to produce the converse of said action. 9th. The combination of an electro-magnet or magnets for controlling the movements of a rotating pipe wheel, an independent electro-magnet in the same circuit for controlling the printing mechanism, and a shunt or branch circuit around the printing magnet only, which is momentarily closed at a determinate point, once in each and every revolution of the type wheel, by a device moving synchronously with the type wheel. 10th. The combination of a rotating type wheel, an electro-magnet or magnets for controlling the same, and a union stop which automatically locks the type wheel at the zero point and releases it by the action of the said electro-magnet when the latter is traversed by a current of increased strength. 11th. The combination of an electro-magnet or magnets for controlling the movement of a rotating type wheel, a yielding stop which limits the arc of vibration of the armature of said electro-magnet while the latter is under the influence of a normal current and a union stop upon the type wheel which is controlled through the yielding stop by increasing the normal strength of magnetism in the type wheel magnets. 12th. The combination of an electro-magnet or magnets for controlling the movements of a rotating type wheel, a yielding stop which limits the arc of vibration of the armature of said electro-magnet or magnets when under the influence of a current of normal strength, a union detent or stop normally resting in the path of the type wheel and adapted to arrest the same at the zero point in each revolution, and a connection from the said yielding stop to the union detent, which withdraws the same and releases the type wheel whenever the normal strength of current through the type wheel magnet is increased. 13th. The combination of a rotating type wheel, a union detent or stop adapted to arrest the rotation of said type wheel at the zero point in each revolution, an electro-magnet which withdraws said stop and releases the type wheel when the normal strength of the current traversing its coils is increased, and a circuit closer revolving synchronously with said type wheel and acting to momentarily increase the strength of current in said electro-magnet, simultaneously with the arrest of the type wheel by the union stop. 14th. The combination of a rotating type wheel, an electro-magnet or magnets, an armature, a yielding stop for limiting the arc of vibration of said armature, and a rock shaft carrying the said yielding stop, and also a union detent for locking the type wheel. 15th. The combination of a type wheel, a movable lever constructed in two parts, the platen of impression pad being mounted upon one part, and the armature of the actuating electro-magnet upon the other, and an adjustable point or connection between the two parts of the lever. 16th. The combination of a vibrating armature actuated by one or more electro-magnets a resilient arm having one of its ends rigidly secured to the axis of said armature, and stops which limit the vibration of the free end of said resilient arm in each direction.

No. 13,199. Improvements on Sewing Machines. (*Perfectionnements aux machines à coudre.*)

John M. Fair, (Assignee of Nicholas Meyers,) Buffalo, N. Y., U. S., 1st August, 1881; for 5 years.

Claim.—1st. The combination of a looping mechanism, a shuttle mechanism, a shuttle race in which both mechanism are arranged, and an adjusting device whereby either the hook of the looping mechanism or the shuttle can be placed in operative connection with the needle and an elastic chain stitch or a lock stitch be formed at the desire of the operator. 2nd. The combination, with the circular shuttle rack H, of the adjustable supporting plate h, a plate I provided with a hook i, and a plate K provided with a shuttle carrier K. 3rd. The combination, with the shuttle plate k provided with groove k¹ k² and mechanism whereby an oscillating movement is imparted to the plate K, of the hook plate I provided with pin i³. 4th. In a sewing machine adapted to make either a chain or lock stitch, the combination, with the looping hook i, of a device b whereby the loop is caught and held open. 5th. A shuttle race constructed with a vertical needle chamber r and an intersecting horizontal recess b¹ forming a projecting lip b², whereby the loop of the chain stitch is opened. 6th. The combination of the shuttle race provided with a stationary needle chamber l, and openings l¹ on both sides thereof, the movable block t¹ and mechanism for adjusting the same, whereby the openings l² can be closed when the shuttle is used, and opened when the hook is used. 7th. The combination of the horizontal shaft a and upright shaft C, the spherical eccentric e², sliding box e³ and rock arm e⁵ provided with open frame e⁴. 8th. The combination, with the rock shaft F, of an arm g² secured to the same, a reciprocating slide g¹ actuated by the arm g² and having an inclined projection g⁴, and a feed dog G provided with an inclined slot g¹. 9th. The combination, with the rock lever D and the rock shaft F, of an arm A secured to the shaft F, a connecting rod a² attached to the lever D and provided with a bearing f² which slides on the arm A, and a set screw and nut, whereby the connecting rod can be raised and lowered. 10th. The combination, with the shaft a, of the wheel B secured thereto and provided with a sleeve b, the pulley b¹ turning loosely on the sleeve b, set screw b³ and washer b⁴ provided with bolts b⁵ extending through the wheel and bearing against the loose pulley. 11th. The combination, with the spool post m provided with a supporting disk m¹ made concave on its upper side, of the loose clamping disk m² provided with tapering hub m³ and a thread guide m⁴. 12th. The combination of the post n, a stationary arbor supported by said post, the tension wheel N, adapted to turn on said arbor, the break m, spring n⁴ and eccentric. 13th. The combination, with the middle bar a and tension wheel N, of the grooved block O arranged in rear of the needle bar at such height that the thread will be clamped in the groove of the block, during the last position of the downward movement of the needle bar, and be lifted out of the groove, during the upward movement of the needle bar. 14th. The combination, with the shaft a, of the cam p⁴, lever p³, and clamping button p provided with spring p². 15th. The combination, with the head plate A provided with a stud q⁶, of the presser foot rod q¹ spring q², tightener q³ resting on the upper end of the spring and provided with hooks q⁵ adapted to engage with the stud q⁶. 16th. The combination, with the bar a and the rotating shaft a, of a crank and pin R, a block r¹ sliding in vertical ways r² and provided with a horizontal slot r³, the link r⁴ swinging on a fulcrum pair r⁵ secured to the block r¹, and the rod r⁵ connecting the upper end of the link with the bar r⁴. 17th. The combination, with the head of a sewing machine, of the arm P adjustably secured thereto with its upper end and provided, at its lower end, with a socket t², and the bar t³ held in the socket t² and provided with a clamp for the reception of the attachment. 18th. A shuttle having its body s constructed to receive the bobbin or ball of the thread and provided with a notch s² and opening s³, and a lid s¹ hinged to the body of the shuttle and provided with a tension disc s².

No. 13,200. Improvements in Grain Separators. (*Perfectionnements aux séparateurs des grains.*)

John A. Krake Buffalo, N. Y., U. S., 1st August, 1881; for 5 years.

Claim.—1st. The combination of an upper shoe with pivoted side hangers of unequal length and counter braces pivoted at one end to the frame of the mill, and at the other end to the shoe. 2nd. The combination of the lower shoe with the side hangers, the forward end of which is pivoted at one end to the upper shoe, and at the other end to the lower shoe in suitable brackets, one of which is provided with an elongated slot to allow for the vertical throw of the lower shoe by a jolter, and the rear hanger being pivoted to the side of the mill and the lower shoe, and the pivoted counter braces at the lower side of the shoe. 3rd. The combination of the upper and lower shoes, with the system of side hangers and counter braces as shown, the forward end of the lower shoe being suspended from the upper shoe, thereby partaking of its vertical motion at the forward end. 4th. As a means of imparting a double motion to the shoe for each separate motion of the rock shaft or pitman, a toggle joint located at any convenient part of the shoe and operated by suitable mechanism. 5th. As a means of imparting to the shoe, either a single or double motion for each separate motion of the rock shaft, or pitman, a crank arm provided with two projecting bars, suitable connections with the shoe, which connections can be changed at will for imparting either single or double motion to the shoe. 6th. The combination of the upper and lower shoes with a rock shaft to which is secured a crank arm for each shoe, provided with two projecting bars and suitable connections with the shoes, by means of which the single or double motion can be changed in either or both of the shoes. 7th. The counter braces pivoted at one end of the sides of the mill, and at the other end to the shoe. 8th. The slide m adjustable in the lower shoe, in combination with the apron l. 9th. The combination of the adjustable slide m with the removable partition n. 10th. The metal plate o¹ provided with inclined notches o² and secured in recesses in the sides of the shoe for the purpose of adjusting the front of the screens. 11th. The curved plate p³ provided with inclined notches and adapted to be secured in the forward end of the lower shoe. 12th. The curved metal brackets p driven in and through the side of the shoe, and projecting from the inside a sufficient distance to serve as a shelf or rest for the rear ends of the screen. 13th. The adjustable and removable deflector O adapted for use, in

connection with inclined notches in the side of the shoe, as a means of regulating the direction and intensity of the blast upon the screens. 14th. The screen provided with side pieces, the outer edges of which are raised above the screen, and the inner edges of which are flush with the screen, thereby forming an inclined surface.

No. 13,201. Improvements on Harrows.

(*Perfectionnements aux herbes.*)

Robert Johns and James C. Essick, Pana, (Assignees of Addison Low, Ohlman), Ill., U.S., 1st August, 1881; for 5 years.

Claim.—1st. In a harrow, the turning blades F, formed and bent as shown, and adapted to evenly turn and lay the earth cut by the front teeth or knives. 2nd. The blades F, constructed as described, in combination with the diamond-shaped sections and series of curved cutting knives D, alternately arranged as specified.

No. 13,202. Improvements on Gas Cooking Stoves.

(*Perfectionnements aux poêles de cuisine d gaz*)

Francis B. Whittemore, Toronto, Ont., 1st August, 1881; for 5 years.

Claim.—1st. In a gas stove provided with one or more gas jets, extending within the oven, and having outlets arranged to throw the gas upwardly in a vertical direction, or at any angle above the horizontal, the combination of a deflecting plate situated a short distance above the gas jets, and flanged as to form an open chamber to receive the gas discharged from the jets. 2nd. In a gas stove, a pipe or narrow chamber arranged around the top of the oven to receive the supply of gas after having been mixed with air, in combination with a series of pipes leading from the said chamber and perforated on their top side at any point above the horizontal, was to distribute and discharge the gas evenly over and against a deflecting plate situated a short distance above the pipes referred to.

No. 13,203. Improvements in Knitting Machines.

(*Perfectionnements aux machines à tricoter.*)

William A. S. Magrath, Yorkville, Ont., 1st August, 1881; for 5 years.

Claim.—In connection with a main driving spindle of a knitting machine, having a cross notched *d* and a circular slot *b* cut in its circumference near its outer end, a pulley or drum C keyed to the spindle B, near its inner end, and a handle D adjustably fitted to the spindle, in combination with the notched pin E actuated by the spring F, and operated in connection with the notch *d* and slot *b* on the spindle B.

No. 13,204. Improvements on the Manufacture, Embossing and Colouring of Panels and Mouldings.

(*Perfectionnements dans la confection, le bosselage et le coloris des panneaux et moulures.*)

Frederick Walton, London, Eng., 1st August, 1881; for 15 years.

Claim.—The manufacture of an embossed and colored fabric by spreading a plastic composition upon a suitable backing material, embossing or raising a pattern in relief upon the plastic composition by means of a suitably engraved roller, and then whilst the compound fabric is still upon the surface which supported it when it was embossed, printing colour onto the embossed surface by means of printing rollers so as to register accurately with the embossed or raised surface. 2nd. The manufacture of an embossed and colored fabric, by spreading a plastic composition upon a suitable backing material, embossing or raising a pattern in relief upon the plastic composition by means of a suitably engraved roller, and then in the same machine and whilst the compound fabric continues to be held, so that it cannot change its form, printing color onto the embossed surface by means of printing rollers, so as to register accurately with the embossed or raised surface. 3rd. The conduct of the process set forth in the first and second claiming clauses, causing the compound embossed fabric to be carried from the point where the raised pattern is produced by the action of the embossing roller through a cooling chamber in which, by a current of air or other cooling means, the composition is cooled and hardened to the printing roller or rollers, by which the color is applied to register accurately with the raised or embossed pattern. 4th. In the manufacture of an embossed and colored fabric, the application of a revolving and oscillating brush or roller travelling at the same speed as the surface of the printed fabric to dab it and soften the outlines. 5th. The manufacture of an embossed and colored fabric by spreading a plastic composition upon a suitable backing material, and afterwards producing a raised pattern in colors upon this compound fabric by applying to it colored composition by means of an engraved roller or rollers, the hollows of which have been previously filled with such composition or compositions. 6th. The manufacture of an ornamented fabric from a woven fabric and paper combined, by a suitable composition with which also the paper is surfaced by producing thereon an indented pattern applying colored composition over it, and finally removing the surplus composition so as to leave the color only in the lines of the pattern. 7th. The means of simultaneously embossing and coloring paper or other fabrics on which a layer of oxidized oil composition has been previously spread by the use of an embossing roller, the sunken pattern of which is colored by means of elastic color rollers, and into the hollows of which embossing roller so colored the paper is afterwards forced. 8th. The method of embossing and printing paper consisting in passing paper between a pair of embossing rollers, and whilst the embossed paper still remains on the roller on which is the raised pattern, applying color to the raised pattern, applying color to the raised parts only of the paper by means of elastic color rollers. 9th. The method of constructing, embossing or pattern rollers, by the use of interchangeable rings and mandrel, such rings being capable of being arranged upon the mandrel in different orders to form a variety of patterns. 10th. The machine as described for the production of narrow borders for picture frames, mouldings and the like. 11th. The machine for attaching embossed borders to wooden mouldings. 12th. The combination of paraffine wax or it may be other wax, with compositions of oxidized or solidified oil, by which the compositions are prevented

from sticking to the rollers by which they are spread or embossed. 13th. The use in the manufacture of coated fabrics, of a composition consisting of castor oil reduced by evaporation to a semi-solid condition, and mixed with other ingredients. 14th. The machines for the manufacture of panels in which a number of moveable dies corresponding to separate panels can be assembled upon the same roller or carrying surface. 15th. The method of ornamenting floor cloth by producing thereon an indented pattern, applying colored composition over it, and finally removing the surplus composition over it, and finally removing the surplus composition so as to leave the color only in the lines of the pattern.

No. 13,205. Improvements on Cultivators.

(*Perfectionnements aux cultivateurs.*)

Phillip F. Wells, Milford, Mich., U.S., 1st August, 1881; for 5 years.

Claim.—1st. A cultivator, the frame of which is constructed of a bar of metal bent to form the front and two sides in a single piece, and a bar joining its ends to form the rear of the frame, the latter bar so bent as to provide a central recess into which the operator may step to handle the lever. 2nd. A cultivator in which the side bars of the frame are united at their rear ends by a cross bar or bars which serve to brace the ends, and so bent as to project forward and from a re-entrant angle at the middle, and fastened at this point to another cross bar of the frame. 3rd. In a cultivator, a forward cross bar from which straining rods extend to the shovel standards, said cross bar stiffened and strengthened by a second parallel or nearly parallel bar and intermediate posts, the whole forming a truss. 4th. In a cultivator frame with parallel or substantially parallel sides, the said sides bent outwardly, at their rear ends and forming at these extremities supports for the rear shovel standards. 5th. The rear cross piece made to extend forward at the middle, and provided between the middle and its rear extremity with a short bend which constitutes a seat and support for the upper end of a shovel standard.

No. 13,206. Applications of Oxidized Oils to Panels, Mouldings, &c.

(*Applications des huiles oxydées aux panneaux, moulures, etc.*)

Frederick Walton, London, Eng., 1st August, 1881; for 15 years.

Claim.—1st. The novel application of oxidizing or solidified oil compositions to give to panels, slabs, mouldings, ornamental letters or signs for shop windows, and other articles of wood, or other hard and solid material, an impermeable moulded surface. 2nd. The novel application of oxidized oil or solidified oil composition, to give to cords of fibrous material an impermeable moulded surface.

No. 13,207. Improvements in Milk Cans.

(*Perfectionnements aux boîtes de lait.*)

John C. Gilpin, St. Mary's, Ont., 1st August, 1881; for 5 years.

Claim.—1st. The combination of a glass tube *a* with the milk pan. 2nd. The depressed cover *d*.

No. 13,208. Improvements on Veber-Meters.

(*Perfectionnements aux compteurs veber.*)

Thomas A. Edison, Menlo Park, N.J., U.S., 1st August, 1881; for 15 years.

Claim.—1st. A vebermeter consisting of two electro-depositing cells, one of which deposits with greater rapidity than the other. 2nd. The combination, with an electro-depositing cell, of a resistance whose increase compensates for the decrease in resistance of the cell. 3rd. The combination, with the cathode plate, of an electro-depositing cell, having a curved or hooked extremity, of a projection extending above the cells, and a set screw for attaching the cathode plate to the projection. 4th. The combination, in a vebermeter, of two electro-depositing cells having circular cathode plates of different diameters. 5th. The combination in a vebermeter, of two electro-depositing cells, one of which acts as a check to the others.

No. 13,209. Improvements in Window Awnings.

(*Perfectionnements aux tentes des fenêtres.*)

James E. Dwinelle, Baltimore, Md., U. S., 1st August, 1881; for 5 years.

Claim.—An awning made of sections which are capable of being arranged in various positions for shading and ventilating the room. 2nd. A window awning constructed of a double frame allowing it to be opened at either top or bottom, or both. 3rd. A window awning consisting of the bent bars *a* and *b* hinged together at their ends, and adapted to be adjustably attached to a window frame by means of screws *c* combined with the cover *B*, which is connected, at its upper and lower edges respectively, to the said bars *a* and *b*.

No. 13,210. Improvements on the Manufacture of Illuminating Gas.

(*Perfectionnements dans la production du gaz d'éclairage.*)

Francis J. Bolton and James A. Wanklyn, London, Eng., 1st August, 1881; for 5 years.

Claim.—The method of removing ammonia from coal gas by the dry way, by causing the gas to pass through a porous mixture of sulphate of lime and phosphate of lime, with or without admixture of phosphate of iron, the absence of free acid from the mixture, having been previously insured.

No. 13,211. Process of Manufacturing Glucose and Grape Sugar from Grain.

(*Procédé de fabrication de la glycose et du sucre de raisin, avec du grain.*)

Horace Williams and John L. Alberger, Buffalo, N. Y., U. S., 1st August, 1881; for 5 years.

Claim.—1st. The process of manufacturing glucose from grain, by cooking the meal in a solution of acid and water just strong enough to quickly convert the sugar producing elements of the grain into soluble dextrine, and to coagulate the gluten and albumen, but not strong enough to convert the dextrine into sugar, then filtering the solution thus obtained, for the purpose of separating from it the gluten, albumen and fibrous matter of the grain, then increasing the acid in the filtered solution and raising the temperature thereof, until the saccharification is completed. 2nd. The process of treating the refuse by filtering the coagulated gluten, albumen and fibrous matter from the primary solution of soluble dextrine, acid and water, then treating the gluten, albumen and fibrous matter thus contained with a weak solution of alkali and water, for the purpose of neutralizing the acid, then washing the albumen, gluten and fibrine with hot water, for the purpose of clearing and purifying it. 3rd. The method of crystallizing and treating grape sugar, by cooling and stirring it in the reduced syrup, a small percentage of powdered grape sugar, then washing the sugar with cold water, then pressing out the water and coloring matter, for the purpose of obtaining the sugar in a pure white cake. 4th. The process of washing off and eliminating the impurities of crystallized grape sugar by pressure or centrifugal force.

No. 13,212. Improvements in Oil Cabinets.

(*Perfectionnements aux réservoirs à l'huile.*)

John R. McLaren, jr., Montreal, Que., (Representative of Hugh A. Sharp, Hopewell, N.B.), 2nd August, 1881; (Extension of Patent No. 1,293).

No. 13,213. Improvements on Saw-Mills.

(*Perfectionnements dans les scieries.*)

Watson P. Widdifield, Siloam, Ont., 4th August, 1881; (Extension of Patent No. 6,386).

No. 13,214. Machine for Planing and Matching Lumber.

(*Machine à raboter et bouter la planche.*)

Edwin Benjamin, Chicago, Ill., 4th August, 1891; (Extension of Patent No. 6,406).

No. 13,215. Machine for Resawing Lumber.

(*Machine à refendre le bois.*)

Edwin Benjamin, Chicago, Ill., U.S., 4th August; (Extension of Patent No. 6,401.)

No. 13,216. Improvements on Weather Strips.

(*Perfectionnements aux bourrelets des portes.*)

Joshua Johnston, Lindsay, Ont., 6th August, 1881; (Extension of Patent No. 1,095.)

No. 13,217. Improvements on Feather Renovators.

(*Perfectionnements aux appareils à rafraîchir la plume.*)

Horace E. Rowe, John M. Hibstenberg and Charles O. Garrison, East Saginaw, Mich., 8th August, 1881; for 10 years.

Claim.—1st. In a device for renovating feathers, a double walled cylinder mounted on a hollow shaft, on which it rotates, in combination with close or imperforate pipes communicating with said hollow shaft outside of the cylinder, and passing through one head of cylinder, and extending through the interior of the same, to a point near the opposite end; and there communicating with its hollow or double wall. 2nd. In combination with the hollow shaft B and double walled cylinder A, the perforated pipes C having both ends communicating with the shaft B, and the close pipes E connected at one end with the shaft B, outside of the cylinder, passing through one head of said cylinder and communicating with the double wall of the same from the interior. 3rd. The double walled cylinder A provided with the perforated plates *h*, hollow shaft B provided with the perforated pipes *c* and close steam pipes E, valves *d*, opening *b* and its cover D, annular space *a* and pipes F.

No. 13,218. Combined Portemanteau and Shawl Straps.

(*Portemanteau avec courroies pour les châles combinés.*)

Diana S. Matthews, Adrian, Mich., U. S., 8th August, 1881; (Extension of Patent No. 6,424.)

No. 13,219. Improvements on Hay and Cotton Presses.

(*Perfectionnements aux presses à foin et coton.*)

William A. Pridgen, Saitillo, Miss., U. S., 8th August, 1881; for 5 years.

Claim.—1st. The combination of a tilting frame or baling chamber C, with a hinged head G, the said head being entirely separated and distinct from the chamber, and having secured to it a shaft, by means of which the follower is moved. The combination of a wagon having the frame B, secured upon its top, with the baling chamber C pivoted upon the top of the frame B, and which chamber when tilted backward has its lower end to rest solidly upon the ground.

No. 13,220. Improvements on Waggon Axles.

(*Perfectionnements aux essieux des wagons.*)

James Adams, Paris, Ont., 8th August, 1881; for 5 years.

Claim.—1st. In a trussed axle, the formation of a groove or chamber for the truss rod, in the lower side of the iron arm or skein.

No. 13,221. Improvements on Dish Handles.

(*Perfectionnements aux poignées des assiettes.*)

John B. Timberlake, Jackson, Mich., U. S., 8th August, 1881; for 5 years.

Claim.—1st. A detachable handle for vessels having the upper bent part A, one or more downwardly extending parts A² A², and the clamping parts A¹ A¹ connecting the separate parts A² A² upon one side, with the corresponding part of the handle upon the opposite side. 2nd. A detachable handle for vessels formed of two elastic wires joined together at the upper part A having the diverging parts A² A², and the connecting portions A¹ A¹. 3rd. A detachable handle for vessels having the bent U-shaped part A at the top and downwardly extending elastic parts A² A², and the parts A¹ lying in the planes transverse to the parts A² A². 4th. The detachable handle for dishes having the bent U-shaped part A, the dish supporting parts A¹ and the spring parts A² A², in combination with the sliding clamp B. 5th. A detachable handle for dishes having the elastic parts A² A², the connecting parts A¹ A¹ for engaging with and supporting the vessel, and the upper portion A to connect the downwardly extending elastic parts A¹ A¹. 6th. A detachable support for dishes, consisting of the upper part A, the elastic part A² and the feet or legs C extending below the vessel and attached to the elastic parts A, which clamp them in place upon the vessel. 7th. A detachable support for vessels, it consisting of legs or projections adapted to be extended below the vessel and to be clamped against it by means of elasticity. 8th. A detachable handle adapted to permanently support itself upon a dish, it being formed of a single piece of elastic metal bent into U-form to automatically press inwardly against the sides of the dish by elasticity and arranged to have the two legs diametrically opposite when attached. 9th. A detachable handle adapted to permanently support itself upon a dish and constructed to have two elastic legs *c* diametrically opposite when attached, and each provided with a clamp held automatically in engagement by the elasticity of said legs. 10th. The combination, in a detachable handle for dishes, of two diametrically opposite elastic legs C C and two clamps constructed to bear against the upper side and the lower side of a bead formed on a dish, and arranged to be held in engagement with said bead by the elasticity of the legs.

No. 13,222. Improvements on Waggon Wheels and Axles.

(*Perfectionnements aux roues et aux essieux des wagons.*)

Corydon Morton, Albion, Penn., U. S., 8th August, 1881; for 5 years.

Claim.—1st. In a waggon wheel hub consisting of a shell or body, and flange *d* of one piece of metal, said flange *d* having double dovetailed spoke sockets formed on the inner side thereof, in combination with movable flange *d* and bolts F. 2nd. The axle A A¹, the part A¹ being squared, in combination with thimble N having a squared opening for said part A¹ and the collar C with attaching strap or arm C¹. 3rd. The combination, with the axle A A¹, of the thimble N and wooden cores G. 4th. The combination, with the axle A A¹ and hub D, of the thimble N, nut a washer W and nut N.

No. 13,223. Improvements on Centre Boards for Boats.

(*Perfectionnements aux quilles mobiles des bateaux.*)

Montraville W. Atwood, Clayton, N. Y., U. S., 8th August, 1881; for 5 years.

Claim.—1st. A centre board for boats that is elevated or lowered by turning the revolving bolt on which it hangs. 2nd. The centre board consisting of the leaf F, provided with the rectangular slot *c*, the shoulder *a*, and the inclined and curved edge *b*, the leaf G provided with the double fan-shaped slot *d* and the stop *f*, and the flattened king bolt H passed through the slots of the said leaves, and provided with the lever handle H¹. 3rd. The combination, with the leaf F provided with rectangular slots *c*, rectangular shoulder *a* and inclined and curved edge *b*, of the leaf G provided with double fan-shaped slot *d* and slot *f*. 4th. The combination, with the centre board box E, the leaf F provided with the rectangular slot *c*, the shoulder *a*, and the inclined and curved edge *b*, and the leaf G provided with the double fan shaped slot *d*, of the slot *f*, of the flattened king bolt H provided with the lever handle H¹ and the nut I.

No. 13,224. Improvements on Railway Switches.

(*Perfectionnements aux aiguilles de chemin de fer.*)

Adélfard F. Martel and Charles A. Martel, Montreal, Que., 8th August, 1881; for 5 years.

Claim.—In a railway switching apparatus, the combination and arrangement of inner rail P of the main line, outer rail S of the main line, outer rail O of the siding, inner rail R, of the siding frog F, guide rails G, H and H¹, stationary point B, moving point A, rod L, switching lever M, projections N and N¹, post C, weight D and rope S¹.

No. 13,225. Improvements on Stove Grates and Fire Pots.

(*Perfectionnements aux grilles et aux boîtes à feu des poêles.*)

Alonzo W. Eldridge, Big Rapids, Mich., U. S., 8th August, 1881; for 5 years.

Claim.—1st. In combination with the grate C, the fire pot A provided with a ring B, supported below the bottom of said fire pot and forming a support of the grate, which may be rotated therein. 2nd. In combination with the stationary fire pot A, the dome-shaped grate C, rising vertically nearly parallel with the fire pot, and extending horizontally under and past the same. 3rd. In combination with the ring B, suspended by arms E, from the stationary fire pot A, the grate C, provided with a ring D, resting on said ring B and forming a bearing on which the grate may be rotated.

No. 13,226. Improvements in Telephones.

(*Perfectionnements dans les téléphones.*)

James R. Holcomb, John D. Holcomb and Charles F. Holcomb, Mallet Creek, Ohio, U. S., 8th August, 1881; for 5 years.

Claim.—1st. The combination of a box having an opening and two parallel concave convex diaphragms with air chamber between extending across said opening. 2nd. The diaphragm, in combination with the tension wires, and adjusting bars, located within the box, and

the wires connecting the diaphragm with the bars, whereby the movement of the latter, controls the position of the diaphragm. 3rd. An insulator consisting of a loop having an eye at one end, and a hook and eye at the side.

No. 13,227. Improvements on Warming, Equalizing and Ventilating. (*Perfectionnements dans le chauffage, la distribution et la ventilation.*)

Alexander C. Ridout, Hillsdale, Mich., U. S., 8th August, 1881; for 5 years.

Claim.—1st. The described heater and furnace for warming and ventilating an apartment, or series of apartments. 2nd. The double register N, connecting ducts M and I, with hot air chamber E. 3rd. The inverted double register F, connecting duct H, draft pipe Z and ventilator T. 4th. The combination with the stove A, and hot air chamber E, the double register N, ducts M and H, inverted double register F, draft pipe Z, ventilator T and smoke pipe J.

No. 13,228. Process of, and Apparatus for Making Ice. (*Procédé et appareil pour faire la glace.*)

John Miller, Whitesborough, N. Y., U. S., 8th August, 1881; for 5 years.

Claim.—The method of forming ice blocks for storage, consisting in exposing a tank or vessel of water to freezing temperature, until a crust of ice is formed around the sides and top of the tank of sufficient thickness to form a self-sustaining ice shell capable of containing the water in the centre thereof, then inverting the tank and removing the same from the ice shell, and completing the freezing of the water contained in said shell by exposure of the sides and bottom thereof, while retarding or preventing the formation of ice at the top.

No. 13,229. Steel Tempering Furnace. (*Fourneau pour recuire l'acier.*)

The Guelph Carriage Goods Company, (Assignee of John B. Armstrong,) Guelph, Ont., 8th August, 1881; (Re-issue of Patent No. 4,034.)

Claim.—1st. The process of hardening and tempering steel, placing the articles to be acted upon with a close retort or oven so arranged, in connection with a furnace, that the articles within the retort shall be heated by the diffusion of heat from the walls of the retort without being subject to the direct action of flames or heat from the furnace. 2nd. The combination of a retort or oven, having a door, independent of the furnace door and set within the said furnace, so as to drive the fullest benefit from the combustion, without the possibility of the flame or direct heat entering the retort. 3rd. The retort D, set within a furnace and provided at intervals around its entire length with partitions E¹, to form narrow passages or flues E, said flues being arranged or opening alternately, first on one side, and then on the other, so that they take the draught from, and deliver it at alternate sides of the furnace, thus equalizing the distribution of the heat over the whole surface of the retort. 4th. A furnace and retort with the doors H, consisting of the frames H¹, constructed to leave a margin of brick work between the inner edge of the furnace and retort openings, and the iron door H², fitted in with fire brick h. 5th. The combination and arrangement in a furnace for heating steel in the tempering, of furnaces A C, retort D constructed with alternate opening and discharging flues E, E¹, blast pipe F F² and doors H H¹ H² composed of iron and fire brick. 6th. A close retort or oven within a furnace, in combination with a pyrometer arranged to indicate the temperature of the interior of the closed retort containing the articles of steel being heated.

No. 13,230. Improvement on Railway Train Indicators. (*Perfectionnement aux indicateurs des trains de chemins de fer.*)

Thomas H. Norton, Salem, Mass., U. S., 8th August, 1881; for 5 years.

Claim.—1st. The combination, for operating the train indicator sheet B, such consisting of the rolls or rods C D, the horizontal shafts F F¹, vertical shafts I K, and their connecting level gears G G¹ H H¹, all being arranged in the case A and adapted in the manner described. 2nd. The combination for operating the hour and minute hands L M of the dial, such consisting of the four shafts N O T U and their four connecting gears P Q R S, arranged and applied as represented. 3rd. The combination of the train sheet and the dial and its hands with the case, and with means as described, for supporting and operating the train sheet, and for operating the hands of the dial, all being arranged as described. 4th. The combination of the case and its transparent dial, and hour and minute hands, and transparent train sheet, and mechanism for operating such sheet and hands, with means of illuminating both sheet and dial.

No. 13,231. Improvements on Machines for Sawing Lapboards. (*Perfectionnements aux machines à scier la planche à clin.*)

Simeon Babcock, Manistee, Mich., U. S., 8th, August, 1881; for 5 years.

Claim.—1st. In a machine for sawing lapboards, the means of feeding or adjusting the log to the saw consisting of a revolving bed or supports upon which the log rests, and to which it is dogged, said bed or supports being rigidly secured to a continuous shaft G, extending the whole length of the log and mounted on a frame adjustable laterally, in order to compensate for the fact that the centre of the log, and the centre of the shaft upon which the log supports rotate, are not quite coincident with each other, so that each cut may be made directly toward the centre of the log. 2nd. The combination of the shaft G with two or more head blocks, of supports rigidly secured thereto, and upon which the log to be sawed rests, and worm wheel and pinion for rotating and fixing the same at required distances. 3rd. The combination in a lap-board machine, of the main saw, sap saw, and severing saw, with the mechanism for feeding the log forward. 4th. The re-

volving head blocks or supports for the log, provided with a series of dogs for securing the log thereto, the same being adapted to receive and support a half log of any length, and rotated coincidentally with each other, by being secured rigidly to one continuous shaft, so that the half log may be turned or rotated.

No. 13,232. Improvements on Printing Mediums and Mechanism for Using the same. (*Perfectionnements aux moyens d'imprimer et aux appareils pour s'en servir.*)

Benjamin Day, West Hoboken, N. J., U. S., 8th August, 1881; for 5 years.

Claim.—1st. A printing film made as described, and consisting of a thin gelatine, or like plate, with an elastic face in relief, so as to permit an impression to be taken therefrom by the abrasive action of a stylus on its back. 2nd. A printing film or medium, for transferring lines, dots, stipples, and other configurations made of gelatine. 3rd. The combination with a printing medium frame of a device for adjusting the same longitudinally and transversely over the work. 4th. The combination with the printing medium frame, of devices for adjusting the same longitudinally and transversely over the work, and permitting the same to be swung from the work. 5th. The combination, with the frame to which the printing medium is attached, of longitudinally and transversely adjustable hinges. 6th. The combination, with the frame to which the printing medium is attached, of longitudinally and transversely adjustable hinges, and of a frame surrounding the stone or block. 7th. The combination, with the frame to which the printing medium is attached, of longitudinally and transversely adjustable hinges and of a transversely, longitudinally and vertically adjustable frame surrounding the stone or block. 8th. The combination, with the frame B, to which the printing film A is attached, of the clamps B¹, the spring pindle D¹, the screw pindle D² and devices in which these pintles fit. 9th. The combination, with the frame B, to which the printing film A is attached, of the clamps B¹, the spring pindle D¹, the screw pindle D², the clamp plates G and G², and the adjustable blocks E¹ and E², through which the above pintles pass. 10th. The combination, with the clamp plate G¹, provided with jaws F¹ of the block E¹, the screw T, the dial W and the pointer V. 11th. The combination, with the clamp plate G², provided with jaws F² of the block E², the screw pindle D², and the locking nut K, provided with a handle R. 12th. The combination, with the frame B, of the frame formed of the rails K¹ K² and K³, the screws M, the nuts M¹, the binding screws N and the standards M². 13th. A mechanism for using printing mediums, made as described and containing the following elements to wit: a frame to which the printing film is attached longitudinally and transversely adjustable hinges in this frame and a vertically longitudinally and transversely adjustable frame surrounding the stone, and carrying the adjustable hinges of the film holding frame. 14th. The method of making wider or thicker lines, by means of a printing film, consisting in printing one set of lines, and then adjusting the film, so that the second set of lines will be in contact with the first set, or partly over lap them whereby the thicknesses of the lines are increased.

No. 13,233. Apparatus for the Purification of Products Resulting from the Distillation of Wood. (*Appareil pour l'épuration des produits résultant de la distillation du bois.*)

Jean A. Mathieu, New York, N. Y., U. S., 8th August, 1881; for 5 years.

Claim.—1st. The combination or system of distilling vessels A B and C communicating with one another, and each having its perspective condenser, whereby the separation of the products of wood distillation is carried on continually and simultaneously. 2nd. The combination, with the distilling vessels A and B, having communicating pipe a¹, and with the condensing and combining vessel D, of the tank E and its stirrer T, whereby the more volatile products of distillation are freed from acid traces by passing them through a basic solution obtained from the products of the second distillation. 3rd. The combination, with the distilling vessel A, of the tank E, provided with a stirrer T, the column H, the U-tube K and the condenser M, whereby the distilled products are freed during one operation from acid, alkaline and watery impurities. 4th. The combination, with the distilling vessel A and condenser O, of the intermediate closed settling or purifying tank E connected, at the bottom, with the top of the vessel A by a bent pipe a, and, at the top, with the condenser O by a bent pipe G. 5th. The combination with purifying vessel E and condenser O, and with the pipe W connecting the same with the washing column H, of an inverted cup N, dropping into the liquid in an annular cup surrounding the mouth of the pipe W, to close and seal said pipe. 6th. The combination, with the retort C and drip catch Q, of an open curved pipe c connecting the retort with said drip catch, and a valve governed direct pipe g¹ connecting the bottom of the drip catch with the retort. 7th. The combination, with the dome or upper end of the upright washing column H, and with the upper end of the upright condensing tube K, of the transverse connecting pipe J, the drip catch J¹ encircling the mouth of the pipe K, and the return pipe V connecting the bottom of the said drip catch with a tray or shelf in the column H, and a draw cock j to discharge the same.

No. 13,234. Improvements in Grain Drills. (*Perfectionnements aux semoirs-traceurs.*)

Malcolm B. Williams and George Turner, Kalamazoo, Mich., U. S., 8th August, 1881; for 5 years.

Claim.—1st. In a harrow or cultivator, the curved spring teeth, extending back from their supporting beams over the next adjacent beam, as described for the object set forth. 2nd. A spring tooth drill, the spring teeth in combination with flexible or yielding grain tubes, resting against their rear face and co-acting with them, whereby the grain is thrown directly in the furrow made by said teeth, without retarding their oscillation. 3rd. The tooth beam provided with the holder, in combination with spring teeth secured in said holder and extending over the next adjacent beam, whereby a great contraction of the frame is effected and the teeth are readily adjusted. 4th. The tooth holder

with the lower edge of its removable side shouldered, and fitting under the mortise or groove of the base portion secured to the tooth beam, said holder being adapted to conform to changes of location. 5th. In a harrow provided with removable tooth beams, the combination of the beams, the strap or casting supporting the pulley, the pulley with its chain, and the studs and evener to which the chain is secured, as set forth, for the object specified. 6th. The removable tooth beams, the lever, the link rod and spring secured to the lever and to the stud, which is secured to the rear beam, all in combination as described. 7th. A spring or yielding tooth, or share, provided with the clamp tube holding device, in combination with flexible or yielding grain tubes, for the purpose specified. 8th. In a harrowing device provided with revoluble share beams, the serrated bars coupling the beams, and the set screw or bolt, in combination with means for operating said share beams, for the object specified. 9th. The combination of the following named elements, beams D D, straps C C, lever L, spring E, link rod f, bar a, pulley a, chain f, studs d¹ d² d³ and evener v.

No. 13,235. Improvements on Roller Skates.
(*Perfectionnements aux patins à roulettes.*)

Samuel Winslow, Worcester, Mass., U.S., 8th August, 1881; for 5 years.

Claim.—1st. The combination, with the hanger B provided with the coupling eyes D D arranged obliquely, of the roller frame composed of a bar I with a screw hole at its centre, and having bent ends K K, a bar M connected at one end to said bar I and provided at the other end with a pivot pin or journal O, which fits in one of the eyes D, and a screw P passing through the hole in the bar I and through the other eye of the hanger, thus forming one of the pivots of the roller frame. 2nd. The combination, with the hanger having the inclined plate E terminating in the eyes D D, of the roller frame having the bar M provided with the inclined face N and shoulder N¹, pivot pin or journal O and recess or depression M¹, the bar I connected to the said lever M and provided with a central hole, and bent ends K K, the roller shaft supported by said bent ends and the bar M, the screw P and the elastic cushion Q, arranged between the inclined plate E and the inclined face N. 3rd. The combination, with the hanger having the inclined plate E and eyes D D, of the hanger frame having the inclined face N, pivot O and a suitably supported screw arranged to pass through one of the eyes D, and the elastic cushion Q arranged between the inclined face N and plate E in position to be compressed by said screw. 4th. The combination, with the hanger and roller frame coupled together, of an intermediate elastic cushion and the inclined screw coupling pin or pintle adapted to act directly upon the cushion. 5th. In a roller skate, the combination of a roller frame or support having a central oil chamber, and spindles or axles provided with means for conducting oil to the bearing surface thereof, with the foot plate hangers and rollers. 6th. The roller frame having the oil chamber or reservoir and screw threaded sockets, the hollow and apertured axles or spindles having screw threaded inner ends and heads at their outer ends, in combination with the foot plate, hanger, and rollers turning on the axles. 7th. In a roller skate, a swivelling roller carrier provided with laterally projecting lugs arranged to strike suitable stops upon the bottom of the foot piece, and limit the rocking motion of said foot piece. 8th. In a roller skate, the suitably supported swivelling sleeve E having a flat upper surface and provided with lugs G G arranged to strike suitable stops on the bottom of the foot piece, in combination with the rubber block arranged between said flat upper surface and the bottom of the foot piece. 9th. In a double roller skate, the swivelling or vibrating standard, provided at its lower end with the elongated tubular bearing, in combination with the removable loose axle arranged in said bearing and the loose wheels mounted upon the ends of said axle. 10th. In a roller skate, the separate plates K K¹ carrying the swivel pin supports and provided with the recesses to receive the ends of the rubber blocks.

No. 13,236. Improvements on Fruit Cake Machines.
(*Perfectionnements aux machines à gâteaux aux fruits.*)

Walter S. Owens, Buffalo, N.Y., U.S., 8th August 1881; for 5 years.

Claim.—1st. Rollers h h¹ having a suitable platform or feed box to receive the dough, and the means for giving the required motions, a fruit box D₂ provided with air opening V at the bottom, a plunger E₁ and its accompanying mechanism for operating it, in combination with a second pair of rollers l l¹, a platform J₁ and an endless apron A₂, the whole combined for joint operation, whereby three sheets of cake material may be made and smoothly laid together as specified. 2nd. In a cake machine, two pairs of rollers h h¹ and l l¹, each provided with a suitable platform J or J₁, in combination with an apron or belt A₂, and a suitable means for giving each their proper movements, whereby two sheet of cake material may be made and laid together. 3rd. The combination of the rollers h h¹ and the endless apron A₂, with the fruit box D₂, and their operating mechanism as specified, for producing a single sheet of cracker or cake material covered with a thin layer of fruit. 4th. The combination of one pair of rollers h h¹, a fruit box D₂, a pair of rollers l l¹ and their operating mechanism, with an endless movable apron A₂, and a roller V₃.

No. 13,337. Improvements in Combined Door Plates and Mail Receivers.
(*Perfectionnements aux plaques des portes et aux boîtes à lettres combinées.*)

Henry Free and Hosea Y. Fuller, Lewiston, Me., U. S., 8th August, 1881; for 5 years.

Claim.—1st. A combined door plate and mail receiver composed of the spring hinges D having set screws G, the hanging rod E, the plate F having its edges flanged and its middle part cut away, the hinged inner plate I and the spring catch K. 2nd. The combination, with the flanged plate F, of the hinging wire E and the spring hinges D, whereby the plate F is hinged to, and held against the door. 3rd. The combination, with the springs D that hinges the plate F to the door, of the set screws G for regulating the pressure with which the plate F is held against the door. 4th. The combination, with the plate F, the hinging rod E and the springs D, of the hinged plate I and the spring catch K, whereby the name card is secured in place in the flange plate F.

No. 13,238. Improvements in Pails and Tubs.

(*Perfectionnements dans les seaux et cuvettes.*)

Valance E. Fuller, Hamilton, (Assignee of James S. McMurray, Toronto), Ont., 11th August, 1881; (Extension of Patent No. 6,454).

No. 13,239. Ventilator and Chimney Top.

(*Ventilateur chapeau de cheminée.*)

John B. Robertson, Toronto, Ont., 11th August, 1881; (Extension of Patent No. 6,440).

No. 13,240. Improvements on Horse Rakes.

(*Perfectionnements aux rateaux à foin.*)

Charles La Dou, Ballston, and James H. Melick, Albany, N.Y., U.S., 11th August, 1881; (Extension of Patent No. 6,438.)

No. 13,241. Improvements in Stove Pipes.

(*Perfectionnements aux tuyaux de poêles.*)

Henry Cook, Leadville, Col., U.S., 11th August, 1881; for 5 years.

Claim.—The combination, with a stove pipe joint or section B having a series of indentations in its rib D, of the joint A having an interior lengthwise groove, and the thumb-screw F and chain E, said screw passing through the latter and entering an indentation in joint B.

No. 13,242. Improvements on Water Closet Bowls.
(*Perfectionnements aux cuvettes des latrines.*)

George E. Hatch, Meriden, Ct., U.S., 11th August, 1881; for 15 years.

Claim.—1st. The method of making water-closet bowls from glass, consisting in blowing the glass in a mould, constructed with a cavity around the top corresponding to the flange required around the opening but broader than that flange, so that the glass will enter said cavity and form a corresponding cavity upon the reverse or inside of the top, then cutting away the upper edge of the flange projection into the cavity upon the inside, so as to separate the central part and form the upper opening. 2nd. A bowl for water-closets, made from glass blown in a mould. 3rd. A bowl for water-closets, made from glass blown in a mould, and protected by a metal casing or jacket.

No. 13,243. Improvements on Clamps for Harrow Frames.
(*Perfectionnements aux embasures des bâtis de herse.*)

Albert Wilcox, Clarence, Iowa, U.S., 11th August, 1881; for 5 years.

Claim.—The combination of the angular harrow-bars A B, the clamps F F¹ recessed, to receive them, and the shouldered tooth C having round screw threaded shank and nut, whereby the series of teeth may be adjusted and the tooth bars set rigidly at different angles.

No. 13,244. Improvements on Harvesters.

(*Perfectionnements aux moissonneuses.*)

Frank M. Waters and George H. Earnest, Springfield, Ohio, U. S.: 11th August, 1881; for 5 years.

Claim.—In a reciprocating cutter-bar, a vibrating arm and a connecting pitman, whereby said cutter-bar is actuated, in combination with a laterally movable and longitudinally adjustable support for said vibrating arm, whereby registration of the cutters may be adjusted. 2nd. The combination, with the gears D D rigidly attached to the drive shaft, of the double faced cylindrical bored non-rotating oscillation E rocking upon a fusiform sleeve or collar H upon said shaft. 3rd. In combination, with the said oscillator E, of the removable fusiform sleeve H upon the shaft of the drive gears. 4th. The rod or pitman connection L L¹ K from the main frame to the oscillator, to prevent the oscillator from rotating while permitting its oscillation. 5th. In suitable provisions I M N N to enable adjustment of the length of pitman or connecting rod L L¹ for the purpose designated. 6th. In combination with frame C, drive gears D D and the oscillator E, the pitman connections L L¹ thereof with the frame and the rigid projecting sickle driver F unconnected with the frame. 7th. In combination with the oscillator E and the drive gears D D, the washers G interposed between said oscillator and drive gears.

No. 13,245. Improvements on Pipe Couplings.

(*Perfectionnements aux manchons des tuyaux.*)

Stafford Lightburne, jr., San Francisco, Cal., U. S., 12th August, 1881; for 5 years.

Claim.—1st. The flange elastic packing rim f, in combination with the meeting ends of a pipe or hose coupling. 2nd. The end A of a hose or pipe coupling having the groove or channel a with the levelled projections b and the notches D, in combination with the male portion of the coupling having the lugs B with the triangular or inclined ends, and the spring locking levers c. 3rd. In a hose or pipe coupling, the female portion A having the groove or channel a with bevelled projections b and notches D, and the channel or groove d with its elastic packing ring, in combination with the lugs B and the locking latches C. 4th. In combination with a coupling having the male portion provided with lugs B and locking latches or levers C, and a female portion having the corresponding groove or channel a and the notches D, the device E having the tapering ends for compressing the latches simultaneously and releasing them from the notches. 5th. The cap J with the lugs Q and spring latches r to fit the groove a and the notches D of the coupling A, in combination with the cap M fitting over the cap J and having the inclined groove O into which the ends of the levers r enter, and the stem or spindle L provided with the springs n, by which it and the caps M are held or returned to a position which will allow the latches r to operate. 6th. The female portion A with its grooves a and d bevelled projections b and the elastic packing ring f, in combination with the male or entering portion of the coupling fitted to press against

the elastic packing ring and having the locking lugs B. 7th. The hose or pipe coupling having a collar W provided with projecting lugs W, which engage in the groove or channel X'X', upon the inner face of the outer end of the connecting coupling and held therein by the expansive force of an elastic packing, the said projecting portions X interlocking and forming a clutch coupling.

No. 13,246. Improvement in Telephones. (*Perfectionnement dans les téléphones.*)

The Canadian Telephone Company, Montreal, Que., (Assignee of George L. Anders, Boston, Mass. U. S., 12th August, 1881; for 5 years.

Claim.—1st. That improvement in the art or method of telephonic communication which consists in passing a main battery circuit through transmitting instruments adapted to cause variations in the resistance of the said circuit, and in locating receiving instruments in branches connected with the said main circuit on opposite sides of a suitable resistance. 2nd. A main battery circuit and a transmitting instrument therein adapted to cause variations in the resistance of said circuit, in combination with a local battery circuit connected on opposite sides of the transmitting instrument so that the local battery current passes through the transmitting instrument in the said direction as that of the main battery. 3rd. The receiving telephone apparatus consisting of a coil wound on a soft iron core provided with the usual diaphragm, and a battery placed in a local circuit passing through the said coil, and being a branch or shunt of the main line circuit connected on opposite sides of a suitable resistance. 4th. In an electrical system comprising a main circuit with resistance transmitters therein, and branches with receiving instruments and batteries therein, connected with the main circuit on opposite sides of said transmitters.

No. 13,247. Improvement in Telephones. (*Perfectionnements dans les téléphones.*)

The Canadian Telephone Company, Montreal, Que., (Assignee of Thomas A. Watson, Everett, Mass. U. S., 12th August, 1881; for 5 years.

Claim.—1st. In a telephone exchange system, a series of normally open subscribers circuit, all passing through a single central instrument and adapted to be closed at any subscriber's station, through an instrument at said station and the central instrument, and apparatus used in conjunction with said subscribers circuit adapted to operate or control an audible signal. 2nd. In a series of telephonic circuits, all passing through a single instrument at a central station to the ground, each circuit having one or more subscribers stations located therein, provided with a circuit closer normally open, to make a ground connection when desired, and condensers at the extremity of the said circuit to allow a variation in the tension of an electric current to affect the instruments in the said circuit, and prevent the passage of steady currents. 3rd. The combination, with a single telephonic instrument, of a series of telephonic circuits, all centering in and passing through the said instrument, said circuits being normally open, or practically open with respect to the currents employed for telephonic communication. 4th. The combination of a number of line circuits centering in a union or common instrument circuit at a central office, and adapted to prevent the division of currents from one circuit into the others by polarized relays, located at the ends of said circuits and operating to ground the latter as required, through branches of small resistance.

No. 13,248. Improvements on Spring Hoes. (*Perfectionnements aux hoes à ressort.*)

Jesse O. Wisner and Wareham S. Wisner, (Assignees of Richard B. Sheldon, Brantford, Ont., 12th August, 1881; for 5 years.

Claim.—In a spring hoe in which the hoe is held in working position by the action of a spiral spring, a bell crank with one of its arms connected and pivoted to the bottom edge of the drag bar, and its other arm connected to the spindle of the spiral spring, the combination of a link connected at one end to the hoe and extending in an upward oblique direction to the bell crank, to which it is connected by a pin passing through the centre hole of the bell crank.

No. 13,249. Improvements on Glass Furnaces. (*Perfectionnement aux fourneaux de verre.*)

Carl F. Schad, Bellefonte, Penn., U. S., 12th August, 1881; for 5 years.

Claim.—1st. The combination, in a furnace, of a combustion-chamber, composed of two arches having an intervening space connected with a blast supply, the inner arch being provided with apertures leading from the space to the combustion-chamber, whereby a blast of air may be supplied to said combustion-chamber. 2nd. In combination with the combustion-chamber, the removable section located in front of the lower part of said combustion-chamber. 3rd. In combination, with the combustion chamber, the hollow front section connected with a suitable blast supply, and provided with apertures in its inner wall whereby a blast of air may be directed forward into the combustion chamber. 4th. In combination with the ash pit of the furnace, the blast pipe leading from a blast supply up through one of the escape flues, then traversing the tops of the oven, then down through the diagonally opposite flue, and into the ash pit, the said pipe being provided with a damper or valve. 5th. In combination with the arches forming the combustion chamber, a blast pipe leading from a suitable blast supply up through one of the escape flues of the furnace, then traversing the top of the oven and connecting with the space between the arches, the said pipe being provided with a valve or damper.

No. 13,250. Improvements on Grain Sieves. (*Perfectionnements aux cribles à grain.*)

Samuel McClure, Watford, Ont., 12th August, 1881; for 5 years.

Claim.—The combination of plates BC having perforations D, holders F, screws H, buttons G, wires E and frame A.

No. 13,251. Improvements on Circular Sawing Machines. (*Perfectionnements aux scieries à scies circulaires.*)

Calvin Bryant, Reeve, N. H., U. S., 12th August, 1881; for 5 years.

Claim.—The combination of the griper G with the adjustable feed roller F.

No. 13,252. Improvements in Hydro-Carbon Furnaces. (*Perfectionnements aux fourneaux à hydro-carbures.*)

William W. Thomas, Jersey, N. J., U. S., 12th August, 1881; for 5 years.

Claim.—1st. The combination, with a furnace, a perforated retort arranged therein, and means for introducing steam and hydro-carbon liquid into said retort, of partition plates above and below said retort between which gas may escape from retort and the upper one of which is constructed with apertures, and air tubes projecting upwards from the lower partition plate, through which air may pass upwards to combine with the gas, and which are heated by the gas. 2nd. The combination of the furnace A, the perforated retort B, the atomizer C, the plate d and tubes g projecting upwards from said plate, and the plate f having apertures h.

No. 13,253. Improvements on Self-Lubricating Wheels. (*Perfectionnements aux roues à lubrification automatique.*)

René C. E. Ganjot, Marmora, Ont., 12th August, 1881; for 5 years.

Claim.—The combination of the chamber B, spring E, and valve F.

No. 13,254. Improvements in Carriage Springs. (*Perfectionnements aux ressorts des voitures.*)

Robert M. Robertson, Montreal, Que., 12th August, 1881; for 5 years.

Claim.—In a spring composed of homogeneous rods lying closely side by side and in each half vertically over each other.

No. 13,255. Three-Wheeled Dray. (*Camion à trois roues.*)

John J. Carnell, Halifax, N. S., 12th August, 1881; for 5 years.

Claim.—1st. The combination of the fore end of the dray and the angle iron ring D, with the angle iron ring E placed in an inverse position to the first and made to fit therein. 2nd. The combination of the fore end of dray angle iron D and a ring having a horizontal web made to fit within the first, with the axle of the front wheel and hangers passing over said axle and under the inner ring to which they are secured. 3rd. The combination of a front wheel of a three-wheeled vehicle, its axle and hangers at each end thereof secured to the underside of inner ring E, with thills or tongue braces K pivoted to said axle. 4th. The combination of the front wheel of a three wheel dray, its skein provided with an oil hole at each end, and the axle C with adjustable collars A. 5th. The combination of the front wheel of a three wheel dray and its axle, with thill braces K and each provided with an eye K' encircling said axle.

No. 13,256. Improvements on Middlings Purifiers. (*Perfectionnements aux épurateurs des gruaux.*)

Kingsland Smith, St. Paul, Minn., U. S., 12th August 1881; for 5 years.

Claim.—1st. The combination, with a feed hopper and cantboards, of a moving electrified surface to attract and remove the bran from the falling middlings. 2nd. In a revolving roller, a cushion and a scraper to remove the bran from the electrified surface, in combination with means for supplying a thin stream of middlings so as to fall vertically near the electrified surface. 3rd. In a middlings purifier, the combination with revolving electrified rollers, of a frame supporting the axis of rollers, and mechanism for moving the frame, and rollers laterally, to adjust the same, and means for supplying a thin vertical strata of falling middlings. 4th. The combination, with the revolving roller in a middlings purifier, of a cushion against which the roller revolves, means for adjusting the cushion, to regulate its pressure, a scraper to remove the bran, and a spring to press upon the scraper.

No. 13,257. Improvements in Smoke Consumers and Gas Generators. (*Perfectionnements aux foyers fumivores et générateurs à gaz.*)

Charles McWilliam, Montreal Que., Hascal A. Hogel, New York, N. Y., U. S., and Alice F. Foster, Cowansville, Que., 12th August, 1881; for 5 years.

Claim.—1st. In a furnace or steam generator, a pipe, or flue arranged to discharge smoke and unconsumed gases, mingled with heated air and steam, from a branch pipe extending along the inside front of the fire chamber, or above the door. 2nd. The combination, with the pipe A and branch pipe A', of the chamber B having an opening in its upper side. 3rd. In combination with the chamber B and pipe A, the pipe E receiving air from underneath the grate. 4th. The steam pipe D having attached thereto T-pipes d, in combination with the branch A' of the flue A. 5th. A chamber arranged near the budge, adapted to receive the products of combustion, and to deliver the same to a retort or apparatus for manufacturing gas. 6th. In combination with the chamber B the steam pipe C. 7th. The dampers a and e, in combination with the pipe A and air pipe E operated simultaneously.

No. 13,258. Improvements in Nut Locks. (*Perfectionnements aux arrête-écrous.*)

Charles H. Denison and Erastus F. Mead, New York, N. Y., U. S., 12th August, 1881; for 5 years.

Claim.—The bolt A having the screw threads b and cam-shaped or eccentric shank C, in combination with the nut B and the jam-nut D having the cam like or eccentric bore or interior, corresponding in shape to the cross section of the shank c of the bolt.

No. 13,259. Improvements on Boots. (*Perfectionnements aux bottes.*)

Julius M. Hospitalier, Parsons, Ks., U.S., 12th August, 1881; for 5 years.

Claim.—1st. In the construction of a close fitting boot leg, the combination, with each other and with the vamp and quarter of the boot, of a front piece made to overlap the back piece on each side of the leg, the two being fixed and secured together, at top and bottom, but left free to spread apart the remainder of their length. 2nd. The combination, with the edge of the front piece in a boot leg made, adapted and arranged to overlap its back piece of transverse elastic strips secured to the back piece, to pass under the top of the front piece, and engage and confine the same in the manner described. 3rd. The combination of the front and back piece in a boot leg with open overlapping joints, in which the back piece passes under the edges of the front piece, which so curve to the front at their lower end as to intersect the vamp in front of the seam between the vamp and quarter.

No. 13,260. Improvements on Seal Locks.

(*Perfectionnements aux serrures scellées.*)

Adélaré F. Martel and Charles A. Martel, Montreal, Que., 12th August, 1881; for 5 years.

Claim.—1st. In a car seal lock having the spring latch D and seal aperture E, the shield C¹. 2nd. A car seal lock having the shield C¹ in combination with the spring latch D, seal aperture F and door jam B. 3rd. In a railway car door, the door jam B in combination with the catch G, spring latch D and shield C¹.

No. 13,261. Improvements on Door and Sash Clamps. (*Perfectionnements aux mordaches des portes et des croisées.*)

Atley W. Ale, Caro, Mich., U.S., 12th August, 1881; for 5 years.

Claim.—1st. The supporting bars *d i*, movable clamping slides *h e*, levers *l m*, rock shafts *a f*, provided with crank arm links *l m*, and operating lever *n*, combined with the supporting frame A. 2nd. The combination of the movable bars *d i*, clamping slides *h e* and ear pieces *k d*, with the supporting bars *c*, and lever mechanism for simultaneously moving the clamping slides. 3rd. The connecting rock shafts *a f* provided with crank arms, the levers *l m* and links *l m*, in combination with the apertured bars *c d*, and clamping slides.

No. 13,262. Improvements in Water-Closets.

(*Perfectionnements dans les latrines à l'eau.*)

Michael J. O'Rielly, Buffalo, N. Y., U. S., 12th August, 1881; for 5 years.

Claim.—1st. The combination, with the bowl A and water supply pipe E, of an air vessel J, a lifting device L *m*, a valve F, operated by the seat, whereby the pipe E is connected with the vessel J, when the seat is depressed and the air vessel connected with the lifting device when the seat is raised, a valve G which is actuated by the water pressure in the lifting device, and a pipe *n* through which the water escapes from the lifting device. 2nd. The combination in a water closet, of a bowl A, water supply pipe E, valve F, provided with two valve discs and seats opened or closed alternately, air vessels J connected with the chamber *f*, lifting device L *m*, connected with the chamber *f*, water escape pipe *n*, lever *o* actuated by the lifting device and connected with the valve G, the latter being interposed between the water supply E and the bowl A, and the seat D, whereby the valve F is operated. 3rd. The combination, with a lifting device L *m*, of the pipe *n* and the stop cock *n*, whereby the escape of water from the lifting device is regulated. 4th. The lifting device composed of a chamber L and a flexible diaphragm *m*. 5th. The air vessel J cast in one piece, with a receiving hopper C. 6th. The valve G, composed of the chambers *q r* *q*, valve seats *r* *r*, valves R R¹, whereby the seats *r* *r* are alternately opened and closed, the chamber *q* having no outlet except the valve seat, whereby the cushion is formed which prevents the sudden closing of the valve R.

No. 13,263. Improvements on Ice Ploughs.

(*Perfectionnements aux charrues à glace.*)

Samuel Richards, Philadelphia, Pa., U.S., 14th August, 1881; for 5 years.

Claim.—1st. The combination, with the bow of a steamboat, of an inclined flat platform for raising the ice out of the water, and the wedge shaped device *t* for directing the raised ice aside on the top of the adjacent ice. 2nd. The adjustable lower scorers *m* and *m*¹, in combination with devices. 3rd. The adjustable upper scorers *t t*¹ *t*², and the adjustable lower scorers *m* and *m*¹, in combination with devices for raising and lowering the same, for the purpose of scouring the upper and under surfaces of the ice simultaneously in advance of the front edge of the inclined platform. 4th. The detachable swinging deflector, in combination with the inclined platform and the wedge *t*, for the purpose of throwing on either side at will all the ice raised by said platform. 5th. In combination with frame *b b*¹ *b*² and the bars *h* forming an open inclined flat platform, the float *m*², for assisting to support said platform. 6th. The frame *b b*¹ *b*² and bars *h*, constituting an inclined platform, the shaft *d*, upon which said platform hinges, the abutments *q* and the chain F, with its hoisting attachments located on the boat, forming a combination which secures for said platform the capacity of being raised or lowered as required. 7th. The combination of the frame of the inclined platform with the drum *i*² and the worm *J*², for raising and lowering the said platform and its fixed attachments.

No. 13,264. Improvements in Shaft and Axle Bearings. (*Perfectionnements aux coussinets des arbres de couche et des essieux.*)

Joseph N. Bitting, Camden, N.J., U.S., 14th August, 1881; for 5 years.

Claim.—A ring or box *a*, the central opening of which is bounded by a series of segmental lugs, against the crowns of which the said shaft or axle has its bearing, said lugs being formed integral with the box or ring.

No. 13,265. Improvements on Clothes Wringers. (*Perfectionnements aux essoreuses à linge.*)

Orvis D. Hudson, Wanpou, Wis., U.S., 14th August, 1881; for 5 years.

Claim.—In the right angled springs F F, pivoted to the upper front corners of the machine, carrying at their rear ends the roller H, and having their lower ends connected by a cross piece I having thumb screw J, for regulating pressure and securing the machine.

No. 13,266. Improvements in Rotary Ploughs.

(*Perfectionnements aux charrues rotatoires.*)

Charles R. Foster, Chicago, Ill., U.S., 14th August, 1881; for 5 years.

Claim.—The cranked axle F, diagonally supported in bearing on the frame of the machine, and having journalled on its outer end the rotary disk plough E, in combination with the hand lever T, keyed to the axle F and working in connection with a quadrant J. 2nd. The cranked axle F, diagonally supported in bearings on the frame of the machine, with a rotary disk plough E journalled on its outer end, and a hand lever I keyed to it, in combination with the axle G, bent from the bearing, supporting it on the frame of the machine, so as to throw forward the rotary disk plough E journalled on the end of the axle G, which axle is connected to the axle F by the gear H. 3rd. In a revolving disk plough, in which the ploughs are journalled upon adjustable axles, the combination of a scraper R secured to the axle of each plough and extending over the cutting edge thereof.

No. 13,267. Process of Manufacturing Syrup and Grape Sugar from Corn and other Grain. (*Procédé de fabrication du sirop et du sucre de raisin avec du blé d'inde et autres grains.*)

John L. Alberger, Buffalo, U.S., 14th August, 1881; for 5 years.

Claim.—1st. Manufacturing glucose from grain by the following process, viz: first, treating the meal or grain in hot water and steam only until all its starch is converted into a solution of soluble dextrine and water, and its gluten and albumen coagulated; second, separating the solution of converted starch and water from the coagulated albumen, gluten and refuse of the grain by filtration or straining; third, saccharifying the converted starch after its separation by filtration, by means of acid, or malt liquor, and heat. 2nd. Washing the converted starch out of the centrifugal or filter with hot water, and using the said wash water in preparing the succeeding " mash."

No. 13,268. Improvements on Machines for Channelling and Piercing the Soles of Boots and Shoes. (*Perfectionnements aux machines à graver et percer les semelles des chaussures.*)

Mary A. C. Holmes, Newport, R.I., U.S., 14th August, 1881; for 5 years.

Claim.—1st. The combination, with an arm, of the rock shaft which carries the piercing awl, and the moving lever of a pivoted connected bar, adapted to be connected positively to said moving lever or removed therefrom. 2nd. The combination of the rocking shaft 60, carrying the piercing awl and arm 44, with the bar 45, lever 47, spring 61 and detaching lever 49. 3rd. A channelling knife having an inclined blade 5 approximately straight, and vertically offset 6, in combination with the presser foot, the chamfering knife and the sole support, the upper point of said offset being underneath, and a short distance below the surface of the presser, whereby an inclined and vertical cut are made without removing a strip. 4th. The feed device 24, in combination with the springs 26 and 26, with the impelling cam, and the adjustable set screw 79, whereby the feed is made variable. 5th. The combination of a movable chamfering knife with the impelling mechanism, whereby the said knife is made vertically adjustable in height in relation to the other parts at the will of the operator while the machine is in motion. 6th. The combination of the mechanism for moving the vertically adjustable chamfering knife with the mechanism for moving the supporting wheel laterally, whereby the clamber is made wider and thicker at the same time and by the same lever. 7th. In a sole for boots and shoes, a channel consisting of an inclined cut towards the sole edge, and a straight vertical cut extending upwards from the lower end of the inclined cut, bearing a flap and a ridge between the channel and chamfer edge.

No. 13,269. Improvements on Vehicle Springs.

(*Perfectionnements aux ressorts des voitures.*)

Thomas J. Magner, Hornellsville, N.Y., and Charles L. Thomas, Janesville, Wis., U.S., 14th August, 1881; for 5 years.

Claim.—As an improvement in vehicle springs, the torsional spring B having cranks *b* at their outer ends, fixed at their inner ends to the central clips E, upon the under faces of the side bars D, and supported near their outer ends by the clips F, in combination with the semi-elliptical springs A.

No. 13,270. Improvements on Seed Sowers.

(*Perfectionnements aux semoirs à grains.*)

Samuel S. Speicher, Urbana, Ind., U.S., 14th August, 1881; for 5 years.

Claim.—1st. The thin metallic lip or rim *b* projecting below the bottom of the grain receptacle. 2nd. The extended shallow recesses or notches *l l*, in forward edges of vibrating feed plate E. 3rd. The vibrating feed plate E, in combination with the downwardly projecting thin lip or rim *b*, surrounding the feed opening from the grain receptacle. 4th. The distributing plate K, in combination with the reversed curved wings *i i*. 5th. A vibrating plate E provided with the tongue *e* bent at right angles, curved upward and outward, and terminating in bifurcated end *e* to engage the eccentric spindle J. 6th. The removable sustaining rod R in combination with the grain receptacle of a seed sower.

No. 13,271. Improvements on Well Boring Machines. (*Perfectionnements aux machines à percer les puits.*)

John W. Teetzel, Benton Harbour, Mich., U.S., 14th August, 1881; for 5 years.

Claim.—1st. The combination of the cylinder C, sweep D, cylinder P and A, means of connecting the sweep to the cylinder P so as to cause it to revolve with the one C and the standards Q for revolving the drill or auger. 2nd. The combination of the revolving cylinder P, standards Q and perforated guide plate U provided with the pulleys V. 3rd. In an auger consisting of a body having a continuous spiral groove X made in its outer surface, and a blade that is made in sections, each section being placed in position by having its inner edge made to engage with the groove at the lower end of the body, and then move spirally upward. 4th. A reamer composed of the tubular body C, having the collars G and cutters I fastened to its lower end, in combination with the tube N, which is fastened to the body C by means of slots and set screws, and which has the perforated plate R secure to its lower end, for expounding and closing the cutters.

No. 13,272. Improvements on Gates. (*Perfectionnements aux barrières.*)

Israel L. Landis, Lancaster, Pa., U.S., 14th August, 1881; for 5 years.

Claim.—1st. In combination with the parallel bars and side battins, the adjustable clips and bolts, the latter being provided with recesses or shoulders adapted to engage the edges of the slot in the rear clip, or bear directly against the battins, and with eyes to sit upon the pintles of the gate post. 2nd. In combination with the parallel bars and the battins of the gate, the diagonal bar or bars, the clamping bolt and the cam and lever carried by the bolt, for clamping and holding the parallel bars in position. 3rd. In combination with the parallel bars of the gate, the sliding latch bolt and friction spring, arranged to bear upon and hold the latch bolt in position when the gate is elevated.

No. 13,273. Improvements on Sewing Machines. (*Perfectionnements aux machines à coudre.*)

Thomas Westgate, Cleveland, Ohio, U.S., 14th August, 1881; for 5 years.

Claim.—The braiding device consisting of the plates A B, the intermediate adjustable guide plate E, thumb screw D and socket C, and the needle notch F.

No. 13,274. Improvements on Saw Handles. (*Perfectionnements aux manches des scies.*)

Harvey W. Peace, Brooklyn, N.Y., U.S., 14th August, 1881; for 5 years.

Claim.—A saw handle provided with two adjustable curved plates B B', the said plate B having four projecting arms c c' d d', one arm being shorter than the other, the several parts so constructed and arranged that, in connection with a bolt and thumb nut, the said handle may be secured on the plane of the saw blade, or at an angle thereto, without its removal therefrom.

No. 13,275. Improvements in Magic Lanterns. (*Perfectionnements aux lanternes magiques.*)

Edward B. Foote, jr., New York, N.Y., U.S., 14th August, 1881; for 5 years.

Claim.—1st. In a magic lantern or megascope, the cases A and B, the latter having the deep notches b' b' to engage with the sides of A when in use, and adapted to fit one within the other when the device is packed. 2nd. The extra reflector E relative to the light and the picture, so as to approximate the effect of two lights. 3rd. The swinging reflector E arranged to serve the double functions of throwing light upon the picture and screening the picture aperture according as it is adjusted in one position or the other.

No. 13,277. Improvements in Bearings for Car Axles, &c. (*Perfectionnements aux coussinets pour les essieux des voitures, &c.*)

Jackson R. Baker, Jersey, N. J., U. S., 14th August, 1881; for 15 years.

Claim.—1st. A bearing-brass for axles, shafting, etc., with a convex bearing formed on its upper surface surrounded by a concentric curb, and with concentric semi-circular curbs or stops also formed on its upper surface, in combination with a metal disc with a concave lower surface fitted on to the convex bearing. 2nd. A convex bearing and curb and stops on its upper surface, in combination with a disc fitted thereon, and a journal box or housing with a recess in the under side of its top plate, said recess being surrounded by a curb. 3rd. Sides k, in combination with parallel stops K secured to the under side of the top-plate of the housing or axle box. 4th. The combination of an axle or shaft with a bearing-brass provided with a convex bearing surface and with curbs and stops, and a metal disc fitted thereto and an axle box with the under side of its top-plate provided with a circular recess and surrounding curb and parallel stops.

No. 13,277. Improvements in Carriage Springs and Reaches. (*Perfectionnements aux ressorts et aux cols de cygne des voitures.*)

John A. McConnell, Camden, N. J., and Abijah H. Rowen, Philadelphia, Pa., U. S., 17th August, 1881; for 5 years.

Claim.—1st. In a vehicle, a reach composed of one or more flat flexible bars, curved laterally and having their flat faces or sides set vertically to the horizontal plane in which they are arranged, and springing laterally and longitudinally. 2nd. The spring reaches A A and equalizing rods B B, in combination with side springs C C'. 3rd. The combination of the side springs C C', the spring reach A A and equalizing rods B B, with the head block or front axle and the rear axle of the vehicle.

No. 13,278. Improvements on Couplings in Steam or Air Brakes. (*Perfectionnements aux manchons d'accouplement dans les freins à vapeur ou atmosphériques.*)

Horace B. Howard and Aaron W. Burnside, Belvidere, Ill., U. S., 17th August, 1881; for 5 years.

Claim.—1st. The combination of a receiving pipe provided with a flaring mouth of a longitudinally adjustable coupling tube, a spring for retaining it in its retracted position, and devices for forcing its outer end into the flaring mouth of the receiving pipe on the next adjacent car. 2nd. The combination with a receiving pipe constructed with a flaring mouth, of a long longitudinally adjustable coupling tube, a spring for retaining it in its retracted position, and flexible connection with a winding shaft for moving the coupling tube against the force of the spring. 3rd. The combination, with the receiving pipe, constructed with a flaring mouth, of a longitudinally adjustable coupling tube, a spring for retaining said tube in its retracted position, a chain winding shaft, and ratchet and pawl for forcing the coupling tube outwardly into engagement with the mouth of the receiving tube, and retaining it in contact herewith. 4th. The combination, with the tube of an air or steam brake, of a valve, jointed valve rod, crank arm and connecting rod extending to the top of the car. 5th. The combination, with the tube of an air or steam brake, of a rubber block supported in a casing, said block serving to support the tube and allow it to move either laterally or vertically. 6th. The combination, with the coupling tube of an air or steam brake, of a rubber block supported in a casing, and a thimble located in said block and encircling the coupling tube.

No. 13,279. Improvements on Cross Cut Saw Handles. (*Perfectionnements aux manches des scies de travers.*)

James Hilton, Newark, N. J., U. S., 17th August, 1881; for 5 years.

Claim.—The block A having the hollows a a', formed upon one side, and the single slot b to the saw blade upon the opposite side, in combination with the split or slotted bolt B inserted through the block at the intersection of the hollows a a', and provided with a nut for clamping the parts to the saw blade.

No. 13,280. Improvements on Feed Water Heating Apparatus for Locomotives. (*Perfectionnements aux appareils à chauffer l'eau d'alimentation des locomotives.*)

Charles H. Magoon, St. Johnsbury, Vt., U. S., 17th August, 1881; for 5 years.

Claim.—The combination, with the boiler of a locomotive engine, of a heater case 4, bolted to the frame of the engine beneath the boiler and close to the saddle, the conduit water pipe consisting of the simple and continuous coil 11, extending through the heater case in a direction generally parallel with the boiler stays, for holding said coil in position, the drip pipe 10, the feed pipe 3, the steam pipe 9, for admitting and conducting steam to the case 4, and the exhaust pipe 8.

No. 13,281. Improvements on Steam Augers. (*Perfectionnements aux tarières à vapeur.*)

William F. Leach, St. Clair, Mich., U. S., 17th August, 1881; for 5 years.

Claim.—1st. The rotary engine A D E, the handles F G, the breast plate H I and the tool holder J. 2nd. The combination, with the rotary engine A D E, of the handle F G, whereby the machine can be conveniently carried and held. 3rd. The combination, with the rotary engine A D E, of the breast plate H I, whereby the operator can press the boring tool forward with his body. 4th. The combination, with the rotary engine A D E, of the tool holder J, whereby a boring tool can be detachably connected with the mechanism of a rotary steam engine. 5th. The combination, with a rotary engine A D E, of the handle F G, the breast plate H I and the tool holder J, whereby a rotary steam engine is made to operate a boring tool.

No. 13,282. Improvements on Pumps. (*Perfectionnements aux pompes.*)

Benjamin C. Vandusen, Cincinnati, Ohio, U. S., 17th August, 1881; for 5 years.

Claim.—1st. A suspended pump, having its suspending platform or flange so constructed that the plungers and plunger rod, together with the lower valve, can be lifted out without displacing the stationary pump cylinder, discharge pipe or said suspending flange. 2nd. The suspending flange A made with the central opening large enough to permit the application and removal of the pump, plungers and plunger rod, without disturbing the main pump cylinder or suspending flange itself, combined with a removable guide for the plunger rod. 3rd. The nut R, the pipe Q and the cylinder K, combined with the cap P, the cylinder B and the flange A, having a large central opening. 4th. The cylinder B, suspended from the flange A by means of the pipe D having the air pipe I within it, and the screw rod E. 5th. The pump cylinders B and K, made of different diameters and locked together by being braced from the centre cap P. 6th. The pump cylinders B and K, formed with a joint between them, by which the part K can be lifted off and removed from the stationary part B. 7th. The flange A, having an enlarged central opening, combined with the removable cap P. 8th. The flange A, having an enlarged central opening, combined with the removable cap P and nut R. 9th. The flange A, having an enlarged central opening, combined with the removable cap P, adjusting nut R, pipe Q and detachable cylinder K. 10th. The combination, with the removable cap P suitably supported and detachable cylinder K, of the adjustable nut R and pipe Q. 11th. The cylinder B, cast with a water way C on one side and a lug F on the opposite side, for the connection of the devices by which said cylinder is suspended from the flange A.

No. 13,283. Improvements on Car Moving Devices. (*Perfectionnements aux appareils à déplacer les chars.*)

Christian D. Stanley, Lima, Ind., U. S., 17th August, 1881; for 5 years.

Claim.—1st. As an improvement in car-movers, in a forked lever or bar having a laterally projecting rigid hook. 2nd. The bar or lever provided with a forked spring and with a laterally projecting rigid hook. 3rd. The lever or bar A having spring fork B provided with outward bent tines C and the laterally projecting rigid hook D.

No. 13,284. Improvements on Horse Powers. (*Perfectionnements aux manéges.*)

Jabez T. Warren, Le Roy, N. Y., U. S., 17th August, 1881; for 15 years.

Claim.—1st. The combination of the planet-wheel having the trunnion and annular recess of the top plate, and the lug or lugs which form the bearing of trunnion. 2nd. The combination of the top plate, the sweep, rests or sockets, for the sweep mechanism for securing the sweep in place, and removable plates for regulating the height of the sweep. 3rd. The combination of the top plate, the lug and bolt for securing the sweep to the plate, a rest or socket on each side of the lug, the rests being of different heights and removable plates for regulating the height of the sweep. 4th. The combination of the sweep having a series of bolt holes therein, the top plate, rests for the sweep and a bolt for securing the sweep in place, whereby the sweep can be adjusted in length. 5th. The combination of the sweep, the shafts attached thereto, the pins on the shafts, the slotted draft rods which rest or slide on the shafts and the eveners. 6th. The combination of the shafts H and R with the knuckle or flexible joint described, for transmitting power, consisting of a head which is angular or square, in cross section, and rounded in longitudinal section, and a socket angular or square, in cross section, in which the head works. 7th. The combination of the shafts H and R, the socket s having the socket opening s, and the head r.

No. 13,285. Improvements in Bottles.

(*Perfectionnements dans les bouteilles.*)

Joseph Birney and John L. Birney, Toronto, Ont., 17th August, 1881; for 5 years.

Claim.—In a bottle A provided with a stopper D held in position by the locking wire, in combination with a sealing paper C extending over or under the wire B and stuck to the bottle.

No. 13,286. Improvements on Lathes.

(*Perfectionnements aux tours à tourner.*)

James B. Sherman, Waterloo, and Loren D. Phelps, Bolton, Que., 17th August, 1881; for 5 years.

Claim.—1st. In a compound lathe for turning a number of articles at the same time, the combination and arrangement of the frame, the lathe shaft carrying the three armed frames and revolving spindles, the friction roller blocks and cam plate and cam for moving the spindles longitudinally, and the mechanism for rotating the spindles. 2nd. The combination of the shafts a B¹, pulleys A¹ B A², the pulleys A and B being arranged to slip upon each other and provided with projections b, a series of revolving spindles secured to the shaft B, and cutters secured to a suitable rest and arranged relatively to the projections b. 3rd. The combination of the frame, the revolving shaft, a series of independently revolving and sliding spindles connected therewith, the vibrating feed lever connected by intermediate mechanism with the lathe shaft, and the pick up plates connected with said shaft and arranged to accurately register with the movements of the revolving spindles and feed lever. 4th. The combination of the shaft B¹ with its revolving spindles shaft 4, the gear wheels 2 3, the disk 5, with its projecting pins, the spring bar I, rock shaft K, feed lever L and feed hopper. 5th. The combination of the power shaft and pulley shafts N and Q¹, pulleys T and v, shaft V and saw U¹ with intermediate gearing.

No. 23,287. Improvements in the Preparation of Monetary Paper. (*Perfectionnements dans la préparation du papier monétaire.*)

Francis Nowlan, London, Eng., 17th August, 1881; for 5 years.

Claim.—A compound safety paper for cheques, and other documents, composed of two or more superposed sheets cemented together, and enclosing a ground work with the lettering (when such exists) said ground work and lettering being formed partly of permanent, and partly of alterable pigments, or reagents, or of one of these alone, so applied that any attempt to modify the surface writing on such paper may be rendered visible by the mechanical or chemical action or both, on the pigments or reagents beneath.

No. 13,288. Improvements in Machinery for Making Cylindrical Blocks to be Converted into Spools. (*Perfectionnements aux machines à faire des blocs cylindriques pour être convertis en bobines.*)

Charles E. Burns, Lancaster, N. H., U. S., 17th August, 1881; for 5 years.

Claim.—1st. The combination for effecting the lateral intermittent movements of the butt carriage C, it consisting of the two brackets or arms c, the rotary wheel Z and its adjustable fingers a b, and its shaft X, the bevel gears v w, shaft N, pin wheel O and its rotary actuator or pronged wheel M, carried by the cam shaft. 2nd. The combination for operating the cam shaft H, such consisting of the friction wheels I L, treadle K, movable box o, shaft p, worm gear q and the worm r and its shaft s. 3rd. The combination of the cam shaft operating mechanism (consisting of the friction wheels I L, treadle K, movable box o, shaft p, worm gear q and shaft s) with such cam shaft H, and the mechanism for effecting lateral movements of the butt carriage, and consisting of the pronged wheel M, pin wheel O, shaft N, gears v w, shaft x, wheel z, adjustable fingers a b and the brackets or

arms c. 4th. The combination for operating the butt feeding roll, such consisting of the gears g¹ R, pawls h m, spring o¹, wheel n¹; the slotted arms p¹, connection rod r¹, cranked wheel t, its shaft x, and the gears n, v. 5th. The combination of the cam G and the rod k, and its stud or roller m, with the cam shaft H, and the table D and its butt supporting carriage C. 6th. The combination of the butt carriage C, its movable table D, and the cam shaft H, with the cam G and studded rod k, and with the mechanism for automatically effecting intermittent lateral movements of the butt carriage. 7th. The combination of the butt carriage, its movable table and cam shaft, mechanism applied to the latter for automatically moving such table a mechanism for laterally moving the butt carriage and mechanism for automatically feeding the butt. 8th. The saw carrying frame, adjustable vertically in the main frame and provided with saws and adjusting devices, in combination with the mechanism for supporting a butt and moving it to enable the saws, while in revolution, to separate it into cylindrical blocks. 9th. The tubular saw block expeller provided with one or more pins or studs for agitating or stirring the saws or bit dust, while the saw may be in revolution.

No. 13,289. Improvements in Grinding Mills. (*Perfectionnements aux moulins à mouder.*)

David F. Brown, Fall River, Mass., U. S., 17th August, 1881; for 5 years.

Claim.—1st. The two conical grinding rolls A B, grooved or dressed helically. 2nd. The combination of the two helically grooved or dressed conical rolls A B provided with shafts and connecting gears, and with means of adjusting one roller lengthwise relatively to the other.

No. 13,290. Improvements on Screw Propellers. (*Perfectionnements aux propulseurs à hélice.*)

Robert Davis, Kingston, Ont., 17th August 1881; for 5 years.

Claim.—A screw propeller, constructed of a hub A, having flat sides C, with dove tail groove D, and blades E having at the heel a screw F with shoulders G, the parts slipping together and held by a screw H passing through the joint.

No. 13,291. Improvements on Combined Snow Ploughs and Melters. (*Perfectionnements aux charrues à neige et fondeurs combinés.*)

Crisfield Johnson, East Aurora, N. Y., U. S., 17th August, 1881; for 5 years.

Claim.—1st. A compartment mounted upon wheels and having at its front a furnace the outer wall of which forms both the plow and melting surface, and a fan blower in said compartment for furnishing a blast of air to the surface. 2nd. A furnace, the outer or front wall of which forms both the plow and the surface for melting the snow. 3rd. A furnace constructed with an outer or front wall of metal and a rear wall of non-conducting material. 4th. A furnace, the outer or front wall of which serves as plow, and which consists of a plain surface sloping from the bottom, at any angle of about 45 degrees, and having the central part of the upper portion of wedge-shape, the sides of such wedge-shaped portion being vertical or nearly so, and the rear wall of the furnace being parallel with the front wall. 5th. In a furnace, the central portion of whose walls are wedge-shaped having the same general configuration as the upper wedge-shaped portion of the furnace and forming an extension of the same. 6th. A furnace, the outer wall of which serves as a plow and melting surface, said furnace being provided with openings in its rear walls, said openings having hinged and sliding doors to permit the insertion of fuel without an escape of gas and cinders. 7th. A flue provided with passages for observation. 8th. The combination, with a furnace, the outer wall of which serves as the plow and melting surface, of openings provided with hinged and sliding doors, a flue which forms a combination of said furnace, and a fan blower for furnishing a blast of air to the furnace. 9th. The furnace provided along the bottom of the front wall with a gutter d which slopes each way from the centre, and the auxiliary gutter d¹ located above the gutter d for carrying off the water to the sides of the track. 10th. The combination, with a furnace, the outer or front wall of which serves as the plow and melting surfaces, said wall being entirely a plain sloping surface of a removable wedge-shaped plow, hinged at or near the top of said furnace and extending down the plain surface thereof. 11th. The removable wedge-shaped plow provided with the wires or chains K⁴ attached at the points K³ for lifting the plow K, so as to permit the snow to strike the entire front surface of the furnace, and adapted to be secured in position by the catch K⁵.

No. 13,292. Improvements on Road Waggon. (*Perfectionnements aux wagons de roulage.*)

Cyrus W. Saladee, Wolcottville, Ct., U. S., 17th August, 1881; for 5 years.

Claim.—1st. In a vehicle, the combination of the axles and bolster, upper side springs, lower central spring and a brace connected to the latter and to the body supports. 2nd. The combination of the upper and lower springs D D E, bars F E G G, and brace I connected to the bars G G and to the spring E. 3rd. The combination of the spring platform and a brace I consisting of a bar of metal, curved downward and inwards at both ends. 4th. The combination of the curved brace, bent to form eyes at the ends, and stays J J connected to bolts passing through such eyes.

No. 13,293. Improvements on Oven Doors. (*Perfectionnements aux portes des fours.*)

George G. Wilson, London, and John W. Thomas, Toronto, Ont., 17th August, 1881; for 5 years.

Claim.—1st. The door B of an oven A having apertures D E covered with wire gauze or perforated metal F G, to generate a current of electricity. 2nd. The mode of generating, in an oven, a current of positive electricity by means of apertures D E in the doors B, admitting the outer air. 3rd. In combination with the oven A, the perforated baking or roasting tin H.

No. 13,294. Improvements on Dams and Locks. (*Perfectionnements aux digues et aux écluses.*)

John Du Bois, Du Bois, Pa., U. S., 17th August, 1881; for 5 years.

Claim.—1st. The method of constructing river locks without working below water, by building upon land a floatable wooden structure embracing a bottom, main gates, flumes, and flume gates, side walls of a height greater than the depth of the water where the structure is to be located, and means for temporarily excluding the water, and then launching the structure and floating it over the position selected for it, and finally sinking it directly to its place. 2nd. A floatable lock constructed of timber with cells to receive stone or ballast, and with elevated walls and end gates whereby it is adapted to float to its place, when completed, to a height greater than the depth of the water in which it is to be used, and loaded with ballast. 3rd. A floatable or lock provided with thin vertical angle irons or mud-sills extending transversely across the underside. 4th. A floatable dam or lock having at its bottom transverse depending sharp edged irons or ribs adapted to cut their own way into, and take a firm hold in the bed of the stream. 5th. The combination of a jointed or flexible dam or lock gate adapted to rise and fall beneath the water, a chamber or passage beneath the gate to admit water for elevating the same, a secondary gate connecting with said chamber, and controlling the escape of water therefrom below the gate, and a float located above the dam and arranged to operate the second gate. 6th. In combination with a jointed dam B and the water passage thereunder, the pivoted gate *g* having pinion *i* and the float located above the dam and provided with rock bar acting upon the pinion. 7th. In a hinged dam or water gate, a water-tight hinge consisting of a series of eye bolts applied to the surface to be connected and a continuous rod *d* inserted through the eye bolts and seated against both of the surfaces, whereby the rod is caused to serve the double purpose of a hinge pin and a packing. 8th. The floatable lock provided with the internal gates C D and with the end gates E hinged thereto, and arranged to turn down in the bed of the stream when not required for use. 9th. The floatable lock consisting of the foundation and side walls constructed of timber and provided with water channels, the two flexible gates and the two end gates. 10th. In a lock, the combination of the lower lock gate, the upper jointed gate and the end gate E located above the upper lock gate. 11th. The combination of a base or foundation, and a floatable dam or lock constructed for application thereto. 12th. In a base or foundation for dams and locks, the combination of the flooring, the timbers thereon, and the bolts having collars between the floor and the timbers.

No. 13,295. Improvements on Musical Reed Instruments. (*Perfectionnements aux instruments de musique à anches.*)

Moses O. Nichols, Clyde, Ellis L. Mundy and George Butt, Norwalk, Ohio, U. S.; 18th August 1881; (Extension of Patent No. 13,197.)

No. 13,296. Improvements on Musical Reed Instruments. (*Perfectionnements aux instruments de musique à anches.*)

Moses O. Nichols Clyde, Ellis L. Mundy, and George Butt, Norwalk, Ohio, U. S., 18th August, 1881; (Extension of Patent No. 13,197.)

No. 13,297. Railway Car Axle Box. (*Boîte à graisse d'essieu de char de railroute.*)

Joseph N. Smith: Jersey, N. J., U.S., 18th August, 1881: (Extension of Patent No. 7611.)

No. 13,298. Improvements on Vehicle Seats. (*Perfectionnements aux sièges des voitures.*)

Wellington Bristol, Madoc, Ont., 18th August, 1881; (Extension of Patent No. 7,883.)

No. 13,299. Improvements on Car Locks. (*Perfectionnements aux serrures des chars.*)

George A. Shaw, (Assignee of Robert W. Semple,) Toronto, Ont. 22nd August 1881; Extension of Patent No. 6,477.)

No. 13,300. Glove Fastener. (*Agrafe de gant.*)

William F. Foster, Chicago, Ill., U. S., 22nd August, 1881; (Extension of Patent No., 6,478.)

No 13,301. Improvements in Cooking Stoves. (*Perfectionnements aux fourneaux de cuisine.*)

George W. Johnson, Yarmouth, N. S., 22nd August, 1881; (Extension of Patent No. 6,459.)

No. 13,302. Improvements in Cooking Stoves, (*Perfectionnements aux fourneaux de cuisine.*)

George W. Johnson, Yarmouth, N. S., 23rd August, 1881; (Extension of Patent No. 6,459.)

No. 13,303. Improvements in Processes for Converting Iron into Steel. (*Perfectionnements dans les procédés pour convertir le fer en acier.*)

Henry H. Date, Toronto, Ont., 23rd August, 1881; for 5 years.

Claim.—The mode of converting cast or forged iron into steel, by subjecting it in a heated retort or oven to the action (without pressure) of gases generated from hydro-carbon fluid and charcoal. 2nd. The manufacture of steel tools from properly shaped pieces of forged iron by the mode of process.

No. 13,304. Improvements in Fire-Escapes. (*Perfectionnements aux sautoyeurs d'incendie.*)

Charles A. Gregory, Montreal, Que., 23rd August, 1881; for 5 years.

Claim.—A box or receptacle fastened to the building near the eaves and holding a chain ladder, or equivalent device, said box being opened and the ladder allowed to fall by means of a connection near the ground, or at one of the windows. 2nd. In combination with the box A the vertical rod D, its lower end being enclosed in the box E, from which it is operated. 3rd. In combination with the box A and chain, ladder B, the rod or hanger C.

No. 13,305. Improvements in Bracket Pieces for Screen Frames. (*Perfectionnements aux goussets des consoles pour les chassis d'écrans.*)

Edward N. Porter, Morrisville, and Lorenzo G. Burnham, Burlington, Vt., U.S., 23rd August, 1881; for 5 years.

Claim.—Corner brackets having the face plate A, the inwardly projecting angular flange B with lugs, spurs or screws, and adapted to be secured to a frame. 2nd. The bracket, or corner pieces fastened to a frame by attachment which enter the frame in opposite directions. 3rd. A double corner bracket composed of two bars, whose extremities are braced together. 4th. In combination with the bracket or corner pieces, the double corner bracket with bracing, and adapted to be secured to a frame and cross bars.

INDEX OF INVENTIONS.

Arcs of electric lamps, equalizing, E. Weston..... 13,122
 Alumina, J. G. L. & T. S. Harrison..... 13,186
 Armature, E. Weston..... 13,125
 Armatures, H. S. Maxim..... 13,116
 Atomizer, hydrocarbon, W. W. Thomas..... 13,180
 Augers, steam, W. F. Leach..... 13,281
 Axle, car axle, J. M. Smith..... 13,297
 " wagon, C. Morton..... 13,222
 " " J. Adams..... 13,220
 Awning, window, J. A. Dwinelle..... 13,209
 Bark cutting machine, S. R. Thompson et al..... 13,150
 Bearing brasses, J. R. Baker..... 13,276
 " shaft and axle, J. N. Bitting..... 13,264
 Beaters, egg, A. Luttrell..... 13,078
 Bee hives, W. S. Blaisdell..... 13,151
 Belt tightener, R. Thomson et al..... 13,141
 " abrasive, G. H. P. Flagg..... 13,168
 Binder, grain, A. King..... 13,147
 Board for boats, centre, M. W. Atwood..... 13,223
 Bodies, carriage, H. W. Titus et al..... 13,135
 Boot, J. M. Hospitalier..... 13,259
 Boots and shoes, M. A. C. Holmes..... 13,268
 Bottles, J. & J. L. Birney..... 13,285
 Bowls, water closet, G. E. Hatch..... 13,242
 Box, car axle, J. N. Smith..... 13,297
 Bracket pieces for screen frames, E. N. Porter et al..... 13,305
 Brake, car, S. Fairman..... 13,193
 " coupling, steam, H. B. Howard et al..... 13,278
 Breaking machines, stone, P. W. Gates..... 13,178
 Buffing machine, sole, G. H. Flagg..... 13,145
 Bushing and faucet, H. F. Gaines..... 13,196
 Cabinet, oil, J. R. McLaren..... 13,212
 Cake machine, W. S. Owens..... 13,236
 Can, butter, T. G. F. Dolby..... 13,162
 " metal, T. McDonald..... 13,088
 Caps, manufacture of, D. W. Northrup..... 13,095
 Cars, dumping, M. Van Wormer et al..... 13,184
 " moving devices, C. D. Stanley..... 13,283
 " sleeping, A. F. & C. A. Martel..... 13,185
 Carbon conductors, H. S. Maxim..... 13,120
 Carriage bodies, H. W. Titus et al..... 13,135
 Carrying device, fruit, G. A. Cochrane..... 13,149
 Caster, furniture, J. Toler..... 13,157
 Chain tightener, R. Thomson et al..... 13,141
 Characters, printing, A. A. Rogers..... 13,191
 Chimney top, J. B. Robertson..... 13,239
 Churn, F. M. Wright..... 13,148
 " J. Campbell..... 13,174
 " J. R. Hollis..... 13,172
 " power, J. A. Mumford..... 13,130
 Cigarette machine, J. A. Bonsack..... 13,104
 Clamp, door and sash, A. W. Ale..... 13,261
 " for harrow frames, A. Wilcox..... 13,243
 Closets bowls, water, G. E. Hatch..... 13,242
 " water, M. J. O'Reilly..... 13,262
 Cockle mill, J. M. King..... 13,103
 Coffee percolators, W. A. Petry..... 13,098
 Compass, mariners', F. A. Brown et al..... 13,166
 Conductors, carbon, H. S. Maxim..... 13,120
 " insulating, A. A. Knudson et al..... 13,165
 Consumers, smoke, C. McWilliam et al..... 13,257
 Converter and furnaces, S. G. Thomas et al..... 13,163
 Cooking stove, gas, F. B. Whitmore..... 13,202
 " " The N. S. Vedder Pattern Wks., Bascom, Galbraith & Co..... 13,108
 " " G. W. Johnson..... 13,301
 Corn sizing machine, G. W. Bronson et al..... 13,097
 Corset, I. D. Warner et al..... 13,181
 Coulters, J. Clayton..... 13,131
 Coupler, car S. Fairman..... 13,193
 Coupling, " A. G. Hohensheld..... 13,129
 " " C. H. Shippee..... 13,093
 " in steam brakes, H. B. Howard et al..... 13,278
 " pipe, S. Lightburne..... 13,245
 Coverings, head, R. Cream et al..... 13,169
 Crushing machines, stone, P. W. Gates..... 13,178
 Cultivators, P. F. Wells..... 13,205
 Cutting machine, bark, S. R. Thompson et al..... 13,150
 " " hoop, J. Greenwood..... 13,188
 Damper, stove pipe, W. F. Green..... 13,134
 Dams and locks, J. Dubois..... 13,294
 Distributor, grain drill, J. Noxon..... 13,146
 Door hanger, S. H. and E. Y. Moore..... 13,084
 " oven, G. G. Wilson et al..... 13,293
 Dray, three wheeled, J. J. Carnell..... 13,255
 Drilling apparatus, E. E. Gilbert..... 13,112

Dynamo-electric machines, E. Weston..... 13,124 13,125
 " " " H. S. Maxim..... 13,115 13,116
 Engine, steam, W. Monk et al..... 13,196
 " traction, W. S. Fletcher..... 13,079
 Equalizing, warming and ventilating, A. C. Rideout..... 13,227
 Fastener, glove, W. F. Foster..... 13,300
 Faucet and bushing, H. F. Gaines..... 13,196
 " measuring, D. Drawbaugh..... 13,102
 Feather renovators, H. E. Rowe et al..... 13,217
 Feed water heating apparatus, C. H. Magoon..... 13,280
 " purifying, J. H. Dane..... 13,194
 Fence, J. Kinney..... 13,100
 Fire-escapes, C. A. Gregory..... 13,304
 Firepot and grate, stove, A. W. Eldridge..... 13,225
 " for soldering irons, J. B. Robertson..... 13,110
 Former, eave trough, J. Dunn..... 13,082 13,083
 " trough, D. Johns..... 13,167
 Fruit carrying device, G. A. Cochrane..... 13,149
 Furnace, glass, C. F. Schad..... 13,249
 " hydro carbon, W. W. Thomas..... 13,253
 " steel tempering, The Guelph Carriage Goods Co..... 13,229
 " and converter, S. G. Thomas et al..... 13,163
 Gas, illuminating, F. J. Bolton, et al..... 13,210
 Gate, I. L. Landis..... 13,272
 Gear trip, harvester, R. Thomson et al..... 13,139
 Generator, electric, C. E. Ball..... 13,164
 " gas, C. McWilliams et al..... 13,257
 " " P. J. Fitzgerald..... 13,154
 " steam, I. R. Blumenberg..... 13,170
 Glucose, manufacturing, H. Williams et al..... 13,211
 Grain binder, A. Kay..... 13,147
 " drill, M. B. Williams, et al..... 13,234
 Grape sugar manufacturing, H. Williams, et al..... 12,211
 Grate and fire pot, stove, A. W. Eldridge..... 13,225
 Gutter former, D. Johns..... 13,167
 Grinding mills, D. F. Brown..... 13,289
 Handle, dish, J. B. Timberlake..... 13,221
 " saw, H. W. Peace..... 13,274
 " J. Hilton..... 13,279
 Hanger, door, S. H. & E. Y. Moore..... 13,084
 Harrow, B. Johns et al..... 13,201
 Harvester, F. M. Waters et al..... 13,244
 " and reaper, R. Thomson et al..... 13,143
 " gear trip, " " " 13,139
 Harvesting machine, " " " 13,142 13,144
 Heating apparatus, feed water, C. H. Magoon..... 13,280
 Hives, bee, W. S. Blaisdell..... 13,151
 Hoe, spring, J. O. & W. S. Wisner..... 13,248
 Hollow articles, F. Walton..... 13,187
 Hoop cutting machine, J. Greenwood..... 13,188
 " pointing and lapping, J. Naylor..... 13,089
 Horse power link, B. L. Olds..... 13,081
 Ice making apparatus, J. Miller..... 13,228
 Indicator, train, T. H. Norton..... 13,230
 Insulating conductor, A. A. Knudson et al..... 13,165
 Iron into steel, converting, H. H. Date..... 13,303
 Irons, fire pot for soldering, J. B. Robertson..... 13,110
 Knitting machines, W. A. S. Magrath..... 13,203
 Lamp, E. S. Piper..... 13,128
 " electric, E. Weston..... 13,122 13,123
 " " H. S. Maxim..... 13,117 13,118 13,119 13,120
 " " The European Electric Co..... 13,137
 Lantern, magic, E. B. Foote..... 13,275
 Lapboard sawing machine, S. Babcock..... 13,231
 Lathes, J. B. Sherman et al..... 13,286
 Link, horse power, B. L. Olds..... 13,081
 Locks and dams, J. Dubois..... 13,294
 " car, G. A. Staw..... 13,299
 " seal, A. F. & C. A. Martel..... 13,260
 Lubricators, L. B. Bailey..... 13,085
 Mail receiver, H. Free et al..... 13,287
 Match safe, F. S. Dangerfield..... 13,132
 Matching and planing machine, E. Benjamin..... 13,214
 Melter, snow, C. Johnson..... 13,291
 Meter, veber, T. A. Edison..... 13,208
 Mill cockle, J. M. King..... 13,103
 Mittens, H. W. Price..... 13,165
 Mould, pipe, R. J. Wilson..... 13,091
 Mouldings, applications of oxidized oils to, F. Walton..... 13,206
 " embossing and colouring, F. Walton..... 13,204
 Mowing machine, R. Thomson et al..... 13,140
 Musical reed instruments, M. O. Nichols, et al..... 13,197 13,296
 Nails, finishing the heads of, The Abington Tack and Machine Association..... 13,090
 Nut lock, C. H. Denison, et al..... 13,258

Oil cabinet, J. R. McLaren..... 13,212
 " panels, application of oxidized, F. Walton..... 13,206
 Ores, treatment of, T. G. Walker..... 13,152
 Oxygen, removing atmospheric, H. S. Maxim..... 13,121
 Packing piston, A. N. Matthews..... 13,107
 Pails and tubs, W. E. Fuller..... 13,238
 Pan, milk, J. C. Gilpin..... 13,207
 Panels, application of oxidized oils to, F. Walton..... 13,206
 " embossing and colouring, F. Walton..... 13,204
 Paper, preparation of monetary, F. Nowlan..... 13,287
 Percolator, coffee, W. G. Petry..... 13,098
 Perforating machines, paper, F. Anderson et al..... 13,088
 Pipe coupling, S. Lightburne..... 13,245
 Pitman connection, R. Thomson et al..... 13,140
 Plating machines, G. W. Hendall..... 13,156
 Planing and matching machines, E. Benjamin..... 13,214
 Plate, door, H. Free, et al..... 13,237
 Plough, A. W. Hazelton..... 13,189
 " S. Seigmiller..... 13,161
 " gang, R. Holgate..... 13,190
 " ice, S. Richards..... 13,283
 " point, R. R. Decker..... 13,179
 " rotary, C. R. Foster..... 13,266
 " snow, C. Johnson..... 13,291
 Point, plough, R. R. Decker..... 13,218
 Portmanteau, D. S. Matthews..... 13,110
 Pot for soldering irons, fire, J. B. Robertson..... 13,130
 Power, churn, J. A. Mumford..... 13,284
 " horse, I. T. Warren..... 13,175
 " manual, J. Bates..... 13,219
 Press, bay and cotton, W. A. Pridgen..... 13,192
 Presses, paper, J. H. Pratt..... 13,191
 Printing characters, A. H. Rogers..... 13,232
 " mediums, B. Day..... 13,290
 Propellers, screw, R. Davis..... 13,282
 Pumps, B. C. Vandusen..... 13,138
 " C. Powell..... 13,106
 " force, M. B. Brooks..... 13,136
 " steam, J. H. Pettibone et al..... 13,233
 Purification of products resulting from the distillat-
 ing of wood, J. A. Mathieu..... 13,256
 Purifiers, middlings, K. Smith..... 13,194
 Purifying apparatus, water, J. H. Dane..... 13,092
 Railway track laying, T. Adams..... 13,240
 Rake, horse, C. La Dou et al..... 13,126
 " J. Larsen et al..... 13,277
 Reach, carriage, J. H. McConnell et al..... 13,143
 Reaper and harvester, R. Thomson et al..... 13,114
 Reaping machines, J. Mills..... 13,144
 " R. Thompson et al..... 13,111
 Refrigerating room, M. Kimball..... 13,215
 Re-sawing machine, lumber, E. Benjamin..... 13,217
 Renovators, feather, H. A. Rowe et al..... 13,090
 Rivets, finishing the heads of, The Abington Tack and
 Machine Association..... 13,101
 Roofing saturating felt, J. W. Paterson..... 13,182
 Rowlocks, R. Kirkpatrick..... 13,132
 Safe match, T. S. Dangerfield..... 13,127
 Safeguards for berths, E. A. McMann..... 13,274
 Saw handles, H. W. Peace..... 13,279
 " I. Hilton..... 13,213
 Saw mills, W. P. Widenfield..... 13,251
 Sawing machines, C. Bryant..... 13,213
 " lapboard, S. Babcock..... 13,215
 " lumber, E. Benjamin..... 13,305
 Screen frames, bracket pieces for, E. N. Porter et al..... 13,298
 Seat, vehicle, W. Bristol..... 13,200
 Separators, grain, J. A. Krake..... 13,199
 Sawing machine, J. M. Fair..... 13,273
 " T. Westgate..... 13,250
 Sieve, grain, S. McClure..... 13,097
 Sizing machine, corn, G. W. Bronson et al..... 13,113
 Skates, C. Brewster..... 13,235
 Skates, roller, S. Winslow..... 13,177
 Soldering machines, C. R. Merrian et al..... 13,145
 Sole buffing machine, G. H. P. Flagg..... 13,268
 " machines for channelling, M. A. C. Holmes..... 13,270
 Sower, seed, S. S. Speicher..... 13,195
 Space and type holders, L. K. Johnson..... 13,171
 Spinners staple cleaning, C. A. Dresser..... 13,288
 Spools, cylindrical blocks for, C. E. Burns..... 13,277
 Spring, carriage, J. H. McConnell et al..... 13,254
 " R. M. Robertson..... 13,269
 Spring, vehicle, L. J. Maguar et al..... 13,171
 Staple, cleaning Spinners', C. A. Dresser..... 13,303
 Steel, converting iron into, H. H. Date..... 13,133
 Stick, printers' side, J. A. Burke et al..... 13,178
 Stone breaking machines, P. W. Gates.....

Stove cooking, G. W. Johnson..... 13,301
 " " " "..... 13,302
 " " The N. S. Vedder Pattern Works, Bas-
 com, Galbraith & Co..... 13,108
 Stove gas cooking, F. B. Whitmore..... 13,202
 " grate and fire pots, A. W. Eldridge..... 13,225
 " oil, T. C. Collins..... 13,160
 Stovepipe, H. Cook..... 13,241
 Strap, shawl, D. S. Matthews..... 13,218
 Sugar manuf'g., grape, H. Williams et al..... 13,211
 " " J. L. Alberger..... 13,267
 Suspenders, pantaloons, H. Turner..... 13,105
 Switch railway, A. F. & C. A. Martel..... 13,224
 Tacks, finishing the heads of, The Abington Tack and
 Machine Association..... 13,090
 Telegraph printing, The Union Telegraph Company..... 13,198
 Telegraphic paper, F. Anderson, et al..... 13,086
 Telegraph, T. J. Mayall..... 13,159
 Telephone, J. R., J. D. & C. F. Holcomb..... 13,226
 " The Canadian Telephone Company..... 13,158
 " " " "..... 13,246
 " " " "..... 13,247
 Track laying apparatus, T. Adams..... 13,092
 Trough former, D. Johns..... 13,167
 " " eave, J. Dunn..... 13,082
 " " " "..... 13,083
 " " " "..... 13,238
 Tubs and pails, V. E. Fuller..... 13,195
 Type and space holders, L. K. Johnson..... 13,087
 Valves, The Hancock Inspirator Company..... 13,298
 Vehicle seat, W. Bristol..... 13,227
 Ventilating, equalizing and warming, A. C. Rideout..... 13,239
 Ventilator, J. B. Robertson..... 13,292
 Wagons, road, C. W. Salade..... 13,227
 Warming, equalizing and ventilating, A. C. Rideout..... 13,096
 Washer, spring, D. R. Pratt..... 13,094
 Washing machine, D. F. Babb et al..... 13,109
 Water proof compounds, P. Crippen..... 13,194
 " purifying, feed, J. H. Dane..... 13,216
 Weather strips, The Johnston's Pat. W. P. and Domin-
 ion Sash, Door and Frame Manufg. Company..... 13,271
 Well boring machines, J. W. Teetzel..... 13,080
 Wheel, railway, The Atwood Railway Wheel Co..... 13,253
 " self lubricating, R. C. E. Gaujot..... 13,222
 " waggon, C. Morton..... 13,173
 Wires, protecting electric, The European Electric Co..... 13,233
 Wood, purification of products resulting from the distil-
 lation of, J. A. Mathieu..... 13,265
 Wringer, clothes, O. D. Hudson..... 13,192
 Writing machines, type, J. H. Pratt.....

INDEX OF PATENTEES.

Abington Tack and Machine Ass'n, The, tacks, nails and
 rivets..... 13,090
 Adams, J., Waggon axles..... 13,220
 " T., track laying apparatus..... 13,092
 Alberger, J. L., grape sugar and syrup..... 13,267
 Ale, A. W., door and sash clamp..... 13,261
 American Union Telegraph Co'y, The, printing tele-
 graphs..... 13,198
 Anders, G. L., telephone..... 13,158
 Anderson, F., et al., paper perforating..... 13,086
 Armstrong, J. B., steel tempering furnace..... 13,229
 Atwood, A., railway wheels..... 13,080
 " M. W., centre board for boats..... 13,223
 " Railway Wheel Co'y, The, railway wheels..... 13,080
 Austin, R., metal cans..... 13,088
 Babb, D. F., et al., washing machines..... 13,094
 Babcock, S., lapboard sawing machines..... 13,231
 Bailey, L. B., lubricators..... 13,085
 Baker, J. R., bearing brasses..... 13,276
 Ball, C. E., electric generator..... 13,164
 Bates, J., manual powers..... 13,175
 Benjamin, E., lumber re sawing machine..... 13,215
 " matching and planing machines..... 13,214
 Birney, J. and J. L., bottles..... 13,285
 Bitting, J. N., shaft and axle bearing..... 13,264
 Blaisdell, W. S., bee hives..... 23,151
 Blakeley, C. T., et al., side sticks..... 13,133
 Blumenberg, J. R., engine generator..... 13,170
 Bolton, F. J., et al., illuminating gas..... 13,210
 Bonsack, J. A., cigarette machine..... 13,104
 Bowen, A. H., et al., springs and reaches..... 13,277
 Brewster, C., skates..... 13,113
 Bristol, W., vehicle seat..... 13,298
 Bronson, G. W. and A., et al., corn sizing machine..... 13,097
 Brooks, M. B., force pumps..... 13,106
 Brown, D. F., grinding mills..... 13,289

Brown, F. A., et al., mariners' compass.....	13,166	Holcombe, J. R., J. D. and C. F., telephone.....	13,226
Brownell, S. and F., et al., dumping cars.....	13,184	Holgate, R., gang plough.....	13,190
Bryant, C., sawing machines.....	13,261	Hollis, J. R., churn.....	13,172
Buckingham, R., et al., side sticks.....	13,133	Holmes, M. A. C., machines for channeling soles.....	13,278
Burke, J. A., et al., printers' side stick.....	13,133	Hospitaller, J. M., boots.....	13,259
Burnham, L. G., bracket pieces for screen frames.....	13,305	Howard, H. B., et al., coupling in steam brakes.....	13,275
Burns, C. E., cylindrical blocks for spools.....	13,288	Hudson, O. D., clothes wringer.....	13,263
Burnside, A. W., et al., coupling in steam brakes.....	13,278	Hussey, C. A., electric lamp.....	13,137
Butt, G., et al., musical reed instruments 13,197 13,295	13,296	“ “ protecting electric wires.....	13,173
Campbell, J., churn.....	13,174	Hyslop, J., tacks, nails and rivets.....	13,990
Canadian Telephone Coy, The, Telephone 13,158 13,246	13,247	Johns, D., trough former.....	13,167
Carnell J. J., three wheeled dray.....	13,255	“ R., et al., harrow.....	13,261
Carrier, C. W., et al., steam engines.....	13,176	Johnson, C., snowplough.....	13,291
Clary, T. E., et al., piston packing.....	13,107	“ L. K., type and space holders.....	13,195
Clayton, J., Coulters.....	13,131	“ S. W.; et al., bark cutting machine.....	13,150
Cochran, G. A., fruit carrying device.....	13,149	Johnston, G. W., cooking stove..... 13,301	13,302
Collins, T. C., oil stove.....	13,169	“ J., weather strips.....	13,216
Cook, H., stovepipe.....	13,241	Johnston's Pat. W. P. and Dom. Sash, Door and Frame	
Cooley, O., belt tightener.....	13,141	Man'fg. Co'y, The, weather strips.....	13,216
“ “ harvester gear trip.....	13,139	Kane, F., L. et al., electrical conductors.....	13,165
“ “ harvesting machines..... 13,142	12,144	Kay, A., grain binder.....	13,147
“ “ pitman connection.....	13,140	Keene, S. D., cleaning spinners staple.....	13,171
Coy, F. W., sole buffing machine.....	13,145	Kimball, M., refrigerating room.....	13,111
Cream, R., et al., head covering.....	13,169	King, J. M., cockle mill.....	13,103
Crippen, P., waterproof compounds.....	13,109	Kenney, J., fences.....	13,100
Dane, J. H., feed water purifying.....	13,194	Kirkpatrick, R., rowlocks.....	13,182
Dangerfield, F. S., match safes.....	13,132	Knudson, A. A., et al., electrical conductors.....	13,165
Date, H. H., converting iron into steel.....	13,303	Krake, J. A., grain separators.....	13,200
Davis, R., screw propellers.....	13,290	La Dou, C., et al horse rake.....	13,240
Dawes, J. L., plough point.....	13,179	Landis, I. L., gate.....	13,272
Day, B., printing medium.....	13,232	Larsen, J., et al., horse rake.....	13,126
Decker, R. R., plough point.....	13,179	Leach, W. F., steam augers.....	13,281
Denison, C. H., et al., nut lock.....	13,258	Lewis, J., et al., mariners' compass.....	13,166
Dolby, T. G. F., butter can.....	13,162	Lightburne, S., pipe coupling.....	13,245
Drawbaugh, D., measuring faucet.....	13,102	Luttrell, A., egg beater.....	13,078
Dresser, C. A., cleaning spinners' staple.....	13,171	McClure, S., grain sieves.....	13,250
Dubois, J., dams and locks.....	13,294	McConnel, J. H., et al., springs and reaches.....	13,277
Dunn, J., eave trough formers..... 13,082	13,083	McDonald, F., metal cans.....	13,088
Dwinelle, J. A., window awnings.....	13,209	McLaren, J. R., oil cabinet.....	13,212
Earnest, G. H., et al., harvester.....	13,244	McMann, E. A., safeguards for berths.....	13,277
Edison, T. A., Veber meter.....	13,208	McMurray, J. S., pails and tubs.....	13,238
Eldridge, A. W., stove grate and firepot.....	13,225	McWilliam, C., et al., smoke consumer.....	13,257
Elward, J. H., et al., steam pumps.....	13,136	Magner, T. J., et al., vehicle springs.....	13,269
Essick, J. C., et al., harrow.....	13,201	Magoon, C. H., feed water heating apparatus.....	13,280
European Electric Co'y, The, electric lamps.....	13,137	Magrath, W. A. S., knitting machine.....	13,203
“ “ protecting electric wires.....	13,173	Martel, A. F. and C. A., railway switch.....	13,224
Fair, J. M., sewing machines.....	13,199	“ “ “ seal lock.....	13,260
Fairman, S., car brake and coupler.....	13,193	“ “ “ sleeping cars.....	13,185
Fitzgerald, P. J., gas generators.....	13,154	Mathieu, J. A., purification of products resulting from	
Flagg, G. H. P., abrasive belt.....	13,168	the distillation of wood.....	13,233
“ “ sole buffing machine.....	13,145	Mathews, A. N., et al., piston packing.....	13,107
Fletcher, W. S., traction engines.....	13,079	Mathews, D. S., shawl strap.....	13,218
Foote, E. B., magic lantern.....	13,275	Maxim, H. S., dynamo electric machine..... 13,115	13,116
“ T. M., et al., paper perforating.....	13,086	“ “ electric lamp..... 13,117 13,118 13,119	13,120
Foster, A. F., et al., smoke consumer.....	13,257		13,121
“ C. R., rotary plough.....	13,266	Mayall, T. J., telegraphy.....	13,159
“ W. F., glove fastener.....	13,300	Mead, E. T., et al., nut lock.....	13,258
Free, H., et al., door plate.....	13,237	Melick, J. H., et al., horse rakes.....	13,240
Fuller, H. Y., et al., door plates.....	13,237	Merriam, C. R., et al., soldering machine.....	13,177
“ V. E., pails and tubs.....	13,238	Meyers, N., sewing machine.....	13,199
“ “ et al., corn sizing machine.....	13,097	Miller, J., ice making apparatus.....	13,228
Gaines, H. F., faucet and bushing.....	13,196	Mills, J., reaping machine.....	13,114
Galbraith, R., cooking stove.....	13,108	Monk, W. and H., et al., steam engine.....	13,176
Galloway, T., et al., horse rakes.....	13,126	Moore, S. H. and E. Y., door hanger.....	13,084
Gates, P. W., stone crushing machines.....	13,178	Mumford, J. A., churn power.....	13,130
Garrison, C. O., et al., feather renovators.....	13,217	Mundy, E. L., et al., musical reed instruments... 13,197	13,295
Gaujot, R. C. E., self lubricating wheels.....	13,253		13,296
Gilbert, E. E., drilling apparatus.....	13,112	Naylor, J., hoop pointing and lapping.....	13,089
Gilchrist, P. C., et al furnace and converter.....	13,163	Nichols, M. O., musical reed instruments 13,197 13,295	13,296
Gilpin, J. C., milk pans.....	13,207	Northrup, D. W., manufacture of caps.....	13,095
Goodfellow, J. H., stovepipe damper.....	13,134	Norton, C., wagon wheels.....	13,222
Gordon, W., abrasive belt.....	13,168	“ T. H., train indicator.....	13,230
Green, W. F., stovepipe damper.....	13,134	Nowlan, F., preparation of monetary paper.....	13,287
Greenwood, J., hoop cutting machines.....	13,183	Noxon, J., grain drill distributors.....	13,146
Gregory, C. A., fire escapes.....	13,304	Olds, B. L., horse power link.....	13,081
Guelph Carriage Goods Co, The, steel tempering furnace	13,229	O'Rielly, M. J., water closets.....	13,262
Hamilton, E. M., pipe moulds.....	13,091	Ovens, W. S., cake machines.....	13,236
Hancock, J. T., valves.....	13,087	Paterson, J. W., saturating felt roofing.....	13,101
“ “ Inspirator Co'y, The, valves.....	13,087	Peace, H. W., saw handles.....	13,274
Harrison, J. G. L., and T. H., alumina.....	13,186	Petry, W. G., coffee percolators..... 13,098	13,099
Hastings, G. H., et al., bead covering.....	13,169	Pettibone, J. H., et al., steam pumps.....	12,136
Hatch, G. E., water closet bowl.....	13,242	Phelps, L. D., et al., lathes.....	12,286
Hazelton, A. W., plough.....	13,189	Piper, E. S., lamp.....	13,128
Hibstenberg, J. M., et al., leather renovators.....	13,217	Porter, E. N., et al., bracket pieces for screen frames....	13,305
Hilton, J., saw handles.....	13,279	Powell, C. N., pumps.....	13,138
Hindall, G. W., plating machines.....	13,156	Pratt, D. R., spring washer.....	13,096
Hogel, H. A., et al., smoke consumer.....	13,257	Pratt, J. H., type writing machines.....	13,192
Hohinstein, A. and G., car coupling.....	13,129	Price, H. W., mittens.....	13,155

Pridgen, W. A., hay and cotton press.....	13,219	Tuerk, C. T., et al., side sticks.....	13,133
Ravenaugh, A. O., carriage bodies.....	13,135	Turner, G., " grain drill.....	13,234
Richards, S., ice plough.....	13,263	" " H., pantaloons suspenders.....	13,105
Rideout, A. C., warming, equalizing and ventilating.....	13,227	Vandusen, B. C., pumps.....	13,282
Robertson, J. B., chimney top.....	13,239	Van Hoverbergh, H., printing telegraphs.....	13,198
" " fire pots for soldering irons.....	13,110	Van Wormer, M., et al., dumping cars.....	13,183
" " R. M., carriage spring.....	13,254	Vedder Pattern Works, Bascom, Galbraith, and Co.	
Rogers, A. H., painting characters.....	13,191	The N. S., cooking stoves.....	13,108
Rowe, H. A., et al., feather renovators.....	13,217	Walker, T. G., treatment of ores.....	13,153
Saladee, C. W., road waggons.....	13,292	Walton, F., application of oxidized oils to mouldings.....	13,206
Schad, C. F., glass furnace.....	13,249	" " embossing panels, etc.....	13,204
Seigmiller, S., plough.....	13,161	" " hollow articles.....	13,187
Semper, C., alumina.....	13,186	WanKlynn, J. A., et al., illuminating gas.....	13,210
Semple, R. W., car locks.....	13,299	Warner, J. D., et al., corset.....	13,181
Sharp, H. A., oil cabinets.....	13,212	Warren, J. T., horse powers.....	13,284
Shaw, G. A., car lock.....	13,299	Waters, F. M., et al., harvester.....	13,244
Sheldon, R. B., spring hoe.....	13,248	Watson, T. A., telephone.....	13,247
Sherman, J. B., et al., lathes.....	13,286	Wells, P. F., cultivator.....	13,205
Shippee, C. H., car coupling.....	13,093	Westgate, T., sewing machines.....	13,273
Smith, L., et al., soldering machine.....	13,177	Weston, E., electric lamp.....	13,122
" " K., middlings purifiers.....	13,256	" " dynamo electric machine.....	13,124
Speicher, S. S., seed sowers.....	13,270	Whittemore, F. B., gas cooking stove.....	13,202
Stanley, C. D., car moving devices.....	13,283	Widdifield, W. P., saw mills.....	13,213
Tallman, J. C., et al., corset.....	13,181	Wigle, M. J., et al., washing machines.....	13,094
Teetzel, J. W., well boring machine.....	13,271	Wilcox, A., clamp for barrow frames.....	13,243
Thomas, S. G., et al., converter and furnace.....	13,163	Williams, A. R., et al., belt tightener.....	13,141
" " J. W., " oven doors.....	13,293	" " " harvester gear trip.....	13,139
" " W. W., hydro-carbon furnace.....	13,252	" " " harvesting machine.....	13,142
" " " atomizers.....	13,180	" " " pitman connection.....	13,140
Thomson, R., et al., belt tightener.....	13,141	" " " reaper and harvester.....	13,143
" " " harvester gear trip.....	13,139	" " H., " glucose and grape sugar.....	13,211
" " " harvesting machine.....	13,142	" " M. B., " grain drill.....	13,234
" " " reaper and harvester.....	14,143	Wilson, G. G., " oven doors.....	13,293
" " " pitman connection.....	13,140	" " R. J., pipe moulds.....	13,091
" " S. R., et al., bark cutting machine.....	13,150	Winslow, J. M., et al., piston packing.....	13,107
Timberlake, J. B., dish handles.....	13,221	" " S., roller skates.....	13,235
Titus, H. W., et al., carriage bodies.....	13,135	Wisner, J. O. and W. S., spring hoe.....	12,248
Toler, J., furniture castor.....	13,157	Wright, F. M., churn.....	13,148

Patents issued up to 28th September, 1881, Claims and Drawings of which will appear in a subsequent number of the Patent Record.

- No. 13,326. E. Adams, East Salisbury, Mass., "Spring Heel Turned Shoe," August 29th, 1881.
- No. 13,327. R. Robinson, Antrim, N.H., "Hammock Chair," August 29th, 1881.
- No. 13,328. P. Lord, E. Mignault and J. B. Vinet, Montreal, Que., "Hose Coupling," August 29th, 1881.
- No. 13,329. R. Troy and G. O. Roberts, Oshawa, Ont., "Ironing Boards," August 29th, 1881.
- No. 13,330. B. H. Renners and J. Williamson, Glasgow, Eng., "Refining Sugar Saccharine, Oil, &c.," August 29th, 1881.
- No. 13,331. J. Naylor, jr., Rochester, N.Y., "Barrel Hoops and Method of Dressing and Coiling the same," August 29th, 1881.
- No. 13,331. W. D. McCallum, Truro, N.S., "Flower Stand," August 29th, 1881.
- No. 13,332. W. D. McCallum, Truro, N.S., "Flower Stand," August 29th, 1881.
- No. 13,333. F. Ward, Chatham, Ont., "Hoop Coiler," 29th August, 1881.
- No. 13,334. R. Lang and J. B. Lang, Lindsay, Ont., "Combined Harrow, Seeder and Roller," August 29th, 1881.
- No. 13,335. C. H. Moore, Yonkers, N.Y., "Attachments for Wash Basins, Baths, &c.," August 29th, 1881.
- No. 13,336. S. D. Maddin, St. Paul, Minn., "Harvesters," August 29th, 1881.
- No. 13,337. J. Brewer, Bloomfield, Ont., "Car Replacer," August 29th, 1881.
- No. 13,338. G. M. Hathaway and Benjamin S. Taylor, Jersey, N.J., "Locks," August 29th, 1881.
- No. 13,339. W. S. Oliver, Halifax, N.S., "Magazine Accoutrements," (Extension of Patent No. 6,781), August 29th, 1881.
- No. 13,340. B. B. Brewer, Sacramento, Cal., "Water Lifter," August 30th, 1881.
- No. 13,341. J. Gast, Brooklyn, N. Y., "Labor Saving Stigmagraph," September 1st, 1881.
- No. 13,342. W. M. Wilkin, East Saginaw, Mich., "Reciprocating Saw Mill," Sept. 1st, 1881.
- No. 13,343. R. Weir and L. N. Keating, Muskegon, Mich., "Log Canters," Sept. 1st, 1881.
- No. 13,344. W. A. Baglin and J. Gray, Brooklyn, N. Y., "Hat Felt-ing Machine," Sept. 1st, 1881.
- No. 13,345. C. B. Morse, Blunback, N.Y., "Manufacture or Production of Hollow Ingots or Tubes of Cast Steel," Sept. 1st, 1881.
- No. 13,346. D. B. Shantz, Berlin, Ont., "Chuck for Button Polishing," Sept. 1st, 1881.
- No. 13,347. W. H. B. Morgan, Bridgetown, Ont., "Elevating Hand Trucks," Sept. 1st, 1881.
- No. 13,348. A. Mitchell, Fredericton, N.B., "Carpet Stretcher," Sept. 1st, 1881.
- No. 13,349. W. Thompson, Limehouse, Eng., "Improvements in the Manufacture of White Lead," Sept. 1st, 1881.
- No. 13,350. J. Bond, jr., Philadelphia, Penn., "Lock Stitch Sewing Machine," Sept. 1st, 1881.
- No. 13,351. A. Bureau, Brussels, Belgium, "Lamps," Sept. 1st, 1881.
- No. 13,352. D. Roberge, New York, "Horse Hoof Expander," Sept. 1st, 1881.
- No. 13,353. D. A. Hopkins, Park Ridge, N.J., "Journal Bearings for Railroad Car Axles," Sept. 1st, 1881.
- No. 13,354. L. G. Woolley, Union City, Indiana, "Electric Lamp," Sept. 2nd, 1881.
- No. 13,355. L. Onderdonk, Adam Station, C. C. Brown and H. P. Wells, N.Y., "Plaiting Attachments for Sewing Machines," Sept. 2nd, 1881.
- No. 13,356. D. F. Van Liew, Aurora, Ill., "Car Door Hangers," Sept. 2nd, 1881.
- No. 13,357. A. G. Wilkins, Cooperstown, Penn., "Shoe Button Fasteners," Sept. 2nd, 1881.
- No. 13,358. W. W. Green and L. G. Stark, Chicago, Ill., "Exhaust and Blowing Fans," Sept. 2nd, 1881.
- No. 13,359. H. McKenzie, Caro, Mich., "Spark Arresters," Sept. 2nd, 1881.
- No. 13,360. S. M. Allen, Duxbury, Mass., "Manufactured Dried Wood Pulp for Transportation and Sale," Sept. 2nd, 1881.
- No. 13,361. T. F. Williams, Lower Cascades, Washington, "Revolving Dip Nets," Sept. 2nd, 1881.
- No. 13,362. W. Munsie, Victoria, B.C., "Catapult Lance," Sept. 2nd, 1881.
- No. 13,363. The Canadian Telephone Company, Montreal, Que., (Assignee of George L. Anders, Boston, Mass., "Electric Speaking Telephone," Sept. 2nd, 1881).
- No. 13,364. Ed. Spaulding, Brooklyn, N. Y., "Elliptic Spring (Extension of Patent No. 9,896), Sept. 2nd, 1881.
- No. 13,365. Ed. Spaulding, Brooklyn, N. Y., "Elliptic Spring," (Extension of Patent No. 6,493), Sept. 4th, 1881.
- No. 13,366. John H. McMechan, London, Ont., "Overshoe," (Extension of Patent No. 6,493), Sept. 4th, 1881.
- No. 13,367. A. E. Ellinwood, Akron, Ohio, "Drill Chuck," Sept. 4th, 1881.
- No. 13,368. C. Holland, Chicago, Ill., "Hydro-Carbon Burner," Sept. 4th, 1881.
- No. 13,369. J. Heron, Phil., Penn., "Friction Gear," Sept. 4th, 1881.
- No. 13,370. P. Bargion, Black Diamond, California, "Rails and Railway Telegraphs," Sept. 4th, 1881.
- No. 13,371. A. C. Foster, Lake, Ill., "Hoisting Apparatus."
- No. 13,372. B. B. Ward, Kingston, Ont., (Assignee of Addison G. Waterhouse and B. B. Brewer, Sacramento, California), "Steam Engines," Sept. 4th, 1881.
- No. 13,373. J. H. Harper and J. B. Powell, Philadelphia, Penn., "Spring Motors," Sept. 4th, 1881.
- No. 13,374. C. G. Wheeler, Chicago, Ill., "Saccharated Extracts."
- No. 13,375. J. F. N. Macay, Charapoto, London, Eng., "Rotary Decanting Tilter," Sept. 4th, 1881.
- No. 13,376. L. Stennuler, Victoria, British Columbia, "Perforated Swing Top Can Lid," Sept. 4th, 1881.
- No. 13,377. W. H. Brown, Norwich, Ont., "Clothes Driers," Sept. 4th, 1881.
- No. 13,378. J. K. Harris, Springfield, Ohio, "Button Hole Attachment for Sewing Machines," Sept. 4th, 1881.
- No. 13,379. P. F. Henleg, London, Eng., "Date Breverage and Apparatus," Sept. 4th, 1881.
- No. 13,380. C. Holland, Chicago, Ill., "Hydro-Carbon Furnaces," Sept. 4th, 1881.
- No. 13,381. J. J. Houle, Fishkill, N.Y., "Anchors," Sept. 4th, 1881.
- No. 13,382. S. Marcotte, Montreal, Que., "Self Sealing Covers for Jars," Sept. 8th, 1881.
- No. 13,383. G. P. Warner, N.Y., "Combined Shirt Bosom and Cuffs."
- No. 13,384. J. Norris, St. Catharines, Ont., (Assignee of D. Moore and W. A. Robinson, Hamilton, Ont.), "Crowning Glory," (Extension of Patent No. 6,533), Sept. 8th, 1881.
- No. 13,385. W. B. Malcolm, Toronto, Ont., "Self-Feeding Circulating Hot Water and Steam Boilers," Sept. 13th, 1881.
- No. 13,386. W. F. Moulton, Jericho, Vermont, "Water Tubing," Sept. 13th, 1881.
- No. 13,387. J. L. Haycock, Catarqui, Ont., "Pruning Shears," Sept. 13th, 1881.
- No. 13,388. G. W. Darby, Hamilton, Ohio, "Ruffing Attachment for Sewing Machines," Sept. 13th, 1881.
- No. 13,389. C. W. Woolsey, Jersey, N.J., "Rife Raft," Sept. 13th, 1881.
- No. 13,390. N. H. Long, Muncie, Indiana, "Swinging Gate," Sept. 13th, 1881.
- No. 13,391. F. M. Weaver, W. A. Hance, Springfield, J. B. Lewis, J. H. Neily, Belleville, Ohio, "Treadles," Sept. 13th, 1881.
- No. 13,392. E. Ker, Pelham, Ont., "Machines for the Evaporation of Fruit and Vegetable," Sept. 13th, 1881.
- No. 13,393. P. Hall, Brooklyn, N. Y., "Type Writing Machines," Sept. 13th, 1881.
- No. 13,394. John Cross, Oakville, Ont., "Fruit Package," Pa., Sept. 13th, 1881.
- No. 13,395. Samuel Jackson, Philadelphia, Penn., "Signal Fusee," Sept. 13th, 1881.
- No. 13,396. Mitchell Renz, Bridgeport, Conn., U. S. A., "Nut Crocker," Sept. 13th, 1881.
- No. 13,397. Robert David Fowler and Robert Neill, both of Chicago, Ill., "Steam Drying Apparatus," Sept. 13th, 1881.
- No. 13,398. William Jones Thorn, Ottawa, Ont., "Wooden Horse Collar," Sept. 13th, 1881.
- No. 13,399. Martin A. Howell, Chicago, and Hubert R. Ives, Montreal, "Wire Stretcher," Sept. 13th, 1881.
- No. 13,400. Benjamin Boyman Prentice, Osgood, Ont., "Cabinet Creamer Churn," 13th Sept., 1881.
- No. 13,401. Elizabeth Ann Fowler, (Assignee of Nathaniel Clarke Fowler), Boston, Mass., "Fire-proof Material," Sept. 13th, 1881.
- No. 13,402. Christopher Columbus Bradley, (Assignee of Robert Dighton Warner), Syracuse, N.Y., "Improvement in Harvesters," (Extension of Patent No. 6,572), Sept. 13th, 1881.
- No. 13,403. William Monk and Henry Monk, Hadlow Cove, and Charles William Carrier, Lewis Quebec, "High and Low Pressure Cylinder, (Extension of Patent No. 13,176), Sept. 14th, 1881.
- No. 13,404. William Monk and Henry Monk, Hadlow Cove, and Charles William Carrier, Lewis, Que., "Combined Valve High and Low Pressure Cylinder," (Extension of Patent No. 13,405,) patented September 14th, 1881.
- No. 13,405. Charles William Carrier, Lewis, Que., (Assignee of Adolphus Davis, Montreal,) (Extension of Patent No. 12,961,) patented September 14th, 1881.
- No. 13,406. Charles William Carrier, Lewis, Que., (Assignee of Adolphus Davis, Montreal,) (Extension of Patent No. 12,961,) patented September 15th, 1881.
- No. 13,407. David Bousseau and William Coudray Smith, both of New York, N. Y., "Electric Railway Signal," (Extension of Patent No. 6,537,) patented September 15th, 1881.
- No. 13,408. Joseph Archer, Quebec, Que., "Non-Bursting Lamp Water Conductor," (Extension of Patent No. 1,153,) patented September 15th, 1881.

- No. 13,409. Henry Ira Hotchkiss Berlin Falls, N. H., "Automatic Cradle," patented September 17th, 1881.
- No. 13,410. H. F. Parsons, San Francisco, Cal., "The Parson's Hand Power Rock Drill," September 17th, 1881.
- No. 13,411. H. B. Nickerson, Orleans, Mass., "Mechanical Musical Instrument," September 17th, 1881.
- No. 13,412. E. Pope, Quebec, Que., "Signal Switch," September 17th, 1881.
- No. 13,413. S. B. Ferguson, Hallowell, Ont., "Cheese Vat," patented September 17th, 1881.
- No. 13,414. J. Schweizer, Soleure, Swiss, "Electric Clocks," patented September 17th, 1881.
- No. 13,415. H. B. Howard and A. W. Burnside, Beloidere, Ill., "Car Coupling," patented September 17th, 1881.
- No. 13,416. E. Steer and John Sheldon, Birmingham, Eng., "Metallic Fencing and Infastening in Joining Wires and Strips or Bands for Metallic Fencing," patented September 17th, 1881.
- No. 13,417. L. Q. Dion, Natick, Mass., "Boot and Shoe Last," patented September 17th, 1881.
- No. 13,418. W. B. Malcolm, Toronto, Ont., "Cone Grate Self-Feeding Boilers, Stoves and Furnaces," patented September 17th, 1881.
- No. 12,419. J. B. Armstrong, Guelph, Ont., "Flanging Punch," patented September 17th, 1881.
- No. 13,421. J. B. Armstrong, Guelph, Ont., "Vehicles," patented September 17th, 1881.
- No. 12,422. C. J. Shiereff, Brockville, Ont., "Clothes Wringers," patented September 17th, 1881.
- No. 13,423. M. G. Farmer, New Port, R. I., "Electro-Magnetic Motors," patented September 17th, 1881.
- No. 13,424. J. H. Henry, Hinsdale, N. H., "Cylinder Machine for Making Paper," patented September 17th, 1881.
- No. 13,425. P. Pearson, Manchester, Eng., "Coffee Roaster," patented September 17th, 1881.
- No. 13,426. E. W. Blackhall, Toronto, Ont., "Fountain Ruling Pen," patented September 17th, 1881.
- No. 13,427. A. M. Kerr, Westminster, Ont., "Spark Arrester," patented September 17th, 1881.
- No. 13,428. W. F. Sexton, sr., W. F. Sexton, jr., Toronto, Ont., patented September 17th, 1881.
- No. 13,429. F. Honston, Toronto, Ont., "Over Coat Sleeve Lining," patented September 17th, 1881.
- No. 13,430. J. H. Reed, Lancaster, Wis., "Writing Charts," patented September 17th, 1881.
- No. 13,431. B. B. Brewer and B. B. Ward, Sacramento, Cal., "Engine Governor," patented September 17th, 1881.
- No. 13,432. J. A. Osgood, Grantville, Mass., and E. P. Monroe, New York, "Metallic Packing," patented September 17th, 1881.
- No. 13,433. J. McCree, Lausing, Mich., "Car Coupling," patented September 17th, 1881.
- No. 13,434. G. A. Ganover, Trafalgar, Ont., "Tumbling Churn," patented September 17th, 1881.
- No. 13,435. J. A. Baldwin, Shelburne, Vt., "Combined Extension Shelf and Portable Door for Closing Openings in Refrigerators and Milk Bureau," patented September 17th, 1881.
- No. 13,436. G. A. Stewart, Toronto, Ont., "Grain Elevators," patented September 17th, 1881.
- No. 13,437. F. P. Simonds, Natick, Mass., "Boot Treering Machine," patented September 17th, 1881.
- No. 13,438. J. Gesard and P. Tremblay, Newton, Kansas, "Washing Machines," patented September 17th, 1881.
- No. 13,439. H. Sells, Vienna, Ont., "Husking Corn Machines," patented September 17th, 1881.
- No. 13,440. E. Hickman, Red Bluff, Cal., "Car Couplings," patented September 17th, 1881.
- No. 13,441. M. H. Barnard, Forestville, Conn., "Cattle Stanchions," patented September 17th, 1881.
- No. 13,442. J. Cavers, North Dunfries, Ont., "Fanning Mills," patented September 17th, 1881.
- No. 13,443. H. G. Dennis, New Bedford, Mass., "Bell Point for Coupling Pipes," patented September 17th, 1881.
- No. 13,444. J. Alexander, Toronto, Ont., "Refrigerator," (Extension of Patent No. 12,923,) patented September 18th, 1881.
- No. 13,445. A. M. Bechard, R. D. Morkill and J. R. Woodward, Sherbrooke, Que., "Self-Acting Freight Car Coupler," patented September 18th, 1881.
- No. 13,446. L. H. Bailey, Morrisville, Vt., "Composition of Matter for Coloring and Preservation of Butter," patented September 20th, 1881.
- No. 13,447. W. E. Eastman, C. K. Kimball and C. H. Murch, Boston, Mass., "Freight Car Heater," patented September 20th, 1881.
- No. 13,448. T. S. Lewis, Saco, Maine, "Guide Rein Terret," patented September 20th, 1881.
- No. 13,449. A. Weed, Philadelphia, Penn., "File Cutting Machine," patented September 20th, 1881.
- No. 13,450. G. Gruber, Detroit, Mich., "Brushes," patented September 20th, 1881.
- No. 13,451. D. A. Dyer, Ferudale, Cal., "Submarine and Surface Walls," patented September 20th, 1881.
- No. 13,452. E. Andrews Williams, Port Pennsylvania, "Auxiliary Saw Handles," patented September 20th, 1881.
- No. 13,453. G. Nicholson, (Assignee of T. A. Weber, New York,) "Bale Band Fastening," patented September 20th, 1881.
- No. 13,454. The Morley Sewing Machine Company, (Assignee of J. H. Morley, Holyoke, Mass.,) "Method of Stitching," patented September 20th, 1881.
- No. 13,455. A. F. Martel, Montreal, Que., "Nut Lock," patented September 20th, 1881.
- No. 13,456. A. W. Gifford, Worcester, Mass., "Machine for Making Metal Screws," (Extension of Patent No. 6,900,) patented September 20th, 1881.
- No. 13,457. C. M. Warren, Brookline Norfolk, Mass., "Anchor Roof," (Extension of Patent No. 6,606,) patented September 20th, 1881.
- No. 13,458. C. M. Warren, Brookline Norfolk, Mass., "Anchor Roof," (Extension of Patent No. 6,606,) patented September 21st, 1881.
- No. 13,459. A. A. Crosby, (Assignee of S. Gilzinger, Rondout, N. Y.,) "Vehicle Spring," (Extension of Patent No. 6,575,) patented September 22nd, 1881.
- No. 13,460. A. A. Crosby, (Assignee of S. Gilzinger Rondout, N. Y.,) "Vehicle Spring," (Extension of Patent No. 6,575,) patented September 23rd, 1881.
- No. 13,461. C. Sneider and Daniel Slote, "Binders," patented September 23rd, 1881.
- No. 13,462. E. Robinson and A. N. Detmer, Cinn, Ohio, "Coffee Pot and Urn," patented September 23rd, 1881.
- No. 13,463. W. F. Wilkins, Adamsville, Que., J. Wilkins, Toronto, Ont., patented September 23rd, 1881.
- No. 13,464. G. A. Schram, St. Thomas, Ont., "Shirt Board," patented September 23rd, 1881.
- No. 13,465. E. Wheeler, Philadelphia, Penn., "Articles of Steel," patented September 23rd, 1881.
- No. 13,466. N. E. Reynier, Paris, France, "Lampe Electrique," patented September 23rd, 1881.
- No. 13,467. T. A. Edison, Menlo Park, N. J., "Commutators," patented September 23rd, 1881.
- No. 13,468. R. I. Creelman and R. Creelman, Georgetown, Ont., patented September 23rd, 1881.
- No. 13,469. J. W. Maloy, Somerville, Mass., "Sole Edge Burnishing Machines," patented September 23rd, 1881.
- No. 13,470. G. H. Zschech, Indianapolis, Indiana, "Water Heaters and Purifiers," patented September 25th, 1881.
- No. 13,471. C. H. Wilbard, Aurora, N. Y., J. D. Brooks, Albany, N. Y., "Cigar Lighter," patented September 25th, 1881.
- No. 13,472. St. G. L. Fox, London, Eng., "Electric Lamp," patented September 25th, 1881.
- No. 13,473. H. Edwards, Lobo, Ont., "Specific for the Cure of Cancers," patented September 25th, 1881.
- No. 13,474. J. B. Lamb, Ottawa, Ont., "Grain Gatherer and Binder," patented September 25th, 1881.
- No. 13,475. R. E. Birch, Templeton, Que., J. R. Fleming, Ottawa, Ont., "Diphtheria Cure," patented September 25th, 1881.
- No. 13,476. T. A. Putman, New York, N. Y., "Electric Danger Signal for Railways," patented September 25th, 1881.
- No. 13,477. G. Milson, Buffalo, N. Y., "Elevating and Weighing Devices for Vessels," (Extension of Patent No. 6,596,) patented September 28th, 1881.
- No. 13,478. J. Varney, Montreal, Que., "Dodd Machine," (Extension of Patent No. 6,599,) patented September 28th, 1881.
- No. 13,479. N. E. Fuller, Hamilton, Ont., (Assignee of J. S. McMurray, Toronto, Ont.,) "Handle and Bail Ear," (Extension of Patent No. 6,627,) patented September 28th, 1881.

THE CANADIAN PATENT OFFICE RECORD.

ILLUSTRATIONS.

Vol. IX.

SEPTEMBER, 1881.

No. 9.

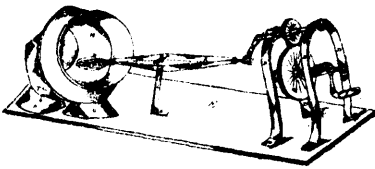

13078 Luttrell's Improvements on Egg Beaters.

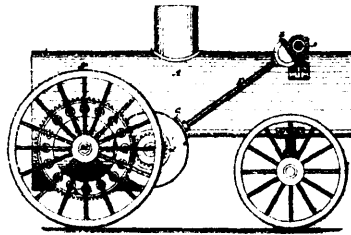

13079 Fletcher's Improvements on Traction engines.

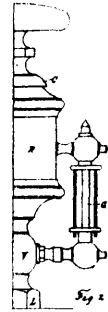

13085 Bailey's Improvements in Lubricators.

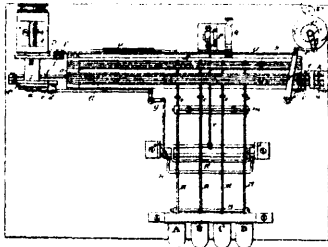

13086 Anderson & Foote's Improvements on Machines for Perforating Paper for Telegraphic Purposes.

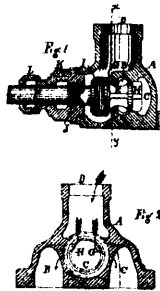

13087 Hancock's Improvements on Valves.

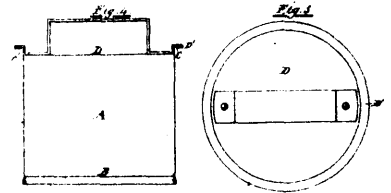

13088 Austin's Improvements on Metal Cans.

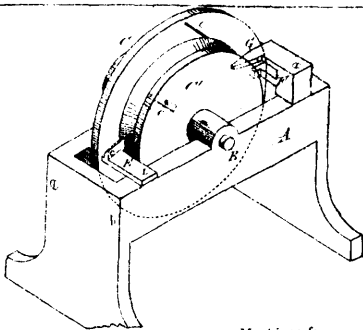

13089 Naylor's Improvements on Machines for Pointing and Lapping Hoops.

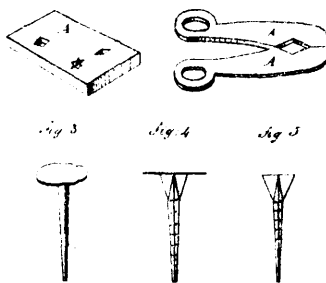

13090 Hyslop's Improvements on the Method of Finishing the Heads of Tacks, Nails and Rivets.

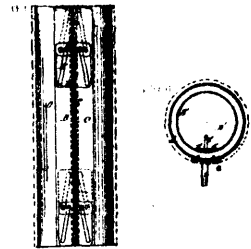

13091 Hamilton's Improvements in Pipe Moulds.

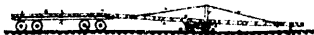

13092 Adams's Improvements on Apparatus for Laying Railway Tracks.

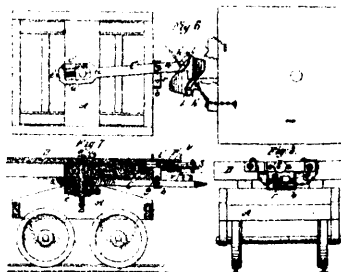

13093 Shippee's Improvements on Car Couplings.

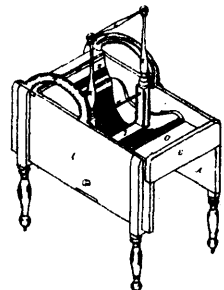

13094 Babb & Wigle's Improvements on Washing Machines.

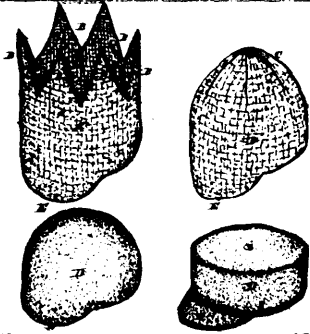

13095 Northrup's Process for the Manuf. ure of Caps.

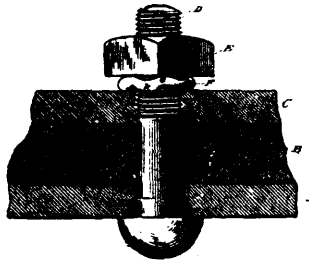

13096 Pratt's Improvements on Spring Washers.

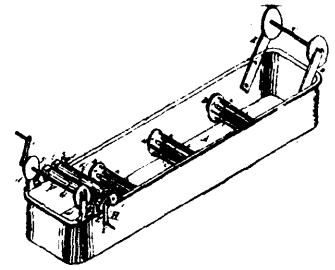

13097 Paterson's Improvements in Implements for saturating felt Roofing.

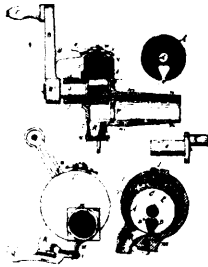

13102 Drawbaugh's Improvements on Measuring Faucets.

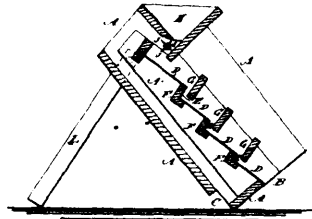

13103 King's Improvements on Cockle Mills.

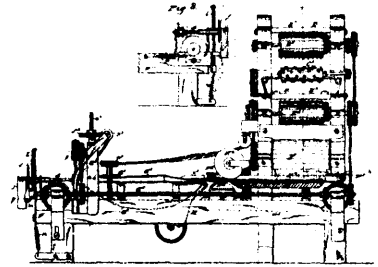

13104 Bousak's Improvements in Cigarette Machines.

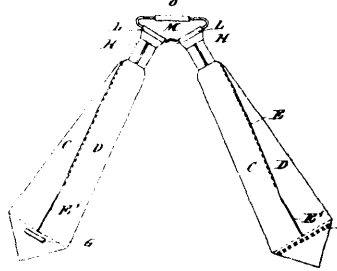

13105 Turner's Improvements in Pantaloons Suspenders

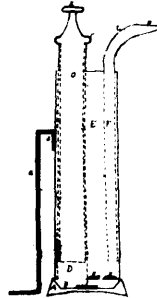

13106 Brooks's Force Pump.

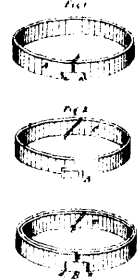

13107 Matthews's Improvements on Steam Piston Packing.

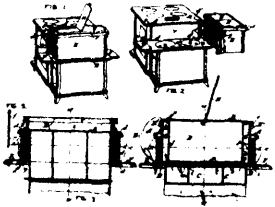

13108 Galbraith's Improvements in Cooking Stoves.

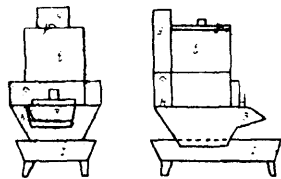

13110 Robertson's Improvements on Fire Pots Soldering Irons.

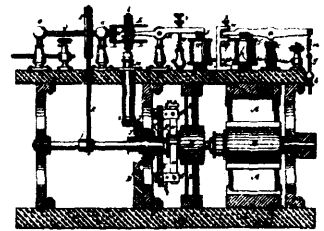

13115 Maxim's Improvements on Dynamo-electric Machines.

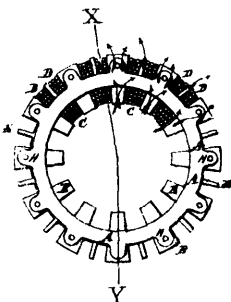

13116 Maxim's Improvements on Armatures for Dynamo-electric Machines.



13117 Maxim's Improvements on Electric Lamps.

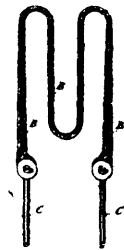

13118 Maxim's Improvements on Electric Lamps.

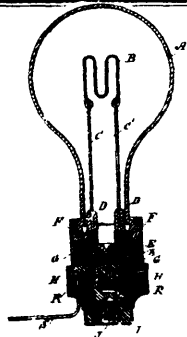

13119 Maxim's Improvements on Electric Lamps.

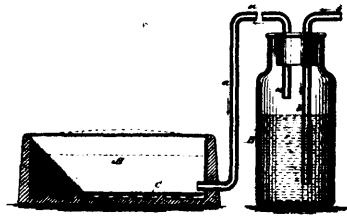

13120 Maxim's Process of Manufacturing Carbon Conductors for Electric Lamps.

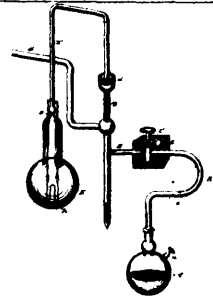

13121 Maxim's Process of Removing Atmospheric Oxygen from the Globes of Electric Lamps.

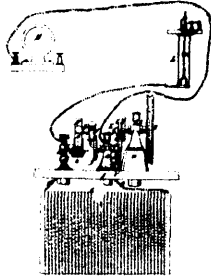

13122 Weston's Improvements on Devices for Equalizing the Arcs of Electric Lamps.

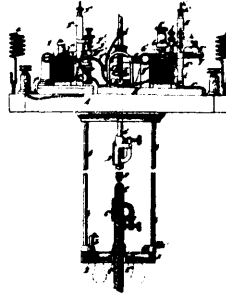

13123 Weston's Improvements on Electric Lamps.

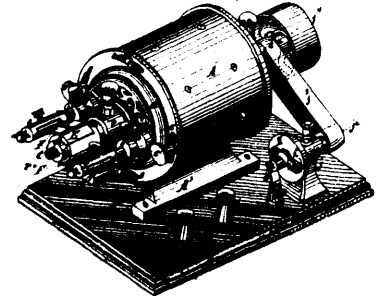

13124 Weston's Improvements on Dynamo-electric Machines.

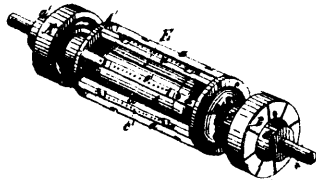

13125 Weston's Improvements on Rotating Armatures for Dynamo-electric Machines.

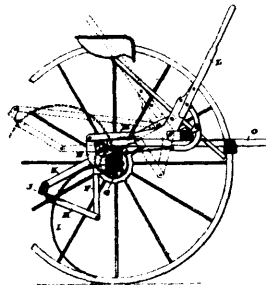

13126 Larsen's Improvements on Horse Rakes.

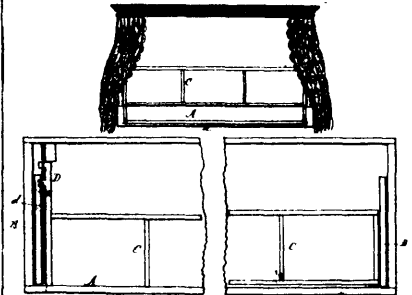

13127 McMann's Improvements on Safe-guards for Berths for Railway Cars and Steamships.

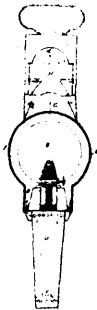

13128 Piper's Improvements on Lamps.

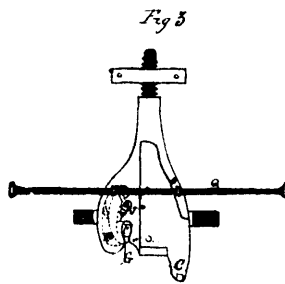

13129 Hohenstein's Improvements on Car Couplings.

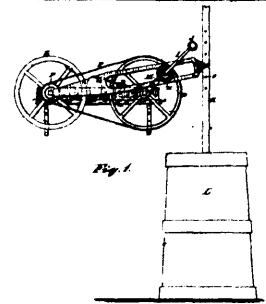

13130 Mumford's Improvements on Churn Power.

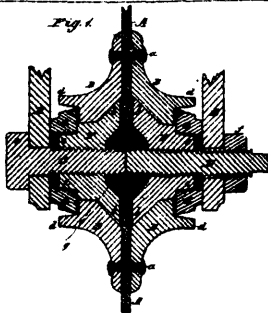

13131 Clayton's Improvements on Couthers.

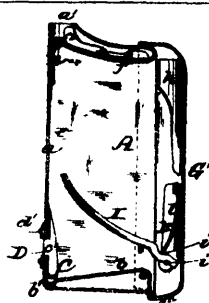

13132 Dangerfield's Improvements on Match Safes.

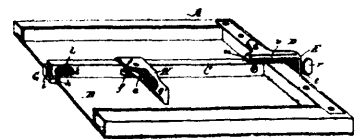

13133 Burke's Improvements on Printers' Side Sticks.

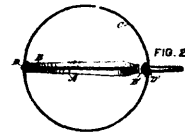
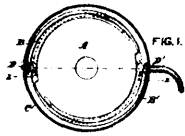

13134 Goodfellow's Improvements on Stovepipe Dampers.

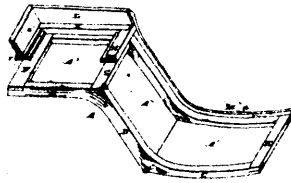

13135 Titus's Improvements on Carriage Bodies.



13136 Pettibone's Improvements on Steam Pumps

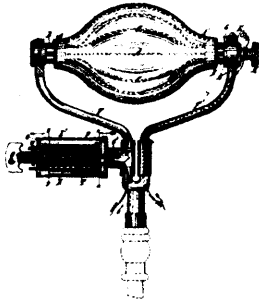

13137 Hussey's Improvements on Electric Lamps.

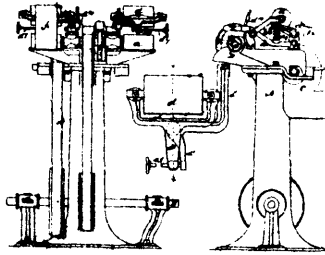

13146 Coy's Improvements on Machines for Buffing Soles.

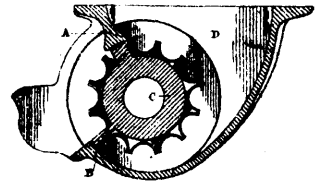

13148 Noxon's Improvements in Grain Drill Distributors.

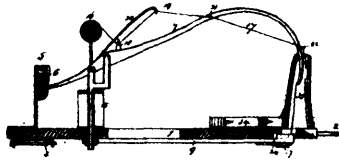

13147 Kay's Improvements on Grain Binders.

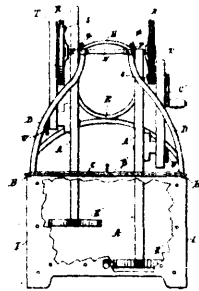

13148 Wright's Improvements on Churns.

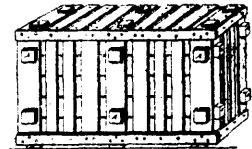

13149 Cochrane's Improvements on Devices for Carrying Fruit.

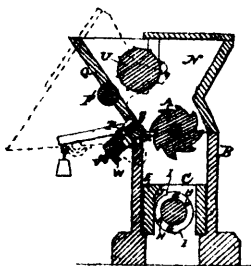

13150 Thompson & Johnson's Improvements on Bark Cutting Machines.

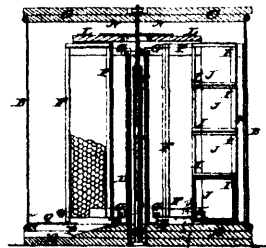

13151 Blaisdell's Improvements on Bee Hives.

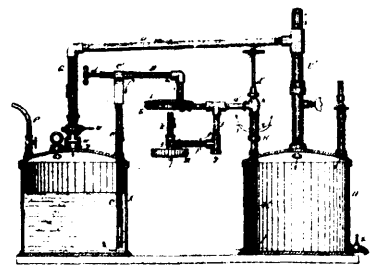

13154 Fitzgerald's Improvements on Hydro-carbon Gas Generators.

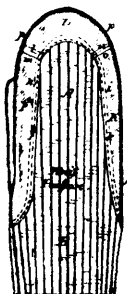

13155 Price's Improvements on Mittens.

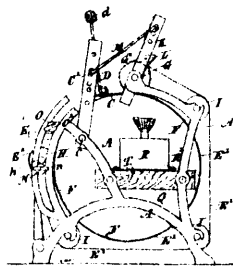

13156 Kendall's Improvements in Plaiting Machines.

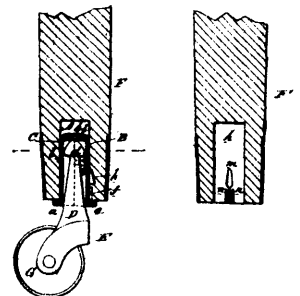

13157 Tolet's Improvements in Furniture Casters.

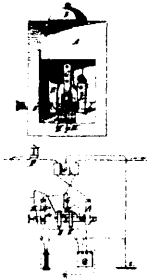

13158 Anders's Improvements in Telephones.

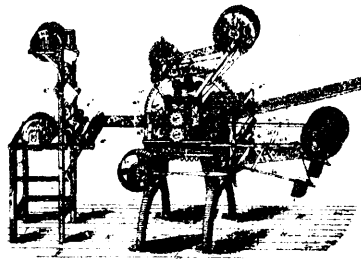

13159 Mayall's Improvements in Telegraphy.

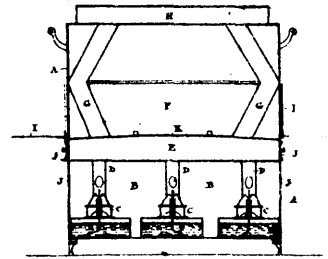

13160 Collins's Improvements on Oil Stoves.

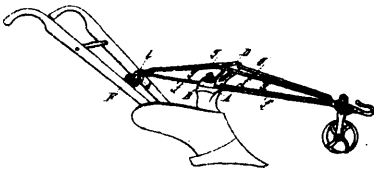

13161 Seegmiller's Improvements on Ploughs.

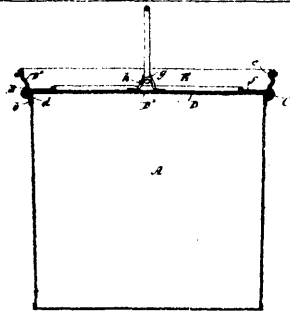

13162 Dolby's Improvements in Butter Cans.

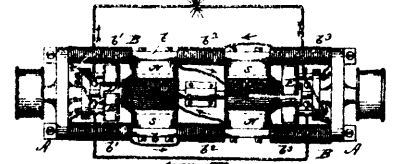

13164 Ball's Improvements in Dynamo or Magneto Electric Generators.

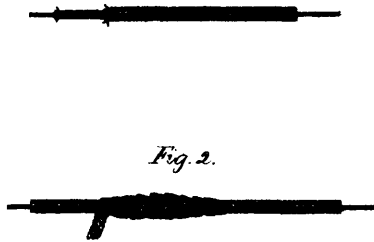

13165 Knudson & Kane's Improvements on Insulating Electrical Conductors.

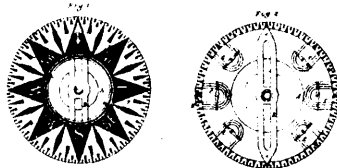

13166 Brown & Lewis's Improvement in Mariners' Compasses.

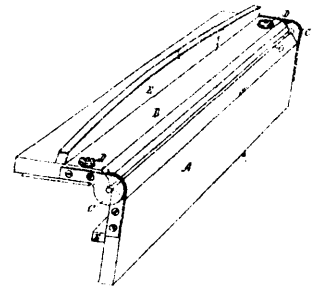

13167 John's Trough and Gutter Former.

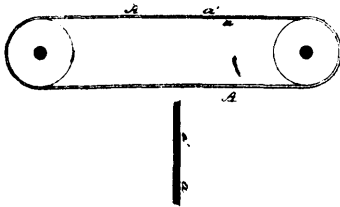

13168 Flagg & Gordon's Abrasive Belt.

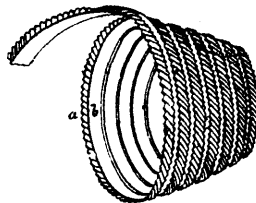

13169 Crean & Hastings's Improvements in the Manufacture of Head Coverings.

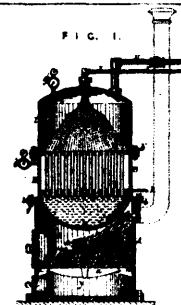

13170 Blumenberg's Improvements on Generators for Hydro Carbon Engines.

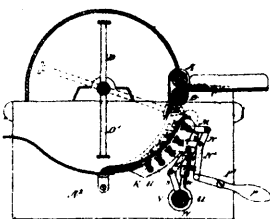

13171 Keene's Improvements on the Art of Cleaning and Opening Spinners' Staple.

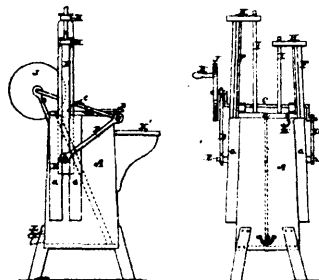

13172 Hollis's Improvements on Churns.

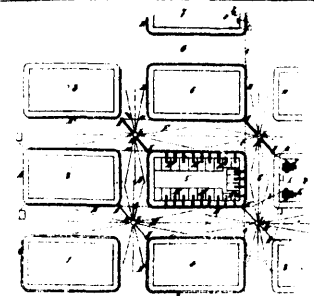

13173 Hussey's Improvements in Means of Supporting and Protecting Wires for Electrical Purposes.

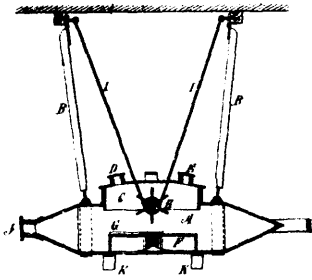

13174 Campbell's Improvements on Churns.

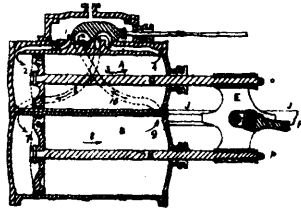

13176 Monk's Improvements on Steam Engines.

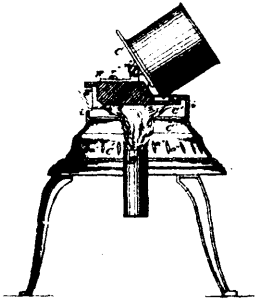

13177 Merriam's Improvements on Soldering Machines.

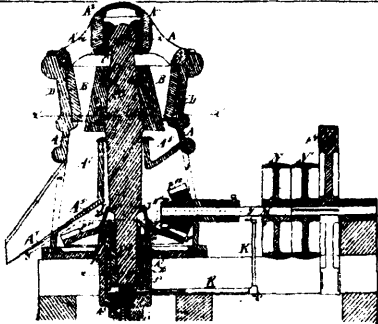

13178 Gates' Improvements on Machines for Breaking and Crushing Stones.

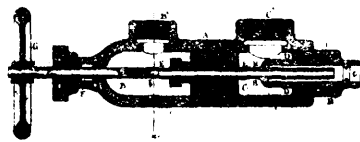

13180 Thomas' Improvements on Atomizers for Hydro-carbons.

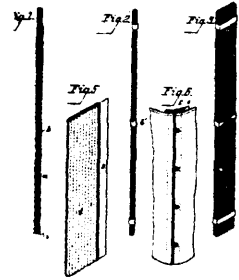

13181 Warner & Tallman's Improvements on Corsets.

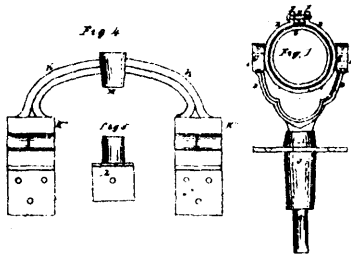

13182 Kirkpatrick's Improvements on Rowlocks.

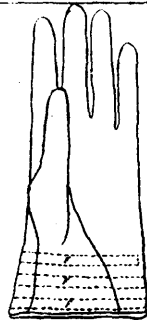

13183 Urwick's Improvements on Gloves.

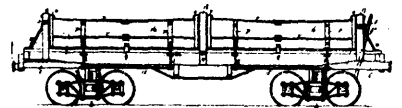

13184 Van Wormer's Improvements on Dumping Cars.



13185 Martel's Improvements on sleeping Cars.

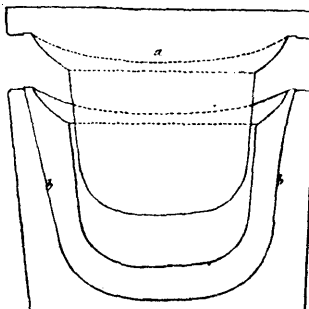

13187 Walton's Improvements in the Manufacture of Hollow Articles.

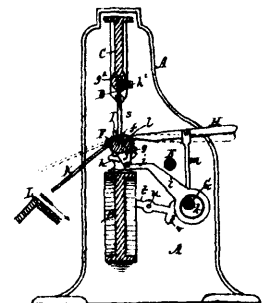

13188 Greenwood's Improvements on Hoop Cutting Machines.

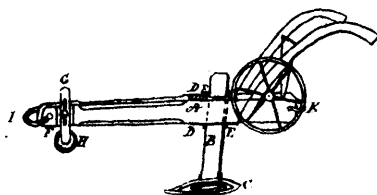

13189 Hazelton's Improvements on Ploughs.

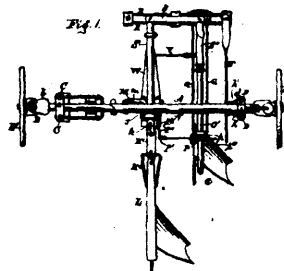

13190 Holgate's Improvements on Gaug Ploughs.

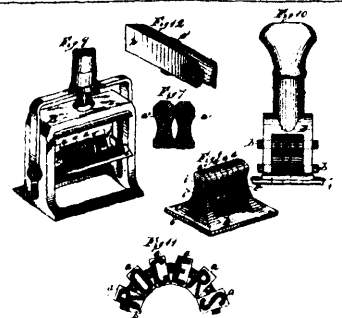

13191 Rogers' Improvements on Printing Characters and in Composing Devices Therefor.

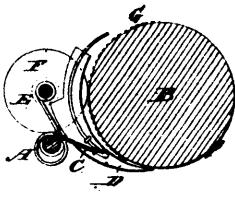

13182 Pratt's Improvements on Paper Pressers for Type Writing Machines.

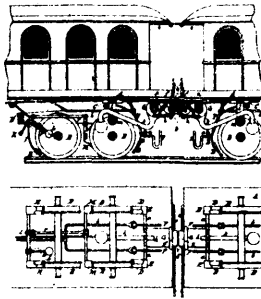

13193 Fairman's Combined Car Brake and Coupler.

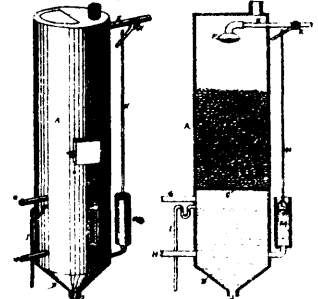

13194 Dane's Improvements in Apparatus for Purifying Feed Water for Steam Generators.

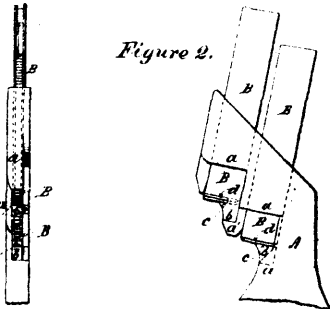

13195 Johnson's Improvements on Type and Space Holders.

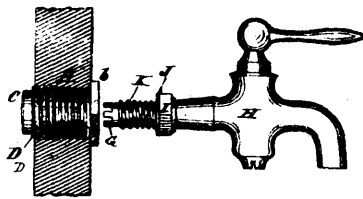

13196 Gaines's Improvements on Faucet Bushings and Faucets Combined.

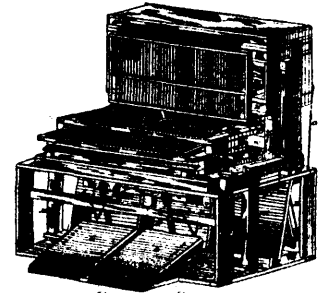

13197 Nichols's Improvements on Musical Reed Instruments.

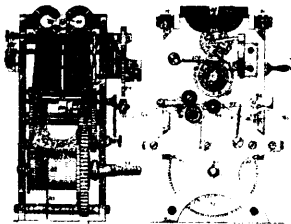

13198 Van Hovenbergh's Improvements on Printing Telegraphs.

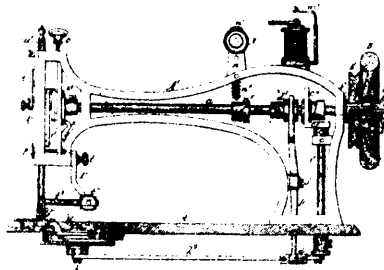

13199 Meyers's Improvements on Sewing Machines.

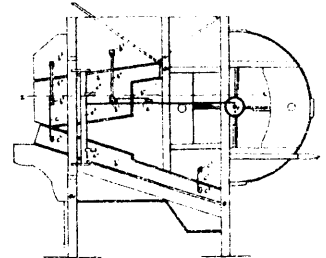

13200 Krake's Improvements on Grain Separators.

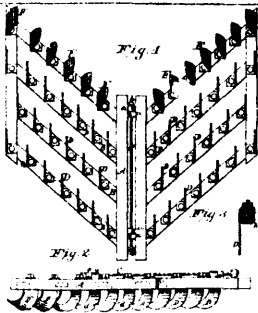

13201 Low's Improvements on Harrows.

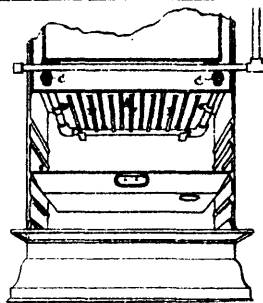

13202 Whittmore's Improvements on Gas Cooking Stoves.

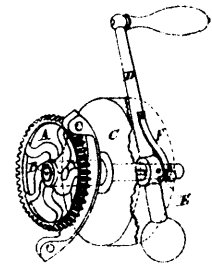

13203 Magrath's Improvements in Knitting Machines.

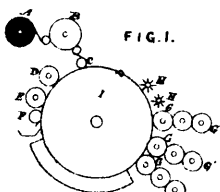

13204 Walton's Improvements on the Manufacture, Embossing and Colouring of Panels and Mouldings.

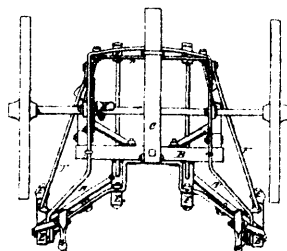

13205 Wells's Improvements on Cultivators.

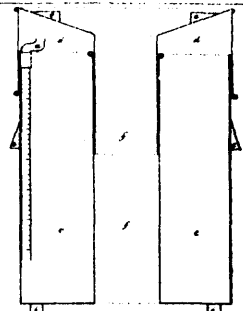

13207 Gilpin's Improvements in Milk Cans.

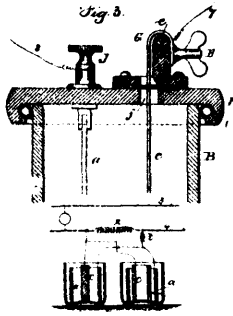

13208 Edison's Improvements on Voltmeters.

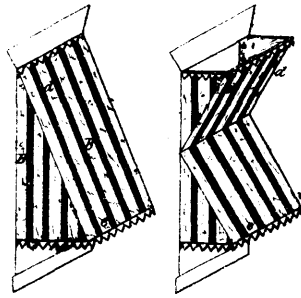

13209 Dwinelle's Improvements in Window Awnings.

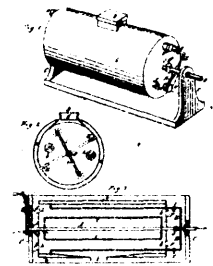

13217 Rowe's Improvements on Feather Renovators.

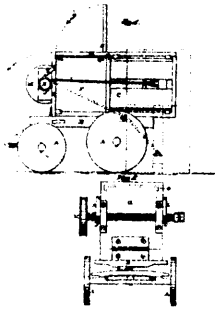

13219 Pridgen's Improvements on Hay and Cotton Presses.



13220 Adams's Improvements on Waggon Axles.

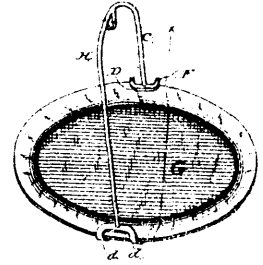

13221 Timberlake's Improvements on Dish Handles.

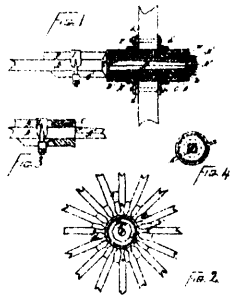

13222 Norton's Improvements on Waggon Wheels and Axles.

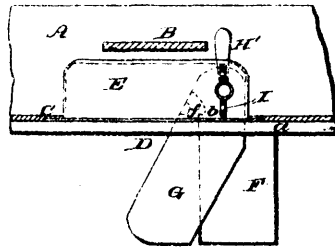

13223 A: wood's Improvements on Centre Boards for Boats.

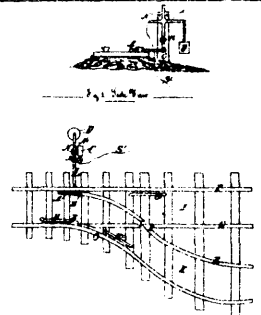

13224 Martel's Improvements on Railway Switches.

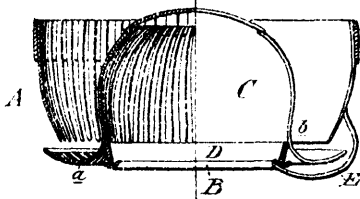

13225 Eldridge's Improvements on Stove Grates and Fire Pots.

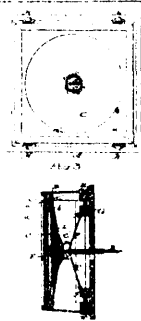

13226 Holcomb's Improvements in Telephones.

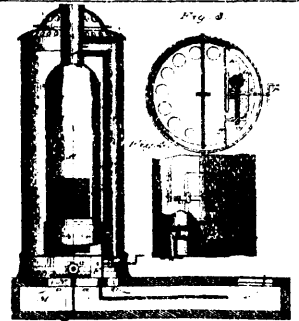

13227 Rideout's Improvements on Warming, Equalizing and Ventilating.

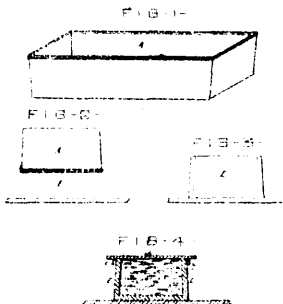

13228 Miller's Process of, and Apparatus for making Ice.

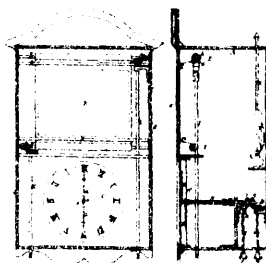

13230 Norton's Improvement on Railway Train Indicators.

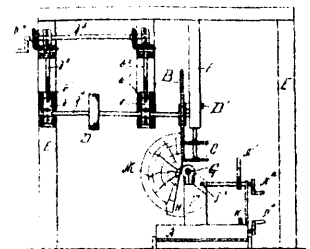

13231 Baccock's Improvements on Machines for Sawing Lapboards.

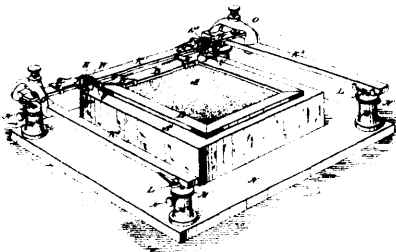

13232 Day's Improvements on Printing Mediums and Mechanisms for using the same.

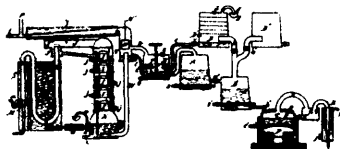

13233 Mathieu's Apparatus for the Purification of Products Resulting from the Distillation of Wood.

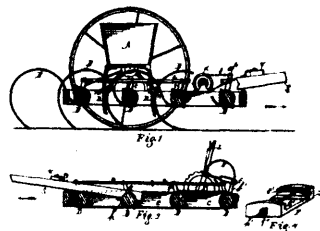

13234 Williams & Turner's Improvements in Grain Drills.

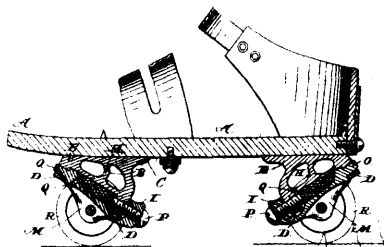

13235 Winslow's Improvements on Roller Skates.

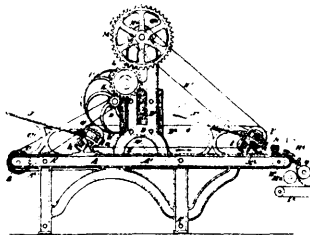

13236 Ovens' Improvements on Fruit Cake Machines.

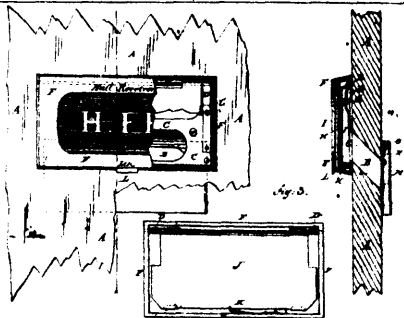

13237 Free & Fuller's Improvement in Combined Door Plates and Mail Receivers.

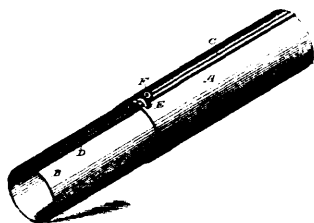

13241 Cook's Improvements in Stove Pipes.

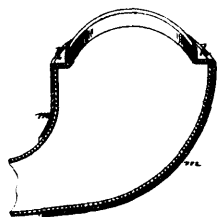

13242 Hatch's Improvements on Water Closet Bowls.

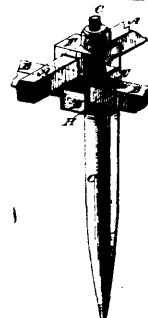

13243 Wilcox's Improvements on Clamps for Harrow Frames.

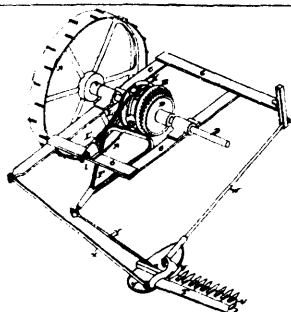

13244 Waters & Earnest's Improvements on Harvesters.

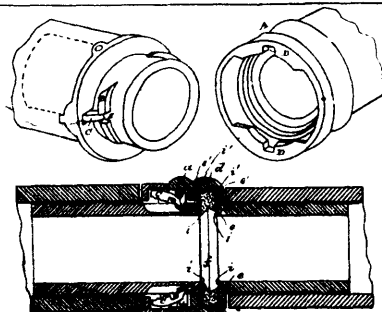

13245 Lightburne's Improvements on Pipe Couplings.

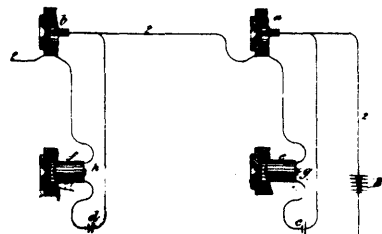

13246 Anders' Improvement in Telephones.

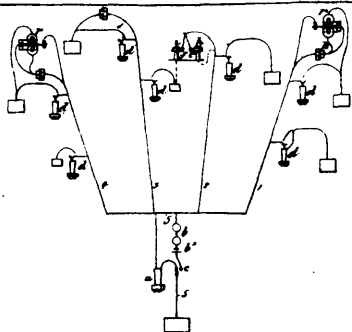

13247 Watson's Improvement in Telephones.

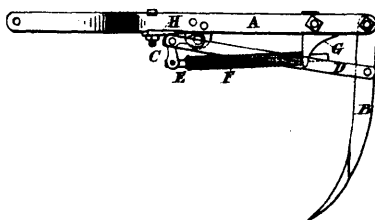

13248 Sheldon's Improvements on Spring Hoes.

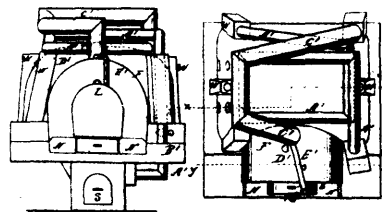

13249 Schad's Improvements on Glass Furnaces.

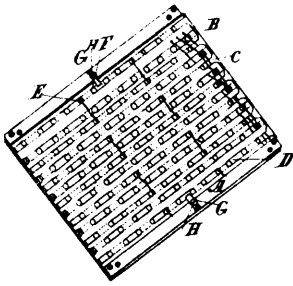

13250 McClure's Improvements on Grain Sieves.

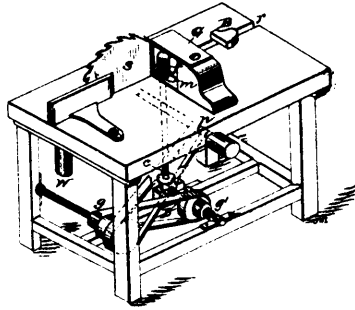

13251 Bryant's Improvements on Circular Sawing Machines.

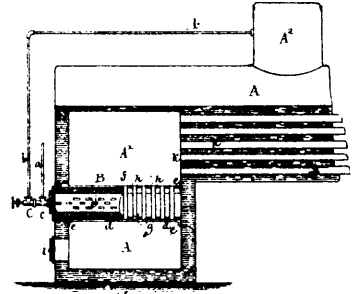

13252 Thomas's Improvements in Hydro-carbon Furnaces.

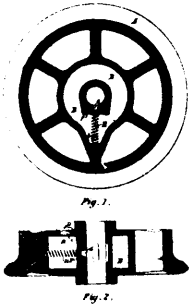

13253 Gajot's Improvements on Self-lubricating Wheels.

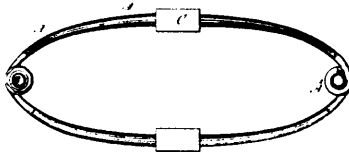

13254 Robertson's Improvements in Carriage Springs.

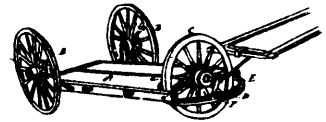

13255 Carnell's Three Wheeled Dray.

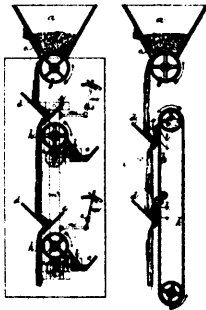

13256 Smith's Improvements on Middlings Purifiers.

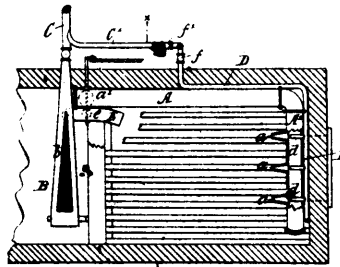

13257 McWilliam's Improvements in Smoke Consumers and Gas Generators.

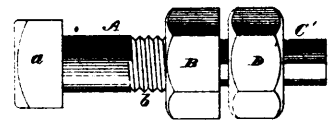

13258 Denison's Improvements in Nut Locks.

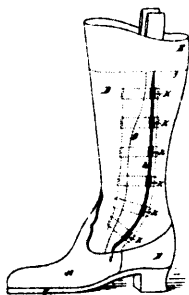

13259 Hospitalier's Improvements on Boots.

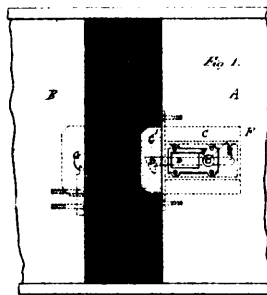

13260 Martal's Improvements on Seal Locks.

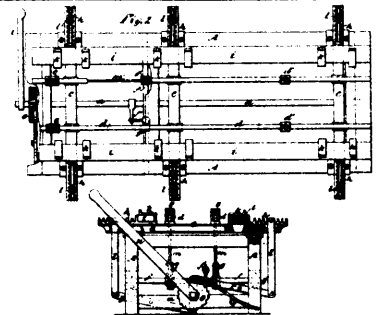

13261 Ale's Improvements on Door and Sash Clamps.

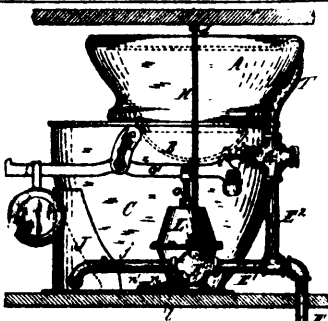

13262 O'Rielly's Improvements in Water Closets.

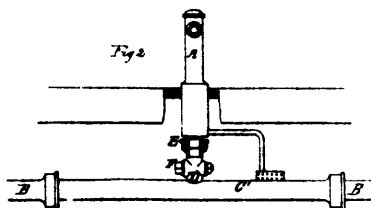

13263 Richards's Improvements on Ice Ploughs.

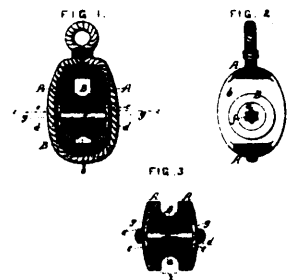

13264 Bitting's Improvements in Shaft and Axle Bearings.

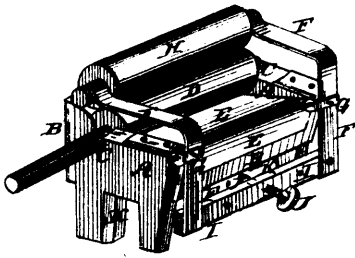

13265 Hudson's Improvements on Clothes Wringer.s

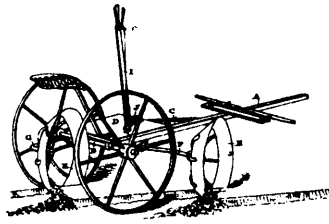

13266 Foster's Improvements in Rotary Ploughs

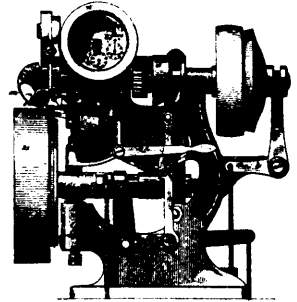

13268 Holmes's Improvements on Machines for Channelling and Piercing the Soles of Boots and Shoes.

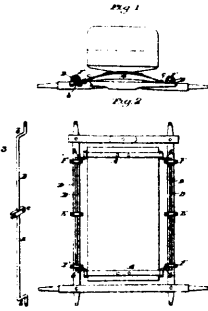

13269 Magnier & Thomas's Improvements on Vehicles Springs.

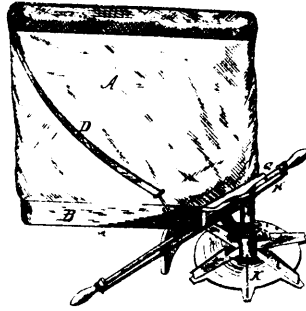

13270 Spelcher's Improvements on Seed Sowers.

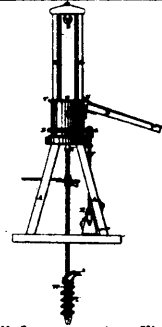

13271 Teetzel's Improvements on Well Boring Machines.

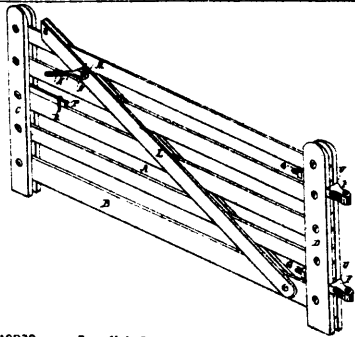

13272 Landis's Improvements on Gates.

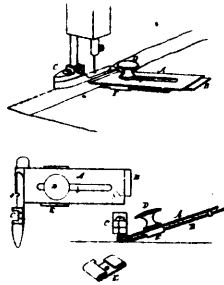

13273 Wesgate's Improvements on Sewing Machines.

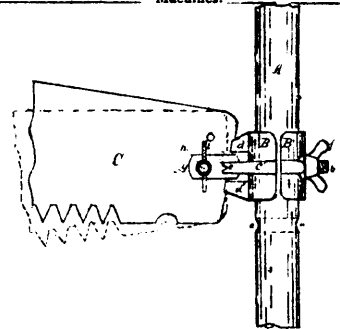

13274 Peace's Improvements on Saw Handles.

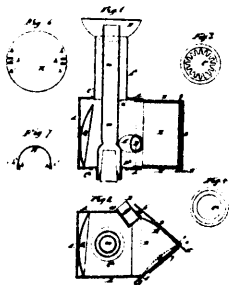

13275 Foote's Improvements in Magic Lanterns.

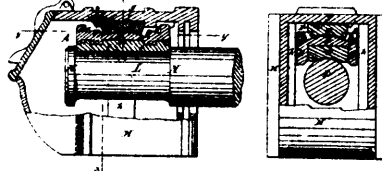

13276 Baker's Improvements on Bearing Brasses for Car Axles.

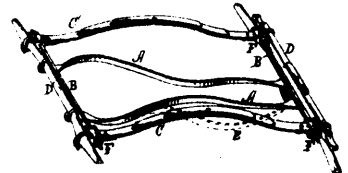

13277 McCannell's Improvements on Carriage Springs and Reaches.

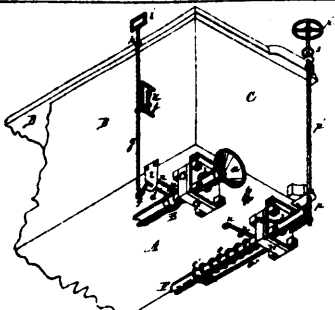

13278 Howard's Improvements on Couplings in Steam or Air Brakes.

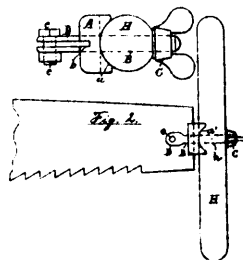

13279 Hilton's Improvements on Cross Cut Saw Handles.

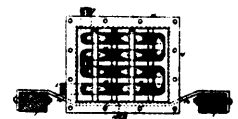

13280 Magoon's Improvements on Feed Water Heating Apparatus for Locomotives.

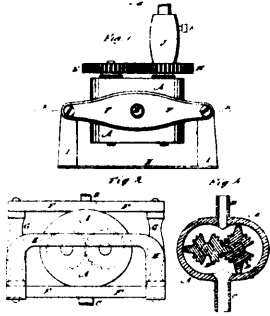

13281 Leach's Improvements on Steam Augers.

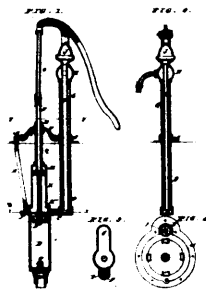

13282 Vandusen's Improvements on Pumps.

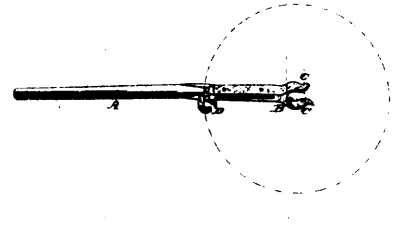

13283 Stanley's Improvements on Car Moving Devices.

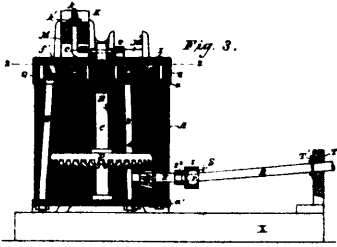

13284 Warren's Improvements on Horse Powers.



13285 Birney's Improvements in Bottles.

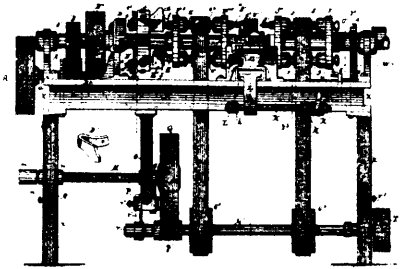

13286 Sherman & Phelps' Improvements on Lathes.

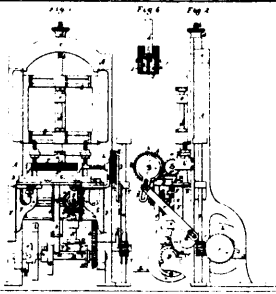

13288 Burns's Improvements in Machinery for making Cylindrical Blocks to be Converted into Spools.

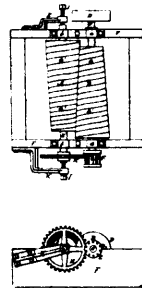

13289 Brown's Improvements in Grinding Mills.

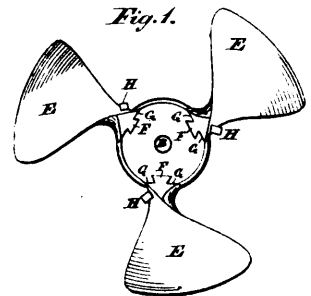

13290 Davis's Improvements on Screw Propellers.

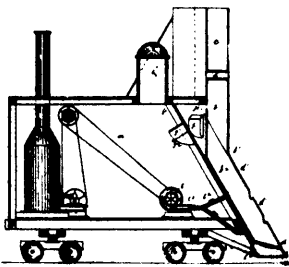

13291 Johnson's Improvements on Combined Snow Ploughs and Melters.

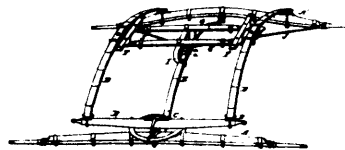

13292 Saladee's Improvements on Road Waggon.

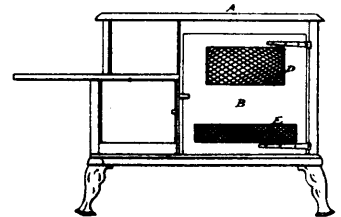

13293 Wilson's Improvement on Oven Doors.

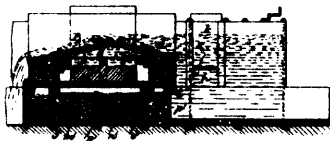

13294 DuBols's Improvements on Dams and Locks.



13304 Gregory's Improvements in Fire-escapes.

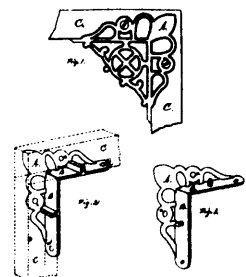

13305 Porter's Improvements in Bracket Pieces for Screen Frames.