

MADISON, N.J., PARK BRIDGE.—Designed by H. G. Tyrrell, C. E.

P
Tech
U

University of Toronto Engineering Society
Transactions and year book.

No. 14.

1900-1901

PAPERS

READ BEFORE THE

ENGINEERING SOCIETY

OF THE

SCHOOL OF PRACTICAL SCIENCE TORONTO

PRICE, - - - - 50 CENTS.

96742
22/6/09

TORONTO:
THE CARSWELL CO., LIMITED
1901

Entered according to the Act of the Parliament of Canada, in the year on
thousand nine hundred and one, by the Engineering Society of the School of
Practical Science, in the Office of the Minister of Agriculture.

T
gineeri
session

A
branch
contain
useful
engage
Wood
mark a
which

T
papers
A. W.
which

T
contrib

TI

Toront

PREFACE.

The present volume consists of papers read before the Engineering Society of the School of Practical Science during the session 1900-1901.

As in the past, the papers all deal with some of the numerous branches of engineering. Besides being interesting reading, all contain valuable information and will, it is believed, be found useful not only by students, but also by graduates and others engaged in active professional life. The papers on Chemical Wood, Pulp and The Conservation of Water for Power Purposes, mark a growing interest in those branches of engineering, upon which the development of this country largely depends.

The Society is to be congratulated upon having secured papers from Mr. H. G. Tyrrell, Mr. C. H. Mitchell, and Mr. A. W. Campbell, each a recognized authority on the subject of which he writes.

The thanks of the Society are due to all who have, by their contributions, or in any other way, materially aided its usefulness.

The present edition consists of 1,500 copies.

Toronto, April 17th, 1901.

CONTENTS.

	PAGE.
President's Address	F. W. Thorold, '00 1
Chemical Wood Pulp	J. A. Decew, '96 6
The Bonding of Broken Stone Roads. A. W. Campbell, C.E.	15
Exploring New Ontario	Alexander H. Smith 22
Ratio of the Cylinders of a Compound Engine and what takes place in them	Wm. Hemphill, '00 31
Thomson Recording Wattmeter....	C. G. Carmichael, '01 49
Portland Cement vs. Bone Ash Cupels.....	H. Roy Stovel 56
Peat	Arthur G. Ardagh 59
The Conservation of Water for Power Purposes. C. H. Mitchell, A.M. Can. Soc. C.E.	64
Some Notes on Greater Ontario.....	E. V. Neelands, '00 81
The Madison Draw Bridge at Portland, Oregon. H. G. Tyrrell, C.E., '86	89
Handling Daylight	W. J. Withrow 124
Air Brakes ..	W. E. Foreman, '99 133
Signaling	R. Latham 163
Index to First Fourteen Numbers	199

F. V.

T.
R. W.

Fourth-y
J. F.

GENERAL COMMITTEE, 1900-1901.

President :

F. W. THOROLD, '99.

Vice-President :

W. G. CHASE, '01.

Rec. Secretary :

A. G. LANG, '02.

Cor. Secretary :

W. P. BRERETON, '01.

Treasurer ;

R. W. MORLEY, '02.

Librarian ;

GEO. HUNT, '01.

Editor :

M. B. WEEKES, B.A.Sc.

Asst. Librarian :

A. A. WANLESS, '02.

Graduates' Representative :

C. H. FULLERTON, '00.

Fourth-year Representative :

J. R. ROAF, '00.

Third-Year Representative :

J. T. BROUGHTON, '01.

Second-Year Representative :

J. J. MCKAY, '02.

First-Year Representative :

E. A. JAMES, '03.

LIST OF MEMBERS.

HONORARY MEMBERS.

J. Galbraith, M.A., M. Can. Soc. C.E.
W. H. Ellis, M.A., M.B.

E. J. Chapman, Ph.D., LL.D.
A. P. Coleman, M.A., Ph.D.

LIFE MEMBERS.

Allen, J. R., O.L.S., '92.	Elliott, H. P., B.A.Sc., '96.	Leask, J. D.
Allen, T. R.	Evans, R. B., '95.	Lott, A. E., '87.
Anderson, A. G., '92.	Ewart, J. A., B.A.Sc., '94.	Main, W. T., '92.
Angus, R. W., B.A.Sc., '94.	Fairchild, C. C., O.L.S., '92.	Marani, C. J., '88.
Ardagh, E. G. R., '00.	Fowler, C. P.	Martin, T., B.A.Sc., '96.
Armstrong, J., O.L.S., '95.	Fraser, A. T.	Martin, F. A., O.L.S., '87.
Aspey, J. F., O.L.S., '88.	Francis, W. J., '93.	Macbeth, C. W., B.A.Sc., '96.
Ashbridge, W. T., '88.	Gibbons, J., O.L.S., '88.	McAllister, J. E., C.E., B.A.Sc., '91.
Bain, J. W., B.A.Sc., '96.	Gibson, H. H., O.L.S.	McAllister, A. L., B.A.Sc., '93.
Ball, E. F., A.M. Can. Soc. C.E., '88.	Goldie, A. R., '93.	McCallum, A. F., B.A.Sc., '93.
Ballantyne, H. F., B.A.Sc., '99.	Goodwin, J. B., B.A.Sc., '92.	McCollum, T. B.
Beauregard, A. T., B.A.Sc., '94.	Gray, A. T., B.A.Sc., '97.	McChuson, A. J.
Bergey, A. E., '94.	Hanley, J. B.	McDougall, J., B.A.Sc., '84.
Blackwood, A. E., '95.	Haight, H. V., B.A.Sc., '96.	McFarlen, T. J., '93.
Bow, J. A., '92.	Hare, W. A., B.A.Sc., '99.	McGowan, J., B.A.Sc., '95.
Boswell, E. J., B.A.Sc., O.L.S., '95.	Harkness, A. H., B.A.Sc., '95.	McKinnon, H. S., B.A.Sc., '95.
Bowman, F. M., O.L.S., C.E., '90.	Haultain, H. E. T., '89.	McKay, O., O.L.S., '85.
Brodie, W.M., B.A.Sc., '95.	Herald, W. J., B.A.Sc., '94.	McKay, W. N., '95.
Bucke, M. A., M.E., '90.	Hicks, W. A. B., '97.	McPherson, A. J., B.A.Sc., '93.
Bucke, W. A., B.A.Sc., '94.	Holcroft, H. S., '00.	McPherson, C. W., O.L.S.
Burns, D., O.L.S., '83.	Hull, H. S., B.A.Sc., '95.	McTaggart, A. L., B.A.Sc., '94.
Burwash, L. T., '96.	Hunt, G. A.	Merrill, E. B., B.A.Sc., '90.
Canniff, C. M., '88.	Hutcheson, James, O.L.S., '90.	Mines, W. H., B.A.Sc., '93.
Carey, A. B., '89.	Irvine, J., '89.	Minty, W. M., B.A.Sc., '94.
Carpenter, H. S., O.L.S., B.A.Sc., '97.	Irwin, J.	Mitchell, C. H., B.A.Sc., C.E., '92.
Chalmers, J. C., O.L.S., '94.	James, D. D., O.L.S., B.A.Sc., '91.	Mickle, G. R., B.A., '88.
Charlesworth, L., O.L.S., '93.	Job, H. E., B.A.Sc., '94.	Mill, F. X., '89.
Chewett, H. J., B.A.Sc., C.E., A.M. Can. Soc. C.E., '88.	Johnson, A. C., B.A.Sc., '94.	Mollins, C. B., '96.
Clement, W. A., '89.	Johnson, S. M., B.A.Sc., '94.	Moore, J. E. A., C.E., '91.
Deacon, T. R., O.L.S., '91.	Johnson, Geo.	Moore, H. H.
Dobie, J. S., B.A.Sc., O.L.S., '95.	Keele, J., B.A.Sc., '93.	Neelands, E. V., '00.
Duff, J. A., B.A., '90.	King, C. F., '97.	Newman, W. M., O.L.S., '91.
Duggan, G. H., M. Can. Soc. C.E., '83.	Kirkland, W. A.	Paterson, C. E.
Dunn, T. H., '93.	Laing, A. T., B.A.Sc., '92.	Pinhey, C. H., O.L.S., D.L.S., '87.
	Lane, A., O.L.S., '91.	Piper, A. G.
	Laschinger, E. J., B.A.Sc., '92.	Proudfoot, H. W., '97.
	Lash, F. L., '93.	
	Lea, W. A., B.A.Sc., '92.	
	Lea, E. P.	

Raymer, A.
Richards,
Richardson
Robinson
Rolph, H.
Rose, K.,
Roseburgh,
'89.
Ross, R. A.
Russell, T.
Scott, W.
Shields, J.
Shillinglaw
Shipe, R. I.

Alexander,
Alison, T.
C.E., '92.
Allan, J. I.
Alison, J. C.
Andrews, E.
Bain, J. A.,
Barker, H.
Barley, J. I.
Barrett, R.
Beatty, H.
Beatty, W.
Bertram, G.
Black, R. G.
Bowers, W.
Booth, T. I.
Boswell, M.
Bowman, F.
D.L.S., '83.
Bowman, A.
Brandon, E.
Brereton, W.
Broughton,
Brown, L. I.
Brown, G. I.
Brown, D. I.
Boyd, D. G.
Boyd, W. H.
Burnside, T.
Burton, T.
Carmichael,
Campbell, R.
Campbell, G.
Carter, W. H.
'98.
Chalmers, W.
Charlton, H.
'97.
Chubbuck, L.
Clark, J. T.
Clark, N., '01.
Clark, J., '00.
Clarke, F. F.

LIFE MEMBERS.—Continued.

Raymer, A. R., '84.
 Richards, E., B.A.Sc., '99.
 Richardson, G. H., '88.
 Robinson, F. J., O.L.S., '95.
 Rolph, H., '94.
 Rose, K., '88.
 Roseburgh, T. R., M.A., '89.
 Ross, R. A., E.E., '90.
 Russell, T. S., O.L.S.
 Scott, W. F., '97.
 Shields, J. D., B.A.Sc., '94.
 Shillinglaw, U. H.
 Shipe, R. R., '96.
 Shiple, A. E., B.A.Sc., '98.
 Sifton, E. I.
 Silvester, G. E., O.L.S., '91.
 Sims, H. B., '95.
 Smith, Angus, O.L.S., '94.
 Smith, A. H.
 Speller, F. N., B.A.Sc., '93.
 Squire, R. H., B.A.Sc., O.L.S., '93.
 Stern, E. W., '84.
 Stewart, L. B., D.L.S., D.T.S.
 Stocking, F. T., '95.
 Stovel, Roy H.
 Symmes, H. D., '91.
 Taylor, W. V., O.L.S., '93.
 Thomson, T. K., C.E., '86.
 Thomson, R. W., B.A.Sc., '92.
 Tremaine, R. C. C., B.A.Sc., '95.
 Troupe, G. E., '95.
 Ty, A. T., '96.
 Webster, E. B.
 Wickson, F. R.
 Wilkie, G.
 Wright, C. H. C., B.A.Sc., '88.

ORDINARY MEMBERS.

Alexander, F. H.
 Alison, T. H., B.A.Sc., C.E., '92.
 Allan, J. L., '00.
 Alison, J. G. R., '02.
 Andrews, E., '97.
 Bain, J. A., '00.
 Barker, H. F., '94.
 Barley, J. H., '00.
 Barrett, R. H., '01.
 Beatty, H. J., O.L.S., '91.
 Beatty, W. G., '01.
 Bertram, G. M., '01.
 Black, R. G.
 Bowers, W. J., '01.
 Booth, T. R.
 Boswell, M. C., '00.
 Bowman, H. J., O.L.S., D.L.S., '85.
 Bowman, A. M., C.E., '86.
 Brandon, E. T., '01.
 Brereton, W. P., '01.
 Broughton, J. T., '01.
 Brown, L. L., '95.
 Brown, G. L., O.L.S., '93.
 Brown, D. B., O.L.S., '88.
 Boyd, D. G., '94.
 Boyd, W. H., B.A.Sc., '98.
 Burnside, T., B.A.Sc., '99.
 Burton, T.
 Carmichael, C. G., '01.
 Campbell, R. J., '95.
 Campbell, G. M., '96.
 Carter, W. E. H., B.A.Sc., '98.
 Chalmers, W. J., '89.
 Charlton, H. W., B.A.Sc., '97.
 Chubbuck, L. B., '99.
 Clark, J. T.
 Clark, N., '01.
 Clark, J., '00.
 Clarke, F. F., '00.
 Clothier, G., '99.
 Collins, C. D.
 Connor, A. W., B.A., '95.
 Cooper, C., '99.
 Coulthard, R. W., B.A.Sc., '99.
 Craig, J. A., '99.
 Conlon, F. T., '02.
 Chace, W. G., '01.
 Christie, A. G., '01.
 Cockburn, J. R., '01.
 Darling, E. H., '98.
 Davison, J. E., '00.
 De Cew, J. A., '96.
 Dill, C. W., '91.
 Dixon, G., '00.
 Dickenson, E. D., '00.
 Dixon, H. A., '00.
 Dunbar, M.
 Duff, W. A., '01.
 Elliott, J. C., '99.
 English, A. B., '90.
 Evans, J. W.
 Eason, D. E., '01.
 Fairburn, J. M. R., '93.
 Finch, H. J. W.
 Fingland, W., '93.
 Foreman, W. E., '99.
 Forester, C., '93.
 Forward, E. A., '97.
 Fullerton, C. H., '00.
 Gagné, L., '01.
 Garland, N. L., '90.
 George, R. E., '02.
 Gibson, N. R., '01.
 Gordon, C. B.
 Grant, W. F., B.A.Sc., '98.
 Gray, R. L.
 Guernsey, F. W., '95.
 Guest, W., '00.
 Gurney, W. C., '96.
 Guy, E., '99.
 Hall, G. A.
 Hamer, A. T. E., '01.
 Harvey, C., '01.
 Hanning, G. F., '89.
 Henderson, S. E. M., '00.
 Hemphill, W., '00.
 Henry, J. A., '00.
 Henry, J. S., '02.
 Herman, E. B., O.L.S., D.L.S., '86.
 Hudspeth, W. S.
 Innes, W. L., O.L.S., C.E., '90.
 Irwin, C. A., '95.
 Jones, J. E., '94.
 Jackson, F. C., '01.
 Johnson, H. A., '00.
 Johnson, J. C., '00.
 Johnson, J. A., '00.
 Laidlaw, J. G., B.A.Sc., '93.
 Laidlaw, A.
 Laird, R., O.L.S., '86.
 Laing, W. F., '96.
 Langley, C. E., '92.
 Latham, R., '99.
 Lash, N. M., '94.
 Lavrock, G. E., '98.
 Little, F. J.
 Lumbers, W. C., '00.
 Marani, V. G., '93.
 Matheson, W., '01.
 Mace, F. G., '02.
 Meadows, W. W., O.L.S., '95.
 McArthur, R. E., '00.
 McAree, J., O.L.S., D.L.S., B.A.Sc., '82.
 McCullough, A. L., O.L.S., '87.
 McDougall, A. C., '01.
 McDowall, R., O.L.S.,
 McFarlane, G. W., O.L.S., '88.
 McIntosh, D., '98.

ORDINARY MEMBERS—Continued

McKenzie, J. R., '00.	Robinson, A. H. A., B.A.Sc., '97.	Tyrrell, W. J., O.L.S., D.L.S., C.E., '83.
McMurchy, J. A., '96.	Roper, W. P.	VauEvery, W. W., '99.
McMaster, A. T., '01.	Ross, J. E., O.L.S., '88.	Vercoe, H. L. '98.
McMillan, G., '01.	Roundthwaite, C. H. E., '00.	Wagner, W. E., B.A.Sc., '99.
McMillan, J. G., '00.	Russell, R., '93.	Watson, R. B., '93.
McLennan, A. L., '02.	Russell, W., '91.	Watt, G. H., '99.
McMichael, C.	Saunders, G. A., '99.	Weekes, M. B., B.A.Sc., O.L.S., '97.
McNaughton, F.D., O.L.S., '98.	Saunders, H. W., '00.	Weir, H. M., '00.
McVean, H. G., '01.	Shanks, T., B.A.Sc., '99.	Weldon, E. A., '97.
Milne, C. G., B.A.Sc., '92.	Shaw, J. H., O.L.S., '98.	White, A. V., '92.
Miller, L. H., '00.	Smallpiece, F. C., '98.	Whitson, J. F., O.L.S.
Monds, W., B.A.Sc., '99.	Smillie, R., B.A.Sc., '97.	Withrow, J. D., '00.
Moore, F. E.	Smith, A. D., '92.	Willson, R. D.
Morris, J. L., O.L.S., C.E.,	Smith, R., '98.	Wickett, T., '89.
Morphy, E. J.	Spotton, A. K., '94.	Wiggins, T. H., O.L.S., '90.
Nicholson, C. J., '94.	Stacey, G. E.	Wilkinson, T. A., '98.
Paterson, J., '99.	Stewart, J. A., M.A., '98.	Williamson, D. A., B.A.Sc., '98.
Perry, F. N.	Stull, W. W., O.L.S., B.A.Sc., '97.	Withrow, A. J., '90.
Playfair, N. L., '92.	Tennant, D. C., '99.	Withrow, F. D., '00.
Pope, A. S. H., '99.	Tennant, W. C., '00.	Woolverton, C. E.
Phillips, E. H., '00.	Taylor, A., '00.	Wright, R. T., '94.
Price, H. W., '01.	Thorold, F. W., '00.	Wright, T. D.
Revell, G. E., '99.	Thorne, S. M., '00.	Yeates, E. G., '99.
Ritchie, N. T., O.L.S.	Troupe, W. J.	
Rodger, J., O.L.S., '87.		
Robertson, J. M., '93.		

UNDERGRADUATE MEMBERS.

Acres, H. G., '03.	Cumming, R., '02.	Harcourt, F. T., '03.
Algie, J., '03.	Davison, A. E., '03.	Hayes, L. J., '03.
Angus, H. H., '03.	Depew, H. H., '03.	Henderson, F. D., '03.
Barber, H. G., '02.	Douglas, W. E., '02.	Hendry, M. C., '03.
Batt, T. W., '02.	Dunlop, R. J., '02.	Henwood, C., '02.
Beatty, F. R., '02.	Eakins, S. W., '03.	Horton, J. A., '03.
Beatty, J. A., '03.	Edwards, W. M., '02.	Irving, T. C., Jr., '03.
Begg, A. W., '03.	Elmsley, B. R., '02.	Jackson, J. G., '03.
Belton, C. H., '03.	Elwell, W., '02.	Jackson, J. H., '03.
Blair, W. J., '02.	Empey, J. M., '02.	James, E. A., '03.
Bonnell, M. B., '03.	Evans, H. W., '03.	Johnston, D. M., '02.
Breslove, J., '02.	Fensom, C. J., '03.	Johnston, C. K., '03.
Brown, G., '03.	Fleck, J. G., '03.	Johnston, H., '03.
Brown, J. M., '02.	Fuce, E. O., '03.	Keagey, J. W., '03.
Bryce, R. B., '03.	Fuller, V. M. S., '03.	Knight, R. H., '02.
Burgess, E. L., '03.	Gaby, F. A., '03.	Kernahan, M. G., '03.
Burley, R. J., '03.	Gardner, J. C., '03.	Lang, A. G., '02.
Burnham, F. W., '03.	Gibson, A. E., '02.	Langmuir, F. L., '02.
Burwash, N. A., '02.	Gillespie, P., '03.	Larkworthy, W. J., '03.
Campbell, A. R., '02.	Goodwin, A. C., '02.	Latournell, A. J., '03.
Campbell, W., '02.	Gordon, E. R., '03.	Legge, A. H., '03.
Challies, J. B., '03.	Gordon, J. P., '03.	McAuslan, H. J., '03.
Charlebois, J. P., '03.	Gourlay, W. A., '02.	McBride, A. H., '02.
Christie, W., '02.	Gray, A., '03.	McCuaig, O. B., '03.
Connor, H. V., '02.	Green, E. A., '03.	McFarlane, J. A., '03.
Corbett, J. T., '03.	Greenwood, W. K., '03.	McGuire, R. A., '03.
Corrigan, T. E., '02.	Gurney, E. H., '03.	McKay, J. J., '02.
Costin, W. E., '02.	Gzowski, H. N., '03.	McKay, J. T., '02.
Coulson, C. L., '03.	Hamilton, J. F., '03.	McKellar, J. O., '03.
Culbert, M. T., '02.	Hanes, G. S., '03.	McKittrick, C. W., '03.

McKinnon,
McNaughton,
Madden, J. I.
Mathieson, F.
Maher, W.
Marriott, F.
Marrs, C. H.
Meador, J. E.
Milden, A. J.
Miller, M. L.
Mills, J. E.,
Milne, W. G.
Montgomery,
Mans, C. A.
Moore, F. A.
Morley, R. W.
Morton, P. E.
Mullins, E. E.
Nash, T. S., '0
Nevitt, I. H.
Oliver, E. W.
Oliver, J. P.,

UNDERGRADUATE MEMBERS.—Continued.

McKinnon, H. D., '03.	Pace, J. D., '03.	Steele, T. J., '02.
McNaughton, A. L., '03.	Pardoe, W. S., '03.	Stevens, W. A., '03.
Madden, J. F. S., '02.	Paris, J., '03.	Sutherland, W. H., '02.
Mathieson, P., '02.	Patten, B. B., '03.	Taylor, T., '02.
Maher, W. R., '03.	Philip, H. D., '03.	Teasdale, C. M., '02.
Marriott, F. G., '03.	Plunkett, T. H., '03.	Thorne, W. F., '03.
Marrs, C. H., '02.	Pinkney, D. H., '03.	Townsend, C. J., '03.
Meador, J. E., '03.	Porte, W. B., '03.	Trees, S. L., '03.
Milden, A. J., '03.	Powell, G. G., '02.	Umbach, J. E., '03.
Miller, M. L., '03.	Ratz, W. F., '02.	Waldron, J., '03.
Mills, J. E., '03.	Robertson, D. F., '02.	Wass, S. B., '03.
Milne, W. G., '03.	Robertson, H. D., '02.	Wanless, A. A., '02.
Montgomery, R. H., '03.	Rose, H. G., '03.	Weddell, R. G., '03.
Mans, C. A., '03.	Ross, R. B., '03.	Whelihan, J. A., '02.
Moore, F. A., '02.	Roy, J. E., '02.	White, F., '03.
Morley, R. W., '02.	Rutherford, F. N., '03.	Wilson, J. M., '03.
Morton, P. E., '03.	Shipe, H. M., '03.	Wilson, N. D., '03.
Mullins, E. E., '03.	Sinclair, D., '02.	Williams, C. G., '03.
Nash, T. S., '02.	Small, H. S., '03.	Worthington, W. R., '03.
Nevitt, I. H., '03.	Smith, H. G., '03.	Young, C. R., '03.
Oliver, E. W., '03.	Smith, J. H., '03.	Young, W. H., '03.
Oliver, J. P., '03.	Steele, D. L., '03.	Zahn, H. T., '02.

OBITUARY NOTICE.

It is with regret that we have here to chronicle the death of one of our undergraduate members, Mr. G. C. McCollum, a student in the Mechanical and Electrical department of the Third Year. Mr. McCollum was the eldest son of ex-Mayor J. R. McCollum, of Welland, Ont., and was twenty-two years of age. He took ill on Thursday, December 20, 1900, and after two weeks of pain died at Toronto General Hospital on January 4. Interment took place with military honors at Welland, on January 7.

Mr. McCollum was a lieutenant in the 44th Welland Regiment. Among his fellows always popular, his decease robbed us of a friend and fellow student.

The

GENTLE

It
meeting

To
a heart
me to th

Yo
the offic
operatio
assist m
the past

It
ing the
the hist

The
stitution

I w
derived
student
importan
papers i
did so.

ENGINEERING SOCIETY

—OF—

The School of Practical Science TORONTO.

PRESIDENT'S ADDRESS.

GENTLEMEN:—

It affords me much pleasure to welcome you to the opening meeting of our Society.

To those of you who are about to become members, I extend a hearty welcome, while to the older members who have elected me to the highest position in their power I extend my thanks.

You have conferred a great honor upon me in electing me to the office of President, and I sincerely trust that, with the cooperation of the energetic committee which you have elected to assist me, the Engineering Society will continue to prosper as in the past.

It is necessary that each member should do his share in assisting the committee to make this year one of the most successful in the history of the Society.

The objects of the Society are already set forth in the Constitution, copies of which may be obtained from the librarian.

I would like particularly to emphasize the great value to be derived from reading papers at the meetings of our Society. The student members are beginning to take an active interest in this important branch of the School work and those who have read papers in the past will all state that they are exceedingly glad they did so.

Since we recognize no year distinctions, and all papers on engineering subjects are acceptable from our members, I trust that you will carefully consider the many advantages gained and continue to contribute towards the contents of our pamphlet.

Don't let the thought that you are not a senior student keep you from contributing a paper, for it is at our meetings that we have to become more thoroughly acquainted with each other.

As President of the Engineering Society I have to procure the papers to be read at our meetings and published in the pamphlet and I can assure you from my experience this summer that this is no easy task.

There should be no reason why it should be difficult to secure papers from the undergraduate members unless it be that they are not fully aware of the benefits to be derived therefrom.

There are a great many reasons why you should avail yourselves of the opportunity offered to contribute papers and read them at the meetings, and with your permission I will mention a few of these.

The Council of the School, when granting honors, consider the papers read before the Society, so that not only those who listen but also the writer receives much benefit.

One other great advantage of reading papers at our meetings, which is very often overlooked, is that the reader gains considerable confidence in speaking in public. No doubt a number of you will be called upon, at some time in the practice of your profession, to state your views and support them before a meeting of directors of some company or a Town Council. A great deal more weight is attached to a person's opinions if they are given forcibly and without effort, and at our meetings you have a splendid chance to become more proficient in this branch of your profession.

Another advantage gained in compiling a paper is the knack of arranging your material in proper systematic order, which is so essential in the work of the engineer. The notes taken, the extra reading, the concentration of the mind on the subject, and the opinion of your fellow students on your efforts are also of advantage.

After a paper is read at our meetings I would like you to have questions to ask and if possible create some discussion, for in this way many points are brought out which may have been overlooked in the paper.

Last year we were very fortunate in having several of our papers illustrated with lantern slides which were generously supplied by the School. In this respect I might say that a considerable amount of time was expended by some members of the Faculty and the Fellows. In particular I wish to thank Mr. C. H. C. Wright and Mr. A. H. Harkness for their untiring efforts in providing us last year with so many lantern slides, and I trust that this year we may look forward to seeing more of the slides on the screen.

After the papers have been read at our meetings they are filed away until it is time to arrange the material for the pamphlet. They are then submitted to the Editor, who has charge of the publication, and is appointed by the Council of the School, who selects those most suitable for publication in the proceedings of the Society.

Last year 1,500 copies of the pamphlet were printed. Copies of this were sent to all life members of the Society, and all the prominent magazines and colleges in the world. We also make exchanges with a few similar societies in other colleges.

The Engineering Society handles all the draughting paper and laboratory note books used in the School. This year we will purchase our note books direct from the wholesale, but I am sorry to say this is impossible with the draughting paper, as the paper we use is manufactured in Germany. At a meeting of the committee held last May we discussed the advisability of purchasing our paper direct from Germany, but had to give up this idea on account of the lack of funds in the treasury. A great saving in the cost of the paper could be made if we had the necessary money to order our season's stock direct from the manufacturer in May.

This matter has received careful consideration, and the problem of increasing our funds was constantly with me during the past summer. During next summer if each member of our Society both graduate and undergraduate, could obtain an advertisement

to be inserted in our annual pamphlet, the finances of the Society would be placed in such a secure state that we could then buy all our materials direct from the manufacturers. This would mean that our funds would be further increased. There is no reason to reduce the cost of the materials now sold to the students, as they are now below the prices of the retail dealers. This then would mean that we would be able to spend a considerable sum annually in purchasing new and up-to-date books for our library. We could easily spend a few hundred dollars in this work, and it is my opinion that the money could not be spent in a better way. The first object of the Society, as stated in Article 2 of our Constitution, is "the encouragement of original research in the Science of Engineering," and this cannot be encouraged in a more practical way than in providing literature on various scientific subjects for the use of the members of our Society.

I trust that next summer you will avail yourselves of the opportunity thus afforded of helping to place the library of the Engineering Society in a condition that it will be of use to our members.

At our last annual meeting, Mr. Shanks, the retiring President, introduced a new system of voting, which gave such general satisfaction that I feel I cannot conclude without mentioning it. By-law four of our Society states that "a majority of the total number of votes cast shall be necessary for election to any office." When there were over two candidates for any office, under the old system of voting, this would very often make it necessary to hold two or even three elections before one candidate would receive a majority of the votes cast. This caused an annoying delay in the elections and a great deal of unnecessary trouble and work to the scrutineers as well as to the members.

In the new system this was overcome by the voter marking opposite the candidate for whom he wished to vote the figure 1, while opposite his second choice for this office he marked the figure 2, and opposite his third choice the figure 3, and so on. When the number of "first choices" were added, if any candidate had received a majority he was declared elected, but if not then the "second choices" of the lowest candidate were distributed among

the o
lowest

T
exper
an ele

B
the Sc
Scienc
years,
thorou
obtain
ing ra
little r
depart
vided
educat

A
the hig
modat

It
the Pa
of the
Engin
us this
much
I am s
Mr. D
he wil
ings o

I
honor
in you
succes

the others. If no candidate was then elected the ballots of the lowest candidate were again distributed among the others.

This system was very satisfactory and little more trouble was experienced in counting the ballots than in the ordinary way, and an election was always assured.

Before concluding I would like to make a few remarks about the School. The reputation of the Ontario School of Practical Science, as an engineering college, has been rising for a number of years, until now it is looked upon as being one in which a very thorough knowledge of the foundation of engineering science is obtained. The number of students in attendance has been increasing rapidly each year and it has arrived at the point where very little more accommodation can be afforded. It is crowded in every department and in a year or two if more accommodation is not provided the students will have to go to other colleges to obtain their education.

A large grant from the Government is needed to maintain the high reputation which the School now enjoys, and to accommodate the students who are flocking here annually.

It is with regret that I have to refer to the illness of one of the Past Presidents of our Society, and a member of the Faculty of the School. Mr. Duff has always taken a keen interest in the Engineering Society, but unfortunately will not be able to be with us this year. I am glad to be able to announce that he is very much better and hopes to continue his work in the School next fall. I am sure that it is the wish of every member of the Society that Mr. Duff's health and strength will soon return to him and that he will again be able to continue his lectures and attend the meetings of our Society.

I will conclude my remarks by again thanking you for the honor you have conferred upon me, and will ask that you do all in your power to help the committee make this one of the most successful years in the history of the Society.

F. W. THOROLD.

CHEMICAL WOOD PULP.

J. A. DECEW, '96.

In preparing this paper on Chemical Wood Pulp, I have merely attempted a synopsis of the subject, which may convey to those who heretofore have given the subject but little attention, some idea of the methods employed and the chemistry involved in this industry. It is needless to mention that as far as our broad Dominion is concerned, this industry is but in its infancy, for the larger portion of our northern, uninhabited lands are well timbered with spruce, which is one of the best of the paper making woods. Consequently this subject demands more attention than it receives from Canada's Practical Science students, because it has already taken a deep hold upon the financial world, and because our profession above all others, should keep in touch with the industries of the country.

The word pulp is a term which generally may be applied to a number of materials, which are quite variable in character but more or less similar in appearance, therefore if we first classify these in a general way, we shall have a somewhat clearer conception of that special kind, that we are about to discuss. We may divide them into four classes according to quality, namely:

I. Rag Pulp—which is made from cotton, linen or hemp fibres.

II. and III. Wood Pulps—which are of two kinds, chemical and mechanical.

IV. Straw Pulp—which is a chemical product of inferior quality.

As the manufacture of mechanical wood pulp was very ably described in a paper read before this Society last year, the subject matter of this article will deal exclusively with its half-brother of the chemical species, which is in reality another product from the same substance.

Mechanical pulp is simply wood, ground to a fine powder and consists chemically of a combination of celluloses and lignocelluloses. Now if instead of grinding, we treat the wood with a chemical solution, which disintegrates it and dissolves out the lignocelluloses, we then have left what is commonly called chemical pulp, and this consists of those celluloses which have resisted the action of the solvent. As about half of the woody substance is thus removed and destroyed, the remaining product must necessarily be more costly than the ground pulp, but the fibres remaining are white and unbroken and are only comparable with the cheaper product when quality is not required. Mechanical pulp has a very short fibre, little felting power, is quickly discolored in air and light, and is only used as a filling material in news, wrapping, and other papers of a temporary character. Chemical wood pulp, however, makes a good, white, permanent paper, and is the source of most of our writing materials, although it makes neither as strong nor as resistant a paper as do the rag pulps.

The pulps prepared from straw are pronounced oxycelluloses, and have considerably more chemical activity than those prepared from the woods.

There are two distinct methods of preparing the chemical wood pulp, which may be designated as the alkaline and the acid. In the alkaline or soda process the usual method employed is to pack the wood in the form of chips into a horizontal cylindrical, rotating digester, which has a capacity of about three cords.

Here it is digested, with about seven hundred gallons of a six to nine per cent. solution of sodium hydrate, which is heated to high temperatures by means of live steam. The boiling lasts from eight to ten hours, at pressures which may vary from sixty to two hundred and ten pounds per sq. in. The products resulting from this "cook" are a grayish brown pulp and a dark brown liquor, which are dumped into iron washing tanks, and after the liquor is drained off, the pulp is thoroughly washed. But as these wash waters are finally evaporated in order to recover the contained soda, they are used until they become quite concentrated, the pulp being washed continuously with a less concentrated solution until all the alkali is removed. The pulp is now treated with a bleaching solution, which contains twelve to fourteen pounds of bleaching powder

for every hundred pounds of pulp, and this removes the remaining ligneous matter, leaving a pure white cellulose.

The recovery of the soda from the waste liquor is accomplished by evaporation in vacuum pans until it has a density of 40° Baume, when it is burned in a special furnace to remove the organic matter. The remaining ash contains the soda in the form of a carbonate, and when this is heated in tanks with slaked lime, in the proportion of one hundred of soda to sixty of lime, the lime is precipitated as calcium carbonate and the soda becomes caustic again.

Another method of recovering the soda, which has been lately adopted, consists in heating three parts of ferric oxide with one of soda carbonate, when sodium ferrate is formed. And on heating this with hot water, it decomposes forming sodium hydrate and ferric oxide once more. The liquors of the alkaline process, sometimes contain large quantities of the sulphate or carbonate which are cheaper although weaker in action than the hydrate. In addition to the recovery of the soda from these liquors, a valuable product in the form of acetate, may be obtained from the organic matter of the solution. As perhaps you are aware, one of the standard methods for the manufacture of oxalic acid, is the treatment of wood or sawdust with alkaline hydrates at temperatures ranging from 200° to 250° C.

Now if the heating is prolonged and oxidation is allowed to take place, either from contact with air or oxidizing agents, a large percentage of acetic acid is formed. Therefore if the soda liquor is evaporated and charred at temperatures from 350° to 400° C, the organic matter reacts with the soda to form sodium acetate ($\text{Na C}_2\text{H}_4\text{O}_2, \frac{1}{2}\text{H}_2\text{O}$). This product comprises about 38 per cent. of the soluble portion of the char, and about 16 per cent. of the residue. With Esparto liquor five to six per cent. of the weight of the original fibre was obtained.

In the soda process poplar is largely used, although maple, cottonwood, white birch and basswood, are also employed. The spruce, pine and hemlock yield a long fibre but are a little more difficult to treat. The main objections to the process are—

1. The high temperatures and pressures required.

2. The formation of dark colored products which are difficult to remove from the pulp.

3. The destructive action that the alkalis have on the celluloses themselves, as the less resistant are attacked and dissolved in the severe treatment required to remove the ligneous portion.

The acid or sulphite process:—

This is the process which is now being most commonly introduced into this country, because it has several important advantages over the alkaline treatments just described. In the first place, the cost in chemicals is less; and a larger yield of fibre is obtained, which is not weakened by the treatment.

And secondly, the paper, which is made from this pulp, is harder and more transparent and durable than that from wood pulps made by other methods.

The treatment consists in digesting the wood at high temperatures with an acid sulphite solution.

The acid radical unites with the products of hydrolysis to form soluble sulphonated derivatives, while the base unites with the acid products of the decomposition. The hydrolitic action is greatly increased by the presence of sulphurous acid, and for this reason, the bi-sulphite (Na H SO_3) solution effects a reduction in less time, and at lower temperatures, than a neutral sulphite solution would.

Now, turning our attention to some of the details of the treatment, we find that the bark and knots and also the resinous matters of the wood, are very slightly acted upon by these sulphite solutions, and must in consequence be carefully removed. Sound knots may be allowed to pass through the digester and be afterwards removed from the pulp by screens. Before very high temperatures are reached it is necessary that the wood be thoroughly impregnated by the solution, and the absorption is hastened by previously crushing the wood. Dry and green woods, or woods of different species, should not be treated together in the same digester as they will be unequally reduced and leave chips in the pulp.

The first step in the preparation of the sulphite liquor is the formation of sulphur dioxide (SO_2) from the combustion of either

sulphur or its compounds. As this gas must be absorbed by water to form sulphurous acid ($H_2 SO_3$), it is evident that the less it is diluted with other gases the more complete will be its absorption. Therefore the sulphur is burned in specially constructed furnaces with the object of obtaining a complete combustion with the smallest possible draught. If the combustion of the sulphur is incomplete, a part of it sublimes and re-acts with the sulphur dioxide to form thiosulphuric acid ($H_2 S_2 O_3$) which in turn forms thio-sulphates. These will decompose on boiling, and precipitate the sulphur into the pulp, which, being practically insoluble, it is impossible to remove. When this sulphur becomes oxidized to sulphuric acid it is very injurious to the paper making machinery as well as the pulp.

When pyrites is used in the production of sulphur dioxide more complicated burners are used, and additional care is taken to avoid overheating, for slags are easily formed which impede the draught and are difficult to remove. Blowers or exhaust fans are used to improve the draught through the furnace, and these cause a lot of fine dust to be carried over with the burned gases. This dust never reaches the pulp however, as the gases pass directly from the furnace into a dust chamber where it settles before the gases enter the cooler.

From the fact that one volume of water at zero centigrade will absorb sixty-nine volumes of sulphur inoxide; and at forty degrees will absorb but seventeen volumes, it is evident that the temperature of both gases and liquor will be kept down as much as possible during absorption. In practice the temperature of the cooler varies from ten to fifteen degrees. The absorption apparatus are of two kinds, namely, that in which the gas is absorbed by water holding the base in suspension or solution; and that in which the gas and water react together upon lumps of the carbonate of the base. The latter method, which is the older and simpler, consists of a high shaft or tower packed with limestone or dolomite, which is covered by a thin film of water that enters from above. The gases enter the base of the tower under pressure sufficient to force them up through the limestone and out at the top. The sulphur dioxide meeting the moist limestone, reacts with it, forming at first sulphurous acid ($H_2 SO_3$), and then calcium sulphite

(Ca SO₃)
dioxide
soluble
tank a
sists of
in solu

In
just de
calciun
with n
In prac
ed by
is draw
require

T
liquor
may be
digeste
protect
acid.

linings
further
The ob
have b
of exp
buckle

B
scales
have w

B
is now
cement
to the
first it
a depo
imperv
lining

(Ca SO_3), while this insoluble product unites with more sulphur dioxide to form calcium bi-sulphite [$\text{Ca H}_2 (\text{SO}_3)_2$], which being soluble is washed out by the descending water. The former or tank apparatus is the one generally used in this country, and consists of a series of tanks filled with water which holds the carbonate in solution or suspension.

In this case the chemical reaction is practically the same as just described, for as the sulphur dioxide is absorbed, the insoluble calcium sulphite is precipitated, but becomes redissolved as it reacts with more sulphur dioxide to form the bi-sulphite [$\text{Ca H}_2 (\text{SO}_3)_2$]. In practice more or less of the insoluble sulphate (Ca SO_4) is formed by oxidization, which is allowed to settle and then the liquor is drawn off and stored in air tight, lead lined tanks, until it is required for use.

The real process of pulp making begins when the chips and liquor are brought together in the digesters, which vary in size, and may be either upright or rotary. But the great difficulty in making digesters for this process, is to obtain a suitable lining which will protect the iron plate from the corrosive action of the sulphurous acid. The usage in the past has been generally in favor of lead linings, as they are but slightly acted upon by the acid, and are further protected by the coating of lead sulphate which forms. The objection to the use of lead, to overcome which many devices have been tried, is the fact that it has about double the co-efficient of expansion of iron, so that in alternate heating and cooling, it buckles and draws to such an extent as to soon necessitate repairs.

Bronze linings have been used with some success, and boiler scales in the form of sulphite of lime or silicates of iron and calcium have worked very well.

But the digester lining that takes the precedence and which is now being rapidly introduced, is merely a layer of Portland cement of about four inches in thickness, and this may be applied to the boiler directly or first made into slabs and then fitted in. At first it is more or less porous, but the interstices are soon filled by a deposit of sulphate and sulphite of lime which render it quite impervious. The cheapness of the application and repair of this lining will recommend its general adoption.

In a digester containing two cords of chips, about twenty-five hundred gallons of a three and one-half per cent. liquor is used. The temperature is raised slowly until after the wood has become saturated with the liquor, and then a steam pressure of sixty-five to eighty-five pounds is turned on, which is equivalent to a temperature of one hundred and fifty-five to one hundred and sixty-five degrees centigrade. At these high temperatures the bisulphite is decomposed into sulphurous acid, and the normal sulphite, which being insoluble is deposited in the pipes or pulp. The sulphurous acid gas forms a hydrostatic pressure, which, added to that of the steam for the given temperature, gives the total pressure in the boiler.

Thus the pressure may be considerably increased, by the formation of this gas, without an equivalent rise in temperature. On account of the greater convenience the digesters are heated by means of live steam, which, by condensing in the pulp, is continually diluting the solution, but by employing a non-conducting jacket very little difficulty is experienced in practice, especially when cement linings are used.

At the end of the cook the gas is nearly all blown off and then the pulp is blown out under a pressure of about thirty pounds. This saves time in handling and the trouble of beating. It must now be thoroughly washed to remove any of the precipitated sulphite, especially when bleaching is to follow, for the sulphite is a strong antichlor itself, as it takes up the free oxygen formed by the action of the chlorine.

The pulp is never a pure, permanent white until after the ligneous and coloring matters remaining, have been broken up and removed by the action of a bleaching agent. The true bleaching action is purely an oxidization, which breaks up the coloring matters into simple colorless oxidized derivatives. With bleaching powder (Ca O Cl_2) the chlorine unites with the hydrogen of the water and this action liberates the oxygen which does the work. Pure oxygen, ozone or hydrogen peroxide, may also be used with equal effect. On the other hand the bleaching action of sulphurous acid is of a quite different character, for it combines with the coloring matters to form colorless compounds, which are easily reduced with a return of the color when the acid is neutralized.

Y
in this
for thi
but th
pond o
half th
these l
acid be
water,
the gill
could n
the res
directio
that is
is that
research
oxalic c

R
the res
they ar
resin w
W
treated
oxidizin
Spruce
process.

If
a high
isolation
an acid
cellulose
basic h
although
cellulose
empirie
but the
many o

You will naturally wonder what becomes of the waste liquor in this process, and this is one of the problems that has been left for this century to decide. In some places the gas is recovered but the general practice is to dump the liquors into the nearest pond or stream to get rid of them. This not only means a loss of half the woody structure and the gas in solution, but the effect of these liquors in fishing streams is remarkable. The sulphurous acid being a reducing agent, combines with the free oxygen in the water, and the organic paste in the solution forms a coating over the gills of the fish; therefore the fish have left no atmosphere and could not breath it if they had. If the waste liquor is evaporated the residue has no fuel value, therefore we must look in other directions for methods of conversion into valuable bi-products. All that is known concerning the chemical composition of these liquors, is that they are sulphonates containg the OCH_3 group. Future research may result in the manufacture of either glucose, alcohol, oxalic or acetic acid, from this organic residue.

Resinous woods are not very suitable for pulp making, as the resins are insoluble in hot bi-sulphite solutions, and although they are dissolved by the alkaline solvents, every hundred parts of resin will neutralize eighteen parts of the alkali.

Woods such as chestnut, which contain tannin, should not be treated by the sulphite process, as the tannic acid would act as an oxidizing agent, converting the sulphurous into sulphuric acid. Spruce and poplar are used almost exclusively in the sulphite process.

If a compound cellulose such as wood is treated with water at a high temperature, a hydrolitic action takes place with the partial isolation of cellulose and the formation of soluble compounds with an acid reaction. All of the commercial methods of isolating cellulose depend upon this hydrolitic action. The soda process is a basic hydrolysis, and the sulphite process is an acid hydrolysis, although the chemical reactions that actually take place in the cellulose molecule, are yet but a matter of conjecture. The emperical composition of cellulose is the same as starch ($C_6 H_{10} O_5$), but they differ remarkably in resistance to hydrolysis and in many other ways. This indicates a difference in the linking of the

unit groups, and in the reactivities of the OH groups, which in cellulose exercise a purely alcoholic function. The investigations of Cross and Bevan indicate that the cellulose formula is $C_6 H_6 O (O H)_4$, or some multiple of this which is in a more or less hydrated condition, according as it is more or less resistant to hydrolytic action. All those celluloses that are eaten and digested by the herbivora are extremely hydrated forms, and they become more resistant to external agencies as the water of hydration is removed. This fact is well exemplified in the discriminating way that fodder eating animals usually select their foods.

Be
fore you
briefly
first step
sign is
surface
This tre
grading
soil whi
foundati
form of
decayed
drainage
but whe
drainage
usually c
of soil,
need for

An
street, cu
consolida
into frag
such as v
or if the
example
is particu
of varyin
breadth o
narrow s
breaking
stone chi
structure
a cheaper

THE BONDING OF BROKEN STONE ROADS.

A. W. CAMPBELL, C.E.

Before entering upon the subject which I have brought before you today, in the title of this paper, it will be well to review briefly the construction of a broken stone road. In general, the first step in the construction of a broken stone road of modern design is to prepare the natural sub-soil, on which the stone road surface is to rest, so as to make of it a firm and strong foundation. This treatment of the sub-soil for the most part, is a matter of grading and under drainage, especially the latter. It is the natural soil which must bear up the weight of traffic, and a wet, yielding foundation is not a suitable support, when bridged over with any form of paving material. With the exception of light, and partly decayed vegetable mould, nearly all soils, when kept dry by under-drainage, are sufficiently strong to support the heaviest traffic, but when saturated with water, every soil is weakened. Natural drainage is frequently sufficient, so that artificial under-drainage, usually of common porous tile, is not always necessary. The kind of soil, whether clay, gravel, sand, loam, and the facilities and need for drainage will indicate the means to be adapted.

An excavation is made to receive the stone; if a town or city street, curbing is placed along the sides; the sub-soil is thoroughly consolidated with a roller, and upon this is placed the stone, broken into fragments varying in size from stone dust and screenings to such as will pass through a 2½ inch ring. If the traffic is great, or if the soil is of a kind particularly difficult of drainage, as for example what is described as an "oily clay," a Telford foundation is particularly useful. A Telford foundation is composed of stones of varying sizes, not exceeding ten inches in length, six inches in breadth on the broadest side, nor four inches in thickness on the narrow side. These stones are placed lengthwise across the road, breaking joints as much as possible; the interstices are filled with stone chips, all projecting points are broken off, and the whole structure is wedged, consolidated and made as firm as possible. As a cheaper means, the stones are commonly placed flat on the road,

closely together. The surfacing metal is then placed on this "pitched" foundation, in the usual way, usually to a depth of at least six inches, and for heavy traffic may have a depth of ten or twelve inches.

In placing this broken stone in the roadway it is spread in layers of about four inches in thickness, and a steam roller passed over each layer to consolidate them. The road surface should serve two ends. It should present a smooth, hard surface to traffic; and it should be impervious to moisture, so that rain falling upon it will not pass into, and soften the earth on which it rests. That is to say, it should answer the purpose of both a floor and a roof. These objects are attained by making the surface of the roadway higher at the centre than at the sides, so as to shed the water to the side gutters, and by compressing and compacting the material of which the road is composed. This compressing of the roadbed is usually performed either by traffic or by means of a heavy roller, aided by intermixing with the stone, certain fine stuff, screenings (the chips and stone dust created by crushing), sand, loam, street scrapings and even clay.

The use of a binding material in the construction of broken stone roads, is a matter which has been the subject of much discussion, with a corresponding diversity of opinion. The kind of material, the amount, the method of using, forms an interesting chapter in the history of road-making, and it is to this, together with the use of a roller, to which the title of this paper draws attention.

The use of the roller, and therefore the bonding of the road, begins with the earth sub-soil. The roller used on the natural soil will serve two purposes; it will find the weak spots in the sub-soil; will consolidate it, and assist in providing a firm foundation. Unless the sub-soil is rolled, uneven settlement is likely to take place after the road is completed, creating depressions in the road surface, a matter obviously to be avoided. By rolling it, on the other hand, wherever there is a quantity of loose soil, created in drainage excavation, in filling, or is weak because of its composition, it will be forced down beyond the possibility of settlement. The earth sub-soil too, if given a crown similar to the finished surface

of
a ter
such

upon
If th
resul
into
The
drain

or ot
also r
spread
of th
accor
the si
of the
while
graded
shoul
stance
six inc
to roll
compa
depth
consoli
into he

T
stones
mecha
by traf
method
and is a
roller,
tires an

of the road, and its surface thoroughly hardened, will have, itself, a tendency to assist in the drainage of the road by throwing off such water as may percolate through from above.

When this is consolidated, it will form a hard and firm base, upon which to roll and consolidate the succeeding layers of stone. If the stone is merely placed upon an unconsolidated sub-soil, the result can readily be imagined; the stones are forced by rolling into the sub-soil, and the earth is worked up among the stones. The subsequent rolling is less effective, and whatever beneficial drainage would result from a smooth sub-soil surface is lost.

The sub-soil, then, having been thoroughly rolled, a Telford or other "pitched" foundation, if required, may be laid, and this also rolled. Upon this, the broken stone is placed. It should be spread in layers, and each layer thoroughly rolled. The thickness of the layers, as spread over the road for rolling, will vary in accordance with many circumstances, the weight of roller used, the size and hardness of the broken stone, the ultimate thickness of the road bed, etc. Six inches loose should be a maxim thickness, while three or four inches is preferable. Where the stone is graded, as it should be, into different sizes, each size of stone should be placed on the road and rolled separately. As an instance of what might be done, take the case of a layer of stone to be six inches in depth when consolidated, it would be most practicable to roll down two layers of four inches thickness, loose, which, when compacted will make about the required depth. The greater the depth of loose material under the roller, the less perfect will the consolidation be, and there is the possibility of its being crowded into heaps over which the roller cannot pass.

The effect of the roller on the stone mass is to wedge the stones against one another, interlocking them, and giving them a mechanical clasp, one of the other, which is not readily disturbed by traffic. The roller is now used in preference to the old-time method of merely allowing traffic to do this work of consolidation, and is absolutely necessary to the best workmanship. Without the roller, the sub-soil is much disturbed by the pressure of narrow tires and by horses hoofs, before the surface protection becomes a

protection, an effect much increased by wet weather. Before consolidation is attained under traffic, the sharp angles of the stones, which materially aid in procuring a durable bond, will be worn off. Without a roller, too, the stone cannot, with the best results, be placed in the roadbed in graded courses, the largest stones in the bottom and the finest on top, for traffic over the loose material will intermix them, allowing the large stones to work to the top.

The objection to large stones, of say $2\frac{1}{2}$ inches in diameter, at the surface of the road, is that they do not assume so firm a bearing, as will smaller stones; they are more readily disturbed by pressure at one corner or at one side and are apt to be found rolling loosely under the wheels, and feet of the horses, nor do the different sized stones, if at the surface, wear evenly, the smaller wearing more quickly than the larger, so that a roughened surface results. On the other hand, it is urged that the finer stones intermixed with the larger, will lessen the percentage of voids in the mass. While this is no doubt true, yet the presence of large stones at the surface becomes very objectionable, and it is probable that the voids in the mass may be sufficiently filled by other means.

Rollers may be operated by horses or by steam power. Horse rollers usually weigh four or five tons, but may be weighted to six or eight tons. Steam rollers for broken stone roads weigh from eight to twenty tons. The objection to a heavy roller is that it cannot be used in soft material, as it bunches the earth or stone, creating mounds over which the roller cannot pass. An excessively heavy roller crushes the stone into position, breaks off the sharp angles, instead of working the stones gradually into a wedged condition. The heaviest roller, too, is apt to injure gas and water mains if at shallow depths, and they strain bridges, culverts and crossings. In a number of English cities, London among these, eight ton rollers are employed to prevent injury to city gas mains. Very light rollers, however, do not do the work of consolidation so quickly or perfectly as will one of moderate weight. Ten, twelve and fifteen tons will render the best service, twelve being a good standard. Where under-ground pipes, culverts, etc., are not a consideration, and two rollers are obtainable, a light roller for the loose material, and a heavy roller to complete the consolidation will

give the best results. Horse rollers are not desirable, as they are too light, and the efforts of the horses to move them disturb the loose metal very much. This last objection would not be so great if the horses were always well-trained, and the drivers understood their work; but, particularly in starting the roller, or on grades, the horses are not apt to pull together and their clumsy efforts before they get under way do very noticeable injury. While even in England, road rollers are not in use by all corporations, there remains no doubt as to their being essential to the most successful and economical results.

The percentage of voids in loose crushed stone varies according to the size of the stone, and whether or not the stone is screened into grades of equal size. The smaller the stones the greater the percentage of voids, and if graded the percentage of voids is also greater than where the stones are of unequal dimensions. For various conditions the percentage of voids has been found by experiment to range from 41% to 51%. For loose graded stones of $2\frac{1}{2}$ inches diameter, the voids may be accepted as about one-half. The effect of rolling is to reduce the voids about one-half, leaving the per cent. of voids about one-third of the consolidated roadbed.

It is evident that to secure an impervious road covering which will protect the sub-soil from moisture, this considerable percentage of voids must be filled. "Nature abhors a vacuum," and unless the right material is used to fill the vacuum, the wrong material will be apt to force its way in. Without some material to occupy the space, the earth from below and the dirt from above will ultimately be forced and absorbed into it.

The materials commonly used for that purpose have been previously enumerated, stone screenings, sand, gravel, clay, loam, and street sweepings; but of these the two first are those most commonly employed. The manner of applying them is in general the same. A light coating of the binding material is spread over each layer of broken stone, is sometimes harrowed in, and the roller is then used.

The use of these materials as a "filler" is neglected in the name now applied to them, "binding materials." The real reason

for their use at all, by most engineers, is that they assist in producing a quick consolidation, less rolling being required than when they are omitted, of which the use of such materials as clay, loam and street scrapings is in evidence.

Of these materials as a "binder" the only one which receives the full approbation of the most reliable engineers, is screenings—the fine chips and dust produced in crushing. There is a quality possessed by this material which is exhibited by no other, that of cementing and re-cementing. This is a matter which of recent years has attracted much attention, and the quality of a stone as a road material is not to be judged merely by its hardness and toughness; but also by the cementing qualities of the dust. This dust is an important factor, it is supplied to the road in the first instance, it is constantly being created by the use of the road. It is in this way that limestone holds its place as a good road metal, for which it is apt to be soft. The dust possesses splendid cementing qualities making one of the most impermeable road surfaces. The dust of trap rock, ranks exceedingly well in this regard, which supplementing the hardness and toughness of the stone, makes it the most satisfactory for road purposes. On the other hand, granite, while hard and tough is lacking in cementing power, and is not as satisfactory as might be anticipated. Quartzite also is an instance of a poor cementing stone, and sandstone, unless bituminous, is also defective in this regard. So important is this quality considered by the Massachusetts Highway Commission, that they regularly test the stone used on the State roads for the cementing power of the stone dust, together with tests for absorption, impact and abrasion.

The use of foreign material, that is, all except stone dust, was strongly condemned by Mr. McAdam; in France, where road-making is more exactly studied than elsewhere, it is universally condemned, and the best practice of all countries forbids it. Clay, loam, and even sand, it is recognized, can only be used at the expense of the durability of the road. They assist in producing an apparently good roadbed with the least amount of rolling, but the bond is temporary, very subject to changes of weather, particularly wet weather, and alternate freezing and thawing, matters which

have
"bin
inter-
bindi
of me
place
the ti
ready
T
ing an
be pla
voids,
emplo
materi
only a

have to be carefully guarded against in this climate. When foreign "binders" are used, there is lacking in the road the firm mechanical inter-locking which continued rolling will produce; they lack the binding properties of stone dust; most of them are very absorbative of moisture, are even slippery, so that the stones are readily displaced by traffic, and a roughened and rutted surface ensues. In the time of a prolonged draught, foreign binding materials are most ready to contract, so that there is a tendency for the road to unravel.

The conclusion, therefore, which we come to is, that for bonding and inter-locking a broken stone road, first dependence should be placed upon the roller. For what it will not do in filling the voids, the dust and chips created in crushing the stone should be employed, bringing with them an added cementing value; foreign material, such as sand, clay or loam, can be included in the roadbed only at the expense of ultimate durability.

EXPLORING NEW ONTARIO.

ALEXANDER H. SMITH.

During the last session of the Ontario Legislature, a scheme was evolved for the exploration of unsurveyed lands north of the Canada Pacific Railway line, for information as regards the soil, timber, and mineral resources. For the purpose a sum of \$40,000 was voted; and during the summer ten parties were organized to do this work. Eight of these were simply exploratory parties, the other two ran base lines as well as explored.

The exploration parties consisted of, in each case, a land surveyor, a timber and land estimator, a geologist, a cook, and men to act as guides and canoeemen. The surveyor controlled and directed the work of the whole party, he also made a track survey of the principal rivers and lakes in the region, took notes on the meteorological phenomena and acquired information as to the soil and forest growth, the fish, fauna and flora.

The duties of the timber and land estimator were to note the kinds of forest trees and their dimensions, estimating their extent and the quantity in feet B. M. or in cords as the case might be. He also had to note how such timber could be transported, and if the streams were capable of floating such timber. As regards the land; he had to note the soil whether sandy, clayey, etc., and its capacity for growing crops, and of what kind.

The geologist took cognizance of the general topography of the country, its rivers, lakes, hills, and valleys, the rock formations, whether Laurentian, Huronian, or of later age; mapping their strike (if any), direction of contacts, and length and breadth of formation, where such could be made. Of necessity his chief work was to discover if the formations yielded any economic minerals, and to determine the kind and richness of such. Another branch of his work was to examine the fauna and flora and the Indian occupation.

The three officers of each party were required to keep careful field notes as well as diaries, and their whole object was to collect as much useful information as possible on the country that came under their notice. The region was so mapped out that the whole of it might be examined in one season, each party having a distinct territory to work in.

Early in June I was informed by Mr. Archibald Blue, Director of the Bureau of Mines, that I had been appointed Geologist to exploration party No. 8. This party had the region immediately to the west of Lake Nepigon, and the Nepigon river to Dog lake, up Gull river and the country around Black Sturgeon lake. David Beatty, O.L.S., of Parry Sound, was in charge, while John Piche, of Copper Cliff, was to act as timber and land estimator. Towards the end of June our party met at Collingwood and proceeded to Port Arthur by boat thence east to Nepigon Station on the C.P.R., where we started our work. During the greater part of the season our party consisted only of eight men, two of them being University of Toronto men who were anxious to see this grand country and try their prentice hands—and heads—at the noble arts of paddling, and “totting” supplies across rough trails and portages.

Our outfit consisted of four canoes, two Peterboroughs and two small barks; four tents and two tons of provisions, the estimate that was made in regard to the latter, being a pound and a half each of flour and pork a man per day. Of course other supplies were taken, such as sugar, raisins, rice, etc., this amount of provisions was calculated to last us about five months; only half the supplies were taken up to Lake Nepigon, where we started our work, the other half being stored at Nepigon Station.

Owing to a hitch in the forwarding of our supplies to Nepigon Station, our party was unable to proceed up the river for a number of days, so I accepted the kind invitation of Mr. Walter Beatty, M.P.P., to accompany him on a trip to the east side of Lake Nepigon to look at some mineral deposits he had seen there years before. By this I escaped the disagreeable wait at Nepigon. Mr. Beatty also arranged to send me across Lake Nepigon so that I could join my party at Gull river.

On the way up the river, we were fortunate enough to catch a number of the large speckled trout that make this region the most wonderful trout fishing place in the world.

Mr. Beatty was rewarded in his search by finding a large deposit of hematite, which I measured in a number of places and found to be over a hundred feet wide. The iron is banded with jasper and appears to be wholly in the Huronian formation, the lead running for a number of miles east and west. Since Mr. Beatty's discovery, there has been a regular stampede of local men into the region and numerous claims have been taken up, and other ranges parallel to it discovered. While on the east side of Lake Nepigon I saw what is known as the Shuniah silver mine, near Poplar Lodge. This deposit appears to be a green quartzite, containing native silver and galena. During my stay on the east shore I managed to get about sixty miles inland, and was thus able to see that the country was well wooded with good spruce.

I should not be at all surprised if valuable mines are opened up in this region when means for transportation are found. I believe there is a charter for an electric railway into this country, the power for operating it to be procured from the Nepigon river. The Sturgeon river, the largest flowing into Lake Nepigon, is quite close to the iron range, and is capable of producing a large amount of power when required.

Leaving Poplar Lodge, H. B. Co. post, on the east side, and after an all day and night's trip with two Indians across Lake Nepigon I reached Nepigon House, the Hudson's Bay's chief post on this lake. This trip shows how large a lake this is, as the Indians kept steadily at work, only resting now and again to eat. The lake in fact is about 80 miles long by fifty broad; the water is beautifully clear and very deep, and simply teems with speckled and lake trout, white fish, pickerel, pike and sturgeon. From Nepigon House another half day's trip brought me to Gull river, where I joined my party.

Our method of exploring was this; the surveyor made a track survey of all watercourses taken; this he did with a prismatic compass and a Rochon micrometer, generally using a ten link target. The disks—which were celluloid—were one foot in diameter, one

red and
attached
for very
distance
and a tr
seven or
The tra
latitude
rate ma
employe
veyor, s

The
to the ri
miles ap
ing awa
method
estimated
a good d
used to t
camping
good ide
obtained.

Any
be explor
this purp
by eye, o
and rivers
pose of t
Taffrail l
shape, tie
tion a reg
the first d
to eat and
gauge for
was practi
the indicat

These
land, takin

red and the other white. For short distances a small disk was attached to the centre of the pole, thus giving a five link base; for very short distances one disk itself answered. With this target, distances of a mile could be estimated with considerable accuracy, and a traverse of a lake or river could be made very rapidly, often seven or eight miles of crooked river being surveyed in one day. The track survey was checked by taking frequent observations for latitude and also for magnetic variations, in this way a fairly accurate map of the country could be obtained. This work generally employed five men, two for the disk canoe and two for the surveyor, supplies were moved in the canoes used for the traverse.

The timber estimator and myself made numerous explorations to the right and left of the track survey at distances of about five miles apart, walking inland five or six miles and very often remaining away from the camp all night. In these explorations our method was to take a straight compass line and time ourselves; we estimated that our progress was one mile an hour in a straight line; a good day's work being ten or twelve miles: now and again we used to take our blankets and provisions and walk inland all day, camping for the night, and returning the next day. In this way a good idea of the country on each side of the water route was obtained.

Any side water route that we had not time to survey would be explored by either the timber estimator or myself, taking for this purpose an Indian as guide. Distances were estimated either by eye, or timing, and compass readings taken, outlines of lakes and rivers being carefully mapped in the field book. For the purpose of these explorations our party was supplied with a Kay Taffrail log, an instrument very much like a trolling spoon in shape, tied to a long line. This spoon while revolving set in motion a register which registered the miles travelled. Unfortunately the first day I used it, a large pike mistook it for something good to eat and proceeded to bend the flanges of the spoon, and as the gauge for straightening them had not been sent, the instrument was practically useless. Another drawback to the instrument was the indicator, which refused to work after registering ten miles.

These canoe explorations sometimes led us long distances inland, taking three or four days, and often a week, to com-

plete; and it was often very difficult to calculate the exact amount of provisions to carry with one. Of course every unnecessary thing was left behind, and only the absolute necessities taken. Unfortunately I was unable to speak Indian very well, so when I left the main party I had to take two Indians, as I found out that with only one I was always in danger of having to turn back, as he would get very lonely and be afraid to venture farther inland, with two Indians they would keep each other company, and as long as they had enough to eat they seemed quite happy.

The equipment for three men on one of these explorations, consisted of pork, flour and tea, three tea tins, a pail, frying pan, blankets, and a canvas tarpaulin for a tent. All through the summer we never used a tent except when with the main party; the bulkiest part of our equipment would be, of course, our blankets. We generally depended on shooting enough partridge and ducks to help out the other provisions, and with these additions we were always able to cut down our supply of pork and flour. Some surprisingly accurate work was done with only estimated distances; three explorations I made between two fixed points showed an error of only a couple of miles when the exploration was plotted, although the distance travelled was very long, in one case about ninety miles. Two common errors can exist, first an inaccurate compass reading; and second a wrong estimation of the distance, but I found out that these errors had a happy faculty of compensating each other. In this work all portages were paced, allowing about twenty-five paces to the chain. It must not be thought that these side explorations were in any way correct, but they will be of some value to the further opening up of this country, as they will show fairly accurately a large number of canoe routes, the number and length of portages, and the general direction taken by the route.

Much valuable information was thus procured as regards timber, land, and the geological formations.

In calculating the amount of timber in the region explored, the method the timber estimator used was to pace off an average acre, estimate the average diameter of the trees and counting them, this was rather a tedious process, but then a fairly accurate determination of the timber in the region was procured. The number

of ea
lumbe
spruce
sional

T
under
the ba
T
of the

O
countr
topogr
the he
of an a

F
party
miki
gneiss
immed
Animil
numere
the G
porphy

D
Kewee
consists
and wh
mostly
gillaceo
red and
stratifie
amount
gives a
topped
Lake N
Th
named

of each variety of tree was noted, and their suitability for either lumber, pulp wood or railroad ties. The timber consisted of spruce, jack pine, poplar, white birch, tamarac, balsam, and occasional scattered groves of red and white pine and white cedar.

The character of the soil was noted by the exposures seen under the roots of freshly fallen trees, or by the exposures along the banks of small streams.

The areas and depths of any peat deposits were noted, an idea of the depth being obtained by means of a pole.

Outside the general work of exploring and mapping out the country, the geologist was required to get a general idea of the topography of the region, the main and subsidiary water sheds, the heights of mountains and hills, which he estimated by means of an aneroid, two of which were carried by the party.

Four series of rocks were met with in the region explored by party No. 8. The Laurentian, Huronian, Keweenawan and Animikie. Roughly mapping these, the Laurentian area, which was gneiss as a rule, is around Dog lake. Keweenawan formation immediately to the west of Lake Nepigon and Nepigon river, the Animikie along Nepigon bay and west along Lake Superior, while numerous areas of Huronian rocks were noted at the headwaters of the Gull river. The rocks of this latter series being schists and porphyroids.

Dr. Robert Bell of the Canadian Geological Survey calls the Keweenawan series of rocks the Nepigon series. This formation consists of the following rocks in ascending order, white grits, red and white sandstones, with conglomerate beds, the pebbles being mostly jasper in a sandy matrix of different colors; compact argillaceous limestones, shales, sandstones, and red indurated marls, red and white sandstones and red and white conglomerates, interstratified with diabase layers. These are covered by an enormous amount of trappean overflow crowning the formation, this overflow gives a singularly wild and weird aspect to the country; high, flat-topped hills or ridges, rising with sheer cliffs along the shores of Lake Nepigon and inland, making a strikingly odd landscape.

The rocks of the Animikie (which by the way means thunder, named after Thunder Bay district), are represented by (1)

greenish arenaceous conglomerates with pebbles of quartz, jasper and slate; (2) thinly bedded churts, mostly of a dark colour with argillaceous and dolomitic beds; (3) black and gray shales, with sandstone and ferruginous dolomitic bands, together with layers and intrusive masses of diabase.

I have named and classified these rocks rather fully, as they are of much importance in this district owing to the economic minerals associated with them.

Every one has heard of the Silver Islet mine near Thunder Cape. This mine is in the Animikie, together with a great many other mines that have been worked with considerable profit.

By far the greatest region I explored is covered with the Keweenawan series, but it is not so extensive as is shown on the geological maps of that region. And it is encroached on by the Laurentian from the west and also by a considerable area of Laurentian gneisses around Black Sturgeon lake. This formation yields lead, iron and copper. It is to the iron that I wish to refer more particularly. Two iron deposits were found in the Keweenawan region, one on the east side of Black Sturgeon lake, and another to the north-east of Dog lake. These deposits are large and consist of very good hematite. Undoubtedly with further prospecting more iron will be found. The iron appears close to the contact between the Laurentian and Keweenawan formations. Numerous lead and copper deposits have been found in this series of rocks, and as there is an extensive area of them in the district I explored, I am sure that new and valuable finds will be made when the country is opened up.

Evidently the Huronian areas travelled over are not barren, as I picked up a piece of pyrrhotite in this region that assayed 0.75% nickel and a trace of copper and silver.

Large deposits of beautiful marble are reported to be in the interior of this region, and samples have been brought out but I was unable to see them. Some of the sandstones and impure dolomites would make splendid building stone, while the whole world could be supplied with the very best road material in the shape of the tough fine grained traps that are found. A very peculiar thing in this formation is the occurrence of brine springs, which are

found
them
used t

T
do not
fit for
patches
could
five pe
latter

W
country
believe
replaced
evidence
ed pine
as pro
be a w
dous q
we con
paper r
into l
of lum
to the v
way co
large ta
and oak
wooden
lumber
pine wi
it is rep
theless i
to look
whole th
near the
operatin
shipped

found in numerous places, the salt can be seen in the bottom of them in the shape of white grains. In former years the Indians used to get their supply of salt from these springs.

The chief question is what will this country be good for. I do not believe that more than twenty-five per cent. of the land is fit for cultivation, as the soil is too sandy and rocky, but there are patches of splendid land that could be cultivated. Good root crops could be grown and the hardy kinds of grain. The other seventy-five per cent. is taken up by lakes, rocky hills and muskeg, the latter affording a large amount of first class peat.

With the exception of a few patches of burn the whole country is covered with a healthy growth of timber. This district I believe was once a large white pinery but has been burnt over and replaced by other mixed conifers as the jack pine, spruce and balsam; evidences of this are to be seen all over the country in large scattered pine on the remains of dead ones. Unless nurseries are started as proposed by the forestry commission this country will never be a white pine country. As regards the spruce there is a tremendous quantity and this will be a great asset to the country; when we consider that "a cord of wood manufactured into cheap newspaper may be valued at \$40, but would only be worth \$7 sawed into lumber;" also the manufacturing of wood pulp and the sawing of lumber could be carried on in this district economically, owing to the water power to be found close at hand, providing that railway communication could be got. As regards the other timber, large tamarac is to be found in the district, this, next to rock elm and oak, makes the best boat building material. Unfortunately wooden boats are no longer built, but for piles and railroad ties and lumber this timber should be very valuable. Undoubtedly the jack pine will find a place as a marketable tree some day. At present it is represented as the most worthless tree we have got. Nevertheless it does make good pulp and railroad ties. So we are forced to look on this wood as of some value. Taking the district as a whole the timber represents the most valuable asset. At present, near the Canada Pacific Railroad, numerous pulp wood camps are operating, employing over six hundred men, the pulp wood being shipped to the United States and Canadian manufactories.

What Lake Nepigon and the Nepigon river is chiefly noted for is its wonderful speckled trout fishing; people travel for miles to enjoy a couple of weeks fishing on this beautiful river. Americans are forced to pay about \$25 license for the privilege of fishing, while people in Ontario pay \$5. During the summer months this river swarms with disciples of Isaac Walton, and the Indians derive a considerable income by acting as guides and canoemen.

As the pulp wood industry develops care should be taken that the fish in this river are protected and not killed out by the debris and rubbish which follows the using of a river for driving purposes and has caused so much harm to other rivers where fish were to be found. The protection of the fish in this lake and river should not be treated lightly, and strong efforts should be made to keep it clear and free from any filth that is likely to kill the fish. A larger income can be derived from selling licenses.

I have mentioned the prospects for mining development in this country, nothing definite can be said till further exploration is carried out.

Another asset to the country is the fur trade. At present the Hudson Bay Company with a few rival companies control the whole output. This region at one time was very rich in fur-bearing animals, but they are getting fewer in number and the trade is nothing as compared to twenty years ago. The caribou, moose and black bear are to be found, but are not plentiful. All the common animals are found, such as the beaver, mink, otter, etc.

The rivers in the district are rapid as a rule, with many falls, and as a number of them have a considerable volume and steadiness of flow, no great difficulty would be found in finding numerous places where power plants could be installed.

I have spent four summers in other parts of New Ontario, and have tried to observe carefully any natural resources that may come under my notice. Although I have seen better districts along the height of land farther east than this region, as regards timber, soil and game, yet taking it as a whole, I believe this country will prove of great value, not perhaps as a farming country, but rather as a lumbering, mining and game country. It will never be thickly populated, but still men will be able to derive wealth, if not great fortunes, by the development of its natural resources.

RATIO

In
engine
everyth
show th
sion of
cylinder

I v
running
enters t
I will n
and l. p.
For uni
a short t
not inte

Wh
chest it
it may a
allow th
cylinder
ing stea
this cont
entering
and the
piston is
commen
release is
decreases
contained
so if we
escape, t

**RATIO OF THE CYLINDERS OF A COMPOUND ENGINE AND
WHAT TAKES PLACE IN THEM.**

BY WM. HEMPHILL, GRAD. S.P.S.

In taking up the subject of the compound engine or a steam engine of any kind, some authorities consider that practically everything is known about the engine, but I will endeavour to show that we have something to learn and prove about the expansion of steam and the ratio of the volumes of the h. p. and l. p. cylinders.

I will assume I have a compound engine before me all ready running, and I will first explain what takes place when the steam enters the cylinder and follow it throughout the stroke. For this I will not assume any given ratio between the volumes of the h. and l. p. cylinders, but that expansion takes place in each cylinder. For uniform action it would be better to have the engine running a short time, all parts being thus warmed up, so that cold metal will not interfere with any suppositions.

When the steam enters the h. p. cylinder from the steam chest it is at a certain pressure and the corresponding temperature; it may also be considered saturated. Just as the valve opens to allow the first portion of the steam to enter the h. p. cylinder, the cylinder and the piston are at a lower temperature than the entering steam, so some of the steam is immediately condensed, and this continues until the cylinder becomes the temperature of the entering steam, *i.e.*, the portion of the cylinder between the piston and the end of the cylinder that is open to the live steam. The piston is pushed forward to the point of cut-off and now the steam commences to expand and continues expanding until the point of release is reached. During this expansion the pressure of the steam decreases, consequently its temperature lowers; but the steam contained a certain amount of heat when it entered the cylinder, so if we had a perfect engine from which no heat could enter or escape, the heat liberated by the fall of temperature caused by

lower pressure, would be taken up in the steam which would be superheated during expansion, and the steam that was condensed at the first part of the stroke would be evaporated again, but as we have not an ideal engine to work with, we do not get such perfect results. The heat that is liberated by the fall of temperature is partly used in heating the cylinder walls as the piston moves out, exposing new portions of the walls to the steam, some of which heat may be used in re-evaporating the water caused by initial condensation. In fact this seems to be reasonable, for in working out tests we find as a rule a little more steam in the cylinder at release than at cut-off. Now release occurs and the steam is exhausted into a receiver or the l. p. steam chest. During exhaust the steam

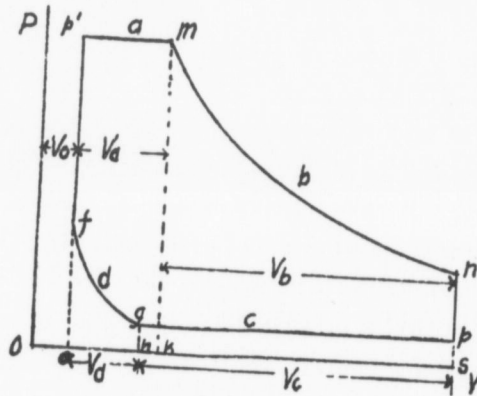

Fig. 1

is superheated owing to the large quantity of heat that is liberated by the drop in pressure. Then the l. p. cylinder takes the steam from the receiver and it is still further expanded until release occurs and the steam is exhausted into the condenser or air, according as the engine is condensing or non-condensing. Now with this rough idea of what takes place during the stroke, I will follow it out more particularly.

By following a method known as Hirn's Analysis we can determine the work done in thermal units for different parts of the stroke. In Fig. 1 the portions of the stroke are indicated by the subscript letters, thus a for admission, b for expansion, c for exhaust, d for compression. Then—

V_a = volume in cu. ft. described by piston during admission.

sion.
V
L
severa
priate
T
T
T
T
T. U.
T
(T
T
the ste
Rd, the
R
R
R
R
E
Q
admissi
Q¹
Q
Let
which M
in steam
space ea
be meas
Then th
its temp
Q = M(
3

V_b = volume in cu. ft. described by piston during expansion.
 V_c = volume in cu. ft. described by piston during exhaust.
 V_d = volume in cu. ft. described by piston during compression.

V_o = volume in cu. ft. of clearance space.

V = whole volume displaced by piston.

Let the work done in thermal units by the steam during the several portions of the stroke be represented by T with its appropriate subscript, thus—

T_a = work done during admission = area $ep'mke$ in B. T. U.

T_b = work done during expansion = area $Kmnsk$ in B. T. U.

T_c = work done during exhaust = area $hgps h$ in B. T. U.

T_d = work done during compression = area $efg h e$ in B. T. U.

$T_a + T_b$ = absolute work done by steam = area $ep'muse$.

$(T_a + T_b) - (T_c + T_d)$ = net area of indicator diagram.

The quantities of heat in thermal units exchanged between the steam and the metal are represented by areas R_a, R_b, R_c, R_d , the areas being drawn to the same scale as the work diagram.

R_a = heat exchanged between metal and steam during adm."

R_b = heat exchanged between metal and steam during exp."

R_c = heat exchanged between metal and steam during exh."

R_d = heat exchanged between metal and steam during comp."

E = heat lost by external radiation.

Q = the quantity of heat supplied to cylinder per stroke by admission steam.

Q^1 = the quantity of heat supplied from jacket.

$Q + Q^1$ = total heat supplied.

Let M lbs. = weight of wet steam admitted per stroke, of which Mx is dry steam, and $M(1-x)$ is weight of water present in steam. Let also the weight of steam retained in the clearance space each stroke = Mg . (The actual weight of this steam may be measured knowing the pressure g at beginning of compression.) Then the heat Q required to raise M lbs. of water from 32° F. to its temperature of admission, and to evaporate the portion Mx is $Q = M(h + xL)$ [h is sensible heat L = latent heat of steam].

For superheated steam heated from normal temperature t_n of saturated steam to temperature t_s — $Q = M [h + L + .48 (t_s - t_n)]$.

The internal heat of the steam in clearance space at commencement of compression, assuming the steam dry= $Mg (hg + lg)$.

Where Mg , hg , lg represent weight, sensible heat, and internal heat at pressure and volume at point g on the diagram Fig. 1.

The internal heat at cut-off= $(M + Mg) (hm + x_m \rho_m)$, where x_m =dry steam fraction on the diagram.

The internal heat at end of expansion—

$$= (M + Mg) (hn + x_n \rho_n)$$

and similarly for the other points of the cycle.

Now to find the heat R_a . The heat supplied is Q , the heat in the cylinder at admission is—

$$Mf (hf + xf \rho_f)$$

the work done is T_a ; and the heat remaining in the steam at cut-off is $(M + Mg) (hm + x_m \rho_m)$. Then—

$$Q + Mf (hf + xf \rho_f) = T_a + R_a + (M + Mg) (hm + x_m \rho_m)$$

from this can find R_a as all other quantities known.

To find R_b . The heat in the steam at the end of expansion is $(M + Mg) (hn + x_n \rho_n)$; the extenal work is T_b , the heat present at beginning of expansion is $(M + Mg) (hm + x_m \rho_m)$. then—

$$(M + Mg) (hn + x_n \rho_n) = T_b + R_b + (M + Mg) (hm + x_m \rho_m)$$

from which R_b may be determined.

To find R_c . The heat in the steam at end of expansion is $(M + Mg) (hn + x_n \rho_n)$; the work done upon the steam during exhaust is T_c ; the heat in the steam at beginning of compression, assuming the steam at compression dry: is $Mg + x_g \rho_g$.

To determine the heat rejected to the condenser must be done by a test of the engine, and weighing the steam condensed in a given time, and dividing this weight by the number of strokes made by the engine in that time. This will give the weight of steam M exhausted per stroke. Then M lbs. of steam become water at temperature t . The heat in this condensed steam is now Mht . The heat carried away by the condensing water equals the

weig
of t
Then

from

gini
upon
steam

from
taking
cylind

A
B
b
o

V
and 3,
heat u
T
propor
the 1.
a volu
the dis
Fig. 2,
diagram
in a ve

weight of condensing water W per stroke multiplied by its increase of temperature in passing through the condenser = $W (t_1 - t_2)$. Then:—

$$(M + Mg) (hn + xn \rho n) + Te = Re + Mht + W (t_1 - t_2) + Mg (hg + xg \rho g)$$

from which Re may be obtained.

To find the heat Rd . The internal heat in the steam at beginning of compression is $Mg (hg + xg \rho g)$. Then work is done upon it = Td during compression; and the internal heat of the steam at end of compression is $Mf (hf + xf \rho f)$; then—

$$Mg (hg + xg \rho g) + Td = Mf (hf + xf \rho f) + Rd$$

from which Rd may be found. This applies to one cylinder, by taking the other indicator card this may be applied to the 1-p. cylinder.

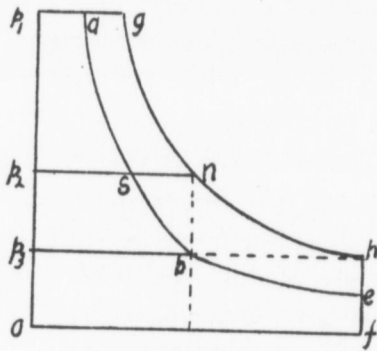

Fig. 2

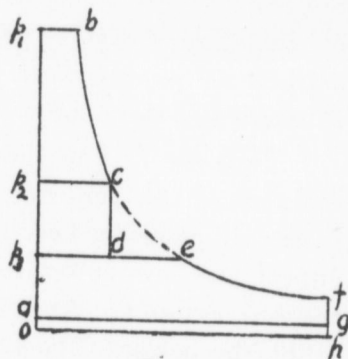

Fig. 3

We are now in a position to follow the diagram of Figs. 2 and 3, and follow the action in the cylinder on other lines than heat units.

To do this it will be more satisfactory to assume some definite proportions, let the ratios of the cylinders be 1:2; the cut-off in the 1-p. cylinder to be constant at .5 of stroke and to enclose a volume at cut-off equal to the volume of the h.p. cylinder. Then the distribution of power between the cylinders may be shown by Fig. 2, in which I assumed hyperbolic expansion. In practice this diagram would be subject to a number of changes, but it illustrates in a very satisfactory way various results in a compound engine.

Take cut-off at .25 of the stroke in the h.p. cylinder and at an initial pressure p , shown on Fig. 2, the steam expands along $a b$ until it reaches the pressure $p_3 = p_1 \times .25$ neglecting clearance (this is also the pressure in the receiver). The work diagram of the h.p. cylinder equals area $p_1 abp_3$, and of the 1.p. cylinder the area $p_3 befo$, point b being the cut-off in the 1.p. cylinder.

Suppose now we make the cut-off in the h. p. cylinder at .5 of stroke, then nearly twice the weight of steam is supplied per stroke, and the steam at release is at a higher pressure than when cut-off occurred earlier. Call this pressure p_2 as shown on Fig. 2, and the pressure of the receiver, p_2 , is the back pressure on the h.p. piston and the forward pressure on the 1.p. piston to the point of cut-off at n now, and the work diagram is now given by the areas $p_1 gnp_2$ and $p_2 nhfo$ by the small and large cylinders respectively. A glance at fig. 2 shows the difference in the work by changing the point of cut-off in the h.p. cylinder; it shows a marked increase in work for the 1.p. piston, while the h.p. work is practically the same.

Thus we find to increase the power of the engine we have to increase the per cent. of cut-off, but the larger share of the increased power comes from the 1 p. cylinder; while with early cut-off and low power the larger share of the work comes from the h.p. cylinder. And as this power can be decreased to a minimum, the power of the 1.p. cylinder may be reduced to zero.

Now consider the effect of throttling the steam supply with the same ratio of cylinders, and cut-off fixed in both cases at .5 of stroke without "drop." The initial pressure was p_1 before and let it be throttled to $p_2 = \frac{1}{2}p_1$. Then in fig. 2, the distribution of work is seen as area $p_2 sbp_3$ for the h.p. cylinder and $p_3 befo$ for the 1.p. cylinder. This shows the work area for the 1.p. cylinder the same for steam throttled as with high pressure, with cut-off at .25 of stroke, but the work area in the h.p. cylinder is much less, when the steam is throttled, giving a less satisfactory distribution of power between the cylinders for throttling than having cut-off earlier. It shows that theoretically, throttling to a pressure p_2 is less economical than changing the cut-off from .5 to .25 with constant initial pressure, for in both cases the same weight of steam

is exha
f e, tho
area p_1
the act
off.

An
between
cylinder
cylinder
of the
change
the wo
1.p., p_2
then th
the 1.p.

In
cylinder
pound
ceive
the 1.
and th
pound

N
line o
would
volum
The e
back
pressu

radiat
in the
increa
initia
pressu
which
receiv

is exhausted per stroke, *i.e.*, the 1.p. cylinder volume at pressure p_1 , though with throttling the useful work area is reduced by the area $p_1 a p_2$. This theoretical gain would not all be realized in the actual case owing to cylinder condensation with an early cut-off.

Another way of remedying the unequal distribution of power between the cylinders is by having a variable cut-off in the 1.p. cylinder. Let us take the cylinder ratios 1:4 and cut-off in each cylinder at half stroke, and let $p_1 b c d p_3$ fig. 3, be the work area of the h.p. and $p_3 e f g a$ the work area for the 1.p. cylinder. Now change the cut-off in the 1.p. from .5 to .25 of the stroke; then the work areas will be changed, the h.p. being $p_1 b c p_2$ and the 1.p., $p_2 e f g a$. Conversely if the cut-off in the 1.p. be made later then the work area in the h.p. will be increased, and decreased in the 1.p. cylinder.

In the above methods the effect of the receiver between the cylinders was not taken into account. In the majority of compound engines a receiver is placed between the cylinders to receive the exhaust steam from the h.p. cylinder and to give it to the 1.p. cylinder. This receiver often takes the form of a pipe and the valve chest. (The above has reference to a cross-compound engine.)

Now if this area were indefinitely large, the back pressure line of the h.p. and the forward pressure of the 1.p. cylinder, would be each a horizontal straight line. In practice the receiver volume is from $1\frac{1}{2}$ to several times the volume of the h.p. cylinder. The effect of the restricted volume of the receiver is to make the back pressure line of the high and the admission line of the low-pressure diagram irregular.

The receiver volume is made as small as possible to avoid radiation of heat, but space is an important factor to consider in the size of the receiver. The effect of a small receiver is to increase the small cylinder's back pressure and to increase the initial pressure of the large cylinder. Sometimes an increase in pressure occurs in the 1.p. cylinder towards the point of cut-off, which is caused by the h.p. cylinder's exhaust passing into the receiver before cut-off has taken place in the low.

In designing an engine it is usual to get the diameter of the l.p. cylinder first, and then the diameter of the h.p. cylinder depends on a number of conditions, but the main object is to have the power evenly divided between the two cylinders. After looking through a number of catalogues, I find the ratio of the volumes of the cylinders range from 1:2½, 1:3, and 1:4, rarely higher, or the diameter of the l.p. cylinder is twice that of the h.p. cylinder minus two. Nearly all the manufacturers cling to this idea of ratios, which later on I will endeavor to show is an error in the point of economy in the engine.

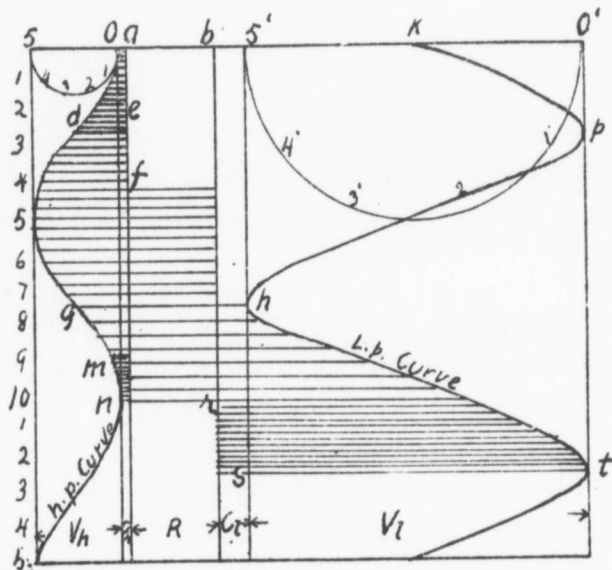

Fig. 4

Let us now construct a diagram which will show the piston displacement in a compound-engine. To do this it is necessary to assume ratios of cylinders, clearance and receiver volumes for a given compound-engine. By this diagram it will be possible to follow the steam through the engine, and it illustrates the changes of volume and pressure between the points of entering and leaving the cylinder.

In fig. 4, horizontal lines are lines of volume, and vertical lines are divided into portions of a revolution. Then let $aO =$ volume of h.p. clearance (Ch); $O5 =$ volume of h.p. piston displacement (Vr); $ab =$ volume of receiver (R); $b5' =$ volume of

l.p. cl
ment (C
O
revolut
equal
set off
diagram
assume
stroke
the po
zonal
the nu
the co
displac
and th
of hat
cylind
the fig
cylind
initial
off at
then c
port c
exhau
cation
the v
closed
cut-of
gram
as sh

at rig
der b
diagr
is se
occur
is kn

1.p. clearance (Cl); and $5'O' =$ volume of 1.p. piston displacement (Vl).

On the lines O5 and O'5' draw semicircles representing half a revolution of the crank-pin and divide it into any number of equal parts, say five. On the vertical line to the left of fig. 4, set off ten equal parts representing parts of a revolution. The diagram shown is for one and a half revolutions. The cranks are assumed at right angles, when the h.p. piston is at beginning of stroke O and the 1.p. piston is at centre of stroke K. Through the points on the vertical line numbered 1, 2, 3, etc., draw horizontal lines, let these intersect the vertical lines drawn through the numbers on the semicircle, the intersection of these lines for the corresponding number gives a point on the "curve of piston displacement." Obtain a number of these points for both cylinders and the curves can be swept in as shown. The different grades of hatching show the volumes in the cylinder as admission to h.p. cylinder, expansion in h.p. cylinder, etc. It is easily seen from the figure all these points and also the connection between the two cylinders. The h.p. clearance Oa is first filled with steam at initial pressure, and the steam is continued to the point of cut-off at half stroke, and volume in cylinder = de. The steam is then expanded to nearly the end of the stroke, when the exhaust port opens, and at f the steam passes into the receiver. Now the exhaust side of the h.p. cylinder and the receiver are in communication, as shown, until the 1.p. steam port opens at h. Here the volume of the steam = gh. At m the h.p. exhaust port is closed, and compression begins. At the point r in the 1.p. piston cut-off takes place and the steam expands to volume st. This diagram can be applied to the indicator diagrams of compound engines as shown fig. 5.

This figure shows the piston displacement curves for cranks at right angles, the theoretical indicator diagram of the h.p. cylinder being drawn below the h.p. piston curve, and the 1.p. indicator diagram below the 1.p. curve. The initial pressure is known, and is set up from the zero line of pressure. In the diagram cut-off occurs at .4 of stroke in the h.p. cylinder, and as the initial pv is known, all other points in the cycle may be determined, assum-

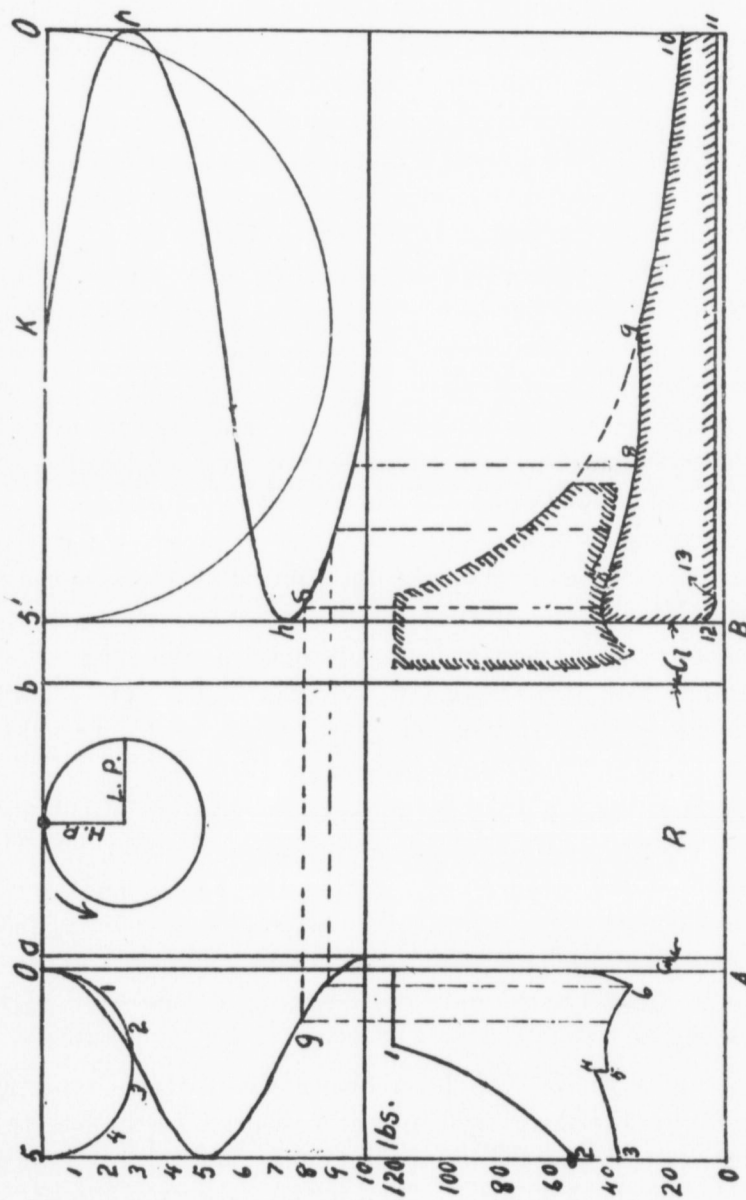

Fig. 5

ing hy
scripts
ing th
steam
vertica
vertica
When
with t
receiv
piston

For
then:—

from v
cut-off

from v
therefo

The
follow

R
fig. 5,

A
receiv

B
cylind
the m
valve
to p₅,

V
with t
p
T
ing fo

ing hyperbolic expansion. In the following equations the subscripts refer to the figures on the portions of the diagram representing the theoretical indicator diagram. Thus V_3 = volume of steam at point 3, measured from beginning of stroke, *i.e.*, from vertical line Oa and to the left in the h.p. diagram, and from vertical line through B and to the right in the 1.p. diagram. When the exhaust side of the h.p. cylinder is in communication with the 1.p. cylinder, then the volume including that of the receiver, is given by the horizontal intercept between the lines of piston displacement.

For this diagram it may be assumed that $p_v = a$ constant, then:—

$$p_1 (v_1 + Ch) = p_{10} (v_{10} + Cl),$$

from which the terminal pressure is obtained, and the point of cut-off in the 1.p. cylinder being known, then—

$$p_3 (v_3 + Cl) = p_{10} (v_{10} + Cl),$$

from which p_3 or the pressure at cut-off in the 1.p. cylinder, and therefore the pressure in the receiver at that time is known.

Then the pressures at all other points may be obtained by the following equations:—

Referring to the theoretical diagrams in the lower part of fig. 5, then for the h.p. cylinder

$$p_1 (v_1 + Ch) = p_2 (v_2 + Ch).$$

At point 2 the steam exhausts and mixes with that in the receiver, which is at some pressure p_3 previously calculated.

$$p_2 (v_2 + Ch) + p_3 R = p_3 (v_3 + Ch + R).$$

But during the return of the h.p. piston, so long as the 1.p. cylinder is not open to receive steam, the volume enclosed is for the moment reduced, hence the pressure rises to p_4 until the 1.p. valve opens the port to steam, when the pressure instantly falls to p_5 , then—

$$p_3 (v_3 + Ch + R) = p_4 (v_4 + Ch + R).$$

When the 1.p. valve opens to steam, the receiver steam mixes with that in the clearance space of the 1.p. cylinder; thus—

$$p_4 (v_4 + Ch + R) + p_{12} Cl = p_5 (v_5 + Ch + R + Cl).$$

This action continues, and meanwhile the 1.p. piston is moving forward and increases the displacement, causing the pressure

to fall to p_6 , when the h.p. exhaust valve closes, and compression begins in the h.p. cylinder; then—

$$p_5 (v_5 + Ch + R + Cl) = p_6 (v_6 + Ch + R + Cl + v_s).$$

where v_s is the volume displaced by the l.p. piston from the beginning of its stroke, and which volume may be measured by the horizontal intercepted between the lines of piston displacement, as shown by the dotted projectors. The back pressure p_{11} in the l.p. cylinder is fixed—

$$(p_{12} Cl) = p_{11} (v_{13} + Cl).$$

The same principles may be further extended to represent changes in any number of cylinders taking two at a time. In fig. 5 the h.p. diagram is shown dotted over the l.p. diagram to show more clearly the relation between them.

In what I have said so far on the compound-engine it was not necessary to take into account the ratios of the volume of the h. and l.p. cylinder; all the assumptions that were made were very limited, as I only wanted to show what took place in the cylinders, to follow the steam through the stroke, illustrating it by diagrams, and also how the work was divided up, giving the latter in heat units as well as work units. It is now my intention of dealing with the ratios of the volumes of the cylinders, and endeavor to show that it is an error in assuming that everything is now authoritatively settled about the design of the steam engine which seems to be the prevailing idea in the minds of those who write text-books on thermodynamics and heat engines, although in a general way this idea may be accepted as true, for the steam engine of James Watt considered as an automatic mechanism was not different in any essential particular to what we have to-day. The fact of cylinder condensation was known then although not understood to the extent that it is to-day.

A great many compound corliss and marine engines have been built in the last twenty or thirty years, but only in the last eight or ten years has anything been known experimentally of the most economical volumes of cylinder ratios. We see, as I mentioned before, that in Europe and America the ratios run from 1:4. The reason of this is the fact that an engine so proportioned avoids more than a very slight "drop" in pressure from that at the end

of exp
in the
When
caused
withou
sible in
of Wa
no cha
I can
demy
of the
sures.

Pou

P
should
"drop
a sudd
ments
the tro
true th
this "
The "
by sud
mediat
togeth
lowing

"
the ex
it is c
receiv
on a
as the
cylind
than i
pressu
expan

of expansion in the smaller cylinder to the pressure at cut-off in the large cylinder, with reasonable ratios of expansion in each. When "drop" occurs it is because free expansion takes place, caused by the sudden enlargement of the volume of the steam without doing work against a piston. As this "drop" is not reversible in the idea of a cycle it is considered loss. Since the time of Watt's invention the steam pressure has been increasing, but no change has been made in the ratios of the cylinders. So far as I can learn Carl Busley, Professor at the German Imperial Academy at Kiel, is the only authority who would change the ratios of the cylinders in compound engines for different steam pressures. He gives the following ratios:—

Pounds per sq. in.	60	90	105	120
Ratio	1:3	1:4	1:4.5	1:5

Professor Ewing is very positive in his statement that care should be taken not to allow free expansion into the receiver as "drop" occurs which would be shown on an indicator diagram by a sudden fall at the end of the h.p. expansion. All these statements about "drop" being wasteful were assumed, no one taking the trouble to perform experiments to prove the supposition. It is true that "drop" is wasteful, but I think the effect of allowing this "drop" can be utilized to make "drop" a gain in the end. The "drop" I refer to must not be mistaken for the drop caused by sudden radiation or condensation, but that resulting from intermediate expansion, although it looks as if authorities put the two together under the same head. In D. K. Clark's Rules, the following discussion occurs on the influence of "drop."

"That the work of expanding steam is to be calculated from the expansion upon a moving piston only is obvious enough when it is considered that the steam may expand into an intermediate receiver, and into intermediate passages, without doing any work on a piston, whilst at the same time the pressure falls or drops as the volume is enlarged. Under these circumstances the second cylinder receives the steam at a lower pressure and in larger volume than it has when there is no intermediate expansion and fall of pressure, and there is less work done, whilst the ratio of active expansion is necessarily reduced. If the second cylinder, however,

be enlarged in capacity in proportion to the enlargement of the volume of steam and the fall of the pressure by intermediate expansion, the ratio of expansion and the work done in it would remain the same." These quotations considered by themselves would commit Clark to the common belief that "drop" produced by intermediate expansion causes a serious waste. He goes a little farther in the right direction than others have done, however, in the suggestion that the waste occasioned by "drop" may be balanced by enlarging the second cylinder; but he does not, in this immediate connection, draw attention to the fact that the loss in pressure of the receiver steam, due to the practice of taking more steam by volume from the receiver than it gets from the h.p. cylinder is accompanied by an increase of work in the h.p. cylinder. By this the back pressure in this cylinder is reduced and at the same time the initial pressure in the l.p. cylinder. Therefore the loss occasioned by receiver expansion is much less than Clark implies in his quotation, and if high boiler pressures are used with a moderate amount of "drop" this loss, even from a thermodynamical point of view is quite insignificant. Let us now consider the causes of "drop" and the advantages that accompany its moderate use.

There are two causes of "drop." The first is intermediate expansion. When more steam by volume leaves the receiver than is put into it per stroke (assuming no steam made or condensed in the receiver), the receiver pressure must be less than the pressure in the h.p. cylinder at release. The other cause of "drop" is cylinder condensation and clearance in the l.p. cylinder. If a receiver compound engine had neither clearance or condensation in the l.p. cylinder, there might still be any amount of "drop" if the cut-off on that cylinder were lengthened enough. Again, if the cut-off were adjusted just right to prevent any "drop" in such an engine, and the cylinder had the usual amount of clearance and condensation, a "drop" of from 12 to 15 pounds might result. Even this could be prevented by making the cut-off earlier in the stroke. Therefore it is seen that cut-off may be a cause or a corrective of "drop." But the point of cut-off is dependent on considerations other than its effect on drop. It would be desirable

to have
of ex
peratu
the los

It
of cut-
tion ha
would
the ga
This d
necess
panied
in am
mediat
sumpt
very u
variab
the en
the re

A
would
pound
economi
two e
pressu
find l
circum
piping
to cyl
appea
allowa
five.
"drop
sions
of 11
omy.
work,

to have the cut-off occur late in the stroke were it not for the loss of excessive free expansion, as this would reduce the range of temperature of the l.p. cylinder walls, and would, therefore, reduce the loss from initial condensation in this cylinder.

It is easily seen from the foregoing that unless the best point of cut-off, chosen with reference to the waste by initial condensation happens to coincide with that particular point at which "drop" would be entirely prevented, a compromise must be made between the gain by lengthening cut-off and the loss by free expansion. This does not have to be done in cylinder ratios of 1:3, but it is necessary for larger ratios as 1:6 or 1:7. If "drop" is accompanied by a reduction of initial condensation in the large cylinder, in amount sufficient to overbalance the waste of power by intermediate expansion, it is at least, no detriment to the coal consumption to allow that much "drop." This "drop" is considered very useful in plants driving a varied load, as it allows a widely variable cut-off in the second cylinder without either looping at the end of expansion in the first cylinder or materially changing the receiver pressure.

After dealing at some length with intermediate expansion it would be well to consider some of the general theory of the compound engine. We will assume the proposition that the highest economy to be obtained in an engine of any type is the result of two conditions—using a volume of steam at the highest possible pressure and expanding it the greatest number of times. But we find both the pressure and expansions are limited by practical circumstances; the pressure by the increase in cost of boilers and piping, while the ratio of expansion, by the increase in waste due to cylinder condensation, friction and repairs. All the authorities appear to agree that there is a minimum number of expansions allowable in each cylinder. This number is between four and five. But in an engine with cylinder ratio 1:3, practically no "drop" will occur, and custom has limited the number of expansions for such an engine to 12 or possibly 15. A steam pressure of 115 pounds for such an engine gives the best result as to economy. A higher pressure would enable the engine to do more work, but the number of expansions remaining the same the steam

consumption would not be affected. Now if higher pressures are going to be used with the idea of improving the economy, it would be necessary to add another cylinder so that increased expansion could take place. The average pressure for triple expansion engines is from 150 to 160, and even higher; but with the usual ratio of cylinders—1:2.75 :6.5—the number of expansions in each cylinder would be much less than that given above. The reason of this is that 150 pounds pressure is not enough to permit the larger number without developing too little pressure at release in the 1.p. cylinder.

Now in the triple expansion engine we have increased the engines from two to three, as a compound engine really consists of two engines, each requiring the same number of parts and the same equipment all through. To this we have added the third which will increase the cost of the engine, an important item in the majority of cases. The volume of steam in the h.p. cylinder is expanded from that volume to the volume of the 1.p. cylinder; it is not done direct but through the intermediate cylinder, but amounts to the same thing in the end. Now for mill engines and all stationary plants I think that this increased expansion could take place in the two cylinders instead of three. In fact I find for stationary work the compound engine is preferred to the triple expansion engine. Now I think if the ratio of the cylinders in the compound engine were increased to 1:7 or 1:8, and perhaps even greater for mill work, or any stationary work, the economy in fuel would be nearly if not quite equal to the triple expansion engine. The only way to prove this is to perform a number of tests on each kind of engine, *i.e.*, the triple expansion and a compound engine of different cylinder ratios, some large and some small. I do not say that the compound engine, with large ratios, will prove the more economical with regard to fuel and water supply, but if the pressures in each case are, say 180, it will hold a very high place.

I will now give a few results of some tests with regard to fuel and water, that have been obtained by competent men on compound engines using the ordinary ratio of the volume of cylinders. One of the large ratio I have considered above, also a triple

expans
think
more 1
pansio
sion e
So far
engine
made
two su
Test 1
K
Goldie
I
S
I
C
V
Test 2
K
by Ru
F
S
I
C
V
Test 3
K
ock E
I
S
C
I
C
V
Test 4
I
I
S

expansion engine. The results will speak for themselves, and I think the large ratio for compound engines will soon be taken up more favorably, and will take the place entirely of the triple expansion engine, although I think, in marine work, the triple expansion engine should be retained, if only for mechanical reasons. So far as I can learn I think there have been only a few of these engines made with the large ratio for the cylinders. These were made by the American Wheelock Engine Company, and all but two surpassed the makers guarantee for fuel and water supply.

Test 1.

Kind of engine—Cross-compound Wheelock engine, made by Goldie & McCulloch, Galt, Ont.

Ratios of cylinder, volumes 1:3.4.

Steam pressure, lbs. 82.5.

I. H. P. 239.

Coal per I. H. P. hr. 1.9.

Water per I. H. P. per hr. 17.2 lbs.

Test 2.

Kind of engine—Tandem-compound, four valve type, made by Russel Engine Co., Massillon.

Ratios of cylinder volumes 1:4.3.

Steam pressure 160 lbs.

I. H. P. each engine 300.

Coal per I. H. P. per hr. 2.55 lbs.

Water per I. H. P. per hr. 15 lbs.

Test 3.

Kind of engine—Cross-compound, made by American Wheelock Engine Co.

Ratios of cylinder volumes 1:7.2.

Steam pressure 140 lbs.

Cut-off h.p., .287 of stroke; 1.p., .236 of stroke.

I. H. P. 650.

Coal per I. H. P. per hr. 1.18 lbs.

Water per I. H. P. per hr. 11.89 lbs.

Test 4.

Kind of engine—Allis triple expansion pumping engine.

Ratios of cylinder volumes 1:2 $\frac{3}{8}$:4 $\frac{1}{2}$.

Steam pressure 185 lbs.

I. H. P. 750.

Coal per I. H. P. per hr. 1.02 lbs.

Water per I. H. P. per hr. 10.48 lbs.

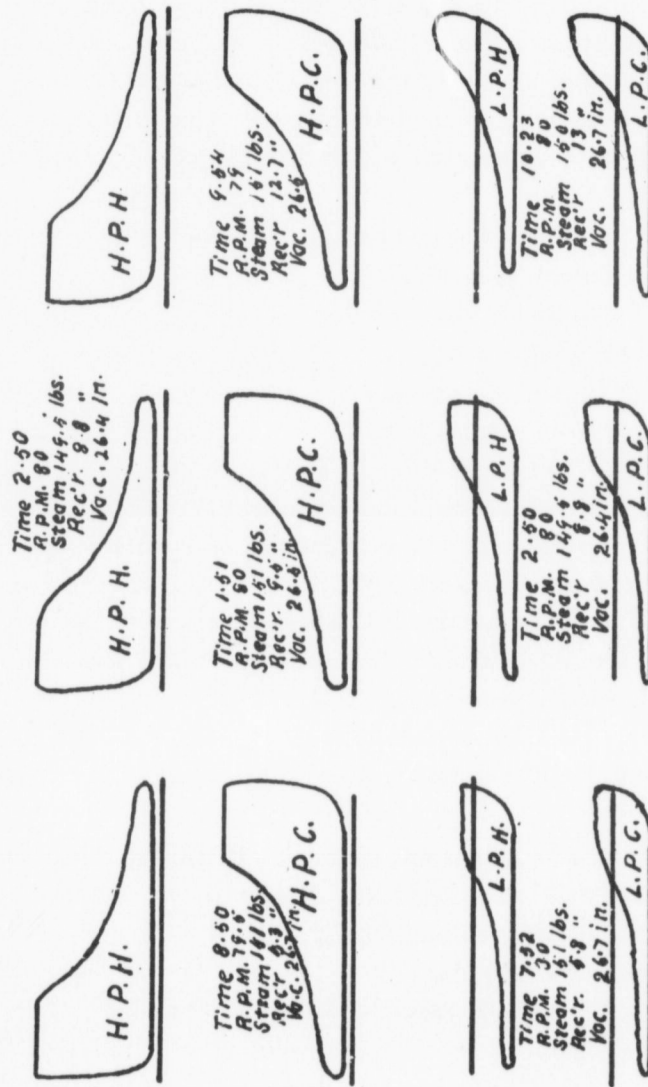

Fig. 6

Fig. 6 is a copy of some indicator cards taken from the engine while Test 3 was going on. The cards are very good and there is nothing to indicate in the 1.p. cards that the increased volume is detrimental.

THOMSON RECORDING WATTMETER.

C. G. CARMICHAEL, '01.

While comparisons between the meter and contract systems are no longer necessary, the choice of a meter is an important consideration: Shall it be an ampere meter registering the current, or a wattmeter registering the energy? To answer this let us examine effects of voltage on a 16 candle power, 3.1 watt incandescent lamp. A variation in voltage of 3% from normal is quite common, but the 2% variation given in Table 1, is quite sufficient for our purpose.

Table 1.—Effects of voltage on a 16 C. P., 3.1 watt incandescent lamp. Normal voltage 100.

Volts.	Candle p'w'r	Watts per Candle	Amperes	Total Watts
98	14.40	3.33	0.485	47.5
99	15.20	3.21	0.492	48.8
100	16.00	3.10	0.496	49.6
101	16.96	3.00	0.504	50.8
102	17.92	2.91	0.512	52.2

Suppose the Electric Light Co. is able to dispose of its power at the low rate of 10 cents per kilowatt hour. From Table 1, we see that a 16 C. P., 3.1 watt lamp at normal voltage takes 0.496 amperes. Since an ampere meter is calibrated from an indicating wattmeter, the voltage being kept constant at normal for this case a rate of 10 cents per K. W. H. is same as 1 cent per ampere hour. Also here a rate of 10 cents per K. W. H. is same as 0.031 cents per candle power hour.

We can now deduce the following table of charges per lamp hour, according to above three methods.

Table 2.—Charge per lamp hour.

Voltage	Charge per lamp hour at 10 cents per K. W. H.	Charge per lamp hour at 1c per ampere hour.	Charge per lamp hour at 0.031c. per candle pow'r hour.
98	0.4751c	0.485c	0.4464c
99	0.4880	0.492	0.4712
100	0.4960	0.496	0.4960
101	0.5088	0.504	0.5258
102	0.5220	0.512	0.5555

It can thus be seen that when voltage is below normal the ampere meter records more power than is used, and when voltage is above normal this same meter records less power than is actually consumed. Apparently it might therefore be argued that it would pay to use ampere meters and keep the voltage low. But any Electric Light Co. could soon tell you how many customers it would have at the end of a year were it to supply only 14 C. P. and charge for 16 C. P.

Now consider the customer. He wants so much light. Virtually he wants to pay so much per candle power hour. Say he is a merchant and in a year he uses 200 sixteen candle power lamps for 500 hours or 100,000 lamp hours. From Table 2, his lighting bill is found.

For a voltage of 98—

By Wattmeter his bill would be\$475.10
 By Ampere Meter his bill would be 485.00
 His just bill at 0.031 cents per C. P. hour is 446.40

That is Ampere Meter charges him too much by \$38.60, and Wattmeter too much by \$28.70, that is Wattmeter is more nearly correct by \$9.90.

For a voltage of 102—

By Wattmeter his bill would be\$522.00
 By Ampere Meter his bill would be 512.00
 And his just bill at 0.031 cents per C. P. hour is. 555.50

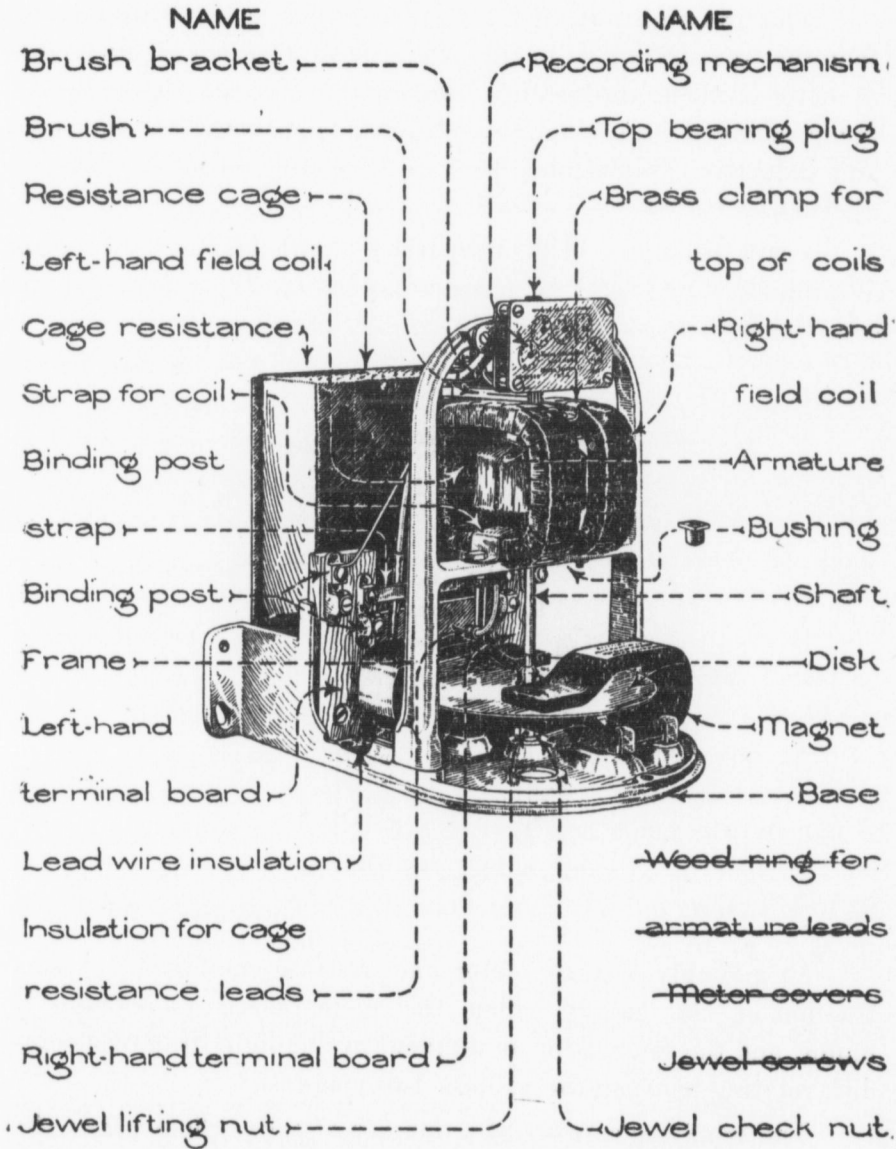
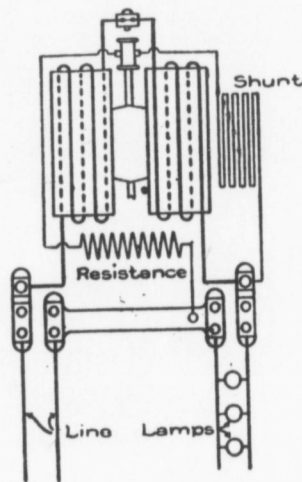

FIG. 1.

That is by registration of current the merchant is charged too little by \$43.50, and by registration of energy too little by \$33.50, again showing a difference, of \$10.00, in favour of the Wattmeter.

The first requirement essential to a perfect recording meter is therefore registration of energy and not current, one of its factors. A meter must be, simple and durable; able to resist tampering and independent of atmospheric conditions; independent of frequency and inductive circuits and must be adaptable to either direct or alternating current.

I will attempt a brief description of the Thomson Recording Wattmeter. In Fig. 1 is shown a 5 ampere, 220 volt meter, the connections being shown in Fig. 2.



Two wire, up to 50 amp.

FIG. 2.

It is simply a small motor and dynamo combined. A small fraction of the energy which the meter measures operates the motor, and the retardation is supplied by the light drag of a copper disk rotating between the poles of two magnets.

The armature consists of a number of coils of fine wire wound upon a frame of pressed paper, which is fastened to the vertical shaft. The commutator bars are made of silver and the brushes are tipped with that metal. The armature, in series with a suitable resistance and the shunt, is connected across the line. The fields consist of a number of turns of stout copper wire of size

sufficient
meter.
line the
the mo

Th
calibrat
fact we
opposit
spring
meter o

Th
By mo
the nu
ponds t
shaft is

As
armatur
number
the fiel
giving

In
tachabl
the end
should
new on
a metal
on the
base is
possible

W
cating
certain

gives w
with th

sufficient to carry a current of twice the rated capacity of the meter. These fields are connected in series with one side of the line the full current passing through them. Hence the torque of the motor is exactly proportional to the watts.

There is no iron about the motor, and the meter when once calibrated is adaptable to either direct or alternating current. In fact were we to replace the brushes by two connections affixed to opposite segments in the commutator and attaching a suitable spring and pointer to the shaft, we would have an indicating wattmeter capable of being used on any circuit.

The copper disk rotates between the poles of two magnets. By moving the magnets out or in the speed is regulated so that the number of revolutions of the disk in a certain time corresponds to energy delivered to the circuit in that time. On the shaft is a worm which operates the recording mechanism.

As before stated the shunt is connected in series with the armature and resistance across the line. It consists of a suitable number of turns of fine wire and is inserted in the inside of one of the field coils. Its object is to assist meter on light loads, thus giving the meter great accuracy on all loads.

In the lower end of the shaft is a polished, hardened steel detachable pivot. The shaft sits on a jewel mounted on a spring in the end of a screw. So that if from any cause jewel or pivot should be damaged both can be easily removed and replaced by new ones without removing the cover. The meter is protected by a metallic cover which is drawn tightly down on to a strip of felt on the base, thus rendering it dust proof. To the underside of the base is fastened a metallic plate, when it is sealed up it is impossible to tamper with the meter without breaking the seals.

Wattmeters are tested by connecting them up with an indicating Wattmeter; and with a stop watch noting the time of a certain number of revolutions of the disk. The formula,

$$\frac{3,600 \times \text{constant} \times \text{number of revolutions}}{\text{time (in seconds.)}}$$

gives watts recorded by the recording meter and this should agree with the reading of the indicating wattmeter. If there is not a

close enough agreement the magnets are moved out or in, according as meter is fast or slow.

The formula is derived as follows:

Let 1 revolution of disk in 1 hour = 1 watt hour.

Hence 1 revolution of disk in 1 sec. = 3,600 watt hours.

Or N revolutions of disk in 1 sec. = $3,600 \times N$ watt hours.

Or N revolutions of disk in t sec. = $\frac{3,600 \times N}{t}$ watt hours.

Now suppose we took a 25 amp., 100 volt meter and passed 100 amperes at 100 volts. through it, the disk would rotate at the abnormal speed of 166.68 R. P. M. If the field coils were made with one-quarter of the number of turns of wire the torque, and hence the speed of the disk would be one-quarter of what they were before. Since the disk is running at one-quarter of the speed necessary to record the power in the circuit, the dial will indicate only one-quarter of the power, so the dial reading is multiplied by 4, or as it is termed "constant 4." Then formula becomes

$$\frac{3,600 \times \text{constant} \times \text{number of revolutions}}{\text{time (in seconds)}}.$$

Another way of looking at it is—

Let W = watt hours.

N = number of revolutions.

t = time in seconds.

K = constant.

$$W \propto 3,600 \frac{N}{t}$$

W \propto Revolutions per hour.

$$W = K \frac{3,600N}{t}$$

By choosing the proper value for $\frac{3,600N}{t}$ we can have any value of K, $\frac{1}{2}$, 1, 2, etc., depending on the size of the meter.

Everything should be carefully considered before selecting the proper size of wattmeter to be used. If a building is to be illuminated with 400 lamps it does not of necessity follow that a 400 light meter will do. Take the case of a theatre using 300 sixteen candle power lamps. Probably ten of the lights would be

used a
etc., a
perform
mentio
the m
meter

F
regard
spot p
there i
while
expect
locatio

W
compe
after i
ful us
which

used a greater portion of the day to light up the ticket office, lobby, etc., and remaining 290 would only be used a short time during a performance. Now I would place a ten light meter on the first mentioned circuit, and a two hundred light meter on the lights in the main part of the theatre. It is far better to have too small a meter on an intermittent load than too large a one.

Heretofore it seems to have been the practice, especially in regard to house lighting, to locate the meter in the most undesirable spot possible. Garrets and cellars are favorite spots. In the former there is a 120° range of temperature between winter and summer, while in the latter it is usually damp. Is it not unreasonable to expect good results from meters located in such places? A good location is any of the back living rooms in the house.

When a meter is set up it should be examined annually by a competent person. Don't suppose that it is going to run forever after it has first been inspected and sealed up. In fact, the successful use of wattmeters depends largely upon the intelligence with which they are looked after.

PORTLAND CEMENT vs. BONE ASH FOR CUPELS.

H. ROY STOVEL.

The use of bone ash for cupels is so universal, that it is with great diffidence one seeks to introduce any other substance in place of it.

Portland cement on first thoughts does not recommend itself to one for this purpose, on account of its hardness when set. Through having had it suggested to me in a chance conversation I concluded to give it a trial, and have had most satisfactory results, finding it equal to and if anything slightly better than bone ash in every way.

The cement cupels being much harder and stronger, will admit of any kind of handling both in and out of the furnace. They can be dropped or even thrown down without any material damage. Neither are they so liable to fracture in the furnace as are the bone ash ones. In twenty experiments I have only found one with a crack in the cup, and that one so small that it was impossible for any bead but a very minute one to fall into it.

The cement being slightly heavier than bone ash with equal absorbing powers, it follows that size for size the cement cupels will absorb more lead, while for ordinary size buttons they may be made shallower, thus enabling one to see more of the cup while in a small muffle, and at the same time a saving is made in material.

As will be seen in the accompanying table the loss with the cement cupels is, in most cases, slightly less than with the bone ash ones, varying for 18 cupellations, of from 2 to 600 mgs. of silver, from nothing to 4.86%.

The relative cost of the two materials, locally, is much in favour of the cement, bone ash costing by bulk 7 cents per lb. while the price of cement is \$6.50 at Yellow Union per bbl., being only a fraction of the price of the bone ash.

Summing up and using the results of the few experiments I have made, which, having had to be done in spare moments, are not as many as I would have liked to have done before laying this paper before you, I find results to be as follows:

Time of cupellation about the same.

Loss in cupellation slightly in favour of the cement.

Cement cupels less liable to breakage and fracture in the furnace.

Absorbing power of cement, size for size, greater than that of bone ash.

Cost of cement being only a fraction of that of bone ash.

In sending this paper to be read before you it is in hope that some members of the Society who are interested in assaying may become sufficiently interested in this subject to carry on some more experiments in the laboratory of the school, the results of which I would very much like to know.

N.B.—I neglected to state that the cement cupels are made in identically the same way as the bone-ash ones.

NOTE.—Portland cement cupels have been in use in the assay laboratory of the School for the past three years. In the Spring of 1899, Mr. Mickle, being unable to get a good quality of bone-ash, commenced some experiments with cement, the result of which led to their almost exclusive use in our laboratory. The only drawback to cement cupels is the fact that after they have been brought to the proper temperature they have to be kept thus for from 10 to 15 minutes before putting in the lead, otherwise "spitting" will ensue.—*Editor.*

PEAT.

ARTHUR G. ARDAGH.

Peat or turf, by which latter name it is generally known by those acquainted with it in the old lands, commands an interest to-day from more than one point of view. While you may be interested in it from a scientific point of view purely—a matter for research, if no further, there are those who have been giving many years and much money in endeavouring to devise suitable machinery for compressing it, and thus to place it on the list of successful commercial industries. Expired patents are legion, and for 30 or 40 years we have records of experiments. I can also assure you that there are also many who, with no interest in its manufacture, are waiting to use it in their homes just as soon as it can be procured.

I would not touch upon the commercial side of the question if we were not as engineers specially interested with that aspect, and in fact a constant question is "Can it be made in paying quantities?"

The fascination of the subject and golden hopes of success have ever brought forward fresh brains and resources to fill the breach. Up to this time commercial success has not been attained, but we have good grounds to hope that we are on the eve of it. Although the public hear less of the subject than formerly, there are many earnest workers employed in solving (and I believe they will be successful, if indeed they are not so already) the difficulties of the situation. I think we have crossed the mountains and are descending the foot hills.

Most of us have gathered our hearsay information in regard to peat from old country people. There are deposits throughout Northern Europe in those countries which have sent our fathers and forefathers here. Ever since Caesar's time, at least, the peat fire has been burning.

Here also in Canada there are deposits of a similar nature, for all peats are not alike. If we class decomposed vegetable matters under the general name of peat, we have deposits formed of decayed grasses, sedges, aquatic plants, etc., we have cranberry marshes and pockets of "swamp muck," as it is called, scattered over the country. The farmer is well acquainted with its qualities who has to fight the swamp fire till the snow comes. Speaking of peat, Dana says:

"In temperate climates it is due mainly to the growth of mosses of the *genus sphagnum*. This plant forms a loose turf, and has the peculiar property of dying at the extremity of the roots below, while it continuously grows and increases above the surface, and by this process a bed of great thickness is formed."

It is specially of this kind of peat that I speak. There are two deposits I know well, that of 4,000 acres in Welland County, and a somewhat smaller deposit in Perth County, north of Stratford.

I believe there are a large number of deposits of this sphagnum peat in Canada. There are, I am told, bogs of excellent quality and extensive area in Newfoundland, Quebec and Ontario. There are huge muskegs in the northern part of Ontario, Manitoba and elsewhere, we know, but they are yet to be proved workable deposits. In Ireland beds of great thickness are found in which are embedded and preserved great oaks of a time long since. The peat is cut year by year off the face of the bank left the previous season. The upper stratum of "recent peat" is more fibrous and the colour brown when dry. In "older peat" there are few traces of fibrous matters, and it presents a pitchy hue when cut. It will dry out more or less brown unless it is puddled, when the density increases the dark colour. The upper stratum is called slave turf, because it can be dug with a slave, an instrument like a spade with a wing to enable the bricks of peat to be cut on two sides with one action. The lower stratum is often not cohesive enough to be handled in bricks as it comes from the bog, and this is tramped on the bank and then moulded by hand. It is called mud turf, hand turf, stone turf, or puddled peat.

The output of these operations is, in general, used locally. Most landlords in Ireland have bogs from which they get their

own supply, and the right to cut peat generally goes with a tenant's lease also.

But as to shipping it to a distance, the bulky nature and the dust prevent this being done to any extent. Hence the great efforts made in every country where peat is found to compress it into a more portable and marketable shape.

The process of excavating and drying the peat as performed on the Ellice marsh, north of Stratford, in 1899 and 1900, was as follows: Trenches were staked out 3' 8" wide, and at intervals two men, side by side, were set digging with the ordinary steel spades with lifting handles. The peat was dug out one spading deep at a time and spread along the bank, when this was dry on one side it was stacked in small stooks of four or five with the wet sides out, three or four pieces on end and one on top. Subsequently these stooks were gathered into larger piles to make way for the spreading of a second spading and so on. To gather in the dry peat, portable tracks were laid over the ditches and the peat thrown into trams carrying from $\frac{3}{4}$ of a ton to one ton and conveyed to sheds or huge stacks to be thatched with lumber or moss.

A factory was erected to press the peat, which at present is shut down awaiting the perfecting and trial of mechanical drying, which is occupying the attention of those interested in the enterprise at present.

There are various dryers about to be tested more fully this summer, enough has been done to warrant our hoping we have overcome this crux.

Peat reabsorbs moisture easily, and if spread in a finely disintegrated state on the surface of the bog it will never dry enough to render artificial drying unnecessary

As to its burning qualities, peat ignites easily, requires practically no draught when once the fire has taken hold, gives intense heat, and a banked fire will not burn out nor will it go out until the fuel is consumed. It burns with a flame for some time, and then for a longer period in red hot coals. The gases emitted in the initial stages of burning are not only innocuous but considered by some medicinal, especially against lung troubles. The percentage of ash will vary with the deposit from which the peat

is taken. The following analysis was made of samples of compressed fuel made from the product of the Welland bog with the moisture reduced to a suitable amount:

Moisture	12
Volatile matter	58.20
Fixed carbon	26.
Ash	3.80

The absence of soot, clinkers and practically of smoke (when burned under proper conditions) are qualities which will appeal to all classes of consumers. Peat in its crude state varies very much in weight—about 600 lbs. to the cubic yard may be taken as a fair density. The fuel as consolidated by the Dickson press will weigh from slightly under soft coal to slightly over hard coal, neither frost nor a damp atmosphere will affect it, but it should be protected from rain.

In the Dickson press the peat, after being broken to a powder in a breaker, is disposed automatically by gravitation towards the lower and stationary dies or moulds, which consist of two steel tubes about twelve inches long, of uniform bore and open at both ends, into which work two punches. Each charge of peat which flows in when the punch rises is compacted into a solid block on the top of the previously made blocks which occupy the lower two-thirds of the tube, and this column of blocks is forced down a distance equal to the depth of the block made, and thus each time one drops out at the bottom. The resistance thus obtained is yielding. Processes which involve the consolidation of the crude peat in a wet or hot state leave it subject to disintegration upon drying or cooling.

To dry peat in the air it must be exposed to the wind in brick form, and never more than 4 or 5 inches thick whatever length and breadth it may have. It will never dry in heaps or in powdered form either, unless it were spread an inch deep on boards, which is practically out of the question. Air drying may be done on racks, but the initial cost of the racks will be large.

I believe that in such a situation as the Ellice bog, where my own plant is situated, that the peat can be easily harvested after air drying with only 25% of moisture. This would make the

task of reducing the moisture another 10 or 15 per cent. by artificial means an easy one.

It is proposed by some to squeeze the first 30 or 40 per cent. of moisture out of it, and for this purpose an hydraulic press has been set up at the Trent Valley Peat Fuel Works. Fresh peat contains from 75 to 90 per cent. of water, which shows what an amount has to be handled to secure one ton dry weight. The time of drying varies with the weather, the handling it gets, and the artificial shelter, if any.

It might dry in a month easily, but count on six weeks on the average.

In well designed plants an endeavour will be made to eliminate hand-labour as much as possible. The plant will cover quite an area of ground, but the storage building will be inexpensive. They will be all connected with conveyors.

Dredging machinery will be used in some bogs, in which case the peat will be squeezed and artificially dried, and what takes now six weeks will occupy less than an hour.

THE CONSERVATION OF WATER FOR POWER PURPOSES.

C. H. MITCHELL, B.A. Sc., C. E., A. M. CAN. SOC. C. E.

In Canada and particularly in the Province of Ontario where the wealth of water powers is known to be almost inexhaustible, the study of conservation of water for power purposes seems almost superfluous. Conditions, however, frequently arise where the concentration of water at one point from a limited area becomes highly necessary for commercial purposes.

The following paper was prepared in the form of a report, made in October, 1900, for a well known mining company in Ontario, and with their consent the writer has arranged it for the Engineering Society in the hope that it may provide information on a subject upon which but little has appeared in the Society's publications.

The circumstances leading to the examination of this hydraulic proposition required that sufficient water be provided from a very limited area, for the present small experimental plant, and ultimately for a proposed plant of large capacity. The grade of the ore in this locality was such as to render it preferable to develop direct power at this point even at considerable expense for the collection and storage of water. The power is required for running a crushing and washing plant in the process.

GENERAL.

1. The mine now worked by your company is situated on Lot 3, Con. xviii., Township of Raglan, with the present mill situate on Lot 2, about a mile distant by road. These works are about 6 miles south of the Village of Combermere, and 20 miles south from Barry's Station on the Canada Atlantic Railway. They are at an elevation of about 200 feet above, and a mile west from the York River, which is a considerable stream tributary to the Madawaska River, the junction of which is about 4 miles north from the mill. This will be seen by reference to the "General Map" accompanying this report.

2. Access is had to the works from Combermere at present by road only, the country being very hilly, and the roads for the

most
them.
York
which
for 8
track
3
Lake
with v
This o
the "
north
mill),
fed by
known
lake o
the pro
season
large e
A
Brook
pocket
the Be
T
tion of
area th
drainag
outlet t
Th
the Tow
Raglan
4.
of lake
to a ge
Long L
rather t

most part rough, though improvements have been lately put on them. Transport can be effected by water via the Madawaska and York Rivers to a point within about 1.5 miles of the works, from which a road is now being constructed. This water is available for 8 months of the year through to Barry's Bay, where a spur track is in contemplation to the wharf.

3. The mill is situated upon a small creek known as Long Lake Creek, and was formerly a small saw-mill, and is supplied with water for power from the creek by means of a small dam. This creek has its sources to the west, and above the junction in the "Menzie Meadow," about 2 miles distant, trends from the north on the one hand from Long Lake (about 200 feet above the mill), and from the west, from a series of small lakes and meadows fed by a considerable area of hilly district. The latter branch is known as Lennon's Brook. At the extreme end of this is a small lake or pond which is called Summit Lake, about 150 feet above the present mill, the waters of which flow westward, though in wet season much of it would come east. This appears to be fed to a large extent by the country to the north.

At a point about 0.75 miles west of the mill, Robilliard's Brook enters the Long Lake Creek. This drains an area in a pocket among the hills in which is a small pond called, by settlers, the Beaver Meadow, some 200 feet above the mill.

To the north-west of Long Lake lies Echo Lake, at an elevation of nearly 400 feet above the mill, which, though of larger area than any lake in the vicinity has a comparatively small drainage area, the water from which flows by Round Lake and outlet to the Madawaska to the north and away from Long Lake.

The greater part of the drainage area outlined above lies in the Townships of Carlow and Bangor, smaller portions being in Raglan and Radcliffe.

4. The general nature of the country is very hilly, with areas of lake marshes and low ground lying between. The hills rise to a general height of about 500 feet above the valley of the Long Lake, and Lennon Brooks, and lie in an irregular position rather than in any particular direction of ridges, a fact which is

favorable for water supply, and storage. The slopes and crests of the hills are covered to a considerable extent with hard wood and second growth brush. The valleys are more or less open, with patches of second growth.

5. The prevailing temperatures in this locality are extreme, the summer average being at times as high as 90 degrees F., and the winter as low as — 30 degrees F., frequently much lower. This is a considerable factor in water supply owing to the evaporation in summer, and the freezing of springs, watercourses, and rainfall in winter.

RAINFALL, SOURCES AND STORAGE.

6. The most essential feature in the supply of water from this locality for power is the available rainfall. Having examined the streams during the first week in October of this year, the writer was able to determine the average fall flow of water available, a part of which, though small in quantity, may be termed "ground water" rising from springs, and quite independent of the rainfall. The rainfall source of supply appears to be variable from year to year, and even by monthly comparison.

The nearest meteorological observing station to this locality is situated at Renfrew, about 45 miles to the east as the crow flies. Observations on rainfall have been carried on at this point since 1884, though at times they have been omitted, and there are some readings which there is reason to doubt. Below is a table showing the totals of annual rain and snow fall equivalents in inches. Observations in the years not shown are incomplete:

	Rain.	Snow.	Total.
1884	13.54	8.60	22.14
1885	16.56	11.48	28.04
1886	19.00	7.35	26.35
1888	13.19	4.35	17.54
1889	23.26	7.87	31.13
1890	17.15	6.70	23.85
1891	21.14	4.71	25.85
1893	22.71	2.76	25.47
1894	13.20	1.75	14.95
1895	9.13	4.47	13.60
1897	13.50	5.20	18.70
1898	19.67	6.45	26.12

eviden
cords
these
a tota
cludin
year
given
the n

1885,
table,

The abnormally low rainfall in the years 1894 and 1895 is evidently due to incorrect readings, as an examination of the records would lead one to suspect. Omitting the observations of these two years, the average of 10 years, as above since 1884, is a total fall of rain and snow combined of 24.52 inches, while, including the two years mentioned, it becomes 22.81 inches. The year 1898, being the nearest to the average in recent years, is given below so as to illustrate the monthly variation, although the months September and October are abnormally high:—

Year 1898.

	Rain.	Snow.	Total.
January	0.00	2.00	2.00
February	0.00	1.80	1.80
March	0.62	0.00	0.62
April	0.47	0.10	0.57
May	2.51	0.00	2.51
June	2.87	0.00	2.87
July	2.15	0.00	2.15
August	2.05	0.00	2.05
September	4.09	0.00	4.09
October	4.91	0.00	4.91
November	0.00	0.80	0.80
December	0.00	1.75	1.75
Totals	19.67	6.45	26.12

The average month by month covering the typical years 1885, 1886, 1888, 1890, 1897 and 1898, is given in the following table, which shows the rain, snow and total for each month.

	Rain.	Snow.	Total.
January	0.44	1.25	1.69
February	0.16	1.38	1.54
March	0.32	0.91	1.23
April	0.95	0.95	1.90
May	1.61	0.02	1.63
June	2.70	0.00	2.70
July	2.40	0.00	2.40
August	2.65	0.00	2.65
September	1.85	0.00	1.85
October	2.13	0.04	2.17
November	1.01	0.68	1.69
December	0.13	1.64	1.77

This by inspection would lead to the assumption that while the "dry weather" season occurs in the winter months the precipitation is fairly constant throughout the year, that is to say that the July, August, September and October weather so frequently known as "dry" produces quite as much rainfall as other seasons, and that if there is any shortage of water it is caused solely by evaporation and absorption. The northern country is well known to give a "dry weather" season in March, a fact which is borne out in this locality by the last table, the precipitation being nearly all snow water.

The inference from these tables is that generally speaking the "dry weather" occurs not in the summer or fall, but in February and March, during the extreme cold weather, and that conservation of water must look toward that season and not so much toward the warm summer season.

7. The character of the country has much to do with the securing of rainfall water as under any circumstances a certain portion of the water is lost, the amount depending upon the general inclination of the slopes, and the character of the soil, etc. Flat country and very gentle slopes give a less percentage of the total rainfall capable of being collected and stored, than does steep, hilly and rocky country. This amount of water reaching the basins or streams is termed "run-off." By an examination of all the conditions in the areas for supply for your purposes the writer does not think it wise to assume the run-off in excess of 50%, which is a moderate and conservative figure for such country. The remainder of the precipitation would be lost through evaporation, absorption and seepage into underground channels.

Assuming as an average annual precipitation for calculating purposes the amount of 24 inches, the run-off can be safely assumed as 12 inches of rainfall per annum. Twelve inches of water over one square mile of area would produce about 27,880,000 cubic feet of water.

8. The main area as shown on the general map of the supply, comprising Long Lake with its tributaries, and the Lennon Brook, etc., comprises about 13.0 square miles. Within this area there is about 0.65 square miles (5%) or 435 acres of water surface

at or
Lake
area o
cubic
ground
cubic
in the
per ann
By
years b
togethe
approxi
been m
ing the
not exc
extreme
April, 1
50 to 7
year be
9.
ver Mea
square
Springs
rainfall,
feet per
amounts
water fro
¾ miles
10.
sheds, an
250 acre
springs, a
area shou
100 milli
should no
maximum
cubic fee
lion cubic

at ordinary times, *i.e.*, including lakes, streams and marshes. Long Lake has an area of about 90 acres, at its present level. The area of thirteen square miles should produce about 362,000,000 cubic feet of run-off water per annum. The writer estimates the ground water as indicated by the October flow at about 48,000,000 cubic feet per annum, thus bringing the total water available in the main water shed area to a flow of 410,000,000 cubic feet per annum.

By an examination of the average monthly rainfall for many years back, and having regard for the snow, ice and spring freshets, together with an assumed constant ground water flow, estimated approximations for the total monthly flow from this area have been made. These lead one to believe that the average flow during the months of December, January, February and March, will not exceed say 11 million cubic feet per month, and might at extremely cold and dry seasons run as low as 8 million cubic feet. April, May and June might be assumed at an average of from 50 to 70 million cubic feet per month, the other months of the year being from 20 to 40 million cubic feet.

9. The area shown by the general map comprising the "Beaver Meadow" and Robilliard's Brook drainage, gives about 1.5 square miles, of which about 25 acres ($2\frac{1}{2}\%$) is water surface. Springs in this locality are numerous, and these, together with the rainfall, it might be estimated would give about 46 million cubic feet per annum. This would produce monthly about one-tenth the amounts shown for the general area. The greatest part of the water from this area reaches the Long Lake Creek at a point about $\frac{3}{4}$ miles above the mill.

10. The Echo Lake area lies high above the previous water sheds, and consists of a drainage of about 3 square miles, of which 250 acres or 10% is water surface. This lake is fed largely by springs, and the slopes are comparatively short and steep. This area should produce with the ground water a total flow of about 100 million cubic feet per annum. The cold weather winter flow should not be less than about 2 million cubic feet per month, the maximum spring flow for three months about 15 to 20 million cubic feet per month, and remaining average about 7 to 10 million cubic feet.

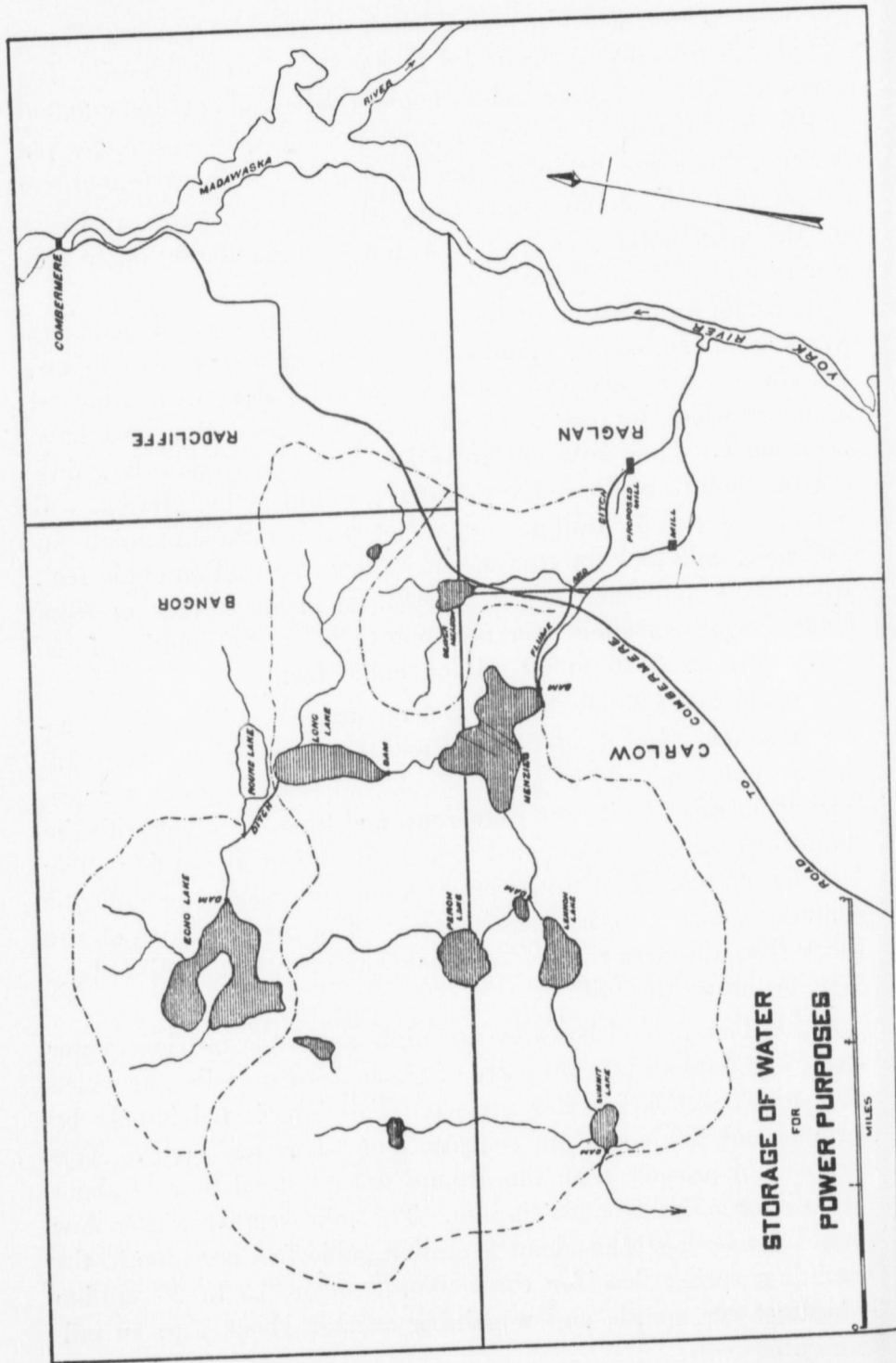

Lake
feet
was
impo
inclu
draw
to a
ated
unde
head
This
purpo

devel
of w
crush
per d
the r
15 ho
the m
made
requir
poses,
ments

1
that u
5 cub
wash
carefu

12th,
gives
month
outlet
from

PRESENT MILL AND PLANT.

11. The present mill is situated in the gorge of the Long Lake Creek, immediately below a log and earth dam, about 15 feet in height. The dam was originally built for a saw-mill and was increased in height and strength for the present mill. This impounds water to only a small extent of surface as the creek inclination is somewhat steep. Water for driving the mill is drawn from the dam by means of a 15 inch spirally rivetted pipe to a point about 300 feet below the dam, where power is generated by a 37 inch "Cascade" impulse wheel, with five nozzles, under a normal head of about 44 feet, variable on account of head water; at this head the wheel gives about 39 horsepower. This plant has been in operation only since July, for experimental purposes.

At the time of the writer's visit (October) this wheel was developing about 30 horsepower, and was using about 7 cubic feet of water per second when all machinery was on. The heavy crusher machinery was running at that time only about 4 hours per day out of the 20 hours run, using about 15 horsepower, and the remainder of the time the lighter machinery used only about 15 horsepower, with 3.6 cubic feet of water. The ore treated in the mill was about 20 tons per day of 20 hours, and observations made on the performance of this experimental mill show that it requires about 1 horsepower per ton of ore treated for all purposes, although this should be considerably decreased by improvements which can be made.

12. Measurements of water coming down to the mill show that under normal conditions in October as indicated above, about 5 cubic feet per second of water was being used for all purposes, washing, leakage, and other loss. The latter can be saved by careful attention to the dam, which is now being done.

A series of measurements extending from May 17th to July 12th, 1900, on the water flowing over a 70 inch weir at the mill gives an average discharge of about 60 million cubic feet per month. During this interval, however, a dam was placed in the outlet to Long Lake on June 4th, thereby cutting off supply from that district. Previous to this date the average for the 18

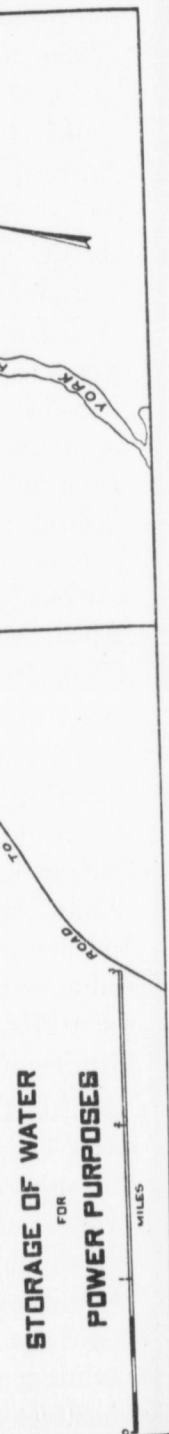

days in May was at 26 cubic feet per second, or at the rate of about 70 million cubic feet per month. This figure includes the Robilliard area, but does not include the water from the west end of the main area, which it is contemplated to bring to the mill. Though the rainfall at Renfrew for the first five months of 1900, and for the month of May, shows about 25% greater than the average for the periods, as indicated in paragraph 6 above, nevertheless the above discharge as measured appears to agree with the run-off production indicated in paragraph 8. After the dam was placed in Long Lake the rate of flow for 38 days in June and July was 20 cubic feet per second, or about 53 million cubic feet per month, during which time Long Lake was filling according to subsequent measurements at the rate of about 5 million cubic feet per month. These figures also appear to agree fairly well with the previous deduction from the rainfall and run-off.

13. There is no doubt whatever that this flow of 5 cubic feet per second as measured cannot be maintained throughout the winter months or during a particularly dry season in the fall. This is shown by the fact that the present plant has been drawing to a small extent this year upon the Long Lake reservoir since August 24th. This lake was dammed on June 4th by a small dam and allowed to fill until the former date to a height of about 30 inches. Since that time water has been drawn from it at the rate of about 0.7 to 1.0 cubic feet per second, of which from 0.4 to 0.5 cubic feet is storage water.

While a minimum of water of about 5 cubic feet per second will be required to be maintained during the present winter, a greater amount, about 8.0 cubic feet per second will be required next year in view of the contemplated enlargement of the present experimental mill, when a wheel of greater power may be installed. A 50 horsepower wheel could be run with this water on the same principle as at present, running all the machinery at full power about one quarter of the time, and the lighter machinery at about 20 horsepower during the remainder.

PROPOSED FOR PRESENT PLANT.

14. The present dam will require to be carefully overhauled and strengthened so as to ensure its security and close the leaks.

The stability of this dam is most essential, as the mill is situated immediately below it. The immediate construction of a sufficient spillway through the dam to provide for the spring freshets, is advisable, the former wasteway having been closed, and it would be well also to clear the mill pond of brush and logs, etc.

15. The chief problem for the present plant is to provide the supply of 8 cubic feet of water at the mill the year round. To do this requires the utilization of storage areas sufficient to store water to supply the deficiency in the dry and cold weather months, viz., December to March, inclusive, and possibly October and November at times.

The writer is of the opinion that the main area, together with the Robilliard area, as before indicated, will provide sufficient run-off water to do this, and that storage reservoirs in the Menzie Meadow and on Long Lake can be suitably arranged to store water for the dry seasons.

Assuming that the minimum dry season produces by the run-off from these two areas 8 million cubic feet per month for the four winter months, December, January, February and March, and 18 million cubic feet per month for October and November, which is a conservative figure, the storage areas must supply the deficiency up to the 8 cubic feet per second limit. The amount of water required by the mill at this figure running 24 hours per day, 31 days in the month, will be approximately, 22 million cubic feet per month. Consequently the draft on the storage areas would be 14 million cubic feet per month for the winter months and 4 million cubic feet for October and November. That is to say a total of 64 million cubic feet would be required, without considering losses by evaporation, freezing, absorption, etc.

16. To provide for this, dams for storage will be required at the outlets of the Menzie Meadow, and Long Lake.

The Menzie Meadow dam is proposed at the point shown in the plans, and should be built so as to impound water to an elevation of 185.0 feet above the datum of levels as per the contour plan, or about 14 feet above the level of the creek immediately above the outlet. This dam can be built of logs, earth and stone, which can be easily found in the locality. Its extreme height

would be about 17 feet and its length about 200 feet, at the located site, assuming the water to be within a foot of the top at high water, the crest of the dam being at elevation 186.0. This dam should be made perfectly tight and with a spillway to provide the passage of high water in the spring. It should have stop logs or a gate so arranged as to deliver the required amount of water over and into the creek bed. The amount of water delivered will not need to be as much as 8 cubic feet per second as the Robilliard stream and springs in the valley will provide a portion of the water required for the mill.

The Menzie Meadow thus dammed so as to raise the water to an elevation of 185.0 would provide for a storage of about 83 acres, which, with the dam arranged so as to draw off the upper 13 feet of the pond, would store about 46 million cubic feet. The evaporation and absorption during the summer months, together with temporary loss in the winter by frost, should not exceed about 20% of the amount if the brush and trees, particularly within the upper pond area, are cleared so as to reduce the evaporation to a minimum. The writer is of the opinion that a storage of 37 million cubic feet can be considered as reliable for this reservoir, at the height of dam indicated. Should more water be required at any time in the future, it can be impounded by raising this dam a few feet; the dam might be built with this in view.

It appears from the precipitation that there will not be sufficient rainfall this fall and winter season (1900-1901) to provide any water for storage above that now being used, but the immediate construction of this Menzie dam is advisable, so that when the spring thaw and rains set in the reservoir may be filled by the flood water. This water will then become available in the fall and winter of 1901.

The dam placed at the outlet of Long Lake in June, 1900, serves to raise the water about 2.5 feet. If this were raised so as to impound water to a depth of 10 feet above the old lake level, a storage of about 42 million cubic feet would be secured. Deducting about 20% as before, for evaporation, etc., about 34 million cubic feet would be available. This is quite feasible and its construction during the coming winter is also advisable to

secure the flood water in the spring. The area draining into Long Lake is not large, and would not be sufficient to fill the pond as proposed unless the outflow were shut off entirely. This, however, can easily be done, as the surplus water from the western portion of the main area, coming to and over the Menzie dam would be sufficient to run the mill. With a properly constructed dam and excavation the water of Long Lake could be drawn down even lower than originally.

17. For the demands of the coming dry winter season, before these dams fill, steam power will be required if the mill is to be kept running. Under the present circumstances a 15 horsepower steam plant ought to be quite sufficient as an auxiliary to the water plant with what water comes down. This can subsequently be used for heating and other purposes.

The following is a recapitulation of the works proposed for improving the present plant:—

1. Strengthening present mill dam, stopping leaks, constructing spillway, and possibly ultimately raising crest.
2. Possible ultimate installation of larger wheel and feed pipe, for say 50 horsepower.
3. Building Menzie dam, and clearing area.
4. Building Long Lake dam.

Water provided—8 cubic feet per second.

Available water stored—71,000,000 cubic feet.

PROPOSED NEW MILL.

18. There is in contemplation, the construction of a new mill at the location shown on the plans, of much greater capacity than the present experimental mill, if the construction is justifiable by circumstances. Such a course would entail the abandonment of the present mill, and the use of the machinery and the water for the new plant. The following hydraulic considerations are upon this basis.

19. As has been previously shown the total water available from the three drainage areas is constituted of: main area, 410 million cubic feet per annum, Echo Lake area 100 million, and Robilliard area, 46 million, a total of 556 million cubic feet. Of

this, by a conservative estimate, more than 80% could be utilized for the mill, or say a maximum of 444 million cubic feet, a monthly average of 37 million cubic feet. This is at the rate of 14 cubic feet per second used constantly.

It appears from previous figures that the dry weather flow for the four winter months will not exceed 11 million cubic feet per month from all sources; and that the months of October and November cannot be depended upon beyond 25 million cubic feet per month. Hence a deficiency of water under the requirement of 37 million cubic feet per month, occurs in six months of the year, the draft for the four winter months being at the rate of 26 million, and for October and November 10 million, a total deficiency for the year of 124 million cubic feet, without considering evaporation, etc.

20. The proposed location of a new mill of large capacity, as shown on the plans, is in a ravine immediately below the mine. The advantages of this location are evident. Ore can be sent direct to the mill by gravity, with a short haul. A very high head of water can be secured, and transport for produce easier. A possible advantage is its location out of the line of discharge from the country above, should any of the storage dams go out.

As shown by the map, a mill could be constructed with a water wheel at elevation about 20.0 feet above datum. As previously shown, the elevation of the surface of the storage reservoir at Menzie's already proposed, about 2 miles distant, is 185.0, a difference of 165 feet. This head of course could not all be utilized, as it is proposed to draw the storage of the Menzie reservoir down to elevation 172.0, and as about 18 feet head will be lost in bringing water down the valley, thus leaving an available head on the wheel of 134 feet. Fourteen cubic feet of water per second as is shown above appears to be the maximum which with close regulation can be depended upon as a supply from the areas. This amount of water with 134 feet head would provide 180 horsepower on the shaft for the new mill, running constantly.

PROPOSED WORKS FOR NEW MILL.

21. The proposition of securing such a large percentage of the total available supply from the areas and storing say 150

million cubic feet (124 million to be available), though quite feasible, will require the utmost attention to construction and regulation to ensure success. The sites for storage are four in number, as follows:

(1) Menzie Meadow. As before proposed, with a dam, however, 5 feet higher, at which level it is estimated 66 million cubic feet can be stored above elevation 172.0, of which, after deducting 20% for evaporation, etc., 53 million cubic feet should be available.

(2) Long Lake. As before proposed, at same elevation, and capacity, viz., 34 million cubic feet.

(3) Echo Lake. By means of a dam at the outlet of Echo Lake, 6 feet in height, 66 million cubic feet could be impounded in the 250 acres extent above the present level. Deducting from this the 20% for evaporation, etc., as before, there would be 53 million cubic feet available water.

(4) Perch Lake. A small storage reservoir can be made in this locality by the construction of a dam at the outlet to its waters. This dam at a height of not more than 10 feet will impound at least 24 million cubic feet, or say 20 million available, though it would not be necessary unless difficulty were found in filling the other reservoirs, or it might be built instead of raising the Menzie dam. It would also be found difficult to fill a dam at this point if water was also being impounded at Menzie's, as the 14 cubic feet flow to the mill must be maintained.

A small storage reservoir could also be made available at the Beaver Meadow, though it is a question if it would be wise or would pay, as the road would require to be moved east up the hill, at considerable expense.

No doubt difficulty will be found in securing the storage of these waters simultaneously, while at the same time maintaining the adequate supply to the mill. This can be arranged only by close regulation of the discharge through the different dams in the spring.

22. A small dam will be required at the western outlet of Summit Lake, so as to turn its waters eastward, also the eastern high water outlet improved and deepened through the marsh.

23. The means of getting the available water to the mill will require considerable work, and comprises the main part of the expense of the project.

Echo Lake lies nearly 200 feet above Long Lake, the brook outlet being very rapid, and falling into Round Lake some 23 feet below the level of Long Lake. Consequently to secure the waters of Echo Lake for power purposes, a conduit will be required from some point on this brook such that the water may be carried over to Long Lake. The proposed location of this is shown in the general plan, and is about 2,400 feet in length, following around the base of the hill which is more or less rocky. This will necessitate the construction of a small flume rather than of a ditch, although part of it might be ditched. A ditch or flume of about 2.5 square feet wet cross section should be sufficient with the grades. The water may be caught at the Echo Lake Brook by a small log dam at the outlet of the lake above. The construction of the latter dam is recommended at least a year before its water will be required.

The Menzie dam being the lowest point on the storage areas, should be specially arranged with regulating gates, easily operated. Irrespective of the level of the water in this reservoir its discharge should at all times be delivered to the head bay immediately below the dam at an elevation of 172.0 so as to provide the drawing out of all the water above the dam. From this point to the proposed forebay above the mill is about 9,400 feet, following the course of the proposed flume and ditch line as shown on the contour plan. This conduit is proposed at a grade throughout of about 0.20% or 1 foot in 500, with a wet cross section of about 6 square feet; in ditch, in earth and gravel the water would be about 18 inches deep, the bottom width 2 feet and slopes 1 to 1½, while in flume the width could be 3 feet and depth of water 18 inches. These dimensions would discharge 14 cubic feet per second at the mill.

There are at least two points where the water will require to be carried by flume, viz., at Robilliard Creek, and at the ravine to the east. There will be other points also where it may be cheaper to flume than blast rock. It may be assumed that of the 9,400 feet total length, 1,200 feet would be flume.

Under this plan the waters of the Robilliard area will require collecting at a point above the flume line, and to be led by a small ditch or flume to the main line. This could discharge constantly.

The proposed ditch line will intercept all water coming to it from the hills to the north, but cannot secure water coming to the present creek bed from the south. This water would be but little, but could be caught at the present mill dam and might be utilized in some manner.

When this ditch is cut through sandy or loose soil, or in loose rock, it should be lined with clay or clayey gravel to make it tight. Difficulty will no doubt arise in any case for the first year or so by this absorption and loss by leakage, but as the ditch gets silted up this will disappear.

24. The works at the forebay on the side hill above the mill should be of sufficient size and capacity to regulate the flow of water through the penstock, deliver the surplus over a spillway, take care of ice, brush, leaves, etc. The penstock to the mill should be 24 inches diameter steel pipe riveted, and should be anchored down the slope to the mill.

A difficulty arises in regulation of the water supply to the penstock at the forebay. The supply coming down the ditch must necessarily be constant unless partially shut down for more than a few hours, consequently provision must be made for the spillway of surplus water. This can be done either at the forebay or at the mill. If at the mill its value is lost unless it can be utilized at periods when it is discharged as surplus. It is recommended then to provide a small reservoir in the ravine above the mill, providing a head of say 60 to 80 feet, into which surplus water of a few hours shut down or slack discharge can be spilled. This can be done by a small dam at slight cost. The water from this can be carried down to the mill and utilized for the washing processes and other work, perhaps to run the lighting.

The power at the mill can be developed by an impulse wheel, such as either the Cascade, Pelton or American Impulse, with two or more nozzles, upon the number of which the size will depend.

The tail water can be disposed of without difficulty as there is a good fall to the York River.

25. The following is a recapitulation of the proposition for the new mill:

Water provided—14 cubic feet per second.

Available water stored—140 million cubic feet.

Working head—134 feet.

Available on shaft—180 horsepower.

FINAL.

26. It has been found that as the timber is cut off and the country cleared near the sources of streams, the yield of water decreases. This affects the run-off as the evaporation is more likely to increase. In the present instance, however, it is not expected that the general conclusions would be affected, as the district cannot be said to be heavily wooded, and the water coming down more readily in the spring would be caught by the dams.

27. The advantage of having the mill near the present deposit of ore, which is the best of those owned by the company, is considerable, and if a new mill of large capacity were built in the proposed location, no risk will be run with regard to the power. If some years hence it were found that the available water collected from all sources failed to a serious degree by climate changes in rainfall, or by the clearing of land, power can be obtained by electric transmission from sources elsewhere.

The writer understands that a considerable power is available at Palmer's Rapids, on the Madawaska, 6 miles below the mill, and that other powers now owned by the company exist 20 miles up the York River, distances which are quite feasible for electric transmission. These powers will no doubt be developed in the near future in any case, for other purposes, such as for mining and electric railway, which is already talked of in the locality to connect with railroads to the south.

which
write
portio
south
son's
Canad
preclu
paper
discus
as bri
its nat
R
like a
to the
from
of this
extend
Arable
to the
River
which
limit o
area, p
tamara
and D
TH
bank o
the Nip
and tw
6

SOME NOTES ON GREATER ONTARIO.

E. V. NEELANDS, '00.

In attempting a description of the vast country to our north, which has been not inaptly termed "Our Northern Heritage," the writer proposes to confine himself exclusively to the more unknown portion, north of the "Great Divide," between the waters flowing south to the St. Lawrence system, and those draining into Hudson's Bay, whose southern boundary is roughly determined by the Canadian Pacific Railway. The enormous extent of this territory precludes anything in the nature of a thorough investigation in a paper of this character, and necessitates a statement rather than a discussion of the facts. I will, therefore, endeavour to present in as brief and concise a manner as possible, an account of the district, its nature and resources.

Regarding the region from a geographical standpoint it may, like ancient Gaul, be divided into three parts. Roughly parallel to the C. P. R., a rocky belt traverses almost the entire district from the Ottawa river to the Manitoba boundary. To the north of this in the eastern portion, a clay area, in shape, a rough triangle, extends from Temiscamingue and Abitibi to the Missanabie river. Arable land also occurs in the valley of the Kaministiquia river to the west of Thunder Bay, and in several parts of the Rainy River District. From the northern boundary of the clay land, which in the Moose river basin coincides roughly with the northern limit of the Archean rocks, to the bay, lies an enormous swamp area, practically devoid of timber except small scrubby spruce and tamarac, and underlaid by palæozoic rocks of Upper Silurian and Devonian age.

The northern boundary of the rocky belt follows the eastern bank of the Montreal river from Lake Temiscamingue, and crosses the Nipissing-Algoma boundary line at a point about one hundred and twenty-four miles north of the C. P. R. It then is roughly

traced by Niven's Base Line Lat. $48^{\circ} 27' 54''$ to the Missanabie river. Here it bends to the north and areas of clay occur on the Ka-hina Kagami and Kenogami rivers to the west, whose southern limits probably represent its continuation. Farther to the westward rocky country generally prevails to the Rainy River District. Rocky areas also occur farther north in some parts, the most important being a ridge of considerable elevation forming the Height of Land between the Abitibi and the water flowing south to the Quinze. The principal formations in this district are the Laurentian and Huronian, widely spread throughout the whole region and consisting mainly of gneisses and green schists, and the Animikie or Nipigon series in the vicinity of Thunder Bay. Cambrian rocks occur to the north-west of Sudbury, and a small area of Niagara Limestones and Dolomites is found to the north of Lake Temiscamingue and on some islands in the same lake.

It is in this region that the economic minerals, and to a large extent the timber of Greater Ontario are to be found. Valuable finds of iron, nickel, copper, zinc, gold and silver, all of which are mined farther south, are reported from the northern portion of the district, but as little or no work has been done up to the present time nothing very definite as to the extent of the deposits can be said except that the most promising surface showings occur in many parts.

The timber of the district is a less doubtful quantity. White and red pine occur up to Lake Abitibi in the east, but nowhere else east of Lake Superior is it found so far north. In the Rainy River District it is abundant in the south, and is found sparingly as far north as Lac Seul. Banksian or jack pine, white and black spruce and tamarac, poplar, balm of gilead, white and red birch and cedar occur everywhere throughout the district, jack pine being usually found on the sandy ground, spruce and tamarac in wetter country, and the others along the banks of rivers. Fire has played great havoc in the timber of this district, especially in those parts adjacent to the railway, and unless the trees are protected by nature in some way they are usually burned before maturity.

The northern limit of the clay belt cannot be well defined, as it is impossible to draw a sharp line of demarcation. Good land is

foun
Alge
Fart
neigh
vatio

potat
Ever
Com
Exce
cerea
supp
be cu
same
ripen
early
mont
perat
sum
from
and
whic
was a

being
gilea
six in
The
the s
have
lake
knott

and f
of th
a few
surfa

found generally as far north as Lat. $49^{\circ} 15'$, on the Nipissing-Algoma line, beyond which it gradually merges into muskeg. Farther north small areas of arable land occur, usually in the neighbourhood of rivers, but generally the country is unfit for cultivation.

Everywhere in this district the common garden vegetables, potatoes, cabbages, cauliflowers, etc., mature without difficulty. Every Hudson's Bay Post has its garden, and the officers of the Company raise with little trouble such green stuffs as they require. Except in the Temiscamingue and the Rainy River Districts, cereals have not been seriously attempted, but there is no reason to suppose that in the southern parts of the country they could not be cultivated with as much success as in districts to the west in the same latitude. Barley has been grown at Moose Factory, but its ripening cannot be depended on as severe frosts frequently occur early in the autumn and sometimes even during the summer months. Farther south the crops would be much safer, as low temperatures are the exception rather than the rule. In the past summer the thermometer did not fall below the freezing point from June 1st to Sept. 8th in the region north of Lake Superior, and I was informed by the officer in charge of Long Lake House, which is situated about eighty miles north of Jackfish Bay, that it was a fair average summer as far as the temperature was concerned.

The timber in this region is similar to that further south, being mainly spruce, tamarac, jack pine, poplar, birch, balm of gilead and balsam. The trees sometimes attain a diameter of thirty-six inches but the average of the larger sort is not above fifteen. The country has been burned everywhere except near water and the second growth is very thick, so that the majority of the trees have not an opportunity to mature. Along the rivers and on the lake shores the timber is larger but has a tendency to be very knotty and twisted.

North of the clay region the country becomes more swampy and finally merges into open muskeg, often as bare as the prairies of the west for many miles, the only break in the landscape being a few clumps or ridges of small stunted spruce and tamarac. The surface of the country is covered with moss many feet thick, which

often stretches across large areas of water, lying on its surface like a blanket and quivering under every footstep. Dry land seldom occurs except in the immediate neighborhood of running water, where clay banks rise up like dykes and separate the rivers from the swamp. On these banks the only large timber is found, usually in a belt not over a few chains in width and frequently even less. In many cases, where the river banks are upwards of thirty feet above the water, open muskeg occurs within a hundred yards of the stream.

In the spring the rivers, whose water volumes are subject to enormous variations, often overflow the banks, and during the dry season the extreme flatness of the country prevents an adequate drainage. This, in addition to the water formed by the snow melting over such large areas, largely accounts for the swampy nature of the country.

The character of the rivers alters greatly immediately upon entering this region. In the south they are usually swift flowing streams with abrupt descents over ledges of rocks, but in the great muskeg district they cut wide channels for themselves, since the erosion of the soft banks is much more rapid than that of the bottom—which is usually flat-lying limestone strata. As a result the great rivers entering James' Bay have strong heavy currents and are wide but very shallow. The Moose at the mouth is about two miles in width, but the depth is seldom greater than a few feet; and the Abitibi can be crossed on foot in places where its width exceeds half a mile. No portages occur on the Abitibi for about 50 miles from its junction with the Moose, and the navigation of the Moose is uninterrupted for considerably over a hundred miles, and that of the Albany for over two hundred. Numerous smaller streams show similar characteristics, which demonstrates the flatness of the whole region. These rivers are all very sensitive with regard to water volume. Nominally the streams flow over flat-lying rocks and have sloping banks covered with alders and "blue joint," crowning the banks are fringes of timber, which mark the high water level, usually many feet above the stream in the autumn. At New Port, about one hundred miles up the Abitibi, accurate measurements showed the spring level of the water to be thirty feet above the river in September.

gypsu
on th
Miss
smith
also
not e
of lig
may
coal f

It is
peat
wild,
from
of Gr
and e
Moose

throu
factor
opene
than
tically
desce
can b

I
the m
showi
1878

The only minerals of economic importance in the district are gypsum and lignite coal. The former occurs in large quantities on the French river, a tributary of the Moose, and also on the Missanabie, and a bed of the latter crosses the Abitibi at the Blacksmith's Rapids about thirty miles above the Moose. Lignite also exists on Coal river, a tributary of the Missanabie. Though not extensive these deposits are important as proving the existence of lignite in the region, and it is possible that future exploration may reveal large quantities of this mineral. An analysis of the coal from the Abitibi deposit, by W. A. Parks, Ph. D., gave:

Fixed carbon, 50.408 p. c.

Volatile matter, 38.63 p. c.

Moisture, 8.016 p. c.

Ash, 2.945 p. c.

Heating power, 6995 cal.

Perhaps this region is most important as a source of peat. It is claimed that the moss of the muskegs when decomposed forms peat of an excellent quality, and if this is the case the value of our wild, useless swamp lands is inestimable. The muskegs of value from this standpoint are very widely spread throughout the whole of Greater Ontario. Large areas occur in the Rainy River District and eastward to the great muskeg region in the basins of the Lower Moose and Albany rivers.

It seems probable that the water power now being wasted throughout the whole of Greater Ontario will be a very potent factor in commercial industries of all kinds when the country is opened up. Few countries are better supplied with natural power than this district. The number of rivers of large size with practically an unlimited water supply, and having usually very abrupt descents is sufficient in itself to guarantee that abundant power can be developed to supply all the needs of the country.

In conclusion is appended a list of what may be regarded as the more important resources of the country, and also a table showing the mean monthly temperatures at Moose Factory during 1878 and 1879.

MINERALS.

- Coal.—Deposits of Lignite on Coal and Abitibi rivers.
- Gold.—Found on Sturgeon Lake, Lake Seul, Lake Minnetakie and other points in the Rainy River District. Along the north shore of Lake Superior and in parts of southern Algoma and Nipissing.
- Silver.—Found at several points along the north shore of Lake Superior.
- Iron.—North shore of Lake Superior and in parts of the Rainy River District and in southern Algoma and Nipissing.
- Copper.—Same localities as iron.
- Graphite.—Found in some districts north of Lake Superior.
- Zinc.—North of Lake Superior.
- Nickel.—Reported in districts north of Sudbury.
- Anthraxolite.—Found in districts north of Sudbury.

TIMBER.

- White Pine.—North of the Temagamingue country, and about the head waters of the Mattagami, also in the Rainy River District.
- Red Pine.—Same as white pine.
- Black Spruce.—Very common throughout the whole district.
- White Spruce.—Found everywhere but less common than black spruce.
- Banksian or Jack Pine.—Common everywhere on the more sandy soil.
- Tamarac.—Common throughout the whole district especially in swampy parts.
- Poplar.—Common on clay land and near water.
- Balm of Gilead.—Same as poplar.
- Birch.—Common throughout the whole district, found in same localities as poplar.
- Balsam.—Common on clay land and near water.
- Cedar.—Occurs throughout district, generally in swamps or near water.

Whit
Blac
Blac
Polar
Moos
Woo
Beav
Fox-
Otter
Mart
Mink
Fishe
Weas
Musk
Whit
Lake
Sturg
Brook
Pike.
Picke
Suck
Whit
Duck
Geese
Partr
Prair

White Elm.—Found sparingly in Rainy River District and in the more southern parts.

Black Ash.—Occurs occasionally in the south and is of small size.

FUR AND GAME.

Black Bear.—Common in certain localities.

Polar Bear.—Occasionally seen about Moose Factory.

Moose.—Common in the more southern parts and in the Rainy River District, rare north of Lake Superior.

Woodland Cariboo.—Common in most parts except in the wetter muskegs.

Beaver.—Common in most parts.

Fox.—Common throughout the district.

Otter.—Common in most districts.

Marten.—Common in most districts.

Mink.—Common in most districts.

Fisher.—Common in most districts.

Weasel.—Common in most districts.

Musk-rat.—Common in most districts.

White Whale.—James Bay.

Lake Trout.—Common in larger lakes.

Sturgeon.—Found in some of the larger lakes and rivers.

Brook.—Common in many streams.

Pike.—Very common, found in nearly all lakes and rivers.

Pickerel.—Common.

Sucker.—Common everywhere.

White Fish.—Found in many lakes and streams.

Ducks.—Many varieties found everywhere in the district.

Geese.—Common in the district though only in the spring and fall.

Partridge, Grey and Spruce.—Common everywhere.

Prairie Chicken.—Common in parts of the Rainy River District, and said to be coming east along the burnt land about the C. P. R.

Table showing mean monthly temperatures at Moose Factory.

Months.	Temperatures Fahrenheit 1878, 1879.	
January	- 1.07°	- 3.92
February	13.71°	- 6.72
March	20.39°	12.08
April	35.59°	24.19
May	47.32°	39.95
June	57.04°	50.24
July	66.91°	60.26
August	62.99°	57.78
September	51.66°	48.98
October	40.94°	45.14
November	26.48°	20.80
December	7.57°	- 11.20

THI
T
first-c
Engin
intere
M
order
I
and b
cross
replac
T
long, a
width
tion fi
the sw
specifi
C
track,
U
R
with 1
centre
apart.
S
R
alterna
boiled
M
steel;

Factory.

renheit

3.92

3.72

2.08

4.19

9.95

0.24

0.26

7.78

8.98

5.14

0.80

1.20

THE MADISON DRAW BRIDGE AT PORTLAND, OREGON.

BY H. G. TYRELL, C.E., '86,

Designing Engineer for Boston Bridge Works.

The following bridge work is believed to be a typical case of first-class American Draw Bridge practice, and it is offered to the Engineering Society with the hope that it may be useful and interesting.

My calculations and strain sheets are given in full in the order that they were made.

In October, 1899, the City of Portland advertised for designs and bids for a highway and double track street railway bridge to cross the Willawette River at Madison Street, the bridge to replace the wooden one then in place.

The new bridge to consist of one steel swing span 316 feet long, and a width of 25 feet centre to centre of trusses, and a total width out to out of hand rail of 40 feet, and seven Pratt combination fixed spans of 190 feet in length each, and the same width as the swing span. The whole to be designed according to Thatcher's specification of 1894, with the following conditions:

Concentrated Live Load—2 electric cars coupled, on each track, weighing 20 tons each, or 15 ton road roller.

Uniform Live Load—100 pounds per square foot all over.

Roadway Floor—5-in. wood paving block on 3-in. plank, laid with $\frac{1}{2}$ -in. open joints, on 6 x 8 joist laid cross-wise of bridge $2\frac{1}{2}$ -ft. centres. All the above supported on steel stringers about 5-ft. apart.

Sidewalk Floor—2-in. plank on wood joist.

Roadway will be crowned 3 ins., and have cast scuppers in alternate panels on each side. Wood paving blocks 4 in. x 8 in. x 4 in. boiled in asphalt.

Material—Lateral rods, iron; drum and loading beams, soft steel; balance, medium steel.

Unit Stresses—Tension Only.

Chords, Ties, Counters, and Long Suspenders—

Wrought Iron.	Soft Steel.	Medium Steel.
$9400 \left\{ 1 + \frac{\text{Min.}}{\text{Max.}} \right\}$	$10800 \left\{ 1 + \frac{\text{Min.}}{\text{Max.}} \right\}$	$11700 \left\{ 1 + \frac{\text{Min.}}{\text{Max.}} \right\}$

Plates and Shapes—

$8500 \left\{ 1 + \frac{\text{Min.}}{\text{Max.}} \right\}$	$9700 \left\{ 1 + \frac{\text{Min.}}{\text{Max.}} \right\}$	$10500 \left\{ 1 + \frac{\text{Min.}}{\text{Max.}} \right\}$
---	---	--

Tension Flanges of Built Beams Girders, Same Gross Area as
Compression Flanges.

Floor Beam Hangers through pin holes—

	Wrought Iron.	Soft Steel.	Medium Steel.
	6800	7800	8400
Lateral Rods	20000	23000	25000

Compression Only.

Flat Ends	$10750 - 399 \frac{l}{r}$	$12500 - 500 \frac{l}{r}$	$13750 - 577 \frac{l}{r}$
One flat & one pin	$10750 - 444 \frac{l}{r}$	$12500 - 556 \frac{l}{r}$	$13750 - 642 \frac{l}{r}$
Pin Ends	$10750 - 489 \frac{l}{r}$	$12500 - 612 \frac{l}{r}$	$13750 - 707 \frac{l}{r}$

Lateral Struts, add 25% to above units for pin ends.

l = length of member in feet.

r = least radius of gyration in inches.

For top chords the stresses per square inch due to weight of member will be deducted from the above unit stresses.

The reduction for chords flat at one end being one-half, and for chords flat at both ends, one-third of the amount for members with pin ends.

No allowance will be made for wind stress combined with stress from dead and live load, unless the combined stress exceeds by 50 per cent. the stress from dead and live load only, in which case the combined stress will be used with a unit stress 50 per cent. greater than above given.

Girders.

In the compressed flanges of beams and girders, the allowed stress per square inch shall not exceed—

	Wrought Iron.	Soft Steel.	Medium Steel.
For riveted girders,	9400	10800	11700
	$1 + .0288 \frac{l^2}{b^2}$	$1 + .0288 \frac{l^2}{b^2}$	$1 + .0288 \frac{l^2}{b^2}$
For rolled beams,	10000	11500	12500
	$1 + .0288 \frac{l^2}{b^2}$	$1 + .0288 \frac{l^2}{b^2}$	$1 + .0288 \frac{l^2}{b^2}$

l = unsupported length in feet.

b = width of flange in inches.

Floor beams and stringers will be considered unsupported between end bearing.

Alternate Tension and Compression.

For the greater stress—

$$9400 \left\{ 1 - \frac{\text{max. less}}{2 \times \text{max. greater}} \right\} \quad 10800 \left\{ 1 - \frac{\text{max. less}}{2 \text{ max. greater}} \right\}$$

$$11700 \left\{ 1 - \frac{\text{max. less}}{2 \text{ max. greater}} \right\}$$

For compression only use compression formula.

Use the one giving the greatest area of section.

Combined Stress.

A member subject to transverse stress in addition to the tension or compression due to its position shall be considered as a beam of one panel length supported at the ends, for section in centre of panel, and fixed at ends, for sections at ends of panel. The member will be proportioned to sustain the algebraic sum of the stresses resulting from direct compression or tension and the transverse loading in which the allowed stress per square inch will not exceed—

	Wro't Iron	Soft Steel	Med. Steel.
At centre of panel	10000	11500	12500
At end of panel	12500	14400	15000
On pins and rivets shearing	9000	10000	11000
On webs of girder	6000	7000	7500
Diam. of pins and rivets bearing.....	15000	17000	19000
Extreme fibre of pins bending	20000	23000	25000

Field rivets will have 25 per cent. excess section over the above requirements.

Timber.

Fibre stress 1200 pounds per square inch.

Flat ends	1075 - 112 $\frac{l}{d}$
One flat and one pin	1075 - 125 $\frac{l}{d}$
Pin ends	1075 - 138 $\frac{l}{d}$

l=length of member in feet.

d=least diameter in inches.

Shearing—Sliding the grain = 130 pounds per square inch.

Direction of " = 1200 " "

Perpendicular " = 300 " "

Wind Bracing—Bottom lateral bracing will be proportioned to resist a uniformly distributed moving force of 300 lbs. per lineal foot.

Top lateral bracing to resist a uniformly distributed moving force of 150 pounds per lineal foot.

Track Stringer.

Steel, 21 feet long, about 5 feet apart.

$$M \text{ uniform live} = \frac{5 \times 21.1^2 \times 100}{8} = 25326 \text{ foot pounds.}$$

$$M \text{ from road roller} = 5456 \times 8 = 43648 \text{ foot pounds.}$$

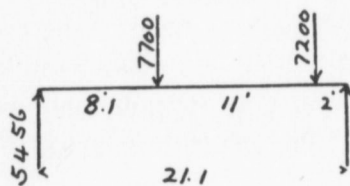

FIG I

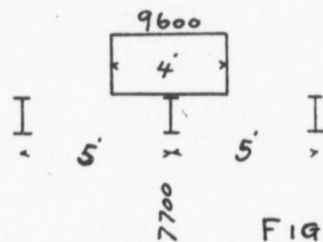

FIG 2

For dead moment, assume weights as follows :

4-in. paving @ 5 lbs. = 20 lbs.

3-in. plank @ 3½ " = 10.1 " ½-in. open joints.

Rails..... 4. "

Steel..... 9.

6 x 8 cross joist 2½ ft. c to c. 5.6 "

48.7 " per sq. ft.

Then M dead = $\frac{48.7 \times 5 \times 21.1^2}{8} = 13551$ ft. lbs.

M live 43648 "

M total = 57199 "

Try riveted stringer—21 ft. long, unsupported sideways 4 angle's $5 \times 3 \times \frac{5}{16}$ 1 Pl.

Allowable stress per square inch = $\frac{11700}{1 + .0288 \frac{l^2}{d^2}} = 10430$

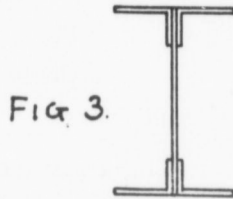

Required depth of web = $\frac{57199 \times 12}{10430 \times 4.8} = 13.71$

Distance back to back = $13.71 \div 2 (.68) = 15.07$ inch.

Weight per lineal ft. = 45.55 lbs.

Try beam stringer, 21 ft. long, unsupported sideways, floor support not considered.

Allowable stress per sq. in. = $\frac{12500}{1 + .0288 \frac{l^2}{d^2}} = 8800$ lbs.

Required S = $\frac{57199 \times 12}{8800} = 78$. S for 18 in. I @ 55 lbs. = 88.

Try beam stringer braced sideways, 10 ft. between supports. Allowable stress per square inch = 11400 lbs.

Required S = $\frac{57199 \times 12}{11400} = 60.2$ 15 in. I. @ 45 lbs. will do.

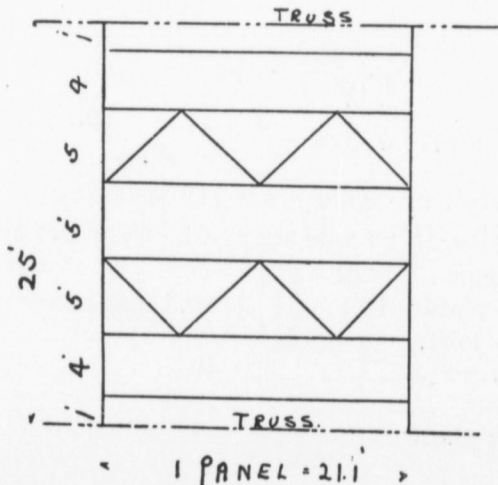

FIG 4.

Weight of stringer bracing for 2 beams:

4 angles $2\frac{1}{2} \times 2\frac{1}{2} \times \frac{1}{4} \times 7$	112 lbs.
5 pls. $8 \times \frac{1}{4} \times 1$ ft. - 3 ins.	40 "
5 angles $2\frac{1}{2} \times 2\frac{1}{2} \times \frac{1}{4} \times 1$ ft. - 3 ins.	25 "
60 rivets	20 "
	197 "

For 1 beam = 98.5 lbs. = 4.7 lbs. per ft.

Beam.....	45.0	"	"
Total.....	49.7	"	"

Comparative economy of 3 stringers:

Built stringer, 45.55 lbs. @ .0267c. per lb.	= 1.2282c.	
18 in. I @ 55 lbs. @ .0247c. per lb.	= 1.3585c.	
15 in. I @ 45 lbs. @ .0237c. "	= 1.0665c.	} Use this.
Bracing 4.7 lbs. @ .0275c. "	= .1292c.	
	1.1957c	

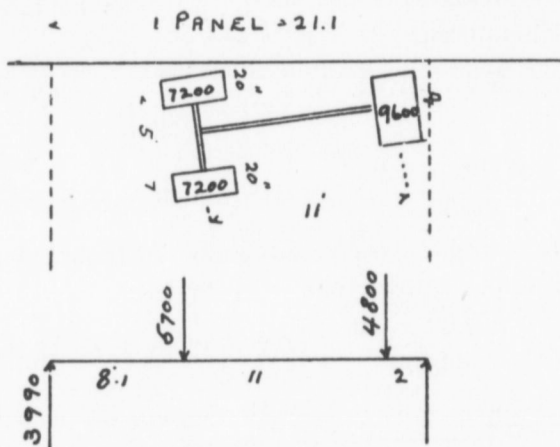

FIG 5.

Side stringer. M uniform live = $\frac{3 \times 21.1^2 \times 100}{8} = 16530$ ft. lbs.

M from road roller = $3990 \times 8 = 31920$ ft. lbs.

Dead load per lin. ft. on side stringer. (See section.)

Paving, $20 \times 2\frac{1}{4}$	} = 80.3 lbs.
3-in. plank, $10.1 \times 2\frac{1}{4}$	
6 x 8 joist, $5.6 \times 2\frac{1}{4}$	
Steel.....	40. "
Guard	10.5 "
Walk plank	7. "
	137.8 "

Then M dead = $\frac{137.8 \times 21.1^2}{8} = 7668$ ft. lbs.

M live..... = 31920 "

M total = 39588 "

Required S.

Unsupported 21 ft. $\frac{39588 \times 12}{8800} = 54$.

15 in. I @ 42 lbs. has S = 58.9 which use.

Walk stringer 2 ft. apart.

Load, live..... = 100 lbs. per sq. ft.

dead 15 " "

Total 115 " "

Total load on stringer = $115 \times 2 \times 21 = 4830$ lbs., use 4 x 14.

For outside stringer with half load, use 3 x 14.

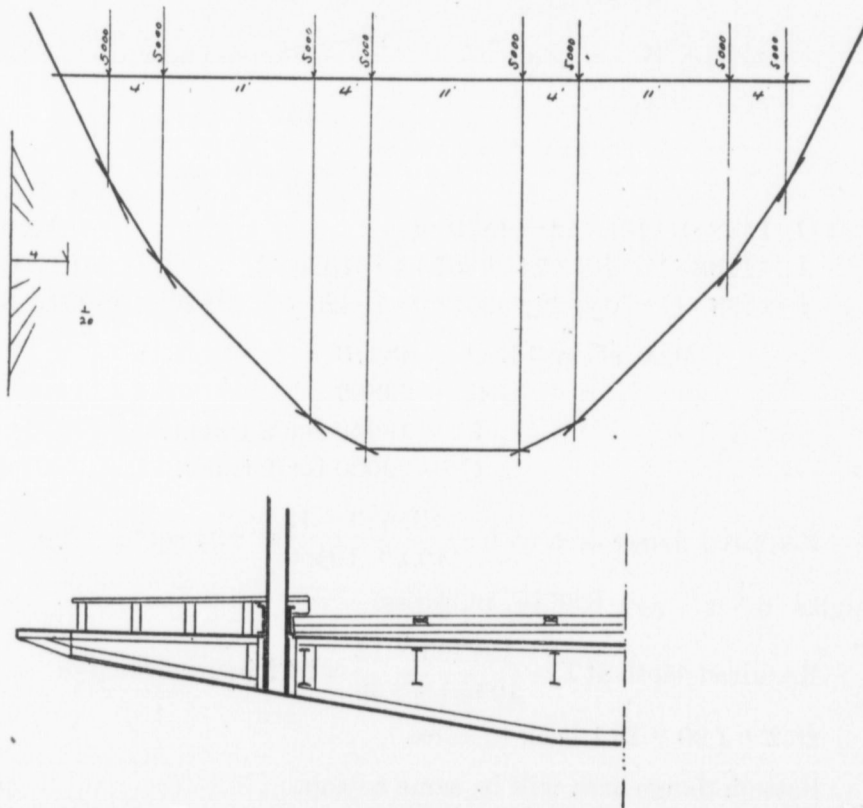
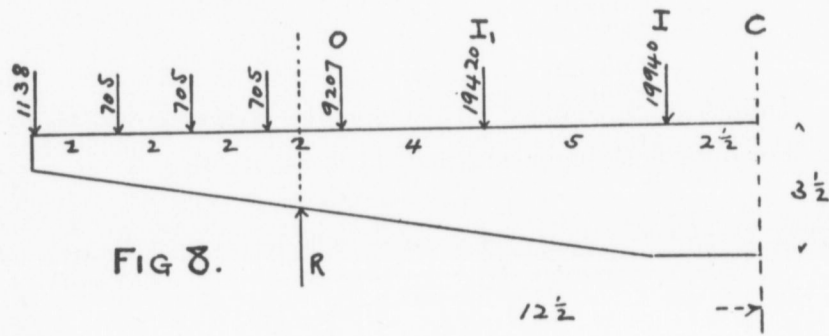
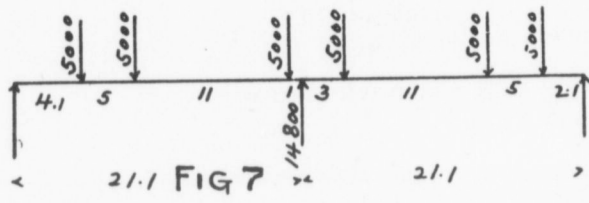

FIG 6.

Floor Beam.

Dead load at I' = $4\frac{1}{2} \times 48.7 \times 21.1 = 4621$ lbs.

" I = $5 \times 48.7 \times 21.1 = 5137$ "



ft. lbs.

M at O = $1138 \times 8 + 705 \times 12 - 51820 \times 1 = 34260$

" I₁ = $1138 \times 12 + 705 \times 24 + 9207 \times 4 - 51820 \times 5 = 191700$

" I = $1138 \times 17 + 705 \times 39 + 9207 \times 9 + 19420 \times 5 - 51820 \times 10 = 291413$

Max. shear—R O = 48570
 O I₁ = 39360
 I₁ I = 19940 for 2 tracks.
 I₁ C = 9000 for 1 track.

Required flange area at I = $\frac{291413 \times 12}{40.1 \times 10450} = 8.34$ sq. in. Use 2

Angles $6 \times 4 \times \frac{7}{16} = 8.36$ sq. in. gross.

Required depth at I₁ = $\frac{191700 \times 12}{10450 \times 8.36} = 26.2$ inches effective.

$26.2 + 1.90 = 28.1$ back to back.

Bottom flange area will be same as top.

700
 2300
 Portland
 42 5x3 1/2

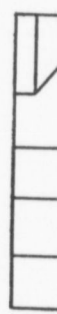

Walk Bracket.

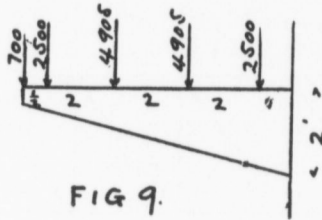

FIG 9.

$$M = 2500 \times 1 + 4905 \times 8 + 2500 \times 7 + 700 \times 7\frac{1}{2} = 64490 \text{ ft. lbs.}$$

$$\text{Flange stress} = \frac{64490}{1.8} = 35800 \text{ lbs.}$$

$$\text{Flange area required} = \frac{35800}{11400} = 3.14$$

square inches.

Use .4 angles $3\frac{1}{2} \times 2\frac{1}{2} \times \frac{5}{16}$, $\frac{1}{4}$ -in. web plate.

Top Laterals.

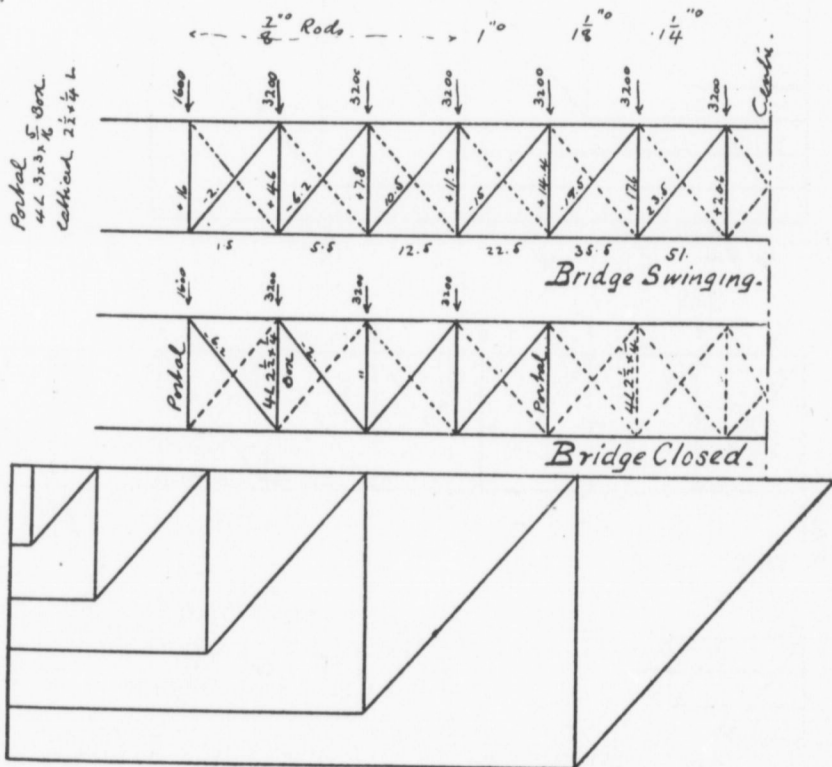

FIG 10.

C
3 1/2

ft. lbs.
= 34260
= 191700
0 = 291413

n. Use 2

ective.

Bottom Laterals.

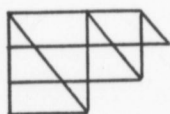
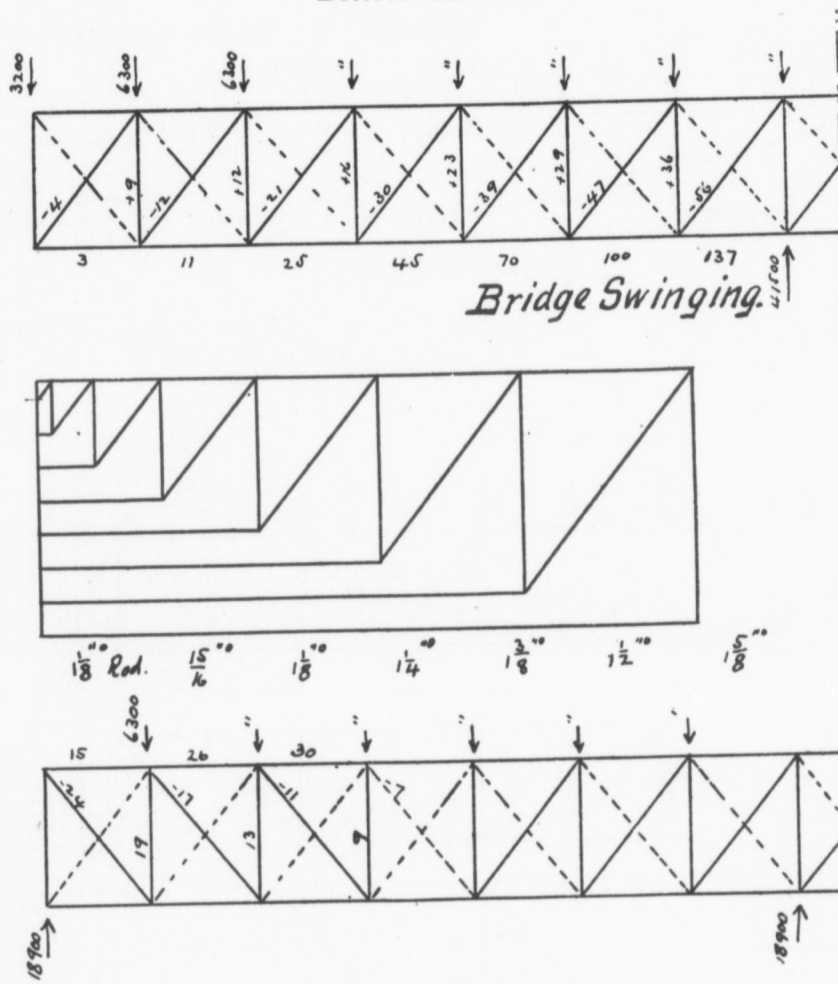

FIG 11.

Weight of Laterals (Half Span).

Upper—

6 rods	$\frac{7}{8}$ -in. x 35 ft. long	- - - -	420
2 "	1-in. x 35 "	- - - -	189
2 "	$1\frac{1}{8}$ -in. x 35 "	- - - -	238
3 "	$1\frac{1}{4}$ -in. x 35 "	- - - -	440
			—1287



Lower—

4 rods	$1\frac{1}{8}$ -in. x 35 ft. long	- - - -	476
2 "	$1\frac{5}{16}$ -in. x 35 "	- - - -	161
2 "	$1\frac{1}{4}$ -in. x 35 "	- - - -	294
2 "	$1\frac{3}{8}$ -in. x 35 "	- - - -	350
2 "	$1\frac{1}{2}$ -in. x 35 "	- - - -	420
3 "	$1\frac{5}{8}$ -in. x 35 "	- - - -	735
			—2436

Sways—

8 rods	1-in. x 26 ft. long	}	- - - - 1628
4 "	30 "		
4 "	32 "		
4 "	37 "		
8 "	$1\frac{1}{4}$ -in. x 35 "	- - - -	1176
			—2804

2 Portals—

8 angles	$3 \times 3 \times \frac{5}{16} \times 27$ ft.	- - - -	1317
24 angles	$2\frac{1}{2} \times 2\frac{1}{2} \times \frac{1}{4} \times 6$ ft.)	}	- - - - 885
24 "	" " " 3 ft.)		
	Details	- - - -	600
			—2802

4 Top Struts—

16 angles	$2\frac{1}{2} \times 2\frac{1}{2} \times \frac{1}{4} \times 25$ ft.	- - - -	1640
	Details	- - - -	680
			—2320

4 Portal Brackets—

8 angles	$3 \times 3 \times \frac{1}{4} \times 8$ ft	- - - -	320
8 angles	$2\frac{1}{2} \times 2\frac{1}{2} \times \frac{1}{4} \times 3$ ft.)	}	- - - - 160
4 "	" " " 4 ft.)		
	Details	- - - -	320
			— 800

6 Sway Struts—

24 angles	$2\frac{1}{2} \times 2\frac{1}{2} \times \frac{1}{4} \times 24$ ft.	- - - -	2361
	Details	- - - -	1020
			—3381



100 MADISON STREET DRAW BRIDGE AT PORTLAND, OREGON.

Dead weight per lineal foot of bridge—

Paving 23½ ft. wide 4 in. thick @ 5 lbs. =	- - -	470
3-in. plank 23½ ft. wide @ 3½ lbs. =	- - - - -	236
6 x 8 wood joist @ 3½ lbs. =	- - - - -	131
Rails, 80 less 28 paving	- - - - -	52
Walk plank, 17 ft. x 2 in. thick, ½-in. open joints,		114
2 guards, 6 x 6	- - - - -	21
6 joist, 4 x 14 on walk	- - - - -	98
2 " 3 x 14 "	- - - - -	24.5
Hand rail	- - - - -	60
Steel stringers	- - - - -	264
Floor beams	- - - - -	140.8
Lateral system	- - - - -	100.2
Stringer bracing	- - - - -	18.7
Trusses (assumed)	- - - - -	750.

Total dead weight per lineal ft. = 2479.

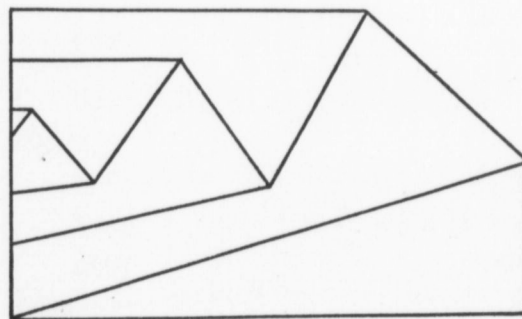
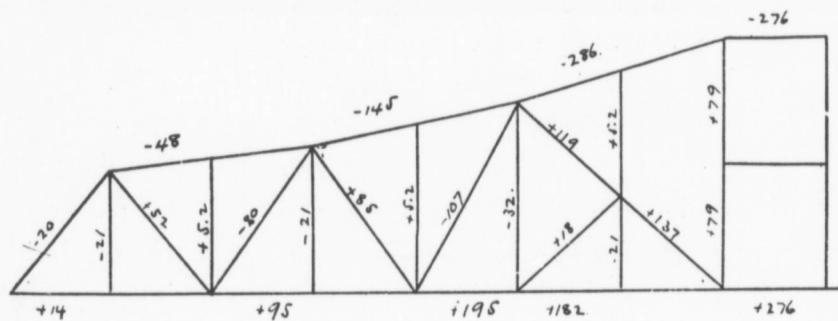
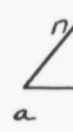

FIG 12

(1) De
(2) Li
(3) De
(4) Li
Case 1

Case 2

R1 =



102 MADISON STREET DRAW BRIDGE AT PORTLAND, OREGON.

Max. Reaction R1 :

Loads at b c d e f g	$2.293 \times 34800 = 79800$
c d e f g	$1.494 \times \text{"} = 52000$
d e f g	$.888 \times \text{"} = 30900$
e f g	$.461 \times \text{"} = 16000$
f g	$.191 \times \text{"} = 6650$
g	$.049 \times \text{"} = 1700$

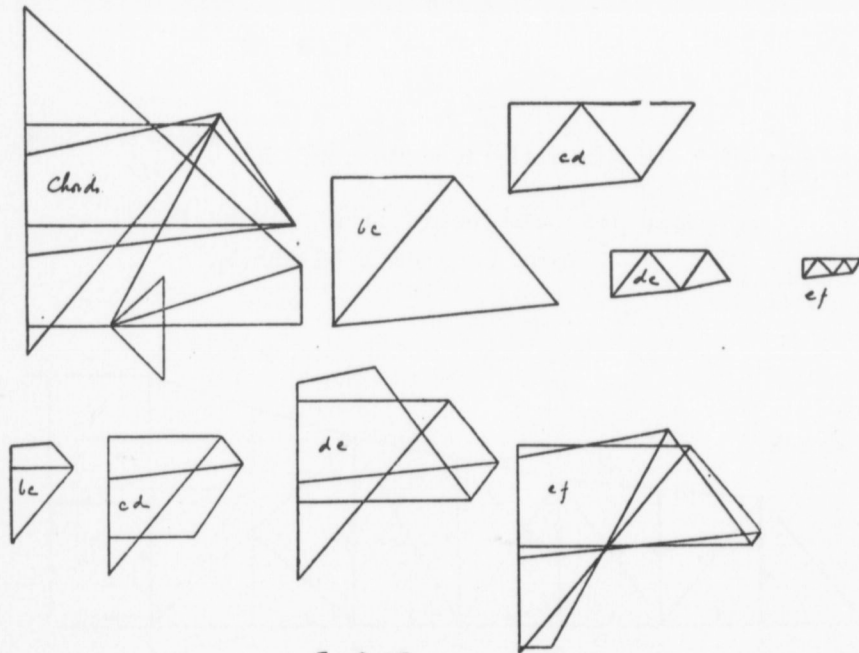
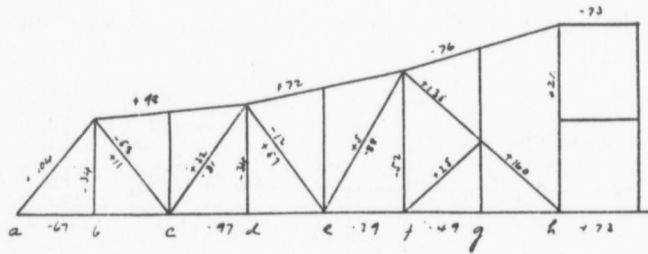

FIG 15.

Max. Reaction R1 :

Loads at b	.799 × 34800 = 27800
bc	1.405 × " = 48900
bcd	1.832 × " = 63700
bcde	2.112 × " = 73500
bcdef	2.244 × " = 78100
bcdefg	2.293 × " = 79890

Case 3.—Each arm single span. Dead load.

Dead load per foot of bridge = 2479 lbs.
 " " panel per truss = 26200 lbs.

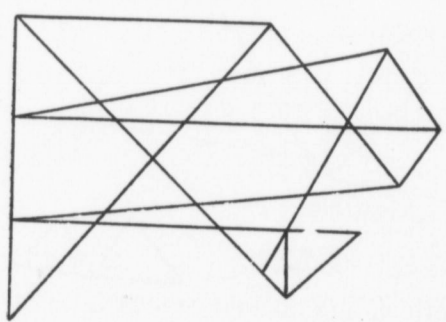
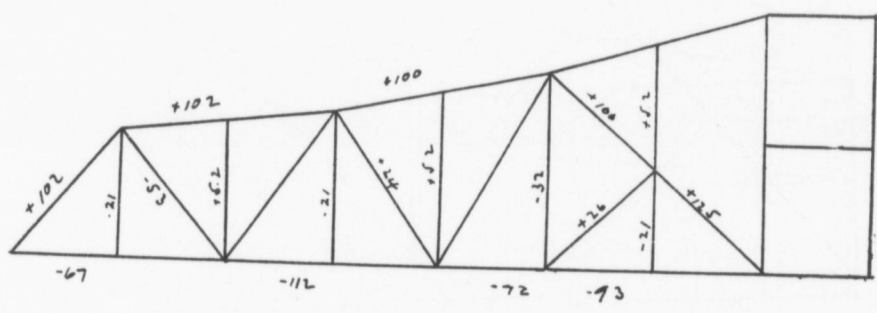

FIG 16.

cf

Case 4.—Each arm single span. Live load.

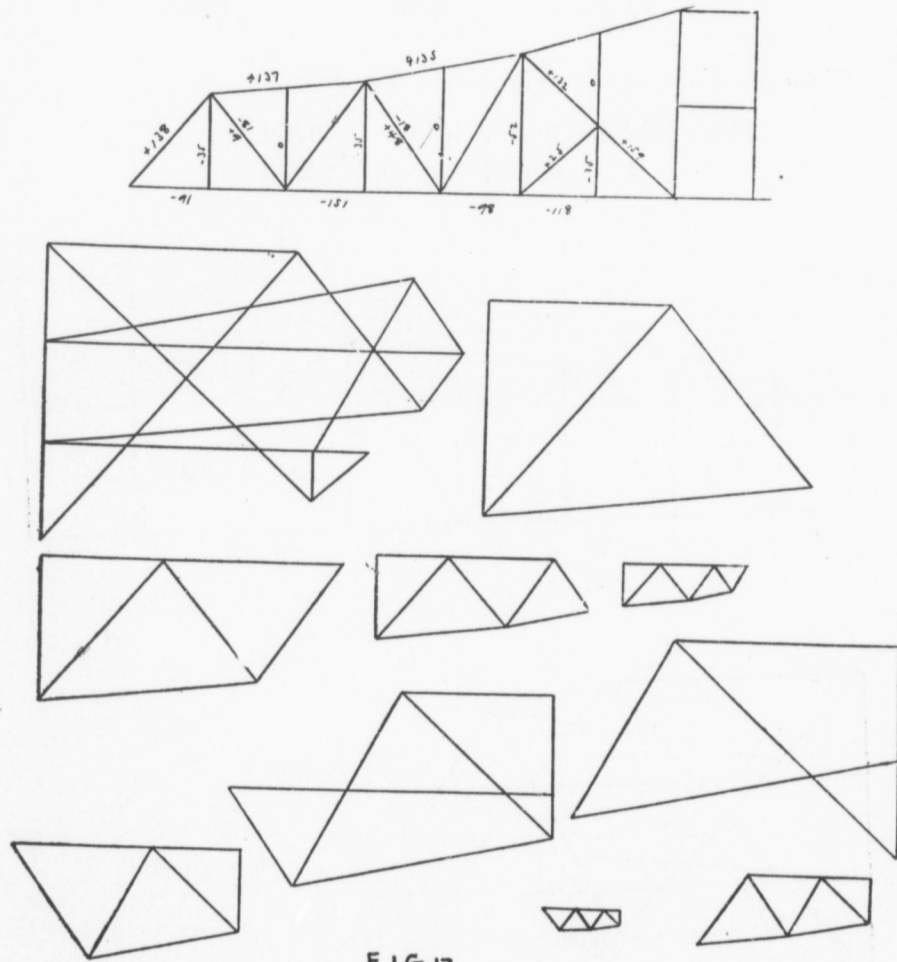

FIG 17

Member
1
2
3
4
5
6
7
8
9
10
10½
11
12
13
14
15
16
17
18
19
20
21
22
23
24
25
26
27
28
29
30
31

No. 1
F
S

TABLE OF STRESSES.

Member	Combine these.		Combine these.		Combined. Max. Stresses	
	Case 1.	Case 2.	Case 3.	Case 4.	+	-
1	+ 14	-- 67	-- 67	-- 91	14	158
2	+ 14	-- 67	-- 67	-- 91	14	158
3	+ 95	-- 97	-- 112	-- 151	95	263
4	+ 95	-- 97	-- 112	-- 151	95	263
5	+ 195	-- 29	-- 72	-- 98	195	170
6	+ 182	-- 49	-- 93	-- 118	182	211
7	+ 182	-- 49	-- 93	-- 118	182	211
8	+ 276	+ 73	o	o	349	
9	+ 79	+ 21	o	o	100	
10	+ 79	+ 21	o	o	100	
10½			o	o		
11	-276	-- 73	o	o		349
12	-286	-- 76	o	o		362
13	-286	-- 76	o	o		362
14	-145	+ 72	+ 100	+ 135	235	145
15	-145	+ 72	+ 100	+ 135	235	145
16	-- 48	+ 98	+ 102	+ 137	239	48
17	-- 48	+ 98	+ 102	+ 137	239	48
18	-- 20	+ 104	+ 102	+ 138	240	20
19	-- 21	-- 34	-- 21	-- 34	o	55
20	+ 52	-- 58	-- 53	+ 9	-- 81	63
21	+ 5.2	o	+ 5.2	o	5	134
22	-- 80	+ 32	+ 17	+ 51	-- 27	68
23	-- 21	-- 34	-- 21	-- 34	68	111
24	+ 85	+ 57	+ 24	+ 48	-- 18	55
25		o	+ 5.2	o	5	18
26	-107	+ 5	-- 88	-- 52	8	195
27	-- 32	-- 52	-- 42	-- 52	8	84
28	+ 119	+ 135	+ 100	+ 132	254	
29	+ 25	+ 25	+ 21	+ 25	50	
30	+ 5.2	o	+ 5.2	o	5	
31	-- 21	-- 34	-- 21	-- 34	5	55
31	+ 137	+ 160	+ 125	+ 159	297	

Proportioning Members.

No. 1 and 2 + 14000, - 158,000.

For alternate tension and compression unit =

$$11700 \left\{ \frac{\text{max. less}}{1 - 2 \text{ max. greater}} \right\} = 11200 \text{ lbs.}$$

From dead weight of member. } = $\frac{21 \times 50 \times 21 \times 12}{8 \times 42 \times 3} = 260.$
 Stress per sq. in. on outer fibre.)

106 MADISON STREET DRAW BRIDGE AT PORTLAND, OREGON.

Allowable unit = 11200 - 260 = 10940 lbs.

Required sectional area = $\frac{158000}{10940} = 14.4$ sq. in.

Use 2 channels 12 in. @ 25 lbs. = 14.7 sq. in. gross.

No. 3 and 4. Stresses are + 95000 and - 263000.

For alternate tension and compression unit = 9734

Less for dead weight 270

9464 lbs. per sq. in.

Required sectional area = $\frac{263000}{9464} = 27.7$ sq. in.

Use 2 channels 12 in. @ 30 lbs. = 18 sq. in. gross.

2 Pls. $11\frac{3}{4} \times \frac{3}{8}$ - - - - = 9 " "

Total - - 27 " "

No. 5. Stresses are + 195000 and - 170000.

For all compression unit is $13750 - 707\frac{1}{r}$, where $\frac{1}{r} = \frac{21}{4.2} = 5$.

Hence " " " = 10215 lbs.

From dead weight of member, stress per

sq. in. on outer fibre = $\frac{21 \times 90 \times 21 \times 12}{8 \times 52 \times 3} = 470$ "

Allowable for direct compression - - = 9745 " per sq. in.

For alternate tension and compression unit =

$11700 \left\{ 1 - \frac{16600}{2 \times 180000} \right\} = 6282$

From dead weight unit = 380

Total allowable unit - 5902

Required sectional area = $\frac{195000}{5902} = 33.1$ sq. in. gross.

Use 2 channels 12 in. @ 35 = 21 sq. in. gross.

2 plates $11\frac{3}{4} \times \frac{1}{2} = 12$ " "

33 " "

No. 6 and 7. Stresses are + 182000 and - 211000

For all compression unit = 10200

Less from dead weight 400

—————
9800

For alternate tension and compression unit =

$$11700 \left\{ 1 - \frac{165000}{2 \times 204000} \right\} = 6973 \text{ lbs.}$$

Less from dead weight 400 "

—————
6573 "

Required sectional area = $\frac{211000}{6573} = 32.1 \text{ sq. in.}$

Use 2 channels 12 @ 35 = 21 sq. in. gross.

2 plates 12 × $\frac{1}{2}$ 12.5 " "

—————
33.5 " "

Dead, live and wind for No. 6 + 282000 and - 281000

" " " " " " 7 + 319000 and - 311000

Unit for above = 6573 + (50% of 6573) = 9858

282000 ÷ 9858 = 28.6 sq. inches } both of which are less than

319000 ÷ 9858 = 32.4 " " } for dead and live only.

No. 8. Stress is 349000 lbs.

For all compression, 2 square ends, unit =

10800 lbs. per sq. in.

Less from dead weight = 400 " " " "

—————
10400 " " " "

Required sectional area = $\frac{349000}{10400} = 33.5 \text{ sq. in.}$

Use 2 channels 12 in. @ 35 lbs. = 21 sq. in.

2 plates 12 × $\frac{1}{2}$ " " 12 " "

Total - - 33 " "

No. 9. Stress is + 100000 lbs.

$$\frac{l}{r} = \frac{24}{3.5} = 7.1 \text{ Unit} = 13750 - 642 \frac{l}{r} = 9130 \text{ lbs.}$$

Required sectional area = $\frac{100000}{9130} = 10.6 \text{ sq. in.}$

Use 2 channels 10 @ 20 lbs. = 12 sq. in.

108 MADISON STREET DRAW BRIDGE AT PORTLAND, OREGON.

No. 10 is same as No. 9.

No. 10½ Stresses - 349000 and - 260000.

$$\text{Unit stress for all tension} = 11,700 \left\{ 1 + \frac{\text{min.}}{\text{max.}} \right\} =$$

$$11700 \left\{ 1 + \frac{260,000}{349,000} \right\} = 20830 \text{ lbs.}$$

$$\text{Required sectional area} = \frac{349000}{20830} = 16.6 \text{ sq. in.}$$

$$\text{Use 4 bars } 4\frac{3}{4} \times \frac{7}{8} \text{ in.} = 16.6 \text{ sq. in}$$

No. 11 and 12. Stresses are - 362000 and - 271000.

$$11700 \left\{ 1 + \frac{\text{min.}}{\text{max.}} \right\} = 20840$$

$$\text{Required area} = \frac{362000}{20840} = 17.3 \text{ sq. in.}$$

$$\text{Use 4 bars } 5 \times \frac{7}{8} = 17.5 \text{ sq. in.}$$

No. 13 and 14. Stresses are + 235000 and - 145000.

For all compression unit = 10800 lbs.

$$\begin{array}{r} \text{Less from dead weight} \quad 400 \text{ "} \\ \hline 10400 \end{array}$$

For alternate tension and compression unit =

$$11700 \left\{ 1 - \frac{\text{max. less}}{2\text{max. greater}} \right\} = 8280 \text{ lbs.}$$

$$\begin{array}{r} \text{Less from dead weight} \quad 380 \text{ lbs.} \\ \hline 7900 \text{ "} \end{array}$$

$$\text{Required sectional area} = \frac{235000}{7900} = 29.6 \text{ sq. in.}$$

Use 2 channels 12 @ 35 lbs. = 21 sq. in.

$$1 \text{ Plate } 18 \times \frac{1}{2} \quad 9 \text{ "}$$

$$\text{Total } 30 \text{ "}$$

No. 15 and 16. Stresses are 239000 and - 48300 lbs.

For all compression unit 10400

$$\begin{array}{r} \text{For alternate tension and compression} = 10620 \\ \text{Less from dead weight} \quad \quad \quad 400 \\ \hline 10220 \end{array}$$

$$\text{Required sectional area} = \frac{233000}{10200} = 22.8 \text{ sq. in.}$$

$$\text{Use 2 channels 12 @ 30} = 18 \text{ sq. in.}$$

$$1 \text{ Plate } 18 \times \frac{5}{16} \quad \quad \quad 5.6 \text{ "}$$

$$\text{Total} = 23.6 \text{ "}$$

No. 17. Stresses are + 240000 and - 20000.

For all compression unit = 8660.

$$\text{Required area} = \frac{232000}{8660} = 26.8 \text{ sq. in.}$$

$$\text{Use 2 channels 12 @ 35} = 21.$$

$$1 \text{ Pl. } 18 \times \frac{3}{8} = 6.7$$

$$\text{Total} \quad - \quad - \quad \underline{\quad} \quad 27.7 \text{ sq. in.}$$

No. 18, 22, 30. Stresses - 55000 and - 19000.

$$\text{Unit for all tension} = 10500 \left\{ 1 + \frac{\text{min.}}{\text{max.}} \right\} = 14300 \text{ lbs}$$

$$\text{Required sectional area} = \frac{53000}{14300} = 3.7 \text{ sq. in.}$$

$$\text{Use 2 channels 8 @ } 11\frac{1}{4} = 6.6 \text{ sq. in. gross.}$$

$$4.5 \text{ " net.}$$

No. 26. Stresses are - 84000, and - 32000.

Unit for all tension, 14500 lbs.

$$\text{Required sectional area} = \frac{84000}{14500} = 5.8 \text{ sq. inches.}$$

$$\text{Use 2 channels 9 in. @ } 13\frac{1}{4} \text{ lbs.} = 8 \text{ sq. in.}$$

No. 20 and 24. Stress + 5200. Use 2 [8 @ 11 $\frac{1}{4}$ lbs.

No. 19. Stresses are + 63000 and - 134000.

Allowable unit = 9160 lbs.

$$\text{Required sectional area} = \frac{131000}{9160} = 14.3 \text{ sq. in.}$$

$$\text{Use 2 channels 9 @ 25 lbs.} = 14.7 \text{ sq. in.}$$

110 MADISON STREET DRAW BRIDGE AT PORTLAND, OREGON.

No. 21. Stresses are + 68000 and - 111300.

Allowable unit = 7830.

$$\text{Required sectional area} = \frac{111300}{7830} = 13.1 \text{ sq. in.}$$

Use 2 channels 9 @ 25 lbs. = 14.7 sq. in. gross.

No. 23. Stresses are + 142000 and - 18000.

Unit for all compression = 7950 lbs. per sq. in.

“ “ alternate tension and compression = 10900

$$\text{Required sectional area} = \frac{142000}{7950} = 17.7 \text{ sq. in.}$$

Use 2 channels 12 @ 30 lbs. = 18 sq. in.

No. 25. Stresses are + 8000 and - 195000.

$$\text{Unit for all tension} = 11700 \left\{ 1 + \frac{\text{min.}}{\text{max.}} \right\} = 14620 \text{ lbs.}$$

$$\text{Required sectional area} = \frac{195000}{14620} = 13.3 \text{ sq. in.}$$

Use 4 bars $4\frac{1}{2} \times \frac{3}{4} = 13.5 \text{ sq. in.}$

No. 27. Stress = + 254000.

$$\frac{l}{r} = \frac{28}{5.6} = 5 \text{ allowable unit} = 10540 \text{ lbs.}$$

$$\text{Required sectional area} = \frac{254000}{10540} = 23 \text{ sq. in.}$$

Use 2 channels 15 @ 33 lbs. = 19.8 sq. in.

1 Plate $18 \times \frac{1}{4}$ 4.5

24.3 “ “

No. 31. Stress + 297000.

$$\text{Required sectional area} = \frac{297000}{10540} = 28.1 \text{ sq. in.}$$

Use 2 channels 15 @ 33 lbs. = 19.8 sq. in.

1 Plate $18 \times \frac{7}{8}$ 7.9 “ “

27.7 “ “

No. 28. Stress = + 44000.

$$\frac{l}{r} = \frac{28}{3.1} = 9 \text{ allowable unit} = 7387 \text{ lbs.}$$

$$\text{Required sectional area} = \frac{44000}{7387} = 6 \text{ sq. in.}$$

Use 2 channels 8 @ $11\frac{1}{4}$ lbs. = 6.6 sq. in.

Weight and Quantities in bridge above turntable.

2 Trusses	@ 120140	240280
12 Floor Beams Intermediate	2602	31224
2 " " End	2100	4200
15 Panels Stringer Bracing	394	5910
2 Lines Stringer 15 in. I @ 42		} 83952
4 " " 15 in. I @ 45		
32 Walk Brackets	368	11776
Operator's Platform		4384
Top Laterals		2788
Bottom Laterals		6635
4 Portals		5560
18 Top Struts		10440
12 Portal Brackets		2400
2 Tower Portals		2780
Sway Rods		3200
Ladder		500
28 Railing Posts	48	1400
4 Trolley Poles	514	2056
2 Trolley Struts	738	1476
900 Hook Bolts		700
120 Plain Bolts		360
		422021

90 ft. Gas Pipe Railing

630 ft. Lattice Railing

4 Cast Iron Newel Posts

Wood Joist 11.1 M.

Flooring, etc., 44.9 M.

Wood Block Paving 4 in. deep = 825 sq. yds. = 29700 ft. B.M.

Maximum Stress in Thousands.

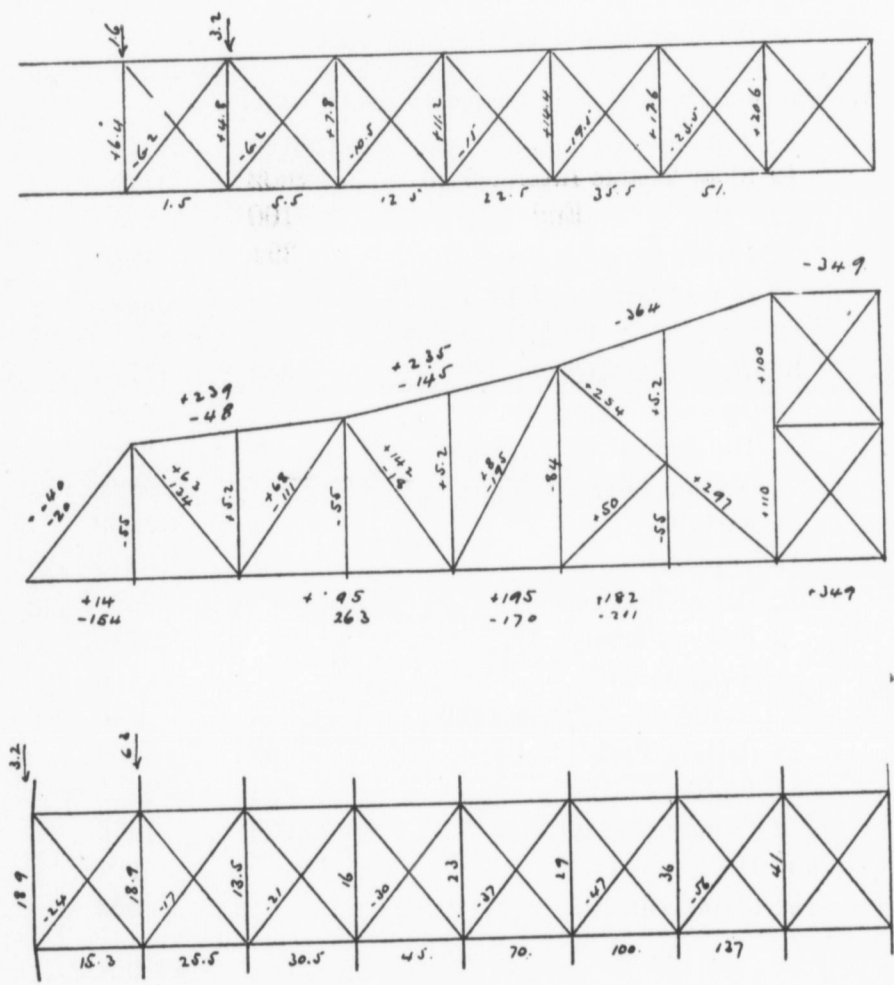
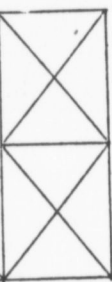

FIG 18.

Diagram of Sizes.



-J49



rJ49

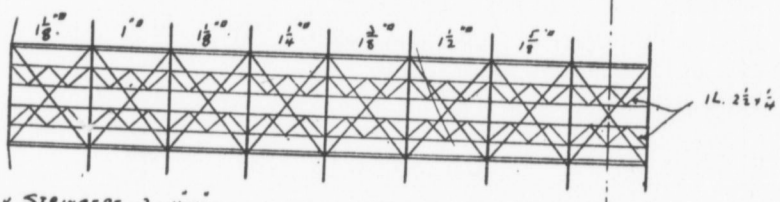
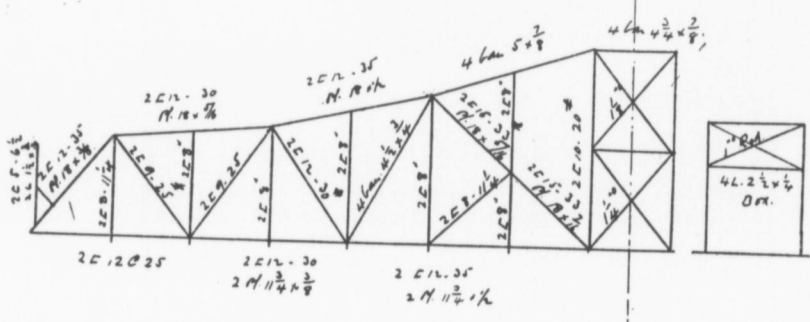
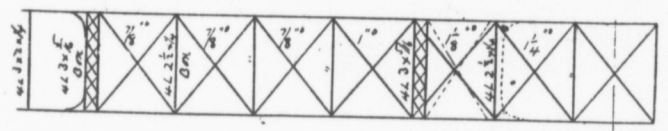

WALK STRIPERS. 3. 4x4
1-3x4

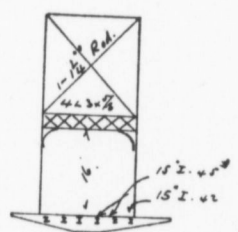
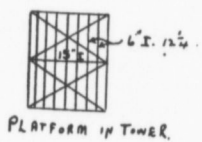

FIG 19.

DM = 4L 6x4 3/8
PC 42x4.
WALK BRACKET
4L 2 3/4 x 3 1/4
A. 2'

Trolley Support at End of Draw.

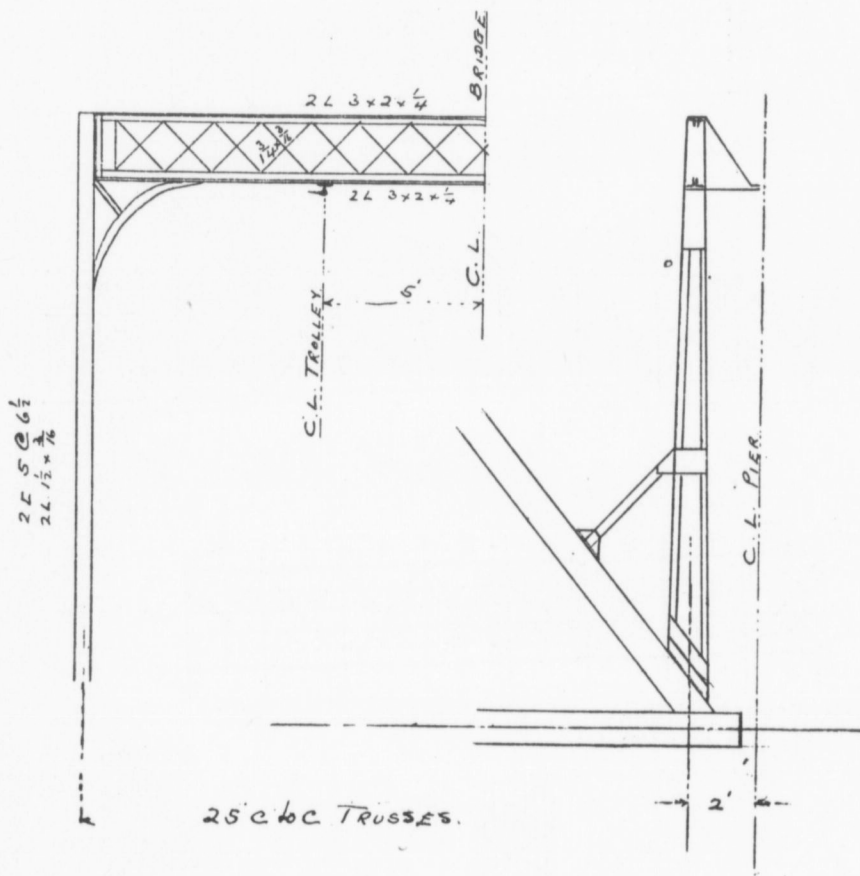

FIG 20.



only
Loa

Drum (Soft Steel) 27 ft. Diam.

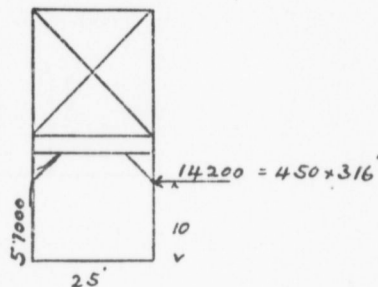
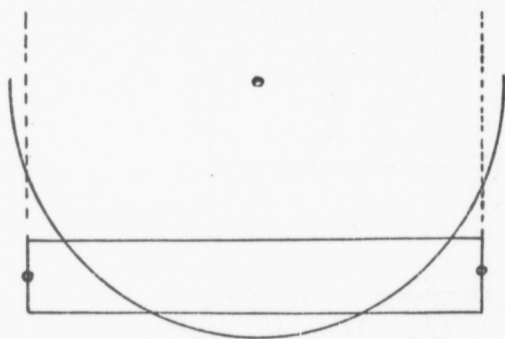

FIG 21

FIG 22.

Max. Load on Drum.	Lbs.
With draw closed.—Live load = $3300 \times 168 =$	554400
Dead load = $2480 \times 316 =$	783700
Centre platform	25000
	<hr/>
Total load on drum =	1363100
Load on half drum	681600
Wind	57000
	<hr/>
	738600
	<hr/>
$\frac{1}{4}$ load on drum	= 369300
Load on Drum.	
Draw open.—Dead, 2480×316	783700
Snow, 800×316	252800
Centre platform	25000
	<hr/>
	1061500
Load on $\frac{1}{4}$ drum	265400
Wind	28500
	<hr/>
Max. load on $\frac{1}{4}$ drum	= 293900

The above considers 1 foot of snow all over bridge and walk, only when draw is open.

Loading beam distributes $\frac{1}{4}$ load of bridge on two points about 6 ft. apart.

Consider 3 wheels not bearing. Then Drum is a girder 6 ft. long, with centre Load 135000 lbs.

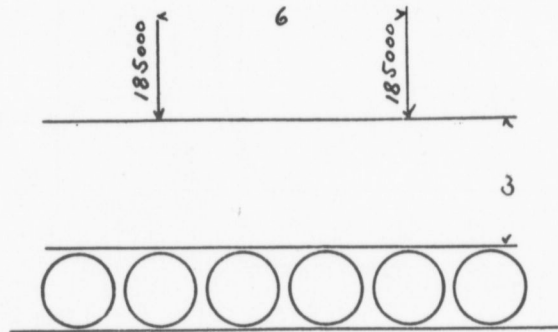

FIG 23.

Hence Required Flange Area is $\frac{92500 \times 3}{3 \times 9000} = 10.3$ sq. in. net.

Use 2 angles $5 \times 5 \times \frac{1}{2} = 8$ sq. in. net.

1 Cover Plate $16 \times \frac{1}{2} = 7$

— Total 15

Max. Shear 185000 lbs.

Web Area Required = $\frac{185000}{9000} = 19$ sq. in.

Use Plate $36 \times \frac{1}{2} = 18$ sq. in.

With stiffeners $4 \times 3 \times \frac{1}{2}$ angles.

Wheels, say 20 in. diameter.

Circumference of Track is about 81 ft. Hence use say 40 wheels.

Allowable pressure on wheels per lineal inch = $600 \sqrt{d}$ live
 $1200 \sqrt{d}$ dead

Total Live Load = 554400 lbs.

“ Dead “ = 808700 lbs.

“ Lineal inches required = $554400 \div 2680 = 207$ inches.

$808700 \div 5360 = 151$ “

— Total 358 “

Hence Face of Wheel = $358 \div 40 =$ say 9 in.

Loading Beam (Soft Steel).

Max. load on 1 quadrant of drum = 369300 =

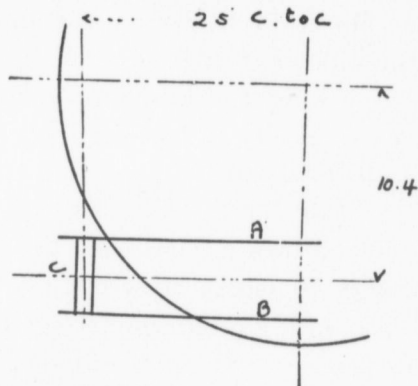

Fig 24.

Inside beam A.—

$$\text{Required flange area} = \frac{369300}{2} \times \frac{2}{2.5 \times 12000} = 12.3 \text{ sq. in.}$$

Use 2 angles $6 \times 6 \times \frac{5}{8} = 12 \text{ sq. in. net.}$

Web, $30 \times \frac{1}{2}$, reinforced with 2 plates $\frac{3}{8}$ in. thick at ends.

Outside beam B.—

$$M = \frac{369300}{2} \times 6. \quad \text{Assuming beam 30 in. deep, then flange}$$

$$\text{area} = \frac{369300 \times 6}{2 \times 2.5 \times 12000} = 37 \text{ sq. in.}$$

$$\frac{1}{6} \text{ of 2 web plates, } 30 \times \frac{5}{8} = 6 \text{ sq. in.}$$

$$2 \text{ plates, } 20 \times \frac{1}{2} = 16 \text{ "}$$

$$2 \text{ angles } 6 \times 6 \times \frac{7}{8} = 16 \text{ "}$$

$$38 \text{ "}$$

Max. shear = 185000.

$$\text{Web area} = 185000 \div 7000 = 26 \text{ sq. in. Use 2 webs, } 30 \times \frac{5}{8} = 26 \text{ sq. in. net.}$$

$$\text{Girder C.—Flange area required} = \frac{369300 \times 2}{2 \times 2. \times 12000} = 15.5 \text{ sq. in.}$$

Use 2 angles $6 \times 6 \times \frac{3}{4} = 15 \text{ sq. in net.}$

Shear = 185000. Use 2 pls. $28 \times \frac{5}{8}$.

Turning Gear.

What is the required horse-power to turn bridge ?

No wind acting.

From experiments by Mr. A. P. Boller on the new London drawbridge, he deduced the following rule :

$$\text{H.P.} = \frac{.01wv}{550}, \quad \text{where } w = \text{weight of bridge pounds.}$$

$$\text{H.P.} = \frac{.01 \times 973000 \times .67}{550} = 11.8$$

Velocity assumed for end of draw = 6 miles per hour (average).

This turns bridge through 90 deg. in 30 seconds.

Extra power required to open bridge against an unbalanced wind pressure of 5 pounds per sq. ft. on total exposed surface of bridge.

Wind pressure on half bridge (one end) = $15 \times 158 \times 5$.

$$\therefore \text{Thrust at rack} = \frac{15 \times 158 \times 5 \times 158}{13.5 \times 2} = 62400 \text{ lbs.}$$

Length of quadrant = 23.5 ft. \therefore Work done = 62400 lbs. \times 23 $\frac{1}{2}$ = ft., lbs. in 30 seconds.

$$\therefore \text{H.P.} = \frac{62400 \times 23\frac{1}{2}}{2 \times 33000} = 22.$$

Total required H.P. = wind 22.

Friction and inertia 11.8

33.8

Use say 30 H.P. General Electric motor, which will stand overloading to about twice its rated capacity.

Rack. Proportion this for capacity of 30 H.P. motor. Work done on rack 23 $\frac{1}{2}$ ft. long in 30 sec. = $30 \times 33000 \times 2$.

$$\therefore \text{Thrust on rack} = \frac{30 \times 33000 \times 2}{23.5} = 84000 \text{ lbs.}$$

Assume this thrust of 84000 lbs. resisted by 2 teeth.

42000 " " " 1 tooth.

For cast iron 1200 p. f. = 42000, p. and f. are pitch and face of rack.

Assume face = 9 in. Then pitch = 3.7 in.—circular.

Turning Gear.

Hand lever.

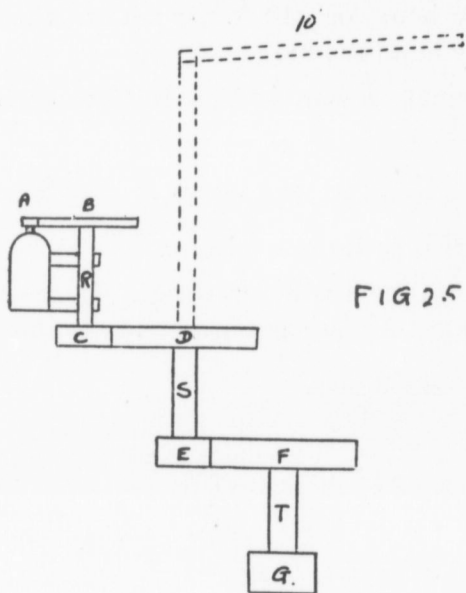

Gears A and B go with motor. A has 14 teeth, and $4\frac{2}{3}$ in. diameter. B has 67 teeth, and $22\frac{1}{3}$ in. diameter. Shaft R is $3\frac{1}{4}$ diameter to fit motor boxes.

Take average speed of motor at 400 revolutions per minute. Then shaft R has 85 revolutions per minute.

If bridge opens in 30 seconds, then speed of shaft T is $11\frac{1}{2}$ revolutions per minute. Therefore required speed reduction is

$$\frac{85}{11.5} = 7.4.$$

Use 2 reductions of 3.7 each.

Then if we assume pinions E and C at 9 in. diameter each, gears D and F will be $9 \times 3.7 = 33.3$ in. diameter.

To proportion teeth, use the following formula: $W = 1200$ p. f. where W = thrust on tooth, p. and f. are pitch and face.

Gears are steel. C and D have $1\frac{1}{2}$ in. pitch, $4\frac{1}{2}$ in. face.

E " F " $2\frac{1}{2}$ " 6 "

G has $3\frac{3}{4}$ in. pitch, 9 in. face, 15 in. diameter.

To proportion shafts, use the following formula for steel:

$$\text{Diameter} = \sqrt[3]{\frac{T}{2200}}, \text{ where } T = \text{torsional moment in inch lbs.}$$

Hence shaft S = $4\frac{3}{4}$ in. diam. Shaft T = 6 in. diam.

Hand Turning Arrangement.

Number of revolutions of pinion required to open draw = $5\frac{1}{2}$ in 30 seconds. Number of revolutions of lever required to open draw = $5\frac{1}{2} \times 3.7 = 20$.

Circumference of walk = $10 \times 2 \times \pi =$ say 60 feet.

\therefore Distance walked in opening draw = $60 \times 20 = 1200$ ft.

If man walks $2\frac{1}{2}$ miles per hour, or 240 ft. per minute, then time required to open bridge by hand is $1200 \div 240 = 5$.

Power required with no wind blowing is 11.8 H. P. to open bridge in 30 seconds.

Hence power required to open bridge is 5 minutes = $\frac{11.8}{5 \times 2} = 1.18$ H. P. = $1.18 \times 33000 = 38900$ ft. lbs. per minute.

One man can push 50 lbs. on lever while walking. Hence 1 man power = $240 \times 50 = 12000$ ft. lbs. per minute. Hence number of men required = $\frac{38900}{12000} =$ say 3 men.

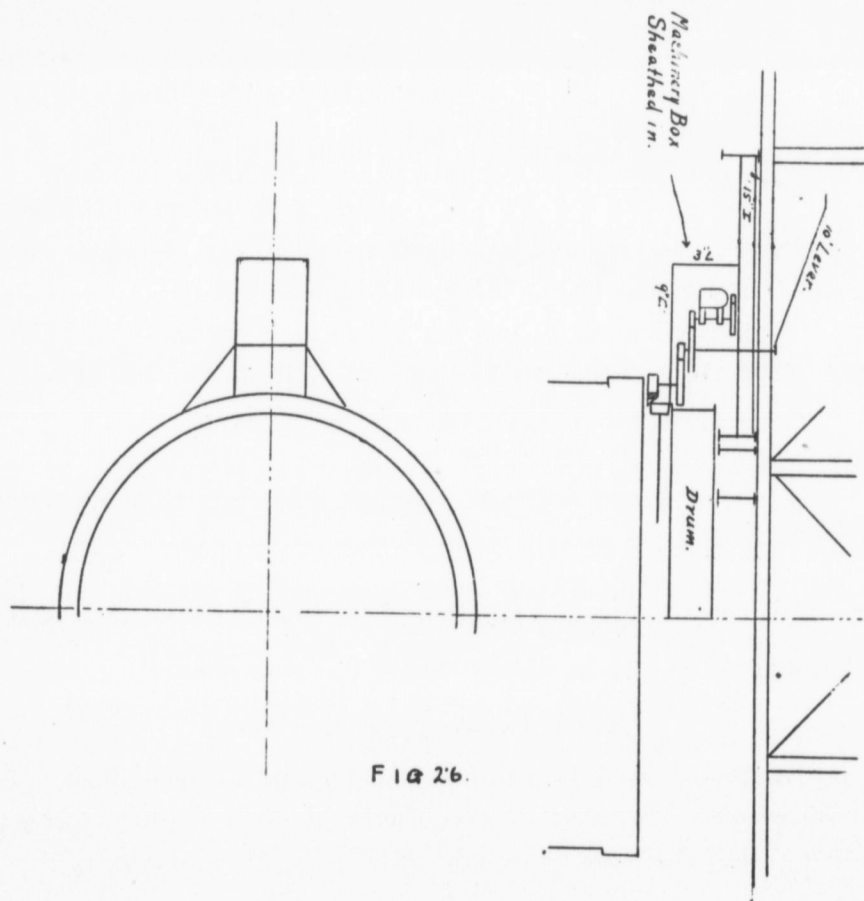

FIG 26.

Turn-table.

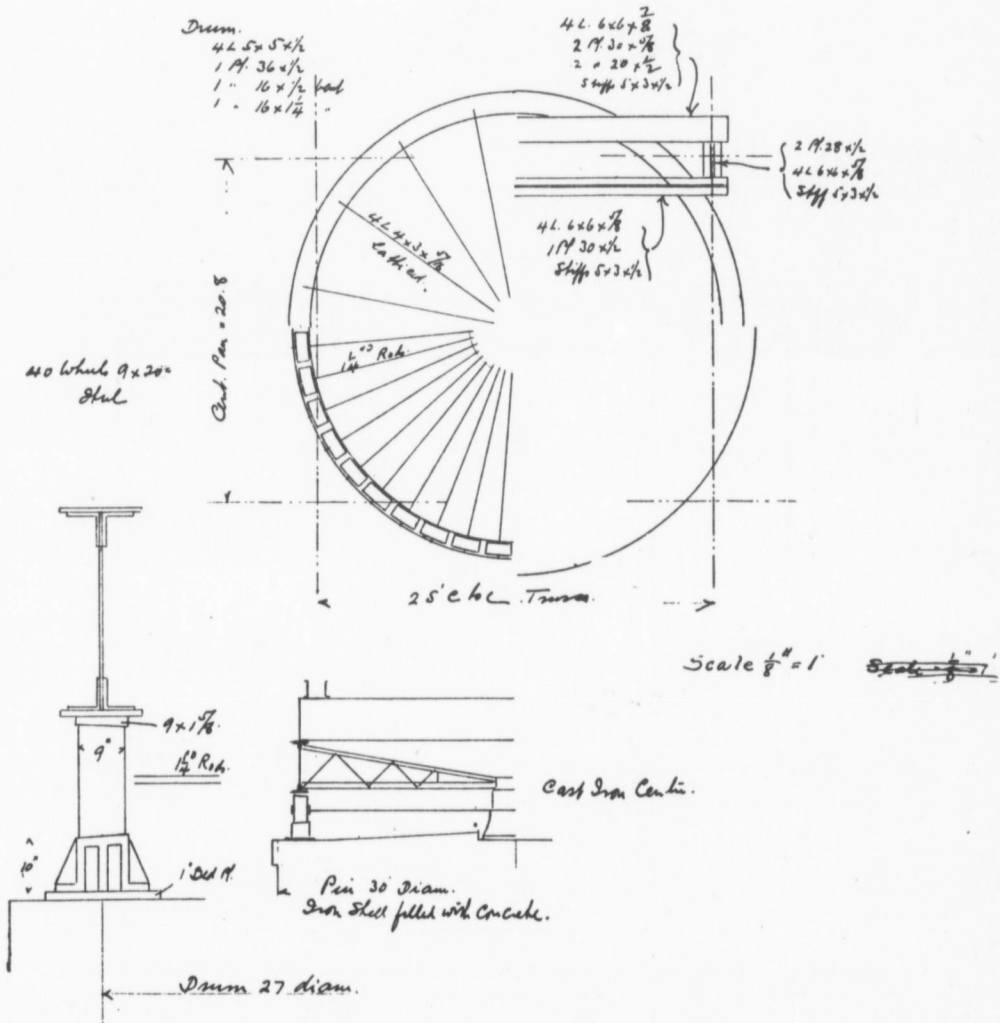

FIG 27

End Lifting Machinery.

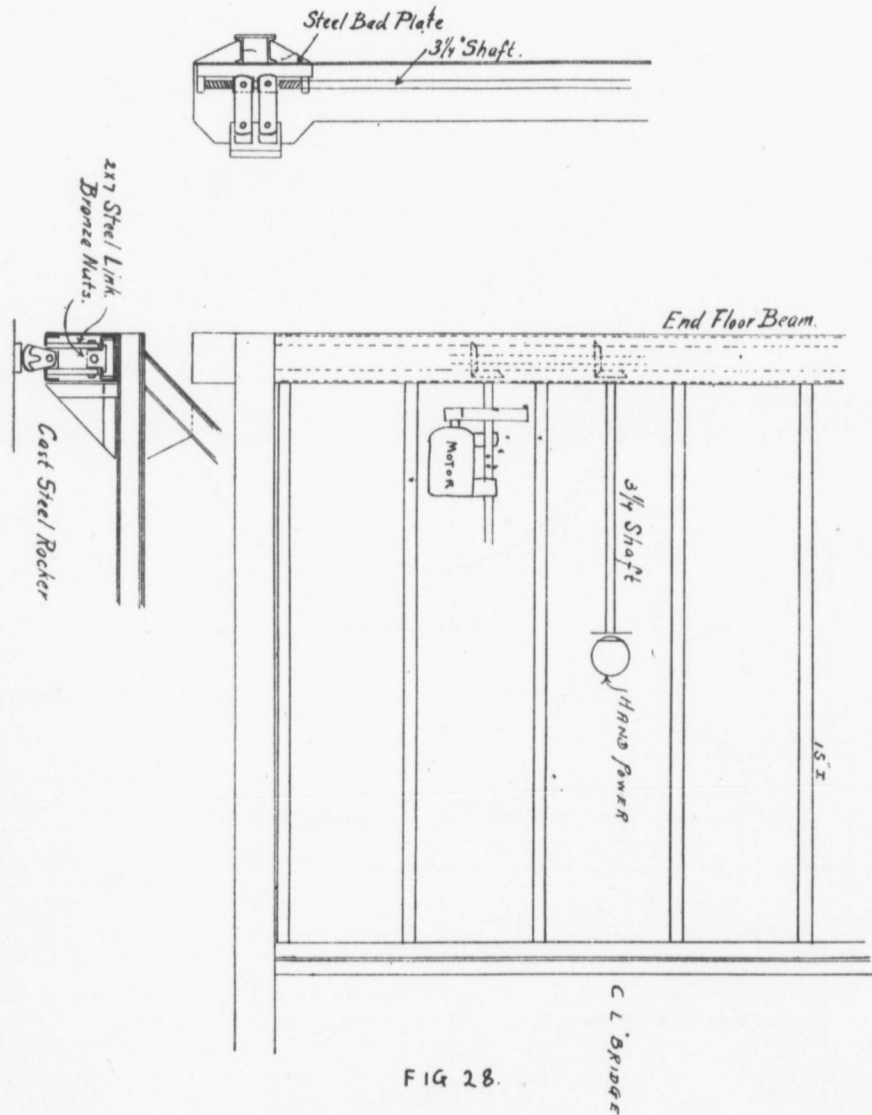

FIG 28.

opera
Total
This
f

Weight of Turn-table.

2 Loading Beam	16356
2 " "	11218
Drum	20572
16 Drum Struts	9056
Machinery Box	3871
Bed Plates	7288
40 Wheel Rods	1900
4 x 1/2 Wheel Bars	1360
2 Centre Discs	1360
4 Loading girders	5644
Wt. of T. T. without machinery =	<u>78625</u>
Rack and Track	25500
40 Wheels 20 x 9 in.	18000
Centre Machinery	13900
2 Sets end Machinery	15600
	<u>73000</u>

3 electric motors, 30 H. P. with rigging for operating same. Besides these, there is required submarine cables, track rails, operator's house in tower, signals, gates, etc.

Summary of Weights.

Bridge proper	338000
" Joist	84000
Turn-table	78600
Machinery	73000

Total wt. of Metal = 573600 = 44 lbs. per sq. ft. of floor and walks. This weight per sq. ft. of floor agrees very nearly with my formulæ for weight of drawbridges, which is weight per sq. ft. =

$$3 + \frac{\text{Total Span}}{8}$$



The Madison Street Bridge.

7 fixed spans @ 190	- - - = 1330 feet
1 draw span	- - - = 316 "
Total length	- - - = 1646 "

HANDLING DAYLIGHT

W. J. WITHROW.

It is with extreme pleasure that I have the privilege of standing on this platform once more after the elapse of over a decade.

Prismatic lighting, to the consideration of whose properties I invite your attention this afternoon, is of engineering interest, not so much on account of any abstruse calculations, as for its proved usefulness as a new application of certain well known laws of Optics to the practical lighting with daylight of dark interiors. At the risk of mentioning a good deal that is familiar to you, I will endeavor clearly to outline the general principles governing the use of this light-bending window glass.

As you all know, a light ray travels in a straight line through a uniform transparent medium, such as air at a constant density, but alters its direction on passing obliquely into a medium of different density. This may be well represented by considering a company of soldiers marching on even ground and striking obliquely the edge of a ploughed field. The end of the company entering the soft ground first is held back, while those still on firm ground, keeping up their old speed of marching, swing their end ahead. If the company still marches at right angles to its front it now moves in a new direction, more nearly at right angles to the line of demarcation between the firm and the soft ground. The greater the difference in the ground, the greater the change of direction, and the sharper the angle at which the company strikes the edge of the soft ground the greater the resultant change of direction. On moving from soft ground to hard again the operation is reversed—*i.e.*, the first files out move faster, thus swinging the company around more nearly parallel with the edge of the soft ground. One can easily imagine the company emerging at such a sharp angle that the first files out would swing their end so far ahead as actually to double back into the field. This will be referred to later on when considering total internal reflexion of light.

trates
prism
the si
partic
in the
other
incide

X Y
the ray
the re
I
manuf
the re
Sin I
O
betwe
Z, des

This, though an unscientific demonstration yet clearly illustrates the fundamental law of Optics, which forms the basis of prismatic lighting, viz.—the sine of the angle of incidence equals the sine of the angle of refraction multiplied by a constant. The particular constant for any two bodies varies with the difference in their relative densities and to a minor extent possibly with their other properties.

In Fig. 1. I, the angle of incidence, is the angle between the incident ray of light i and the perpendicular $A Z$ to the surface

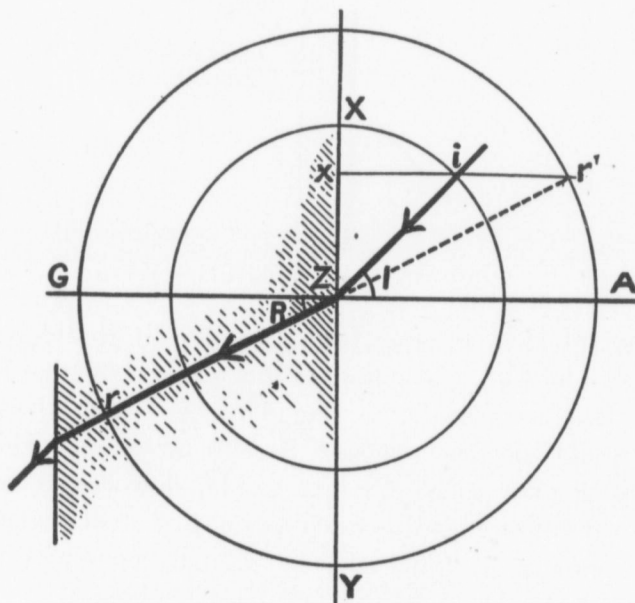

FIG. 1.

XY of contact between the two transparent media through which the ray passes, and R , the angle of refraction, is the angle between the refracted ray rZ and the same perpendicular AZG produced.

It is found that for air and flint glass, such as is used in the manufacture of prisms, the constant a equals 1.53, consequently the refractive power of this glass in air may be stated thus— $\text{Sin } I = 1.53 \text{ Sin } R$.

Or, to express this graphically, see Fig. 1. In the plane XY , between the body of air A and the body of glass G , at the centre Z , describe two circles Xi and Yr at distances relatively of 1 and

1.53. Let iZ be any incident ray of light piercing the plane XY from the body of air A at the point Z and cutting the circle Xi at i . Through i draw xir' perpendicular to the plane XY , cutting the circle Yr at r' and the plane XY at x —then rZr' produced will be the direction and sense of the refracted ray, iZA the angle of incidence and GZr the angle of refraction, and $\text{Sin } iZA = 1.53 \text{ Sin } GZr$.

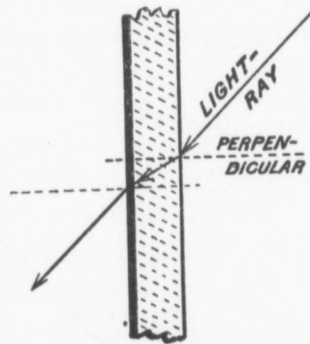

FIG. 2.

A ray of light passing from glass to air would require the constant a to be 1.53, and investigation would show that on passing through a surface parallel to the plane XY into the air again, the ray would be bent back to its old direction. This is what happens with plate glass, see Fig. 2. If, however, it pass out of the glass through a plane inclined to the first it will assume a new direction, see Fig. 3. This latter is what happens with prisms.

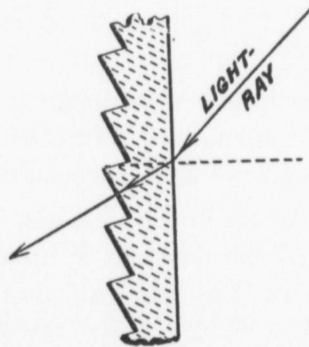

FIG. 3.

If both surfaces were made continuous one edge of the wedge so formed would be very thick, and the whole too heavy for use

in a window, see Fig. 5. One surface of a prism plate is therefore made in a succession of inclined planes forming a series of small wedges instead of one large one. By increasing the angle between the two surfaces of the prism plate the divergence of transmitted

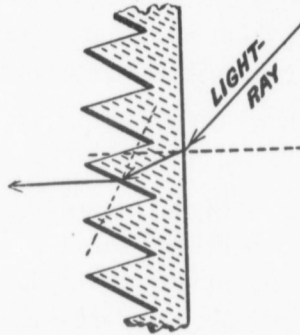

FIG. 4.

light would be increased, see Fig. 4. For this reason prism plates are made with different inclinations varying by 5° in the several plates of the series. These plates are made 4" square, as larger sizes cannot be sharply moulded, and are strongly glazed together

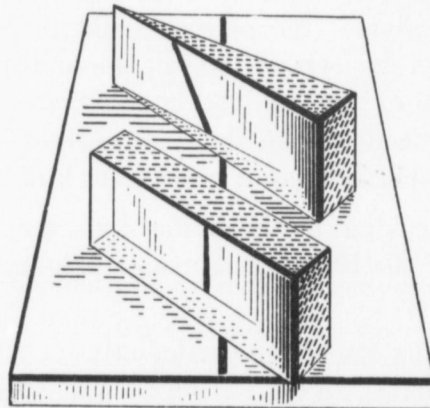

FIG. 5.

in copper by a patented electrolytic process to form large sheets of any required shape.

In order to bend incident light laterally, two complete series of prism plates are manufactured with the prism tilted up, one to the right, and the other to the left, at an angle of $22\frac{1}{2}^\circ$. By placing a right tilted prism on its side, we get a left tilt of $67\frac{1}{2}^\circ$,

and reciprocally with the left tilt prism. By tilting an ordinary prism plate half way to right or left, we obtain 45° right or left tilts, whereas tilting it completely to right or left we get right or left tilts 90° .

With this range of prism plates and certain cases of using the prisms inside-out, light from any source, falling upon a window, may be directed to any part of the interior.

Having considered the theory of prisms, we will now consider their application.

Stand any place in a room. Look out through the window. The part of the room where you stand is primarily lighted from that particular part of the outside world that you can see. If you see a dark wall, you will be in the dark—if you see a bright sunlit or white washed wall, or generally better still—the open sky, then where you stand will be well lit, if, of course, the window space is large enough for the room.

This primary lighting is more or less modified by light reflected to you from any particularly well lit part of the same room. If a bright sunlit pavement outside throws a strong light on the ceiling near the window, the reflected light therefrom may make the whole room bright. Or, if the sun shines directly through the window for a part of the day, the interior may be rendered light throughout by reflection from the spot on the floor or wall where it shines, or by radiation from a translucent blind or window.

Generally speaking, however, the sky space, as seen from the window, is by far the brightest source of light available for illuminating the interior.

If, as generally happens—particularly in our more congested city districts, the bright sky is cut off by some obstruction opposite the window, such as a building, trees, etc., then the usefulness of prisms comes into play. Here, with ordinary window glass, the bright light from a more or less confined sky-space above falls bright and clear upon the floor immediately inside the window, where it is mainly absorbed by the non-reflecting carpet, dark flooring or furniture, and the rear of the room is left dark and

more or less gloomy, see Figs. 6 and 7. If, now, the window, frequently, merely the upper part, be glazed with prisms of a refracting angle merely sufficient to bend the light from the sky immediately over the top of the building opposite, sending it horizontally or slightly upwardly back through the room, then all the rest of the light from the sky up to the zenith will be spread equally along the rear and side walls and across the floors toward the window, giving an even illumination throughout.

In order to get a satisfactory result in each case, it is, of course, necessary to instal a sufficient area of prisms to suit the size of the room and the available sky space outside.

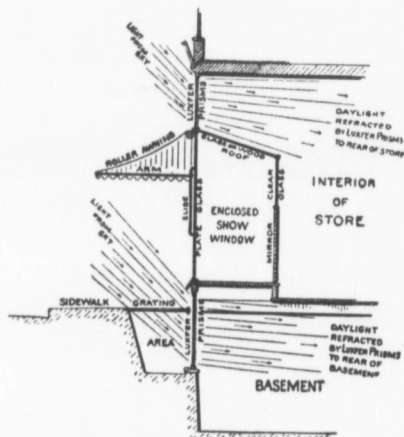

FIG. 6.

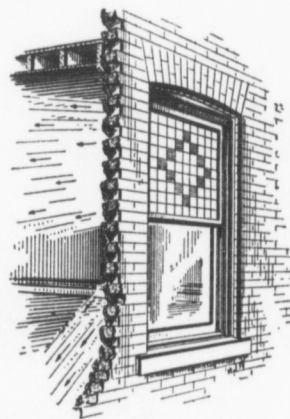

FIG. 7.

Some of the refinements of prismatic lighting which may make or mar its efficiency—I shall now briefly indicate.

If a very high building opposite has a low one, or none at all, close to right or left, then the use of one of the tilted prisms will draw light from the open side, bending it back into the room with greater illuminating effect than could be obtained by drawing light from the narrow band of sky seen over the top of the building. If the space above is extremely narrow, as in narrow lanes between buildings, or in light wells, the light may fall so steeply that the usual vertical window intercepts very little of it. In this case a canopy of prisms is hung outside in front of the upper part

of the window, see Fig. 8. Any of the various forms of prisms mentioned above may be used here if the refracted light is required to be thrown merely a short distance into a room to light desks or other articles near the window. Prisms can only be adapted to refract light up to about 60° , in fact anything beyond 45° of refraction begins to lose in brilliancy.

If, on the other hand, the almost vertically falling light is required to be thrown horizontally back into a room, the principle of refraction will not answer. In this case a form of prism is used in which the light entering the plane surface falls upon an inner

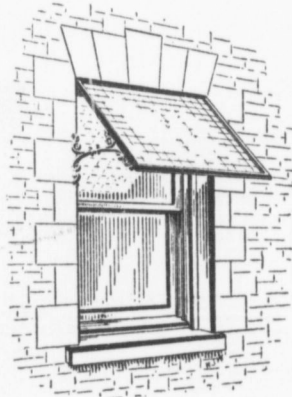

FIG. 8.

surface at such an angle as to cause its total reflexion. This surface will reflect with all the brilliancy of a silvered mirror, throwing the light into the room through the third surface of the prism.

For sidewalks this principle is adopted—the Standard prism, has two unequal downwardly projecting prisms of unequal angle, so adapted as to throw light falling vertically downward inwardly toward the basement—the unequal points being introduced to prevent the reflected light from being stopped by the next prism point in front. See Figs. 9 and 12.

A later and better form is the Multiprism, which has a single downwardly projecting wedge, having its reflecting and inward transmitting surfaces curved so as to cause the light reflected from

the c
as cl



are se
give
V
basem
their

prisms
refract
prisms
the lig
rear.
traffic

the different parts of the surface of one prism to successively pass as close to the bottom of the next prism as possible. These prisms

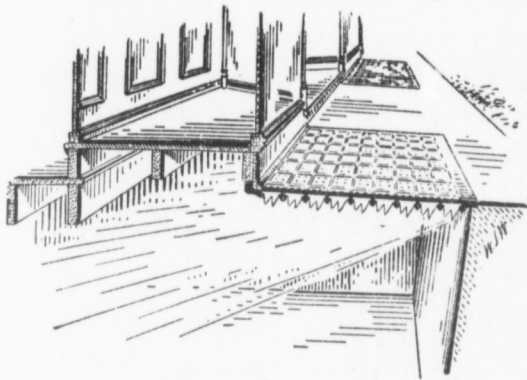

FIG. 9.

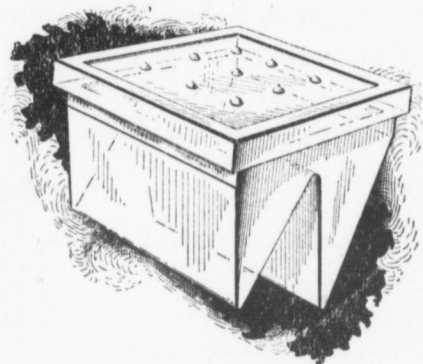

FIG. 12.

are set brick fashion, so as to break joints, and from the basement give the appearance of an unbroken sheet of light. See Fig. 10.

Where a stringer, joist or other inside obstruction on the basement ceiling, prevents the pavement prisms from throwing their light back to the rear of the cellar, a curtain of window



FIG. 10:

prisms of slight refractive power near the top increasing to high refractive efficiency at the bottom, is hung between the pavement prisms and the cellar. This curtain gives a second refraction to the light from the pavement illuminating the whole interior to the rear. This form of curtain works well in open areas where traffic does not necessitate the use of pavement prisms.

All these prism panels, pavement and window, light not merely the space in front of them, but fan-out their light sideways in exactly the same proportion as the sky space from which they derive their light is spread laterally.

In the case of window prisms, if there is a heavy overhang or reveal, the upper prisms would be over-shadowed and useless. In this case the prism panel is either hung in a separate wooden

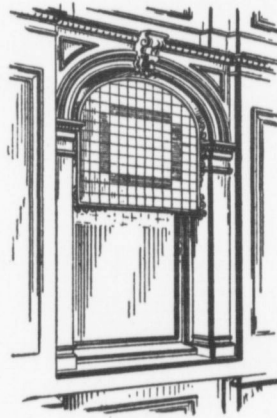

FIG. 11.

or ornamental iron frame out near the front of the wall or cornice, see Fig. 11. A more recent way is to remove the upper part of the window, placing the prisms in a closed frame near the front of the wall, and uniting the bottom of the prisms with the deep-set lower part of the window by a transom bar, in which is installed a ventilating device.

TH
describ
proven
ought
a gener
can be
would
terestin

TH
interest
power
The m
"Hydr
century
Air."
they in
the Au
George
introduc
the abov
form un

Th
rival th
to-day i
will con
site to t
ciple up
pipe, wh
of air; a
atmosph
in such a

AIR BRAKES.

W. E. FOREMAN.

The subject of "Air Brakes" is so broad, that to properly describe it, a detailed description of each part, showing the improvements that have been made in each during the last few years ought to be given. But as I am both limited by time and space, a general description of the principal systems now in use is all that can be attempted at present. Besides the general description I would like to bring before you for consideration a few very interesting problems which are closely connected with this subject.

The "Air Brakes" has quite a long history, which forms very interesting and instructive reading. Many different forms of power brakes were in use in the early years of the last century. The most important of these were the "Chain Brake," and the "Hydraulic Brake." Then in the second half of the nineteenth century these were superseded by the "Vacuum" and "Straight Air." And again a few years after the introduction of the above, they in turn were also displaced by the Automatic Vacuum and the Automatic Air Brakes. The latter was invented by Mr. George Westinghouse in the year 1873, just four years after the introduction of the "Straight Air" brake. From year to year the above gentleman patented many improvements upon this latter form until it reached its present form of perfection.

THE VACUUM BRAKE.

The Vacuum Brake, which at one time was the greatest rival the Westinghouse Company had to contend with, but which to-day is nearly extinct as far as this continent is concerned, we will consider just a moment. In principle it is diametrically opposite to that made use of in the Automatic Air Brake. The principle upon which this brake operates is as follows:—The train pipe, which extends the full length of the train, is always kept free of air; and when an application of the brakes is desired, the air at atmospheric pressure is admitted to the train pipe, and sets a valve in such a position that one side of the brake diaphragms is directly

connected to a reservoir from which the air is exhausted. The excess pressure on the other side of the diaphragm which is exposed to the atmospheric pressure, forces the diaphragms forward and applies the brakes. To release the brakes, the air is again exhausted from the train pipe, and the valves and brake diaphragms take or return to their normal positions.

The following apparatus comprise the Automatic Vacuum Brake:—

1. The ejector, the function of which is to maintain the vacuum in the train pipe and brake diaphragms.
2. A continuous train pipe line with hose couplings between each car.
3. Brake diaphragms from which the air is exhausted, causing the pressure of the atmosphere to force the rubber disks into the iron shell and set the brakes.
3. The reservoir, in which a vacuum is maintained, and into which the air is constantly exhausted from the diaphragms.
6. Finally the valve which forms the connection between the reservoirs and the diaphragms. Its objects are to control the passage of air from the brake diaphragms to the reservoir, and partially or wholly apply the brakes.

In Fig. 1, is shown the Eames' Automatic Vacuum Brake, which ranks among the first of this kind.

The "Quick Action Automatic Brake," which is a decided improvement on the previously mentioned "Automatic," was first introduced shortly after the Master Car Builders' braking tests, conducted at Burlington during the year 1887. It is in use on all railroads in America; and in England and the continent it is fast driving its competitors from the market. The Westinghouse Company have equipped by far the largest proportion of trains with their system. The New York Company are second, while the percentage of cars equipped with other systems is so small as to be negligible.

The following general description of the operation of the Air Brake will apply equally as well to the New York Company's as to the Westinghouse, since the apparatus for each system fulfil the same functions and only differ in construction.

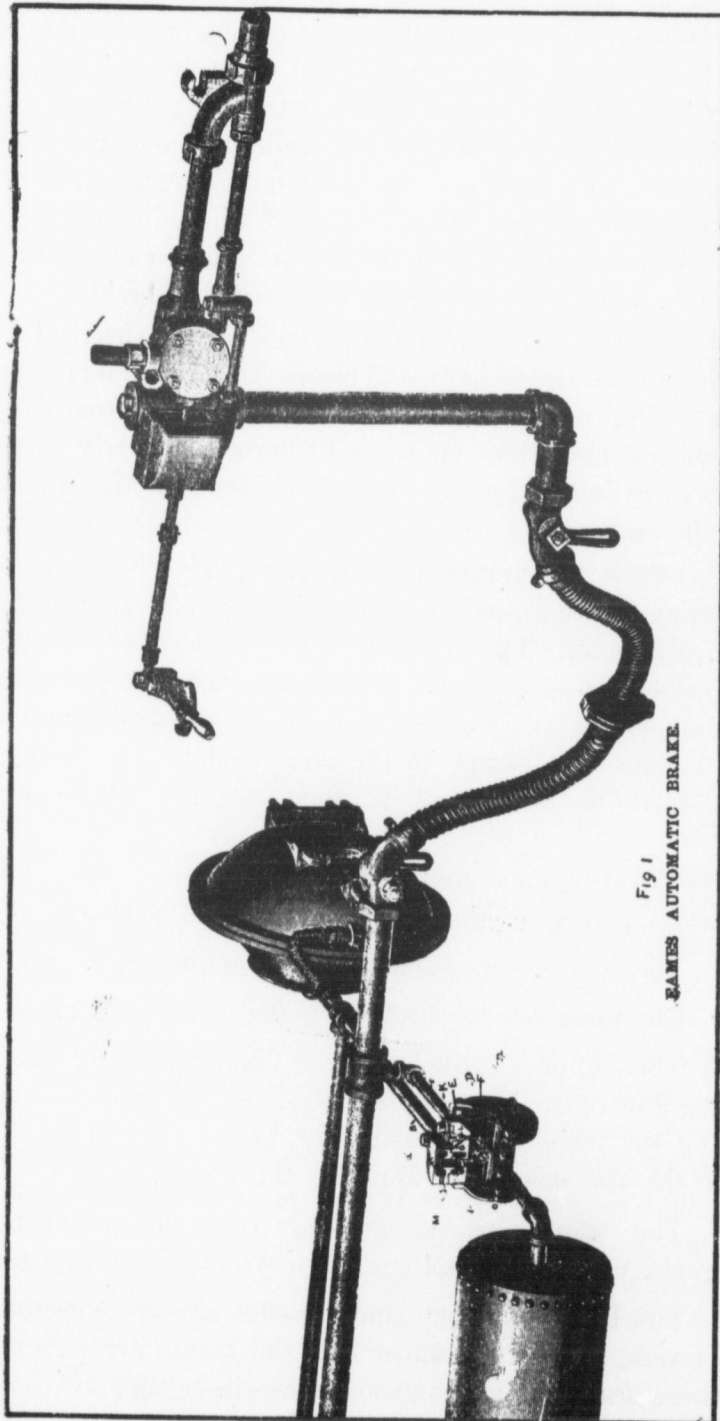

Fig 1
JAMES AUTOMATIC BRAKE.

The air, compressed by the pump, is first delivered into the main reservoir. From there it flows to the engineer's valve; thence through the train pipe to the triple valve on each car, passing through the latter to the storage or auxiliary reservoirs. During normal conditions of running, the train pipe and reservoirs, excepting the main reservoir on the engine, contain air under a pressure of 70 lbs. per square inch. With the engineer's valve, changes of pressure in the train pipe are made, causing the triple valves to operate either to apply or release the brakes.

Moving the handle of the engineer's valve a specified distance permits air from the train pipe to escape, thus reducing the pressure therein. This reduction of pressure operates the sensitive triple valve, which then allows air to pass from the auxiliary reservoir to the brake cylinder, forcing the brake piston in the direction to apply the brakes.

To release the brakes, the engineer's valve is moved back to its running position, and the train pipe pressure is then raised to 70 lbs. per sq. in. This increase in train pipe pressure causes the triple valve to reverse its position, closing the connection between the auxiliary reservoir and the brake cylinder, allowing the air from the latter to escape to the atmosphere. The brake piston then returns to its running position, and the brakes are thus released.

The Westinghouse and New York Quick Action Automatic Air Brakes consist of the following principal parts:—

1. The compressor or pump which compresses the air.
2. The main reservoir in which the compressed air is stored.
3. The engineer's equalizing and discharge valve, which regulates the flow of air into the train pipe and auxiliary reservoirs for charging the train and releasing the brakes, and from the train pipe to the atmosphere for applying the brakes.
4. The train pipe, which leads from the engineer's valve throughout the train, supplying air to the auxiliary reservoirs.
5. The brake cylinder which has its piston connected to the brake levers, in such a manner that the brakes are either applied or released according as the piston moves in or out.

6.
car is e
auxilia
the bra
from th
7.
cient ai
8.
to the
the pre
desired
9.
car to t
10.
pressur
main re
11.
dividual

The
fication
trains w
Express
the quic
ducing
cylinder
auxiliary
applicati
cylinder
it then c
limit is a
cylinder.
pressure,
exerted o
exerted o
the speed

6. The quick action automatic triple valve, with which each car is equipped. The valve controls the admission of air from the auxiliary reservoir to the brake cylinder, the discharge of air from the brake cylinder to the atmosphere, and the admission of air from the train pipe to the auxiliary reservoir.

7. The auxiliary reservoir, which stores upon each car sufficient air to operate the brakes upon that car.

8. The pump governor, which regulates the supply of steam to the pump, automatically stopping the supply of steam when the pressures in the train pipe and reservoirs have reached the desired point.

9. The hose couplings, which connect the train pipe of one car to the train pipe of the next.

10. The duplex air gauge, which indicates on one scale the pressure in the train pipe, and on the other the pressure in the main reservoir.

11. The conductor's valve, which is operated by that individual when he wishes to apply the brakes.

WESTINGHOUSE HIGH SPEED BRAKE.

The Westinghouse High Speed Brake is another form or modification of the Automatic just described, and which is used on trains which run at very high speed, such as the "Empire State Express" and "Congressional Limited." This brake consists of the quick-action, with the addition of an automatic pressure reducing valve. One of these valves is connected to each brake cylinder, and the air pressure supplied to the train pipe and auxiliary reservoirs considerably increased. In ordinary service application the valve remains inoperative, unless the pressure in the cylinder exceeds a certain fixed limit (usually sixty pounds), when it then operates to discharge air from the cylinder until the fixed limit is again reached, and then ceases to discharge air from the cylinder. The reason for this variation of the brake cylinder pressure, is that at high rates of speed greater pressure can be exerted on the wheels without causing them to skid, than can be exerted on wheels revolving at a low velocity. Consequently, as the speed of the train is materially reduced, the pressure in the

brake cylinder has also been reduced. We have thus increased the retardations during the early part of the stop, while running no danger of skidding the wheels. Trains can be stopped by this brake, when they are running at the rate of sixty miles an hour, in about 450 feet shorter distance than when they are equipped by the ordinary Quick Action Automatic Brake.

The triple valve is the most important link in the whole air brake system. On it we depend for the rapidity of the application of the brakes. If, for one short instant it fails to operate, when required, the brakes on that car are inoperative.

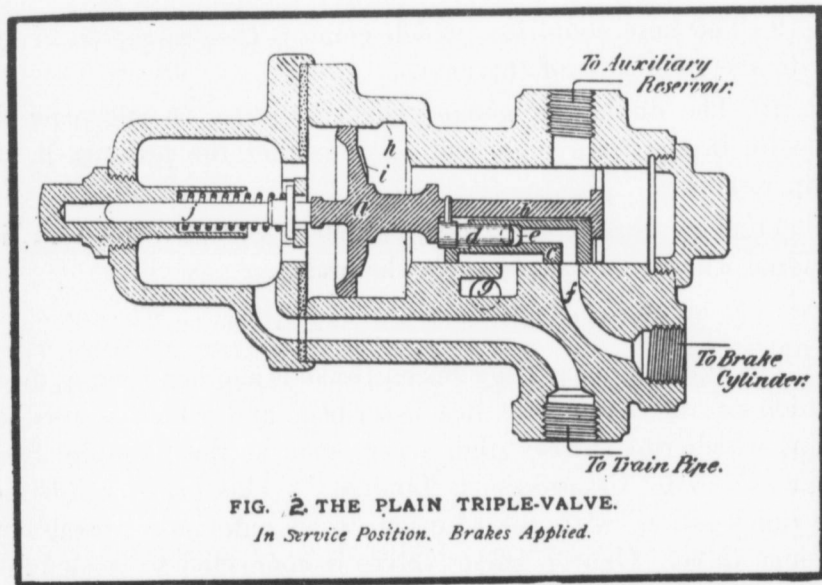

The triple valve has undergone many changes and improvements before it reached its present forms. The first valve was invented by Mr. George Westinghouse, Jr., in 1872, and the last shortly after the Burlington tests in 1887.

Before describing the valve we must understand why they are called triple valves. It performs the triple function of (1) Admitting air from the train pipe to the reservoir, for the purpose of charging it with air under pressure. (2) Admitting air from the reservoir to the brake cylinder, for the purpose of applying the brakes, and (3) Establishing communication between the

brake
the air
T
matic,
Quick
emerg

with th
efficient
Fig
matic v
brakes r
were re

brake cylinder and the atmosphere for the purpose of discharging the air from the brake cylinder and releasing the brakes.

There are two Westinghouse Triple Valves, the plain Automatic, which is used in ordinary service applications, and the Quick Action Automatic, which is designed both for service and emergency applications. This latter valve is simply a plain triple

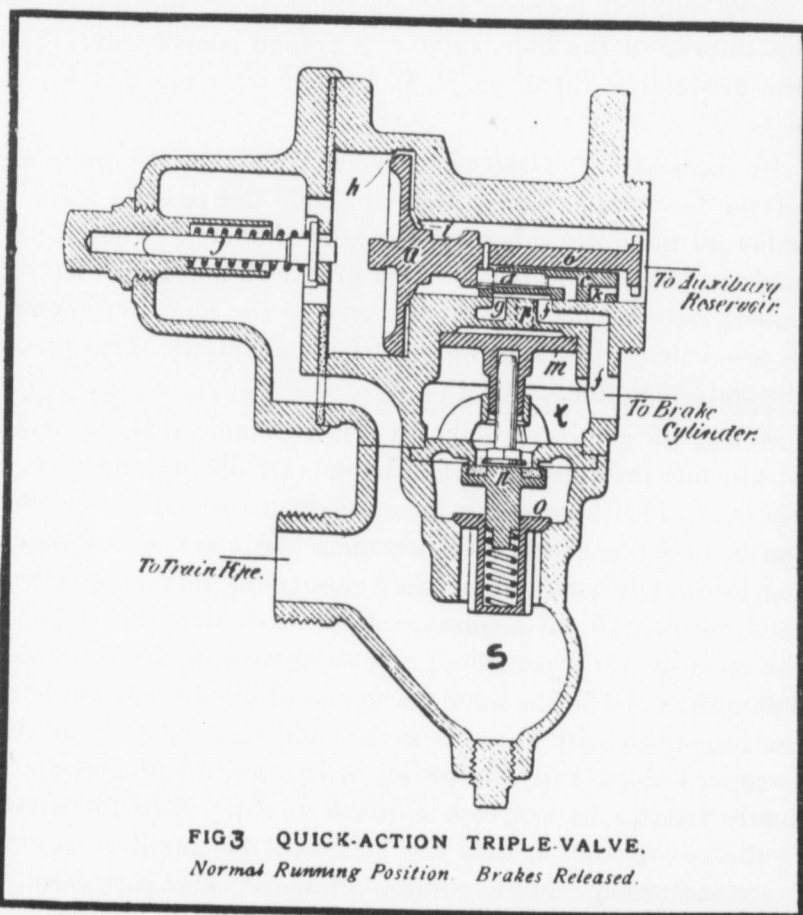

FIG 3 QUICK-ACTION TRIPLE-VALVE.
Normal Running Position. Brakes Released.

with the addition of a few more valves which render it more efficient in emergency applications than the plain triple.

Fig. 3 is a drawing of the Westinghouse Quick Action Automatic valve, with its parts in the normal running position with brakes released. If, the part p, and the chambers below it, s and t, were removed, the valve would be transformed into a plain triple.

The emergency parts of this valve are then, the chambers s and t, the piston m, and the valves n and o. The locations of the pipe connections to the train pipe, the auxiliary reservoir, and the brake cylinder are clearly indicated. A piston, a, is adapted to move backward and forward, while its stem, b, extends forward into a somewhat smaller valve chamber containing a slide valve c, which is loosely confined between two shoulders upon the piston stem. In the interior of the slide valve c, is a small poppet valve, d, called the graduating valve, which is secured by a pin to the piston stem b.

In the position of the parts shown in fig. 3, the compressed air from the train pipe enters through the passage ways and chamber on the outer side of piston a (to the left). Then it passes around the piston, through the feed grooves h and i into the valve chamber, from which it passes directly to the auxiliary reservoir. This reservoir is thus kept charged with air at the same pressure as the train pipe line.

When the engineer makes a service application, he reduces the train line pressure about five pounds by discharging a portion of the air. This lessens the pressure upon the outer face of the piston a, and the excess pressure upon the other side forces the piston to the left, at the same time closing the feed grooves h and i, thus cutting off all communications with the train pipe, and simultaneously withdraws the graduating valve d, from its seat in the slide valve. The shoulder at the end of the piston stem b, then comes in contact with the end of the slide valve c, which is thereafter moved along with the piston in its outward progress; which is finally arrested by contact with the stem j. Then the part e is over the passageway f, and the air from the auxiliary reservoir has a clear passage to the brake cylinder. The part e extends transversely through the slide valve and conducts air from the auxiliary reservoir into the passageway in the slide valve, which has now been uncovered by the outward movement of the graduating valve d. The discharge of air from the auxiliary reservoir to the brake cylinder is accompanied by a reduction of the air pressure in the auxiliary reservoir and the valve chamber of the triple valve, which continues until the pressure is slightly lower

than t
at the
pressur
until t
The pi
resistan
of the
cylinder
remain
which

If
makes
operati
pressed
ating,
graduat

TH
quick a
of the
charged
the pres
erance o
a to tra
the stem
passagew
m, bein
air from
which f
gency v
this inst
source h
while ha
auxiliary
valve o,
gency va
the train
cylinder,

than that of the air remaining in the train pipe, and at the chamber at the outside of the piston *a*. The slight preponderance of pressure on the outside of the piston causes it to move inwardly until the graduating valve *d* becomes seated in the slide valve. The piston is prevented from moving any further by the frictional resistance offered by the slide valve and its seat. Upon the closing of the graduating valve *d*, communication between the brake cylinder and the auxiliary reservoir is shut off, and the brakes remain applied with so much force as is due to the compressed air which has already been admitted into the brake cylinder.

If the engineer finds that he needs more braking force, he makes a further slight reduction in the train pipe, and the above operation is again repeated, admitting a further quantity of compressed air to the brake cylinder. This operation is called graduating, and entirely depends upon the proper working of the graduating valve *d*.

The above description applies both to the plain and the quick action triples in service stops. In an emergency application of the quick action triple a considerable quantity of air is discharged from the train pipe, causing a great difference between the pressures on the sides or faces of the piston *a*. This preponderance of pressure on the inner face of the piston causes the piston *a* to travel outwardly with more force, compressing the spring on the stem *j*, until it is arrested by the end of the chamber. The passageway *p*, which admits the compressed air above the piston *m*, being thereby uncovered, instantly conducts the compressed air from the auxiliary reservoir to the upper face of the piston *m*, which forces that piston downward and thereby opens the emergency valve *n*, as shown in Fig. 4. It is to be observed that at this instant, (1) the brake cylinder is empty, no air from any source having yet entered it; (2) the air pressure in the train pipe, while having been reduced considerably below the pressure in the auxiliary reservoir is still great, and has, by merely lifting the valve *o*, a capacious and unobstructed passageway, around the emergency valve *n*, into the empty brake cylinder. Thus the air from the train pipe lifts the check valve *o*, and rushes into the brake cylinder, until the pressure in the brake cylinder and the train

pipe are equalized. Then the check valve closes, shutting off all connections between the train pipe and the chamber *t*. The air which has been admitted to the brake cylinder, increases the available braking force which may be obtained in the brake cylinder.

The effect of the discharge of air from the train pipe into the brake cylinder of the first car does not merely more quickly

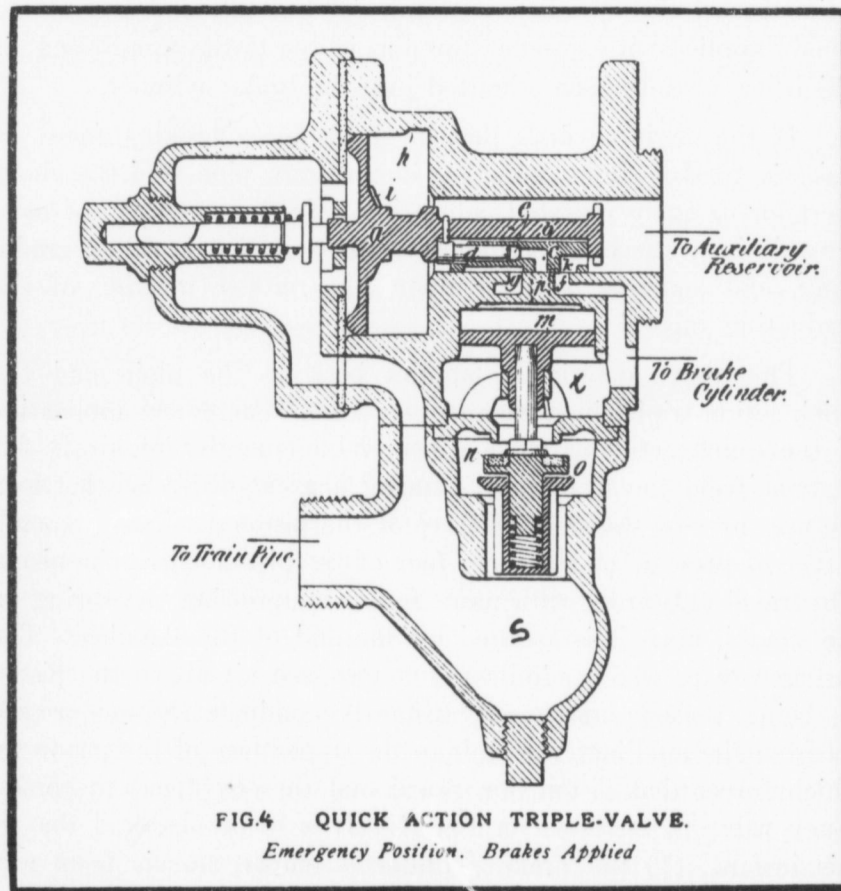

and powerfully apply the brakes on that car, but also causes a sudden and material reduction of the pressure upon the outer face of the piston *a*, on the next car. Thus the action which is described above is greatly accelerated on the whole train, the first triple hastening the action of the second, and the second the action of the third, etc., throughout the whole train.

To
pipe is
pressur
tion. A
for run
made f
haust p
from th

Th
quick a
matic i

Th
action p
remain
vice pa
ation o
indicate

"P
seat by
be open
valve 1
reservo
moves t

"M
and serv
which p
ing F, a
the pres
such tha
as in ser
opening

"A
stop will
this case
enough,
enough t

To release the brakes with both styles of triple, the train pipe is recharged to its normal pressure, which preponderance of pressure on the outer face forces the piston a, to its running position. At the same time the slide valve c, is carried to its position for running, as shown in Fig. 3, where a direct connection is made from the brake cylinder, through the passageway f, and exhaust port g, to the atmosphere. Thus the air being exhausted from the brake cylinder the brakes are released.

NEW YORK TRIPLE.

The New York Air Brake have also both a plain triple and quick action triple. Like the Westinghouse they are both automatic in their action.

The quick action triple is shown in Fig. 5. The quick action parts occupy the left and top portions of the drawing, and remain inoperative under ordinary service applications. The service parts occupy the central portion of the drawing, the operation of these parts can be traced on the drawing which clearly indicates them.

"Referring to the figure, the vent valve 71 is held to its seat by spring 132, assisted by train pipe pressure, and can only be opened when piston 129 is forced to the left. Quick action valve 138-139 is held to its seat by spring 140, assisted by the reservoir pressure, and can only be opened when piston 137 moves to the right."

"Main piston 128 has the same stroke both for emergency and service applications, but is extended to form a cylinder in which piston 129 is fitted. Through piston 129 is a small opening F, allowing the train pipe air to pass through and equalize the pressure on both sides. The dimensions of this opening are such that when the main piston 128, moves slowly to the left, as in service applications, the air in space G will be forced through opening F without disturbing piston 129 from its position shown."

"A sharp reduction of train pipe pressure for an emergency stop will cause main piston 128 to move rapidly to the left. In this case air from space G cannot flow through passage F fast enough, and exerts a momentary pressure upon piston 129, strong enough to overcome its resistance and cause valve 71 to be forced

from its seat. This allows train pipe air to enter the passage H and escape to the atmosphere through holes J and M, while at the same time, it forces piston 137 to the right, which unseats valve 139 and allows the full power of the reservoir pressure

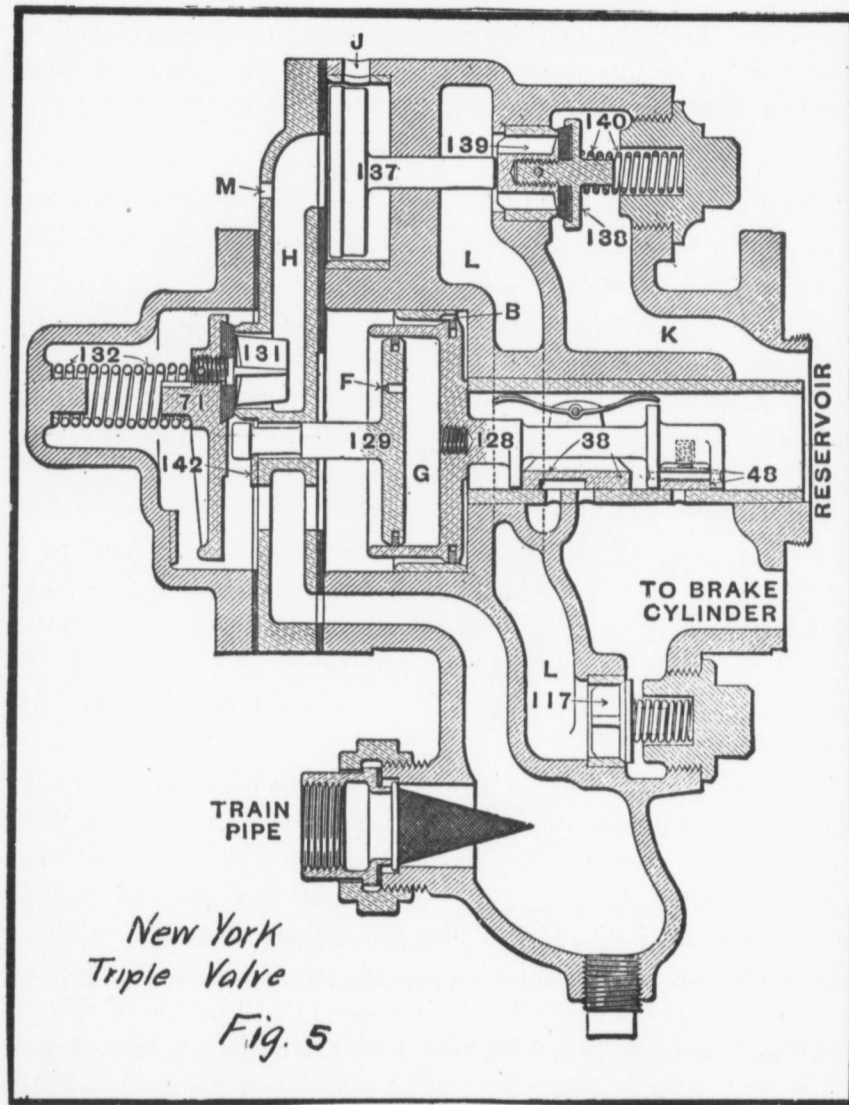

to be instantly effective in the brake cylinder through the large passageways K, L, and check valve 117."

"Meanwhile, as passage F is always open, the temporary pressure exerted by the air in chamber G, has rapidly lost its

effect,
stopping
reduced
returns
137 ha
in the

"T
48 to
auxiliar
brake c

"T
serial r
best ap
simple v
simplest
ditions,
propaga
in a qu
An eme
wherein
producin
to operat
sive imp
2.5 secon

The
car serv
to single
manual l
is so gre
their cars
air brake

The
securing
two ways
compresso
motor-car

effect, and spring 132 has returned valve 71 to its seat, thus stopping the escape of air when train pipe pressure is sufficiently reduced to properly apply the brakes. As valve 71 closes, it returns piston 129 to its original position. Valve 139 and piston 137 have also been returned to their former positions, as shown in the figure."

"Restoring the train pipe pressure causes the valves 38 and 48 to return to their normal positions as shown, allowing the auxiliary reservoir to be recharged, and the air to escape from the brake cylinder, thus releasing the brakes."

"The astonishing and almost inconceivable rapidity of the serial recurrence of quick-action triple value operation may be best appreciated by comparison with the rate of propagation of simple vibrations through a clear and quiescent atmosphere. The simplest illustration is that of sound, which, under ordinary conditions, travels at the rate of about 1,100 feet per second. The propagation of a sound disturbance to a distance of 2,000 feet in a quiet atmosphere, requires little more than 1.8 seconds. An emergency application of the brakes upon a fifty car train, wherein one piece of mechanism is caused to operate, thereby producing an impulse, which causes a second piece of mechanism to operate, and so repeated through fifty mechanisms with successive impulses, is serially propagated throughout the 2,000 feet in 2.5 seconds."

The increasing use of heavy and high speed cars in street car service, seems to make the application of the air brake even to single cars, a logical necessity. Under present conditions the manual labor and careful attention required by the hand-brake is so great, that the motormen are not able to retain control of their cars and make the most efficient stops. The principle of the air brake has been successfully adapted to the street cars.

The great difficulty in applying this style of brakes was the securing of compressed air. The air was finally compressed in two ways, first by attaching an eccentric, which worked an air compressor, to the axle of the car, and second by installing on the motor-car a rotary air pump driven by a motor. In the first

method about forty revolutions of the car wheels suffices to fill the reservoirs with air, at a pressure of 32 pounds. Having attained that pressure, a governor automatically cuts off in such a manner that the piston stops working against pressure. The motor-man applies the brake by simply turning the controlling valve, which allows the air to enter the cylinder. Only three pounds of the storage pressure are required for each application. When the brakes are released and the car starts again, the piston once more operates against pressure to restore the reservoir pressure to 32 pounds; but by an automatic device this does not begin until the car has gathered headway. Then only five revolutions are required to recharge the reservoir to its normal pressure.

In the second method or system the running of the air pump and the maintenance of the reservoir at the desired pressure is entirely independent of the speed of the car. The pump is driven by a motor which is supplied with electricity from the trolley wire. The current to the motor is automatically turned on or shut off as the reservoir pressure drops below or attains the desired pressure. Besides the motorman has control of the current supply to the motor if desired.

An important subject or division of this topic, is the relations which exist between the various forces which are brought into existence by an application of the brakes. Some of the problems which we will now discuss, bearing on this subject, are; first, the transfer of weight from the rear to the front truck during an application of the brakes; second, the transfer of a certain percentage of the weight borne by each pair of wheels of a four wheel truck when unbraked, from the rear to the front wheels when the wheels are braked; third, the relation between the brake shoe friction and the rail friction; fourth, the proper angle at which to hang the brake shoes, so that the brake shoe pressures may approach, as near as possible, those theoretical relations or values which we will determine in Problem I.

These problems were first discussed by Mr. R. A. Parke, who read a paper before the New York Railway Club in 1897, giving his views and solutions of the foregoing problems. He thus proceeded to consider and solve Problem I.

T
sustain
W
The fo
by an
plate o
case w
shoes a
is not

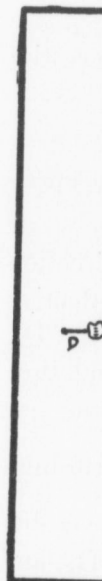

Let
is of co
body wh
P₂ :
H =
the cent
its veloc
force ap
D₁ :
a positiv

PROBLEM I.

To determine the proportionate weight which each truck sustains during an application of the brakes.

We will represent the car with its trucks removed by Fig. 6. The force which each truck exerts upon the car body is indicated by an arrow. This force must be exerted through the centre plate of each truck. In this case we are considering only the case where the brake shoes are hung from the trucks. Brake shoes are so seldom hung from the car body that their discussion is not very profitable.

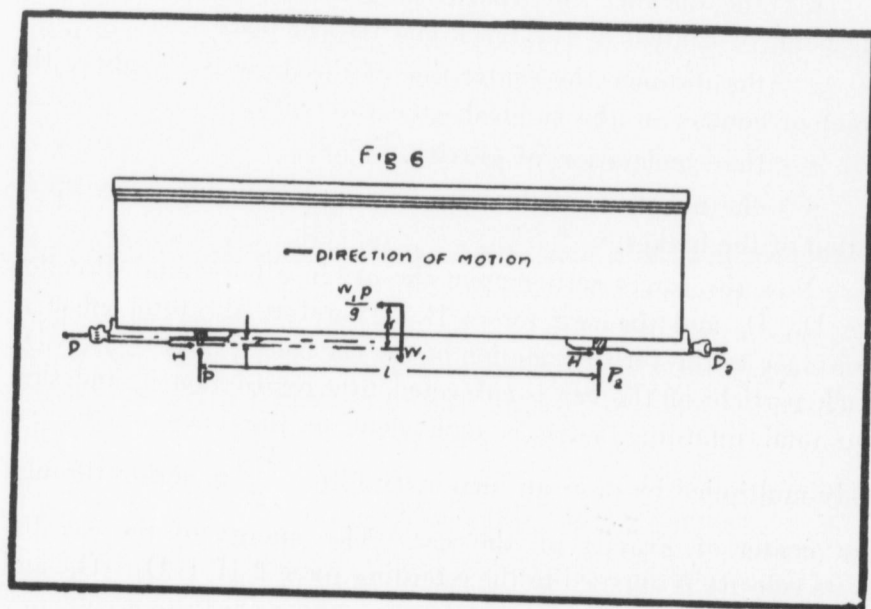

Let P_1 = the supporting force from the forward truck, which is of course the same as that portion of the weight of the car body which is born or carried by that truck.

P_2 = the supporting force from the rear truck.

H = the retarding force exerted upon the car body, through the centre plates, to reduce the energy of the car body due to its velocity and slacken its speed. We assume that the braking force applied to each truck is the same.

D_1 = the pull upon the draw bar. This quantity is generally a positive quantity when the car is empty and braked to its full

capacity and a locomotive attached ahead. Sometimes this force may become negative when the cars ahead push back upon the draw bar, or the unbraked cars in the rear are pushing this braked car into those ahead.

D_2 = the backward pull on the rear draw bar. This may be a positive quantity due to the action of the cars ahead or may be negative due to the action of the cars behind.

W_1 = the weight of the car body, acting through the centre of gravity of the car body.

l = the distance from centre to centre of the trucks.

k = the distance the centre of gravity is vertically above the point of contact of the truck and the car body.

z = the distance the centre line of the draw bar is above the point of contact of the car body and the truck.

g = the acceleration of gravity.

p = the negative acceleration or retardation due to an application of the brakes.

Now the forces acting upon the car in a horizontal direction are D_1 , D_2 and the two forces H . Therefore the total effective resistance to the forward motion of the car body is $2H + D_2 - D_1$. Each particle of the car is subjected to a retardation p , and thus the total retarding force is equivalent to the mass of the car body multiplied by p , or an imaginary force $\frac{W_1}{g}p$, acting through the center of gravity of the car. The energy of the car due to its velocity is opposed to the retarding force $2H + D_2 - D_1$; and thus the force $\frac{W_1}{g}p$ is equal and of opposite sign to the retarding force, and their algebraic sum is zero. That is

$$2H + D_2 - D_1 = \frac{W_1}{g}p; \text{ or } H = \frac{W_1}{2g}p + \frac{D_1 - D_2}{2}. \quad (1)$$

Taking the algebraic sum of the moments of the forces, real and imaginary, about the point of intersection of the forces H and P , at the front centre plate,

$$P_2l + (D_1 - D_2)z + \frac{W_1}{g}pk - W_1\frac{1}{2} = 0,$$

From which we get

$$P_2 = \frac{W_1}{2} - \frac{W_1}{g} \frac{k}{l} \cdot p - (D_1 - D_2) \frac{z}{l}. \quad (2)$$

Similarly by taking moments about the point of intersection of the forces H and P_2 at the rear center plate we get,

$$P_1 = \frac{W_1}{2} + \frac{W_1}{g} \frac{k}{l} \cdot p + (D_1 - D_2) \frac{z}{l}. \quad (3)$$

Now, $D_1 - D_2$ can never be a negative quantity. And z , even if it is negative, is always very small. Therefore from the two equations for P_1 and P_2 , it is evident that the sustaining force P_1 is always greater than the sustaining force P_2 during an application of the brakes. Or that portion of the weight of the car body supported by the forward truck during an application of the brakes is greater than that supported by the rear trucks.

Therefore to avoid skidding the wheels, consideration of the rear truck which bears the least weight is only necessary. This brings us to the second problem, namely the conditions which prevail on the rear truck during an application of the brakes. To simplify our calculations we will let the algebraic difference $D_1 - D_2 = D$. Then the force with which each truck retards the car body is

$$H = \frac{W_1}{g} p + \frac{D}{2}. \quad (4)$$

Also substituting the value D for $D_1 - D_2$ in equation (2) we get

$$P_2 = \frac{W_1}{2} - \frac{W_1}{g} \frac{k}{l} - \frac{D}{2} \frac{z}{l}. \quad (5)$$

which is the portion of the weight of the car body carried by the rear truck during an application of the brakes.

PROBLEM II.

To determine the conditions existing at the rear truck during an application of the brake.

The skeleton of the truck is shown in Fig. 7. The various forces which act on the truck are indicated, and defined as follows:—

R_1 = the pressure of the forward pair of wheels on the rails.

R_2 = the pressure of the rear pair of wheels on the rails.

T_1 = the retarding frictional force applied by the rails to the forward pair of wheels, and keeps up their continued rotation in spite of the friction of the brake shoes.

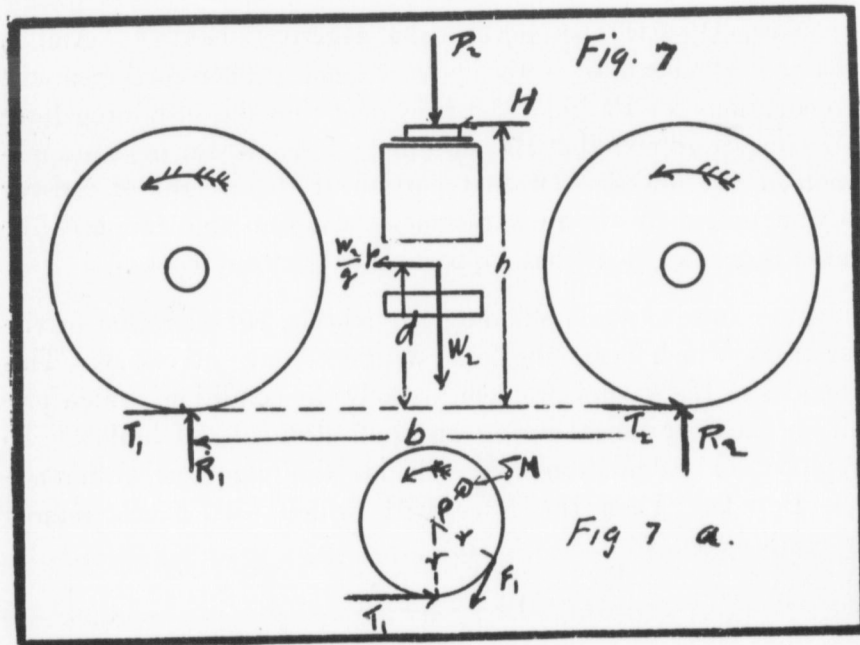

T_2 = the retarding frictional force applied by the rails to the rear pair of wheels, and keeps up their continued rotation in spite of the friction of the brake shoes.

P_2 = the pressure of the car body upon the rear truck. We obtained the value of this in Problem I.

H = the force with which the car body drags the truck forward. This we also obtained in Problem I.

h = the distance between the point of contact of the car body and the truck, and the top of the rail.

d = the distance the center of gravity is above the top of the rail.

b = the base of the truck.

W_2 = the weight of each complete truck.

Each particle of the truck suffers a retardation p , and the total retarding force absorbed by the truck is equal to the mass of the truck multiplied by p or $\frac{W_2}{g} p$. And this imaginary force acts at the center of gravity of the truck in opposition to the retarding forces, and must be the equivalent of the difference between the sum of the retarding forces $T_1 + T_2$ and the force H which urges the truck forward. Thus,

$$T_1 + T_2 - H = \frac{W_2}{g} p \dots \quad (6)$$

Now taking the algebraic sum of the moments of the real and imaginary forces, first about the point of contact of the rear pair of wheels and the rails, we get

$$Hh + W_2 \frac{b}{2} + P_2 \frac{b}{2} + \frac{W_2}{g} pd - R_1 b = 0.$$

Then taking moments about the point of contact of the forward wheels and the rails we derive—

$$Hh - W_2 \frac{b}{2} - P_2 \frac{b}{2} + \frac{W_2}{g} pd + R_2 b = 0.$$

Substituting in the last three equations the values of H and P_2 already determined, the equations become respectively:—

$$T_1 + T_2 - \frac{W_1}{2g} p - \frac{D}{2} = \frac{W_2}{g} p,$$

$$\frac{W_1}{2g} ph + \frac{D}{2} h + W_2 \frac{b}{2} + \frac{W_1}{2} \frac{b}{2} - \frac{W_1}{g} \frac{k}{1} p \frac{b}{2} - D \frac{zb}{12} + \frac{W_2}{g} pd - R_1 b = 0,$$

$$R_2 b + \frac{W_1}{2g} ph + \frac{D}{2} h + \frac{W_2}{g} pd - W_2 \frac{b}{2} - \frac{W_1}{2} \frac{b}{2} + \frac{W_1}{g} \frac{K}{1} \cdot p \cdot \frac{b}{2} + D \frac{z}{1} \cdot \frac{b}{2} = 0.$$

From the first of these equations

$$p = \frac{2T_1 + 2T_2 - D}{W_1 + 2W_2} g. \quad (7)$$

Again, substituting in the second and third of the above equations the value of p and collecting similar terms, we get—

$$\frac{W_1\left(h - \frac{bk}{l}\right) + 2W_2d}{W_1 + 2W_2}(T_1 + T_2) + \left\{ \frac{W_1\left(\frac{bk}{l} - h\right) - 2W_2d}{W_1 + 2W_2} + h - \frac{bz}{l} \right\} \frac{D}{2} + (W_1 + 2W_2)\frac{b}{4} - R_1b = 0.$$

$$R_2b + W_1\left(h + \frac{bk}{l}\right) + 2W_2d - \frac{W_1\left(h - \frac{bk}{l}\right) + 2W_2d}{W_1 + 2W_2}(T_1 + T_2) + \left\{ h + \frac{bz}{l} - \frac{W_1\left(h - \frac{bk}{l}\right) + 2W_2d}{W_1 + 2W_2} \right\} \frac{D}{2} - (W_1 + 2W_2)\frac{b}{4} = 0.$$

Solving these equations for R_1 and R_2 respectively, substituting for $W_1 + 2W_2$, the complete weight of the car, body and two trucks, the term W ,

$$R_1 = \frac{W}{4} + \frac{W_1\left(\frac{h}{b} - \frac{k}{l}\right) + 2W_2\frac{d}{b}}{W}(T_1 + T_2) + \frac{W_1\frac{k-z}{l} + 2W_2\left(\frac{h-d}{b} - \frac{z}{l}\right)}{2W}D$$

$$R_2 = \frac{W}{4} - \frac{W_1\left(\frac{h}{b} - \frac{k}{l}\right) + 2W_2\frac{d}{b}}{W}T_1 + T_2 - \frac{2W_2\left(\frac{h-d}{b} + \frac{z}{l}\right) - W_1\frac{k-z}{l}}{2W}D.$$

R_1 and R_2 are the pressures of the forward and rear wheels upon the rails, when T_1 and T_2 are the retarding frictions exerted upon the wheels by the rails, and D is the algebraic difference of the pulls on the forward and rear drawbars.

Now the co-efficient of $T_1 + T_2$ in each of the last two equations, is under all conditions of ordinary service a positive quantity. Therefore, the sign before each second term remains unalterable. Again the co-efficient of D is also a positive quantity and the algebraic sign of the last term is unalterable. Under certain conditions the value of the co-efficient of D in the last equation, becomes very small, but does not become negative. When D is zero the last terms disappear. The car is then free and braked to its full capacity. In this case it is evident that R_1 is larger than R_2 . And the sign of co-efficient of D remaining unalterable R_1 is evidently greater than R_2 . Therefore we conclude that

under a
same p
most li
shoe pr
will no

No
of whee
depende
wheels,

Ar
a maxim
7 may

D
then be
assumin
mum va
pushed
Substitu
minimum
brake sh

Eq
determin
wheels.
prevent
And the
are direc
Of
forward
that a m
of wheel

under any conditions when the brake shoes are applied with the same pressure to each pair of wheels, the rear pair are the most liable to slide upon the rails; and thus the maximum brake shoe pressure should be so designed that the rear pair of wheels will not slide when the brakes are applied.

Now the greatest pressure upon the rails of the forward pair of wheels which at all times and under all circumstances may be depended on for rail friction to cause continued rotation of the wheels, is when $D = 0$.

$$R_1 = \frac{W}{4} + \frac{W_1 \left(\frac{h}{b} - \frac{k}{l} \right) + 2W_2 \frac{d}{b}}{W} (T_1 + T_2). \quad (8)$$

And under the same conditions R_2 is a minimum when D is a maximum. To determine the maximum value of D , equation 7 may be transformed into the form

$$D = 2T_1 + 2T_2 - \frac{W}{g} p \dots \quad (9)$$

D and p are the only variables in this equation; and D will then be a maximum when p is a minimum. We are justified in assuming that the minimum value of p is zero. Then the maximum value of D is $2T_1 + 2T_2$. This occurs when the car is pushed forward from a state of rest with the brakes fully applied. Substituting this value of D in the equation for R_2 we get the minimum pressure of the rear pair of wheels upon the rails. The brake shoe pressures must be designed for this.

$$R_2 = \frac{W}{4} - \left(\frac{h}{b} + \frac{z}{l} \right) (T_1 + T_2). \quad (10)$$

Equations (9) and (10) are the fundamental equations for determining the proper brake shoe pressures for each pair of wheels. The rail frictions T_1 and T_2 which are obtainable to prevent skidding of the wheels are proportional to R_1 and R_2 . And the maximum brake shoe pressures upon both pair of wheels are directly dependent on the values of T_1 and T_2 .

Of course it is customary to apply the same pressure to the forward as to the rear pair of wheels; but our reasoning shows that a much greater pressure could be applied to the front pair of wheels with no greater danger of sliding.

PROBLEM III.

Our next problem is to find the relation between the brake shoe friction and the rail friction; or to determine the maximum safe brake shoe friction upon each pair of wheels.

Let f_1 = the coefficient of static friction between the wheels and the rails.

Then

$$T_1 = f_1 R_1, \text{ and } T_2 = f_1 R_2,$$

or,

$$R_1 = \frac{T_1}{f_1}, \text{ and } R_2 = \frac{T_2}{f_1}.$$

Let F_1 = that friction between the brake shoes and the wheels which is necessary to cause the rail resistance T_1 upon the forward pair of wheels.

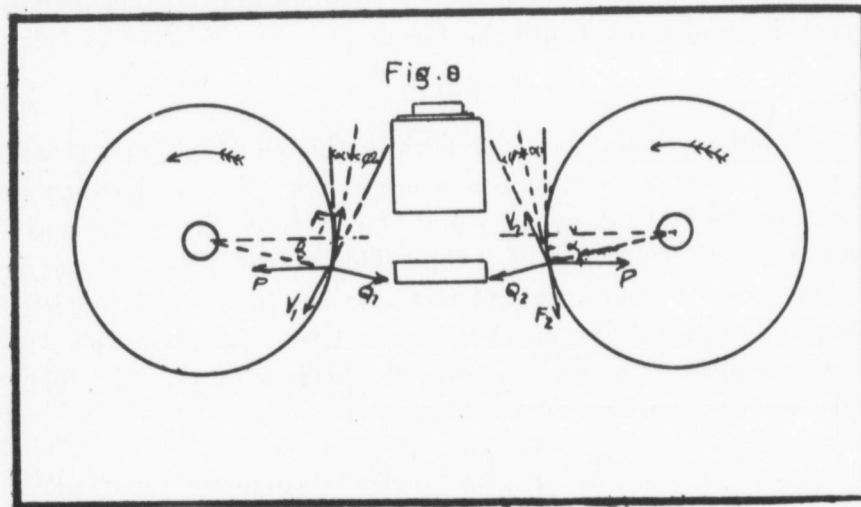

F_2 = that friction between the brake shoes and the wheels which is necessary to cause the rail resistance T_2 upon the rear pair of wheels.

In Fig. 8 are shown the forces that affect the relation of the forward pair of wheels. T_1 is the frictional force which causes rotation and F_1 is the frictional force resisting rotation, and is caused by the brake shoes. Let r be the radius of the wheel and ρ be the distance of any elementary mass, dM , of the wheels from the center. The retardation at the periphery of the wheels

is the same as that of the car, and the retardation at the distance ρ from the centre is $\frac{\rho}{r}p$.

The force which is exerted on the mass dM to cause a retardation at the rate $\frac{\rho}{r}p$ is $dM \frac{\rho}{r}p$. The friction F_1 must be sufficient to produce this retarding force upon each elementary mass of the pair of wheels, and also to cause the frictional resistance T_1 at the rails. Now taking the algebraic sum of the moments about the center line of the wheels, we get

$$F_1 r - T_1 r - \int dM \frac{\rho}{r} p = 0,$$

or

$$F_1 = T_1 + \frac{p}{r^2} \int dM \rho^2$$

$$= T_1 + M \frac{r_1^2}{r^2} p.$$

In the above equation r_1 is the radius of gyration of each wheel, M represents the mass of both wheels. If $w =$ the weight of each wheel, then $M = \frac{2W}{g}$. From careful calculations it has been found that the square of the radius of gyration is equal to 0.6 times the square of the radius of the wheel. Substituting these values in the above equation,

$$F_1 = T_1 + \frac{1.2w}{g} p \dots \quad (11)$$

Proceeding to consider the rear pair of wheels as we have the forward we obtain for the value.

$$F_2 = T_2 + \frac{1.2w}{g} p \dots \quad (12)$$

The value of p is given in equation (7) where

$$p = \frac{2T_1 + 2T_2 - D}{W_1 + 2W_2} g \quad (13)$$

Since we desire to find the condition which exists when the weight supported by each wheel is a minimum, we will consider the values of F_1 and F_2 when R_1 and R_2 are minimum values.

We have previously shown that when $D = 0$, R_1 is a minimum, and then the value of p is

$$\frac{2T_1 + 2T_2}{W_1 + 2W_2}g \text{ or } \frac{2T_1 + 2T_2}{W}g.$$

During an emergency application of the brakes F_1 and F_2 have a fixed value, and the values of T_1 and T_2 are obtained when R_1 is a minimum, from the following equations.

$$F_1 = T_1 + \frac{2.4w}{W}(T_1 + T_2); \quad F_2 = T_2 + \frac{2.4w}{W}(T_1 + T_2)$$

Solving for T_1 and T_2 we get,

$$T_1 = \frac{W + 2.4w}{W + 4.8w}F_1 - \frac{2.4w}{W + 4.8w}F_2 \quad (14)$$

$$T_2 = \frac{W + 2.4w}{W + 4.8w}F_2 - \frac{2.4w}{W + 4.8w}F_1 \quad (15)$$

Substituting these values for T_1 and T_2 in equation (8), bearing in mind that $R_1 = \frac{T_1}{f_1}$, equation (8) becomes

$$\frac{(W + 2.4w)F_1 - 2.4F_2}{f_1(W + 4.8w)} = \frac{W}{4} + \left\{ \frac{W_1}{W} \left(\frac{h}{b} - \frac{k}{l} \right) + \frac{2W_2d}{Wb} \right\} \frac{W(F_1 + F_2)}{W + 4.8w} \quad (16)$$

Now when R_2 is a minimum D is a maximum, and $p = 0$. Therefore, under these conditions $F_1 = T_1$ and $F_2 = T_2$ obtained from equations (11) and (12). Substituting these values for T_1 and T_2 bearing in mind that $R_2 = \frac{T_2}{f_1}$ equation (9) becomes,

$$\frac{F_2}{f_1} = \frac{W}{4} - \left(\frac{h}{b} + \frac{z}{l} \right) (F_1 + F_2) \dots \quad (17)$$

Combining equations (16) and (17) we get two equations from which we can obtain the values of F_1 and F_2 , which will be the maximum brake shoe frictions upon the forward and rear pair of wheels, and may be used with perfect safety from wheel skidding in an emergency application of the brakes.

$$F_1 + F_2 = f_1 \frac{W}{2} - \frac{\frac{1}{f_1}(W + 4.8w)}{W_1 \left(\frac{1}{f_1} + \frac{k+z}{l} \right) + 2W_2 \left(\frac{1}{f_1} + \frac{h-d}{b} + \frac{z}{l} \right) + 4.8w \left(\frac{1}{2f_1} + \frac{h}{b} + \frac{z}{l} \right)} \quad (18)$$

and

$$F_1 - F_2 =$$

So
less wei
weight
This le
the bra
the grea

The
brake sh
ation of

Fig
upon ea
in line
shoe. T
shoes ex
force F_1
with wh
of wheel

and

$$F_1 - F_2 = f_1 \frac{W}{2} - \frac{W_1 \left(2 \frac{h}{b} - \frac{k-z}{l} \right) + 2W_2 \left(\frac{h+d}{b} + \frac{z}{l} \right) + 4.8w \left(\frac{1}{2f_1} + \frac{h}{b} + \frac{z}{l} \right)}{W_1 \left(\frac{1}{f_1} + \frac{k+z}{l} \right) + 2W_2 \left(\frac{1}{f_1} + \frac{h-d}{b} + \frac{z}{l} \right) + 4.8w \left(\frac{1}{2f_1} + \frac{h}{b} + \frac{z}{l} \right)} \quad (19)$$

So far we have determined that, first, the rear truck supports less weight than forward truck, and the rear pair of wheels less weight than the forward pair during an application of the brakes. This led us to the conclusion that if we design our riggings for the brake pressures, the front wheels of each truck must receive the greater pressures than the rear wheels.

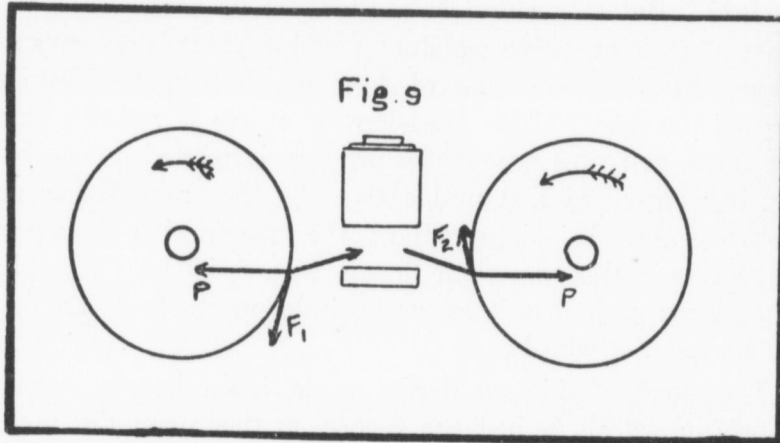

The following discussion will show that this inequality of brake shoe pressures may be provided for by the proper inclination of the brake hangers.

PROBLEM IV.

Fig. 9 represents diagrammatically the action of the brakes upon each pair of wheels of a truck, when the brake hangers are in line with the tangent to the wheel at the centre of the brake shoe. The same pull P is applied to each brake beam. The brake shoes exert on the forward pair of wheels a downward frictional force F_1 , and on the rear pair an upward frictional force F_2 . Now with whatever force the shoes act downward on the forward pair of wheels, the wheels will react with an equal and opposite force.

Similarly the rear pair of wheels will react with an equal and opposite force to F_2 . Considering the forward pair of wheels, the upward force F_1 is directly resisted by the brake hangers, which are now under compression equal to the force F_1 . Similarly the rear brake hanger is subjected to a tension equal to the frictional force F_2 .

Consider now an exaggerated case, in which the angularity of the brake hangers is increased, as shown in Fig. 9. Each brake beam is subject to the same pull P . When the front brake shoes have been brought into contact with the forward pair of wheels, the force which is brought into existence by the friction of the two surfaces, tends to carry the shoe upward, along the surface of the wheel. But this action is resisted, by its brake hangers, on account of their excessive angularity. Thus there is a very strong tendency to force the forward pair of wheels away from the centre of the truck. This tendency of course is resisted by the truck frame and thus a powerful pressure is exerted on the brake shoes, in addition to that pull exerted by the brake beams upon the brake shoes. In this way the brake shoe friction F_1 is materially greater in this case than that in Fig. 8, where the angle of the hanger is such that it exerts no influence to force the brake shoes against the wheels.

The effect of this angularity of the brake hanger upon the rear pair of wheels is just the reverse to that upon the forward pair. The reacting downward friction of the rear pair of wheels upon the brake shoes tends to force the brake shoes away from the wheel. This tendency diminishes the frictional force which retards the velocity of the wheels. Now if the angularity is so increased that the brake hanger would be parallel or in line with the pull P then the frictional force practically becomes zero upon the rear pair of wheels, while the mere initial contact between the brake shoes and the forward pair of wheels would almost instantly result in creating such a high frictional force F_1 that the wheels would immediately be locked and skidded.

Therefore, we must conclude from this that between these two extreme cases or limiting values of the angle of angularity it is possible to so adjust your brake shoe hangers, that the increased and diminished weights supported by the front and rear

trucks
ward v
Thus v
way de
brake s

It
in the
will no
of the
reverse
leading
shoe pr
pressur

TH
meet th
wheels.

Th
brakes,
into ex
extent,
is movi
rails ca
tire mo
moving
ward m
moment
brakes a
to mov
more d
either i
keep up
force is
to rest
brakes
friction
then eq
rail. T
between

trucks will be taken care of by the increased pressure on the forward wheels, and the diminished pressure upon the rear ones. Thus we may proportion the frictional forces F_1 and F_2 in any way desired by a proper adjustment of the angularity of the brake shoe hanger.

It will also be observed that, if in Fig. 9 the wheels rotate in the opposite direction, what has been the rear pair of wheels will now become the forward pair. At the same time the effect of the inclined hangers upon the two pairs of wheels has been reversed, so that it is still, under the reversed conditions, the leading pair of wheels which is subjected to the greater brake shoe pressure, and the rear pair which is subjected to the reduced pressure.

Thus we are enabled by this method to design brakes to meet this transfer of weight from the rear to the forward pair of wheels.

The following description of the general action of railway brakes, and the nature of the frictional forces which are brought into existence, through an application of the brakes, is to some extent, a repetition of the discussion of Problem I. When a train is moving at a given velocity the adhesion of the wheels on the rails cause them to rotate. Every point on the surface of the tire moves around at the same rate as that at which the train is moving forward. But every such point, in relation to the forward movement of the train, comes successively to rest at the moment when it comes in contact with the rail. Now when the brakes are applied with a slight pressure only, the wheel continues to move round at the same rate as the train is moving, but with more difficulty. This increased difficulty in moving is shown, either in an increase in the traction force, which is required to keep up the forward movement, or, in cases where the accelerating force is not kept up, by the tendency of the moving mass to come to rest in a shorter time. But if the pressure with which the brakes are applied be increased, a point is reached, at which the friction between the brake shoes and the wheels first approaches, then equals and finally exceeds the adhesion of the wheel to the rail. This adhesion corresponds to the static friction which exists between two surfaces at rest. The point on the circumference

of the wheel, which is in momentary contact with the rail is at rest during that instant. Thus we apply the ordinary equations for static friction to obtain this adhesive force between the wheels and the rails. Now when the friction between the brake shoes and the wheels exceeds the static friction between the wheels and the rails, the wheels first begin to revolve more slowly, and finally cease to revolve at all and slide along the rails. In this case the static friction between the wheels and the rails changes to dynamical friction, or the friction caused by one surface moving over another. The coefficient of dynamical friction is much less than the coefficient of static friction. This has been proved by experiment. And thus the retardation in this case is much less than that in the previous one. Therefore, the most efficient and the quickest stops are made, when the friction between the brake shoes and the wheels is a little less than the friction which can be obtained between the wheels and the rails.

The friction between the brake shoes and the wheels is a variable quantity, depending on the coefficient of friction between these moving surfaces. Captain Galton in a series of exhaustive tests and trials of railway brakes during the years 1878 and 1879, succeeded in obtaining the relation between the coefficient of friction and the velocity of the train. As the velocity of the train increases the coefficient of friction decreases. This is plainly indicated in the following table, constructed from Captain Galton's experiments.

V.	COEFFICIENT OF FRICTION f .		V.	COEFFICIENT OF FRICTION.		
	Calculated.	Observed.		Calculated.	Observed.	
0	.326	.330	45	.126	.127	...
5	.277	.273	50	.118	.116
10	.241	.242	55	.111	.111
15	.213	.223	60	.105	.074
20	.191	.192	65	.099
25	.173	.166	70	.094
30	.158	.164	80	.085
35	.146	.142	90	.078
40	.135	.140	100	.072

These values of f can only be used, when the conditions are the same as those under which these trials were conducted. that is with cast iron shoes and steel tired wheels.

C
found
so that
tion be
the wh
hesion
same w
the san
no mat
that th
speed i
make u
and still

An
was tha
increase
decrease
"Each
hills an
are thes
these su
table ill

Dynami
Cast
S

Just coming
When movi
"
"
"
"
"
"
"
"

It is
which if
II

Captain Galton from a further study of his experiments, found that the point at which the rotation of the wheels is arrested, so that they slide on the rails, depends upon the amount of friction between the brake shoe and the wheel, the weight upon the wheel, and the condition of the rails which govern the adhesion between the wheels and the rails. Therefore, with the same weight upon the wheels, and the rails in a similar condition, the same amount of friction will stop the rotation of the wheels, no matter at what speed they are revolving. The relation then that the speed has to this subject is, as stated before, that as the speed increases the brake shoe pressure must also be increased to make up for the decrease in the value of the coefficient of friction and still maintain the friction constant or a maximum.

Another feature that was brought out by these experiments, was that as the duration of time of the application of the brakes increased, the friction between the brake shoes and the wheels decreased. This the above experimenter explains as follows:—“Each surface is composed of a series of small mountains and hills and the longer the surfaces remain in contact, the quicker are these irregularities worn down, and thus the friction between these surfaces will at the same time decrease.” The following table illustrates the point fully:

Dynamic Friction Cast Iron or Steel.	VELOCITY.		COEFFICIENT OF FRICTION.				
	Ft. per Sec.	Miles per hour	At Com- mence- ment.	After 5 Secs.	After 10 Secs.	After 15 Secs.	After 20 Secs.
Just coming to rest.....	1 to 3	$\frac{3}{4}$ to 2	.250				
When moving at.....	10	6.8	.242				
“ “	20	13.6	.213	.193			
“ “	25	17.0	.205	.157			
“ “	30	20.4	.182	.152	.133	.110	
“ “	40	27.3	.171	.130	.119	.116	.099
“ “	45	30.7	.163	.107	.099	.081	.072
“ “	55	37.5	.152	.096	.083	.069	
“ “	60	40.9	.144	.093	.070		
“ “	70	47.7	.132	.080	.070		
“ “	88	60.0	.072	.063	.058		

It is evident from consideration of Table I, that the pressure, which if applied would stop the rotation of the wheels when the

velocity is great, is much larger than that required to stop them when their velocity is small. Thus we may apply to the brake shoes at the beginning of the application of the brakes when the speed is high, an excessive pressure; and as the speed slackens gradually reduce this pressure, so that there will be no liability of the wheels ceasing to revolve before the train is brought to rest.

The force which may be exerted on the brake shoes besides being dependent on the speed of the train, is also dependent on the condition of the rail. The condition of the rail affects the coefficient of adhesion between the rail and the wheel. And since the frictional force caused by the brake shoes must not exceed the friction between the wheel and the rail, the brake shoe pressure, which may be used is dependent upon the coefficient of adhesion. The following table gives approx results showing the proportion that the brake pressure should bear to the weight on the wheels at different speeds and with different coefficients of adhesion for the rail and wheel contact.

SPEED.		APPROXIMATE RATIO.			
Feet per hour	Miles per hour	Coef. of adhes. .30	Coef. of adhes. .25	Coef. of adhes. .20	Coef. of adhes. .15
11	7.5	1.2	1.04	0.83	0.60
22	15.0	1.41	1.18	0.94	0.70
29	20.0	1.64	1.37	1.09	0.82
44	34.0	1.83	1.53	1.22	0.92
59	40.0	2.07	1.73	1.38	1.04
73	50.0	2.48	2.07	1.65	1.24
88	60.0	4.14	3.47	2.77	2.08

The coefficient of adhesion is affected by the condition of the rails. In wet weather and with a greasy rail the coefficient is small. With a dry rail the coefficient is high. If sand is applied under each wheel when the rail is in its worst condition, the coefficient is increased to near the value it has when the rail is dry.

For passenger service 90% of the weight of the car, when empty, is the maximum brake force allowable. And for freight service 70% of the weight of the car when empty, is the maximum allowable brake force.

T
that h
signal
crease
grade
being
splend
perfect
contin
comple
ranted
expensi
ning sp
distance
necessar
and so
ning so
a mile a
the train
day and

Th
without
portance
on impo
ping a t
the aid
safety an

The
course, h
apparatu
locking t

SIGNALING.

By R. LATHAM.

There is perhaps no other branch of railroad engineering that has taken such great strides within the last thirty years as signaling. Its growth has necessarily accompanied the vast increase of traffic, higher speed of trains and the multiplication of grade crossings, both highway and railroad, the latter of course being the most important. We have to look to some of those splendid systems in the United States to find perhaps the most perfect systems of signaling. The mileage of railroads on this continent is necessarily very great, hence the great expense of complete signal equipment; yet the demands of traffic have warranted in some cases, the installation of the most modern and expensive apparatus to protect the trains while running at lightning speed, and to keep them so spaced that there shall be ample distance in which they may be brought under full control and if necessary to a dead stop, in case of derailments or accidents ahead, and so avoid collision. Protected in this way we have trains running sometimes within sight of each other at speed greater than a mile a minute without the slightest danger of collision (provided the trainmen are in their proper senses), all signals being visible day and night.

The problem of grade crossings have been greatly simplified without elevation or depression of tracks. This is of great importance, especially in America where there are so many even on important roads. The clumsy and costly precaution of stopping a train at every grade crossing is now done away with by the aid of interlocking apparatus and signals, with the greatest safety and success.

The first expense of installing these interlocking plants is, of course, high, involving as they do a system of signals and derailing apparatus with the necessary mechanical connection with an interlocking tower, and there is the secondary and constant expense

of manual operation. But it has been found that even with the lightest traffic on single or double tracked roads that the sum saved annually pays a high rate of interest upon the investment.

A great deal could be written on the subject of signaling. It is not in its highest stage of development and so far its fundamental principles are not by any means numerous. Experience has taught that to space trains by time is vastly inferior to spacing them by distance, but it is a strange fact that only about fourteen per cent. of the railroads in America use the latter system, the rest using the former or some modification of it. The idea of the "space interval" system originated in England where the "time interval" system also was in use, and it was only a short time after the first trains were run under the space interval or block system that practically every English road had adopted the same system. In America the "time interval" system, which is practically a flagging system when trains become disabled, was in use as in England, but unlike the English, the "train despatcher" system was introduced as an intermediate step between the "time interval" and block systems, two systems which vary so much in their principles. It is a fact worthy of note, that wherever the block system has been introduced, it has never been abandoned, so satisfactory have been its results.

In this paper, no attempt will be made to exhaust the subject, but a sketch of English and American practice will be drawn, paying more attention to the latter, as it seems to show signs of higher development than the former, although the English still hold the record for the least number of accidents due to false signals. The fact that the English ideas of signaling are far more conservative than American, perhaps accounts for the fact that there are practically no automatic block signals in England, while in America they are becoming numerous, owing to their economy and satisfactory results. It is the intention of the writer to compare briefly the English and American practice after the principles of each have been described, so that the relative advantages and defects of each may be noted; the reader of course being at liberty to judge for himself from remarks made, which seems to him the better practice of the two.

by E
about
its ad
of suc
of sig
T
of ou
trains
into se
traffic.
blocks
less fre
is perm
succeed
tower
block c
time of
of him.
a train
that san
the latte
The
for the l
cal "lock
methods
towers p
block), k
block at
cabins ar
from mai
often pla
switches n
and 900
may be w
town its

MANUAL BLOCK SIGNALING.

Manual block signaling is the system universally employed by English double tracked roads. The system was introduced about 1853, and subsequently parliament passed an act requiring its adoption by all important passenger lines. The consideration of such a system means a study of English practice, with its forms of signals, colors, and rules of operation.

The term "block signaling" is applied to that arrangement of outdoor signals and electric communication by which two trains may be kept spaced. In other words, the line is divided into sections or blocks whose lengths vary with the necessities of traffic. Lines with heavy traffic or great frequency of trains, have blocks a mile in length and sometimes less; those which run trains less frequently, have sections as long as five miles. Only one train is permitted to be in a block at a time and permission to enter a succeeding block is given by an attendant situated in a signal tower at the beginning of that block. The attendant at each block cabin keeps watch of the trains passing him, records the time of their arrival and informs the attendant at either side of him. He sends to the signal tower in advance a warning that a train is approaching and to the tower in the rear the assurance that same train has arrived and passed his cabin, thus authorizing the latter to set his signals for a second train.

The English block system has remained practically unchanged for the last quarter of a century. The invention of new mechanical "locking" devices has wrought some slight changes, but the methods have remained the same. A series of signal cabins or towers placed at different distances (according to the length of the block), keep the trains so spaced that only one train can be in a block at once (except when "permissive" blocking is done). These cabins are so located that they can operate switches and cross-overs from main lines. Near important towns and junctions they are often placed within sight of each other, as the distance from switches must not exceed about 540 feet in the case of split switches, and 900 feet in the case of throw switches, in order that they may be workable. When once a train has been despatched from a town its running is left entirely to the cabin operators, so that

safe handling depends entirely upon the watchfulness and obedience to rules on the part of the operators themselves. The operation of one signalman is contingent upon that of another owing to the use of electric locking apparatus between two succeeding cabins, and by having electrical communication, both may act in conjunction.

When operator at A wishes to send a train into the block section A-B by push button and bell signal, he registers "be ready" on an indicator instrument with which each cabin is supplied, and then it is repeated back to A, whereupon the operator at A gives a description of train by bell signal, and if B is ready to accept train, he puts the handle of his instrument in the position meaning that he accepts train. This causes indicator at A to go to "line clear," whereupon A can set his signals at "safety," after which he gives a dial signal to B, showing train on line, which B acknowledges. Such messages require only a few seconds for transmission, so that the fastest flyer may proceed from block to block finding signals set at "safety" for each block, although normally at danger. When the blocks are short and trains frequent it will sometimes keep the signalmen on the alert, to have their signals properly set, and in this case the operators are permitted to give the warning "be ready" in advance, so that the signals may be "pulled off" considerably in advance of passing trains.

Sometimes more than one train is permitted into a block at one time. This is called "permissive" blocking, and is only practiced on busy freight tracks, on block sections in large cities. The operator A records the number of trains he has allowed into the block, and operator B recording when each train leaves the block, keeps operator A posted as to how many trains are left in the block.

Form of Signals.

Practically the only form of signal in use on the important lines of England, are of the semaphore type. For main line switches a ground disc signal is used. The almost exclusive use of the semaphore type is the result of a joint agreement of the roads. The Board of Trade, which has power from parliament

to ce
comm
it ha

or an
being
home
tail e
from
face
the a
positi
When
horizo
the se
Englis
block
signal
ing to

T
red on
a black
green f
white
on the
to anot
to be a
taken.
land an
is the
tive col
mistake
signal.
of white
ments o

to control in some respects the railroads of Great Britain, has recommended the universal employment of the semaphore type and it has therefore become the standard signal for practically all lines.

The English semaphore differs little from others; the blade or arm is about 6 feet long and 9 inches wide throughout there being no taper to the arm, unlike the American. The blades of home signals have square ends, those of distant signals have fish-tail ends. Those for low speed or freight tracks are distinguished from those for high speed tracks by a white circular ring on the face and a black one on the back. The horizontal position of the arm is taken to mean "danger" or "stop," while the inclined position (at 45° or 60° with the horizon) "safety" or "proceed." When there is nothing on line these are set at danger or in the horizontal position, or, in other words, the "normal" position of the semaphore is always at "danger." This seems to be a rule of English railroad signaling that is observed on every road. The block signals are interlocked with main line switches nearby, the signal cabins being so placed as to serve the purpose of interlocking towers for the switches.

Color of Signals.

The blades of the home and distant signals are painted alike, red on face with a white band across it, and white on back with a black band across it. Nearly all important roads have adopted green for safety and red for danger for night signals. Originally, white was the standard color for safety, which is still the case on the majority of roads in America. To change from one color to another means a great expense to a railroad, so it would have to be almost a case of compulsion before such a step would be taken. The fact that in such a densely populated country as England an observer at night would see nothing else but white lights is the reason for such a change. It was found that a distinctive color for safety was required so that the engineer would not mistake the light on some bridge, or in a house, for his safety signal. This is perhaps the strongest objection raised to the use of white light for safety, and it has had such weight with managements of the various roads, that in spite of the great expense in-

involved, they have one and all abandoned the white and adopted the green light for safety.

A second reason for the change from white to green, lies in the fact, that it was the custom of some roads to have their semaphores show a green light (meaning caution) in large stations and busy yards, as the running of trains through these parts had to be done with the greatest caution. The arm would be set at "safety" while the light indicated "caution." In the country the arm would be set at safety while the light indicated "proceed." This inconsistency led to the belief that a signal meaning caution should be discarded as unsafe, and that there should be but two signals, "stop" and "proceed," and if caution in running through certain districts be required, let it be expressed by order board or written order.

Placing of Signals.

The position of signals, so that they may be viewed with ease, is a problem not always easy to solve. The shape of the road, the presence of cuts or bluffs, will present difficulties in placing signals. In England, railroads run exclusively on the left hand tracks, and this practice is carried on to some extent in America. In most cases the signal posts are placed to the left of the track they govern, the arm pointing away from it. This is the rule, but it often happens on curves that the signal post governing the left hand track is placed on the right of the railway line, making the situation rather complicated to the observer, but to the engine driver who knows every foot of his road, perhaps this is of little consequence. He of course can remember the rule that all signals governing his train have the blades pointing to the left from the post. This rule, of course, is of use to him only during the day when the blades are visible, but at night he has to be on his guard and know the peculiarities in the placing of signals.

Sighting of Signals.

The "sighting" of signals, *i.e.*, the placing high or low that they are visible to the engine driver, is done with the greatest care so as to get the best possible height for clear vision. Posts as high as

fifty
times
them
tions a
nal br
give an
light, r
as each
stead o
bracket
means
natural
intende
terpreta

In
tween th
blades an
the fish-t
however,
green are
tant signa
ger he kn
and slack
stop with
is simply
expect to

The l
and are th
signals are
home sign
heaviest tr
permissive
stop at the
order from
 $\frac{1}{2}$ mile) the

fifty feet are required for this purpose, and even then it is sometimes necessary to build a back ground for signals in order to make them visible day and night. On four track lines and near junctions and terminals, where there are numerous parallel tracks, signal bridges spanning the tracks are constructed high enough to give ample head room for brakemen. These structures are built of light, usually of iron, and afford the best means of placing signals as each track can have its governing signal directly over it. Instead of these bridges a cheaper stand for signals is found in bracketed posts, a signal being placed on each bracket. This means of placing signals is getting away from the simple and natural way of having each signal directly over the track it is intended to govern, and then there can be no mistake in the interpretation of the signals.

Distant and Home Signals.

In English block signaling there is really no difference between the home and distant signal as far as the position of the blades and color of lights are concerned. The distant signal has the fish-tail end while the home has the square end. At night, however, only the lights are supposed to be seen, and red and green are used for "danger" and "safety" on both home and distant signals. If an engine driver finds his distant signal at danger he knows that he may expect to find the home at the same, and slackens speed so that, if necessary, he may come to a full stop without passing the home signal. The distant signal then is simply a forewarning to the engine driver as to how he may expect to find the home signal.

The home signals mark the end or the beginning of the block and are therefore placed opposite the signal towers. The distant signals are placed from 2,000 to 2,500 feet in the rear of the home signals, giving sufficient distance for the speediest and heaviest trains to stop before passing the home signal. When permissive blocking is done the train is required to come to a full stop at the home signal and is then allowed to proceed on verbal order from the towerman. When the blocks are short (about $\frac{1}{2}$ mile) the distant signal of a block is often placed on the home

signal post of the block in its rear. This is found convenient and economical. The fact that a distant signal might not be visible owing to the lamp being out or burning dimly is provided for by means of an apparatus which rings a bell in the cabin. In foggy weather, torpedoes are placed on the track opposite the distant signals as a warning to the engine driver that he is approaching the home signal.

AMERICAN BLOCK SIGNALING.

The manual blocking just described is practically the only system of signaling in use on English railroads, and it has been found to be the only practicable one suited to English traffic which necessarily is very heavy. In America different conditions prevail. The railroads here have a great mileage, many lines have only one track, some two, three and four tracks. Some of these run through country sparsely populated as well as through thickly populated districts, so that we often find more than one system of signaling on the same road, the system being more complete in the thickly populated districts than in the open country.

Telegraph Blocking.

The simplest form of block signaling in America is the telegraph block system. This resembles very much the English manual blocking, but has not the same degree of interlocking of switches and signals as the latter. It is used only on lines of great traffic between important cities where trains run very frequently. It is fast being superseded by the automatic system as the expense of operating involved in salaries of operators, maintenance of apparatus and structures is great compared to the latter.

The track is divided into blocks or sections varying in length from one to four miles. Signal cabins are placed at the beginning of each block. The signals operated from these cabins authorize trains to enter the various blocks. Figure 1 represents a block section with the home signals a & b. A train in passing in the direction A B is permitted to enter the block by the lowering of semaphore arm of signal a, operated by the attendant at cabin A. If arm of signal a is in the horizontal position, the engine driver knows that block is not clear and awaits until it

is lower
permis
cabin
to dang
has pas
for and

Th
arrange
six feet
home sig
near the
green on

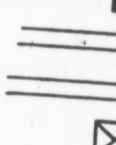

on woode
hand of
right of t
horizontal
and the sig
of the pos
green ligh
and white
home sign
distant sig
assumed th
thrown to
"caution."
place the d
block in th

is lowered, when he may proceed as far as signal b, where he gets permission to enter the next block B-C. After train has passed cabin A, it is the duty of the attendant at A to bring his signals to danger—the normal position of all home signals. After train has passed B, he notifies A, so that he (A) may lower his signals for another train.

Signals.

The signals are of the semaphore type, with the arm so arranged as to give three positions. The arms are from five to six feet in length and taper towards the point of suspension. The home signals are painted yellow or red on the face with a band near the end, and white on the back. The distant are painted green on the face with white on the back. They are mounted

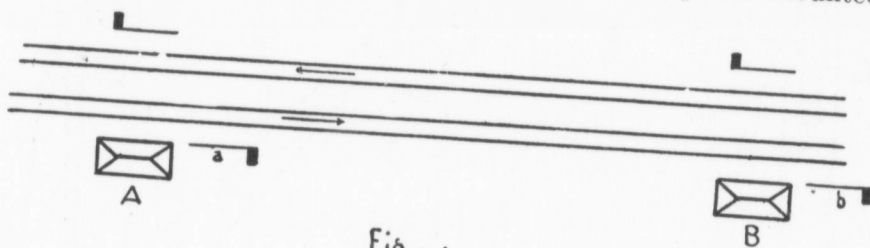

Fig. 1

on wooden posts usually from 20 to 30 feet high, set on the right hand of the track they govern with the blade swinging to the right of the post. A counterweight causes blade to assume the horizontal position should the wire connection between the cabin and the signal post break. Distant signals are used as an indication of the position of the home signals, being fitted with white and green lights, the home signals showing three lights—red, green, and white. They are placed from 800 to 2,500 feet from the home signals, the levers operating each are interlocked so that distant signals cannot be thrown to safety until the home has assumed the same position; and therefore a home signal can be thrown to the danger position the distant must be thrown to "caution." Where blocks are short it is found economical to place the distant signal of a block on the home signal post of the block in the rear.

Figure 2 is a sketch of the three position semaphore; the semaphore casting is so constructed as to carry red and green lenses. The position (a) means danger, (b) caution, (c) proceed. Positions (b) and (c) are the only ones assumed by the distant signal. Where blocks are long, it is often desired to do "permissive blocking," or allow more than one train in a block at once. The home signal is made to assume the position as shown in (b), which means that the train may proceed with caution, or else the signalman may leave his home signal at danger, and use a green flag (by day) or light (by night) to allow a second train into the block.

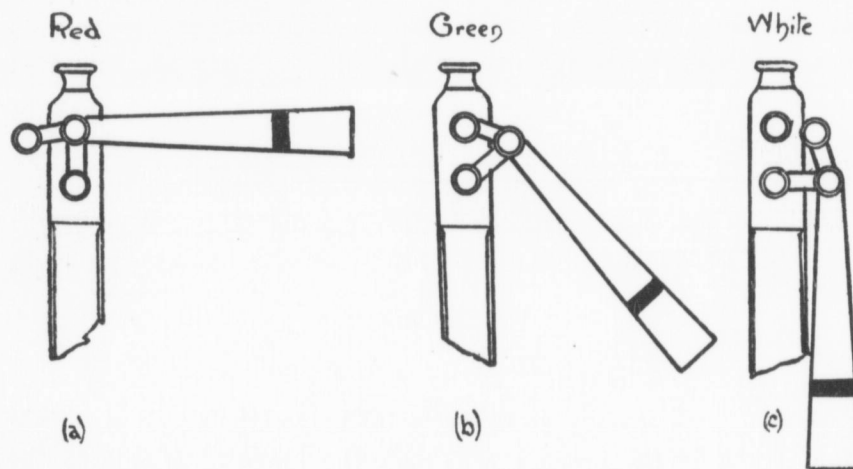

Fig 2

Single Track Blocking.

Not only has the simple telegraph block system been in use on lines of two tracks or more, but also on lines of single track. The success with which such a system has met seems to have led largely to its adoption on single track roads. A system of signaling that will give full protection to trains as well as quick handling on lines of two, three or four tracks will give the same results on single track lines. This system has proved a success even when stations are twenty miles apart, provided there is not too great a frequency of trains. With trains running every hour

and station used advantageously. train despatches are received according to the semaphore setting to indicate the known block engine and despatches meet and given.

The block signal his particular signals is thus made may be a

The blocking, described phase section of the arm position is done of latter the The arm and clear

Each of the right. T placed from and curve

and stations not exceeding thirty miles apart, this system has been used advantageously, the station agents under the direction of the train despatcher, performing the duties of signalmen. The train despatcher arranges the spacing and crossing of trains. Orders are received by the station agents who must operate their signals accordingly. A train having reached a certain station, has semaphore set at "clear," so that it may proceed. This does not indicate that the block ahead is clear, but merely that so far as is known by the agent at that station, it may proceed. But the engineman having received duplicate orders from the train despatcher can proceed to the next station or side track where they meet and cross an opposite train to which similar orders have been given.

The signalman at each block station is required to keep his block signals set normally at "danger," except during hours when his particular signals are authorized to be closed. The closing of signals is only done when there is a scarcity of trains. Blocks are thus made larger, so that through freights and passenger trains may be allowed to pass stations without slackening speed.

Forms of Signals.

There are different forms of signals in use in single track blocking, some roads having designed special semaphores. Those described in the double track blocking are the commonest. Three phase semaphores with the horizontal and two inclined positions of the arm, one being above the horizontal are in use. The latter position is used when it is desired to do permissive blocking (only done of course with trains running in the same direction). The latter then is a cautionary signal and means proceed with caution. The arm is inclined at 60° to the horizontal in both the caution and clear positions.

Position of Signals.

Each set of signals (home and distant) is placed to the right of the track so trains will always find governing signals to the right. The arms are swung to the right. Distant signals are placed from 800 to 2,500 feet from home, according as the grades and curves run in the vicinity of the block station. The home

signals are often placed on the block station itself, having only one home for both directions and operated from inside. The distant signals are operated solely by hand power, having pipe and wire connections from a lever to the signal post.

The Controlled Manual Blocking.

The controlled manual blocking used in American practice, is almost identical with English manual blocking. It is so called because the operations of a signalman at one end of a block are contingent upon those of the signalman at the other end. This is made possible by the use of electrical apparatus invented by "Sykes," an English engineer. Briefly, the apparatus consists of a series of electro magnets so connected with the levers operating the signals at one end of the block (call it A), that the levers operating signals at the other end of the block (call it B) control those at A. In order that a train may be admitted into a block A-B, the permission of both A and B is required. For example, when A sends a train to B he at once places his signal at danger, and it is impossible for him (A) to release that signal until B unlocks it, and B cannot do that until train has cleared the section. In case B should, by mistake, try to unlock A's lever before train had cleared the section, an automatic arrangement is provided so that A after having admitted train and placed his signal at stop, cannot unlock his signal to "clear" until train itself has actually passed out of the section. This is done by running an electric circuit controlling A's lever, through two or three rail lengths of track just beyond B. The current goes from the battery to one rail of the insulated section of track, thence by wire to A's signal, which it holds "locked" at "stop" by energizing an electro-magnet. When train passes over the insulated rails most of the current passes through the wheels and axles from one rail to the other, and thence back to the battery without going to the electro-magnet at A. This demagnetizes that instrument so that signal may be cleared for next train.

The automatic arrangement becomes useless if permissive blocking is done. There being two trains in the section, the first

one will
tion, th
third t

TH
telegrap

A
atus ma

Th
all, owi
of railro
it adopt
system.
through
ual syst
short, a
ginning
and day
could b
for the
ruin. I
to the
block si
working
they ha
for the
equival
the erec

As
operatio
invented
These d
though
tricity v
ties clai
of signa
ing and

one will release A's lever while there is a second train in the section, thus allowing a careless operator to clear his signals for a third train.

The form and color of signals are similar to those used in telegraph blocking.

A full technical description of the controlled manual apparatus may be found in the Railroad Gazette of August 24, 1900.

Automatic Block Signaling.

The manual system of block signaling is the most expensive of all, owing to the cost of operating. In America where the mileage of railroads far exceeds that of English, it is not surprising to find it adopted by comparatively few of the roads that favor the block system. It is only in use over small sections of line running through a populated country between important towns. The manual system here referred to is that where the blocks are made short, and stations for sole object of signaling are built at the beginning of each block. The employment of an attendant night and day at every station is an expense which few American roads could bear, and the first expense in establishing these stations for the sole purpose of signaling would sink many roads into ruin. Even the lines that have adopted the manual system, owing to the enormous expense have been deterred from placing the block signals as near together as they ought to be for convenient working. In consequence of the excessive lengths of the blocks they have introduced the permissive system, virtually suspending for the time the safeguards of the block system. This seems to be equivalent to throwing away a portion of the money spent for the erection and maintenance of plant.

As the result of the enormous expense attached to the manual operation of block signals, various automatic devices have been invented to eliminate the employment of human attendants. These depend upon the aid of electricity and compressed air, although elaborated systems have been devised from which electricity was eliminated altogether. American signaling authorities claim that automatic devices to replace the manual operation of signals, afford the most perfect and economical means of spacing and handling trains. The automatic system is the outcome

of necessity arising from a great mileage with increasing traffic, with a financial inability to employ human attendants.

The earlier forms of automatic signals depended, for communication between blocks, upon wires strung on poles. Electrical apparatus was used to hold a signal at the beginning of a block at "danger" until train had cleared that block. Owing to fact that a train might break in two, leaving one portion of it in a section while the other had cleared, the track circuit system was adopted.

Track Circuit System.

In this system the current is conducted by the rails of the track and so long as that current remains uninterrupted the signal is held at safety by an electro-magnet. A train entering the section makes a metallic connection between right and left rails. The current being interrupted causes signal to change from safety to danger.

Signals.

Figure 3 represents a form of disc signal used commonly in automatic signaling. It is mounted upon a hollow iron post about sixteen feet high. It consists of a disc or target D, which is fixed to a vertical spindle on the top of which the lantern stands. The latter has red and white (or green if white is not used for safety) lenses on opposite sides. The spindle is connected with clockwork (in box B) operated by a weight which hangs down the centre of the post. The weight has to be wound up at regular intervals.

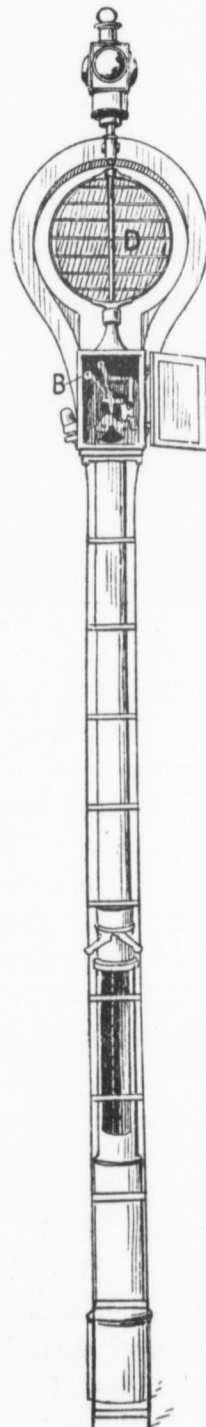

FIG. 3.

The disc D is painted red on both sides, and when set with its face towards the engineman means "stop," when turned with its edge towards the train means all clear. Sometimes a second disc fixed to the spindle and at right angles to the red disc is used. This is painted white (or green if white is not used) on both sides and indicates "all clear."

The clockwork is governed by an electro-magnet. As the current ceases the clockwork is allowed to move until the spindle has been turned through a quarter of a revolution. In case the clockwork should be run down completely and by chance leave the signal at "all clear," the current is made to pass through a pair of springs which are held together when the weight is wound up, but which are separated when the weight has nearly reached the bottom; so that just before the clockwork is run completely down the current is opened and signal left standing at "stop."

Positions of Signals.

Home signals are usually placed directly at the beginning of the block they protect, and to the right of the track they govern if it is the rule for trains to run on the right hand track. In order that the enginemen may know that signals are working properly, a block signal standing at "all clear" is made to change to "danger" when the train is within 200 feet of the block. The objection sometimes raised to this, is that a misplaced switch might cause the signal to move to danger just as the train was entering the section, and the engineer would naturally suppose that his train was the cause of it. On the other hand, where signal changes to "danger" after train has entered section, there is no check upon the working of the signals. To station brakemen, on the rear end of trains, to observe the working of signals is attended with too much difficulty to be practicable. But in any case where automatic signals are used, there should be no doubt as to their efficiency, as experience has proven that care and close inspection of apparatus warrant the assumption that dangerous failures—the greatest of which is failure to go to "stop" when train enters a section—will not occur.

Arrangements of Signals.

Figure 4 represents an arrangement of automatic disc signals. In this system the signal stands "normally" at danger until a train enters the block in the rear, and then if everything is clear in the block, it assumes the clear position, which it retains until the first pair of wheels passes the block insulation shown -[-] when it assumes the "danger" position. Train A having passed D, H, and D₂ holds them at danger, but since the clearing section of H₂ has been entered the signal H₂ stands at safety.

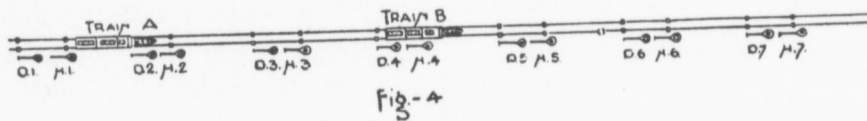

Train B has entered the clearing section of D₅ and H₅, but a broken rail shown -(-)- in advance holds them at danger, for which reason train B will stop upon reaching H₅ and then proceed with care until it reaches D₆ and H₆, which are in the clear position. D₇ and H₇ naturally stand at danger, since no train has entered the clearing section in their rear.

Overlaps.

Instead of providing distant signals the overlap is employed. By an overlap is meant one block section overlapping another. The overlap is about 2,000 feet long and is only used when the "normal danger" arrangement of signals is employed.

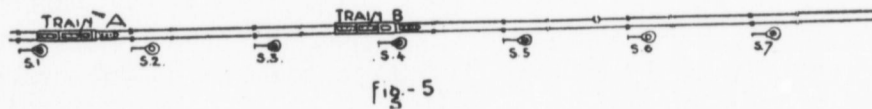

Figure 5 represents an arrangement of signals where there are no distant signals, the overlap being used instead. A signal occupies the danger position until a train enters the block in its rear, and then if everything is safe on the block and overlap in advance it assumes the clear position, which it retains until the first pair of wheels passes the block insulation shown -[-] near the foot of the signal post, when it resumes the danger position

and holds it under all circumstances until the last pair of wheels has passed the overlap insulation, shown -||- beyond the next signal in advance. The signal may then be cleared by an approaching train as in the first instance, but will otherwise remain at danger. Train A having passed S₁, holds it at danger, but as it has entered the clearing section of S₂ and nothing intervenes in advance, S₂ is found in the clear position. Train B having passed into the block of S₄ holds it as well as S₃, whose block it has not entirely left, at danger. Under ordinary circumstances S₅ should be in the clear position, since there is no train in advance of it, but in this case there is a broken rail, shown -()- which holds S₅ at danger. For the same reason S₆ is in the clear position, for in this arrangement of circuits, it is the interruption of the circuit in the block immediately in the rear of the signal which tends to clear that signal. This feature, which at first glance seems singular, is consistent, since it is the danger in *advance* of a signal which it is supposed to indicate. Train B will pause upon reaching S₅ and after waiting a certain number of minutes will proceed with care through the block section until it reaches S₆, when its course will be clear.

Wire Circuit System of Automatic Block Signals.

Those who favor the wire circuit system claim that the track circuit is not so scientific as the former, and that a broken rail, although serious enough to cause derailment, does not affect circuit sufficiently to cause a danger signal. The wire circuit system operating *enclosed* disc signals is perhaps the most efficient and reliable, owing to the simplicity of its apparatus and to the fact that the current is conducted by wire.

Form of Signals.

Figure 6 is a cut of the signal itself. It consists of a hollow case of metal or wood with a white glass aperture, and painted black, which forms a contrasting color to white (safety) or red (danger), thus forcibly attracting the attention of the engineer. Figure 7 represents the interior of the case. It contains an electromagnet which, on being energized, holds a red disc (made of silk

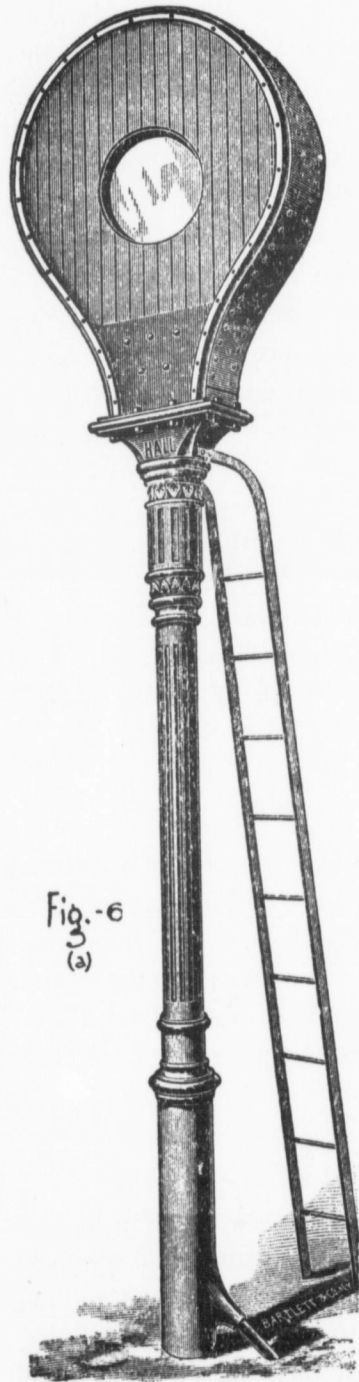

Fig.-6
(a)

"LINE CLEAR."

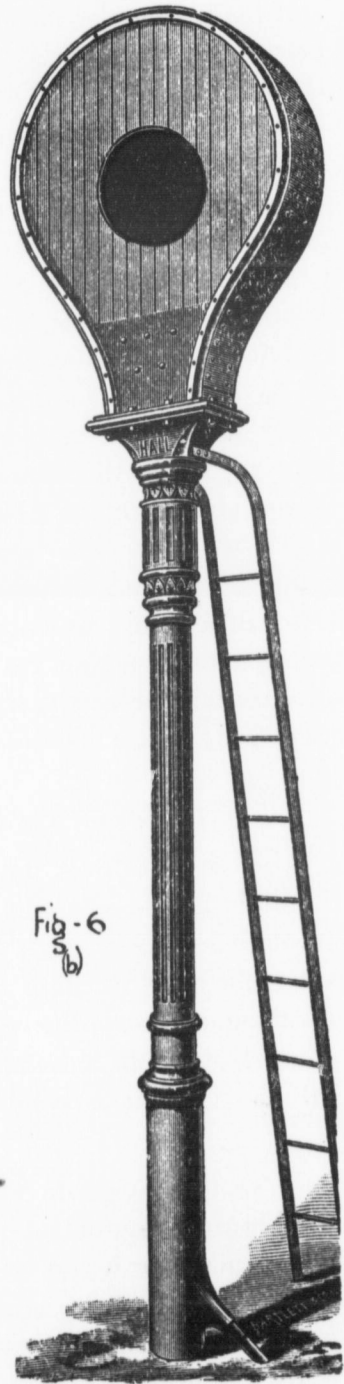

Fig.-6
(b)

LINE BLOCKED"

stre
dow
dan
wh
posi
lum



the

stretched on an aluminum ring) up, which otherwise would fall down owing to gravity and cover the glass aperture making the danger signal. A white reflector is shown through the aperture when the red disc is drawn up, making the safety signal. The position of the lamp is shown in Fig. 6. During the day it is hung below the glass.

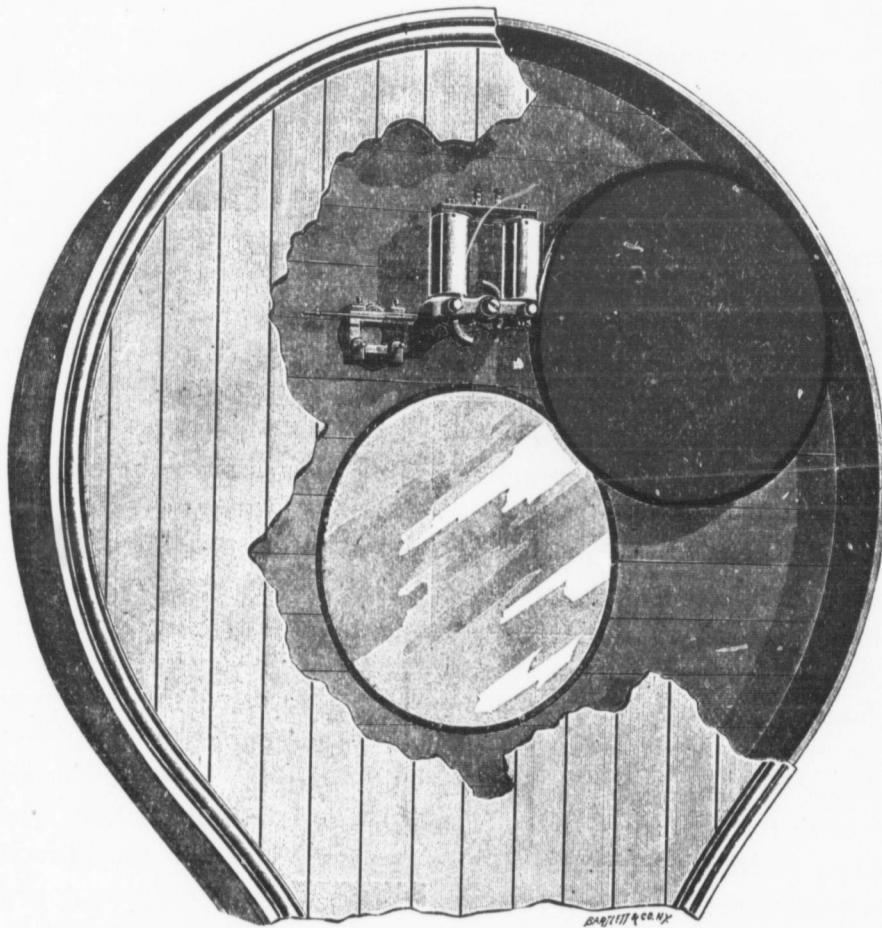

INTERIOR VIEW OF SIGNAL CASE.

"SAFETY."

POSITION OF SIGNAL (BY ELECTRO-MAGNETISM).

Fig. 7

Distant Signals.

The distant signals are practically the same as the home, only the discs are green instead of red. They are included in the cir-

cuit, and therefore act in conjunction with the home; that is, a green distant signal indicates that the home will, or is likely to be, red. A white distant signal corresponds to a white home signal. They are placed about 1,000 feet in advance of the home signal. By a judicious arrangement of these distant or cautionary signals, no home signal need ever be made visible beyond a few hundred feet.

The prominent feature of the enclosed disc signal is that the moving parts are protected from wind and rain and snow, and therefore can be made light enough to be moved by an electro magnet of moderate size.

The principle upon which this signal is operated and constructed is that the first wheel entering a block section sets the signal at danger, and at the same time breaks an electric circuit in such a way that under no possible contingency can the signal again show safety until the train passes out of the block section and operates a track instrument which restores the circuit. If a wire breaks or is grounded, or two wires become crossed, the signal falls to danger by gravity. The failure of the battery or derangement of parts always brings signal to danger. In other words the safety position of the signal is dependent upon an uninterrupted circuit through the magnets of the signal instrument in the case. It is simply the attractive power of electro magnetism that holds the signal at safety. The movement of signal to danger position is not dependent upon the action of force such as the unfastening of a mechanical lock or opening of a valve, but simply by the action of gravity on the interruption of the electric current from a lack of force to hold it in the safety position. The safety position therefore is only assumed when all the apparatus is in perfect order and no train has entered the section.

Track Instruments.

Track instruments are used to break and make the circuit, being operated by the wheels of passing trains. Two are required for each (simple) block. The first, called the "block" instrument, is located at the beginning of the section, and is constructed as to break the circuit (when operated by train) so that the home and distant signals fall to danger and caution respectively. The

second, called the "clear" instrument, is placed about 2,000 feet beyond the beginning of the succeeding section, so that when the first pair of wheels of the longest train has operated that instrument (thus closing the circuit), the whole of the train will be out of the first section.

"Clear" Track Instrument.

Figure 8 represents sectional view of the clear track instrument for closing the circuit. L is a lever or treadle operated by a passing train. The lever being depressed at track end, forces

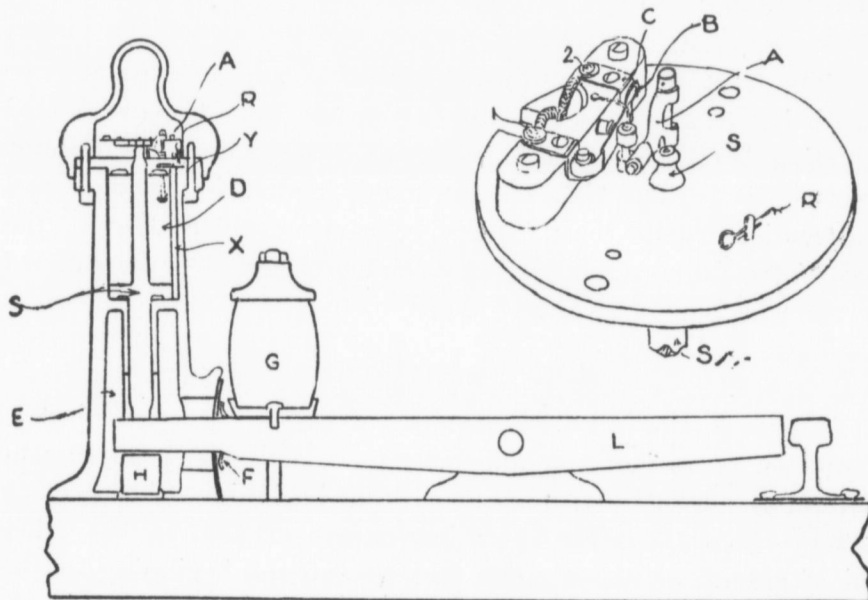

Fig.-8

the piston S moving in an air chamber D, and communicates motion to the key lever A of the circuit closing apparatus. The upper and lower ends of the air chamber are connected by a post X, so arranged that when the piston is forced upwards a portion of the air above the piston is forced out through the opening Y. When the piston has risen high enough to cover the opening Y, communication with the lower end of the cylinder is cut off and the air remaining in the upper chamber forms a cushion, preventing the piston from being thrown forcibly

against the top cap. Upon being actuated by the lever L its bevel top engages a roller on the arm A, which forces the spring B to a contact with its anvil C, thus completing a circuit between the wire connections of 1 and 2.

The piston having been raised by a passing train the air above it is driven through the port X and enters the air chamber below the piston, thus forming a cushion preventing serious shocks. R is a valve for regulating air pressure. The lower end of piston rod moves in closed chamber E. Movable plates F attached to the levers keep this opening closed. H and G are two compressor rubber springs, so that hand cars, velocipedes or any weight less than an ordinary car wheel will not operate the piston.

The track instrument just described is used to close the circuit, being so placed as to allow the longest train to have cleared a section before the signal protecting that section assumes the clear position. The "block" instrument is alike in principle and construction to the "clear" track instrument, except that in the case of the former, the current is broken when lever is actuated by the wheels of a passing train.

Block Signal Circuits.

Figure 9 shows the arrangement of battery wires and instruments for operating a simple circuit. D is block instrument (heretofore described), placed at the beginning of the block section. B is the clear track instrument situated at the other end of circuit, or about 2,000 feet beyond the beginning of the next block. R is a relay and X the battery, both of which are located anywhere within the block. In Fig. 9 (a) the circuit is closed and signal is held at safety, the circuit being from battery X wire 1, anvil E, spring D, wire 2, electro-magnet S, wire 3, contact points p, p¹ of relay R, wire 4, electro-magnet r, wire 5, to battery. The first wheel of a train entering a section operates the block track instrument breaking the circuit between spring D and anvil E, demagnetizing electro-magnets r and s. Signal falls to danger and contact points p and p¹ are broken. When train has completely cleared the block track instrument D, contact between spring D and anvil E is restored, but as circuit is still broken at points p, p¹, the signal will remain at danger until

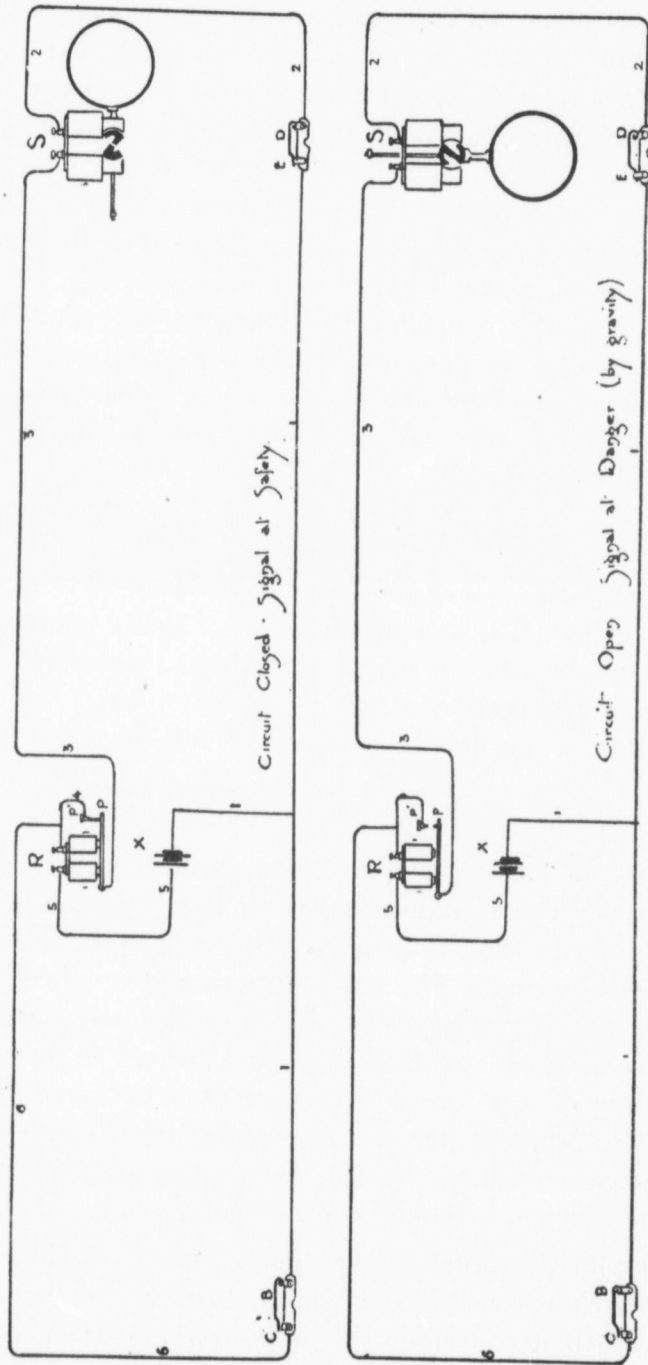

Fig. 1 - 9

train operates clear track instrument B, which energizes electro-magnet r, thus completing circuit from battery X, wire 1, spring B, anvil C, wire 6, electro-magnet r, wire 5, to battery. This closes contact points p, p¹, but the signal still remains at danger until train has wholly cleared the clear track instrument, on account of the fact of there being two circuits, one through the clear track instrument and relay magnet and another through block track instrument, signal magnet and relay magnet. As the resistance of the latter is much greater than that of the former, the signal will remain at danger as long as clear track instrument spring is in contact with its anvil, which under action of air cushion previously referred to is continuous during passage of train at ordinary speed.

Switches in Signal Circuits.

Any number of switches may be included in a circuit. A misplaced switch, that is a switch set for a siding, causes a break in circuit by operating a switch instrument similar to the track instrument. This causes signal to fall to danger, and as long as the switch is misplaced the signal cannot be cleared.

Single Track Blocking with Disc Signals.

The use of automatic disc signals as described, is calculated for two tracks where trains run always in the same direction on the same track. They may be used equally well, however, for single track blocking. The block sections are arranged to extend from side track to side track. The signals are controlled by electric interlocking and they may be arranged to automatically give the right of way to one train or another but not to both. It is impossible, however, for any mechanical contrivance to choose between a passenger and freight, or between an east bound fast stock train and a west bound train of empty cars.

As automatic signals are confined usually to lines of more than one track where traffic is heavy, their application to single track lines will not be discussed, as most single track lines space their trains by the time interval system, or a system of station blocking.

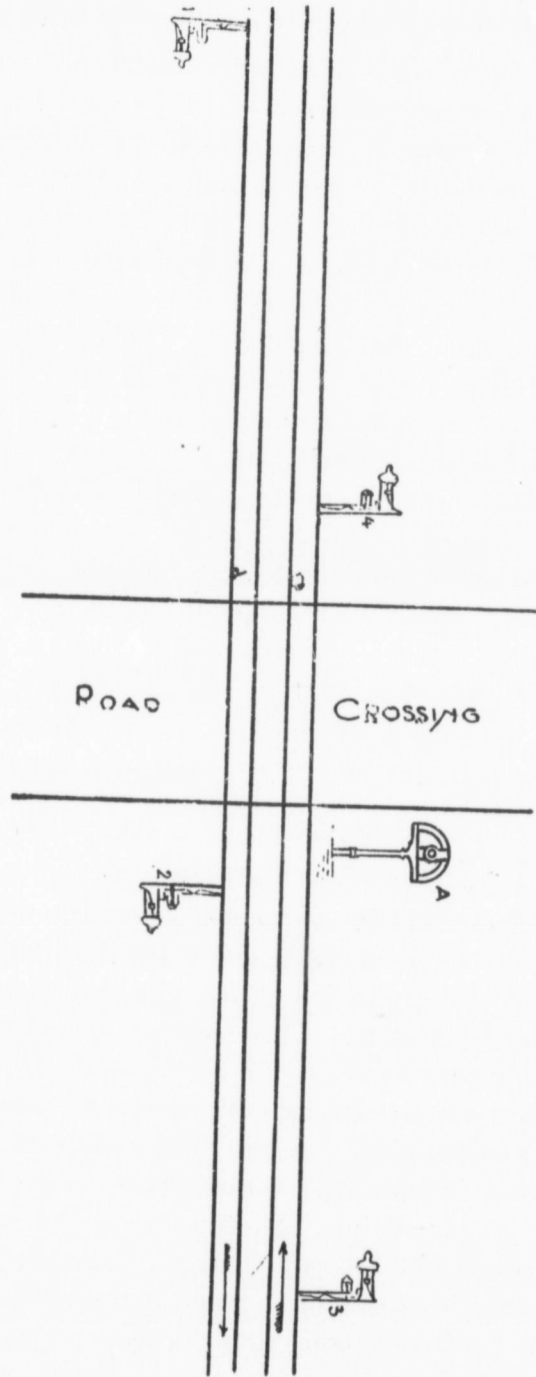

Fig. 10

Audible Highway Crossing Signals.

The track instruments described in connection with the wire circuit system of automatic signals may be used advantageously to give audible warning to pedestrians of passing trains at road crossings. Figure 10 is a plan of signal and track instruments used in connection with a double track. The wire conducting an electric current by means of which an approaching train sets the bell ringing is run to the track instrument, located at any desired distance from the crossing. The circuit is normally open. A west bound train in passing over track instrument 3 closes a circuit and energizes an electro magnet A in an interlocking instrument located together with the battery at the crossing. This closes a local circuit through spring D and its anvil d and starts the bell ringing. The instrument now being locked, the bell continues ringing until train shall have reached instrument 4, which closes a circuit energizing unlocking magnet B, which breaks the contact between spring D and its anvil d, thus opening the bell circuit and silencing the bell.

By an arrangement of interlocking instruments and track instruments the bell may be made to ring by a train approaching from either direction on a single track.

The Electric Semaphore.

The electric semaphore signal to be used in automatic blocking, is the latest development. The claim has been made that disc signals are less distinctive to the eye than semaphores, but this is a matter of dispute. This fact led to many experiments with electrical apparatus to operate a semaphore arm of full size, apparently with success although no extensive installations have been made. The prominent feature of this style of signal is that each has its own independent motive force. An electric motor of about $\frac{1}{2}$ H.P. placed in a box attached to the post below the arm, and supplied with current from an Edison-Lalande battery of 10-16 cells, winds a cable on a drum, thereby lifting a counterweight (which holds the signal arm normally at danger), giving the arm the inclined or all clear position. With such a powerful force exerted by motor, and use of a heavy counterweight, difficulties of snow and sleet causing arm to stick is overcome. The

motor has an automatic brake, consisting of a resistance coil, which retards the revolutions of a soft iron circular disc fixed to the armature shaft.

The semaphore blades are same in design as the standard; ball bearings are introduced to eliminate friction. Bells are provided at main line switches, which may only be opened when bells are not ringing. A train in a section to the rear of the one in which a switch is located causes the bell to ring. On the other hand when the switch is opened the signal at entrance to the block is drawn to danger. The signals are operated by track circuits.

Electro-pneumatic Block Signals.

This style of signal has been in use since 1885. They are only used on the busiest portions of lines, usually four track roads, where the sections are short. The power is supplied by compressed air, which flows through valves operated by an electric current. Air compressing plants are established where possible in yards, where they serve the purpose of supplying air for electro-pneumatic systems of interlocking switches, and air for several miles of blocking outside the yard.

The essential parts of the system are:—

- (1) The electrical apparatus, consisting of the battery, track relay and connections, and electro-magnet for controlling admission of air to cylinder.
- (2) The signal, which is a full-sized semaphore.
- (3) A cylinder with piston for moving signal.
- (4) An air compressor plant with reservoirs and cooling pipes to precipitate any excess of moisture, and a pipe to convey air under pressure to signals.

The block sections being very short it is found economical and convenient to place two signals on one post, one being the home signal of a section and the other the distant signal of the following section. The former is placed at the top and is of the standard form with a square end. The latter is placed below and has a fish-tail end to distinguish it from the home signal.

On roads of more than two tracks it is usual to define the blocks by signal bridges spanning the tracks, each pair of signals being placed over the track they govern.

This system of automatic blocking is necessarily very costly, owing to the great expense of operating compressor plant, laying of pipe, pneumatic cylinders and electrical apparatus, and this has consequently limited its use to roads where *one* line of pipe will operate the signals of several tracks.

Manual versus Automatic Signaling.

The opinion as to the relative efficiency of manual and automatic systems is divided, even in America. The controlled manual, about which there is a certain amount of automatism on account of the electrical apparatus which makes the setting of signals at the beginning of a block contingent upon that at the end, is operated by human attendants who are not infallible, and liable to error, the result of which may be serious, or slight, or even of no consequence. The element of contingency between the operators eliminates to a great extent any errors made by one. Methods are known to expert operators of "cheating" the machines, by which mistakes may be rectified.

The efficiency of the manual system depends to a great extent upon the operators themselves, some of whom may show a tendency to getting "out of order" themselves once in a while, when duties are light, or, in other words, when the frequency of trains is small, the operator may fall asleep, and although no very serious results may happen, his neglect of duty may cause delay, something which every railroad tries to avoid. Cases have been known where the operator would deliberately prepare for a nap, by getting an unlock from the towermen on each side of him so that he could clear his signals; in which case train must stop at tower in the rear and procure a caution card and then proceed under full control to the tower of the "sleeping beauty."

Such cases could not properly be cited as dangers of the system, but merely defects which may be remedied by the employment of reliable operators. In England, where the controlled manual is practically the only system in use, the record of train

acci
is a
oper
that
traff
alon
for
enti

ual
Trai
with
appa
spec
twee
insta
repo
ning
defe
port

that
oper
to b
cienc
tion
nals
are i
ment
block
that
may
misc
ing o
signa

signa

accidents due to misplaced signals is remarkable, a fact which is attributed largely, if not altogether, to the reliability of the operators themselves. It is claimed by English signal engineers that in such a country where there is such extreme heaviness of traffic that the manual is the only system practicable, and this fact along with the highly satisfactory results of such a system accounts for the reluctance on their part, to adopt any system entrusted entirely to mechanical operation.

The disadvantages, apart from expense, inherent in the manual system are few and small. The advantages are manifold. Trains are absolutely spaced and enginemen cannot "run" signals without detection. Permissive blocking is only allowed when apparatus is seriously out of order, which only happens when inspection is poor. If locks fail there is bell communication between towers. If these fail there is the telegraph in complete installations to fall back on. Wrecks, derailments, etc., are easily reported, so that aid may be quickly summoned and trains running on parallel tracks stopped and protected. Any dangerous defects in condition of trains may be noted by towermen and reported to those in advance.

Automatic signals have reached such a stage of perfection that their reliability can no longer be questioned. A million operations of a signal with only one false clear indication, ought to be sufficient to dispel doubt as to their reliability. The efficiency of their working depends almost entirely upon the inspection of the apparatus. The main defect of the automatic signals is that the protection of switches is incomplete. The switches are included in the circuit and have a bell or indicator attachment by which the position of the signal at the beginning of the block is known to the trainmen at the switch. It is possible that trainmen may not observe the indicator, or that the bell may fail to ring by poor adjustment, or by getting broken by mischievous trespassers, so that train using the switch has no warning of another train, which may have already passed the protecting signal and entered the section.

It is sometimes stated that enginemen disregard automatic signals, there being no one to report them. As a matter of fact

this is seldom done. A sane engineman is not going to plunge recklessly into danger when by waiting a specified time at a block signal set at danger, he may then proceed with caution through the block to the next, where he is likely to find the line clear.

The advantages of the automatic system are perhaps not as numerous as those of the manual; a train broken in two is fully protected; broken rails, if rail circuit is used, usually cause signal to go to danger. The former system has decidedly a great advantage over the latter in point of cost, and in this respect it is the most suitable for roads with great mileage and heavy traffic running through open country. The maintenance of both is about the same, but the cost of operation is a factor which does not occur in the automatic, but which is constant in the manual system. For this reason blocks are often too long to give prompt handling of the traffic. With the automatic system the blocks may be made as short as required without materially increasing cost of maintenance, the first cost of installation being practically the only expense to be taken into consideration.

The paramount objection raised by English railroad men against automatic signals of all kinds, is not that they are unsafe, not that they are costly or troublesome in care and maintenance, but rather that the exigencies of heavy traffic prove too much for them thereby causing delay.

The question of the relative merits of the two systems resolves itself into a straight question; which one will operate 100,000 or 1,000,000 times with the least number of unnecessary stoppages of trains. The Railroad Gazette of January 24, 1890, says, referring to the use of a form of automatic signal on a line of heavy traffic: "Going since May 30, 1888, and being used as a positive block signal, it has never got out of order, caused an unnecessary stop, or shown safety when danger existed, thus making a remarkable mechanical record."

Other Systems of Signaling.

There are other schemes by which trains are kept spaced. These are of less importance, being used on roads of light traffic where demands for which handling of trains are not sufficient to

warrant the expense attached to installing complete signal systems. Many roads of light traffic still use the "time interval" as a means of keeping their trains spaced. But the protection of a train that has unexpectedly come to a stop by the ordinary method of sending a man back with a visible or audible signal, is unsafe, except when carried out by men of best judgment. Both the flagman who is to give the signal and trainmen of the following train must never fail to practise the most extreme caution; and as safety is always contingent upon the flagmen having sufficient time to get back to warn following train, another element of danger is introduced. The great deficiencies of this system are all well understood by railroad men. Much of the loss of life, and collisions, are due to ineffective flagging caused by sheer neglect of trainmen to whose judgment is entrusted practically the running of the trains. But while admitting that the time interval system is an unsatisfactory protection for trains, many roads in this country have had to deny themselves the advantages of the block system on account of the cost attached to it.

The Train Staff or Tablet System.

A modified form of the block system is found in the train staff or tablet system. These are exactly the same in principle, the apparatus being somewhat different. It is an old English idea, the track being divided into blocks or sections, and before a train can pass over a block it must have in its possession a metallic tablet or train staff.

The apparatus of the staff system consists of a receptacle for holding a number of metallic staffs, one of which is given to each engineman to authorize him to proceed over a specified length of track. There is a receptacle or "pillar," as it is called, at each end of the block section, and these two are electrically connected or interlocked, so that two staffs cannot be out at the same time. Such a system is only used on single track over short sections.

The sections are laid out varying from 4 to 20 miles in length, according to the distance between towns on the line, a tablet station being established at each.

The electric tablet instrument containing the tablets, is placed at each station which defines the blocks. Before a tablet can be obtained from the instrument at either end of a section, the consent of the operators at each end of the section must be given, and only one tablet can be taken out of the two instruments of a section at a time, so that trains travelling in opposite directions are fully protected.

The tablet is placed in a leather pouch before being handed to the train driver, who, in turn, delivers the tablet for section just travelled. This necessitates trains to come almost to a dead stop before exchanges can be made. Apparatus was invented by which a train running 40 miles an hour could catch up and deliver tablets, thus allowing through trains to proceed without a stop.

The tablet system is sometimes used with the block system where it is desired to suspend the latter temporarily and do permissive blocking. In order to pass a block signal set at danger, it is necessary for the engineman to procure a permissive tablet, which gives him running power over the section protected by the suspended block signal.

Interlocking at Grade Crossings.

A word or two might be said upon the protection of grade crossings. It is done by a system of signals and derailing switches. Experience has taught the best location for the signals, the number, and safeguards necessary in case a train should pass the danger signal.

Figure 11 shows plan of simple grade crossings. Figure 11 (a) represents a single track diamond crossing. The distant signals shown with fish-tail ends are placed 1,200 feet from the home signals, and in each case to the right hand of the track. In case a train should pass a home signal set at danger, the last precaution taken is a derail placed 50 feet from the home signal and about 300 feet from the centre of the diamond.

The signals and derails are operated entirely from a signal tower, there being pipe and wire connections between each and levers in the tower. It is common practice to have the distant

signals lock their home signals in the clear position. One lever operates a pair of derails on each track. The signal levers are so interlocked that only one track can have its signals cleared at a time.

The installations for double tracks are obviously as simple as those for single track; in the latter case trains being supposed to run always in the same direction on same track.

Although the high cost of installation and operation has deterred lines from installing these plants, it has been found that the time saved would often warrant the expenditure even on lines of light traffic. In cities where all sorts of crossings are encountered, such plants are an absolute necessity, at any cost. Where track crossings and junctions become complicated, manual power for working the levers is dispensed with in the most recent installations. The use of electricity in combination with compressed air, affords the speediest and most reliable means for handling of trains.

Yard Signaling.

Before concluding these remarks reference might be made to signaling in yards. This is a subject in itself, being one in which difficult problems arise, as in the case of great complications of tracks, where one road crosses another in the vicinity of large yards, or makes junctions or borrows track. Such problems are left for solution to the signal engineer who devises schemes for a systematic operation of switches and signals, the former affording a means of transit from one track to another, the latter protecting trains while performing this operation.

The mechanical side of yard signaling, involving as it does interlocking, is too great to admit of discussion here, so only a few general principles will be referred to.

As the main lines for incoming or outgoing trains are often run through the yards themselves, it is of the greatest importance that signals governing them (main lines) should be absolutely placed. The most common way of placing them is on a light bridge or superstructure, placing signal directly over the track it governs. Where the block system is in use the sections are

s
v
n
e
y
at
k
re



sho
plac
the
of t
and
thro
ther

unn
mon
tion
elec
pow
and
vant
oper
man

yard
air
the
oper
ally
mar
defin
cabi
sign
are
and

short, from one-third to one-half mile in length; signal cabins are placed at the beginning and end of each, where they serve also the purpose of interlocking cabins for main line switches. Each of the cabins has electrical communication between one another, and sometimes between the train starter. As trains run slowly through yards "permissible blocking" is allowed in most cases, there being practically no danger caused by it.

Signals.

The signals are of the semaphore type, distant signals being unnecessary on account of slow speed of trains. They are commonly worked by levers in towers, having pipe and wire connections. The most perfect installations are now operated by the electro-pneumatic system, which, of course, is far superior to hand power levers. It is only in cases of great complication of tracks and switches that these installations are made. The great advantage of the electro-pneumatic system is that signals may be operated at greater distances, and one man can do the work of many in the interlocking towers.

Automatic block signaling may be done advantageously in yards, preferably by the use of compressed air and electricity. One air compressing plant will suffice for the operation of signals of the largest yard. Figure 12 is a cut of a yard whose signals are operated by electro-pneumatic block signals, which stand nominally at danger. The signal bridge in the front of the picture marks the beginning of a section, the two blocks being visibly defined by the two signal bridges in the distance. Interlocking cabins provided with electro-pneumatic levers operate the switch signals and switches. At important road crossings small cabins are built for signal men, whose business it is to operate the gates and give flag warnings.

Al
Ar

Ar

Ar
Ba

Ba

Ba
Bl

Bo
Bo
Br

Bu
Ca

INDEX TO THE FIRST FOURTEEN NUMBERS.

	VOL. PAGE.
Allison, J. L. Transition Curves	ii. 52
Andrewes, E. Notes on the Geology of Rossland Ore Deposits	xiii. 128
Angus, R. W., B.A.Sc. The Gas Engine	x. 61
The Shaft Governor	xi. 76
Ardagh, Arthur G. Peat	xiv. 59
Bain, J. W., B.A.Sc. Planimeters	ix. 19
Notes on Stamp Mill	x. 6
The Accuracy of the Assay of Pyritic Ores	xi. 67
Ball, E. F., A.M. Can. Soc. C.E. Asphalt Pavements	i. 40
Sewers	iii. 39
Water Supply	iv. 60
The Computation of Earthwork and Overhaul by Means of Diagrams	v. 48
Hydraulic Cements	v. 82
Sewage Filtration	vi. 44
Barber, T. Notes on the Development of Water Power	xiii. 189
Blackwood, A. E. President's Address	viii. 1
Description of the Finlayson Marine Pipe Boiler	viii. 189
Bowman, A. M. System of Survey in British Columbia	i. 19
Bowman, H. J., O.L.S. Municipal Engineering in Ontario	x. 177
Bryce, P. H., M.A., M.D. Underground Waters as Sources of Public Water Supplies in Ontario	iv. 15
The Chicago Canal and Some Sanitary Problems connected Therewith	ix. 55
Disposal of Sewerage	xi. 44
Land Drainage in its Sanitary Relations	xii. 119
Principles of Ventilation in their Application to Public Buildings	xiii. 174
Butler, M. J., C.E. Silica Portland Cement	xii. 100
Campbell, A. W., C.E. Roads and Streets in Ontario	x. 14
Road Construction	xi. 18
Pavements	xii. 106
Roadmaking	xiii. 167
Bonding of Broken Stone Roads	xiv. 15

	VOL.	PAGE.
Campbell, G. M. Vice-Work.	viii.	33
Carmichael, C. G. Thomson Recording Wattmeter....	xiv.	49
Carter, W. E. H. President's Address	xii.	1
Chalmers, J. Double Track Tunnel Hamilton T. H. & B. Railway	ix.	61
Rat Portage Water Works	xii.	85
Chubbuck, L. B. Modern Systems of Interior Wiring..	xii.	58
Hydraulic and Electric Elevators	xiii.	91
Chewett, J. H., C.E. The Removal and Destruction of Garbage	vii.	11
Christie, Fred. W., C.E. Gold Mining in Nova Scotia..	xi.	129
Coleman, Prof. A. P., M.A., Ph. D. Mount Brown and the Sources of the Athabasca	vii.	62
Connor, W. A., B.A. Solutions	viii.	223
Corrigan, G. D. Modern Copper Smelting	iv.	100
Davidson, J. L. Location and Construction of Crow's Nest Pass Railway	xii.	135
Deacon, T. R. North Bay Water Works	vi.	91
DeCew, J. A. Chemical Wood Pulp	xiv.	6
Dobie, J. S., Grad. S. P. S. The Action of Heat on Cement	ix.	126
Duff, J. A., B.A. Presidential Address	iii.	82
The Fundamental Principles of Dynamics	v.	27
Diagrams	v.	61
The Country Roads of Ontario	viii.	49
Tests on Tensile Strength of Steel Boiler Plate....	x.	184
Neely's Formula for the Strength of Wooden Beams	xii.	194
Elliott, H. P., B.A.Sc. Lightning Arresters	ix.	13
A Discussion of the Considerations Affecting the Cost of Electric Power	xi.	113
Ellis, W. H., M.A., M.B. Junker's Gas Calorimeter..	xii.	143
Fire Making	xiii.	201
Foreman, W. E. Air Brakes	xiv.	133
Galbraith, Prof. Technical Education	v.	100
Goodwin, J. B., B.A.Sc. Tunnel at Niagara for De- velopment of Power	vi.	34
Niagara Falls Sewerage System	x.	38

Gray, R. A. L. Power Switchboard and Dynamo Tending	viii.	201
Greenwood, H. F., C.E. Concrete on Trent Valley Canal .x.		80
Gurney, Cromwell, Illustrative Casualties in the Workshop	ix.	8
Haight, H. V. Gear Cutting	viii.	173
Standards in Machine Shop Practice	ix.	38
Air Compressors	x.	123
Hare, W. A. The Process of Manufacturing Mechanical Wood Pulp	xii.	12
The Problem of Speed Regulation in Plants Driven by Water Power	xiii.	37
Harkness, A. H. Crushing Strength of White Pine	x.	180
Harvey, C. J., C.E. The Conjunction of the Nineteenth and Twentieth Centuries from an Engineering Standpoint	xii.	156
Haultain, H. E. T. Presidential Address	iii.	11
Extract from Letter from	iii.	109
Some Experiences with a Canadian Turbine in Austria	vi.	83
Hemphill, W. Construction of the Hamilton Cataract Power Company's Plant at DeCew Falls	xii.	76
Ratio of the Cylinders of a Compound Engine and what takes Place in Them	xiv.	31
Innes, W. L., C.E. Grading	viii.	5
A Brief History of Astronomy	ix.	26
James, D. D. Surveying in the City and Suburbs of Toronto	iii.	57
Johnson, S. M. The Maintenance of English Roads	viii.	17
Brickwork Masonry	ix.	153
Kennedy, J. H., C.E. Reference Points and Bench Marks	i.	27
Laing, A. T., B.A.Sc. The Waterworks System of Amherstburg and Essex	v.	55
Laing's Planetarium	ix.	138
Latham, R. Signaling	xiv.	163

	VOL.	PAGE.
Iaschinger, E. J. Hirn's Analysis of Heat Distribution in the Cylinder of a Steam Engine	viii.	120
Lea, W. A. Photography	iv.	82
President's Address	vi.	1
Leask, W. Corrugations on Mill Rollers	iii.	63
Lott, A. E. A Re-Survey in Ontario.	i.	24
Notes from an Engineer's Pocket Book	xii.	145
Ludgate, B. A. Problems from an Engineer's Pocket Book	xii.	145
MacDougall, A., C.E. Professional Prospects	vii.	7
McAree, J., O.L.S., D.T.S. The Crawford Gold Mine.	vii.	26
McCulloch, A. L. Mortars and Cements	ii.	25
McDowell, R. Foundations	iv.	54
McFarlen, T. J. The Nickel Mining and Smelting In- dustry of Sudbury ..	vi.	48
McKinnon, H. L. The Cleaning and Annealing of Castings	viii.	132
McLennan, J. C., B.A. Roentgen Radiation	ix.	142
MacNabb, J. C., O.L.S. Proposed St. Clair and Erie Canal	vii.	62
McPherson, A. J., B.A.Sc. Specifications for Sidewalks.	x.	20
Marani, C. J. Historical Review of Sanitary Science and the "Germ Theory."	iii.	20
The Separate System and the Brockville Sewers.	iv.	36
Sanitary Plumbing	v.	7
Marani, V. G. A Short, Practical Essay on "The Sea and Its Waves."	v.	73
Merrill, E. B., B.A., B.A.Sc. Electric Traction as Ap- plied to the Street Railway	vi.	57
Dynamo Design	viii.	205
Mickle, G. R. Freiberg Smelting Process	iv.	89
The Value of Undeveloped Mineral Claims	xii.	181
Minty, W. M., B.A.Sc. Notes on the Relation of the Mechanical Properties of Steel to the Chemical Composition	xi.	145
Mitchell, C. H., B.A.Sc. Earthworks on Roads and Railroads	v.	37
Triangulation Survey ..	vi.	23
Aerial Mechanical Flight	viii.	74
The Conservation of Water for Power Purposes.	xiv.	64

	VOL.	PAGE.
Monds, W. Circulation in Water Tube Boilers	xiii.	112
Morris, J. L., C.E. Masonry Foundations	iii.	52
Retracing Old Compass Lines	v.	70
Mundie, W. B., F.A.I.A. The High Building Problem . . .	x.	28
Neelands, E. V. Some Adventures on the Abitibi	xii.	149
Mine Timbering	xiii.	137
Some Notes on Greater Ontario	xiv.	81
Newman, W. The Drainage System in Essex and Kent . . .	iv.	76
Palmer, R. K. Some Notes on Bridge Drafting	xiii.	119
Pedder, J. R., O.L.S. The Beeton Waterworks System . . .	vii.	18
Raymer, A. R. Railway Surveys	ii.	34
Richardson, G. H. Rodding on Railway Work	ii.	9
Richards, E. The High Pressure Steam Boiler	xii.	9
Cold Storage	xiii.	76
Rosebrugh, T. R., B.A. Scale Calculus	iii.	48
Ross, D. A., B.A. Railroad Location in the Crow's Nest Pass Railway	xii.	29
Russell, S. Track Laying	iii.	73
Offsets from Tangent on a 1° Curve	iii.	111
Notes on Railway Location and Construction in the North-West	iv.	42
Russell, W. Township Survey	iii.	98
Scott, A. M., '96 Arts. The Pendulum	ix.	81
Shanks, T. President's Address	xiii.	1
Shields, J. D. President's Address	vii.	11
Shillinglaw, W. H. Hot Water Heating	v.	20
Shipe, E. F. The Hardening and Tempering of Steel . . .	viii.	169
Smith, C. B., Ma.E. Canadian Steam Railways	xiii.	158
Smith, Alexander H. Exploring New Ontario	xiv.	22
Southworth, T. Forestry	xii.	114
Speller, F. N., B.A.Sc. Asphalt and Asphalt Paving . . .	vii.	44
The Use of Asphalt in Engineering Construction . . .	viii.	150
The Modern Open-Hearth Process	xi.	5
Stern, E. W. Notes on Field Work of Railroad Con- struction	i.	9
Notes on Iron Bridge Building	ii.	44
Cable Railways	iii.	36

	VOL.	PAGE.
Stewart, L. B., D.T.S. Description of a Timber Limit		
Survey in the Rocky Mountains	iii.	68
Distance Measuring Micrometers	iii.	92
An Exploratory Trip Through the Rockies	vi.	96
A Canoe Trip on the Saskatchewan	vii.	74
A Single Form of Telemeter	ix.	148
Longitude by Lunar Distances	xi.	53
A Trip to the Yukon	xiii.	145
Stovel, H. R. Hints to Prospectors	xii.	177
Cement vs. Bone Ash Cupels	xiv.	56
Stull, W. W. History and Chemistry of the Cyanide		
Process	xi.	25
Tennant, D. C. Tensile Strength of Rivets and Bolts.	xiii.	206
Thomson, R. W., B.A.Sc. President's Address.	v.	1
Sewage Disposal in Ontario	viii.	194
Thomson, T. K., C.E., A.M. Can. Soc. C.E. Angle Blocks.	ii.	50
Bridge Specifications	vi.	5
Notes on Cement	vii.	36
Foundations for a Twenty-one Story Building.	x.	96
Thorold, F. W. Electrolysis	xii.	72
Presidential Address	xiv.	1
Tye, A. T. The Canadian Dawn Animal	viii.	138
Tye, W. F. Cross Sectioning	i.	31
Tyrrell, H. G. Explorations on the Battle River	ii.	20
Madison Draw Bridge at Portland, Oregon	xiv.	89
Tyrrell, J. W., C.E. Hydraulic Mining in British Columbia	x.	88
On Snowshoes from the Barren Lands	x.	104
Van Buskirk, W. F., A.M., Can. Soc. C.E. The Ven-		
tilation of Sewers	viii.	128
Wagner, W. E. Aerial Cableways	xiii.	10
Withrow, W. J. Petroleum	ix.	38
Handling Daylight	xiv.	124
Wright, C. H. C., B.A.Sc. Aspect and Prospect	ix.	134
The Strength of Glass	xiii.	221