

Technical and Bibliographic Notes / Notes techniques et bibliographiques

The Institute has attempted to obtain the best original copy available for filming. Features of this copy which may be bibliographically unique, which may alter any of the images in the reproduction, or which may significantly change the usual method of filming, are checked below.

L'Institut a microfilmé le meilleur exemplaire qu'il lui a été possible de se procurer. Les détails de cet exemplaire qui sont peut-être uniques du point de vue bibliographique, qui peuvent modifier une image reproduite, ou qui peuvent exiger une modification dans la méthode normale de filmage sont indiqués ci-dessous.

Coloured covers/
Couverture de couleur

Coloured pages/
Pages de couleur

Covers damaged/
Couverture endommagée

Pages damaged/
Pages endommagées

Covers restored and/or laminated/
Couverture restaurée et/ou pelliculée

Pages restored and/or laminated/
Pages restaurées et/ou pelliculées

Cover title missing/
Le titre de couverture manque

Pages discoloured, stained or foxed/
Pages décolorées, tachetées ou piquées

Coloured maps/
Cartes géographiques en couleur

Pages detached/
Pages détachées

Coloured ink (i.e. other than blue or black)/
Encre de couleur (i.e. autre que bleue ou noire)

Showthrough/
Transparence

Coloured plates and/or illustrations/
Planches et/ou illustrations en couleur

Quality of print varies/
Qualité inégale de l'impression

Bound with other material/
Relié avec d'autres documents

Continuous pagination/
Pagination continue

Tight binding may cause shadows or distortion along interior margin/
La reliure serrée peut causer de l'ombre ou de la distorsion le long de la marge intérieure

Includes index(es)/
Comprend un (des) index

Title on header taken from:/
Le titre de l'en-tête provient:

Blank leaves added during restoration may appear within the text. Whenever possible, these have been omitted from filming/
Il se peut que certaines pages blanches ajoutées lors d'une restauration apparaissent dans le texte, mais, lorsque cela était possible, ces pages n'ont pas été filmées.

Title page of issue/
Page de titre de la livraison

Caption of issue/
Titre de départ de la livraison

Masthead/
Générique (périodiques) de la livraison

Additional comments:/
Commentaires supplémentaires:

This item is filmed at the reduction ratio checked below/
Ce document est filmé au taux de réduction indiqué ci-dessous.

10X	12X	14X	16X	18X	20X	22X	24X	26X	28X	30X	32X
								✓			

The Canadian Patent Office

RECORD

Vol. I.—No. 9.

DECEMBER, 1873.

Price in Canada \$1.50 per A. n
United States - \$2.00 "

CONTENTS.

INVENTIONS PATENTED,	185
INDEX OF INVENTIONS,	186
INDEX OF PATENTES,	187
ILLUSTRATIONS,	199

No. 2795. W. P. BARTLEY, Montreal, Que., 11th October, 1873, for 5 years: "Improvements on Walking Beam Steam Engines." (Perfectionnements aux machines à vapeur à balanciers.)

Claim.—1st. The two reciprocating cylinders *g*, and *L*, with high pressure or low pressure steam or both in combination with the beam *d*; 2nd. The combination of the cylinders *g*, and *l*, beam *d*, elongation *e*, and three centres *h*, *i*, and *k*.

No. 2796. W. P. MILLER, New York, U. S., 11th October, 1873, for 10 years: "Improvements in Saw-Teeth." (Perfectionnements aux dents de scies.)

Claim.—An insertible saw-tooth, having a circular base of more than half a circle, the said base pierced as at *C*, and separated as at *e*, for springing the heel laterally to insert the base in the socket as described.

No. 2797. E. J. EMMONS & M. J. KEANE, New York, U. S., 11th October, 1873, for 5 years: "Improvements in Children's Chairs." (Perfectionnement aux chaises: d'enfants.)

Claim.—1st. The frame *a*, slide bars *b*, spring *d*, and seat *c*; 2nd. The adjustable foot board in combination with the frame *a*, bars *b*, spring *d*, and seat *c*; 3rd. The hinged table forming also a head rest when its position is changed; 4th. The handles *g*, combined with the frame *a*, bars *b*, spring *d*, and seat *c*.

No. 2798. W. H. SIMMONDS, Acton Vale, Que., & T. R. JOHNSON, Montreal, Que., 13th October, 1873, for 5 years: "A Burglar Detector." (Un délateur de voleurs.)

Claim.—1st. The construction of a metal block which may be of various sizes and shapes with any number of holes or chambers at the sides, ends or top; 2nd. The screws at the ends to close chamber *B*, and to fasten the machine; 3rd. The application and arrangement of the springs by means of which the cap is fixed and the several chambers are caused to go off, and arouse the neighbourhood and burglar or burglars by the simple application of the various parts.

No. 2799. W. BEBRO, Eng., 17th October, 1873, for 15 years: "Improvements in Ticket Printing Machine." (Perfectionnements aux machines à imprimer des billets.)

Claim.—1st. The combination of the revolving cylinder *A*, with the travelling saddle piece *P*; 2nd. The combination with the cylinder *A*, and the saddle piece *P*, of the rollers *g*, *r*, and perforators or dividers *s*, *z*; 3rd. The combination of the revolving cylinder *A*, with the rollers *c*, *c*; 4th. The combination with the cylinder *A*,

and rollers *c*, *c*, of the bearing blocks *o*, *o*, the internal toothed wheel *h*, and the stud *i*; 5th. The combination of the lock catch *s*, with the wheel *h*.

No. 2800. G. F. DEAN & F. Y. C. HILL, Montreal, Que., 17th October, 1873, (Re-issue of Patent No. 2685), for 5 years: "A Combined Chair and Lounge." (Chaise et Causeuse combinées.)

Claim.—The combination of the side pieces *A*, bent pieces *D*, legs *H*, and connecting bars *K*, as described.

No. 2801. F. V. ROULEAU, St. Jean-Baptiste de l'île Verte, Que., 17th October, 1873, for 10 years: "Machine for Drying, Cleaning and Purifying Magnetic Sand." (Machine à sécher, nettoyer et purifier le sable magnétique ou ferrugineux.)

Claim.—1o. La table *C*; 2o. Le fourneau *B*; 3o. Le cylindre *D*, électro-aimanté au moyen des bobines à l'intérieur qui reçoivent le courant électrique par des électrodes communiquant aux piles; 4o. Le cylindre *F*, qui donne le mouvement au reste de la machine, le tout fonctionnant tel que décrit.

No. 2802. P. MUTTER, Hamilton, Ont., 17th October, 1873, for 5 years: "A Joint Preserver and Nut Protector for Railway Rails." (Un couvre-joint et couvre-écrou pour les lisses de chemins de fer.)

Claim.—The joint preserver, nut protector and check block *b*, as shown in Figs 1, 2, 3, 4, and 5, in combination with railway rails, arranged and constructed as specified.

No. 2803. A. C. JOHNSON, Pittsburgh, Penn., U. S., 17th October, 1873, for 5 years: "Improvements on Wash Boards." (Une planche à laver.)

Claim.—A wash-board, the rubbing surface of which is constructed of sheet metal furnished with conical rubbing or friction points *D*, as described.

No. 2804. S. G. HADLEY, Theresa, New York, U. S., 17th October, 1873, for 5 years: "Improvements in Snow Ploughs for Railway." (Perfectionnement aux charrues à neige de chemins de fer.)

Claim.—1st. The combination of the frame *I*, and truck *A*, operated by the screw *F*, as specified.

No. 2805. E. H. MADDOCK, Guelph, Ont., 17th October, 1873, for 5 years: "Improvements on Scaffolding." (Echafaudages perfectionnés.)

Claim.—The combination of the bracket *B*, with the post *A*, by means of the straps *C*, *C*, rope *D*, pin *E*, and guys *F*, *F*, by the strap *G*, as set forth.

No. 2806. JOHN WRIGHT, Sandwich, Ont., 18th October, 1873, for 5 years: "Cigar Making Machine." (Machine à faire des cigares.)

Claim.—1st. A plate N, and plate O, with projection o_1 , o_1 , acting in combination with the spaces or openings N₁, N₁, &c., or their equivalents, working with a bunch or cigar mould; 2nd. A plate D, and plate H, or their equivalents acting in combination with the spaces or openings N₁, N₁, &c., or their equivalents working with a bunch or cigar mould.

No. 2807. HERMAN FRANKELN, Toronto, Ont., 18th October, 1873, for 5 years; "A door spring." (Un ressort de porte.)

Claim.—1st. The spindle C, in combination with the spiral spring E, and arm H, in fig. 1, lug H, in fig. 2, arranged, formed, and operating, as described; 2nd. The clutch F, secured to the spindle C, in combination with the sockets G, in fig. 1, and the lug H, in fig. 2, arranged for the purpose of increasing the tension of the spiral spring E.

No. 2808. CHARLES PARKER, Meriden, Ct., U. S., 18th October, 1873, for 15 years: "Manufacture of sheet metal boxes." (Fabrication des boîtes métalliques.)

Claim.—1st. A case or box for eye-glasses, spectacles, matches, and similar purposes, formed from two plates A, and B, closed together; 2nd. A box or case for eye-glasses, spectacles, and similar purposes, formed from two plates A, and B, lined and closed together and with or without the flange f; 3rd. The dies constructed as described for closing or securing the edges of sheet metal boxes, cases and like articles.

No. 2809. JOSEPH PROCTOR, Boston, Mass., U. S., 18th October, 1873, for 5 years: "Sewing Machine Motor." (Moteur de machine à coudre.)

Claim.—The combination with the interior frame or plates a , b , and train of gears embraced therein, the outer plates c , d , constructed and arranged as set forth.

No. 2810. MARTIN LOCKWOOD, Cuba, N. Y., U. S., 18th October, 1873, for 5 years: "A Churn." (Une baratte.)

Claim.—1st. The upper dasher K, provided with a socket for its handle, and a guide for the handle of the lower dasher, in combination with the lower dasher K₁, having a socket for its handle when said sockets are eccentrically situated for the reception of the handles; 2nd. The levers E, E, provided at each end with fastening buttons p , p , for the attachment of the rods F, and dasher handles I.

No. 2811. DAVID B. MOORE, Oswego, N. Y., U. S., 18th October, 1873, for 5 years: "A Stove Pipe Shelf with Damper and Clothes Drier." (Une tablette à tuyau de poêle avec clé et séchoir à linge.)

Claim.—1st. The combination of the perforated pan A, with collar a , and sliding damper n , plate D, with collar a' , and plate C, with opening b , and damper h ; 2nd. The combination of the pan A, the arms p , p , and catches i .

No. 2812. CHARLES BLACKTIN, St. Stephens, N. B. (Assignee of John Kerr), 27th October, 1873, for 5 years: "A Saw-mill Feed Wheel." (Une roue d'alimentation de scierie.)

Claim.—The feed wheel a , having a triangular sided V shaped rim and arranged in combination with the sleeve b , arms c , c , and operating lever or rod h , and pawl i .

No. 2813. CHARLES D. KNAPP, Northfield, Vt., U. S., (Assignee of Joshua Sawyer), 27th October, 1873, for 5 years: "A Marble Wash." (Une lessive à marbre.)

Claim.—The application of muriatic acid to the stone while it is wet with the sal soda, thereby preventing the acid from injuring or colouring the stone in any way, in the proportions and for the purposes set forth.

No. 2814. PHILIP H. JENKINS, Toronto, Ont., 27th October, 1873, for 5 years: "Manufacture of Staple Fibre and Paper Pulp from Burdock." (Fabrication de produit fibreux et de pâte à papier de bardane.)

Claim.—The manufacture of staple fibre and paper pulp by the process described, or by any such process by which the fibre is separated and the weed becomes a staple of manufacture.

No. 2815. JAMES E. GILLESPIE, Norwich, Ct., U. S., 27th October, 1873, for 5 years: "Improvements in Rotary Pumps or Motors." (Perfectionnements aux pompes rotatives ou moteurs.)

Claim.—1st. The combination of sliding, and revolving radial pistons and loose eccentric rings E, for operation together; 2nd. The stationary eccentric D, and loose ring E, in combination with the radial pistons of a rotary pump or motor; 3rd. The radially sliding pistons C, having extensions c , c , towards the shaft in combination with the correspondingly recessed or grooved revolving drum and loose eccentric ring E; 4th. The combination of the pins upon the piston C, with the recesses e , in the loose ring E; 5th. The blocks a , to the pistons C, made adjustable from the outside of the cylinder or case.

No. 2816. EDWARD J. DEUROCHE & WILLIAM WARD, Petrolia, Ont., 27th October, 1873, for 5 years: "Improvements on Well Tube Stuffing Boxes." (Perfectionnements aux boîtes à étoupe de tuyaux de puits.)

Claim.—1st. In combination with the well tube or casing F, a stuffing box A, provided with vent holes C, and having a packing seat or groove I, for the reception of a packing gasket, and a central orifice to form in combination with the pump tubing E, an annular space D; 2d. In combination with the well casing F, packing box A, and pump tube E, the lid or cover B, holding the pump tube suspended, and arranged to press upon the packing in the packing seat I, by the gravity of the pump tubing as set forth.

No. 2817. DAVID W. LONG, Parkersburg, W. Va., U. S., 27th October, 1873, for 5 years: "Improvements on Hinges." (Perfectionnements aux pentures.)

Claim.—The leaves A, and B, combined with the additional leaf D, which latter is to be secured to the post at right angles to the plane of the door when closed, the knuckles and the pintle both falling without the plane of the leaves A, B, when they are both in a right line, this arrangement being such as to allow the door to move through half a circle, all as described.

No. 2818. ANTOINE LANGELLIER, Concord, N. H., U. S., 27th October, 1873, for 5 years: "Improvements on Car Couplings." (Perfectionnements aux attelages des voitures de chemins de fer.)

Claim.—The combination of the link B, having the pawl a , spring D, spring A₁, chain H, lever or bracket c , with a draw-head A, all arranged to operate in the manner set forth.

No. 2819. ANTOINE LANGELLIER, Concord, N. H., U. S., 27th October, 1873, for 5 years: "Improvements in Car Couplings." (Perfectionnements aux attelages des voitures de chemins de fer.)

Claim.—The combination of the pawl M, catch N, chain or rope L, pin F, levers J, flat bar I, with the draw-head A, all arranged to operate as set forth.

No. 2820. ANTOINE LANGELLIER, Concord, N. H., U. S., 27th October, 1873, for 5 years: "Improvements in Car Brakes." (Perfectionnements aux freins de wagons.)

Claim.—1st. The car brake, composed of the friction wheel F, Figs. 1 and 2, with their respective axle-trees and chains, M, N, and P, Q; 2nd. The combination of the whiffle-trees E, O, A₁, and A₂, with the chains M, N, and P, Q, attached thereto; 3rd. The combination of the rods B, B₁, and B₂, and the rods C, e , and F₁, with their respective springs D₁, M₁; 4th. The combination of the slotted lever L₁, and the spring M₂, Fig. 2, with the friction wheel F; 5th. The combination of the bunters A, A, and S, S, combined, adjusted and operated as set forth.

No. 2821. WILLIAM SIMPSON, Berlin, Ont., 27th October, 1873, for 5 years: "Mirror and Picture Frame Holder." (Porte-cadre et portemiroir.)

Claim.—A wire holder B, having a loop-apex a , equal sides b , and extensious d , and end c , arranged and applicable as described.

No. 2822. EDMUND W. ELMSLIE, London, Eng., 30th October, 1873, for 5 years: "Improvements in the Means of an Apparatus for Opening Hermetically Closed and other Cases, Boxes and Cans." (Perfectionnements dans la manière d'ouvrir les caisses, boîtes et bidons fermant hermétiquement et autrement, et dans les appareils à cette fin.)

Claim.—The placing of the wire in the case, box or can in such manner with the end or ends exposed so as to be able by pulling the same to cut through the skin or plate in the manner described and illustrated by the drawings; also the use of an opening instrument in combination with the inserted wires in the manner described.

No. 2823. JAMES LAIDLAW & JAMES KIDD, Paisley, Ont., 30th October, 1873, for 5 years: "Sickle Cushion for Mowers and Reapers." (Coussinet pour les lames des faucheuses-moissonneuses.)

Claim.—The application of the two cushions or springs O, O, slant locally on the spring bar K, which is slotted to receive the lug s, which passes through the said lug being instoned on the sickle, the cushions or springs accelerating the momentum of the sickle and retaining the otherwise lost power to expedite the return of the same, the sickle B, passing rapidly between the fingers W, the lug s, strikes alternately the spring O, O, at each end of the stroke thereby operating as set forth.

No. 2824. GEORGE A. RUMRILL & JAMES F. PHIPPEN, Kingston, Ont., 30th October, 1873, for 5 years: "Improvements on Forge Bellows." (Perfectionnements aux soufflets de forges.)

Claim.—1st. The combination with the air chest A, of a forge bellows constructed as set forth, the nozzles J, J, J, each provided with a sliding valve K, whereby a series of continuous blasts can be regulated and ejected; 2nd. Providing the bellows B, with a hinged trap M; 3rd. The removable roof G, and removable diaphragm D, and guide rods I, operating as set forth.

No. 2825. EDWIN C. SEELY, Port Medway, U. S., 30th October, 1873, for 5 years: "A Compression Pump." (Une pompe à compression.)

Claim.—1st. The combination of the cylinder A, piston or head B, having openings H, and valves I, rod D, cross head F, and discharge pipe K; 2nd. The combination of the cylinder A, (provided with openings and valves) piston B, rod D, cross-head F, and discharge pipe K.

No. 2826. ANDREW J. ROBERTS, Boston, Mass., U. S., 30th October, 1873, for 5 years: "Improvements on a Machine for making Horse Shoes." (Perfectionnements à une machine à fer à cheval.)

Claim.—1st. A longitudinal former X, arranged to travel backward and forward on a suitable supporting frame, connected with one end of a horse-shoe machine and having on the rear a curved cam t, and curved downward on the forward part to allow the passage over it of the bar, and curved inward on the sides and flanged and curved on the front end to conform to the inner contour of the shoe; 2nd. In combination with the above travelling, longitudinal former, a slotted frame Y, formed on its forward portion with an aperture J, and provided with vertical flanged rollers r, r; 3rd. Levers Z, Z, pivoted to the former frame Y, and formed on their rear with lateral projecting rollers, and curved and formed on their forward ends respectively, with jaws and with a cutter, in combination with the cam K of a travelling former X; 4th. A horse-shoe machine, a transverse feeder formed to receive a pivoted ratchet or other suitable bar holder and arranged to travel on a frame G, having a cut-off block A, in combination with a former X, frame Y, and levers Z, Z; 5th. Adjustable transverse formers, U, formed on the inner ends at the back to conform each to the half contour of a horse-shoe, curved and otherwise formed to fit in and be readily attached to or removed from recessed portions in the top of annular plates T, formed with lateral inner projecting bifurcated ears i, and pivoted so as to oscillate on a horse-shoe machine table; 6th. A horse-shoe machine, a plunger m, having an upper socket to receive a plunger-piston to which it is held by a transverse bolt, or otherwise, and recessed and curved on the front and sides to receive a die, and formed on its sides with vertical grooves or channels q, for the introduction of water to the bottom of the die, and provided with screws o, turning in its bottom and bearing upon so as to adjust the die; 7th. An adjustable die m' curved in the contour of a horse-shoe and formed on its bottom with flanges, and prongs to form the grooves and nail holes of the shoe and having a horizontal curved yoke z, formed with screw ends extending through a cross u, and held by screw nuts w, turning on said ends; 8th. A driving shaft

Q, formed with cams N, P, Q, formed by grooves running parallel for a certain distance, or distances and there inclining in opposite directions; 9th. The combination of the former A, plate X, table C, lever W, off set-bar V, roller p, cam P, and driving shaft O; 10th. The combination of the plunger-piston J, frame Q, table C, levers or beams H, lever-arms K, K, platform A, lever L, off set-bar M, roller p, cam N, and driving shaft O; 11th. The combination of the formers U, plates T, table C, arms S, plate E, off set-bar R, roller k, cam Q, and shaft O; 12th. A revolving elongated tapering cam J, connected with one end of a rotating longitudinal shaft in combination with a roller r, lever-arm H, platform A, lever K, frame G, and travelling feeder D; 13th. The formers U, in combination with the former X, and feeder D; 14th. The plunger m, provided with a suitable die, in combination with the formers U, X, levers Z, Z, and feeder D; 15th. A rotating shaft Q, connected at one end with a cam J, and formed with cams P, Q, N, and provided at the other end, with a gear wheel L, operated by a gear wheel L', attached to a driving wheel M, turning on an axle connected with the table of a horse-shoe machine, or arranged to be operated by any other suitable mechanism for imparting motive power to it, in combination with the several mechanical devices described connecting with and operated by the said cams J, P, Q, N, to produce an automatic reciprocating, intermittent movement to the feeder D, formers X, U, and plunger m, 16th. A horse-shoe machine provided with a transverse travelling feeder, a longitudinal travelling former, oscillating transverse formers, and a plunger having a suitable die, each connected by suitable operating mechanical devices, respectively with a cam connected with and cams formed on a rotating shaft, so that by the rotation of the said shaft, an automatic reciprocating intermittent movement is produced to the said feeder, formers and plunger by which a bar is at the proper time and in a suitable manner led along by the said feeder through a cut-off block, held, borne down and severed by a bar-holder lever and a cut-off lever, pivoted to the sides of the longitudinal former frame and operated by a curved cam on the rear of the longitudinal former, by which former it is advanced, bent and slung between vertical flanged rollers and carried forward and shaped between properly curved ends of the said oscillating transverse formers and grooved and punched with nail holes beneath the plunger die, which by the return movement is raised to release the finished shoe which is carried back by the retrograde movement of the longitudinal former, knocked off by a stem, or other knock off device on the holder lever and dropped through an aperture formed in the frame of the longitudinal former, which former at the termination of its return movement is at once advanced to repeat the operation for the formation of a new shoe as specified.

No. 2827. CREASY J. WHELLAMS, Toronto, Ont., 30th October, 1873, for 5 years: "A Dowel Nail." (Un goujon.)

Claim.—1st. The dowel nail A, constructed as shown in Figs. 1 and 3; 2nd. The punch D, used for the purpose of driving the dowel nail A.

No. 2828. WILLIAM H. CORY & EDWARD CORY, London, Eng., 30th October, 1873, (Extension of Patent No. 2572), for a 3rd period of 5 years: "Fuel Moulding Machine." (Moule à combustible.)

Claim.—1st. A pressing and moulding machine, the combination of the revolving moulding table A, containing mould cavities B, with the cover G, and feed hopper K, and with the plungers C, working on the helical tramway D; 2nd. The use for moulds of such apparatus of sliding covers L, L', fitted with rollers L', and L', which work in cam grooves in the cover G; 3rd. The mode of fitting the plungers C, which form the bottoms of the moulds B, with rims and inner plungers M, worked by rods N, so as to lift the moulded blocks clear of the said rims; 4th. The combination with the pressing and moulding apparatus of the wipers S, and travelling band T, for removing the moulded blocks from the revolving table; 5th. The method of adjusting the charge of the moulds and regulating the pressure to which the material is subjected in moulding by means of the moveable parts V, and W, of the inclined tramway and the springs w, which support the latter.

No. 2829. FRANCIS W. GLEN & GEORGE J. BARCLAY, Oshawa, Ont., 30th October, 1873, for 5 years: "Improvements in Middlings and Flour Purifiers." (Perfectionnements aux purificateurs des gruaux et de la farine.)

Claim.—1st. The wind spout N, placed above the screens C, in combination with the feeding spout T, or hopper O, arranged so as to cause a blast of air to pass through the middlings before it reaches the screens C; 2nd. The wind spouts N', placed between the return boards H, and screens C, above the latter arranged so as to cause a blast to pass through the middlings while falling from the return boards H, to the screens C, below; 3rd. A vibrating shoe B, containing two or more screens C, in combination with the suction fan L; 4th. A vibrating shoe B, containing two or more screens C, in combination with the blast fan K, and suction fan L; 5th. Covering the exterior mouth of the blast fan K, with bolting cloth or any suitable material that will admit air to the fan, but will prevent any dust passing through; 6th. The combination with the bottom of the vibrating shoe of two or more wind spouts R, with a hinge valve r, for the purpose of distributing the different grades of middlings purified by the machine to separate bins; 7th. The combination of the knockers I, and the strips with studs J, and J', actuated by the motion of the vibrating shoe B; 8th. The wind-chamber N, and wind spouts N, N', N', in combination with

the suction fan L; 9th. The wind chamber N, and wind spouts N₁, N₂, N₃, in combination with the blast fan K, and suction fan L.

No. 2830. JOSEPH P. BASS, assignee of EMILE R. WESTON, Bangor, Me., U. S., 31st October, 1873, for 5 years: "Improvements on polished photographs." (Perfectionnements aux cartes photographiques polies.)

Claim.—1st. A photograph, the surface of which has been polished by the process of burnishing accomplished by a machine for which the said Emile Riens Weston has obtained a patent under the Patent Act of 1872, dated the twenty-second day of January, in the year one thousand eight hundred and seventy-three, and numbered 1995.

No. 2831. MALCOLM MACVICAR, Potsdam, N. Y., U. S., 7th November, 1873, for 15 years: Apparatus for objective teaching in arithmetic and reading." (Appareil pour l'enseignement démonstratif de l'arithmétique et de la lecture.)

Claim.—1st. The independent slides arranged on the sides of the opening frame a; 2nd. The slides c adapted for presenting either cards or objects before the opening in frame a; 3rd. The object frame b; and 4th. The frame a, independent slides I, slide c and frame b, when the parts are combined arranged to operate as described.

No. 2832. ROBERT BROWN, Dayton, Ohio, U. S., 7th November, 1873, for 10 years: "Improvement in hubs for carriage wheels." (Perfectionnement des moyeux de roues de voitures.)

Claim.—1st. The male and female hub bands A A, correspondingly mortised and bevelled; and 2nd. The combination of the male and female mortised bands A A', and the grooved hub B.

No. 2833. ROLLIN A. LEE, Cleveland, Ohio, U. S., 7th November, 1873, for 5 years: "A combination lock." (Une serrure à combinaison.)

Claim.—1st. The combination and arrangement of the discs F, G, H, with the adjusting plate I, and means for securing the same, for changing the combination of numbers; 2nd. In combination with the discs F, G, H, and adjustable plate I, the tumbler c, with projections c₁, c₂, c₃; 3rd. Three or more ratchet or counting wheels O, P, Q, provided with spaces or teeth and spring pawls p, q, r, operating conjointly as set forth; 4th. The pivoted tumbler C, bolt or dog B, and arbor D, with projections d₁, d₂, constructed and arranged as set forth; and 5th. The combination of the discs F, G, H, devices I, J, K, ratchets, O, P, Q, pawls p, q, r, tumblers c, bolt B, and arbor D, d₁, d₂, all constructed and operating as set forth.

No. 2834. JAMES G. MOORE, Lisbon, N. H., U. S., 7th November, 1873, for 15 years: "Improvement on machinery for grinding wood for paper pulp." (Perfectionnement des appareils à triturer le bois pour la pâte à papier.)

Claim.—The rotary carrier B, in combination with the stationary grinding case A, provided with the abrasive peripheral surface or such and the receiving and discharging trough, all being arranged to operate as specified.

No. 2835. JETHRO B. HUSTED, Vergennes, Vt., U. S., 7th November, 1873, for 5 years: "Improvements on machines for finishing horse shoe nails." (Perfectionnements aux machines à finir le clou à cheval.)

Claim.—1st. The rotating die P, in combination with the stationary support R, for trimming horse shoe nails; 2nd. The rack C, with the slide and weight, or their equivalents, arranged to feed the nails to the operating mechanism; 3rd. The slotted feed wheel L, for feeding the nails to the die, and holding them in position being operated upon; and 4th. The hammer H, and anvil O, in combination with the automatic feeding devices arranged to operate as set forth.

No. 2836. JOHN E. LEEPER, Godfrey, Ill., U. S., 7th November, 1873, for 5 years: "Improvements on Iron Freight Cars." (Perfectionnements aux wagons à fret en fer.)

Claim.—1st. An iron car composed of a double casing or shell of sheet metal of the form and construction described; 2nd. The running board G; 3rd. The combination of running board G, and the balustrade H; 4th. The air passage Q, between the two shells along the top of the car, in combination with the air channels

between the ribs and at the ends and sides of the car, as shown in Fig. 2, by the arrows L, M, N; 5th. The casing or shells A, B, in combination with the timbers I, P, ribs D, and bolts F, for firmly securing all together as shown in Fig. 2; 6th. The shells A, B, in combination with the compartment J, and suspended chambers or vessels K, for refrigerating purposes.

No. 2837. WILLIAM S. HOUGH, Port Royal, Ont., 7th November, 1873, for 5 years: "Composition of Matter for the destruction of Thistles." (Composition pour la destruction des charbons.)

Claim.—A compound made of chloride of sodium, nitrate of potash and protoxide of calcium in about the proportions specified with or without the addition or admixture of ochrous earths and alkaline ashes, for application either in a dry, or liquid state with water to the leaves and stalk of the noxious weed or thistle for destroying vegetable life as set forth.

No. 2838. FRANKLIN LEONARD, Cleveland, Ohio, U. S., 7th November, 1873, for 5 years: "Improvements on Link Machines." (Perfectionnements aux machines à mailles.)

Claim.—1st. The link C, and spring D, in combination with the arms B, B; 2nd. The pillow block T, arranged in relation to, and in combination with the rollers a, b, and arms J, K; 3rd. The gauge V, as arranged in relation to the standard L, rollers a, b, and arms J, K; 4th. The dies or prints c, d, of the hammer and block constructed as described and co-operating in the manner specified.

No. 2839. ISAAC BROWN, Edinburgh, Scot., 7th November, 1873, for 5 years: "Improvements on Irrigating and Manuring Land and in Hurdle Grazing it for Effectually Utilizing the Grass upon that known as Pasture Land, and in the Treatment and utilization of Sewage for Agricultural Purposes." (Perfectionnements dans l'irrigation et l'engrais des terres, le parage alternatif, pour mieux utiliser l'herbe des pâturages et dans le traitement et l'emploi des vidanges pour les fins agricoles.)

Claim.—1st. The system or mode of applying moisture in the form of fine showers or spray to land by the use of finely punctured pipes A, (Figs. 1, 2, 3, 4 and 5), in connection with mains supplied with water under pressure either by force pumps direct or by gravitation. 2nd. The protecting from injury the perforated pipes A, employed in manuring, irrigating or watering land by laying the same in a grooved furrow made in the soil and by placing suitable shields B, (Figs. 1, 2, 3, 4 and 5), over the perforations; 3rd. The peculiar construction and modes of applying slotted shields or covers B, to perforated pipes A, employed in irrigating or manuring land as illustrated in the drawings; 4th. The application and use to and in the straining or filtration of liquid sewage or diverting it of its solid matter whether for the purpose specified or for its being passed by a continuous flow in a sufficiently purified condition for its entering rivers without polluting them, of filters or strainers composed of wire gauze and faggot work of withes or other suitable materials; 5th. The application and use to and in the straining or filtering of liquid sewage matter for the purpose specified or for its being passed by a continuous flow into rivers without polluting them, of fine wire gauze, arranged in moveable frames, so as to cleanse what is known as town sewage or other liquids from their solid constituents by a continuous flow; 6th. The combination of a depositing tank with brindles or faggots of withes or their equivalents and with fine wire gauze screens; 7th. The modes of cleansing the said wicker filter or faggot work and wire gauze filter screens; 8th. The conversion of the sludge or solid deposited matter of sewage into a free and portable manure by the thorough admixture therewith in any convenient manner of ground phosphate of lime and sulphuric or other suitable acid in suitable proportions; 9th. The system or mode of manuring or applying fertilizing agents to land for their more certain utilization by first spreading a dry manure or fertilizing agent on the surface of the land and then causing a fine rain shower or water spray to descend thereon from finely punctured pipes; 10th. The system or mode of protecting grass for pasture grazing or other grown crops upon land to be eaten off by sheep or cattle from waste by means of a hurdle or hurdles composed of a main beam A, and arms B, B, projecting therefrom as described and illustrated on Fig. 6, of the drawings.

No. 2840. LLEWELLYN E. AINSWORTH, East Bolton, Que., 7th November, 1873, for 5 years: "A Fire-escape." (Un appareil de sauvetage.)

Claim.—The combination of the pronged and bent bar G, tooth a, and lever J, with a ladder A, B, all constructed as set forth.

No. 2841. JOHN M. KILLIN, Pittsburgh, Penn., U. S., 13th November, 1873, for 5 years: "Moulder's Gate." (Jet de fonte.)

Claim.—1st. A moulder's flat gate or sprue, consisting of a thin plate or board A, having an enlarged centre C; 2nd. In combination with the gate or sprue A, C, the handle D.

No. 2842. OBADIAH SHERWOOD, Jr., Brome, Que., 13th November, 1873, for 5 years: "Self-railway Car Coupler." (Attelage automatique de chemin de fer.)

Claim.—1st. The peculiar shape of the bunter A, K, and Y, Y; 2nd. The coil spring C; 3rd. The iron slide D; 4th. The block E.

No. 2843. DANIEL DE CASTRO, Mortlake, and RICHARD BURTON, Camden Town, London, Eng., 13th November, 1873, for 5 years: "Compensating Wet Gas Meter." (Compteur à gaz compensatoire.)

Claim.—1st. The combination in wet gas meters of the water reservoir b, with the adjusted waste water pipe l, and the pipe m, having an adjustable opening for admitting gas into the water reservoir. — 2nd. The valve n, required, and the pipe k, for admitting gas to the drum arranged as explained; 2nd. The flexible top and bottom of the chamber w, by which the height of the pipe m, is regulated.

No. 2844. WILLIAM A. TELLING & SAMUEL JOHNSON, Wood Green, Eng., 13th November, 1873, for 5 years: "Dry Gas Meter." (Compteur sec à gaz.)

Claim.—1st. The combination with the diaphragm, in a dry gas meter of the weighted balance lever G, arranged so that it assists in lifting the weighted lever p, used for reversing the slide valve w, and thus renders the action of the diaphragm continuous and equable as shewn in the drawing; 2nd. The combination with the pins m, m', driven by the diaphragm of the curved or cycloidal shaped weighted lever which drives the slide w, so that the downward pressure upon the pins is reduced; 3rd. The arrangement of the lever L, rod M, oscillating pallet N, driving the pallet wheel P, for the purpose of driving the registering apparatus of dry gas meter, as shewn in the drawing.

No. 2845. JOSEPH BRUNET & LEON BELLEFEUILLE, Montreal, Que., 13th November, 1873, for 5 years: "Machine for Pressing Peat." (Machine à presser la tourbe.)

Claim.—1o. La combinaison dans une machine à comprimer la tourbe, des huit couteaux E, avec l'arbre moteur D; 2o. La combinaison des grattoirs F, avec l'arbre moteur D, pour comprimer et repousser la tourbe dans le moule placé sous le quart de tambour L; 3o. La combinaison des moules A, à cinq compartiments pour façonner des briques de tourbe; 4o. La combinaison de la machine et de ses parties, couteaux et grattoirs, tel que décrit.

No. 2846. JOHN K. HORNE, Almonte, Ont., 13th November, 1873, for 5 years: "Pattern for Pipe Elbows." (Gabarit de coudes de tuyaux.)

Claim.—1st. A pattern for pipe elbows to describe the required sweep or mitre previous to being formed into sections and which when united at the mitre joints forms a pipe elbow of any required angle; 2nd. The pivot C, so placed as to give the exact sweep or curve of the edge C, C, to scribe the large and small ends of the elbow to be made; 3rd. The sector plates A, and B, having a series of scales pivoted together at the point C, and provided with the slot D, and screw E, or other suitable fastenings.

No. 2847. DEWITT C. BAKER, Fulton, N. Y., U. S., 13th November, 1873, for 5 years: "A Cultivator." (Un cultivateur.)

Claim.—1st. The novel combination of the beam A, with its handles B, B, the stocks C, and D, adjustable hinged wings E, E, slotted brace bar G, cultivator teeth H, H, and I, all operating together as specified; 2nd. The slotted brace bar G, in combination with the adjustable stocks D, D, for the side cultivator teeth H, H, and adjustable wings E, E; 3rd. The hinged wings E, E, constructed and arranged as specified, in combination with the shovel stocks D, D.

No. 2848. DEWITT C. BAKER, Fulton, N. Y., U. S., 13th November, 1873, for 5 years: "Bolt Holder for Railroad Rails." (Porte-Ecrous pour les lisses de chemin de fer.)

Claim.—A bolt holder, consisting of a hook, or grapple A, and a socket lever B, hinged together and operating in the manner specified.

No. 2849. SAMUEL RUE, Philadelphia, Penn., U. S., 13th November, 1873, for 5 years: "Improvements on Injectors for Steam Generators." (Perfectionnements aux injecteurs de vapeur.)

Claim.—1st. The injector consisting in a single casting with two chambers at the ends thereof, a plug in each chamber, and an intermediate tube extending from one chamber to the other; 2nd. The tapering bores of the plugs and intermediate tube diminishing from the steam pipe to the delivery tube; 3rd. A jet of steam introduced into the overflow; 4th. The lever M, applied as described and adapted for a right or left hand injector; 5th. A valve in the overflow as set forth; 6th. The steam pipe S, in combination with the tube H, and overflow chamber; 7th. The tubular passage T, with opening T', and the valve V, in combination with the overflow, the tube H and plug D.

No. 2850. JOHN W. STOCKWELL, Portland, Me., U. S., 13th November, 1873, for 5 years: "Machine for the Manufacture of Cement Pipes." (Machine pour la fabrication de tuyaux en ciment.)

Claim.—1st. The manufacture of pipe of the kind mentioned by the use of the core one, forming rings and rotary tamping or pressing devices; 2nd. The combination of the carriage r, and its accompanying devices with the rollers shown in fig. 12; 3rd. The manner of keeping the core and case stationary during the manufacture of a joint of pipe; 4th. The combination cam fig. 7, clutch b, and rod a; 5th. The combination with the clutch b, of the device shown in fig. 6; 6th. The combination of the rod a, the slide z, and lever x; 7th. The box w, and sliding portion t; 8th. The form of clutch shown in figs. 10 and 11; 9th. The combination of the catch H, shaft B, cam fig. 7 clutch b, and rod a; and 10th. The combination of the upright piece o, and horizontal pieces n, to contract and expand the core as set forth.

No. 2851. JOHN W. STOCKWELL, Portland Me., U. S., 13th November, 1873, for 5 years: "Improved Mixing Machine." (Bouloir perfectionné.)

Machine for mixing the materials of which hydraulic cement pipes are made.

Claim.—1st. The rotary mixer or blade D, operating within a rotor or receptacle. 2nd. The combination of the receptacle B, vertical rotary shaft C, and mixer D, with the trap I.

No. 2852. SAMUEL B. MUNSON, jr., Chicago, Ill., U. S., 13th November, 1873, for 15 years: "Fire-proof Shutter." (Contrevent réfractaire.)

Claim.—1st. A window or door shutter composed of corrugated plates combined together to form a series of vertical air passages; 2nd. A window or door shutter composed of corrugated plates combined together to form a series of vertical air passages, when the ends of said passages communicate by means of lateral openings with the external air.

No. 2853. GIDEON W. COTTINGHAM, St. Mary's, Texas, U. S., 13th November, 1873, for 5 years: "Machine for Ironing Clothes." (Machine à repasser le linge.)

Claim.—1st. The table D, having base b, vertical parts b', b', and elevated portion E, in combination with the guides c, c, and rollers a, a; 2nd. The rock shaft R, braces f, f, and curved arm S, having handle h, in combination with the iron T; 3rd. The table D, and iron T, in combination with treadle M, cord O, lever P, arm S, roller F, and cords H, H, all arranged as described.

No. 2854. HENRY BOLTON, Brantford, Ont., 13th November, 1873, for 5 years: "Improved double adjustable piano stool back." (Dossier de banc de piano mobile, perfectionné.)

Claim.—The combination of curved spring B, attached to seat C, L, strap D, and set screw E, and also attached to back A, by strap F, and set screw G.

No. 2855. HATHERLEY SPEAR, Cape Elizabeth, Me., U. S., 13th November, 1873, for 5 years: "A Pump." (Une Pompe.)

Claim.—A pump constructed of the reservoirs A, A', A'', A'', A', A', A', the pipes B, B', B', and the valves C, the pipes n, and n, the cylinder S, and the double acting piston working therein.

No. 2856. NATHANIEL C. LOCKE, Salem, Mass., U. S., 13th November, 1873, for 5 years: "Pressure regulator for steam or water." (Régulateur de pression pour la vapeur ou l'eau.)

Claim.—A regulator constructed as described, that is, with a water chamber G, an air chamber H, a supply valve F, check-valve C, and safety valve L, and the whole arranged together for operation as specified.

No. 2857. MOSES MERRICK, (Assignee of H. Tilden), Oswego, N. Y., U. S., 14th November, 1873, for 5 years: "Gas Machine." (Machine à gaz.)

Claim.—1st. The combination of the cylinder *a*, bell *f*, basin *c*, pipe *g*, hydro-carbon compartment *i*, standard *b*, and drip-cup *m*; 2nd. The construction and arrangement of cylinder *a*, bell *f*, basin *c*, pipe *g*, hydro-carbon compartment *i*, standard *b*, and drip-cup *m*; 3rd. The sial hemp, in the lower part of the hydro-carbon compartment *i*, in combination with the charcoal in the upper part above the screen *k*, separating the charcoal from the sial hemp, as described.

No. 2858. EDWARD BEANES, Maidenhead, Eng., 14th November, 1873, (Extension of Patent No. 341), for 5 years: "Improvements in Brewing." (Perfectionnements dans la fabrication de la bière.)

Claim.—The process of brewing, the treating the brewing materials with sulphurous acid, or the salts of sulphurous acid hereinafter mentioned before their entrance into the mash tun, during the process of mashing or during the process of boiling the wort with the hops and consequently before the fermentation of the liquor has taken place, and the production thereby of an improved quality of beer substantially in the manner described.

No. 2859. GAIL BORDEN, White Plains, and JOHN G. BORDEN, South East, N. Y., U. S., 14th November, 1873, for 15 years: "Manufacture or Product of Condensed Milk." (Préparation ou produit de lait condensé.)

Claim.—The manufacture or product of condensed milk rendered preservative by heating the milk under pressure to a degree above the boiling point or above two hundred and twelve degrees Fahrenheit, by the process and operation set forth.

No. 2860. GAIL BORDEN, White Plains, and JOHN G. BORDEN, South East, N. Y., U. S., 14th November, 1873, for 15 years: "Process of Preserving and Condensing Milk." (Procédé de conservation et de condensation du lait.)

Claim.—The destruction of the element or property in milk which leads to putrescence, or fermentation, by heating the milk under pressure, to a degree above the boiling point, or above two hundred and twelve degrees Fahrenheit, for the purpose set forth.

No. 2861. W. G. DUNN, Hamilton, Ont., 14th November, 1873, for 5 years: "Moveable Self-Feed Attachment for Coal Cooking Stoves." (Alimentateur-automate de poêle de cuisine à charbon mobile.)

Claim.—A removable self-feeder *b*, with flange *c*, adapted to and combined with coal cooking stoves; 2nd. A removable self-feeder *b*, with flange *c*, used in combination with a raised extended top *d*, or the same countersunk in the top of a stove over the fire box; 3rd. The plate or top *d*, raised and extended as shown, or countersunk in the top of a coal cooking stove; 4th. The arrangement of a sliding damper *g*, in the feeder *b*, as, and for the purpose specified.

No. 2862. THOMAS O. KEMP, Clinton, Ont., 15th November, 1873, for 5 years: "Attachment for removing Scum and other Impurities from Steam boilers." (Appareil pour enlever l'écume et autres impuretés, des chaudières à vapeur.)

Claim.—The combination of interior and partially submerged pipes *G*, *G*, with an exterior reservoir *E*, by which combination a current is maintained for the removal of scale, scum and suspended impurities from steam boilers.

No. 2863. EBER C. FLINT, Belleville, Ont., (Assignee of Elias P. Needham), 15th November, 1873, for 5 years: "Improvements on Keys for Pianos and other Musical Instruments." (Perfectionnements aux clés de pianos et autres instruments de musique.)

Claim.—A key *a*, for organs, piano-fortes, and other musical instruments having its upper front edge rounded off, and a veneer extending from its top continuously on such rounded edge, and down its front.

No. 2864. JAMES K. FINLEY, Delphi, Ind., U. S., 15th November, 1873, for 15 years: "A Gate." (Une barrière.)

Claim.—The combination of the gate *A*, with horizontal projecting bar *D*, and the gate post *C*, with the frame *G*, and lever *L*, said frame being composed of the slotted horizontal part *a*, vertical part *b*, and curved part *d*, and the lever having its upper end *e*, weighted and the lower end *f*, wedge shaped.

No. 2865. CHARLES KENDALL, Beloit, Wis., U. S., 15th November, 1873, for 10 years: "Machine for Renovating and Drying Feathers." (Machine à rafraîchir et sécher la plume.)

Claim.—1st. A feather renovator and drier, the central cylinder *F*, provided with a partition *K*, at one end in combination with the branch tubes *H*, and *I*, the surrounding chamber *B*, and the inlet and outlet hollow bearings *C*, *D*; 2nd. The renovator described, having all its parts constructed and arranged for joint operation as shown in the drawing.

No. 2866. RILEY BURDETT, Erie, Penn., U. S., 15th November, 1873, for 5 years: "Improvements on Reed Organs." (Perfectionnements aux orgues à anches.)

Claim.—1st. The veil *B*, in combination with the reed mute *A*, to allow of a partial or full opening thereof; 2nd. The reed board *I*, having three, either full or partial, sets of reeds in front of the tracker pins, two of which sets enter the reed board obliquely.

No. 2867. JOHN C. FORD & AUSTIN D. CABLE, Montreal, Que., 15th November, 1873, for 5 years: "Horse Halter." (Enchevêtrement de cheval.)

Claim.—1st. An adjustable leg halter to be used for attaching horses either to the vehicle in, or to which they are harnessed or to any part of the harness, or if a saddle horse to the saddle, composed of an adjustable strap *A*, *B*, and adjustable clasp *G*; 2nd. The clasp *G*, for encircling either fore leg of a horse, made with or without hinge joint and fastened by a snap clasp, or in any convenient manner.

No. 2868. ANTONIO PELLETIER, Washington, D. C., and the Rev. JOHN B. A. BROUILLET, Walla-Walla, Washington Ty., U. S., and HONORÉ LAFLEUR, Yamaska, Que., 18th November, 1873, for 15 years: "Composition for the Manufacture of Artificial Stone and other purposes." (Composition pour la fabrication de la pierre artificielle et autres fins.)

Claim.—1st. The described composition, consisting of sard. cement, oxides and chlorides, prepared and united as described; 2nd. As a new article of manufacture an artificial stone prepared as set forth; 3rd. A fire proof cement or coating prepared as described; 4th. The use of an oxide and corresponding chloride, in connection with silicious matter and cement as a means of forming a compact solid mass, whether the same be moulded into blocks or be used in any other form.

No. 2869. MATHEW HENRY, Parkhill, Ont., and JOHN B. STEELE, Montreal, Que., 21st November, 1873, for 5 years: "Composition for Lighting Fires." (Composition pour allumer le feu.)

Claim.—A composition of matter composed of asbestos, pumice stone, plaster of Paris and salt, in the proportions specified.

No. 2870. JOHN WEST, Maidstone, Eng., 21st November, 1873, for 5 years: "Method of Manufacturing Ga- and Apparatus therefor." (Méthode et appareil de fabrication du gaz.)

Claim.—1st. The charger *E*, Fig. 8, and shewn in detail in Figs. 2, 3, and 4, with all its appliances; 2nd. The construction used and application of long mouth pieces with lids; 3rd. The arrangement of coke chambers; 4th. The traveling carriage *K*, Figs. 8 and 11; 5th. The application of steam, air or gas for producing an alteration in the level of the liquid in the hydraulic main by means of the apparatus described and shewn on the drawings.

No. 2871. CHARLES V. DIT GADBOIS, Baltic, U. S., 21st November, 1873, for 15 years: "A Washing Machine." (Une machine à laver.)

Claim.—1st. A washing machine consisting of an outer casing or tub *A*, frame *B*, and cover *C*, and of an inner washing drum *D*, constructed as set forth; 2nd. A washing machine, the drum *D*, with cover *D*, cross-boards *c*, and rows of pegs *d*, with holes *e*; 3rd. The combination with the tub *A*, and drum *D*, of the toothed wheel *g*, and pinion *h*.

No. 2872. ALFRED WILSON & EDWARD M. LAW, Bell Ewart, Ont., 21st November, 1873, for 5 years: "A Sash Fastener." (Un tourniquet de persiennes.)

Claim.—1st. The combination and arrangement with each of the various parts of the device C, namely: the plate e, the point a, the flanges c, c', the thumb-piece b, and the straight slot d; 2nd. The fastener C, in combination with a window, or other sash B; 3rd. The fastener C, in combination with a window or other frame A.

No. 2873. ELBRIGE B. SIMS, ANTWERP, N. Y., U. S., 21st November, 1873, for 5 years: "Improvements on Door Bells." (Perfectionnements aux cloches de portes.)

Claim.—1st. The bell-case A, cast in any suitable shape, when used in combination with an attachment and detachable metallic band D, which surrounds the same; 2nd. The arrangement and combination with the case A, of the cog-wheels E, F, tappet H, bent arms I, I', coiled springs L, and hammers K, operating as described.

No. 2874. WILLIAM VINCENT, Arborfield, Eng., 21st November, 1873, for 15 years: "Gas Apparatus." (Appareil à gaz.)

Claim.—1st. The retort constructed and arranged within the furnace; 2nd. The peculiar construction of the mouth of the retort and the contrivances arranged in combination therewith for closing the same; 3rd. The providing of the retort with an internal grating; 4th. The peculiar construction of the furnace with grate-bars curved to correspond with the form of the underside of the retort and with contrivances for regulating the admission of air; 5th. The oval and tapered stand pipe and mouth piece attached to the retort immediately in front of the furnace and provided with the gratings and with the safety cock; 6th. The condenser constructed as described (either with or without the purifier) and provided with partition plates dipping into water contained therein and with agitating wheels arranged between the said partition plates; 7th. The providing of the end of the gas inlet pipe below the surface of the water in the said condenser with a balance valve; 8th. The apparatus for manufacturing gas, consisting of the aforesaid furnace retort, stand pipe, condenser (either with or without the purifier) and other novel and peculiar contrivances described, constructed and arranged in combination with each other and with a gas holder as set forth.

No. 2875. HARVEY BREWER, East Parsonfield, Me., U. S., 21st November, 1873, for 5 years: "A Waggon Brake." (Un frein de wagon.)

Claim.—The combination of the spring brake D, constructed as shown and operated by the rod F, having at its ends, the tumbler H, provided with its lugs a, a', for the attachment of the flexible chains J, J', with the spring supporting bar C, the whole arranged and operating as set forth.

No. 2876. ANDREAS J. SORENSSEN, Erie, Penn., U. S., 21st November, 1873, for 5 years: "Improvements on Cases for Cabinet Organs." (Perfectionnements aux buffets d'orgues de salons.)

Claim.—1st. An organ case constructed with ends A, A', of less width below the key-board than the body and projection B, leaving recesses at the front and corners of the same; 2nd. The reel organ top, having in its receptacle E, and hinged door F, in front of same; 3rd. The fall I, hinged at K.

No. 2877. W. R. PECK, Chatham, Ont., 21st November, 1873, for 5 years: "Machine for Moulding the Frame Work of Vessels, Ships, &c." (Machine à courber les membrures des navires.)

Claim.—The sliding braces B, B', B'', in combination with the batons A, A', A'', and the combination of the thumb screws, hinges and clips.

No. 2878. C. B. HUNT, Springville, Penn., U. S., 21st November, 1873, for 5 years: "Improvements in Drills." (Perfectionnements aux forets.)

Claim.—1st. The art or process of manufacturing hammered twist drills as specified; 2nd. The curved lips b, b', of the drill as specified.

No. 2879. HANSON GREGORY, Jr, Rockland, Me., U. S., 24th November, 1873, for 15 years: "Elastic Friction Band for Booms of Vessels." (Bande élastique de friction pour les beauprés de vaisseaux.)

Claim.—1st. A springing shackle, in combination with the boom of a vessel for relieving strain resulting from a slot; 2nd. The metallic band A, provided with the vertical flange B, in combination with the revolving friction band D, and the springing shackle H, constructed and operating as described; 3rd. The springing shackle H, and the revolving friction band D, in combination with the boom C; 4th. The springing shackle H, composed of arms G, G', p, n J, and K, springs L, L', and cross plate F, constructed and arranged as set forth.

No. 2880. HUGH HINDS, Ottawa, Ont., 24th November, 1873, for 5 years: "Improvements on Drum Heaters." (Perfectionnements aux poêles sours.)

Claim.—1st. The cylinder E, arranged and applied centrally and internally in combination with the suspended cylinder B, and exterior drum A, whereby an intermediate air chamber or passage is formed into which cold air is admitted by the pipe C, and ejected through the pipe D; 2nd. Constructing the intermediate drum B, with a cone top to prevent lodgment of soot.

No. 2881. JOSEPH LEWIS, Manchester, Eng., 24th November, 1873, for 5 years: "Locomotive." (Une locomotive.)

Claim.—1st. A circular valve arranged between two cylinders, supplying steam to, and exhausting from both cylinders, in combination with a mechanism capable of reversing and rotating or oscillating said valve; 2nd. The combination with a rotary valve of a worm pinion upon the valve-shaft, and a worm wheel upon the crank-shaft, when the pinion is fitted to slide upon the valve-shaft, engaging a fixed worm upon the crank-shaft, or when the worm is fitted to slide upon the crank-shaft, engaging a fixed pinion upon the valve-shaft constructed and operating as specified; 3rd. The rotary valve for locomotive engines made with an even number of supply passages c, taking steam at both ends, and in the middle at the annular space d, and with the same number of exhaust passages a, as described; 4th. The conical rotary valve swung in the conical valve casing by stuffing boxes or by equivalent means and moveable longitudinally within the casing, so that the space between the surfaces may be adjusted for the purpose specified; 5th. The combination of the rotary valve, valve-shaft D, connected thereto by a ball and socket or universal joint M, and borne in a frame L, at the other end, and the gear-wheels H, F, borne upon the valve-shaft and crank-shaft respectively.

No. 2882. CHARLES CARPENTER, Hamilton, Ont., 24th November, 1873, for 5 years: "Improvements in Door Knob Attachment." (Perfectionnement dans l'ajustage des boutons de portes.)

Claim.—1st. The combination of the flanged circular plate f, and hub or bush g, as shown, with the door a, spindle b, shank c, and knob d; 2nd. The arrangement and combination of the rivet n, holes r, and wedge o, with the shank b, and spindle c, as specified.

No. 2883. LINUS O. THAYER, Montreal, Que., (Assignee of Joseph Duval), 24th November, 1873, for 5 years: "Breech Loading Rifle." (Carabine se chargeant par la culasse.)

Claim.—1st. The novel combination of the parts trigger p, spring b', tumbler v, spring d', needle o, lever r, m, breech block e, and extractor r'; 2nd. The lever m, tumbler v, and needle o, in combination with the breech block e; 3rd. The spring d', in combination with the tumbler v, lever m, and breech block e; 4th. The ends l, in combination with the projections e', and i'; 5th. The tumbler v, with needle o, attached thereto; 6th. The tumbler v, with projections e', in combination with fork l'; 7th. The breech block e, having recesses n, of the configuration shown; 8th. The breech block e, having recesses o, g; 9th. The breech block e, with recess h; 10th. The lever m, having forked end l, in combination with recess k, and projections i', of the breech block e; 11th. The frame r, constructed separate from the shell b; 12th. The frame r, in combination with the trigger p, tumbler v, and lever m, pivoted thereto; 13th. The pivot u, in combination with the lever m, and tumbler v; 14th. The shell b, in combination with recess q; 15th. The trigger p, in combination with bolt p'; 16th. The lever m, in combination with the catch n'.

No. 2884. TRUBY W. PERRY, Ringwood, Ont., 25th November, 1873, for 5 years: "A Table Sauce." (Une sauce de table.)

Claim.—A compound composed of apples, raisins, sugar, salt, onions, ginger, mustard seed, Cayenne pepper and vinegar, in the proportions described.

No. 2885. GEORGE K. PROCTOR, Salem, Mass., U. S., 25th November, 1873, for 15 years: "Castor Attachment for Sewing Machine Tables, &c." (Ajustage des roulettes de tables de machines à coudre, &c.)

Claim.—The castor frame D, the same consisting of the two bars a, each carrying two castor wheels, and the connecting rod d, which bars together with the rod d, are hung to the standards c, for movement as described.

No. 2886. DAVID SAUL, New Edinburgh, Ont., 25th November, 1873, for 5 years: "Improvements in Hoisting Machines." (Perfectionnements aux élévateurs.)

Claim.—A hoisting machine for elevating building materials consisting of the trestle A, and platforms B, and B', constructed as set forth; 2nd. The combination with trestle A, and platforms B, and B', of the ratchets C, pawls i, j, connecting rods k, k', and m, rectangular levers j, j', coiled spring l, shipper handle n, ropes b, and c, and pulleys e, e', and d, d', and d''.

No. 2887. WALTER M. RICE & AUSTIN D. CABLE, Montreal, Que., 25th November, 1873, for 5 years: "Improvement in Laying the Permanent Way of Railways." (Perfectionnement dans la pose des voies de fer fixes.)

Claim.—The rails B, arranged with cushions C, placed underneath them, as set forth.

No. 2888. THOMAS PAXTON, WILLIAM TATE & CHARLES PAXTON, (Paxton, Tate & Co.), Port Perry, Ont., 25th November, 1873, for 10 years: "Improvements on Gang-Ploughs." (Perfectionnements aux charrues à socs multiples.)

Claim.—The combination of the lever D, with the axle B, and connecting with axle A, by means of rod C, and lever F.

No. 2889. JOHN C. SCHOONMAKER, Kansas City, Mo., U. S., 23th November, 1873, for 10 years: "Lightning-Rod." (Paratonnerre.)

Claim.—1st. A lightning-rod constructed of a series of twisted copper and tubular wires; 2nd. The lightning-rod specified, consisting of a series of twisted copper wires A, twisted round a central supporting wire a.

No. 2890. WILLIAM W. WEAVER, New Haven, N. Y., U. S., 28th November, 1873, for 15 years: "Improvements on Turbine Wheels." (Perfectionnements aux turbines.)

Claim.—A turbine water wheel, the improved scroll flume A, having the inner surfaces of its side walls a, inclined outwardly from top to bottom, in such a manner that the width of the passage between said walls, shall be greater at its lower than at its upper part.

No. 2891. JUNIUS G. LOGGINS & P. P. WILKINS, Williston, Vt., U. S., 28th November, 1873, for 5 years: "Improvements on Machines for Cutting the Notches in Wooden Hoops for Barrels, &c." (Perfectionnements aux machines à faire les coches des cercles de futaille.)

Claim.—The gauge bar P, and cramp B, constructed and arranged as described in combination with a hollow barrel shaped cylinder P', provided with knife H; 2nd. The gauge bar P, and cramp K, in combination with the hollow frustrum of a cone G, provided with cutter I, and spur G'.

No. 2892. CORNELIUS CAMPBELL, Montreal, Q., & JOSEPH A. LAEMLE, Staten Island, U. S., 28th November, 1873, for 5 years: "Improvements on Printers' Furniture." (Perfectionnements aux garnitures d'imprimeries.)

Claim.—The process of milling and cutting to the required size and gauge of "cast iron furniture," and mode of operation of the circular steel cutters Figs. 3 and 4.

No. 2893. The HON. HENRY AYLMEY, Melbourne, Que., 23th November, 1873, for 5 years: "Clap-board Machine." (Machine à douve.)

Claim.—1st. The frustrums, O, P, Q, and R or S, rotated, and all, or one of each pair driven from any going part of the sawing machine; 2nd. The frustrums O, P, Q, and R, all or one of each pair

composed of a rigid core T, and elastic coating V; 3rd. The frustrums Q, and R, or passive cones, arranged with the spindles to bear against springs W.

No. 2894. GEORGE BOUCHER de BOUCHERVILLE, Quebec, 28th November, 1873, for 5 years: "Mode of using waves for ship propelling." (Manière de se servir des lames pour propulser les navires.)

Le principe de l'invention consiste à utiliser le mouvement des lames, en employant pour cela, dans le navire une (ou plusieurs) plateforme, plancher, ou faux-pont, suffisamment chargé de fret, et convenablement suspendu dans le navire qui, par ses oscillations puisse communiquer le mouvement à l'hélice, au moyen du mécanisme décrit, ou son équivalent.

The principle of the invention consists in making use of the movement of the waves by employing in the ship for that purpose, one (or several) platform, floor, or false deck, sufficiently loaded with cargo and suitably suspended in the ship, which, by its oscillation can communicate movement to the screw, by means of the mechanism described or its equivalent.

Reclame.—L'emploi, dans un navire, d'une plate-forme, plancher ou faux-pont B (Pl. II, fig. 1) que l'on peut charger de fret, suspendu de manière à pouvoir osciller aux mouvements du tangage, des tiges C, C', et D, D', des deux plates-formes, planchers ou faux-ponts P, P', et des leviers E, E' et L, L', auxquels ils sont reliés; des pincés (B. fig. 3 et 4); des leviers R, R', et de leurs oliquets T, T', des roues à rochet S, S', fixées de chaque côté de la roue V, tournant librement avec R, R', sur l'essieu F, du pignon angulaire V, et des roues et pignons de l à 9 et du levier Z, tous combinés ensemble pour les fins réclamées et tel que décrit.

No. 2895. JULIA C. LIVERMORE, wife of Edward M. Livermore, Boston, Mass., U. S., 28th November, 1873, for 5 years: "Skirt Protector." (Protecteur de Jupons.)

Claim.—A skirt protector, composed of waistband, bag pocket or strip, and intermediate connections all arranged as explained.

No. 2896. HENRY PARKER, Gananoque, Ont., 28th November, 1873, for 5 years: "Improvements on the Art or Process and Mould for casting cores." (Perfectionnements dans l'art ou le procédé de fondre des noyaux et aux moules pour cet objet.)

Claim.—1st. The art or process of forming or casting cores of plastic material by moulding semi-covers in corresponding semi-core mould and uniting the semi-covers by adhesion and pressure while in the moulds by closing the moulds together and hardening the cores so formed previous to removal from the semi-core mould; 2nd. The mould for casting cores, having flasks B, impressed with corresponding semi-core moulds D inserted removable in a case A, formed of dishes a, a', hinged and closing together; 3rd. Providing the dishes a, a', of the case A, with openings C, at the back to facilitate removal of the flasks B, by pressure as set forth.

No. 2897. JOSEPH P. BASS, Bangor, Me., U. S., (Assignee of H. C. Bucknam,) 28th November, 1873, for 5 years: "Process for cleaning surface condensers." (Procédé de nettoyage des condenseurs superficiels.)

Claim.—Introducing and passing a grease solvent, through condenser with the exhaust steam or its equivalent; 2nd. The combination of the opening C, in the exhaust pipe of a engine with a condenser B, and an opening G, for removing the sediment before it reaches the boiler.

No. 2898. FRANCIS H. PERRY, Drummondville, Ont., 28th November, 1873, for 5 years: "Clothes Washing Machine." (Machine à laver le linge.)

Claim.—The arrangement and use of the series of arms or ribs F, less or more in number, the perforated holding plate, spider or hoops E, E', braces B, B, shield C, C, and rubber or spring H.

No. 2899. WILLIAM C. SILLAR, London, ROBERT G. SILLAR, Lee, and CHRISTOPHER RAWSON, London, Eng., 5th December, 1873, for 5 years: "Improvements on deodorizing, purifying and utilizing sewage, urine, night soil, excreta and excrementitious and refuse matters." (Perfectionnements dans la méthode de désinfecter, purifier et utiliser les vidanges, les excréments et les ordures.)

Claim.—1st. The treatment of sewage, urine and night soil in a diluted state and other excrementitious matters, for the purpose of purification, deodorization, by adding thereto a mixture composed substantially of blood, clay, magnesia or one of its compounds, lime, burnt clay, animal and vegetable charcoal and magnesia

limestone, and adding to the mixture of sawage and the above substances alum or sulphate of alumina; 2nd. The dried sawage precipitate or native guano being the result of this treatment; 3rd. The absorption and deodorization of excreta or night soil (as distinguished from sawage) and animal matters by the use of a mixture composed substantially of blood, clay, magnesia or one of its compounds, lime, burnt clay, animal and vegetable charcoal and magnesians limestone, with or without the addition of dried sawage, precipitate or alum or sulphate of alumina; 4th. The use of the dried sawage precipitate or native guano referred to for absorbing and deodorizing excreta or night soil, [as distinguished from sawage] and animal matters essentially as described.

No. 2900. SYRANUS STANDISH, Eureka, Nev., U. S., 5th December, 1873, for 10 years: "Improvements on brooms." (Perfectionnements aux balais)

Claim.—The screw threaded handle B, and the wedge C, in combination with the sheet metal head A, provided with the screw threaded socket E, and having its wider sides inclined toward each other, all constructed and arranged as set forth

No. 2901. CHARLES STORER, Montreal, Que., (Assignee of Israel Fisher), 5th December, 1873, for 5 years: "Improvement on Mechanism for Lighting Gas Burners." (Perfectionnements à un appareil à allumer le gaz.)

Claim.—1st. The shell b, and diaphragm n in combination with link a, actuating cock v; 2nd. The cock v, having passages y and groove z in combination with socket K, and passage H; 3rd. The pipe i, and small burner as described in combination with the cap K, cover H, links O, and S, and diaphragm n; 4th. The combination of the burner l, with the burner on pipe i, and cock v.

No. 2902. EUGENE MOREAU, San Francisco, Cal., U. S., 5th December, 1873, for 5 years: "Improvements on Sewing Machines for Embroidering and Stitching Button Holes." (Perfectionnements aux Machines à coudre pour la broderie et les boutonnières.)

Claim.—1st. In combination with the stitch forming mechanism composed of a vibrating needle and reciprocating shuttle, the automatic feeding clamp B, and take up lever T₂, when constructed and operating as described for producing a button hole stitch of peculiar form; 2nd. The clamp B, so operated by suitable mechanism that it moves in angular paths, beneath the needle and without any circular or rotary motion around it and holds and presents the material in a regular and automatic manner to the sewing mechanism; 3rd. The clamp carriage C, for supporting and moving the clamp arranged and operated as described to produce a longitudinal movement of the clamp; 4th. The laterally moving stand C₁, for supporting the clamp carriage, when constructed, arranged and operated as described to produce a lateral movement of the carriage and clamp; 5th. The oscillating frame W with its sliding rods W₁, W₂, when constructed and operated as described to give a vibrating movement to the levers D₁, F₁; 6th. The mechanism for producing a lateral reciprocation of the clamp carriage C, consisting of the stand c₁, the flanged bar c₂, actuated by the lever D₂, and the oscillating frame operated by the cam V, through the shaft V₁, and connection rod W₁; 7th. The combination and arrangement together of the cam D, secured upon its shaft E, the sliding stand F, and the vibrating lever D₃, for throwing the lever at the proper times into and out of action with the oscillating frame W; 8th. The mechanism for producing the longitudinal progressive movement of the carriage and clamp consisting of the cam D₂, secured on the shaft E, the sliding stand F₂, and the bell crank lever F₃, connected to its stand and with the side of the clamp carriage c; 9th. The combination and arrangement together of the cam D₁, secured upon the shaft E, the sliding stand F₁, and the flanged bar c₂, supporting the reciprocating slide E, for throwing the bell crank lever F₃, at the proper times into and out of action with the oscillating frame W; 10th. The mechanism for producing the longitudinal reciprocation of the carriage c, and clamp at the proper times, when the head and end of the button hole are being formed consisting of the reciprocating slide E, and the bell crank lever F₃, connected with the slide and with the side of the carriage c; 11th. The combination and arrangement with the reciprocating flanged bar c₂, and stand c₁, of the cam D₃, its stand F₃, and the sliding wedge E₁, for the purpose of producing a side movement of the stand c₁, and the clamp carriage; 12th. The mechanism for giving an intermittent rotary motion to the series of cams D, D₁, etc., consisting of the eccentric G, actuated by the driving shaft N, the forked connection rod G₁, with its projecting pin g, and the loose collar H, turning on the shaft and provided with the arm h, and pin h₁, and feed dogs H₂, H₃, combined, arranged and operating to move the cam D₃, intermittently forward; The combination and arrangement with the rim or surface d₃, on the cam D₃, of the stop lever z, its catch z₁, and the horizontal half z₂, provided with the arm z, for the purpose of automatically arresting the motions of the cams and throwing the feeding mechanism out of action; 14th. The series of graduated gauges I; 15th. The combination with the cam shaft E, and the bar I, carrying the gauges I, the means for adjusting the cams and gauges simultaneously consisting of the vertical shaft operated by the lever K, its arm d₂, connected with the journal box D₄, and the arm k, attached to the end of the sliding bar I; 16th. In combination with the clamp B, when actuated as described the take-up lever T₂, for controlling the needle thread, when arranged and operated by mechanism in such rela-

tion to the movement of the clamp that it draws the needle thread up tight at each movement of the clamp for the purpose of causing it to lie in a straight line along the edge of the button hole; 17th. In combination with the cam U on the shaft T, and mechanism actuated by it for moving the clamp carriage and the mechanism operated from the pulley shaft N, for actuating the shuttle; the crank P, pitman S, links S₁, S₂, and needle arm R, for giving the proper movements to the needle bar with relation to the motions of the clamp carriage; 18th. The cams composed of the series of steps or surfaces D, D₁, D₂, D₃, arranged upon the sliding shaft E, and operated and adjusted by mechanism for the purpose of increasing the capacity of the machine to automatically work upon holes of different sizes; 19th. The slotted plate B₂, hinged within upper jaw b and raised by the action of the spring b₄ when combined with the lower jaw of the clamp B, for the purpose of forming an adjustable holding surface; 20th. In combination with the slotted plate B₂, the sliding bridge b₃, constructed, arranged and operating in the manner described.

No. 2903. THOMAS BATY, Westminster, Ont., 5th December, 1873, for 5 years: "A Fence." (Une clôture.)

Claim.—1st. The kind of fastenings which hold the stakes B, B; 2nd. The position of the fastenings C, being above the first rail from the bottom end D, below the second rail from the top; 3rd. The spike as set forth.

No. 2904. ISAIE FÉLICHETTE, St. Hyacinthe, Que., 5th December, 1873, for 5 years: "Improvements on Reaper Rakes." (Perfectionnements aux rateaux de moissonneuses.)

Réclame.—1o. La combinaison du rateau C, avec le dévidoir B, de l'équerre E, ou de son équivalent, et du frein F, ou de son équivalent; 2o. La combinaison du rateau C, avec les bagues D, ou leurs équivalents, avec le frein F, et l'équerre E, ou leurs équivalents; 3o. La combinaison de l'arbre A, avec le rateau C, le dévidoir B, la bague D, avec une rainure courbe ou le frein F, et l'équerre E, ou leurs équivalents, tel que décrit.

No. 2905. DAVID HEATON, Providence, R. I. U. S., 5th December, 1873, for 5 years: "Improvements in Combination Tools." (Perfectionnements aux outils combinés.)

To be used as a screw driver, hammer, carpet stretcher or wrench.

Claim.—The construction of the implement as shown in the drawing with a sliding clasp C.

No. 2906. FREDERICK ROGERS, Lynn, Mass., U. S., 5th December, 1873, for 5 years: "Improvement on the Manufacture of Shoes." (Perfectionnement dans la fabrication des souliers.)

Claim.—1st. As a new article of manufacture in a nailed turned shoe wherein the points of the nails are clinched or rivetted in the sole channel; 2nd. The manufacture of turned nailed shoes, the method described of clinching or rivetting the nails in the channels by the introduction of channel plates of metal; 3rd. The metallic sectional channel plates B, B₁, B₂.

No. 2907. JOHN L. COLES & DAVID H. COLES, New York, U. S., 5th December, 1873, for 5 years: "Improvements on Sewing Machines." (Perfectionnements aux machines à coudre.)

Claim.—1st. The combination of a driving wheel mounted on an eccentric pin with a friction wheel mounted on the main shaft of an organized sewing mechanism, and with a cloth plate which supports the main shaft and is connected to the table of the machine on one side by hinges while its other side bears down upon elastic pads; 2nd. The combination of an oblique cam slide with the feed bar of a sewing machine; 3rd. The arrangement of a ring plate in the inner end of the arm, which carries the feed dog, said ring plate being provided with a slot to receive an oblique cam, feathered on a rotary arbor and connected to the feed lever; 4th. In combination with the oblique feed slide a feed lever the fulcrum of which is moveable while its bifurcated inner end engages with a groove in the circular hub of the oblique feed slide; 5th. The combination with the feed dog of an eccentric button mounted on a lever which is actuated by an eccentric and imparts to the feed dog the desired upward movement, said button serving to adjust the feed dog in relation to the surface of the throat plate; 6th. The combination with the feed lever and its adjustable fulcrum of an index and scale to show the variation in the feed; 7th. In combination with the oblique feed slide, the feed dog and feed lever a handle which moves on a suitable dial and is mounted on a shaft that is geared together with the feathered arbor of the oblique feed slide; 8th. The arrangement of a presser foot having the throat or needle hole in its centre in combination with a feed dog

acting on the work on two or more opposite sides of the needle and arranged to feed in different directions; 9th. The combination of a presser foot having two throats with a feed dog acting on the work on two or more opposite sides of the needle; 10th. In combination with a universal feed, a presser foot which revolves round the needle slide, the throat in the presser foot being situated in line with the axis of its revolution; 11th. The combination of a revolving spool carrier with a revolving presser foot and with an organized sewing mechanism.

No. 2908. JOHN MILLER, Perth, Ont., 5th December, 1873, for 5 years: "Improvements on Sewing Machines." (Perfectionnements aux machines à coudre.)

Claim.—1st. The hook A, adjustably secured to the wrist piece B, and held by a set screw C, or other contrivance; 2nd. The hook A, constructed with a slot D, or incision at the angle of curvature for holding the loop during its partial ascent; 3rd. In providing the shuttle on its side edge, near its lower end with an angular raised edge E, to divide the loop; 4th. The application to the shuttle case of a bent bar F, to act eccentrically on the shuttle to adjust it to the use of fine or coarse thread; 5th. In providing the shuttle case internally with a bow spring C, to act automatically on the shuttle to retain it in proper position; 6th. Providing the shuttle case at its lower end with a pivot plate or moving bar H, and device for keeping it in a fixed position when closed to admit of the removal of the shuttle; 7th. The pin I, having an eccentric head to engage with the feed bar, to regulate the feed; 8th. The employment of the screw sleeve J, in combination with the presser bar and spiral spring for regulating the pressure of the foot; 9th. The securing of the machine to the table by lugs K, cast on the bed plate and receiving a bolt L, hinged thereto passing through rubber packing rings in the table and fastened underneath by screw nuts M, in the manner set forth.

No. 2909. GEORGE H. COPPING, Toronto, Ont., 5th December, 1873, for 5 years: "Improvements on Lozenge Machines." (Perfectionnements aux machines à pastilles.)

Claim.—1st. The various parts of the printing apparatus, in combination with each other comprising the trough A, ink lifting roller W, converging roller N, type roller M, ratchet arm P, depressing shaft U, with long arm C, and short arms D, d, and in combination with the table A, also in combination with the frame H, also in combination with the head V; 2nd. The various parts for giving motion to the ratchet arms b₁, b₁, from the arm Y, in combination with each other comprising the rod a, lever b₁, rods c₁, c₁; 3rd. The various parts in combination with each other for communicating motion to the brush N, namely the pulley K, on rotating axle C, the pulley M, on cylindrical brush N, the belt L, and the brush N.

No. 2910. HENRY J. DAVIES, Brooklyn, N. Y., U. S., 5th December, 1873, for 5 years: "Machine for Printing and Embossing Skirts" (Machine à imprimer et gaufrer les jupons.)

Claim.—The combination of one or more conical printing or embossing rollers, a conical impression roller, an open sided frame, supporting said rollers and a feed table having an arc formed guide, the whole arranged as described, for the purpose set forth.

No. 2911. HENRY F. KNAPP, New York, U. S., 5th December, 1873, for 5 years: "Improvements on Means of Raising and Floating Wrecks." (Perfectionnements aux appareils à relever et remettre à flot les bâtiments naufragés.)

Claim.—1st. As a means of raising or passing raising chains under sunken vessels, in the curved tube B, having perforations in A, for facilitating the passage of the tube through mud or sand by allowing of the escape of a forced current of water, along or outside of said tube; 2nd. The combination with the primary, or smaller tube C, of one or more larger sized tubes E, for operation in relation with each other; 3rd. The curved needle C, having an attached tube B, arranged to extend along it, for use in raising or floating sunken vessels; 4th. The combination of the lifting chains F, with the curved needle C; 5th. The use by projection into the mud or sand as described of any number of hydro-pneumatic jacks G, having full open bottoms, said jacks being forced into the mud or sand by superincumbent pressure consequent on exhausting them of air, or air and water and subsequently, and after their attachment to the wreck, forcing air into them to raise the wreck; 6th. A combination of hydro-pneumatic jacks G, the connection of the same by hose O, pipe I, for operation one by the other, subject to control by a cock P; 7th. A hydro-pneumatic jack G, provided with a man-hole H, in its upper portion.

No. 2912. JOSEPH VARNEY, Montreal, Que., 5th December, 1873, for 5 years: "A Washing Machine." (Une machine à laver.)

Claim.—1st. The spring suspended and swinging rubbing block m, in combination with wash board b; 2nd. The board b, having opening c, and roller d.

No. 2913. DONALD S. MCKINNON, Carleton Place, Ont., 5th December, 1873, for 5 years: "Improvements in Sewing Machine Stands and Covers." (Perfectionnements aux tables et couvercles de machines à coudre.)

Claim.—1st. A sewing machine stand and cover, so constructed that all the parts are put together with screws and may be taken to pieces for transportation; 2nd. The combination with a sewing machine stand of an extension loaf E, and extra-loaf F; 3rd. The combination of the adjustable treadle bearers or rests e, e, clamped to the partition C, and C₁, by thumb-screws or their equivalent through guiding slots g; 4th. The arrangement for securing the box g, and the machine by means of the cover I, locking in the extension loaf E; 5th. The combination with a sewing machine of the connecting bar k, for the purpose of rocking a cradle when the machine is operated; 6th. The combination with the table top D, of the pin cushion r.

No. 2914. PERLEY D. CUMMINGS, MANASSEH SMITH & JAMES C. JORDAN, Portland, Me., U. S., 5th December, 1873, for 5 years: "Match Slitting Machine." (Machine à fendre les allumettes.)

Claim.—1st. The method of slitting and stacking match cards by one operation, and in the same machine; 2nd. The method of notching and slitting match cards by one operation; 3rd. The combination of a hopper or hoppers a₁, a, plunger or plungers d₁, d, and with drawing knives p₁, p, p₂, p, 4th. The combination of hoppers a₁, a, plungers d₁, d, with drawing knives p₁, p, and a receiving hopper b; 5th. The combination with the hoppers a, a₁, the feeders or followers s, s₁; 6th. The spring plunger r; 7th. The method of withdrawing the slitting knives p, or p₁, either upwards, downwards or to one side in order to leave a small portion of the butt of a match card unslit and to allow the plunger to push forward the slit card to a proper position; 8th. The reciprocating frame c, carrying the plungers d, d₁; 9th. The method of slitting match cards, in the manner described.

No. 2915. THEODORE A. HEINTZMANN, Toronto, Ont., 5th December, 1873, for 5 years: "Improvements on Piano-fortes." (Perfectionnements aux pianos-fortes.)

Claim.—1st. The casting of the bridge C, with an unbroken connection, to the frame B; 2nd. The combination of the bridge C, lip or flanging point c, holes c₁, shoulder c₂, and flange B₁, forming component parts of the frame B, with the strings E, and tuning pins D.

No. 2916. WILLARD M. FULLER, New York, U. S., 5th December 1873, for 5 years: "Heating Apparatus." (Appareil de chauffage.)

Claim.—1st. The process of forcing steam through the radiators or connecting pipes from the generator B, the steam after being condensed returning to the generator and kept in continous operation without any additional supply of water; 2nd. The pipe D, at or near the top of the generator B, allowing steam to be generated in an apparatus having free circulation without forcing the water into such pipe; 3rd. The trap E, in combination with the pipes C, D, and boiler B.

No. 2917. MAGLOIRE THIBAUT, Hull, Que., and SAMUEL BENOIT, Ottawa, Ont., 5th December, 1873, for 5 years: "Machine for Cutting Nails." (Machine à découper les clous.)

Claim.—1st. A machine for punching the nails or other articles from sheet metal plates constructed and operated as set forth; 2nd. A rotary punching machine, the combination of the wheel C, with the eccentric wheel D, the punches F, and the dies E; 3rd. Combination with the wheel C, the roller g, and inclined plane n, actuating the shaft I, of the plate holder (t; 4th. Combination with the shaft I, the lever arms o, and projection m, and l; 5th. In combination with the punches F, and dies E, a plate holder G, attached to the shaft I, and composed of the four slides h, projections r, springs j, projections or ring k, aperture d, and slots c, for feeding the metal plates to the punches and dies and separating the chippings from the nails as described.

No. 2918. DANIEL M. LAMB, Strathroy, Ont., 5th December, 1873, for 5 years: "Improvements on Filters for Oil and other Liquids." (Perfectionnements aux filtres pour l'huile et autres liquides.)

Claim.—1st. The series of two or more pans A, A₁, each constructed with a conical or funnel-shaped bottom, conducting to a central discharge aperture; 2nd. The combination of the heating jacket C, and filtering pans A, A, &c.; 3rd. The combination of charcoal and cotton as a filtering medium, applied in funnel-shaped pans as set forth.

No. 2919. DANIEL M. LAMB, Strathroy, Ont., 5th December, 1873, for 5 years: "Improvements on Manufacturing and Treating Vulcanizable Gum and Hydro-Carbon oils." (Perfectionnements dans la fabrication et le traitement des gommes vulcanisables et des hydro-carbures.)

Claim—The mode or process for the combined treatment of vulcanizable gum and petroleum or any product thereof by dissolving the gum in the oil and subsequently distilling the solution.

No. 2920. DANIEL M. LAMB, Strathroy, Ont., 5th December, 1873, for 5 years: "Compound Vulcanizable Gum." (Composition à gomme vulcanisable.)

Claim—The compound vulcanizable gum, consisting of caoutchouc with the inspissated juice of milk weed.

No. 2921. WILLIAM A. GIBB, Sewardstone, and ALFRED BORWICK, London, Eng., 10th December, 1873, for 5 years: "Improvements on Apparatus and Arrangements for Drying." (Perfectionnements aux appareils et systèmes de dessiccation.)

Claim—1st. The combinations and arrangements of parts constituting the improved drying apparatus consisting of revolving case A, with pan B or D, and other mechanism and severally illustrated in figures 1, 2, 3, 4, 5, 6, 7, 8, 9, 10, 11, 12, 13, 14, & 15. 2nd. In heating the revolving drying case or cylinder A, or B (where used with an air duct c) both externally and internally in the several ways described and severally illustrated in figures 1, 2, 3, 4, 5, 6, 7, 8, 9, 10, 11, & 12; 3rd. Making the air duct D, with two or more longitudinal slits with or without lips as described, and illustrated in figs. 13, 14 & 15; 4th. The use of a revolving air duct D, mounted in a revolving drying cylinder or case B, as described, and illustrated in figures 10 to 15 (both inclusive) whether such air duct have one longitudinal slit or several such slits; 5th. The application to the revolving drying cases A, of counterbalanced scrapers a^o, and I, illustrated in figures 1, 5, 6 & 9; 6th. The application to the revolving drying cases B, of scrapers J, mounted on a longitudinal bar b, to which reciprocatory motion is imparted as described and illustrated in figures 4, 5, 6 & 8; 7th. The application to the revolving air duct D, described of longitudinal bars d^t, carrying scrapers d^s, and furnished with pins dⁱ, capable of sliding radially as described and illustrated in figures 13, 14 & 15; 8th. The combination of a drying floor e^t, e^s, and e^x, with a revolving drying case or cylinder A, (when such case or cylinder is used with an air duct or with several such cases or cylinders, as described and illustrated in figure 9; 9th. The combination of the hot blast pan C, and the air duct B, with a stationary or an oscillating trough A, furnished with apparatus for moving in such trough the substance being dried as described and illustrated in figures 16 and 17; 10th. The use of the hot blast pan C, and air duct aforesaid for the purpose of drying hay, and other cut crops, as described and illustrated in figures 18, 19, 20 and 21, that is to say mounting the said hot blast pan and air duct a short distance above the ground, and disposing at each side of the said air duct the crop to be dried, such crop being lifted or "lightened up," either by means of forks c^t, attached to oscillating levers c^s, as represented in figures 18, and 19, or by means of revolving tines arranged and actuated as represented in figures 20 and 21; 11th. The improved apparatus described and illustrated in figures 22 and 23 for drying sheaves in the open air or under temporary shelter, that is to say a horizontal supply main A, communicating with branch pipes a^t, furnished with vertical perforated pipes a^s, in which the sheaves are spiked, hot air being forced into such pipe through a hot blast pipe, furnished by preference with a valve for directing such hot air alternately into one or other portion of the main aforesaid, as and for the purpose described.

No. 2922. MICHAEL A. WIGLE, Kingsville, Ont., 10th December, 1873, for 5 years: "Blacking for Boots and Shoes." (Cirage à chaussures.)

Claim—A compound composed of gum shell lac, tar, lamp-black, rosin and beeswax, dissolved and held in alcohol in the proportions set forth.

No. 2923. HAZEN P. HUNTOON, (Assignee of James R. Brown), Cambridge, Mass., U.S., 10th December, 1873, for 5 years: "Pipe Tongs." (Tenailles à tuyaux.)

Claim—1st. The hook jaw lever adjusting screw pivoted within and connected with such lever and screwed into and through the fulcrum pin, arranged within and applied to the slot of such lever and to revolve within the tooth jaw lever as shown in figures 1, 2, & 3; 2nd. A yoke combined with the toothed and hook jaw levers, their fulcrum pin and the adjusting screw or screws thereof as shown in figures 5, 6, 7, 8 & 9; 3rd. The combination of an arm

hinged to the tooth jaw lever with adjusting screws, so connected with or applied to the said arm and the hook jaw lever as to be capable by revolving one of them of moving the arm and the tooth jaw lever either toward or away from the hook jaw in order to adjust the jaws nearer to or further from each other as occasion may require.

No. 2924. AURIN WOOD, Worcester, Mass., U. S., 10th December, 1873, for 15 years: "Improvements on Bolt Cutting Machines." (Perfectionnements aux machines à fileter les boulons.)

Claim—1st. A bolt cutting machine, the arrangement of the control axially through the cutting die and a curved guiding control d^t, in the holder, the two rigidly connected and combined so as to have a movement longitudinally and in axial line with the said cutting die; 2nd. In combination with a fixed control d^s, the slides No. 3, provided with the cams T₂, T₃.

No. 2925. ARETUS A. WILDER, Detroit, Mich., U. S., 10th December, 1873, for 5 years: "Track Bolt Forging & Slotting Machine." (Machine à forger et mortaiser les boulons pour les voies des chemins de fer.)

Claim—1st. A bolt forging machine, the employment of a punch for transversely slotting the bolt while the same is being forged; 2nd. The combination of the cam wheel L, lever K, bar J, and punch e, arranged and operating with relation to the bolt formers b, G₁, G₂, and shaft B, all constructed as described.

No. 2926. SAMUEL SWITZER & SAMUEL O. McGWIN, Sydenham, Ont., 10th December, 1873, for 5 years: "An Axle Oiler." (Une boîte à l'huile.)

Claim—The spring E, bar F, pins G, G, and felt H, arranged, applied and operating in the journal box A, for lubricating the axle b, in the manner set forth.

No. 2927. CHARLES BURGESS, Portsmouth, Ohio, U. S., 10th December, 1873, for 5 years: "Manufacture of Iron & Steel." (Fabrication du fer et de l'acier.)

Claim—1st. The process for the manufacture of fined or partially refined cast-iron by subjecting the metal to a high heat apart from the fuel in a covered furnace until the mass is seen to swell or jets of blue flame appear; 2nd. The manufacture of steel direct from cast iron in a puddling or boiling furnace by exposing the mass to a high heat while in a molten state to burn out a portion of the impurities and partially decarburize it, having the furnace as free from flame as possible by the time the metal reaches a full boil and closing the damper while the mass is acquiring its final spongy condition; 3rd. A composite cast iron produced by the mixture of fined or partially refined cast iron with soft gray cast iron; 4th. The process of fining or partially refining cast iron as a step in the manufacture of malleable iron castings.

No. 2928. GIRDLESTONE B. IZZARD, Hamilton, Ont., 10th December, 1873, for 5 years: "An Adjustable Bed Bottom." (Un fond de lit mobile.)

Claim—1st. The arrangement and combination of the adjustable slats c, c, and adjustable head and foot pieces B, B, hoops D, and spring supports A, A; 2nd. The arrangement of the ties E, E, in combination with the adjustable slats c; 3rd. The arrangement and combination of the pins G, and cord E, with the adjustable slats c, for securing the slats in their place; 4th. The adjustable bed bottom constructed to fit and be adjustable to single and double bedsteads; 5th. The arrangement of the blocks J, J, in combination with the spring support A, A, and slats, ties E, E, and braces K, K.

No. 2929. EBEN C. FALES, Foxborough, Mass., U. S., 10th December, 1873, for 10 years: "A Hat Blocking Machine." (Un bloc à chapeau.)

Claim—1st. The block A, and sectional ring B, arranged as described, in combination with the tip-block K; 2nd. The sectional ring B, with its encircling band E, spring bands G, and head I, in combination with the block A; 3rd. The tip block A, having yielding spring a, and guide stems o, o, all carried by the head I, in combination with sectional ring B, of said head I, and block A.

No. 2930. HILAIRE HEBERT, Montreal, Que., 10th December, 1873, for 5 years: "An Engine Boiler." (Une chaudière à vapeur.)

Claim—1st. The form of boiler, being flat on the bottom; 2nd. The combination of flues with tubes as heating surfaces for the boiler; 3rd. The spanners c, c; 4th. The division plate d, d.

INDEX OF INVENTIONS.

Axle oller, Samuel Switzer, and Samuel O. McGwin.....	2926	Holsting machines, David Saul.....	2886
Bed bottom, adjustable, Glrdlestone B. Izzard.....	2928	Hoops, machines for cutting the notches on, for barrels, &c., Junius G. Loggins and P. Wilkins.....	2891
Blacking for boots and shoes, Michael A. Wigle.....	2922	Horse hutter, John C. Ford and Austin D. Cable.....	2867
Bolt cutting machine, Aurlin Wood.....	2924	Horse shoes, Andrew J. Roberts.....	2826
Boxes, sheet metal, Charles Parker.....	2808	Horse shoe nails, finishing, Jethro B. Husted.....	2835
Breech loading rifle, Linus O. Thayer.....	2883	Injectors for steam generators, Samuel Rue.....	2849
Brewing, Edward Beanes.....	2858	Iron and steel manufacture, Charles Burgess.....	2927
Brooms, Syranus Standish.....	2900	Ironing clothes, machine for, Gideon W. Cottingham.....	2853
Burdock, manufacture of staple fibre and paper pulp from, Phillip H. Jenkins.....	2814	Irrigating, manuring and hurdle grazing land and treating and using sewage for agricultural purposes, Isaac Brown.....	2839
Burglar detector, W. H. Simmonds and T. R. Johnson.....	2798	Lightning-rod, John C. Schoonmaker.....	2889
Car brakes, Antoine Langellier.....	2820	Link machines, Franklin Leonard.....	2838
Car couplings, ".....	2818	Lock, combination, Rollin A. Lee.....	2833
" ".....	2819	Locomotive, Joseph Lewis.....	2881
Car coupler, railway, self, Obadiah Sherwood, Jr.....	2842	Lozome machines, George H. Coppling.....	2909
Cars, iron freight, John E. Leeper.....	2836	Magnetic sand, machine for drying, cleaning and purifying, F. V. Rouleau.....	2801
Cement pipes, manufacture of, John W. Stockwell.....	2850	Marble wash, Charles D. Knapp.....	2813
Chairs, children's, E. J. Emmons and M. J. Kear.....	2797	Match splitting machine, Perley D. Cummings, Manasseh Smith and James C. Jordan.....	2914
Chair and lounge combined, G. F. Dean and F. Y. C. Hill.....	2800	Middlings and flour purifiers, Frances W. Glen and George J. Barclay.....	2829
Churn, Martin Lockwood.....	2810	Milk, manufacture, or produce of condensed, Gail Borden and John G. Borden.....	2859
Cigar making, John Wright.....	2806	Milk, process of preserving and condensing, Gail Borden and John G. Borden.....	2860
Clapboard machine, Hon. Henry Aylmer.....	2893	Mirror and picture frame holder, William Simpson.....	2821
Coal cooking stoves, moveable self-feed attachment for, W. G. Dunn.....	2861	Mixing machine, John W. Stockwell.....	2851
Compression pump, Edwin C. Seely.....	2825	Moulder's gate, John M. Killin.....	2841
Condensers, process for cleaning surface, J. P. Bass.....	2897	Mowers and reapers, sickle cushions for, James Laidlaw and James Kidd.....	2823
Cores, process and mould for casting, Henry Parker.....	2896	Nails, machine for cutting, Magloire Thibault and Samuel Benoit.....	2917
Cultivator, Dewitt C. Baker.....	2847	Oils, hydro-carbon and vulcanizable gum, manufacturing and treating, Daniel M. Lamb.....	2919
Deodorizing, purifying and utilizing sewage, &c., Wm. C. Sillar, Robert G. Sillar and Christopher Rawson.....	2899	Opening hermetically closed and other cases, boxes and cans, Edmund W. Elmslie.....	2822
Door bell, Elbrige B. Sims.....	2873	Organs, reed, Riley Burdett.....	2866
Door knob attachment, Charles Carpenter.....	2882	Organs, cases for cabinet, Andreas J. Sorensen.....	2876
Door spring, Herman Frankelen.....	2867	Paper pulp from burdock, Phillip H. Jenkins.....	2814
Dowel nail, Creasy J. Whellams.....	2827	Paper pulp, grinding wood for, James G. Moore.....	2834
Drills, C. B. Hunt.....	2878	Peat, machine for pressing, Joseph Brunet and Leon Be lefeuille.....	2845
Drum beaters, Hugh Hinds.....	2880	Photographs, polished, Joseph P. Bass.....	2830
Drying, apparatus and arrangement for, William A. Gibb and Alfred Borwick.....	2921	Pianos and other musical instruments, keys for, Eber C. Flint.....	2863
Embossing and printing skirts, Henry J. Davies.....	2910	Piano-fortes, Theodore A. Helutzmann.....	2915
Engine boiler, Hilaire Hebert.....	2930	Piano stool back, double adjustable, Henry Bolton.....	2854
Feathers, renovating and drying, Charles Kendall.....	2865	Picture frame and mirror holder, William Simpson.....	2821
Fence, Thomas Baty.....	2903	Pipe elbows, pattern for, John K. Horne.....	2846
Filters for oil and other liquids, Daniel M. Lamb.....	2918	Pipe tongs, Hazen P. Huntoon.....	2923
Fires, composition for lighting, Mathew Henry and J. B. Steele.....	2869	Printer's furniture, Cornelius Campbell and Joseph A. Laemle.....	2892
Fire-escape, E. Atsworth Llewellyn.....	2840	Printing machine, ticket, W. Bebro.....	2799
Forge bellows, George A. Rumrill and James F. Phlippen.....	2824	Printing and embossing skirts, Henry J. Davies.....	2910
Friction band, elastic, for booms of vessels, Hanson Gregory, Jr.....	2879	Pump, Hatherley Spear.....	2855
Fuel moulding machine, Wm. H. Cory and Edward Cory.....	2828	Railways, laying the permanent way of, Walter M. Rice and Austin D. Cable.....	2857
Gang ploughs, Paxton, Tate & Co.....	2888	Railway rails, joint preserver and nut protector for, P. Mutter.....	2802
Gas burners, mechanism for lighting, Charles Storer.....	2901	Railway rails, bolt holder for, D. C. Baker.....	2848
Gas machine, Moses Merrick.....	2857	Railway snow ploughs, S. G. Hadley.....	2804
Gas, manufacture of and apparatus, John West.....	2870	Reaper rakes, Isaac Fr�chet.....	2904
Gas apparatus, William Vincent.....	2874	Rotary pumps or motors, J. E. Gillespie.....	2815
Gas meter, compensating wet, Daniel De Castro and Richard Burton.....	2848	Sash fastener, A. Wilson and E. M. Law.....	2872
Gas meter, dry, William A. Telling and Samuel Johnson.....	2844	Saw mill feed wheel, C. Blacktin.....	2812
Gate, James R. Finley.....	2864	Saw teeth, W. P. Miller.....	2796
Gum, vulcanizable and hydro-carbon oils, manufacturing and treating, Daniel M. Lamb.....	2919	Scaffolding, E. H. Maddock.....	2805
Gum, compound vulcanizable, Daniel M. Lamb.....	2920		
Hat blocking machine, Eben C. Fales.....	2929		
Heating apparatus, Willard M. Fuller.....	2916		
Hinges, David W. Long.....	2817		

Sewing machine motor, J. Proctor	2809	Bolton, Henry, double adjustable piano stool back	2854
“ “ castor attachment for, G. K. Proctor.....	2885	Borden, John G., and Gull Borden, manufacture or product of condensed milk.....	2859
“ “ for embroidering and stitching button holes, E. Moreau.....	2902	Borden, John G., and Gull Borden, process of preserving and condensing milk.....	2800
Sewing machine, J. L. Coles, and D. H. Coles	2907	Borden, Gull, and John G. Borden, manufacture or product of condensed milk	2859
“ “ J. Miller	2908	Borden, Gull, and John G. Borden, process of preserving and condensing milk.....	2860
“ “ stands and covers, D. S. McKinnen.....	2913	Borwick, Alfred, and William A. Gibb, apparatus and arrangements for drying.....	2921
Ships, &c., machine for moulding the frame work of, W. H. Peck.....	2877	Boucherville, George Boucher De, mode of using waves for ship propelling	2894
Ships, &c., mode of using waves for propelling, G. B. De Boucherville.....	2894	Brewer, Harvey, waggon brake	2875
Shoes, manufacture of, F. Rogers.....	2906	Brouillet, Rev. John B. A., Antonio Pelletier, and Honoré Lafleur, composition for the manufacture of artificial stone and other purposes.....	2868
Shutter, fire proof, S. B. Munson, Jr.....	2852	Burdett, Riley, reed organs	2866
Skirt protector, J. C. Livermore.....	2895	Burgess, Charles, manufacture of iron and steel.....	2927
Steam engine, walking beam for, W. P. Bartley.....	2793	Burton, Richard, and Daniel de Castro, compensating wet gas meter.....	2813
Steam generator, injectors for, S. Rue.....	2849	Cable, Austin D., and John C. Ford, horse halter.....	2867
Steam or water pressure, regulator for, M. C. Locke.....	2856	“ “ and Walter M. Rice, laying the permanent way of railways	2887
Steam boilers, removing scum and other impurities from, T. O. Kemp	2862	Campbell, Cornelius, and Joseph A. Laemie, printers' furniture.....	2892
Steel and iron manufacture, C. Burgess.....	2927	Carpenter, Charles, door knob attachment.....	2882
Stone, &c., composition for artificial, A. Pelletier, Rev. J. B. A. Brouillette & H. Lafleur.....	2868	Coles, David H., and John L. Coles, sewing machines.....	2907
Stove pipe shelf, D. B. Moore.....	2811	Coles, John L., and David H. Coles, “ “	2907
Stuffing boxes, well tube, E. J. Deuroche and W. Ward.....	2816	Copping, George H., lozenge machines.....	2909
Table sauce, Truby W. Perry	2881	Cory, Edward, and William H. Cory, fuel moulding machine	2828
Teaching, objective in arithmetic and reading, Malcolm MacVicar	2831	Cory, William H., and Edward Cory, fuel moulding machine	2828
Thistles, matter for destruction of, William S. Hough.....	2837	Cottingham, Gideon W., machine for ironing clothes.....	2853
Ticket printing machine, W. Bebro	2799	Cummings, Perley D., Manasseh Smith and James C. Jordan, match slitting machine	2914
Tools, combination, David Heaton.....	2905	Davies, Henry J., printing and embossing skirts	2910
Track bolt forging and slotting machine, Aretus A. Wilder.....	2925	Deau, G. F., and F. Y. C. Hill, combined chair and lounge De Castro, Daniel, and Richard Burton, compensating wet gas meter.....	2813
Turbine wheels, William W. Weaver.....	2890	Deuroche, Edward J., and William Ward, well tube stuffing boxes.....	2816
Waggon brake, Henry Brewer.....	2875	Dunn, W. G., moveable self-feed attachment for coal cooking stoves.....	2861
Wash board, A. C. Johnson.....	2803	Elmslie, Edmund W., apparatus for opening hermetically closed and other cases, boxes and cans	2822
Washing machine, Charles V. dit Gadbois.....	2871	Enimons, E. J., and M. J. Keane, children's chairs.....	2797
“ “ Francis H. Perry.....	2898	Fales, Eben C., hat blocking machine	2929
“ “ Joseph Varney.....	2912	Finley, James R., gate.....	2864
Water or steam, pressure regulator for, Nathaniel C. Locke	2856	Filini, Eber C., keys for pianos and other musical instruments.....	2863
Well tube stuffing boxes, Edward J. Deuroche and William Ward.....	2816	Ford, John C., and Austin D. Cable, horse halter.....	2867
Wheels, carriage, hubs for, Robert Brown	2832	Fraukelen, Herman, door spring	2807
Wrecks, means of raising and floating, Henry F. Knapp..	2911	Fréchette, Isafe, reaper rakes.....	2904
INDEX OF PATENTEES.			
Aylmer, Hon. Henry, clappboard machine	2893	Fuller, Willard M., heating apparatus	2916
Ainsworth, Llewellyn, E., fire-escape	2810	Gadbois, Charles V. dit, washing machine	2871
Baker, Dewitt C., cultivator.....	2817	Gibb, William A., and Alfred Borwick, apparatus and arrangements for drying.....	2921
“ “ bolt holder for railway rails	2818	Gillespie, James E., rotary pumps or motors.....	2815
Barclay, George J., and Francis W. Glen, middlings and flour purifiers.....	2829	Glen, Francis W., and George J. Barclay, middlings and flour purifiers.....	2829
Bartley, W. P., walking beam steam engine	2795	Gregory, Hanson, Jr., elastic friction band for booms of vessels	2879
Bass, Joseph P., (assignee), polished photographs.....	2830	Hadley, S. G., snow ploughs for railway.....	2804
“ “ process for cleaning surface condensers	2897	Heaton, David, combination tools.....	2905
Baty, Thomas, fence	2903	Hebert, Hilaire, engine boiler	2930
Beanes, Edward, brewing	2858	Heintzmann, Theodore A., piano-fortes.....	2915
Bebro, W., ticket printing machine	2799	Henry, Mathew, and John B. Steele, composition for lighting fires.....	2969
Bellefeuille, Léon, and Joseph Brunet, machine for pressing peat.....	2845		
Benoit, Samuel, and Magloire Thibault, machine for cutting nails.....	2917		
Blackitt, Charles, saw mill feed wheel.....	2812		
Brown, Isaac, irrigating, manuring and hurdle grazing land and treatment of sewage.....	2839		
Brown, Robert, hubs for carriage wheels.....	2832		
Brunet, Joseph M., and Léon Bellefeuille, machine for pressing peat.....	2845		

THE CANADIAN PATENT OFFICE RECORD.

ILLUSTRATIONS.

Vol. I.

DECEMBER, 1873.

No. 9.

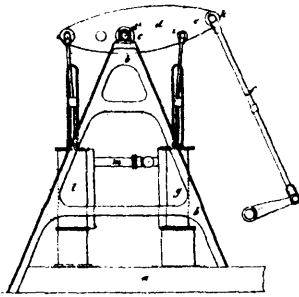

2795 Bartle's Improvements on Walking Beam Steam Engines.

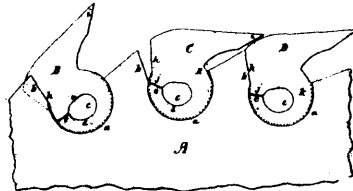

2796 Miller's Improvements in Saw-Teeth.

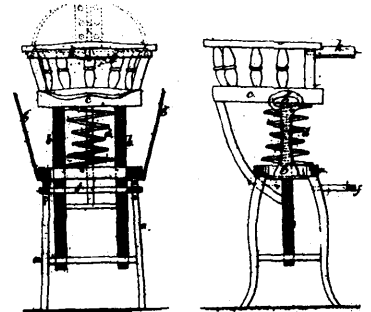

2797 Emmons & Keane's Improvements in Children's Chairs.

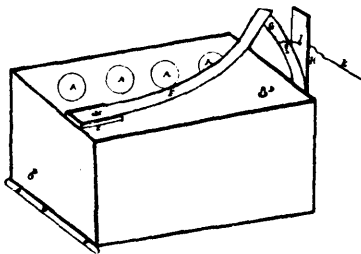

2798 Simmonds & Johnson's Burglar Detector.

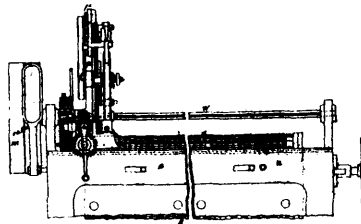

2799 Bebro's Improvements in Ticket Printing Machine.

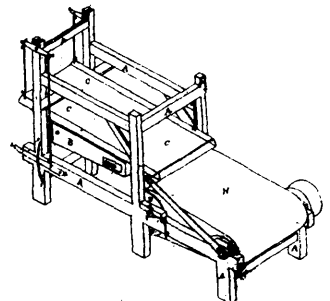

2801 Rouleau's Machine for Drying, Cleaning and Purifying Magnetic Sand.

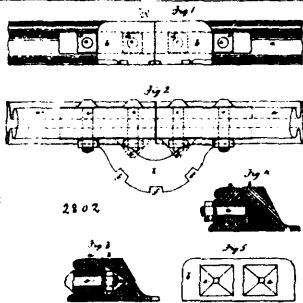

2802 Mutter's Joint Preserver and Nut Protector for Railway Rails.

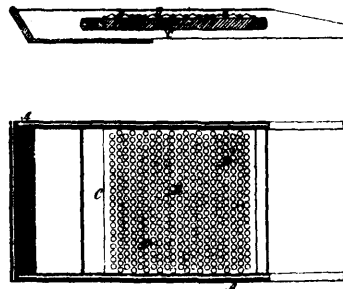

2803 Johnson's Improvements on Wash Boards.

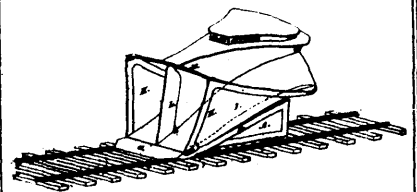

2804 Hadley's Improvements in Snow Ploughs for Railway.

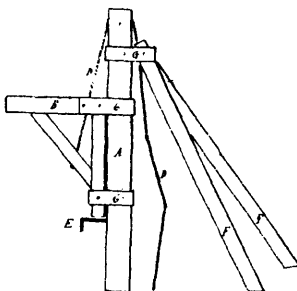

2805 Maddock's Improvements on Scaffolding.

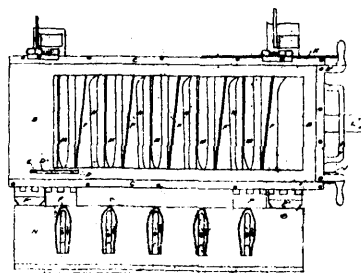

2806 Wright's Cigar Making Machine.

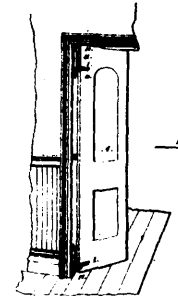

2807 Frankelen's Door Spring.

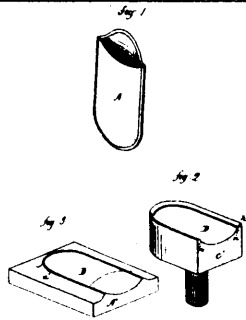

2808 Parker's Manufacture of Sheet Metal Boxes.

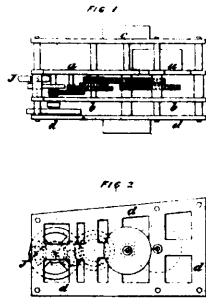

2809 Proctor's Sewing Machine Motor.

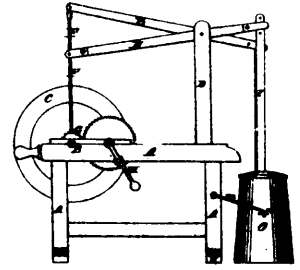

2810 Lockwood's Crutch

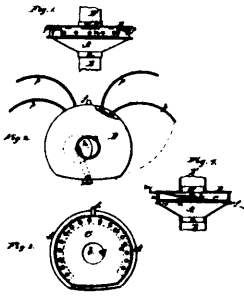

2811 Moore's Stove Pipe Shelf.

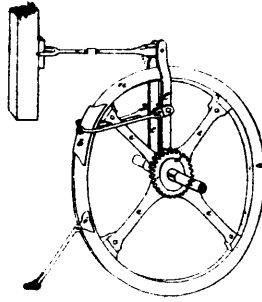

2812 Kerr's Saw-mill Feed Wheel.

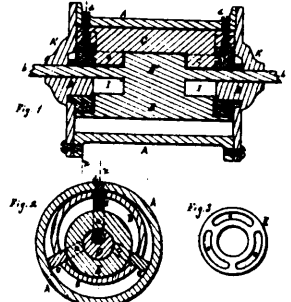

2815 Gillespie's Improvements in Rotary Pumps or Motors.

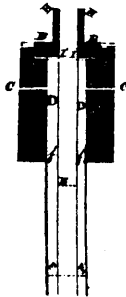

2816 Deuroche & Ward's Improvements on Well Tube Stuffing Boxes.

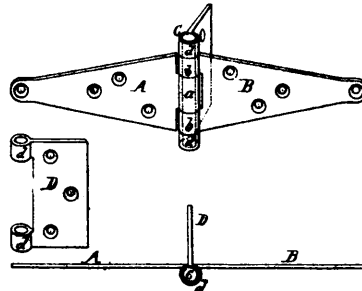

2817 Long's Improvements on Hinges.

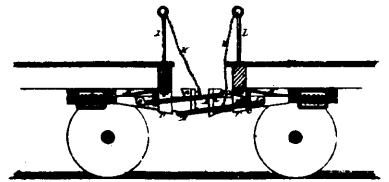

2818 Langellie's Improvements in Car Couplings.

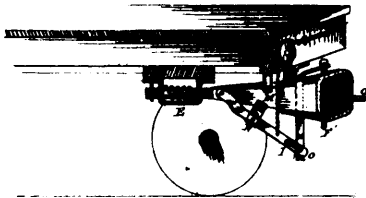

2819 Langellie's Improvements in Car Couplings.

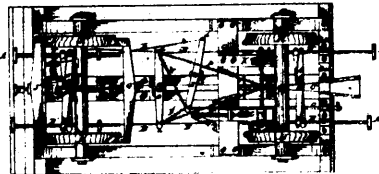

2820 Langellie's Improvements in Car Brakes.

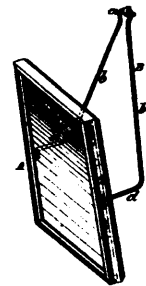

2821 Simpson's Mirror and Picture Frame Holder.

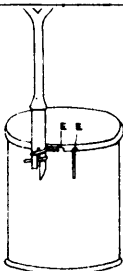

2822 Elmslie's Improvements in the Means of an Apparatus for Opening Hermetically Closed and other Cases, Boxes and Cans.

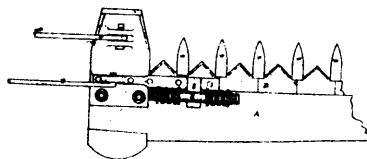

2823 Laidlaw & Kidd's Sickle Cushion for Mowers and Reapers.

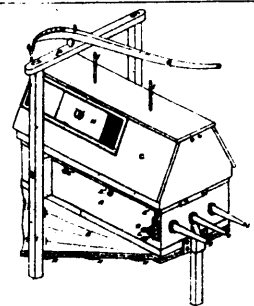

2824 Rumrill & Phippen's Improvements on Forge Bellows.



2825 Seely's Compression Pump.

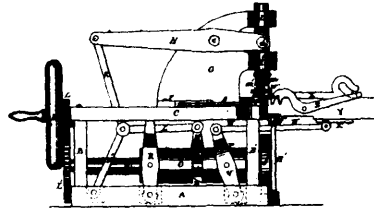

2826 Roberts' Improvements on a Machine for making Horse Shoes.

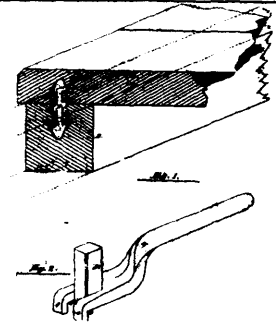

2827 Whellams' Dowel Nail.

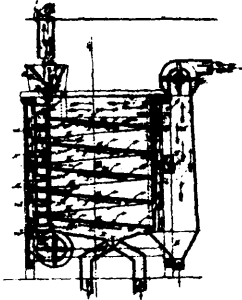

2829 Glen & Barclay's Improvements in Middlings and Flour Purifiers.

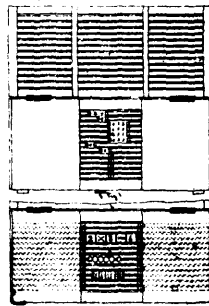

2831 MacVicar's Apparatus for Objective Teaching in Arithmetic and Reading.

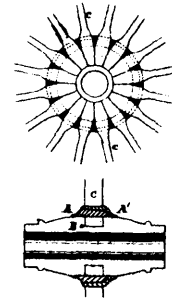

2832 Brown's Improvement in Hubs for Carriage Wheels.

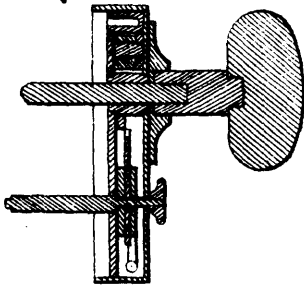

2833 Lee's Combination Lock.

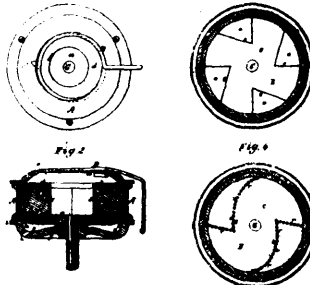

2834 Moore's Improvement on Machinery for Grinding Wood for Paper Pulp.

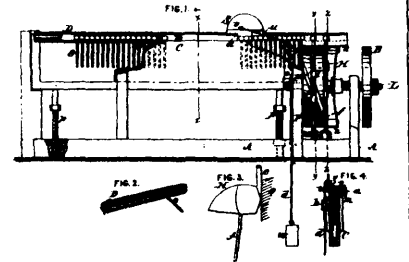

2835 Husted's Improvements on Machines for Finishing Horse Shoe Nails.

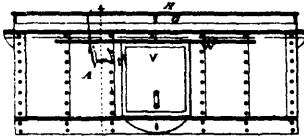
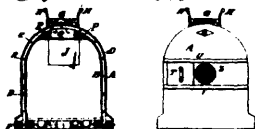
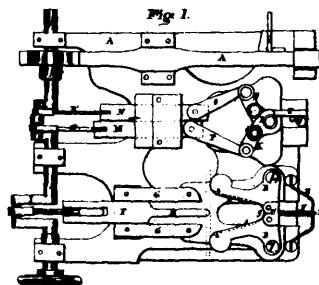

Figure 2. Figure 3.



2836 Leepers' Improvements on Iron Freight Cars.



2838 Leonard's Improvements on Link Machines.

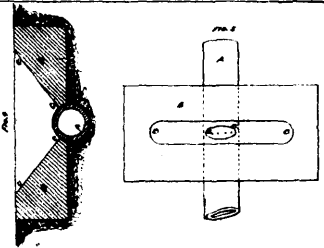

2839 Brown's Improvements on Irrigating and Manuring Land and in Hurdle Grazing it for Effectually Utilizing the Grass upon that known as Pasture Land and in the Treatment and Utilization of Sewage for Agricultural Purposes.

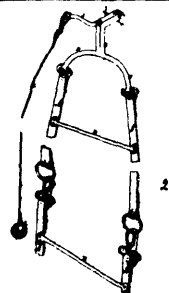

2840 Ainsworth's Fire-escape.

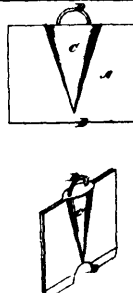

2841 Killin's Moulders Gate.

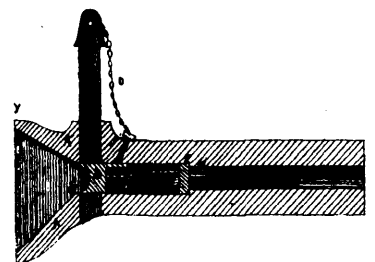

2842 Sherwood's Self-railway Car Coupler.

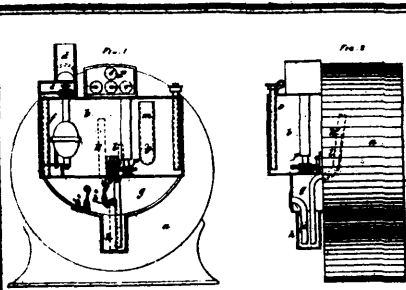

2843 De Castro & Burton's Compensating Wet Gas Meter.

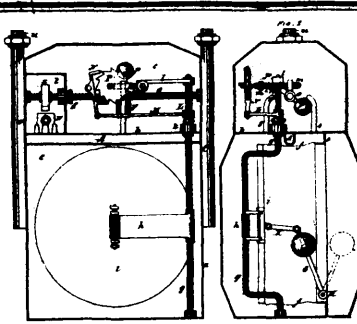

2844 Telling & Johnson's Dry Gas Meter.

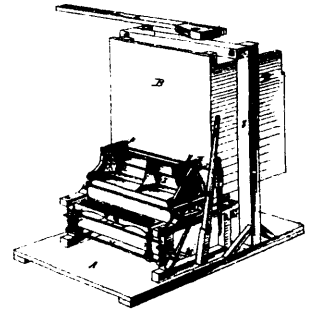

2845 Brunet & Bellefueille's Machine for Pressing Peat.

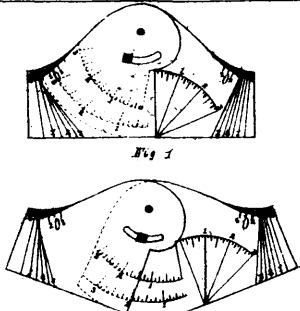

2846 Horne's Pattern for Pipe Elbows.

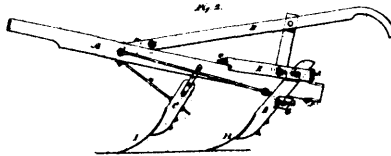

2847 Baker's Cultivator.

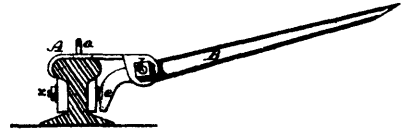

2848 Baker's Bolt Holder for Railroad Rails.

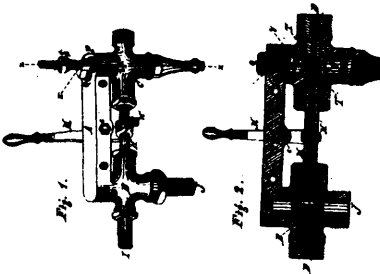

2849 Rue's Improvements on Injectors for Steam Generators.

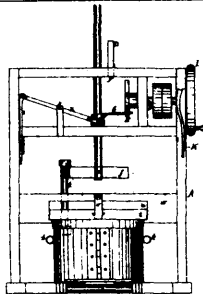

2850 Stockwell's Machine for the Manufacture of Cement Pipes.

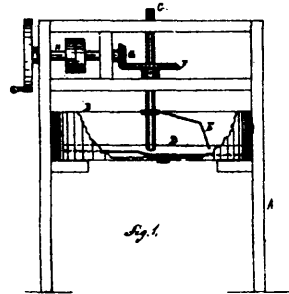

2851 Stockwell's Improved Mixing Machine.

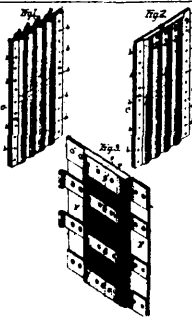

2852 Munson's Fire-proof Shutter.

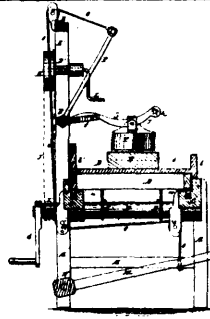

2853 Cottingham's Machine for Ironing Clothes.

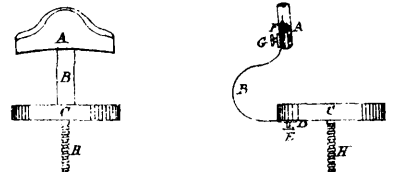

2854 Bolton's Improved Double Adjustable Piano Stool Back.

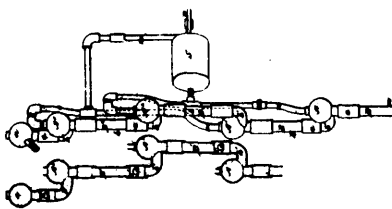

2855 Spear's Pump.

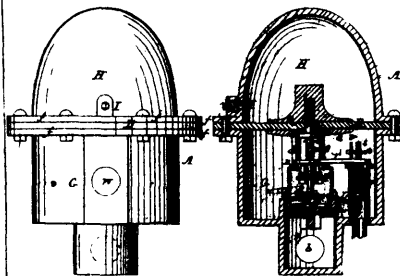

2856 Locke's Pressure Regulator for Steam or Water.

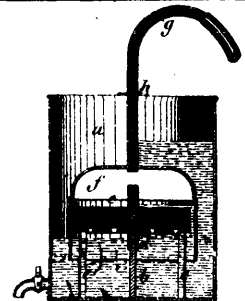

2857 Tilden's Gas Machine.

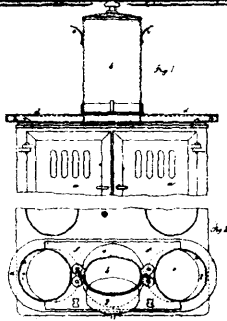

2861 Dunn's Moveable Self-feed Attachment for Coal Cooking Stoves.

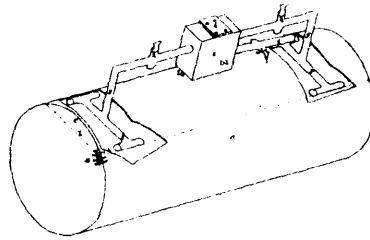

2862 Kemp's Attachment for Removing Scum and other Impurities from Steam Boilers.

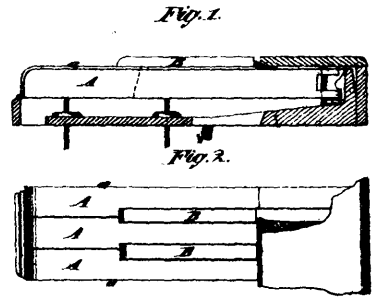

2863 Needham's Improvements on Keys for Pianos and other Musical Instruments.

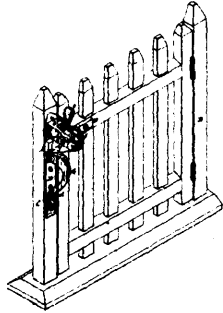

2864 Finley's Gate.

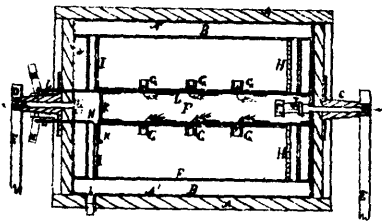

2865 Kendal's Machine for Renovating and Drying Feathers.

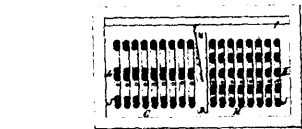
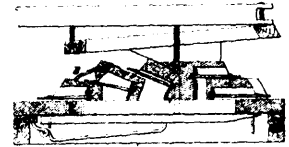

2866 Burdett's Improvements on Reed Organs.

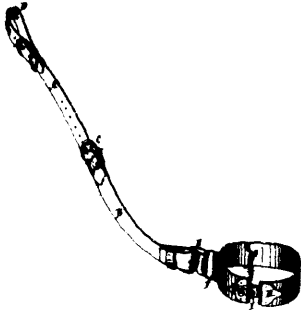

2867 Ford & Cable's Horse Halter.

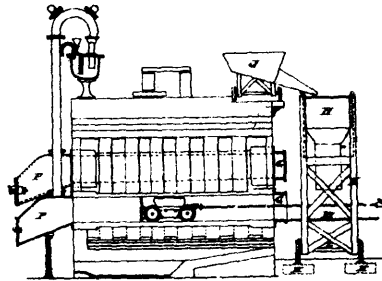

2870 West's Method of Manufacturing Gas and Apparatus therefor.

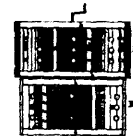
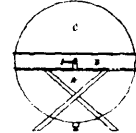

2871 Gadbois' Washing Machine.

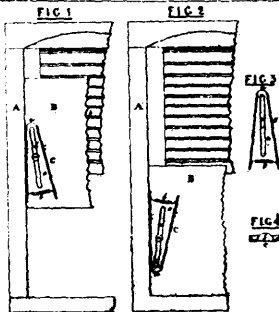

2872 Wilson & Law's Sash Fastener.

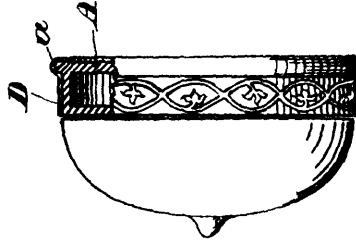

2873 Sims' Improvements on Door Bells

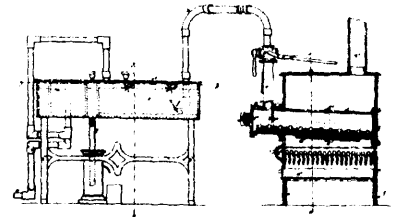

2874 Vincent's Gas Apparatus.

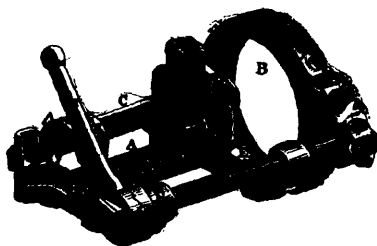

2875 Brewer's Waggon Brake.

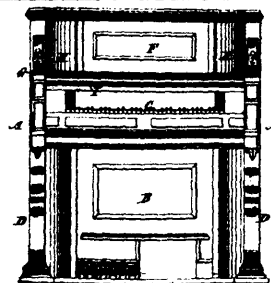

2876 Sorensen's Improvements on Cases for Cabinet Organs.

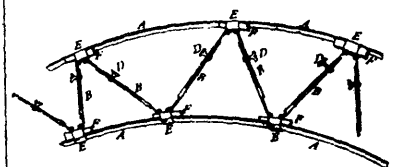

2877 Peck's Machine for Moulding the Frame Work of Vessels, Ships, &c.

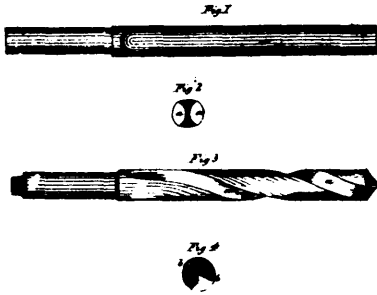

2878 Hunt's Improvements in Drills.

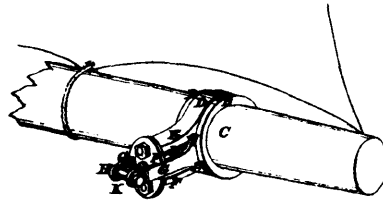

2879 Gregory's Elastic Friction Band for Booms of Vessels.

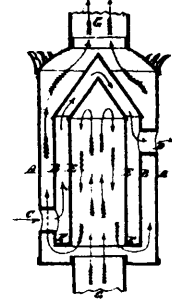

2880 Hinds' Improvements on Drum Heaters.

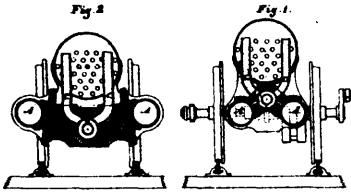

2881 Lewis' Locomotive.

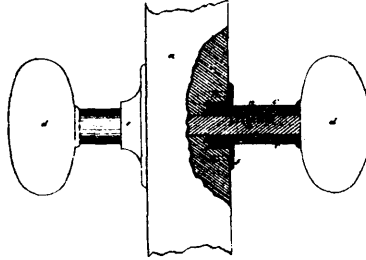

2882 Carpenter's Improvements in Door Knob Attachment.

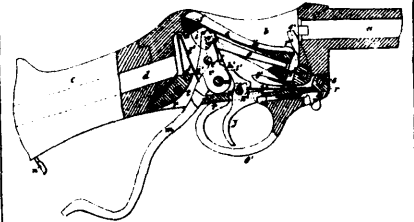

2883 Duval's Breech Loading Rifle

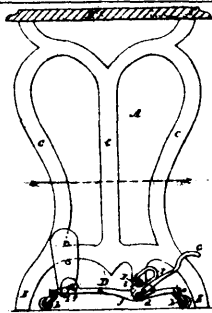

2885 Proctor's Castor Attachment for Sewing Machine Tables, &c.

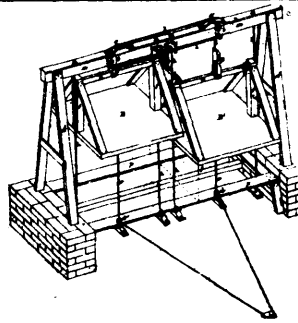

2886 Saul's Improvements in Hoisting Machines.

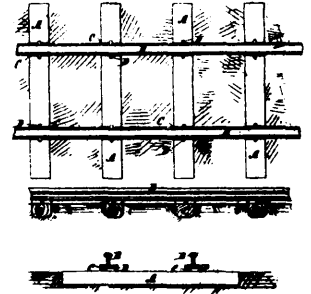

2887 Rice & Co's Improvements in Laying the Permanent Way of Railways.

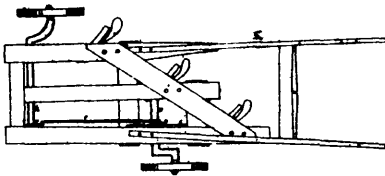

2888 Paxton, Tate & Paxton's Improvements on Gang-Ploughs.

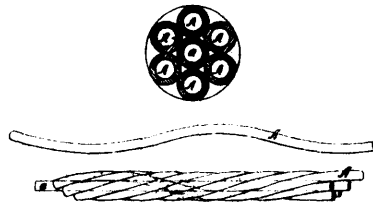

2889 Schoonmaker's Lightning-Rod.

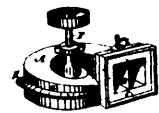

2890 Weaver's Improvements on Turbine Wheels.

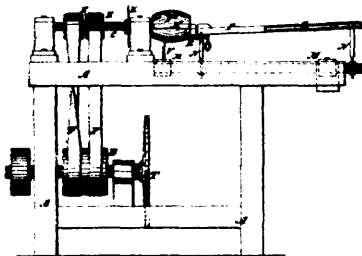

2891 Loggins & Wilkins' Improvements on Machines for Cutting the Notches in Wooden Hoops for Barrels, &c.

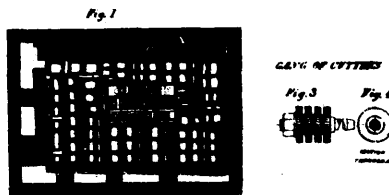

2892 Campbell & Laemie's Improvements on Printers' Furniture.

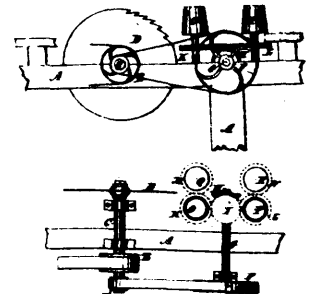

2893 Aylmer's Clap-board Machine.

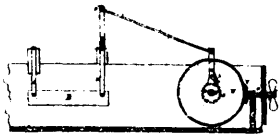
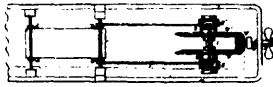
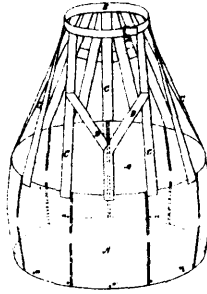

Fig. 2



2894 De Boucherville's Mode of Using Waves for Ship Propelling.



2895 Livermore's Skirt Protector.

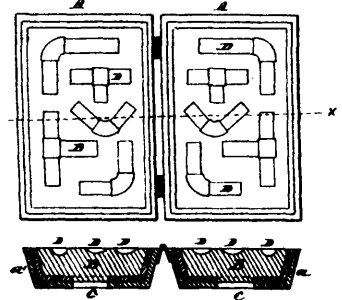

2896 Parker's Improvements on the Art or Process and Mould for Casting Cores.

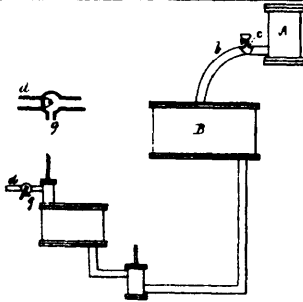

2897 Bucknam's Process for Cleaning Surface Condensers.

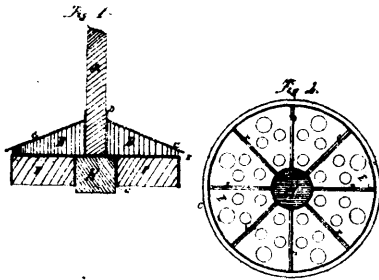

2898 Perry's Clothes Washing Machine.



2900 Standish's Improvements on Brooms.

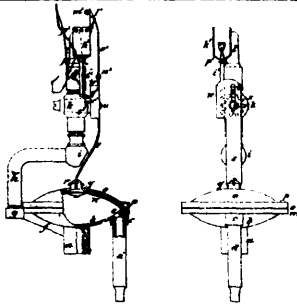

2901 Fisher's Improvement on Mechanism for Lighting Gas Burners.

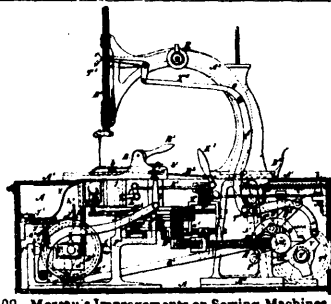

2902 Moreau's Improvements on Sewing Machines for Embroidering and Stitching Button Holes.

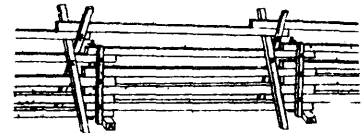

2903 Baty's Fence.

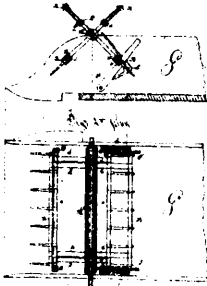

2904 Frechette's Improvements on Reaper Rakes.

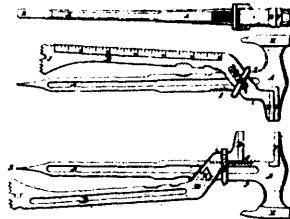

2905 Heaton's Improvements in Combination Tools.

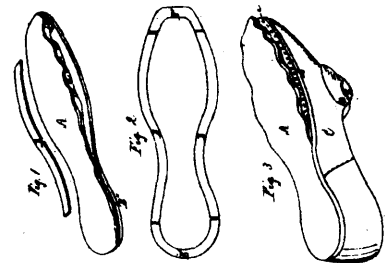

2906 Rogers' Improvement on the Manufacture of Shoes.

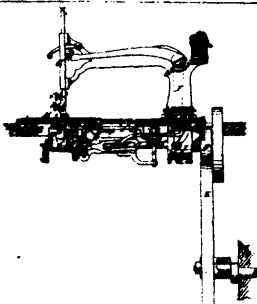

2907 Coles' Improvements on Sewing Machines.

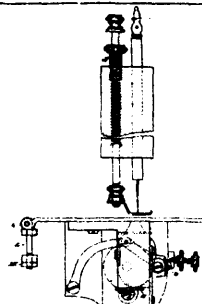

2908 Miller's Improvements on Sewing Machines.

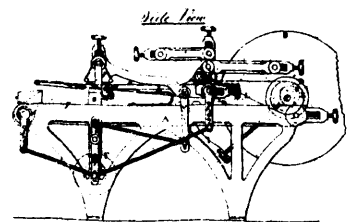

2909 Copping's Improvements on Loxenge Machines.

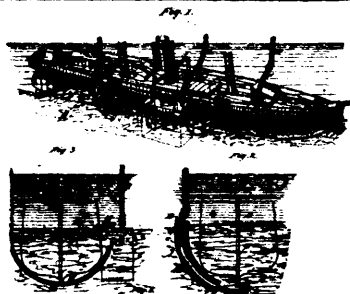

2911 Kaapp's Improvements on Means of Raising and Floating Wrecks.

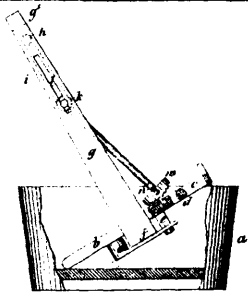

2912 Varney's Washing Machine.

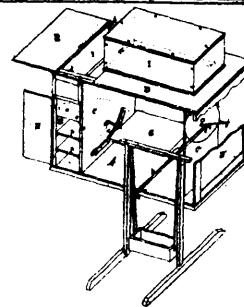

2913 McKinnon's Improvements in Sewing Machine Stands and Covers.

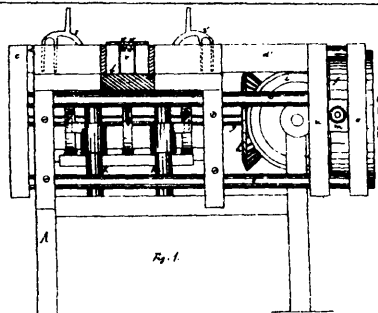

2914 Cummings, Smith & Jordan's Match Slitting Machine.

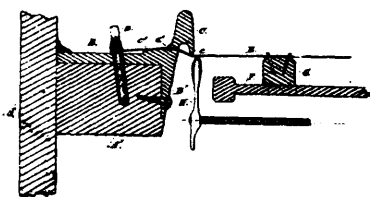

2915 Heitzmann's Improvements on Piano-fortes.

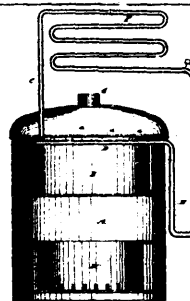

2916 Fuller's Heating Apparatus.

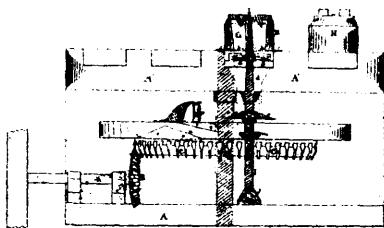

2917 Thibault & Benoit's Machine for Cutting Nails.



2918 Lamb's Improvements on Filters for Oil and other Liquids.

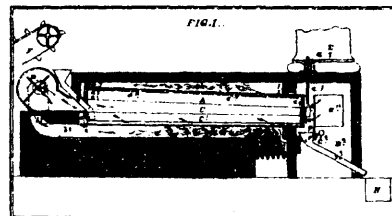

2921 Gibb & Borwick's Improvements on Apparatus and Arrangements for Drying.

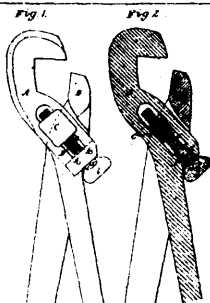

2923 Brown's Pipe Tongs.

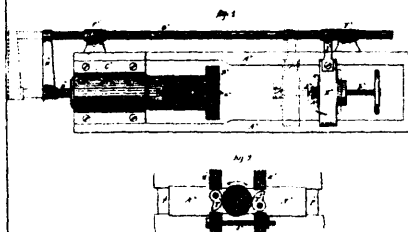

2924 Wood's Improvements on Bolt Cutting Machines.

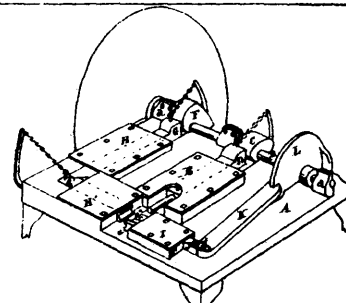

2925 Wilder's Track Bolt Forging and Slotting Machine.

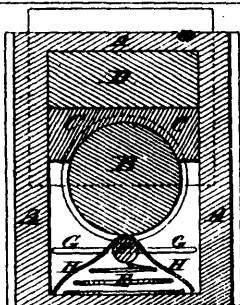

2926 Switzer & McGwin's Axle Oiler.

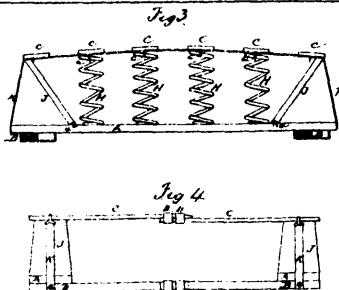

2928 Izzard's A-Adjustable Bed Bottom.

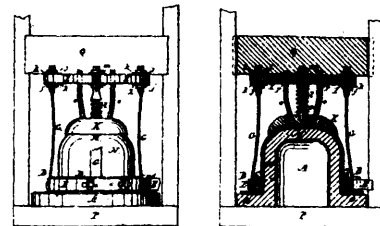

2929 Fales' Hat Blocking Machine.