

Technical and Bibliographic Notes / Notes techniques et bibliographiques

The Institute has attempted to obtain the best original copy available for filming. Features of this copy which may be bibliographically unique, which may alter any of the images in the reproduction, or which may significantly change the usual method of filming, are checked below.

L'Institut a microfilmé le meilleur exemplaire qu'il lui a été possible de se procurer. Les détails de cet exemplaire qui sont peut-être uniques du point de vue bibliographique, qui peuvent modifier une image reproduite, ou qui peuvent exiger une modification dans la méthode normale de filmage sont indiqués ci-dessous.

- Coloured covers/
Couverture de couleur
- Covers damaged/
Couverture endommagée
- Covers restored and/or laminated/
Couverture restaurée et/ou pelliculée
- Cover title missing/
Le titre de couverture manque
- Coloured maps/
Cartes géographiques en couleur
- Coloured ink (i.e. other than blue or black)/
Encre de couleur (i.e. autre que bleue ou noire)
- Coloured plates and/or illustrations/
Planches et/ou illustrations en couleur
- Bound with other material/
Relié avec d'autres documents
- Tight binding may cause shadows or distortion along interior margin/
La reliure serrée peut causer de l'ombre ou de la distorsion le long de la marge intérieure
- Blank leaves added during restoration may appear within the text. Whenever possible, these have been omitted from filming/
Il se peut que certaines pages blanches ajoutées lors d'une restauration apparaissent dans le texte, mais, lorsque cela était possible, ces pages n'ont pas été filmées.
- Additional comments:/
Commentaires supplémentaires:

- Coloured pages/
Pages de couleur
- Pages damaged/
Pages endommagées
- Pages restored and/or laminated/
Pages restaurées et/ou pelliculées
- Pages discoloured, stained or foxed/
Pages décolorées, tachetées ou piquées
- Pages detached/
Pages détachées
- Showthrough/
Transparence
- Quality of print varies/
Qualité inégale de l'impression
- Continuous pagination/
Pagination continue
- Includes index(es)/
Comprend un (des) index
- Title on header taken from: /
Le titre de l'en-tête provient:
- Title page of issue/
Page de titre de la livraison
- Caption of issue/
Titre de départ de la livraison
- Masthead/
Générique (périodiques) de la livraison

This item is filmed at the reduction ratio checked below/
Ce document est filmé au taux de réduction indiqué ci-dessous.

10X	12X	14X	16X	18X	20X	22X	24X	26X	28X	30X	32X
<input type="checkbox"/>	<input type="checkbox"/>	<input type="checkbox"/>	<input type="checkbox"/>	<input type="checkbox"/>	<input type="checkbox"/>	<input type="checkbox"/>	<input checked="" type="checkbox"/>	<input type="checkbox"/>	<input type="checkbox"/>	<input type="checkbox"/>	<input type="checkbox"/>

626

Vol. XIV., No. 8.

**SPECIAL
SWINE NUMBER**

\$1.00 per year.

FARMING

APR.
1897



PUBLISHED BY THE BRYANT PRESS, TORONTO, CANADA.

RENNIE'S SEEDS

FOR Farmer's Collection
A Big Assortment \$1.00

Are the Most Popular with Farmers.

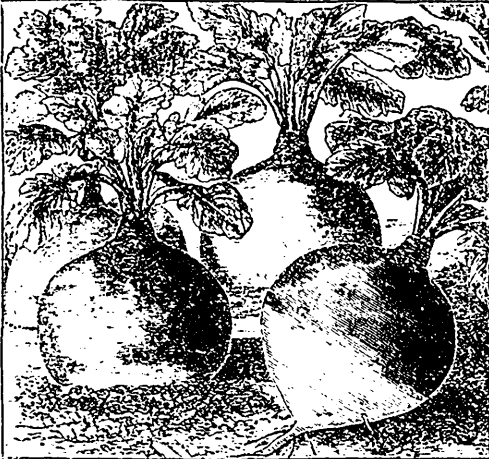

Rennie's Prize Purple Top,

The very best among the many varieties of Swedes. 5 lbs. \$1.

WM. RENNIE, TORONTO

Best and most suitable varieties for the Farm Garden—1 lb. Beans (Butter), 1 oz. Beet, 1 pkt. Cabbage, 1 oz. Carrot (Red), 1 lb. Corn (Sweet or Sugar), 1 pkt. Cucumber, 1 pkt. Lettuce, 1 pkt. Musk or Sugar Melon, 1 pkt. Water Melon, 1 pkt. Citron, 1 oz. Onion, 1 pkt. Parsnip, 1 pkt. Pepper, 1 pkt. Pumpkin, 1 pkt. Radish, 1 pkt. Squash, 1 pkt. Tomato, and 1 pkt. Sage. Regular price, \$1.65. Special Offer, 3 Farmers' Collections to separate addresses for \$2.

NEW THINGS FOR 1897

"ODDFELLOW," the New Field Pea, entirely bug-proof, distinct from all others, grand yielder, fine quality. Note—Every bushel sown this season will be required for seed next year, at high prices. Prices for 1897—Lb. 20c.; 6 lbs. \$1, by mail, postpaid. Pk. \$1.75; bush. \$1.50; bush. \$2.50; carriage extra.

"DANISH IMPROVED," the Red Top Sugar Beet used exclusively by the world's famous butter makers in Denmark. Imported direct expressly for our own trade. If you keep milch cows, try it. Prices for 1897— $\frac{1}{2}$ " 20c.; $\frac{3}{4}$ lb. 30c.; 1 lb. 50c.; by mail, postpaid.

"ROSE OF THE NORTH," the Greatest (Early) Potato Novelty of the Century. Originated with Mr. Wm. Naismith, the Canadian potato expert. Scarcely once in one hundred years is a variety like this secured, yielding at such an enormous rate—900 bushels per acre. Prices for 1897—Lb. 50c.; 2 $\frac{1}{2}$ lbs. \$1, by mail, postpaid. $\frac{1}{2}$ pk. \$2.50; 1 pk. \$4; carriage extra.

These Novelties are controlled exclusively by Wm. Rennie, and sold only direct to Farmers, to avoid every possibility of fraud. Read about them in our 1897 Catalogue, free to all intending purchasers.

Manitoba

Look up its advantages
Before going elsewhere!

25,000 farmers produced over 60,000,000 bushels of grain in 1895.

Over 10,000,000 acres of land in the province have never been cultivated, and can be purchased on easy terms from \$2.00 to \$10.00 per acre.

For information write to

HON. THOMAS GREENWAY,
Minister of Agriculture, Winnipeg.

OR

W. D. SCOTT,
Manitoba Emigration Agent, Toronto.

**PIONEERS and
HEADQUARTERS
FOR
ENSILAGE and
FODDER CORNS**



We carry the following varieties in stock:

- OUR CELEBRATED M.S.S.
(So well and favorably known)
- WHITE CAP (dent)
- CUBAN GIANT (dent)
- HURON (dent)
- EARLY MASTEDON (dent)
- STAR LEAMING (dent)
- BUTTER (dent)
- LONGFELLOW (flint)
- PEARCE'S PROLIFIC (flint)
- COMPTON'S EARLY (flint)
- ONE HUNDRED DAY (flint)

Write for prices, and state quantity wanted.

ALSO

New Beardless Barley—"Success"

Six rowed; unusually fine heads; solid plump grains. Straw strong and stiff; immense yield. Try it, if only in a small way. Per lb., 25c.; 3 lbs. for 50c., post paid. Peck, 50c.; bushel, \$1.75; two bushels, \$3.25. Bags free. Express or freight purchaser's expense.

Pearce's Half Long White Carrot

The heaviest yielder, easiest pulled, and altogether the best white carrot in cultivation. Yield at College, Guelph, 1,000 bushels per acre. Has headed all competitors for four years in succession. Price, per lb., post paid, 40c.; 5 lb. lots, \$1.75, post paid. Try it.

John S. Pearce & Co. = London, Ont.

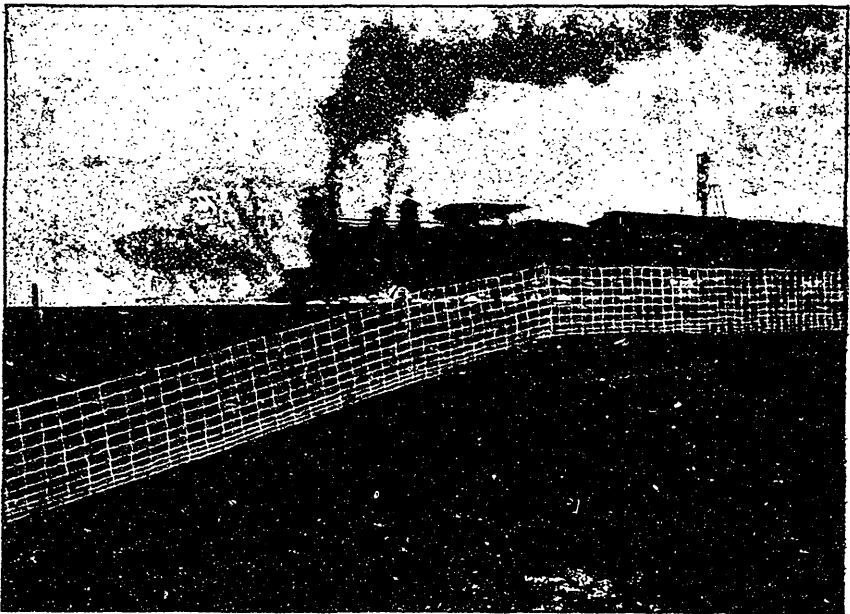

Page Woven Wire Fence on the G.T.R. near Clinton, Ont. Nearly 100 miles of it now in use on this railroad. And Page is just as popular with the farmers as with the railroads. Both want a first-class fence at a low price. If you will write the Page Fence Co., at Walkerville, Ont., they will be glad to send you their advertising matter, containing many pictures similar to above.

Will 1897 be a Good Season ?

That depends a great deal upon what the dealers and farmers make it, and in YOUR case upon whether you have good machines or not. If you want the BEST WE have them.

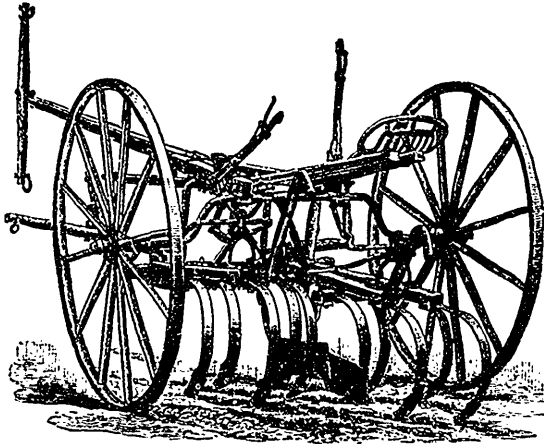

Our NEW AMERICAN

Double or Single Lock Levers

Is unequalled by any other machine in the market as a

Harrow, Cultivator, Bean Harvester, Planter, Seeder, Fertilizer, or Stalk Cutter

OUR

WINDSOR DISC

Is the neatest, most practical, and best general purpose DISC HARROW ever made

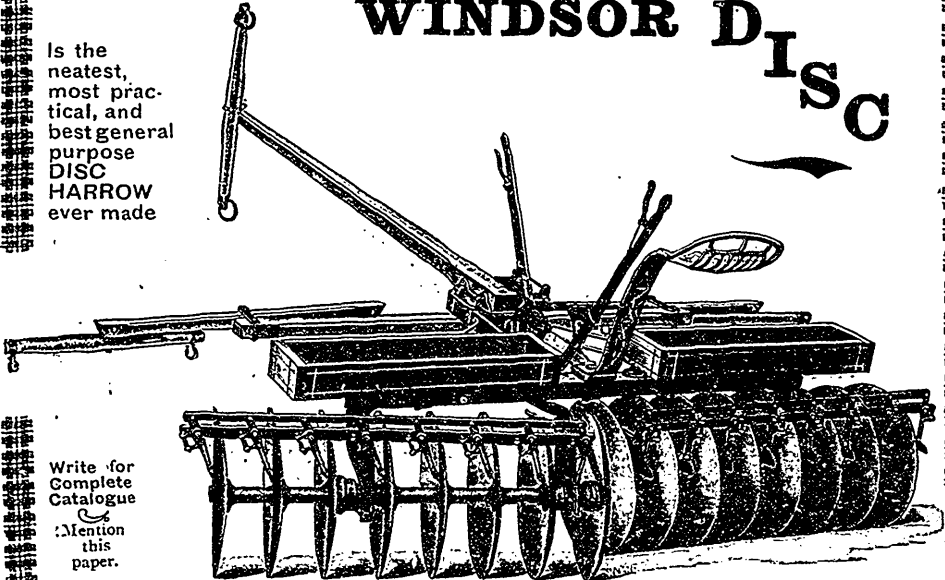

Write for Complete Catalogue
Mention this paper.

American Harrow Co., WINDSOR, - ONT.

HORSES AND SHORTHORNS.

THORNCLIFFE STOCK FARM.

I have on hand the best young **Clydesdale Horses and Mares** on this continent. Bred from the well-known sires, Prince of Wales, Darnley, Macgregor, Energy, Lord Montrose, The Ruler, Carruchan Stamp, Knight Errant, and other celebrities.

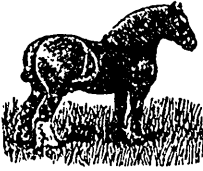

SHROPSHIRE.

Orders can now be booked for Shearling Rams, Ram Lambs and Ewes, sired by the celebrated prize-winning English ram, Bar None. Also rams and ewes of this year's importation.

SHORTHORNS.

Choice young Heifers and Bulls by the celebrated Cruickshank bulls, Northern Light and Vice-Consul.

My stock in the above lines were very successful at all the large shows last year. Call and examine stock before purchasing elsewhere. Terms reasonable.



599

ROBT. DAVIES, PROP., TORONTO, CANADA.



GLENBURN STOCK FARM

For Sale—One yearling Shorthorn Bull, two Berkshire Boars 11 months old and a few choice fall sows. Prices moderate.

Jno. Racey, Jr.,
Lennoxville, Que.,

FOR SALE ————— → ◆

Two Choice **CLYDESDALE STALLIONS**

Large size, good color, and breeding of the best. Also one Shorthorn Heifer, two years old, which will make a prize-winner. Terms reasonable.

JOHN DAVIDSON,
ASHBURN, ONTARIO



"THE BRIARS"

SUTTON WEST, ONT.

Shorthorns of all ages bred from the best, and raised under the most favorable circumstances. No person who does not intend business need apply by letter. Visitors are welcome. Also young thoroughbred roadsters for sale.

F. C. SIBBALD,
J. CARSON, Agent, Yorkton, Assa.

631

H. I. ELLIOTT, Danville, P.Q.

Breeder of Scotch Shorthorns of Duchess of Gloster, Lovely, and Nonpareil strains. Young bulls and heifers for sale at the lowest prices.



SHIRE HORSES

We have a number of Fillies, Mares in foal, and Stallions for sale. Imported and homebred; all choice, registered animals.

Address

Morris, Stone & Wellington
WELLAND, ONT.



W. J. BIGGINS SHORTHORN BULLS

CLINTON,

Ontario.

AND HEIFERS

of Select Scotch
Breeding at Low Prices.

Fashionable Hackneys AND Prize-Winning Clydesdales

Of the best known strains

For Sale

A number of superior Hackney stallions and mares sired by such well-known prize-winners as Ottawa, Banquo, Seagull, and the world-renowned JUBILEE CHIEF, winner of the Hackney championship at the World's Fair. Also a number of Clydesdale stallions and mares sired by such famous stockgetters as Sir Walter and Eastfield Laddie.

MATCHED HIGH-STEPPING CARRIAGE HORSES
SUPERIOR SADDLE HORSES

FASHIONABLE COBS
HANDSOME PONIES

R. BEITH & CO., - Bowmanville, Ont.

SHORTHORNS.

W. C. EDWARDS & CO., Breeders and Importers.**PINE GROVE STOCK FARM,
Rockland, Ont.**

On the C.P.R. and G.T.R. Railways.

Special bargains on young bulls of superior merit and select Scotch breeding. Also thick young heifers at the right prices. Two imported Cruickshank Bulls for sale; also Ayrshires, Jerseys, Shropshire Sheep, and Clydesdale Horses.

Post Office, Telegraph Office, and Steamboat Landing, Rockland, Ont., on the C.P.R.

703

JOS. W. BARNETT, Manager.

**LAURENTIAN STOCK and
DAIRY FARM,**

North Nation Mills, Que.

Ayrshires, imported and homebred; herd headed by Imported Tam Glen 2nd, No. 1310 D. A. H. B. Jerseys all of the celebrated St. Lambert family; herd headed by Lisgar Pogs of St. Anne's 25704 A. J. C. C. Berkshire Pigs. Young stock of all the above breeds for sale. Post Office, Telegraph Office, and Railway Station, North Nation Mills, P.Q., on the C.P.R.

A. E. SCHEYER, Manager.

Arthur Johnston

EENWOOD, ONT., P.O. and Telegraph Office,

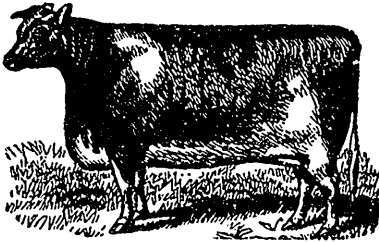

Has for sale, at temptingly low prices, a number of extra good Shorthorn Bulls, fit for service, and an equally good lot of Cows Heifers—the very best we ever bred. Send to Catalogue and prices. Enquiries answered promptly. Our motto—"No business, no harm."

Claremont Station, C.P.R.

Pickering Station, G.T.R.
696**SIMMONS & QUIRIE****Shorthorns and Berkshires.**

The herd is headed by the imported bull, Blue Ribbon 17095 (63706). He by Royal James (54992) dam, Roslantz, Vol. 38, p. 298, E. H. B., by Gravesend (92460). Among the females are representatives of the Strathallans, Minas, Golden Drops, Mysies, Elviras—all pure Scotch breeding, except the Elviras, which are Scotch crosses.

The herd of Berkshires includes many prize-winners, and are an exceedingly choice lot.

Farm 7 miles from Ilderton Station, G.T.R. Stock of all kinds for sale. Apply to

O. M. SIMMONS, Ivan, Ont., or

JAMES QUIRIE, Delaware, Ont.

For Sale...

- 3 Scotch Shorthorn Bulls. 3
- 10 Heifers now being bred. 10
- 30 Shropshire Ram Lambs. 30
- 40 Shropshire Ewe Lambs. 40
- 10 Perfectly Broken Small Ponies. 10

All of the best breeding and quality, and all for sale at low prices.

JOHN MILLER & SONS, Brougham, Ont.

SHORTHORNS**SIX BULLS
FOR SALE**

fit for service, at reasonable prices.

Write for particulars.



LINTON LUSTRE 18425

D. ALEXANDER,
Brigden, Ont.**FOR SALE Shorthorns, Berkshires,
Southdowns
and Leicesters.**

Four very choice young bulls and a number of young cows and heifers. A fine lot of boars and sows of different ages. Also a few ram and ewe lambs.

WRITE ME, OR
COME AND SEE.

532

E. JEFFS & SONS, Bond Head, Ont.

**FOR SALE, Five Shorthorn Bulls, aged from
nine to twenty months, of the best
Scotch Breeding—good size, good color, and A1 animals.
Prices and terms to suit the times.**

742

DAVID MILNE, Ethel, Ont.

Cargill Herd**of Shorthorns**

For Sale Three Young Bulls and thirteen Heifers, all of good breeding and individual merit. Also a number of good homebred cows. Prices away down.

H. CARGILL & SON,

CARGILL STATION AND P.O., ONT.

AYRSHIRES.

ISALEIGH GRANGE STOCK FARM...

April Announcement

Ayrshire and Guernsey Cattle.
Improved Yorkshire Swine.
Shropshire Sheep.

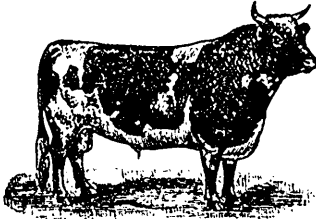

Our Shropshire sheep and Yorkshire Swine are unexcelled. We offer the choicest stock of both For Sale at reasonable prices. Our herds of Ayrshires and Guernseys are also in first class condition. We can fill orders from prize-winning and imported animals of the very best strains' Particulars furnished on application to



T. D. McCallum, Manager, Danville, Que.
J. N. GREENSHIELDS, Proprietor

PARK HILL HERD

OF

AYRSHIRES



Young Stock of both sexes for sale from the best milking strains. For pedigrees and full information address

JAS. DRUMMOND
PETITE COTE, - QUE.

MENIE STOCK YARD.

AYRSHIRE CATTLE

POULTRY

Light and Dark Brahmas; P. Cochins; S. G. and Colored Dorkings; B. P., Rocks; S. C. Brown, S. C. Black, R. C. Brown, and White Leghorns; Indian Games; S. S. Hamburgs; Golden Polish; Houdans; Bronze Turkeys; Toulouse and China Geese; Aylesbury and Rouen Ducks.

EGGS AND STOCK FOR SALE AT REASONABLE PRICES.

Wm. Stewart & Son,

Hoard's Station, G.T.R.

MENIE, ONT.

GLENHURST HERD OF AYRSHIRES

Noted prize-winners. Choice quality and heavy milking families. Extra fine young animals of both sexes or sale.

Also Leicester Sheep and Berkshire Swine.



DAVID BENNING, Breeder,
WILLIAMSTOWN, ONT.

596

Persons replying to advertisements will please mention FARMING.

AYRSHIRES
... For Sale

I now offer for sale the celebrated stock bull
"DOMINION CHIEF,"

which is considered one of the best stock bulls in Canada; also two choice young bulls, fit for service, sired by **"Dominion Chief,"** as well as several choice young imported cows and heifers, and two Shorthorn heifers, sired by **"Gibson Duke."**

These bulls will be sold cheap if taken at once. Write me for particulars.

JOHN H. DOUGLAS,
WARKWORTH, - - ONTARIO.

Maple Cliffe Herd of Ayrshires



NOTED PRIZE WINNERS, And heavy milking families. Choice Young Stock. For sale at prices to suit the times.

Apply to

ROBERT ROBERTSON, Compton, Que.

MAPLE CLIFF STOCK AND DAIRY FARM

FOR SALE-3 young bulls, also our stock bull **Gold King**. Would exchange one for an imported bull or first cross from imported stock. **Gold King 1387** is by Chieftain Barcheskie (imp.) 1128, from Nellie Osborne (imp.) 2018. We are finished with **Gold King**, having used him three seasons. His heifers are a very promising lot.

R. REID & CO.,
Hintonburg, Ont.

CHOICE AYRSHIRES OF DEEP MILKING STRAIN
Largest and Oldest Herd in Canada

We have for sale this year a choice lot of young bulls and heifers sired by Leonard Meadowside, sweepstake bull at Ottawa.

Berkshire pigs and Shropshire Sheep always on hand.

Terms to suit the times.



J. YULL & SONS,

Carleton Place.

AYRSHIRES.

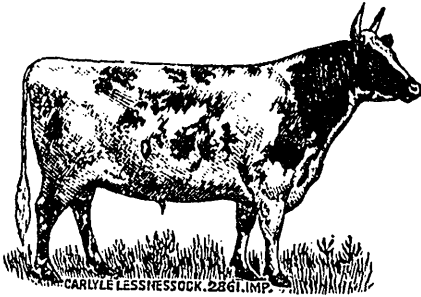

MAPLE GROVE AYRSHIRE STOCK FARM

IMPROVE YOUR STOCK.
INCREASE YOUR WEALTH.

Imported from Scotland from the most noted milk, butter and prize record Ayrshires, Champions of Scotland. The Stock Bull, Carlyle of Lessnessock, heads the herd. His grand dam was never defeated in milk and butter contests in England and Scotland, competing against all dairy herds for years in succession, and awarded more gold medals, cups and money prizes than any Ayrshire ever exhibited. With the large importation of females of noted individual records places me in possession of the choicest herd of Ayrshires in America. Live dairy farmers will consult their best interests by improving their Dairy Stock at reasonable prices. Stock always for sale.

R. G. STEACY, Importer and Breeder, LYN, Ont.

Wooler Stock Farm.

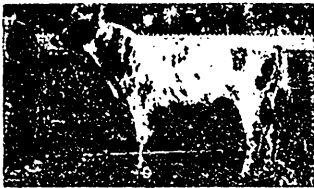

Dominion Lad, No. 1802.

First prize at Toronto, 1895; second, Toronto, and first at six other leading fairs in 1896.

Prize Winning Ayrshires.

Oxford Downs and Berkshires.

My Ayrshires are very strong in young stock and are all in fine shape. At the Toronto Fair last year I won first for herd of four calves under one year, also second and third on Bull calves under one year, and second and third on Heifer calves under six months. My Ayrshires are all of the best milking strains.

YOUNG STOCK FOR SALE.

Satisfaction Guaranteed.

A. TERRILL, - - Wooler, Ont.

Choice Ayrshire Bull Calf for Sale

Sire, Grand Duke (bred by Jas. McCormack, Rockton, Ont.); Dam, Brownie of Burnside (bred by R. Robertson, Howick, Quebec). Also Young Berkshires, not akin, from Snell's stock, along with our stock boar Watchman, sire (Imp.) Baron Lee 4th.
R. E. WHITE, Perth, Ont.

THOMAS GUY

Sydenham Farm, Oshawa, Ont.



AYRSHIRE CATTLE LEICESTER SHEEP
BERKSHIRE PIGS

FOR SALE

6 Fine Young Bulls ⁴ Yearling
2 Two-year-olds and 4 Heifers

- CHOICE AYRSHIRES -

Two very handsome massive two-year-old bulls, five yearling bulls, and a few yearlings for sale. All guaranteed of the best quality and breeding. Also a fine lot of spring calves from Douglas of Loudoun 1384, bred by D. Morton & Sons, of Hamilton. Prices to suit. Write at once for particulars.



F. W. TAYLOR,

Wellman's Corners, Ont.
Hoard's Station, G.T.R.

Woodroffe Dairy and Stock Farm

OTTAWA, CANADA.



AYRSHIRE
BULLS
FOR SALE.

One two and three-year-old. All prize winners at Ottawa Exhibition in 1896.

CLYDESDALES. YORKSHIRES.

J. G. CLARK, Ottawa.

SOUTH BRANT STOCK FARM.

T. BROOKS & SONS, Breeders of Ayrshire Cattle, Imp. Chester White and Tamworth Pigs.

In Cattle we have fine young animals of both sexes for sale, showing good milking points. Two young bulls now fifteen months old, first quality, and fit to head any herd. Of Tamworths we are sold out for this month. Twenty-five Chester Whites, now four months old, useful stock. Come and see what we are offering at prices to suit the times, or address:
T. BROOKS & SONS, Box 86, Brantford, Ont.

AYRSHIRES

-OF THE-

RICHEST MILKING STRAINS

-AND THE-

CHOICEST BREEDING

ARE KEPT AT THE GLEN FARM.

YOUNG BULLS AND HEIFERS FOR SALE

531

WHITESIDE BROS.,

Correspondence solicited.

INNERKIP, ONT.

AYRSHIRES.

Ayrshires and Yorkshires

YOUNG BULLS.—Young cows and heifers in calf, and yearling heifers and calves of both sexes. Grade young cows and young calves. All combining show ring and deep, true dairy breeding. No culls. Orders filled for young pigs. Orders promptly and honorably filled. Write for particulars.

ALEX. HUME & CO.,

Importers and Breeders of Ayrshires and Yorkshires

Burnbrae P.O., Ont.

Hoard's Station, G.T.R.

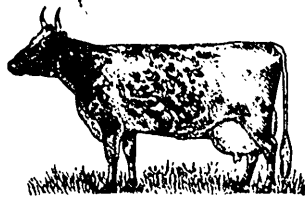

AYRSHIRES

Always for sale. Some choice young bulls and heifers bred from the Glenhurst herd.

John Sandilands, Williamstown, Ont. 852

8 six to eighteen months and a fine lot of in-calf Ayrshire cows and heifers that we will sell cheap. **Bulls** Have still a few good Red Tamworths, and a grand lot of sows in farrow for spring, also some good Berkshires. Write us now.

CALDWELL BROS.,

"BRIERY BANK FARM." Orchard, Ont.

FOR SALE

Choice young Ayrshires, of both sexes, sired by imported bulls Silver King and Glencairn. Write, or come and see them.

DANIEL DRUMMOND
Petite Cote, Que.

558

For Cheap Can load on Grand Trunk or Can. Pac. Railways.

Car lots and less quantities.....

Cattle

ADDRESS—

JAMES WILSON,
Monkland Mills. Fergus, Ont.

Feed

ELM SHADE FARM



HOWICK, QUEBEC.
FOR SALE—
Lord Sterling, 1st Prize and Diploma at Sherbrooke, and 1st at Montreal.
Dainty Lad, 1st at Sherbrooke and winner at Montreal, and other choice animals from prize winners. For pedigrees, etc., write

WM. WYLIE,
Howick, Que., OR 228 Bleury St., Montreal.

BOYS FOR FARM HELP

THE Manager of Dr. Barnardo's Homes desire to obtain good situated boys with farmers throughout the country for bright, healthy little boys from ten to twelve years of age, who will be arriving from the London Homes in several parties during the present season. There are at present nearly 5,000 in these Homes receiving an industrial training and education to fit them for positions of usefulness in life, and those who are sent to Canada will be selected with the utmost care with a view to their moral and physical suitability for Canadian farm life. Farmers requiring such help are invited to apply to

MR. ALFRED B. OWEN,
Agent Dr. Barnardo's Homes,
214 Farley Avenue, TORONTO, Ont.

775

JERSEYS.

Dawes & Co., LACHINE, QUE.

—BREEDERS OF—

Ayrshire and Jersey Cattle and
Berkshire and Yorkshire Pigs.

FOR SALE

A CHOICE LOT OF Jersey Heifer Calves

of good colors and rich breeding, both purebred and high grade. Dams have averaged the past year 330 lbs. of butter each, all sired by Canada's Hero, whose dam has a seven days' record of 19 lbs. 5 oz. For description and prices write to

W. C. SHEARER, Bright, Ont.

JERSEY COWS AND HEIFERS

The highest testing strains.
Rich breeding and good colors.

454 **ALSO TAMWORTH PIGS.**

JOHN PULFER, Brampton, Ont.

REGISTERED

Lee Farm Jerseys

Young Bulls fit for service. Cows and Heifers in calf. Bull and Heifer calves. Solid Colors. Dairy qualities unsurpassed in Canada. Farmers, prices. Come and see or write for particulars.

E. PHELPS BALL, "Lee Farm," Rock Island, P. Q.

BRAMPTON JERSEY HERD

A.J.C.C.

FOR SALE—Nineteen registered and high-grade heifers, sired by or bred to Sir Ollie, also heifer calves. Six registered young bulls, suitable to head a show or dairy herd, bred from imported and the best homebred stock attainable. Pure St. Lambert and St. Helier blood. Prices low, quality considered. Now is the time to order B. Plymouth Rock eggs, bred direct from imported birds, price \$2 per setting. Farm within two miles of G.T.R. and C.P.R. stations. Inspect or communicate

B. H. BULL & SONS, Brampton, Ont.

THE MANOR FIELD FARM OF JERSEYS

Combines blue blood with vigorous constitutions and undeniable dairy qualities. The St. Lambert bull, Kaiser Fritz 21173, bred by D. S. Dodge, Connecticut, U.S., heads the herd. Write for prices on young stock.

WILLIAM BACON,

Orillia, Ont.

548

FREE TO EXPECTANT MOTHERS.

Full information about painless childbirth, etc. Avoid suffering, prevent danger and insure a rapid recovery by writing Dr. J. H. Dye Medical Institute, Buffalo, N.Y.

POLLED ANGUS AND HOLSTEINS.

"RAPIDS FARM" LACHINE RAPIDS, ... QUEBEC ...



Royal Blackbird of Craigston.

POLLED ANGUS AND AYRSHIRE CATTLE

THIS successful and present head of the herd is now for sale; also two young Bulls fit for service. Prices to suit the times.

COMMUNICATIONS REGARDING STOCK TO BE ADDRESSED TO

W. W. OGILVIE, Proprietor.

ROBERT HUNTER, Manager.

WILLOW GROVE STOCK FARM.



Breeders and importers of highly bred Aberdeen Angus Cattle. Two prize-winning yearling Bulls and a splendid lot of females for sale at reasonable prices.

WILLIAM STEWART & SON,
Lucasville, Ont.

HOLSTEINS.

GEM HOLSTEIN HERD.

STOCK FOR SALE

We only keep and breed Registered Holstein-Friesians. We have now some Choice Young Bulls and Heifers, also some older animals, all of the very best dairy quality, that we will sell one or more at a time on reasonable terms. Correspondence solicited.

690
Shipping Stn., TORONTO.

ELLIS BROS.,
Bedford Park, Ont.

Helbon Stock Farm



Holstein-Friesians of the highest producing strains, founded on the best imported families of NORTH HOLLAND.

FOR SALE ---

Twenty females and a few young bulls, rising one year old. A rare chance to get the best stock at bargain prices.

J. W. LEE, 809 Simcoe, Ont.

HOLSTEIN-FRIESIANS.

Purebred stock of all ages, male and female, of Netherland, Johanna, Moore, and Peel strains, for sale at lowest prices.
519 JOHN MCGREGOR, Constance, Ont.
Londesboro Stn.

Holstein - Friesians

Choice young bulls and heifers, richly bred from BARNTON, BARRINGTON MERCEDES, and ARTIS strains. Prices reasonable.

T. W. CHARLTON, St. George, Ont.

Four Superior Young Holstein Bulls

of the very richest breeding for sale.

Also Eggs in season from choice pens of B. P. Rocks, Golden and S. L. Wyandottes, at \$1 for 15. Orders booked in rotation.

H. BOLLERT, Cassel, Ont.

GOLD MEDAL HERD OF HOLSTEINS.

MARCH OFFERING

One officially tested two-year-old Heifer and two Heifer calves, from dams rich in butter fat. Also a few extra choice Berkshire sows ready to breed, and a fine litter now on hand from prize-winning stock.

O. J. GILROY & SON,
Maple Glen Stock Farm. Glen Buell, Ont.

Evergreen Stock Farm

HOLSTEIN-FRIESIANS of the Pietertje, Jewel, Sir Henry of Maplewood, and Mercedes strains. Two choice fall Bull Calves for sale. Prices right, to suit the times.

Brockville, on
G.T.R. and C.P.R.

THOS. DAVIDSON,
577 Spring Valley, Ont.

We have a number of

Choice Young Holstein Bulls and Heifers FOR SALE

Price and quality must sell them!

Mostly sired by Slepke 3rd Mink Mercedes Baron, a World's Fair prize winner.

Heifers and young cows bred to Sir Paul De Kol Clothilde, a milk and butter prince. His nineteen nearest relatives average twenty-two pounds of butter a week, and fourteen average 16,83 pounds of milk in one year. Write us for records of the dams of these young bulls. Four of our cows have won money in public tests (more to follow).

A. & G. RICE, Brockbank Stock Farm, Currie's P.O., Oxford County, Ont.

SPRING BROOK STOCK FARM

Holstein-Friesian Cattle and Tamworth Swine.

A few choice bulls ready for service. Also a grand choice in females of all ages. A bargain in bull calves. Breeding for quality and quantity. Write at once or come and see. Prices right. Tamworths of all ages for sale.

413

A. C. HALLMAN,

New Dundee,
St. Petersburg, G. T. R. Main Line. Waterloo Co., Ont.

HOLSTEINS.

MAPLE HILL

Holstein-Friesians

A grand lot of cows and heifers of all ages now for sale; all bred to the milk and butter king, Sir Pieterje, Josephine Mechthilde, and the great show bull, Count Mink Mercedes. Heavy production, fashionable breeding, and showing quality are characteristic of this herd.

No more bulls for sale at present.

G. W. CUMMONS - St. George, Ont.

ALVA FARM

GUERNSEYS



Awarded first prize at Montreal for BREEDERS' YOUNG HERD. Young animals of MERIT for sale. Pedigrees and particulars to parties wishing to purchase. Address,

SYDNEY FISHER, Knowlton, Que.

HEREFORDS.

**Ingleside
Herefords . .**

Largest herd of choice-bred Herefords in Canada. Winners of both the first and second herd prizes at Toronto, Montreal, and Ottawa, 1895 and 1896, also silver medals same years for best bull and best female.

This herd is of the "up-to-date-beef-kind," combining early maturity and quality.

Young Bulls for Sale.

As I am leaving for England January 16th, for three months, please address correspondence to FRED. MORTON, Herdsman, Compton, Que.

Farm 2 1/2 miles H. D. SMITH, Ingleside Farm,
from G. T. R. station. 526 Compton, Que.

ONTARIO VETERINARY COLLEGE

Temperance St., Toronto, Can.

Patrons: Governor-General of Canada and Lieutenant-Governor of Ontario. The most successful Veterinary Institution in America. Experienced teachers. Classes begin on Wednesday, Oct. 14th, 1896. Fees, \$65 per session.

PRINCIPAL PROF. SMITH, F.R.C., V.S.,

254 TORONTO, CANADA

MEN AND WOMEN

Everywhere, to conduct business at home. No canvassing; work is simple writing and copying lists of addresses received from local advertising, to be forwarded to us daily. No previous experience required, but plain writers preferred. Permanent work to those content to earn \$6 or more weekly in spare time. Apply to WARREN Pub. Co., LONDON, ONT.

FOR SALE.

EMERGENCY SALE

-OF-

CHOICE SHORTHORNS

As my farm is about changing hands, I am compelled to offer for sale at a sacrifice my entire herd, consisting of cows, bulls, heifers, and calves, selected from some of the best herds, including those of Lord Polwarth, J. & J. Russell, Bow Park, and John Miller & Sons. The whole lot are of the most superior quality and breeding. In good showing order. Took first prizes last year wherever shown. Full particulars on application to

DR. E. D. MORTON,
201 Bloor St. East, TORONTO,

Or to T. G. MORTON,
On the Premises, ALLANDALE, Ont.

McDougall's

SHEEP DIP



-AND-

CATTLE WASH

Non-poisonous and reliable.

Mail orders promptly supplied.

Imported and for sale by

S. E. STONE, Guelph, Ont.

Seed Oats For Sale.

SALVER'S SILVER MINE

A leading variety of White Oats, strong grower, and great yielder. Also a quantity of

IMPROVED AMERIOAN

A splendid White Oat and

GOLDEN PROLEFIO.

Price for bushel, 50 cents. In ten bushel lots or more, 40 cents per bushel. Bags free.

ROBERT ROSE, Glenmorris, Ont.

FOR SALE

- ▼ One First-Class, Second-Hand Alexandra
- ▼ Cream Separator, capacity 600 lbs. per hour;
- ▼ runs by hand or power. A First-Prize Imported
- ▼ Guernsey Bull out of Irma 3421, silver-medal cow
- ▼ at Toronto, 1896. Write

W. J. BUTLER & SONS,
Dereham Centre, Ont.

WHITE SIBERIAN OATS

FOR EASTERN ONTARIO

Average yield at Guelph for 8 yrs, 83.3 bush.

"Undoubtedly our best White Oat," (Mr. Zavitz, Toledo, 1897).

These oats did splendidly with us last season, growing straw of good length free from rust, grain bright with very thin hull, ripening ten days earlier than our common varieties.

CLEAN SEED 50 cts per bushel, 10 bushels and over 45 cts. Jute bags, 20 cts.

J. J. Ferguson, SMITHS FALLS, Ont.

Seed Oats **SIBERIAN WHITE**
40 cents per bushel,
Bags 20 cents extra.
JOHN LEE,
Galt, Ont.
Box 323.

SHEEP AND SWINE.

OXFORD DOWNS For Sale

Ram and Ewe Lambs and Ewes of all ages, all registered. Yorkshire Pig, bred from J. E. Brethour's prize-winning stock.

Plymouth Rocks, best strain.

John Couslins & Sons,
HARRISTON, ONT.

693

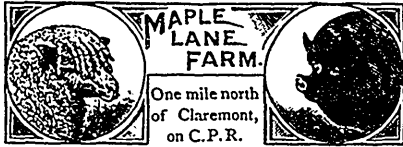

One mile north of Claremont, on C.P.R.

MY GOTSWOLDS won, in 1896, at three provincial and three county fairs 38 firsts, 31 seconds, 8 thirds, and 1 fourth, being first and second 26 times, and all pens shown for except one, and it was simply a give-away. We offer twenty good ram lambs, shearing and two-shear, at farmers' prices. Some excellent shearing ewes, bred to our best studs; fit for any company.

BERKSHIRE SOWS, ready to breed. Boars fit for service. 20 **PLYMOUTH ROCK COCKERELS**, choice. Visitors welcome.

632 **C. T. GARBUTT**, Box 18, Claremont, Ont.

OXFORD DOWNS

FOR SALE. — A fine lot of ram and ewe lambs, bred from imported sire and dams.

Prices to suit the times.

SMITH EVANS,
491 GOUROCK, ONT.
BREEDER and IMPORTER

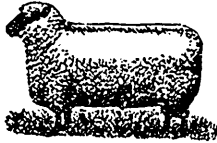

FAIRVIEW SHROPSHIRE.

A few choice Ewes still for sale, of superior breeding, and bred to first-class rams. 1896 Ram Lambs, a choice lot for customers to select good sires from. 1897 Lambs by Newton Lord and The Captain (Imp. Mansell ram) are unusually promising.

Good values offered for early orders.

JOHN CAMPBELL,
Fairview Farm. WOODVILLE, Ont.



"MINNIE MILES," twice winner over all breeds.

FARNHAM OXFORD DOWNS

I have for sale rams and ewes of all ages and both sexes at reasonable prices. All registered. Satisfaction guaranteed.

Some Choice Ewes for Sale, bred to imported Rams. Won many honors at World's Fair.

HENRY ARKELL,

Guelph, G.T.R. Arkell, C.P.R. 776 **ARKELL P.O.**

Carter & Coyn

Portage la Prairie, Man.

PRIZE TAMWORTH AND CHESTER WHITE SWINE
Mammoth Bronze Turkeys

For sale. Write us.

858

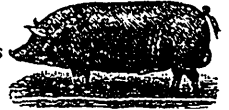

LARGE ENGLISH BERKSHIRES

Some prize-winners and some pigs from prize-winning boars and sows, September and October litters. Some fine young sows, farrowed in May. Also Clydesdale mares, from yearling to seven-year-old, eligible to registry. Prices right.



GEO. THOMSON, Bright, Ont.

Sunnyside Farm, 3 miles from Bright Sin., G.T.R.

A SPECIALTY OF **Improved Chester Swine and Leicester Sheep**



We have for sale a number of Chesters of both sexes and all ages.

Eggs from the following varieties of hens at \$1.00 per thirteen, L. Brahmas, Buff and P. Cochins, P. Rocks, S. G. Dorkings, S.L., G. L. and White Wyandottes, W. and B. Leghorns, Golden Polands, Indian and Pitt Game. Settings of above mixed if desired.

Bronze Turkey \$1.50 per nine. Pekin, Rouen and Aylesbury Ducks, \$1.50 per eleven. Have also for sale a few Cockerels, Gobblers and Drakes.

GEORGE BENNETT & PARDO,
770 CHARING CROSS, ONT.

POLAND-CHINAS at Willisroft. ARE THE RIGHT KIND.

Brood sows for sale. Boars ready for service. Young sows ready to breed. Lots of pigs two to three months old; good long pigs with heavy bone. Prices right. Mention FARMING.



493

R. WILLIS, Jr., Glen Meyer, Ont.

Ghester Whites and

Berkshires

For a boar or sow of any age, that are right in quality, right in breeding, right in price, and guaranteed to be all right. Address,



804

JAS. H. SHAW, Simcoe, Ont.



LARGE

ENGLISH BERKSHIRES.

My herd won 306 prizes, 11 diplomas, and 5 medals since 1888. Choice stock of all ages for sale.

GEORGE GREEN, FAIRVIEW, ONT.
Stratford Station and Telegraph Office.

Registered Poland-China Swine

Orders booked for Spring pigs bred from imported stock, also Eggs for Hatching from choice pens of B. P. Rocks and Black Minorcas. Orders booked at \$1.00 per setting, or two settings for \$1.50.



R. B. McMULLEN, Blytheswood, Ont.

SWINE.

JOS. CAIRNS, Camlachie, Ont.

IMPORTER AND BREEDER OF
Chester White Hogs

Stock on hand for sale at all times of all ages, and at right prices.

LARGE ENGLISH BERKSHIRES

Sows in pig. Young boars fit for service. Orders booked for young pigs, sired by Baron Lee IV, and Victor XII. For prizes won by us see Toronto Industrial and Guelph Fat Stock Show of 1895 and 1896.



Write for prices or come and see us.

J. G. SNELL, Snelgrove, Ont.
Brampton Stn., C.P.R. and G.T.R. 820

MAYFIELD HERD OF BERKSHIRES

Now is the time to place orders for young pigs of January, February, and March litters. Sired by my champion English winner **Manor Hero** (5141) 4117. Four choice imported sows in herd. Some good young sows bred to Manor Hero for sale. Write for prices. Satisfaction guaranteed.

686 **S. COXWORTH,** Whitby, Ont.

NITHSIDE FARM HERD of BERKSHIRES

Four Choice Young Sows, also Two Yearling Sows, For Sale, bred to the fine young boar, Nonpareil, a son of Baron Lee IV. and Lady.

As we have been breeding Berkshires for the last fifteen years from the best that can be got, our customers can rely on getting choice pigs. None but first-class stock sent out, and satisfaction guaranteed in every case.



E. E. MARTIN,
Paris Station, G.T.R. 464 Canning P.O., Ont.

OAK LODGE HERD

IMPROVED LARGE YORKSHIRES.

ONLY ONE BREED KEPT

But the very best of that breed. A large herd to select from, and prices very moderate. Write for prices.

J. E. BRETHOUR,
Burford, Ontario.

Maitland Stock Farm... Large English Berkshire PIGS

OF THE BEST TYPES. Stock guaranteed. Young stock on hand and for sale at all times.

FRANCIS RUSSELL,
CEDARVILLE, ONT.

SWINE.

Large English Berkshires

Choice Breeding Stock for Sale from Show Animals—both sexes, all ages, show boars and sows. Sows in farrow. Satisfaction guaranteed. Mention FARMING.



C. R. Decker, Chesterfield P.O., Ont. Bright Station. 698

Pine Grove Herd Duroc-Jersey SWINE
NOW IS YOUR CHANCE

to secure a choice breeding sow cheap. Also a choice lot of fall pigs to hand.



Write for particulars.

754 **CHAS. ANSTICE,** Springford, Ont.

FOR SALE

REGISTERED { POLAND CHINA TAMWORTH DUROC-JERSEY } SWINE

AND SHROPSHIRE SHEEP

Brood Sows. Boars ready for service. Young sows ready to breed, and pigs from six weeks to four months old of above breeds, descended from imported stock and prize-winners at Toronto and London. Have won more prizes than any other herd in Huron County. Prices reasonable. Address,

WES. W. FISHER, Benmiller, Ont.

GOLDSRING HERD OF TAMWORTHS



Herd headed by the famous **King George**, an unbeaten winner, assisted by **Red Knight**, and such famous dams as **Amber Rose**, **Trilby**, **Coldspring Girl**, and **Nellie Bond**. Young boars ready for service, and sows ready to mate. Two grand September litters ready to ship. Prices right.

NORMAN BLAIN - St. George.

Parkhill Berkshire Herd

—AND—
POULTRY YARDS.

I have a choice stock of all ages and sex for sale at all times. Terms and prices reasonable. Write for what you want. I am prepared to book orders for Spring Pigs, and can furnish pairs and trios not akin. Will book orders for Eggs from choice pens of **L. Brahmas**, **W. and B. P. Rocks**, **W. and B. Leghorns**, **W. and S. L. Wyandottes**, **W. Minorcas**, **S. G. Dorkings**, **P. Cochins**, 12 eggs, \$1.26; \$1.50. Rouen and Pekin Duck Eggs, 10 for \$1. Al. Bronze Turkey Eggs, 20c. each, 9 \$1.50. **D. A. GRAHAM,** Parkhill, Ont.



TAMWORTH SWINE

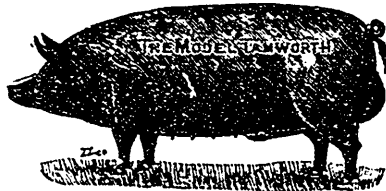

For Sale—Young Pigs from three to ve months old. Address, **JOHN BELL** Clydesdale Far Agincourt Station, G.T.R. and C.P.R. Amber P.O.

SWINE AND POULTRY.

DENNIS HAWKINS, Woodville, Ont.

BREEDER OF

BERKSHIRE PIGS

Of the most approved types. Lord Randolph (3387) and Select Knight (4117) at head of herd. Stock for sale at reasonable prices. Also Black Minorca Eggs \$1.00 per setting.

IMP. CHESTER WHITE AND TAMWORTH SWINE.

Having won the sweepstakes for the best boar and two sows at Toronto Exhibition of 1896, we are booking orders for spring pigs from imp. stock in pairs not akin. Stock for exhibition purposes a specialty. Pedigrees furnished. Reduced rates by express. Drop a card for prices before buying elsewhere.



H. GEORGE & SONS, Crampton, Middlesex Co., Ont.

Improved Yorkshires

Choice young Pigs for sale of the best breeding.

Eggs for Hatching

From high-scoring prize stock, in S. C. B. Leghorns, S. C. W. Leghorns, B. P. Rocks, Buff and P. Cochins, D. Brahmas, S. L. Wyandottes, Red Caps, G. and S. Polands, S. S. Hamburgs, and Houdans. \$1.25 per 13 \$2.00 per 26. Stock for sale. Send for description.

Seed Potatoes

Genuine Carman No. 1. Heavy cropper, best quality. \$1.00 per bag.

WM. C. WILSON, East Oro, Ont.

THE SWEEPSTAKES HERD OF

TAMWORTHS



has won the highest honors for the last three years. Boars and sows of all ages by the Industrial and London first prize-winner, Glen Sandy. 559

WALTER. T. ELLIOTT, Hamilton, Ont.

BUY NO INCUBATOR

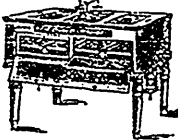

and pay for it before giving it a trial

The firm who is afraid to let you try their incubator before buying it has no faith in their machine. We will sell you ours ON TRIAL. NOT A CENT until tried, and a child can run it with 5 minutes' attention a day.

We won **FIRST PRIZE, WORLD'S FAIR**, and will win you for a steady customer if you will only buy ours on trial. Our large catalogue will cost you 5 cents and give you \$1.00 worth of practical information on poultry and incubators and the money there is in the business. Plans for Brooders, Houses, etc., 25 cents. N.B.—Send us the names of three persons interested in poultry and 25 cents and we will send you "The Bicycle: Its Care and Repair," a book of 180 subjects and 80 illustrations, worth \$5 to any bicycle rider.

VON CULIN INCUBATOR CO., Box 320, DELAWARE CITY, DEL.



FOR SALE

Famous heavy-yielding *Beardless Barley*, at \$1.10 per cwt., or \$1 if 10 cwt. be taken. Out-yielded other Barley by one-third in past two years. Bags 15c extra. Also eggs from P. Cochins, S. and W. Wyandottes, B. P. Rocks, Houdans, and B. Minorcas. Birds in our yards hatched from eggs from England this year. At six fall fairs (1895) we won 78 prizes; over 70 per cent. shown for. Last fall won 80 per cent. of all prizes. Have several breeds besides above. Males of India Games, Light Brahmas, and P. Rocks, \$2 each—dandies. Eggs from now on at \$1 per 13. No trouble to answer enquiries.

J. WEAVER & SONS, Chatham, Ont.

CHAMPION'S

IMPORTED BLACK MINORCAS

Winners in England and Michigan's largest shows. Eggs \$3 per 13. My native stock is headed by imported cock. Eggs \$1.50 per 13. My Black Breasted Red Games were imported January 17. They were winners in England's best shows. Eggs \$3.00 per 13. Imported birds, male and female, of above for sale, also Indian Games, Aylesbury and Pekin ducks. Also ten other varieties of native stock for sale. Eggs \$1.50 and \$2 per 13. Send for circular and catalogue. 5 cents in stamps gets it, 48 pages, 7 x 10. Agt. W. Woods Poultry Yds. Edwinstowe, Eng. **S. CHAMPION, Cass City, Mich.**

BLACK AND WHITE MINORCAS, GOLDEN WYANDOTTES, LIGHT BRHAMAS.

These fowls are very high bred, scoring from 90 to 98 points, and have taken many prizes at leading exhibitions. Eggs per 13, \$1.50.

J. F. N. KENNEDY, Cedar Grove, Ont.



Eggs

From Prize-winning Stock of Barred Plymouth Rocks, Silver Laced Wyandottes, Black Minorcas, and Partridge Cochins. Two Prize-winning Black Wyandotte Hens, at \$2 each.

Box 183.

DUNCAN & FRASER, Petrolia, Ont.

...SILVER... WYANDOTTE Eggs

\$2 per thirteen, from first-class stock. One Indian Game Cockerel for sale at a bargain.

J. R. HAND, Fenelon Falls, Ont.

Do you keep CHICKENS?

Send for free pamphlet on feeding, treatment, etc., and catalogue of foods, etc.



To **SPRATT'S PATENT Ltd.**

239 E. 56th St., New York.

POULTRY.

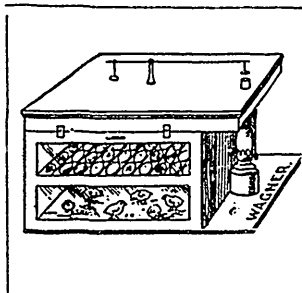

Wagner's 50 Egg-Hatcher \$9.50

Thermometer and Egg Tester included
Self regulating; has drying-room underneath egg tray

7 MEDALS and NUMEROUS PRIZES

Buff **EGGS** For hatching, from prize pen, \$3 for 13
Leghorn From great laying stock, \$1.50 for 13

WAGNER INCUBATOR CO.

726 King Street W. - Toronto, Ont.



GEO. BLAMEY, Oshawa, Ont.

Brown Leghorn and W. P. Rock fowls (Forsyth and Rice strain). Young stock for sale, \$2.00 each; \$5.00 per trio. Eggs in season, \$1.00 per setting. 1013

GAMES GAME COCHIN AND POLISH BANTAMS

THE FINEST STOCK IN AMERICA.

Thousands of premiums at the leading shows. Also Boston Terrier Dogs and Angora Cats of the bluest blood. Stamp for Catalogue.

PEIRCE BROS. Lock Box L. Winchester, N.H.

S. L. Wyandottes, Red Caps, and Rose Comb Black Minorcas.

EGGS, \$1 per 13.

Wyandottes and Red Caps for Sale.

All high-class stock.

W. H. KIRBY, Oshawa, Ont.

HATCH Chickens BY STEAM— With the MODEL
EXCELSIOR Incubator
Simple, Perfect, Self-Regulating. Thousands in successful operation. Lowest priced first-class hatcher made.
GEO. H. STAHL, 114 to 122 R. 8th St. Quincy, Ill.
Circulars free. Send for this Catalogue.

Eggs for Hatching from first-class Stock

Blue Andalusians, \$1.50 per 13. Black Javas, \$1.50 per 13.
Partridge Cochins, \$1.50 per 13. S. S. Hamburgs, \$1.50 per 13.
Brown Leghorns, \$1.50 per 13. Black Hamburgs, \$1.00 per 13.
Rouen Ducks, \$1.50 per 11.

One Rouen Drake, at \$2.00, also stock of any of the above varieties.

W. R. KNIGHT, Bowmanville, Ont.

LAKESIDE POULTRY YARDS

S. HOBART, COBOURG, ONT.

S. C. WHITE, BROWN, BLACK, BUFF LEGHORNS and BUFF COCHINS. Finest stocks of the above varieties. Noted for large size and great laying qualities. I have in my yards strains of the best breeders in America, **Twenty-five fine Cockerels For Sale**, either for Exhibition or as Stock Birds. **EGGS FOR SALE.** Satisfaction Guaranteed in every case.

The Safety Incubator Won First Prize

At Toronto Industrial, hatching 8 1/4 per cent. after carrying the partly hatched eggs over fifty miles, while our competitors, whose machines were built and operated right in Toronto, hatched only 5 1/4 per cent. and 40 per cent. These facts should tell you exactly what machine to buy. Our machines for 1897 are surpassed by none. Consult your own interests by writing us for all further particulars.

A fine lot of **SILVIE WYANDOTTES** for sale.
J. E. MEYER, Box M, Kossuth, Ont.

RIVER VIEW POULTRY YARDS

Eggs for Hatching, \$1.25 per 13.

Light and Dark Brahmans, Buff, Black, and Partridge Cochins, Golden Wyandottes, Black and White Plymouth Rocks, Black Spanish, R. and S.C. Brown and K.C.W. Leghorns. Settings mixed if desired. No discount on quantities.

SPETTIGUE & GEORGE

Young breeding stock for sale. 52 Clarence St., London.

For Sale

Silver Laced, Black, and White Wyandottes, White Plymouth Rocks, American Dominiques, S. C. White Leghorns, and Black Cayuga Ducks

Our birds won 70 prizes at the last exhibitions in Toronto, London, and the Ontario Poultry Show. Birds for sale at reasonable prices at all times. EGGS, \$1.50 per 13. Satisfaction guaranteed.

GEORGE BOGUE - Strathroy, Ont.

They Must Go!

Golden and Silver Wyandotte Cockerels \$1.50 to \$3.00 each

Pullets, \$1 to \$2 each. Eggs in season, \$1 per 11. Stock bred for exhibition and utility.

Bronze Turkey Gobblers

All stock guaranteed \$3 each; hens, \$2.50. Very large, and fine breeding quality.

JAMES LENTON, Park Farm,

733

OSHAWA.

BARRED ROCKS EGGS, \$1 per setting

Bradley strain. No bird in pen scoring less than 90 points.

LANGSHANS EGGS, \$1 per setting

Forsythe strain. All high-scoring birds. Orders booked now.

A few fine birds for sale.

W. T. GIBBEARD, Napanee.

132 Yards High Glass Fowls
New Improvements
SELF REGULATING.

PROFITS IN POULTRY!

tells how to earn these profits. What others are doing you can do. One hundred and forty-eight pages of valuable, practical matter.

INCUBATORS and BROODERS!

The Improved Reliable is Warranted to Hatch 80 percent of the fertile eggs. Hundreds of recent testimonials. Sixteen popular kinds of THOROUGHbred FOWLS FOR SALE, also full line of Poultry Supplies. Price of Guide 10c. in stamps—worth one dollar. **Reliable Incubator and Brooder Co., Quincy, Ill.**

Our Eleventh Annual Poultry Guide and combined catalogue

POULTRY.

The "Toronto" Incubators and Brooders

Awarded Two First Prizes at Toronto Industrial, 1896.

ARE THE

BEST MANUFACTURED

We have won three out of our First Prizes at Toronto Exhibition during 1895 and 1896.

SEND FOR CIRCULAR AND PRICE LIST.

Address the Manufacturer,

T. A. WILLITTS,

642 Manning Avenue.

TORONTO, CAN.

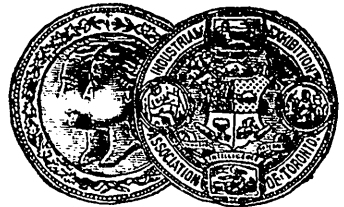

Silver and Bronze Medals

These are the Highest Awards.

Also Silver Medal, 1895.

SPRING BANK STOCK FARM

**SHORTHORN CATTLE
OXFORD SHEEP
BRONZE TURKEYS**

Have on hand for sale 14 shears, 3 shearing rams; also a number of ram and ewe lambs. Prices right.

462 JAS. TOLTON, Walkerton, Ont.

Sunnyside Poultry

Mammoth Bronze Turkeys. Stock Gobbler weighs 40 pounds. Eggs per setting, \$3.00.

Black Langshans, English Grey Dorkings, Silver Laced Wyandottes, Barred Plymouth Rocks, Black Minorcas, Light Brahmas. Stock and eggs for sale.

T. A. COX, Brantford, Ont.

A. F. DIMMA,

Locust Hill Station. CEDAR GROVE, Ont.

Breeder prize-winning Rose Comb and Single Comb White Leghorns. The head of my Single Comb pen has taken nine first prizes out of ten exhibits. Eggs \$1.00 per setting of 13.

LUCKNOW POULTRY YARDS

Breeders and Importers of Buff Cochins, Light Brahmas, Houdans, Red Caps, S. L. Wyandottes, Black Minorcas, Pyle Games. Eggs \$1.50 per 13. B. P. Rocks, White and Brown Leghorns and and Pekin Ducks, \$1.00 per 13. Eggs warranted fresh. Correspondence solicited.

Address J. C. LYONS, Lucknow, Ont.

N.B.—Pen Imported Brown Red Games, eggs \$3.00 per 13. Our stock won 80 prizes at Owen Sound, Woodstock and Seaforth winter shows.

DELOS REESOR Box Grove, Ont.

Breeder of choice Red Caps, S.C.B. Leghorns, B. P. Rocks, and Duck Wing Bantams. Red Caps have won wherever exhibited. Young stock of above varieties for sale. Eggs, \$1 per setting of 13. Satisfaction guaranteed. 1080

W. W. REID, { Send for } Circulars } BREEDER OF AYR, ONTARIO

20 Varieties of High-Class Land and Water Fowl.

1077

Send Birds and Eggs for sale in season.

VERY CHOICE PURE BRED SILVER GREY DORKINGS

From the noted prize-winning Cockerel and Hen. The hen that the above stock is from was purchased at the enormous sum of thirty-five Guineas, at Kintore Palace, Aberdeenshire, Scotland. Eggs per setting of thirteen, \$2.00.

John Isaac,

Kinellar Lodge, MARKHAM, ONT.

SNELGROVE POULTRY YARD.

Barred Plymouth Rocks Exclusively. Eggs for Hatching \$1.00 per setting, three settings, \$2.00.

W. J. CAMPBELL, Snelgrove, Ont.

**THE IMPROVED
VICTOR Incubator**

Hatches Chickens by Steam. Absolutely self-regulating. The simplest, most reliable, and cheapest first-class Hatcher in the market. Circulars FREE. Address
GEO. ERTEL & CO., LONDON, ONT. or QUINCY, ILL.

Cats. 4 cts.

Cheap Cockerels!

Farmers who wish to increase the egg yield from their poultry should use a thoroughbred male bird of a well known egg-producing strain. Mr. Thomas A. Duff, Toronto, is offering Cockerels for this purpose of White and Black Minorcas and Barred Plymouth Rocks (same blood as his winners), at the extremely low price of \$1.50 each. Readers of FARMING who keep poultry cannot expend \$1.50 better than by investing in one of these Cockerels. Eggs \$3 per setting, \$5 for two settings.

THOMAS A. DUFF, Toronto, Ont.

MISCELLANEOUS.

Begin Right Here, Now.

New Family Record A BEAUTIFUL PICTURE
IN 12 RICH COLORS

Upon a Back Ground of Solid Gold.

Tremendous Seller.

Agents Wanted.

We have hundreds of other pictures ; genuine oil paintings, water colors, fac simile pastels, chromos and engravings that sell in art stores at one dollar up to fifteen dollars. Our agents sell them at less than half these prices and make money fast.

Samples Free for 12 cents to pay mailing expense. Take your choice of Family Record, Marriage Certificate or Memorial Picture. Names and dates filled in by pen artist for 50 cents extra for each picture, lovely work. This offer is made to secure agents. Triflers, and boys and girls under 18 years of age need not answer this advertisement. We can supply new, quick selling goods all the year round. We refer to any Bank or Commercial Agency in the United States or Canada.

Address, *AMERICAN SUPPLY HOUSE, 82 to 90 West Seneca St., Buffalo, N.Y.*

FOUR LEADERS

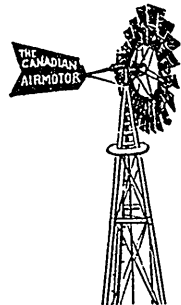

The Canadian (Steel) Air-motor
For Power and Pumping
Galvanized or Painted.

The Haymaker Carrier
With Steel Wood Track.

The Little Giant Spray Pump

And our Iron and Wood Pumps

**WILL CARRY THE TRADE,
AND DO CARRY IT.** Wherever
introduced and pushed.

These goods are sold entirely on their merits and the large and steady increase in our trade is the most satisfactory proof of their merit. Send for Illustrated Catalogue describing our full line which we are glad to mail free to all intending purchasers.

ONTARIO WIND ENGINE AND PUMP CO. LTD.

Mention FARMING. 359 Spadina Ave., TORONTO, CAN.

53 KING, W. / TORONTO.



CUTS FOR ADVERTISEMENTS,
NEWS PAPERS, CATALOGUES,
MAGAZINES, CIRCULARS.

LIVE STOCK
ENGRAVING & PHOTOGRAPHING
A SPECIALTY.

**A PAIL
WITHOUT
HOOPS**

That means a long lasting Pail.
Its many qualities are unique.
The price makes it available to all.

THE E. B. EDDY CO'S
INDURATED FIBREWARE
PAILS, TUBS, PANS, DISHES, ETC.

**FIRE PROOF
ROOFING**
ILLUSTRATED CATALOGUE FREE
METALLIC ROOFING CO
MANUFACTURERS, TORONTO

BREEDERS' DIRECTORY.

Cards under this head inserted for one year at the rate of \$1.50 per line when not exceeding five lines. No card accepted under two lines, nor for less than six months.

HORSES.

DANIEL BRIMS, Atheistan, Que., Breeder of purebred Clydesdales, Shorthorns, and Shropshire Sheep. Stock for sale. 525

SHORTHORNS.

BONNIE BURN STOCK FARM, Stouffville station and P.O., D. H. Rusnell, proprietor, Breeder of thoroughbred Shorthorn Cattle and Berkshire Swine. 799

GALLOWAYS.

A. M. & R. SHAW, Brantford, Ont., Breeders of Galloway Cattle. Choice young animals for sale. 735

DAVID McCRAE, Janefield, Guelph, Canada, Importer and Breeder of Galloway Cattle, Clydesdale Horses, and Cotswold sheep. Choice animals for sale. 630

AYRSHIRES.

J. McCORMACK, Rockton, Ont., Breeder of Ayrshire Cattle, Toulouse Geese, and Colored and Silver-Grey Dorkings. 629

W. M. & J. C. SMITH, Fairfield Plains, Ont., Breeders of World's Fair prize-winning Ayrshires, Merino Sheep, Poland-China Pigs, and Poultry. Stock for sale. 526

W. F. & J. A. STEPHEN, Brook Hill Farm, Trout River, Que., Breeders of Ayrshire Cattle and Yorkshire Pigs. Young stock for sale at reasonable prices. 635

W. H. TRAN, Cedar Grove, Ont., Breeder of Pure bred Ayrshires from the Registered Plantagenet Stock. Choice young Bulls and Heifers for sale.

WALTER NICHOL, Plattsville, Ont., Breeder of Ayrshire Cattle and Leicester Sheep. Choice young stock for sale. 527

JERSEYS.

WM. ROLPH, Glen Rouge Farm, Markham, Ont., Breeder of Jersey Cattle. Herd nearly all pure St. Lambert. Young stock always for sale at reasonable prices. 708

E. P. BALL, Rock Island, Que., Breeder of Standard-bred E. and Roadster Horses, St. Lambert Jersey Cattle, and Shropshire Sheep. 766

D. H. KITCHESON, Menie, Ont., Breeder of A. J. C. C. Jerseys, Shropshire Sheep, and Berkshire Pigs. Stock for sale. Hoard's Station (G.T.R.). 737

WM. WILLIS, Pine Ridge Farm, Newmarket, Ont., breeder of St. Lambert Jersey Cattle, also Cotswold Sheep, registered. Stock always for sale. 855

ROBT. REESOR, Locust Hill, Ont., Breeder of Jersey Cattle and Shetland Ponies. Young stock for sale at reasonable prices. Locust Hill is 20 miles from Toronto on the C.P.R. 744

J. H. SMITH & SON, Willow Grove Farm, Highfield, Ont., Breeder of St. Lambert and St. Helen's Cattle. Prize herd at the last Industrial. Young stock for sale. 702

OUR READERS are particularly requested to mention FARMING when writing to advertisers. It will pay them to do so.

HOLSTEINS.

E. PANNABECKER, Fairview Farm, Hespeler, Ont., Breeder of Registered Holsteins. Stock for sale. 720

WM. ARMSTRONG, Locust Hill, Ont., Breeder of Purebred and High-Grade Holstein Cattle. Stock for sale. 694

JOHAN A. RICHARDSON, South March, Ont., Breeder of Holstein-Friesian Cattle, Dorset Horn Sheep, and Tamworth Swine. All registered. 745

DEVONS.

W. J. RUDD, Eden Mills, Ont., Breeder of Devon Cattle, Cotswold and Suffolk Sheep, Berkshire Pigs, and Plymouth Rock Fowls. Young stock for sale. 740

SWINE.

R. J. LAURIE, Wolvorton, Ont., Breeder of Tamworth Swine, Toulouse Geese, Rouen and Aylesbury Ducks. Stock for sale. 840

COLLIE DOGS, Tamworth Swine, Duroc-Jersey Swine, Oxford Sheep, Bronze Turkeys, Toulouse Geese, Pekin Ducks, and Buff Leghorns. A. ELLIOTT, Pond Mills, Ont. 618

M. E. STRATFORD, Brantford, Ontario, has twenty very fine thoroughbred Tamworth and Improved Chester sows, just now ready for service. Prices right. 802

I. O. FRASER & SON, Fellows, Ont., registered Duroc Jersey swine, bred, and for sale. 856

SHEEP.

J. AS. P. PHIN, The Grange, Hespeler, Ont., breeding and importing Shropshire Sheep a specialty. 736

A. TELFER & SONS, Paris, Ont., Breeders and Importers of registered Southdown Sheep. Stock for sale. 670

J. NO. A. MCGILLIVRAY, Q. C., Jerseyville Farm, Uxbridge, Ont., Breeder and Importer of Dorset Horned Sheep, Jersey Cattle, and Tamworth Pigs. 494

J. OHN JACKSON & SONS, Abingdon, Ont. Southdown Sheep. Champion flock at World's Fair. Awarded 20 prizes—10 firsts. 628

J. OSEPH STRATFORD, Brantford, Ontario, has twenty beautiful thoroughbred Dorset rams, one, two, and three shear. Prices right. 803

D. A. CAMPBELL, Mayfair, Ont., Breeder of registered Lincoln Sheep. 600

W. H. BEATTIE, Wilton Grove, Ont., Breeder and Importer of Shropshire Down Sheep, Collie Dogs, and B. and W. Turkeys. 607

POLLED ANGUS.

WALTER HALL, Washington, Ont., Breeder of registered Polled Angus Cattle of the choicest strains. 562

J. AMES BUCHANAN, Napier, Ont., breeder of registered Aberdeen-Angus Cattle. Choice young stock by Lord Forest for sale.



Representative Canadian Swine Breeders.

1. C. M. Simmons, Ivan, Berkshires. 2. Joseph Featherstone, M.P., Streetsville, Yorkshires and Essex. 3. Edward Jeffs, Bond Head, Berkshires. 4. George Thomson, Bright, Berkshires. 5. Thomas Teasdale, Concord, Berkshires. 6. J. G. Snell, Snelgrove, Berkshires. 7. C. R. Decker, Chesterfield, Berkshires. 8. George Green, Fairview, Berkshires. 9. Thomas Brooks, Brantford, Chester Whites and Tamworths. 10. E. E. Martin, Canning, Berkshires. 11. C. T. Garbutt, Claremont, Berkshires. 12. H. George, Jr., Crampton, Tamworths and Chester Whites. 13. Francis Rusnell, Cedarville, Berkshires and Yorkshires. 14. J. H. Shaw, Simcoe, Chester Whites and Berkshires. 15. T. A. Cox, Brantford, Berkshires. 16. T. D. McCallum, Isaleigh Grange, Danville, Que., Yorkshires. 17. R. H. Harding, Thorndale, Chester Whites. 18. R. Willis, Jr., Glen Meyer, Poland-Chinas. 19. George Bennett, Charing Cross, Chester Whites. 20. L. Pardo, Charing Cross, Chester Whites. 21. Thomas Caldwell, Orchard, Tamworths. 22. Alex. Hume, Burnbrae, Yorkshires. 23. R. B. McMullin, Blytheswood, Poland-Chinas. 24. D. A. Graham, Parkhill, Berkshires.

FARMING

Vol. XIV.

APRIL, 1897.

No 8.

THE PRESIDENT OF THE DOMINION SWINE BREEDERS' ASSOCIATION.

In connection with our "Special Swine Number," we wished to mark our appreciation of the good work which the Dominion Swine Breeders' Association is doing for the development of the swine breeding industry of Canada, by putting upon our front cover page the portrait of a representative

member of the association. As was natural, we chose for this purpose the president of the association, Mr. J. E. Brethour, of Oak Lodge, Burford, in the County of Brant; and we are sure we are doing the reputation and popularity of the president no more than scant justice, when we say that from the whole body of the swine breeders of Canada we believe we could not have chosen any other gentleman whom the breeders themselves would have been more desirous to select as their representative.

Mr. Brethour was born in 1861, and so now is only thirty-six years of age, although he has already won for himself an enduring reputation as a breeder of swine of the highest type of excellence, a reputation which extends everywhere where Yorkshire pigs are bought or sold—that is not merely throughout this country, but in the States, and in England as well.

Mr. Brethour's native county was Halton, and he was educated at the Oakville High School; but although he is English by affinity and connection, he is especially proud of the fact that by birth and education he is a true Canadian.



Mr. J. E. Brethour,
President of the Dominion Swine Breeders' Association.

At the early age of seventeen Mr. Brethour began farming on his own account upon a farm near Oakville; but three years later he sold his first farm and bought his present one, "Oak Lodge," in the County of Brant.

In 1882, at the age of twenty-one, he bought a small herd of Shorthorns, and continued to breed Shorthorns till about four years ago, when he determined to give his entire attention to the development of the Oak Lodge Yorkshires.

It was in 1884 that Mr. Brethour first began to breed swine. But his first purchases were Berkshires, and he continued to breed that breed till 1890.

Mr. Brethour's present preference for the Yorkshire

breed is well known. We therefore quote, without apology to our Berkshire friends, his words respecting his change from "black to white." "In 1889," he writes, "I came to the conclusion that if I wished to keep in the market I must produce a different sort of hog from that which I

had been breeding. With this object in view, in company with Messrs. Green Bros., of the Glen, Innerkip, I purchased two Yorkshire boars and four Yorkshire sows from the celebrated herd of J. Walker Jones, Little Mollington, England. I continued breeding Berkshires for one year after this importation of Yorkshires, in order that I might make for myself a comparison of the two breeds. After carefully observing the two breeds for the year I came to the conclusion that the Large White Yorkshires were more suitable for the requirements of the pork and bacon market than the Berkshires, and I then disposed of all my Berkshires."

In 1890 Mr. Brethour made his first appearance as an exhibitor at the larger fairs. His successes as a prize-winner were at once most marked, and success has remained with him ever since. In his first competition at Toronto he secured every first prize but one in the classes in which he exhibited, including the sweepstakes prize which entitled him to hold for one year the Holywell challenge cup which Mr. Sanders Spencer, of England, had presented for competition among Canadian Yorkshire breeders. In 1891 he again won the Holywell cup, which then became his permanent possession. His success in Montreal and Toronto these two years were equally remarkable, and a

all these exhibitions since those earlier dates his first good fortune has been steadily maintained.

In 1893 Mr. Brethour's herd made a splendid record for itself at the World's Columbian Exhibition, at Chicago, having won 21 prizes with 22 head. Among these prizes was the sweepstake for best Yorkshire sow of any age.

Mr. Brethour justly takes special pride in the fact that nearly every one of the numerous prizes awarded to him since he began exhibiting have been won by hogs bred in Canada, and by hogs, too, nearly all of which have been bred by himself.

The Oak Lodge herd is the largest herd of Yorkshires in Canada, and over 200 head are annually sold from it for breeding purposes. Many of the best Yorkshire herds in Canada have been founded upon stock bred at Oak Lodge, and representatives of the herd are also found in many American herds.

Mr. Brethour is an active member of the Dominion Swine Breeders' Association. In December, 1895, he was elected president of the association, and in 1896 he was re-elected to the office. As said at the beginning of this notice, his brother swine-breeders hold him in the highest esteem.

OUR SPECIAL SWINE NUMBER.

Some time ago we promised our readers a "Special Swine Number." Later on circumstances occurred which made it advisable for us to defer the publishing of this number to a later date than what we originally intended. But the publication of our "Special Poultry Number" made our swine-breeding friends desirous that we should publish our "Swine Number" at as early a date as possible. In fact, we have received so many enquiries after the number, and so many requests from our friends to publish it at an early date, that we decided to make our April issue relate almost wholly to swine and be what its name implies, a "Special Swine Number."

In preparing this swine number our one aim has been to get together information of the most *practical sort* regarding the breeding, care, and management of swine. We have not tried to get together articles that were merely novel. Every article is written by a man of recognized ability as a swine-breeder; some of the articles are by men whose reputations extend over the whole swine-breeding world.

A word as to our illustrations. Almost all of them are from actual photographs. A number of them are of hogs of great prize-winning renown. All of them may be considered as typical animals of the breeds they belong to; although in this respect we must remind our readers that among breeders there are always great differences of opinion as to what a true type is.

Our "Special Poultry Number," published in January, was the most popular number of *FARMING* ever issued. We could easily have disposed of 5,000 more copies of it had we printed them. Enquiries for it are coming in all the time. We have not been able to spare a single copy since the first of February. We advise every one of our readers who has a copy of that number to preserve it most carefully. It contains more practical information relating to poultry-keeping than was ever before got together under a single cover.

Our "Special Dairy Number" published in February was also a great success. Although a great part of it was taken up with professional dairying, a still greater part was taken up with matter of the most practical value to every progressive farmer of to-day.

Dairying, swine-raising, and poultry-keeping are industries that are pursued on every farm without exception. There is not a farmer in the land who is not interested in every one of these branches of farm work. This is why we have thought it best to gather in special numbers information of the most practical sort possible bearing specially on these industries separately, believing that our readers will be pleased with our efforts to furnish them with matter that they know they can thoroughly rely upon, in branches of farm work in which every one of them is more or less engaged.

SWINE.*

By THOMAS SHAW, Professor of Animal Husbandry, University of Minnesota.

How the Modern Breeds of Swine Originated.

It is generally admitted that the many different kinds of domesticated swine have all had their origin in wild species similar to those found in some parts of the world to-day. In Britain, however, the hog has been domesticated for a long time, and the many kinds of swine that are now found there seem to be descended from two very distinct stocks; namely (1) *the old English hog*, a large animal, found principally in the northern

It is to the Chinese breed, however, that most of the improvement mentioned above is to be ascribed.

Desirable Characteristics in Swine.

In all breeds of swine the following characteristics are desirable:

(1) Ability to make a good use of a large amount of food.

(2) Quietness of disposition, without which, indeed, the above characteristic cannot be manifested.

(3) An aptitude to mature early.

(4) The production, when slaughtered, of a small amount of offal, or waste, in proportion to the original live weight.

These characteristics belong, in a greater or less degree, to all domesticated swine, but in a modern improved breed they are required to be specially developed.

Principal Breeds.

The different breeds of swine are sometimes divided into two classes, in respect to size; namely, *the small breeds* and *the large breeds*. Authorities differ, however, as to which of these classes certain breeds belong to. Among the small breeds are generally ranked the Small Yorkshire, the Suffolk, the Essex, and the Improved Berkshire. Among the large breeds are generally ranked the Middle Yorkshire, the Large Yorkshire, the Tamworth, the Duroc or Jersey Red, the Chester White, and the Poland China. The Suffolk, Essex, Berkshire, Yorkshire, and Tamworth, are English breeds; the Duroc or Jersey Red, the Chester White, and the Poland China, are American breeds. All these breeds have been introduced into Canada, and several of them are extensively bred here.

NOTE.—There is not the same definiteness in the classification of the breeds of swine that obtains in other kinds of live-stock. This is largely owing to the want of sufficient association among the breeders of the different classes. In England, the Berkshires and the Tamworths are always separately classified; but the other breeds are generally ranked either as "blacks," or as "small whites," "middle whites," or "large whites." In the United States, the classification is more distinct; but the American names and English names do not always correspond.

With respect to the Essex, it should be said that, though mentioned here, since its name often appears in lists of swine, yet it is considered extinct in England, having been absorbed by too much crossing with the Berkshires and Suffolks. It was a wholly black breed, somewhat small in size, and was developed by Fisher Hobbs, of

*From "The First Principles of Agriculture," by President Mills and Professor Shaw. Published by The Bryant Press, Toronto. Price, 40 cents.



Thomas Shaw,

Professor of Animal Husbandry, University of Minnesota.
Joint author of "Public School Agriculture."

and western counties of England, tall, gaunt, very long in the body, with pendent ears, and a thick covering of bristles; and (2) *an ancient Scottish breed*, small, dusty-brown in color, with upright ears, and coarse bristles along the spine, found principally in the mountainous parts of Scotland. From those very distinct breeds have been obtained, by selection, crossing, and the admixture of other breeds, the many varieties of the modern British pig; but in their improvement two foreign breeds have been of especial service: (1) *the Chinese or Siamese pig*, varying in color from a pure white to a pure black, and remarkable for its early-maturing propensity and its fineness of bone; and (2) *the Neapolitan pig*, of Italy, an almost hairless breed, having a slaty-blue colored skin, and remarkable for its extreme fineness of bone.

Essexshire, about the year 1840, out of the Neapolitan breed. The modern Suffolk which greatly resembles it, and to some extent owes its origin to it, may be said to have taken its place. In the United States there is also a breed named the Essex. It is black in color, and is supposed to owe its origin to the original English Essex breed.

THE SMALL BREEDS.

The Small Yorkshire.

The small Yorkshire is somewhat similar to the other types of Yorkshire pigs described in section 448, differing from them, however, very considerably in size and fineness of build. It is, indeed, the smallest and finest of all the white breeds of swine. In external appearance, it is distinguished



Typical Small Yorkshire Sow and English Suffolk Boar.
From "Public School Agriculture." By Mills & Shaw.

for its short dished face or snout; its short, thick jowl; its long, heavy, deep body; its short legs; and its remarkably fine bone. No breed matures earlier, fattens more quickly, or is more docile, than the Small Yorkshire, and in Britain, where they have long been bred, they are very popular.

The Suffolk.

The improved Suffolk breed of pigs, as recognized and bred in England, is a race of small, hardy animals, altogether black in color, with little short heads, great jowls, broad foreheads, dished faces, and short, broad ears, inclining to droop forward. Their bodies are cylindrical, and comparatively long; their hams, well developed; their legs, short, and small in the bone; and their hair, long, fine, and silky. They are not large eaters, and thrive well on fare not of the best. Moreover, they mature early. They are sometimes thought to fatten too easily, but this fault is no doubt due to injudicious feeding.

When properly fed, they produce a large proportion of lean meat. They are hardy, and stand both heat and cold well. In Britain they are a popular breed, and are especially valued as consumers of the waste products of the dairy or market garden.

The Suffolk, as bred in the United States, and also to some extent in Canada, is quite distinct from the Suffolk, properly so-called, described above, being in origin merely a variety of the

English white Yorkshire, and corresponding in size to the Middle Yorkshire, described below. This American Suffolk, as it may be named, is entirely white in color, and is characterized by a small and very short head; a dished face; short, thin, upright ears; a short neck; good length of body; well filled out flanks; fine bone; pinkish skin; and fine, silky hair. It is much prized for the delicacy of its flesh, and for its early-fattening qualities, and is popular in some parts of the United States, and also in Canada.

The Berkshire.

The Berkshire is probably the most numerous of all the British breeds of swine. It has been extensively imported into Canada, and has been very greatly instrumental in improving our common stocks of swine perhaps more so than any other breed. The Berkshire derives its name from the county of Berks, in England, where the breed originated—very probably from crossings and improvements made with both the original native breeds mentioned above, and also by means of the Chinese and Neapolitan breeds. The Berkshire is of medium size, and, under fair treatment, has the merit of developing at a steady pace from birth to an early maturity. In its meat, the fat and lean are well intermixed. In color, the Berkshire is black, with white "points"; that is, with a white star or stripe on the face, four white feet, and a white "switch" or end of tail. Its face should be broad and well-dished, and rather short and fine; its ears small, thin, soft, and almost erect; its jowl, full; its neck, short and thick; its back, broad and straight; its hams, thick, round, and deep; its tail, fine, small, and set well up; and its legs, short, fine, straight, and strong. The Berkshires are good grazers, and have proved themselves in every way an excellent breed for the purposes of the Canadian farmer.

THE LARGE BREEDS.

The Middle and Large Yorkshires.

The Yorkshire pig is bred in several varieties, known as the Small Yorkshire, the Middle Yorkshire, and the Large Yorkshire. Though differing greatly in size, they have many characteristics in common; and especially is this true of the two larger sizes. The Middle and Large Yorkshires are very popular in England, owing to their ability to produce, in a short time, a fine quality of bacon, in which the lean meat is well developed. They are long and deep in the body, short in the head, very decidedly dish-faced, strong but not

coarse in the bone, and covered with a thick coat of silky hair. Their ears are of good size and point forward without drooping. Their skin is of a pinkish color, with an occasional bluish spot; their hair, however, should always be white. They have been quite largely introduced into

somewhere about 1855, but much greater improvements have been effected in very recent years. The modern improved Tamworth is especially noted for the great proportion of *lean* bacon which it produces; bacon, too, of the choicest quality. The breed, as improved, are prolific, hardy, quick-growing, and early to mature. In color, they are red or bright chestnut, inclining to brown as they grow older; the black spots of the original race are all bred out. In frame, they are very massive, the body being long and deep (sometimes 6½ feet in girth, and the same in length). Their head is small; their ears, medium-sized and erect; and their snout inclined to be long. Their hair is silky, long, and thick, protecting them against both winter cold and summer heat. In England they have become very popular largely so on account of the high market value of their bacon.

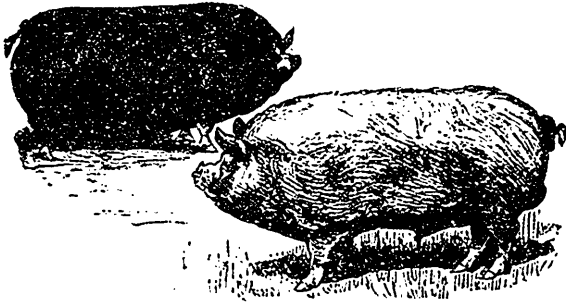

Typical Berkshire Sow and Improved Large Yorkshire Boar. From "Public School Agriculture." By Mills & Shaw.

Canada, and are fast becoming popular. Though the Large Yorkshires attain to immense sizes (perhaps the greatest of all the breeds of swine), yet they are not coarse animals; their appearance, on the contrary, is rather pleasing; and their bacon, as is characteristic of all the Yorkshire varieties, is of the best quality.

The Tamworth.

The Tamworth is the most recently developed of all the British breeds of pigs. It derives its name from Tamworth, a town on the borders of Staffordshire and Warwickshire, in England, in which counties the breed is most numerously found. The Tamworths are descended from an original race of "sandy-and-blacks," once common in the districts named. Their first improvement is due to Jonas Webb (the improver of Southdown sheep),

The Duroc or Jersey Red.

The Duroc or Jersey Red, often called the Duroc-Jersey, originated in the State of New Jersey about the middle of this century. They are supposed to be founded upon the Tamworths of England. The Duroc-Jerseys are a large breed,

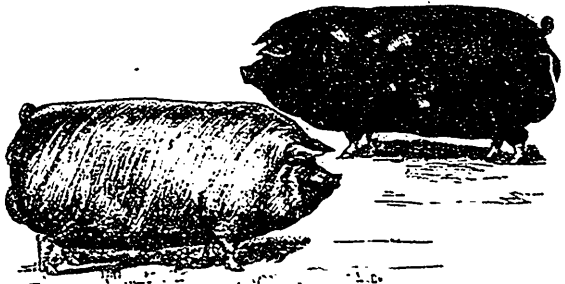

Typical Chester White Boar and Poland China Boar. From "Public School Agriculture." By Mills & Shaw.

long and deep in the body, and broad rather than rounded in the back, with large ears, lapping over the eyes. In color they are red, ranging from a glossy cherry, or dark red, or even a brownish color, to a light yellowish red, with occasionally a fleck of black on the under-line and legs.

The Chester White.

The Chester Whites are so named from Chester County, Pennsylvania, where the breed originated. They are long and deep in the body, and broad in the back, and have deep, full hams. Their legs are short; their head is short, broad between

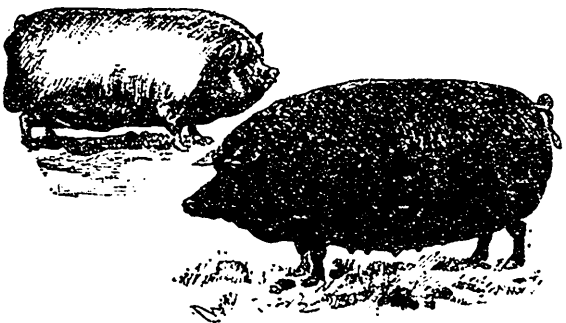

Typical Suffolk Boar (American) and Tamworth Sow. From "Public School Agriculture." By Mills & Shaw.

the eyes, and only slightly dished; and their ears project forward and lap at the point. Their neck is short, thick, and well arched; and their jowl is large. In color, as their name implies, they are white. Their hair is plentiful, and sometimes a little wavy. The Chester White is, at present, a very popular breed in the United States, and to some extent in Canada, being distinguished for its ability to grow rapidly and mature early. In size, too, it is one of the very largest breeds known.

The Poland China.

The Poland Chinas originated in crossings made with several breeds by various stockmen in Warren and Butler counties, Ohio, during the

period from 1816 to 1842. Among these original breeds, the white Chinese and the black Berkshire were, perhaps, the most important. The present name of the breed was adopted in 1872. The Poland Chinas resemble the Chester Whites, excepting that their ears droop more, and that their color is black, with spots or sheets of white. The white color is being gradually bred out, so that its markings now are very similar to those of the Berkshire. The Poland China has proved itself one of the most popular of the American breeds; indeed, in the great pork-producing regions of the middle and western States, it is, perhaps, more highly valued than any other breed. It fattens easily and early, and attains to great weights.

ON THE MANAGEMENT OF YOUNG PIGS.*

By SANDERS SPENCER, Holywell Manor, St. Ives, Hants, England.

It is each year becoming more generally acknowledged that it is most important to keep young animals in a continually progressive state, from their birth upwards, as the loss of a certain portion of that youthful flesh or fat which is stored up by the animal while still trusting to its dam for the greater portion of its sustenance, necessitates at a later period of its life an expenditure of food far greater in proportion to that which, if given to the youngster, would have prevented this loss of condition.

YOUNG PIGS SHOULD BE KEPT CONSTANTLY GROWING.

If this be so with those of our domesticated animals, such as cattle, which are not generally ripe for the knife until they have lived a comparatively long life, how much the more needful is it with the pig, which at the present time is, in many instances, born, fattened, cured, and eaten within the short period of nine months. A fortnight lost here means a considerable percentage of the life of the pig, and one far greater than that of a steer as it is usually kept. Not only is it on this account imperative to so feed the pig from its youth up that it "never looks behind it," as the old saying goes, but the quality of the flesh appears to be considered to show a greater deterioration from this check in the well-doing of the pig, than is observable from the same want of care in the feeding of other animals. The pork is said to be less tender, succulent, and delicate in flavor, or as lacking in those very points which the epicure of the present day values most highly, and for which the article vended by certain of our

purveyors and bacon-curers have justly acquired so high a repute.

If the above statements be admitted—and we see no just cause why they should not be accepted—we may, perhaps, spend at a profit a few spare minutes in the consideration of how best to treat the young grunter from its entrance into this world until it has acquired a sufficiency of age and experience to be independent of its dam.

An objection may be raised by those more experienced readers, on the ground that the writer has nothing new to communicate on this interesting subject, since he has so frequently and for years held forth on it, but it must not be forgotten that the breeding and feeding of pigs is one of those matters connected with agriculture which has been least studied and most generally neglected by the majority of our farmers, and therefore it is desirable that the number of pig-keepers should be increased. It is also possible for the oldest hands to discover some points on which their former practice may be and is improved upon, or they may be satisfied with their own mode of proceeding, when they find it is the one usually adopted.

EVERY YOUNG PIG SHOULD HAVE THE USE OF A PERFECT TEAT.

We will take it for granted that the owner of the sow about to farrow knows that she is a fairly good mother, quiet, gentle, and capable of furnishing a sufficiency of milk for the number of pigs left on her. The first duty of the attendant will be to notice if the sow has perfect teats enough for her litter, that none of the teats are

* From a paper first published in "The Live Stock Journal Almanac," but sent by Mr. Spencer to FARMING for publication in this Special Swine Number.

what is usually termed blind, *i.e.*, those which on the pressure of the little pigs tongue retreat instead of becoming more prominent; this is not an infrequent failing with pedigree pigs of a certain variety, which has been for years bred more with a view to win prizes than for the far more important object of paying their way as farm or general stock. Then it will sometimes be found that the teats are uneven in size, one or more of them being about half the size of the majority. It is useless to trust to one of those to rear a pig profitably, as but a very small flow of milk will the pig receive to whose share this small teat is allotted by its brothers and sisters.

youngsters is too great for the mother to thoroughly suckle.

LITTERS SHOULD NOT BE TOO LARGE.

As to the exact number of pigs each sow should have left on her, this will entirely depend on several circumstances, such as the time of year, age of the sow, and even the breed of the sow; thus, sows of the small breed will not usually rear as many pigs as sows of a larger variety. Again, sows with their first litter, especially if they have been mated early, so that their pigs arrive by the time the dams are not more than a year old, should have fewer pigs left on them; and this again should be regulated ac-

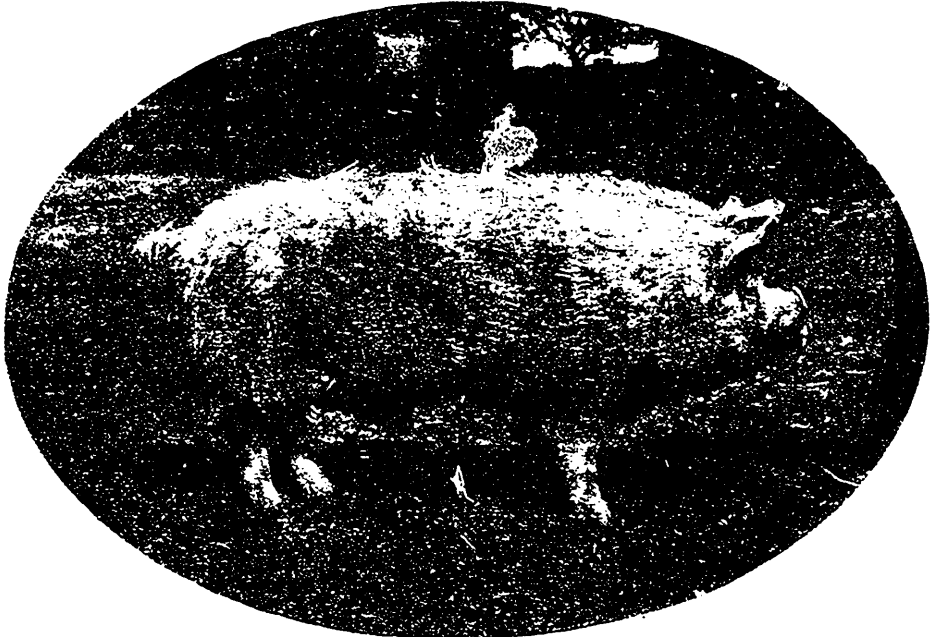

Holywell Minor. Improved Yorkshire Boar,

The property of and bred by Sanders Spencer, of Holywell Manor, St. Ives, Hants, Eng. Winner of many prizes, including the Windsor Royal Jubilee, 1889.

This might not be so important were it not a fact that each little pig has its own particular teat from an early date, so that the short lacteal supply from one teat is not compensated by a full supply at another time from a different teat. The result is, the pig dwindles away, and either dies or becomes weak; is compelled to eat a portion of the sow's food before its digestive organs can convert the unnatural diet; diarrhoea sets in, and the other pigs of the litter become affected, and a general state of unthriftiness results. I am aware that to many people it appears little less than a sin to knock on the head young pigs as soon as they are born, but this is a system now often adopted when the number of

cording to the time of the year, as a sow which farrows in April will rear a litter of ten pigs quite as well, and with as little strain on herself, as would another sow bring up eight pigs if farrowed in October. Many persons look upon a litter of seven or eight pigs as fully large enough for a young sow, and ten or eleven for a sow with her second and succeeding litters until the sow has passed her best, when the flow of milk will be smaller, and its quality deteriorated.

TEMPORARY TEETH SHOULD BE BROKEN OFF.

Having selected the pigs intended to be kept it is generally advisable to break off the four temporary teeth with which the little pig has been endowed by nature; this dentistry will

prevent the suckers injuring each other in their endeavors to secure a particular teat, and also from biting the sow's udder, which is naturally in an inflamed and sensitive condition. We are of opinion that many little pigs are lost and sows spoilt by not adopting this simple plan of rendering the combative pigs harmless. The sow will often shriek with pain when the youngsters bite her udder in their fighting for a particular teat, and if this painful experience be oft repeated the sow will simply lie flat on her body, and refuse to suckle her pigs.

TREATMENT OF CAKED BAG.

If the flush of the first milk is not withdrawn by the little pigs, or by human help, the udder becomes still more tender and inflamed, and the almost certain result is what is commonly called a caked bag, or in other words, inflammation sets in, and the udder becomes hard and very hot to the touch. As soon as this is apparent hot fomentations must be continuously applied, and the milk extracted as completely and as often as possible. A gentle dose of salts or other cooling and aperient medicine must also be fed to the sow in a little warm slop made as tempting as possible by the addition of a small quantity of scalded linseed or linseed cake dust. If this and milking are carefully carried out, and the teeth of the little pigs broken off, the sow will often turn on the side and give down her milk so effectively that further attention is not needed. Sometimes, however, the medicine given to the sow, and the heated condition of the milk, will cause the young pigs to scour. This will soon pass off if care be taken not to feed the sow too generously for a day or two, and a sod of earth, a lump of chalk, or some cinder dust or small coal be thrown into the sty.

SORE TAILS IN LITTLE PIGS.

Another trouble which often attends little pigs is soreness of their tails; this will first show itself by the unnatural redness of the lower end of the caudal appendage; then a dark red spot will appear on the upper side of the tail, about three-fourths of an inch from its root, and if neglected a scab will form, and the tail, from the sore downwards, will die as soon as the soreness extends quite round the tail, and eventually that portion will drop off, and the little pigling will become a bob-tailed pig, decreased in its fancy value, and overlooked by the judges at shows as an incomplete pig, and unworthy of a prize if it has competitors not so disfigured.

Many persons assert that this liability to become bob-tailed is hereditary. It may or may not be, since those pigs most generally affected are those with the most delicate skin and that

are the most deficient in hair. We attribute the trouble rather to cold, damp, and unhealthy weather, which causes the circulation of the newly-born pigs to be impaired, when that part most distant from the heart and from its small size most easily chilled, suffers most. There are many nostrums for this troublesome and unsightly complaint; some old breeders recommend the application of some caustic to the sore spot; others advise this sore being scratched off by the attendant's nail; again, the rubbing of the tail with oil is said to be a perfect cure, but in my experience none of these can be relied upon as an infallible cure. We have for years used boroglyceride as soon as ever the little pigs' tails become unduly red, and assume that lifeless look which is unmistakable when once it has been pointed out. A little boroglyceride is taken between the finger and thumb and the tail of the pig drawn between the thumb and finger so that it becomes quite moist with the mixture; if this be carefully done night and morning for a couple of days, the pig-keeper's optics need not be offended with the sight of a bob-tailed pig. We have now over three hundred grunTERS on hand and not one of them is curtailed, although some of them, particularly those from aged sows and yelts with their first litters, gave some little trouble.

MEDICINE SHOULD BE USED SPARINGLY.

It is a very common practice with some pig-keepers to trust to the aid of medicine to give that relief to the bowels and bladder of the sow, which it is highly necessary to stimulate in some way for two or three days after she has farrowed. This dosing may at times be desirable and even necessary, but these occasions are far less frequent than is generally believed. It is far better, since it is more natural, to walk the sow out of her sty within twelve hours of her farrowing, and to repeat this at intervals for two or three days, when the requisite relief will be obtained, and the pigs will not be injuriously affected, as is sometimes the case after medicine has been given to the sow.

THE WEANING PROCESS SHOULD BE A PERFECTLY NATURAL ONE.

A paragraph which has recently gone the round of the press is credited to a person whose experience with pigs has been mostly confined to fattening, slaughtering and converting them into bacon. It is that to feed a suckling sow in the same place as that in which the little ones are is sure to lead to trouble, inasmuch as the little pigs will try to eat some of the sow's food. This is exactly the very thing a thoughtful pig-feeder likes to see, so that the strain on the sow quickly

becomes reduced, and the youngsters less dependent on their dam. Many persons adopt various methods to get their little pigs to eat as early in life as possible, and we may safely trust to nature to have given to young pigs, as to all other animals, just sufficient of instinct to know when their teeth and digestive organs are sufficiently developed to make the best use of some liquid food. We have frequently noticed that the best litters of pigs at weaning time are those which have taken most kindly to feeding in their early youth, and further, that their dams are in better condition and show less of that strain on the constitution inseparable from the charge of a large family of bonhams. One of our most successful breeders of times long ago, Mr. Stearn, used to advocate the feeding of the little pigs at a very early age, by placing a trough in a place out of reach of the sow, and giving the youngsters new milk, etc. The chief care required is to feed the sow on such food as sharps and bran which the youngsters are able to digest easily.

FITS.

Sometimes the pigs of a small litter, or those from a particularly good milking sow, will become too fat and affected with fits. These pigs when attacked suddenly fall over, and remain almost motionless, generally recovering in a few minutes. The cause of these fits appears to be overfeeding, and the remedy is to reduce the quantity and quality of the food on which the sow is being fed, and at the same time to give in the food a gentle aperient, and also to place within reach of both sow and pigs a lump of earth, and some cinders or small coal. If the cause of these fits be not removed the little pigs will oftentimes succumb to repeated attacks.

MANAGEMENT OF THE GROWING PIGS.

When the piglings are some three or four weeks old our system is to turn out the sow on to a pasture for an hour or two in the morning, and, during the sow's absence, a small quantity of sharps, stirred, if possible, with skim-milk, is fed to the youngsters, who will readily eat all they wish, and the remainder will be cleared up by the sow on her return. If there be no difficulty in giving this attention, both sows and pigs will thrive better in the summer time if the sows are let away from their pigs two or even more times. The sows obtain a good portion of their food in the shape of grass, whilst the sty is kept cooler and sweeter for the young pigs. A few peas, or whole wheat, fed to the little pigs in the absence of the sow, will help them very considerably; the wheat is perhaps the best in the warm, and the peas in the cold weather, although we like both at times, since little pigs, like all young animals, thrive best on a diversity of foods.

When the pigs reach the age of five or six weeks they will eat a considerable quantity of food, and so become far less dependent on the sow, whose terms of absence may be extended; until at the age of about seven weeks in summer, and nine to ten weeks in winter the pigs will be gradually weaned, the latter not missing the mother, nor the sow likely to suffer from an over-supply of milk.

Those of the young pigs not intended for breeding purposes should be attended to when they are about six weeks old, care being taken that they are not fed for some twelve hours before they are operated upon. There is *far less* suffering and risk in this early attention than if those pigs were left longer, or until after they were weaned.

FEED "OFTEN AND LITTLE."

One of the secrets of success in rearing young pigs is to feed often and little. Anyone not thoroughly acquainted with pigs would be surprised at the very great number of times during the twenty-four hours a sow suckles her little pigs. Two reasons for this are evident: one is that the sow is unable to carry a large quantity of milk for her numerous family, and the other that the stomach of the pigling is not capacious enough to stow any great quantity of food at one time.

As the pigs arrive at weaning time, we generally mix with the sharps a proportion of meal, this being increased as they grow older, until at, say, ten weeks old, the youngsters will thrive well on one-fourth meal.

VALUE OF MILK.

In some parts of the country where the keeping of cows is commonly carried on and the price of milk is very low, as it generally is in April and May, young pigs will give a far better return for it than converting it into butter. No single food appears to have so beneficial an effect on pigs as new milk; still it is possible and generally advisable to take the cream or butter fat and then, by the aid of linseed thoroughly crushed and scalded, or whole and boiled, to supply any deficiency of oil or fat.

TREATMENT OF DIARRHŒA.

One of the greatest troubles in the rearing of young pigs is their great liability to diarrhœa. There is an old saying amongst pigmen that each litter is bound to have at least one attack of it. It usually shows itself about the time when the little pigs begin to eat. The first symptoms observable by an old hand are that the bowels of the pigs are constipated, and if a dose of medicine be given to the sow, the causes of the constipation are removed, and diarrhœa does not supervene. The food of the sow should also be slightly reduced, and mould, coal, or cinders should be fed to her. If diarrhœa be neglected and dysentery sets in, the patient will often die or be very much checked in its growth. Diarrhœa often extends from one litter of pigs to others near. It should, therefore, be attacked at once.

FROM THE FARROWING PEN TO THE BLOCK.*

By THEODORE LOUIS, Louisville, Wisconsin.

MR. THEODORE LOUIS, of Louisville, Wisconsin, whose practical addresses on swine-raising, here re-published, were considered by those who had the good fortune to hear them as among the ablest and most useful contributions to swine knowledge ever uttered, is one of the most notable stock-men not merely of the state in which he lives, but of all the northern middle states of the Union. He has won the enviable reputation he enjoys by dint of hard work, indomitable energy, an unconquerable thirst for "more knowledge," and an unbounded enthusiasm for his favorite "hogs." His personal history is so interesting that we here print in full a somewhat lengthy account of it, written especially for this number of FARMING by one who knows Mr. Louis well. We may say in passing that Mr. Louis's innate modesty of character made it extremely difficult for us to get the portrait of him which we here present to our readers; but his fondness for "his favorites" finally conquered his unwillingness to be made much of in public, and he had the photograph, from which our engraving is made, especially taken for our "swine number."

"THEODORE LOUIS, a German by birth and a silversmith by trade, at eighteen years of age left his native country as a fugitive in the revolution of 1848. He came to America in that year and landed in Milwaukee. Not finding employment at his trade, he hired out on a farm at \$5 a month. Afterwards he was a fireman on a lake-steamer. The winter of '48-'49 found him a lumberman in the pineries. Then he became a fireman, and later an engineer in a lumber mill. But nature had not intended him to be a lumberman; so he hired out again as a farm hand; this time in connection with a distillery. Here he got his first practical acquaintance with his future calling—which was not, it should be said, drinking whiskey, but feeding hogs. The concern he worked for, however, went into bankruptcy, and he was out of a place again. During his idleness he went to help a neighbour to build a log house. While so en-

gaged he split his ankle with an axe; and before long all his hard-earned savings were spent in doctor's bills and hotel expenses, and with only two shillings in his pocket he had to face the world anew.

"He set out on foot and wandered off to Galena, Illinois, 150 miles distant, where he found employment for a time at his trade; but by this time he had been weaned from his interest in silversmithing, and his love for 'the hog' soon forced him to be again looking for work to do as a swine-feeder. In this, however, he failed; and he entered the service of a Fur Company,

and spent three years in the Rocky Mountains. In 1854 he returned to Wisconsin, and investing his earnings in a team and wagon, began business at Watertown as a teamster, drawing wheat to Milwaukee and store goods back again. But fortune was still against him; he lost his team by disease, and he was forced to start the world again.

"He then went to Northwestern Wisconsin and took up land. When he had taken out his pre-emption papers he had only 25 cents, and his rifle, and his dog left. These were his total possessions. He began, however, with a will. He built his first log shanty with his own hands, gathering the logs together for the purpose by carrying them on his own

broad shoulders. The land for his first crop of a half acre was prepared by spading it. He brought the seed potatoes, with which he planted it, five miles on his back, and soon he seemed to be on his feet again.

"But even in farming, working hard as he did, he was not at first successful. Like so many others, he staked his all on grain-raising. But the soil of his farm was light and sandy, and after some years of toil and struggle, he found his farm encumbered with a mortgage of \$1,500, and his future prospects dim enough.

"It was then that the hog saved him. He returned to his first love, and he has been faithful to it ever since; and so well has his love served him in return that he is now a wealthy man. His reputation as a



Mr. Theodore Louis, Louisville, Wisconsin.

* From notes taken of the addresses given by Mr. Louis at the annual meeting of the Dairymen's Association of Western Ontario, held at Woodstock, January 7th, 8th, and 9th, 1896.

successful swine raiser extends throughout all swine-producing countries. In granges, at farmers' institutes, at meetings of agricultural associations, at dairymen's conventions, he is a frequent and always an effective speaker. But his theme, 'first, last, and all the time,' is 'the hog.' There are few villages in Wisconsin and Minnesota where he has not been called upon to talk about his favorites. He has also been much sought after for similar purposes outside of these two states. He has even ventured to sound the praises of the hog in fashionable New York and cultured Boston.

"But in nothing has Mr. Louis shown his indomitable energy more than in the pains he has taken to thoroughly instruct himself in everything relating to the industry to which he has devoted his life. When he came to America he did not know a word of English. Even when he began farming on his own account his English was still broken and he could not read in English; but when he began to breed hogs he bought a German and English dictionary, and began to read in the language of his adopted country. He subscribed for agricultural papers, and studied these. His object was to perfect himself in the knowledge of his calling. He studied how to feed his hogs; not only so, but how to feed his land. He found that the one sort of knowledge supplemented the other. As his hog raising became more and more scientific his land, poor enough naturally, began to raise better and better crops. The

land fed the hogs; the hogs fed the land; and by growing crops of clover he managed to get nitrogen from the air that fed both hogs and land.

"As said above, Mr. Louis, despite all the hardships of his earlier career, has long since been comfortably well off. This well-being he attributes entirely to his hogs. As he himself says: 'The hogs paid of the mortgage on the farm, replaced the log cabin by a fine modern house, and built new barns and houses for his stock.' With respect to these buildings it should be said that Professor Henry, Dean of the College of Agriculture in the University of Wisconsin, in his 'Hand Book for the Homeseeker,' describes and illustrates them as models of what farm buildings should be.

"Mr. Louis is now retired from the active management of his farm; and the duty of looking after 'his favorites,' as he calls them, falls upon his son, who, it may be said, is a worthy son of a worthy sire. The Poland Chinas raised by the younger man, Mr. Louis, senior, thinks would be a credit even to the 'old hand.' But he maintains that his saying is true that: '*He who would be a successful breeder must always remain a scholar and a learner; and he who is not will never be one.*' He also maintains that another saying of his is equally true, namely, that '*the hog is a sure rewarder of those that hold him in esteem; and to him that intelligently cares for and feeds him great profit shall be given.*'"

PART I.—SHELTER AND FEEDING.

To approach the subject of swine husbandry before a dairy meeting always seems strange, and yet no dairyman will deny the fact that, if he has learned the art of feeding, if he has learned to use all his by-product in a manner that will pay him, the hog is a paying investment as an adjunct to

the dairy. And yet how few there are who really understand the art of feeding. How few there are that know how to feed the by-product of the dairy intelligently. How many there are who seem to have the idea that the more the hogs can put away, the more whey or milk the hogs can



Holywell Minor. Improved Large Yorkshire Boar,

Imported by and the property of J. N. Greenshields, Isaleigh Grange Farm, Danville, Quebec. Sire Holywell Plymouth, out of Holywell Squeak. Holywell Minor was first prize winner at the Royal before being imported, and in Canada has been first in almost every exhibition where shown. He has been head of the Isaleigh Grange Show herd for some years.

consume, the better. That seems to be the fault of a great many dairymen; they do not consider whether the hog can assimilate all it eats.

HOGS NEED GOOD SHELTER.

But I am not going to take up the subject of feeding first. I think that shelter should be the first consideration. I have before me an audience of, say a thousand farmers. If I were to ask all those who have good shelter for their hogs to raise their hands I fear that only 40 per cent. of the thousand would raise their hands. There seems to be prevalent the idea that the hog does not need any shelter—that a hog is a hog, and that he is the scavenger of the farm. I am a stranger in your country, and I do not know what you do or do not have; but I daresay that as many hogs in this province sleep in straw piles as in the States. I daresay that as many hogs have simply a roof over them and a wire fence or a rail fence at the sides for the wind to blow through. The man who leaves his hogs without shelter, and lets them sleep in a straw pile, is the man who is constantly asking the questions, "Why do my hogs get lame?" "Why do they cough?" "What ails my hogs?" If you were the editor of an agricultural paper you would find your desk strewn with just such questions as these.

WHY SOME HOGS COUGH.

Have you ever thought—you who let your hogs sleep in a straw pile—why they cough, when you look at them sleeping all huddled together, becoming in a heated condition, and sweating through the pile heat from below, and a cold, chilly air striking them from above? Have you ever considered why they cough? Or, if you sleep them upon floors simply sheltered where the bedding is, the bedding never being removed perhaps for months, and more bedding constantly being added until it becomes dusty, so that every time your hogs disturb the nest the dust rises, have you ever wondered what ails your hogs when they cough?

I could name a hundred different conditions that are held before the hog as resting places that are most detrimental to his life and to his future offspring. When once a disease, especially one of lung origin, is created within our breeding hog, let me say it will be handed down for generations to come.

EXPENSIVE SHELTERS NOT NECESSARY.

What kind of shelter should we have for our hogs? From the early days, although I had but few dollars or conveniences to meet my wants, I made a close study of the conditions which would be best for the hog. You consider very closely

what will be best for your cows. You study out what stables and stalls will give your cows most comfort. Did you ever consider that comfort is required for any animal that is a flesh-producing animal, and that comfort means the same to the hog precisely what it does to any other animal? When I first went into Minnesota in connection with the institute work I found that the farmers there had admirable stables for their horses and splendid barns for their cows, but there were no hogs, and when the hogs came to hand there was no shelter for them. Yet these men burned thousands of tons of straw every year upon their farms. I advised them to press their straw into bales, lay a foundation of stone, then put the straw bales upon it brick fashion (a ton of straw would lay a wall eighteen feet long and six feet high), lay boards across the top, and cover them with clay mortar. This I guaranteed would make a warm shelter for the hogs, even if the temperature were down to forty degrees below zero. Many of them followed my advice, and I am gratified to say they are doing well.

A 7x8 SHANTY HOUSE.

On my own place I have always found that a 7 x 8 house—a shanty-like house—will give better satisfaction for the feeding of and the shelter for breeding hogs than anything else. A pen 7 x 8 in dimensions will sleep comfortably four hogs in summer or five in winter. They can lie one alongside of the other and not become heated. It will make a comfortable breeding pen if there is a fender inside of it. I used to lay scantling right on the ground (2 x 4), set a corner post up at each corner, then board it round about and put on a shanty like roof. I want it seven feet high in front and five feet at the rear. I want the door cut at least four feet high and hung on leather hinges. I am not talking here simply to the man who is financially able to do things. It has been customary for me to feel that I speak to all classes of farmers when I come before a convention or an institute audience. I feel that I come before a class of men who are not all financially able to do things, and the simple sort of hog pen that I describe is often a leader that is very valuable to them.

I want a door, say four feet high, so that I can get into the pen at the time of breeding, when probably my assistance is needed at farrowing time. Sometimes a man takes me out to his farm to see his hogs. He shows me them. He says, "If you will get right down on your hands you will see my sow." I don't want to be kneeling down when I am going to see a sow.

It is astonishing what conditions we do find. In Minnesota I once went up to the farm of a Scotchman. He had a fine daughter, like most

Scotchmen have, and he says to her: "Lassie, go and let out the hogs." And the lassie went into a hole in the straw pile and out came the hogs. And he had stately barns and stately stables for his horses and his cows.

HOG HOUSES.

Hog houses, especially on a dairy farm, should be erected with a view to elevation where there will be a natural drainage. I do not approve, in my section of the country, where our temperature falls to thirty degrees below zero, and where our winter snows are heavy, of a double hog pen with an alley in the centre through. One side of a hog house so built must naturally face either the west or the north, and as our prevailing winds

tion of a feed and cook house, and proceeded to explain its advantages. The alleys were, he said, five feet wide, and there was a fender, raised eight inches from the floor, in each stall. He pointed out the desirability of having secure fenders to prevent the sows from overlying their young, and asserted that a man could ill afford to be without a fender. The gates were 2 x 3, and had a rope and pulley attachment to facilitate their opening. When they wanted to feed the hogs they allowed just as many into the feeding pen as they had enough room for. He urged the importance of having sufficient trough room, and remarked that he had been surprised to go on farms and find ten hogs expected to eat out of a trough a foot deep and four or five feet long. The result was that the stouter pigs got the lion's share and the little fellows none at all.

In each partition between the stalls in his

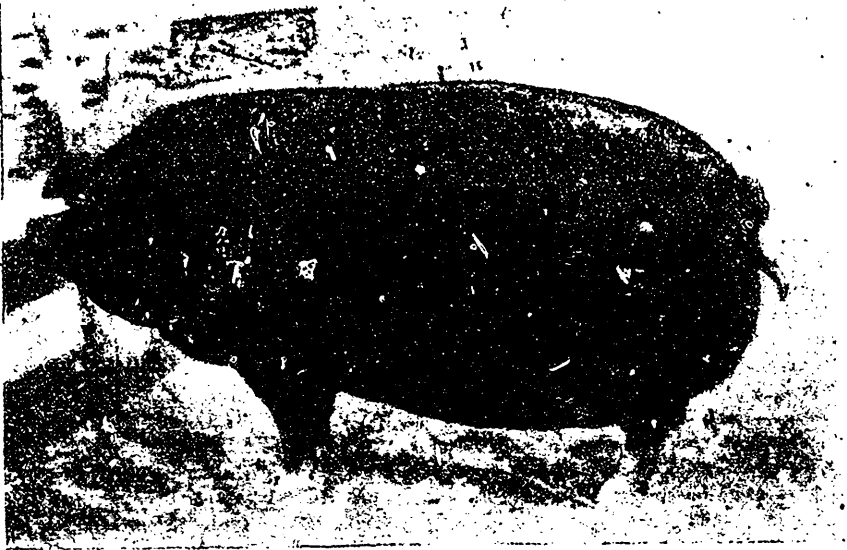

Lady Darkness. Poland China Sow,

The property of W. & H. Jones, Mount Elgin, Ont. Winner of first prize at Fat Stock Show, 1896, for sow over nine and under fifteen months.

are from the east or the north during the winter, it always gives the hog house a cold condition. In the spring of the year, when we have a double hog house with a double roof, when the snow melts, the yards in front of the hog house are always muddy. On the north side of the hog house they are not thawed out until the first of May. This is one of the reasons why I say we should have a house on lofty ground, so that the yards may be kept clean and dry. For convenience, as an illustration, I have brought my charts along.

MR. LOUIS' OWN HOG HOUSE.

Mr. Louis here unfolded a large chart showing the plan and superstructure of his hog house, which he said was 100 feet long, with an addi-

tion of a feed and cook house, and proceeded to explain its advantages. The alleys were, he said, five feet wide, and there was a fender, raised eight inches from the floor, in each stall. He pointed out the desirability of having secure fenders to prevent the sows from overlying their young, and asserted that a man could ill afford to be without a fender. The gates were 2 x 3, and had a rope and pulley attachment to facilitate their opening. When they wanted to feed the hogs they allowed just as many into the feeding pen as they had enough room for. He urged the importance of having sufficient trough room, and remarked that he had been surprised to go on farms and find ten hogs expected to eat out of a trough a foot deep and four or five feet long. The result was that the stouter pigs got the lion's share and the little fellows none at all.

In each partition between the stalls in his hog house there were doors that rose upwards, so that the hog could be easily transferred from one to the other. He showed the desirability of having easy access to the stalls. One should never have to climb over a partition to get into the hog pen. The man who had to do that was not very apt to clean the pen out. He remarked that men cleaned out the stables of their cows and horses twice every day, but their hog pens were rarely touched. The manure was often allowed to accumulate, and some people held the opinion that it was healthy for a hog to live under such conditions. This Mr. Louis emphatically denied. The yards in front of his hog house were the same width as the stalls, and twenty feet long. There was a window over each stall. When he was building his hog house people had laughed at him for putting in windows. It seemed in the eyes of some people

that whatever you did for your hogs you were doing too much, and whenever you said you were going to favor your hogs you fell just so much in the eyes of your neighbor. There seemed to be the old Mosaic law hanging still around the hog—"Thou shalt not eat thereof"—and yet we little knew how large a profit the hog was to us.

His hog house was twelve feet high in front, and right above it was a chamber for the storing of hay and straw. There was a ventilator over each pen through which they could drop the bedding into the stalls. A pig when breeding should have fresh bedding every morning, and when a man had to go to a straw pile to get it the pig often had to do without this desirable comfort.

He had a pair of scales on the floor at the further end of the alley, with a fence around it. A pair of scales and a pencil was a better educator to the feeder than he (the speaker) would be if he were to talk to them all day. When he gave a pair of scales and a pencil to his son upon the farm, his son became an intelligent feeder. Mr. Louis continued:

THE USEFULNESS OF A PAIR OF SCALES.

Every feeder of swine should know how many pounds of live weight he was making out of a given quantity of feed. When you let your hogs step onto the scales once every twenty-four hours you know precisely what you are doing. You may say to me that you have plenty of by-product, and that you hardly know how to get away with your by-product. Have you ever thought that a hundred pound pig, or a pig weighing between seventy and one hundred pounds, cannot, during twenty-four hours, eat and assimilate so as to give you the best returns more than twelve pounds of milk? And yet you are, in all probability, feeding sixteen pounds of milk a day to every one of your pigs, when you could have made on the same feed the same amount of live weight gain on two hogs as you have done on one.

TWO PIGS MAY BE RAISED ON THE FOOD GIVEN ONE.

Dairymen often make a mistake by feeding their milk without grain. They say, "I have the milk, I am bound to feed it, and my hogs must get away with it." Have you ever thought that you have simply the one kind of food—a nitrogenous-food? If you add to each one hundred pounds of milk thirty pounds of corn meal or of barley meal, or barley and rye mixed, you will find that you are making two pounds of live weight where you made one before on your skim milk alone. You will find that you can raise two hogs in the place of one.

The competition in the breeding and feeding of swine is becoming greater and greater every year, and it is only by economical feeding that we can possibly hold our own.

THE MALODOROUS MILK BARREL.

It is customary upon some dairy farms, where there are not enough pigs to consume all the by-product, to store the milk in barrels. I cannot think of anything—although I am a German, and they say all Germans like sauerkraut, and I do—I cannot think of anything more detrimental to good feeding and to the lives of our hogs than the storing of milk in barrels. Think of the swill barrel that stands at the back door, in which are put the washings of the creamery, and the milk, and the house offal, until everything becomes mixed up in the barrel, so that when the man comes to feed his hogs he holds his nose with one hand and the pail with the other. And then that man complains that his hogs are not doing well! He forgets that when milk becomes acidulated in a barrel it is losing the four per cent. of sugar that the skim milk contains. It has turned into alcohol or vinegar. I do not know why some men persist in constantly feeding the sour stuff, and aiming to get it sour for their hogs. There seems to be an opinion that it is necessary to have the food sour in order to get the hogs to eat it. Let us judge the hogs by ourselves. We want a pickle sometimes, but we could not take pickles all the time without anything else. I believe that under a system of high feeding, when we are fattening the animal in its last stages, it may be a good thing to give it a slightly acid food, but when food has turned to vinegar or alcohol we certainly should not feed it any more.

FEEDING THE BROOD SOW.

Now, as to the feeding of brood sows. How are they fed? Is there any consideration on the general farm as to the feeding of brood sows? Are they not fed precisely like the rest of the hogs? You are probably not corn feeders like we are in our section, but possibly you feed barley and rye. I do not know what feed material you are using, but how many men are there that ever take into consideration that the pregnant sow should receive consideration in feeding: that she should be fed on the feed that is of use to her digestion? Instead of this there are men who simply feed the brood sow at the same time as the others, and get them into a fatty condition like the ordinary hogs, and then complain of the failure of their sows to breed.

PIG GROWTH SHOULD NEVER BE LET COME TO A STANDSTILL.

It is hard to enumerate all the mistakes that are made in the feeding of our swine. If it takes four pounds and a half of feed to give us one pound of live weight in a one hundred pound pig,

fed on three rations a day, there are men who are simply feeding to sustain life. The pig should grow from the time it is born until it goes to the block, and every moment the pig stands still—I care not if it is a pig that the dairyman keeps simply for the consumption of his by-product, or if it is the hog the farmer keeps for profit—it is money out of pocket to the owner. During the winter the hog requires nearly two pounds and a half of feed in order to sustain life, and we have to add the other two pounds in order to make one pound of live weight again. It must also be remembered that you have to feed against temperature, and it is here that the advantages of a good house come in.

that will aid him in digestion, and that will take the sour elements out of his system.

CHARCOAL AS AN AID TO DIGESTION.

Have you ever thought that you are dealing with an animal with the smallest stomach with the exception of a horse? Have you ever thought that digestion in the hog goes onwards into the intestines with assimilation at the same time? Have you ever thought that when you put more food into the animal than he can eat clean at one time, you are simply feeding to a disadvantage? A hog, under a high system of feeding, should have a condiment. It is my practice to give my hogs charcoal. I presume this is a

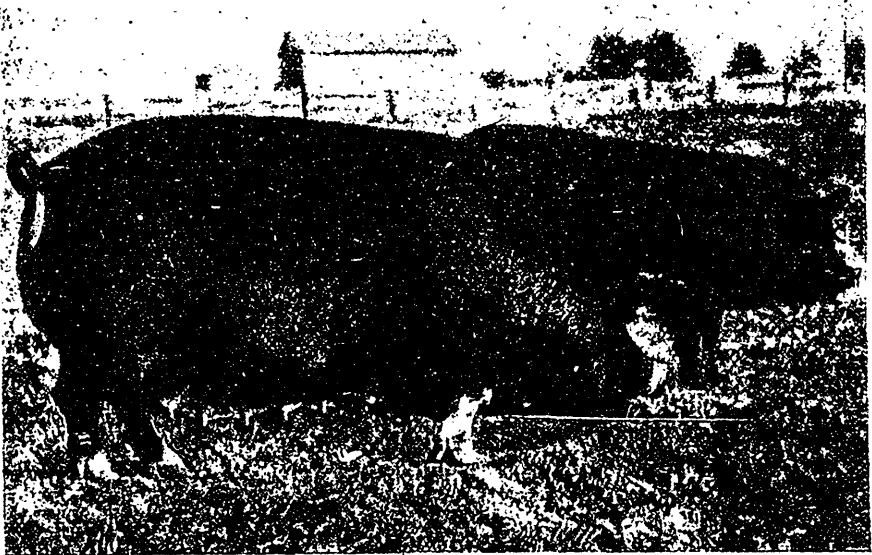

Flora Macdonald and Flora Queen. Berkshire Sows,

The property of C. R. Decker, Chesterfield, Ont. Flora Macdonald is four years old, and was not shown till 1896, when without fitting she won many first prizes. Flora Queen, ten months old, is out of Flora Macdonald.

EXERCISE IN HOG RAISING MEANS MONEY.

I find from conversation that you have small yards, that you feed your hogs in pens, and have simply a small yard for them. Gentlemen, I have found that exercise means money. I have found that when feeding high it is an advantage to give hogs plenty of room; they do better. Under the highest system of feeding, and especially with you dairymen that are feeding so much sour stuff, you will often find that the hogs are everlastingly rooting and throwing up your yards regardless of everything. You will probably attribute it to the breed. It is nothing of the sort. Under high feeding the hog must be stimulated in its digestion. He roots not out of mischief but for those things he finds in the soil

timber country where you have lots of charcoal. It is not so with us. We have got to pay high prices for our charcoal, and therefore we take our corn cobs and burn them into charcoal. I do it in this way. I dig a hole in the ground four feet deep, a foot in diameter at the bottom, and about four feet at the top. I set a fire in this and by degrees add the corn cobs, first about a bushel, and then three or four bushels more. When one side of the cobs have been burned I turn them over, and I continue to add until the hole is full of glowing cobs. Then I shut it up with earth, and in the morning I can take out ten or twelve bushels of charcoal.

This charcoal is just the thing to aid the pig's digestion. Take six bushels of charcoal and

break it up into the size of a hazel nut (it won't matter if half of it is dust), and add to this six pounds of salt and a bushel of wheat shorts. Put it on the floor and mix it well with a shovel. Then dissolve a pound and a quarter of copperas in a large pail of water, and by means of a sprinkler sprinkle it over the charcoal mixture. Then mix thoroughly and put in a box. Stand this in your yard, and fix securely with stakes. You will be astonished what an amount of this mixture the pigs will consume, and you will also

be surprised to find how it will assist their assimilation and digestion.

If I should take the floor again you would do me a great favor if you would ask me questions in any direction in which you may wish information, or where you may think I am in error. I have had an experience of feeding swine extending over nearly thirty years, and by your questions I shall be enabled to add to the instructiveness of my lecture.

FROM THE FARROWING PEN TO THE BLOCK.

By THEODORE LOUIS, Wisconsin.

PART II.—FEEDING.

THE VALUE OF A CONDIMENT IN FEEDING.

I left my subject this morning on the question of condiment for feeding. Some of you who are feeding swine may not think it essential to have a condiment in the feeding system. I will give you an explanation. You will generally find when you are finishing off the hogs for the market, and especially when you are feeding them on one kind of food, that then they will root, and then comes in the necessity of a condiment. I had once forty hogs—shoots. I was finishing them off, and they were weighing two hundred and fifty pounds when eight months old. I was going to make a trial, because a great many men had said that it was simply my imagination that there should be a condiment before our hogs in order to give them better health, and aid them in digestion. Let us remember when the animal is ripening for the block the digestive organs are loaded with fat more or less, and that the pigs are losing their power of assimilation and digestion. There were forty-eight shoots at the time of my trial. I weighed out eight pounds of shorts, and I gave them a pailful of the charcoal that I told you about this morning. I always find that the nearer a hog ripens for the block the more eager he is to eat either sand or something of that sort. It is simply that there is a want of power for assimilation and digestion. I weighed out sixty pounds of sandstone each twenty-four hours, a pailful of charcoal, and eight pounds of swill. These hogs were fed upon the feeding floor. We have one in our hog house, so that in fine fall and spring weather we feed everything on the floor. I think feeding on the ground is a wasteful process. In the twenty-four hours these hogs

used sixty pounds of sandstone and a pailful of charcoal, but they did not consume in that time the eight pounds of swill. The swill would last from forty-eight to sixty hours, so that I found that they did not really need that amount of swill. I simply make this statement to show the truth of the assertion that we must aid the animal under a system of high feeding.

TO WHAT EXTENT FEED SHOULD BE BOILED.

A MEMBER: Do you boil the feed after you grind it?

MR. LOUIS: We have made experiments in boiling feed. We use a steamer in our hog house. We gain nothing by boiling feed, but we gain considerable if we bring our water to a boiling heat and then put the feed in, and feed it in winter time at from eighty to ninety degrees. By this means we artificially supply animal heat. While the experiment stations say it does not pay to heat the feed, I say it does in this manner. But it never pays to put it in a barrel and boil it for several hours. Remember that one hundred pounds of shorts, or one hundred pounds of cornmeal or any grain will make forty-two gallons of whiskey. When you go to work and boil your feed for any length of time you are simply evaporating your sugar from your grain, and you are not a gainer. You are evaporating all the time substances out of your grain.

THE BROOD SOW.

The feeding of a brood sow while she is nursing the pigs is an art. But there are few men that realize this. The brood sow on my place has to take the place of the cow on the farms of you-dairymen. A brood sow will give as much milk.

ON THE 15TH OF THE MONTH

Until further notice **FARMING** will be published so as to reach its subscribers on or about the 15th of th. month.

Owing to the large number of illustrations which are usually inserted in **FARMING**, it is a much more tedious process to print it than to print an ordinary magazine or journal. The printing establishment at which **FARMING** is produced is one of the largest and most complete in Toronto, and for that matter in the Dominion, and yet its resources are often taxed to the utmost to turn the publication out on time. The fact, too, that **FARMING** is printed in magazine form, instead of in the common large broadside form, lengthens the time to produce it many times over.

In future, all matter intended for publication must reach this office not later than the 1st of the month of issue. The forms for advertisements and for stock notes will close on that date; and we ask our patrons to remember this fact, and to send in their changes of advertisements or stock notes accordingly.

THE BRYANT PRESS

PUBLISHERS AND
PRINTERS OF **FARMING**

during twenty-four hours as an average cow. Now, do not ask me if I have ever milked one. (Laughter.) I want everyone who is within my hearing to have a pair of scales handy when they are feeding their pigs. A pair of scales now-a-days can be bought for twelve dollars. A pair of scales and a lead pencil are a better educator than I would be if I were to talk here for a day. When the litter of pigs is born take them two hours or four or five hours after they are born, and put them on the scales, and you will find that they weigh from twelve, fifteen to eighteen pounds, according to the size of the litter and the age of the sow. You weigh these pigs every twenty four hours, and you will find that they have made a gain of from two to five pounds, according to the ability of the sow to give milk.

we are gradually changing it. My pigs nurse three months or ten weeks. They must wean themselves. You probably in your dairy business wish to wean them earlier. I do not believe in feeding the pigs separately in the trough. I adhere to the principle that the pigs should learn to eat with the dam. When they become accustomed to a course of feeding along with the dam's milk, you will never have that back-set that you otherwise would have when you take them away from the mother.

We should always endeavor to have our sows brood as near as possible at the same time. Then we have the young pigs all together. One of the great things is to have hogs all of a size and age. When we can put them on the market all of a size and age a buyer will never refuse a few extra cents.



Yearling Berkshire Boar,

Winner of first prize in his class at Toronto, 1895. Bred by J. G. Snell, Snelgrove. Now owned by Mr. T. A. Cox, Brantford, who is shown in the engraving.

THE BROOD SOW SHOULD BE A MILKER.

So you see, gentlemen, I look for a milker in my breeding sow just precisely the same as you dairymen do. I want to say, especially to the young men, that when you are making a selection of an animal you should get a milk-giver, for it is with the sow that the young pig gets his first start in life. When we are feeding a sow we should feed her with an eye to milk production, just as you are feeding the cow for milk production.

FEEDING THE SOW.

It would be a great mistake to feed your sow on ground meal or on corn alone. She must have them mixed. There is where the mistake comes in. The change of feed will always be a question in the art of feeding. One kind of feed will never give us the same satisfaction as when

A MEMBER: How would you prepare the feed for a sow that was nursing the pigs?

MR. LOUIS: My favorite feed for a sow that is nursing pigs is shorts mixed. If the sow is a sow that weighs from three hundred to four hundred, according to her size and age, as a matter of course we must then always feed to supply as many pounds. I prepare two parts of shorts and one part of cornmeal. I steam this feed in the same manner as I said before. I feed it warm. I find that in the month of April, and especially in the earlier months of the year, when the temperature is low, when I feed the sow warm feed of from eighty degrees temperature, she will keep healthier. In this wise I change the sow's feed. If I have mixed barley meal and cornmeal with the shorts I always add a little oil meal to that ration. Even with oil meal at twenty-two dollars you will find that it pays you to add it to the

cornmeal. Nothing could be worse than to have your sow grow constipated, because it would cause constipation in your pigs. I never would add milk to any steamed or boiled feed until I feed it.

A MEMBER: You believe in feeding your pigs with the dam?

MR. LOUIS: Yes. Another thing: when I want to teach my pigs to eat with the sow, I go through the alley in the morning, and I take a handful of oats and I throw some into each stall. A pig is naturally very inquisitive, and when they hear the oats drop on the floor they will pick them up, crack them, turn up one ear and look very wise, and that is the first lesson the little pigs get to eat with the dam.

MR. LOUIS' HOG STABLES.

A MEMBER: What is the floor?

MR. LOUIS: My floor is a wooden one. That brings something into my mind. The feeding of your soil must go hand-in-hand with the feeding of your live stock. I live upon a very sandy place, so sandy that it sometimes drifts, and yet you would be astonished at the wealth of crops that I produce there. I calculate that while I feed my hogs I must be feeding my lands, and I save the manure for that purpose.

A MEMBER: Do you ever use concrete for floors?

MR. LOUIS: I would not want a concrete floor in my hog-house for breeding purposes. A concrete floor would be too cold at the time of farrowing, and your pigs would become chilled, and you would be very apt to lose them. Therefore I would rather have a wooden floor.

A MEMBER: How far above the ground would you put the floor?

MR. LOUIS: About a foot from the ground.

A MEMBER: What direction do you prefer the drainage of the pen to take?

MR. LOUIS: My floors are level. I do not need any drainage in my hog-house. It is said that the hog is the dirtiest animal there is upon the farm. I say it is the cleanest animal that ever was upon the farm, and I except no animal.

A MEMBER: Is your yard paved?

MR. LOUIS: My yard is not paved, but it would be a good idea if you could pave the yards with blocks. We clean our hog stables just as regularly as we would cow stables. Professor Henry says that I steal my wife's broom to sweep out my hog-pen with. I know that a new broom sweeps awful clean. (Laughter.) Along the fence we put out new bedding every morning. We find that the sow uses this for her droppings, and every cussed little pig follows her example.

A MEMBER: Have you had any experience in the use of stone pens?

MR. LOUIS: If I was going to build a stone pen I would build a double wall and leave a space between, because if you do not you will have a damp stable, and the great trouble would be that you will have more or less rheumatism in your pigs.

FEEDING AGAIN.

I spoke just now about feeding shorts to the sows. You probably raise great quantities of oats, and it is generally said that oats are good feed for pigs. I say they are not. The pig is different from the cow, and you do more injury than good by feeding young pigs on ground oats. When you use shorts you have economy, and a feed that gives better results.

A MEMBER: I have fed sour whey and have been successful.

MR. LOUIS: Probably you have never taken an account of the grain that you fed with it. If you had fed one of the pigs on grain mixed with sweet whey, and another lot on the sour stuff, I think you would have found that you would have made better results out of the sweet whey than you did out of the sour whey. I have said that it is desirable sometimes when finishing off the pigs to feed them on sour whey.

A MEMBER: Have you any experience in feeding roots?

MR. LOUIS: No swine feeder, I care not if he is a dairyman or not, should ever go without roots, especially for winter purposes. In winter we go upon our barn floor and we gather up the clover leaves and the clover heads, a barrel full every morning, and we carry it to the hog-house. We fill the barrel with water and we put a steam hose in and bring it to a boiling heat, and then mix grain with it. We find that we can winter our pigs and brood sows better in this way than in any other. Aside from this, each of our hogs during the winter receives a root. We are great people to grow squash. We grow an acre or two simply for the purpose of feeding. We do not grow them in the corn any more.

SQUASH, PUMPKINS, AND ENSILAGE.

A MEMBER: How would pumpkins do?

MR. LOUIS: Pumpkins are not as good as squash. They retain more water, and when you are fattening your hogs, and can feed the one against the other, you will find that the hogs will leave the pumpkins and go for the squash. I use the old variety of squash.

A MEMBER: Has MR. LOUIS had any experience in feeding corn ensilage?

MR. LOUIS: I have had no personal experi-

ence. Two or three years ago I was in Minnesota, when the man in charge of the insane asylum farm, which is one of the finest institutions in the State, came to me and said: "Mr. Louis, ensilage is the finest feed for hogs there ever was. I am wintering all my sows on ensilage." I told him that I could not imagine that there was enough in ensilage to sustain the life of the sow, and warned him that if he continued to feed it his pigs next year would be born without hair, and otherwise deformed. It may be good to feed ensilage in the winter as a change, but as a regular feed it can't be depended upon.

A MEMBER: Have you fed artichokes?

MR. LOUIS: I have, I am sorry to say. My

choose his own breed of hog—that which suits him best, that which suits his market best, that which gives him the best results.

ROOTS.

A MEMBER: How do you feed your roots?

MR. LOUIS: I feed them raw, but when we have a great many, like we had this fall, we steam them and then mix the grain with them.

A MEMBER: Where do you steam them?

MR. LOUIS: We have a steam cooker that cost \$35, and it takes us only about thirty minutes to set a barrel of water boiling.

A MEMBER: Do you cut or pulp the roots?

MR. LOUIS: We cut them with a spade, and



King Highclere. Berkshire Boar,

The property of George Green, Fairview, Ont. First at Montreal, first at Ottawa, and second at Toronto, for boar one year old and under. Head of first prize herd both at Montreal and Ottawa.

first experience with artichokes was enough for me. I planted a couple of acres, and the first year I got good-sized artichokes. Then they kept coming up year after year for five or six years—little things about the size of a hazelnut—and it was with the greatest difficulty that I could keep them from spreading all over the farm.

A MEMBER: What breed of pigs do you consider most profitable?

MR. LOUIS: The one that gives me the greatest return for feed consumed. (Applause.) When we come to talk about breeds we talk about a fancy. It is simply a point of fancy with every man. I would say, let every man independently

then we cook them thoroughly, so that they almost pulp themselves, and then we mix the grain with them.

HOW OFTEN HOGS SHOULD BE FED.

A MEMBER: How often do you approve of feeding the hogs?

MR. LOUIS: That is a good question. In winter time it is not well to disturb the hogs before daylight. I found that by experience. As our days are short, I believe that twice feeding in winter is better than feeding three times, but in the fall of the year and in the summer it is better to feed three times than twice. Feeding is one

of the great arts. The trouble is that men feed a great lot of stuff all at once—more than the hog can consume. Let it be the maxim on every farm, no matter what the feed, never to give the hog any more than it will eat clean, so that it may go hungry to its next meal. Then you will find that you will make better growth on the young pigs, and that you are fattening your animals in a way that will make more gain.

A MEMBER: Have you any experience in feeding corn-cob meal?

MR. LOUIS: If you grind it fine—the cobs should be ground as fine as the corn-meal—you will find that you can make precisely the same live weight gain out of a bushel of corn and cob meal as you can out of clear meal. The cob meal is an aid to digestion. But it should not be fed dry; it should be fed wet. There is no profit in feeding any kind of meal in a dry state. Another point is that hogs should be fed regularly. If you feed at eight o'clock to-day you want to feed at eight o'clock to-morrow; if at four or five o'clock, at that same hour the next day, and right along. You will be surprised what a difference it makes in the gain of the hogs.

A MEMBER: At this time of the year (January) how would it do to feed at seven, twelve, and six o'clock?

MR. LOUIS: Those would be good hours.

DISEASES OF HOGS.

A MEMBER: What about diseases of hogs?

MR. LOUIS: Almost all the diseases that the human being is subject to, the hog is subject to. He is subject to typhoid fever, measles, colds, and hundreds of other diseases, and most of them are caused by injudicious feeding. For instance, probably one of the greatest complaints among your hogs is paralysis of the loins. You know, the hog that drops right behind and drags his feet after him. I presume I hit a good many men just now. That is simply the result of feeding. While the hog is the quickest of digestion of any of our animals, remember that when you stuff the animal to excess and feed injudiciously, without any condiment or salt, or feed your dairy product without any grain, you are injuring him. Constipation sets in, and then you have the first step towards disease. As for colds, we know when we take cold. Let that observation be followed out in the case of hogs, and then we can avoid those little diseases that so often destroy the lungs of our hogs. It is better to avoid them than to look for remedies.

A MEMBER: Is there any remedy for paralysis?

MR. LOUIS: The only remedy that I know of is to take turpentine, or any liniment, and pour

it freely over the loins of your hog. Keep the animals in a warm quarter, and give them something that will have an effect on their bowels. There is a constipated condition, and you must relieve the animal. For general information, I may say that if you have a sick hog, and you must give him physic, give it to him this way: Take a piece of boiled pork and slice it about the thickness of your fingers. Then slit it, and put a few grains of calomel in. First, give the hog a little piece of the pork without the medicine. A hog must be pretty sick when it won't eat a piece of boiled pork. Hold it before him and he will swallow it. Then give him the other piece of pork with the calomel in it. Away it will go like the first. That is the nicest way of giving medicine that I know of.

A MEMBER: How many grains of calomel?

MR. LOUIS: According to the size and weight of your animal. You can give a hog at least four or five grains more than any man could take. Of course, you must consider the age of the pig. I am not here to advocate giving medicine to your hogs. I am advocating here to-day judicious feeding without medicine.

MILK FEVER.

A MEMBER: How do you manage milk fever when you have it?

MR. LOUIS: You will have milk fever in your brood sow if you have fed her on a heating food before she farrowed. If you have fed her on barley or on corn, and have confined her, you can depend upon it that at the time she goes down to farrow she will have milk fever; her udder will be hard and caked. At these times you will find that she rises right up and refuses to let the pigs nurse. She stands right there and stares at them, and when she cannot relieve herself at all she goes to work and eats her own pigs. There is a law of nature that teaches her what will give her relief. The only way that I know of to relieve her is to give her a lot of linseed oil. Pour it in some milk on feed. Then get some hot water as hot as your hand can bear it and kneel down beside her. With a cloth bathe her udder in the hot water. She will have a fearful pain, therefore be careful. Keep washing the udder for about half an hour at a time. When the water cools get some more. Afterwards rub with liniment, and then I think you will be able to save your sow. Farmers often make another mistake. As a rule, when a man sees a litter of pigs in his stable he is so pleased that he gives the sow an extra feed—the biggest she ever had in her life. He goes into the stable next morning, and then the chances are he will find that his sow has milk fever. She will refuse to let the little fellows

nurse. Care should be taken not to give the sow much milk-giving feed until the little ones are able to take care of the milk. When you hear the little pigs squeal for the milk, and become hungry, then you can increase the feed from day to day. Give the sow, immediately after farrowing, a handful of shorts with some water, and you will find that you will never have any trouble.

A MEMBER: What is the best time of the year for farrowing?

Mr. LOUIS replied that that depended upon the shelter that was provided for the hogs, and on how good a man the farmer was to take care of the sow. To illustrate this last point he showed that by over-feeding a whole litter might be killed. He touched upon the importance of using caution in feeding the sow. She should be liberally fed, but not to excess. The pigs should have plenty of fresh air and exercise. The latter could be provided in the pen with the aid of a hazel switch when the weather was too stormy for the pigs outside.

FROM THE FARROWING PEN TO THE BLOCK.

By THEODORE LOUIS, Wisconsin.

PART III.—BREEDING.

HOG RAISING A PROFITABLE ACCOMPANIMENT OF DAIRYING.

I intend this morning to take up a part of the subject of breeding. I know it is one of the greatest sciences. You here in Canada have a

midst cannot help but admire the intelligence and energy with which you pursue these questions. It is right that you should experiment to the utmost in dairying. I have experimented to the utmost in order to understand the life of the

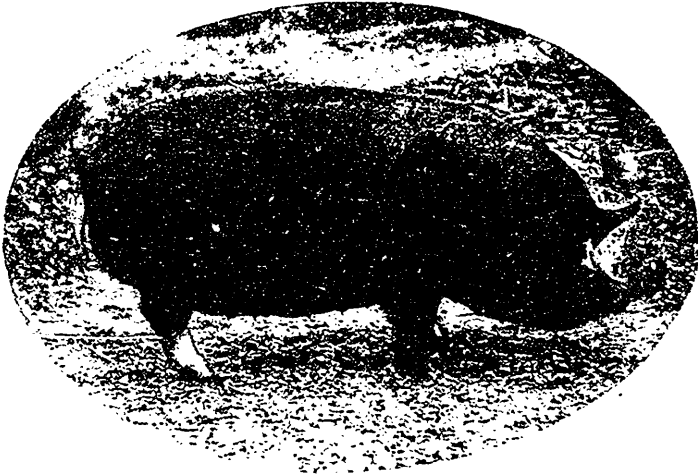

Berkshire Sow,

The property of J. G. Snell, Snelgrove, Ont. Winner of sweepstakes prize for best sow of any age or breed, at Provincial Fat Stock Show, Guelph, 1896.

future before you that we have not in the United States. Your government assists you in a great many matters, whereas we can find no assistance in the matter of markets. When I listened to Professor Robertson last night, I found that your government is trying to find markets for you. Now, while the possibility lies before you that you can successfully compete in your dairy by-products with Denmark and other countries that put the finest of bacon and ham upon the English market, and while you have studied the dairy question, and are still studying it to the highest perfection, the stranger who comes into your

animal that I represent. I never go to Chicago but what I step into Armour's factory, and there one great lesson is brought before us—not a hair nor a drop of blood is lost that comes from the hog. Where you dairy farmers have a by-product so valuable for feeding hogs as skimmed milk and whey are, it must necessarily be one of your great studies how to make the most out of that by-product. At Armour's factory, all the labor employed about the slaughter-house is paid for out of the by-products. Is it not possible for the dairy-farmer to pay his hired help and other farm expenses out of his by-product?

CHOOSE YOUR OWN BREED.

But I want to talk about breeding this morning. You must be the selectors of your own breed of hogs. I believe it is in the power of every breeder to form an animal by intelligent breeding that will answer his purpose. I believe that if I took my Poland-Chinas, and fed them on the more nitrogenous food that you are in possession of for a few generations, and adhered to the principle of pasturing, and gave them more range to run about, I could form an animal that would answer, equally as well as their own the purpose of those animals which they have in Denmark, and that they boast so much of. I think this is one of the examples that lies before you, that you may breed an animal for years that will give you the best satisfaction.

CONSEQUENCES OF IMMATURE BREEDING.

In the States—I do not know how it is here—there is a tendency to breed from young sows, and every year the sow is changed. They object to the aged mother sow upon the farm, because there is a danger of her overlying her pigs. But the consequences of immature breeding are equally dangerous. When you follow a course of immature breeding from year to year, and make your selection always from your pigs to breed from, remember that you are pursuing a downward course, in size, in constitution, and in vigor. The animal must perfect herself before we can expect to have perfect offspring, and in the immature animal you will certainly never have this. You will have a deficiency in both size and strength after proceeding along that line for a few years.

CHOOSING THE BROOD SOW AND THE SIRE.

How shall we select a good sow? I said yesterday that a sow gives from twenty to thirty pounds of milk during twenty-four hours, and I know just what I am talking about, because I have tested it with the scales. If eleven pounds of milk give us one pound of growth in an animal of from seventy to one hundred pounds, it stands to reason that if my litter have gained three or four pounds in twenty-four hours, the milk must have amounted to thirty or forty pounds. This, then, should be our selection—a good milking mother, one of a quiet disposition and of the build that we desire.

I have here a chart taken from life. It is a young sow, but remember that she has all the qualifications of a good mother. She is broad in her forehead, she has her eyes prominent and wide apart, and she stands wide apart with her forelegs, and she was selected with the first cross.

I select a sow for the same purpose as you do a cow. I want a good milker. If you adhere to this principle throughout your line of breeding, you will be astonished what a lot of good milking sows you will get, and remember that the good milking sow is always the good mother.

Here we have the first cross. You see the improvement that has been made. The improvement is even made down to the hoofs, as the animal is securer upon its feet. It is a better build altogether. Here is the thermometer of the hog (pointing to the tail). One curl indicates good vigor and life; two curls are just about the best sign of health that I know of. (Laughter.)

What kind of an animal should we refuse for breeding purposes? Always refuse an animal that has a drop back of the shoulder. Never choose for a sow or a sire one so affected, because it denotes a shortness of the ribs, and there is where the vitality of the animal lies. You must have an animal of great vitality in order that it shall be a profitable feeder. We want to select an animal that is deep through the chest, that is deep through the flank, and for the sow, I would not want one so closely built as I would have the sire.

As a rule, every man selects his pig, or a great many do, when the young pigs are nursing. They say, "Oh, here is the prettiest pig of the lot; that is going to be my future sow." Never select a pig that way. Wait till the pigs have been weaned and have been fed on natural feed, then take from the litter the animal that shows the greatest improvement, and that suits you best according to your judgment for your breeding purposes. Remember that a pig, after it has done nursing, may take on an entirely different conformation, and not suit you probably.

If you have any questions to ask me, I shall be glad to answer them.

DISCUSSION.

A MEMBER: What about blind staggers?

MR. LOUIS: Blind staggers come from one of the great errors of feeding. It is not a hereditary disease in swine. When you and I eat too much we have a headache. There are men who feed swine regardless of their power of digestion and assimilation, and they gorge their animals with one kind of food. Suppose you feed your hogs on whey, and whey alone, and do not mix some oil meal and shorts with the whey, you will probably find you have blind staggers among your animals. When the digestive organs become so disturbed that constipation has taken place and digestion has ceased, inflammation of

the brain sets in. Then the next step is blind staggers. The hog has a severe pain in its forehead, and it commences to run around in a circle, and is almost blind. The only remedy I know of is to give the animal physic. Give it some common clearing medicine to remove the constipation, and then take a knife and split open the skin of its forehead right down to its nose, and put some salt and pepper in there in order to relieve the irritation of the brain.

A MEMBER: At what age should a young sow be bred?

MR. LOUIS: A sow should not be bred until she is eight or nine months of age.

A MEMBER: What about the age of the sire?

MR. LOUIS: He should not be used until about

for your hogs, but I could not think for one moment that my pigs should not enter upon pasture as soon as they are able to run with the sow. I want my pigs to run upon a clover pasture. You will also find barley mixed with winter rye a satisfactory pasture. You will have healthier and better hogs if they have pasture. We aim to let our hogs run in pasture in May when the clover has fair hold of the field, and when our hogs are once upon the pasture we feed twice a day.

A MEMBER: Do you ring your hogs?

MR. LOUIS: No, we never ring our hogs. If you give them the condiment that I spoke of yesterday, namely, salt and charcoal, there is no need to ring them. A hog roots simply because there is a want of phosphate to make bone growth.



Aged Berkshire Sow,

Bred and owned by George Thomson, Bright, Ont. Mr. Thomson himself is seen standing in the rear.

the same age and he should be retained upon the farm. I think that every farmer must become more or less a breeder to become successful. I would advise every farmer to hold his sows when they have satisfaction in one line. If you have a line of sows, hold yourselves to that same line and make your improvement by the sire. Never use your sire any younger than eight or nine months; never use him to excess.

A MEMBER: At what age would you put pigs into pasture? How long and what kind of pasture?

MR. LOUIS: That is one of the greatest arts. As I said before, your pigs should have pasture. I do not know to what extent you have pasture

The higher you feed the hog the more he will root. If a man is under obligation to ring his hogs it is best to put a ring on each side of the nose; never put a ring in the centre, because you will thus very often disturb the nerves that are connected with the eye and the brain. You will often notice that when you ring the nose right through the pigs will draw back from the trough.

When our pigs are weaned (we let them nurse three months) we generally have in readiness two or three acres of peas. You can grow peas far superior to ours, I know, because when I want a new kind I generally send here to get them, but I am always scared of getting the Canada thistle with them. (Laughter.) We sow, as a rule,

upon our farm five acres of peas to feed our hogs on. Right in connection with your business I don't think you can do any better than this. I have moveable fences upon my farm. If any of you gentlemen desire to get a pattern of them I shall be pleased to give you a drawing so that you can make them.

When our pigs are weaned—and we generally make it a point to breed our sows closely together, so that our pigs are nearly all of an age, as I said yesterday—we commence to cut the peas. I take a wheelbarrow and cut a few peas and place them on the feeding floor. Remember, you can never make a sudden change from one feed to another that will be accomplished with success. When you make a change of feed do it gradually. When I have fed the pigs nearly a week on the peas that I have cut I turn them into about two

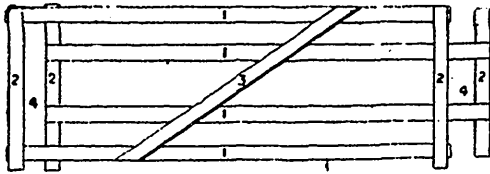

Portable Hurdle Fence.

The above figure represents the moveable hurdle fence used on the farm of Mr. Louis. It is used for hurdling swine, but is equally valuable for sheep and cattle. The width between the bars and the height of the hurdles may be made to suit the sort of animals to be kept by it. *Description:* (1) fence boards, 12 feet long; (2) one by three-inch or four-inch slats; (3) two-inch slat. Observe that the slats (1) are alternately reversed. The open space (4) must be one inch wider than the slats (2). The fence stands worm or zig-zag fashion, the right hand end of one panel protruding through the left hand end of the next panel, and so on throughout the whole fence. If required stakes may be driven x fashion to hold the fence firm.

acres just when the peas are ready for table use. If you have fed those pigs about eight days, you will be surprised how methodically they will go to work and commence to crop the peas and eat them. Here comes a time when you have very little trouble with your pigs. You have not got to do something for them three times a day. They are right there in the peas helping themselves. I give them some swill in the sties. Remember that peameal is often constipating.

Whatever you do watch constipation in your hogs. I do not care whether you are feeding skim-milk or peas, or anything, *watch constipation*. When the peas are nearly all harvested and the gleaning process commences, I have a piece of sweet corn alongside that field, which I commence to cut and give them. Remember that when the gleaning process is on your pigs will fall away. They must not do that; they must continue to grow right up to the block.

A MEMBER: At what age would these pigs be that you speak of?

MR. LOUIS: From about three months old. I want to give a word of caution right here. If you have two fields of peas and the pigs have been gleaning in one of them for a week or two while you have fed them corn in addition, do not turn them at once into the other field where the peas are ripe. If you do you will certainly have one or two dead pigs. They will go at them so ravenously that they will swallow the peas whole.

A MEMBER: Do you breed your sows twice a year?

MR. LOUIS: As a rule I do not; only exceptionally. It should never be a practice, especially if you are breeding from young sows, to breed twice. If she has gone through the strain of breeding and raising a litter she should not be exposed again; she should be allowed to perfect herself in growth. If we wish to breed two litters in one year we should take an old sow to do it.

A MEMBER: Did you ever have any trouble with sows killing their pigs?

MR. LOUIS: I had in former years, in my infancy of swine breeding, but I never have nowadays. If you feed your sow right there will be very little danger of her eating her pigs. If you have given her some roots every day and shorts during the winter you will never have any trouble in this direction. I have never known a sow that runs to pasture to eat her pigs. When they do it is simply owing to the feverish condition that you have put them in.

A MEMBER: Do you recommend the roots to be boiled?

MR. LOUIS: If you have conveniences to boil them, yes; if not, they are just as well fed raw.

A MEMBER: How do you feed your squash?

MR. LOUIS: We feed them both raw and steamed. The advantage the squash has over the pumpkin is that if the pumpkin freezes it is worthless; but it is not so with the squash. We can put a great lot of squash, three or four loads, in a straw pile and use them along in December and January. In the winter time we steam them. We cut them up, put them in a barrel, and steam them thoroughly. Then we mix our other food with them. We do not use the hard shell; we use the larger yellow variety of squash. Remember when you are feeding the animal, especially if you have fed him on grain or corn, that his teeth have become sore and it is better to cut the squash.

A MEMBER: How do you keep your squash during the winter?

MR. LOUIS: We have a hole in the straw pile and put them right in there and cover the straw over them. We have no cellar to keep them in.

A MEMBER: If a sow has eaten one pig what will prevent her from eating the whole litter?

MR. LOUIS: Take the pigs away and then give her a large piece of fat pork, as I told you yesterday, or some linseed oil.

A MEMBER: Have you any experience with black tooth, and is it connected with blind staggers?

MR. LOUIS: No, they are not connected. When you are feeding a great deal of acidulated food it will often cause black tooth. The best way is to pick out the black tooth with a pair of pincers.

A MEMBER: What would you make charcoal out of if you had no corn cob?

MR. LOUIS: Hardwood.

A MEMBER: What kind of wood would be the best, maple or elm?

MR. LOUIS: Maple would give you the best results.

A MEMBER: Do you approve of feeding oil cake to fatten hogs?

MR. LOUIS: I approve of feeding ground oil

cake under all and every condition. There is nothing that gives me so much satisfaction as that a portion of my hogs' ration shall be oil cake.

A MEMBER: Do you approve of much straw in the pens for breeding purposes?

MR. LOUIS: Yes. Here is my practice. A fortnight before a sow farrows I put her into the pen, and I feed her there mornings and nights, but I let her go along with the rest of the sows, so that she does not become scared. I do this up to within three days of farrowing, and I then confine her in the stall all the time. A sow carries her young 112 days—116 days at the outside. The sow knows that she has been treated well in that stall, and that there is no danger about it; and remember that the sow always looks out a secure place in which to farrow. The second day after I have confined her I give her plenty of bedding and let her make her own nest. Of course, you may have too much bedding. You will have to use your own judgment about that.

THE BREEDING AND MANAGEMENT OF PIGS.*

By ALEXANDER WATT, F.S.I.

For many years there has been a considerable difference of opinion as to the most profitable class of pigs to rear, but at no period during my thirty years' experience has the point been more clearly defined than at the present time. There can be little doubt that much mischief has been done to some of our best breeds by over-feeding for shows, and by selecting for that purpose a class of animals more calculated to produce fat than lean meat.

BACON PIGS REQUIRED.

The death-blow has, however, been given to this system by the decided action of our extensive bacon curers in demanding a class of pigs suitable for their trade, and even small breeders have now no difficulty in dealing directly with one or other of these establishments.

In almost every district one sees a class of pigs well calculated to suit the climate and mode of living; and I have found that by a careful selection of the type most in demand, and a judicious introduction of fresh blood to prevent in-breeding, a more profitable herd may be established than if the old lot were cleared out and some highly-bred animals brought from another district to replace them. Holding this opinion as the result of considerable experience and observation, I am unwilling to give undue preference to any one

breed to the exclusion of all others, and therefore propose to take a wide view in dealing with this matter.

We find the objects aimed at by all intelligent breeders are the production of an animal carrying a large proportion of lean flesh, deep and long-sided, not too wide at the shoulder, fairly-sprung ribs, wide loins, good square quarters with hams let down close to hocks, and plenty of hair. Either of the three breeds [now most generally bred in England, the Berkshire, the Tamworth, and the Large Yorkshire] are in themselves good baconers, and will leave their mark in the improvement of the many excellent local breeds.

LEAN FLESH ALWAYS DESIRABLE.

It may be contended that there is in many districts a market for other classes besides bacon pigs, notably porkers, and that the smaller breeds are most suitable for the purpose; this may be so in some instances, but I invariably find that there is as much demand for a good proportion of lean flesh in the porker as in the bacon pig. Both the bacon curer and the pork butcher find that the class I have described suit their purpose best, having less offal, and carrying the most meat in the best parts, while, compared with many of the show-yard sorts, the farmer soon finds them more

* From *The Live Stock Journal Almanac* 1890.

prolific, healthy, and hardy, and that they are got ready for the market at less cost.

THE SOWS.

A farmer, having once settled on the class of pigs he intends to keep, should select sows from spring or summer litters; they must be the progeny of deep milking dams, possessing, as far as possible, all the qualities already described, with twelve sound teats, a strong constitution, and of a docile temperament. From eight to nine months old is a very good time for putting the young sows to boar, so that those farrowed in the early spring may be served in the fall, and drop their first litter when they are about twelve or thirteen months old.

If matters are properly managed, the older

nourishing, but nothing of a heating or stimulating nature must be given. I find that for this purpose bran, pollard, or sharps, mixed with boiled roots or cabbages, answers well; but let it be clearly understood that there must be no pampering, either in diet or habit, and a fair amount of exercise, without undue exposure, should be permitted to the last.

FARROWING.

As the end of the sixteen weeks approaches see that the animal is not in any way worried or hurriedly driven about, that she is the sole occupant of *her own sty*, and that in it she has a fair supply of short and dry litter. Sows usually get accustomed to a particular sty, and an observant pigman will soon see that not only is she more

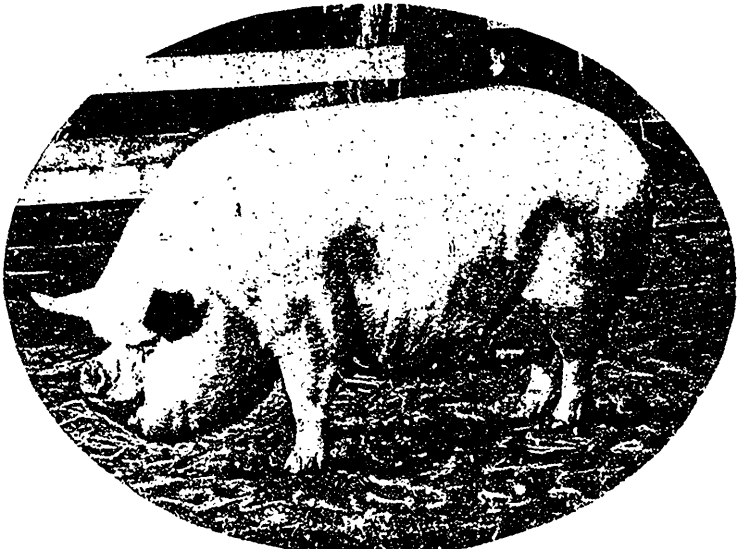

Yearling Yorkshire Sow,

Bred and owned by Joseph Featherstone, M.P. First in her class at Ottawa, Montreal, and Sherbrooke, 1895.

sows should have two litters a year, but to do this in proper season no time must be lost in putting to boar after they wean the spring litter. To make sure of getting young sows stunted, it is well to let them run with a boar; in fact, this plan may be applied to old as well as young, and seeing that many do not give decided signs of being in heat, I find it advisable to let them have access to the boar as soon as their farrows are weaned.

For keeping-in-farrow sows there is no more healthy and economical plan than giving them a run to grass, with a little wash, waste vegetables, or roots once or twice a day, according to the season of the year. When within three or four weeks of farrowing, the diet must be a little more

contented in it than in any other, but she knows what are the best positions for farrowing. It is well to have in all the breeding styes a rail fixed round the sides, from ten to twelve inches high and about nine inches from the side wall; this allows the farrows to get out of the way of clumsy mothers when they are lying down.

The less attention they need and get, during the time of farrowing, so much the better, and with fairly good-tempered sows I never have better results than when no one goes near them. Some sows are, however, so irritable during the time pains are on, that they will often kill several in each litter if they are not well looked after; in such cases it may be necessary to remove the farrows for a short time, during which they must be

kept warm, but of this the attendant will be the best judge. If it is found, however, that the practice becomes habitual, the sow should be converted into bacon with all possible speed.

FEEDING THE SOWS AND YOUNG PIGS.

At this stage sows must be fed on a warm and nourishing diet, so as to promote the secretion of milk, and the sty should be kept clean, dry, and warm. Boiled roots, scalded barley meal, pol-lard, or bran and milk make a very good ration, giving only a small quantity of meal to start with, and increasing it as the young ones get stronger. In no case should dry grain be given during the period of nursing, and even on the diet pre-scribed, if the sow gets at all costive, it may be necessary to give her two ounces of salts and two ounces of sulphur; this will have the desired effect without af-fecting the milk.

About the mid-dle of the fourth week the farrows will begin to feed from the trough, and the sow may then be let out in a covered yard, or, if fine, to grass for a short time daily. In the ab-sence of a covered yard, and if the weather is unfavor-able, an hour or two in a separate sty will give the sow a little rest and change, and while she is away

the farrows will learn to feed all the better. Food for the young pigs must be sloppy and nourishing, but of the same kinds as are being given to their dam. At about eight weeks old they will be fit to wean, and at this period a full supply of skim or buttermilk fed to them will pay well; all castration should be done about a week before weaning, and when they are actually moved from the sow; their sty should be dry and warm, with a good bed, and room to take plenty of exercise.

If intended for porkers, the litter must be pushed on sharply, feeding often, but giving small quantities at a time, and on each occasion removing any food that may be left from a former meal, so as to prevent it souring.

A good mixture of two or three sorts of ground grain, such as barley, beans, corn, peas, and

wheat, either scalded or steamed, and mixed in the early stages with a little boiled potatoes, mangels, or swedes, giving milk and garden waste for a change, will get porkers fit for the market in from fifteen to seventeen weeks.

In the management of bacon pigs a different system has to be pursued. After they are weaned, and can feed well, they should be al-lowed plenty of exercise, with such food as will promote growth and keep up the lean meat, always taking care that the sucker's flesh is never lost.

A good run to grass, with raw mangels, swedes, potatoes, or garden stuff, and a little whole grain thrown out to them, always taking advantage of "nutting" or "stubbling" in the autumn where available, is, I believe, the best treatment for ba-coners till they are five or six months old.

During the time they are running as stores, this class as well as breed-ing sows, must have rings put in to prevent them rooting; t h e y should at all times have access to rock salt, and have a supply of cinders put into the covered yards once or twice a week.

I have found it

profitable to take one litter from young sows that are not intended to be kept for brood sows, and by keeping them well, so as to retain their store flesh during the time they are nursing, they will go out as baconers in five or six weeks after weaning. By this plan the surplus of young sows may be made to earn their living and give the breeder a better chance of disposing of them for stock purposes, for which rather higher prices can generally be made.

FEEDING FOR THE MARKET.

When the ordinary run of bacon-pigs are taken up—to prepare for market—at the age I have already given, it is well not to confine them too closely for the first week; otherwise they may go off their food. In fact, I find that during the whole period of fattening they will do better if allowed to move from their styes at least once a day.



Combination's Choice, Chester White Boar,

Two years old Dec. 1896. The property of Wm. Butler & Son, Dereham Centre, Ont. Imported by Mr. Butler, jr., from Warren Co., Ohio. Won first prize in his class at Toronto, Montreal, and Ottawa, 1896. Considered by good judges to be a perfectly typical specimen of the breed. Shown in the engraving in breeding condition.

As to the food most suitable for bacon pigs, I find that some prefer uncooked for the first portion of the time; but from my own experience, and that of many other practical men, I am led to recommend wholly cooked food for at least the first half of the time. Nothing will move healthy, growing stores faster and put on more lean flesh when they are first shut up than unground barley and a few turnips or mangels boiled together, and well squeezed up with skim milk or whey.

After the first month, add a little barley or other meal to the boiled mixture, gradually reducing the cooked portion, and replacing it with ground meals of almost any sort, as the time of finishing draws near. For this class of animal, however, I do not care to use any considerable quantity of cornmeal, as, when given freely to pigs that are being rapidly prepared, the fat is never so firm, and shrinks in the frying-pan.

In the use of grain for this class of stock, a good deal must depend on the prices at which the various sorts can be purchased in the district, and also, in a measure, on the quantities that are available from the home-grown cereals; but, as is the case with most of our domestic animals, a variety of foods is best, and will give the quickest return.

FINISHING.

To finish with, nothing will make firmer bacon than a mixture of barley and pea-meals, scalded or steamed, made into a paste with skim milk, and followed by a little more milk or whey as a drink.

The food should be given in small quantities, and often, say four times a day, at equal intervals, taking care to remove any that may be left from a former feeding, which may be given to stores. The utmost regularity must prevail as to the hours of feeding, as when this is not attended to the animals get restless and discontented, causing the period of fattening to be materially prolonged, and the profits therefore reduced.

Nothing seems to disturb a regularly-fed pig, for, no matter at what time his sty is visited, the greatest exertion he will make is to sit up on his haunches and give a grunt or two of satisfaction.

PIGS REQUIRE DECENT QUARTERS.

It is surprising how many people *still* believe that pigs are naturally dirty animals, and treat them accordingly. This is, however, a very mistaken notion, and those who act on it pay dearly for their ignorance. Warm, well-ventilated, fairly lighted, and cleanly kept styes will always give better results than the old slipshod system of adding fresh litter and letting the animals lie on their manure for weeks together, or, in some instances, all the time that they take to fatten.

I have tried almost every class of material for the floors of styes, and find that, on the score of economy as well as for comfort, concrete is better than anything. The sleeping benches should be raised, say four or five inches above the level of the feeding floor, so as to keep the bed always clean and dry, and prevent waste of litter. No underground drains should be permitted inside a piggery, and those outside for carrying off the liquid manure, either to a tank or for irrigation, must receive it through well-trapped gratings.

I find it advisable to wash the inside wall of piggeries and styes at least three times a year with freely slaked lime. This effectually destroys all obnoxious germs, and adds material to the health and comfort.

In calculating the profits made on pigs, farmers very often find that the margin is small, but forget in many instances to take into account the value of manure made by them; it is considerable, and if this product was in all cases kept in covered yards and mixed with that from the stables and cowsheds, no waste could take place, and, to my mind, a better mixture for either growing root crops or dressing grass-land cannot be used.

ON THE PRODUCTION OF LEAN MEAT IN SWINE.*

By ALEX. W. SHAW, President of the Irish Pig Improvement Association.

LEAN MEAT DEMANDED BY EVERYONE.

Time was when no bacon could be too fat for the English palate, and when lean was comparatively less sought after, but it may now be taken as an indisputable fact that within the past twenty years the public taste has shown a decided predilection for lean, as compared with fat, bacon and pork. The reasons for this revolution have

been investigated by many writers, and among those alleged are changes in the mode of living, the more sedentary and less open-air lives of the people, and the increased digestibility of lean bacon through its being preserved by modern methods with less salt than heretofore. But whatever the fundamental cause, the fact is a stubborn one for pig breeders and pork producers,

*From a paper published in *The Live Stock Journal Almanac*, 1891.

inasmuch as the demand for fat is daily declining, while lean meat is the unvarying cry of every housekeeper. That this state of things will continue there is not the slightest doubt, and it behoves the farming community to consider what is the best way of producing the article required by the public.

BREED, DIET, AND EXERCISE THE FACTORS.

The most important factors in the production of lean meat are *breed, diet, and exercise*. I think that if judicious crossing with the Yorkshire, the Berkshire, and the Tamworth were properly practised, according to the wants of each particular district, a pig disposed to produce lean

thick, with very light limbs but carrying a large amount of fat, I believe that crossing with the large Yorkshire, not the very largest type, (for I do not consider him the most thrifty animal in the world), but a large York of reasonable size would, in a great measure, eradicate the faults specified. Again, when pigs are fairly long in the body, and also in the leg, they should be crossed with the old Berkshire, if the right stamp of this inimitable breed can be had. Whereas, in districts where swine run thick in the jowl or fore-end, and are too short in the head, yet have good hams and middle pieces, a dash of Tamworth blood might be advisable. In a paper of this

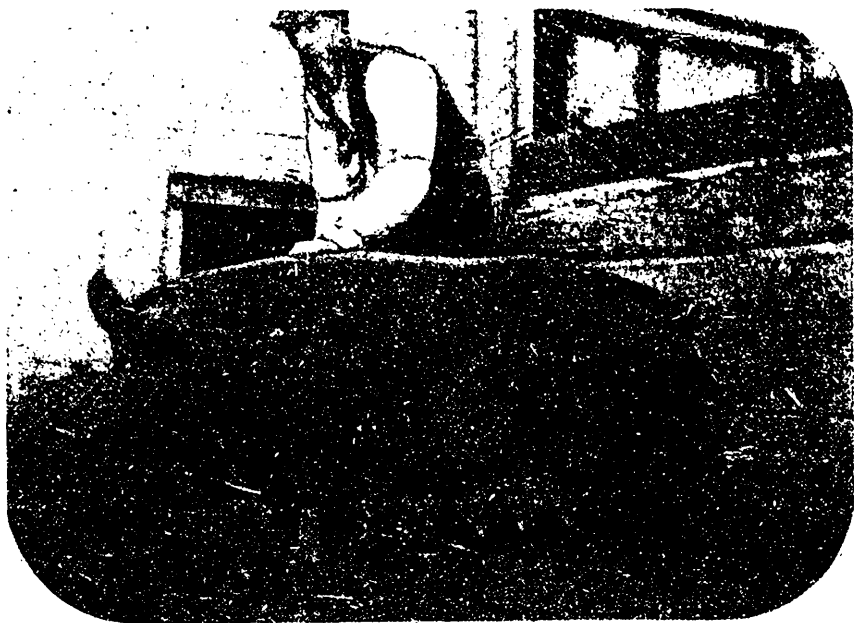

Amber Rose. Aged Tamworth Sow,

Bred and owned by Norman Blain, St. George, Ont. Sire and dam imported. Winner of many first prizes at county and township shows, 1896.

meat would be developed; but this development must be studied in relation to the local abuse, to which these pure breeds have been subjected—abuses of close breeding, injudicious crossing, etc., etc. Some breeders are of opinion that *the one pig* has at last been found whose particular strain is to act as a kind of panacea for all existing evils; but it should be remembered that one district differs from another in the character of its pigs as much as it does in that of any animal family.

THE INFLUENCE OF THE SIRE IN THE PRODUCTION OF LEAN MEAT.

For example, where pigs are very short and

scope it is manifestly impossible to diagnose the wants of each several locality, but I can state generally that where lean meat, growth, fecundity, bone, and constitution are alike lacking, the large Yorkshire, as before mentioned, would seem best to answer these requirements. At least, at the moment, I know of no more useful existing breed. The coarse, rough, unthrifty animal, generally found in localities far removed from populous centres, would, on the other hand, require the introduction of the grand old Berkshire blood; while, to repair the blemishes of cross-breeding, too fine bone, short snout, and heavy jowl, the Tamworth might be resorted to.

As to the *modus operandi* in these admixtures of blood, every breeder of experience knows that form and shape come from the sire; size, constitution, and maternal instincts from the dam. This being so, the boar must be looked to for whatever improvements are desired in external points, and while he is right and perfectly suitable, the sow is an animal of comparative indifference.

DIET IN RELATION TO LEAN MEAT.

Secondly, with regard to diet. One cannot have figs from thistles, neither will fattening food form lean meat. Where, for instance, is the flesh to come from in pigs, such as American, that are fed almost exclusively on Indian corn, which, excepting perhaps, rice, is one of the most fatten-

meal, makes a most useful mixture. A wholesale and indiscriminate use of Indian meal for pig-feeding has cost the country in the matter of over-fattening, millions of pounds in recent years. I do not say that Indian meal should not be used at all.

PRACTICAL ADVICE.

Mr. Harris, of Calne, the greatest living English authority upon bacon, and whose opinion is worth having, says that barley-meal and whey, with some pea or bean-meal, are calculated to produce as good lean pork as anything he knows of. My own advice as to feeding is: Take the foods you can produce on your farm, class them according to their merit as flesh-formers, feed



Improved White Yorkshire Barrow,

Bred and owned by Henry Deddels, Kossuth, Ont. Winner of first prize at Provincial Fat Stock Show, Guelph, 1896.

ing foods we know of, and invariably gives a vast proportion of fat compared to lean? It is palpable that, if the most lean-producing breed in the world be fed for a generation or two upon entirely fat-creating food, it will not only lose its leanness, but its capacity for forming lean. A feeder desiring to produce streaky bacon must use some substance in which there is a considerable element of lean as well as of fat-forming components. Bean-meal or pea-meal is well known as a lean-making food, but I know that if pigs were fed entirely upon such stringent substances they would be neither healthy nor satisfactory. The pig, of all animals, thrives best upon a mixed diet. Barley-meal is one of the very best all-round foods for the production of good meat, and, added to a little pea-meal and some Indian

your pigs on a diet which contains a fair amount of the latter, and you will succeed in having the best and leanest pork that your district can produce and at the most moderate price.

EXERCISE IN RELATION TO LEAN MEAT.

Our third point is exercise. That a pig should be fairly well fed from the time it is weaned until it gets the butcher's knife is absolutely necessary. In other words, he must be kept going from start to finish, but there is no need for his internal machinery to be running at full speed all the time. After weaning the young fellows should be let run about a grass field during the day time, and be fed twice a day on a moderate amount of food until they attain the age of four and a half months. They may then be put into a sty, kept conveniently warm, and fed abundantly. In eight

or nine weeks' time they ought to scale 168 pounds dead weight, which is about the weight of hogs from which the choicest class of bacon for the London market is produced. But, although these pigs will be closely confined while being fattened at some pressure for eight or nine weeks, still they must have a run every day, if the weather permit, for, say, an hour, to give them the necessary fresh air to keep the appetite going, and exercise to digest their food. If they are

famine alternate day feeding of the Irishman who supposed that fat and lean would be deposited on the carcass accordingly. Like other animals domestically reared, young swine that are compelled to exist upon semi-starvation will not pull up arrears for many months, if at all, and, in the case of boars, this early neglect is always very injurious, and generally irreparable.

NEVER FEED RAW FOOD.

One word more: I never give my animals any



Chester White B-bar,

Bred by J. H. Shaw, Simcoe, Ont., from "Blanche," a sow of his own breeding, and sired by "Ohio Boy," a boar imported from L. B. Silver, Cleveland, Ohio. Farrowed May 6th, 1896. Weight March 15, 1897, 325 lbs., that is over a lb. for each day of his age. Mr. Shaw is deservedly proud of this fine boar. He was recently sold (by means of the advertising columns of FARMING, so Mr. Shaw says,) to Mr. D. B. Scott, Fergus, Ont.

kept shut up and highly fed during this latter period of their existence, without being allowed any exercise, the odds are that some will become apoplectic, and others will lose appetite and pine away. The nucleus of lean is forming when the young pig is running about from the period of weaning till he is four and a half months old; but it must ever be borne in mind that even then he cannot live solely upon the grass of the field, upon the air of heaven, or upon the feast and

raw food, their diet being, without exception, either steamed or cooked. And where regular exercise is prescribed, my remarks may be modified by climatic conditions.

If the foregoing hints should meet with anything like general adoption, I am confident we should soon have a far more uniform, healthy, and lucrative race of swine, which would defy and dissipate many of the horrors of competition from any part of the world.

MR. ARTHUR JOHNSTON, of Greenwood, Ont., writes: "FARMING is doing its patrons more good recently than it has done for years."

MR. E. E. MARTIN, of Canning, Ont., writes: "Enquiries for my stock are plentiful, thanks to FARMING, which is the best stock paper published."

MR. E. H. BATE, of Brighton, Ont., writes: "I think a great deal of FARMING. I think it about the best paper of its kind on the continent. I wish it every success."

MR. A. E. VENNING, of Tryon, P.E.I., says: "FARMING has greatly improved, and should undoubtedly be in the hands of every farmer."

A HANDSOME RECOMMENDATION.—After several years experience in advertising I must say that FARMING is by far the best medium for live stock I have ever tried. It brings enquiries with almost every mail and reaches the best class of stockmen. I can cheerfully recommend it to any one wishing to advertise stock. C. R. DECKER, Chesterfield, Ont.

THE DAIRY AND THE HOG.*

By CHARLES H. EVERETT, Beloit, Wisconsin.

MR. CHARLES H. EVERETT is one of the most popular institute workers in the State of Wisconsin, a State where farmers' institute work is perhaps more effectively developed than elsewhere in the American Union. He is still in the prime of life, being only forty two years old; but



his reputation as a practical farmer of very advanced ideas and very successful experience has now been well established for many years. He owns and cultivates the farm (220 acres) on which he was born, and of which his parents, who were of the best sort of New York stock, were the

I am very glad to be with you this morning. I am to discuss the plain, homely subject of the hog, and I want to talk about it in a practical way just as I would if you were in my hog-house or barnyard over in Wisconsin. You know that I come from a state where there are many noted swine-breeders. Among them is Theodore Louis, who, perhaps, is not a stranger to all of you. He is an old German, living up in the woods in the northwestern part of our state, and he has grown rich and wise through breeding swine. He says many funny things. On one occasion he was talking to an audience of farmers, and advising them to feed the hogs dry feed. A farmer jumped up and said: "You are all wrong; it takes the hogs too long to eat dry feed." "Ish dot so?" answered Louis. "Will you tell me, mein friend, vat is de hog's time worth?" I could wish for your sakes that our old friend were here to take my place.

first settlers. This farm has, in recent years, been devoted exclusively to dairying and the raising of purebred Poland China swine. On it he has put into practice the best methods of modern farming, so that by the careful saving of manure, judicious rotation, and the growing of clover, he has not only not diminished its fertility by reason of the large crops which he has obtained from it, but he has every year been making it more and more productive. Mr. Everett is of an investigating turn of mind, and has tested for himself all the methods which in his institute work he recommends to his brother farmers. He has, for example, made a special study of the feeding values of ensilage as made from corn of different varieties and from other fodders, and of the value of skim milk as food for sows and the methods of feeding it, and as to the best methods of growing clover, peas, and other leguminous crop for the purpose of restoring to the soil the nitrogen it has lost by other cropping, etc., etc. Mr. Everett's reputation as an effective speaker, possessing a thorough and practical knowledge of what he speaks about, has caused him to be much sought for institute work outside of his own State. He is also an effective writer on practical agricultural topics, and a contributor to *Hoar's Dairyman*, *The Northwestern Agriculturalist*, and other agricultural journals. Mr. Everett is, taken altogether, an excellent representative type of man that our modern agricultural methods are developing; a type which is destined to have a great influence on the status of our agriculture in the future. In an editorial reference to him the editor of *Hoar's Dairyman* recently said: "Mr. Everett's whole successful career, as farmer, institute worker, agricultural writer and editor, exemplifies the utility of combining brains with business." Here in a nutshell is a statement of the great requirement of modern farming: "thinking power and business methods," and we are glad to have the opportunity of presenting to our readers an account of one who has shown in his work that he possesses this requirement.

CHOOSE THE BREED YOU LIKE BEST.

First, let me say I am not advocating any particular breed of hogs. You ought to choose the breed you like best, for the simple reason that a man will do best with what he likes best. If you don't like dairying, keep out of it, and go into some business that you do like. If you can't stand it to have the cow whip her tail around your neck, but you must get mad and whack her with the milking-stool, don't go into dairying. My business is dairying and swine, and they go well together. The hog has not had access to good society in days gone by, and I suppose it was partly due to the fact that I also was denied that privilege in my early days, that I took naturally to the company of the hog. And I have stuck to him, because he has been a good friend to me, and has helped me out of many financial scrapes. We ought to choose what we like best. If you like the Poland China hog the best, stand by him,

* Being notes of an address given by Mr. Everett at the annual meeting of the Dairymen's Association of Western Ontario, held at Stratford, January 16th, 1895.

and you will do well with him. Not that he is necessarily the best, but your thinking him the best makes him so for you.

SWINE-BREEDING AN UNLIMITED INDUSTRY.

I would like you to understand clearly that I speak from the standpoint of a feeder for the market. It is true I sell many hogs for breeding purposes, but I also put from fifty to a hundred hogs on the Chicago market each year. We cannot all be breeders of pure swine, but we cannot now see a limit to the number of those who may feed swine for the market.

PURE BREEDS OF SWINE ARE BEST.

While I put a good many on the market, every hog I sell is purebred and entitled to register—I can't afford to keep any other kind. One reason is that a purebred hog will make me more pounds

those of the Missouri muddy. But at length the line grows less and less defined, and finally the stronger-colored waters of the Missouri dominate the others, and the Mississippi loses the distinctive character it formerly had. So it is in breeding. If you try to breed general purpose cattle, the stronger strain will predominate in the offspring.

THE SOW.

We breed from pure sows, beginning at one year old, preferably up to three or four years old. We sometimes keep sows until they are six years old, but by that time they grow very wise—they know every door and gate on the farm, and we can do nothing with them. Besides, they tend to grow lean. So we get rid of them. But if you have a good sow—a uniform breeder, a good

milker, a good mother—keep her as long as she has these good qualities. I think it is a mistake to do as many of our farmers do—to sell the old sow because there is a lot of pork there, and then breed a young sow. The old sow is more likely to raise a uniform litter. I have sows four, five, and six years old that give me two litters a year, of seven or eight pigs each, and never a titman among them.

THE SIRE.

The sire is more than half the herd. We ought to exer-

cise very great care in choosing the sire. Many of our farmers are looking for a hog that has large, coarse bones. Over in the States they say hogs are becoming too fine, that they do not stand up well on their legs. This is not the result of breeding, it is the result of feeding. I am looking for the fine-boned sire; I will take care of the quality of that bone after I get it. I want the hog that has good hams and good shoulders, the hog that has a tapering ear—I am speaking of the Poland China breed. I want a hog with good length, but if I must choose between width and length, I would rather have the width.

FEEDING—DON'T FEED TOO MUCH CORN.

The sow must be fed right while she is raising her litter. Corn makes heat and energy, but it



Fitz Lee. Berkshire Boar.

An unbeaten yearling weighing 625 lbs. at fifteen months. Brantford. Sired by J. G. Snell's Baron Lee 4th. Bloom.

The property of T. A. Cox, Dam J. G. Snell's Heather

of pork for a given quantity of feed, than one that is not purebred, and then I am able to sell the best of my swine for breeding purposes. It costs a little more to start with purebred swine, for you must purchase one or two purebred dams and must pay for purebred sires. But by using purebred sires always, your hogs are always pure.

It is the same as with the dairy cow. The dairy cow has been produced by constant breeding in one direction, the object being to get a cow that will produce the most milk for the feed that is given her. If that object is lost sight of and another strain introduced, you begin to breed away from dairy lines. After the Missouri joins the Mississippi the two streams flow side by side in the same bed, the line dividing them being clearly marked, the Mississippi waters being clear,

does not make bone and muscle. We must feed those things that are rich in protein, which makes animal growth—such things as skim-milk, clover hay, cottonseed meal, linseed meal, and so on. That will suit you here very well for you are not such great corn producers as we are. We are apt to put too much corn into the swine where there is so much of it. The result of such a course is that the bones become spongy—the hogs are apt to be attacked by cholera, they fall down behind, and stand up forward, and can't get up on their feet. This is a matter requiring attention, not only in relation to swine, but in relation to dairy cows, sheep, and every other animal on the farm.

THE USE OF SKIM MILK.

Now, being in the winter dairying business, we have a good deal of skim-milk, which we feed to the sows, and we always feed it sweet. We feed our brood sows skim-milk and wheat shorts; we use some water if we have not milk enough. Sometimes we are wintering a lot of fall shoats, and we may not have enough milk to go round. The brood sows get all of this slop they want, twice a day. Our hogs do not get ice water any more than our cows, because it does not pay. We have a fire under the big kettle every day from fall to spring, not to cook the food, for experiment shows that that also does not pay, but to feed the drink warm.

THE USE OF GRAINS AND ROOTS.

We feed also whole oats on the floor or on the clean earth twice a day. We feed that way because we want the sows to get plenty of exercise. They get exercise in picking up the oats, and they digest their food all the better. We feed breeding sows corn once a day. Once a week we give a feed of roots, and they digest their food all the better. We feed breeding sows corn once a day. Once a week we give a feed of roots—in our case sugar beets or mangel wurzel. Sugar beets are a little the best, and we can raise them cheaply. We do not feed them for growth or for fattening purposes, but because they keep the animal's system clean and neutralize the bad effects of the heating food. We feed roots more often—up to three times a week—as farrowing time approaches.

INEXPENSIVE HOG-HOUSE DESCRIBED.

We have discarded permanent hog houses. I would not advise you to build expensive hog houses, for I think you will become dissatisfied with them. One reason is that disease germs get into the floors and under the floors and into the timbers, and it is almost impossible to eradicate them. It is most important that the hogs should have sunshine and exercise, and it is difficult for them to get enough of these in expensive per-

manent hog houses. We have an expensive house we built some years ago, but we make no use of it now except as a feeding place and to keep sires in. We use a pen that costs about five dollars. We make a platform eight feet square, using 2x4 for sills. On this platform place a floor of boards each one foot wide and eight feet long. That makes a floor eight feet square. Now take boards a foot wide and sixteen feet long, and saw them into even lengths. Make a roof of these, using 2x4 for a ridge pole. The building has no perpendicular sides, the roof acting as the sides also. Batten the cracks. Put a door at one end 2x3 feet, hanging it at the top so that it will swing out and back, so that whether the hog is out or in it may be always closed. Leave a space of four inches under the door. Over the door put in a large pane of glass to let in the sunlight. The eaves, as we might say, make a perfect fender; that is, the old sows can't get down into the corners, but the little pigs can. All that is necessary is to put a piece 2x4 or 2x6 across the end furthest from the door, and the pen is fully fendered. The little pigs will run clear round the outside, and when the old sow lies down she cannot lie on the little pigs.

MAY BE USED AS BREEDING PENS.

This pen can be used in special cases as a breeding pen by tipping up one side and placing a stone or block of wood under it to keep it in position, with the floor slightly inclined. The sow will never lie down with her back down hill. A rail can be placed across the lower portion of the pen and a portion boarded up so that a narrow alley is left the long way of the pen. The sow will lie down with her back up hill, her udder will extend under the rail, and the little pigs will reach under the rail and suckle the dam, while the dam has no chance of overlying them.

OTHER ADVANTAGES.

Two men can lift one of these pens. We place a stoneboat under it, and haul it to any part of the farm we wish. One year we take them down to the clover field, and next year that is plowed up, and the pens are removed. Then in winter we draw them back to the yard, and there they are used for sleeping pens.

TRY TO HIT THE MARKET RIGHT.

Sometimes we winter over a large number of September shoats. It is not wise for everybody to do the same. We have plenty of skim-milk in the winter. Then, if we can be ready for the July or August market, we strike the best market of the year. The fall market, with us, is the worst of the year, for the Chicago packers are on the market with both feet, stamping the life out of prices. If we can get large growth before the

cold weather sets in, then, by careful handling in the winter, we can put the hogs on the market early, when prices are remunerative.

TREATMENT OF SOWS AND LITTLE PIGS.

I come back to the sow again. When the little pigs are born, don't feed the sow anything for three or four days, except a thin slop. If you feed her more than that, she will have more milk than the little pigs can take, and there is danger of cake in the udder. Besides, you may cause indigestion on the part of the young. When the little pigs begin to take all the milk from the sow, start to feed. As soon as possible, we teach the little pigs to drink sweet skim-milk, and then we feed both dam and pigs all we can get them to eat, largely of material that makes growth. We

thing we must avoid. If they are weaned at six or eight weeks, they never get over it.

A GOOD HOG MEDICINE.

Because hogs will eat almost anything we feed them it does not follow that it is well to feed them all they will eat. They are great assimilators of good food, good utilizers of the products of the farm. I have spoken of our friend Theodore Louis, and I want to give you his receipt for hog medicine, one that I have used on my farm for many years. Take five bushels of charcoal and break it up fine, then two or three bushels of wood ashes and a pound of copperas dissolved in salt water. Wet the charcoal thoroughly with water. Sprinkle the copperas water over the charcoal and mix in your ashes, and three or four quarts of salt. Each particle of charcoal becomes coated with copperas, and a little ashes and salt stick to it. Place the mixture where the hogs may help themselves. A good plan is to put it in a box with a cover that they can rise and that will fall down when they don't want any of the medicine. When we feed heavily we find that the hogs eat a great deal of this mixture. It keeps the animal free from intestinal worms, free from cough, and we



Aged Berkshire Boar,
Bred and owned by George Thomson, Bright, Ont.

feed corn always once a day—soaked; we never grind the corn. We wouldn't draw it to the mill and back if the miller would grind it for nothing, unless something should prevent us from soaking it.

NEVER WEAN YOUR PIGS.

We never wean the pigs. Let the sow do that. We frequently have seven or eight pigs sucking the old sow when they weigh eighty pounds each. They do get a great deal of nourishment—that is proven by the fact that the sow increases instead of decreases in flesh. We aim to have the sows increase in flesh when they are suckling. But the little nourishment these large pigs get from the dam seems to do them good. The pigs do not know when they cease to depend upon the sow for their living, and begin to depend upon us, so we never have any setback there—that is some-

are not troubled with hog cholera, owing, as we believe, to the effect of this medicine and the movable pen. Also we frequently mix up a batch of mortar and let it harden. They will work away at that. You know swine sometimes tear apart a brick wall to get at the mortar. It is sometimes complained that hogs do so much injury by rooting. The hog does not root for fun—he is looking for something to eat. If we can supply him he will get over this bad habit of rooting.

IT IS THE YOUNG HOG ONLY THAT PAYS.

A point we should remember is that it is the young animal that gives the best return for the feed he gets. Many experiments have been made, and, speaking generally, they show that a hog weighing 100 pounds will neither gain

nor lose, if he is given $1\frac{1}{2}$ pounds of feed a day. Take the same hog after he has been raised to 200 pounds, and it takes 2 pounds of feed per day to hold him at that weight. Run him up to 400 pounds, and he will take 4 pounds a day and show no gain for it. At 600 pounds he will take 5 pounds and not gain. So you see it is the young hog that pays.

HOW TO GET THE MOST OUT OF A BUSHEL OF CORN.

When the fattening period arrives we never shut the swine up in close yards or pens, but give them the run of the clover pastura. We think we are doing well when we make from twelve to fifteen pounds of pork from a bushel of corn or its equivalent in other foods. If I had a bushel of corn and wanted to make twelve or fifteen pounds of pork with it, I would buy ten or fifteen cents' worth of skim milk and some corn and shorts. In order to get the best out of your forty-cent bushel of corn you must make a combination—one kind of feed will not give the best results. Ash makes bone. If you were to burn 100 pounds of corn you will have $1\frac{1}{2}$ pounds of ashes left; from 100 pounds of oats you would have 3 pounds of ash, and from 100 pounds of bran or clover hay 5 pounds of ash. So you see we are not making much bone when we feed corn.

PROFESSOR HENRY'S EXPERIMENTS.

Professor Henry, in his experiments, took a litter of nine pigs and divided them into three equal lots. The first he fed on corn and water; the second on corn, water and wood ashes; and the third on corn, water and skim milk. The first lot made the most rapid growth for some days, and did remarkably well, but soon began to assume the shape of old hogs, their jowls dragged on the floor they were so fat, and they were weak and could hardly keep their feet. The second lot did better, and the third better still. The pigs were all killed, and their thigh bones taken out and tested for their strength on a machine for the purpose. The thigh bones of the first lot required a weight of 300 pounds to break them; the second 700 pounds; and the third as much as 1,200 pounds. That was a valuable experiment, for it goes to show what is the matter with hogs we so often see; when they have reached a weight of 200 or 250 pounds they cannot get up behind.

You can always make a good quality of bone by paying attention to what you feed your hogs.

FEED NOT FOR INCREASE SIMPLY, BUT FOR PROFIT.

We do not try to simply increase the weight of the hog regardless of what it costs us. We are trying simply as a matter of dollars and cents, to

get the best returns we can from the feed we give. There is often a rivalry among farmers to increase the weight of their hogs, and jealousy is excited by one advancing more rapidly in this respect than another. The fact that a man has made a heavier hog than his neighbor does not prove that he has done better—the cost of production must be considered.

A SWINEBREEDER'S SUCCESS DEPENDS UPON HIMSELF.

We cannot control the market end of our business; that is beyond us. But we can improve the quality of our hogs and lessen the cost of getting them to market. The other day at one of our institutes, I was talking dairying and urging the farmers to feed their cattle better. A gentleman rose and said that if he could get more for his milk he could afford to feed better. He looked at the wrong end of his business—the market end. We can control the home end of our business; we can reduce the cost of production. In that way a man's success depends upon himself. I think I have told you everything I know about the hog, but there may be some points that I have overlooked. If so, I hope you will put in your questions, so that if I have the information you want I may be able to give it to you.

DISCUSSION.

MR. DILON: At what age do the pigs leave the sow generally?

MR. EVERETT: We have sows that suckle pigs three months. Usually at ten or twelve weeks scarcely any of the pigs will be suckling.

MR. HUNTER: Do you consider these cheap board pens sufficiently warm to keep hogs in cold weather such as we have here?

MR. EVERETT: I certainly do, and I may say a word further about these pens. I spoke of having a swinging door on the pen. If the pens are battened we usually find them too warm with these doors on, so we take the doors off. But when the thermometer goes down, as it sometime does with us, to thirty or forty degrees below zero, we put on the doors and close them up. We do not want to keep swine too warm. Keep them dry. Never let the hogs sleep together in large numbers; never let them sleep in straw stacks. They generate moisture very rapidly, and then going out in the cold are apt to contract lung diseases.

A MEMBER: Do you have board floors in the pens?

MR. EVERETT: In some of them we have. But the natural earth is the best place for the hog to sleep, because there is no chance for the drafts

to get under him. But if you use the earth for a floor, arrange the pen so that the water will not run in.

A MEMBER: Do you keep your sire hogs in the pens all winter?

MR. EVERETT: They have a yard in addition for exercise.

MR. BLANEY: Do you use bedding?

MR. EVERETT: Yes, changing it twice a week.

A MEMBER: You say you feed your corn soaked. Theodore Louis advises that it should be fed dry. Why do you differ from him? He is an authority, is he not?

MR. EVERETT: Mr. Louis is an authority. But our experience convinces us that there is no advantage in feeding dry. We feed a great deal of peas and pea meal, using them both for dairy cows and for swine. Of course you here grow peas very largely, and they are excellent for swine.

A MEMBER: How about rye?

MR. EVERETT: We have fed some rye to swine, but it does not give us the good results we get from oat and pea meal and wheat shorts.

A MEMBER: How do you feed roots; do you cook them?

MR. EVERETT: The only thing that we make any attempt at cooking is small potatoes, and we simply put them in the kettle and bring the water to the boiling point and then put the fire out.

A MEMBER: About the breeding sow or sire. You say you prefer width to length. In Chicago the heavy, fat hogs are quoted the highest, but in Toronto they would only take that hog at a scalp price. I would like to know whether the American packers cater for the old country trade. If they do, and if they are right in their prices, the Canadian packers are wrong, for they want the long lean hog.

MR. EVERETT: I would not be understood as saying that I prefer the short hog to the lengthy hog as such. I want the hog that has got ham and shoulder. He will make as good a bacon hog, and is more profitable to feed.

A MEMBER: How do you manage to get your breeding sows to give two litters a year when you allow them to wean the pigs themselves?

MR. EVERETT: We do not raise two litters from all sows.

A MEMBER: Are you ever troubled with black death in young pigs?

MR. EVERETT: No. That disease is caused by lack of exercise and sunshine. We have never had it among our swine since we used the portable pens.

MR. WOOLEY: I would like to ask if there is not trouble with frozen feed, so that the hogs do not all get the same quantity regularly? Another point. Last night Mr. Gould spoke about getting down to the level of the ordinary farmer. That's what I want the speakers to do. But we sometimes find that the speaker who tells us what to do finds it easy to carry on his farming because he has a nice little income from other sources. I



Berkshire Sow,

The property of Albert F. Dawes, Lachine Rapids, Quebec.

would like to know from Mr. Everett how many head of cattle he keeps, and how many hogs, and what he grows, what it costs him and what are his proceeds? He is supposed to be one of the greatest swine breeders in America. We are not that, and we would like to know how his experience can be made of value to us.

MR. EVERETT: I am glad our friend has brought up these points. As to frozen feed, we have very little trouble from that cause. We feed with care and watchfulness, catering all the time to the hog's appetite. We would rather feed a little under than a little over and so waste the feed. As to the other point, I own and control the farm on which I was born forty years ago. It is in southern Wisconsin, and contains 220 acres. The land has been under cultivation fifty

years. One hundred and twenty acres consists of permanent pasture, which has never been plowed under, and the balance is tillable land. I breed each year about 20 sows, turning off, as I have told you, from 50 to 100 fat hogs, and selling anywhere from 10 to 30 for breeding purposes. I milk 20 cows, carrying on the winter dairy business. I produce corn for the swine, corn for the silo, clover for the cows and horses, oats and peas. We produce a little rye and winter wheat

for the purpose of seeding with clover, for we find that if we want to be certain of standing clover we must sow in that way. We follow a four years' rotation, and we go over the farm every four years with a light dressing of manure.

MR. WOOLEY: When do you apply it?

MR. EVERETT: All winter long and as late as we can in the spring. When the ground becomes too soft for this purpose we pile the manure up. We apply some land plaster also.

For FARMING.

THE YORKSHIRE PIGS.

By SANDERS SPENCER, Holywell Manor, St. Ives, Hunts, England.

On few matters connected with stock breeding are there found more varying opinions than on the question as to who were the first improvers of those white pigs, which for the best part of half a century have gone by the name of Yorkshires. The credit has been assigned to various persons, but the evidence furnished in support of each of these benefactors of pig breeders leaves something to be desired. In fact, the good work can not with any amount of certainty be allotted to any one single person, but in varying proportions to many who have given time, attention, and money to the improvement of the white pig.

THE YORKSHIRE BREED IS A VERY ANCIENT ONE.

As to the origin of the Yorkshire pig, this is still shrouded in mystery. Some persons who have endeavored to trace its history hold strongly to the belief that the original pig of the British Isles was of a white color, and in support of this contention quote the fact that in the history of the stock of this country, written some two hundred years since, no mention is made of any pigs other than white ones. The fact is also made use of that, no matter what color the sow may be which is mated with a pure bred Yorkshire boar, the color of the produce will invariably be white. Numerous instances could be cited of the crossing of the Yorkshire boar and a pedigreed Berkshire sow when every pig of the litter was of the color of the sire. From this it is assumed, and with apparent justice, that the Yorkshire or white pig has been bred for a much longer period to its color, if not to its present form and character, than the Berkshire; but even here the admirers of the Yorkshire pig claim that the formation and the character of the pigs, resulting from the Yorkshire and Berkshire cross, are similar to those of the boar to a far greater extent than to those of the sow. Of this there is little doubt, as it is an

open secret that a well known breeder of Large Yorkshires, who has been dead nearly twenty years, was in the habit of using a very large white boar on to Berkshire sows and showing the produce as Large Yorkshires. This dishonest practice was, of course, soon discovered, when he was silly enough to sell any of his boars from this cross for breeding purposes, as the blood of the Berkshire dam would assert itself on the second generation, and parti colored pigs would result. Not only so but the produce would more nearly resemble the Berkshire in both form and size. As this breeder was one of the first to export his pigs to Germany, and as a considerable number of them were disposed of in that country by commission agents, the German breeders of Yorkshires came to the conclusion that all white pigs having blue spots on the skin must of necessity be cross bred, since so many of the produce of those half-bred pigs, shipped as Large Yorkshires, begot pigs not only with blue but black spots on the skin from which sprang black hairs.

BLUE SPOTS NO EVIDENCE OF CROSS BREEDING.

The opinion that blue spots were an indication of cross breeding appears to have become general amongst foreigners, but this really does not follow, although cross-bred pigs would be more likely to have these blue spots on their skin than purebred ones. The Large Yorkshire pig always had more or fewer of these blue spots, and even at the present the very largest pigs of the breed are seldom free from them. Owing to the dislike of foreign customers to these blue spots some of the English breeders are trying to get rid of them, by breeding only from boars and sows which are free from them, but it is a moot point if they will succeed in eliminating them entirely.

THREE SUB-VARIETIES OF YORKSHIRES.

At the present time we have in England three sub-varieties of the Yorkshire pig called the Large

White, the Middle White, and the Small White. The latter is now pretty well bred out. It is useless for practical and commercial purchases and for breeding pure, and the Middle and Large Whites can now be found sufficiently fine in bone, skin, and hair, not to require a slight infusion of Small White blood, a practice which was common in Lancashire and Yorkshire until a quite recent date.

THE ORIGINAL YORKSHIRE.

It appears to be tolerably certain that the

railroads, steam, and the telegraph, soon caused the artisans of Lancashire and Yorkshire to sigh for meat more tender and luscious. The importation of a few Chinese pigs afforded the needed cross, and there is little doubt that these thin-skinned, almost hairless and prolific pigs were crossed on the old-fashioned Yorkshires, and a pig, very similar to many still to be found in Cumberland, was the result. The smallest of the produce were light in the bone, fine in the skin, with little hair, and an excessive amount of fat. Others had short, curly hair; whilst a few pos-

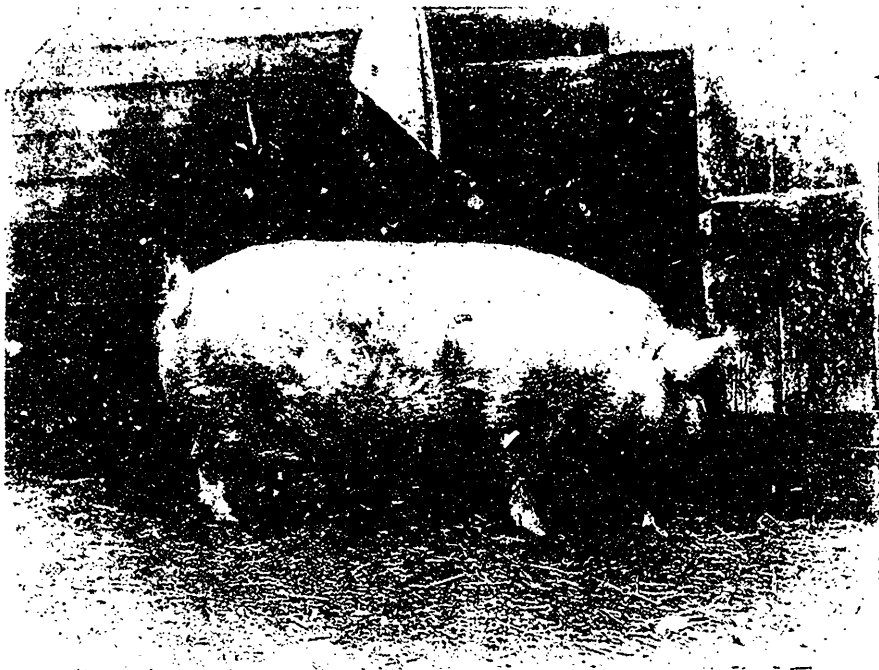

Holywell Middlesboro. Middle White Yorkshire Sow,

Bred and owned by Sanders Spencer, Holywell Manor, St. Ives, Hunts, England. Winner of many champion and class prizes.

original Yorkshire pig was an animal of great size, strong in the bone, slow maturing, and of a white or grey colored hair, and with blue spots or patches on the skin. This style of pig might have been suited to our forefathers who allowed their pigs to search for their own living for one or more years; pigs that after being fattened for several months, killed and salted heavily, and then furnished well-nigh all the animal food consumed in the large and hard working families of their owners.

THE CHINESE PIG CRAZE.

The increased prosperity in the manufacturing districts resulting from the use of machinery, the

possessed a coat more resembling down. But each of these types were very quick-fatteners, and when killed produced a carcass possessing very little lean meat. For a time these animated bladders of lard created quite a furore; exhibitors and judges alike were quite gone on them, until it was discovered that the public declined to eat the soft, oily pork produced by them. All follies die hard, but this hairless or frizzly-haired pig craze was especially pertinacious of life. But the press and the cessation of demand for these fancy pigs proved to be too powerful for mere fancy.

THE MIDDLE WHITES.

Some thirty years or so ago the Royal Agricul-

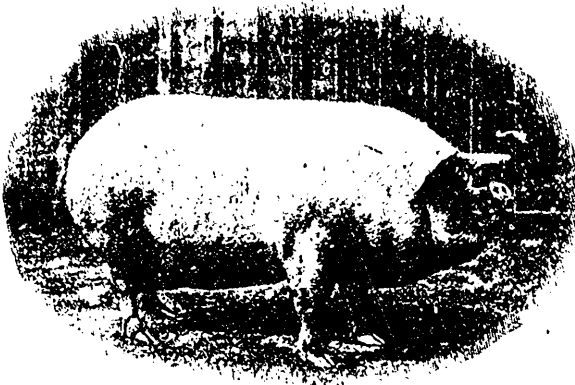

Improved Yorkshire Sow.

The property of J. E. Brethour, Burford, Ont.

tural Society of England gave prizes for Yorkshire pigs of the Large and of the Small breeds, as well as for Berkshires and Small Blacks, separate classes being given for pigs of any other distinct breed. For some years the Middle White pigs pretty well cleared off the whole of the prizes until at last the Council gave separate classes for Middle Whites, a pig which is undoubtedly as valuable a general purpose pig as is to be found, since a really good specimen of the breed will mature early, or if desired will continue to grow and furnish a heavy carcass of pork of splendid quality.

A considerable number of boars of this variety are annually bought by those who make a speciality of supplying the best London houses with what are locally termed "pocket pigs." These should weigh about 80 lbs. dead, and be not more than four and a half months old; if four months so much the better. The sows from which these pigs are bred are either of the Large White, the Middle White, the Berkshire, or of some similar breed or cross. The young pigs are kept well from their birth, and in the most successful yards are fed a considerable quantity of skim milk; this improves the quality, and renders the carcass of a nice bright color.

THE LARGE WHITES AS LEAN MEAT PIGS.

One of the results of the indiscriminate rush for quick-fattening pigs, to which reference has been made, was the attempt to discover some quick-growing pig which had not all its lean meat improved out of it, and yet one with an aptitude to fatten at a comparatively early age. Now came the opportunity of the breeders of those Large White pigs which still retained their natural prolificacy and quick growth. By careful selection the feeding properties of the Large White pigs were immensely improved, whilst the

coarse, round bone, thick skin and heavy fore-quarters — which even at the present time some few judges delight to honor — were gradually bred out by our most practical breeders, with the result that purchasers have come from all parts of the world for these pigs, and what is more to the purpose still continue to come for them; since no matter what the climate of their new home may be, the really best specimens of the Large White speedily become acclimatized, and cross well with the native breeds of pigs in whatever country their new home may be.

POPULARITY AND STABILITY OF THE LARGE WHITES.

On this point I can write with every confidence as I have shipped my pigs to no fewer than forty colonies and foreign countries, with climates as dissimilar as Siberia and the West Indies, Finland and Panama, or Sierra Leone and Norway; whilst bacon curers in Canada, Norway, Sweden, Denmark, Holland, Germany, Spain, Portugal, New Zealand, Russia, and South Africa have proved the value of the highest quality Large White pig for breeding pure or for crossing on the native sows.

So far as one can judge there is every probability of the Large White Yorkshire continuing to hold its unique position, providing that its



Suffolk Sows.

The property of R. Dorsey, Burnhamthorpe (who is also shown in the engraving).

breeders pay particular attention to the quality of bone, of skin, and of meat, and to the lightness of the forequarters of their favorites. The present fashion in many quarters is to go in for short heads, heavy jowls, thick necks and shoulders, and roundness of bone. These points must

be more carefully attended to than at the present by breeders both in this and some other countries. A word to the wise is sufficient, and there are, doubtless, wise men amongst the breeders of Large Whites in Canada.

HOG PENS AND HOG FEEDING.*

By GEORGE WYLLIE, Leeds, Wisconsin.

MR. GEORGE WYLLIE, of Leeds, Columbia County, Wisconsin, is one of the best known institute workers of that State so famous for its institute system. He was born in Argyleshire, Scotland, in 1850, and came out to Wisconsin with his parents when he was seven years old. The following statement concerning Mr. Wylie's career as a swine breeder and dairy farmer is taken from a very entertaining account of him given in *The Wisconsin Farmer*, in December, 1893. We regret exceedingly we cannot quote the article complete:



"In 1864 Mr. Wylie purchased the farm on which he now resides and sat down deliberately to demonstrate the capacity of the Poland-China hog to root a ten per cent. mortgage of forty dollars an acre off a Wisconsin farm. To the credit of the hog and its owner, in this case, the demonstration was complete. Having shown what the Poland-China bred and fed for the pork barrel could accomplish, it was not at all strange that Mr. Wylie should turn his attention to the breeding of Poland-Chinas, with a history in the shape of a pedigree and an individual merit that would not make the pedigree blush. He brought, in 1870, the first purebred Poland-China swine ever seen in Columbia county, and the descendants of the same stock are still to be found on the farm. This is an

COMFORTABLE SHELTER.

In order to realize the best results in raising swine, something in the way of comfortable shelter is an absolute necessity. Occasionally we find a farmer with the idea that an expensive hog

other illustration of the doctrine the *Farmer* has been teaching, that if hogs are properly fed and bred they will not become too fine in the bone or too small.

"Mr. Wylie has adopted the plan that has been followed by all good breeders of buying the best pedigree that has true merit back of it and not higgling about prices. He has thus avoided the rock on which many noble ships have foundered. Some men have gone off with the craze for pedigree, or rather for fancy pedigrees, pinning their faith to special lines of blood and fancy points, while others have gone to the opposite extreme of giving too much importance to individual merit in the individual not backed by like merit in the recorded ancestry. He has avoided both these extremes.

"Mr. Wylie also has never allowed himself to be carried away by the illusion that if he could make money on twenty hogs, he could make twice as much with forty, but he has bred the same limited number of sows each year for fifteen years, and will under no circumstances increase the number. He has never yet been able to grow enough to supply the demand, and has shipped Poland-Chinas for breeding purposes to nearly every western state and territory, and as far north as Winnipeg, in Manitoba.

"In 1878 he began breeding Shorthorn cattle and has followed the same policy that has been successful with hogs. He has bought bulls of the best breeding and highest individual merit, regardless of price. As a Wisconsin farmer he realizes that the Wisconsin Shorthorn must be a profitable dairy cow. The calves are, therefore, raised by hand, the cows regularly milked and the milk made into butter or sold to the creamery. He then weeds out every cow that does not pay a profit in milk and butter above her keep.

"It is from herds of this character that the milking Shorthorn, or, for that matter, the dairy cow, to whatever breed she may belong, must come. The dairy cow must be milked and must have a milking inheritance. Our readers who know George Wylie best (and who among Wisconsin breeders does not know him by reputation, at least?) wish him the most abundant success in his work."

In this good wish we are sure that all readers of *FARMING* who peruse the practical address of Mr. Wylie, here given, will heartily join.

Mr. Wylie is now a member of the Wisconsin State Legislature.

house is necessary to the profitable handling of swine. Where we find one such farmer however, we are likely to find a dozen strongly imbued with the idea that a straw stack or a wire fence serves every purpose or perhaps, present cir-

*Being an address given and the discussion thereon at the "Closing Farmers' Institute of Wisconsin held at Waupaca, Wisconsin, March 18th, 1891.

cumstances forbidding the outlay considered in that direction, they allow their swine just for the present or until something turns up, to shift for themselves on the old "root hog or die" principle. After an experience with almost every method of sheltering and feeding swine, we have come to the conclusion, that an expensive hog house at least is not one of the requisites necessary to the profitable production of pork. Your blue-blooded aristocrat of the human family is satisfied with nothing short of a modernized Queen Anne with a cut stone foundation. But your blue-blooded aristocrat of the porcine species with a gilt-edged pedigree tracing nowadays through ponderous volumes of hog lore is satisfied with any shelter that keeps him warm and dry. A well filled trough, in a "pig's eye," is more appreciated than the grandest design in architecture ever invented.

LARGE HOUSES NOT NECESSARY.

In practice the objection we have found to the large expensive hog house, where any considerable number of swine are kept under one roof, is a difficulty in keeping it clean. In such a pen it is hard to arrange ventilation to keep the air pure and healthy. At farrowing time with ten or twelve or more sows, all in adjoining compartments, if one sow steps or lies on a pig, all the others spring to their feet, and pandemonium ensues. If one sow that necessarily must be fed is given anything, others that should be kept quiet or fed very little, get up and expect the same treatment. The tendency of the whole establishment is towards irritating the tempers of the brood sows, which should be avoided at farrowing time. The larger the hog house the colder it becomes in winter and in summer the more difficult it is to arrange for sufficient access to pasture.

Another strong objection is that the expensive hog house must be a permanent fixture; and where many hogs are kept, any one who has had experience knows that the ground surrounding it after a year or two becomes filthy and permeated with the droppings of the animals. The hogs are also likely to make unhealthy wallows in close proximity to the pen, and these wallows are almost impossible to keep filled up when the ground is used permanently for swine. All this tends toward an unhealthy condition of the stock; and health above everything else in raising swine is of the first importance. In fact the only point I have been able to discover in favor of the expensive hog house is that it is a little more pleasant for the feeder on a cold or stormy day.

INEXPENSIVE PENS ARE BEST.

The pens that have given us the best satisfaction are small, inexpensive, insignificant affairs, costing from \$5 to \$10 each. The strongest point in their favor is health, fewer hogs being kept under one roof; this one point of health of itself should over-balance any objections that might be urged against them. When the ground around the pen becomes foul by continued occupation, these pens are easily moved to a fresh location, and the ground previously occupied by them plowed up

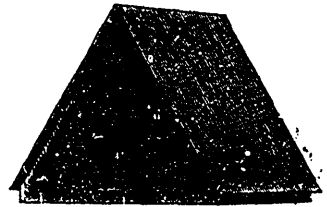

Tent-Roof Moveable Pen.

Bill of lumber for this pen: 256 feet inch boards, 1 x 12—16 ft.; 6—2 x 4—16 ft. 12 bats 16 ft. long, 4 in. wide.

and a crop or two raised from it, by which the soil is purged. After two or three years cropping the ground can again be seeded to grass and the pens returned to their original location. A rotation of hog-pens once in two or three years goes farther in the direction of maintaining fertility than anything I have ever tried. With this kind of pen, or with as many pens of this kind as may be necessary for the number of hogs kept, the original outlay for pens is reduced to a mere nothing in comparison with the large hog house. The pens will pay for themselves every year they are used. With this system, less than half the labor



Shanty-Roof Moveable Pen.

Bill of lumber for this pen: 502 feet 1 x 12—16 ft.; 8—2 x 4—16 ft.; 20 bats, 16 ft. long, 4 in. wide.

will keep the pens clean; they are warmer, the air is purer, the young pigs are healthier, and large numbers at any season may be prevented from piling up together. At farrowing time each brood sow is isolated from the others, and thereby is removed from anything likely to make her irritable or restless. Bear in mind that I have no wish to prevent any farmer with plenty of money from building as expensive a hog house as he desires. I presume that I am talking to farmers who

may think as I used to, that an expensive hog house is necessary to raise fine pigs. But while I recommend cheapness and economy in the way of hog-pens I do not wish to be understood as arguing that "anything is good enough for a hog." The essentials to be secured are health, comfort, warmth and cleanliness; and any outlay of money that goes beyond this must be regarded in about the same light as that in which a prominent breeder regarded his expensive 30x60 hog house. Said he: "It is not much account for swine, but it's awful nice to show to visitors."

A BREEDING BOX.

Nine-tenths of all farmers throughout the country make use of young boars and sows for breeding purposes. A boar six to ten months is used one season and then discarded and another young one put in his place. This is a mistake, especially when the boar proves a good breeder. When a very prepotent sire is found it will pay to buy brood sows to be bred to him. The objection usually urged against keeping a boar is that he gets too large and heavy for service. With the breeding box illustrated herewith any sized boar can be bred to any sow.

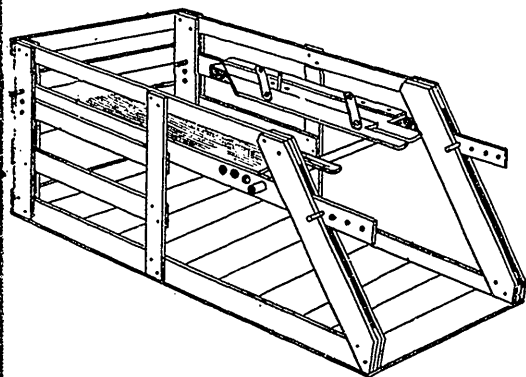

Breeding Box,
As recommended by Mr. Wylie.

The difference between this breeding box and any other box that I have ever seen is that this one can be adjusted almost instantly to fit any sized sow after she is in the box, both as to width, height, and length. The front end is better if boarded up tight. A four or six inch board nailed across the top, four or five inches back from the front end, would effectually prevent sows from getting out over the end. The "chin rest" for the boar so often seen on other boxes is not necessary with this box, as the adjustable steps for the boar's feet effectually prevent his feet from slipping down between the sow's body and the step, so that his weight is at all times on the

steps, and not on the sow. The adjustable step or shelf is six inches in width when closed, but when clear open is about double that in width. The steps on both sides can be made adjustable if desired, but I have found that an adjustable step on one side makes a fit for almost any sow from 200 to 500 lbs., or heavier.

We have used this box for nearly all our sows, old and young, this season, and we find that a young boar will serve a large sow much more easily in the box than out of it. For a young boar and an old sow a small platform for the boar is placed behind the sow. The ends of the sides at the rear end of the box are made slanting because the height of the steps is then more easily adjusted in that manner, and then there are no sharp corners in the way for the boar to fall against in getting off.

The iron rod to hold the sow in the box is a piece of gas pipe one and a quarter inches thick. The boards through which this rod passes must be good sound fencing six inches wide. On the inside of these boards, and up tight against the shelves or foot-rests, a piece of 2x4, about two feet in length, should be nailed to strengthen the shelves or foot-rests, as a heavy boar will sometimes place nearly all his weight on them and they must be stout. The two straps of iron that make the steps adjustable are eight inches each in length between the screw holes, one-quarter inch thick, and one inch wide. Two small bolts through the shelf with the nuts up (or two one and a quarter inch wood screws will do) and two wood screws at the other end hold them. The pin and pin-holes at the upper end allow the step to be adjusted to the width of the sow in the box. At the front end of the box are two pins, one on each side, with different holes for the raising and lowering of the front ends of the boards supporting the shelves; the method of raising and lowering the rear ends will be readily understood.

The floor is put on crosswise; two laths on the bottom lengthwise make it slide easily in moving.

The adjustable step, the method of fastening in the steps or adjusting them as to height, the slanting ends of the box, and the application of the gas-pipe rod in connection with the same, are what is new, and, so far as I am aware, have never been used before. A 600 or 700 lb. boar can serve any sow old enough to breed in this box. The dimensions are 2 ft. 4 in. wide; 2 ft. 6 in. high; 4 ft. long on top and 6 ft. long on bottom—all outside measurements.

DISCUSSION.

QUESTION—How would it do to have a mov-

able yard that you could put in front of either one of the pens if you wanted to pen up a few brood hogs?

MR. WYLIE—That is all right for a short time. But I don't believe in penning up much. Hogs need plenty of range to keep healthy.

QUESTION—Tell us about training a hog.

MR. WYLIE—It depends on the man who handles him. You can train a hog to do almost anything if you use him kindly and don't try to force him. I don't approve of ringing hogs on general principles. If hogs are fed on the right kind of rations they won't root much. If you are only going to keep them a few weeks and turn them to market it might pay to ring them. I raise hogs largely to sell as breeders, but I would not pen them up too closely if I were feeding them for pork.

QUESTION—How much do you value 100 pounds of skim milk for feeding hogs?

MR. WYLIE—Under ordinary conditions skim milk is worth about 20 cts. a hundred pounds, that is, when fed alone; but it is worth more than that fed in connection with something else. It is worth more fed with corn than with most any other ration; skim milk and soaked corn for young pigs can hardly be improved on if cost of production is considered.

QUESTION—Are not whole oats and skim milk good for young pigs?

MR. WYLIE—The oats would be better ground for young pigs, and even then you are not getting the right kind of a ration. You know skim milk is one of the best bone and muscle feeds there is, and so is oats. After a pig is past a certain age, if you will give him all the skim milk he can drink, and give him plenty of exercise, you can safely give him all the corn he will eat, and have the best ration of any. That is working on the principle that the profit is in the first 200 or 250 pounds. It needs judgment to feed right. We have had some mighty good hired men at our place, but they never make a success as pig feeders because they lack that interest in the business that ownership gives.

QUESTION—At what time would you advise the farmer to have his pigs farrow?

MR. WYLIE—Not much before the 15th of April, generally. There are very few men that can raise two litters of pigs with profit. The first litter will be too early in the season and the second will be too late. There is nothing so detrimental to a young pig as cold weather. If any man can do it, it is the dairyman who has lots of skim milk.

QUESTION—How is rye for your pigs?

MR. WYLIE—First rate.

QUESTION—How would you care for March pigs?

MR. WYLIE—I would rather take care of ten brood sows littering the first day of May than two the first day of March. The trouble is they don't get to the ground. The young pig needs fresh earth and grass and warm sunshine. You will have to keep March pigs shut up. You can only give them fresh dirt every day and see that they have exercise.

QUESTION—Do you feed vegetables to sows in winter?

MR. WYLIE—Yes, I feed a certain amount of mangelwurzels.

QUESTION—How many pounds of pork can you make from a bushel of corn?

MR. WYLIE—That is a big question. Twelve is possible, fourteen may be made. The average Wisconsin farmer makes between six and eight.

QUESTION—How old do you have your pigs before you wean them?

MR. WYLIE—I never wean them. The whole success of swine raising is right there in the matter of weaning pigs. A farmer sees a brood sow getting kind of thin when the pigs are about four weeks old, and he says, "Those pigs have got to be weaned." He goes to work to construct a little S by 10 pen and catches the pigs and puts them in there, and the sow is turned out, and in one or two weeks they are pretty effectually weaned; the profit has been all weaned out of them. A pig never should realize that there is such a thing as being weaned. It never should know when it ceases to depend on the dam and begins to depend on you. All the feed that you can get your pigs to eat after two or three weeks, when they should begin to eat, is just so much saved on the dam. They will wean themselves if you feed them right. Scarcely any of them will be suckling at ten weeks old.

QUESTION—Did you ever weigh your pigs when they were two or three weeks old and then in one week afterward, to see how much flesh they had taken on?

MR. WYLIE—My only experience with weighing was with a litter of eight. We weighed that litter the morning of the day they were eight weeks old. They weighed exactly 400 pounds, an average of 50 pounds each; these pigs, however, were better pigs and were better cared for than the average.

QUESTION—At what particular age or size can you make pork the cheapest on them?

MR. WYLIE—A well bred pig handled rightly, will give you as large returns for the food he has consumed along between fifty and one hundred pounds as he ever will.

QUESTION—Then at what size will it be most profitable to dispose of him?

MR. WYLIE—He is making gain right along and doing well, up to 200 or 250 pounds. On general principles, when a hog gets to be about 250 pounds, you had better let him go, and put the feed over into a younger pig. Of course, the market and other things have to be considered. He ought to weigh that when he is seven or eight months old. A pound a day is very good gain.

QUESTION—How would you care for brood sows prior to farrowing?

MR. WYLIE—I would have mature brood sows in the fall in rather thin condition. I would be-

to warm that water with cord wood. Two bucketfuls of hot water will warm nearly half a barrel of slop and you might warm it on the kitchen stove, but that will depend a good deal on the disposition of your wife. We used to warm the water for the pigs on the kitchen stove, but we don't any more. The atmosphere in our kitchen used to get hotter than the water, and we had to quit. We warm the water with a tank heater in a water tank. We start the fire in the morning and by noon it is up to 70°.

QUESTION—If pigs have black teeth, does it hurt their health?

MR. WYLIE—No, that is on a par with hollow horns in cattle.



Yearling Berkshire Sow,

Bred and owned by J. G. Snell, Snelgrove. Winner of first prize at Toronto Industrial, 1896.

gin feeding gradually, start them to gaining and keep them gaining through the entire winter clear up to farrowing time in the spring, when I would have them in good strong flesh and heart. Now if that flesh that you put on during the winter is put on with corn, the pigs won't amount to much, so we don't put it on with corn, we put it on with a combination of oats, shorts and corn in about equal parts. We feed the oats the first thing in the morning, spreading them out thin on a dry floor so they cannot bolt their food. They can only pick up a few grains at a time and masticate their food. At noon we feed them the shorts made into slop, and we feed it warm. I have found out by experience that a pig's stomach is a very expensive place to warm ice water. You can better afford

QUESTION—With a well balanced ration in the winter do you feed ashes?

MR. WYLIE—My hogs always have free access to salt and charcoal and wood ashes. Our sows are fed roots about this way, one meal a week during December, two meals in January, three in February and four in March, and clear up to farrowing time they get four meals. Clover hay might do as well to a certain extent, but I would rather have the roots.

QUESTION—Does it pay to winter hogs for profit?

MR. WYLIE—As a general thing, no. A Wisconsin farmer cannot afford to winter anything but his breeding hogs.

QUESTION—What is the cause of a brood sow eating her offspring?

MR. WYLIE—A diseased condition of the system. If she is fed plenty of roots previous to farrowing time and gets plenty of exercise, she won't do it. Then again at farrowing time they should be fed something laxative, and very light at first.

QUESTION—Do you breed from mature dams?

MR. WYLIE—Yes, mainly.

QUESTION—How long do you keep them?

MR. WYLIE—Usually not longer than four or five years. When you have something as good or better to take her place let the old sow go.

QUESTION—Is it possible to keep the dam from losing flesh rapidly while suckling her litter?

MR. WYLIE—I don't like to say that it can't be done, as most farmers don't feed their brood sows enough; and take it for granted that she will lose flesh anyway. With a mature sow and not too large a litter it can be done. Young sows and old ones, too, with good sized litters will be apt to lose some flesh even if fed all they will eat of the best kinds of food; good brood sows always get a little thin while suckling. In fact a fleshy sow is never a good suckler. The feeder, however, should do his level best to try to make them hold their own.

QUESTION—Do you feed dry or soaked?

MR. WYLIE—We soak corn for spring pigs until the new corn is ready to feed. What little corn we feed brood sows while suckling is usually fed in the ear dry. Shorts we always soak between feeds except in winter.

QUESTION—What is the best pasture for hogs?

MR. WYLIE—I think white clover a little the best, but red clover is good enough and easier to get.

QUESTION—When should hogs be turned on clover, at what stage of growth?

MR. WYLIE—When about 4 inches high.

QUESTION—Should grain be fed to hogs while on clover pasture?

MR. WYLIE—Spring pigs and brood sows should be fed about all they can eat in addition to the clover. But if you have some shoats or old hogs that have been wintered, a run of a month or six weeks on grass alone will put their system in the best possible shape for utilizing the corn to the best advantage when you begin to feed it.

QUESTION—What is a good daily gain for hogs on pasture?

MR. WYLIE—On grass alone a hog will make little or no gain whatever; grass as an exclusive food for hogs has been greatly over estimated; as far as gain made is concerned about all there is in grass for swine is that it keeps the system in shape to utilize the grain fed to the best advantage. If you feed grain to swine on grass the

amount of gain will depend entirely on the amount of grain fed; the more grain you feed the less grass they will eat; this is why I favor a run of a month or six weeks on grass alone for hogs that have been wintered, and then putting them on a full ration of corn to finish them up quickly.

QUESTION—In what manner should corn be fed to hogs?

MR. WYLIE—I usually feed mature hogs corn in the ear; for pigs I shell and soak. I don't think it pays to grind corn if it can be soaked?

QUESTION—Does it pay to grind oats for hogs?

MR. WYLIE—In feeding oats to young pigs if I had plenty of shorts to make slop I would soak the oats. In the absence of shorts I would grind the oats and make slop with them; for mature hogs such as brood sows during gestation I would feed the oats dry without grinding.

QUESTION—Is it advisable to cook food for swine?

MR. WYLIE—An occasional meal of cooked food is good by way of supplying a variety. But the conditions under which it will pay to feed cooked food exclusively are very rare. A large crop of pumpkins or potatoes that there is no market for would justify the feeding of considerable of them cooked and mixed with meal.

QUESTION—Which is considered the cheaper wheat or barley at the same price per pound?

MR. WYLIE—I would take the wheat and grind it as it makes the best kind of slop.

QUESTION—Can you make hog raising a success without dairying?

MR. WYLIE—Yes, but dairying makes it easier, that is if you are making butter.

QUESTION—Can you tell us anything about the feeding value of whey?

MR. WYLIE—As whey is usually fed it has no value in fact. I think it an injury to feed sour, acid whey to young pigs, and even when fed sweet I don't think it of much value, unless a certain amount of shorts or meal is mixed with it; fed in this way it has a feeding value, but not half as much as skim milk.

QUESTION—Have you had any experience in raising fall pigs for fattening the next summer.

MR. WYLIE—Yes, pigs farrowed after the middle of September as a rule seldom pay for raising in this latitude; young pigs are very difficult to make thrive in cold weather, and we should aim to raise them under as favorable conditions as possible when the weather is warm.

QUESTION—What is your treatment in case of scouring in young pigs?

MR. WYLIE—There are several remedies—first hold up on the feed of the dam or change it to

something else. If this does not stop it take a lump of alum the size of a walnut, dissolve it in a pint of water, give each pig a teaspoonful three times a day. Another good remedy is to parch wheat flower until brown, and mix it with skim milk and feed it in the same way; or if the pigs are old enough to eat feed it in a trough. This last is an excellent remedy for scours in calves or young colts.

QUESTION—What is the comparative value of a bushel of corn fed in June or July, when the hogs have the run of a good clover pasture, as compared with a bushel when fed in January or February, with the thermometer 20° below zero?

MR. WYLIE—Over 100 per cent. in favor of summer feeding.

QUESTION—Under what conditions may corn be fed exclusively to hogs?

MR. WYLIE—When they are being finished up for market.

QUESTION—How many breeding sows should run together during gestation?

MR. WYLIE—With plenty of room we allow 15 or 20 during the first half of gestation, but later we divide them up, putting those of the same size and disposition together as near as possible. The last month four or five old sows are as many as we allow together.

QUESTION—Is it essential that pigs should have any corn until 60 days before marketing?

MR. WYLIE—Under certain conditions it may not be necessary, but you should remember that with us corn is cheap feed usually, and I always feed some corn from the time a pig is old enough to eat it.

QUESTION—How many pounds of pork can you make from a bushel of ensilage?

MR. WYLIE—That will depend entirely on the amount of corn in the ensilage. If there is no grain in the ensilage I don't think your hog will get very fat on it, and if there is grain in the en-

silage the hog will eat the grain and leave the stalks and leaves.

QUESTION—Does barley make good food?

MR. WYLIE—I don't like barley to feed by itself; pigs get tired of it very quick unless you are very careful in feeding it; it is best mixed with something else, such as bran or shorts. If I had only bran to feed it with I would grind the barley and mix the bran with it; if I had shorts, I would make slop of the shorts and soak the barley without grinding.

QUESTION—In the absence of skim milk, what is the best food for young pigs?

MR. WYLIE—Good shorts, middlings, or ground rye made into slop and fed in connection with soaked corn.

QUESTION—How about rye for brood sows during gestation?

MR. WYLIE—I don't think it a safe feed for brood sows at that time.

QUESTION—In increasing size which is preferable, a coarse boar or sow?

MR. WYLIE—I think there is not much difference; the progeny will, as a rule, be a compromise between the two as regards size.

QUESTION—How do you kill lice on swine?

MR. WYLIE—Take kerosene and lard, equal parts, melt the lard and pour the kerosene into it; make a swab by tying rags on a stick, and apply at once. Two applications, allowing a week to intervene, will usually be sufficient. Crude petroleum oil will answer the same purpose as the lard and kerosene, but is not always so easily obtained.

QUESTION—What is the size of the small pens that you gave the bills of lumber for?

MR. WYLIE—The A-shaped is 8 feet by 8 feet on the ground, and the roof is the same. The other is 16 feet long and 8 feet wide, 7 feet high in front and 3½ in the back.

FOR FARMING.

THE SOW AND HER PIGS.

By A. SELLE, Mequon, Wisconsin.

MR. A. SELLE, of Mequon, Ozaukee County, Wisconsin, is one of the best known pig-raisers in the State of Wisconsin. He has made a specialty of winter pig-raising and the care of the brood sow and her pigs, particularly of the latter. He is an enthusiastic believer in Farmers' Institutes, and one of the most earnest and valued members of the Wisconsin State staff of institute workers.

His own knowledge of pig-raising is, he says, gained wholly from personal experience, and to perfect his knowledge he has himself carried on many experiments. The art of "little pig-raising" is, he thinks, still in its infancy. The following article by Mr. Selle was specially sent to us by him for publication in this "Special Swine Number." For portrait of Mr. Selle, see next page.

Now that it is the time when little piggies commence to put in their appearance, it may be well to offer a few items. In order to raise good and

healthy pigs it is a general rule to begin four months previous to their birth. Having selected a sow with well-developed characteristics of the

espective breeds, in order that they will be transmitted to her progeny, and from a mother that has proved to be a faithful mother, a good milker, and has raised a large number of pigs in each litter, it is essential that she receive the proper care, so that the best results may be had. After breeding, feed so as to have her in good flesh; it is not advisable to feed too much corn during gestation, but, on the other hand, do not go to the other extreme and keep her too thin, and make a waiking skeleton of her, especially with young sows coming in with their first litter. If stunted too much of proper food, and it happens they get a large litter, they may easily be fed so that they resemble a bag of bones.



Mr. A. Selle, Mequon, Wisconsin.

CONFINEMENT NOT GOOD.

Do not confine the sow in a small pen during pregnancy and leave her there, and then expect good results. Not only is plenty of exercise in the open air very beneficial to those suffering considerable swelling of the genitals at the end of gestation, but the pure unpolluted air is what they should breathe for the benefit of their health.

KEEP THE BOWELS RIGHT.

The main object is to keep their bowels in a good condition, and it is better to feed more sloppy feed during gestation. Should you notice constipation, especially several days before farrowing, feed some soaked meat scraps or a few doses of a spoonful of Epsom salts. When the sows come in late in the spring, and have a chance to eat grass, then they will do their own

doctoring and keep their bowels regular, but winter is the time when they need attention. Whoever has a supply of roots or unsalable potatoes should feed them daily, either raw or boiled; these things are an excellent substitute for grass. If you have no roots, meat scraps, drugs, or potatoes, run some bright clover hay through a cutter, steep and mix it with middlings, lobbered skim-milk, and water. This is another good and cheap medicine to correct the stomachs of pregnant sows.

CAREFUL FEEDING NECESSARY.

But the feeding of slops and clover as described is not nearly as handy as feeding grain dry and letting the hogs drink at some creek, etc., but with this extra labor I never had trouble with the sow or her pigs. To feed a sow the proper food and have her in the right condition beforehand, is, as a rule, the best assistance we can give her during farrowing time, for then she will not get so feverish and restless, jump up and down, and lie on her pigs; neither will her stomach crave for some unnatural food so as to cause her to make a meal of her newly-born children. We often find some exceptions with the best of care. Some unruly sows will not own their little ones and will eat or kill them. Such cannibals should be discarded from the breeding pen.

FARROWING TIME.

When farrowing time draws near—every intelligent farmer will know the period of gestation with the sow by noting the day of coition—it is a good plan to give her a pen to herself a week or two before farrowing, so that she will get used to her quarters and fix her bedding for herself; but never use too much or too long straw for bedding, because the little ones will sometimes hide in it and get accidentally smothered by the sow lying on them.

Some sows, if they are too heavy and fat, are too lazy and will not get up when they lie on one of their pigs and hear them squeal. I have known sows that would lie their pigs to death, even when they were over a week old. For such careless mothers it is well to have a shelf or pole twelve inches from the floor, under which the little pigs can protect themselves by creeping under it.

Now, in regard to feeding the sow after farrowing, one has to use some judgment. The first day she needs no food at all, and the first week only half rations should be given her; and then increase the feed gradually. Be governed by their conditions as to how much feed they shall have; all do not require the same amount, and no iron

clad rule that will fit every case can be laid down.

CAKED UDDER.

When the pigs are born it is their natural instinct to crawl towards the udder for warmth and their first meal. If they all suck, then they are on the right road to make a living; but if they are restless, squeal, etc., then it is time to investigate, for there is usually something wrong, for very often the sow gets a so-called caked udder. If the swelling is not very bad, it will naturally pass away in a few days without leaving any bad results, very often not being noticed by the owner. If the udder becomes very badly caked there are only two remedies to be applied, either to feed and raise the pigs by hand, or let them die. If the pigs are very valuable it is worth while to bother a little. Some recommend to bathe the udder with hot vinegar and water, or salt water, every half hour or so, and feed the pigs with a bottle.

If the milk can be removed, or the milk flow can be started, it may come out all right, but in many cases it is guesswork. I will give a few cases of my own experience: A few years ago a sow came in with a dozen pigs, but I noticed there was something wrong only when the little ones began to die, and all went that way except two; no bathing with vinegar or salt water gave any relief, for the little ones became weaker by not getting sufficient milk.

Another time a sow farrowed eight pigs and had a badly caked udder. The pigssucked with-

out getting out a drop of milk. We bathed the udder with hot cow's milk and water while the pigs were sucking, and so they got at least some of the cow's milk—which answered two purposes, first to soften the udder, and also to furnish a little for the pigs.

When pigs huddled together in their nest and did not suckle, we heated one-half gallon of beer, in which we melted a pound of fresh, unsalted butter, and rubbed the udder with this mixture. This was to soften the udder and reduce the swelling. If any one is afraid of the beer, and fears he may be led into temptation and drink it himself, he may rub the udder with two ounces of laurel oil and two ounces of marshmallow ointment. Mix well and rub gently and thoroughly. As feed I fed that sow brewers' grain and middlings to increase the milk flow and to encourage the little fellows in sucking. We also washed the udder six or eight times with the cow's milk and water. After the second or third day the natural milk flow set in in the udder and the swelling was reduced, and of course the high feeding of grain and middlings was stopped.

It is hardly necessary to write any more on this subject, for volumes could be written, and we cannot learn it all from hearsay, and experience is the best teacher.

THE YOUNG PIGS.

When the pigs are about three weeks old they will commence to eat. If the sow's trough is long and shallow they will eat a little with her, otherwise place some milk or soaked corn or wheat in a place where she cannot get it, and the little ones will soon find and make use of it. If they have exercise and clean bedding they will gain rapidly, but if once a little pig becomes sickly it is the most sensitive animal on the farm.

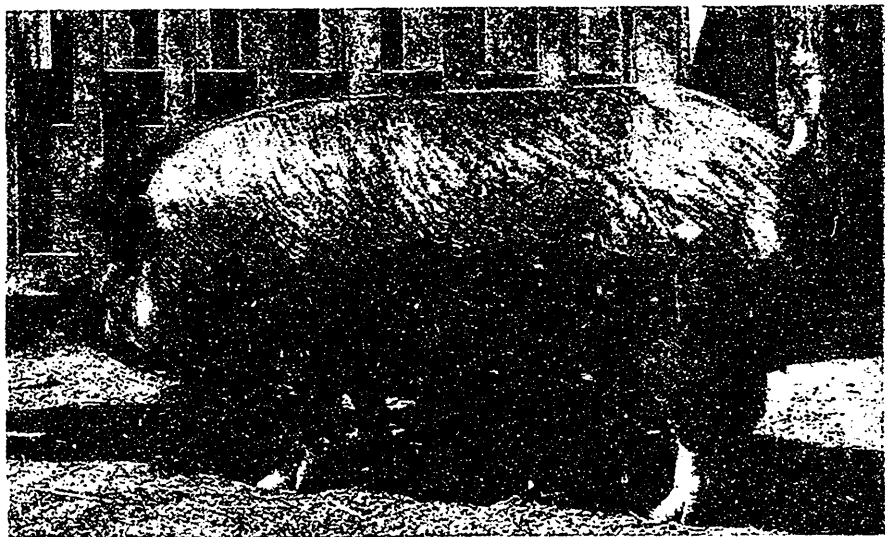

Elphicks' Matchless. Berkshire Sow,

The property of Mr. Edwin Buss, Horsmonden, Kent, England, a well-known advertiser in *FARMING*. Elphicks' Matchless has never been beaten wherever shown. She was first at the Royal, and the Royal Counties, and other leading shows.

SWINE FEEDS AND FEEDING.*

By A. SELLE, Mequon, Wisconsin.

FEEDING.

Almost all kinds of food lack some important elements in their composition, when fed alone, except milk. For instance, use corn and water alone, and in a short time the pigs will become costive and feverish and the appetite grow less. Under all circumstances our domesticated hogs need a variety of food to keep up a keen appetite, and keep them in a healthy and thrifty condition, and if the object is to induce them to eat as much as possible, nothing is so calculated to stimulate the appetite as variety; but for growing hogs this variety should not be all of a concentrated character, as corn, peas, and barley, but rather we should make up half the ration of a coarser or more bulky texture, as clover or ensilage, having less heat-producing and fat-forming elements.

are numerous, and you cannot turn up anything grown on the farm that a hog will not eat. But in order to obtain the best results the feeder should be a little acquainted with the elements of the foods he uses; also with the relative quantities required for sustaining the animals and maintaining their growth. There are certain foods, excellent in their way, which, when given judiciously, are useful to pigs, but which without the addition of other substances would not only fail to increase their weight, however large the quantity given, but would prove not sufficient to keep them in a healthy condition. The cheapest food for hogs that we can raise is clover or grass, and in corn we have perhaps the best food for fattening that can be found. The corn should be brought to the feeding places and simply thrown



Trio of Prize-winning Chester Whites.

Owned by Thomas Brooks, Brantford, Ont. White Bag, in the centre, was bred by Wm. Butler & Sons, Dereham Centre. He is 20 months old and weighs 400 lbs. Lucy and Peggy, the two sows, are sisters. They are two years old and weigh 450 lbs. each in breeding condition. They have had two litters each, 37 pigs in all. The trio have won prizes wherever shown. [NOTE.—The photo from which the above engraving was made shows the pigs dark on a light background; it should have shown them light on a dark background.]

At present prices pork cannot be profitably produced on an all-grain ration; neither can it be produced on an all-grass ration. Where hogs are raised on a large scale, corn still is the handiest food, but there is no manner of doubt that corn is sometimes used unwisely and harmfully, and the hog crop is being raised every year often at a loss, when it might be at a greater gain.

CONSIDERATION IN FEEDING NECESSARY.

In hog feeding there are a good many things to be considered, although it is believed by a large class of people that hog feeding is as simple as that two and two are four, and the idea of conducting a system of feeding seems to them regular nonsense. The foods that are used for feeding

on the ground where the hogs may help themselves, and pick up their food out of the dirt.

GOOD QUARTERS NEEDED.

Most hog stables are nothing but miserable little shanties, very often a fence corner, where the hogs must live in filth and dirt, tormented by all sorts of vermin. Now I will say that it is not necessary to have an expensive or stylish hog-house, but their sleeping places should, in all cases, be clean and dry, well ventilated, and well provided with bedding. Rye straw makes an excellent bed for hogs, and they will appreciate it as much as their owners do a feather bed. When hogs are lying without shelter and in wet stables, they are liable to pile themselves up in their efforts

*From an address given at a Wisconsin Closing Farmers' Institute, published here by the courtesy of Mr. W. H. MORRISON, Superintendent.

to keep warm, and often the under ones are suffocated, and all are liable to scald, or grow mangy; and wet bedding will also produce coughs and distemper, and if a contagious disease is around in the neighborhood the hogs so neglected are just ready to catch it.

Such methods of feeding and handling hogs can in no way be recommended, and it is really strange that hog diseases do not appear more fre-

quently, or a filthy hog pen with improper food, is a genuine hot-bed of diseases.

THE HOG IS A SENSITIVE ANIMAL.

The hog, in its natural, wild state, is more vigorous and enduring than when domesticated, and, therefore, less liable to disease. But as raised and fed under our handling, close breeding and high feeding, it is one of the most sensitive ani-

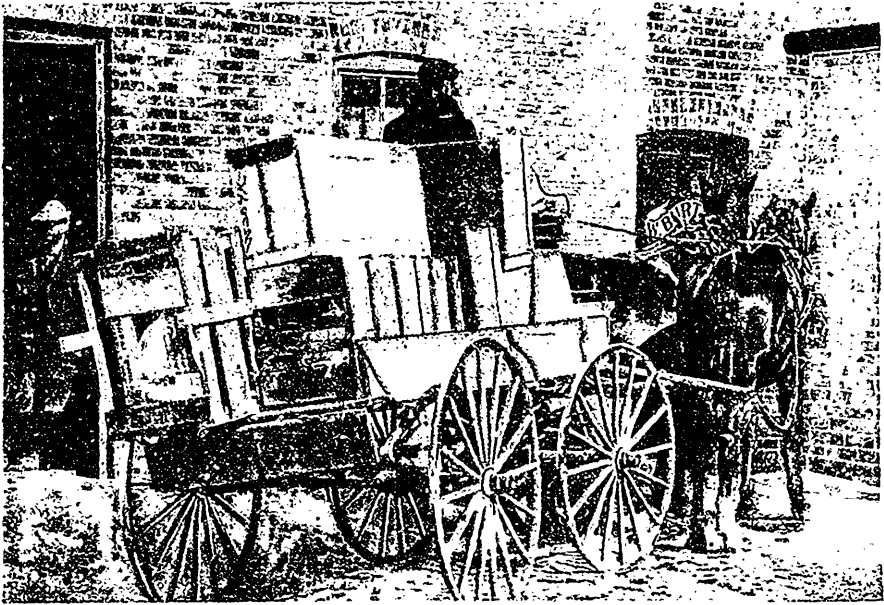

This is a picture of a scene that happens all over the farms of farming. The pigs are off for a ride in the express cars for their houses in the north. The horse is now waiting in the barn and is now ready to leave for the train. Time is nearly up. & trains wait for no one.

March 22nd 1897 Jas. H. Shaw
 Simcoe Ont.

mals on the farm. Disease is not natural to hogs any more than to the horse or cow; they do not get sick easily, but they will succumb to some diseases so rapidly that assistance often comes too late. They are, in many cases, not observed to be sick, until they are seen to creep around, hide themselves, and refuse food, and finally they die, very often without the owner knowing what ailed them. The diseases of hogs are more difficult to diagnose than those of other animals, as their obstinacy or stubbornness makes a thorough examination of them almost impossible. On the other hand, many symptoms, as, for instance, the pulse, cannot be made proper use of. The first reason makes their treatment when sick very difficult, as they refuse to take medicine, and the result is naturally less certain than with other animals. It is, therefore, in the interest of the hog raiser to prevent disease by proper care and food, for in the mistaken idea that a hog can stand everything the hog is often not taken proper care of.

MANAGEMENT.

The manner of hog raising, and the kind of breed most profitable for each particular farm, cannot very well be indicated, as this is a matter of taste or fancy, and all popular breeds are good and have their advocates. One of the first important points to be attended to is the condition of the sow at the time of breeding. She should be in a good healthy condition, well developed, but not too fat. When she is pregnant I give her free exercise in the yard or field, and I do not feed her too much corn. A slop made of ground corn, oats, and middlings, mixed with steeped clover, also vegetables, and all kinds of roots, is good. If one has skim milk it is still better to mix the slop with that, as there is less danger in over-feeding, and the bowels are kept open and regular, which is a good point.

Oats are a natural horse food, but it is very beneficial to give them to growing pigs as well as to breeding stock.

FARROWING.

Next comes farrowing time. Each sow should have a separate pen, in which she is put a week or two before farrowing, in order to get used to it, and not be fretful. Do not use long straw for bedding; a few baskets of coarse straw will do. After the sow has farrowed do not commence to stuff her at once, with strong slop or heavy feed. The first day or two she needs almost nothing, only a little warm water, then a light slop made of clover leaves and middlings, for a few days, and increase her food gradually. Give her some oil-

meal once or twice a week, and don't forget to add skim-milk.

THE YOUNG PIGS.

When the young pigs are about three weeks old they will commence to eat, and it is a good plan to have holes so that the little pigs can slip through them into another pen. In this I put shallow vessels, with milk and ground feed or soaked wheat and corn to induce them to eat. From this time on I give the sow plenty of good rich slop, made of middlings, corn, oatmeal, and bran. Nothing will increase the flow of milk like bran, and I very seldom forget to add skim-milk. Also push the little ones. Give them all they want to eat; keep them growing all the time, and don't stunt them. The most profit I get out of a stunted pig is to knock him on the head. If at the end of six or seven weeks the piggies are growing nicely and look well we may think of weaning, but it should not be determined by their age, but how they are eating and growing, and their ability to take care of themselves. I continue to increase their feed, and begin to diminish the feed of the sow. This must be done gradually and continue two weeks. I then take away the two strongest ones in a litter, the next two two days after, and so on till all are weaned. This will prevent a caked or spoiled udder, and if there are any smaller ones in the litter, on account of poor teats, they can keep up with the rest.

I then put them on the pasture when the weather is suitable, as that is the best place to keep them. If you keep them shut up in an old pen all summer, with its unhealthy surroundings and bad atmosphere, which is particularly injurious, you are losing money.

CONDITIONS OF SUCCESSFUL FATTENING.

Another important point is successful fattening, and the sole end of hog breeding is to obtain a large quantity of meat, of a good quality, in as short a space of time as possible. A cheap and quick fattening depends greatly upon the health and age of the hogs, as well as upon the season and condition of the food. On account of its rapid digestion, hogs cannot assimilate food dry, and it should therefore be prepared in such a manner as to make the loss as small as possible. I would prefer all grain ground fine—only for a change I give it whole, but well soaked. Some good feeders are in favor of giving all grain, as corn, well soaked, and never would feed it ground. Which of the two will give the best results any one can find out easily by giving both methods a trial. To begin to fatten lean hogs with rich food from the start

is a wasting. Full rations of corn or peas ought to be left for the finishing of the process. I feed three times a day. The same amount of feed, given in three portions, is better than when given in two portions. Feeding should be done regularly at the same time each day, and not too early in the morning, for to get up too early does not suit a hog any more than ourselves when we have to get up and build the fire on a cold morning.

On hot days in summer, and when the pigs are on pasture, I only feed twice a day—morning and

CONCLUSION.

To sum up, we have to direct our attention towards obtaining a short and profitable fattening. This, with a normal development of the body, will be greatly assisted by pasturage for the animals, and will be accompanied by the best results the more regular and uniform the feeding takes place during the first seven or eight months. The farmer should not try to get his hogs to an extreme weight, but should sell them before they

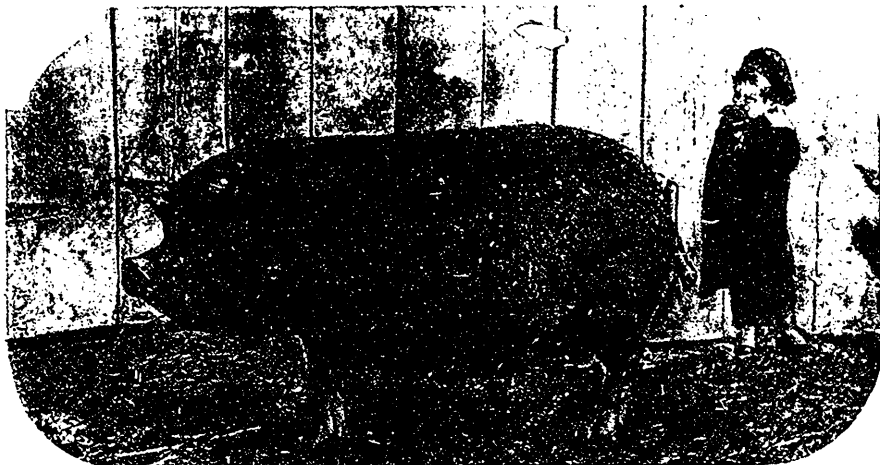

Cressman's Lucy. B. Berkshire Sow,
The property of T. A. Cox. Brantford. Described by her owner as a grand sow and one that is breeding excellent stock.

evening—and I never feed more than what is eaten up clean, as pigs prefer fresh feed, no matter where it comes from. Some rules have to be observed in fattening to insure success. The best rule is to have the previous feed succeeded by one that is more nourishing, and when the appetite begins to diminish to feed less in quantity but of higher quality.

REST AND QUIETNESS.

As much as breeding and growing animals need exercise for their prosperity, hogs that are fattening need rest and quietness.

have cost too much. Besides, the meat of young quick-fattened hogs will sell better than that of older fully fattened animals.

We often see at fairs hogs that look like real monsters. The head is hardly visible, deeply hidden in fat. The legs stick deeply in the body, and are hardly able to carry it. From a short distance the hogs look like giant potatoes resting on four pegs. Such fattening is only a hobby, which may prove useful for the purposes of exhibition to show the fattening capacity of a breed, but it is not profitable to the farmer in any way.

JAMES SHEPHERD, Queenston, Ont., Director of Good Roads Association of Ontario, writes: "Sir,—I am very much pleased with FARMING, especially the report of the Industrial Fair in the October number. I never dreamed you could have got together the different articles in the 'good roads exhibit' so as to make so fine a picture. The 'Good Roads Association' should feel that you have done your part in the work by printing such a fine picture of the exhibit of road-making machinery, and by giving so good an account of the history of the association and of its objects and aims."

THE UNIVERSITY OF WISCONSIN AGRICULTURAL EXPERIMENT STATION, MADISON, WIS. . . . "The appearance of FARMING is certainly fine. I do not wish to have you think that I am seeking to say only sweet things of FARMING, but I really think you are putting the magazine on the same plane in literary merit and press work with our best magazines. I have considerable confidence in the people that read, and I believe they will appreciate what you are giving them." JOHN A. CRAIG (Professor of Animal Husbandry).

SOME NOTES ON THE HOG QUESTION.

By G. E. DAY, B.S.A., Agriculturist, Ontario Agricultural College.

RESULTS OF EXPERIMENTS MUST BE ACCEPTED WITH CAUTION.

Questions relating to the characteristics of different breeds of hogs are of such frequent occurrence, and, moreover, of such importance, that it has been deemed expedient to commence a series of experiments at the Ontario Agricultural College, with a view to studying the question systematically. Breed experiments are attended by many difficulties, and possess some objectionable features which it may be well to note in passing. In the first place, it is difficult to obtain representative animals of the different breeds. Two pigs from the same litter may be obtained which evince a wider difference in characteristics than commonly exists between two distinct breeds. These differences are frequently not noticeable when the pigs are small, but become very apparent before the animals are ready for market, and, as the pigs must be selected while they are small, the results are sometimes very unsatisfactory. This being the case, it becomes necessary to repeat the experiment a great many times before anything like satisfactory conclusions can be drawn. Then

again, the hogs in one group may meet with some accident or other unfavorable condition which interferes with their growth and thriftiness for a time, and which counts against them in the end, affording another reason for repetition.

The objectionable side of the question lies in the fact that the public is too apt to draw hasty conclusions, losing sight of the considerations just mentioned. Also, the admirers of some particular breed are too apt to make capital of the fact that the results of some single experiment

favor the breed in which they are interested, forgetting that subsequent experiments may give different results, and, in some cases, ignoring the results of those tests which give a less favorable showing.

WE MUST NOT EXPECT ONE BREED TO EXCEL ALL OTHERS.

But in spite of difficulties, objections, and abuses, definite information is required, and there is no way to obtain it except by feeding the breeds side by side, studying them under different conditions, and comparing the carcasses after they have been butchered. We must not expect any one breed to excel all others in every respect; that is a position which, in all probability, will never be attained by any breed; so that all that can be hoped for in this line of investigation is to obtain reliable information regarding the purposes to which each breed is peculiarly adapted, and to study *why* it should be regarded as a distinct breed. Every breed has its own merits, and its own deficiencies, and careful experiments will serve to show what these merits and deficiencies are.



G. E. Day, B.S.A.

Agriculturist, Ontario Agricultural College. For biographical sketch of Mr. Day, see *FARMING* for December, 1896, page 277.

THE CAREFUL BREEDER, HOWEVER, MUST WATCH THE RESULTS OF EXPERIMENTS.

As to the experiment conducted at the Ontario Agricultural College last summer a full report of the results appears in our annual report, so that it is needless to state them here. It is to be hoped that no one will draw rash conclusions therefrom, for this year's results may show an entirely different arrangement. But, while it is too soon to draw conclusions, there are certain points brought

out which may set the careful breeder thinking, and place him on his guard. For example, it is stated in the report of the Wm. Davies Co. that the Poland-Chinas in this experiment showed a tendency to thickness of back and thinness of belly. Now, it does not follow that all Poland-Chinas possess this objectionable character, but the fact that the individuals in this experiment were more or less characterized by it, should cause the breeders of Poland-Chinas to be on the lookout for this defect, and to study carefully how it may be avoided. The defect mentioned was not confined to the Poland-Chinas, as a perusal of the report will show, and it has been selected for mention here only as an example of the practical side of the question.

THE TYPE OF HOG NOW DEMANDED BY THE BUYER.

Nearly every breeder knows, or should know, the type of hog which brings the highest price on the market at present. Thick, fat pork is at a discount, and the demand for it is a very limited one. If I were asked to describe the type of hog which the market demands, I should do so somewhat as follows:

- (1) *Weight*: slightly under 200 lbs.
- (2) *Form*: head, medium; neck, medium length, not arched; shoulder, compact, smooth, no wider than back; back, straight, medium in width, uniform in width; side, deep; belly, fleshy, not falling away, thickness through belly being equal to width of back; hind quarters, long, same width as back; ham, well developed, showing no flabbiness.
- (3) *Bone*: medium, not extremely fine, nor yet coarse.
- (4) *Skin*: smooth and fine.
- (5) *Condition*: moderately fat; when cut down the back, the fat should not be more than one inch thick, and should be uniform in thickness from rump to neck. The belly should be thick and fleshy; a thin belly gives poor quality of bacon.

A thick, arched neck and a very broad shoulder indicate too great a depth of fat at this part, while the fat may be lacking in depth over the loin. A loin low and narrow in proportion to remainder of back, indicates lack of depth of fat in proportion to depth on other parts. A very broad back, with the body falling away in thickness towards the belly, indicates a thick, fat back, and a thin, flabby belly.

It is a mistake to assume that the packer wants a "razor back" or a light hammed hog; but he wants something intermediate between this extreme and the "rolly poly" type that used to be popular in the years gone by.

The question arises, can all of our more prominent breeds of hogs be brought to the standard required by the packer? This question cannot be answered off-hand, but will probably require years of patient work. It is possible that the main utility of some of our breeds will be found to lie in their value for crossing purposes, and the question of cross-breeding opens up another important field for experimental work.

THE LIGHT-WEIGHT HOG IS USUALLY THE MOST PROFITABLE.

It is frequently complained that the packer wants the hog at too light a weight, and a few figures obtained from American experiments

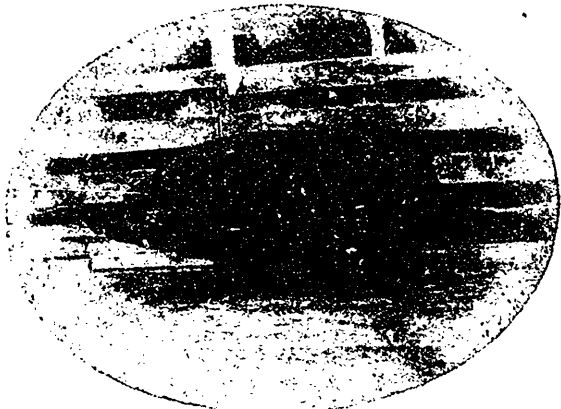

Duroc-Jersey Sow,
The property of W. & H. Jones, Mount Elgin, Ont.

may be of interest just here. The following table shows the gain and cost of gain at different stages of growth, as obtained by Professor Cooke of the Vermont Experiment Station:

	Average weight at end of period.	Average cost of food per pound of gain.
	Pounds.	Cents.
Period 1.	51	2.47
Period 2.	104	3.70
Period 3.	160	4.89
Period 4.	202	5.82

The prices assigned to the foods used in this experiment are considerably in advance of present prices, but the table shows that the cost of producing a pound of pork increases very rapidly as the hog increases in weight, and that there is

little profit in feeding a hog after he passes the 200 pound mark.

It is also complained that buyers do not discriminate in price so closely as they should, and there is considerable ground for this complaint; but the fact that they *do* discriminate shows the tendency of the times. The thin edge of the wedge has been entered, and it is merely a ques-

tion of time until we have a more perfectly graduated scale of prices.

It may be that the opinions advanced in this article may not meet with general approval, but if they serve to set some one thinking, or bring on an intelligent discussion of the subject, they will have answered the purpose for which they were intended.

PRACTICAL POINTS IN SWINE-RAISING.

By E. H. BATE, Brighton, Ont.

Mr. E. H. BATE, of Brighton, Ont., is a member of the well-known firm of L. B. Bate & Son, breeders of South-down sheep and Poland-China and Tamworth pigs. Mr. Bate was born in 1869, and was brought up on his father's farm. Desiring to get as good an education to fit him for farming as he possibly could he determined to take a course at the Ontario Agricultural College, and spent some time there; but the serious illness of his father prevented him from finishing his course. He attributes, however, a good deal of the knowledge which he has since



E. H. Bate, Brighton, Ont.

acquired relating to the care and management of live stock to the ideas which were imparted to him while a student at the college. Since leaving the O.A.C. he has worked continuously on his father's farm improving it as much as possible, and for some years has had entire charge of it. He is an enthusiastic Farmers' Institute worker, and has been a director for some years of the East Northumberland Institute, and an officer in both his township and his county agricultural society. On his farm all grain, etc., is fed, none being sold excepting perhaps at times a little wheat. He is a believer in corn as a cheap food, and raises a good deal both for hogs and cattle.

THE BOAR.

A healthy condition in the breeding boar is a necessary requisite to secure good pigs. The boar should at all times be kept in a good, healthy, muscular condition, and be fed such foods as will develop good bone and muscle. He should not be very fat. He should be fed a variety of foods, such as bran and shorts, with a mixture of oats, corn, or peas, ground together with skim-milk and slops from the kitchen, or with whey when this is at hand. He should have plenty of exercise, and not be confined on a board floor too much. He should be handled and used kindly from a pig up. A good brushing with a stiff brush tends to give him a good coat and a healthy skin, and helps to keep him kind and easy to manage.

BREEDING.

When six months old the boar may serve two sows a week, but it would be better if he were not used until eight months old.

When you breed a sow to him turn her into his pen and let him serve her once, and then turn her out and keep her alone until the period of heat has passed off before you let her go in with her mates again.

Most breeders use a breeding box, and I think this is much the best way, as such a plan is much easier on the boar. By the use of a box a very small boar may serve a very large sow, or a heavy boar may serve quite a small sow.

The young sow may be fed and used in much the same way as I have described for the boar pig. She should not be bred before she is eight months old, and she would develop better if she were not bred until she were about a year old.

Make a note of the date of service and add 112 days and this will give you the date your sow should farrow. She may go a day or so under or several days over, but the period seldom varies more than a day or two.



Chester White Sow and Pigs.

The property of James H. Shaw, Simcoe, Ont. Bred by Willis Whinery, Salem, Ohio. One year old last October. The litter numbers 8 pigs farrowed March 1st last, and sired by Wm. Butler & Sons' "Combination's Choice," who was first in his class at Toronto last fall.

FARROWING.

There are several indications that the event is near. The udder fills and is hot and feverish. As a rule from nine to fourteen hours after you can squeeze milk from the teats you may look out for the young grunters.

The sow should be put in the pen where you intend her to farrow at least a week before her time is up. Handle her gently and make friends with her so that you will be a welcome visitor to her if you are needed when the critical time comes.

The pen should have a guard or fender around three sides of it about eight inches from the wall and about the same distance from the floor. This fender will help to keep the young pigs from being lain upon. The sow should be bedded lightly with cut straw or chaff, as in that case the pigs are not so liable to fall and be trampled on as they would be when long coarse bedding is used.

As a rule, I prefer to stand aside and see what the sow can do herself, but if the weather is cold or the sow inclined to be vicious and eat her young, then it is best to interfere. Have a bushel basket at hand with a blanket to cover it. You should also have some soft cloths with which to wipe and handle the pigs. As each pig is born grasp it with the cloth and cut the navel string (about 10 or 12 inches) with a dull knife or a pair of scissors. Wipe the young pig dry and place it in the basket, and set the basket away from the sow. When the youngsters have all arrived, the pig-bed or after-birth will

nearly always come away. It should then be removed, the former bedding taken away, and clean bedding be supplied. Give the sow a small bran mash. After she eats it, she should be induced to lie down, and then you should give her the pigs, and see that each pig gets his share of nourishment.

MANAGEMENT OF SOW AND YOUNG PIGS.

The bran mash is all that is required for twenty-four hours. Afterwards, for a week, the



Our Choice. Chester White Sow,

The property of Bennett & Pardo, Charing Cross, Ont.
Age 5 months. Weight 235 lbs.

sow should be fed a light, soft diet, after which she should have all the mixed ground grain and bran or shorts she will eat three times a day. Skim-milk, whey or slops, and peelings from the house, will also help to make up the sow's diet.

The pigs may be weaned when a month old, but it is better if they are not weaned until

six or eight weeks, especially if the sow is a good milker.

Some castrate while the pigs are on the sow at two or three weeks old, but I prefer to castrate at eight or nine weeks, as the pigs are larger and stronger, and better able to stand the operation.

FEEDING.

After the pigs are weaned, I think there is nothing that equals skim-milk with a mixture of shorts and oats to give them a good start. If

they are of spring litters, they may be pastured on clover for a few months before being finished off for the block. In winter roots may be used with profit, and take the place of the pasture in summer, but the hogs will then also need a liberal grain ration.

Hogs of all kinds and ages should have access to a mixture of ashes, salt, and sulphur, and if they will not take to it of themselves a little may be mixed with their feed, and constantly fed to them that way.

THE CARE OF THE BROOD SOW.

By S. COXWORTH, Whitby, Ont.

MR. SIDNEY COXWORTH, of Whitby, is one of the younger ones of the men whose successes in the show ring entitle them to a place in the first rank of breeders and importers. He started to keep Berkshires about ten



years ago, and has never since seen reason to give up his preference for that old and well-established breed. He determined, at the very beginning, to work up a good herd. From the first he paid great attention to the feet and legs of his breeding stock, and now has a herd characterized by their strength and soundness of limb, and this without coarseness. He has also worked hard to obtain extra length of body and a strong constitution in his hogs. In this respect he has been very successful. As an exhibitor Mr. Coxworth has had good success. He began, of course, with the smaller shows, but in 1892 he tried the larger shows and had fair success in Toronto, Montreal, and Ottawa, success that was sustained, and even bettered in 1893, 1894, and 1895. In 1894 and in 1895 he went to the Northwest and showed at Winnipeg and Regina, where he was exceedingly successful. In fact, he swept all before him, and the strongest competition he had was from his own stock. In 1896 he went to Winnipeg again, where, with the exception of a first and two seconds, his stock and their get carried off all the first and second awards of the show, a fact which may be taken as a strong testimony to the excellence of his herd. In 1896 Mr. Coxworth first imported for himself. In his importations he laid the greatest emphasis on the same characteristics that he had previously been developing in his own breeding, namely, length of body, depth of side, well-filled hams, and good, sound, strong legs and feet. Mr. Coxworth is entirely a self-made man. He began to farm for himself when only twenty-one years old.

The swine industry of to-day is one of the most important branches of agriculture, and should receive more attention from our farmers. The force of this statement is especially seen when we consider the present low prices of grain: corn, 25c.; peas, 35c.; barley, 25c.; oats, 18c. How the farmer can sell his grain on the market at these prices and make both ends meet is the problem of the day. But when we turn to the pork industry and note the remunerative prices which hogs bring on the stock market, our hopes rise, and we see in the raising of hogs a chance to make money.

A GOOD BROOD SOW ABSOLUTELY NECESSARY.

The first and most essential thing to do in starting out to breed hogs is to select a brood sow; and in this matter we cannot be too careful. Whatever may be the breed of hogs we decide to select from we must make it our first aim to select for our brood sow none but the best.

Every farmer should have, at least, one good brood sow. By purchasing a good spring pig from a reliable breeder, the outlay required to get one will be comparatively small.

No animal on the farm will give its owner such a liberal increase for the money expended on it

and the food consumed by it as a good brood sow. And yet how often we see the brood sow of the farm neglected and turned in to pick up a living with a lot of half-starved hogs, or let loose in the barnyard to do battle with the cattle and run her chances of being gored by them, and compelled whenever she needs rest to lie in some damp, filthy place courteously designated by her owner as the pig pen!

FEEDING THE BROOD SOW.

In order to have your brood sow as good as she can be you should give her proper attention from the time she is weaned. Feed her on such food as will tend to develop bone and muscle without producing too much fat, and, at the same time, feed her such food as will keep her in good condition.

her to the best purebred boar in your district, even though it should take a whole day to do so, and I will assure you that you will be well repaid for your day's work, even though you may have to pay an extra dollar for the service of the boar you choose.

PREPARATION FOR FARROWING.

About ten days before farrowing time place the sow by herself in a warm, dry pen, around which has been placed a 2x4 scantling about ten inches from the wall and eight inches from the floor. This "fender" will prevent the sow from lying on her pigs. Do not allow the sow to become costive, either before or after farrowing. Feed liberally of bran, and if any signs of costiveness appear, put a little salts in her feed.

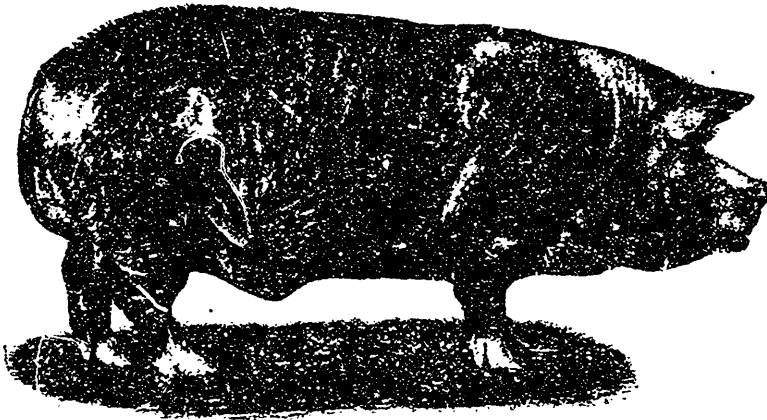

Manor Hero. Imported Berkshire Boar,

Imported by and the property of S. Coxworth, Whitby, Ont. Bred by A. Hiscock, jr., Montcombe, Shaftesbury, Eng. In 1895 Manor Hero was exhibited in six leading shows, and was never beaten.

I have found the best results to follow from feeding a ration of barley and oats ground fine and mixed with an equal amount of shorts. In the summer we supplement this with green fodder, such as clover, corn, rape, or refuse from the garden. In the winter I find nothing better than a feed of sugar beets or mangolds once a day. And in no case should we lose sight of the fact that exercise is essential under all circumstances.

BREEDING.

At the age of eight or ten months the sow should be bred. And here let me say that, if at all possible, breed her to an aged boar, and do not follow the practice too often followed of using the nearest boar that can be found, regardless of breed, age, quality or constitution. Do not lose sight of the fact that "like produces like," and take

KINDNESS ABSOLUTELY NECESSARY.

Too much care cannot be taken to have the sow perfectly quiet, so that, should any difficulty arise in farrowing, she may be thoroughly used to being handled. I have bred Berkshires extensively for the past ten years, and I have never had a sow that would eat her pigs, nor have I had one that was not perfectly quiet, so that I could handle her as I wished.

I have often heard people make such remarks as these: "The blamed sow only had eight pigs, and three or four of them had come dead, and she had lain on the balance of them"; and "We never have had any luck in raising pigs, and have given it up."

On inquiry I have always found that the sow in question had never from her earliest days received any attention or kindness, and had been

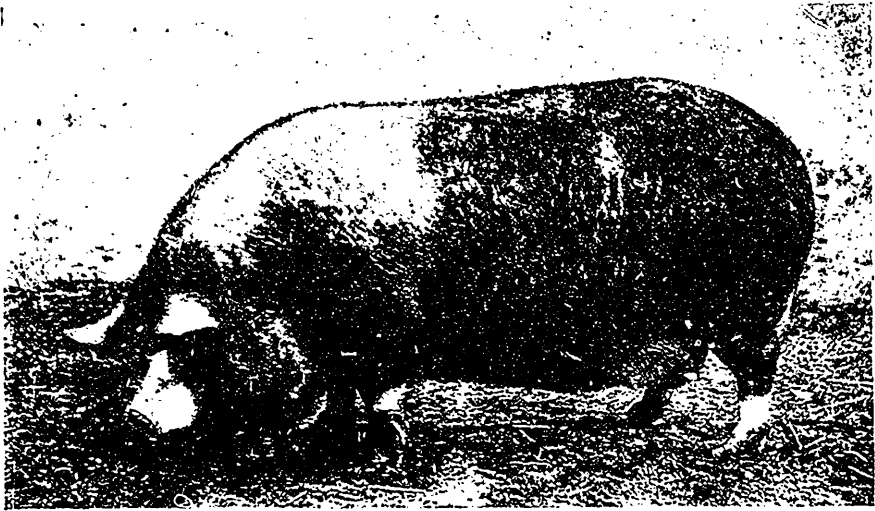

Highclere 20th. Berkshire Boar,
Imported and owned by S. Coxworth, Whitby, Ont. Bred by Edney Hayter, Whitchurch, Hants, Eng., breeder of
the champion sow in England, which sold for 83 guineas. Highclere is of the same family as this sow. The
large size, typical points, and excellent quality of this animal are all finely brought out in the illustration.

compelled to run in the barnyard and root deep in the manure pile for a warm bed, and wade out in the snow for her feed, receiving, besides, an occasional kick if perchance, when in search of something to eat, she should get where she was not wanted.

Let me say that it is a great mistake to suppose that a pig does not appreciate kindness. My experience has taught me that a pig knows and will always recognize its friends, and that there is no animal that will pay for a little kind treatment with better results than a brood sow.

FARROWING TIME.

When the period of gestation is up, watch the sow closely, and as soon as you find the milk starting from the teats you may rest assured that she will farrow within a few hours. Clean the pen out thoroughly, and give her a little chaff or cut straw for a bed. If the pigs come weak, or if the sow becomes restless, and gets up and walks around, I find it a good plan to fill a barrel to within about ten inches of the top with

chaff and put the little fellows in it, and cover them with an old sack or blanket until the sow is done farrowing. Then I place them with her and leave her alone, being careful to see that she is not disturbed. I feed her very light for a day or two, but increase her food gradually until about the tenth day, after which I give her full rations.

"THE THUMPS."

I frequently have the question asked me: What is the cause of young pigs becoming dry in the hair, and having a constant labored breathing, and heaving at the flanks, so that in the course of a few days they die? This trouble is sometimes called "the thumps," and it usually takes the biggest and fattest ones first. Upon close examination it will be found that these young pigs are very costive. One of the best remedies that I know of is to give them a good dose of molasses or "black strap," as it is commonly called. This will act as a purgative and the pigs will recover at once.

SOMERVILLE MCKESSOCK, of Massie, Ont., writes: I like FARMING very much, indeed. It is first-rate, and the January number is specially valuable.

MENIE, Nov. 18th, 1896.—Your October number of FARMING has been received and the contents carefully read. We must say that this one copy is more than worth the entire subscription for the whole year. Wishing you every success, yours truly, Wm STEWART & SON.

TYRONE, March 1st, 1897.—The Bryant Press, Publishers of FARMING: "Dear Sirs,—Please find enclosed one dollar to renew my subscription. I consider FARMING the best agricultural paper in print to-day. No farmer should be without it." Yours truly, R. HAWKEY.

MR. D. ALEXANDER, of Brigden, writes: "I send FARMING to Kansas as soon as I read it. It is just as Mrs. A. says: "Too good for the money. It should be double the price."

HOG-RAISING IN CONNECTION WITH THE DAIRY.

By J. Y. GRIFFIN, of J. Y. Griffin & Co., Pork Packers, Winnipeg.

I hope my remarks on this subject will be the means of giving information to the farmers of this country, and that they may, by swine breeding, realize at an early date a large amount of money on their hogs, by which the country at large will be benefited.

My object is to bring the packing industry, which I represent, to the front; also the farmer and his interest, and also this Manitoba of ours. Without the assistance of the farmer it would be useless for capitalists to invest in such buildings as they have to in order to successfully kill and cure bacon for market.

In the early days of the cheese factory system it was customary, in some cases, to feed the hogs at or near the factory, in some low place, in a hollow, or in a ravine, so that they could get water, by which all the manure that was made was lost by washing away, and thus a manure was wasted which in England is so highly valued as a fertilizer. At the same time the hog was allowed to bask and broil in the hot sun, and flourish as best he could.

What is the custom now if the hogs are fed at the factory? They are provided with a good field and pasture, they are fed regularly with, not whey alone, but also with grain, shorts, and other mixed foods, and they are kept clean, and thereby they pay the man or company who intelligently feeds and cares for them in a proper way. Remember there is no gentleman in the country who appreciates clean quarters, good food, and proper attention more than the hog.

Regarding the whey, some are of the opinion that if it could be taken back to the farm in some way so as not to injure it, it might be of more value and do more good by being mixed with other food and waste from the house and dairy, than by being fed at the factory. There is room for difference of opinion here.

Many of our leading breeders import and show every season, at our exhibitions, the best and most desirable hogs that can be obtained in the old country. Some people think that exhibitions are no good, and that they are a waste of time. Not so in my opinion, since at them the farmer meets the breeder, compares notes, and sees what his neighbors in the country are doing. Besides, they are the best of advertising mediums for a new country like ours (Canada). We ought to be proud of our Winnipeg Industrial Exhibition. It is doing good work.

The packing company which I represent, and, I have no doubt, every other packing company

in the country, are anxious to have the co-operation of the farmers. We want them to feed and breed hogs to a much larger extent than they do, and especially the sort of hogs required to make the fine bacon that now is so much in demand.

BACON HOGS ARE IN UNLIMITED DEMAND.

Remember it will require a large increase in the hogs you must raise in order to supply the several packing and curing houses you have now almost at your doors, provided you breed and feed the kind of hog required for bacon purposes. With our almost millions of bushels of barley, oats, and other cheap grain, which are difficult to ship east as grain, we shall have to do the same as they do in the Western States; put it into hogs, cattle, and dairy products. We would, therefore, recommend the production of hogs, not as a by-industry of the farm, to be taken up now and again, but as a regular, steady, and increasing branch of farm work which will not be dependent upon frozen wheat, good as that food may be, but will have as its basis the raising of a sufficient amount of rough grain and the use of the refuse from creameries and cheese factories, all of which can be profitably converted into hogs.

THE BREEDS TO USE.

There is a difference of opinion in this country as to the best breed of hogs to keep; but one thing is certain, you must breed the hog that will mature quickly and give you a long, lean side of meat necessary to make the fancy quality and shape of fine sides now required in the European market. The Suffolks are now out of fashion, as they give too much shoulder and fat, and are too short and thick. In the past the Chester White, the Berkshire, and of late the Tamworth, have all proved good pork and bacon hogs; but some of the leading packers in the east think (and we agree with them) that the Berkshire crossed with either Tamworth or imported Yorkshire are the best, as they give the long, lean side so much required.

A large number of farmers have been, during the past season, feeding hogs practically, and, I may say, with success. I understand from them that wheat fed at present prices would make a profit to the farmer.

The development of the swine industry, to the point it ought to reach, cannot be accomplished in a day, but pluck, perseverance, push, and brains are bound to succeed.

IMPROVED YORKSHIRES : POINTS IN THEIR FAVOR.

By J. E. COUSINS, of John Cousins & Son, Breeders of Yorkshires, Harriston.

From our experience with Yorkshires, as compared with all other breeds, we would say that they have proved the most satisfactory, not only for sale, but also for pork for our own use, for it is nicely streaked with lean.

The males are quiet and easily handled, and are good, *sure* stock-getters.

The females are better mothers than those of other breeds, are most prolific breeders, and also are quiet to handle.

The males cross well with other breeds, especially the Berkshires, the progeny retaining the characteristics of the sire.

The purebreds, however, give better results than the crosses. By actual test in our own pen with pigs of the same age and with the same feed, the purebreds gained thirty pounds apiece more than the crossbreds.

Finally, as a proof of the quality of the Yorkshire, the buyers are very anxious to get them, and give top prices; and they say that there is more satisfaction in handling them (from a money point of view) than in handling other breeds.

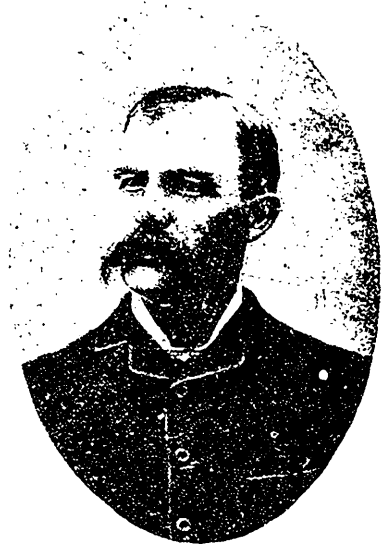

J. E. Cousins, Harriston, Ont.

WHY I BREED IMPROVED YORKSHIRES.

By RICHARD GIBSON, Delaware, Ont.

I breed Improved Yorkshires for the following reasons :

(1) Because they supply the best quality of pork; that which commands the highest market quotations, and that from which breakfast bacon is made. The tendency at the present time is all towards leaner meat. In beef, the big gross, 1,700 pounds to 1,800 pounds steer, is a back number. In mutton, the tallowy, coarse carcass has long been doomed, and now the 60 pounds to 80 pounds, when dressed, command the highest London prices. The public are now shouting for leaner pork and the bacon curers are echoing the cry. I don't purpose fighting this "declaration of independence," but I wish to cater to it by breeding and disseminating the improved Yorkshire.

(2) Because they are so prolific. I have an imported sow that has bred ninety-six pigs in three years (and raises from twelve to fourteen each litter) without the least apparent injury to her constitution; never has she been heavier than at present.

(3) Because they can be grown to the most profitable weights as six months pigs, 160 to 200



Richard Gibson, Delaware.

pounds. I showed a barrow at Guelph Fat Stock Show (he was out of above-mentioned imported sow, and one of a litter of twelve); he weighed 437 pounds fasting when taken off the cars, and was under nine months. Notwithstanding his great weight, he was an exceptionally smooth, handsome pig of great quality. This weight is, of course, greater than the curer demands, but it shows to what weights they will attain by careful feeding.

(4) Because they have hardy, rugged constitu-

tions. I have never to give medicine of any kind (except worm powders), and never have had a "sick hog." They are good rustlers, and don't require pampering.

(5) Because they are good mothers, they will raise two litters a year, and twelve pigs in each, as easily as some breeds will six or seven.

(6) Because they have bone enough to carry the great weights they attain when matured. Their bone is sound and hard, and I have never had a Yorkshire pig break down.

THE TAMWORTH HOG.

By JOHN BELL, Amber, Ont.

MR. JOHN BELL, Amber, Ont., was one of the very first to introduce the Tamworth hog into Canada. In fact, if his importations were not the first they were the first that gained for the breed the notice of other breeders. And it was some time, indeed, before they had even this much of recognition. The present writer remembers well how he used to console Mr. Bell by telling him that as surely as anything could be predicted in this world the



John Bell, Amber, Ont.

time of the Tamworth was coming in Canada, and he would certainly reap the reward of his enterprise if he only "stuck to it." We remember also how, about the same time, one of the best all round stock men in Canada, and a very liberal-minded fellow, too, said: "The Tamworths may suit you, Mr. —, but as for me, they have *too much snout*; the breeders will never take to them." All this has changed. The Tamworth's snout is no longer considered objectionable, and the breeders *do* take to them. Mr. Bell, every year since the first two years, has had more demands for his stock than he has been able to supply. Mr. Bell is almost equally well known as a successful breeder of Clydesdales.

I have bred and imported Tamworth swine for the last eight years, and from what I know and can learn of them I am of the opinion that they did not descend from a race of "sandy-and-blacks," as is stated in our authorized text-book on Agriculture.*

The Tamworth is without doubt the oldest breed in England. We have proof of their existence at the beginning of the present century. Pigs of the name "Tamworth breed" were exhibited by the late Sir William Curtis in 1807. The Berkshire, Oxfordshire, and Tamworth all claim for origin a red or sandy pig which existed in the eighteenth century.

Although for many years the Tamworth was little heard of or thought of, owing to the taste for fat bacon which had arisen among the laboring classes (which taste as we know is now much changed), there was still kept pure in certain districts a fair share of the breed.

About the year 1872 Mr. G. Mander Allender, manager for the Aylesbury Dairy Company, Ltd., being of an enterprising disposition, and believing that no other breed equalled the Tamworth pig for the production of lean meat, took hold of the Tamworths and brought them once more into prominence. His example was followed by many other prominent breeders: and now the Tamworth is the leading hog in England.

Mr. James Long, the notable judge of swine, who gave the single judge system its first start by his superior judging at the Manchester and Liverpool show in 1837, says "the Tamworth has the foundation of a first-class breed. It is a breed which I believe will rival every breed we possess, for it has the distinct advantage of having a better start for the production of the modern bacon-

* The authority for the statement that the Tamworth is descended from the "original sandy-and-blacks" is Mr. W. Godwin, the well known breeder and writer on pig subjects. See "Live Stock Journal Almanac," 1890, pp. 166-7.—Editor FARMING.



Dorchester Hero. Tamworth Boar,
The property of John Bell, Amber. Bred by R. J. Sutherland, Dorchester Station. Sire, Revell's Boar; dam, Dorchester Heroine; both imported.

curer's hog than the other breeds, because in them much has to be undone which has been done for them in a wrong direction; whereas the Tamworth breed, as it now is, produces good saleable bacon. The other pure breeds, taking them collectively, produce a hog which is much too fat."

Mr. Allender, whom I have before mentioned, in an interesting article on the Tamworth breed, puts in a nutshell the reason of their present value and esteem. He says that "by good fortune the Tamworth was never crossed with the Chinese pig; and now that the breeds which were produced by the admixture of Chinese blood have been condemned by the bacon-curer as carrying an excess of fat, this old, lean-fleshed breed will be as useful for a cross in a contrary direction, as the Chinese pig undoubtedly was in the direction of fat some half century ago."

Mr. Allender once showed two Tamworth sows at the Royal Show that weighed over 1,000 lbs. each. In the earlier days of the breed it was not unusual for the "sandy pigs" to weigh 1,100 to 1,300 lbs.

When I first got Tamworths I was compelled to slaughter a few, for we knew nothing at that time in this locality of selling hogs alive. We were, therefore, compelled to slaughter at home. When my Tamworths were brought to market a well known buyer said to me he did not want "those big-legged fellows." But now a change has taken place, and "the big-legged fellows" are the first chosen and the first sold. The buyers want to see the legs sticking up like tent poles.

I find the Tamworth to be thrifty, vigorous, and prolific, and good grazers and early maturers, and just what the bacon curer requires. Mr. Flavelle, of the Wm. Davies Co., Ltd., Toronto, says that there is "no pure bred hog to equal the Tamworth for the purpose of the bacon curer. Other breeds require crossing."

Tamworths are said by some prejudiced critics to be hard keepers. These people do not take into consideration the fact that the Tamworths are not supposed to fatten up like some other breeds—breeds, I may say, that are now fast going out of existence. There is no breed of swine that will give a larger return for food consumed than the Tamworth.

Tamworth breeders are generally shy of exhibiting their swine owing to the fact that it is difficult to get their stock judged accurately, inasmuch as the judges are seldom if ever acquainted with the merits of the breed. Very often men are chosen who do not look with favor on the interloping breed. This, it is true, is somewhat discouraging. But the time of the Tamworth men is coming fast, even here in Canada.

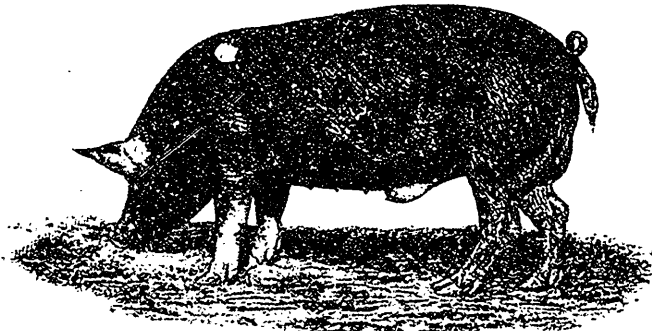

Young Tamworth Boar,
Bred and exhibited by H. George and Sons, Crampton, Ont. Winner of first prize in his class at Toronto, Montreal, and Ottawa. Recently sold to His Excellency Lord Aberdeen, Governor-General, for his stock farm in British Columbia.

THE TAMWORTH THE HOG FOR THE GENERAL FARMER.

By NORMAN M. BLAIN, St. George, Ont.



Norman M. Blain, St. George, Ont.

I do not think it is necessary to say anything to boom the Tamworths, as I am sure they have made it quite plain that they have come to stay and to fill a want as the choice bacon hog of the time. However, here are some of the reasons why I consider the Tamworth the best hog for the average farmer to keep :

(1) Because the Tamworths are the ideal packers' hog, and as such command the highest price in the market to-day; and we, as Canadian farmers, must produce the right class of bacon if we wish to hold and increase our trade with Great Britain.

(2) Because I have found the Tamworths to be very prolific and exceedingly hardy.

(3) Because I find the Tamworths quick-growers and early to mature, thereby giving a speedy return for the money invested in them.

(4) Because the Tamworths are very gentle and of a quiet disposition.

These are some of the reasons why I have bred and still continue to breed the Tamworth, and after five years' experience I am convinced that they are the hog for the average farmer to raise.

TAMWORTH SWINE : POINTS IN THEIR FAVOR.

By J. C. NICHOL, Breeder of Tamworth Swine, Hubrey.

The description of the Tamworths given in "The Public School Agriculture" is all right as far as it goes, but I would add that Tamworths are very deceptive in weight, inasmuch as they always weigh more than what they appear to. (A case comes to my mind. A buyer who buys thousands of hogs put a four months' old Tamworth sow at 120 lbs., but when weighed she turned the scales at 165 lbs.)

The snout of the Tamworth is not so long as it appears to be. I find, in comparing it with the snouts of some of the other breeds of swine, that the Tamworth's snout is no longer, in proportion to the weight of the hog, than any other snout.

The Tamworths are good grazers, and are not

easily fed off their feet. They are fast growers, and often weigh 200 lbs. at five months, thus making quick returns.

Another qualification is that they produce a big proportion of lean meat. The pork curers, as well as the general public, are discriminating more and more in favor of lean pork, and this is the great characteristic of the Tamworth.

Every farmer knows what a good thing it is to have quiet mothers in any kind of stock. The Tamworth sows as mothers are very docile. They are also very prolific, usually having from ten to fourteen pigs at a litter, the pigs frequently weighing four pounds each when farrowed. The sows are also very good milkers.

WHY I LIKE CHESTER WHITES.

By JOSEPH CAIRNS, Camlachie, Ont.

JOSEPH CAIRNS, of Camlachie, has been interested in swine from his earliest youth. He was brought up on a farm, and, as a schoolboy, it was his duty to "feed the



hogs." The fondness for swine then acquired has ever since remained with him. In 1889 he began to breed pure-bred swine; and ever since then he has been trying to get the very best he could get, and by careful mating to keep his herd up to the highest pitch of excellence. Not only is Mr. Cairns a successful farmer, but he is a good business man and public officer as well. He has been postmaster of

Camlachie for over twenty years. He was reeve of the township of Plympton (where, by the way, there is an Agricultural Society) for four years. In 1890 he was warden of the county of Lambton, and was one of the youngest wardens the county ever had. When his term of wardenship expired Mr. Cairns retired from municipal life, and has ever since devoted himself to his farm and to his business.

When I first decided to become a breeder of hogs the first thought naturally was, What breed should I select? I took a deep interest in all stock papers, and read all the hog news I could find. I finally came to the conclusion that I would try the Chester White, the strongest point in favor of the breed in my mind, at that time, being its color. A white pig, in my opinion, presented the cleanest appearance when it was ready for the market, and, as in every commodity presented for sale I always noticed that what takes the eye finds the most ready customer, I thought a white pig would be preferable to a black one or a red one.

I therefore purchased a pair of Chester Whites, and, after breeding a year or two, I found I had not made a mistake. I found I had selected a very contented breed of animals, one that, instead of asking for food in the hog's usual manner, were always hunting and foraging about as though they were full of confidence and had enough of independence to earn their own living. This pleased me because, though I like pigs, I hate their squeal.

THEY ARE OF GOOD DISPOSITIONS.

I also found in the Chester Whites the best disposition I had ever seen in the hog family. I have had several stock boars since I started as a breeder, but I have never yet had on that showed a sign of crossness. If another pig is raising a voice in protest against being reloaded the Chester White boar will turn and walk away as unconcernedly as possible.

It's the same way with the females. I have seen pigs, and many of them, that, if you made one of their number squeal, would all come at you squealing with all their might, every one of them, little and big; but the Chester Whites seem to say, in such cases: "That ain't our funeral."

Their being so docile and of such a gentle disposition is a very valuable trait at farrowing time. The attendant can stay right with them, and when they rise can keep the little pigs from being tramped upon, and, when they lie down again, from being lain on. The good-natured creatures will say, "Umph! Umph!" the only way pigs can say thanks. I have seen it happen that when a sow would partly lie on a pig and we would raise her enough to liberate her prisoner, we got the same thanks from her ladyship.

THEY ARE GOOD AND PROLIFIC MOTHERS.

Another reason I like the Chester Whites is because that, in all the sows I have bred, I have never once been called upon to assist at farrowing, nor have I ever lost a sow at that trying time.

And still another reason is that I seldom ever get a small litter, but mostly one that is in the "teens." In fact, in most cases the litter is too large for the sow to properly raise.



Annie. Chester White Sow,
The property of Mr. R. H. Harding, Thimbleton, Ontario. Winner
of bronze medal for sow and four of her progeny,
London, 1895.

The Chester Whites are also good sucklers of their young, and I have noticed that my sows invariably gain in weight during the nursing period. They can feed their young and make pork at the same time, which shows a vigorous constitution. They are kind mothers, too, and have none of that nervous restlessness which characterizes some other breeds of swine.



Alma. Chester White Sow,
Sired by Coco 2223. The property of Joseph Cairns, Camlachie, Ont. The litter of Alma when three months old tipped the scale at 100 lbs. Miss Long, another Chester White sow of Mr. Cairns', last year gave three litters of 43 pigs, and of these she raised 30.

I also notice that the Chester Whites are grand grazers, and that they will thrive on good pasture equally well with any other animal.

Much more I might say, but this is enough for the present; and, fellow-breeders, don't think for a moment I am trying to belittle any other breed of hog. I am only a firm believer in the principle, that every breeder should think the breed he is interested in is the very best breed

there is. If he doesn't think this he had better quit; for I have no use for the "almighty dollar" breeder, whose first consideration is money, while only his second is the breed. If you buy from that sort of breeder you will invariably find that he was the only one that ever made a dollar on that particular pig. And you know, too, what Paddy said: "If we was all of one mind you would all want my Biddy."

THE DUROC-JERSEYS.

By W. E. BUTLER, Dereham Centre, Ont.

MR. W. E. BUTLER is the junior partner of the well-known firm of Wm. Butler & Sons, of Dereham Centre, breeders of Guernsey cattle, Chester White, and Duroc-Jersey pigs, and fancy poultry. Mr. Butler, jr., the author of the following enthusiastic sketch of the merits of Duroc-Jerseys, although yet scarcely twenty-two years of age, is the manager of all the stock breeding enterprises of the firm, his father, who is the proprietor of the business, devoting himself almost entirely to the working of the crops of the farm. He is, however, of the right sort of stuff, and is determined to lay the foundations of future success in careful present preparation. He is already an Associate of the Ontario Agricultural College, having taken the full two years' course at that institution, and he is now reading for his degree of B.S.A., although he finds it hard to do so and attend to the business interests of his farm at the same time. Besides his enthusiasm for Duroc-Jerseys and Chester Whites, Mr. Butler has an equal enthusiasm for

Guernseys. He believes them to be the best breed for all-round dairy purposes, that will thrive in our Canadian climate. The points he sees in their favor are (1) hardiness, (2) docility, (3) size, (4) capacity for turning fodder into milk at cheap price, (5) richness of milk. The cream of the Guernsey cow he thinks superior to that of any other cow in color and richness. The consequence is that the butter made from it is so rich and deliciously flavored that it is often called "Golden Guernsey Butter." The firm keep about thirty pure-bred Guernseys and large herds of Chester Whites and Duroc-Jerseys. Mr. Butler says that stock interests are looking up. During the last six months he has written over 600 letters on business, most of them being in answer to enquiries for stock or in connection with the sale of stock. He says that as he advertises in FARMING, and in FARMING only, he thinks this is a pretty good evidence of the value of FARMING as an advertising medium.

We feel our inability to do justice to so great and noble a breed of swine as the Duroc-Jerseys. However, we will aim to be modest in what we have to say. We shall not aim to tear down the

reputations of other noble breeds of swine in order to build up that of the Duroc-Jerseys.

We shall not try to give a complete history of the "red hog." Its origin cannot be positively

traced, and it was probably unknown even to the earliest historian of the hog. Its history has been traced back about 50 years, and the breed is said by some to have had its origin about that time



W. E. Butler, Dereham Centre, Ont.

ago. Some claim that it had its origin in the Red Tamworth of England, but this statement is not accepted as a fact.

It is generally conceded that there were two families of "red hogs": One known as the Jersey Red, and the other as Durocs or Red Rocks. The name Duroc was first applied by Isaac Frink, of Milton, N.Y. After the two families were crossed, they were then called Duroc-Jerseys.

Some claim that Henry Clay imported the first pair of "reds" from France, and bred them successfully on his farm in Kentucky; but again this is disputed. The exact history of the breed is not known, and will probably always remain a mystery.

But let the history or origin be as it may the Duroc-Jerseys are now among us, and have come to stay. They are a distinct breed of hogs, and what we want to know is, are they a *profitable* one?—for *profit* is what we are all after.

HE IS A POPULAR AND A PROFITABLE HOG.

With an earnestness born of firm convictions I say that the Duroc-Jersey will, in all probability, be the coming hog for the general

farmer. I consider the breed *one of the best* in the world, all meritorious and derogatory points being taken into account; and I find that the farmers and breeders of the country are gradually coming round to the same way of thinking.

The breed is gaining ground as no other breed has done, and that, too, in the face of the strongest competition ever known in swine breeding in America. There are ten herds to-day of "red hogs" (Duroc-Jerseys) in Canada to every one five years ago. In proportion to their numbers they have captured more than their share of premiums at all exhibitions where they have been in competition. These facts should arrest the attention of all breeders of swine.

If the red hog will bring the farmer more dollars than any other, it is the hog he wants. If the (lop-ear) red hog is a good rustler, an easy fatter, a good grower, and if he puts on more weight for a given amount of food than any other hog, it is the hog he wants. I am satisfied that in all essentials the Duroc-Jersey stands second to none of all the breeds of hogs now bred.

PROOFS.

In proof of the foregoing assertions relative to increase of weight for given amount of food fed, I will refer to the test made in 1894 at the experimental station of the Michigan State College. Three breeds were represented—Berkshires, Poland Chinas, and Duroc-Jerseys; two of each, and all barrows. The pigs were weighed every fourteen days during the experiment, and the test lasted from July 16th to January 31st, or 168 days. It was shown that the two Duroc-Jerseys gained in weight from the beginning, and this is where we find the Durocs to have the advantage of all other breeds. To decrease the cost of pro-



Daisy A. Duroc-Jersey Sow,

Bred and owned by Wm. Butler & Sons, Dereham Centre, Ont. Winner of sweepstakes at Toronto, and also at Guelph, in 1895. Photo was taken just after farrowing.

ducing pork we must decrease the length of time we keep our pigs, and to do this we must have a fast-growing pig from the start. Though as fleshy as any specimens, they were still making excellent gains, and were feeding well up to the time of slaughter. Their average gain was 36.25 lbs. per 14 days, or 2.59 lbs. per day, secured at a cost of 4.65 lbs. of grain for each lb. of live weight. The average gain made by two Berkshires was 29.16 lbs. per 14 days, or 2.08 lbs. per day, secured at a cost of 5.22 lbs. of grain per lb. of live weight. The average gain of the Poland-China was 25.91 lbs. per 14 days, or 1.85 lbs. per day, secured at a cost of 5.87 lbs. of grain per lb. of live weight.

The meat of the different hogs was cooked and tested, and it was the unanimous opinion of those who ate the meat that that from the pigs making the best gain at the time of slaughtering was the most tender and juicy and the sweetest and best, and that was the Duroc-Jersey meat.

MORE PROOF.

Again, I will quote what Mr. Thomas Bennett, of Illinois, an extensive breeder of Poland-Chinas, Tamworths, and Duroc-Jerseys, says of the latter breed: "They are the best general purpose hog in the United States, having a strong constitution, and being more prolific and better sucklers, and where breeders of other breeds raise from three to five pigs to the sow the breeder of Duroc-Jerseys may raise from eight to fourteen. As bred to-day, they grow faster when young, and fatten as readily as any pig when more matured; and they are the only hog to-day that will make their own bed, grind their own feed, and when fat, carry their own carcass to market." This is the unbiased opinion of a man who has had a large experience with three different breeds. I might supplement his statement with the experience of many more breeders who have bred different breeds and finally settled upon the Duroc-Jersey.

WHY DUROC-JERSEYS ARE POPULAR.

They have been tried and not found wanting, weighed and not found light, tasted and found to be good, raised and found profitable. Indeed, they have been found to be the most prolific of all breeds of swine, being the best of mothers, and good sucklers. They also raise the most uniform litters of pigs. You never have to kill a little Duroc-Jersey because he has got "too many white spots," or because he is not white in the right place. The Duroc-Jersey is a red hog, and red all over. He is a hog of very strong bone, of good hams and broad shoulders, and he has good heart room, which makes him a very healthy, vigorous hog as well.

The Duroc-Jerseys are good feeders, and they fatten readily at any age; and, one thing more, they will fatten and grow at the same time, thus making them a profitable hog to grow. They are profitable to feed longer than other breeds of hogs. If the price of pork, when they are fat, does not just suit you can feed them longer, and they will go on and do well. How often do we hear it said, "I shall have to sell my hogs, although the price is a little low, because they are doing no good. I can't see as they gain a pound." We will just say to such a one: Get the Duroc-Jerseys. You can go on and feed them profitably until the price of pork goes up.

Wherever you put the lop ear red hog he is at home, and, like your humble servant, sandy in complexion and ready for his dinner.*

OBJECTIONS CONSIDERED.

Now I wish to make mention of the objections sometimes urged against the Duroc-Jerseys. One man will say, "I do not like his color." Another will say "his tail is too long." Another says "there is too much hair on him." As though these points had anything to do with the profitability of hogs.

I would ask such people what is nicer in hogs, cattle, chickens, or any other sort of stock, than to have them uniform in color, be it what it may.

The red hog has a good coat of hair, and to stand the cold weather of this country he has not one hair too many. You do not have to wrap him in a blanket, and give him warm drinks to keep the frost out of him. He is a rustler, and as to his tail give him plenty to eat and his body will soon grow to fit it. Besides, if you want to take hold of the hog he has a good substantial handle to do it with, one that will never pull off.

The red hog is profitable because a few will raise many, also because he is a good feeder, takes on flesh rapidly, and grows to an enormous size.

In conclusion let me mention the past, present, and future hog. In the past we had a good hog; at the present we have a better one; in the future we want the best; and while looking for the best we dare not pass the Duroc-Jersey by. If we do we may have to retrace our steps and come back to him. Let us see what there is in him that is attracting so much attention. Does not the fact that he is rapidly coming to the front indicate that he is the hog we are all looking for? My prediction is that the Duroc-Jersey will be the hog of the twentieth century.

* Here Mr. Butler facetiously refers to his own complexion.—Editor FARMING.

POLAND-CHINAS.

By R. B. McMULLIN, Blythewood, Ont.

I wish to make a few remarks on my favorite breed of swine, the Poland-Chinas. This breed originated in the Missouri valley, in the State of Ohio, away back in the thirties. It is a cross between several breeds of swine, the Graziers, the Byfields, the Berkshires, and the Big Chinas, being the most important. The Poland-Chinas are a very popular breed in the United States, and are fast gaining friends in Canada. They are, in color, mostly black, with white points; but a few

white spots on the body are not objectionable. They are of good length, and deep in the body. Their backs are broad and straight, their heads and shoulders are large and full, their head is short, their muzzle is fine, their ears are thin and drooping, and their hair is fine. Their legs are short, their feet are very tough and strong. They are good breeders and feeders, and their meat is of the best quality.

THE HOG THAT THE PRESENT MARKET DEMANDS.

By F. W. FEARMAN, Pork Packer and Provision Merchant, Hamilton.



F. W. Fearman, Hamilton, Ont.

The hogs most in demand at the present time are those weighing 140 to 220 pounds each, long and deep in the sides, with small head, and lean.

The pork packers have been asking the farmers for this class of hog for some years, and I am glad to say they are meeting with success. It is not unusual to take in a bunch of 100 to 150 hogs in which there will not be over a half dozen rejected.

There are, however, a number of hog breeders who either do not understand what the market demands or else stubbornly continue to raise a class of heavy fat hogs, which are saleable only at much lower prices. The demand for heavy pork is very limited compared with what it was some

years ago. The lumber and mining camps are using much lighter meats, and even the farmers themselves refuse to purchase fat bacon. The great bulk of the Canadian trade demand lean meats, and the English market almost entirely does so. The farmer has only to consult any newspaper to see the difference being made between the price of lean hogs and that for fat ones. And yet even this discrimination does not compensate the packer for the difference in price of the product when put on the market.

We are asked again and again what breed of hog we prefer. To this I would say: any breed that will turn out a lengthy lean hog weighing 150 lbs. to 200 lbs. at six to eight months old.

We have found the "Tamworth" and "Improved Yorkshire" to furnish these requirements, while we have also had excellent "Chester Whites." Some farmers are more inclined to cross with these breeds. We certainly have had very fine hogs from the "Tamworth" and "Improved Yorks" crossed with the "Berkshire."

If the farmer has purchased a pen of either of these breeds he has made a good start towards raising the right class of hogs. But the best bred hog must be well fed and well taken care of. It is deplorable to see the poor shelter provided for hogs by some of our farmers. The house should be warm, clean, and well lighted. Pine boards and clean straw are cheaper than grain. Some of our farmers cannot understand why their hogs do not grow. The trouble is the feed they give goes to keep the pig warm, when he should have a house and straw bed to do this for him.

The house should be divided into pens, so that the hogs can be divided up into small lots. There will be one or more hogs in every lot that take more than their share of food. These should be

penned off by themselves, so as to give the weaker ones a chance.

There is a good deal of controversy between those farmers who feed cooked and those who feed uncooked grain to their hogs. The farmer must decide this point a good deal from his own experience. I should say it would be found more profitable to keep the pig growing continuously from time of weaning until he is ready for market, rather than to let him shift for himself for months and then cram him full of food to fatten him for the fall killing.

At the present price for first-class lean hogs there should be a good return of profit to the farmer. Grain is cheap, potatoes are cheap, and where dairying is carried on there should be a

good-sized drove of hogs. Irish bacon brings a very high price in the English market on account of its excellent flavor. I think this may be put down almost altogether to the feeding. There the potatoes are cooked and fed to the pig with meal and milk.

Some farmers object to raising hogs in connection with their dairy. This, I think, is a mistake. The hog-pen can be kept clean and odorless just as well as the cow stable. It depends upon the way it is looked after by the farmer himself. I have seen cow stables that it was a pleasure to look into and I have seen others in which it was a disgrace to keep any well-mannered cow. It is the same with the pig-sty.

A LIVE STOCK COMMISSIONER FOR CANADA.

EDITORIAL.

A principal object we had in view in our March number in giving to our readers an account of the work done by the Dominion Dairying Service, was to show, as by an *object lesson*, that what has been accomplished in the development of *one* branch of our agricultural interests may also be accomplished in *other* branches if as wise and as energetic efforts be made in their behalf.

No one can carefully follow the history of the great development of our dairying industries during the past seven years without being convinced, as was pointed out in our article, that a great portion of that development is due to the energy, the knowledge, the ability, the prescience, the enthusiasm, and the organizing skill, of the Dominion Dairy Commissioner.

But great as these personal qualifications of the Dairy Commissioner have been, the one point we must remember is that it was the prestige of his position as a Dominion executive and administrative officer, carrying in himself the authority and the support of the Dominion Government, which enabled him to accomplish what he did in so short a time.

The happy circumstance that an office of magnificent possibilities for great achievement was filled by an officer possessing perfectly apposite abilities and unbounded enthusiasm for his work has resulted in the most splendid chapter of solid material advancement which has ever occurred in the history of our Canadian agriculture. And it must not be forgotten, too, that this great advancement in our dairying industry took place at a time when almost every other branch of our agriculture was languishing; when the price of grain was falling year by year; when, owing to the schedul-

ing of our cattle by Great Britain, our live beef export trade had fallen away greatly; and when, owing to quarantine and tariff complications, our export trade of every sort with the United States had almost ceased. The great development of our dairy industry during those otherwise "seven lean years" (1890-96) was certainly a providential blessing to Canada.

But, as we have said, what has been done for dairying may also be done for our *other* agricultural interests, and especially for our live-stock industry. In the case of our live-stock, the need for something being done is pressing. The possibilities for its advancement and development are ample. Opportunities which might be taken advantage of are presenting themselves all the time, and need only that some one be constantly at hand and ready with sufficient ability and resources to turn them to good account.

CANADA DESTINED TO BE A GREAT STOCK PRODUCING COUNTRY.

Canada is fitted by nature to be a great stock-producing country; perhaps the greatest and the finest in the world. There is not a natural advantage for stock-raising which we do not possess. Even our excesses of climate, our great variations of heat and cold, are points in our favor, since they necessitate that care and attention in breeding, feeding, and management which ensure production of the highest quality. Our beef, our mutton, our pork, our poultry, are unexcelled in flavor and in delicacy. If any country on the face of the globe is predestined to become the world's provider of meat, butter, eggs, poultry, and cheese, Canada is that country. The only need is that we be in a position to

take advantage of our natural facilities to the fullest possible extent. This need is one that government action can help to make good. And the direction of that action should, in our opinion, be entrusted to a thoroughly competent Live Stock Commissioner.

THE LINES WHICH GOVERNMENT ACTION
MAY TAKE.

The lines of action are :

- (1) The constant endeavor to secure better and better facilities for reaching our natural markets and getting therein the highest possible prices.
- (2) The constant endeavor to provide easier and easier means whereby our breeding-stock may be improved.



Aged Berkshire Sow,

The property of Thomas Teasdale, Concord. Winner of first prize at Toronto, 1896. Also with her progeny winner at same show of first prize for sow and four of her produce. For description of this sow see FARMING, October, 1896, page 126. (Mr. Teasdale himself is also seen in the engraving.)

- (3) The constant endeavor to provide our farmers one and all with the right sort of knowledge as to the best methods of feeding and managing stock and of preparing it for the market.

The first line of action is wholly within the sphere of the Dominion Government. The second and third lines devolve upon both the Dominion and the Provincial Governments. It is, however, the responsibility of the Dominion Government in the matter only that we are considering.

Governments come and governments go ; but if a Dominion Live Stock Bureau were established, somewhat similar to our already successfully established Dominion Dairying Service, the work outlined above could go constantly forward with continuity of aim and purpose, no matter what the vicissitudes of Government might be.

WHAT A DOMINION LIVE STOCK COMMISSIONER
MIGHT CONCERN HIMSELF WITH.

In the first line of action described above, freight facilities for the inland transportation of stock ; freight tariffs for stock ; railway, wharf, and steamship accommodations for stock *en route* for exportation ; cold storage facilities ; inspection and branding regulations ; foreign market requirements, etc., etc., would all be matters that would be constantly coming under the purview of a Dominion Commissioner of Agriculture.

If in any of the particulars here detailed a government fails to get the best advantages for the people it possibly can, it is derelict in its duty. As between the people and a corporation possessing public franchises (as a railway, or a steamship line) the government *must see that the people get justice*. (Why, for example, should it have been left to private enterprise to correct the unfairness of our recent railway tariffs respecting the conveyance of purebred live stock ?)

In the same department of action also would come the investigation of the possibilities of probable outlets for our surplus stock. The requirements of foreign markets should be seen into, and their suitability or unsuitability to our products authoritatively demonstrated. In such matters as these a wide-awake commissioner, co-operating with our several live-stock associations—as, for example, with our Shorthorn Association to determine whether Argentina has any possibilities for us as a market for our Shorthorns, or with our Clydesdale Association to see what improvements could be made in our transport service by which our horses could be placed on the London market in a better and more attractive condition—would be of immense advantage to our live-stock producing industries. Similarly the requirements of the British market with respect to mutton, pork, poultry, and eggs, and of the United States markets with respect to lambs and sheep, could be examined into and reported on.

In the second line of action, much could be done by an enthusiastic Live Stock Commissioner, by way of personal advice and the taking of a sympathetic interest in the needs of the stock-raiser. Information as to the different sorts of stock suitable to different localities might be given. Advice, and perhaps, too, more direct encouragement, might be given whereby purebred sires of the best quality could be provided in districts that would otherwise be without them. The formation of syndicates for the purchase of purebred sires might be organized, and breeding be made a co-operative enterprise. The letting o

grade sires for hire could be discouraged, and, perhaps, in course of time, prohibited.

Then, again, our breeding associations should be put upon a Dominion footing. They should be incorporated under a Dominion statute, and their scope and their privileges should be Dominion in character. Their standards for registration should, therefore, be such as would entitle them to this consideration, and every effort should be made to place our records and those of the United States upon a perfect par.

In all this we see what room there is for the activity and ability of an American as Live Stock Commissioner. He should be one who could keep the Dominion Department of Agriculture in perfect touch with what is going on in live stock circles all over the country; also one who could keep our various live stock associations in sympathetic relationship with one another and with the Dominion Department. In every department of work we have outlined nothing should be done rashly. Solid progress is never hasty, and a wise commissioner would aim at substantial advancement rather than at showy results.

Finally, there is the work of instructing the individual farmer to make the most of his opportunities by adopting the best and most economical methods of feeding, care, and management. This will always be slow and discouraging work, but its successful accomplishment is the foundation of everything else. Our conception of a Live Stock Commissioner is one who would constantly be on the alert to ascertain from every source possible the methods most suitable to the farmers of every district in the Dominion, and who would by means of lectures, addresses, personal interviews, bulletins, circulars, etc., get these methods into the practice of the people in the shortest possible time. In this department of work alone there is ample scope for the ability of the best man that can be got.

AN EXPENSIVE DEPARTMENT NOT ADVOCATED.

We are not advocating the institution of an expensive department of governmental machinery; although we say emphatically that expense should be a *secondary* consideration, and efficiency of service the primary one. Even now our live stock products, exclusive of our dairy products, bulk to about *one-third* of our total agricultural production. Including our dairy products, the time ought speedily to come when they would bulk to at least seven-eighths of our total production; for it is the deepest foolishness for Canadian farmers

with their high standard of social life and their advanced intellectual development to persist longer in competing for the production of wheat with the great grain-producing countries of the old world, and of South America, where most of the tillage of the soil is done by rude and ignorant peasants whose daily sufficient wants run all the way from a half down to a tenth or a twentieth of what a Canadian farmer needs for bare subsistence. Considerations of expense, therefore, in developing our live stock industry—an industry whose successful development is, in truth, a condition of our future national existence—are not to be thought of.

But, as said above, we are not advocating an expensive measure at all. What is wanted first, of course, is a *good man*, and one who shall be paid a fitting remuneration for his services. His work for some time will be largely that of inves-

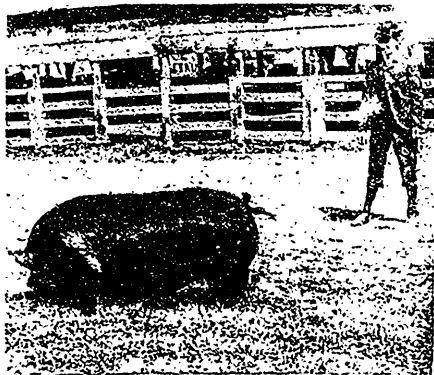

Aged Essex Sow,
The property of Joseph Featherston, M.P., Streetsville.

tigating markets, getting our products known to foreign buyers, and taking steps to see that our beef, our mutton, our pork, our poultry, and our eggs, are got to the foreign market in the best possible condition and receive fair treatment there. Then he will for some time be employed in investigating the condition of our facilities of production, and seeing what we lack in purebred sires, and to what extent the deficiency prevails in different parts of the country, and how best the deficiency can be made right. This is work of the most vital importance; and yet it need not necessarily be expensive. But it will keep the best of commissioners busy for some years. Finally, there is the work of individual instruction. This will be done largely by means of addresses, lectures, etc., and by the use of the printing press. It in no way involves a large outlay.

THE COMMISSIONER MIGHT ACT AS AGRICULTURIST AT THE EXPERIMENTAL FARM.

Also, another economy can be achieved, at least for some time. The position of Agriculturist at the Central Experimental Farm is now vacant. The position should be filled. Dr. Saunders, able and energetic man though he is, has more on his hands than he can possibly attend to. This we say without any disparagement to Dr. Saunders, whom we consider the ablest and the best man in Canada for the post he occupies, as we shall have occasion to say more at length on a future occasion. Certainly we know of no man abler for the position than he. But if for a time the position of Agriculturist were not filled, but the care of the live stock on the Farm and the duty of instituting and carrying on of the live stock experiments were temporarily entrusted to the Live Stock Com-

missioner (under, of course, Dr. Saunders), a double gain would be effected.

First, the live stock experimental work of the Farm would have the advantage of being under the control of one who, from his intimate practical knowledge of the live-stock situation, not only would know intuitively what sort of experiments were most needed for the solution of pressing current live stock questions, but from his position as Live Stock Commissioner would also be able to bring the results of these experiments directly home to those to whom they would be most useful.

Second, the Live Stock Commissioner, in his own immediate sphere of work, would be able to speak with more authority on matters which he had personally investigated in his experiments than he could do had he not had the opportunity of so conducting them.

RECENT DEVELOPMENTS IN LIVE STOCK MATTERS.

By F. W. HODSON, Guelph, Ont.

BEING THE ANNUAL REPORT OF MR. HODSON, AS SECRETARY-TREASURER OF THE DOMINION CATTLE, SHEEP, AND SWINE BREEDERS' ASSOCIATIONS.

As secretary-treasurer of each of the above mentioned associations I have decided to prepare a joint report this year. This is allowable because the annual report of each body is yearly published in one volume. From correspondence and intercourse I learn that the general public have a wrong idea concerning the aims and work of our associations. To put this matter right I will quote a few clauses which form the basis of the constitution of each of the associations.

OBJECTS OF THE ASSOCIATIONS.

"The object of the associations shall be: To encourage a general and constant improvement in the breeding and management of cattle, sheep, and swine, by the dissemination of reliable and practical information on the subject; by co-operating with the officers of the various fair associations in encouraging large, attractive, and instructive displays of cattle, sheep, and swine; by holding, or assisting in holding a winter exhibition of cattle, sheep, and swine; by encouraging the keeping of records of pure-bred animals.

"To improve the judging of live stock by presenting to the secretaries of the larger fair associations, and others who may apply for them, carefully prepared lists, giving the names and addresses of parties who are deemed competent to act as judges of the various breeds of cattle, sheep, and swine.

"To instruct and interest the farmers of Canada in animal husbandry, and to forward the interest of the owners of live stock in every honorable way."

Everyone familiar with the history of these associations knows that these laudable aims have been carried out, and that each of the associations has accomplished a good work, and that the scope of their influence and usefulness has increased each year.

THE ANNUAL REPORTS.

The annual reports issued by our associations have for some years been recognized as among the best publications issued by the Ontario Department of Agriculture, containing, as they do, papers and addresses by the most successful and experienced live stock breeders in Canada and the United States. The ripe experience of a life time is, in many cases, given to the public in a single paper, and the discussion thereon, which is also reported, brings out additional facts of the greatest possible value. It is safe to say that much valuable and practical information, that could have been disseminated in no other way, has been given to the public in these reports. The best methods of breeding, feeding, selling, and shipping, as well as methods and experiments which have proved unsuccessful, have been brought out in strong lights. This serves both as an example and as a warning. The teaching

contained in the annual reports alone have added materially to the wealth of this province, and will continue to do so for many years to come.

IN UNION IS STRENGTH.

Until the Sheep Breeders' Association was organized in 1889, the live stock breeders were disunited in every sense of the word, and as a class were without influence, and therefore at the mercy of each of the corporations with which they had to do. In addition to this, individual breeders were frequently found working at cross purposes to the injury of the entire fraternity. Even in the appointment of judges to make awards at the chief exhibitions of the province, the interests of the rank and file of the live stock men were lost sight of. This state of affairs became a crying evil, and was one of the first defects the associations set about to improve.

SELECTION OF JUDGES BY OUR ASSOCIATIONS.

The first step taken was the selection of a number of men capable of judging each breed of sheep, swine, and cattle. A separate list was prepared for each breed, and a copy of each of these lists was sent to the secretary of each large fair association in Ontario, and two representatives from each association, whose legitimate expenses were paid by the body represented, were sent to look after our interests at the board meetings of each of these exhibitions. Well do I remember the first time I presented a list of sheep and swine judges to the directors at a meeting of the Agriculture and Arts Association. The chairman took the list, and after examining it for a few minutes indignantly exclaimed, "There is not a man from my division named in these lists; we will have nothing to do with them." There were no recognized judges of sheep or swine in his division at that time, but the interests of the exhibitors were forgotten, and the spirit of patronage was dominant. If this condition prevailed among the directors of this ancient and honorable society, whose members were supposed to be farmers, what could we expect from the managers of other exhibition associations? Thanks to the work done by the officers of the Dominion Cattle, Sheep, and Swine Breeders' Associations, this state of affairs has passed away. Our nominees are welcomed by the officers of each of the chief exhibition associations, and in this respect, as in many others, the influence of our associations is gradually increasing. The result of our efforts to improve the judging of stock at the larger exhibitions has been most gratifying, yet we feel that much remains to be done.

THE WORK OF OUR TRANSPORTATION COMMITTEE.

Transportation by freight and express has received much attention from the directors ever since the foundation of the associations. It has long been felt that the rates charged by the great carrying companies have been, in a measure, oppressive, and that the trade in purebred live stock has been injured, and the progress of animal industry throughout the Dominion retarded thereby, which, in itself, has been a great national injury. Believing this, the efforts of our officers to improve the present conditions in this respect have been untiring. The chief officers of the C.P.R. and the G.T.R. have been appealed to again and again, both by correspondence and deputations, and at last we have succeeded. On January 19th, 1897, I was authorized by the officials of the C.P.R. and the G.T.R. to issue the following circular:

RAILWAY FREIGHT RATES ON PUREBRED STOCK.

"The Transportation Committee of the Dominion Cattle, Sheep, and Swine Breeders' Associations has met the representatives of the various Canadian railways, and has obtained the following reductions in shipping rates of purebred animals. The rates at which purebred animals will hereafter be taken by the Canadian railways are as follows. The charge per cwt. remains as heretofore:

	Pounds each.
Bull calves, six months old and under.....	500
Bulls and bull calves, over six months and under one year old.....	1,000
Bulls, one year and up to two years.....	2,000
Bulls, over two years old.....	2,600
Cows, one animal.....	2,000
Cows, two animals in same car.....	3,500
Cows, three animals in same car.....	5,000
Each additional animal in same car.....	1,000
(Must be from one shipper to one consignee, in one shipment, to one destination.)	
Heifer calves, six months old and under.....	500
Heifer calves, over six months and up to one year old.....	1,000
Heifers, over one year and up to two years old....	1,500
Heifers, over two years old, same as cows.	

"Certificates of registration must, in all cases, be produced by shipper. Agents will take note of particulars as to name of animal and age, and keep record of same. Also make note of billing accordingly.

"Pedigreed stock, as above, may be taken without men in charge, provided owners sign the usual contract releasing the company from liability in consequence thereof.

"The above special estimated weights will only apply when owners sign the usual valuation agreement for ordinary stock. If extra values are declared the weights and rates will be as per classification for valuable stock, page 42, classification No. 10."

On February 22nd, 1897, I was authorized by the Association of Freight Agents of Canada to issue the circular given below.

FREIGHT RATES ON PUREBRED CATTLE, SHEEP, AND SWINE, FROM ANY POINT IN ONTARIO TO ANY POINT IN MANITOBA AND THE CANADIAN NORTHWEST.

"The Joint Transportation Committee of the Dominion Cattle, Sheep, and Swine Breeders' Associations has arranged with the officials of the Canadian Pacific Railway, and the Grand Trunk Railway, to carry purebred cattle, sheep, and swine, in car loads, from any point in Ontario and Quebec west of Montreal, at the rate charged on settlers' effects. The charge for a car load of purebred stock from any point in Ontario to any point in Manitoba and westward, may be learned from any agent of the C.P.R. or the G.T.R., and is published in the pamphlet known as *F. T. No. 45, Canadian Pacific Railway Special Through West-bound Tariff on Settlers' Effects*. The rate for a car load of 20,000 pounds from any point in Ontario or Quebec, west of Montreal, to Winnipeg, is \$72 per car load; to Regina, \$90; to Calgary, \$114; and corresponding rates to all other western points. (The rates hitherto in force for a similar car load have been—to Winnipeg, \$130; to Regina, \$164; to Calgary, \$202; and these latter rates are now charged for animals not recorded.)

"Under the new arrangements it is not necessary to load all the animals composing a car load at any one point, *i. e.*, part of a car may be loaded at London, part at Woodstock, part at Toronto, or at any other stations on the direct line between the starting point and the destination of the car. No additional charge will be made for a car so loaded except shunting charges, which are \$3 for the first stop, and \$2 for each subsequent stop.

"One man will be passed free with each car load, and he will be returned from the destination of the car to the original point of shipment at one cent per mile, second class. All animals sent at the above rates must be purebred, and shipped for breeding purposes only; and a certificate of registration for each animal must be presented to the agent at the shipping point. After being examined by the agent, each certificate will be returned to the shipper.

"Parties who wish to ship single animals from any point in Ontario to Manitoba and the west may do so at car load rates by corresponding with the secretary of the associations, and as soon as enough animals to fill a car are offered, the car will be forwarded in charge of a suitable attendant. The price charged for the transportation of such animals will be about \$6.50 per head for cattle over two years old when sent to Winnipeg. If sent to Regina, the charges will be about \$7.50 per head; and to Calgary, \$8.50. Young cattle and sheep and swine will be carried at proportionate rates. (From three to four sheep, and from two to six pigs usually occupy as much space as one bullock.) In addition, each shipper will be required to pay shunting charges necessitated by his shipment. In all cases the shipper must furnish enough feed to support the animal or animals from the starting point to their destination. Freight, in all cases, must be prepaid. Purebred animals shipped to Winnipeg, or other distributing points, in car load lots, may be distributed singly therefrom over the various railway lines at reduced freight rates.

"Further particulars may be had by applying to the general or local freight agents of the C.P.R. or the G.T.R., or to F. W. Hodson, Guelph, Ont."

QUARANTINE REGULATIONS.

Ever since Great Britain scheduled Canadian cattle our officers and members have been most active in their efforts to bring influence to bear

that would cause the British Government to reconsider their decision; we regret to say we failed in this particular. Canada has been most unjustly treated by the mother land in this respect. As a matter of protection England had a perfect right to exclude our cattle; but when she did this on the false plea that our herds were infected with pleuro-pneumonia, the conduct of her statesmen was simply outrageous. As soon as it was found that Great Britain would not reconsider her decision, the officers of our association decided to send a deputation to Ottawa, to induce, if possible, the Canadian authorities to open negotiations with the Government at Washington, looking toward a modification of the quarantine regulations which at that time existed between Canada and the United States, and which were practically prohibitive, especially in the case of cattle. For more than two years this agitation was kept up. The first appeal to the Government at Ottawa was made by a strong deputation, and Mr. Foster, in behalf of the late Government, promised to take the matter in hand. Soon after this the Conservative administration was defeated, and we found it necessary to appeal again to Ottawa. On the 8th of September, 1896, a mass meeting was held on the grounds of the Toronto Industrial Exhibition Association, at which the Hon. Sydney Fisher, Minister of Agriculture for the Dominion, and the Hon. John Dryden, Minister of Agriculture for the Province of Ontario, were present, and there they met the largest and most representative gathering of live stock breeders that has ever convened in Canada. Addresses were delivered by the Hon. John Dryden, Messrs. Hobson, Johnston, Russell, and others. The Hon. Mr. Fisher replied, promising to consider carefully this most important question. Your officers continued to keep this question before the people, and we were gratified when, in December, 1896, the Hon. Mr. Fisher and the Hon. John Dryden left for Washington to confer with the American Government regarding the quarantine regulations. The Hon. Mr. Fisher has favored me with the following history of the case and the outcome of the negotiations.

REMOVAL OF THE CATTLE QUARANTINE BETWEEN THE UNITED STATES AND CANADA.

"Seventeen years ago alarming reports appeared in the American press that rinderpest was epizootic in the neighborhood of Washington, and other points on the Atlantic seaboard. Dr. Duncan McEachran, Chief Dominion Stock Inspector, was commissioned by the Canadian Government, at the instigation of the British Government, to visit the infected districts and make a report as to the nature of the disease. He did so, and found that the disease was not rinderpest, as reported, but contagious pleuro-pneumonia.

THE UNITED STATES SCHEDULED BY GREAT BRITAIN.

"At this time a bill was introduced into the British Parliament by the Duke of Richmond, its object being to lessen the danger of the importation of diseased animals into Great Britain from other countries. This bill provided that all countries in which animal disease of a contagious nature existed should be put on the scheduled list; which meant that the animals would not be allowed entrance into any inland portion of the British Isles, but would be slaughtered at the port at which they landed, within ten days of their landing there. Countries in which no disease existed were to be allowed, as formerly, to land their cattle which could be taken into the interior markets in Great Britain.

"Dr. McEachran had no difficulty in discovering that this disease was widespread in the District of Columbia, on the seaboard of Pennsylvania, in the State of New York, particularly around Brooklyn, and in New Jersey. The report the doctor then made led to the United States cattle being placed on the scheduled list.

"A thorough search was made through Canada, and no contagious disease of cattle could be found. A report to this effect was made to the British Government, with the result that Canadian live stock were allowed free entry to any port in the British Isles.

THE AMERICAN GOVERNMENT TAKE STEPS TO OBTAIN A CLEAN BILL OF HEALTH.

"The consequence of this was that the American Government were induced to adopt measures for ridding the country of this cattle disease, which subsequently led to the establishment of the Bureau of Animal Industries, with Dr. D. E. Salmon as Chief. For a time the Bureau found difficulties in administering the necessary regulations, on account of 'State rights'; this led to an Act of Congress giving them power to deal with these diseases throughout the entire country, and they continued to deal with them actively.

"Nearly three years ago a report was made by the then Commissioner of Agriculture, Mr. Lohring, that the last case of pleuro-pneumonia had been exterminated, and a request was made to the British Government to remove the schedule. It was not considered [by the English authorities] at that time advisable to do so, nor has it since been done.

"On several occasions, on behalf of the Canadian Government, Dr. McEachran made special investigations personally in the previously infected districts of the United States, and failed to find any trace of contagious pleuro-pneumonia. In addition to this, investigations were conducted by veterinaries throughout different parts of the United States, at the Doctor's request, and the result of their reports was that no cases of pleuro-pneumonia could be found.

THE UNITED STATES NOW FREE FROM CONTAGIOUS PLEURO-PNEUMONIA.

"Dr. McEachran attended meetings annually of the members of the veterinary profession of the United States and Canada, notably one during the World's Fair, at Chicago, in 1893, where a paper was read on the subject of pleuro-pneumonia by the late John Gadstone, M. R. C. V. S., of Philadelphia, at which the subject of pleuro-pneumonia was thoroughly discussed. A resolution was passed unanimously at that meeting, which was published in the report of the U. S. Veterinary Medical Association for that year, that it was the unanimous opinion of the veterinary profession of the United States and Canada, there assembled, that contagious pleuro-pneumonia no

longer existed in the United States, and that it never had existed in the Dominion of Canada, except in the quarantine at Quebec, in 1886, whence it had never been allowed to spread. Numerous enquiries have been instituted by Dr. McEachran, and through the profession in the United States, and he had no hesitation in reporting to the Government of Canada that the United States has been free from contagious pleuro-pneumonia for over two years.

EFFECT OF THE QUARANTINE ON OUR TRADE.

"Previous to the establishment of the quarantine between the two countries, there existed a large trade in live stock, more especially in cattle for breeding purposes, and cattle for feeding, usually called 'stockers', or 'store cattle.' The quarantine of ninety days, which was established to satisfy the British Government that the pleuro-pneumonia of the United States would not be admitted to Canada, led to a cessation of this large and valuable exportation of animals from Canada to the United States. Up to this time also large numbers of live stock were exported from Canadian ports, especially by the St. Lawrence route, from Chicago and other western points; this valuable trade was also cut off by the quarantine.

"For a number of years urgent recommendations have been made by the cattle shippers, by the Boards of Trade, by the breeders of thoroughbred stock, and others, to the Canadian Government to have these quarantine restrictions removed, as being no longer necessary, since the disease for which quarantine was established had been extirpated from the United States to the satisfaction of the veterinary advisers of the Canadian Government.

AS CANADA IS NOW SCHEDULED BY GREAT BRITAIN OUR QUARANTINE AGAINST THE UNITED STATES IS INJURIOUS TO US.

"Owing to the bill introduced by Mr. Long, British Minister of Agriculture, making the embargo on Canadian cattle permanent by legislative enactment, on the supposition that pleuro-pneumonia existed in Canada, notwithstanding that no such disease actually did exist, and that there was nothing to support even a suspicion that pleuro-pneumonia had ever existed in Canada, except as above stated in the Quebec quarantine; and being, therefore, satisfied that there was no hope of the embargo on Canadian cattle being removed by the British Government; and meeting the urgent demands of those interested in breeding, in exporting, and in carrying Canadian live stock, the present government have been induced to take steps to remove or modify the quarantine regulations existing between Canada and the United States.

THE QUARANTINE DETENTION BETWEEN CANADA AND THE UNITED STATES NOW DONE AWAY WITH.

"On the 14th Dec., 1896, the Hon. Sydney Fisher, Minister of Agriculture, accompanied by his private secretary and Dr. Duncan McEachran, Chief Inspector of Stock for Canada, visited Washington, and interviewed the American Secretary of Agriculture, the Hon. J. Sterling Morton, and Dr. D. E. Salmon, Chief of the Bureau of Animal Industry, and it resulted in an agreement being entered into between the Canadian Minister and the United States Secretary of Agriculture, the substance of which has already been published. The quarantine of ninety days has been done away with: but no precautions have been overlooked to prevent the possibility of the introduction of any contagious disease from the one country to the other.

"The system of inspection, of testing for tuberculosis, of certificates of freedom of districts and animals from disease, is so thorough that the substitution of the present regulations, while removing unnecessary hindrances to the freedom of trade between the two countries in live stock, and restoring the American market for surplus Canadian animals, both thoroughbred and grade—in no way increases the risk of the introduction of any contagious disease, should such exist in either country.

QUARANTINE AS AGAINST EUROPEAN COUNTRIES
CONTINUED.

"It is provided in the international agreement that cattle from European countries should be dealt with as heretofore, viz.: subjected to a quarantine of ninety days. This is absolutely necessary, for the reason that contagious pleuro-pneumonia has been discovered, both in Scotland and in the neighborhood of London, England, whence most of the animals imported into Canada come, within the last six months. Contagious diseases are known to exist in other European countries. Consequently, it would be unwise to lessen preventive measures instituted for the prevention of these contagious diseases by the establishment of quarantine at the seaboard.

THE PRESENT REGULATIONS REGARDING QUARANTINE
AS BETWEEN CANADA AND THE UNITED STATES.

"The following are the American regulations governing the export of Canadian stock into the United States, which are about the same in every particular as the Canadian regulations for the importation of United States stock:

Washington, D. C., Jan. 23rd, 1897.

(1) All animals imported into the United States from Canada must be accompanied by an affidavit made by the owner or importer, declaring clearly the purpose for which said animals are imported, viz., whether for breeding purposes, for milk production, for work animals, for grazing, feeding, or slaughter, or whether they form part of settlers' effects, or whether they are horses entered for temporary stay, as provided in section 5 of these regulations. Said affidavit must be presented to the collector of customs at the port of entry, who will decide whether the animals are entitled to entry under these regulations, and who will notify the inspector of the Bureau of Animal Industry in all cases where these regulations require an inspection to be made.

(2) All animals imported into the United States for breeding purposes, for milk production, for grazing or feeding, horses for work, and swine for slaughter, must be inspected by an inspector of the Bureau of Animal Industry at the port of entry. All animals covered by this section, except horses and swine for slaughter, must be accompanied by a certificate signed by a Canadian official veterinarian, stating that no contagious disease, except tuberculosis and actinomycosis in cattle, affecting the species of animals imported, has existed in the district in which the animals have been kept for six months preceding the date of importation, except animals which are part of settlers' effects, or belonging to Indian tribes, which may be entered without certification or inspection. The owner or importer must present an affidavit that said certificate refers to the animal or animals imported. The certificate for cattle for breeding and for milch cows must also show that they have been submitted to the tuberculin test and found free from tuberculosis, giving the date of testing, with the chart of reaction, and a description of the cattle, with age and markings. All animals imported for breed-

ing purposes, milk production, grazing or feeding, when not accompanied by the required affidavits and certificates, must be detained in quarantine for one week, at the expense of the owner or importer, under the supervision of the inspector in charge. During this detention a rigid inspection will be made, and cattle for breeding or milk production will be tested with tuberculin. Animals found free from disease at the end of this period will be released. Cattle and sheep for grazing or feeding, if accompanied by the required affidavits and certificates, need not be unloaded for inspection, but all other animals covered by this section must be unloaded and carefully inspected.

(3) All Canadian animals will be admitted at any port in the United States for transit in bond to any Canadian port without inspection.

(4) Cattle and sheep in bond for export will be admitted without inspection at any of the ports named in section 1, in transit to and for export from Portland, Me., Boston, Mass., and New York, N. Y. Horses will be admitted in bond at any port of the United States without inspection for export from any port of the United States. All animals admitted for export will be subject to inspection at port of export.

(5) Horses for temporary stay, whether for pleasure driving, teaming, exhibition, racing, or used in connection with stock raising or mining, cattle and sheep for slaughter, and animals belonging to Indian tribes or forming part of settlers' effects, will be admitted through any port without inspection or certification.

(6) The railroad cars used in the transportation of animals, specified by these regulations, must be thoroughly cleaned and disinfected before said animals are placed therein. All litter from previous shipments must be removed, and the car whitewashed with lime and carbolic acid, one pound of commercial carbolic acid to five gallons of lime wash. Unless this regulation is complied with Canadian animals will not be allowed entry into the United States, and animals from the United States will not be admitted into Canada. Shippers should see that cars are properly cleaned and disinfected before animals are loaded."

RESULTS ALREADY GAINED DUE TO THESE
NEW REGULATIONS.

The practical results of the changed conditions are most gratifying. The trade in purebred stock between the two countries has revived, and will doubtless continue to grow and be of mutual advantage. Since the change in the regulations the trade in light stockers between Canada and Buffalo has been gratifying to Canadians. In the issue of March 3rd, 1897, that excellent paper, *The Breeders' Gazette*, of Chicago, Ill., among other things, says:

"One month has now elapsed since the removal of the quarantine on live stock between Canada and the United States. Up to Monday night last, March 1st, Ontario farmers and feeders had disposed of some 325 car loads of cattle at the Buffalo yards (the first since the quarantine restrictions of 1889, the removal of which went into effect February 1st, 1897), and we understand that bull buyers are visiting Canadian herds contracting stock for shipment to our northern ranges. If any butchers' stock or any breeding stock has been bought by Canadians on this side of the line *The Gazette* has yet to hear of it. It may be said, therefore, that the events of the past four weeks de-

monstrate clearly that under the twenty per cent. *ad valorem* duty of the Wilson-Gorman tariff law the United States markets are easily entered by Canadian feeders' and butchers' stock, and that in the absence of quarantine restrictions, breeding stock—which, under all our tariff laws, have been on the free list—will be in demand again from this side of the line. It is equally clear that no live stock will be bought from us by Canada. In other words, as between the *producers of live stock* on both sides of the line this is reciprocity of the genuine jug-handled brand. There is a good market here for Canadian live stock. There is practically no market for American live stock in Canada. Hence we have one of those instances presented which formed the basis of the doctrine enunciated by Mr. Blaine—that we should use the tariff to 'trade on,' exacting some concession in favor of some American product in exchange for any arrangement of our own customs duties that permits the profitable entry into our markets of any given product of a foreign nation. If the new Congress proposes to legislate along this line it will, therefore, either put a higher duty on Canadian cattle (other than breeding stock), or let it remain where it is, and allow the cattle to continue to enter in return for some amendment to the Dominion tariff that will let American goods of like value into Canadian markets. 'A fair exchange is no robbery.'

The article from which this extract is taken occupies nearly two columns and a half, and should be read by every Canadian farmer and politician.

CANADIAN RECORDS IN THE UNITED STATES.

For many years all animals registered in Canadian records were allowed to be exported to the United States duty free, but in 1889 all Canadian records were discredited by the American government, and in order to pass duty free into the United States purebred animals bred in Canada must be recorded in American records. Canadian records have as high a standard and are in every way as carefully conducted as the American herd, stud, and flock books, therefore the officers of your associations have exerted themselves to induce our American neighbors to recognize Canadian records. Negotiations are now pending.

THE SWINE RECORDS.

Before our associations were established there were no swine records published in Canada. The members of the Swine Breeders' Association at once interested themselves in this matter, and in 1892 the first volume of the Dominion Swine Breeders' Record was issued. Since then six volumes have been published, containing the pedigrees of 8,149 Berkshires, 4,483 Yorkshires, 468 Suffolks, 1,495 Chester Whites, 1,892 Poland-Chinas, 979 Tamworths, and 291 Duroc-Jerseys. The seventh volume is now in the printers' hands.

THE PROVINCIAL FAT STOCK SHOW.

The exhibits and attendance at the Ontario Provincial Fat Stock and Dairy Show, which is annually held under the auspices of these associations, have increased in number each year. A separate report has been prepared, dealing with this department of our work.

QUESTIONS NOW UNDER CONSIDERATION.

During 1897 we hope to consider further the transportation of live stock. A vigorous transportation committee should be appointed by each association. Now that we enjoy reduced transportation rates on purebred stock shipped between Ontario and Manitoba and western Canada, we should do our utmost to extend trade in this direction. The privilege is a very important one, and has already proved a benefit to Ontario sellers and western buyers.

It has been the practice of each association to publish in the annual report each year the name and address of each member and specify the breed he reared. This has grown to be the largest breeders' directory in Canada. During the last three years I have been very frequently asked for these lists by parties desiring to buy purebred stock, and have mailed hundreds of copies, sending them to various parts of Canada and the United States. I believe that if these lists of breeders could be revised and distributed monthly it would be of great value. In order to do this each member of the association would be required to notify me on or before certain dates each month, to be fixed by the association, what animals he or she has for sale, and the price asked. The lists could be revised, and copies of the circular mailed. I have now about 4,000 addresses of live stock breeders and of prominent farmers in Canada and the United States. This plan would cost the associations about \$15 per month, but would increase the membership of the Cattle and Sheep Breeders' Associations, and it would have a tendency to increase the sales made by our members not only in Ontario, but in the distant provinces and in the United States. Besides benefiting the members it would supply the Departments of Agriculture of the various provinces and States, and the secretaries of Farmers' Institutes and agricultural associations, farmers, and American buyers, with just such information as they desire.

STANDARDS OF EXCELLENCE FOR SHEEP AND SWINE.

The annual report of each association is a very important feature, and must be kept up to a high standard. Two years ago the Sheep and Swine Breeders' Associations decided by a unanimous

vote to have a standard of excellence of each breed of sheep and swine bred in Canada prepared and published. As yet little has been done in this respect. I therefore suggest that each association instruct the executive committee to proceed with the work at once. For fuller particulars regarding this subject see the Annual Report for 1893, page 153. A complete standard of excellence for cattle, sheep, and swine

would furnish suitable matter for our next Annual Report, and could be obtained more cheaply and more conveniently than any other suitable matter. This question has been before the Sheep and Swine Breeders' Associations for four years, and at the request of these associations I have got together a good deal of suitable material which will be of value to the committees engaged in the work.

MARCH MEETINGS.

I. DIRECTORS' MEETING OF THE DOMINION CATTLE BREEDERS' ASSOCIATION.

A meeting of the directors of the Dominion Cattle Breeders' Association was held at the Palmer House, Toronto, on Tuesday, March 23rd, the president, Mr. John I. Hobson, in the chair. Other directors present were: J. C. Snell, Snelgrove; David McCrae, Guelph; Arthur Johnston, Greenwood; Alfred Stone, Guelph; G. E. Day, B.S.A., Ontario Agricultural College; Capt. Wm. Rolph, Markham; G. W. Clemons, St. George; Robert Miller, Brougham; H. Wade, Toronto; and the secretary, Mr. F. W. Hodson.

TRANSPORTATION AND TARIFF MATTERS.

After the address of the president, in which he briefly reviewed the work done during the past year, Mr. J. S. McDonald, of Montreal, by request, addressed the meeting on the question of transportation of live stock. For some months past Mr. McDonald has been carefully studying this question. He has been in correspondence with the leading breeders of live stock in this country, and has obtained much valuable information. After some discussion the matter was left in the hands of the Transportation Committee to co-operate with Mr. McDonald.

The report of the committee appointed to meet the Tariff Commissioners of the Dominion Government was given by Mr. John I. Hobson. He reported that the committee held a preliminary meeting and decided just what they wished to bring to the notice of the commissioners. The commission gave them a courteous hearing, but were very non-committal in their replies.

The Transportation and Quarantine Committee reported that a full account of what had been accomplished by them was embodied in the report of the secretary. [This will be found in full on a previous page.]

The following motion was carried unanimously: "That a special committee consisting of Mr. David McCrae and the secretary be appointed to communicate with other live stock associations of the Dominion, and to urge upon the Government the appointment of a Live Stock Commissioner for the Dominion." It is desired that this commissioner should be one in close sympathy with the live stock interests of this country, and that it should be his duty to look after the interests of breeders generally.

MORE PRIZES FOR THE FAT STOCK SHOW.

The rules and regulations governing the cattle department of the Provincial Winter Fair Association were then revised. The most important amendment made was, that animals will hereafter be charged per entry instead of

per head. After consideration it was decided that the prizes in the cattle department remain the same as last year, with the exception that \$100 be added to the prize list in the dairy department. The classes for Hereford and Polled Angus, and Galloways and Devons were left to the following committee to consider the advisability of dividing them into separate classes for each breed: G. E. Day, Alfred Stone, John I. Hobson, David McCrae, and F. W. Hodson.

DEVELOPMENT OF TRADE WITH ARGENTINA.

Mr. H. J. Hill, manager of the Toronto Industrial Exhibition Association, addressed the meeting briefly, advocating a scheme for building up a trade in live stock with the Argentine Republic. He advised that the association ask the Government that delegates from the Republic be invited by Canada to visit this country at the expense of our Government, and that they be taken round to all our large fall fairs. In this way they would see the class of animals bred in this country. A letter was also read from Mr. Wm. Linton, Aurora, urging that action be taken along this line. It is estimated that the expense to the Government to carry out this plan would be about \$1,000. The matter was referred to the Executive.

The report of the secretary, a copy of which had been forwarded to each director, was accepted as read, and referred to the Executive to deal with.

The following committees were appointed:

Executive, Programme, and Transportation: John I. Hobson, F. W. Hodson, J. C. Snell, Arthur Johnston, and David McCrae.

Delegates to the Board of the Provincial Winter Fair: John I. Hobson, J. C. Snell, and G. W. Clemons.

Judges for the Cattle Department at the Provincial Winter Fair: Thos. Crawford, Toronto, and Robert Miller, Brougham. Reserve, James Smith, Brantford.

II. DIRECTORS' MEETING OF THE DOMINION SHEEP BREEDERS' ASSOCIATION.

A directors' meeting of the Dominion Sheep Breeders Association was held in the Palmer House, Toronto, on Wednesday, March 24th, the president, Mr. James Tolton, Walkerton, in the chair. Other directors present were: D. G. Hanmer, Burford; John Jackson, Abingdon; R. H. Harding, Thorndale; G. E. Day, B.S.A., Ontario Agricultural College; Henry Arkell, Arkell; J. T. Gibson, Denfield; T. C. Douglas, Galt; John Kelly, Shakespeare; Richard Gibson, Delaware; John I. Hobson, Mossboro; J. C. Snell, Snelgrove; and the secretary Mr. F. W. Hodson.

The following committee was appointed to confer with the committee from the Cattle Breeders' Association re the appointment of a Live Stock Commissioner: D. G. Hanmer, and John Jackson.

The report of the Tariff Committee, which was similar to that given by the Cattle Breeders' Association, was accepted.

The committee appointed to interview the Minister of Agriculture regarding the Prince of Wales prize reported that they had met the Honorable the Minister of Agriculture, and had been informed that the prize would be given to the association which had not last received it. (It has since been learned that the prize will be given in the cattle department.)

Mr. McDonald, of Montreal, addressed the meeting for a short time on the question of transportation. The matter brought forward by Mr. McDonald, which was similar to that brought forward by him at the Cattle Breeders' meeting, was left in the hands of the Transportation Committee, in conjunction with Mr. McDonald.

The rules and regulations governing the Provincial Winter Fair were then revised. About \$200 was added to the prize list in the sheep department.

The matter of building up a trade in live stock with South America was brought to the notice of the meeting, and was referred to the Transportation Committee. (See similar item in our report of the Cattle Breeders' meeting.)

The report of the secretary (see previous page) was adopted, and left to the Executive Committee to deal with.

The report of the Transportation Committee was similar to that made by the Transportation Committee of the Cattle Breeders' Association.

The following committees were appointed:

Executive, Transportation, and Programme: James Tolton, D. G. Hanmer, F. W. Hodson, John Jackson, and R. H. Harding.

Delegates to the Provincial Winter Fair: John Jackson, D. G. Hanmer, and R. H. Harding.

The judges for the sheep department of the Provincial Winter Fair are to be as follows:

For Long Wools: Joseph Snell, Snelgrove; Joseph Gaunt, St. Helens; and E. Parkinson, Eramosa.

For Fine Wools: Henry Arkell, Teeswater; Wm. Martin, Binbrook; and Mortimer Levering, Lafayette, Ind.

III. DIRECTORS' MEETING OF THE DOMINION SWINE BREEDERS' ASSOCIATION.

A meeting of the directors of the Dominion Swine Breeders' Association was held in the Palmer House, Toronto, on Thursday, March 25th, the president, Mr. Joseph Brethour, in the chair. Other officers and directors were: George Green, Fairview; R. H. Harding, Thorndale; W. E. Butler, Dereham Centre; W. H. Jones, Mt. Elgin; Andrew Elliot, Galt; Thomas Teasdale, Concord; Major G. B. Hood, Guelph; J. C. Snell, Snelgrove; and the secretary, Mr. F. W. Hodson, Guelph.

Thomas Teasdale and Major G. B. Hood were appointed a committee to confer with the committees from the Cattle and Sheep Breeders' Associations regarding the appointment of a Live Stock Commissioner for the Dominion.

The president, for the Tariff Committee, reported that they had met the Tariff Commissioners at Guelph, had

been given a hearing, and hoped that there would be good results.

Mr. McDonald, of Montreal, addressed the meeting on the question of transportation. (See report of the Cattle Breeders' Association.) After discussion the matter was referred to the Transportation Committee.

A letter was read from Mr. George H. Greig, secretary of the Sheep and Swine Breeders' Associations of Manitoba, asking that the members of their association be allowed to register their animals at the same rates as are allowed to members of the Dominion Swine Breeders' Association. It was decided to grant this request. Mr. Greig also asked that a prize be donated from this association towards the prize list of the Winnipeg Exhibition. The association donated \$100 for this purpose, on condition that they receive full credit for the same in the prize list; also that animals winning prizes should be recorded in the Canadian Swine Record.

The rules and regulations governing the swine department of the Provincial Winter Fair were then revised. Animals will hereafter be charged per entry instead of per head. In the prize list a section was added to each class for "three bacon pigs," the prizes to be, 1st, \$15; 2nd, \$10; 3rd, \$5. In the Tamworth and Jersey Red classes the prizes were made equal to those offered for other breeds. The name "Jersey Reds" was also changed to read "Duroc-Jerseys."

The committee appointed to draft a scheme by which fair associations might charge for space instead of per head, was as follows: "We, your committee, recommend that \$1 per pen for an enclosure 7x9 be charged by the Toronto Industrial, and 50 cents per pen at other large fairs, such as Montreal, Ottawa, and London, for pens of similar size. (Signed) Wm. Jones, Chairman."

The report of the secretary-treasurer was then adopted and referred to the Executive to deal with.

The following committees were then appointed:

Executive, Programme, and Transportation: Joseph E. Brethour, George Green, F. W. Hodson, Major G. B. Hood, and J. C. Snell.

Delegates to the Provincial Winter Fair: Joseph Brethour, George Green, and Andrew Elliot.

The judges appointed for the swine department of the Provincial Winter Fair are as follows:

Chester Whites, Poland Chinas, Jersey Reds, and Grades: Joseph Featherston, M.P., Streetsville; Joseph Brethour, Burford. Reserve, J. C. Snell, Snelgrove.

Berkshires, Yorkshires, Suffolks and Essex, and Tamworths: Thomas Teasdale, Concord; W. H. Jones, Mt. Elgin. Reserve, Andrew Elliot, Galt.

IV. THE PROVINCIAL WINTER FAIR ASSOCIATION.

A meeting of the Provincial Winter Fair Association was held in the Palmer House, Toronto, on Thursday, March 25th, to make arrangements for holding the next Provincial Winter Fair.

The following gentlemen were present:

From the Cattle Breeders' Association: John I. Hobson, Mossboro; J. C. Snell, Snelgrove; and G. W. Clemmons, St. George.

From the Sheep Breeders' Association: R. H. Harding, Thorndale; John Jackson, Abingdon; D. G. Hanmer, Burford.

From the Swine Breeders' Association: Joseph Brethour, Burford; George Green, Fairview; Andrew Elliot, Galt.

From the Butter and Cheese Association of Eastern Ontario: R. G. Murphy, Elgin; H. Wade, Toronto.

From the Butter and Cheese Association of Western Ontario: Hon. Thomas Ballantyne, Stratford; Harold Eagle, Attercliffe.

The following officers were elected for 1897: President, John I. Hobson; vice-president, J. C. Snell; secretary-treasurer, F. W. Hodson. Executive and Programme Committee: Messrs. Hobson, Snell, Hodson, Brethour, Jackson, and Clemons.

The committees to manage the various departments of the show are the representatives from the respective associations.

Messrs. G. E. Day and J. B. Reynolds, Ontario Agricultural College, were appointed delegates from that institution to the Board of the Provincial Winter Fair.

The judges for the cattle, sheep, and swine departments have been given in the reports of these associations. The judges for the dairy department are as follows: G. E. Day, R. G. Murphy, and J. C. Snell.

THE FAIR TO BE AT BRANTFORD NEXT YEAR.

The committee appointed to visit places from which a request had been received that the show for next year be held in their town reported as follows:

GENTLEMEN,—We, your committee appointed to visit and report upon the accommodation offered to this association by Guelph, London, Brantford, Lindsay, etc., beg leave to report as follows: The first place we visited was

Brantford.

Here we found one large skating rink, 140 x 90 feet; floor space, 12,600 square feet. This building fairly well meets the requirements of the Provincial Winter Show, but is not as good as the Guelph building. Some distance from this building is situated a magnificent drill shed, which is dry and well lighted, and is a most suitable building for our purpose were it large enough; it is 170 x 84 feet; floor space 14,280 square feet, making a total or the two buildings of 26,880 square feet. In the last-named building are a number of offices. These would in every way meet the requirements of our association.

We next visited

London.

The building offered us here is on the fair grounds, and is with easy access of the street car track and the Grand Trunk freight and passenger switch. This building is 750 x 50 feet, and contains 37,500 square feet of floor space. If this building is arranged as the city authorities say it shall be it is well suited for the purpose for which we require it, both in size and in other particulars.

Lindsay

was next visited. This town has two large skating rinks, situated some distance apart, which have a combined floor space of 24,084 square feet. Both of these rinks are

well situated near the center of the town, and close to hotel and other accommodation. They are well lighted, and contain ample room for offices, board rooms, etc.

The accommodation at

Guelph

is well known to the members of this association. The available floor space is 23,838 square feet, and the offices all that can be desired. The city, the Board of Trade, and the Guelph Fat Stock Club offer the same inducement as heretofore.

The secretary has received official letters from the mayor of each of the above-mentioned towns; these will be read to you to-day.

We beg to draw your attention to the following facts. In 1891, the year before the associations which are here represented took part in the management of the Provincial Fair, there were 81 entries; the next year, the first in which we took an active part in controlling the show, there were 171; in 1893, 362; in 1894, 487; in 1895, 463; in 1896, 617. The total number of entries in 1896, including those for specials and sweepstakes, was 658. The increase between 1891 and 1892 was 112 per cent.; between 1892 and 1893, 112 per cent.; between 1893 and 1894, 35 per cent.; between 1895 and 1896, 32 per cent. This shows an average yearly increase of 72 per cent. for each of the last five years. Last year the building occupied by us at Guelph was overcrowded; the aisles could not be kept free from feed and litter, therefore we did not receive as large gate receipts as we otherwise would. We cannot expect visitors to attend the show when the building is continually overcrowded, and when it is impossible to view the exhibits with any degree of comfort. We, therefore, respectfully suggest that the accommodation provided for next year be at least 25 per cent. greater than that provided last year. We believe that at our next show there will be a larger exhibit of dairy cattle, of sheep, and of swine than we have heretofore seen. This will be especially true if the show is held at Guelph, Brantford, or London.

Respectfully submitted.

(Signed) JOHN I. HOBSON, } Committee.
F. W. HODSON, }

The report as above was adopted, and after some discussion it was decided on the second ballot that the show for 1897 be held at Brantford, on the 7th, 8th, and 9th of December.

INCREASE OF PRIZE MONEY.

The prizes in the cattle department have been increased \$100; in the sheep department \$200; and in the swine department \$200. With these additions the prize list this year will amount to about \$4,500. Besides this, a large number of special prizes have been obtained by the secretary. It is expected that the show will be by far the most successful yet held.

VAN, B.C., Dec. 28th, 1896.—I enclose \$3 for two new and my own subscriptions. I am much pleased with FARMING. Wishing you success for the coming year, yours sincerely, E. DENTON.

GREENBUSH, Nov. 19th, 1896.—I send you a new subscriber. I do not know why every one should not want FARMING. It is full of life and energy, and of the greatest practical value to every farmer. A. W. MILLEK.

"I thank you for your interest in our Institute work, and hope to reward you by sending you a goodly list of new subscribers." R. McCULLOCH, Snelgrove, Ont. (Secretary Peel County Farmers' Institute).

"I am well pleased with FARMING, and will recommend it to others as an up-to-date publication and useful for future reference." W. J. MCNAUGHTON, Lancaster, Ont. (Secretary of Glangary Farmers' Institute).



FARMING

AN ILLUSTRATED MONTHLY MAGAZINE DEVOTED TO FARMING
IN ALL ITS BRANCHES.

Succeeding *The Canadian Live Stock and Farm Journal*.

Published on the first of each month by

THE BRYANT PRESS,

20 BAY STREET TORONTO, CANADA.

Subscription Price—

Canada and the United States, \$1.00 per annum in advance
Great Britain and other countries in the Postal Union,
\$1.50 per annum in advance. Single copies 5 cents.

All subscriptions are received on the understanding that we
be notified when the subscriber wishes to discontinue. FARMING
will be sent to all subscribers until a notice to discontinue
is received and all arrears are paid up.

Renewals—

Money for renewals should not be paid to strangers, and
when subscribers do this it must be at their own risk. It
should be sent by each subscriber direct to this office. We
do not authorize agents to collect money for renewals.

The date opposite the name on the Address Label indicates
the time to which a subscription is paid, and the changing of
this date is sufficient acknowledgment of payment of subscription.
We should be notified when this change is not made promptly.

Remittances—

Remittances should be made by post office money order,
express money order, or registered letter. Sending money in
an unregistered letter is unsafe, and will be at the sender's
risk.

Discontinuances—

Returning a paper is not a notice to discontinue. A sub-
scriber wishing to discontinue must notify us by letter or
postal card. All arrears must be paid up before a name
can be taken from our list.

Changes of Address—

In ordering change of address, be sure to give the old address
as well as the new. We cannot find a name on our books
unless the post-office address is given.

Communications—

All business communications should be addressed to
"FARMING, 20 Bay Street, Toronto, Canada."

Communications for the Editorial Department should be ad-
dressed to "The Editor, FARMING, 20 Bay Street, Toronto,
Canada."

Matter of any kind for publication must reach us before the
15th of the month preceding date of publication.

W. W. CHAPMAN, Representative for Great Britain and
Ireland,

Fitzalan House, Arundel St., Strand, LONDON, ENG.

CONTENTS FOR APRIL.

The President of the Dominion Swine Breed- ers' Association.....	507
Our Special Swine Number.....	508
Swine.....	509
By Professor Thomas Shaw, Minnesota.	
On the Management of Young Pigs.....	512
By Sanders Spencer, Holywell Manor.	
From the Farrowing Pen to the Block (in three parts).....	516
By Theodore Louis, Louisville, Wis.	
The Breeding and Management of Pigs.....	531
By Alexander Watt, F.S.I.	

On the Production of Lean Meat in Swine.....	534
By Alex. W. Shaw.	
The Dairy and the Hog.....	528
By Chas. H. Everett, Beloit, Wis.	
The Yorkshire Pigs.....	544
By Sanders Spencer, Holywell Manor, England.	
Hog Pens and Hog Feeding.....	547
By George Wylie, Leeds, Wis.	
The Sow and Her Pigs.....	553
By A. Selle Mequon, Wis.	
Swine Feeds and Feeding.....	556
By A. Selle, Mequon, Wis.	
Some Notes on the Hog Question.....	560
By G. E. Day, B.S.A., Guelph, Ont.	
Practical Points in Swine Raising.....	562
By E. H. Bates, Brighton, Ont.	
The Care of the Brood Sow.....	564
By S. Coxworth, Whitby, Ont.	
Hog Raising in Connection with the Dairy.....	567
By J. Y. Griffin, Winnipeg.	
Improved Yorkshires : Points in their Favor....	568
By J. E. Cousins, Harriston, Ont.	
Why I Breed Improved Yorkshires.....	568
By Richard Gibson, Delaware, Ont.	
The Tamworth Hog.....	569
By John Bell, Amber, Ont.	
The Tamworth, the Hog for the General Farmer	571
By Norman M. Blain, St. George, Ont.	
Tamworth Swine : Points in their Favor.....	571
By J. C. Nichol, Hubrey.	
Why I Like Chester Whites.....	572
By Joseph Cairns, Camlachie, Ont.	
The Duroc-Jerseys.....	573
By W. E. Butler, Dereham Centre, Ont.	
Poland-Chinas.....	576
By R. B. McMullin, Blythwood, Ont.	
The Hog that the Present Market Demands....	576
By F. W. Fearman, Hamilton.	
A Live Stock Commissioner for Canada.....	577
Recent Developments in Live Stock Matters..	580
By F. W. Hodson, Guelph, Ont.	
March Meetings.....	586

Holywell Windsor.—The name of Mr. Sanders Spencer's Yorkshire pig, whose photo appears on page 513, should be "Holywell Windsor," and not "Holywell Minor." "Holywell Minor" appears on page 517.

Thermometers.—We have just received from Messrs. Derbyshire & Co., of Brockville, a very handsome thermometer manufactured by the R. Hoehn Co., of New York. The fact of its having come from the president of the Butter and Cheese Association of Eastern Ontario, should be a guarantee of reliability, and we are pleased to call attention to it.

Seed Grain and Other Premiums.—Our readers will please remember that we are offering some very valuable premiums for new subscribers. Full particulars regarding these premiums will be found in our January, February, and March numbers. For one new yearly subscription at \$1, with 18c. added to pay for bag, we offer the choice of the following SEED GRAINS: One bushel of White Siberian or Golden Prolific seed oats, or one bushel of Mandscheuri six-rowed barley; or for one new yearly subscription at \$1, with 30c. added, one bushel of BLUE PEAS. OUR SPECIAL collections of VEGETABLE AND FLOWER SEEDS also deserve attention. They are selected and put up for us by Mr. William Rennie, the well known seedsmen, with a special view to meet the requirements of our patrons, and are guaranteed by him to be the best for the purpose obtainable. Every one wants seeds at this time of the year, and who is there who cannot, if he will, obtain at least one new subscriber to FARMING? For one new yearly subscription at \$1 we give a choice of the following: Collection A, 5 packages of vegetable and 5 packages of flower seeds, worth 60 cents. Collection B, 10 packages of vegetable seeds, worth 55 cents. Collection C, 9 packages of flower seeds, worth 60 cents. And for two new yearly subscribers at \$1 each we give, in Collection D., 18 packages of the very choicest vegetable seeds, worth \$1.15. We assure our friends that in no other way can they so easily obtain a most complete and reliable supply of seeds for their season's use. Want of space prevents us from referring in detail to our other premiums, but a perusal of our premium lists for the preceding three months of this year will, we are sure, prove both interesting and profitable.

Keeping Accounts.—The series of account books designed by Mr. Thomas J. Dillon, Superintendent of Dairying of Prince Edward Island, are among the most useful things we know of. Every

factory patron needs his milk pass-book to enable him to tell with accuracy what his cows are doing, and the other books will be found equally useful to those for whom they are designed, namely, secretaries and officers of cheese and butter factories. See Mr. Dillon's advertisement in another column.

Good Crops.—Messrs. Osler, Hammond & Nanton, of Winnipeg, Man., have been kind enough to furnish us with some interesting returns showing results realized from lands sold by them last year. These results are most remarkable and indicate more clearly than all other evidences combined, the wonderful fertility and surprising capabilities of the soil of our western prairie lands under the hands of industrious and capable farmers. Copies of these returns and also of lists of lands for sale may be obtained on application to Messrs. Osler, Hammond & Nanton, 381 Main street, Winnipeg, Man.

Little's Sheep Dip.—This preparation has a reputation of twenty-five years' standing throughout the whole world, and has held the foremost place amongst sheep dips during that time. In addition to its unexcelled curative properties it has the merit of invigorating the growth of the wool by its healthy action on the skin, the testimony of so high an authority as our Minister of Agriculture and other large breeders is conclusive on this point. It is done up in large tins at 75 cents each, making from twenty-five to forty gallons of wash according to strength required. No farmer, let alone stock breeder, can afford to do without it.

Better Than Ever.—The estimation in which Gombault's Caustic Balsam is held in Canada is shown by the following letter: "Morrisburg, Ont., Feb. 23rd, 1897. The Lawrence Williams Co., Cleveland, Ohio. Gentlemen,—Your ad. in *Pharmaceutical Era* regarding horse pictures for free distribution. Would like about one or two hundred

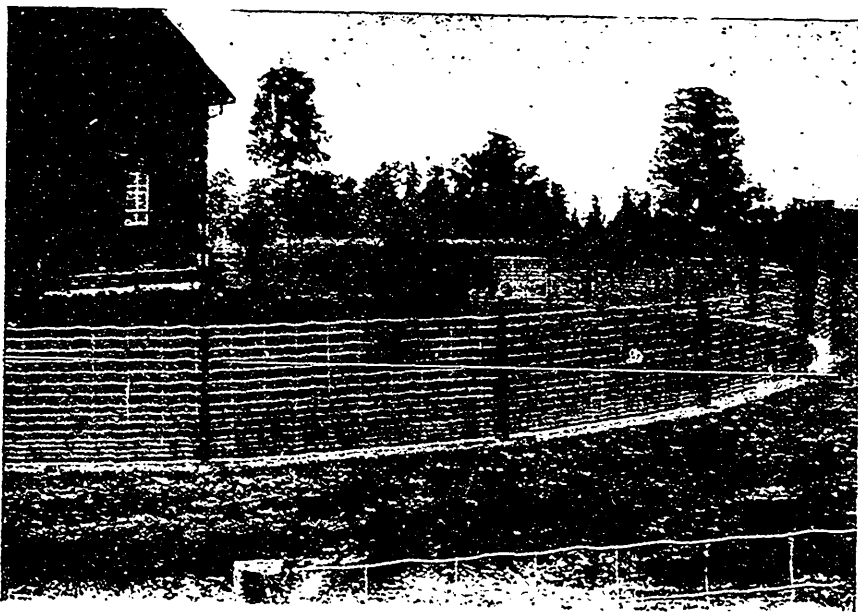

Premises of Thomas F. Routledge, Muirkirk, Ont., Enclosed with Page: Woven Wire Fence,

by mail. I might say, I think I was the first druggist to sell Gombault's Caustic Balsam direct from you over eighteen years ago, and have been selling it ever since. It seems better than ever. I procure it now from the Northrup & Lyman Co., Toronto. Yours, etc., Levi F. Sellick."

The Science of Farming.—No farmer should fail to read Manson Campbell's little book "How to Make Dollars Out of Wind, or, The Science of Farming." It will be sent free on application to him. See advt.

An Early Spring.—Those claiming to be weather-wise predict an early spring. At all events, the time has come when each of us must lay out his season's work. One of the things to be decided now is where to place orders for farm and garden seeds. We are pleased to say we can honestly and conscientiously recommend all those seedsmen whose advertisements appear in this issue. They are well known and old-established houses, whose reputation is too valuable to admit of anything but the most straightforward and honorable methods

"A Book on Silage."—This little work by Professor F. W. Woll, Wisconsin Experiment Station, ought to be in the hands of every farmer. It contains information on planting, cultivating, and harvesting silage crops, particularly corn and clover. Descriptions of how to build many different kinds of silos, and how best to fill them, are also given. A chapter is devoted to the value of silage as a food for different purposes and for different kinds of stock. Rand, McNally & Co., Chicago, are the publishers, and T. J. Day, Guelph, the Canadian agent.

Weighing Produce.—A correspondent writes: "One of the things to be remarked is the fact that farmers, as a rule, depend on other people to weigh their produce, while all other people in business, with scarcely an exception, not only weigh what they sell but also what they buy. Though he is astute enough in other respects, in this matter the average farmer is very confiding, and trusts altogether too much to other people. There is no sort of implement or utensil more necessary on a farm than a good set of scales, and only those who have had experience know to what extent this is true. Even with people who are strictly and unmistakably honest, mistakes are liable to occur, but it is a painful fact that dealers and buyers are not invariably found to be honest, and there is nothing which will serve so well to check mistakes and prevent dishonesty as a good weighing apparatus. The farmer who deprives himself of such utensils from motives of economy makes a great mistake." We have no hesitation in endorsing the last sentence. No farmer can afford to do without reliable scales, but we were not aware that farmers, as a rule, were not already supplied with them. Those who are not should certainly lose no time in supplying the deficiency.

Horns On or Off.—There was a time, not many years ago, when a muley or polled animal, one without horns, was something of a curiosity. Of course, people did not go miles to see them, but most of our readers will remember how oddly and out of place the muley looked. More recently, by almost common consent, the people have demanded that for reasons of profit and humanity, both to man and among the animals themselves, there should be more muleys, and the practice of dehorning sprang into popular favor. This very excellent practice has extended to such breadth that we should not be at all surprised if eventually the animal with horns will be as much a curiosity as the muley was formerly. From

Horse Owners Should Try

COMBAULT'S Caustic Balsam

The GREAT FRENCH VETERINARY REMEDY

A Safe, Speedy and
POSITIVE CURE.



Prepared exclusively by J. E. Gombault ex-Veterinary Surgeon to the French Government Stud.

SUPERSEDES ALL CAUTERY OR FIRING

Impossible to produce any scar or blemish. The Safest and Easiest ever used. Takes the place of all liniments for mild or severe action. Removes all Bunches or Blemishes from Horses or Cattle.

As a HUMAN REMEDY for Rheumatism, Sprains, Sore Throat, Etc., it is invaluable.

WE GUARANTEE CAUSTIC BALSAM will produce more actual results than a whole bottle of any liniment or spray in cure mixture ever made.

Every bottle of Caustic Balsam sold is warranted to give satisfaction. Price \$1.50 per bottle. Sold by Druggists, or sent by express, charges paid, with full directions for its use. Send for descriptive circulars, testimonials, etc. Address
THE LAWRENCE-WILLIAMS CO. TORONTO, ONT.

the very beginning there have been those who bitterly opposed the dehorning of cattle as being an unnecessary and cruel practice, but the tide of public opinion has turned against them, and dehorning is the rule now, rather than the exception. While the operation in itself seems a little severe, it is certainly no more so than is the drawing of a tooth, to which we all submit willingly because it subserves our best interests. The after consequences of dehorning are really fraught with less danger than the drawing of a tooth, and both operations are of such short duration that the pain and shock is very slight. The best way, and, indeed, the only way, to bring a savage to reason is first to disarm him—take from him all defensive weapons. As a result he at once becomes tractable in disposition and is ready to listen to reason. It is so with our horned animals; once remove their horns and they become quiet of disposition and are much more easily and economically handled, for which reason the profit from live stock is greatly enhanced. In the selection of an instrument for dehorning, that one which will remove the horn quickest, cutting clean and not crushing the horn, must occasion the least pain, and therefore be the most humane and best. These are among the claims made for the Keystone Dehorning Clipper by its inventor and maker, Mr. A. C. Brosius, Cochranville, Pa. Write to the gentleman, who will send you circulars, testimonials, etc., which will help you to reason this matter out to your entire satisfaction and profit.

Canadian Horse Show.—The third annual Canadian Horse Show will be held in The Armouries, Toronto, April 29th and 30th, and May 1st, 1897, under the joint auspices of the Country and Hunt Club, of Toronto, and the Canadian Horse Breeders'

Publisher's Desk.—Continued.

Association. Those having it in charge are doing all they can to make the coming show the most successful of any yet held. The prize list is a very creditable one, showing that besides medals and specialisms, about \$4,000 are offered in cash. Special transportation and passenger rates are offered to those who attend. For copies of the prize list write to Mr. Henry Wade, Parliament Buildings, Toronto.

The Ontario Veterinary College.—We regret that want of space prevents us from publishing the graduating list of this excellent institution. The closing exercises were held on Friday, March 25th, when degrees were conferred and addresses delivered by the Principal, Professor Andrew Smith, F.R.S.C. V.S., Major Lloyd, V.S., and Professor J. H. Reed, V.S., of the Ontario Agricultural College, Guelph. The graduating class included a very large number of students from all parts of the world, showing the widespread appreciation in which the college is held. It is a fact of which Canadians should be proud that a certificate of graduation from the Ontario Veterinary College is recognized everywhere as a badge of the very highest qualification in the profession of veterinary surgery.

A Correction.—Our "special dairy number" of FARMING (February) had scarcely gone through the press before we noticed an error in Professor Dean's table, on page 416 of that issue. In the "profit" column of the table the milk is put down at "four cents a gallon." It should have been "four cents a quart." We did not think it worth while, however, to call attention to the error in our March number, because the error is so evident, and what is intended is so obvious, that we supposed that anybody reading the table would know at once what was meant. But we have received a communication from Professor Dean asking us to call attention to the error, for he has had no end of trouble writing letters to our readers who have written to him concerning it, and asked for explanation. We regret exceedingly that the mistake should have given so much trouble; although in a manner we are pleased at the evidence that has been afforded us that the article has been most widely and carefully perused.

Valuable Advice to Stockmen.—Not only stock-breeders, but every one who finds it necessary to spend money in advertising, should be interested in the letter of Mr. C. R. Decker, to be found in another column. It is only by experience, often dearly purchased, that the advertiser can determine which are the best mediums for the purposes of his business. The testimony of Mr. Decker should there-

fore be valuable, when he says that after years of experience as an advertiser he has found in FARMING the very best paying medium for his purpose. He is a keen, shrewd, successful stock-breeder, and knows whereof he speaks. Advertising in FARMING is no experiment. It is a sure and profitable investment to all who deal with the farming community of this country, and that it is so is proved by the testimony of hundreds of people who have used its advertising columns. The best of it all is that every testimonial we have ever received has been purely voluntary, for we have never yet asked an advertiser for a recommendation.

Correction—In the January number on page 345 the statement is made that Mr. Thomas Duff is president of the Toronto Poultry Association. We have since learned that Mr. Duff was president in 1895, and Mr. Barber in 1896, and that Mr. R. H. Essex is the president for 1897.

Canada's Great Victorian-Era Exposition and Industrial Fair, Toronto.—The nineteenth annual fair of the Industrial Exhibition Association of Toronto and Victorian-Era Exposition for 1897 will be held at Toronto on August 30th to September 11th.

Thomas' Phosphate Powder.—Attention is called to the advertisement of Wallace & Fraser, the Canadian agents of H. and E. Albert, of London, Eng., the manufacturers of Thomas' Phosphate Powder. This fertilizer is made from the basic slag taken from the iron smelting furnaces. It contains from 38 to 40 per cent. of hyphosphates, or about 17 to 20 per cent. of phosphoric acid. It has given remarkably good results in England, on the Continent of Europe, and at the Cape of Good Hope. At the German Government Experimental Station at Dermstadt, Professor Paul Wagner has tested it most thoroughly, and unhesitatingly pronounces it the best phosphoric fertilizer at his command. He says: "If you desire to enrich the soil, to provide the soil with a store of phosphoric acid to serve for continuous cultivation for perennial fodder fields, meadows, vineyards, orchards, etc., there can be no phosphate more suitable than Thomas' Phosphate Powder." In another place he says that clover gave a higher yield in ground that had this powder put in it than on ground upon which phosphate manures had been applied. This phosphate was introduced in the Maritime Provinces two years ago, and has met with a ready sale and given astonishing results. The sale there has grown to 1,200 tons in two years. We advise our readers to write to Wallace & Fraser for their pamphlet on manuring.

CANADA FENCE CO., City.

DEAR SIRS,—The "Diamond Grip Fence" constructed by you around the Waterworks property at Springbank in 1893 is satisfactory in every respect, being neat and strong, and, in our opinion, will make a durable fence.

JOHN M. MOORE, Eng. and Supt. E. T. ESSERY, Mayor and Com.
WM. JONES, Chairman. R. K. COWAN, Com. O. ELLWOOD, Sec.

Best American Galvanized Wire, \$2.35
Cash with Order, Duty paid. Barb Wire, Am. Galvanized, \$2.50, Cash with Order, Duty paid.

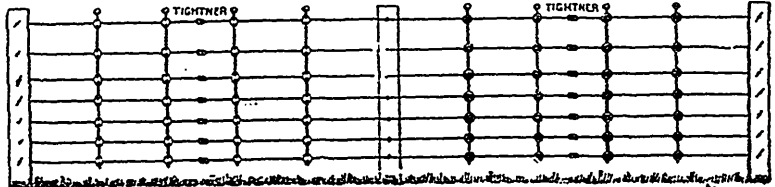

Canada Fence Co.

LONDON, Ont.



Send for Circulars.

W. H. TURNBULL,
Agent at Brantford, Ont.

THE WATER COMMISSIONERS' OFFICE,

London, May 21st, 1897.

Publisher's Desk.—Continued.

A Permanent Wall Coating.—The advertisement of the Alabastine Co. of Paris, Ont., which appears in another column, should interest all good housekeepers at this season of the year.

The Sylvester Farm Implements.—There may be a few of our readers who do not know that the Sylvester Bros. Mngf. Co., of Lindsay, guarantee the successful operation of every machine which leaves their works. This is a distinct advantage to the purchaser, who is thereby assured of getting an implement which will give satisfaction or having a return of his money. A catalogue of the machines made by this firm will be sent free on application to them.

Daisy Machinery.—The Wortman & Ward Mngf. Co., of London, Ont., are the makers of the line of farm implements known as "Daisies," the term being used to indicate its superiority and popularity. At this season, when every farmer is preparing for his spring work, an investigation into the merits of the different machines made is in order, and we advise our readers not to leave out the "Daisies." The manufacturers will give all information free on application.

Stock Notes.

Items concerning conditions of stock, also information as to recent sales, purchases, milk performances, or any other matters that will be of interest to our readers as news freely admitted in these columns. Items describing stock for sale, or anything else of an advertising nature, will be inserted only if paid for.

MR. W. J. CAMPBELL, of Snelgrove, Ont., is offering eggs for hatching from Barred Plymouth Rocks, which he breeds exclusively.

MESSRS. D. & O. SORBY, of Guelph, report their stock of brood mares, stallions and fillies developing well, as also some young stallions.

MR. WM. C. WILSON, of East Oro, Ont., is advertising improved Yorkshire swine, eggs from thoroughbred poultry, and Carman No. 1 seed potatoes in this issue.

MR. J. F. N. KENNEDY, of Cedar Grove, Ont., advertises poultry and eggs from pure bred Black and White Minorcas, Golden Wyandottes, and Light Brahmas in this issue.

MR. WM. C. WILSON, of East Oro, Ont., appears as an advertiser in this issue of Improved Yorkshire swine, eggs from pure bred poultry stock, and choice seed potatoes.

KENT OR ROMNEY MARSH RAMS.—The first annual sale of these celebrated sheep is announced for October 1st, 1897, at Ashford, Kent, England. See advertisement in advertising columns.

MR. J. R. HAND, of Fenelon Falls, has added his advertisement to those of other poultry breeders in our advertising columns. His favorite breeds are Silver Wyandottes and Indian game.

MR. DENIS HAWKINS, of Woodville, Ont., is again to be found as an advertiser in FARMING. As a breeder of registered Berkshire pigs Mr. Hawkins is well and favorably known in central Ontario.

LINCOLN LONGWOOL SHEEPBREEDERS' ASSOCIATION.—The ram sale of this association for 1897 is announced to take place at Lincoln, England, on September 1st. See advertisement in another column.

MCDUGALL'S SHEEP DIP.—Attention is called to the advertisement of S. E. Stone, of Guelph, who has succeeded to the business of the late Mr. F. W. Stone as an importer of this well known and reliable dip:

MR. JAMES P. PHIN, of The Grange, Hespeler, Ont., writes: "My Shropshires have wintered well. The lamb crop is very promising. I have sixteen ewes and fourteen choice rams, all got by Harding, the sire of the first prize ewe lambs, at Toronto last year."

THE DAKE ENGINE

ESPECIALLY ADAPTRD FOR

Creameries and Farm Purposes

From 2 to 14 Horse Power.

Write for prices and other information.

THE PHELPS MACHINE CO., - Eastman, Que.

MANUFACTURERS OF

Engines and Boilers, Machinery, Repairs, Etc.

Also: Band Saws, Drag Saws, Horse Powers, Ensilage Cutters, Thrashers, Etc.



The Cheapest, Most Durable, and Easiest Running

FLY SHUTTLE RAG CARPET LOOM
Made.

Send for Catalogue.

The PLUMMER LOOM CO., Box 63, Campbellford, Ont.

MILLER'S Tick Destroyer

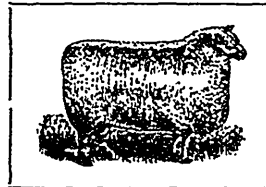

Effectually Destroys

TICKS, SCAB, and all VERMIN. Makes the skin clean and healthy, and imparts a silky softness and lustre to the wool.

HUGH MILLER & CO., - TORONTO, ONT.

THE CANADA SALT ASSOCIATION
Clinton, Ont. For Table or Dairy

Guarantee prompt shipments.
Fine, Coarse or Land Salt.

USE COLEMAN'S SALT

Stock Notes.—Continued.

MR. R. R. SANGSTER'S SALE.—The catalogue of this sale, which will take place at Springburn Farm, near Lancaster, Ont., on April 14th, embrace Mr. Sangster's entire herd, and comprises sixteen females and seven bulls, some of them representatives of the best Scotch Shorthorn cattle to be found in Canada. The farm can be reached by either the G.T.R. via Lancaster, or C.P.R. via Green Valley. Parties writing to Mr. Sangster may be met at either station.

CASH PRIZES FOR COTSWOLDS are offered by the American Cotswold Record, to the value of \$30, for registered Canadian bred Cotswolds, owned by exhibitors, at the Toronto and London Shows, as follows: For the best flock, one ram any age, one ewe two years old or over, one ewe one year and under two years, and one ewe lamb, 1st prize \$10, 2nd prize \$5. For best pen four lambs, consisting of two ram lambs and two ewe lambs, 1st prize \$10, and prize \$5. Further particulars may be obtained from Geo. Harding & Son, secretaries, Waukesha, Wis., U.S.A., or of J. C. Snell, Esq., president, Snelgrove, Ont. Premium lists please copy.

MR. C. T. GARBUTT, of Claremont, Ont., is deservedly proud of his stock, both sheep and swine. His herd of Berkshires is headed by an exceptionally fine animal, General Jackson, a 700 pound boar, bred by Mr. Thos. Teasdale, of Concord. The sire of this animal was the famous Royal Herbert (2402), while his dam was Royal Lady (2871), and was sold to Snell & Sons for \$150. He was by Royal Winner (Imp.) 2,111 (361c), out of Daisy (1544), by Lord Castel (746). His sows are headed by Best On Earth (1049), whose sire is Boydston Boy and dam Nettie (2074), with a record of twenty-two first prizes. He has also another very fine sow in Lady Claremont, imported from Pennsylvania.

MR. GEO. BENNETT, of Bennett & Pardo, the well-known swine breeders of Charing Cross, Ont., had the misfortune to sustain serious and painful injuries recently by being caught in a tumbling rod. His leg was fractured in two places, and he sustained a very serious shock internally as well. While his condition is both dangerous and painful, we believe no fatal results are expected unless complications should arise. At the best, however, he will be confined to his house for a long time. Both he and his family have our sincere sympathy in his misfortune. We hoped to have portraits of some of his fine stock in this number, but the accident made it impossible to obtain the necessary photographs from which the engravings are prepared.

GEO. BENNETT & PARDO, of Charing Cross, write: "Our hog, King of Quality, whose photograph we send you, is ten months old, weighs 380 pounds. He won five first prizes last season as a pig under six months old, and will undoubtedly make a great show hog this year. The two sows, Pride of Kent and Queen of Quality, are full sisters. They are exceedingly choice animals, being very straight and even throughout, and were winners last fall of the prize for sow under one year old. They are now seventeen months old, and weigh, respectively, 520 and 490 pounds. We have other choice animals, as, for instance, Maud, weighing 600 pounds, and Dominion Bell, 575 pounds."

MR. D. A. GRAHAM, of Parkhill, writes: "The demand for both swine and poultry is so great that my time has been almost entirely taken up during the past few weeks in making preparations for shipments and in answering enquiries. My pens of poultry are in grand condition and will turn out some fine birds during the season. The swine are also in excellent shape. Flossie A., 4,205 (Sire Sir Windsor (Imp.) 2880, dam Miss Major, 3460), is now suckling as beautiful and sturdy a litter as can be seen anywhere. The herd comprises eight brood sows and two stock boars, all in the very best breeding condition. I have been a breeder of Berkshires and fancy poultry for eight years, and take great pleasure in everything pertaining to them. My poultry yards contain stock which has met with great success in the show pens, winning last year wherever shown."

D. H. RUSSELL, Stouffville, writes: "My stock have come through the winter very well, not fat, but in the best of breeding form. The Shorthorn cows have all calved with one exception, and that one will come in in the course of a few days. I have five young bulls, one roan and four red ones, and they are all in excellent condition for the coming season's trade. I have sold out all my Berkshires but five, the smallest number I have had for ten years. My Shrophires are becoming profitable. I have seventeen young ones now (20th March) and expect a further increase in the number soon. They are all lusty and strong. Business prospects are very encouraging. There has been a brisk demand for stock of all kinds, and I am thoroughly convinced that we are on the eve of a very decided improvement in the Shorthorn trade especially. The Shorthorn dairy strains beat them all. People are beginning to realize that a cow which will excel in the properties of milk, butter and beef, combined is more profitable and more desirable than one which is good for milk alone."

The ... Wall Paper King OF CANADA



Sample books of Choice Wall Paper for Residences, Churches, Offices, Lodge Rooms, Public Halls, Hotels, Stores, and our booklet "How to Paper," sent free to any address. Write a postal to

C. B. SCANTLEBURY,
P. O. Box 820. Belleville, Ont.

Mention what prices you expect to pay; the rooms you wish to paper and where you saw this advertisement.

☛ We pay express charges.

AGENTS WANTED EVERYWHERE.

CHOICE SEED OATS

Improved American.—This oat has proved to be the heaviest yielder we have tried in recent years. Grain large, white, and plump, with an abundance of straw.

Golden Prolific.—A promising new early variety. Grain plump with thin hull. Straw stiff, and of a good length.

Price 50 cents per bushel. New cotton bags, 20 cents each. New linen bags, 10 cents each.

JOHN MILLER,

Locust Hill, C.P.R. MARKHAM, ONT.
Markham, G.T.R.

WOODSIDE CLYDESDALES FOR SALE

The well-known Clydesdale stallions, "Lawrence Again" and "Life Guard," and a number of highly-bred fillies of all ages. Also the French coach stallion, "Kordofaw," a highly-bred, well-built horse, and a very stylish traveller, with great knee and back action.

Young Ayrshire Stock for Sale.
R. NESS & SONS, - Howick, Que.

THE CANADA SALT ASSOCIATION, CLINTON, ONT.

Guarantee prompt shipments.
Fine, Coarse or Land Salt.
For Table or Dairy Use.

Coleman's
Dairy and Table
SALT

Stock Notes.—Continued.

Mr. C. R. DACKER, Chesterfield, Ont., writes: "Berkshires doing well; they have come through the winter in good shape, and there is a good demand for the right class, that is, good length and good bone, capable of carrying weight. I have four first-class boars, from two to four years old for service, weighing as high as 600 pounds and over when in condition for service, and sows over 600 pounds; also a large stock of boars and sows from suckers up. My recent sales are: Mr. Wm. Lockie, Roseville, Ont., one sow in farrow; A. Orr, Galt, Ont., one sow in farrow and one boar; James Garner, Fenwick, Ont., one boar and one sow; Wm. Currie, Ayr, Ont., one sow; Louis Wettlanfer, Cassel, Ont., one sow in farrow; Dennis Hawkins, Woodville, Ont., one sow in farrow; W. H. Smith, New Hamburg, Ont., one sow in farrow; Hugh Hutchison, Gorrie, one boar; Alex. King, Hickson, one boar; Wm. McArthur, Gables, one boar; John Risk, Rathio, one sow."

Mr. ARTHUR JOHNSTON, of Greenwood, Ont., writes "to say that Shorthorn matters are still steadily improving. Enquiries have never been more numerous in the history of the breed in Canada, and I believe more animals have changed hands during the past three months than have changed hands during any six months of any former year in five years. We have no boom in sight, nor do we want any, but I firmly believe we have at hand vastly better times in store for Shorthorns than we have enjoyed for many years. The Greenwood herd is now at its best, especially the younger things. We have still a number of capital young bulls for sale, fit for immediate service, as well as two-year-old and yearling heifers of the finest quality and best of breeding. We keep no pets. We sell just what our customers want and at moderate prices—in short, they are all for sale. Our show yearlings are coming on in fine form. FARMING is doing its patrons more good recently than it has done in years."

SIMMONS & QUIRRE, of Ivan, Ont., write: "Although we have been breeding Berkshire swine for twenty years, and many of those bred by us have been first prize winners at the leading shows, we have never had any of them photographed. Amongst the many prize-winning animals which we bred was Bonny Lass, one of the very best sows ever shown in Canada. A boar of our breeding took first prize in his class and the silver medal at the Provincial Exhibition at London some years ago, and repeated the same performance at the leading American shows, defeating a fresh importation, that year, belonging to one of the leading Canadian breeders. Another one, which we sold to Mr. Geo. Green, of Fairview, took first prize, and the champion prize for best hog of any breed at the Guelph show three or four years ago. We do a quiet and steady trade, having ready sales for all we breed, and have never found it necessary to push our business. In all our experience, and we have handled many hogs, both dead and alive, of all breeds, we have found the Berkshire most satisfactory in every way."

JAMES McCORMACK & SON, of Rockton, Ont., write: "Our cattle are coming through the winter in good shape. There has been a good demand for stock, the following being some of the sales which we have made since New Year's: To Thos. Pearce, Wallacetown, the successful bull, Bright Star; to W. D. Scott, Toronto, for Hon. Thomas Greenway, the young bull, Leo of Rockton, two young cows, and four heifers; to J. R. Alexander, Brantford, Ont., the young bull, Sir Laughlin 2nd; to Mackie Bros., Eburne, B.C., the show cow, Rose Campbell, a fine large animal, which has won many prizes, including first for best cow, and two of her progeny at Toronto, third at Toronto as a two-year-old, first at London, and third at Toronto as an aged cow, besides other prizes at these shows. At local shows she was always successful, and last fall, on different occasions, was awarded first prize in competition with the first prize cow at Toronto. She is six years old, has five calves to her credit, and is due to calve again in August. Mackie Bros. write us that Sir Laughlin is doing well and giving entire satisfaction, and the yearling heifer, Winsome, bought from us, is a beauty, and without an equal in British Columbia."

B. H. BULL & SON, of Brampton, have exemplified the wisdom of selecting the very best animals for foundation stock. In a few years they have built up a herd of great individual merit and one that is rapidly coming to the front. One of the foundation cows, Corrine of P.M., a pure St. Lambert, of excellent conformation and constitution, has some very satisfactory performances to her credit as a dairy cow, as a glance at the prize list at Guelph in 1896 will show. Her calves have also won distinction in the show ring. Sunteam, of Brampton, her first calf, now rising three years old, has never been beaten, having won first in her class at Toronto in 1896 for two years in succession, and making a record of five first prizes in that year. Her second daughter, Fawn Kitty, of Brampton, was first at Toronto in 1895, and is now carrying her first calf Trilby; the third of Corrine's calves, was also first at Toronto in 1896. The fourth calf is now only a few months old, but promises to be the best of the lot. Other foundation stock has been well chosen, and the young animals from Sir Ollie

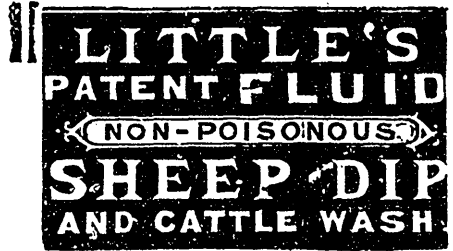

•The Original Non-Poisonous Fluid Dip.

Still the Favorite Dip as proved by the testimony of our Minister of Agriculture and other large Breeders.

FOR SHEEP

Kills Ticks, Maggots; Cures Scabs, Heals Old Sores, Wounds, etc., and greatly increases and improves growth of Wool.

CATTLE, HORSES, PIGS, Etc.

Cleanses the skin from all insects and makes the coat beautifully soft and glossy.

Prevents the attack of Warble Fly.

Heals Saddle Galls, Sore Shoulders, Ulcers, etc. Keeps Animals Free from Infection.

No Danger, Safe, Cheap, and Effective.

BEWARE OF IMITATIONS.

Sold in large tins at 75 Cents. Sufficient in each to make from 25 to 40 gallons of wash, according to strength required. Special terms to Breeders, Ranchmen, and others requiring large quantities.

Sold by all Druggists. Send for Pamphlet.

ROBERT WIGHTMAN, Druggist, Owen Sound,

700 Sole Agent for the Dominion.

Druirholm Poultry Yards...

Breeder of Barred Plymouth Rocks. Eggs, \$1 per setting, \$2.75 per 40.

SOMERVILLE McKESSOCK, MASSIE, ONT.

AYRSHIRES FOR SALE

Our young bull, 16 months old (a handsome animal), and several bull calves dropped this season; all sired by our noted stock bull, Uncle Sam, of Trout River, and from deep milkers. Prices to suit the times. W. F. & J. A. STEPHEN, Brook Hill Farm, Trout River, Que.

Persons replying to advertisements in these columns will find it to their advantage to mention FARMING.

The Canada Salt Association

CLINTON, ONT.

Guarantees prompt shipments.

Fine, Coarse or Land Salt.

For Table or Dairy use

COLEMAN'S SALT

Stock Notes.—Continued.

show his great value as a sire. The head of the herd now is Jolly King, of St. Annes, a pure St. Lambert bull, whose pedigree shows some of the richest butter notes of any bull in Canada.

CLYDESDALE HORSES.—The *North British Agriculturist* in its review of 1896 says: The trade in draught horses during the year has not been very encouraging to the Clydesdale breeders. Quite a new feature has been the importation by the Messrs. Montgomery of a select lot of Clydesdales, bred by Col. Holloway, Illinois, and mostly all sired by the Prince of Wales' horse Cedric, bred by Prof. McCall, Glasgow. One of these Cedrics—Prince Shaply—took first honors in the three-year-old class at both the "Royal" and the "Highland," and another—Prince Sturdy—now owned by Mr. Pilkington, Cavens, was third in the aged class at the "Highland." The sales of pedigreed Clydesdales have, as a rule, been disappointing. One notable exception to this rule was, however, found in the Edengrove sale, where the famous Macgregor mare sold at \$2,250 to Mr. Smith, Blacon Point, and the sixteen animals realized an average of \$584. An old landmark in Clydesdale breeding was removed in the spring by the dispersion of the Kier stud, when fifty-three animals realized an average of \$339 each. At Mr. Sinclair Scott's draft sale the average for twenty-nine animals was \$316, with a highest price of \$850 for the Darnley mare Scottish Rose, also bought by Mr. Smith, Blacon Point. At the Seaham Harbor sale the gelding, Walter, which was first at the "Royal" at Leicester, was sold for \$500 to Mr. Riddell, Blackhall, who has since resold him to Mr. Clark, Netherlea.

A. & G. RICE, of Brookbank Farm, Curries, Ont., report a very brisk demand for Holsteins. The following are among their recent sales: Bright Promise the two-year-old heifer which won second in the milk test, under thirty-six months, at Guelph, sold to J. Yule, Elder's Mills, Ont., and the yearling bull, Jewel Mercedes King, to R. Lee, Connors, Ont. The dam of these fine animals, is Jewel Mercedes Artes Queen, winner of the first prize at Toronto and London last year as a three-year-old cow. She has a record of fifty-three and one-half pounds of milk as a three-year-old, calved last August, is now giving thirty pounds daily; has given more than 800 pounds during the last seven months; and last, but not least, though not yet four years old, has produced three very fine calves, one of which has already been heard of in the show ring. She is a direct descendant of Daisy Foxal, a noted prize-winner and milk-producer, whose offspring have all been exceptionally good. Another calf of Jewel Mercedes Queen was sold to D. O'Mahony, of Renton, who also took the yearling bull Catholine 5th, Baron—Zeania Belle, the richly-bred young cow, whose record as a two-year-old is forty-five pounds, and the two-year-old heifer, Lady Pieterje Mink, whose dam, Lady Pieterje, was winner in a public test as a three-year-old, was bought by J. F. Davidson, of Peterboro'. Another yearling bull, a son of Lady Pieterje, was bought by Geo. Peacock, of Mount Salem; and still another, Brookbank Baron, dam Mascena Pet, record fifty-four pounds at four years old, and who is sired by a World's Fair winner, was sold to D. Nile, of Fenella.

ALEX. HUME & Co., of Burnbrae, write: "Enquiries are more numerous than ever, and our prospects for the coming season's business have never been so bright as they are this year. We have already made several good sales, and many others are certain to follow. The spring calves are now coming in, both purebred and high grade of both sexes, and are the best we have had. All on hand up to the present time are sold, and those expected to arrive shortly will be disposed of as fast as they come. Our yearlings are exceptionally good, and include the winners at Toronto last year of the first and fourth prizes for heifer calves under six months. Amongst the two-year-olds are also two yearling prize winners at Toronto. Eight Ayrshire females, of choice breeding, all bred from the herd of Mr. Stewart, of Menie, have been added to our stock. The following is a partial list of recent sales: Ayrshires, aged bull to H. S. Hunter, Smith's Falls; three-year-old cow to J. G. Horkins, Campbellford; eleven and one-half months' old bull to Jas. McComb, Big Springs; bull calf to J. M. Hurley, M. P., Belleville; heifer calf to J. Booth, Rylstone. Grades—Two cows to J. H. Douglas, Warkworth; four cows to W. Dracup, Wellman's Corners; heifer calf to Marion McComb, Rylstone. Four young sows, in farrow, to four different parties. We now have some sows farrowing of true Yorkshire type and breeding. All the stock sold has given perfect satisfaction, and one of the most pleasing features arising from our dealings with purchasers of stock has been the extremely flattering expressions of approval contained in their correspondence with us."

MESSRS. DEAN'S FARM, DOWSBY HALL, FOLKINGHAM, LINCOLN, ENGLAND.—A short time ago our representative in Great Britain, Mr. W. Chapman, of Fitzalan House, Arundel street, Strand, London, England, paid a visit to the farms of this well-known firm, who are continuous advertisers in our journal. As the Lincoln sheep bred by this firm have a world-renowned reputation, a brief account of the immense business

SEED GRAIN

Mandscheuri Barley and White Siberian Oats— Pure and Clean. Mandscheuri leads all competitors by five bushels per acre in co-operative tests for five years. Siberian Oats has also taken first place several years. Price: Barley, 60c.; Oats, 35c. per bushel. New cotton bags 15c.

THOMAS TEASDALE, Concord, Ont.

Bee Keeping.



On March 8th, 1897, Peter Becker, Hills Green, Ont., writes:

To Goold, Shapley & Muir Co., Ltd. Brantford, Ont.—The bees you sent me last spring are at present in good shape, and they did first-class last summer. They swarmed twice, having three good swarms now, and I received just an even hundred of comb honey. I must say I was highly pleased with your bees. Have you any more for sale?

We have a Limited Number of First-Class Colonies For Sale

Pure Italian \$7.50, partly Italian \$6.50 per colony, including hives, 5% discount for cash and order by April 1st. Also full line of best grade Bee Keeper's Supplies. Price Lists and sample copy *Canadian Bee Journal* free on application.

GOOLD, SHAPLEY & MUIR CO., Ltd., Brantford, Ont.

BRUCE'S Selected ... Seeds

THE FARM COLLECTION OF VEGETABLE SEEDS.

\$1.00 Mailed Free to any address in Canada for \$1.00

- | | |
|-----------------------------|-----------------------------|
| 1 ounce Eclipse Beet. | 1 packet Nonpareil Lettuce. |
| 1 pint Wax Beans. | 1 ounce Danvers Onion. |
| 1 packet Summer Cabbage. | 1 packet Parsnip. |
| 1 packet Winter Savoy. | 1 pint C.P.R. Peas. |
| 1 ounce Guerande Carrot. | 2 packets Radish. |
| 1 packet Spine Cucumber. | 1 packet Squash. |
| 1 pint Non-such Sweet Corn. | 1 ounce New Sweet Peas. |

BRUCE'S ROYAL NOSEGAY OF SWEET PEAS.

This Collection comprises Ten of the finest varieties of recent introduction, with the rarest combination of brilliant colors. Mailed Free for 25 Cents.

THE EMPIRE COLLECTION OF ASTERS.

Comprises Six of the finest types of the Aster family, and includes the brightest and most attractive colors. Mailed Free for 25 Cents.

FARM SEEDS.

The critical Farmer, who uses only exceptionally choice qualities, buys our

Selected and cleaned Red Clover Seed	Per bush. 96 00
" " Alsike " 5 25
" " Lucerne " 6 00
" " flail-threshed unhulled Timothy " 2 75

These qualities must not be classed with the grades known as Choice and Prime, which we sell at much lower prices.

JOHN A. BRUCE & Co., Seed Merchants, HAMILTON, ONT.

Please Note

that it is a distinct advantage to mention Farming when replying to advertisements.

Stock Notes—Continued.

carried on by them will, we believe, be found interesting. The firm of S. E. Dean & Sons was founded by the late Mr. S. E. Dean. The present partners are his two sons, both shrewd and keen business men. An idea of the extent of their business interests may be formed from the fact that the area of the farms occupied by them measures no less than 4,500 acres, the whole conducted and managed in such a way that the highest possible credit on the proprietors. The weekly labor bill averages more than £120 (about \$600), and more than 100 horses are in daily use on the two farms. The chief crops are barley, roots of various kinds, and hay for their large and valuable herds of horses, cattle, and sheep. The live stock department comprises, first of all, a select stud of shire horses, carefully bred from registered mares, or those eligible for registration and registered sires. The young animals are broken to work as soon as they reach the proper age, and all the horses on the farms are required to earn their own living. Thus all the working stock in a few years will either be entered or eligible. The stud horse is Hitchin Drayman, a truly grand shire horse, by the noted champion, Hitchin Conqueror. A most successful sire he has proved to be as his produce fully testify, there being in the stud many animals of great merit. As breeders of shire horses these gentlemen are taking a leading position. The cattle section includes not only pure Shorthorns but also registered Lincoln Red Shorthorns. The herd of pure Shorthorns consists of about fifty head of cattle of the best lines of blood, amongst them being excellent examples of the following well-known families, of which the more prominent are Red Rosas, Kirklevington's, Cherry Duchess, and Wild Eyes. They are really a first-class lot, Cherry Duchess 32nd, sired by the leading stud bull, being a particularly fine animal. Two of the most valuable females in the herd, however, are Oxford Eleanor and Dowsby Oxford Ethel, the latter being a granddaughter of the noted Oxford Annie. Here are indeed animals of grand breeding, whose character and merit fully equal the parent stock, Cambridge Duke 30th, whose descent goes back to Col. Craddock's noted cow, Old Cherry; Waterloo 300th, by Loughton Prince 24th, and her dam Waterloo 59th. The members of the Wild Eyes family are also a grand and typical lot. The young calves and yearlings, both bulls and heifers, are full of promise. The stock bulls are worthy of all praise. Cambridge Duke 30th (60441) is pure Bates' blood, and of great value and repute. Dowsby Waterloo Duke (66915), Lord Chesterfield (62863), and Virtuousa (whose sire, Pride of the Morning, sired Mr. Marr's 300 guinea yearling bull in 1895) are all of great individual merit, being well-framed, and in every respect equal to their high breeding. The Lincoln Red Shorthorns have only become a registered breed within the last few years. It is in reality a Shorthorn breed, but from the fact that breeders in days gone by omitted to register their pedigrees, they were unable to get recorded in Coates' Herd Book. Leading breeders, among them the Messrs. Dean, found that although foreign buyers had taken a great liking to them, they were unable to buy because the breed were not registered. A herd book was therefore started, with the result that the demand for bulls of this breed has increased ten fold. The cattle are uniformly red, have capital quarters, backs, and loins, and have a grand coat of hair. They are such that any casual observer would describe them as first-rate red Shorthorns, as in fact they are, being in nearly every instance the get of Shorthorn bulls. Messrs. Dean's herd, which is a leading one, and one of the first to be registered, all sprung from the registered Shorthorn stock. Many of the young bulls appear to be sired mostly by Dowsby Waterloo Duke (66318), by Lord Chesterfield (62863) out of dams got by Cambridge Duke 30th (60441). Thus both the sires and dams of most of the animals are pure bred Shorthorns. But however good Messrs. Dean's Shorthorns are, they must give place to their flock of Lincoln sheep of world-wide renown. This flock, though comparatively young in years, is rapidly becoming one of the foremost rank. It was founded in 1866 by the purchase of the very best draft ewes that could be had, these being again selected, and only the very best retained and mated with rams from the most noted flocks of the day. The flock has been increased from time to time until it now numbers 1,050 ewes of grand type, symmetry, long and lustrous wool, such as is now in so great demand for Buenos Ayres, where the sheep of this flock have a grand position, having for three years in succession topped the averages at the public sales in that country. During 1896 over 300 rams, besides ewes, were disposed of by private sale. The only consignment sold by auction last year were those sold at the Lincoln Record Ram sale, when they averaged £58 10s. od. each. Messrs. Dean believe in keeping up their stock. In 1893 they paid 200 guineas, in 1894 (jointly with Mr. J. E. Casswell) 152 guineas, in 1895 135 guineas, and in 1896 350 guineas for their top ram. These figures show what a grand lot of sires they have and are using. Most of these rams have in fact been picked from the best flocks in England. One of the sires used in 1896 was Dowsby (350 guineas), bred by Mr. Henry Dudding, a sheep of the greatest merit. He was strongly competed for by expert buyers, and it is said that over £400 (\$2,000) has been refused for him. Upwards of 100 ewes are safe in lamb to him, and he will, therefore, be after all, a very cheap purchase if his stock take after him. At the date of Mr. Chapman's visit he was in grand condition. We regret that our



A pleasant and profitable employment for Young MEN and WOMEN. Proper training for Stenographic or other clerical work is best obtained at the

CENTRAL Business College

TORONTO

Unexcelled facilities. Seven experienced teachers and two lecturers.
 Spring Term from April 5th to continue to July 30th. Get particulars.

W. H. SHAW, Principal,
 Gerrard and Yonge Sts.

DO YOU KNOW

What your cows are doing?
 Every factory should have

DILLON'S

Milk Pass Book.

Secretaries of cheese and butter factories will find that

Dillon's Improved Milk Book Combined

Dillon's Milk Sheets

Dillon's Pass Books

ARE THE BEST AND CHEAPEST

For sale by all Dealers in Dairy Supplies, or

Thos. J. Dillon

Charlottetown, P.E.I.

Siberian Oats

This variety has headed the list in yield at the Ontario Experimental Farm for a number of years. We have a limited quantity of pure seed free from any weeds we know of for sale at 40 cents per bushel. Bags free.

Blue Peas

We have also a limited quantity of this variety for sale at 65 cents per bushel; there are a few bags in them, otherwise a good sample. Bags free.

Mr. W. Rennie, the well-known seedsman and farm manager says: that these are the most profitable varieties of these grains for a farmer to grow.

JAMES BOWMAN.

Elm Park Farm

Guelph, Ont.

The Best Buttermaker
 Cannot make fancy butter
 If poor salt is used.



Is the "Purest and Best,"
 And costs no more than inferior salt.

For Sale by all the Leading Grocers
 in the Dominion.

WINDSOR SALT CO., LTD.
 Windsor, Ont.

SEND FOR OUR
SPECIAL
Farmers'
Catalogue
SEEDS FREE
J. A. SIMMERS, Toronto.

Stock Notes—(Continued).

space will not allow us to give fitting descriptions of other members of this flock, as such a description could not fail to be interesting. Our space will not allow us to individualize, however. The sires have all been most carefully selected and are of great merit, including three other Dudding-bred sheep, bought at very high prices. The whole flock may be truthfully said to be a credit to their breed and breeders. The sales of the present year already numbered 282 ram lambs, at the time of Mr. Chapman's visit, at from 120 guineas downwards, few, if any, bringing less than fifteen guineas. Quite a number of ewes have also been sold at very high prices, whilst there are left, including ninety of the best of the ram hogs, about 150, besides a large selection of ewe hogs. This is necessarily but a brief and very imperfect account of this grand and typical flock. A visit to it will well repay the time spent, and a hearty welcome is given to all visitors, to whom all information is given. Arrangements are also made to meet trains at the railway station. We desire to tender to Messrs. Dean our thanks for their kind and genial hospitality to our representative, and for the great amount of time and trouble they took in showing him the farms and stock, and the information given to him on our behalf.

THE AMERICAN PET DOG CLUB.—At a meeting of this club, held at the Hotel Lincoln, Broadway and 52nd street, New York city, on March 10th, 1897, the club elected as its judges for the ensuing year Mr. Morris, Mr. Rackham, Mr. Mortimer, and Miss Whitney, and as delegate of the American Kennel Club, Mr. T. Farrar Rackham, East Orange, N. J.

MESSERS. MORRIS, STONE & WELLINGTON, of Welland, Ont., are advertising Shire horses in this month's issue. Those who know the kind of stock kept by them need not be told that they have a very choice selection of the finest quality of Shire horses. Illustrations of horses owned by this firm have appeared in our columns (for example, see October, 1896), and from these, as well as from the prize lists we have published, most of our readers will be familiar with the class of stock they keep.

Mr. E. E. MARTIN, Canning, Ont., writes: "Our stock has wintered nicely. We have had exceedingly good luck with our young pigs, the litters being in the very best of health and thriving immensely. Some fine sows are due to farrow this month and next, so that we are in the very best position possible to book orders for spring pigs. The young stock boar Nonpareil has proved a splendid stock-getter, and our customers may look for something choice. Enquiries for stock are plentiful, thanks to FARMING, which is the best stock paper published."

Mr. WESLEY W. FISHER, Benniller, Ont., writes: "My hogs have wintered well and are now in the pink of condition. My stock of Poland-Chinas, Tamworths, and Duroc-Jerseys comprise pigs of almost all useful ages from three years down to as many weeks old. I have several sows to farrow in April, May, and June, and am, therefore, in the best position to book orders for spring stock. My Shropshire sheep are also in good breeding condition, and comprise rams of different ages, and a few excellent ewes."

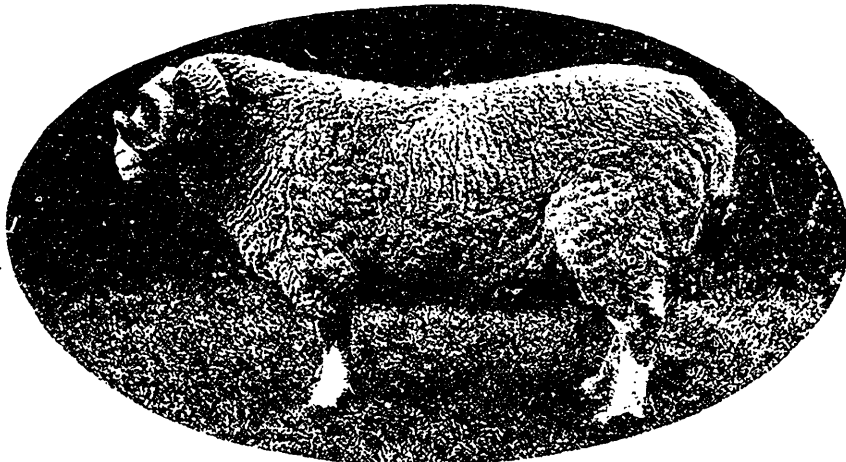

MR. HERBERT FARTHING'S unbeaten Ram LORD BATH, taken in his natural state, after six years' service in his well-known flock, advertised for sale Thurtoxton, Taunton, Somerset, England, on April 22nd, 1897.

Corn

is a vigorous feeder and responds well to liberal fertilization. On corn lands the yield increases and the soil improves if properly treated with fertilizers containing not under **7% actual**

Potash.

A trial of this plan costs but little and is sure to lead to profitable culture.

Our pamphlets are not advertising circulars booming special fertilizers, but are practical works, containing latest researches on the subject of fertilization, and are really helpful to farmers. They are sent free for the asking.

GERMAN KALI WORKS,
93 Nassau St., New York.

SELECTED SEEDS

Illustrated Catalogue now ready and mailed Free to all sending us their address.

Carefully Selected

FARM, GARDEN, and FLOWER SEEDS

Comprising all the best varieties of Europe and America.....

Recleaned Lower Canada Timothy, Clovers, Grasses, Corn, and Seed Grain of all the leading sorts.

WILLIAM EWING & CO.,

Seed Merchants

Montreal, Que.

CENTRAL NURSERY

Our **Trees and Plants** are up to date. Orders are coming in lively. (Thanks.) A splendid assortment to choose from yet. Our stock and prices are right.

Choice Seed Potatoes. Send for priced catalogue

SNAP SHOTS

By Mail, all select, postpaid.

- 8 Lowdon or Columbian Raspberry Plants \$1.00
- 9 Grape Vines, 3 each, M. Diamond, Vergennis, Wordon 1.00
- 6 Beautiful Roses, 2 years all different varieties 1.00
- 2 Clematis, 1 purple, 1 white, Henryl 1.00
- 50 Asparagus Roots, 1 year, Columbia, or Palmetto, or Cot 60c.

A. G. HULL & SON, St. Catharines, Ont.

Dispersion Sale of the entire herd of

Scotch Bred Shorthorn Cattle

TERMS OF SALE....

Nine month's credit on approved joint note, or a discount of seven per cent. per annum for cash.

The Property of R. R. Sangster, Lancaster, Ont.

TO BE SOLD BY

PUBLIC AUCTION

WITHOUT RESERVE, ON

WEDNESDAY, APRIL 14th, 1897.

At Springburn Farm, Lancaster, Ont.

JOHN SMITH, M.P.P., Brampton, R. R. SANGSTER AUCTIONEER.

— THE —

"Rutherford" Butter Box

With Patent Removable Cover—Made with kiln dried lumber.



Dovetailed at corners—Smaller at bottom than top. All boxes paraffined.

TO BE HAD FROM ALL

Dairy Supply Furnishers

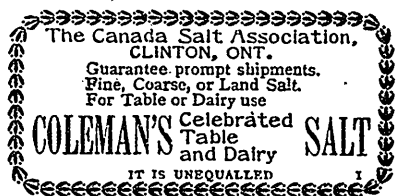
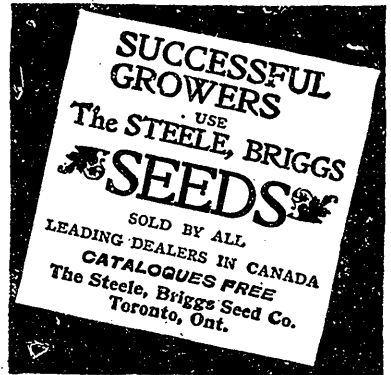

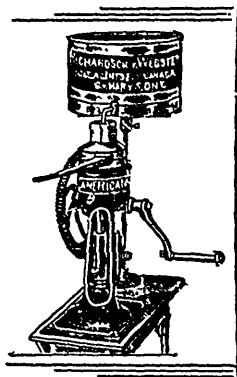

HAVE YOU SEEN

The American Cream Separator

The most simple, durable, and easiest cleaned machine on the market. It is the latest and most improved Separator, being patented in Canada on Feb. 26th, 1896. It has but one piece to the bowl, and for capacity and quality of work is the best and cheapest machine on the market. Any prospective purchaser may try one.

Agents Wanted in all Unoccupied Territory

We still lead in the manufacture of all kinds of Cheese Factory and Creamery goods.

OUR PATENTED STEEL GANG CHEESE PRESS

Continues to be the best, and every user gives it his best recommendation.

If you require anything in our line we solicit your correspondence, and know that we can satisfy you in anything and everything, both in price and quality of goods.

Make all your enquiries to **Richardson & Webster**
ST. MARYS, ONT.

Ayrshires

—BY—

Auction...

The Farm I am moving to in Spring being unsuitable, I am forced to sell out my entire herd of Ayrshires.

The herd, which includes a number of imported animals, has had a most successful showyard career. Has taken either first or second herd prizes, and my noted Imported Bull, **Silver King**, has been champion Ayrshire at Toronto, London, Ottawa, Sherbrooke, Quebec, Hochelaga, and Montreal. I will offer some very fine young bulls that are fit to head the best herds in the country.

Full particulars later as to date and place of sale—catalogue is being prepared. Please write for one to the undersigned, or to **WILLIAM EWING & CO.**, Seedsmen, Montreal.

DUNCAN McLACHLAN,

Near Montreal.

Petite Cote, Que.

ULRICH'S

Ensilage Seed Corn

Leads all other varieties. Sales, 1896, over 150,000 bushels of seed in Canada. Ask your dealer to secure seed for you.

Ten cash prizes—\$104.50—for best yields in Canada on one acre, to be given away in 1897. Open for you. No fancy prices. Write for particulars, book of testimonials, also free samples.

MAMMOTH WHITE | A Specialty.
GIANT PROLIFIC

E. R. ULRICH & SON,
Springfield, Ill., U.S.A.

The Farmer's Advocate will award the above prizes. Just send them an affidavit, giving yield.

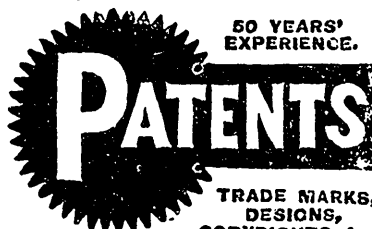

50 YEARS' EXPERIENCE.

Anyone sending a sketch and description may quickly ascertain, free, whether an invention is probably patentable. Communications strictly confidential. Oldest agency for securing patents in America. We have a Washington office. Patents taken through Munn & Co. receive special notice in the

SCIENTIFIC AMERICAN,

beautifully illustrated, largest circulation of any scientific journal, weekly, terms \$3.00 a year; \$1.50 six months. Specimen copies and HAND BOOK ON PATENTS sent free. Address

MUNN & CO.,
361 Broadway, New York.



THIRD ANNUAL

Canadian Horse Show

Under the joint auspices of the Country and Hunt Club of Toronto, and the Canadian Horse Breeders' Association. To be held in

THE ARMOURIES, TORONTO, CANADA

—ON—

Thursday, Friday and Saturday,
APRIL 29th and 30th, and
MAY 1st, 1897.

ENTRIES CLOSE

On Wednesday, April 14th, 1897, and should be addressed to

HENRY WADE,
Parliament Buildings,
TORONTO.

◀ **THE SPRAMOTOR** ▶

This is to certify that at the contest of Spraying Apparatus held at Grimsby, on April 2nd and 3rd, 1896, under the auspices of the Board of Control of the Fruit Experimental Stations of Ontario, in which there were eleven contestants,

The Spramotor

made by The Spramotor Co., of London, Ont., was awarded first place.

H. L. HUTT

M. PETTIT

Judges.

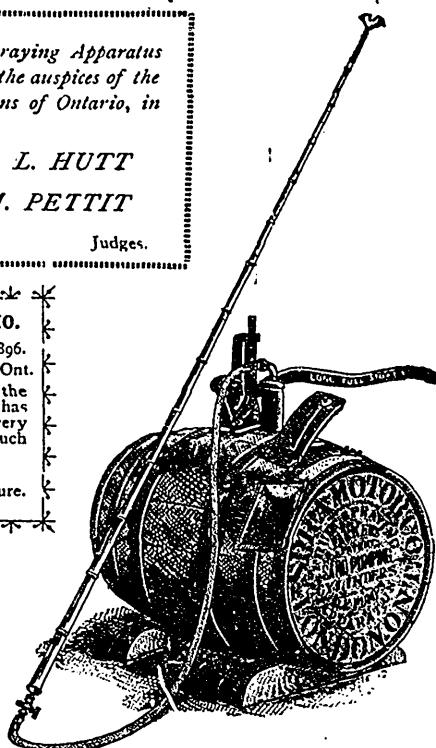

DEPARTMENT OF AGRICULTURE OF ONTARIO.

Toronto, August 28th, 1896.

W. H. HEARD, Manager of Spramotor Co., London, Ont.

DEAR SIR,—I have great pleasure in stating that the Spramotor ordered from your Company this season has given entire satisfaction. It works easily, and is very effective in its operation. Your Company deserves much credit for placing so excellent a pump on the market.

JOHN DRYDEN,
Minister of Agriculture.

CENTRAL EXPERIMENTAL FARM.

Ottawa, March 23rd, 1897.

W. H. HEARD, Manager of Spramotor Co., London, Ont.

DEAR SIR,—I have your catalogue for 1897, and in looking it through I find it quite complete, and I am sure that it will be of great service to fruit growers throughout the country. I am much obliged to you for sending me a copy.

Yours very truly,
JOHN CRAIG, Horticulturist.

Send 3c. stamp for 68-page treatise on the diseases affecting fruit trees and their remedies.

THE FAMOUS

Chatham Fanning Mill

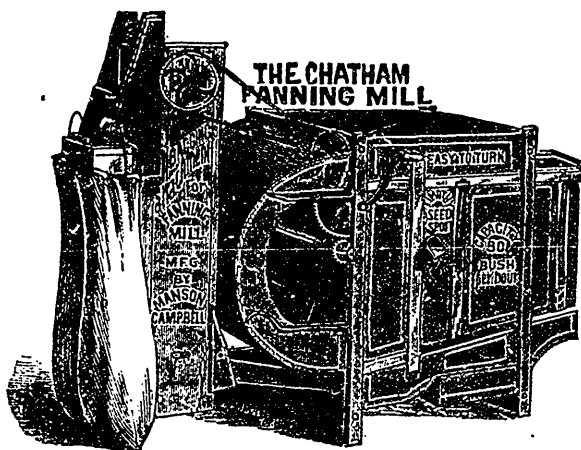

Formerly, industry alone was held essential to good farming. Now, brains are admitted to the partnership with industry. The following is from "How To Make Dollars Out of Wind, or The Science of Good Farming."

"The farmers in Ontario and neighboring States sow broadcast only two bushels of oats per acre, and seldom harvest less than forty bushels per acre, or twenty bushels for one bushel sown, and frequently as high as fifty bushels from one bushel sown. The secret lies in sowing nothing but good, large, heavy seed, the kernels being all of a uniform size, which causes it to ripen evenly, thereby doing away with nearly all the light grain, and a bushel of oats by measure grown from good seed will weigh forty to forty-two pounds instead of thirty to thirty-four. In selling oats, a farmer wants the weight, not the bulk. Out of all the light oats, all the long slim oats, and all those small oats that are sown very few grow. Some may grow, but they bring forth a small, delicate stalk, with only one or two oats on the end of it, and at best, should it amount to anything, it will

not ripen as early as the good seed, and must necessarily be cut green; that part of the oats then will be little better than chaff. Besides the strength is taken from the ground which the good seed should have, to nourish the poor seed.

Don't fail to read this book telling how to obtain good seed. It will be sent free on application to

Manson Campbell = = Chatham, Ont.

BRITISH ADVERTISEMENTS

EDWIN BUSS, Elphicks, Horsmonden, Kent, England

Breeder and Exhibitor in 1895 of the celebrated champion Berkshire Sow "Elphicks Matchless," sold to United States, where she also won first and champion prizes. The champion Yorkshire Boar and Sow Oxford A.S., 1895, also bred at Elphicks.

15 firsts, 4 champions, 7 seconds, and 16 R. & H.O. won during the season 1895.

Boars, Velts, and in-pig Sows always for sale at moderate prices.

Pigs exported to all parts of the world.

Station—**GOUDHURST, S.E.R.**, one mile distant.

33

Henry Dudding

**RIBY GROVE, GREAT GRIMSBY,
LINCOLNSHIRE, ENGLAND.**

Has always for inspection, and sale, the largest flock of pure Lincoln Longwool Sheep in the county, including many prize-winners, having taken prizes for many years at the Royal and other shows for both Rams and Ewes, including champion medals at both the Paris Exhibitions, Vienna, Amsterdam, Canada, Australia, New Zealand, and all the leading prizes at the Chicago Exposition; also the first for the best collection of Lincoln fleeces of wool at the Royal Windsor Show and the Lincolnshire Show, which proves the character of this flock. The sheep are famous for their great size and one hundred and twenty-five year's good breeding. At Lincoln Ram Sale, 1896, this flock's consignment not only made the highest individual average of any consignor, but also made an average price exceeding that made by any other breed in England, *i.e.*, \$512 per head, the first six making an average of \$540. The sheep for sale this year are all sired by noted rams and are fully equal to their predecessors in every way.

Rail Stations: **Stallingborough**, 3 miles distant,
and **Great Grimsby** 7 miles.

40 Telegrams: "**Dudding, Keelby, England.**"

S. E. DEAN & SONS

DOWSBY HALL, FOLKINGHAM,

LINCOLNSHIRE, ENGLAND.

HAve always for inspection and sale fine specimens from their **FLOCK OF PURE LINCOLN SHEEP** (No. 47 in Lincoln Flock Book), including **SHEARLING EWES** and **RAMS**, also **RAM** and **EWE LAMBS**. Sheep from this flock have been exported to nearly all parts of the world, where their great substance and large fleeces of beautiful quality wool give the greatest satisfaction to purchasers. Early in 1894, about twenty Rams from this flock were sold by public auction in Buenos Ayres, and realized the highest average ever obtained for Ram Hoggs exported from England. The flock is most carefully bred, and none but the very best sires used. Messrs. Dean also send out selections from their flock to purchasers who are unable to come to England to inspect them, and they have given great satisfaction. Messrs. Dean have also for sale purebred **Bates SHORTHORNS** and pure **LINCOLN RED SHORTHORNS**.

Dowby Hall is one mile from Rippingale Station, on the Great Northern Railway, Bourne and Stamford Branch.

TELEGRAMS:—**DEAN, RIPPINGALE.**

REGISTERED KENT OR RONNEY MARSH SHEEP.

MR. J. H. PARKIN'S Registered Flock No. 31 of the above Sheep is one from which breeders of these most excellent Mutton and Wool Sheep can rely upon obtaining specimens of the highest merit, with grand wool and even fleeces as well as being true to type and character. The breeding and pedigree of the flock is second to none in England. For the last thirteen years every sire used in the flock was specially selected from that noted flock of Mr. T. Powell, who now has the direct personal management of this flock, from which specimens are always for sale on application to

T. POWELL,

East Lenham, Maidstone, Kent, England.

"THE EARL CARNARVON,"

Highclere Castle, England.

Herd of about 200 Berkshire Pigs, all registered or eligible for registration in the British Berkshire Herdbook. Thirteen awards with fourteen exhibits at four of the leading shows in the country this season, 1895. Boars and Velts always on sale. Prices moderate. Apply to **W. F. HALL, Highclere Farm, Newbury, Berks., England.**

PAGHAM HARBOUR CO.,

Selsey, Chichester, England.

Flock of 1,000 ewes, winners Southdown Challenge Cup in 1893-4, 1st prize Wool, Jubilee, Royal, and Royal Prize Ram Lambs in 1892-93-94. 24

JAMES FLOWER, . . .

. . . Chilmark, Salisbury, Wilts, England.

Registered flock of nearly 1,000 Grand Hampshire Down ewes. Established more than 50 years ago by present owner's father. Prizes won at the Royal, Bath, and West, Royal Counties, and other shows, including the Challenge Cup at Salisbury Fair in 1894, 1895, and 1896. Won 51 prizes out of 53 classes, including champion prizes during last three years. Selections always for sale at home and at the Annual Sale, Bretteford Fair, August 12th. 30

J. E. Casswell,

**Stock Book No. 46. LAUGHTON, FOLKINGHAM,
LINCOLNSHIRE, ENGLAND.**

THIS well-known flock has been established more than 100 years, and the pedigreed Lincoln long-wooled rams and ewes have been noted throughout the Colonies and South America for their "size, symmetry, and lustrous wool." Ewes from this flock have always passed from father to son, and have never been offered for sale. Mr. J. E. Casswell's grandfather Mr. G. Casswell of Laughton, was the first breeder in the county to let his rams by public auction. At Lincoln Ram Fair, 1895, Mr. J. E. Casswell made the highest average for 20 rams. During the last two years the following amongst other noted sires have been used: Bakewell Councillor and Baron Rigby, for each of which very high prices have been refused; Laughton Baron, Laughton Major, Laughton Style Laughton Choice, No. 5; Ashby George, 60 guineas; Laughton Judge, 95 guineas; his son, Laughton Justice Lincoln, 200 guineas; Lincoln, 152 guineas; Welcott, 70 guineas; Lincoln, 72 guineas; and his sire, Laughton Riby. Shire horses, Shorthorn bulls, and Dorking fowls are also bred. Inspection and correspondence invited. Visitors met by appointment. TELEGRAMS: Casswell, Laughton, Folkingham, England.

JAMES LAWRENCE, Stall Pitts' Farm,

Shrivenham, Bucks, England

. . . BREEDER OF . . .

Registered Berkshire Pigs, from stock unsurpassed for true characteristics, size, and quality. One of the oldest established herds in England. 17

Enquiries Solicited. - - Prices Moderate.

J. R. & R. R. Kirkham

BISCATHORPE HOUSE,

LINCOLN, ENGLAND.

Have always for inspection and sale pedigree registered Lincoln Longwool Rams and Ewes from their registered flock (Flock Book No. 32), which has been most carefully bred for upwards of one hundred years, each Ram and Ewe having full pedigree. Royal, 350 guineas, used in the flock this season.

BRITISH ADVERTISEMENTS.

**KENT or ROMNEY
MARSH SHEEP**

ASHFORD RAM SALES.

The First Annual Sale of Registered Kent or Romney Marsh Rams consisting of selected specimens from leading flocks of the breed will be held at

ASHFORD, KENT, ENGLAND,

—ON—

Friday, October 1st, 1897.

Registered Rams will also be offered for sale at **Ashford** on **Tuesday, October 5th** and **12th**, and at **Rye, Sussex** on **Wednesday, October 13th** and **27th, 1897.** Catalogues and full information from **W. W. CHAPMAN**, Secretary Kent or Romney Marsh Sheep Breeders' Association, Fitzalan House, Arundel Street, Strand, London, England.

**Lincoln Longwool Sheep
Breeders' Association**

Ram Sales for 1897.

The Sixth Annual Sale of Lincoln Longwool Rams will be held in

LINCOLN

On **FRIDAY, SEPTEMBER 3rd, 1897.**

The Sixth Flock Book will be sent to Press shortly and will be ready about the end of March. Apply to

St. Benedicts' Square, **Stephen Upton,**
LINCOLN, England. *Secretary.*

Secretary to the National Sheep Breeders' Association of England and the Southdown Sheep Breeders' Association; Hon. Secretary Kent Sheep Breeders' Association.

W. W. CHAPMAN,
**PEDIGREE LIVE STOCK AGENT
AND EXPORTER.**

All kinds of Registered Stock, Horses, Cattle, Sheep, and Pigs supplied on Commission.

References—**JOHN JACKSON & SONS,** Abingdon, Ont.; **N. OLATTON,** Selsoy, Chichester, Eng.

Offices:
Fitzalan House, Arundel St., Strand, London, England.
Registered address for cables—"Sheepcote, London."

BRITISH ADVERTISEMENTS.

HAMPSHIRE DOWN SHEEP.

Great English Pedigree Sales. July, August, and September, 1897.

WATERS & RAWLENCE, Salisbury, England, will sell by auction during the season upwards of

50,000 Pure Bred Ewes, Lambs, and Rams,

including both Rams and Ewes from the best registered prize-winning flocks in the country.

Commissions carefully executed. Address

WATERS & RAWLENCE,
Salisbury, England.

62

MISCELLANEOUS.

☞ **RIDE A STEARN'S AND BE CONTENT** ☞

There is a "best" in everything.

BUY-CYCLES

but do it carefully. There are many GOOD wheels—there are some better than others. . . There is one best

THE STEARNS 

The Yellow Fellow.

Consult your interests by reading our catalogue; it tells many truths about bicycles. Its free.

AMERICAN RATTAN CO.
TORONTO, ONT.
CANADIAN SELLING AGENTS:

Agents Wanted in Unrepresented Districts

THE SALT OF THE EARTH.

**“Rice’s
Pure Salt”**

Absolutely Pure and Doesn't Cake

For Table, Butter, Cheese, Cattle, Land, and all purposes....

MADE UNDER PATENT PROCESS

Sole Makers **The North American Chemical Co.,**
GODERICH, LIMITED ONTARIO.

Seed Premiums ! OUR SPECIAL OFFER FOR APRIL

To anyone sending us TWO new yearly subscribers at ONE DOLLAR each we will send TWO DOLLARS' worth of Seeds selected from the following lists.

To anyone sending us ONE new yearly subscriber at ONE DOLLAR we will send ONE DOLLAR'S worth of Seeds selected from the following lists.

VEGETABLES.

	Price per pkt.
BEEF—Crosby's Flat Egyptian	5
Eclipse Turnip	5
CABBAGE—First and Best	10
Henderson's Early Summer	5
All Seasons	5
Mammoth Red Rock	5
Autumn King	5
CARROT—Chantenay (Stump-rooted)	5
Early Gem, Guerande or Ox-Heart	5
Scarlet Intermediate	5
CAULIFLOWER—The "World's Best" Snowball	25
Extra Early Paris	5
CELERY—Golden-Hearted Dwarf	5
White Plume	5
CRESS, OR PEPPERGRASS—Extra Triple Curled	5
CUCUMBER—Prize Pickle	10
Improved White Spine	5
London Long Green	5
New Giant Pera	5
LETTUCE—Early Curled Silesia	5
MELON, MUSK—Earliest of All	10
Champion Market	5
Early Hackensack	5
MELON, WATER—Early Canada	10
Improved Ice Cream	5
Citron for Preserving	5
ONION—Giant Prizetaker	5
Large Red Wettersfield	5
Southport White Globe	5
Selected Yellow Globe Danvers	5
Red Victoria	5
PARSNIP—Hollow Crown	5
PARSLEY—Champion Moss Curled	5
PUMPKIN—Japanese Pie	10
Quaker Pie	10
RADISH—Crimson Bunch	5
Chartier	5
Scarlet China (Winter)	5
SPINACH—Long Standing	5
SQUASH—Hubbard	5
Long White Bush Marrow	5
Vegetable Marrow, English	5
TOMATO—New "Canada"	10
Imperial	5
Extra Early Atlantic	5
TURNIP—Early Snowball	5
Golden Ball	5
HERBS—Summer Savory	5

FLOWERS.

Order by Number only.	Price per pkt.
112 ADLUMIA—(Alleghany Vine)	5
171 ALYSSUM, SWEET—Little Gem	5
186 ANTIRRHINUM—Tom Thumb, Mixed	5
124 ASTERS—Simple's Branching, Mixed	15
130 " Comet, or Plume, Mixed	10
133 " Jewel, or Ball, Mixed	10
198 BALSAM—Defiance Mixture	10
210 BEGONIA—New Vernon	10
234 CANDYTUFT—Snow Queen (White)	10
245 CANARY CREEPER—(Canary Bird Flower)	5
250 CARNATION—Extra Choice, Double, Mixed	25
254 " Marguerite, Mixed	10
255 CELOSIA—Thompson's Plume	10
277 CINCERARIA HYBRID—Superb Mixed	25
289 CONVULVULUS MAJOR—(Morning Glory)	5
295 COSMOS—Large Flowering, Mixed	10
302 CYCLAMEN—Persicum Gigantum, Mixed	25
311 DIANTHUS (Pinks), Chinesis, Double, Mixed	5
333 EVERLASTING FLOWERS—Splendid Mixture	10
347 GLOXINIA HYBRIDA—Grandiflora	25
354 GOURDS—Nest Egg	10
365 HELIOTROPE—Queen of the Violets	10
379 HOLLYHOCK—Extra Choice, Double, Mixed	10
391 IPOMEA—Setosa (Brazilian Glory)	10
397 LARKSPUR—Giant, Mixed	10
410 LOBELIA—Erius, Mixed (Trailing sorts)	5
425 MARIGOLD—Finest Mixture	5
435 MIMULUS MOSCHATIS—Musk Plant	5
292 MORNING GLORY—Double Flowering	10
793 " Imperial Japanese	10
437 MOONFLOWER—Noctiflora	10
442 MIGNONETTE—Bird's Mammoth	10
447 " Large Flowering	5
453 MYOSOTIS—(Forget-Me-Not), Alpestris Blue	5
460 NASTURTIUM—(Tall), Hybrids of Madame Gunther	10
476 " Tom Thumb, Mixed	5
484 PANSY—Peacock	15
485 " Bugnot Superb	25
492 " Giant Trimardeau, Mixed	10
501 PETUNIA—Superb, Double, Fringed	40
508 " Giants of California, Mixed	20
522 PHLOX DRUMMONDI—Dwarf, Mixed	10
541 POPPY—Shirley, Single, all colors	5
549 PORTULACA—Finest Double, Mixed	10
555 PRIMULA—Superb Fringed, Mixed	25
583 SWEET PEAS—Cupid	10
599 " Eckford's Newest Sorts, Mixed	10
606 STOCKS—New Large Flowering Globe, Mixed	20
635 VERBENA—Mammoth Flowering, Mixed	10
660 ZINNIA—Mammoth Flowering, all colors	10

These Seed Packages are specially selected by Mr. Wm. Rennie, Seedsman, Toronto, and are guaranteed to be of the best quality. THIS SPECIAL OFFER IS ONLY GOOD FOR THIS ISSUE.

THE LADIES' RED BIRD

The beautiful rich color, the superior finish, the ease with which they run, their strength, the perfect construction of every part combine in making this wheel most popular with lady cyclists. Ladies' Red Birds are made in two models and fitted with very light and handsome aluminum chain guards.

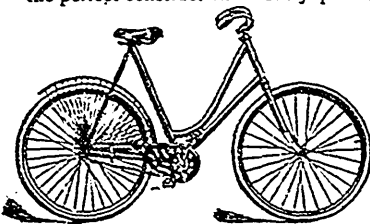

THE COUNTESS OF ABERDEEN

selected a Red Bird in preference to all other makes of wheels offered, thus showing her appreciation of an article of Canadian manufacture that is high-grade in every particular. A post card will bring you our handsome '97 catalogue.

The Goid Bicycle Co., Ltd., Brantford, Ont.

Branches: TORONTO, ONT.
MONTREAL, QUE.

ST. JOHN. N.B.
WINNIPEG, MAN.

SYDNEY, AUSTRALIA.
CAPETOWN, S. AFRICA

Do You Want Good Roads?

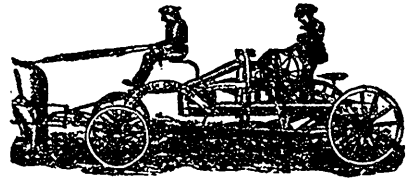
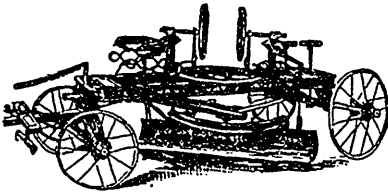

THE CHAMPION REVERSIBLE ROAD GRADERS ARE THE BEST

WRITE FOR INFORMATION ON

- Road Machines
- Rock Crushers
- Road Rollers
- Road Plows
- Wheel and Drag
- Scrapers

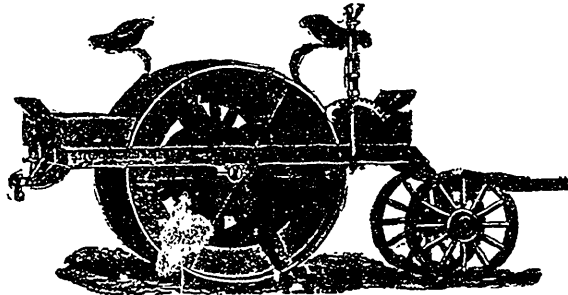

A 7 1/2 TON STEEL CHAMPION ROAD ROLLER will exert a pressure of 255 lbs. per lineal inch —all that is ever desirable.

JOHN CHALLEN,
Manager.

Address **GOOD ROADS MACHINERY CO.,**
Hamilton, Canada.

The Gurney Scale Co.

ESTABLISHED 1856

MANUFACTURERS OF

STANDARD SCALES.



It has paid others to weigh their goods.

Will it not pay you?



Hamilton, - - Ont.

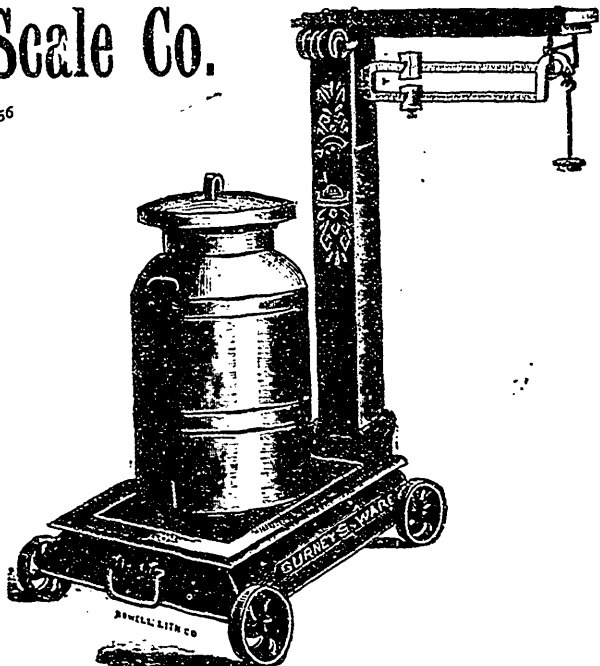



A Little Paint

in the right place, and of the right kind, will make a great change in the looks of the room or a home. The window casing, baseboard, picture mouldings, chairs and tables—all these can be brightened and made clean with paint.

THE SHERWIN-WILLIAMS ENAMEL PAINT

is just the thing for furniture, and decorative work. It gives a fine, glossy, enamel-like surface. The tints are delicate for indoor use. "Enamel Paint" is prepared ready for the brush. Any one can use it. We make paints for every purpose—each is a special kind suited to a special use.

Our booklet "Paint Points," tells all the little kinks about paint—the good and the bad. It tells the best special paint for buggies, boats, farm tools, barns, roofs, houses and all other painted things. Send to-day for a free copy. For booklet address, St. Antoine Street, Montreal.

THE SHERWIN-WILLIAMS CO.

CLEVELAND
CHICAGO
NEW YORK
MONTREAL



CHURCH'S ALABASTINE

The Permanent Wall-Coating.
Does not RUB or SCALE from any hard surface.
Coat over coat can be applied.
No more washing or scraping of walls necessary.
Alabastine is The Sanitary Wall-Coating.
Displaces Kalsomines, which decay on the wall.
Equally adapted for Ornamental work and plain Tinting.
Pleases Painters as well as the general public.
Easily applied by anyone who can handle a brush.
Sixteen beautiful tints and White.
Put up in Five-pound packages, and never sold in bulk.
Ready for use by mixing in Cold Water.
No hot water being needed, SAVES TIME AND WASTE.
Full directions for use on every package.
"The Decorator's Aid" furnished painters, free.
Ask your dealer for Tint-Circular showing colors.
BEWARE OF IMITATIONS bearing similar names.
Sold by leading Hardware and Paint dealers every-where.

THE ALABASTINE CO'Y, LTD.

Sole Manufacturers, PARIS, ONT.

THE "Imperial" Gasoline Engine..

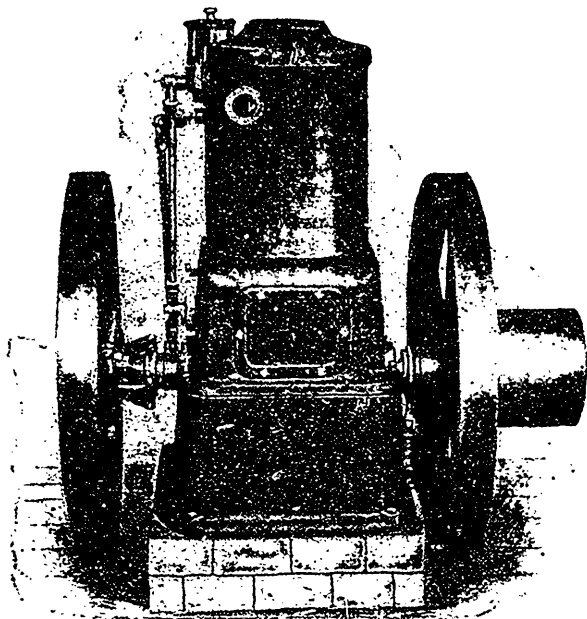

NO ENGINEER

NO FIREMAN

NO BOILER

NO STEAM

The "Imperial" Gasoline Engine having all these advantages, makes it the ideal motor power for the farmer. Light, portable, always ready for use. No waiting half an hour for steam; no waiting for wind; in half a minute it can be going at full speed. Makes its own gas; makes its own power. No danger in its use; no extra insurance; as safe in the barn as out of doors. Takes little room; clean and inexpensive; costs only 16 cents per horse power to run the "Imperial" Gasoline Engine 10 hours. Made in all sizes from 1 to 16 horse power. Send for booklet about it.

THE COOPER MACHINE COMPANY, Limited,

92 Adelaide Street East, TORONTO, ONT.



GEM FENCE

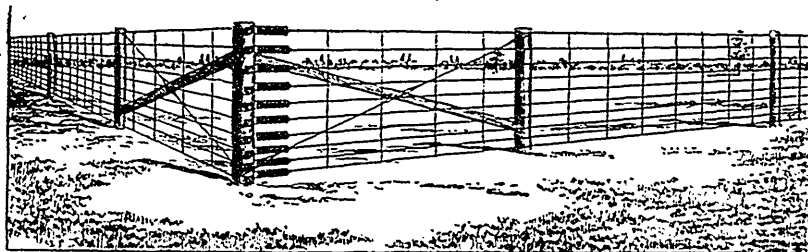

Our **GEM FENCE MACHINE** is what every farmer should have. It will weave any size cross wire large or small, on any kind of wire, Barb, Braided, Twisted or Plain, and so tight that cross wires cannot be stripped. Easily operated. Nothing to wear out or break. One man can weave 40 rods a day. Price of machine can be saved in 30 rods of fencing. No fence complete without our tension device. Send for our printed matter.

McGregor, Banwell & Co., - Windsor, Ont.



Keep Milch Cows In Good Health

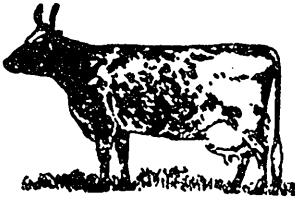

IT PAYS.—It is useless to expect a lean, run-down cow to have a good flow of milk, though she will eat more than an animal in good flesh. The difficulty is the nutriment is not all extracted from the food because her digestion is out of order.

Dick's Blood Purifier

will strengthen the digestion and make the food produce milk. It will cost but fifty cents to try it on the poorest cow you have and you will get back your money with interest in a few weeks.

For sale by Druggists, at general stores or sent post paid on receipt of 50 cts.
Dick & Co., P. O. Box 482, Montreal.

J. C. S. BENNETT
- PHOTOGRAPHER, -

10 1/2 PHILLIP'S SQUARE, - MONTREAL

SPECIALTIES

- PHOTOGRAPHS OF STOCK
- LANDSCAPES
- INTERIORS
- LANTERN SLIDES AND ENLARGEMENTS
- DEVELOPING AND PRINTING FOR AMATEURS
- TRAVELLERS' SAMPLES

TELEPHONE 4853

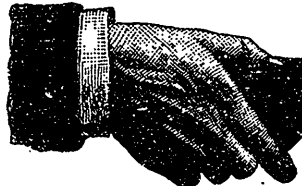

THE
\$5.00
Pocket
...Kodak

TAKES EVERYTHING
IN SIGHT - - - -

BOOKLET FREE

J. G. Ramsey & Co.

89 Bay Street
.....TORONTO

THE Perfect Washer

MANUFACTURED BY
PHILIP VOLLMAR, Chatham, Ont.

◀ ◀ Gives Perfect ▶ ▶
◀ ◀ Satisfaction. ▶ ▶

Has been in use for years and never failed to satisfy the most critical housewife. The Perfect Washer will wash perfectly clean and not injure the clothes in the slightest degree. It saves labor, fuel, time, and wear and tear of clothes. Everyone who has used it recommends it. Sample machine will be

SENT ON TRIAL

to parties furnishing first-class references. County rights to manufacture for sale.

Send for catalogue and information to

PHILIP VOLLMAR,
CHATHAM, ONT.

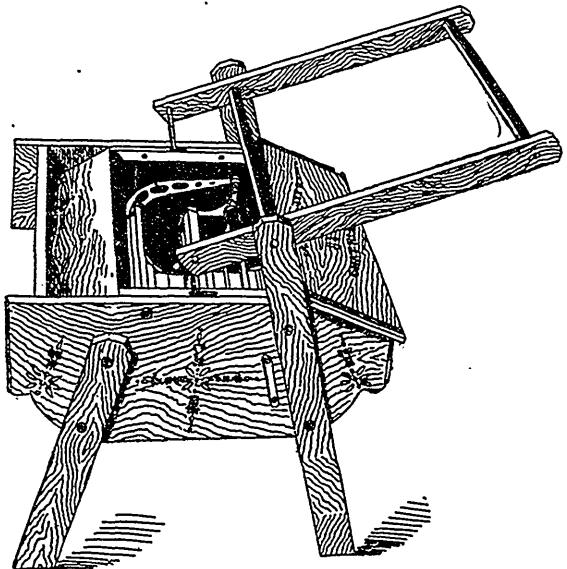

Albert's

**Thomas
Phosphate
Powder** (Registered)



IS THE



**Soluble
Basic
Phosphate
of England**

IT IS THE CHEAPEST AND MOST PROFITABLE
PHOSPHATE MANURE IN THE WORLD



The Concentrated Horticultural Manures
for Fruiting, Gardening, and House Work are
the only absolutely pure and soluble manures in
the market.

Our pamphlets always free.

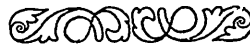

WALLACE & FRASER

ST. JOHN, N.B. = and = TORONTO, ONT.

“ PENNY WISE, POUND FOOLISH ”

Buying a poor bicycle is like buying a poor watch or a poor horse—penny wise and pound foolish. Poor watches make rich watchmakers, poor horses produce wealthy veterinary surgeons, and a poor bicycle is a constant source of revenue to the bicycle repair man. If all bicycles were made of as good material as the Brantford **Red Bird**, as carefully constructed, as thoroughly tested before leaving the factory, the bicycle repair man would soon become extinct; but, unfortunately, they are not, and he continues to thrive and multiply in numbers. To ride the entire season without a cent for repairs is the rule with **Red Bird** riders.

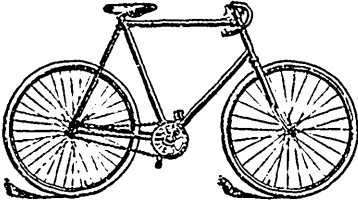

The Gould Bicycle Co., Ltd., Brantford, Ont.

Branches: TORONTO, ONT. ST. JOHN, N.B. SYDNEY, AUSTRALIA.
MONTREAL, QUE. WINNIPEG, MAN. CAPETOWN, S.AFRICA.

LAND FOR EVERYBODY

Free Grants of Government Land

Cheap Railway Lands for Sale on Easy Terms

GOOD SOIL

PURE WATER

AMPLE FUEL

THE construction of the Calgary and Edmonton Railway, and the Qu'Appelle, Long Lake, and Saskatchewan Railway, has opened up for settlement two new districts of magnificent farming land, viz., that between the North and South Saskatchewan Rivers, and that between Calgary and Red Deer.

Full information concerning these districts, maps, pamphlets, etc., free. Apply to

OSLER, HAMMOND & NANTON,

Land Office, 381 Main St., WINNIPEG.

Calgary and Edmonton Ry., Qu'Appelle, Long Lake and Saskatchewan Railway Company.



OUR \$1.00 PER DOZEN PHOTOS
CANNOT BE BEAT. BEST WORK
IN THE DOMINION. TRY US.

C. A. Muerrle

Photographer

11 King Street West

NEAR YONGE STREET

TORONTO - - - ONT.

Capital City Business College

A thoroughly up-to-date institution.

Write for particulars. Address

A. M. GRIMES, President,

OTTAWA, CANADA.

SEED=TIME

Is rapidly drawing near. Are you ready? With a prospect of good prices for grain next fall can you afford to take chances with an old style machine? The scientific seeders and drills illustrated below will largely increase your chances of a good crop. Do not leave this matter till the last minute, as the stock of these goods is rapidly diminishing, and the Company cannot guarantee to fill late orders.

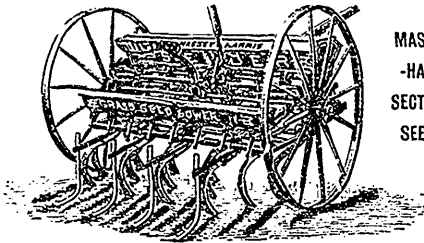

MASSEY-HARRIS SECTIONAL SEEDER.

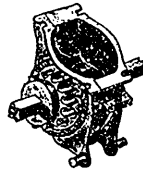

MASSEY-HARRIS SECTIONAL SEEDER. A seed box for grain and also for grass seed is made for attachment to the Massey-Harris Cultivator, when the machine is known as THE MASSEY-HARRIS SECTIONAL SEEDER. There is no broadcast Seeder to equal it; the peculiar springing motion of the teeth covering the seed perfectly. The gearing is very simple. The feed run or distributor is shown above.



MASSEY-HARRIS COMBINED HOE DRILL AND BROADCAST SEEDER.

Seeding and Drilling can be done with equal facility on this eminently successful combined machine. As a Drill it stands without an equal, having every useful adjustment to adapt it to any and every condition of land, while the Seeding device is most complete for all kinds of grain. As a Broadcast Sower it has every facility for perfect work. The method of removing and attaching the Hoes or Teeth is shown above.

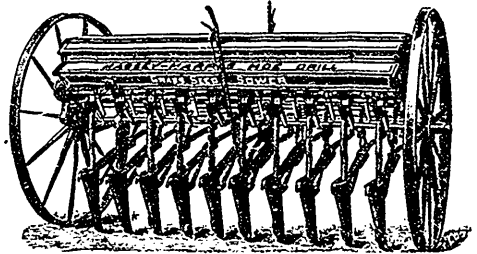

MASSEY-HARRIS SHOE DRILL.



The Shoes cut a knife track in the soil into which the seed falls, the Drag Chains covering it in perfectly, thus the seed is really planted, this machine is of very simple, yet very complete construction. The cut shows the operation of the Controlling and Pressure Lever, also the splendid connection of the Steel Shoes to the Frame. The new Telescopic Metallic Conductors substituted for perishable Rubber Tubes are important.

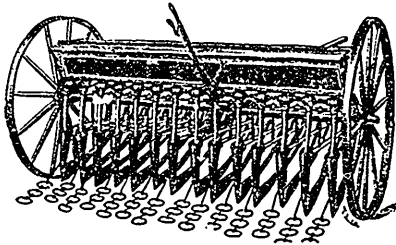

MASSEY-HARRIS SHOE DRILL

MASSEY-HARRIS CO. Ltd.

THE HEAD OFFICES of the Company are at Toronto, Canada.
THE WORKS are located at Toronto and Brantford, Canada.

Branch Offices are located as follows:

ONTARIO BRANCH—915 King St. West, Toronto, Ont.
BICYCLE DEPT.—927-931 King St. West, Toronto, Ont.
NORTH-WEST BRANCH—Princess St., Winnipeg, Man.
QUEBEC BRANCH—640 St. Paul St., Montreal, Que.

MARITIME BRANCH—31-35 Gormain Street, St. John, N.B.
EUROPEAN BRANCH—54 & 55 Bunhill Row, London, Eng.
AUSTRALASIAN BR.—103-109 William St., Melbourne, Vic.
NEW ZEALAND BRANCH—Crawford St., Dunedin, N.Z.

The "Daisy"

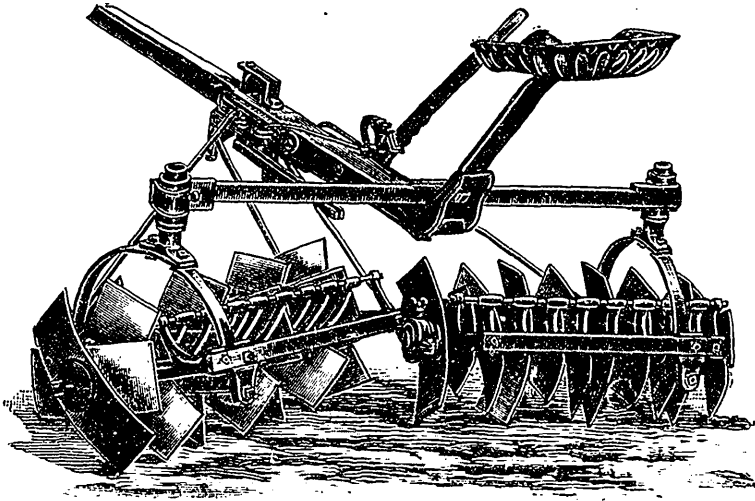

Steel Beam Spade Harrow

THEY ARE ALL!

DAISIES



- The Daisy Churn
- The Daisy Spade Harrow
- The Daisy Disk Harrow
- The Daisy Corn Scuffler
- The Daisy Pea Harvester
- The Daisy Corn Sheller
- The Daisy Straw Cutter
- The Daisy Tread Power
- The Daisy Feed Grinder
- The Daisy Root Pulper
- The Daisy Pumps

WE MAKE NOTHING BUT "DAISIES"
IN FACT, WE ARE THE "DAISY" FIRM



Our goods are right; our prices are right; we treat our customers right. If you deal with us once you will come again. Write for illustrated circulars, prices, etc.



THE WORTMAN & WARD MANUFACTURING CO., - LONDON, ONT.

Queenston Cement

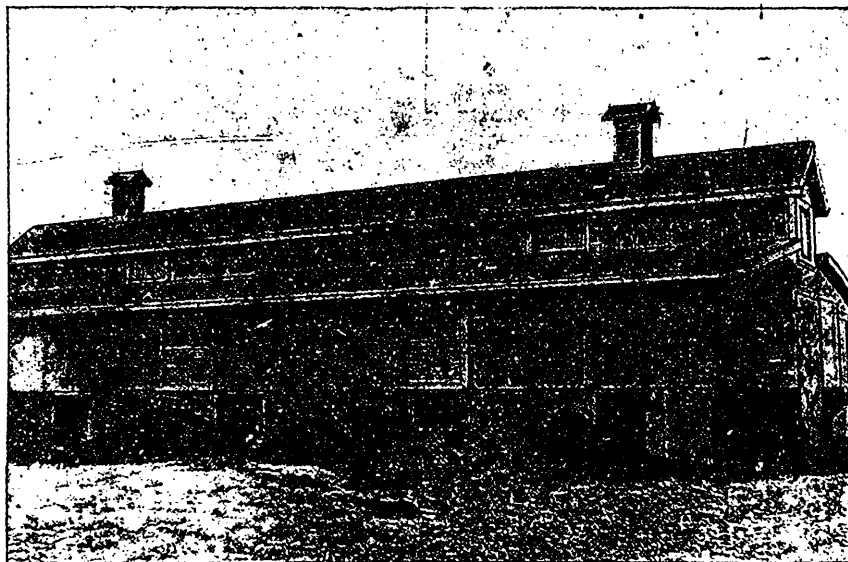

MR. GREEN'S CEMENT CONCRETE PIGGERY.

Mr. F. L. Green, Greenwood, Ont., built a new piggyery last fall, and used **Usher's Queenston Cement** for the floors, troughs, and part of the walls. The piggyery is 30 x 50 ft., and 8 ft. high at the eaves. The walls are 10 in. thick and 4 ft. high, the upper part of the wall being woodwork. A passage 4 ft. wide runs lengthwise through the centre of the building; each side is divided into pens 10 x 11 ft. in size. The floor and feed-troughs are made of cement concrete. A feed-room takes the place of one pen at one end of the building, and in one part of it is a cement cistern 8 ft. deep, into which the water from the roof is run.

The system of ventilation is new. A 2½ in. hole was bored 1 ft. deep in the bottoms of the centre posts, and a cross hole 1½ in. in diameter bored where it ended. Underneath the troughs and under the ends of the posts a 3 in. tile was laid from one end of the building to the other. Openings were made from the tile into the bottoms of the posts. This insures a constant supply of fresh air. Ventilators at the top let out the foul air. About 47 barrels of **Queenston Cement** were used, and the total cost, including the drawing of gravel, etc., and the woodwork, was \$280. Mr. Green says the piggyery has paid for itself this winter. The upper structure of wood is double boarded, with tar-paper between. Doors open outside into yards and also into the passage way in front.

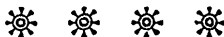

**USE Queenston
Cement...**

For building Stable, Silo and other Walls, Cisterns, Stable Floors, Hog Troughs, Watering Troughs, Etc.

... CHEAPEST AND BEST WALL ...



Send for our New Pamphlet for 1897, containing full instructions, free. For prices of Cement and other particulars, write—

**ISAAC USHER & SON,
Thorold, Ont.**



BRANTFORD Steel Wind Mills

With Patent Roller Bearings

Galvanized Steel Towers and Wheels

The Best in America

Ideal Spray Pumps, Iron Pumps, Water Tanks, Piping, etc.

The Ideal Solid Power Mill, with Roller and Ball Bearings, is a wonder. Send for circular, and mention this paper.

Ideal Spray Pump..

Iron or Brass Parts
Dash Agitator
For Top or Side of Barrel as Ordered
Thousands in use
Guaranteed
Trial Given

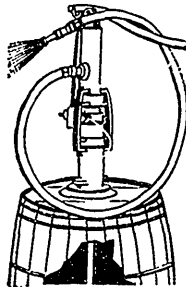

The Celebrated "Maple Leaf" Grinder

20 inch Reversible Plate.
Fine and Coarse Sides.
Ball Bearings for Plate Relief Springs.
For any Power or any Work.
Always Guaranteed.

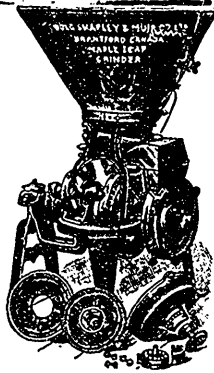

MANUFACTURERS OF

**Steel Wind Mills,
Iron Pumps, Tanks,
Grain Grinders,**

Mention FARMING. **Beekeepers' Supplies**

Canadian By Birth



Not by Adoption

THE Red Bird is Canadian, not because there happens to be dollars in it, but because it was born that way, being originated in Canada and having grown to years of maturity in the land of its nativity. Red Birds are built in a Canadian factory erected by Canadian capital. Employers and employees, alike, are Canadians, and every dollar paid for Red Bird bicycles remains in the country. The Red Bird stands high in the estimation of the cycling public both at home and abroad, a fitting example of Canadian skill and enterprise. You can have our handsome '97 catalogue, pronounced by *Cycling* to be a work of art, mailed to you by sending your address.

The Good Bicycle Co., Ltd.
BRANTFORD, ONT.

Branches: Toronto, Montreal, St. John, Winnipeg, Sydney, Aus., and Capetown, S. Africa.

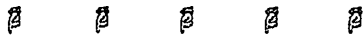

OUR readers are especially requested to mention FARMING when writing to advertisers. A good word said in our behalf will help us very much. Our Advertisers are such that we can recommend their goods to our patrons. See our special premium offer this month.



FARMERS

**B
I
N
D
E
R
T
W
I
N
E**

By experience have learned that the undermentioned brands are the best and most economical to use.

Why are they the best ?

Because they are evenly spun, made on the most improved machinery and by skilled labor. Will run all day without stoppage, and is the only twine that will not stick in the knotter.

Blue Ribbon	Red Cap
Blue Crown	Red Crown
Standard	White Sisal

PURE MANILLA, 650 feet to lb.

See that this name is on the tag :

**CONSUMERS'
CORDAGE
COMPANY (LIMITED)**

Reward hath its merit.

CLEVELANDS

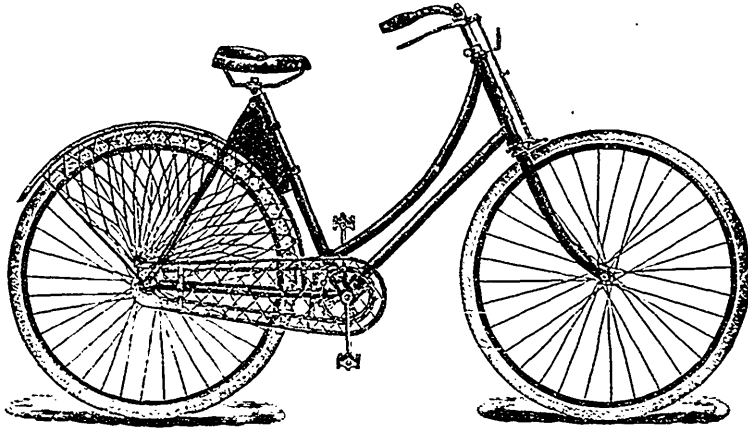

~GOLD MEDAL~

MODELS 22 AND 23, PRICE \$75

The highest grade wheels in the world for the money.



MODELS 27 AND 28, PRICE \$100

Gentlemen's and Ladies' Bicycles, the choicest exemplar of mechanical skill in cycle construction.



MODEL 29, PRICE \$100

Correct lines, remarkable rigidity of frame, and absolute perfection in bearings, chain and sprockets, make this the ideal wheel for track use, and unequalled as a light roadster.



**Agents wanted for unrepresented territories
Send for illustrated catalogue**

H. A. LOZIER CO.

SALESROOM

169 Yonge St. - Toronto

Why ? Because

in these hard times is there such a great demand for this All-Steel Flexible Harrow

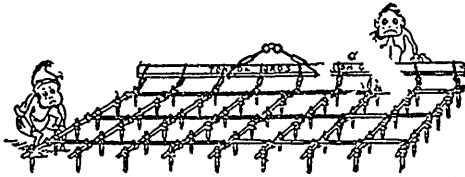

Parties wishing a first-class Harrow will do well to write us direct, or apply to the local agent.

The flexibility of the Harrow enables it to adapt itself as readily to rough and uneven ground as to smooth, and the oscillating motion produced by its flexibility pulverizes the ground, and leaves it in a loose and more porous condition than any other Harrow, and it is made of the very best material money can buy for the purpose. The bars are made of

HARD SPRING STEEL,

very stiff and strong, the hinges and teeth being of solid steel, all of which are of a higher grade than is possible to use in any other make of Harrows. We can guarantee more than double the strength and wear in this Harrow than there is in any other make.

Our Motto, "Not how Cheap, but how Good."

TOLTON BROS., - GUELPH, ONT.

MICA ROOFING

USE

Mica Roofing

On all your buildings.
It is cheaper than shingles.
Waterproof and Fireproof.

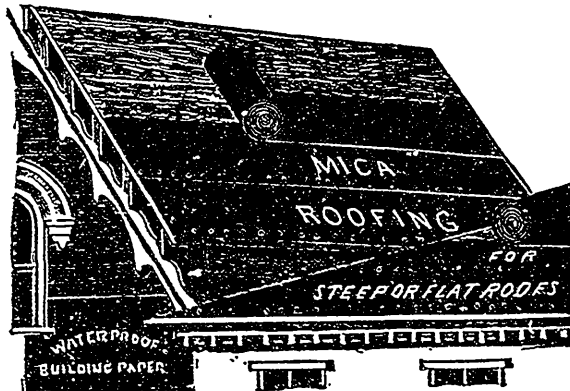

USE

Mica Paint

To Repair Leaky Roofs.
Shingle, Iron, or Tin Roofs painted with it will last twice as long.

RAPIDLY TAKING THE PLACE OF SHINGLES.

Is put up in rolls of one square each, 40 feet long by 32 inches wide, and costs only \$2.25, including nails, thus affording a light, durable, and inexpensive roofing, suitable for buildings of every description—especially flat roofs—and can be laid by any person of ordinary intelligence.

HAMILTON MICA ROOFING COMPANY,

Office—101 Rebecca Street, HAMILTON, ONT.

664

THE VESSOT IMPROVED GRAIN GRINDER

PATENTED Awarded Gold Medal and Diploma World's Fair, Chicago, 1893.
First Prizes at Canadian Exhibitions.

SEE WHAT OUR CUSTOMERS SAY ABOUT IT

CHAS. HART, Boissvain, Man.

"The Vessot Grinder, 'Little Champion,' which I purchased from your agent, some time ago has given entire satisfaction, and is far better adapted for use with wind power than any grinder I have had any experience with. For steam power a larger machine than mine would probably give good satisfaction."

HARRISON & COOK, Newdale, Man.

"The Little Champion grinder manufactured by Vessot & Co., and sold by your firm, is the best grinder we have ever used. It does its work well and grinds very fast. Would not think of using any other kind of grain crusher. We used it last winter grinding for two hundred head of stock."

Scores of other testimonials can be furnished on application.

We also furnish an improved Corn and Cob Crusher.

Send for circular. Information cheerfully given.

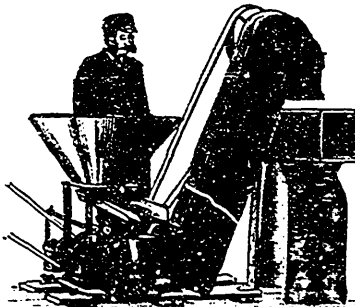

S. VESSOT & CO., Sole Manufacturers **JOLIETTE, P.Q., CANADA**

STEEL SHINGLES



The "Eastlake" Steel Shingles have been on the Canadian market twelve years, and have never failed to give satisfaction. They are absolutely *Fire, Lightning, and Storm Proof*, and very easily applied.

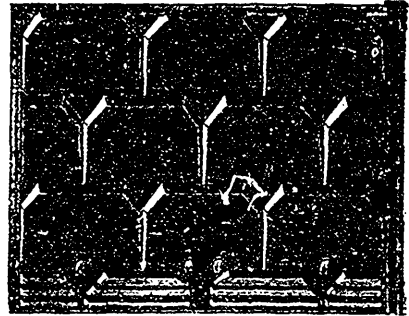

The "Eastlake" Patent Steel Shingle.
"Beware of Imitations."

ROCK FACED SIDING



Looks like solid stone. Just the thing for the sides of wooden buildings.

STEEL	PRESSED	BRICK
MFD. BY		
THE METALLIC ROOFING CO.		
TORONTO		ONT.
SEND	FOR CIRCULAR	



With a layer of paper underneath makes a building warm in winter and cool in summer.

 Write for Catalogue.

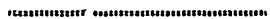

Metallic Roofing Co., Ltd.,

MANUFACTURERS

1194 King St. W.,

TORONTO

Clark's Cutaway Harrow

Supersedes the Plow.
Makes a Perfect Seed Bed.

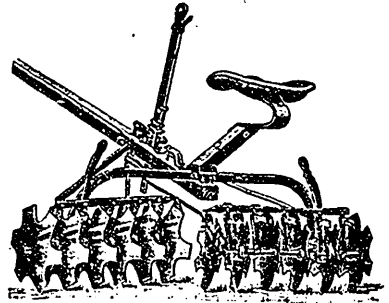

THE SYLVESTER PEA HARVESTER . .

THE CHAMPION PEA HARVESTER OF ONTARIO.



Farmers! Consult your own interests and send in your order for a Champion Pea Harvester or Cutaway Disc Harrow

If the coming season finds you in need of a Disc Harrow, Pea Harvester, Clover Table Binder, Mower, Sulky Rake, Spring Tooth Cultivator, Combined Drill, Double or Single Furrow Plows, Garden Plows, or Corn Cultivator, and you buy a SYLVESTER, you will be well pleased with your selection. Now, then, this we confidently predict: You will bear testimony to the superiority of our machines. Remember, we guarantee the successful operation of every machine leaving our works. It is in the actual work of the machines themselves in the field that the right to claim them the best in the market is exemplified.

SYLVESTER BROS. MFG. CO.

LINDSAY, ONT.

Send for Special Circular.

75,000 IN USE.

BELL PIANOS AND ORGANS

Recommended by leading musicians as superior in tone and touch. Elegant in finish and durable.

Send for catalogues and copies of testimonials to

THE BELL ORGAN & PIANO CO.
(LIMITED)

GUELPH, ONTARIO.

Branch Warerooms at Toronto, Hamilton, London, Etc.

421

Mention this paper.

ESTABLISHED 1864.

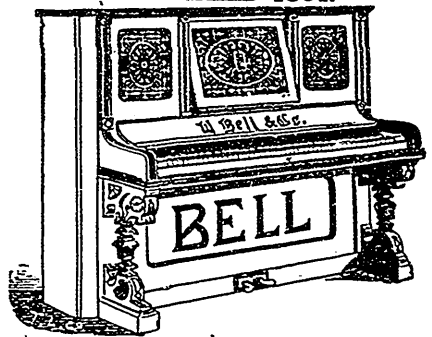

The JOHN ABELL ENGINE AND MACHINE WORKS CO., Ltd.

SOLE MANUFACTURERS FOR CANADA
OF THE

DAVIS CREAM SEPARATORS

WHICH ARE CONSIDERED TO BE

— THE BEST YET —



THE JOHN ABELL ENGINE & MACHINE WORKS CO, Ltd.,

TORONTO, CANADA

WILKINSON PLOUGHS

Two, Three, and Four Furrow Gangs,
Eight or Ten inch cut.

Fitted with Cast Shares, Steel Shares;
or for Manitoba with Soft Centre Steel
Tempered Shares. With or without
Cutters.

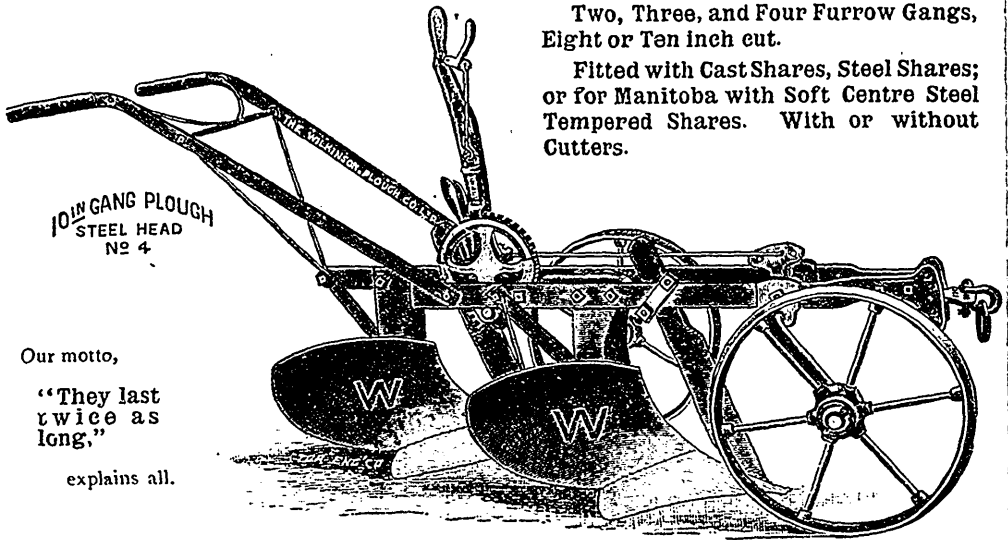

Our motto,

"They last
twice as
long."

explains all.

The Patent Steel Suspension Drum and Roller

Absolutely the only Steel Land Roller within reach of the farmer at present prices.
So simple in construction, so absolutely perfect in detail, that it will last a lifetime.

ALL SIZES ALL WEIGHTS ONLY ONE QUALITY

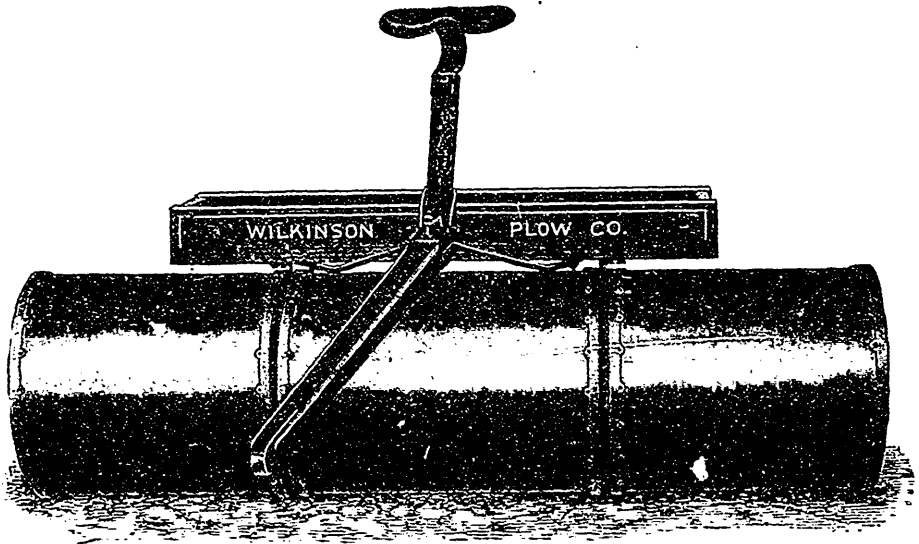

The Wilkinson Plough Company
TORONTO, ONT. (Limited)

Guarantees everything
they make; and assures
value for your money
in every instance.