

**CIHM
Microfiche
Series
(Monographs)**

**ICMH
Collection de
microfiches
(monographies)**



Canadian Institute for Historical Microreproductions / Institut canadien de microreproductions historiques

© 1997

Technical and Bibliographic Notes / Notes techniques et bibliographiques

The Institute has attempted to obtain the best original copy available for filming. Features of this copy which may be bibliographically unique, which may alter any of the images in the reproduction, or which may significantly change the usual method of filming are checked below.

- Coloured covers / Couverture de couleur
- Covers damaged / Couverture endommagée
- Covers restored and/or laminated / Couverture restaurée et/ou pelliculée
- Cover title missing / Le titre de couverture manque
- Coloured maps / Cartes géographiques en couleur
- Coloured ink (i.e. other than blue or black) / Encre de couleur (i.e. autre que bleue ou noire)
- Coloured plates and/or illustrations / Planches et/ou illustrations en couleur
- Bound with other material / Relié avec d'autres documents
- Only edition available / Seule édition disponible
- Tight binding may cause shadows or distortion along interior margin / La reliure serrée peut causer de l'ombre ou de la distorsion le long de la marge intérieure.
- Blank leaves added during restorations may appear within the text. Whenever possible, these have been omitted from filming / Il se peut que certaines pages blanches ajoutées lors d'une restauration apparaissent dans le texte, mais, lorsque cela était possible, ces pages n'ont pas été filmées.
- Additional comments / Commentaires supplémentaires:

L'Institut a microfilmé le meilleur exemplaire qu'il lui a été possible de se procurer. Les détails de cet exemplaire qui sont peut-être uniques du point de vue bibliographique, qui peuvent modifier une image reproduite, ou qui peuvent exiger une modification dans la méthode normale de filmage sont indiqués ci-dessous.

- Coloured pages / Pages de couleur
- Pages damaged / Pages endommagées
- Pages restored and/or laminated / Pages restaurées et/ou pelliculées
- Pages discoloured, stained or foxed / Pages décolorées, tachetées ou piquées
- Pages detached / Pages détachées
- Showthrough / Transparence
- Quality of print varies / Qualité inégale de l'impression
- Includes supplementary material / Comprend du matériel supplémentaire
- Pages wholly or partially obscured by errata slips, tissues, etc., have been refilmed to ensure the best possible image / Les pages totalement ou partiellement obscurcies par un feuillet d'errata, une pelure, etc., ont été filmées à nouveau de façon à obtenir la meilleure image possible.
- Opposing pages with varying colouration or discolourations are filmed twice to ensure the best possible image / Les pages s'opposant ayant des colorations variables ou des décolorations sont filmées deux fois afin d'obtenir la meilleure image possible.

This item is filmed at the reduction ratio checked below /
Ce document est filmé au taux de réduction indiqué ci-dessous.

	10x		14x		18x		22x		26x		30x	
									✓			
	12x		16x		20x		24x		28x		32x	

The copy filmed here has been reproduced thanks to the generosity of:

National Library of Canada

The images appearing here are the best quality possible considering the condition and legibility of the original copy and in keeping with the filming contract specifications.

Original copies in printed paper covers are filmed beginning with the front cover and ending on the last page with a printed or illustrated impression, or the back cover when appropriate. All other original copies are filmed beginning on the first page with a printed or illustrated impression, and ending on the last page with a printed or illustrated impression.

The last recorded frame on each microfiche sheet contains the symbol \rightarrow (meaning "CONTINUED"), or the symbol ∇ (meaning "END"), whichever applies.

Maps, plates, charts, etc., may be filmed at different reduction ratios. Those too large to be entirely included in one exposure are filmed beginning in the upper left hand corner, left to right and top to bottom, as many frames as required. The following diagrams illustrate the method:

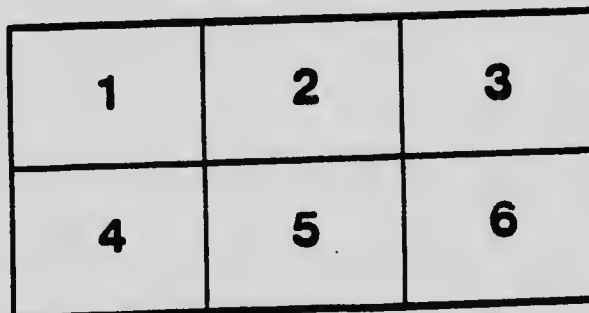
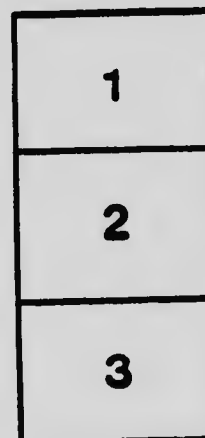
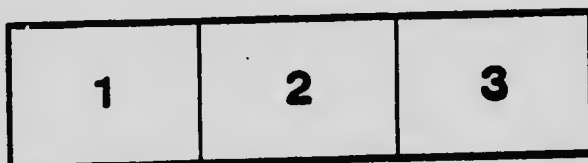

L'exemplaire filmé fut reproduit grâce à la générosité de:

Bibliothèque nationale du Canada

Les images suivantes ont été reproduites avec le plus grand soin, compte tenu de la condition et de la netteté de l'exemplaire filmé, et en conformité avec les conditions du contrat de filmage.

Les exemplaires originaux dont la couverture en papier est imprimée sont filmés en commençant par le premier plat et en terminant soit par la dernière page qui comporte une empreinte d'impression ou d'illustration, soit par le second plat, selon le cas. Tous les autres exemplaires originaux sont filmés en commençant par la première page qui comporte une empreinte d'impression ou d'illustration et en terminant par la dernière page qui comporte une telle empreinte.

Un des symboles suivants apparaît sur la dernière image de chaque microfiche, selon le cas: le symbole \rightarrow signifie "A SUIVRE", le symbole ∇ signifie "FIN".

Les cartes, planches, tableaux, etc., peuvent être filmés à des taux de réduction différents. Lorsque le document est trop grand pour être reproduit en un seul cliché, il est filmé à partir de l'angle supérieur gauche, de gauche à droite, et de haut en bas, en prenant le nombre d'images nécessaire. Les diagrammes suivants illustrent la méthode.

MICROCOPY RESOLUTION TEST CHART

(ANSI and ISO TEST CHART No. 2)



3.0

3.6

4.3

5.0

5.6

6.3

7.1

8.0

9.0

10

11.2

12.5

14.3

16

18

20

22.5

25

28

31.5

36

40

45

50

56

63



APPLIED IMAGE Inc

1653 East Main Street
Rochester, New York 14609 USA
(716) 482 - 0300 - Phone
(716) 286 - 5989 - Fax

A. P. M32-16
324^a *St. Lawrence West*

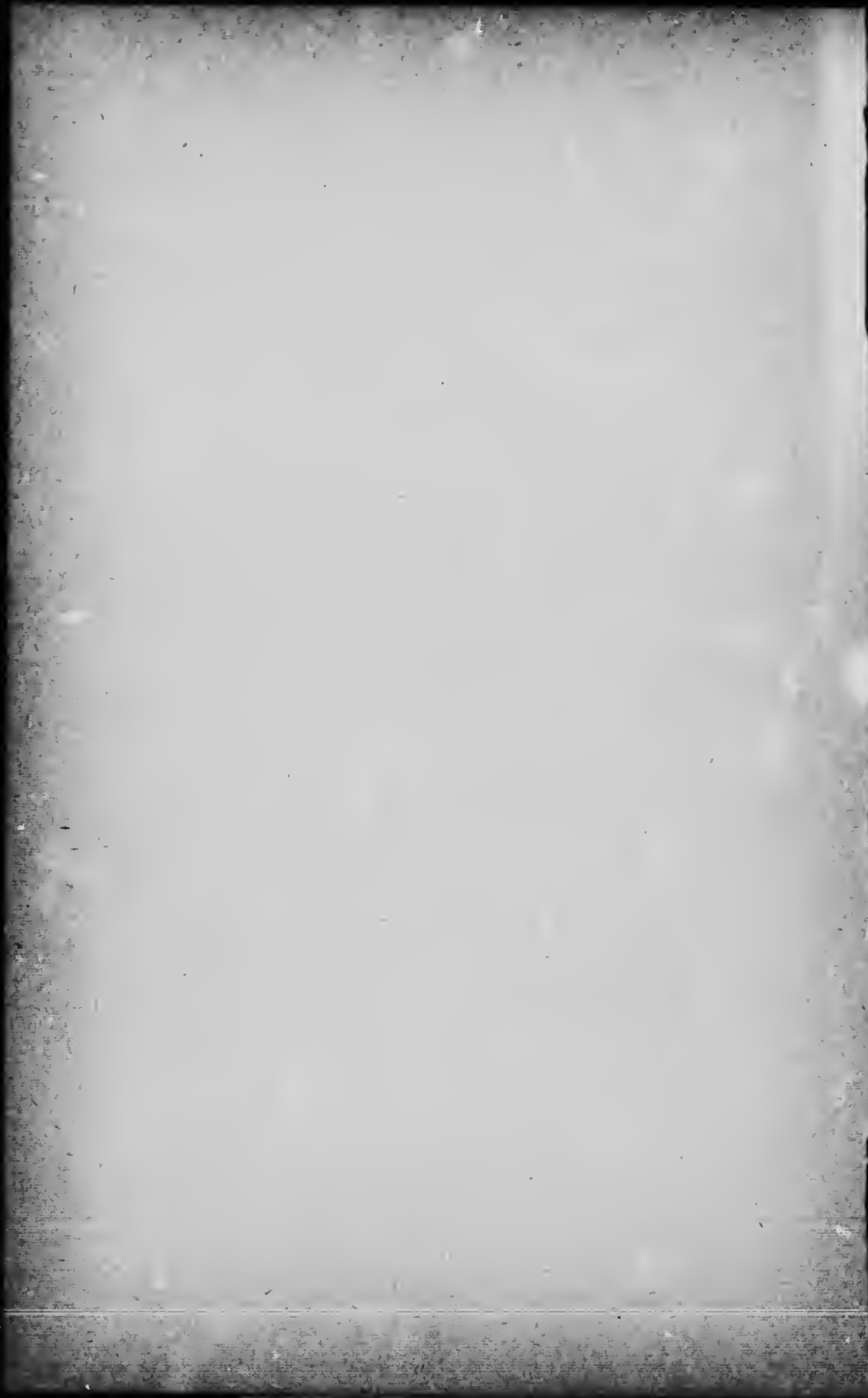



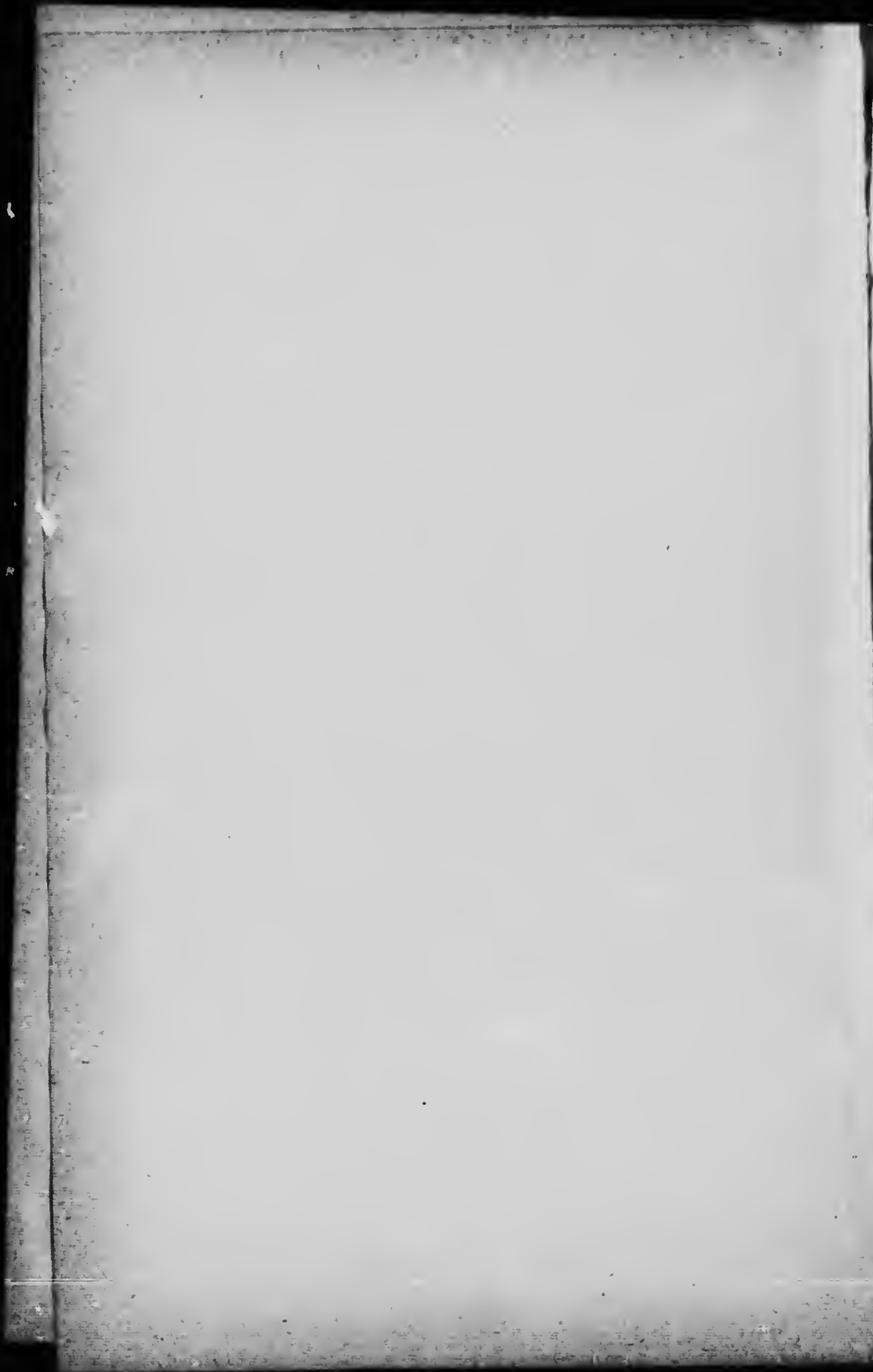

MINES BRANCH
DEPARTMENT OF THE INTERIOR.
HONORABLE FRANK OLIVER, M.P. MINISTER.
EUGENE HAANEL, Ph. D., SUPERINTENDENT OF MINES.

REPORT

ON THE

Experiments made at Sault Ste. Marie, Ont., under
Government auspices, in the smelting of Cana-
dian iron ores by the Electro-thermic Process.

BY
EUGENE HAANEL, Ph. D.

OTTAWA, CANADA
1907.

OTTAWA. February 20th, 1907.

SIR,

I have the honour to transmit herewith the final report on the experiments made at Sault Ste. Marie, Ont., under Government auspices, in the smelting of Canadian iron ores by the electro-thermic process.

The report contains a detailed statement of the work done and results obtained, of all measurements made, of the analyses of the pig and slags produced and of the iron ores employed. To facilitate the comprehension of the text illustrations are given of the furnace employed and changes made in its construction and of the machinery employed. Plans are given of two commercial electric furnaces which have recently been patented. In an appendix a detailed account and description, with illustrations, are given of the recent inventions and improvements made in electric furnaces in Sweden, also an account by Professor Eichhoff, Professor of Metallurgy of the Technical High School at Charlottenburg, Germany, of the advantages of the Heroult electric process of making high class steel and cost of production.

I have the honour to be, Sir,

Your obedient servant,

EUGENE HAANEL.

Superintendent of Mines.

Honourable FRANK OLIVER, P.C., M.P.,

Minister of the Interior,
Department of the Interior, Ottawa.

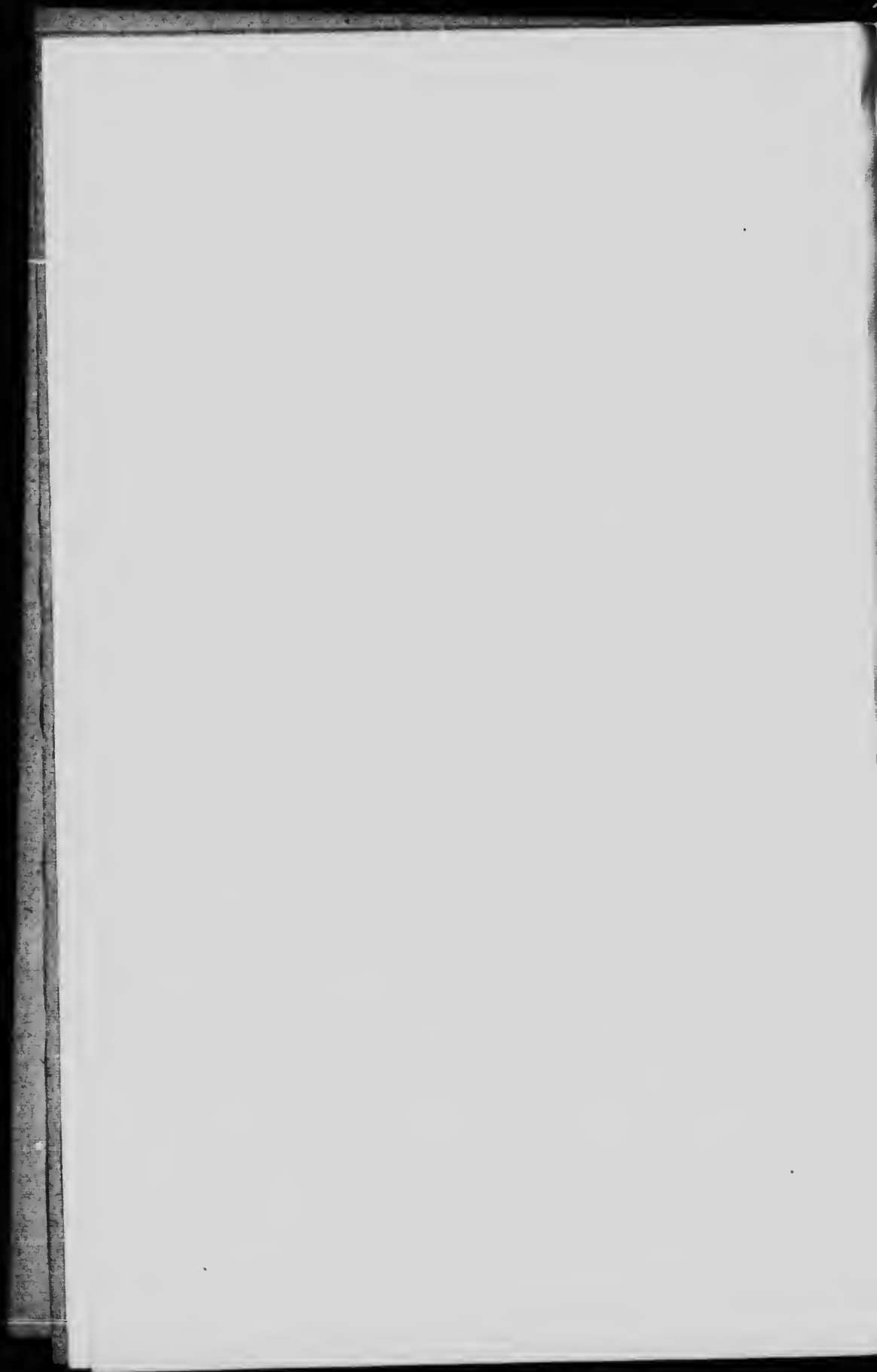

INTRODUCTION

In December, 1903, the Government appointed a Commission to investigate the different electro-thermic processes for the smelting of iron ores and the making of steel in operation in Europe. The results of this investigation were published in 1904 in a report issued by the Mines Branch of the Interior Department, entitled: "Report of the Commission appointed to investigate the different electro-thermic processes for the smelting of iron ores and the making of steel in operation in Europe."

The only experiments for the reduction of iron ores which the Commission was able to witness were those conducted by Dr. P. Héroult, at La Praz, France, and by Messrs. Keller, Leleux & Co., at Livet, France. Dr. Héroult's experiment was only made to show the possibility of smelting iron ores and no data in regard to output, etc., could be obtained.

The experiments of Messrs. Keller, Leleux & Co. were more extensive and continued for a number of days. During this time two different runs were made in different furnaces, but of similar construction. The ore used was a porous hematite containing 3.21% of manganese and only 0.02% of sulphur, an ore, therefore, easily reduced and desulphurized. The electric energy required in the first run was 0.475 E.H.P. years * per ton ** of pig iron, corresponding to an output of 5.769 tons per 1,000 E.H.P. days. The electric energy required in the second run was 0.226 E.H.P. years per ton of product, corresponding to an output of 12.12 tons per 1,000 E.H.P. days. The difference in output of these two experiments was so great that Mr. F. W. Harbord, the metallurgist of the Commission, was compelled to adopt 0.350 E.H.P. years, the mean of the two experiments, as the probable energy required per ton of product. This would correspond to an output of 7.827 tons per 1,000 E. H. P. days.

Before, therefore, a sound judgment could be formed as to the practicability of the electro-thermic process for the smelting of Canadian ores, it

* 365 days

** Of 2,000 lbs.

was desirable to establish with some degree of exactitude the amount of electric energy required per ton of product, the consumption of electrode, and also the following important points referring to Canadian conditions, which were either not taken up or were left in doubt by the Livet experiments:

- 1st. Can magnetite, which is our chief ore and which is to some extent a conductor of electricity, be successfully and economically smelted by the electro-thermic process?
- 2nd. Can iron ores with comparatively high sulphur content, but not containing manganese, be made into pig iron of marketable composition?
- 3rd. The experiments made at Livet with charcoal as a reducing agent in substitution for coke having failed, could the process be so modified that charcoal could be substituted for coke? This is especially important since charcoal and possibly peat coke would constitute home products, while coal-coke for metallurgical processes requires to be imported into several of the Provinces.

The settlement of these questions was of such paramount importance for the formation of a judgment as to the feasibility of introducing electric smelting of iron ores as a commercial process in those provinces of Canada which lack coal for metallurgical coke, but are well supplied with water-power and iron ore deposits, that the experimental investigation of the subject was authorized and a sum of \$15,000 placed at the disposal of the Mines Branch for the carrying out of these investigations.

An agreement was made with Dr. P. Héroult of La Praz, France, who offered to design the furnace and necessary arrangements, to make the experiments.

LOCATION AND DESCRIPTION OF PLANT.

The Lake Superior Corporation at Sault Ste. Marie, Ont., offered, on the recommendation of Mr. F. H. Clergue, the use of a suitable building in which to erect the furnace, and the power of one of their alternators free of expense for four months. At the same time the use of an office, their well equipped laboratory, the services of their chemist and machinery necessary for the conveyance and preparing of the charge were tendered on reasonable terms. As these advantages could not be secured elsewhere, the offer was accepted and the plant ordered to be erected under the superintendence of Mr. Erik Nystrom, member of the staff of the Mines Branch.

A plan of the plant as first erected is given in Plate I and a section in Plate II.

The raw material was unloaded from the cars and dumped either on the roof of the lime kiln room or directly into the bins provided for this pur-

of
e,
s,
s:

nt
ly

ot
n-

nt
so
is
uld
real

nce
ric
ada
wer
ect
nes

who
the

the
nich
ense
ped
the
rms.
pted
Erik

n in

r on
pur-

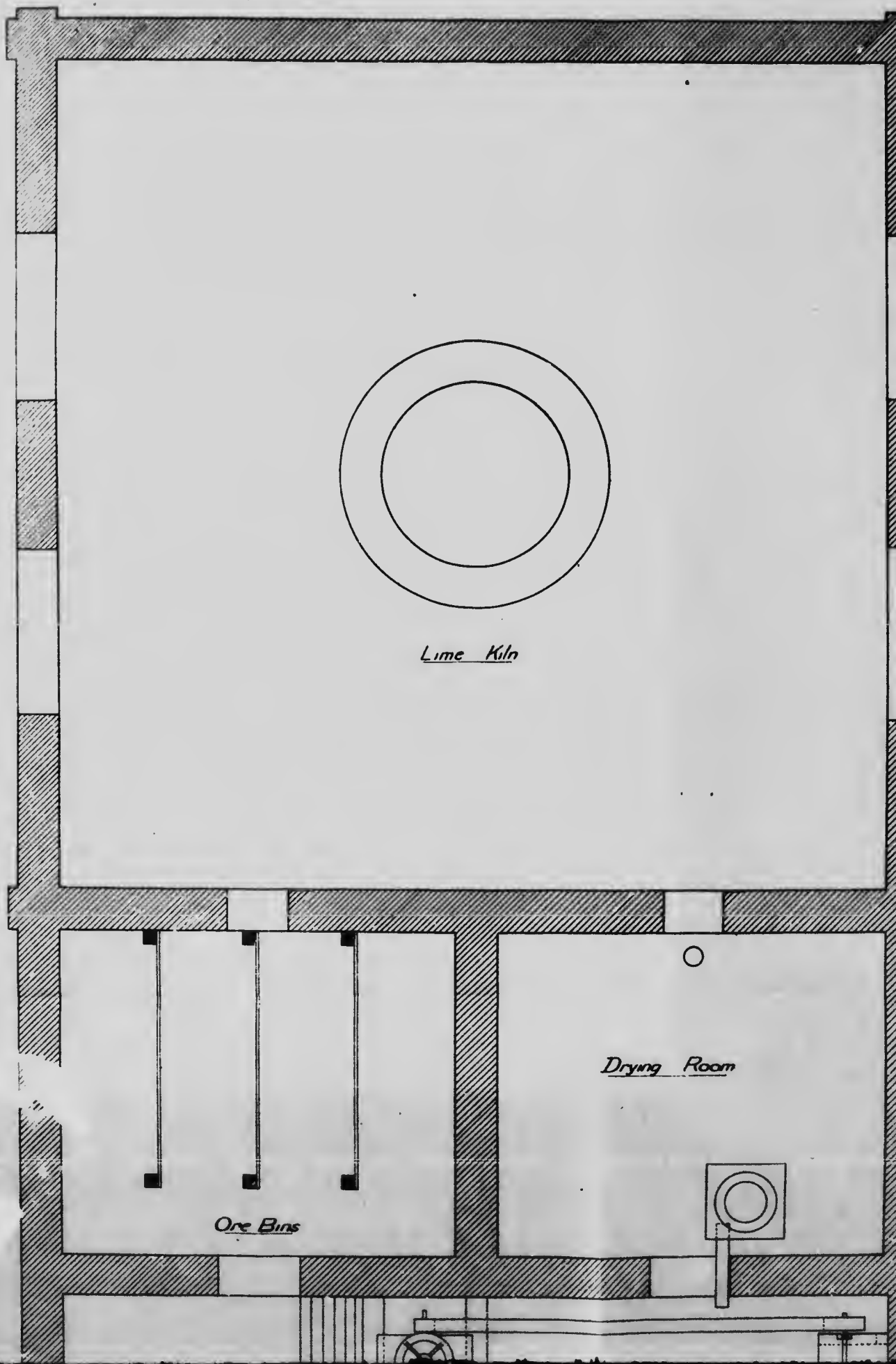

Lime Kiln

Ore Bins

Drying Room

Plate I

PLAN
OF
EXPERIMENTAL ELECTRIC SMELTING PLANT
AT
SAULT ST. MARIE, ONT.

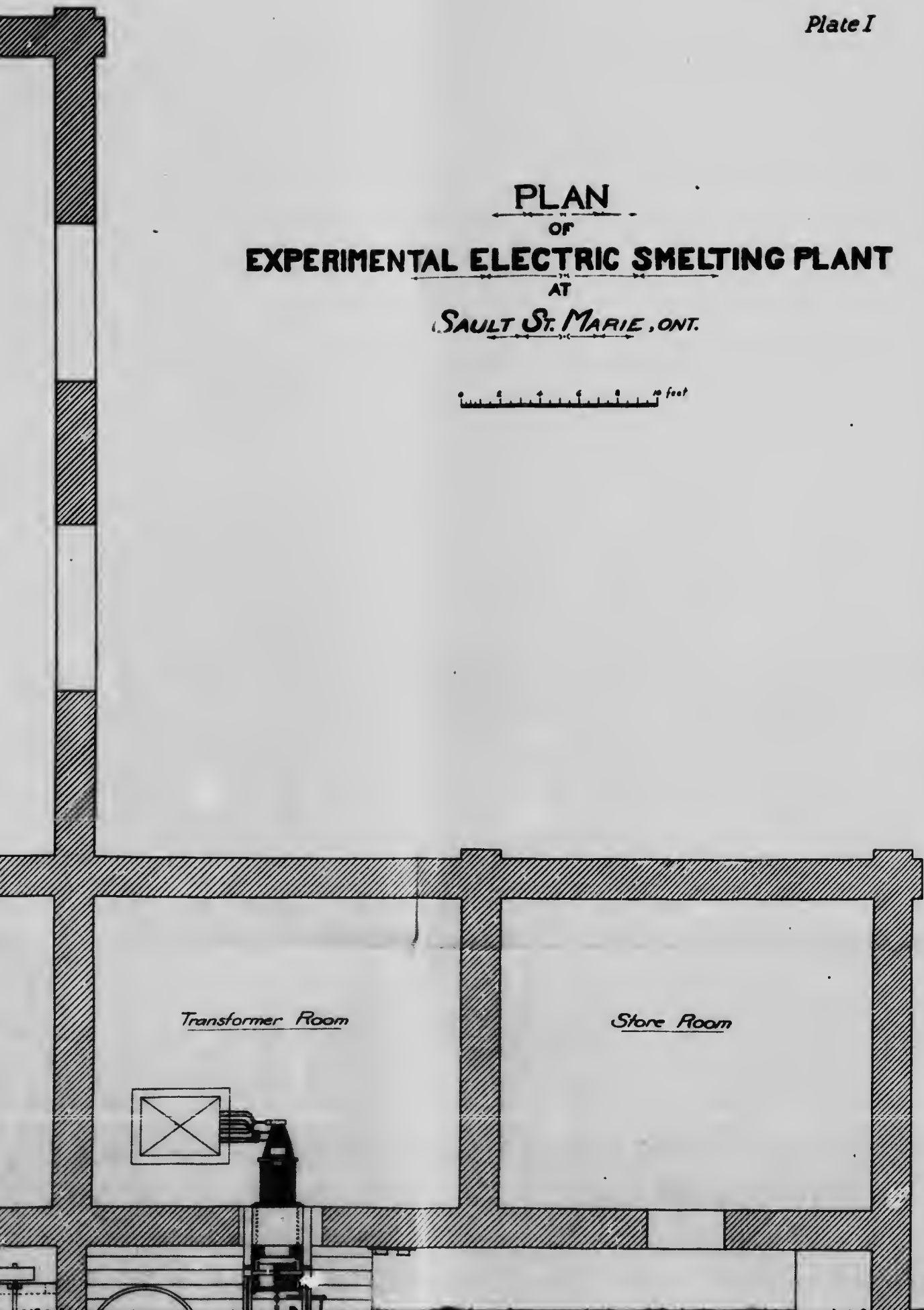

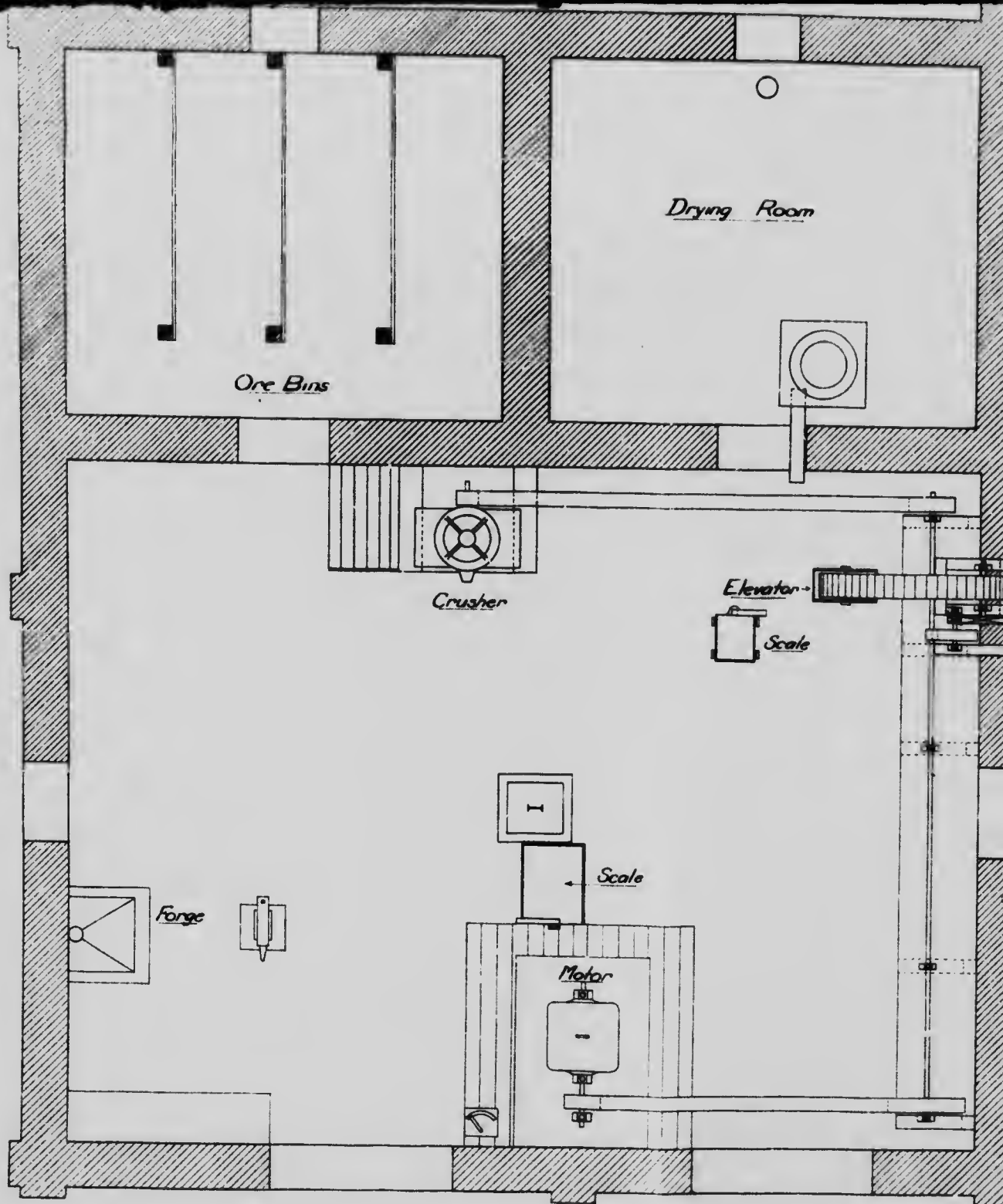

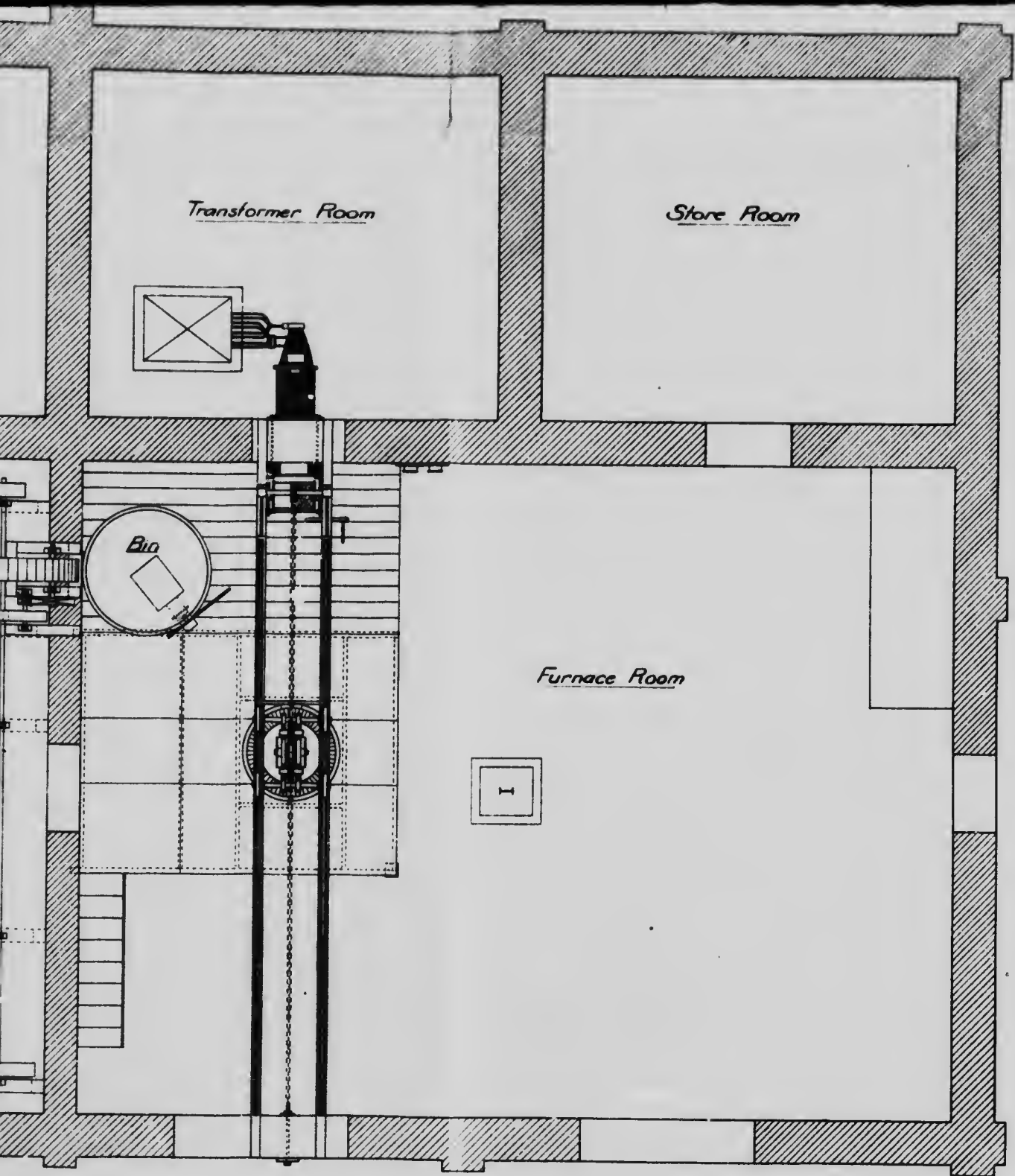

Transformer Room

Store Room

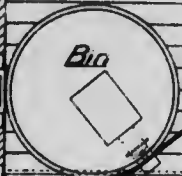
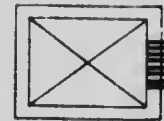

Furnace Room



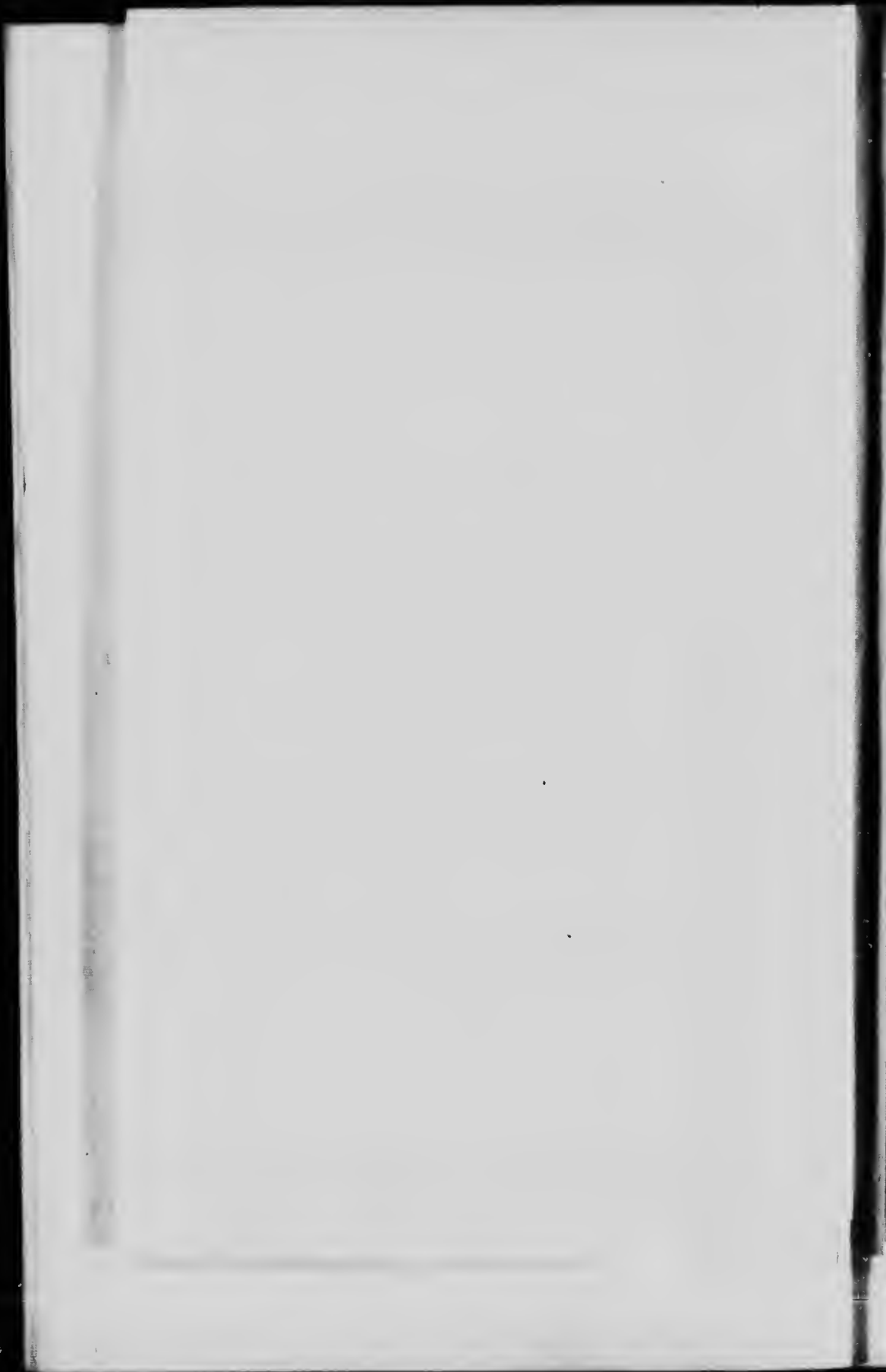

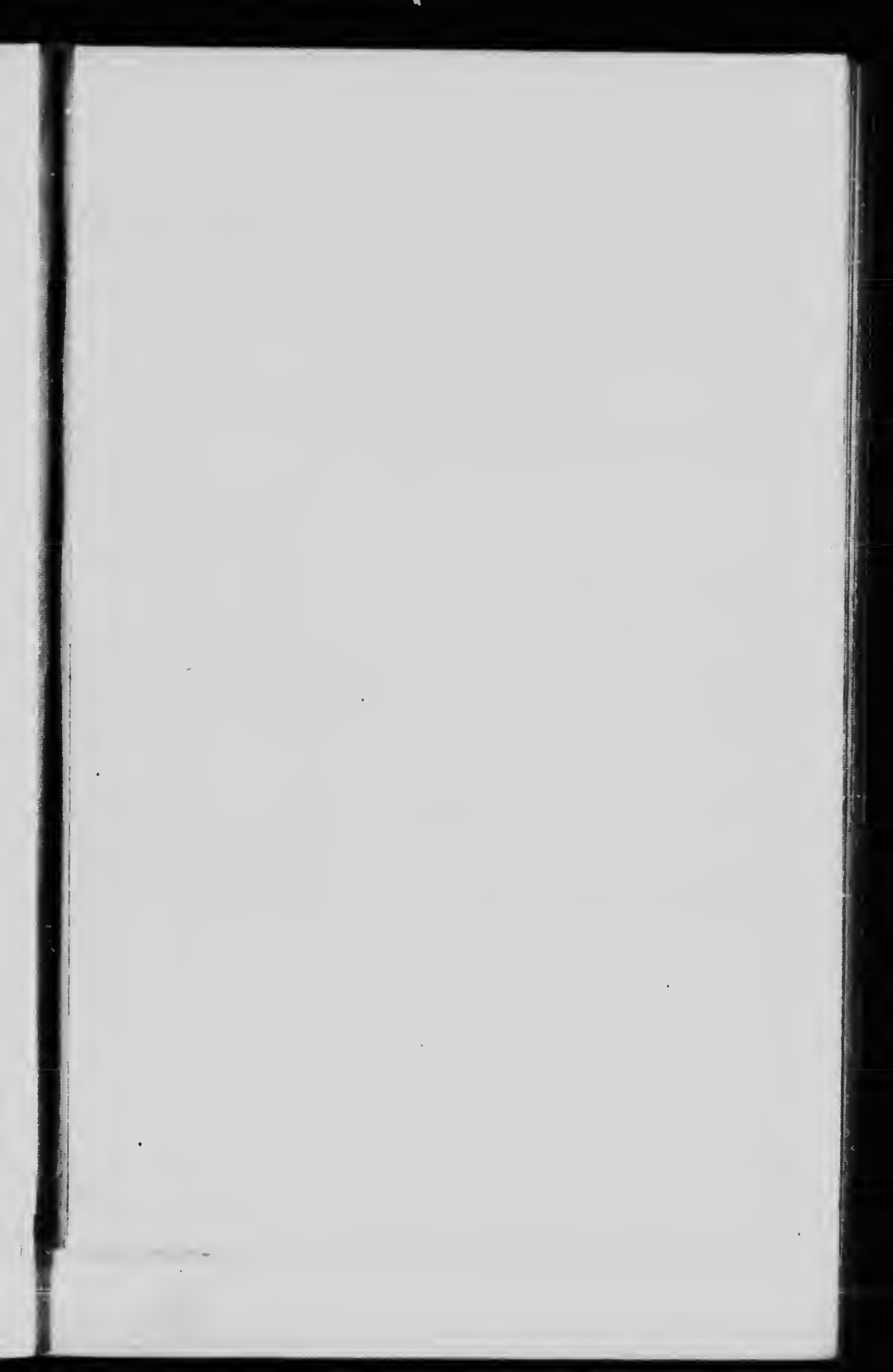

EX

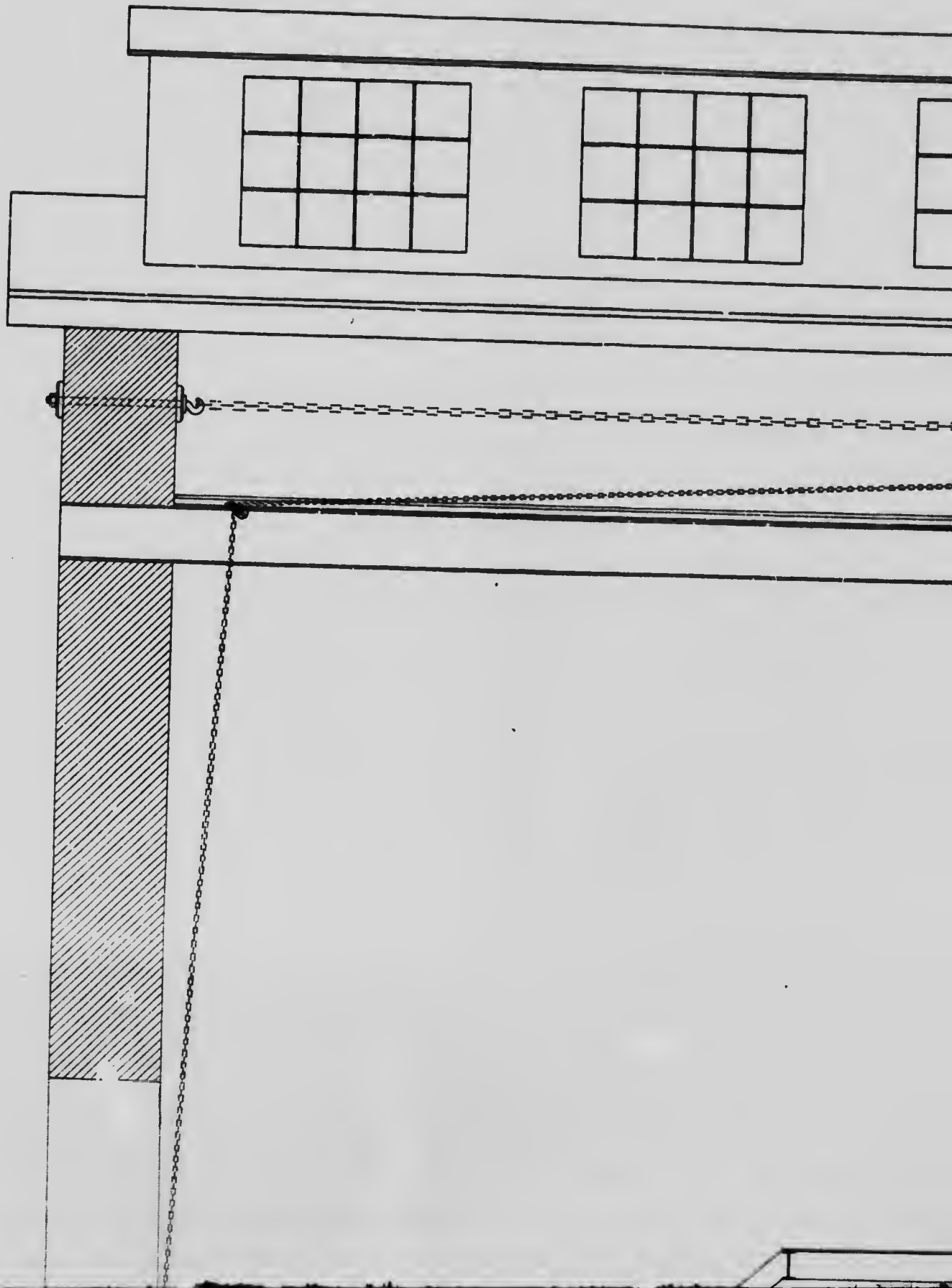

SECTION
OF
EXPERIMENTAL ELECTRIC SMELTING PLANT

AT
SAULT ST. MARIE, ONT.

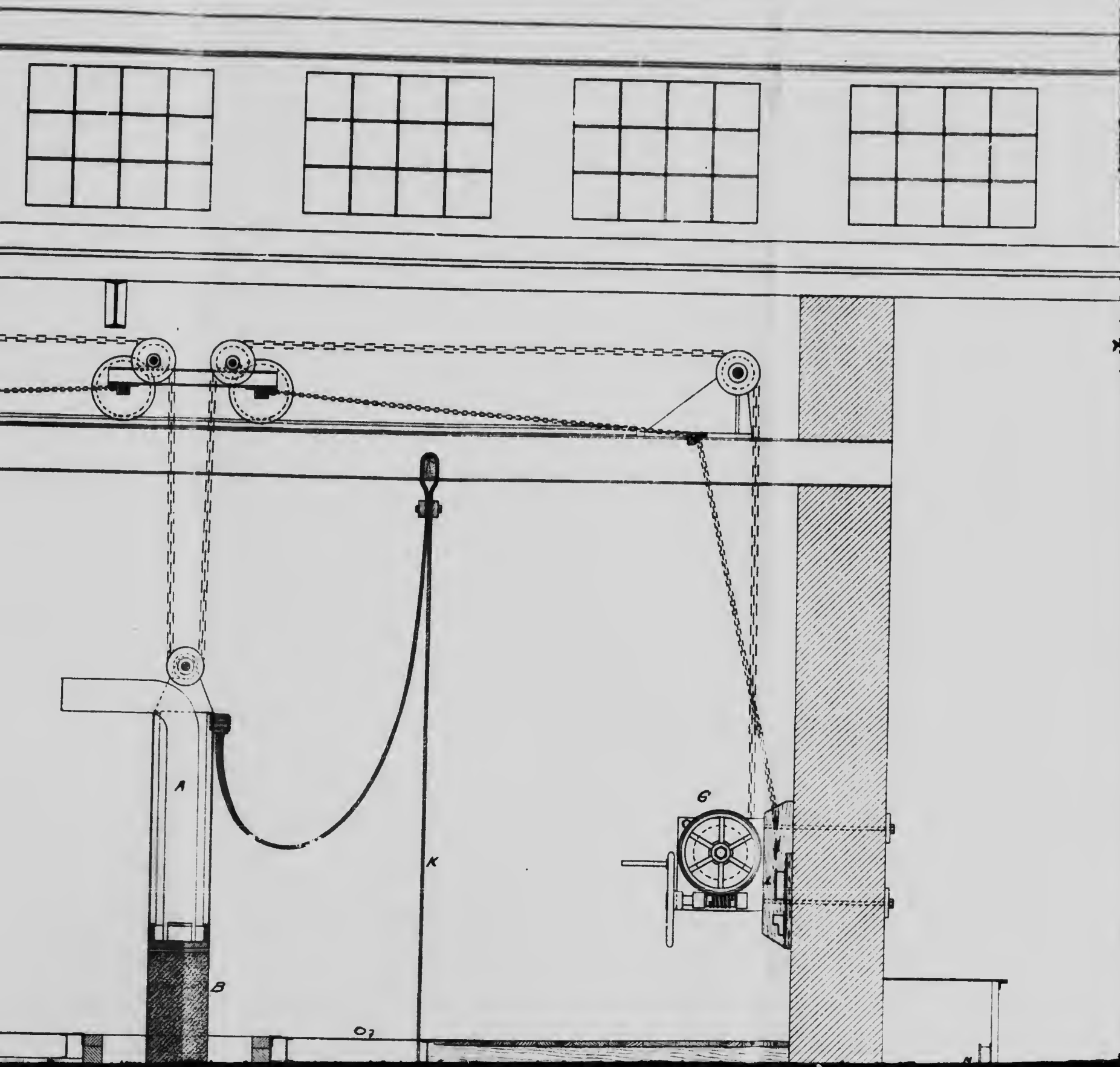

SECTION

OF

ELECTRIC SMELTING PLANT

AT

MARIE, ONT.

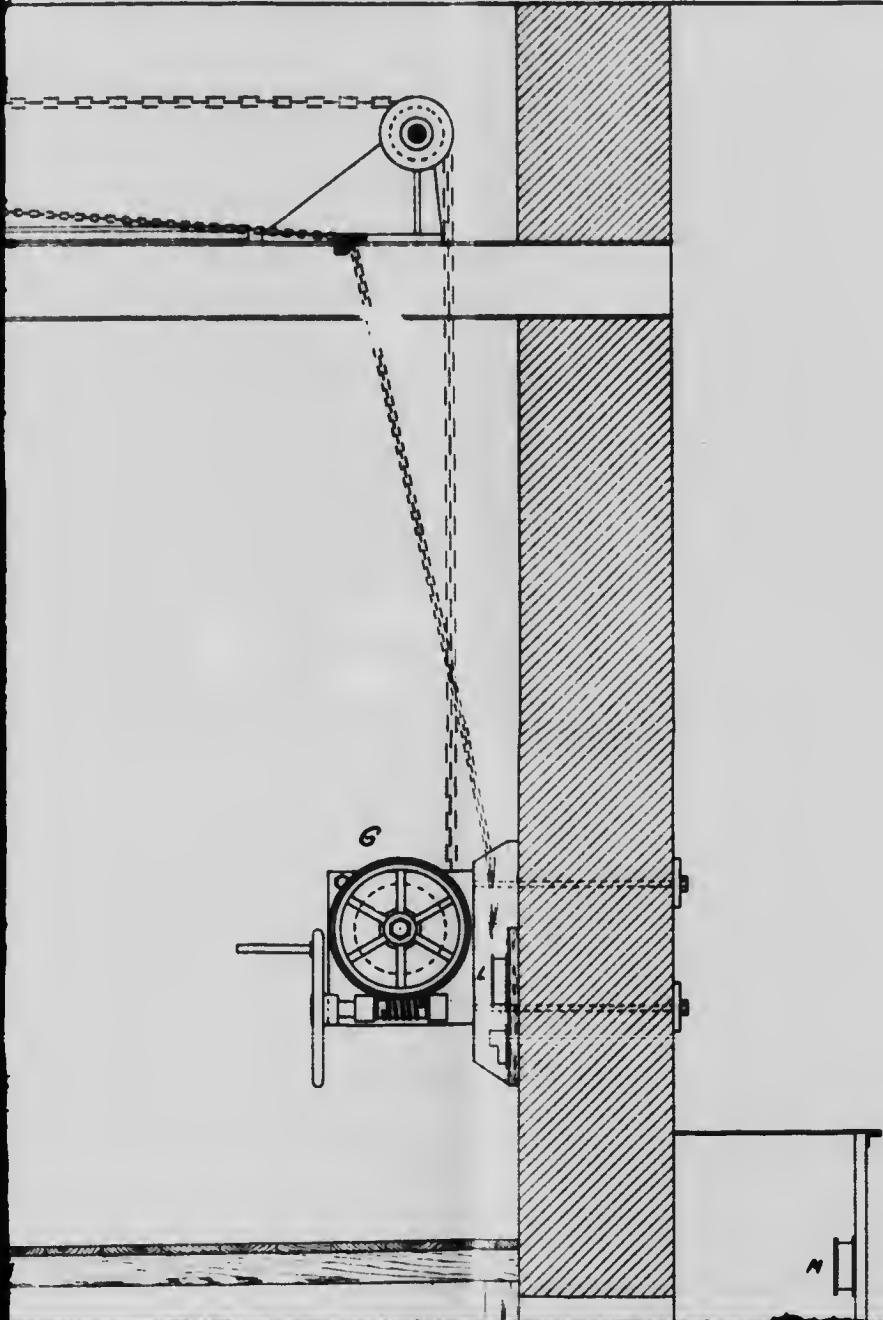
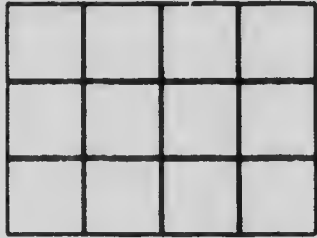
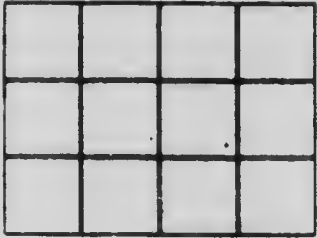



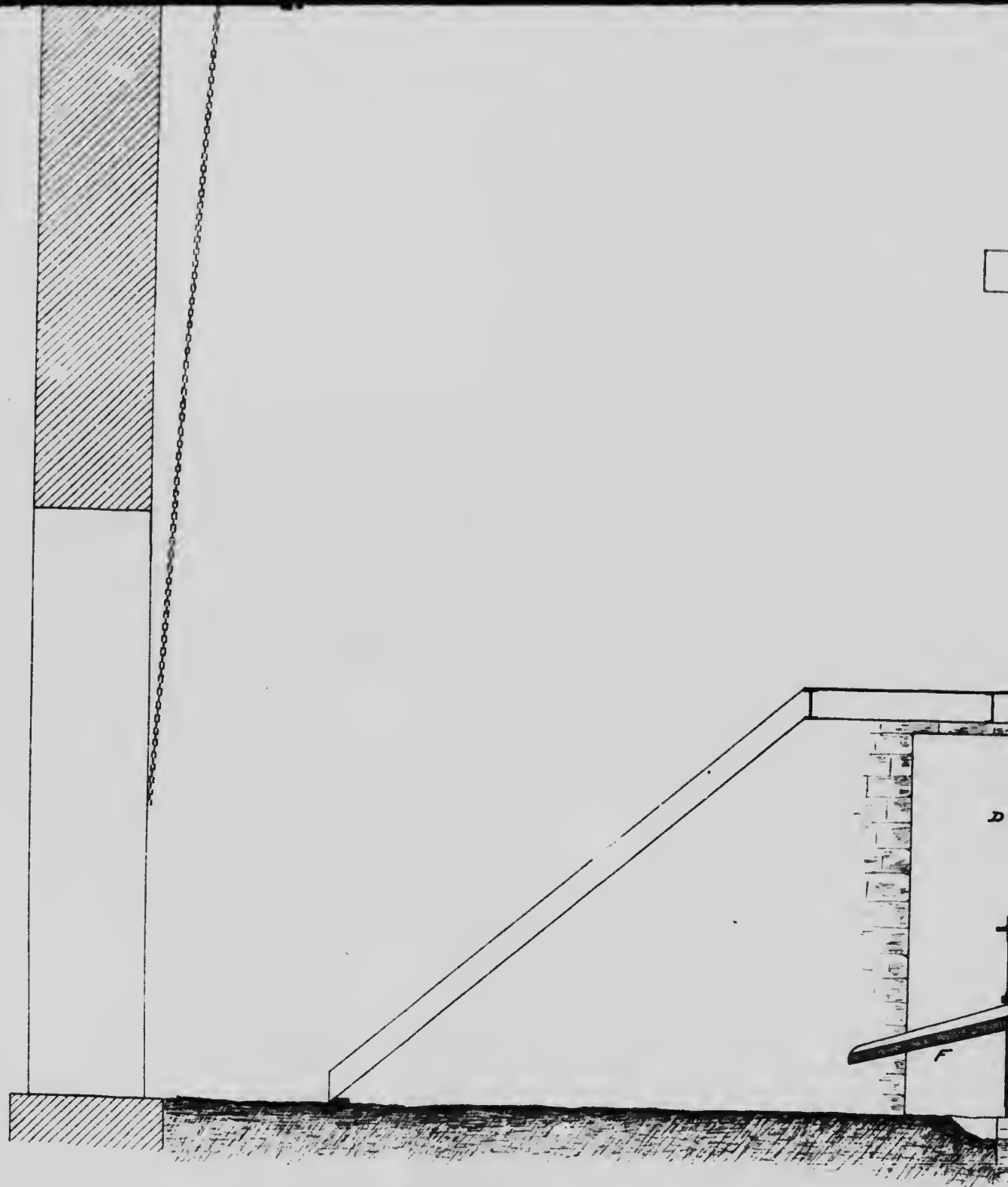

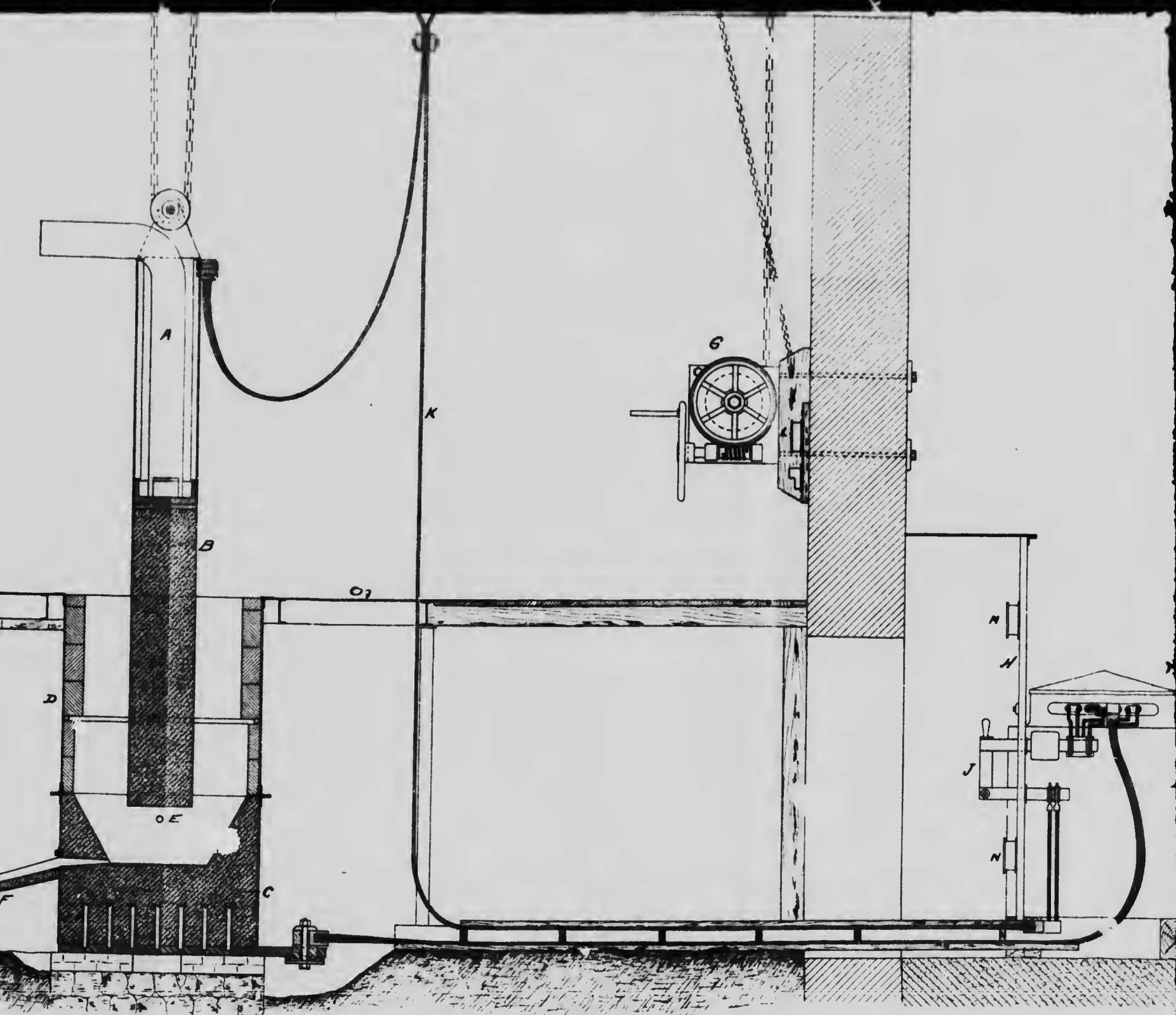

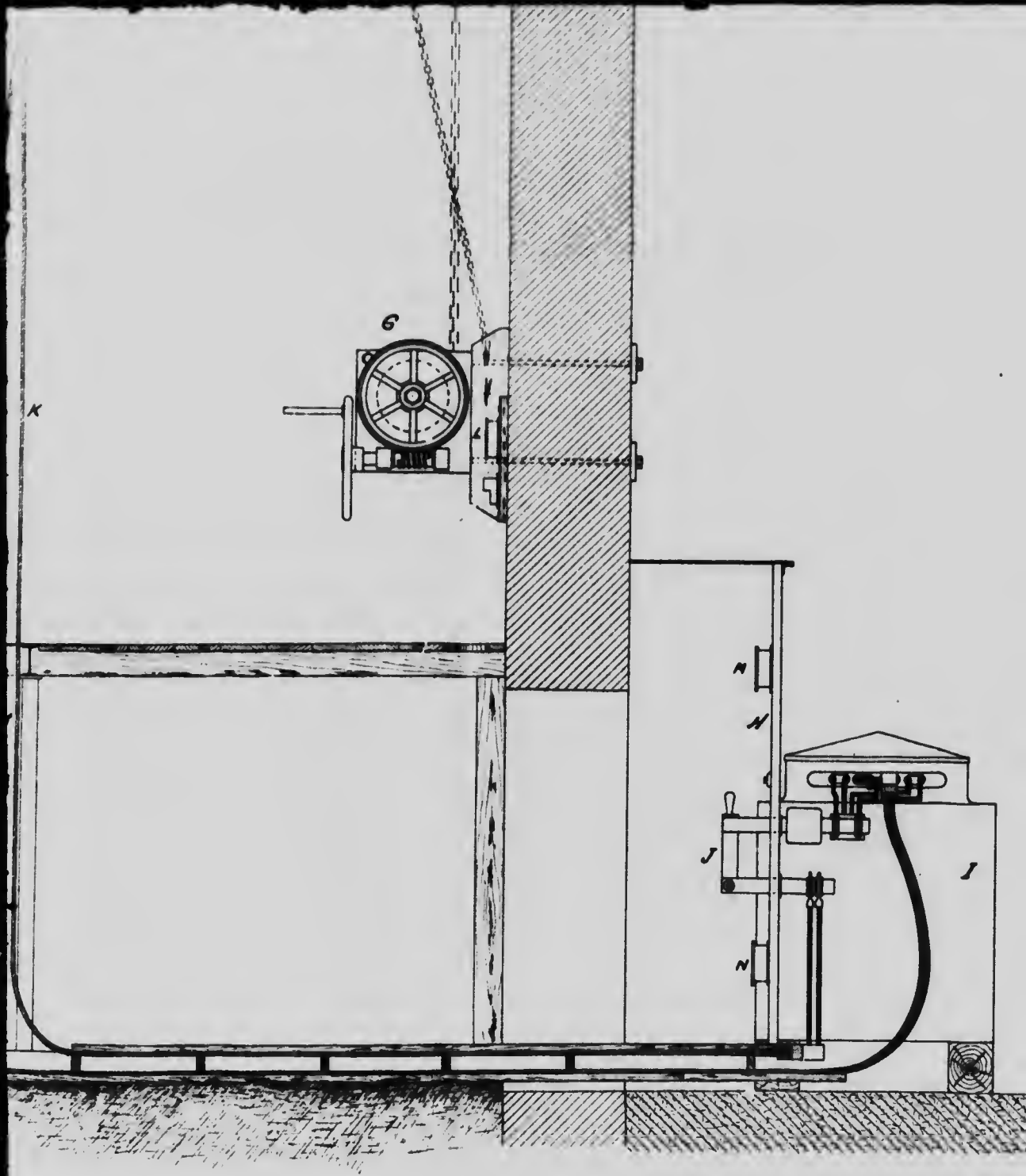



J

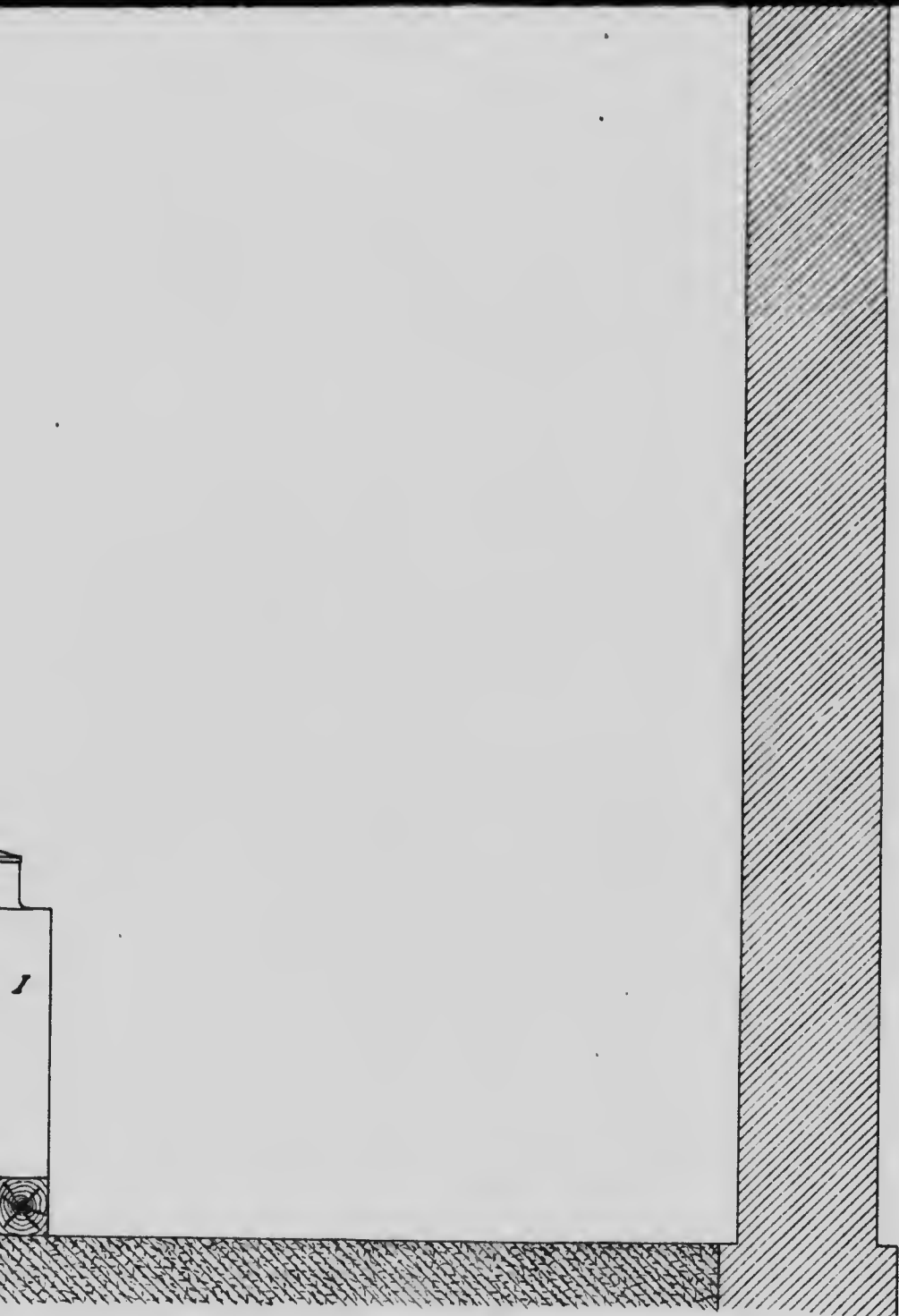

pose in one of the smaller rooms of the building. In the adjoining large room a motor was installed, driving a small Gates Crusher, and an elevator conveying the charge to a bin placed in the furnace room.

DESCRIPTION OF FURNACE.

The furnace as first designed by Dr. Héroult (see Plate II) consisted of an iron casing $\frac{1}{4}$ inch thick, bolted to a bottom plate of cast iron 48 inches in diameter. The casing was made in two sections strengthened by angle irons and bolted together to facilitate repairs, the lower section being 37 inches and the upper one 48 inches high. To render the inductance as small as possible the lines of magnetic force in the iron casing were prevented from closing by the replacement of a vertical strip of 10 inches width of the casing by a copper plate.

Rods of iron were cast into the bottom plate to secure a good contact with the carbon paste rammed into the lower part of the furnace. In an extension of the bottom plate a copper cylinder *c* (see Plate III) was inserted and constituted the contact with the aluminium block into which the aluminium cables constituting the conductor were cast. This block was pressed against the copper cylinder by means of a bolt, as shown in the figure. The bottom as well as the sides of the crucible were made of carbon paste, the lining of the upper part of the furnace being made of fire bricks.

The intention of Dr. Héroult was to utilize the calorific power of the carbon monoxide developed through the reduction of the ore. For this purpose an air pipe provided with holes was put in two feet below the top of the furnaces, by means of which air for the combustion of the carbon monoxide could be pressed in.

The electrodes, manufactured by the Héroult process and imported from Sweden, were prisms of square cross-section with the corners cut off, 16 x 16 inches by 6 feet long. One end of the electrode was planed to fit into the steel shoe *d* (see Plate III), and held tight by means of wedges. The steel shoe was riveted to four copper plates, two of which were strengthened on top with steel plates and carrying a pulley. A pipe, *k*, was put in the electrode holder, by means of which a current of air was produced to cool the holder. This construction of the electrode-holder was adopted in the expectation that it would permit the electrode to go down into the charge until it was practically consumed, leaving only a small stump as waste. The aluminium block into which the cables constituting the conductor were cast was bolted to one of the copper plates. The overhead work for the furnace consisted

of two I beams provided with light rails and a moveable truck with two pulleys. The electrode with its holder was supported by a chain passing under the pulley on top of the holder and over the pulleys on the truck, one end of the chain being fastened to the wall, the other end passing over a winch operated by a worm and worm-wheel. This formed a convenient arrangement for regulating the electrode by hand.

When exchanging electrode, the truck was pulled over in front of the furnace, the cables to the electrode holder being of sufficient length to permit such movements.

ELECTRICAL MACHINERY AND ARRANGEMENTS.

The electric energy obtainable was furnished by one phase of a three phase, 400 K. W., 30 cycle, 2,400 volt, alternating current generator coupled by belt to a 300 H. P., 500 volt, direct current motor, mounted in the Company's power house located some distance from the furnace building.

A current of 2,200 volts was delivered to an oil cooled transformer of 225 K. W. capacity, designed to furnish current to the furnace at 50 volts. The transformer was placed in a separate room in the furnace building, close to the furnace. From the transformer the current was led to the bottom plate contact of the furnace and to the electrode contact by conductors consisting each of 30 aluminium cables, $\frac{3}{8}$ inch in diameter.

The measuring instruments mounted on a switchboard consisted of a voltmeter, an ammeter, a power factor meter and a recording wattmeter. The transformer and electric meters were manufactured by the Westinghouse Electric and Manufacturing Company. An additional voltmeter reading from 10 to 80 volts, supplied by the Keystone Electric Company, was also placed in circuit to serve as a check. The voltmeter and ammeter, which had been mounted on the switchboard, were for convenience of observation removed to a position on the wall at the side of the electrode regulating apparatus.

The recording wattmeter had to be sent to the factory for alterations and was returned too late for the experiments. In order to ascertain the correctness of the remaining instruments, the Westinghouse Company was asked to send an expert for their calibration. In compliance with this request Mr. Chas. Darrall was sent to Sault Ste. Marie. The volt and ammeter were found by him to be correct and the power factor of the furnace to be

0.919, * which figure has been used throughout the experiments for the calculations of electric energy consumed.

EXPERIMENTS.

The experiments were carried out in the following manner: The raw material was first passed through the crusher which delivered a product of about $\frac{3}{4}$ inch diameter and less (a jaw crusher delivering a little larger size and not so much fines would have been more suitable, but none could be obtained at the time.) The ore, carbon and fluxes were then weighed, mixed by hand and delivered at first to the elevator and later charged direct into the furnace by hand. The number of charges used were marked down. The readings of the measuring instruments were taken every 30 minutes. In the tables given are the average figures of volts and amperes for the time elapsed between each tapping of the iron, also the corresponding weights of slag and iron. A sample of each cast and slag produced was collected for analysis.

*

Sault Ste. Marie, Feb. 23, 1906.

Tests made Feb. 23, 1906, at Reduction Works and at Tagona Light and Power Plant.

Readings I, II, and III were made at the alternator switch-board between lowering transformer and furnace.

Readings IV and V were made at furnace. Observations made at 60 feet distance from heavy current to eliminate effect of stray fields on measuring instruments. However, the presence of magnetic ores in the vicinity would suggest that these readings are influenced by same and should be disregarded, and readings obtained at switch-board are reliable especially from integrating meter.

I regard mean power factor of 91.9 as correct.

Weston Voltmeter Readings Meter No. 681. Means.	Ammeter Readings Meter No. 45870. Means.	Apparent Watts.	True Watts Wattmeter No. Weston 3727. Readings.	% Power Factor from True and Apparent Watts.	Integrating Wattmeter Readings.	% Power Factor from Ap. Watts and Integrated Watts.	No. of Test.
1750	123.8	217100	200500	92.2	I
1760	121.3	213800	197500	92.3	195000	91.9	II
1765	122.2	218000	202400	92.8	199000	91.9	III
39.2	5040	197568	185500	94	IV
38.7	5096	197215	185090	93.7	V
Frequency 30 cycles.							

Engineer in charge of test:

(Signed) CHAS. H. DARRALL,

Canadian Westinghouse Co.,

Hamilton, Ont.

For the working of the furnace three men per shift were employed, a few extra men being employed for the preparing and handling of the material used and produced.

The experiments were superintended by Dr. P. Héroult and after my arrival at the works on the 25th of January in great part by myself. When the furnace was working continuously 8 hour shifts were introduced successively in charge of the following gentlemen: Robert Turnbull and Jean Sejournet, Dr. Héroult's engineers, B. F. Haanel and E. Nystrom, of the Mines Branch, Interior Department, who were responsible for the work and notes taken during respective shifts. A few of the analyses were made by Mr. M. F. Connor, the remainder by Mr. H. Leverin.

The following classes of ore were treated:—

1. Hematite (Negaunee).
2. Magnetite from the Wilbur mine, Ont., (Wm. Caldwell, Esq.).
3. Magnetite from the Blairton mine, Ont., (Pierce Co., Marmora, Ont.)
4. Magnetite from the Calabogie Mining Co., (J. G. Campbell, Esq., Perth, Ont.)
5. Magnetite from the Calabogie Mining Co., (J. G. Campbell, Esq., Perth, Ont.)
6. Magnetite from the Calabogie mine (T. B. Caldwell, Esq., Lanark, Ont.)
7. Roasted pyrrhotite from Lake Superior Corporation.
8. Titaniferous iron ore from Quebec (J. G. Scott, Esq., Quebec.)

PRELIMINARY EXPERIMENTS.

A number of experiments required to be made to adjust the capacity of the crucible of the furnace to the energy available and to determine the shape to be given to the interior of the furnace. The lower part of the furnace being in position, it was decided to put on the current on December 11th, 1905, to test the contacts and installation in general.

A low current was first employed to dry the carbon paste and kept on for about 24 hours until 10.30 a.m., December 12th, when the furnace was charged and a stronger current used. The contact in the bottom plate became very hot, however, and the furnace had to be shut down.

To insure a better contact, holes, *r* (see plate III) were bored *half* in the copper and *half* in the cast iron plate and the holes filled with molten aluminium.

PLATE III.

EXPERIMENTAL
ELECTRIC FURNACE

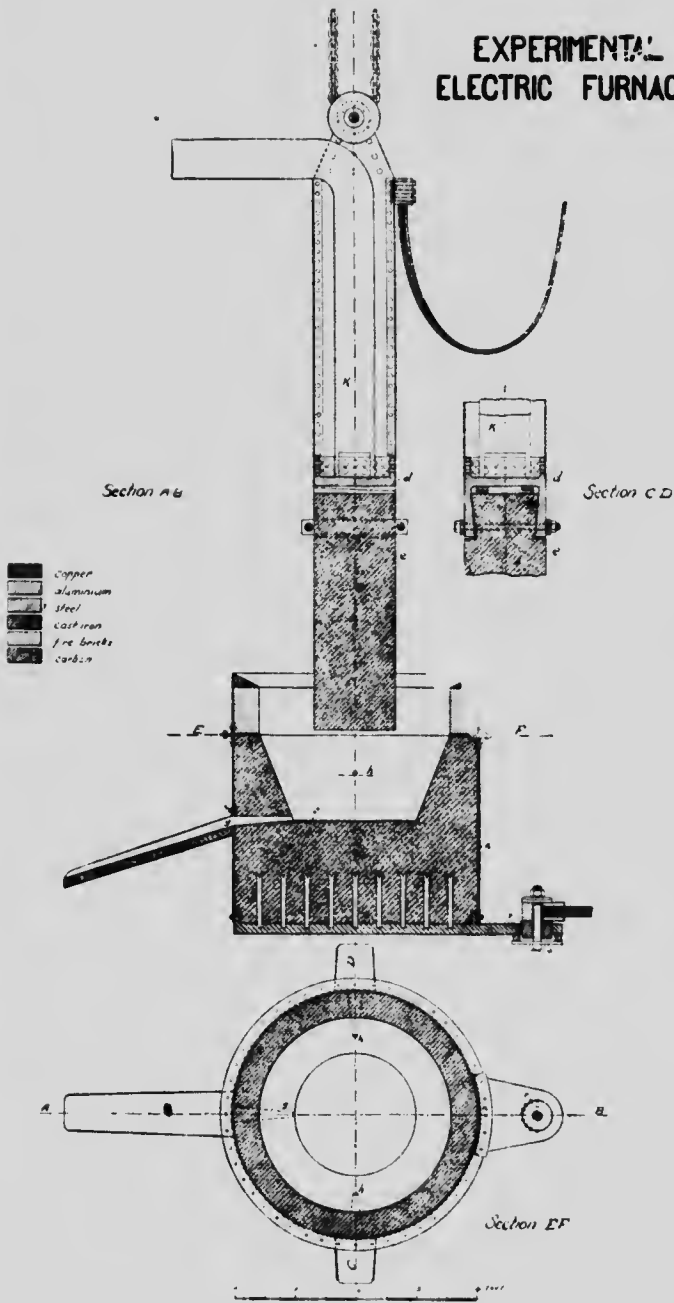

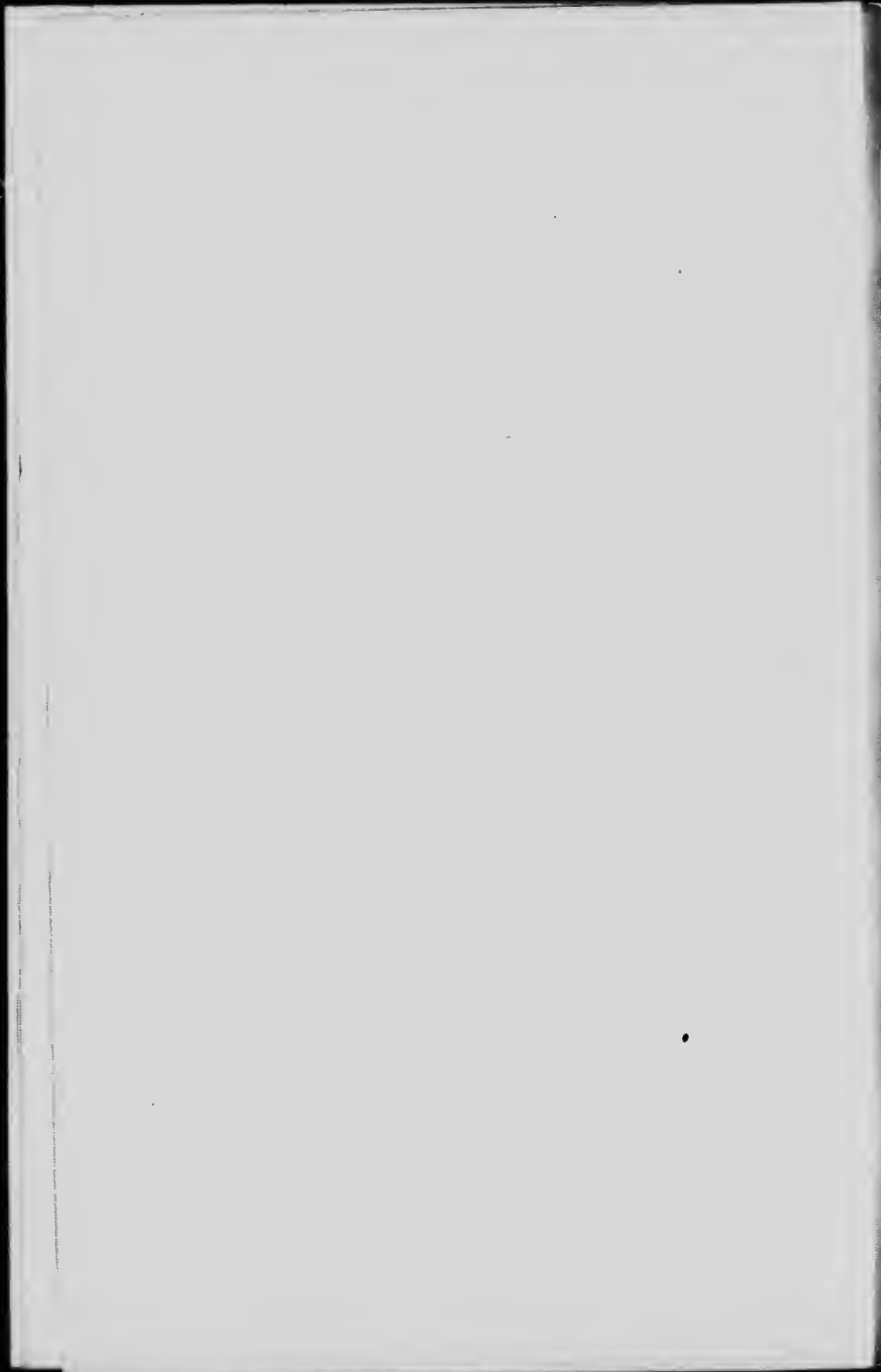

The upper part of the furnace was then put in place (see Plate II), the current put on and the furnace charged on December 18th.

Air, for the combustion of the carbon monoxide developed, was pressed in and the furnace worked well for a few hours. After a little, however, the electrode started to rise and continued to do so until an arc was established between the electrode and the upper layer of the charge, which necessitated the melting down of the material in the furnace. The heat developed by the combustion of the carbon monoxide was so great that the charge in the upper part of the furnace became sticky and would not descend into the furnace, nor could this be remedied by stoking, on account of the narrow space between the electrode and the wall.

The electrode contact did not prove satisfactory. This was remedied to some extent by putting a clamp around the steel shoe *d* (see Plate III).

Further attempt to introduce air into the furnace was, therefore, postponed and the height of the furnace reduced by cutting the upper section in two parts.

On January 3-4, 1906, an experiment was made to produce ferro-nickel from roasted pyrrhotite; the shape and arrangement of the furnace is given in Plate III.

The contact in the bottom plate proved still to be unsatisfactory and was, therefore, changed in the manner indicated in Plate IV for the subsequent experiments. The copper cylinder was removed and a new copper piece, *o*, provided with a flange on top, was inserted in its place. A number of holes, *p*, were bored through this flange and into the bottom plate of the furnace and filled with aluminium, no farther changes were made in this contact throughout the experiments, although its imperfection involved a loss of from $\frac{1}{2}$ to 1 volt.

RUN No. 1.

A section of the furnace used in this run is given in Plate III with the alteration of the bottom plate contact shown in Plate IV.

Ore treated	Hematite
Reducing agent	* Briquettes
Flux.	Limestone

The briquettes, consisting of 80% coke dust and 20% fire clay, were

made for the purpose of obtaining a reducing agent which would not be consumed by the air blast when introduced and at the same time lessen the conductivity of the charge. The briquette machine employed delivered briquettes 4 inches in diameter by 2½ inches in height. These briquettes, after being dried, required to be crushed, producing a considerable quantity of fines, which rendered the charge resistant to the passage of the carbon monoxide formed.

ANALYSIS OF RAW MATERIAL.

Hematite	{	SiO ₂	5.42%	
		Fe ₂ O ₃	88.90 "	Fe=62.23%
		Al ₂ O ₃	2.51 "	
		CaO.	0.61 "	
		MgO.....	0.30 "	
		Mn.	0.16 "	
		P.....	0.044"	
		S.....	0.002 "	
		Loss on ignition.....	2.48 "	
			<hr/>	
			100.426%	
			<hr/>	
Limestone	{	SiO ₂	1.71%	
		Fe ₂ O ₃ + Al ₂ O ₃	0.81 "	
		CaCO ₃	92.85 "	CaO. 51.96%
		MgCO ₃	4.40 "	MgO . . 2.09%
		P.....	0.004"	
		S.....	0.052"	
			<hr/>	
			99.826%	
			<hr/>	
Briquettes	{	Volatile matter.....	4.05%	
		Fixed carbon	69.73 "	
		SiO ₂	15.26 "	
		Fe ₂ O ₃ + Al ₂ O ₃	8.92 "	
		CaO.	0.90 "	
		MgO.....	0.30 "	
		S.....	0.84 "	
			<hr/>	
			100.00%	
			<hr/>	

The furnace was pre-heated with a low current from 11 p.m., January 5th, to 10 a.m., January 6th, when the full current was put on and the furnace charged.

The composition of the charge at first was:—

Ore	200 lbs.
Briquettes.....	70 "
Limestone.....	120 "

13 of these charges were used up and afterwards the limestone was decreased, the charge now consisting of:—

Ore.....	200 lbs.
Briquettes.....	70 "
Limestone.....	80 "

26 of these charges were put into the furnace when the run was stopped at 8.40 p.m., January 7th, and the material not melted down was taken out and the crucible cleaned.

On account of the large amount of fines in the charge the pressure of the gas developed was very great and occasionally the slag was blown out. The charge had to be worked down by stoking and became very sticky, preventing the electrode, which in this run was a short one, from descending. It was, therefore, decided to stop the run and put in a new electrode.

During the run 11 casts were made producing 4484 lbs. of pig iron, the slag produced amounting to 3886 lbs. On account of the men employed being unused to furnace work, the current had to be taken off every time a cast was made, to enable the iron hole to be cleaned and properly plugged. The time lost in this manner during the run amounted to 1 hour and 40 minutes.

ELECTRICAL MEASUREMENTS.

On account of imperfect contacts it was found that a loss of from 3 to 4 volts or on an average 3.5 volts occurred.

In the following table are given the volts on the line as read on the voltmeter and the volts on the furnace, where the loss on the contacts has been deducted; the latter are adopted for calculations, since the loss through poor contacts can be remedied by proper construction:—

Time.	Volts on Furnace.	Volts on Line.	Amperes	Power Factor.
Jan. 6, 10.00 a.m.....	36.5	40	4,500	0.919
10.30 ".....	40.5	44	4,500	"
11.00 ".....	39.5	43	4,500	"
11.30 ".....	39.5	43	4,500	"
12.00 ".....	40.5	44	4,500	"
12.30 p.m.....	39.5	43	4,500	"
1.00 ".....	39.5	43	4,700	"
1.30 ".....	46.5	50	4,500	"
2.00 ".....	39.5	43	4,500	"

Time.	Volts on Furnace.	Volts on Line.	Amperes.	Power Factor.
2.30 p.m.	40.5	44	4,250	0.919
3.00 "	41.5	45	4,250	"
3.30 "	41.5	45	4,500	"
4.00 "	42.5	46	4,500	"
4.30 "	42.5	46	4,250	"
5.00 "	43.5	47	4,500	"
5.30 "	43.5	47	4,500	"
6.00 "	42.5	46	4,000	"
6.30 "	43.5	47	4,500	"
7.00 "	42.5	46	4,500	"
7.30 "	41.5	45	4,250	"
8.00 "	41.5	45	4,000	"
8.30 "	41.5	45	4,250	"
9.00 "	41.5	45	4,250	"
9.30 "	41.5	45	4,500	"
10.00 "	41.5	45	4,500	"
10.30 "	43.5	47	4,000	"
11.00 "	41.5	45	4,500	"
11.30 "	40.5	44	4,500	"
12.00 "	38.5	42	3,500	"
Jan. 7, 12.30 a.m.	36.5	40	4,000	"
1.00 "	38.5	42	4,000	"
1.30 "	38.5	42	4,000	"
2.00 "	38.5	42	4,000	"
2.30 "	38.5	42	4,000	"
3.00 "	36.5	40	4,250	"
3.30 "	38.5	42	4,250	"
4.00 "	36.5	40	4,250	"
4.30 "	36.5	40	3,000	"
5.00 "	36.5	40	4,000	"
5.30 "	37.5	41	4,250	"
6.00 "	38.5	42	4,000	"
6.30 "	36.5	40	4,500	"
7.00 "	42.5	46	4,500	"
7.30 "	36.5	40	4,000	"
8.00 "	39.5	43	4,250	"
8.30 "	39.5	43	4,250	"
9.00 "	39.5	43	4,250	"
9.30 "	39.5	43	4,250	"
10.00 "	39.5	43	4,000	"
10.30 "	39.5	43	4,250	"
11.00 "	41.5	45	4,250	"
11.30 "	39.5	43	4,250	"
12.00 "	41.5	45	4,500	"
12.30 p.m.	40.5	44	4,500	"
1.00 "	41.5	45	4,500	"
1.30 "	36.5	40	4,000	"
2.00 "	38.5	42	4,250	"
2.30 "	39.5	43	4,250	"
3.00 "	36.5	40	4,000	"
3.30 "	36.5	40	4,500	"
4.00 "	43.5	47	4,400	"
4.30 "	43.5	47	4,250	"
5.00 "	43.5	47	4,250	"
5.30 "	43.5	47	4,250	"
6.00 "	43.5	47	4,250	"
6.30 "	43.5	47	4,250	"
7.00 "	43.5	47	4,250	"
7.30 "	43.5	47	4,250	"
8.00 "	41.5	45	4,250	"
8.40 "	Run terminated.			

In the following table are given the time for each cast, amount obtained and average volts, amperes, watts and E. H. P. used.

Time of Casts.	Machine stopped.	Effective length of run.	Pig Iron obtained.	Average Volts on Furnace.	Average Amperes.	Power Factor.	Average Watts.	Average E. H. P.
Jan. 6, 2.10 p.m.		4 h. 10 m.	420 lbs.	40.16	4522	0.919	166862	223.67
5.30 "	10 m.	3 h. 10 m.	487 "	42.21	4383	"	170404	228.42
9.25 "	15 m.	3 h. 40 m.	513 "	42.07	4250	"	164314	220.26
Jan. 7, 1.00 a.m.	10 m.	3 h. 25 m.	509 "	40.25	4156	"	153730	206.07
4.20 "	10 m.	3 h. 10 m.	413 "	37.83	4125	"	143406	192.23
7.25 "	10 m.	2 h. 55 m.	460 "	38.00	4041	"	141120	189.17
9.50 "	10 m.	2 h. 15 m.	317 "	38.90	4200	"	150146	201.27
1.05 p.m.	10 m.	3 h. 5 m.	510 "	40.50	4321	"	160825	215.58
5.00 "	5 m.	3 h. 50 m.	515 "	39.75	4237	"	154778	207.48
8.20 "	15 m.	3 h. 5 m.	312 "	43.16	4250	"	168572	225.96
8.40 "	5 m.	15 m.	28 "
34 h. 40 m.	1 h. 40 m.	33 h.	4484 lbs.	40.30	4250	0.919	157403	211.00

Total length of run	34 hours, 40 min.
Effective length of run	33 hours
Mean volts on furnace	40.3
Mean amperes	4250
Power factor	0.919
Watts = $40.3 \times 4250 \times 0.919$	157403
Pig iron produced	4484 lbs.

$$\text{El. horse power} = \frac{157403}{746} = 211.00$$

Output of pig iron per 1000 El. horse power days =

$$\frac{4484 \times 1000 \times 24}{33 \times 211} = 7.727 \text{ tons}$$

Electric horse power year of 365 days per ton of pig = 0.354

$$\text{The ratio} \frac{\text{Slag } 3886}{\text{Iron } 4484} = 0.866$$

The amount of slag produced was very great on account of the use of briquettes as reducing material and the large amount of limestone added to the charge. In subsequent experiments the limestone was decreased.

The furnace worked cold throughout the run; the slag contained a large amount of unreduced oxide and consequently carried a high percentage of iron.

RUN No. 2.

After a new electrode had been put in, the furnace without any alterations was started up again at 12.15 a.m., Jan. 8.

Ore treated	Hematite
Reducing agent	Briquettes
Flux	Limestone

Analysis of raw material same as in Run No. 1.

The limestone in the charge was decreased, the composition now being:

Ore	200 lbs.
Briquettes	70 "
Limestone	40 "

17 of these charges were put into the furnace, when it was decided to stop the experiment. The furnace worked cold throughout the run and the slag produced was high in iron. At the termination of the run at 12.50 p.m., Jan. 8, the material in the furnace was taken out and the crucible cleaned.

ELECTRICAL MEASUREMENTS.

Time.		Volts on Furnace.	Volts on Line.	Amperes.	Power Factor.	
Jan. 8,	12.15 a.m.	Furnace started.	31.5	35	4,000	0.919
	12.30	"	33.5	37	4,250	"
	1.00	"	35.5	39	4,500	"
	2.00	"	31.5	35	4,500	"
	2.30	"	34.5	38	4,000	"
	3.00	"	36.5	40	4,250	"
	3.30	"	34.5	38	4,000	"
	4.00	"	36.5	40	4,250	"
	4.30	"	36.5	40	4,500	"
	5.00	"	36.5	40	4,500	"
	5.30	"	36.5	40	4,250	"
	6.00	"	36.5	40	4,250	"
	6.30	"	36.5	40	4,250	"
	7.00	"	36.5	40	4,250	"
	7.30	"	36.5	40	4,250	"
	8.00	"	36.5	40	4,250	"
	8.30	"	36.5	40	4,250	"
	9.00	"	36.5	40	4,250	"
	9.30	"	36.5	40	4,400	"
	10.00	"	36.5	40	4,500	"
	10.30	"	39.5	43	4,500	"
	11.00	"	38.5	42	4,250	"
	11.30	"	41.5	45	4,500	"
	12.00	"	41.5	45	4,250	"
	12.30 p.m.	"	31.5	35	5,000	"
	12.50	Furnace stopped.				

Time of Casts.	Machine stopped.	Effective length of run.	Pig Iron obtained.	Average Volts on Furnace.	Average Amperes.	Power Factor.	Average Watts.	Average El. Horse Power.
Jan. 8, 3.45 a.m.		3 h. 30 m.	354 lbs.	33.93	4214	0.919	131476	176.24
7.10 "	10 min.	3 h. 15 m.	450 "	36.50	4321	"	144960	194.31
10.10 "	15 min.	2 h. 45 m.	404 "	36.50	4317	"	144792	194.09
12.50 p.m.	10 min.	2 h. 30 m.	417 "	38.50	4500	"	159217	213.42
12 h. 35 min.	35 min.	12 hours.	1625 lbs.	36.36	4342	0.919	145111	194.51

Total length of run.....	12 hours, 35 min.
Effective length of run.....	12 hours
Mean volts on furnace.....	36.36
Mean amperes.....	4342
Power factor.....	0.919
Watts = 36.36 × 4342 × 0.919.....	145111
Pig iron produced.....	1625 lbs.
	145111
El. horse power = $\frac{\quad}{746}$	194.51

Output of pig iron per 1,000 El. horse power days=

$$\frac{1625 \times 1000 \times 24}{12 \times 194.51 \times 2000} \dots\dots\dots 8.354 \text{ tons}$$

Electric horse power year per ton of pig = 0.328

$$\text{The ratio } \frac{\text{Slag } 1008}{\text{Iron } 1625} = \frac{\quad}{\quad} = 0.620$$

The ratio of slag to iron being decreased on account of the smaller proportion of limestone used and the output of pig iron increased.

On account of the sticky nature of the charge when using briquettes, preventing the free escape of the gases, it was decided to use coke in the next experiment as the reducing agent.

RUN No. 3.

Furnace: No alterations were made in the furnace.

Ore treated.....	Hematite
Reducing agent.....	Coke
Flux.....	Limestone

ANALYSIS OF RAW MATERIAL.

Coke: Volatile matter.....	1.73%
Fixed carbon.....	90.37 "
Ash.....	7.90 "
	<hr/>
	100.00%
Sulphur.....	0.67 "

The analysis of ore and limestone same as in run No. 1.

After the crucible had been cleaned, the furnace was started up at 9.45 p.m., Jan. 8.

COMPOSITION OF CHARGE.

Ore.	200 lbs.
Coke.	60 "
Limestone.	30 "

The furnace worked well for a short time, after which the electrode gradually started to come up. At 11.25 p.m., Jan. 8, the furnace had to be stopped and the iron tapped.

When using coke as the reducing agent, the charge was sufficiently porous to enable the gases to escape without great pressure. The lower part of the furnace being entirely lined with carbon paste, at least part of the current would disseminate itself through the charge, preventing the current at the reducing and smelting zone from attaining such density as would be required for the high temperature necessary; thus also decreasing the resistance and necessitating the raising of the electrode, the electrical installation not permitting the increase of the current over 5,000 amperes at about 40 volts.

Length of run.	1 hour, 40 min.
Mean volts on furnace.	36.5
Mean amperes.	4500
Power Factor.	0.919
Watts = 36.5 × 4500 × 0.919.	150945
Pig iron produced.	264 lbs.
El. horse power = $\frac{150945}{746}$	202.34
Output of pig iron per 1,000 El. horse power days = $\frac{264 \times 1000 \times 24}{1.67 \times 202.34 \times 2000}$	9.375 tons
El. horse power years per ton of pig = 0.292	

RUN No. 4.

FURNACE.

To prevent the current or part of same from passing through the charge to the sides of the crucible, the carbon paste around the crucible was cut out and a brick lining inserted (see Plate IV.), the inner lining being made of magnesite bricks and the outer one of common fire bricks.

PLATE IV.

EXPERIMENTAL
ELECTRIC FURNACE
FOR
RUNS 4 - 5

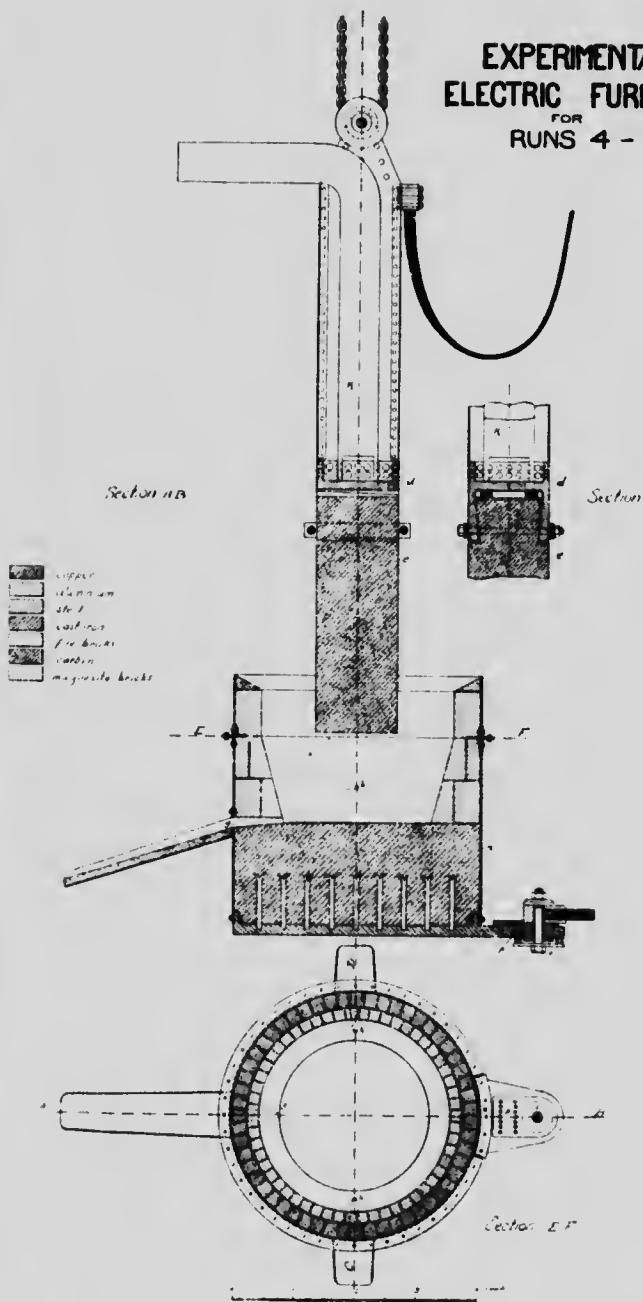

arge
out
e of



The furnace was preheated from 5 p.m., Jan. 11, to 9.15 a.m., Jan. 12, when it was charged.

Ore treated.	Hematite
Reducing agent.	Coke
Flux.	Limestone

The analyses of ore and limestone are given in Run No. 1, and the analysis of the coke in Run No. 3.

COMPOSITION OF CHARGE, WHEN STARTING.

Ore.	200 lbs.
Coke.	60 "
Limestone.	30 "

6 of these charges were put into the furnace.

The electrode was gradually rising and the carbon was, therefore, reduced, the composition of the charge now being:—

Ore.	200 lbs.
Coke.	55 "
Limestone.	30 "

2 of these charges were put in. The electrode, however, continued to rise and the experiment had to be stopped.

The amount of coke used was a little in excess of what actually was needed for the reduction of the ore and the carburization of the iron. This excess of carbon accumulated in the crucible and may have had some effect on the resistance of the charge.

The voltage employed was probably also too high for the comparatively low resistance of the charge.

One cast was made at 11.45 a.m., Jan. 12, 391 lbs. of grey pig iron being obtained.

After this cast the electrode rapidly came up and from 12.30 p.m. no new material was put in. At 3 p.m. part of the material in the furnace was taken out and the balance was melted down and cast at 4 p.m., when 298 lbs. of pig iron were obtained. This iron was white, which often proved to be the case when melting down the furnace, unless carbon was added.

ELECTRICAL MEASUREMENTS.

Time.	Volts on Furnace.	Volts on Line.	Amperes.	Power Factor.
Jan. 12 9.15 a.m.	40.5	44	3,500	0.919
9.30 "	39.5	43	4,000	"
10.00 "	34.5	38	5,000	"
10.30 "	36.5	40	5,000	"
11.00 "	35.5	39	5,000	"
11.30 "	36.5	40	5,000	"
12.00 "	36.5	40	5,000	"
12.30 p.m.	31.5	35	5,000	"
1.00 "	} Material in furnace being melted down.			
4.00 "				

Only taking into account the first cast, the figures are:

Length of run.	2 hours, 30 min.
Mean volts on furnace.	37.17
Mean amperes.	4583
Power factor.	0.919
Watts = $37.17 \times 4583 \times 0.919$	156555
Pig iron produced.	391 lbs.
El. horse power $\frac{156555}{746}$	209.85
Output of pig iron per 1,000 El. horse power days =	
$391 \times 1000 \times 24$	8.944 tons
$2.5 \times 209.85 \times 2000$	
El. horse power years per ton of pig = 0.306	

RUN No. 5.

Furnace: No alterations were made in the furnace.

Ore treated.	Hematite
Reducing agent.	Briquettes
Flux.	Limestone

The analyses of the raw materials are given in Run No. 1.

COMPOSITION OF CHARGE.

Ore.	200 lbs
Briquettes.	70 "
Limestone.	40 "

22 of these charges were put into the furnace.

The furnace worked very badly throughout this experiment. The electrode came up and the material in the furnace had partly to be taken out or melted down.

The furnace in this case, lined with bricks, prevented the current or part of same from passing through the charge to the sides of the crucible, the whole current being forced through the charge, slag and metal to the bottom of the crucible. The resistance offered not being great enough for the comparatively high voltage employed, necessitated the raising of the electrode until a sufficient resistance was obtained. In this experiment the height of the furnace was not sufficient and the electrode continued to rise until an arc was established.

ELECTRICAL MEASUREMENTS.

	Time.	Volts on Furnace.	Volts on Line.	Amperes.	Power Factor.
Jan. 12	4.35 p.m. Furnace started .				
	5.00 "	42.5	46	3,500	0.919
	5.30 "	41.5	45	4,000	"
	6.00 "	44.5	48	4,250	"
	6.30 "	38.5	42	4,000	"
	7.00 "	38.5	42	4,250	"
	7.30 "	38.5	42	4,500	"
	8.00 "	38.5	42	4,500	"
	8.30 "	40.5	44	3,700	"
	9.00 "	38.5	42	4,500	"
	9.30 "	35.5	39	5,000	"
	10.00 "	38.5	42	4,500	"
	10.30 "	36.5	40	5,000	"
	11.00 "	36.5	40	5,000	"
	11.30 "	36.5	40	5,000	"
	12.00 "	35.5	39	5,000	"
Jan. 13	12.30 a.m. { Material in furnace being	36.5	40	5,000	"
	1.00 " { melted	34.5	38	5,000	"
	1.30 " { down	38.5	42	4,500	"
	2.00 " {	34.5	38	5,000	"
	2.30 " Furnace stopped from 2.00 to 3.00 for cleaning of crucible.				
	3.00 "	34.5	38	4,000	"
	3.30 "	32.5	36	5,000	"
	4.00 "	37.5	41	4,500	"
	4.30 "	37.5	41	4,000	"
	5.00 "	34.5	38	5,000	"
	5.30 { Material in furnace being melted down.				
	10.45 " Furnace stopped.				

The furnace was stopped at 10.45 a.m., Jan. 13, and the material left in same taken out and the crucible cleaned.

Only taking into account the time from starting until 12.20 a.m., Jan. 13, after which the material in the furnace had to be melted down, the figures are:

Time of Casts.	Machine stopped.	Effective length of run.	Pig Iron obtained	Average Volts on Furnace.	Average Amperes.	Power Factor.	Average Watts.	Average El. Horse Power.
Jan. 12, 6.20 p.m.		1 h. 45 m.	212 lbs.	42.83	3917	0.919	154173	206.66
10.30 "	10 min.	4 h.	643 "	38.17	4439	"	153720	208.74
Jan. 13, 12.20 a.m.	10 min.	1 h. 40 m.	260 "	36.17	5000	"	166201	222.78
7 h. 45 min.	20 min.	7 h. 25 m.	1115 lbs.	39.06	4452	0.919	159782	214.18

Total length of run.....	7 hours, 45 min.
Effective length of run.....	7 hours, 25 min.
Mean volts on furnace.....	39.06
Mean amperes.....	4452
Power factor.....	0.919
Watts = 39.06 × 4452 × 0.919.....	159782
Pig iron obtained.....	1115 lbs.

159782

El. horse power $\frac{\text{---}}{\text{---}}$	214.18
746	

Output of pig iron per 1,000 El. horse power days =
 $1115 \times 1000 \times 24$

$7.41 \times 214.18 \times 2000$ 8.431 tons

El. horse power years per ton of pig = 0.321

Slag	575	
The ratio $\frac{\text{---}}{\text{---}}$ = $\frac{\text{---}}{\text{---}}$ =		0.516
Iron	1115	

The magnesite bricks were badly eaten away up to the level of the slag hole on account of the slag produced being fairly acid.

RUN No. 6.

FURNACE.

To facilitate the descent of the charge, the lining of the furnace was made cylindrical (see Plate V.), the diameter of the crucible being slightly larger. Around the crucible a lining 4 inches thick of carbon paste was rammed to protect the brick lining from the slag.

Ore treated.....	Hematite
Reducing agent.....	Briquettes
Flux.....	Limestone

The analyses of the raw materials are given in Run No. 1. The furnace was pre-heated from 1.00 p.m., Jan. 16, until 11 a.m., Jan. 17, when the furnace was charged.

COMPOSITION OF CHARGE

Ore.....	200 lbs.
Briquettes.....	70 "
Limestone.....	40 "

13 of these charges were put into the furnace.

From now on each cast was numbered to enable a proper record to be kept.

ELECTRICAL MEASUREMENTS.

Time.	Volts on Furnace.	Volts on Line.	Amperes.	Power Factor.
Jan. 17 11.00 a.m. Furnace started.				
11.00 "	46.5	50	4,000	0.919
11.30 "	37.5	41	4,250	"
12.00 "	36.5	40	5,000	"
12.30 p.m.	38.5	42	4,750	"
1.00 "	36.5	40	4,750	"
1.30 "	36.5	40	4,500	"
2.00 "	36.5	40	4,750	"
2.30 "	37.5	41	5,000	"
3.00 "	39.5	43	4,750	"
3.30 "	37.5	41	4,750	"
4.00 "	38.5	42	4,750	"
4.30 "	38.5	42	4,925	"
5.00 "	35.5	39	5,000	"
5.30 "	36.5	40	4,800	"
6.00 "	37.5	41	5,000	"
6.30 "	37.5	41	5,000	"
7.00 "	37.5	41	4,875	"
8.00 "	37.5	41	5,000	"
9.00 "	32.5	36	5,000	"
9.25 " Furnace stopped.				

Cast No.	Time when Cast.	Machine stopped.	Effective length of run.	Pig Iron obtained.	Quality of Pig Iron.	Slag obtained.	Ratio Slag Iron.
1	Jan. 17, 2.00 p.m.	3 h. 0m.	425 lbs.	Grey	156 lbs.	0.367
2	5.40 "	3 h. 40 m.	631 lbs.	"	293 lbs.	0.464
	6. h. 40 m.	———	6 h. 40 m.	1,056 lbs.	———	449 lbs.	0.425

The electrode started to come up after 7.00 p.m., At 8.00 p.m., 200 lbs. of crude ore were put in, which brought the electrode down a little. It was, therefore, decided to melt down the material in the furnace and start again with a charge containing considerably less carbon.

At 9.25 p.m., a cast was made and the material left in the furnace was taken out.

PLATE V.

EXPERIMENTAL
ELECTRIC FURNACE
FOR
RUNS G-7

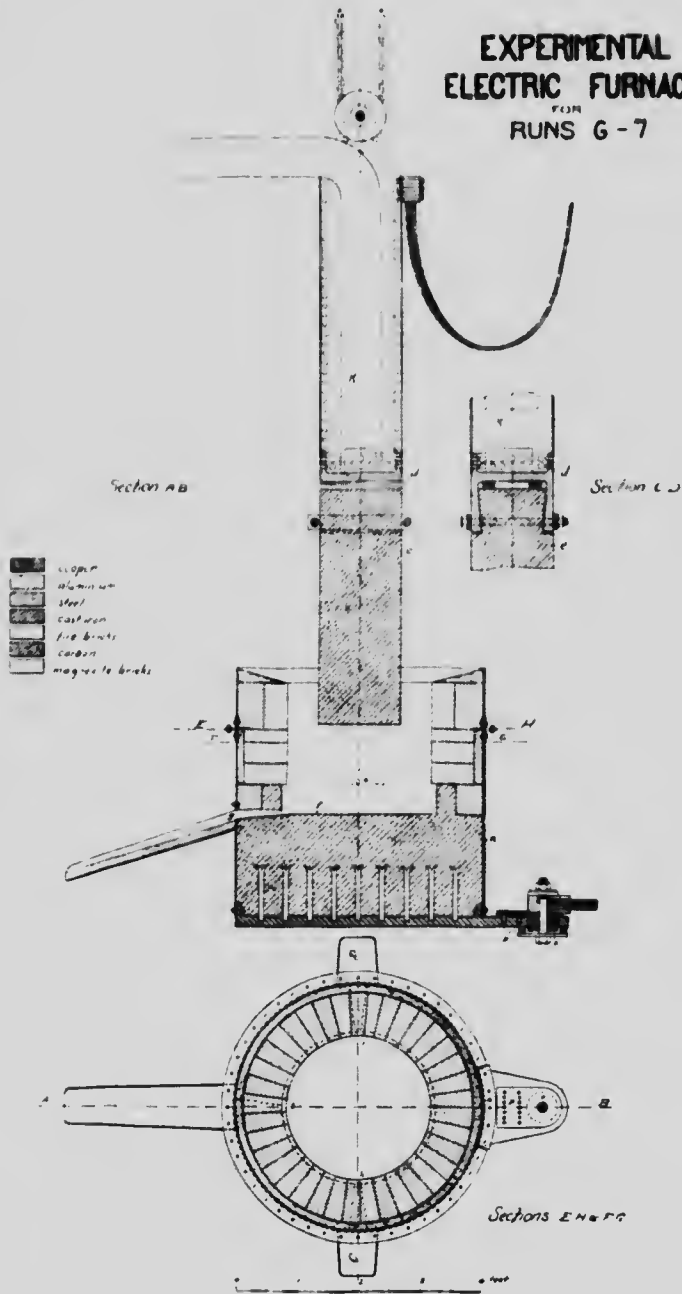

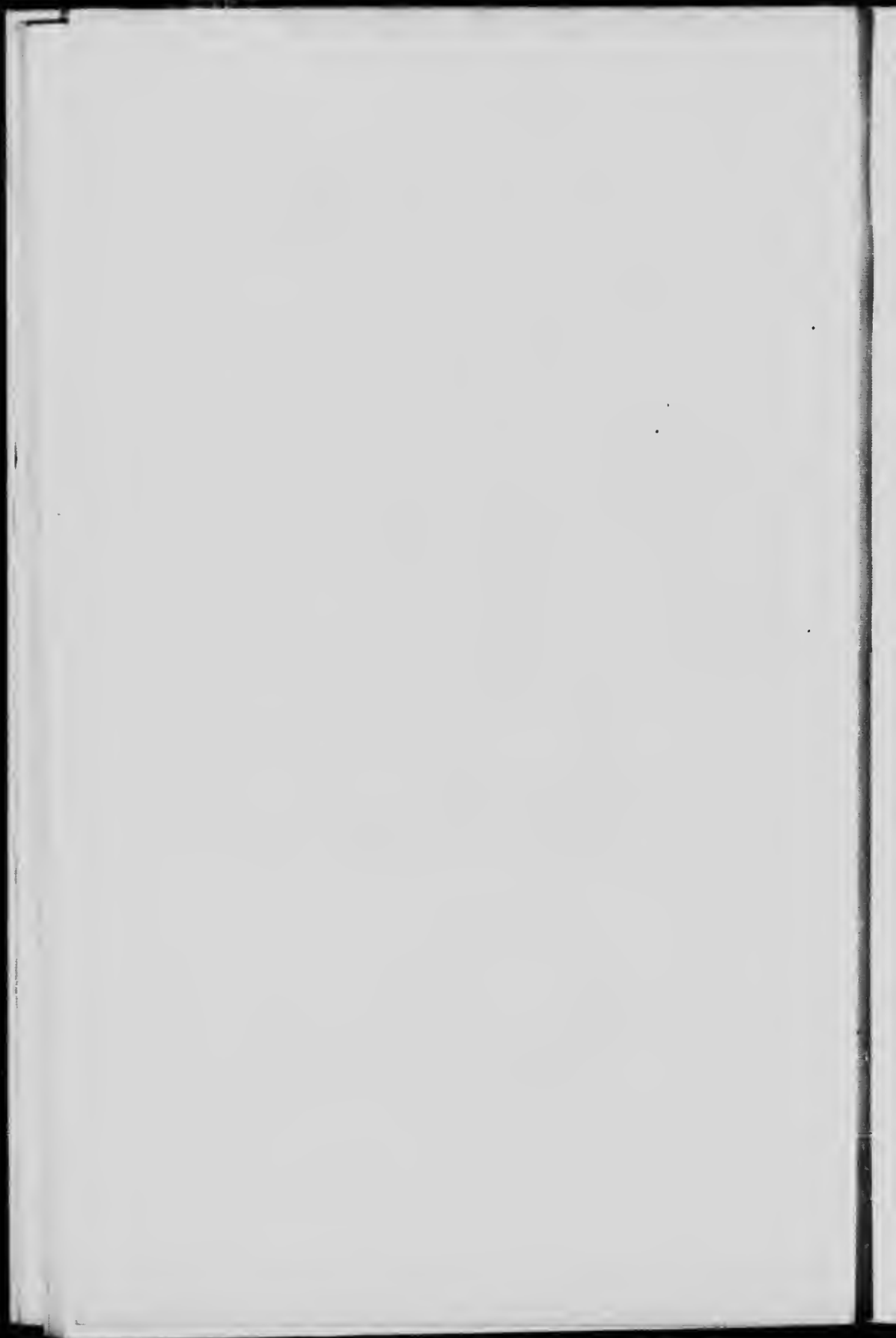

Cast No.	Pig Iron obtained.	Average Volts on furnace.	Average amperes.	Power Factor.	Average watts.	Average El. horse power
1	425 lbs.	38.36	4570	0.919	661027	215.98
2	831 lbs.	37.04	4810	"	100383	223.03
	1,056 lbs.	38.00	4690	0.919	163784	219.55

Only taking into account the two casts referred to above, the following figures are obtained:

Length of run	6 hours, 40 min.
Mean volts on furnace	38
Mean amperes	4690
Power factor	0.919
Watts = $38 \times 4690 \times 0.919$	163784
Pig iron obtained	1056 lbs.
	163784
El. horse power $\frac{\text{---}}{\text{---}}$	219.55
	746
Output of pig iron per 1,000 El. horse power days	
$1056 \times 1000 \times 24$	
$\frac{\text{---}}{\text{---}}$	8.653 tons
$6.67 \times 219.55 \times 2000$	
El. horse power year per ton of pig = 0.310	

ANALYSIS OF PIG IRON PRODUCED.

Cast No.	S.	S.	Total Carbon.
1	2.50	0.021	3.80
2	1.55	0.051	—

RUN No. 7.

Furnace: No alterations were made in the furnace.

Ore treated	Hematite
Reducing agent	Briquettes
Flux	Limestone

The analyses of the raw materials are given in Run No. 1.

After the termination of Run No. 6 the crucible was cleaned out and the furnace again started up at 9.45 p.m., Jan. 17

COMPOSITION OF CHARGE

Ore.	200 lbs.
Briquettes.	55 "
Limestone.	40 "

17 of these charges were put into the furnace. The pig iron obtained from the first two casts was white, full of holes and high in sulphur. In order to produce a better iron the carbon in the charge was increased, the composition now being:

Ore.	200 lbs.
Briquettes.	60 "
Limestone.	40 "

After 8 of these charges had been put in the furnace, the composition of the charge was changed to:

Ore.	200 lbs.
Briquettes.	60 "
Limestone.	50 "

in order to decrease the sulphur in the pig iron.

14 of these charges were put in. The pig iron obtained gradually became greyer with lower contents of sulphur and in order to produce a grey iron the carbon in the charge was further increased. The composition now being:

Ore.	200 lbs.
Briquettes.	65 "
Limestone.	50 "

3 of these charges were put in after Cast No. 8 and the pig iron obtained at Cast No. 9, when the furnace had to be stopped, was grey.

During this run the electrode had no tendency to rise and towards the close of the run the furnace worked very well.

ELECTRICAL MEASUREMENTS.

Time.	Volts on Furnace.	Volts on Line.	Amperes.	Power Factor.
Jan. 17, 9.45 p.m. Furnace started.				
10.00 "	36.5	40	4,750	0.919
10.30 "	36.5	40	4,500	"
11.00 "	36.5	40	4,500	"
11.30 "	39.5	43	4,000	"
12.00 "	36.5	40	4,500	"
Jan. 18, 12.30 a.m.	38.5	42	4,500	"
1.00 "	36.5	40	4,000	"
1.30 "	40.5	44	4,000	"
2.00 "	38.5	42	4,000	"
2.30 "	37.5	41	4,500	"
3.00 "	36.5	40	4,750	"
3.30 "	41.5	45	4,500	"
4.00 "	42.5	46	4,000	"
4.30 "	36.5	40	4,000	"
5.00 "	36.5	40	4,500	"
5.30 "	36.5	40	4,000	"
6.00 "	36.5	40	4,000	"
6.30 "	40.5	44	4,000	"
7.00 "	39.5	43	4,000	"
7.30 "	38.5	42	4,500	"
8.00 "	39.5	43	4,500	"
8.30 "	39.5	43	4,500	"
9.00 "	40.5	44	4,500	"
9.30 "	42.5	46	4,500	"
10.00 "	38.5	42	5,000	"
10.30 "	42.5	46	4,500	"
11.00 "	36.5	40	5,000	"
11.30 "	41.5	45	4,250	"
12.00 "	37.5	41	5,000	"
12.30 p.m.	37.5	41	5,000	"
1.00 "	37.5	41	5,000	"
1.30 "	37.5	41	5,000	"
2.00 "	36.5	40	5,000	"
2.30 "	40.5	44	5,000	"
3.00 "	38.5	42	5,000	"
3.30 "	36.5	40	5,000	"
4.00 "	36.5	40	5,000	"
4.30 "	38.5	42	5,000	"
5.00 "	39.5	43	5,000	"
5.30 "	38.5	42	5,000	"
6.00 "	39.5	43	5,000	"
6.30 "	39.5	43	5,000	"
7.00 "	37.5	41	5,000	"
7.30 "	36.5	40	5,000	"
8.00 "	36.5	40	5,000	"
8.30 "	36.5	40	5,000	"
9.00 "	35.5	39	5,000	"
9.30 "	34.5	38	5,000	"
9.45 Run No. 7 terminated.				
10.00 "	36.5	40	5,000	"
10.30 "	36.5	40	4,750	"
11.00 "	35.5	39	4,750	"
11.30 "	21.5	25	5,000	"
12.00 "	11.5	15	4,500	"
Jan. 19, 12.30 a.m. Furnace stopped.				

After 11 p.m., Jan. 18, the turbines could not deliver enough power, on account of the inlets being blocked with ice, and the furnaces had to be shut down all together at 12.30 a.m., Jan. 19, and the material left taken out. Run No. 7 had, therefore, to be stopped at 9.45 p.m., Jan. 18.

Cnst No.	Time When Cast.		Machine stopped	Effective length of run.		Pig Iron obtained	Quality of Pig Iron	Slag obtained	Ratio Slag Iron.
				h.	m.				
3	Jan. 18,	1.45 a.m.		4	0	501	White, with holes.	382	0.762
4		5.55 "	10 min.	4	0	455	"	429	0.942
5		10 10 "	10 min.	4	5	911	White	390	0.428
6		2.15 p.m.		4	5	723	"	556	0.769
7		5.55 "		3	40	707	"	363	0.513
8		9.45 "		3	50	709	Half grey, half white	405	0.571
24 hours.			20 min.	23	40	4006		2525	0.633
Material in furnace melted down.									
9	Jan. 19,	12.20 a.m.		2	35	331	Grey	191	0.577

Cast No.	Pig Iron obtained.	Average Volts on Furnace.	Average Amperes.	Power Factor	Average Watts.	Average El. Horse Power.
3	501 lbs.	37.62	4344	0.919	150185	201.32
4	455 "	38.25	4281	"	150477	201.71
5	911 "	39.50	4389	"	159320	213.56
6	723 "	38.37	4844	"	170799	228.95
7	707 "	38.36	5000	"	176264	236.28
8	709 "	37.00	5000	"	170015	227.90
	4006 lbs.	38.18	4643	0.919	162923	218.40

Effective length of run 23 hours, 40 min.
 Mean volts on furnace. 38.18
 Mean amperes. 4643
 Power factor. 0.919
 Watts = 38.18 × 4643 × 0.919 162923
 Pig iron obtained. 4006 lbs.
 162923
 El. horse power ——— 218.40

Output of pig iron per 1,000 H.P. horse power days =

$$4000 \times 1000 \times 24$$

9,299 tons

$$23.67 \times 218.40 < 2000$$

H.P. horse power year per ton of pig = 0.294

ANALYSIS OF PIG IRON PRODUCED.

Cast No.	Si.	S.	Total Carbon.
3	0.85	0.127	—
4	0.07	0.132	3.14
5	0.40	0.095	1.35
6	0.17	0.066	—
7	0.55	0.067	4.40
8	0.48	0.073	—

RUN No. 8.

FURNACE.

In order to increase the utilization of the reducing and pre-heating action of the carbon monoxide developed, the height of the furnace was increased 12 inches above the height previously employed. The lining of the furnace was given the shape of a double cone set base to base to facilitate the descent of the charge (see Plate VI). Up to the slag level the lining of the crucible was protected by a few inches of carbon paste, all the rest of the lining being made of common fire bricks.

Ore treated. Hematite
 Reducing agent Briquettes
 Flux. Limestone

The analyses of the raw materials are given in Run No. 1. The furnace was pre-heated from 5.30 p.m., Jan. 22, until 9.30 a.m., Jan. 23, when it was charged, the composition of the charge being:

Ore. 200 lbs.
 Briquettes. 60 "
 Limestone. 50 "

The pig iron produced with this mixture was white and high in sulphur. The slag was black and contained a large amount of molten oxide and globules of iron.

In order to produce a grey iron with lower contents of sulphur, the carbon and limestone were increased, the composition of the charge now being:

Ore.....	200 lbs.
Briquettes.....	65 "
Limestone.....	55 "

The slag became very thick, however, and the limestone was again reduced to its former amount.

At 11.40 p.m., Jan. 23, a cast was tried. The iron was too cold, however, and the material in the furnace had to be melted down. From 11.30 p.m., Jan. 23, to 2.10 a.m., Jan. 24, no new charge was put into the furnace.

In the evening of Jan. 25 the electrode showed a tendency to rise. Some crude ore was, therefore, put in from time to time.

During the latter part of the run the furnace worked very satisfactorily. Upon stopping the furnace it was found that a crust, consisting chiefly of lime, had formed on the sides of the crucible. This material being very refractory and non-conductive very likely helped in concentrating the current and thus increasing the efficiency of the furnace.

ELECTRICAL MEASUREMENTS.

Time.	Volts on Furnace.	Volts on Line.	Amperes.	Power Factor.
Jan. 23, 9 30 a.m. Furnace started.				
9 45 "	41.5	45	4,000	0.919
10 00 "	40.5	44	4,250	"
10 30 "	38.5	42	5,000	"
11 00 "	39.5	43	4,500	"
11 30 "	39.5	43	4,750	"
12 00 "	42.5	46	4,500	"
12 30 p.m.	38.5	42	4,500	"
1 00 "	35.5	39	4,500	"
1 30 "	36.5	40	4,000	"
2 00 "	36.5	40	4,500	"
2 30 "	41.5	45	4,500	"
3 00 "	36.5	40	5,000	"
	Machine stopped from 3.20 to 3.45, fixing electrode holder.			
4 00 "	38.5	42	5,000	"
	Machine stopped from 4.00 to 4.30, fixing cover on electrode.			
5 00 "	38.5	42	4,500	"
5 30 "	36.5	40	5,000	"
6 00 "	37.5	41	5,000	"
6 30 "	38.5	42	4,500	"

PLATE VI.

EXPERIMENTAL
ELECTRIC FURNACE
FOR
RUNS 8-12

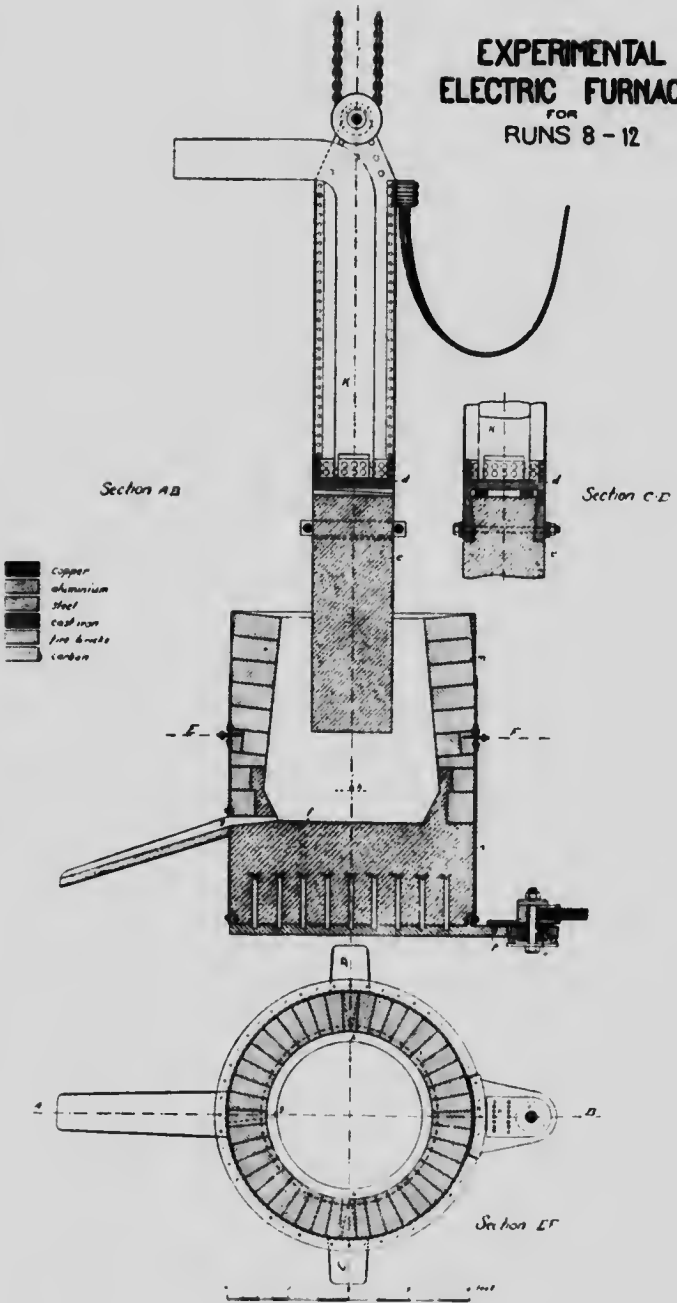



Time.		Volts on Furnace.	Volts on Line	Amperes.	Power Factor.
Jan. 23,	7.00 p.m.	41.5	45	4,500	0.919
	7.30 "	37.5	41	5,000	"
	8.00 "	43.5	47	3,800	"
	8.30 "	42.5	46	4,100	"
	9.00 "	38.5	42	4,750	"
	9.30 "	40.5	44	4,500	"
	10.00 "	41.5	45	4,500	"
	10.30 "	38.5	42	5,000	"
	11.00 "	41.5	45	5,000	"
	11.30 "	41.5	45	4,500	"
	12.00 "	40.5	44	5,000	"
Jan. 24,	12.30 a.m.	42.5	46	4,000	"
	1.00 "	38.5	42	5,000	"
		Machine stopped from 1.05 to 1.10, cleaning and plugging iron hole.			
	1.30 "	37.5	41	5,000	"
	2.00 "	36.5	40	4,000	"
	2.30 "	38.5	42	4,500	"
	3.00 "	41.5	45	5,000	"
	3.30 "	38.5	42	5,000	"
	4.00 "	31.5	35	5,000	"
	4.30 "	38.5	42	4,500	"
	5.00 "	38.5	42	4,750	"
	5.30 "	34.5	38	5,000	"
	6.00 "	37.5	41	4,500	"
	6.30 "	38.5	42	4,000	"
	7.00 "	38.5	42	4,500	"
	7.30 "	38.5	42	4,500	"
	8.00 "	38.5	42	4,500	"
	8.30 "	38.5	42	4,500	"
	9.00 "	41.5	45	4,500	"
	9.30 "	41.5	45	4,000	"
	10.00 "	36.5	40	5,000	"
		Machine stopped from 10.20 to 10.35, fixing motor.			
	11.00 "	31.5	35	4,000	"
		Machine stopped from 11.20 to 11.25, cleaning and plugging iron hole.			
	11.30 "	40.5	44	4,250	"
	12.00 "	38.5	42	4,750	"
	12.30 p.m.	39.5	43	4,750	"
	1.00 "	37.5	41	4,600	"
	1.30 "	36.5	40	5,000	"
	2.00 "	36.5	40	5,000	"
	2.30 "	41.5	45	4,500	"
	3.00 "	41.5	45	4,500	"
	3.30 "	39.5	43	5,000	"
		Machine stopped from 3.55 to 4.25, fixing electrode.			
	4.30 "	37.5	41	5,000	"
	5.00 "	37.5	41	5,000	"
	5.30 "	36.5	40	5,000	"
	6.00 "	42.5	46	4,500	"
	6.30 "	46.5	50	3,500	"
	7.00 "	41.5	45	4,500	"

Time.	Volts on Furnace.	Volts on Line.	Amperes.	Power Factor.
Jan. 24, 7.30 p.m.	41.5	45	4,250	0.919
	Machine stopped from 7.55 to 9.20, repairing motor.			
9.30 "	36.5	40	5,000	"
10.00 "	37.5	41	5,000	"
10.30 "	34.5	38	5,000	"
11.00 "	34.5	38	5,000	"
11.30 "	36.5	40	4,500	"
12.00 "	38.5	42	4,500	"
Jan. 25, 12.30 a.m.	37.5	41	4,750	"
1.00 "	39.5	43	4,500	"
1.30 "	36.5	40	5,000	"
2.00 "	39.5	43	4,500	"
2.30 "	39.5	43	4,500	"
3.00 "	31.5	35	5,000	"
3.30 "	34.5	38	5,000	"
4.00 "	36.5	40	5,000	"
4.30 "	37.5	41	4,750	"
5.00 "	37.5	41	4,750	"
5.30 "	36.5	40	5,000	"
6.00 "	39.5	43	4,750	"
6.30 "	40.5	44	4,750	"
7.00 "	41.5	45	4,500	"
7.30 "	40.5	44	4,750	"
8.00 "	39.5	43	4,750	"
8.30 "	38.5	42	4,800	"
9.00 "	36.5	40	5,000	"
9.30 "	38.5	42	4,500	"
10.00 "	36.5	40	5,000	"
10.30 "	38.5	42	4,800	"
11.00 "	39.5	43	4,500	"
11.30 "	36.5	40	5,000	"
12.00 "	36.5	40	5,000	"
12.30 p.m.	36.5	40	5,000	"
1.00 "	36.5	40	5,000	"
1.30 "	36.5	40	5,000	"
2.00 "	36.5	40	5,000	"
2.30 "	36.5	40	5,000	"
3.00 "	37.5	41	4,600	"
3.30 "	36.5	40	5,000	"
4.00 "	36.5	40	5,000	"
	Machine stopped from 4.15 to 4.35, fixing electrode contact.			
5.00 "	36.5	40	5,000	"
5.30 "	40.5	44	4,750	"
6.00 "	36.5	40	5,000	"
6.30 "	38.5	40	5,000	"
7.00 "	39.5	43	5,000	"
7.30 "	36.5	40	5,000	"
8.00 "	35.5	39	5,000	"
8.30 "	34.5	38	5,000	"
9.00 "	35.5	39	5,000	"
9.30 "	39.5	43	4,500	"
10.00 "	36.5	40	5,000	"
10.30 "	35.5	39	5,000	"
11.00 "	35.5	39	5,000	"
11.30 "	36.5	40	5,000	"
12.00 "	36.5	40	5,000	"
Jan. 26, 12.30 a.m.	36.5	40	5,000	"

Time.	Volts on Furnace.	Volts on Line.	Ampere.	Power Factor.
Jan. 20, 1.00 a.m.	35.5	39	5,000	0.91
1.30 "	35.5	39	5,000	"
2.00 "	36.5	40	5,000	"
2.30 "	36.5	40	5,000	"
3.00 "	38.5	42	4,750	"
3.30 "	39.5	43	4,750	"
4.00 "	38.5	42	5,000	"
4.30 "	38.5	42	5,000	"
5.00 "	38.5	42	5,000	"
	Machine stopped from 5.10 to 5.15, cleaning and plugging iron hole.			
5.30 "	42.5	46	4,500	"
6.00 "	42.5	46	5,000	"
6.30 "	41.5	45	4,500	"
7.00 "	36.5	40	4,750	"
7.30 "	41.5	45	4,500	"
8.00 "	41.5	45	4,500	"
8.30 "	38.5	42	4,750	"
9.00 "	36.5	40	5,000	"
9.30 "	39.5	43	5,000	"
10.00 "	36.5	40	5,000	"
10.30 "	39.5	43	4,750	"
11.00 "	39.5	43	4,750	"
11.30 "	38.5	42	5,000	"
12.00 "	36.5	40	5,000	"
12.30 p.m.	36.5	40	5,000	"
1.00 "	37.5	41	4,800	"
1.30 "	37.5	41	5,000	"
2.00 "	39.5	43	4,750	"
2.30 "	36.5	40	5,000	"
3.00 "	36.5	40	5,000	"
3.30 "	38.5	42	5,000	"
4.00 "	39.5	43	5,000	"
4.30 "	39.5	43	5,000	"
5.00 "	38.5	42	5,000	"
5.30 "	37.5	41	5,000	"
6.00 "	36.5	40	5,000	"
6.00 "	Material in furnace being melted down. Furnace stopped.			

Cast No.	Time When Cast.	Machine stopped	Effective length of run.		Pig Iron obtained	Quality of Pig Iron.	Slag obtained	Ratio Slag Iron.
			h.	m.				
10	Jan. 23, 1.40 p.m.		4	10	515	White White with holes.	372	0.722
11	7.35 "	55 min.	5	0	739		566	0.765
12	Jan. 24, 1 and 2 a.m.	5 min.	6	20	1002	"	1160	1.157
13	Jan. 24, 6.15 a.m.		4	15	658	White	422	0.641
14	11.15 "	15 min.	4	45	780		656	0.841
15	3.40 p.m.	5 min.	4	20	854	"	565	0.661
16	7.35 "	30 min.	3	25	540	"	404	0.748
17	Jan. 25, 2.05 a.m.	1h. 25m.	5	5	778	"	505	0.726
18	5.55 "		3	50	738	"	469	0.635
19	9.00 "		3	5	670	Grey	286	0.427
20	12.30 p.m.		3	30	504	"	232	0.440
21	4.10 "		3	40	696	"	367	0.527
22	7.40 "	20 min.	3	10	502	"	344	0.685
23	11.05 "		3	25	719	"	332	0.461
24	Jan. 26, 2.00 a.m.		2	55	525	"	294	0.560
25	5.05 "		3	5	501	"	261	0.521
26	8.00 "	5 min.	2	50	712	"	289	0.405
27	11.35 "		3	35	701	"	372	0.531
28	2.45 p.m.		3	10	700	"	274	0.391
29	5.05 "		2	20	552	"	227	0.411
13-29	63 h. 5 min.	2h. 40 m.	60	25	11130	—	6349	0.570
26-29	1 ¹ / ₂ hours.	5 min.	11	55	2665	—	1162	0.436
30	Jan. 26, 6.00 p.m.			55 min.	155	Grey	40	0.259

RAW MATERIAL CHARGED.

Number of Charges.	Composition of Charge.			Additional Material.		Total.		
	Ore.	Briquettes.	Limestone.	Ore.	Briquettes.	Ore.	Briquettes.	Limestone.
	lbs.	lbs.	lbs.	lbs.	lbs.	lbs.	lbs.	lbs.
48	200	60	50	9600	2880	2400
40	200	65	55	200	..	8200	2600	2200
26	200	65	50	605	30	5805	1720	1300
						23605	7200	5900

When the furnace was stopped at 6.00 p.m., Jan. 26, it was partly filled with material. Of this 906 lbs. were taken out, but there still remained some in the crucible.

Cast No.	Pig Iron obtained.	Average Volts on Furnace.	Average Amperes.	Power Factor.	Average Watts.	Average El. Horse Power.	Output of Pig Iron per 1000 E. H.P. days.
10	515	39 16	4445	0.919	150066	214 43	6 91
11	739	38 30	4750	"	167180	221 11	7 91
12	1002	10 27	4550	"	168387	225 72	8 41
13	658	37 37	4781	"	164193	220 09	8 44
14	780	38 17	4388	"	153918	206 32	9 55
15	854	39 05	4705	"	168848	226 34	10 45
16	549	40 50	4536	"	168827	226 31	8 40
17	778	37 10	4775	"	162801	218 23	8 42
18	738	36 21	4857	"	161626	216 05	10 67
19	670	39 50	4757	"	172681	231 47	11 27
20	504	37 50	4829	"	166419	223 08	7 75
21	696	36 64	4943	"	166441	223 11	10 20
22	502	37 07	4958	"	171639	230 08	8 28
23	719	36 07	4929	"	163388	219 01	11 55
24	525	36 16	5000	"	166155	222 72	9 72
25	501	38 33	4916	"	173167	232 12	8 41
26	712	41 00	4925	"	174265	233 59	12 92
27	701	3 36	4893	"	172492	231 22	10 16
28	700	37 33	4925	"	168958	226 48	11 73
29	552	38 50	5000	"	176907	237 14	11 98
13-29	11130	37 97	4812	0.919	167912	225 08	9 822
26-29	2665	38 79	4860	0.919	173249	232 23	11 562
30	153	37 00	5000	0.919	170015	227 90	9 00

Taking the figures for Casts 13-29, thus eliminating the three first and the last Cast, when the material in the furnace had to be melted down, the results are the following:—

Effective length of run.	60 hours, 25min.
Mean volts on furnace.	37.97
Mean amperes.	4812
Power factor.	0.919
Watts $37.97 \times 4812 \times 0.919$	167912
Pig iron obtained.	11130 lbs.
	167912
El. horse power $\frac{167912}{746}$	225.08

Output of pig iron per 1,000 El. horse power days	
$11130 \times 1000 \times 24$	
$\frac{11130 \times 1000 \times 24}{60.41 \times 225.08 \times 2000}$	9.822 tons

El. horse power year per ton of pig = 0.279



MICROCOPY RESOLUTION TEST CHART

(ANSI and ISO TEST CHART No. 2)

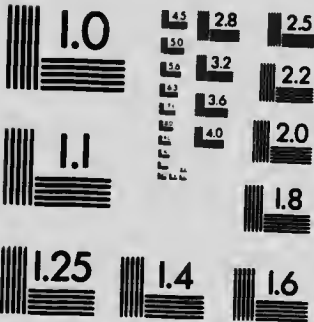

APPLIED IMAGE Inc

1653 East Main Street
Rochester, New York 14609 USA
(716) 482-0300 - Phone
(716) 286-5989 - Fax

Only taking into account the last 12 hours of the run, when the furnace was working well, the results are as follows:—

Effective length of run	11 hours, 55 min.
Mean volts on furnace	38.79
Mean amperes	4860
Power factor	0.919
Watts = $38.79 \times 4860 \times 0.919$	173249
Pig iron obtained	2665 lbs.

	173249	
El. horse power $\frac{\quad}{\quad}$		232.23
	746	

Output of pig iron per 1,000 El. horse power days =

$2665 \times 1000 \times 24$	
$11.91 \times 232.23 \times 2000$	11.562 tons

El. horse power year per ton of pig = 0.236

ANALYSIS OF PIG IRON PRODUCED.

Cast No.	Si	S	P.	Mn.	Graphitic Carbon.	Total Carbon.
10	0.50	0.110				4.42
11	0.07	0.193				3.42
12	0.05	0.149				3.18
13	0.02	0.175				3.13
14	0.34	0.122	0.024	0.01	0.14	4.10
15	0.11	0.094			
16	0.01	0.133				3.04
17	0.02	0.094			
18	0.02	0.173				3.40
19	0.61	0.017			
20	0.79	0.055				5.01
21	1.05	0.021	0.062	0.10	3.86	5.40
22	1.43	0.008				4.71
23	0.94	0.030			
24	1.04	0.020				4.42
25	0.97	0.043			
26	0.82	0.094				3.00
27	0.79	0.044			
28	0.90	0.022	0.067	0.12	3.80	4.64
29	0.57	0.024			
30	1.03	0.019				4.35

ANALYSIS OF SLAG PRODUCED.

Cast No. .	SiO ₂	Al ₂ O ₃	P ₂ O ₅	CaO	MgO	MnO	FeO	S	Fe
14	29.28	15.24	0.281	35.17	2.08	0.22	16.88	0.39	13.13
21	30.28	13.69	0.027	46.22	2.05	0.18	4.79	0.74	3.72
28	33.40	15.30	0.020	45.39	1.97	Trace	1.98	0.79	1.54
General Sample 26-30	34.12	15.00	0.020	45.32	2.20	"	2.34	0.76	1.82
General Sample 10-30	29.44	13.98	0.119	42.62	2.29	0.12	7.11	0.65	5.53

The slag obtained when producing the white pig iron was black with a high content of iron and with a comparatively high content of phosphorus and manganese, showing cold working and resulting in a white pig iron high in sulphur. With increased temperature the phosphoric acid and oxide of manganese were reduced and the iron obtained contained practically all of the phosphorus and manganese present.

RUN No. 9.

FURNACE.

In this experiment it was decided to make a further attempt to utilize the gases developed. No change was made in the shape of the furnace employed in Run No. 8, but an one inch air pipe was put in 12 inches below the top of the furnace.

Ore treated. Hematite
 Reducing agent. Briquettes
 Flux. Limestone

The analyses of the raw materials are given in Run No. 1.

The furnace was started up at 8.30 a.m., Jan. 30th, and when the gases developed began to burn on top the blast was turned on. The heat developed by the burning of the carbon monoxide was so great that the charge in the upper part of the furnace became fused and would not descend into the crucible. The electrode was rapidly consumed by the oxidizing action of the blast and the sheet iron covering the electrode was destroyed in a few minutes. The electrode had to be raised and the material in the furnace melted down twice during the experiments. Any further attempt in this direction with the furnace employed was, therefore, abandoned.

RUN No. 10.

FURNACE.

The furnace employed for this run was the same as in Run No. 9, the holes, however, of the air blast tube were plugged with clay.

Ore treated. Magnetite from Wilbur mine.
 Reducing agent. Briquettes and coke fines.
 Flux. Limestone and sand.

ANALYSIS OF RAW MATERIAL.

Wilbur Ore:	{	SiO ₂	6.20%	} Fe = 56.69%
		Fe ₂ O ₃	55.42%	
		FeO	23.04%	
		Al ₂ O ₃	2.56%	
		CaO	2.00%	} P=0.01%
		MgO	6.84%	
		MnO	0.258%	
		P ₂ O ₅	0.023%	
		S	0.05%	
	CO ₂ and undet	3.609%		
			100.000%	
Briquettes	{	Moisture	0.20%	
		Volatile matter	4.54%	
		Fixed carbon	55.36%	
		Ash	39.90%	
			100.00%	
Ash:	{	SiO ₂	23.24	} 39.90%
		Fe ₂ O ₃ + Al ₂ O ₃	14.06	
		CaO	1.75	
		MgO	0.51	
		Undet	0.34	
			1.05% sulphur	
			0.015% phosphorus	
Coke fines:	{	Volatile matter	1.73%	
		Fixed carbon	90.37%	
		Ash	7.90%	
				100.00%
			Sulphur	0.67%

Sand:	SiO ₂	81.71%
	Fe ₂ O ₃	0.09%
	Al ₂ O ₃	14.27%
	CaO	1.60%
	MgO	1.11%
	Alkali and undet.	1.22%
		100.00%

The analysis of the limestone is given in Run No. 1.

The furnace was started up at 11.00 a.m., Jan. 31, with a charge of composition:—

Ore	200 lbs.
Briquettes	80 "
Limestone	25 "

The pig iron produced from this mixture was white, full of holes and high in sulphur. The carbon and limestone were increased, the composition of the charge now being —

Ore	200 lbs.
Briquettes	80 "
Coke fines	5 "
Limestone	30 "

A grey iron of good quality was then produced.

In order to furthermore decrease the sulphur contents, the limestone was still further increased, but the slag produced became too viscous and after a few charges the limestone was again reduced to the above amount and a little sand put in at the time to make the slag more fluid.

At 9.30 p.m., Jan. 31, a cast was tried, but the iron in the crucible was found to have Some limestone was then put in and at 10.55 p.m. the iron was tapped. The electrode was up rather high, however, and after this cast the material in the furnace was melted down, some earburet briquettes (made of coke and cast iron fines) were added and the iron cast at 12.20 a.m., Feb. 1.

The furnace was then started up with the new charge and worked well during the balance of the run.

ELECTRICAL MEASUREMENTS.

The voltmeter was for this run direct connected with the electrode and the bottom plate of the furnace.

It was discovered toward the later part of the run that the contact of the voltmeter wire with the electrode was very poor and at 10.30 a.m., Feb. 1, the voltmeter was connected with the line.

The readings, taken before this change of voltmeter connection was made, are, therefore, not given.

Time.	Volts on Furnace.	Volts on Line.	Amperes.	Power Factor.
Feb. 1, 10.30 a.m.	37.5	41	5,000	0.919
11.00 "	37.5	41	"	"
11.30 "	38.5	42	"	"
12.00 "	35.5	39	"	"
12.30 p.m.	34.5	38	"	"
1.00 "	37.5	41	"	"
1.30 "	37.5	41	"	"
2.00 "	37.5	41	"	"
2.30 "	35.5	39	"	"
3.00 "	35.5	39	"	"
3.30 "	36.5	40	"	"
4.00 "	37.5	41	"	"
4.30 "	37.5	41	"	"
5.00 "	37.5	41	"	"
5.30 "	37.5	41	"	"
6.00 "	38.5	42	"	"
6.30 "	36.5	40	"	"
6.45 " Furnace stopped.				

After 6.30 p.m., Feb. 1, the electric power delivered rapidly began to decrease and at 6.45 p.m. the furnace had to be stopped on account of ice clogging the inlet to the turbines.

The average volts on furnace during the later part of the run amounted to 36.97, and for the purpose of calculation an average of 37 volts has been assumed for the part of the run taken into consideration.

Cast No.	Time when Cast	Machine stopped.	Effective length of run	Pig Iron obtained	Quality of Pig Iron	Slag obtained	Ratio Slag Iron.
35	Jan. 31, 2.30 p.m.		h. m. 3 30	lbs. 605	white with holes	lbs. 349	0.576
36	" 6.30 p.m.		4	233		"	532
37	" 10.55 p.m.		4 25	719	"	614	0.853
38	Feb. 1, 12.20 a.m.	10 m.	1 15	215	Grey	104	0.484
39	Feb. 1, 4.40 a.m.	20 m.	4	526	"	193	0.367
40*	" 8.00 "	10 m.	3 10	893	"	262	0.293
41	" 11.35 "		3 35	583	"	219	0.376
42	" 4.15 p.m.	5 m.	4 35	754	"	409	0.542
43	" 6.45 "		2 30	439	"	168	0.382
39-43	18 h. 25 min.	35 min.	17 h. 50 m	3195		1251	0.391

*The iron broke through at 4.40 a.m. and had to be cast, but on account of the hole being a little above the regular tap hole some iron was left in the crucible, which explains the large cast obtained in cast No. 40, when the regular tap hole was used.

RAW MATERIAL CHARGED.

Number of Charges.	Composition of Charge.				Additional Material.	Total.				
	Ore.	Briquettes.	Coke Fines.	Limestone.		Ore.	Briquettes.	Coke Fines.	Limestone.	Sand.
22	lbs. 200	lbs. 80	lbs. —	lbs. 25	lbs. 100 Limestone.....	lbs. 4400	lbs. 1760	lbs. —	lbs. 650	lbs. —
10	200	80	5	30	2000	800	50	300	—
4	200	80	5	35	{ Ore..... 200 Briquettes..... 80 Sand..... 40 }	1000	400	20	140	40
15	200	80	5	30	3000	1200	75	450	—
						10400	4160	145	1540	40

When the furnace had to be stopped at 6.45 p.m., Feb. 1, it was partly filled with material. Of this 1023 lbs. were taken out

Only taking into account Casts 39-43, during which time the furnace was in working conditions, the results are:—

Effective length of run.	17 hours, 50 min.
Mean volts on furnace.	37
Mean amperes.	5000
Power factor.	0.919
Watts= $37 \times 5000 \times 0.919$	170015
Pig iron obtained.	3195 lbs.

170015

El. horse power $\frac{170015}{746}$	227.90
--	--------

Output of pig iron per 1,000 El. horse power days =

$$3195 \times 1000 \times 24$$

----- 9.435 tons.

$$17.83 \times 227.9 \times 2000$$

El. horse power year per ton of pig=0.290.

ANALYSIS OF PIG IRON PRODUCED.

Cast No.	Si.	S.	Total Carbon.
35	0.12	0.222
38	2.54	0.033	3.28
39	3.36	0.019
40	1.61	0.029	3.87
41	2.49	0.042
42	2.91	0.043	4.18
43	2.28	0.036

ANALYSIS OF SLAG PRODUCED.

Cast No.	SiO ₂	Al ₂ O ₃	CaO.	MgO.	Fe.	S.
36.	27.20	20.61	18.76	14.24	14.15	0.19
38.	27.18	28.60	28.76	13.91	0.50	0.91
42.	35.00	28.29	20.00	10.72	2.31	0.80

RUN No. 11.

FURNACE.

No alterations were made in the furnace.

Ore treated.	}	Magnetite from Wilbur mine.
Reducing agent.		Hematite (Negannee).
		Coke

The analyses of the magnetite and coke are given in Run No. 10. The analysis of the hematite is given in Run No. 1.

The furnace was started up at 8.25 a.m., Feb. 5, when 70 lbs. of Wilbur ore first were put in, the crucible not being cleaned from the charcoal used for the protection of the electrode during the time the furnace was pre-heated. Three charges left over from Run No. 10 were first put in, the composition being:—

Ore.	200 lbs. (Wilbur ore)
Briquettes.	80 "
Coke fines.	5 "
Limestone.	30 "

The charge was then changed to:—

Ore.	}	100 lbs. Wilbur ore
		100 lbs. Hematite
Coke.		56 lbs.

4 of these charges were put in and in addition 300 lbs. Wilbur ore and 200 lbs. hematite.

The charge was then changed to:—

Ore.	}	100 lbs. Wilbur ore
		100 lbs. Hematite
Coke.		40 lbs.

2 of these charges were put in and in addition 100 lbs. Wilbur ore and 100 lbs. hematite.

The electrode rose steadily however after 1.00 p.m. No new material was put in and the material in the furnace was melted down.

In order to use coke as a reducing agent the current employed must be of a lower voltage than the one we had at our disposal. Any further attempt with coke was, therefore, abandoned and when the furnace practically was cleaned out at 4.40 p.m., Feb. 5, the next run was started up with charcoal.

ELECTRICAL MEASUREMENTS.

The voltmeter was for this run direct connected with the electrode and the bottom plate of the furnace, thus eliminating the loss on the contacts.

Time.		Volts on Furnace.	Amperes.	Power Factor
Feb. 5,	8.25 a.m.			
	8.45 "	41	5,000	0.919
	9.00 "	42	"	"
	9.30 "	40	"	"
	10.00 "	40	"	"
	10.30 "	38	"	"
	11.00 "	38	"	"
	11.30 "	38	"	"
	12.00 "	37	"	"
	12.30 p.m.	38	"	"
	1.00 "	38	"	"
	1.30 "	37	"	"
	2.00 "	37	"	"
	2.30 "	35	"	"
	3.00 "	35	"	"
	3.30 "	40	"	"
	4.00 "	38	"	"
	4.30 "	38	"	"
	4.40 "			
				Run terminated.

Cast No.	Time when Cast	Machine stopped	Effective length of run	Pig Iron obtained	Quality of pig Iron	Slag obtained	Ratio Slag Iron.
44	Feb. 5, 11.45 a.m.		h. m. 3 20	lbs 762	Grey	lbs. 221	0.290
45*	Feb. 5, 4.30 p.m.		4 45	770	Grey	214	0.278

*After 1.00 p.m. material in furnace melted down.

Only taking into account Cast 44, the results are:—

Length of run.	3 hours, 20 min.
Mean volts on furnace.	39.57
Mean amperes.	5,000
Power factor.	0.919
Watts=39.57 × 5000 × 0.919.	181824
Pig iron obtained.	762 lbs.
	$\frac{181824}{762}$
El. horse power	243.73
	746

Output of pig iron per 1,000 H.P. horse power days=

$$\frac{762 \times 1000 \times 24}{3.33 \times 243.73 \times 2000} \dots\dots\dots 11.265 \text{ tons.}$$

El. horse power year per ton of pig=0.243

RUN No. 12.

FURNACE.

No alterations were made in the furnace.

Ore treated. Magnetite from Wilbur mine.
 Reducing agent. Charcoal.
 Flux. Sand.

ANALYSIS OF RAW MATERIAL.

The analyses of the Wilbur ore and sand are given in Run No. 10.

Charcoal	{	Moisture	14.00%
		Volatile matter.	27.56%
		Fixed carbon	55.90%
		Ash.	2.54%
			100.00%
		Sulphur.	0.058%

Immediately after the termination of Run No. 11 the furnace was put in order and started up at 4.40 p.m., Feb. 5, with a charge of composition:—

Ore.	400 lbs.
Charcoal.	104 "
Sand.	28 "

With charcoal as the reducing agent the current employed was suitable and the furnace worked well. At 10.55 p.m. Feb. 5, the iron broke through, however, and the furnace had to be shut down for repair. The lining around the iron hole was badly eaten away and when the iron broke through part of the iron casing of the furnace was destroyed.

7 charges of the above composition were put in and when the crucible was cleaned 676 lbs. of material were taken out. When starting up, some material from the previous run was very likely left in the furnace.

ELECTRICAL MEASUREMENTS.

The voltmeter was direct connected with the electrode and bottom plate of the furnace, eliminating the loss on the contacts.

Time.		Volts on Furnace.	Amperes.	Power Factor
Feb. 3,	4 40 p.m. Furnace started.			
	5.00 "	39	5,000	0.919
	5.30 "	37	"	"
	6.00 "	39	"	"
	6.30 "	35	"	"
	7.00 "	37	"	"
	7.30 "	39	"	"
	7.55 " { Machine stopped, re-			
	8.15 " { pairing iron hole.			
	8.30 "	41	"	"
	9.00 "	38	"	"
	9.30 "	40	"	"
	10.00 "	39	"	"
	10.30 "	38	"	"
	10.55 " Furnace stopped.			

Cast No.	Time when Cast	Machine stopped	Effective length of run	Pig Iron obtained	Quality of Pig Iron	Slag obtained	Ratio Slag Iron
46	Feb. 5, 7.45 p.m.		h. m.	lbs.		lbs.	
47	" 5, 10.55 p.m.	20 min.	3 5	723	Grey.	419	0.579
			2 50	595	"	215	0.361
46-47	6 hrs. 15 min.	20 m.	5 55	1318	Grey.	634	.51

Cast No.	Pig Iron obtained	Average Volts on Furnace	Average Amperes	Power Factor	Average Watts	Average El. Horse Power	Output of Pig Iron per 1000 E. H. P. days
46	lbs. 723	38.00	5000	0.919	174610	234.06	Tons. 12.03
47	595	39.20	5000	0.919	180124	241.45	10.46
46-47	1318	38.60	5000	0.919	177367	237.75	11.256

Effective length of run. 5 hours, 55 min.
 Mean volts on furnace. 38.6
 Mean amperes. 5000
 Power factor. 0.919

$$\begin{array}{r}
 \text{Watts} = 38.6 \times 5000 \times 0.919 \dots\dots\dots 177367 \\
 \text{Pig iron obtained.} \dots\dots\dots 1318 \text{ lbs.} \\
 \qquad \qquad \qquad 177367 \\
 \text{El. horse power} \frac{\quad}{746} \dots\dots\dots 237.75 \\
 \\
 \text{Output of pig iron per 1,000 El. horse power days} = \\
 \frac{1318 \times 1000 \times 24}{5.91 \times 237.75 \times 2000} \dots\dots\dots 11.256 \text{ tons.} \\
 \text{El. horse power year per ton of pig} = 0.243
 \end{array}$$

ANALYSIS OF PIG IRON PRODUCED.

Cast No.	Si.	S.	P.	Total Carbon.
46.	1.84	0.054	0.029	4.10
47.	1.21	0.039	0.019

RUN No. 13.

FURNACE.

The furnace was repaired and given the same shape as the one employed in Runs Nos. 8-12, the diameters of the lower cone being made slightly smaller and the diameter on top a little larger. The height of the furnace was increased three inches and instead of brick lining partly around the tap holes, carbon paste was used entirely, as shown in Plate No. VII. The brick lining was made of common fire bricks on account of difficulty in obtaining basic lining material.

In order to ascertain the consumption of electrode per ton of product, a new electrode was put in covered for a distance of three feet with asbestos and sheet iron.

The electrode weighed when put in 937 lbs.

The furnace was pre-heated from 12.00 noon, Feb. 11, until 9.30 a.m., Feb. 12, when the electrode was taken out and a few loose pieces at the end knocked off. The weight of these pieces amounted to 17 lbs. and consequently the weight of the electrode when starting the experiments was 920 lbs.

Ore treated. Magnetite from Wilbur mine.
 Reducing agent. Charcoal
 Flux. Sand

PLATE VII.

EXPERIMENTAL
ELECTRIC FURNACE
FOR
RUNS 13-19

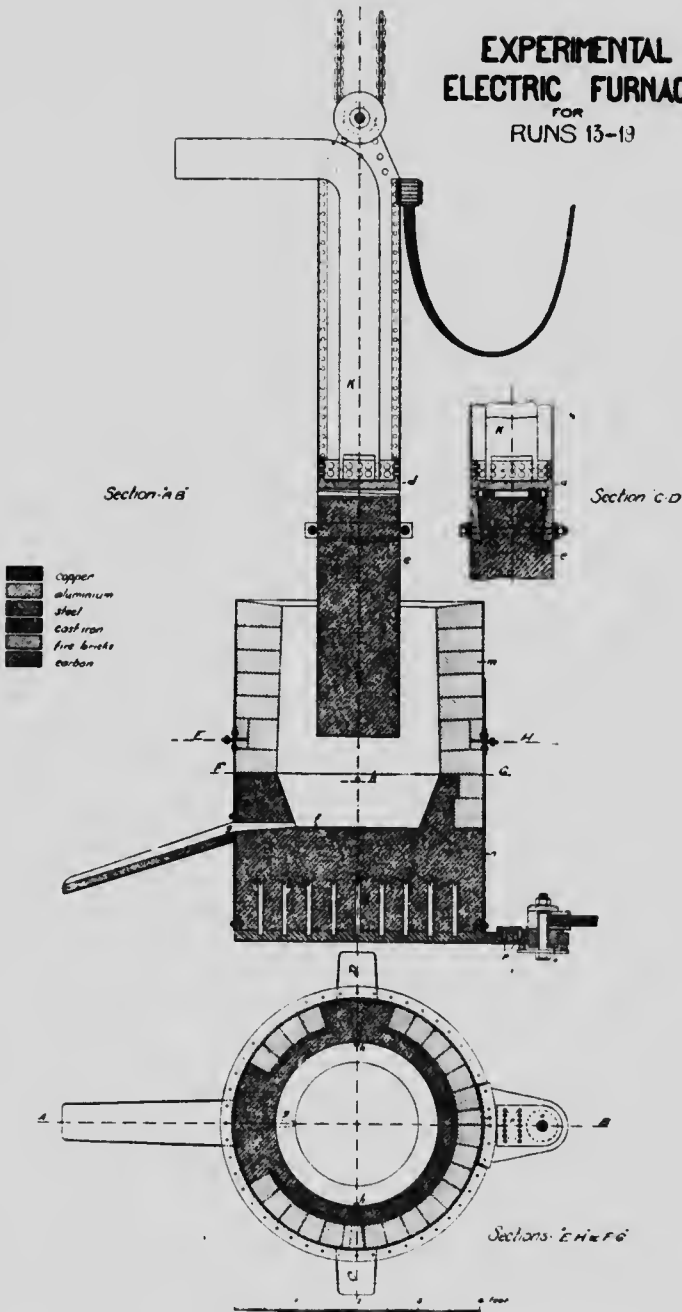

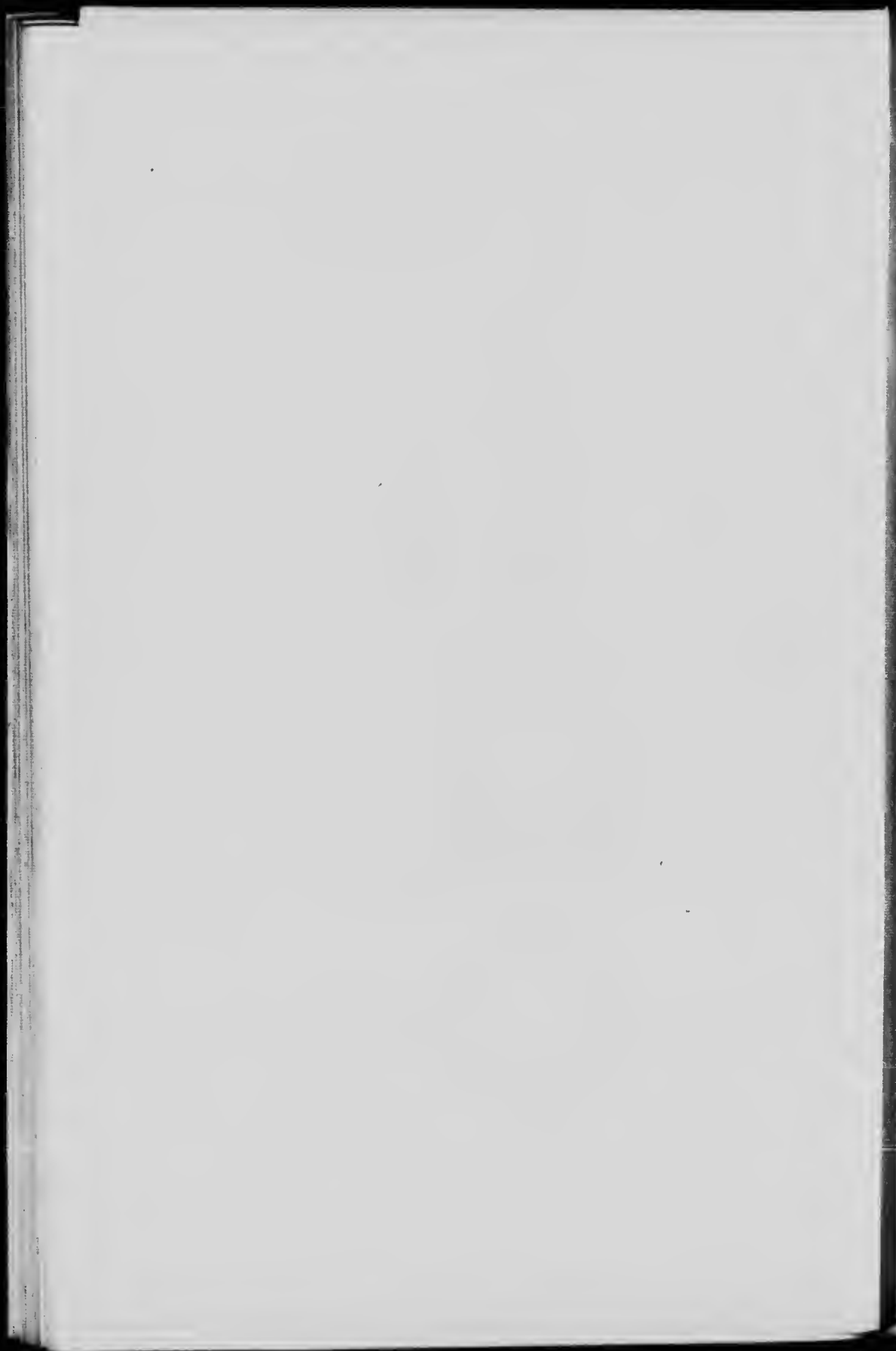

ANALYSIS OF RAW MATERIAL.

Electrode	{ Volatile matter	2.02%
	{ Fixed carbon.	95.78%
	{ Ash.	2.20%
		100.00
	Sulphur.	1.19%

The analyses of the Wilbur ore and sand are given in Run No. 10, and of the charcoal in Run No. 12.

The furnace was started up at 9.45 a.m., Feb. 12, with a charge of composition:—

Ore.	400 lbs.
Charcoal.	104 "
Sand.	28 "

left over from the previous run.

The charge was then changed to:—

Ore.	400 lbs.
Charcoal.	104 "
Sand.	20 "

The furnace worked very badly and the material in the furnace had to be melted down.

At 3.00 p.m., Feb. 12, a cast was tried, but the iron was cold, only 282 lbs. being obtained. Some carburete briquettes were put in, the furnace heated up and the iron cast at 4.50 p.m. In this cast, No. 48, 816 lbs. of iron were obtained. The iron was white and full of holes.

The production of this white iron was occasioned by the cold working of the furnace, resulting from the fact that the furnace when starting had not been sufficiently pre-heated and the temperature was still further lowered by the introduction of the cold charge.

The carbon in the charge was hardly sufficient and it was found that the carbon paste lining of the crucible was partly eaten away.

The furnace was again started up at 6.30 p.m., Feb. 12, with a charge of composition:—

Ore.	400 lbs.
Charcoal.	140 "

to insure an excess of carbon being present and a basic slag to be formed until the furnace was in good working condition. The excess of carbon was regulated from time to time by the putting in of crude ore and the slag was made fluid by means of sand added.

The furnace worked well from the starting, the carbon in the charge was gradually decreased and the sand increased, in order to arrive at the minimum of carbon required and a fluid slag.

With a charge of composition:—

Ore.	400 lbs.
Charcoal.	120 "
Sand	20 "

a white iron was produced and the actual amount of charcoal needed to produce a grey iron lies between 120 and 125 lbs. for 400 lbs. of ore. A certain amount of the charcoal in the charge was burnt on top of the furnace, however: not taking part in the reduction of the ore, and thus increasing the consumption of the charcoal.

ELECTRICAL MEASUREMENTS.

One voltmeter was in this run connected direct with the electrode and the bottom plate of the furnace. A hole was bored in the electrode and a threaded bolt with 2 nuts inserted. The wire to the voltmeter was firmly pressed between the nuts and the contact insured against oxidation by charcoal powder. In the bottom plate a contact was made in similar way. The other voltmeter was in the main circuit.

Time.	Volts on Furnace.	Volts on Line.	Amperes.	Power Factor.
Feb. 12, 6 30 p.m. Furnace started.				
7 00 "	36.5	40.0	5,000	0.919
7 30 "	32.5	36.0	"	"
8 00 "	36.0	39.0	"	"
8 30 "	36.0	38.0	"	"
9 00 "	36.0	39.0	"	"
9 30 "	38.0	40.5	"	"
10 00 "	37.0	40.5	"	"
10 30 "	37.0	40.5	"	"
11 00 "	37.0	40.5	"	"
11 30 "	37.0	40.5	"	"
12 00 "	39.0	42.5	"	"
Feb. 13, 12 30 a.m.	41.0	45.0	"	"
1 00 "	34.0	36.5	"	"
1 30 "	37.0	41.0	"	"
2 00 "	32.0	36.0	"	"
2 30 "	34.5	38.0	"	"
3 00 "	36.0	40.0	"	"

	Time.	Volts on Furnace.	Volts on Line.	Amperes.	Power Factor.
Feb. 13	3.30 a.m.	35.0	39.0	5,000	0.919
	4.00 "	36.5	40.0	"	"
	4.30 "	36.0	40.0	"	"
	5.00 "	31.0	35.0	"	"
	5.30 "	31.0	35.0	"	"
	6.00 "	34.0	38.0	"	"
	6.30 "	33.0	37.0	"	"
	7.00 "	33.0	37.0	"	"
	7.30 "	35.0	38.5	"	"
	8.00 "	34.0	37.0	"	"
	8.30 "	33.0	37.0	"	"
	9.00 "	32.0	34.5	"	"
	9.30 "	36.5	39.0	"	"
	10.00 "	34.0	38.0	"	"
	10.30 "	34.0	38.0	"	"
	11.00 "	34.5	39.0	"	"
	11.30 "	35.0	39.0	"	"
	12.00 "	35.0	39.0	"	"
	12.30 p.m.	36.0	40.0	"	"
	1.00 "	36.0	38.0	"	"
	1.30 "	35.0	38.0	"	"
	2.00 "	34.0	38.0	"	"
	2.30 "	35.0	38.5	"	"
	3.00 "	35.0	38.5	"	"
	3.30 "	35.0	38.0	"	"
	4.00 "	35.0	38.0	"	"
	4.30 "	34.0	37.0	"	"
	5.00 "	32.0	35.0	"	"
	5.30 "	35.0	38.0	"	"
	6.00 "	37.0	40.0	"	"
	6.30 "	35.0	38.0	"	"
	7.00 "	34.0	37.0	"	"
	7.30 "	31.0	34.0	"	"
	8.00 "	35.0	39.0	"	"
	8.30 "	35.0	38.0	"	"
	9.00 "	34.0	37.0	"	"
	9.30 "	34.0	37.0	"	"
	10.00 "	32.0	35.0	"	"
	10.30 "	37.0	40.0	"	"
	11.00 "	35.0	38.0	"	"
	11.30 "	39.0	42.0	"	"
	12.00 "	37.0	41.0	"	"
Feb. 14,	12.30 a.m.	34.0	37.5	"	"
	1.00 "	34.0	37.5	"	"
	1.30 "	35.0	38.0	"	"
	2.00 "	35.0	38.5	"	"
	2.30 "	35.0	38.5	"	"
	3.00 "	36.0	39.5	"	"
	3.30 "	33.0	36.5	"	"
	4.00 "	34.0	38.0	"	"
	4.30 "	38.0	41.5	"	"
	5.00 "	39.0	42.5	"	"
	5.30 "	39.0	43.0	"	"
	6.00 "	40.0	44.0	"	"
	6.30 "	39.0	43.0	"	"
	7.00 "	39.0	42.5	"	"
	7.30 "	39.0	42.5	"	"
	8.00 "	39.0	42.5	"	"
	8.30 "	39.0	42.5	"	"
	9.00 "	40.0	43.5	"	"
	9.30 "	39.0	42.5	"	"

Time.	Volts on Furnace.	Volts on Line.	Amperes.	Power Factor.
Feb. 14, 10.00 a.m.	39.0	43.0	5,000	0.919
10.30 "	37.0	41.0	"	"
11.00 "	39.0	42.0	"	"
11.30 "	34.0	38.0	"	"
12.00 "	35.0	39.0	"	"
12.30 p.m.	34.0	37.0	"	"
1.00 "	36.0	38.5	"	"
1.30 "	38.0	41.5	"	"
2.00 "	38.0	42.0	"	"
2.30 "	38.0	42.0	"	"
3.00 "	37.0	40.0	"	"
3.30 "	37.5	41.0	"	"
4.00 "	36.0	40.0	"	"
4.30 "	36.0	39.5	"	"
5.00 "	36.0	39.0	"	"
5.30 "	38.0	42.0	"	"
6.00 "	39.0	43.0	"	"
6.30 "	39.0	43.0	"	"
7.00 "	38.0	42.0	"	"
7.30 "	37.0	41.0	"	"
8.00 "	36.0	40.0	"	"
8.30 "	36.0	39.5	"	"
9.00 "	36.5	40.5	"	"
9.30 "	36.5	40.5	"	"
10.00 "	36.0	39.5	"	"
10.30 "	37.5	41.5	"	"
11.00 "	35.0	38.5	"	"
11.30 "	37.0	40.5	"	"
12.00 "	38.0	42.0	"	"
Feb. 15, 12.30 a.m.	34.0	37.5	"	"
1.00 "	34.0	38.0	"	"
1.30 "	37.0	41.0	"	"
2.00 "	37.0	40.0	"	"
2.30 "	37.0	40.0	"	"
3.00 "	35.0	38.0	"	"
3.30 "	35.0	38.0	"	"
4.00 "	36.0	39.0	"	"
4.30 "	36.0	40.0	"	"
5.00 "	33.0	37.0	"	"
5.30 "	31.0	34.0	"	"
6.00 "	32.0	36.0	"	"
6.30 "	37.0	40.0	"	"
7.00 "	34.0	37.0	"	"
7.30 "	33.0	36.0	"	"
8.00 "	31.0	34.0	"	"
8.30 "	35.0	38.5	"	"
9.00 "	33.5	36.5	"	"
9.30 "	33.5	36.5	"	"
10.00 "	38.0	41.5	"	"
10.05 " Furnace stopped.				

During the morning of Feb. 15 the volts dropped on account of the motor driving the generator being out of order and at 10.05 a.m., the furnace had to be stopped for repair of motor.

Mean volts on furnace.	35.70
Mean volts on line.	39.18
Loss on contacts.	3.48 volts.

Cast No.	Time when Cast	Machine stopped	Effective length of run		Pig Iron obtained	Quality of Pig Iron	Slag obtained	Ratio Slag Iron
			h.	m.				
49	Feb. 12, 9.35 p.m.	3	5	577	Grey.	23	0.040
50	Feb. 13, 12.45 a.m.	3	690	"	258	0.371
51	4.30 "	3	40	726	"	234	0.322
52	8.50 "	4	15	825	"	238	0.288
53	12.55 p.m.	3	55	819	"	278	0.327
54	4.55 "	3	55	804	"	249	0.306
55	8.55 "	3	55	778	"	229	0.294
56	12.00 "	2	55	619	"	190	0.307
57	Feb. 14, 3.30 a.m.	3	25	646	"	262	0.405
58	6.15 "	2	40	518	"	254	0.490
59	9.30 "	3	5	771	"	280	0.363
60	1.00 p.m.	3	15	636	white with holes	208	0.327
61	5.10 "	4	764	Grey.	190	0.248
62	8.50 "	3	35	815	"	234	0.287
63	Feb. 15, 12.10 a.m.	3	15	755	"	254	0.335
64	3.15 "	2	55	656	"	239	0.364
65	6.15 "	2	50	647	"	262	0.405
66	10.05 "	3	45	782	"	313	0.400
49-66	63 hours, 35 min.	2 h. 10 m.	61 h. 25 m.		12858	4195	0.326

RAW MATERIAL CHARGED.

Number of Charges.	Composition of Charge.			Additional Material.		Total.		
	Ore.	Charcoal.	Sand.	Ore.	Sand.	Ore.	Charcoal.	Sand.
	lbs.	lbs.	lbs.	lbs.	lbs.	lbs.	lbs.	lbs.
4	400	140	..	200	50	1800	560	50
1	400	140	10	50	20	450	140	30
3	400	130	15	100	15	1300	390	60
17	400	125	20	..	40	6800	2125	380
1	400	125	25	400	125	25
5	400	120	25	2000	600	125
2	400	120	20	800	240	40
4	400	125	20	1600	500	80
2	400	125	25	800	250	50
13	400	125	27	5200	1625	351
						21150	6555	1191

Cast No.	Pig Iron obtained	Average Volts on Furnace	Average Amperes	Power Factor	Average Watts	Average El. Horse Power	Output of Pig Iron per 1000 E. H. P. days
	lbs.						Tons.
49	577	35.83	5000	0.919	164639	220.69	10.18
50	690	38.00	"	"	174610	234.06	11.79
51	726	35.13	"	"	161422	215.38	10.97
52	825	33.00	"	"	151635	203.26	11.46
53	849	34.62	"	"	159079	213.24	12.21
54	804	34.88	"	"	160273	214.84	11.48
55	778	34.25	"	"	157379	210.96	11.32
56	619	35.43	"	"	162801	218.23	11.69
57	646	34.57	"	"	158849	212.93	10.67
58	518	38.00	"	"	174610	234.06	9.98
59	771	39.14	"	"	179848	241.08	12.46
60	636	36.29	"	"	166752	223.52	10.50
61	764	37.06	"	"	170290	228.27	10.06
62	815	37.57	"	"	172634	231.41	11.80
63	755	36.64	"	"	168360	225.68	12.35
64	656	35.67	"	"	163903	219.71	12.31
65	647	33.83	"	"	155449	208.37	13.16
66	782	34.37	"	"	157930	211.70	11.82
49-66	12858	35.70	5000	0.919	164042	219.89	11.424

Effective length of run. 61 hours, 25 min.

Mean volts on furnace. 35.70

Mean amperes. 5000

Power factor. 0.919

Watts= $35.7 \times 5000 \times 0.919$ 164042

Pig iron obtained. 12858 lbs.

164042

El. horse power $\frac{\text{---}}{746}$ 219.89

746

Output of pig iron per 1000 El. horse power days= ---

$12858 \times 1000 \times 24$

$\frac{\text{---}}{\text{---}}$ 11.424 tons.

$61.42 \times 219.89 \times 2000$

El. horse power year per ton of pig= 0.239

Charcoal used per ton of pig= 1020 lbs.

The analysis of the charcoal is given in Run No. 12, of the limestone in Run No. 1, and of the sand in Run No. 10.

When the furnace was stopped at 10.05 a.m., Feb. 15, it was filled with the mixture previously used, amounting to practically one charge. After the motor had been repaired the furnace was started up again at 3.00 p.m., Feb. 15, with a charge of composition:—

Ore. 400 lbs.
Charcoal. 125 lbs.

In order to reduce the contents of sulphur in the pig iron the limestone was increased. The high contents of magnesia made the slag very infusible and in order to clean out the crucible 50 lbs. of sand were added and the material in the furnace melted down during Cast 74a. A little sand was afterwards added to the charge and the limestone further increased in order to obtain a greater proportion of lime to the magnesia. Towards the close of the run the carbon in the charge was reduced, the composition now being:—

Ore. 400 lbs.
Charcoal. 120 "
Limestone. 25 "
Sand. 6 "

The iron produced was still grey, showing that with this ore 120 lbs. of charcoal to 400 lbs. of ore was sufficient. On account of the comparatively large amount of slag produced and the infusible nature of the slag, the output was correspondingly smaller than in the previous run.

ELECTRICAL MEASUREMENTS.

Time.	Volts on Furnace.	Volts on Line.	Amperes.	Power Factor.
Feb. 15, 3.00 p.m. Furnace started.				
3.30 "	38.0	41.0	5,000	0.919
4.00 "	35.0	38.0	"	"
4.30 "	37.0	40.0	"	"
5.00 "	36.0	39.5	"	"
5.30 "	35.0	38.0	"	"
6.00 "	38.0	42.0	"	"
6.30 "	35.0	39.0	"	"
7.00 "	36.0	40.0	"	"
7.30 "	35.0	39.0	"	"
8.00 "	37.0	41.0	"	"
8.30 "	0	40.0	"	"
9.00 "	0	42.0	"	"
9.15 "	0	32.0	"	"

Time.	Volts on Furnace.	Volts on Line.	Amperes.	Power Factor.
Feb. 15, 9 30 p.m.	40 0	44 0	5,000	0.919
10 00 "	43 0	47.0	"	"
10 30 "	40.0	41 0	"	"
11 00 "	39 0	43 0	"	"
11 30 "	36 0	40 0	"	"
12 00 "	35 0	39 5	"	"
Feb. 16, 12 30 a.m.	33.0	38 0	"	"
1 00 "	37 0	41 0	"	"
1 30 "	34 0	38 0	"	"
2 00 "	35 0	38 0	"	"
2 30 "	35 0	39 0	"	"
3 00 "	10 0	15 0	3,000	"
3 30 "	35 0	41 0	5,000	"
4 00 "	36.0	40 0	"	"
4 30 "	36 0	40 0	"	"
5 00 "	36.0	40 0	"	"
5 30 "	36.5	41 0	"	"
6 00 "	37 0	41 0	"	"
6 30 "	37 0	41 0	"	"
7 00 "	36 0	41 0	"	"
7 30 "	36 0	40 0	"	"
8 00 "	36 0	40 0	"	"
8 30 "	36 0	40 0	"	"
9 00 "	37 0	40 0	"	"
9 30 "	35 0	39 0	"	"
10 00 "	35 0	38 0	"	"
10 30 "	34 0	38 0	"	"
11 00 "	34 0	37 0	"	"
11 30 "	34 0	38 0	"	"
12 00 "	35 0	39 0	"	"
12 30 p.m.	35 0	38 0	"	"
1 00 "	32.6	36 0	"	"
1 30 "	37 0	40 0	"	"
2 00 "	37 0	40.5	"	"
2 30 "	38 0	41 0	"	"
3 00 "	38 0	42 0	"	"
3 30 "	38.5	42 0	"	"
4 00 "	37 0	41 0	"	"
4 30 "	37.5	41 0	"	"
5 00 "	38 0	41.5	"	"
5 30 "	39 0	42.5	"	"
6 00 "	39 0	42.5	"	"
6 30 "	31 0	35 0	"	"
7 00 "	34 0	37 0	"	"
7 30 "	33 0	36 0	"	"
8 00 "	34 0	37.5	"	"
8 30 "	32 0	35.5	"	"
9 00 "	35 0	38.5	"	"
9 30 "	31 0	35 0	"	"
10 00 "	37.5	41 0	"	"
10 30 "	36.5	39.5	"	"
11 00 "	35 0	39 0	"	"
11 30 "	37 0	40.5	"	"
12 00 "	38 0	42 0	"	"
Feb. 17 12 50 a.m.	36 0	40 0	"	"
1 00 "	35 0	39 0	"	"
1 30 "	37 0	41 0	"	"
2 00 "	39 0	43 0	"	"
2 30 "	39 0	43 0	"	"
Material in furnace melted down Machine stopped from 2. 25 to 2. 40.				

	Time.	Volts on Furnace.	Volts on Line.	Amperes.	Power Factor.
Feb. 17	3 00 a.m.	34.0	38.0	5,000	0.919
	3 30 "	35.0	39.0	"	"
	4 00 "	36.0	40.0	"	"
	4 30 "	34.0	38.0	"	"
	5 00 "	35.0	39.0	"	"
	5 30 "	34.0	38.0	"	"
	6 00 "	34.0	38.0	"	"
	6 30 "	34.0	38.0	"	"
	7 00 "	39.0	43.0	"	"
	7 30 "	38.0	43.0	"	"
	8 00 "	39.0	43.0	"	"
	8 30 "	35.0	39.0	"	"
	9 00 "	35.0	39.0	"	"
	9 30 "	39.5	43.0	"	"
	10 00 "	39.0	42.0	"	"
	10 30 "	40.0	43.5	"	"
	11 00 "	36.5	40.0	"	"
	11 30 "	39.0	42.0	"	"
	12 00 "	36.5	40.0	"	"
	12 30 p.m.	34.0	37.5	"	"
	1 00 "	36.0	39.0	"	"
	1 30 "	36.0	39.0	"	"
	2 00 "	35.0	39.0	"	"
	2 30 "	35.0	39.0	"	"
	3 00 "	35.0	39.0	"	"
	3 30 "	35.0	38.5	"	"
	4 00 "	35.5	39.5	"	"
	4 30 "	33.5	37.0	"	"
	5 00 "	34.0	37.5	"	"
	5 30 "	37.0	40.5	"	"
	6 00 "	38.0	41.5	"	"
	6 30 "	37.0	40.0	"	"
	7 00 "	38.0	41.0	"	"
	7 30 "	38.0	41.0	"	"
	8 00 "	36.0	40.0	"	"
	8 30 "	37.0	40.0	"	"
	9 00 "	40.0	43.5	"	"
	9 30 "	39.0	42.5	"	"
	10 00 "	38.0	41.5	"	"
	10 30 "	37.0	40.0	"	"
	11 00 "	36.0	39.0	"	"
	11 30 "	36.0	39.0	"	"
	12 00 "	36.0	40.0	"	"
Feb. 18	12 30 a.m.	35.0	39.0	"	"
	1 00 "	35.0	39.0	"	"
	1 30 "	36.0	40.0	"	"
	2 00 "	36.0	39.0	"	"
	2 30 "	36.0	39.0	"	"
	3 00 "	36.0	39.0	"	"
	3 30 "	36.0	40.0	"	"
	4 00 "	35.0	38.0	"	"
	4 30 "	36.0	40.0	"	"
	5 00 "	35.0	39.0	"	"
	5 30 "	36.0	39.0	"	"
	6 00 "	36.0	40.0	"	"
	6 30 "	37.0	41.0	"	"
	7 00 "	38.0	42.0	"	"
	7 30 "	37.0	41.0	"	"
	8 00 "	35.0	39.0	"	"
	8 30 "	36.0	40.0	"	"
	9 00 "	36.0	40.0	"	"

Time.		Volts on Furnace.	Volts on Line.	Amperes.	Power Factor.
Feb. 18	9.30 a.m.	36 0	39 0	5,000	0.910
	10.00 "	35 0	39 0	"	"
	10.30 "	35 0	39 0	"	"
	11.00 "	35 0	39 0	"	"
	11.30 "	35 0	38 0	"	"
	12.00 "	35 0	39 0	"	"
	12.30 p.m.	35 0	39 0	"	"
	1.00 "	Furnace stopped.		"	"

Mean volts on furnace*. 35.88

Mean volts on line*. 39.60

Loss on Contacts. 3.72 volts

* Not including Casts Nos. 74a and 84.

Cast No.	Time when Cast	Machine stopped	Effective length of run		Pig Iron obtained	Quality of Pig Iron	Slag obtained	Ratio Slag Iron
			h.	m.				
67	Feb. 15, 8.00 p.m.		5	..	928	Grey.	283	0.306
68	Feb. 16, 12.10 a.m.	5 min.	4	5	811	"	298	0.366
69	" 4.10 "	5 "	3	55	653	"	165	0.253
70	" 9.00 "	5 "	4	45	910	"	284	0.312
71	" 1.00 p.m.		4	..	802	"	301	0.375
72	" 5.00 "		4	..	804	"	308	0.383
73	" 9.15 "		4	15	650	"	244	0.375
74	Feb. 17, 1.00 a.m.	10 min	3	35	557	"	252	0.452
*74a	" 2.20 "	20 min.	1	0	124	"	106	0.84
75	" 6.10 "	15 "	3	35	644	"	313	0.486
76	" 9.45 "	10 "	3	25	664	"	357	0.507
77	" 12.45 p.m.		3	..	622	"	229	0.368
78	" 4.00 "		3	15	525	"	167	0.318
79	" 7.45 "		3	45	689	"	202	0.380
80	" 11.40 "	10 "	3	45	659	"	280	0.438
81	Feb. 18, 3.00 a.m.	5 "	3	15	636	"	281	0.441
82	" 6.30 "	5 "	3	25	608	"	318	0.523
83	" 10.00 "		3	30	703	"	455	0.647
†87-83	65 hours, 40 min.	1h 10m	64	h 30 m	11865	Grey	4786	0.403
‡84	Feb. 18, 1.00 p.m.		3	h. . .	419	"	283	0.690

*Material in furnace melted down.

†Not including Cast No. 74a.

‡Material in furnace melted down.

RAW MATERIAL CHARGED.

Number of Charges.	Composition of Charge.				Additional Material.		Total.		
	Ore.	Char-coal.	Lime-stone.	Sand.	Sand.	Ore.	Char-coal.	Lime-stone.	Sand.
	lbs.	lbs.	lbs.	lbs.	lbs.	lbs.	lbs.	lbs.	lbs.
1	400*	125	...	27	...	400	125	...	27
15	400	125	6000	1875
7	400	125	40	2800	875	70	...
2	400	125	20	800	250	40	...
4	400	125	20	3	50	400	425	20	53
4	400	120	20	3	...	1600	480	80	42
6	400	125	20	3	...	2400	750	120	48
3	400	125	30	3	...	1200	375	90	9
2	400	125	25	3	...	800	250	50	6
11	400	120	25	6	...	4400	1320	275	66
						20800	6425	745	191

*Wilbur ore.

At the termination of this run some material was still left in the furnace.

Cast No.	Pig Iron obtained	Average Volts on Furnace	Average Amperes	Power Factor	Average Watts	Average El. Horse Power	Output of Pig Iron per 1000 E. H. P. days
	lbs.						Tons.
67	928	36 30	5000	0 919	166339	222 97	9 98
68	811	37 27	"	"	171256	229 56	10 39
69	653	31 87	4750	"	139142	186 47	10 71
70	910	36 35	5000	"	167028	223 89	10 27
71	802	31 25	"	"	157378	210 96	11 40
72	804	37 63	"	"	172909	231 78	10 40
73	650	34 62	"	"	159079	213 24	8 64
74	557	35 75	"	"	164271	220 20	8 48
75	644	31 57	"	"	158849	212 93	10 43
76	664	37 07	"	"	170336	228 33	10 23
77	622	37 50	"	"	172312	230 98	10 77
78	525	35 36	"	"	162479	217 80	8 90
79	689	36 50	"	"	167747	224 82	9 80
80	659	37 38	"	"	174764	230 24	9 16
81	636	35 71	"	"	164087	219 95	10 67
82	608	35 86	"	"	164776	220 88	9 68
83	703	36 44	"	"	166063	222 60	10 82
67-83	11865	35 88	4985	0 919	161374	220 34	10 018
81	410	35 00	5000	0 919	160825	215 58	7 60

Not taking into account Casts 74a and 84, when the material in the furnace was melted down, the results are: —

Effective length of run.	64 hours, 30 min.
Mean volts on furnace.	35.88
Mean amperes.	4985
Power factor.	0.919
Watts $35.88 \times 4985 \times 0.919$	164374
Pig iron obtained.	11865 lbs.

164374

El. horse power ———	220.34
---------------------	--------

746

Output of pig iron per 1000 El. horse power days=

$$11865 \times 1000 \times 24$$

10.018 tons

$$64.5 \times 220.34 \times 2000$$

El. horse power year per ton of pig = 0.273

Charcoal used per ton of pig = 1036 lbs.

ANALYSIS OF PIG IRON PRODUCED.

Cast No.	Si.	S.	P.	Mn.	Graphitic Carbon.	Total Carbon.
68.		0.332				
70.	4.51	0.120	0.033	0.07	2.72	3.51
73.	4.98	0.027	0.037	0.11	3.46	3.80
75.	5.15	0.057				
76.	3.75	0.090				
77.	3.60	0.046				
78.	3.30	0.030	0.030	0.10	3.10	4.16
79.	3.05	0.056				
80.	3.53	0.042	0.034			3.73
81.	3.54	0.039	0.024	0.10	2.78	3.98
82.	3.36	0.052				

ANALYSIS OF SLAG PRODUCED.

Cast No.	SiO ₂	Al ₂ O ₃	P ₂ O ₅	CaO.	MgO.	MnO.	FeO.	S.
70. . . .	37.48	11.82	0.018	18.21	30.57	0.01	0.41	2.20
73. . . .	33.46	10.40	0.023	26.58	24.58	0.01	0.65	3.15
78. . . .	33.56	8.95	0.018	30.23	21.86	0.02	0.82	2.40
81. . . .	33.12	8.48	0.016	25.80	30.21	0.02	0.90	2.13
67-81. . . .	36.16	18.21	0.018	23.14	20.41	0.05	0.42	2.00

RUN No. 15.

FURNACE.

No alterations were made in the furnace and the same electrode as in Runs Nos. 13-14 was used.

Ore treated.	Magnetite from Calabogie*
Reducing agent.	Charcoal and charcoal breeze.
Flux.	Limestone
	Sand

ANALYSIS OF RAW MATERIAL.

Calabogie ore:	SiO ₂	3.80%	} Fe=59.38%
	Fe ₂ O ₃	56.24%	
	FeO.	25.76%	
	Al ₂ O ₃	3.73%	
	CaO.	2.00%	
	MgO.	3.42%	
	MnO.	0.27%	
	P ₂ O ₅	0.85%	P=0.371%
S.	0.20%		
CO ₂ and undet.	3.73%		
	100.00%		

The analysis of the charcoal is given in Run No. 12; of the limestone in Run No. 1; of the sand in Run No. 10; of the charcoal breeze used no analysis was made.

The furnace was started up at 3.10 p.m., Feb. 18, when 20 lbs. of charcoal first were put in and afterwards the charge of composition:—

Ore.	400 lbs.
Charcoal.	125 "
Limestone.	30 "

The pig iron produced with this mixture was white and high in sulphur. The carbon and lime in the charge were, therefore, increased and the iron produced became grey and with low content of sulphur.

* Calabogie Mining Co.

At 3.15 p.m., Feb. 19, the machine had to be stopped for repair of the motor. The furnace was cooled down considerably during this time and when starting up again at 5.45 p.m. the iron in the crucible froze up and the material in the furnace had to be melted down.

At 12.40 a.m., Feb. 20, the furnace was again charged with a charge of composition:—

Ore.	400 lbs.
Charcoal breeze.	135 "
Limestone	45 "

The iron produced became gradually white and the carbon was, therefore, increased. The charcoal breeze which was wet and consisted mostly of fines did not prove satisfactory and towards the termination of the run a charge with 145 lbs. of charcoal (in lumps) was put in and a gray iron produced.

ELECTRICAL MEASUREMENTS.

The carbon around the bolt screwed into the electrode and the voltmeter contact was partly eaten away and when putting the electrode in place this bolt broke. The readings were, therefore, taken on the voltmeter connected with the main circuit and from these readings the average loss, 3.72 volts, on the contacts, ascertained in the previous run, are deducted.

Time.		Volts on Line.	Amperes.	Power Factor.
Feb. 18	3.10 p.m. Furnace started. . .			
	3.30 "	43.0	5,000	0.919
	4.00 "	41.5	"	"
	4.30 "	38.5	"	"
	5.00 "	41.0	"	"
	5.30 "	40.0	"	"
	6.00 "	40.0	"	"
	6.30 "	38.0	"	"
	7.00 "	38.0	"	"
	7.30 "	39.0	"	"
	8.00 "	41.0	"	"
	8.30 "	41.0	"	"
	9.00 "	42.0	"	"
	9.30 "	42.0	"	"
	10.00 "	42.0	"	"
	10.30 "	41.5	"	"
	11.00 "	41.5	"	"
	11.30 "	41.0	"	"
	12.00 "	42.0	"	"
Feb. 19	12.30 a.m.	41.5	"	"
	1.00 "	41.0	"	"
	1.30 "	40.5	"	"
	2.00 "	41.0	"	"
	2.30 "	41.5	"	"
	3.00 "	40.5	"	"

	Time.	Volts on Line.	Amperes.	Power Factor.
Feb. 19	3.30 a.m.	40.5	5,000	0.919
	4.00 "	39.5	"	"
	4.30 "	40.5	"	"
	5.00 "	40.5	"	"
	5.30 "	41.5	"	"
	6.00 "	41.5	"	"
	6.30 "	41.5	"	"
	7.00 "	42.5	"	"
	7.30 "	41.5	"	"
	8.00 "	40.5	"	"
	8.30 "	40.5	"	"
	9.00 "	37.5	"	"
	9.30 "	36.5	"	"
	10.00 "	37.0	"	"
	10.30 "	39.0	"	"
	11.00 "	39.0	"	"
	11.30 "	38.0	"	"
	12.00 "	38.0	"	"
	12.30 p.m.	37.0	"	"
	1.00 "	37.0	"	"
	1.30 "	37.0	"	"
	2.00 "	38.0	"	"
	2.30 "	39.0	"	"
	3.00 "	38.0	"	"
	Machine stopped from 3.15 p.m. to 5.45 p.m. for repair of motor.			
	5.45 "	38.0	"	"
	6.00 "	37.0	"	"
	6.30 "	39.0	"	"
	7.00 "	37.0	"	"
	7.30 "	38.0	"	"
	8.00 "	38.0	"	"
	8.30 "	37.0	"	"
	9.00 "	38.0	"	"
	9.30 "	Material in furnace melted down and furnace cleaned.		
Feb. 20	12.40 a.m.			
	1.00 "	42.0	4,500	"
	1.30 "	39.0	4,750	"
	2.00 "	40.5	5,000	"
	2.30 "	38.5	"	"
	3.00 "	40.0	"	"
	3.30 "	39.0	"	"
	4.00 "	40.0	"	"
	4.30 "	40.0	"	"
	5.00 "	39.5	"	"
	5.30 "	40.5	"	"
	6.00 "	39.5	"	"
	6.30 "	40.5	"	"
	7.00 "	39.5	"	"
	7.30 "	39.5	"	"
	8.00 "	39.5	"	"
	8.30 "	38.0	"	"
	9.00 "	37.5	"	"
	9.30 "	40.0	"	"
	10.00 "	40.0	"	"
	10.30 "	40.0	"	"
	11.00 "	40.0	"	"
	11.30 "	38.0	"	"
	12.00 "	40.5	"	"
	12.30 p.m.	40.5	"	"
	1.00 "	40.0	"	"

	Time.	Volts on Line.	Amperes.	Power Factor.
Feb. 20	1 30 p.m.	39 5	5,000	0,919
	2 00 "	39 5	"	"
	2 30 "	38 5	"	"
	3 00 "	39 0	"	"
	3 30 "	38 0	"	"
	4 00 "	38 5	"	"
	4 30 "	38 5	"	"
	5 00 " Run terminated.			

Mean volts on furnace during first part of run (3.10 p.m., Feb. 18. to 3.15 p.m., Feb. 19):—

$$40.01 - 3.72 = 36.29$$

Mean volts on furnace during second part of run* (12.40 a.m., Feb. 20. to 5.00 p.m., Feb. 20):—

$$39.49 - 3.72 = 35.77$$

Cast No.	Time when Cast	Machine stopped	Effective length of run	Pig Iron obtained	Quality of Pig Iron	Slag obtained	Ratio Slag Iron
85	Feb. 18, 7.35 p.m.		h. m				
86	" 11.35 "	5 min.	4 25	870 lbs.	white.	292 lbs.	0 335
87	Feb. 19, 3.35 a.m.	5 "	3 55	784 "	"	154 "	0 196
88	" 6.55 "	5 "	3 55	750 "	Grey. . . .	188 "	0 250
89	" 11.00 "		3 15	670 "	"	193 "	0 288
90	" 3.15 p.m.		4 5	804 "	"	323 "	0 401
			4 15	642 "	"	185 "	0 288
85-90	24 hours, 5 min.	15 min.	23 h. 50 m	4520 lbs		1335 lbs.	0.295
91**	Feb. 20, 12.20 a.m.	2h. 30 m.	6 h. 35 m.	1012 lbs	Grey. . . .	584 lbs.	0.577
92	" 5.00 "	20 min.	4 20	729 "	"	299 "	0.410
93	" 9.05 "	5 "	4 ..	695 "	white. . . .	235 "	0.338
94	" 1.00 p.m.		3 55	765 "	"	278 "	0.363
95	" 5.00 "		4 ..	532 "	Grey. . . .	80 "	0.150
92-95	16 hours, 40 min.	25 min.	16 h. 15 m.	2,722 lbs.		892 lbs.	0.327

*Not including Cast No. 91.

**During part of this run, the material in the furnace was melted down.

RAW MATERIAL CHARGED.

Number of Charges.	Composition of Charge.				Additional Material.			Total			
	Ore.	Charcoal.	Charcoal breeze.	Lime-stone.	Sand.	Charcoal.	Ore.	Charcoal.	Charcoal breeze.	Lime-stone.	Sand.
6	lbs. 400	lbs. 125	lbs. ...	lbs. 30	lbs. ...	lbs. 20	lbs. 2400	lbs. 770	lbs. ...	lbs. 180	lbs. ...
2	400	125	...	35	800	250	...	70	...
1	400	130	...	35	400	130	...	35	...
2	400	130	...	35	800	260	...	70	10
6	400	135	...	50	5	...	2400	810	...	300	30
6	400	135	...	40	2400	810	...	240	...
7	400	...	135	45	2800	...	945	315	...
2	400	...	140	45	800	...	280	90	...
2	400	...	145	40	800	...	290	80	...
1	400	145	...	40	400	145	...	40	...
							14000	3175	1515	1420	40

Cast No.	Pig Iron obtained	Average volts on Furnace	Average Amperes	Power Factor	Average Watts	Average El. Horse Power	Output of Pig Iron per 1000 E. H. P. days
	lbs.						Tons.
85	870	36.17	5000	0.919	166201	222.79	10.62
86	784	37.78	"	"	173599	232.70	10.34
87	750	37.34	"	"	171577	230.00	10.00
88	670	37.11	"	"	170520	228.58	10.80
89	804	35.61	"	"	163628	219.34	10.78
90	642	34.03	"	"	156368	209.60	8.65
85-90	4520	36.29	5000	0.919	166752	223.52	10.183
91	1012	34.03	5000	0.919	156368	209.60	8.80
92	729	36.11	4917	"	163171	218.72	9.23
93	695	35.59	5000	"	163536	219.21	9.51
94	765	36.15	"	"	166109	222.66	10.54
95	533	35.06	"	"	161100	215.95	7.40
92-95	2722	35.77	4979	0.919	163673	219.40	9.208

1st part of run. (Casts 85-90).

Effective length of run. 23 hours, 50 min.

Mean volts on furnace. 36.29

Mean amperes. 5000

Power factor. 0.919

Watts = $36.29 \times 5,000 \times 0.919$ 166752

Pig iron obtained. 4520 lbs.

166752

El. horse power $\frac{\text{---}}{\text{---}}$ 223.52

74%

Output of pig iron per 1000 El. horse power days =

$4520 \times 1000 \times 24$

$\frac{\text{---}}{\text{---}}$ 10.183 tons

$23.83 \times 223.52 \times 2000$

El. horse power years per ton of pig = 0.269

2nd part of run. (Casts 92-95):—

Effective length of run. 16 hours, 15 min.

Mean volts on furnace. 35.77

Mean amperes. 4979

Power factor. 0.919

Watts = $35.77 \times 4979 \times 0.919$ 163673

Pig iron obtained. 2722 lbs.

163673

El. horse power $\frac{\text{---}}{\text{---}}$ 219.40

74%

ANALYSIS OF RAW MATERIAL.

Cala'ogic ore:	SiO ₂	6.06%	} Fe=59.85%
	Fe ₂ O ₃	58.00%	
	FeO	24.78%	
	Al ₂ O ₃	1.00%	} P=0.020%
	CaO	0.40%	
	MgO	6.00%	
	P ₂ O ₅	0.046%	
S	0.17%		
CO ₂ and undet.	3.544%		
		100.000%	

Charcoal:	Moisture	2.20%
	Volatile matter	20.60%
	Fixed Carbon	74.40%
	Ash	2.80%

The analysis of the limestone is given in Run No. 1; of the quartz used no analysis was made.

The furnace was started up at 6.20 p.m., Feb. 20, when it was filled with one charge of the mixture employed in the previous run.

The composition of the new charge was:—

Ore	400 lbs.
Charcoal	125 "
Limestone	50 "
Quartz	5 "

Later the charge was changed to:—

Ore	400 lbs.
Charcoal	130 "
Limestone	45 "

The electrode rose, however, to a position too high above the crucible; the iron became cold and the crucible filled up with a scale, preventing the charge from going down, which resulted in the very small output obtained in Cast No. 101. To reduce the excess of carbon in the furnace some crude ore was put in, the carbon in the charge was decreased and a little quartz added to the charge. The electrode came down, the output increased again and a fluid slag was produced. At 9.00 a.m., Feb. 22, the furnace had to

be stopped on account of power giving out, the inlet to the turbines being blocked with ice.

ELECTRICAL MEASUREMENTS.

The volts were read in the same manner as in the previous run and 3.72 volts deducted for the loss on the contacts.

Time.		Volts on Line.	Amperes.	Power Factor.
Feb. 20,	6.20 p.m. Furnace started.			
	6.30 "	42.0	5,000	0.919
	7.00 "	39.0	"	"
	7.30 "	40.0	"	"
	8.00 "	39.0	"	"
	8.30 "	39.0	"	"
	9.00 "	41.0	"	"
	9.30 "	40.0	"	"
	10.00 "	40.0	"	"
	10.30 "	39.0	"	"
	11.00 "	39.0	"	"
	11.30 "	40.0	"	"
	12.00 "	41.5	"	"
Feb. 21	12.30 a.m.	40.0	"	"
	1.00 "	40.0	"	"
	1.30 "	41.0	"	"
	2.00 "	40.0	"	"
	2.30 "	40.0	"	"
	3.00 "	39.0	"	"
	3.30 "	39.0	"	"
	4.00 "	40.0	"	"
	4.30 "	38.0	"	"
	5.00 "	38.0	"	"
	5.30 "	39.5	"	"
	6.00 "	40.0	"	"
	6.30 "	40.0	"	"
	7.00 "	39.0	"	"
	7.30 "	39.0	"	"
	8.00 "	39.0	"	"
	8.30 "	38.5	"	"
	9.00 "	38.0	"	"
	9.30 "	37.0	"	"
	10.00 "	38.0	"	"
	10.30 "	39.5	"	"
	11.00 "	41.0	"	"
	11.30 "	41.5	"	"
	12.00 "	41.5	"	"
	12.30 p.m.	41.5	"	"
	1.00 "	38.0	"	"
	1.30 "	41.5	"	"
	2.00 "	42.0	"	"
	2.30 "	42.0	"	"
	3.00 "	41.0	"	"
	3.30 "	41.0	"	"
	4.00 "	41.5	"	"
	4.30 "	41.5	"	"
	5.00 "	41.5	"	"
	5.30 "	41.5	"	"
	6.00 "	42.5	"	"
	6.30 "	40.5	"	"

	Time.	Volts on Line.	Amperes.	Power Factor.
Feb. 21	7 00 p.m.	41 5	5,000	0 910
	7 30 "	40 5	"	"
	8 00 "	42 0	"	"
	8 30 "	44 5	"	"
	9 00 "	43 0	"	"
	9 30 "	42 5	"	"
	10 00 "	43 5	"	"
	10 30 "	43 0	"	"
	11 00 "	42 5	"	"
	11 30 "	40 0	"	"
	12 00 "	39 5	"	"
	Feb. 22	12 30 a.m.	44 0	"
1 00 "		42 0	"	"
1 30 "		42 0	"	"
2 00 "		40 0	"	"
2 30 "		39 0	"	"
3 00 "		37 0	"	"
3 30 "		38 0	"	"
4 00 "		37 0	"	"
4 30 "		37 0	4,800	"
5 00 "		40 0	4,800	"
5 30 "		40 0	5,000	"
6 00 "		41 0	"	"
6 30 "		41 0	"	"
7 00 "		33 0	"	"
7 30 "		35 0	"	"
8 00 "	34 0	"	"	
8 30 "	39 0	"	"	
9 00 "	41 0	"	"	

The furnace had to be stopped after the cast at 9.00 a.m., Feb. 22, on account of power giving out, the inlet to the turbines being blocked with ice.

Mean volts on furnace=40.06—3.72=36.34.

Cast No.	Time when Cast	Machine stopped	Effective length of run		Pig Iron obtained	Qual. of Pig Iron	Slag obtained	Ratio Slag Iron
			h	m				
96	Feb. 20 10.00 p.m.		3	40	627	Grey.	153	0 244
97	" 21 1.45 a.m.		3	45	771	"	153	0 198
98	" 6.00 "	15 min.	4	..	697	"	233	0 334
99	" 9.40 "		3	40	695	"	211	0 303
100	" 12.50 p.m.		3	10	500	"	119	0 198
101	" 5.05 "		4	15	611	"	139	0 227
102	" 9.00 "		3	55	900	"	529	0 587
103	Feb. 22 1.00 a.m.		4	..	777	"	115	0 148
104	" 5.05 "	5 min.	4	..	789	"	488	0 618
105	" 9.00 "		3	55	683	"	416	0 609
96-105	38 hours, 40 min.	20 min.	38 h.	20 m.	7150	Grey.	2556	0 357

RAW MATERIAL CHARGED.

Number of Charges.	Composition of Charge.						Additional Material.				Total.			
	Ore.	Charcoal.	Limestone.	Quartz.	Ore.	Limestone.	Quartz.	Ore.	Charcoal.	Limestone.	Quartz.	Total.		
												lbs.	lbs.	
1	400*	145	40	..	400	400	145	40	..	145	40	..
6	400	125	50	5	2400	750	300	..	2400	300	30
9	400	130	45	3600	1170	405	..	3600	405	15
2	400	125	45	..	200	10	15	1000	250	100	..	1000	100	..
1	400	120	45	400	120	45	..	400	45	..
1	400	125	45	400	125	45	..	400	45	..
2	400	125	45	3	800	250	90	..	800	90	6
2	400	120	45	5	800	240	90	..	800	90	10
2	400	125	45	5	800	250	90	..	800	90	10
2	400	125	45	2	800	250	90	..	800	90	4
								11400	3550	1295		11400	3550	75

* Same ore as employed in Run No. 15.

ANALYSIS OF SLAG PRODUCED.

Cast No.	SiO ₂	Al ₂ O ₃	P ₂ O ₅	CaO	MgO	MnO	FeO	S
96	33.50	20.37	0.055	46.22	12.38	0.10	0.31	2.14
99	34.32	9.86	0.009	37.29	17.25	0.20	0.49	1.32
102	28.42	8.83	0.009	31.90	25.71	0.24	0.82	1.14
105	31.82	12.20	0.055	30.17	23.82	0.20	0.32	1.03
96-105	30.88	9.67	0.014	36.14	20.82	0.14	0.73	1.23

RUN No. 17.

FURNACE.

No alterations were made in the furnace, but a new electrode was put in.

Ore treated. Magnetite from Calabogie mine*
 Reducing agent. Charcoal
 Flux. { Limestone
 { Quartz

ANALYSIS OF RAW MATERIAL.

Calabogie ore:	SiO ₂	4.00%	} Fe = 58.29%
	Fe ₂ O ₃	55.31%	
	FeO	25.20%	
	Al ₂ O ₃	2.24%	} P = 0.415%
	CaO	2.40%	
	MgO	4.00%	
	P ₂ O ₅	0.95%	
	S	0.45%	
CO ₂ and undet.	5.45%		
		100.00%	

The analysis of the charcoal is given in Run 15; of the limestone in Run No. 1; of the quartz no analysis was made.

The furnace was started up at 9 a.m., Feb. 26, with a charge of composition.

Ore. 400 lbs.
 Charcoal. 130 "
 Limestone. 10 "

* Owner, T. B. Caldwell, Esq.

Three of these charges were put in and the composition of the charge changed to:—

Ore.....	400 lbs.
Charcoal.....	120 "
Limestone.....	10 "

Two of these charges were put in.

The electrode came up very quickly after starting and the iron in the crucible, when trying to tap same at 12.30 p.m., was found too cold. 100 lbs. of crude ore was then put in and the iron again tried at 2.00 p.m., but was still too cold. At 2.30 p.m., 100 lbs. more of crude ore were put in and the material in the furnace had to be melted down. Some limestone and carburette briquettes were added from time to time and at 8.30 p.m. the iron was hot enough. During the melting down, iron came through the slag hole every time the slag was tapped. The weight of the iron obtained at 8.30 p.m., (Cast 108), including that which was previously obtained through the slag hole, amounted to 1333 lbs. The weight of the slag was 642 lbs.

The furnace was again started up at 8.30 p.m., Feb. 26, with a charge of composition:—

Ore.....	400 lbs.
Charcoal.....	135 "
Limestone.....	45 "
Quartz.....	5 "

to insure an excess of carbon being present. After the furnace was in working condition the carbon was reduced and later the limestone was reduced and the quartz omitted, a pig iron with low contents of sulphur still being produced.

During the night of Feb. 27 a few charges with Wilbur ore were put in by mistake. A very infusible slag was produced and the electrode started to come up on account of the excess of carbon used in these charges. Crude ore was put in and quartz added to the charge until the furnace was again in its proper condition, when the composition of the charge was made the same as the one employed before the Wilbur ore was put in.

ELECTRICAL MEASUREMENTS.

In this run the connections for the voltmeter were made in the same manner as in Run No. 13, one voltmeter being connected with the electrode and bottom plate of the furnace and the other put in the main circuit.

Time.	Volts on Furnace.	Volts on Line.	Amperes.	Power Factor.
Feb. 26, 8.30 p.m. Furnace started.				
9.00 "	37.0	40.5	5,000	0.919
9.30 "	38.0	41.5	"	"
10.00 "	39.0	42.0	"	"
10.30 "	38.0	41.0	"	"
11.00 "	39.0	42.0	"	"
11.30 "	39.0	42.0	"	"
12.00 "	40.5	44.0	"	"
Feb. 27 12.30 a.m.	38.0	41.0	"	"
1.00 "	38.0	41.0	"	"
1.30 "	36.0	39.0	"	"
2.00 "	36.0	39.0	"	"
2.30 "	34.0	37.0	"	"
3.00 "	36.0	39.0	"	"
3.30 "	37.5	40.0	"	"
4.00 "	36.0	39.0	"	"
4.30 "	38.0	41.0	"	"
5.00 "	36.0	39.0	"	"
5.30 "	36.0	39.0	"	"
6.00 "	35.0	38.0	"	"
6.30 "	37.0	40.0	"	"
7.00 "	38.0	41.0	"	"
7.30 "	37.0	40.5	"	"
8.00 "	37.0	40.5	"	"
8.30 "	35.0	39.0	"	"
9.00 "	37.0	40.5	"	"
9.30 "	38.0	41.5	"	"
10.00 "	37.5	41.0	"	"
10.30 "	38.5	41.5	"	"
11.00 "	37.0	40.0	"	"
11.30 "	38.0	41.5	"	"
12.00 "	38.0	41.5	"	"
12.30 p.m.	35.5	39.0	"	"
1.00 "	35.0	39.0	"	"
1.30 "	37.0	41.0	"	"
2.00 "	36.0	40.0	"	"
2.30 "	38.0	41.5	"	"
3.00 "	37.0	41.0	"	"
3.30 "	37.0	41.0	"	"
4.00 "	38.0	41.0	"	"
4.30 "	36.0	40.0	"	"
5.00 "	36.0	39.5	"	"
5.30 "	39.0	42.5	"	"
6.00 "	40.0	44.0	"	"
6.30 "	39.0	43.0	"	"
7.00 "	38.0	41.5	"	"
7.30 "	37.0	40.0	"	"
8.00 "	37.0	40.5	"	"
8.30 "	36.5	40.0	"	"
9.00 "	36.0	40.0	"	"
9.30 "	35.0	39.0	"	"
10.00 "	39.0	43.0	"	"
10.30 "	40.0	43.5	"	"
11.00 "	38.0	42.0	"	"
11.30 "	38.0	41.5	"	"
12.00 "	37.0	40.5	"	"
Feb. 28 12.30 a.m.	37.0	40.5	"	"
1.00 "	38.0	41.0	"	"
1.30 "	37.0	40.5	"	"
2.00 "	36.5	40.0	"	"
2.30 "	37.0	40.5	"	"

	Time.	Volts on Furnace.	Volts on Line.	Amperes.	Power Factor.
Feb. 28	3 00 a.m.	37.0	40.5	5,000	0.919
	3.30 "	38.5	41.5	"	"
	4.00 "	37.5	41.0	"	"
	4.30 "	36.5	40.0	"	"
	5.00 "	36.5	40.0	"	"
	5.30 "	36.0	39.5	"	"
	6.00 "	36.5	40.0	"	"
	6.30 "	38.0	41.0	"	"
	7.00 "	38.0	41.0	"	"
	7.30 "	36.5	40.0	"	"
	8.00 "	36.0	40.0	"	"
	8.30 "	35.0	39.0	"	"
	9.00 "	34.0	38.0	"	"
	9.30 "	34.0	38.0	"	"
	10.00 "	34.0	38.0	"	"
	10.30 "	36.0	40.0	"	"
	11.00 "	35.0	39.0	"	"
	11.30 "	36.0	40.0	"	"
	12.00 "	39.0	43.0	"	"
	12.30 p.m.	35.0	39.0	"	"
	1.00 "	33.0	37.0	"	"
	1.30 "	34.0	38.0	"	"
	2.00 "	33.5	37.0	"	"
	2.30 "	34.0	38.0	"	"
	3.00 "	33.0	37.0	"	"
	3.30 "	33.0	37.0	"	"
	4.00 "	35.0	38.0	"	"
	4.30 "	34.0	36.0	"	"
	5.00 "	36.0	40.0	"	"
	5.30 "	36.0	40.0	"	"
	6.00 "	39.0	42.5	"	"
	6.30 "	35.0	39.0	"	"
	7.00 "	35.0	39.0	"	"
	7.30 "	38.0	41.5	"	"

From 7.40 p.m., to 2.00 a.m., March 1, the material in the furnace was melted down.

Mean volts on furnace (8.30 p.m., Feb. 26 to 3.45 p.m., Feb. 28)=36.75

Mean volts on line (8.30 p.m., Feb. 26 to 3.45 p.m., Feb. 28)=40.26.

Loss on contacts. 3.51 volts.

Cast No.	Time when Cast	Machine stopped	Effective length of run		Pig Iron obtained	Qual. of Pig Iron	Slag obtained	Ratio Slag Iron
			h.	m.				
109	Feb. 26, 11.30 p.m.		3	..	558	Grey.	257	0.460
110	" 27 3.30 a.m.		4	..	728	"	171	0.235
111	" 7.20 "		3	50	683	"	378	0.553
112	10.20 "		3	..	613	"	250	0.407
113	1.20 p.m.	10 min.	2	50	543	"	147	0.270
114	4.15 "		2	55	631	"	245	0.388
115	7.15 "		3	..	541	"	206	0.380
116	10.15 "		3	..	486	"	114	0.236
117	Feb. 28 1.30 a.m.		3	15	643	"	317	0.493
118	5.00 "		3	30	733	"	317	0.432
119	8.30 "		3	30	701	**	301	0.429
120	11.45 "		3	15	611	"	290	0.474
121	3.45 p.m.		4	..	832	"	272	0.326
109-121	43 hours, 15 min.	10 min.	43 h.	5 m.	8303	Grey.	3265	0.393
122**	Feb. 28, 11.30 p.m.		10 h.	15 m.	1128	Grey.	611	0.541
	Mar. 1, 2.00 a.m.							

*Whiter than previous.

**Material in furnace melted down.

RAW MATERIAL CHARGED.

Number of Charges.	Composition of Charge.				Additional Material.				Total.			
	Ore.	Charcoal.	Limestone.	Quartz.	Ore.	Limestone.	Quartz.	Ore.	Charcoal.	Limestone.	Quartz.	Total.
												lbs.
2	400	135	45	5	800	800	270	90	10	1560
2	400	125	45	5	800	800	250	90	10	1560
2	400	125	45	..	800	800	250	90	..	1560
12	400	125	20	..	4800	4800	1500	240	..	7560
2	400*	125	20	..	800	800	250	40	..	1340
1	400*	125	20	3	400	..	20	400	125	20	23	978
2	400*	125	20	5	800	..	40	800	250	40	50	1360
4	400	125	20	5	150	30	15	1750	500	110	35	2400
7	400	120	20	5	200	20	20	3000	840	160	..	4000
4}	400	125	20	1800	562	90	..	2452
								15750	4797	970	183	21700

* By mistake a few charges with Wilbur ore were put in.

Cast No.	Pig Iron obtained	Average Volts on Furnace	Average Amperes	Power Factor	Average Watts	Average El. Horse Power	Output of Pig Iron per 1000 E. H. P. days
	lbs.						Tons.
109	558	38.33	5000	0.919	176126	236.09	9.45
110	728	37.00	"	"	170015	227.90	9.58
111	683	36.57	"	"	168039	225.25	9.51
112	613	36.91	"	"	169601	227.34	10.79
113	543	37.00	"	"	170015	227.90	10.10
114	631	37.17	"	"	170796	228.94	11.36
115	541	38.00	"	"	174610	234.06	9.24
116	486	36.75	"	"	168866	226.36	8.59
117	643	37.86	"	"	173966	233.19	10.18
118	733	37.07	"	"	170336	228.33	11.00
119	701	36.57	"	"	168039	225.25	10.67
120	611	34.83	"	"	160044	214.53	10.51
121	832	34.31	"	"	157654	211.33	11.81
109-121	8303	36.75	5000	0.919	168866	226.36	10.217

Length of run. 43 hours, 5 min.

Mean volts on furnace. 36.75

Mean amperes. 5,000

Power factor. 0.919

Watts= $36.75 \times 5,000 \times 0.919$ 168866

Pig iron obtained. 8303 lbs.

168866

El. horse power $\frac{168866}{746}$ 226.36

746

Output of pig iron per 1000 El. horse power days= $\frac{8303 \times 1000 \times 24}{43.08 \times 226.36 \times 2000}$

$8303 \times 1000 \times 24$

10.217 tons

$43.08 \times 226.36 \times 2000$

El. horse power year per ton of pig=0.268

Charcoal used per ton of pig=1017 lbs.

ANALYSIS OF PIG IRON PRODUCED.

Cast No.	Si	S	P	Mn	Graphitic Carbon	Total Carbon
109	1.99	0.021	0.456	Trace	2.12	3.71
110	1.75	0.021				
111	1.53	0.012	0.645	Trace	2.46	3.60
112	2.20	0.017				
113	1.39	0.009	0.476	Trace	3.00	3.70
114	1.10	0.054				
115	1.99	0.009	0.512	Trace	3.00	3.47
116	1.65	0.007				
117	1.51	0.006	0.102	Trace	3.30	4.02
118	1.46	0.011				
120		0.078				
121	1.43	0.045	0.465	Trace	1.10	3.28

ANALYSIS OF SLAG PRODUCED.

Cast No.	SiO ₂	Al ₂ O ₃	P ₂ O ₅	CaO	MgO	MnO	FeO	S
109	36.21	15.40	0.014	34.42	13.22	0.26	0.26	1.07
115	28.10	18.80	0.096	34.51	17.00	0.38	0.26	1.55
117	41.00	9.07	0.018	25.60	23.22	0.28	0.39	0.03
121	33.18	16.15	0.009	32.21	17.00	0.22	0.30	1.17
109-122	33.06	15.22	0.016	33.00	16.92	0.32	0.37	1.17

RUN No. 18.

FURNACE.

No alterations were made in the furnace.

Ore treated. Roasted pyrrhotite*
 Reducing agent. Charcoal
 Flux. Limestone

ANALYSIS OF RAW MATERIAL.

Roasted Pyrrhotite	SiO ₂	10.96%	} Fe=45.80%
	Fe ₂ O ₃	65.43%	
	Al ₂ O ₃	3.31%	
	CaO	3.92%	
	MgO	3.53%	
	S	1.56%	
	P	0.016%	
	Cu	0.41%	
Ni	2.23%		

The analysis of the charcoal is given in Run No. 16 and of the limestone in Run No. 1.

The furnace was started up at 2.15 a.m., March 1, with a charge of composition:—

Ore. 400 lbs.
 Charcoal. 120 "
 Limestone. 120 "

* The pyrrhotite came from the mines near Sudbury, Ont., and was finely crushed and roasted at the Lake Superior Corporation's plant at Sault Ste. Marie for the production of sulphuric acid gas. The roasted ore was afterwards briquette^d with some lime.

The ferro-nickel pig produced was very low in sulphur. The limestone and charcoal in the charge were gradually decreased until the composition was:—

Ore.	400 lbs.
Charcoal.	105 "
Limestone.	40 "

When decreasing the limestone in the charge, the silicon in the pig increased, but the sulphur was still very low. The large amount of slag produced naturally decreased the output and for a commercial production of ferro-nickel pig from this ore, when the silicon contents have to be kept between 2 and 2.5%, necessitating further addition of lime, the output will decrease still more.

After the conclusion of the experiments the plant was bought by the Lake Superior Corporation, and the furnace was employed for the production of ferro-nickel pig during several months. The results then obtained are given later.

ELECTRICAL MEASUREMENTS.

The same electrode and connections with the voltmeters as in the previous run were employed.

Time.	Volts on Furnace.	Volts on Line.	Amperes.	Power Factor.
Mar. 1, 2.15 a.m. Furnace started.				
2.30 "	38.0	42.0	5,000	0.919
3.00 "	37.0	41.0	"	"
3.30 "	37.0	41.0	"	"
4.00 "	38.0	42.0	"	"
4.30 "	37.0	41.0	"	"
5.00 "	36.5	40.0	"	"
5.30 "	36.0	39.0	"	"
6.00 "	36.5	39.5	"	"
6.30 "	36.0	39.0	"	"
7.00 "	37.0	41.0	"	"
7.30 "	35.0	39.0	"	"
8.00 "	35.0	39.0	"	"
8.30 "	36.0	40.0	"	"
9.00 "	37.0	40.0	"	"
9.30 "	37.0	40.0	"	"
10.00 "	35.5	39.0	"	"
10.30 "	35.0	39.0	"	"
11.00 "	36.0	40.0	"	"
11.30 "	38.0	42.0	"	"
12.00 "	39.0	42.5	"	"
12.30 p.m.	38.0	41.5	"	"
1.00 "	37.0	40.0	"	"
1.30 "	38.0	41.0	"	"

	Time.	Volts on Furnace.	Volts on Line.	Amperes.	Power Factor.
Mar. 1,	2 00 p.m.	38 0	41 0	5,000	0 919
	2 30 "	37 0	40 0	"	"
	3 00 "	38 0	41 0	"	"
	3 30 "	36 0	40 0	"	"
	4 00 "	35 5	39 5	"	"
	4 30 "	35 0	39 0	"	"
	5 00 "	36 0	40 0	"	"
	5 30 "	38 0	42 0	"	"
	6 00 "	38 0	42 0	"	"
	6 30 "	37 0	40 5	"	"
	7 00 "	35 0	39 0	"	"
	7 30 "	37 0	41 0	"	"
	8 00 "	36 0	40 0	"	"
	8 30 "	38 0	41 5	"	"
	9 00 "	39 0	42 5	"	"
	9 30 "	37 0	41 0	"	"
	10 00 "	38 0	41 5	"	"
	10 30 "	37 0	41 0	"	"
	11 00 "	37 0	41 0	"	"
	11 30 "	38 0	42 0	"	"
	12 00 "	36 5	40 0	"	"
Mar. 2	12 30 a.m.	37 5	40 0	"	"
	1 00 "	38 0	41 5	"	"
	1 30 "	37 0	40 5	"	"
	2 00 "	37 5	41 5	"	"
	2 30 "	38 0	41 5	"	"
	3 00 "	36 0	39 5	"	"
	3 30 "	35 5	39 0	"	"
	4 00 "	35 0	38 0	"	"
	4 30 "	36 0	39 5	"	"
	5 00 "	35 0	39 0	"	"
	5 30 "	33 5	37 5	"	"
	6 00 "	34 0	37 5	"	"
	6 30 "	36 0	40 0	"	"
	7 00 "	37 0	40 5	"	"
	7 30 "	36 0	39 0	"	"
	8 00 "	36 0	39 0	"	"
	8 30 "	37 0	40 0	"	"
	9 00 "	36 0	39 0	"	"
	9 30 "	35 0	39 0	"	"
	10 00 "	36 0	40 0	"	"
	10 30 "	37 0	40 5	"	"
	11 00 "	38 0	41 0	"	"
	11 30 "	36 5	40 0	"	"
	12 00 "	38 0	41 0	"	"
	12 30 p.m.	37 0	40 0	"	"
	1 00 "	35 0	38 5	"	"
	1 30 "	37 0	40 0	"	"
	2 00 "	36 0	39 0	"	"
	2 30 "	35 0	38 0	"	"
	3 00 "	36 0	39 0	"	"
	3 30 "	35 0	38 5	"	"
	4 00 "	35 5	39 0	"	"
	4 30 "	35 0	38 5	"	"
	5 00 "	36 0	40 0	"	"
	5 30 "	36 0	40 0	"	"
	6 00 "	37 0	41 0	"	"
	6 30 "	37 0	40 5	"	"
	7 00 "	37 0	40 0	"	"
	7 30 "	37 0	40 0	"	"
	8 00 "	37 0	40 0	"	"

Time.		Volts on Furnace.	Volts on Line.	Amperes.	Power. Factor.
Mar. 2,	8 30 p.m.	34 5	38 0	5,000	0 919
	9 00 "	33 0	36 5	"	"
	9 30 "	31 5	38 0	"	"
	10 00 "	35 0	39 0	"	"
	10 30 "	35 0	39 0	"	"
	11 00 "	36 0	40 6	"	"
	11 30 "	36 0	40 0	"	"
	12 00 "	35 0	39 0	"	"
Mar. 3,	12 30 a.m.	34 0	39 0	"	"
	1 00 "	34 0	39 0	"	"
	1 30 "	35 0	39 5	"	"
	2 00 "	34 0	39 0	"	"
	2 30 "	36 0	40 0	"	"
	3 00 "	35 5	39 5	"	"
	3 30 "	39 0	42 0	"	"
	4 00 "	37 0	40 0	"	"
	4 30 "	36 0	40 0	"	"
	5 00 "	35 0	39 0	"	"
	5 30 "	35 0	39 0	"	"
	6 00 "	34 0	38 0	"	"
	6 30 "	36 0	40 0	"	"
	7 00 "	36 0	40 0	"	"
	7 30 "	36 0	40 0	"	"
	8 00 "	34 0	38 0	"	"
	8 30 "	34 0	38 0	"	"
	9 00 "	33 0	37 0	"	"
	9 30 "	33 0	37 0	"	"
	10 00 "	33 0	36 5	"	"
	10 30 "	31 0	3 0	"	"
	11 00 "	36 0	39 5	"	"
	11 10 "	Run terminated.			

Mean volts on furnace == 36.12

Mean volts on line == 39.76

Loss on contacts == 3.64 volts

Cast No.	Time when Cast	Machine stopped	Effective length of run		Pig Iron obtained	Quality of Pig Iron	Slag obtained	Ratio Slag Iron
			h	m				
123	Mar. 1	6.15 a.m.	4		546	Grey.	377	0.690
124		10.15 "	4		514	"	332	0.646
125		3.10 p.m.	4	55	596	"	472	0.792
126		8.10 " 5 min.	4	55	717	"	486	0.678
127	Mar. 2	1.15 a.m.	5	5	612	"	512	0.836
128		5.25 "	4	10	505	"	410	0.811
129		9.15 "	3	50	500	"	371	0.742
130		1.15 p.m.	4		476	"	362	0.760
131		5.10 "	3	55	541	"	338	0.624
132		9.30 " 5 min.	4	15	610	"	554	0.908
133	Mar. 3	1.55 a.m. 5 min.	4	20	634	"	345	0.544
134		7.40 " 20 min.	5	25	677	"	344	0.508
135		11.10 "	3	30	408	"	157	0.385
123-135	56 hours, 55 min.	35 min	56 h.	20 m	7336	Grey.	5060	0.689

RAW MATERIAL CHARGED.

Number of Charges.	Composition of Charge.				Additional Material.						Total.			
	Ore.		Charcoal.	Limestone.	Ore.	Charcoal.	Quartz.	Fluorspar.	Ore.	Charcoal.		Limestone.	Quartz.	Fluorspar.
	Ibs.		Ibs.	Ibs.	Ibs.	Ibs.	Ibs.	Ibs.	Ibs.	Ibs.		Ibs.	Ibs.	Ibs.
10	400		120											
12	400		110	100			20							
3	400		110	75										
2	400		110	60	50			20					20	
3	400		105	50	50			20				20		
1	400		105	40										
5	400		110	50		10							5	
									14500	4050	3185	40	25	

Cast No.	Pig Iron obtained	Average Volts on Furnace	Average Amperes	Power Factor	Average Watts	Average El. Horse Power	Output of Pig Iron per 1000 E. H. P. days
	lbs.						Tons.
123	516	37.00	5000	0.919	170015	227.00	7.18
124	511	36.06	"	"	165695	222.11	6.91
125	596	37.10	"	"	171853	230.36	6.32
126	717	36.35	"	"	167028	223.89	7.82
127	612	37.60	"	"	172772	231.50	6.21
128	505	36.25	"	"	166508	223.28	6.52
129	500	35.69	"	"	163995	219.83	7.12
130	476	36.56	"	"	167993	225.19	6.31
131	541	35.60	"	"	163995	219.83	7.55
132	610	35.80	"	"	161914	221.06	7.79
133	631	35.00	"	"	160825	215.58	8.15
134	677	35.79	"	"	161455	220.45	6.81
135	408	33.43	"	"	153611	205.91	6.79
123-135	7336	36.12	5000	0.919	165971	222.48	7.024

Length of run. 56 hours, 20 min.

Mean volts on furnace. 36.12

Mean amperes. 5,000

Power factor. 0.919

Watts= $36.12 \times 5000 \times 0.919$ 165971

Ferro-nickel pig obtained. 7336 lbs.

165971

El. horse power ——— 222.48

746

Output of Ferro-nickel pig per 1000 El. horse power days=

$7338 \times 1000 \times 24$

————— 7.024 tons

$56.33 \times 222.48 \times 2000$

El. horse power year per ton of pig=0.390

Charcoal used per ton of pig=1104 lbs.

ANALYSIS OF FERRO NICKEL PIG PRODUCED.

Cast No.	Si.	S.	P.	Mn.	Graphitic Carbon	Total Carbon	Cu.	Ni.
123		0.009						
124		0.012						
125	4.83	0.006	0.059	0.10	3.05	3.23	0.72	3.68
128		0.005						
129	3.83	0.004	0.042	0.12	3.30	3.40	0.71	4.39
130	4.50	0.006	0.037			3.38	0.87	4.12
131	4.91	0.006	0.043	0.10	2.95	3.40	0.67	4.10
132	4.03		0.012	0.10	2.00	3.15	0.62	4.10
135	7.34	0.006	0.035	0.69	2.10	2.60	0.70	3.70

The furnace was started up at 11.30 p.m., March 3, with a charge of composition:—

Ore.....	400 lbs.
Charcoal.....	110 "
Limestone.....	50 "
Fluorspar.....	80 "

The slag produced was very fluid and the fluorspar in the charge was decreased to 50 lbs. The slag was still very fluid, but further experiments had to be abandoned on account of the bad condition of furnace.

ANALYSIS OF PIG IRON PRODUCED.

CAST No. 137.

Si.....	5.89
S.....	0.011
P.....	0.144
Mn.....	0.12
Total Carbon.....	2.95
Graphitic Carbon.....	2.72
Ti.....	0.43
Cr.....	0.34

ANALYSIS OF SLAG PRODUCED.

	Cast No. 137	Casts Nos. 136-138
SiO ₂	18.70	19.34
Al ₂ O ₃	12.39	12.64
FeO.....	1.40	0.72
CaO.....	24.96	23.90
MgO.....	7.04	9.28
MnO.....	Trace	0.27
Cr ₂ O ₃	Trace	Trace
TiO ₂	17.72	17.34
P ₂ O ₅	0.002	0.002
S.....	0.67	0.60
Fl.....	9.22	8.28

Mr. A. J. Reynolds, New York, has made extensive experiments with titaniferous ores. See Vol. III. Transactions of the American Institute of Mining Engineers and Tests of Titaniferous Slags, by C. N. Cox and L. C. Lennox. Electro-chemical and Metallurgical Industry, Vol. IV., Dec., 1906.

THE SMELTING OF MAGNETITE.

It was expected that considerable difficulty would be experienced in the smelting of magnetite, on account of its conductivity. It was thought that with the furnace in use, in which the electrode was immersed in the charge, the current would disseminate itself laterally from the sides of the electrode through the charge, preventing the current at the reducing and fusion zone from attaining such density as would be required for the high temperature necessary for reduction and fusion. With charcoal as a reducing agent this difficulty was not experienced, nor was the inductance of the furnace increased by the presence of magnetite.

It should, however, be mentioned that the phenomenon of rapid temporary decrease of ohmic resistance of the charge, described by J. Bronn in his article entitled "Zur Anwendung lose geschichteter kleinstückiger Leiter für elektrische Heizwiderstände,"* was occasionally observed in some of the runs made. By adding a few shovels of iron ore, omitting flux and charcoal, it was sometimes possible to cause the electrode, which to keep the current constant had by hand regulation been elevated, to return to its normal position. In some instances, however, this method failed, especially when the furnace was choked with fines and the gases evolved escaped under great pressure. Since the electric installation did not permit the compensation of the temporary increase of conductivity of the charge by decrease of voltage with constancy of current, the electrode in such case rose to the top of the furnace and it became necessary to melt down the charge and start anew.

If the explanation offered by Bronn is correct that the decrease of the ohmic resistance during the "Anheizungsphase" is occasioned by the more intimate contact of the conducting pieces of the charge due to pressure of escaping gases from the pores of the carbon and the carbon dioxide evolved from the limestone, it is evident that preheating the charge, which might be effected by utilizing the carbon monoxide resulting from reduction, would entirely overcome this difficulty, *if the charge were sufficiently porous to permit the gases evolved to escape at low pressure.* Under such conditions the electrode would maintain its normal position throughout the operation, requiring to be lowered only to keep step with its consumption.

The ores treated, with the exception of the hematite and the roasted pyrrhotite, contained a high percentage of magnesia, producing a very infusible slag. When the furnace had been running for some time this infusible material formed a scale around the crucible, the electric energy available not being sufficient to keep it in a molten condition. The crucible and lower

* "Electrotechnische Zeitschrift," 1906, Heft 9.

part of the furnace were, therefore, partially filled up, preventing easy access of the charge to the reducing and melting zone. This slower feeding left the charcoal on top of the furnace exposed to the air a longer time, thus increasing the amount of charcoal required and decreasing the output. With a greater current than was available and consequent higher temperature, the formation of the scale would have been prevented and the output correspondingly increased.

The electric installation at our disposal was far from ideal for electric smelting experiments. Aside from the drop of voltage due to the frequent slipping of the belt connecting motor and generator, it was impossible to increase the current beyond 5,000 amperes at from 35 to 40 volts. This inelasticity of the system prevented the determination of the most suitable current and voltage for a given charge in the furnace.

THE USE OF CHARCOAL AS A REDUCING AGENT.

It was of great importance to ascertain whether charcoal without being briquetted with the ore could be used instead of coal-coke. No difficulty whatever was experienced, in fact so admirably adapted was charcoal, when crushed to pass a $\frac{3}{4}$ inch ring, as a reducing agent in the electric furnace that coke and briquettes of coke with clay were abandoned and all the experiments with magnetite and roasted pyrrhotite described were made with charcoal. Some of the charcoal available was of very poor quality, being little better than charred wood containing only about 56 per cent. of fixed carbon. This and the fact that a considerable quantity of the charcoal was consumed on top of the furnace account for the large quantity of charcoal used per ton of product. A modification of the furnace, protecting the upper layer of the charge from the atmosphere, and the use of charcoal properly carbonized would decrease considerably the amount of charcoal which was actually used in the experiments and consequently reduce the cost of production as given.

POWER FACTOR.

The power factor of the furnace was found by Mr. Chas. Darrall, of the Canadian Westinghouse Company of Hamilton, Ont., to be 0.919. This high power factor is due to the construction of the furnace casing, as previously described.

Since the true electric power is the apparent electric power multiplied by the power factor, it is evident that any error made in the determination of the power factor which tends to decrease its value will appear to decrease

the consumption of energy per ton of product. The large output of 12.12 tons per 1,000 electric horse-power days, *i.e.*, the small amount of electric horse-power absorbed per ton of product in the second Livet experiments, was obtained in a furnace with the abnormally low power factor 0.564. Whatever doubt may be engendered as to the correctness of the figure obtained for the absorption of electric energy on account of this low power factor of the Keller furnace, such doubt cannot arise regarding the figures obtained with the Héroult furnace for the absorption of electric energy in the Government experiments on account of its remarkably high power factor, 0.919.

Moreover, since the cost of alternate current generators increases with increase of capacity, furnaces with high power factors (which can utilize a high percentage of the capacity of the generators) will be more economical as regards the first cost of the electrical installation of an electric smelting plant than furnaces with low power factors.

CONSUMPTION OF ELECTRODE.

A new electrode was put in on February 11. The weight of same was then 937 lbs. After having used the electrode for preheating the furnace it was taken out of the furnace and a few loose pieces at the end knocked off. The weight of these pieces was 17 lbs. The total weight of the electrode when starting was, therefore, 920 lbs.

In the following table the weights of the iron produced and the time consumed are given in detail:—

Date.	Furnace heated.		Time Consumed in Producing.		Material in Furnace Melted Down.	Total Time†		Pig Iron Produced.		Total Pig Iron Produced.	
	hours	min.	Grey Iron.	White Iron.		hours	min.	lbs.	White Iron.		
					hours					min.	hours
Run No. 13—											
Feb. 11.....	12	0	5	20*	1	50	12	55	577	1098	
12.....	9	30	23	20	21	55	5291	1675	
13.....	19	50*	23	20	3514	5291	
14.....	9	40	23	5	2840	4150	
15.....	9	40	..	2840	
Run No. 14—											
Feb. 15.....	8	55*	8	55	928	928	
16.....	23	40	23	40	4630	4630	
17.....	22	0	1	0	23	0	4484	4484	
18.....	9	55	3	0	12	55	3257	2357	
Run No. 15—											
Feb. 18.....	18	25*	8	40	1654	1654	
19.....	8	20	3	0	21	25	2866	2866	
20.....	0	20	16	35	2274	3734	
Run No. 16—											
Feb. 20.....	5	40*	5	40	627	627	
21.....	23	45*	23	45	4274	4274	
22.....	8	55	8	55	2249	2249	
App. Run‡—											
Feb. 23.....	4	15	3	0	7	15	952	952	
Total.....	21	30	192	0	25	5	230	45	37863	4848	42711

* Part of this time used for the first cast on following day.
 † Balance of time current taken off.
 ‡ The furnace was run on Feb. 23 to enable measurements for the calibration of the instruments to be made.

PLATE VIII.

Fig. 1



Fig. 2

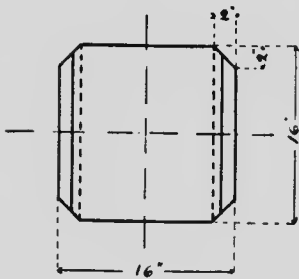
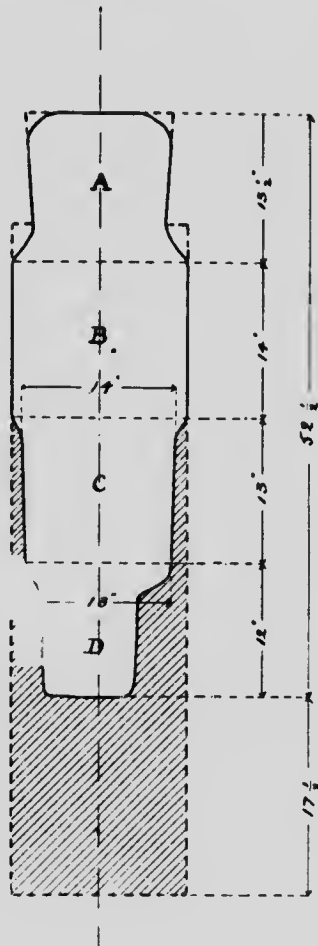

Total pig iron produced = 42,711 lbs.

The electrode was taken out on Feb. 24 to enable an estimate of the consumption of same to be made before the experiments with the roasted pyrrhotite, requiring a very limey slag, were commenced.

The weight of the electrode when taken out was 472 lbs. The upper part of the electrode, not having been protected from the atmosphere, was badly eaten away. This loss can easily be prevented and in the following calculation only the consumption of the lower part of the electrode is taken into account.

In Plate VIII Fig. 1 represents the electrode when put in, and Fig. 2, the electrode when taken out. The shaded part in Fig. 2 represents the electrode consumed.

Volume of electrode when put in:—

$$16 \times 16 \times 70 - 4 \left(\frac{2 \times 2}{2} \times 60 \right) - 2 \times \frac{10}{2} (1.25 + 2) \times 16 =$$

$$16920 \text{ cub. in.} = 9.7916 \text{ cub. feet.}$$

Specific weight =

$$\frac{937}{62.32 \times 9.7916} = 1.535$$

Weight of one cub. in. electrode = 0.0554.

The original length of the electrode was 70 in. Deducting from this the $27\frac{1}{2}$ in., (A + B), which may be considered to be left intact (see Fig. 2, Plate VIII), we have only to deal with the remaining $43\frac{1}{2}$ in.

The weight of piece A	=	94 lbs.
" " " B + C	=	310 "
" " " D	=	6 "

Total weight of electrode when taken out = 472 lbs.

Volume of piece B =

$$16 \times 16 \times 14 - 4 \times \frac{2 \times 2}{2} \times 14 = 3472 \text{ cub. inches.}$$

Weight of piece B = $3472 \times 0.0554 = 192.35$ lbs.

Weight of piece C = $310 - 192.35 = 117.65$ lbs.

Volume of electrode consumed=

$$16 \times 16 \times 42.5 - 4 \times \frac{2 \times 2}{2} \times 42.5 = \text{volumes of C + D} =$$

10540—volumes of C + D eub. inches.

Weight of electrode consumed = $10540 \times 0.0554 = 185.65 - 17^* = 381.26$ lbs.

Consumption of electrode per ton of pig iron produced =

$$\frac{381.26 \times 2000}{42711} = 17.85 \text{ lbs.}$$

MODIFICATION OF EXPERIMENTAL FURNACE FOR COMMERCIAL PRODUCTION OF PIG IRON.

Probably the largest unit which can at present be constructed on the model of the experimental furnace will not exceed 2,000 horse-power.† The construction of the experimental furnace to fit it for the production of pig iron on a commercial scale will require to be modified in the following important particulars:—

(1) The top of the furnace requires to be modified to permit of the application of labor-saving machinery for charging.

(2) Provision requires to be made for the collection and utilization of the carbon monoxide produced by the reduction of the ore; this involves also the protection of the charge from combustion on top of the furnace.

(3) The regulation of the electrode should be effected automatically.

(4) The shaft containing the charge should be sufficiently high to permit the heated CO to effect maximum reduction of ore and the electrode should not be immersed in this shaft but contained in a side chamber supplied with the charge from the main shaft.

For the successful operation of an electric furnace constructed on the lines of the experimental furnace employed it is essential that a certain current density pass through the magma formed beneath the electrode, consisting of unreduced and partially reduced ore, slag and carbon. In using a carbon

* 17 lbs. knocked off lower end.

† A furnace of this capacity is now in process of erection at Baird California.

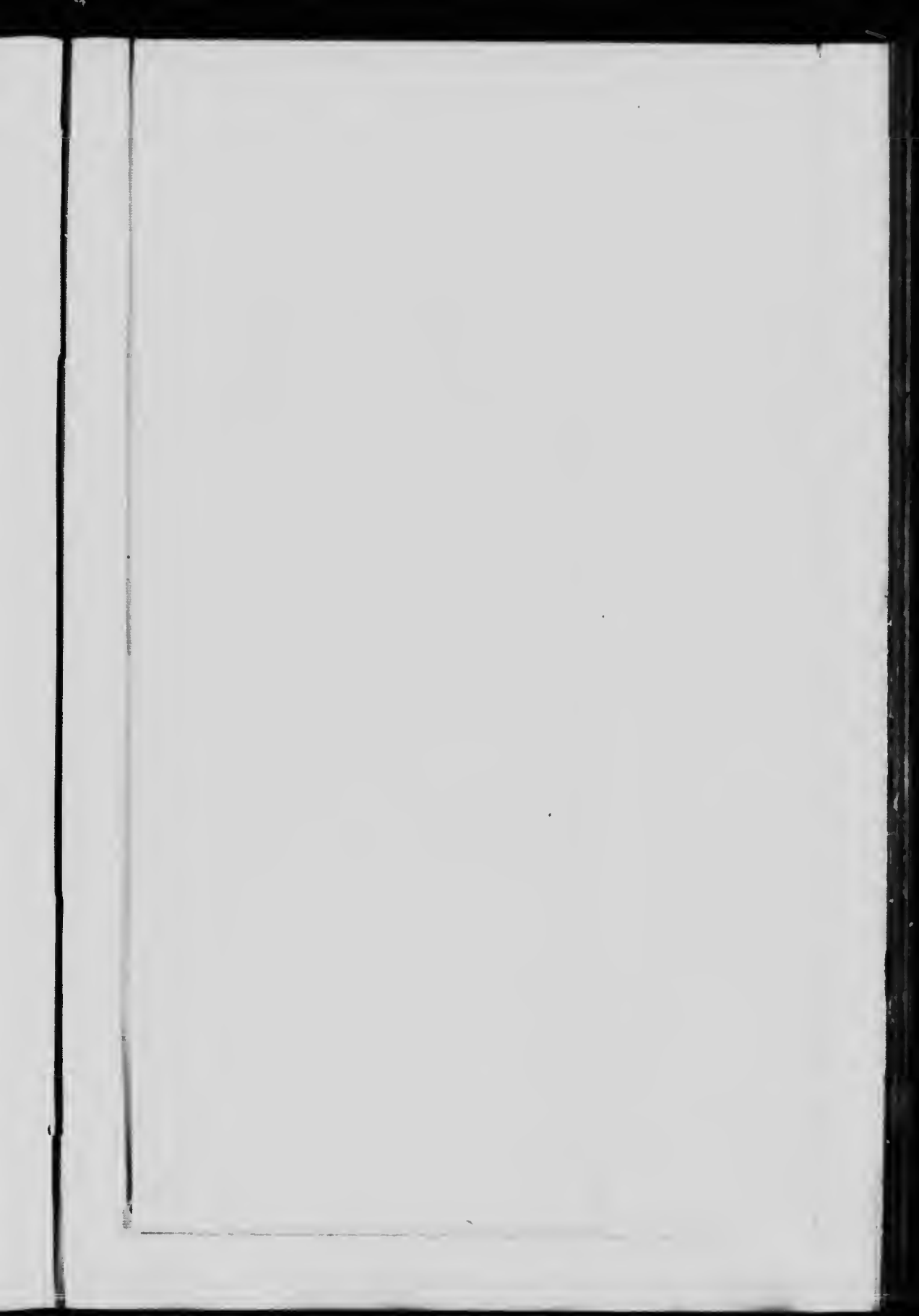

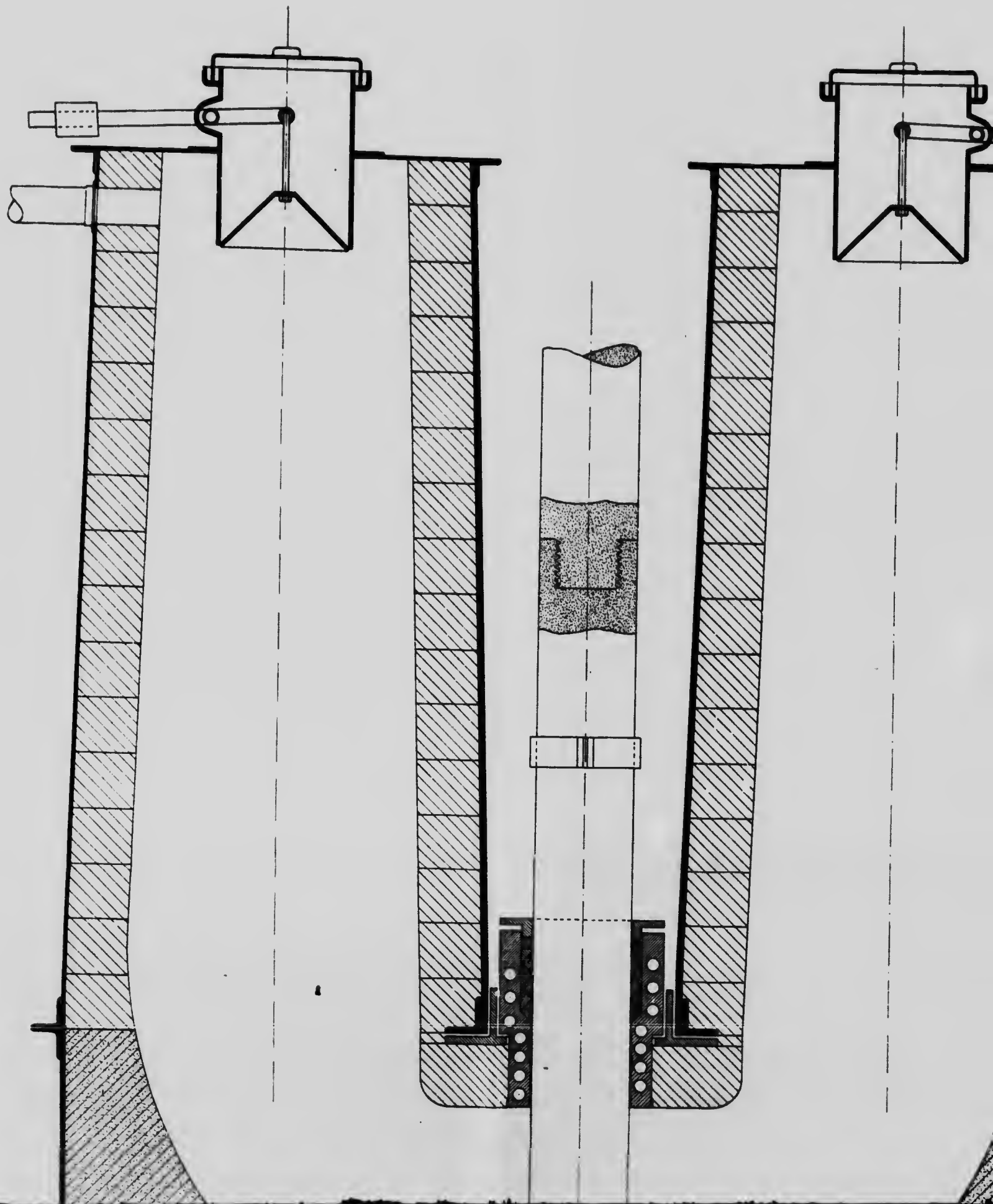

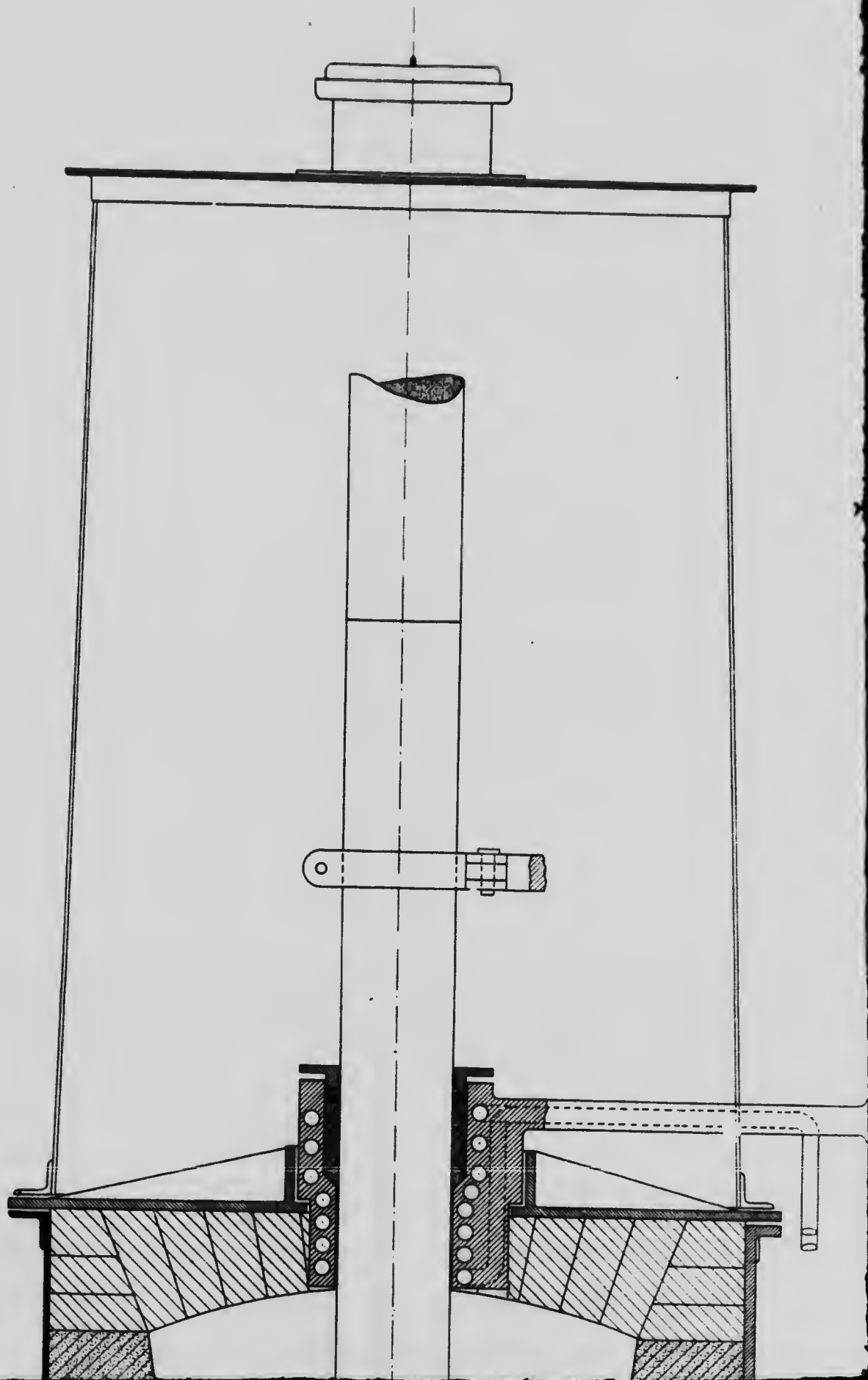
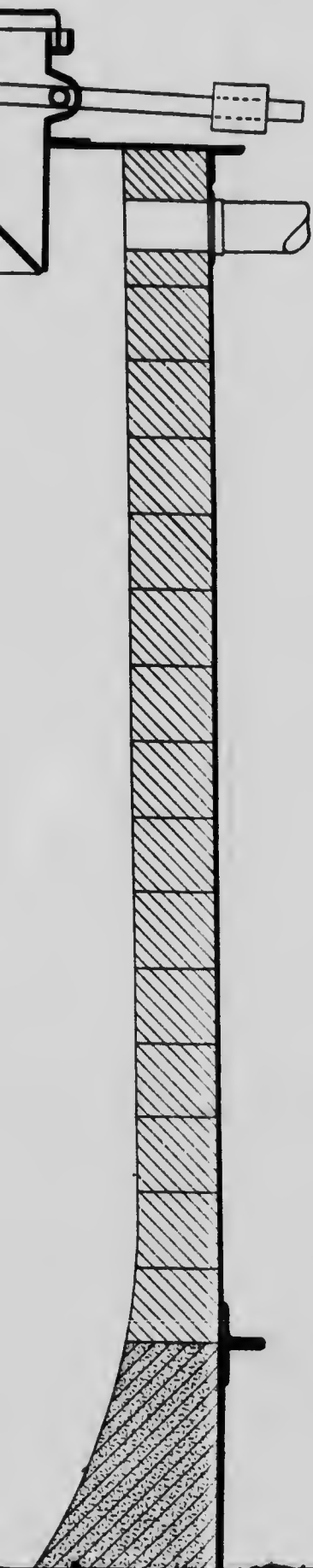

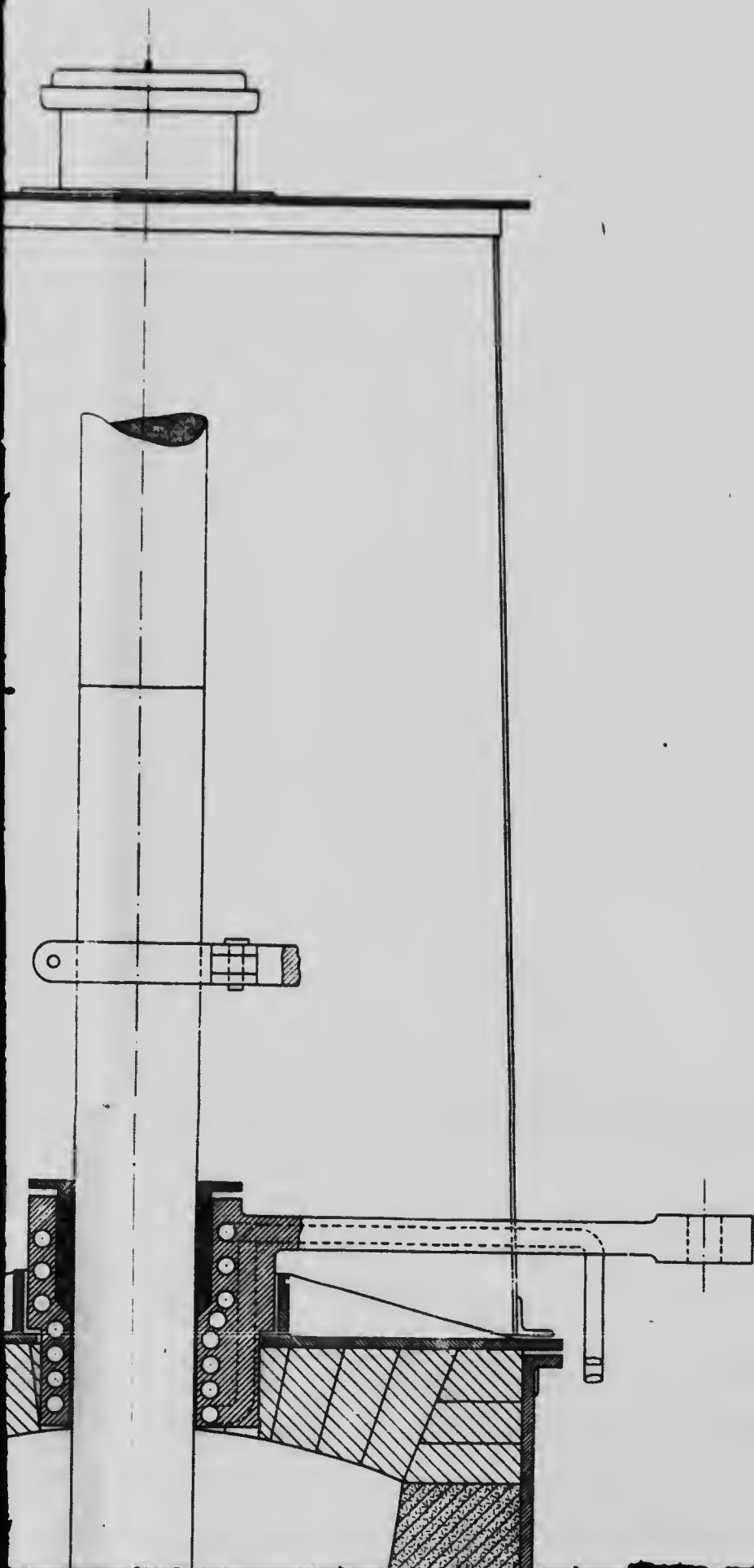

TWO SHA
IS

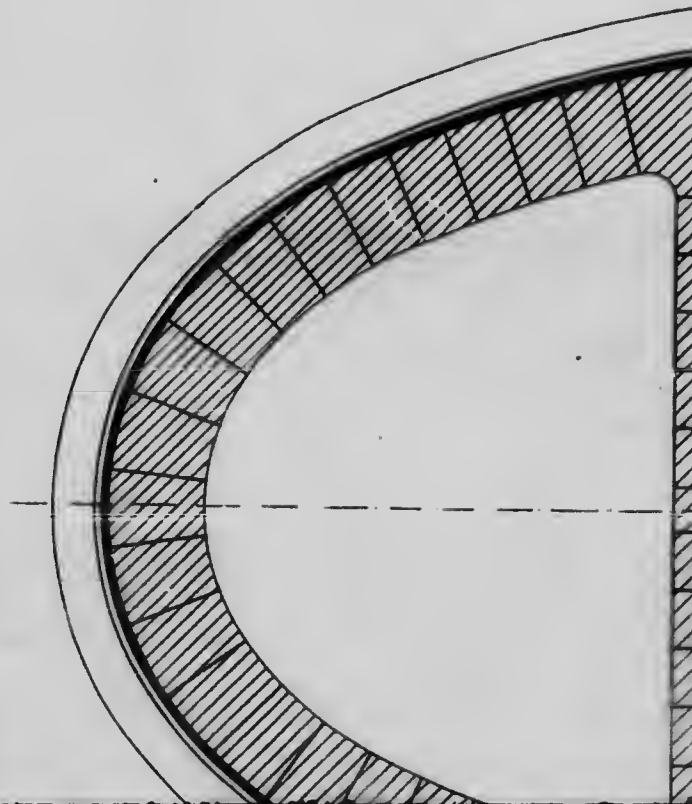
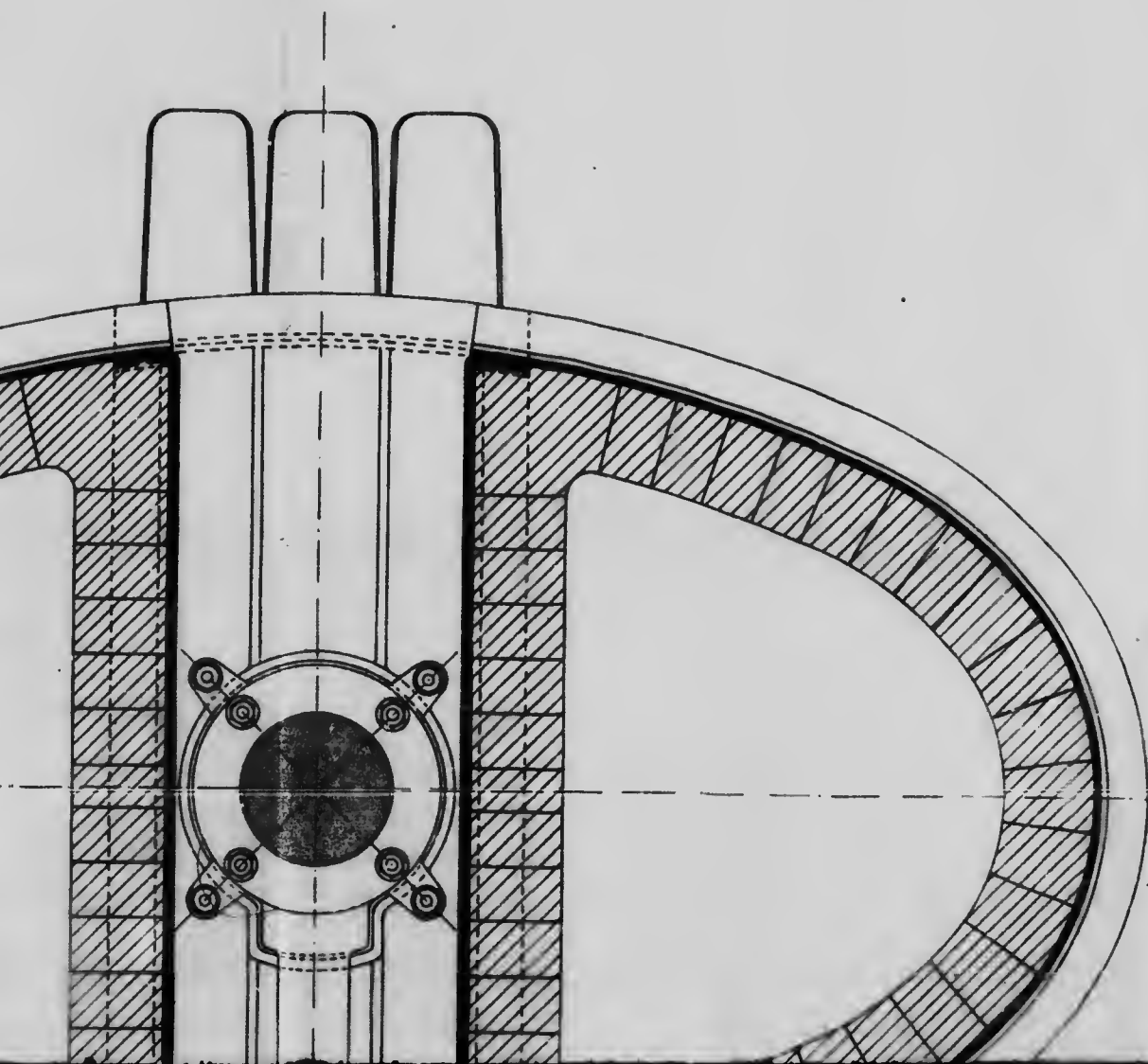
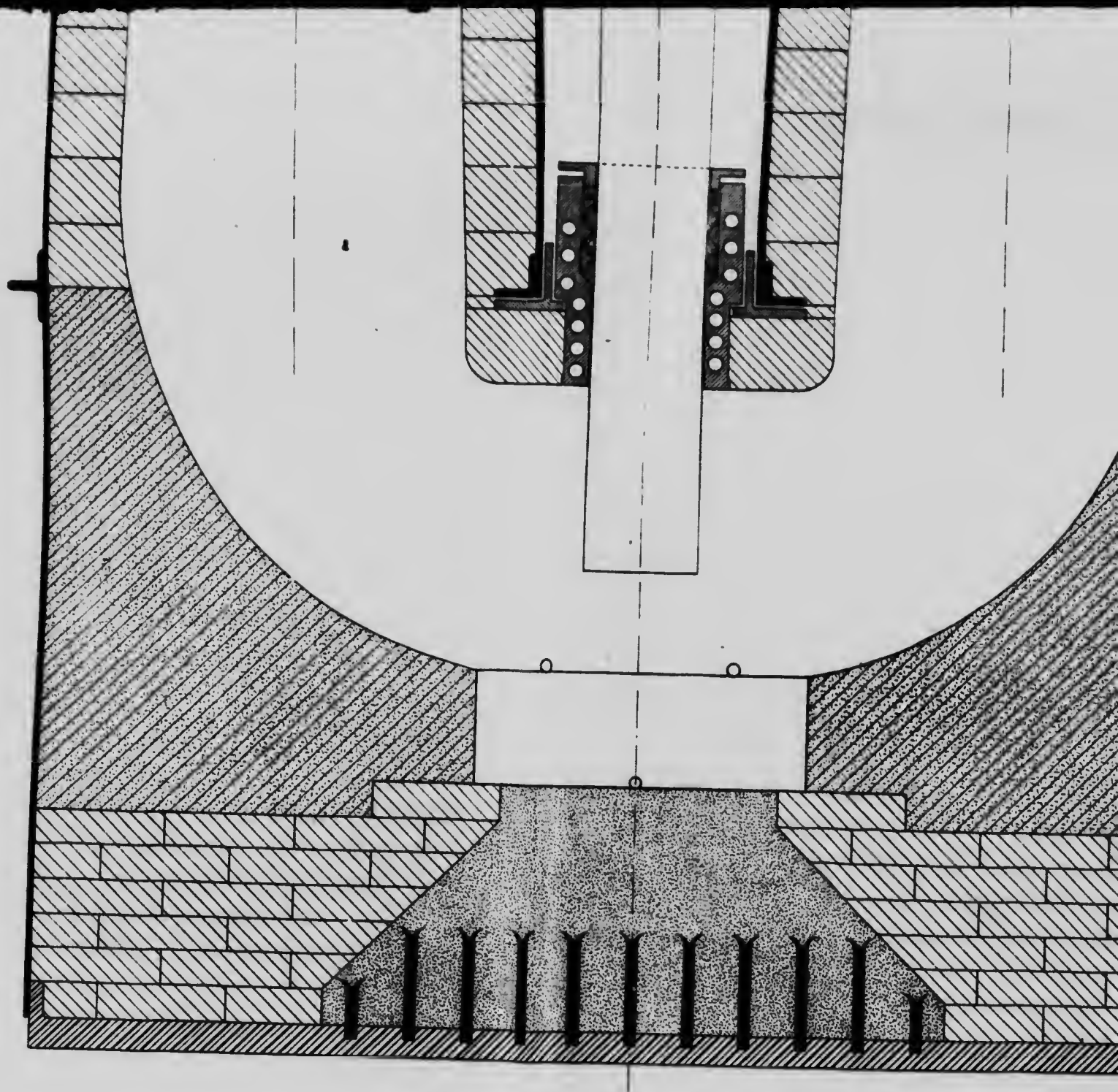

Plate IX

**SHAFT ELECTRIC FURNACE WITH
ISOLATED ELECTRODES**

HAANEL-HÉROULT PATENT





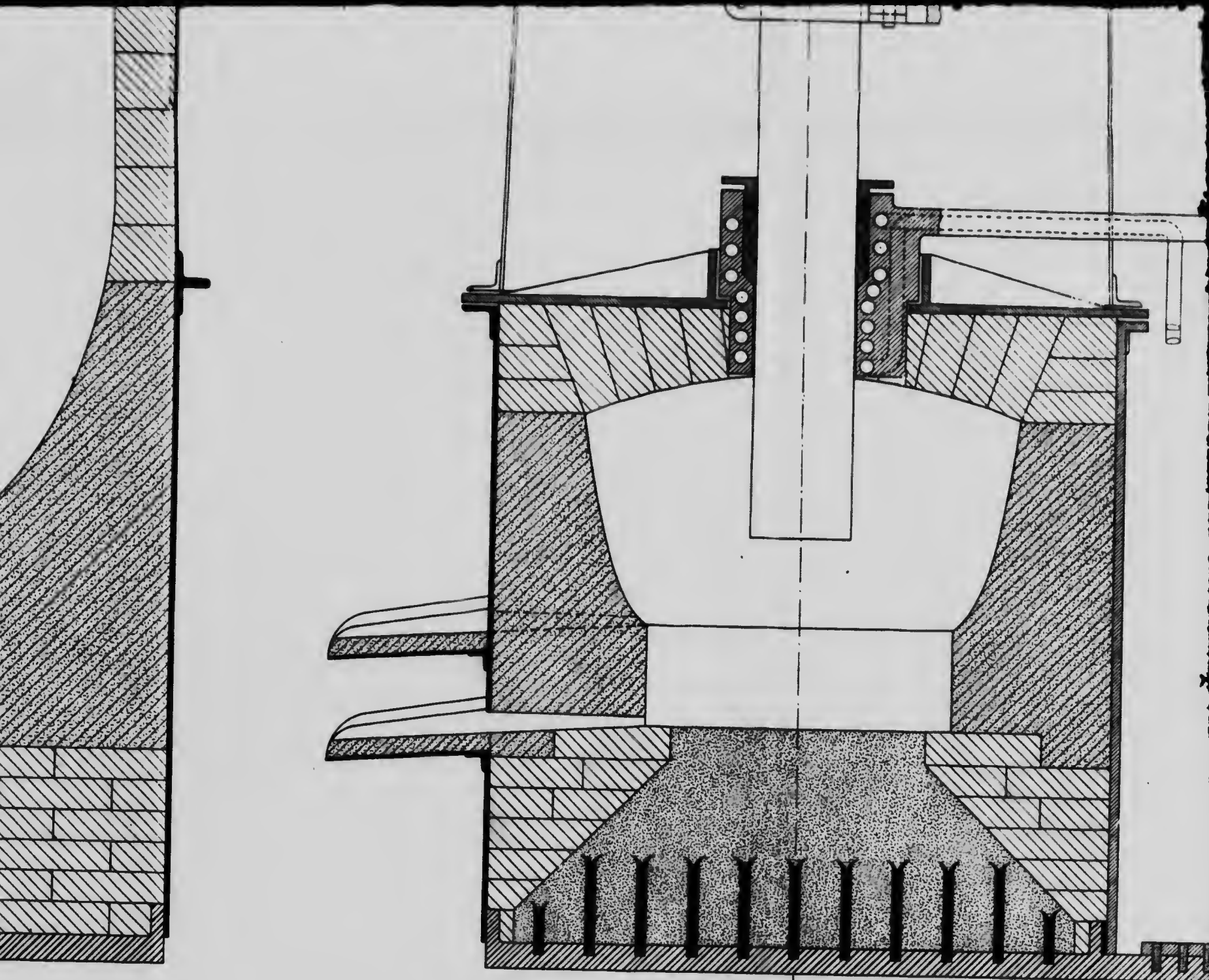

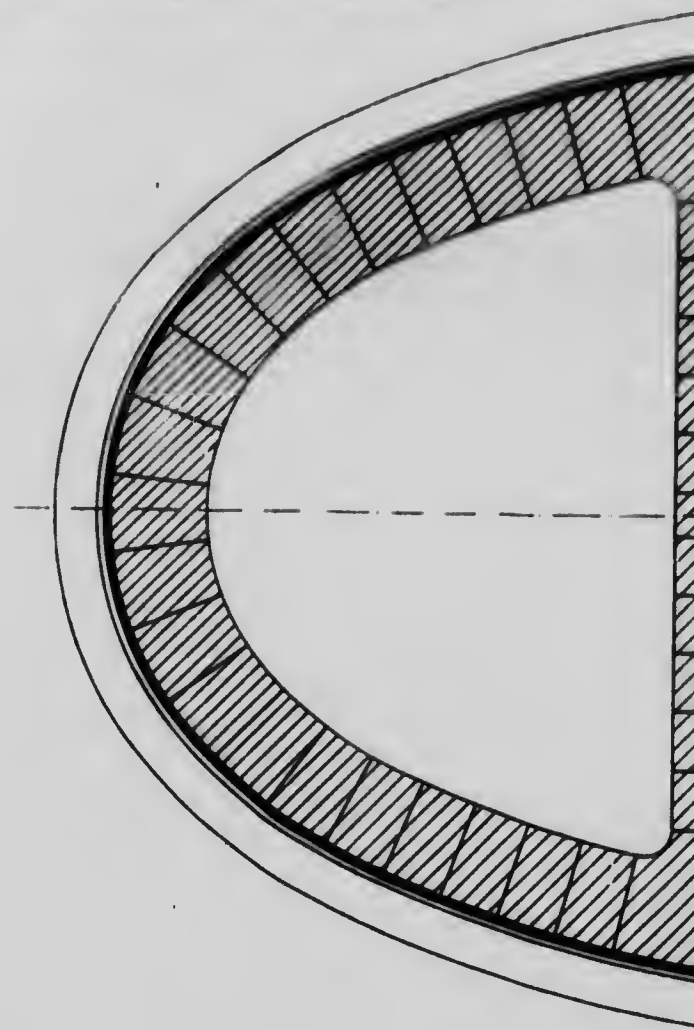
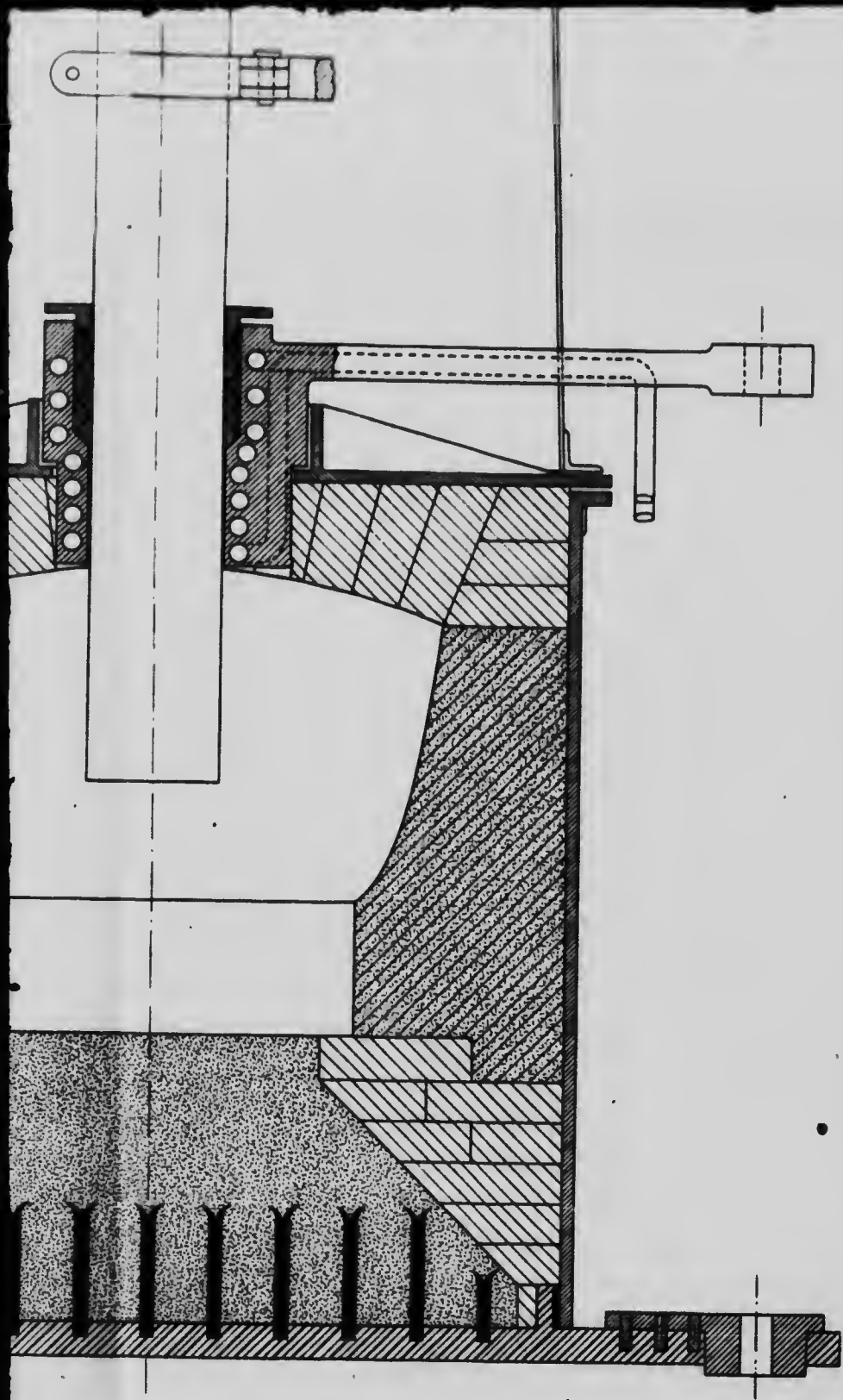

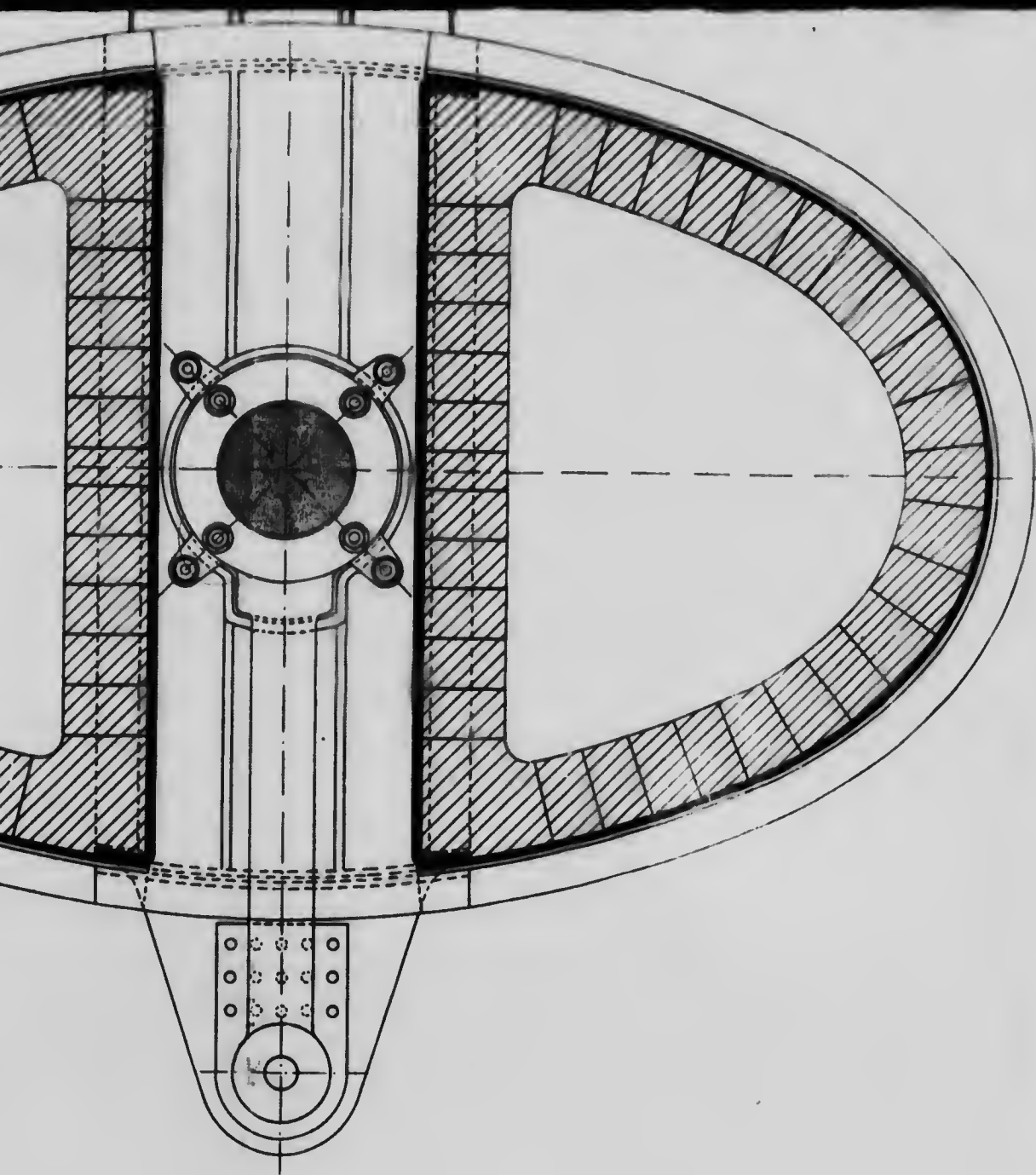

crucible in electric communication with the outer case, it is manifest that the current will distribute itself over the whole area of the crucible and pass out through the case and bottom plate, preventing the requisite rise of temperature immediately below the electrode for the proper working of the furnace. In a number of experiments made it was observed that the furnace worked best when a scale of limey, very infusible slag, containing calcium carbide, had been formed against the sides of the crucible, preventing the dissipation of the current laterally and forcing the current at the requisite density to pass through the magma and melted iron into the bottom plate, which constituted the lower pole. In a new construction of furnace this condition, necessary to successful smelting, should be met by lining the sides of the crucible with magnesia or silica brick, depending on the nature of the slag to be formed, leaving only the carbon bottom in electric communication with the base plate of the furnace. These suggestions are incorporated in the 2-shaft-furnace represented in Plate IX, recently patented.

Moreover, the capacity of the crucible should be adjusted to the energy employed to insure the proper current density for effective working of the furnace. The greater capacity insuring less loss of heat by radiation and the modification of the furnace to permit of the utilization of the carbon monoxide will materially increase the output beyond that ascertained by the experimental furnace. The experiments indicated that under *normal* conditions about 11.5 tons were produced by an expenditure of 1,000 electric horse-power days. It is, therefore, not unreasonable to assume that under similar conditions with a properly constructed plant the output per 1,000 horse-power days would certainly reach 12 tons. This figure has been adopted in calculating cost of production per ton of pig.

The protection of the charcoal of the charge from combustion on top of the furnace will materially decrease the amount of charcoal necessary for reduction and consequently lessen the cost of this item. This saving has, however, not been taken into account in the estimate of cost.

PRODUCTION OF FERRO-NICKEL PIG.

The Lake Superior Corporation has acquired the Government plant by purchase and has employed it for the semi-commercial production of ferro-nickel pig. The furnace operations were left entirely in the hands of the workmen, who had been trained during the progress of the Government experiments. The furnace worked with admirable regularity, the regulation of the electrode requiring hardly any attention, and the output was of excellent and uniform quality.

On account of the value of the product, the smelting of roasted nickeliferous pyrrhotite by the electrothermic process, as carried out with the Govern-

ment experimental plant, admits of immediate commercial application without other modification of the furnace than increase of its capacity.

Mr. E. A. Sjöstedt, Chief Metallurgist of the Lake Superior Power Company, who has had charge of the smelting operations, reports regarding the production of ferro-nickel pig as follows:—

“During the first few weeks of our experiments minor changes in the shape of the furnace were made, also in the electrode holder, the lime charges were purposely kept low (from 15 to 18 per cent. of the ore charge) in order to observe the influence and efficiency of the lime in the elimination of the sulphur and silicon. During this time the furnace product averaged 2,700 lbs. per diem of ferro-nickel with 0.01 per cent. S and Si contents, varying from 5 to 11 per cent. Returning to our old practice and running on 50 per cent. lime charge, the product decreased somewhat (yielding from April 4 to May 5 on an average 2,456 lbs. per diem), but the Si contents were reduced to about 3 per cent. The further increase of the lime charge tended to further decrease the Si contents, but at the sacrifice of the production. Finally we settled down to an ore charge of 400 lbs. of briquettes (carrying from 1.5 to 2.25 per cent. S), 140 to 150 lbs. limestone of the composition given in Run No. 1 and about 120 lbs. charcoal.

Up to August 1 about 168 short tons of ferro-nickel pig had thus been produced. Omitting the first few weeks and taking into consideration only the four full months, April to July, inclusive, during which time the furnace was in continuous operation, with the exception of such unavoidable interruptions as were caused at the power plant and for the changing of electrodes, the following average results were obtained:—

Total product.	154 short tons.
Total working time, 114.8 days of 24 hours.	
Average product per working day.	1.3415 short tons.
Mean volts on furnace.	38
Mean amperes.	4,800
Power factor.	0.919
Mean electric horse-power on furnace, approx . . .	225

Output of ferro-nickel pig per 1,000 E. H. P. days=

$$\frac{1.3415 \times 1,000}{225} = 5.96 \text{ short tons.}$$

During this period the following average amounts of raw material were consumed for the production of one short ton of ferro-nickel pig (of an average

composition of about 2.75 per cent. Si; 0.01 per cent. S; 0.03 per cent. P; 4 per cent. N₂; and 0.8 per cent. (Cu) —

Roasted pyrrhotite (about 2 per cent. S content)	2 tons.
Limestone	1,500 lbs.
Charcoal, 60 bushels at 20 lbs	1,200 "
Electrodes	40 "

THE ELECTRIC FURNACE AS COMPARED WITH THE BLAST FURNACE.

The tendency among iron manufacturers for some time has been to increase the size and capacity of blast-furnaces until the enormous capacity of 600 to 800 tons per day with a furnace stack 100 feet high has been reached.

But for the economical working of a blast-furnace there is a point beyond which the furnace can be neither increased nor decreased in size. It seems to have been established that furnaces with a height of 90 feet and corresponding output prove the most economical. While fuel is cheap and ore of good quality and high iron content is still abundant, any disadvantages of such large units will not be felt. It may, however, be of value to call attention to some of the disadvantages connected with the employment of large units. These are as follows:—

- 1st—Large first cost of furnace.
- 2nd—Excessive cost of charging machinery and upkeep of same.
- 3rd—Large expense and probable idleness through break-down.
- 4th—Cost of and difficulties of making repairs, relining, etc.
- 5th—Serious complications resulting from scaffolding, involving loss of life and money.
- 6th—Financial loss resulting from wrong composition of charge, involving many tons of iron before correction can be made.

Yet, with even these drawbacks the blast-furnace of to-day, representing the result of a hundred years' experience and inventive skill, must be pronounced a perfect machine, hardly permitting further improvement, and if the electric furnace, which is yet in its infancy, is able in its present state of development to compete with a blast-furnace under the special conditions of cheap electric energy and high price of metallurgical fuel, what may we not expect of its performance when all the calories available in an electric furnace will have been utilized by proper design, as the result of years of experience?

It is, therefore, scarcely to the point to speak of faults or disadvantages of a new invention, which, as they are realized, may be corrected, but it is of great importance to point out any advantages a new apparatus may possess over a long-tried machine. The following are some points in favor of the electric furnace:—

- 1st—Original small cost of furnace.
- 2nd—Absence of bulky or costly charging machinery.
- 3rd—Small expense involved through breakdown.
- 4th—Small cost and ease with which repairs may be made.
- 5th—No serious complications arising from scaffolding.
- 6th—Loss due to wrong composition of charge reduced to a minimum.
- 7th—Perfect control of the temperature in the reducing and melting zone.

In reviewing the advantages arising from the introduction of the electric furnace, it must be understood that a smelting plant operated by electricity is composed of several small units, the disablement of any one of which will not render the plant idle. Again, in case of accident, such a furnace will cool down in a comparatively short time, permitting repairs to be made in the least possible time.

It is well known that blast furnaces, producing cyanide of potassium, yield a bad quality of iron. The formation of cyanides in the blast furnace is effected by the nitrogen of the blast in presence of a basic slag, and concurrently the nitrogen combines with the ferrite to form nitride of iron, the presence of which in the iron renders it brittle. This fact has only lately been discovered, and since then we must reckon nitrogen a new enemy of the metal, iron. All processes, therefore, which employ in the production of iron and steel atmospheric combustion as the heating agent, may lead to the introduction of nitride of iron in the resulting product, and hence injuriously affect the mechanical qualities of iron and steel. This explains what has so far been regarded as inexplicable—that certain iron and steels with low sulphur and phosphorus show great brittleness. It is for this now known reason that electrically produced iron and steel are superior to that made by the old process, since nitrogen is eliminated from the process.

GENERAL REMARKS.

The far-reaching consequence of the gratifying results achieved by these experiments will at once be apparent. Many of our magnetites are too high in sulphur to be handled by the blast-furnace and consequently have so far been of no commercial value. But the very best of pig iron, as has been

proven, can be made from ores which contain as high as 1.5 per cent. of sulphur. A blast-furnace will not usually handle an ore which contains more than 0.1 per cent. of sulphur and requires, therefore, an ore which cannot be obtained at a low figure.

Regarding the water-power required for the application of this process it may be stated that many water-powers exist in Ontario and Quebec, surrounded by iron ore fields, in localities ill adapted for the application of electric energy for any other purpose, which could be developed to furnish an electric horse-power year for from \$4.50 to \$6.00. With such a price for the energy required, the small consumption of electrode, the cheapness of the ore employed and the peculiar excellence of the pig iron produced, electric smelting of iron ores in Canada in properly constructed furnaces, using charcoal or peat-coke made from our peat bogs of enormous extent, may be pronounced commercially feasible. Under the prevailing conditions in Canada it now only remains for the engineer to design a plant on a commercial scale, say of 100 to 150 tons daily output, with all the necessary labor-saving appliances. Just as in the case of the blast-furnace so likewise with the electric furnace, experience gained will result in further economy and the day may not be far distant when the carbon monoxide, which is of high calorific value and which at present as a product of the reaction taking place in the electric furnace is allowed to escape without utilization, will be employed for increasing the output by something like one-fourth. When this is accomplished, the blast-furnace could not compete with the electric furnace, even under conditions where coke might be cheaper than at present quoted in Ontario and Quebec.

With the present advance which has been made in the transmission of electric energy, batteries of electric furnaces could be set up at various iron ore deposits, which could be fed with electric energy from some centrally located water-power, thus effecting a saving of the transportation costs of the ore from the mine to the furnace.

The following is a summary of the results of the experiments which have been made under Government auspices at Sault Ste. Marie:—

- 1st—Canadian ores chiefly magnetites can be as economically smelted as hematites by the electrothermic process.
- 2nd—Ores of high sulphur content can be made into pig iron containing only a few thousandths of a per cent. of sulphur.
- 3rd—The silicon content can be varied as required for the class of pig to be produced.

4th—Charcoal which can be cheaply produced from mill refuse or wood which could not otherwise be utilized and peat-coke can be substituted for coke without being briquetted with the ore.

5th—A ferro-nickel pig can be produced practically free from sulphur and of fine quality from roasted nickeliferous pyrrhotite.

6th—Titaniferous iron ores containing up to 5 per cent. can be successfully treated by the electrothermic process. This conclusion is based upon an experiment made with an ore containing 17.82 per cent. of titanitic acid, yielding a pig iron of good quality.

The results of the introduction of electric smelting into countries possessing iron ore deposits and water-powers, but lacking metallurgical fuel, may be summarized as follows:—

1st—The utilization of water-powers which cannot at present be profitably employed for any other purpose.

2nd—The utilization of peat bogs for the production of peat coke, to be used as reducing material for the operation of electric furnaces, and utilization of mill refuse and sawdust, for which there has so far been no practical use.

3rd—Rendering such countries independent of fuel import for metallurgical processes.

4th—Enabling them to produce their own pig iron for home consumption and consequently retaining in their country the money which otherwise would have to be sent abroad to purchase pig iron in the crude and manufactured state.

5th—The development of steel plants and rolling mills using only electric energy.

**Estimate for a 10,000 Horse-power Plant Producing 120 Tons of Pig Iron
per day of Twenty-four Hours.***

Furnaces, contacts, overhead work.....	\$ 24,500
Bins, chutes, elevators.....	14,000
Crushers.....	4,000
Hoists and regulators.....	10,500
Instruments.....	1,400
Cables for conductors.....	8,400
Building.....	10,500
Mixer and casting machine.....	10,000
Travelling crane and tracks.....	5,000
Ladles.....	1,500
Slag trucks.....	3,000
Ore bins.....	3,000
Repair shop.....	5,000
	<hr/>
	\$100,800
Charcoal plant.....	50,000
Power plant (assuming cost of developing one electric horse-power=\$50.00).....	500,000
	<hr/>
	\$650,800
Electrode plant.....	6,000
Unforeseen expenditure.....	43,200
	<hr/>
	\$700,000
Amortization: 5% } Depreciation: 5% } 15% on \$700,000.....	\$105,000
Interest: 5% }	
On a production of 43,200 tons per year of 360 days per ton of pig iron.....	\$2.43
 Cost of Production of Pig Iron per Ton.	
Ore (55% metallic iron) at \$1.50 per ton.....	\$ 2.70
Charcoal, one-half ton at \$6.00 per ton.....	3.00
Electric energy, amortization, etc.....	2.43
Labor.....	1.00
Limestone.....	0.20
Eighteen lbs. of electrode at 2 cents per lb.....	0.36
General expenses.....	1.00
	<hr/>
Total.....	\$10.69

* This estimate is given on the authority of Dr. P. Héroult.

APPENDIX

New Inventions of Electric Smelting and Reduction Furnaces.

In Sweden, where conditions in regard to the raw material for the iron industry are in many respects similar to the conditions in several Provinces of Canada, the question of utilizing electric energy for smelting purposes has lately been given considerable attention. The attempts so far have been made to improve the induction furnaces and at present extensive experiments are being carried out in Sweden, for which a sum of 200,000 kronor (\$55,000) has been appropriated by Stora Kopparbergs Bergslags Aktiebolag.

These inventions were made by Messrs. A. Grönwall, A. Lindblad and O. Stålhaue and for their exploitation a company, "Elektrometall," address Ludvika, Sweden, has been formed.

Induction Furnaces for Steel Smelting.

The principal disadvantage in earlier induction furnaces has been the great phase displacement, which prevented the construction of furnaces for larger charges. Different inventors (Kjellin, Friek, Schneider, Colby, etc.) have made certain improvements and also at several places erected furnaces intended for commercial production. The difficulty with the phase displacement still remained, however, and in order to work their furnaces these inventors have been forced to employ a current of exceptionally low frequency. For smaller furnaces a current of 12 to 15 periods and for larger furnaces a current of 5 and even 3 periods has been proposed. This low frequency of the current necessitates the instalment of special machinery, involving a heavy outlay, and prevents the connection of these furnaces with already installed power plants erected for ordinary purposes.

The position of the primary coil around the leg of the transformer surrounded by the bath of the metal to be smelted was another disadvantage, which, by the inventions described later, has been overcome, and the inventors previously mentioned now claim that induction furnaces for commercial production and for any charge can be constructed.

If :

φ = angle of phase displacement,

c = constant,

s = frequency,

a = area of bath of metal to be smelted,

l = length of bath of metal to be smelted,

ρ = specific resistance in ohms of the bath,

W_s = magnetic resistance around the secondary (the bath),

W_p = " " " " primary coil.

we have for the tangent of the angle of phase displacement:—

$$\text{Tang } \varphi = \frac{c \cdot s \cdot a}{l \cdot \rho} \cdot \left(\frac{1}{W_s} + \frac{1}{W_p} \right)^*$$

From this formula it is evident that if $\cos \varphi$ = power factor, it is increased by:—

1st—decreasing the frequency,

2nd—increasing the ohmic resistance of the bath,

3rd—increasing the magnetic resistance of the two leakage fields.

Decreasing the frequency of the current causes, as previously explained, so great disadvantages that such a course ought to be avoided.

The only means left to decrease the phase displacement are consequently: increase of the ohmic resistance of the bath and increase of the magnetic resistance of the two leakage fields.

The inventions by Messrs. Grönwall, Lindblad, and Stålhane to accomplish this are fully described in the accompanying patent specifications.

Attention is here called to the fact, however, that by giving the bath the form of a groove, † surrounding one leg of the transformer and provided with parallel extensions in connection with each other, and not the customary circular form, the following advantages result from such construction:—

1st—a greater ohmic resistance of the bath,

2nd—an increased resistance for the leakage fields, on account of the closeness of the circular part of the bath to the iron core of the transformer.

3rd—A further increased resistance for the secondary leakage, because the extensions of the groove form a so-called "bifilar" winding.

* According to Lindblad.

† See further Patent Specification No. 4



MICROCOPY RESOLUTION TEST CHART

(ANSI and ISO TEST CHART No. 2)



4.5



5.0



5.6

6.3

7.1

8.0

9.0

10

11.2

12.5

14.3

16.0



APPLIED IMAGE Inc

1653 East Main Street
Rochester, New York 14609 USA
(716) 482 - 0300 - Phone
(716) 288 - 5989 - Fax

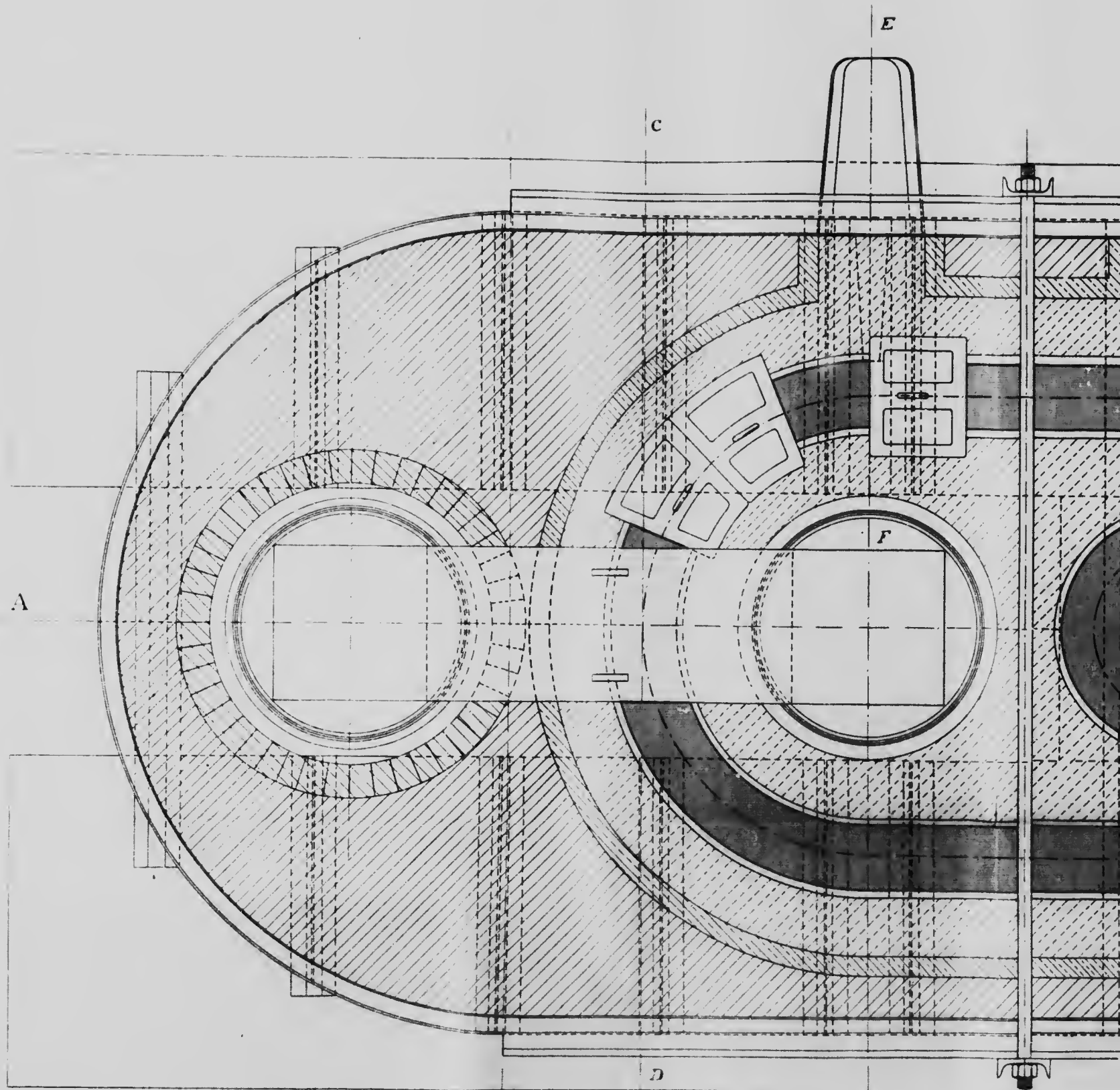

8-TONS ELECTRIC STEEL FURNACE

PLAN

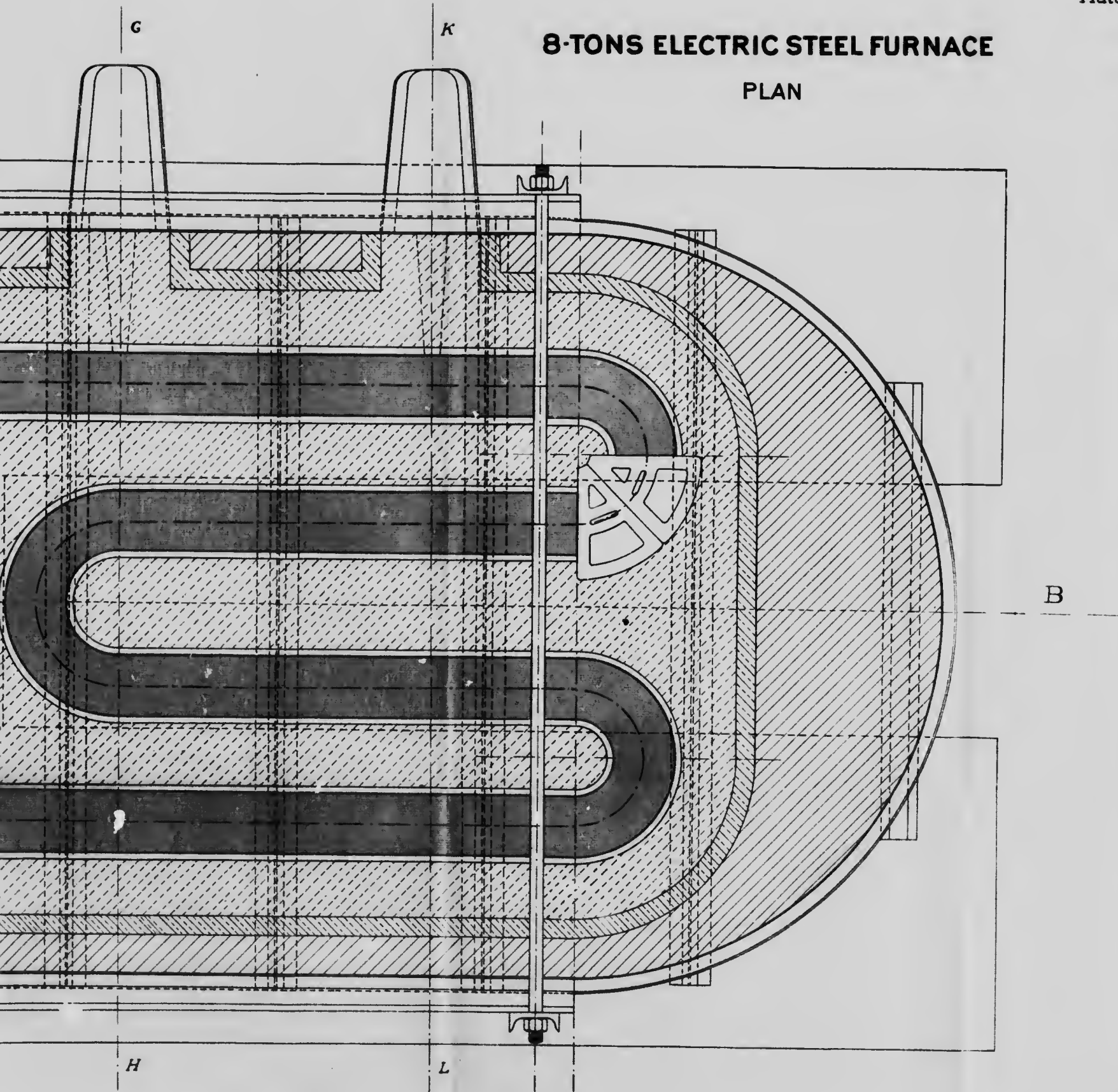





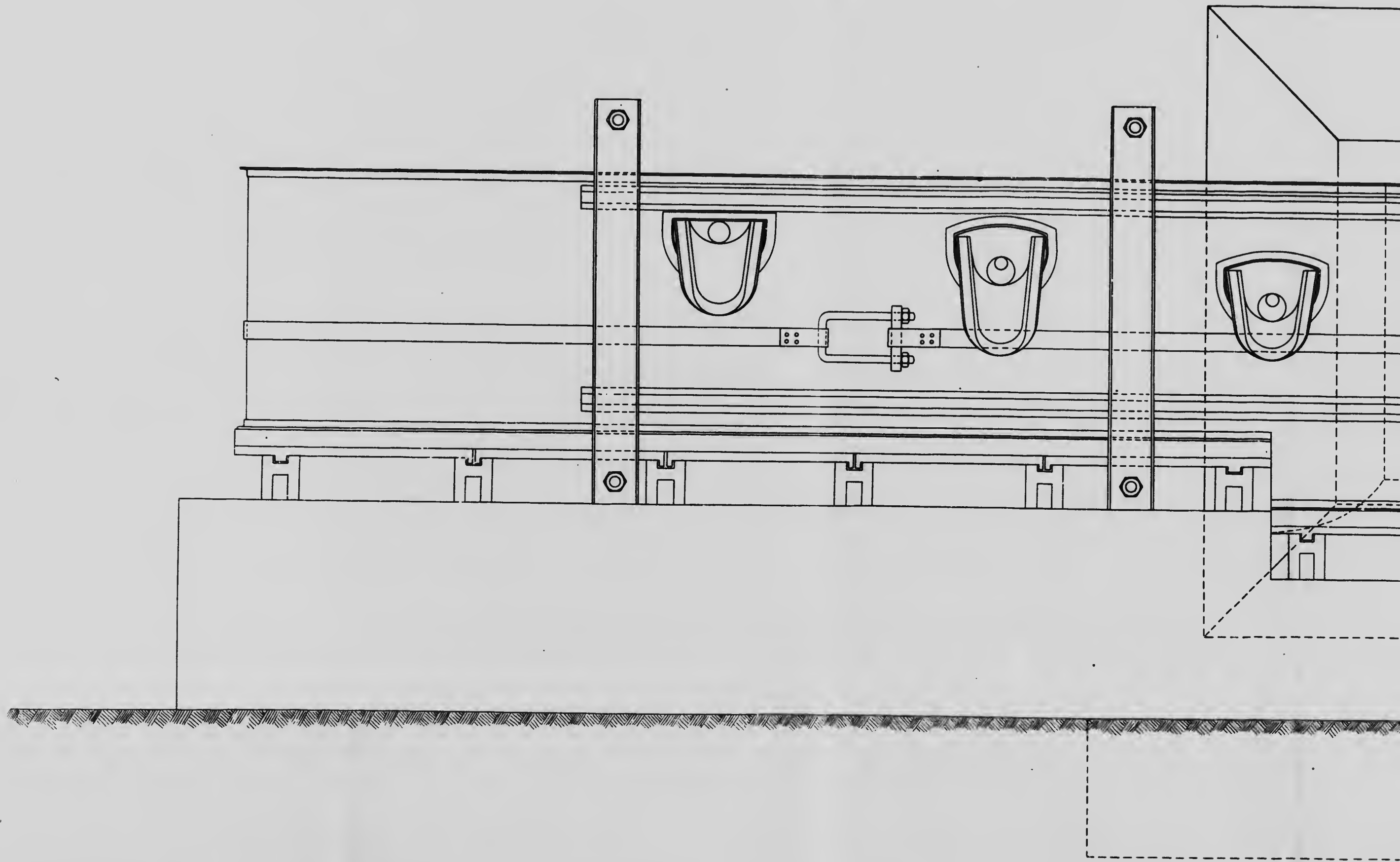

8-TONS ELECTRIC STEEL FURNACE

SIDE VIEW

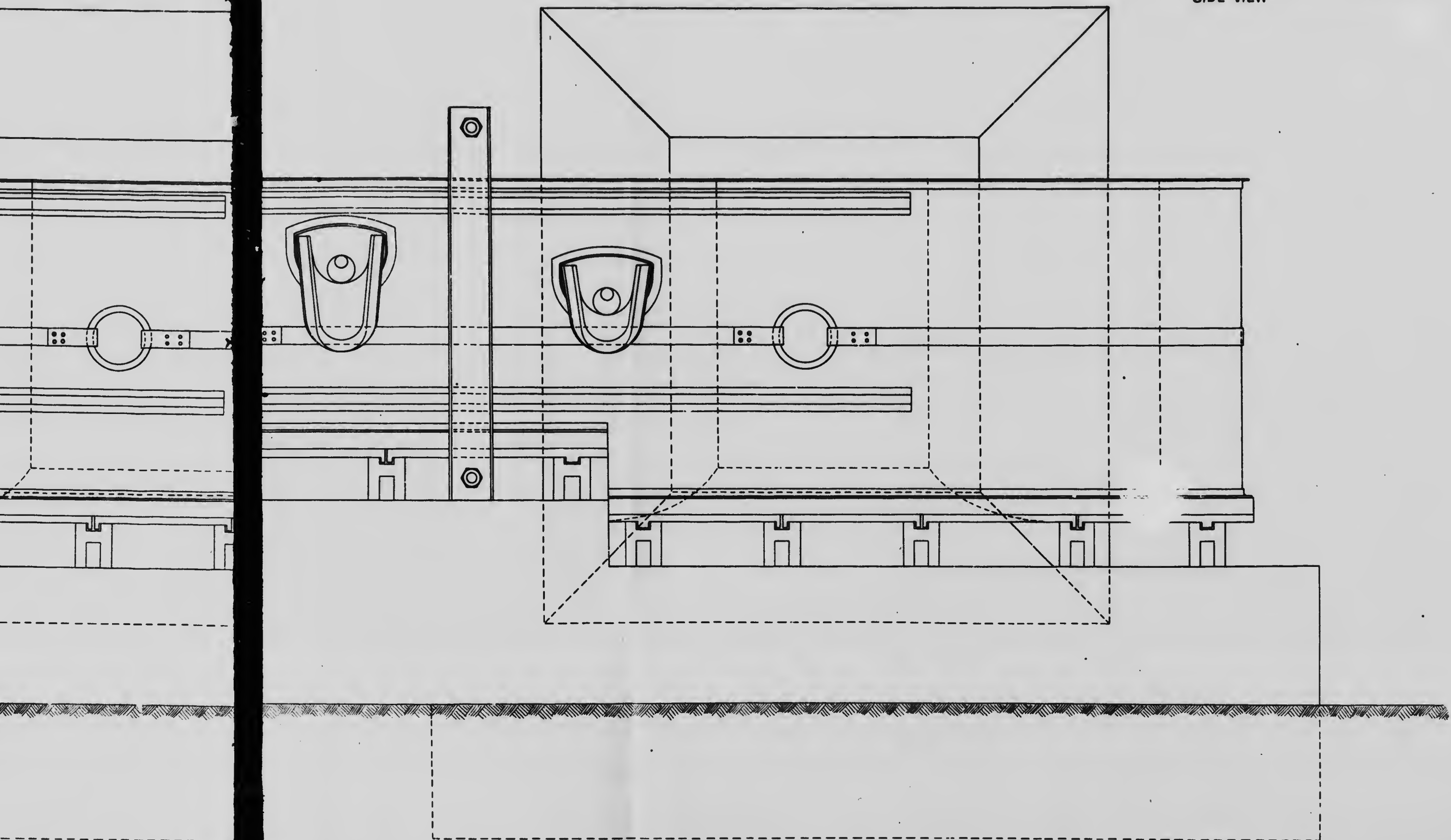





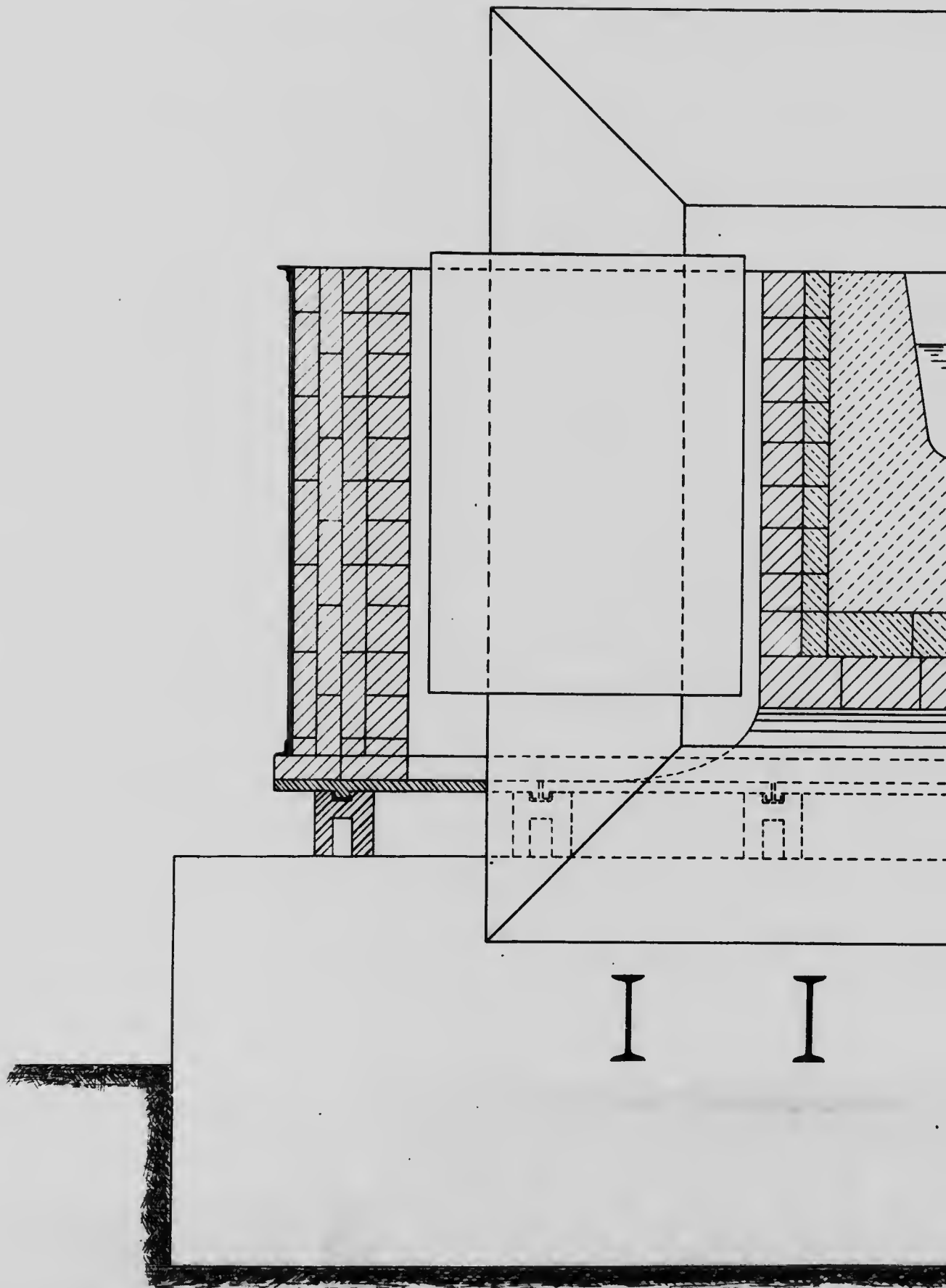

SECTION A-B

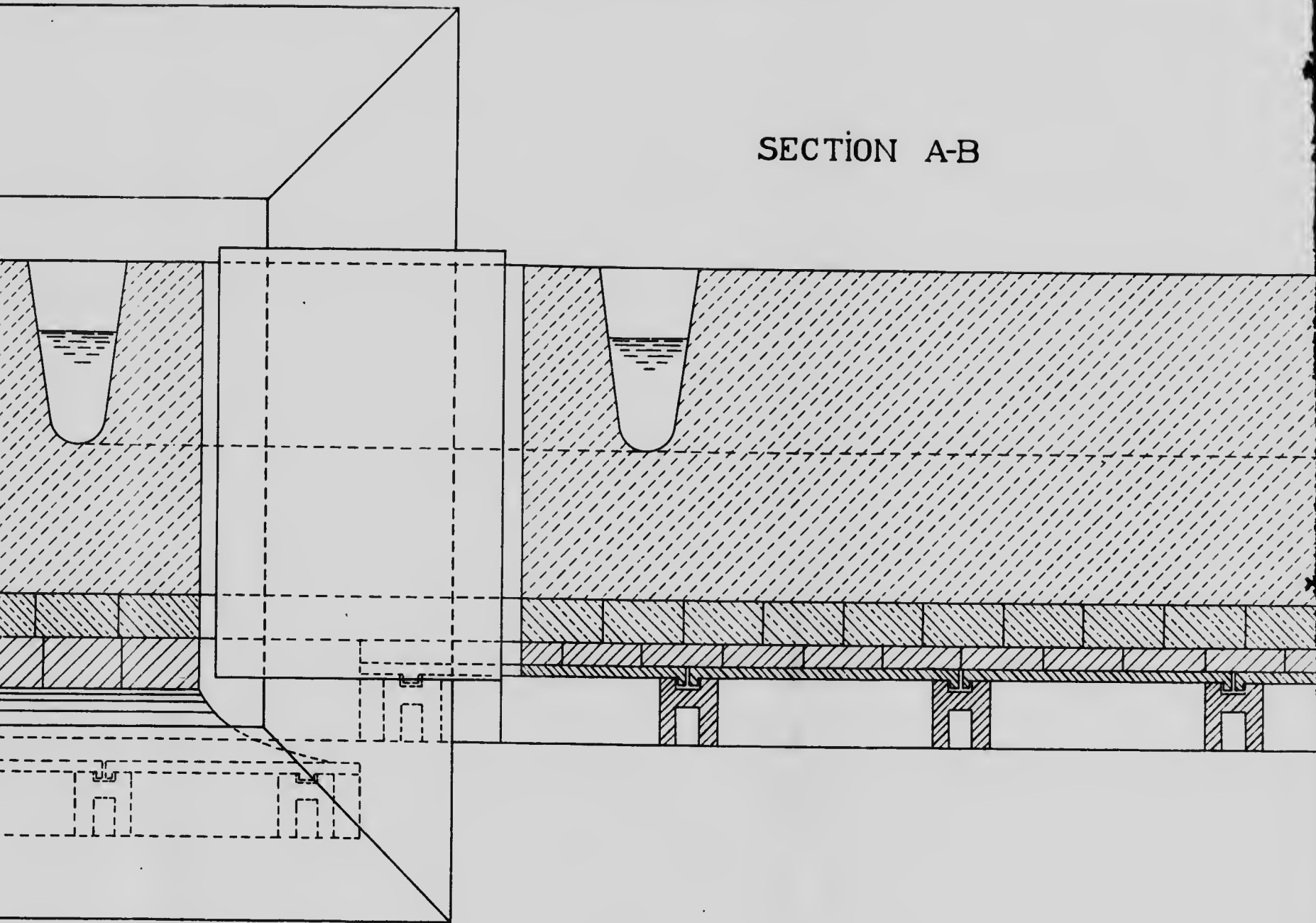

I

I

SECTION A-B

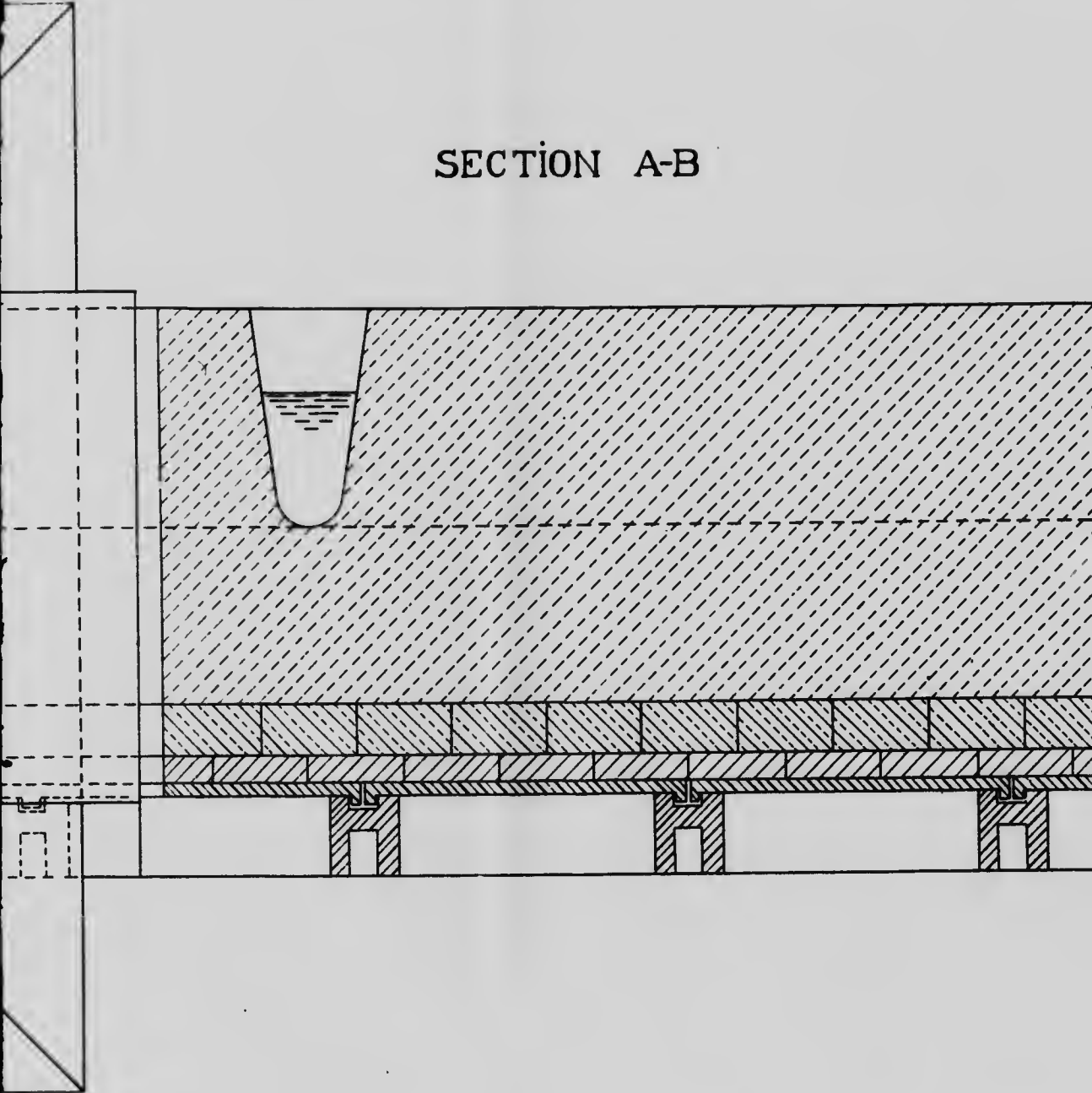

8-TONS ELECTRIC STEEL FURNACE

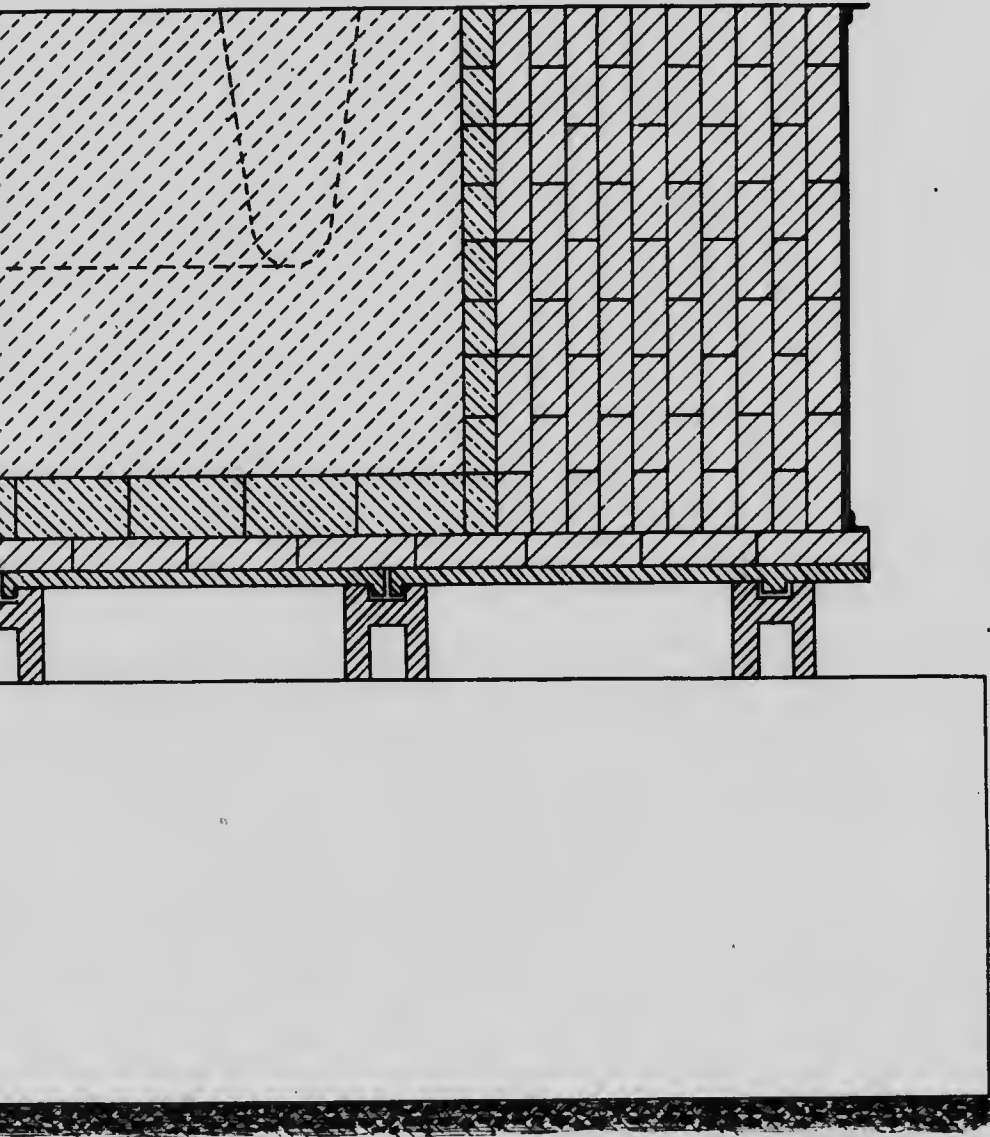



SECTION K-L

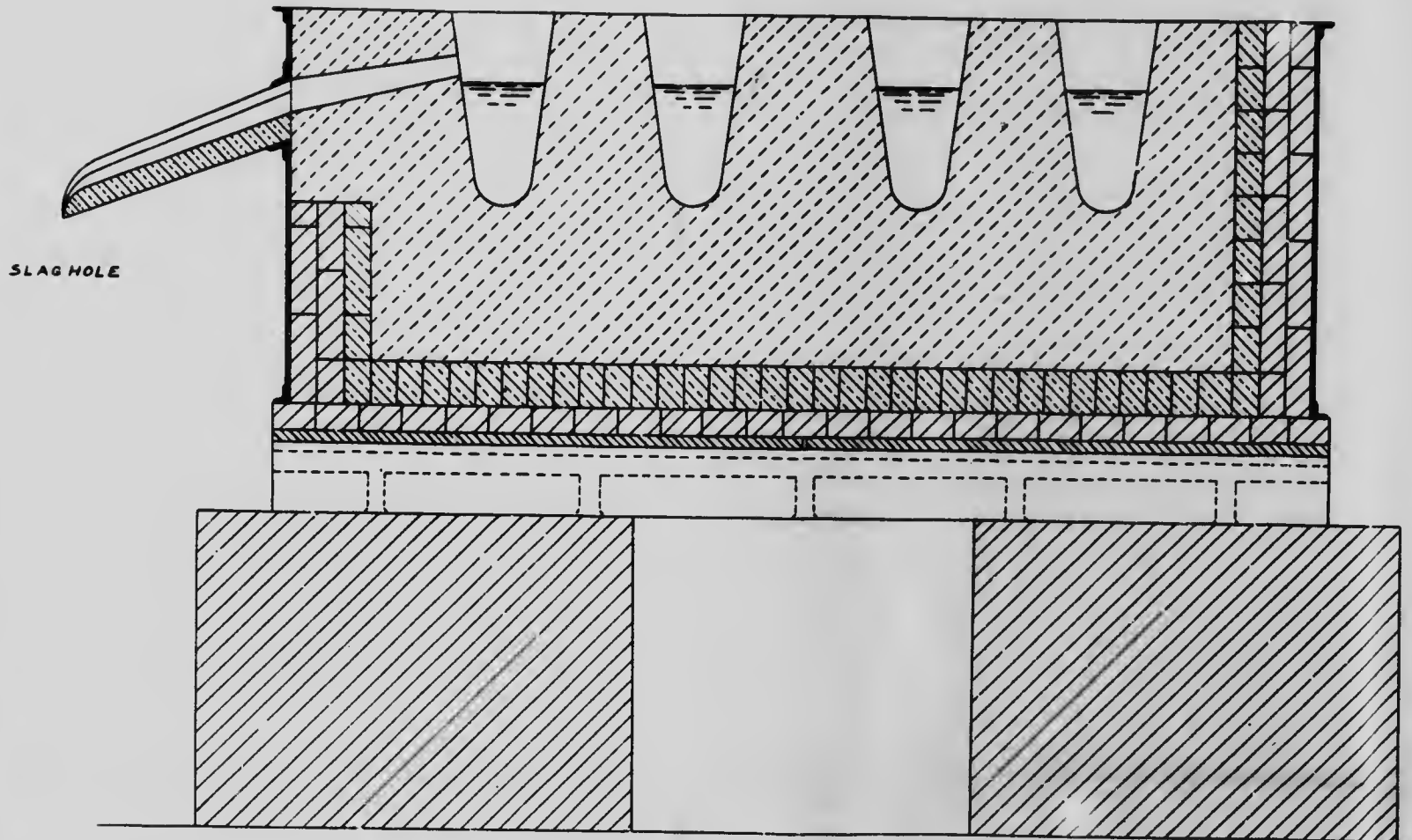

SECTION G-H

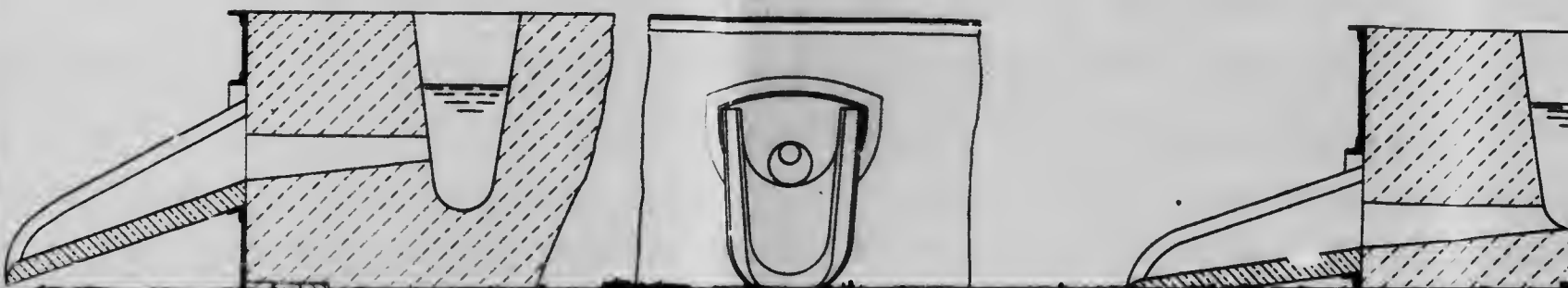

8-TONS STEEL FURNACE

SECTION C-D

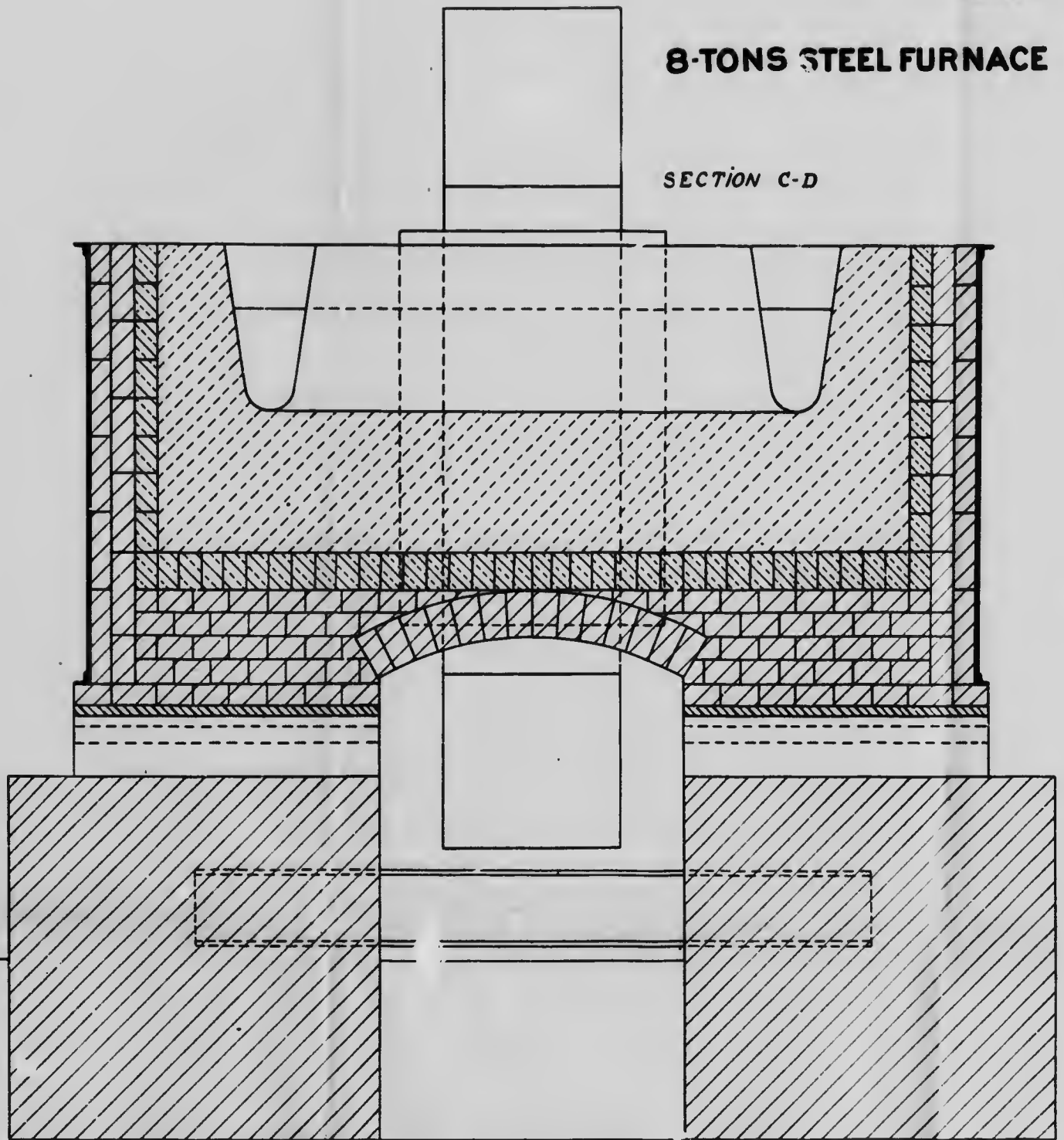

SECTION E-F





SECTION G-H

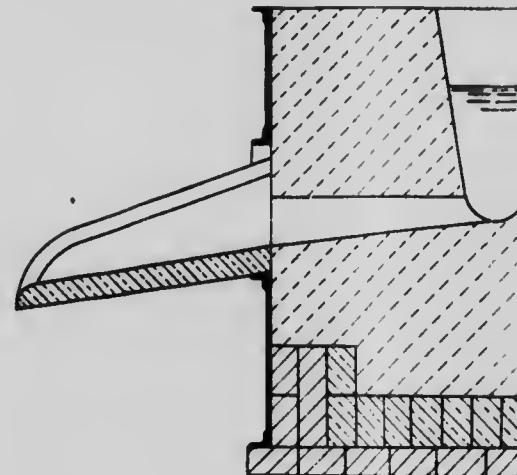
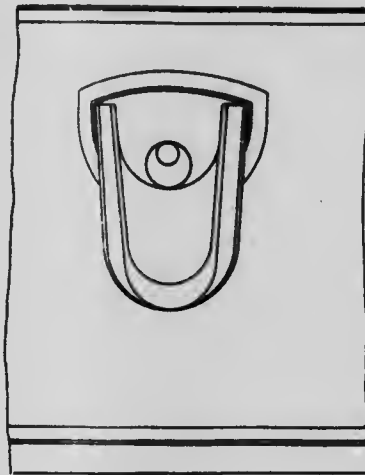
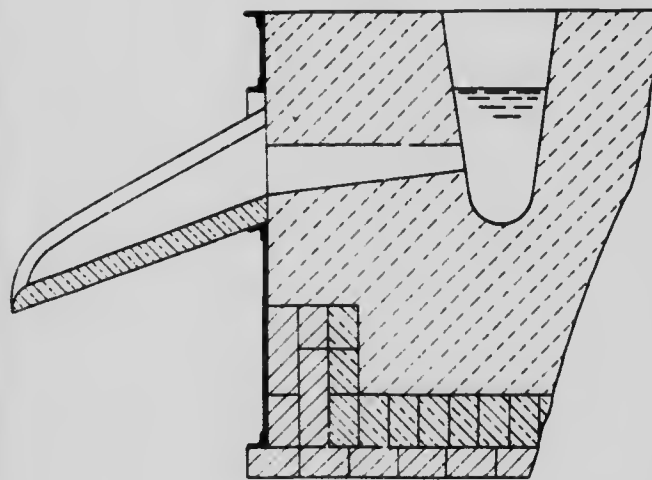

UPPER IRONHOLE

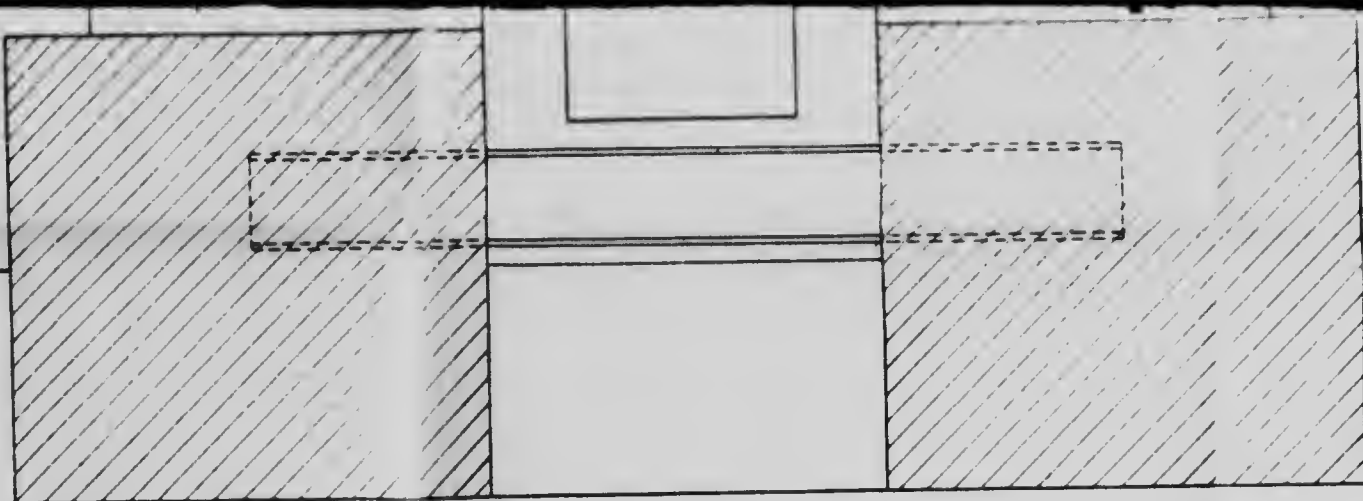

SECTION E-F

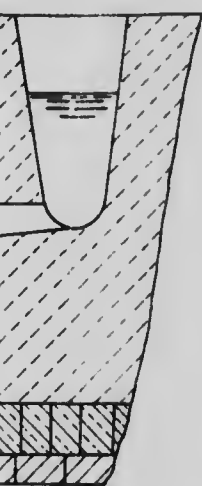

LOWER IRONHOLE

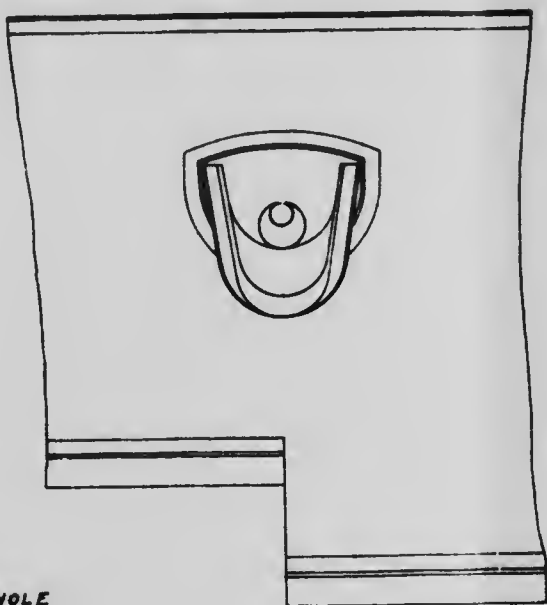

The invention described in patent specification marked No. 1 and further in patent specification No. 1a is of special importance and consists of two coils, which are not connected with the primary current (or connected in the manner described in spec. No. 1a). These two coils, so called "compensation coils," are connected with each other in such a manner that the electromotive force induced in the one is counteracted by that in the other. The details of this invention are fully described in the patent specification, from which it also is evident that the position of the primary coil relatively to the bath is of no importance regarding the leakage, which is of great advantage—in fact, if smelting plants with induction furnaces are to be erected on a larger scale, the plants must be so constructed that the furnaces can be direct connected with the transmission lines from the power plant, in order to obtain economic conditions of working. If a large amount of power is required first to be passed through a transformer, the efficiency of the installation is decreased and the cost and maintenance increased.

The present method of placing the primary coil around the leg of the transformer surrounded by the bath will undoubtedly, even for comparatively low voltage, result in considerable difficulties and for higher voltage it will probably be impossible to obtain the necessary insulation, on account of the high temperature of the bath, which has a destroying effect on the delicate insulation of the primary coil, and the use of water-cooling between the coil and the bath is not likely to prove effective.

From what has been said it is evident that no earlier construction of any induction furnace can without risk for the insulation be direct-connected with a power-transmission of high voltage. It is only through the invention of the compensation coils, which makes the position of the primary coil relatively to the bath indifferent, that such a connection is possible.

The accompanying Plates Nos. X-XIII of an 8 ton steel furnace of 750 horse-power at present being erected show the utilization of these inventions.

The primary coil is placed around that leg of the transformer which is not surrounded by the bath, in a specially made well, where it is exceedingly well protected from the heat and all danger to the men attending the furnace of coming in contact with the high voltage transmission is excluded. The leakage field developed around the primary coil produces no direct phase displacement, as the leaking lines of force are forced, on account of the arrangement of the compensation coils, to again produce effective lines of force through the compensation coil placed around that leg of the transformer surrounded by the bath. In order, therefore, that a phase displacement shall be produced due to the primary leakage, it is necessary that a new leakage field shall be developed around the compensation coil last mentioned. The leaking lines of force due to the primary are consequently forced to pass through the air around the primary and also through the air around the compensation coil placed inside the bath. The distance which these leaking lines of force have to travel has, therefore, been greatly increased and con-

sequently also the magnetic resistance which they have to overcome in order to produce a phase displacement.

Another very effective way of decreasing the primary leakage proposed by the inventors refers to the construction of the transformer core. This invention is fully described in patent specification No. 2. The effect of this invention in combination with the compensation coils is that the leaking lines of force, which, as already explained above, in order to produce a phase displacement must pass through the air both around the primary coil and the compensation coil placed inside the bath, are forced to pass four times through the side surfaces of the iron core and thereby encounter a greatly increased magnetic resistance.

Patent Specification No. 3 refers to an invention also intended to decrease the magnetic leakage in transformer furnaces. This invention consists of the use of a short circuited conductor or conductors of low resistance, which are placed in the way of the leaking lines of force, but not in the way of the effective lines of force of the transformer. The invention is fully described in the patent specification and will in certain cases be used by the inventors.

Electric Furnaces for the Reduction of Ores.

Transformer Furnace.

The arrangements of this type of furnace are described in patent specification No. 4.

The necessary electrical machinery and arrangements are based on the same principles as for the steel furnace previously described. The parallel extensions of the groove are drawn into the hearth or lower part of a shaft furnace (or other similar furnace). Thus the hearth of the shaft furnace will consist of a part of the smelting groove of the induction furnace and the material heated or smelted in the shaft furnace will directly drop down into the smelting bath of the electric furnace and will there be submitted to further treatment by means of an electric current. The smelted pig iron may by means of these arrangements be brought to continuously flow out from the shaft furnace into the smelting groove of the electric furnace. The groove is given such cross sections in its different parts that the principal heat is developed inside the shaft furnace. The groove outside the shaft furnace is completely bricked in, forming a closed canal.

The inventors further propose to use part of the gases developed for heating and reduction purposes in a manner similar to the one proposed by Henri Harmet.

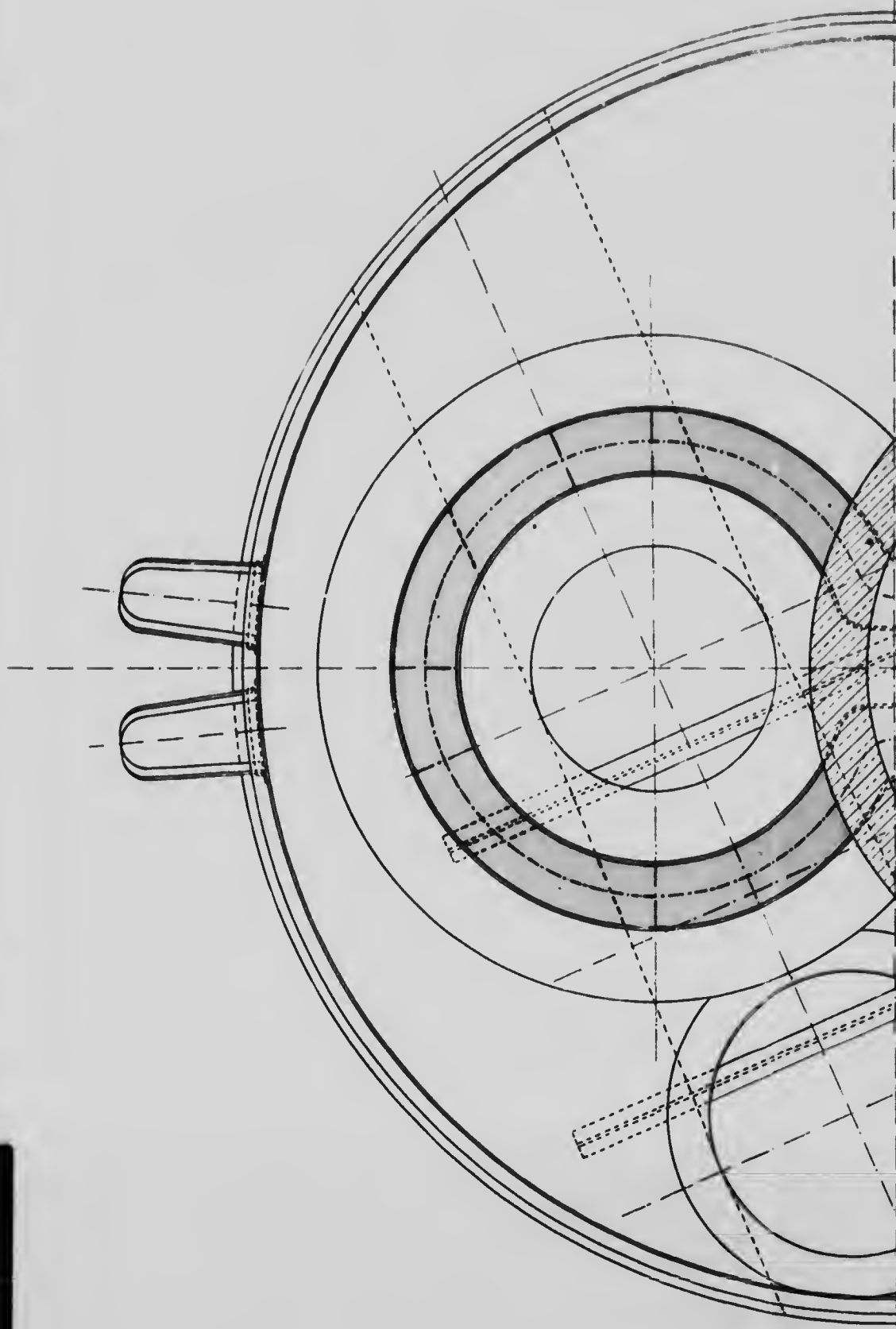
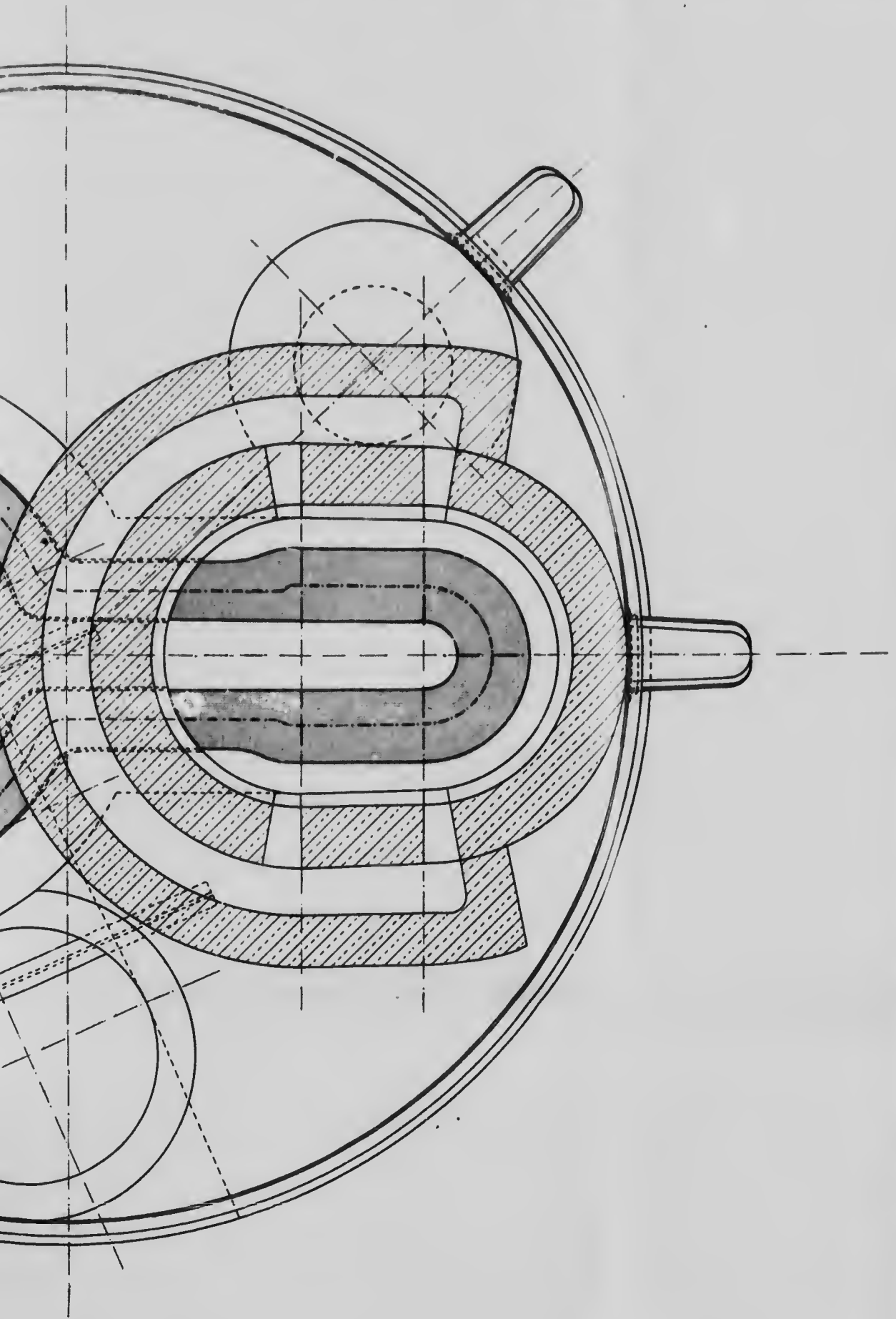
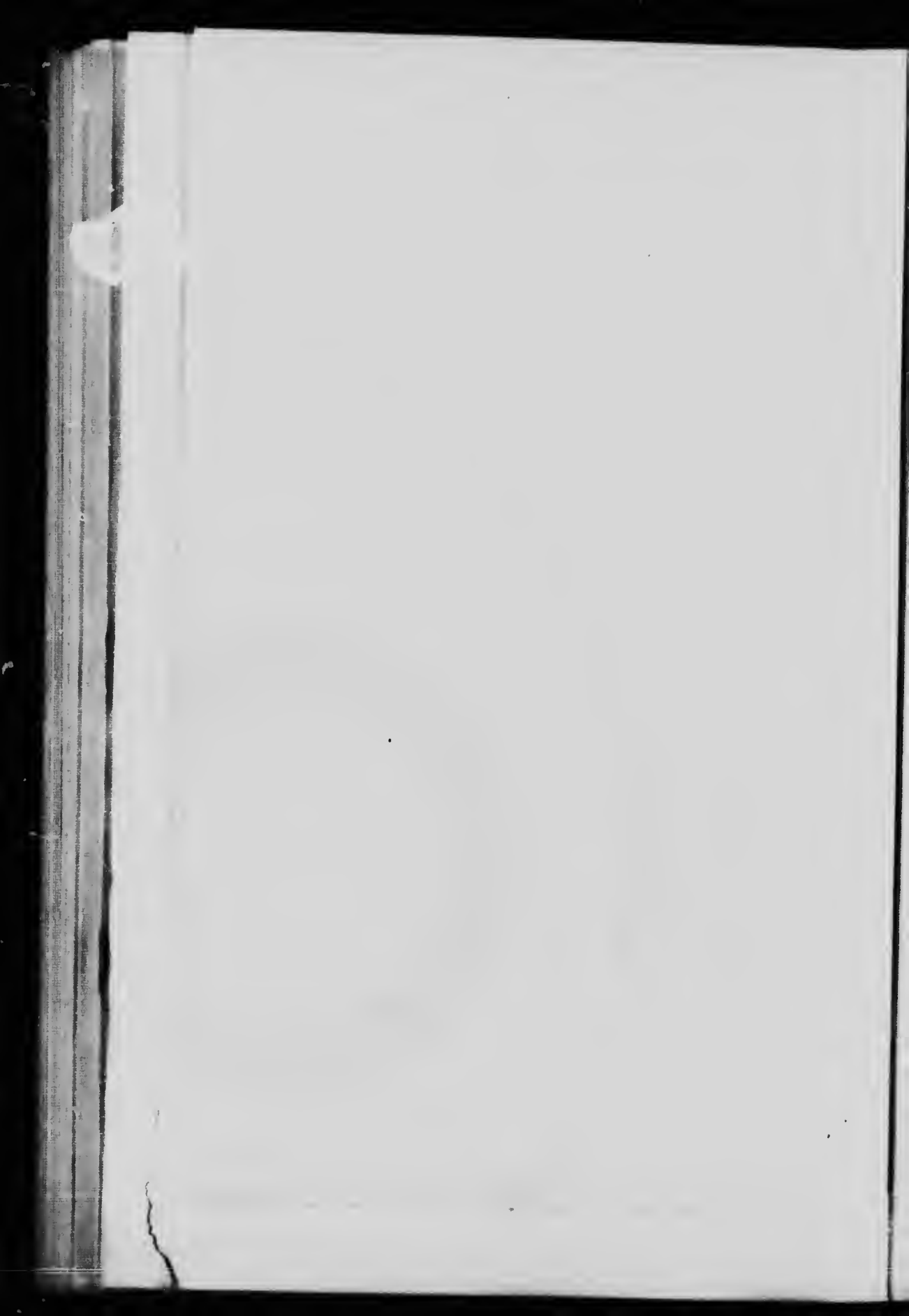

Plate XI

TRANSFORMER FURNACE COMBINED WITH SHAFT FURNACE.

PLAN





TRANSFORMER FURNACE COMBINED WITH SHAFT FURNACE.

SECTION.

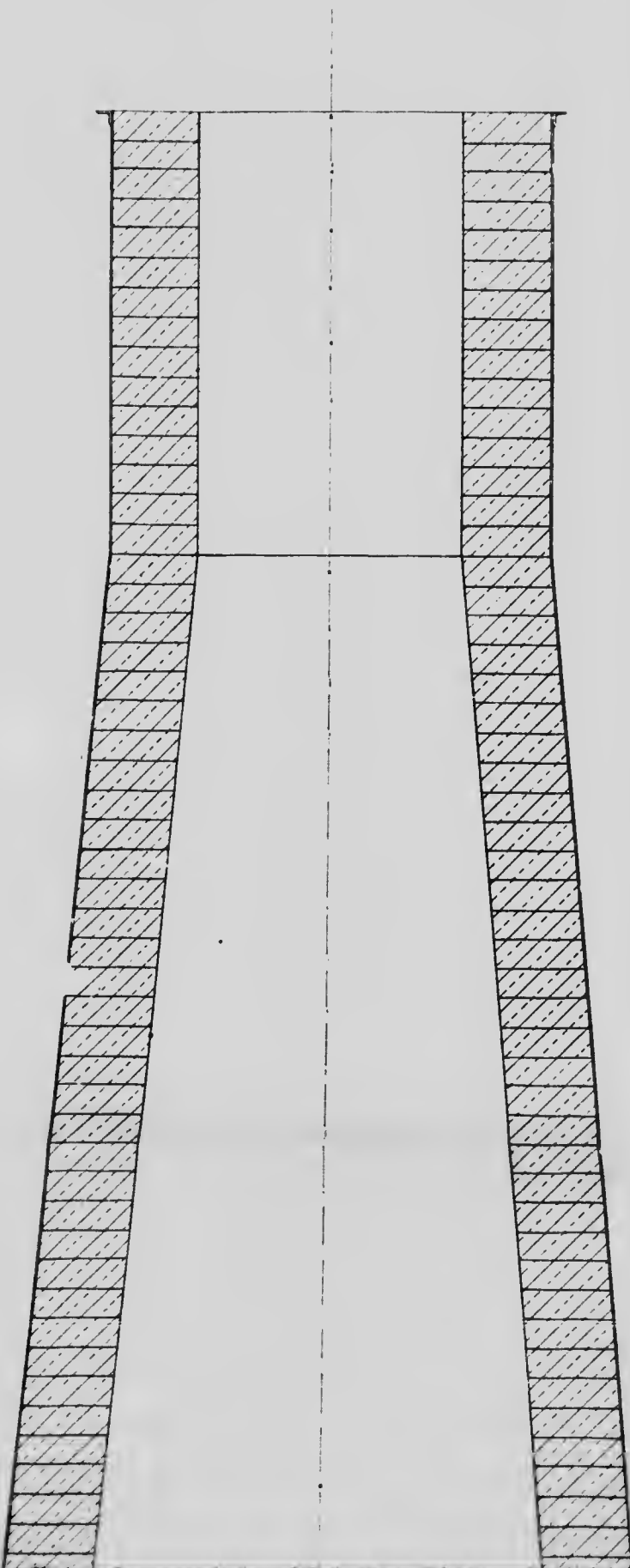

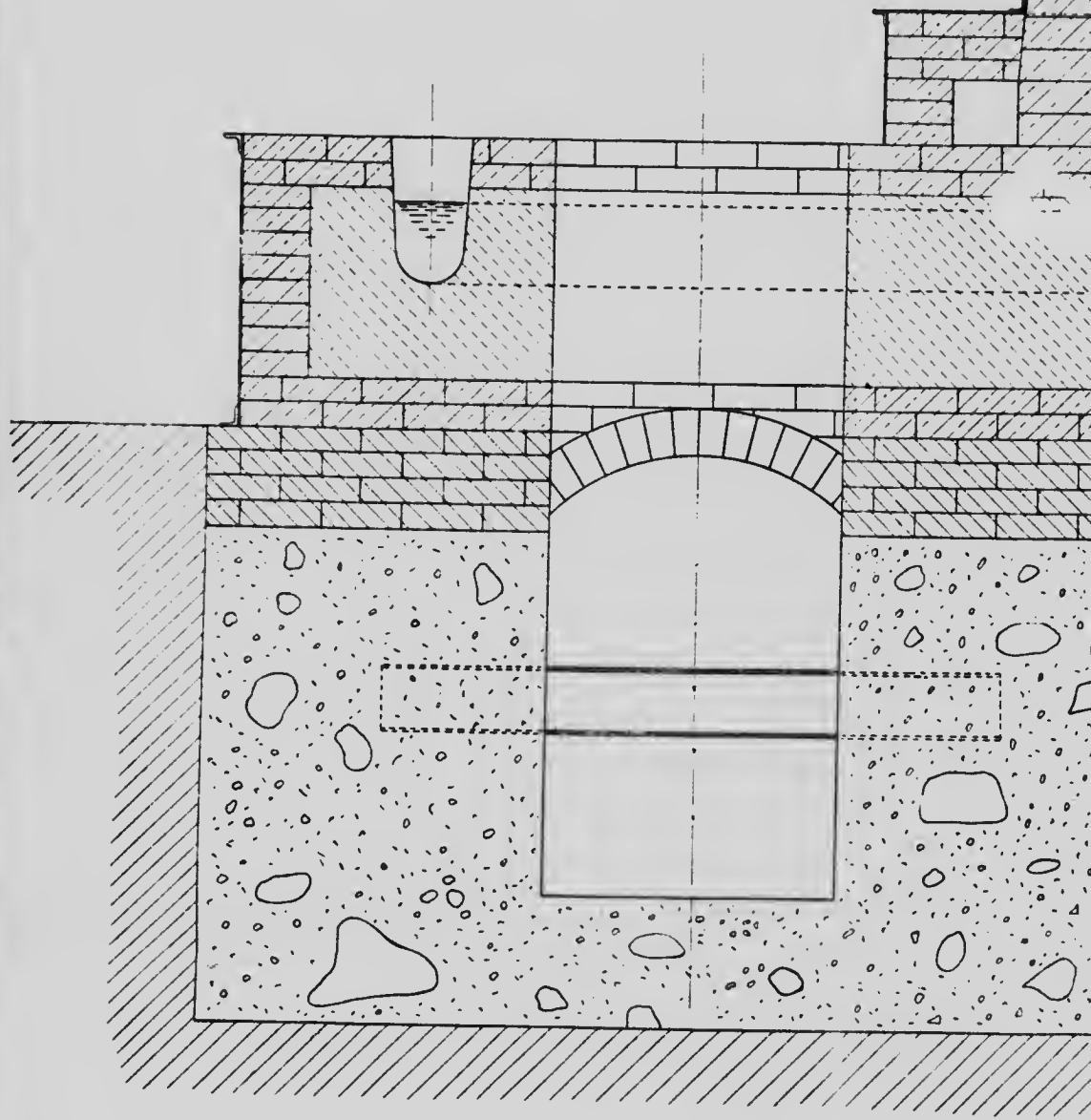

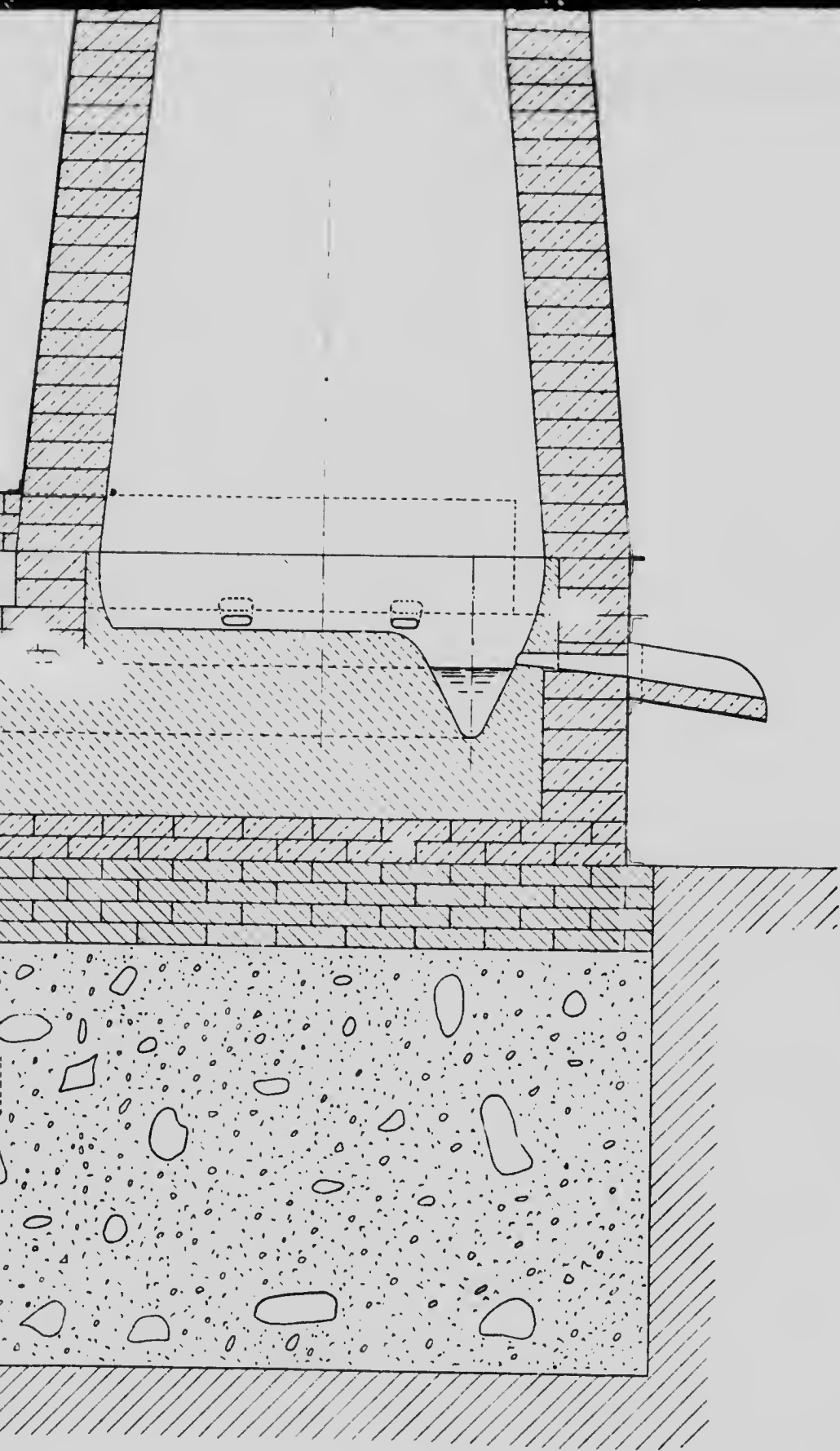

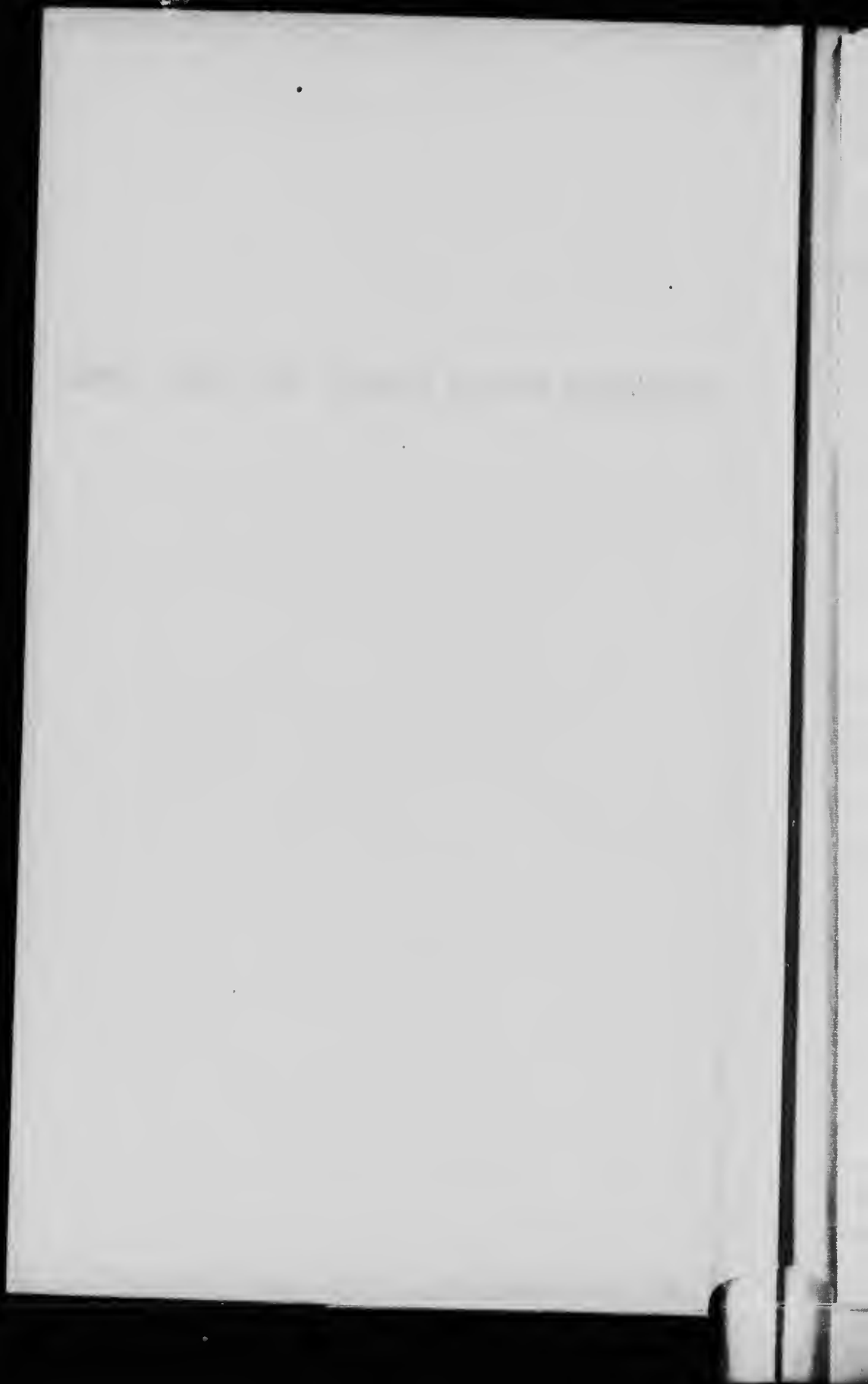

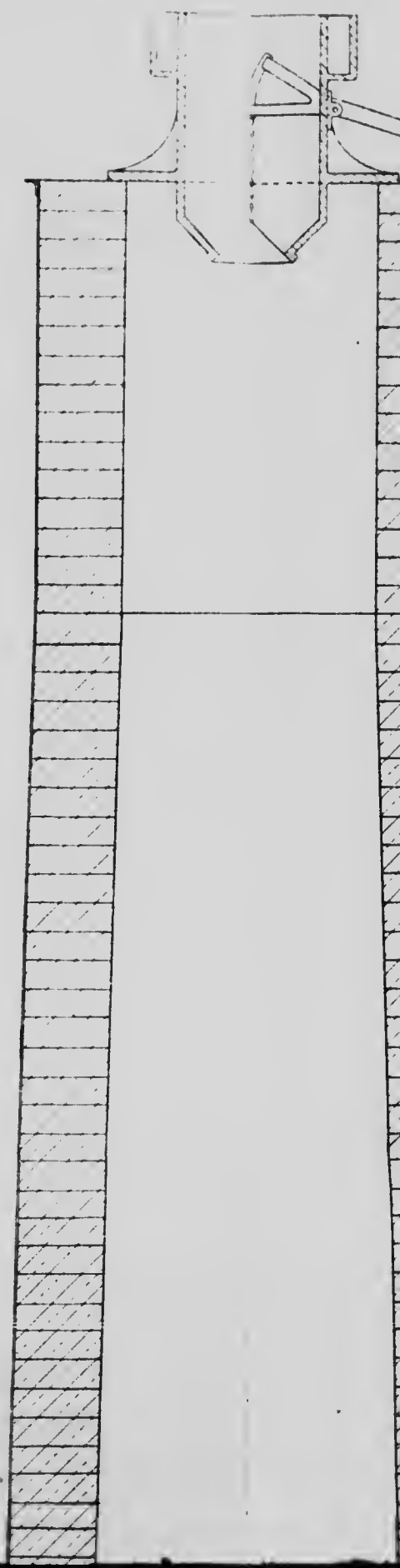

TRANSFORMER FURNACE, COMBINED WITH SHAFT FURNACE.

SECTION

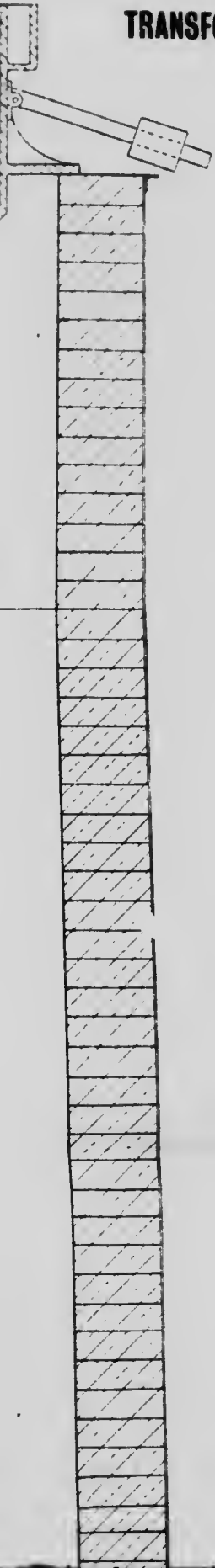

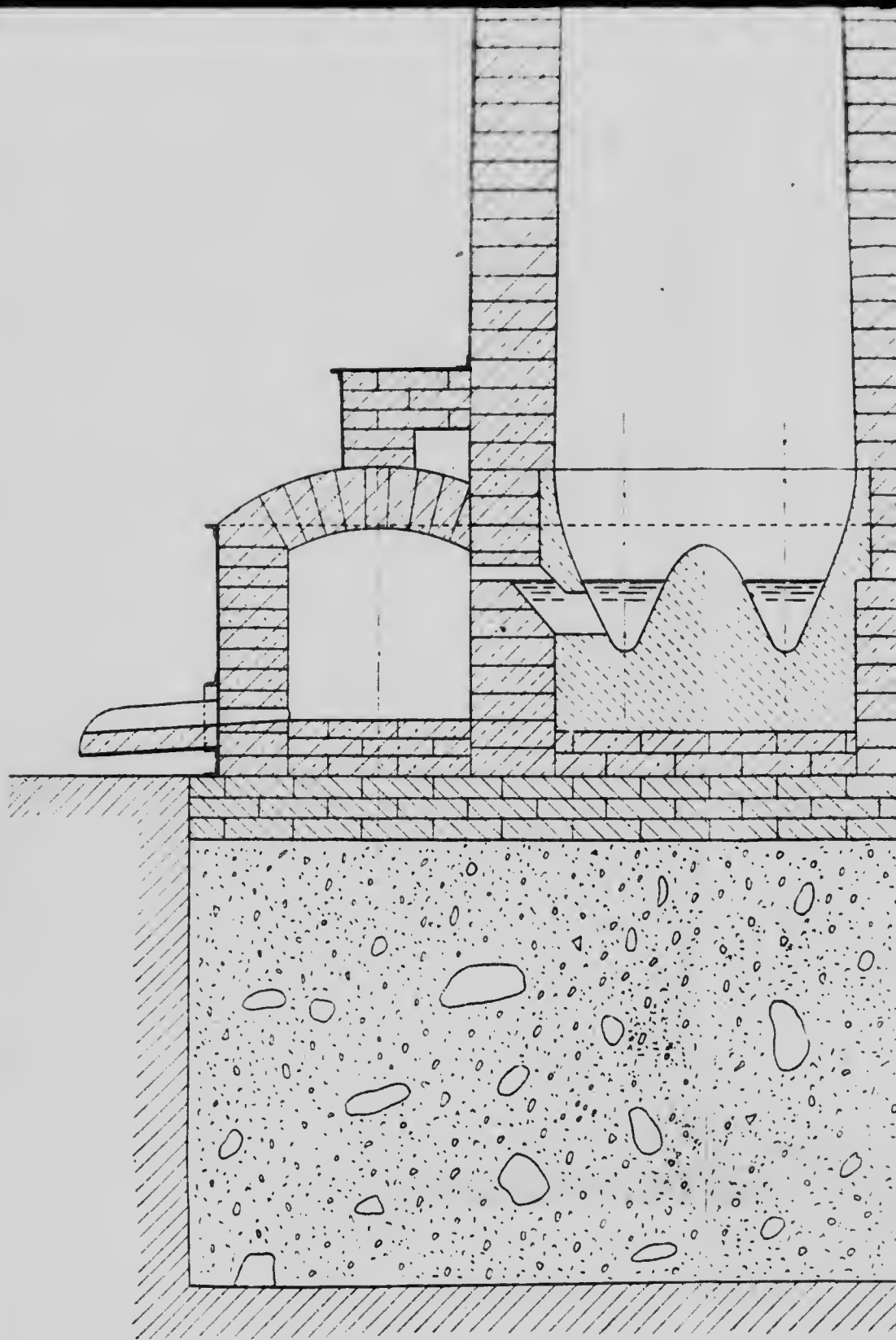

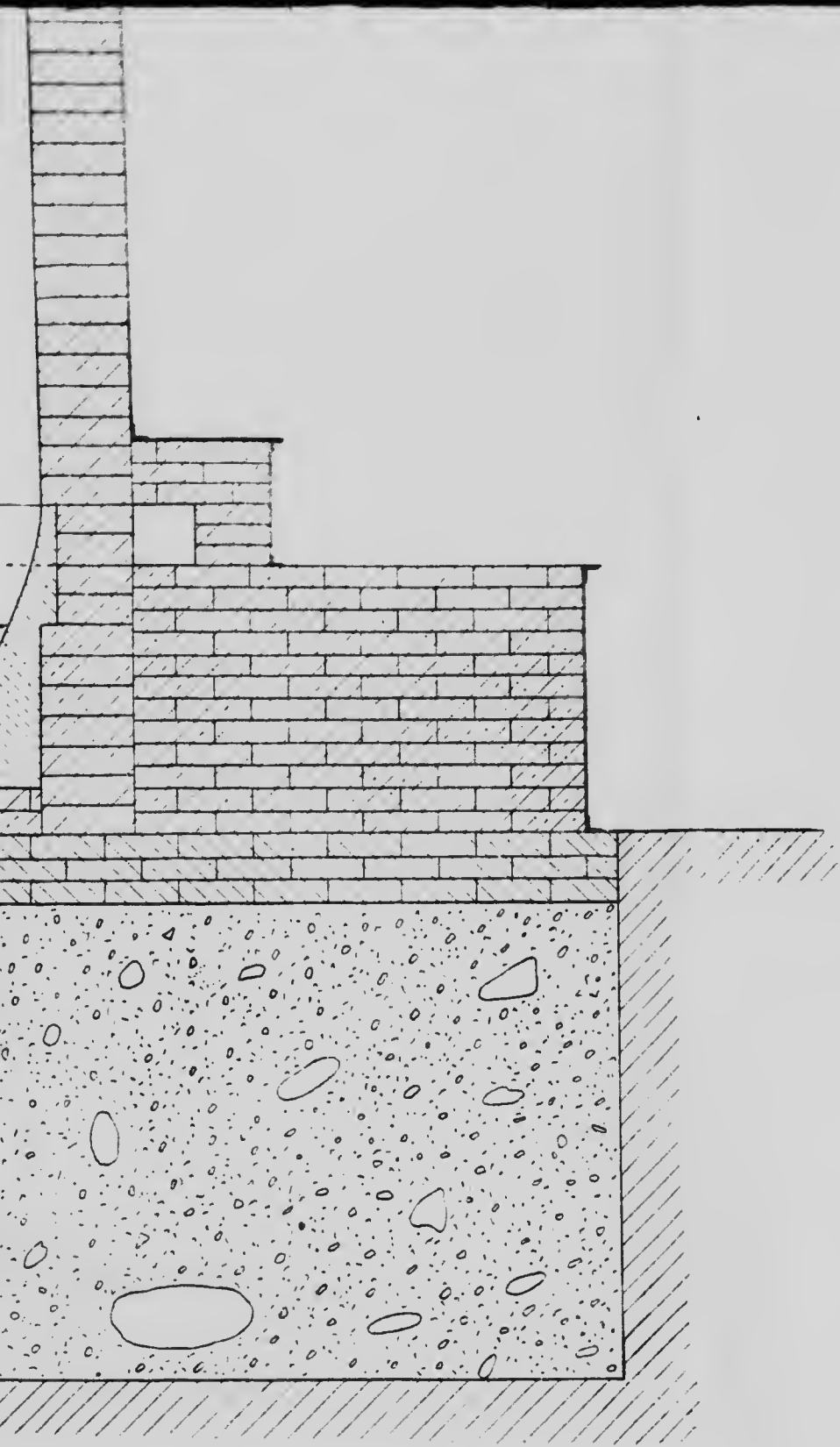

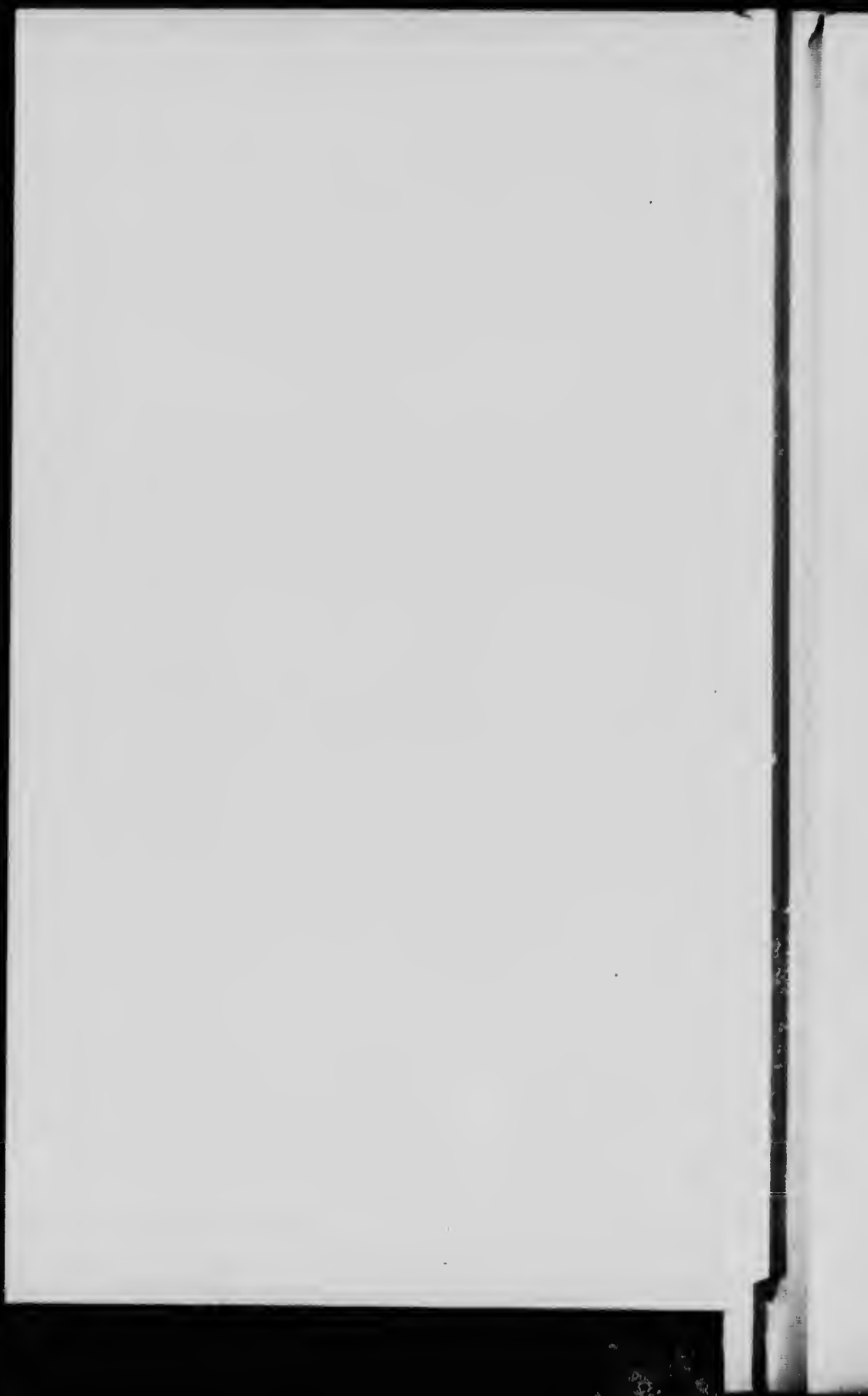

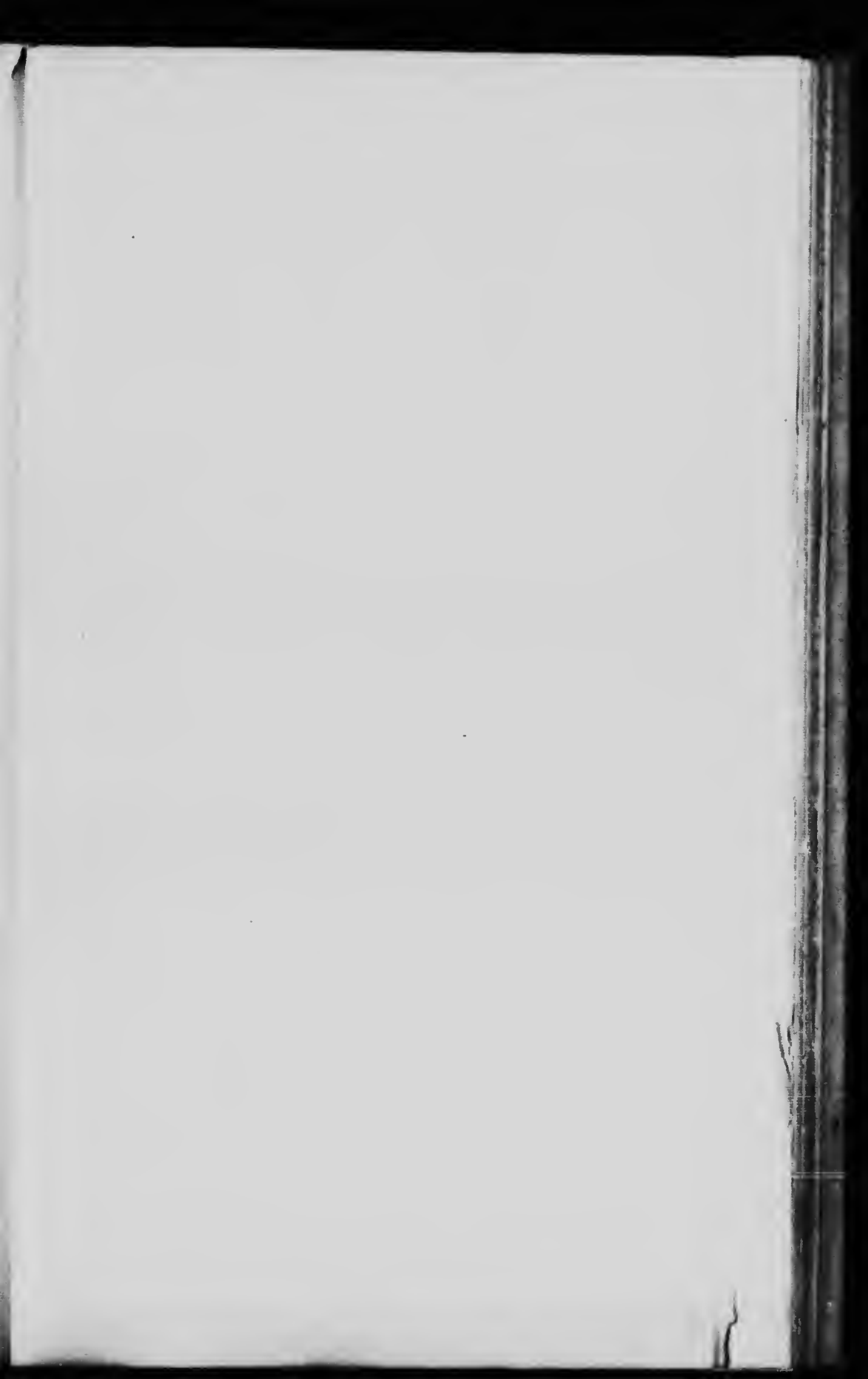

CONTACT FURNACE

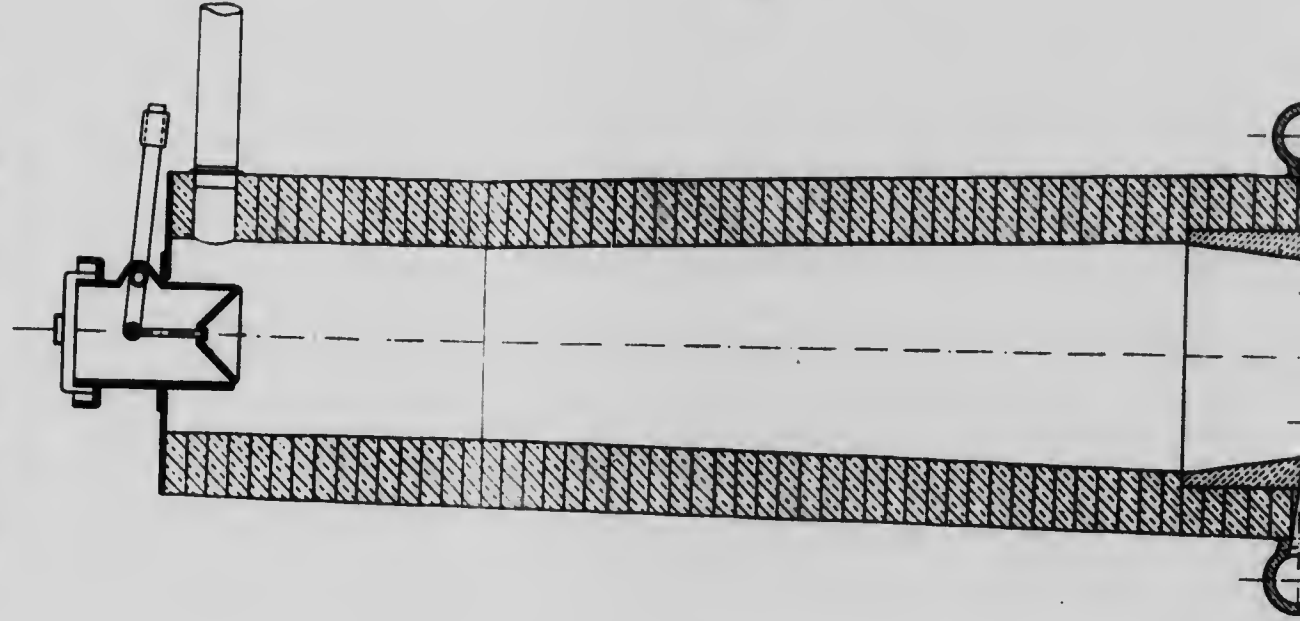

SECTION A-B

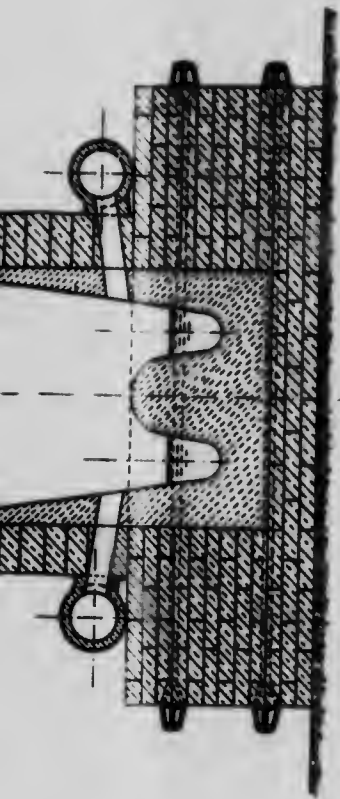

PLAN

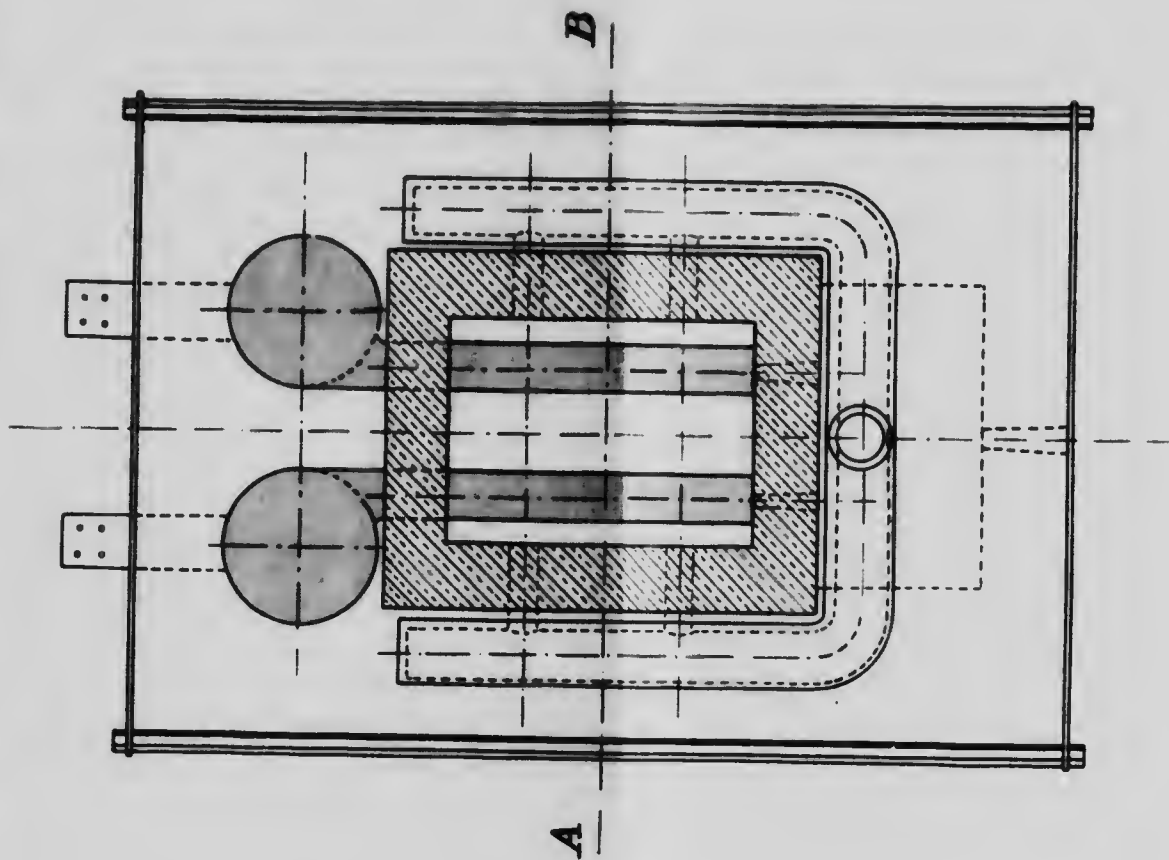

To the charge for the shaft furnace only enough carbon is added as is necessary for the reduction of the ore. The gas (or part of same) from the furnace is pressed by an exhauster or other suitable arrangement through a suitable heating apparatus and further through the canal formed by the covered part of the smelting groove into the furnace a little above the hearth. The gas is consequently kept in continuous circulation and as new gas is constantly formed through the reduction of the ore and air excluded, the percentage of nitrogen in the gas will gradually decrease to an insignificant quantity. As a result of this a great part of the reduction will be effected by the gases.

An experimental furnace of 600 to 700 h.p. is at present being erected in accordance with this invention, the construction of which is shown in Plates Nos. XIV-XVI.

Contact Furnace.

The same inventors also propose to employ a furnace of the contact type for the direct smelting of ores.

This invention is described in patent specification No. 5 and one form of the construction is shown in Plate No. XVII. The lower part of a shaft furnace is divided into two parts by means of a wall of fire proof material, so that two grooves are formed, which extend through openings in the brick work outside the furnace. The molten material in each groove forms the electrodes for the current, connections being made by means of blocks or other suitable arrangements with the transmission lines, one end of each groove. The electric current passes from one electrode, through the molten product in one of the grooves, across the charge in the furnace and out to the other terminal through the material in the other groove. The charge in the furnace through its resistance to the current is heated and smelted.

Rotating Furnace.

This invention, also proposed by the same inventors, consists of an electric furnace in combination with a series of rotating cylinders and is fully described in patent Specification No. 6.

This invention may prove of value especially for finely divided ores, for instance for the treatment of concentrates of the iron sands in Canada, which in this case do not need to undergo any briquetting process.

Specification No. 1.*Improvement in Transformer Furnaces relating to the arrangement of Compensation Coils for the decrease of the Magnetic Leakage.*

The present invention relates to electric smelting furnaces of the transformer type. In such transformer furnaces of the construction hitherto known one of the greatest difficulties has been the great magnetic leakage and the resulting phase displacement, which has caused the necessity of a relatively great and expensive machinery and thus heavy original costs. In order to avoid or reduce these difficulties different methods have been tried for reducing the magnetic leakage. Every invention intended for that purpose and carried out in practice has been based on the principle to render it more difficult for the leaking lines of force to close themselves or meet through the air. Thus it has been attempted to lessen the area through which the leaking lines of force may close themselves through the air for instance by placing the primary coil within the area enclosed by the smelting bath. This disposal of the primary coil, however, on account of the high temperature of the smelting bath, which is placed near by, is connected with great difficulties, especially if, as usually is the case, the primary coil is supplied with alternating current of relatively high voltage.

The present invention has for its object a device by which the disadvantageous leakage is limited to the space within the smelting bath, independent of the position of the primary coil relatively to the smelting bath.

In order to more fully explain the idea of this our invention, the following description of it is given with reference to the accompanying schematical drawing, in which is shown a vertical section of a transformer furnace embodying the present invention.

1 is the iron core of the transformer, 2 the smelting bath and 3 the primary coil, which in the form of the furnace shown in the drawing is located around that leg of the transformer core, which is outside the smelting bath. 4 and 5 are two other coils, which are not connected with the primary source of current. Of these latter coils the one, 4, surrounds the same leg of the transformer core as the primary coil and the other, 5, is placed within the smelting bath and surrounds the same leg of the transformer core as this latter. These two coils, 4 and 5, are connected with each other in such a manner that the electromotive forces induced in the same counteract each other. If these two coils have the same number of windings or turns, the electromotive forces induced or excited in the same should completely neutralize or nullify each other, provided that no primary leakage is developed in the transformer. If, however, not all of the lines of force generated by the primary coil, 3, pass through the smelting bath, 2, and the coil 5, but instead of this a part of them in longer or shorter curves close themselves through the air, more leaking lines of force will pass through the coil 4 than through the coil 5, wherefore

the electromotive force induced in the former will have a value greater than that induced in the latter. In consequence of this an alternating current will flow through the two coils 4 and 5, connected with each other, the strength of said current being dependent on the number of lines of force leaking around the primary coil. From this it follows that if the coils are connected with each other in the manner above stated, the coil 5 will magnetically co-operate with the primary coil. On this account the lines of force which are leaking around the primary coil 3 will be forced to generate useful lines of force by means of the coil 5.

Evidently there arises also around the coil 5 a disadvantageous leakage, but this leakage, being limited to the space enclosed by the smelting bath, will not be very great, provided the said space be sufficiently small. As the coils 4 and 5 may be made with only a few windings, it follows that the tension induced in the same will be relatively low and it is obvious that the insulation of the same also may be relatively slight or thin, whence it finally follows that the space between the smelting bath and the leg of the transformer core surrounded by the same may practically be made as small as if there were no coil. Obviously it is not necessary that the iron core 1 has the form shown in the drawing, neither is it necessary that the primary coil be placed as shown in the drawing, but this latter may be located on the transformer core in any other suitable manner. The primary coil may also be subdivided in two or more sections or parts located in any suitable manner. Nor is it necessary that the coil 4 be placed in the manner shown in the drawing. It may instead be located around, above or underneath or in any other suitable manner near the primary coil, provided it always be so arranged that all or a part of the lines of force leaking around the primary coil 3 act inductively on the same. The coil 5 may also, of course, be located otherwise than shown in the drawing, but preferably it is placed within the area enclosed by the smelting bath. The coils 4 and 5 may, of course, be made with any suitable number of windings and may also be divided in several sections.

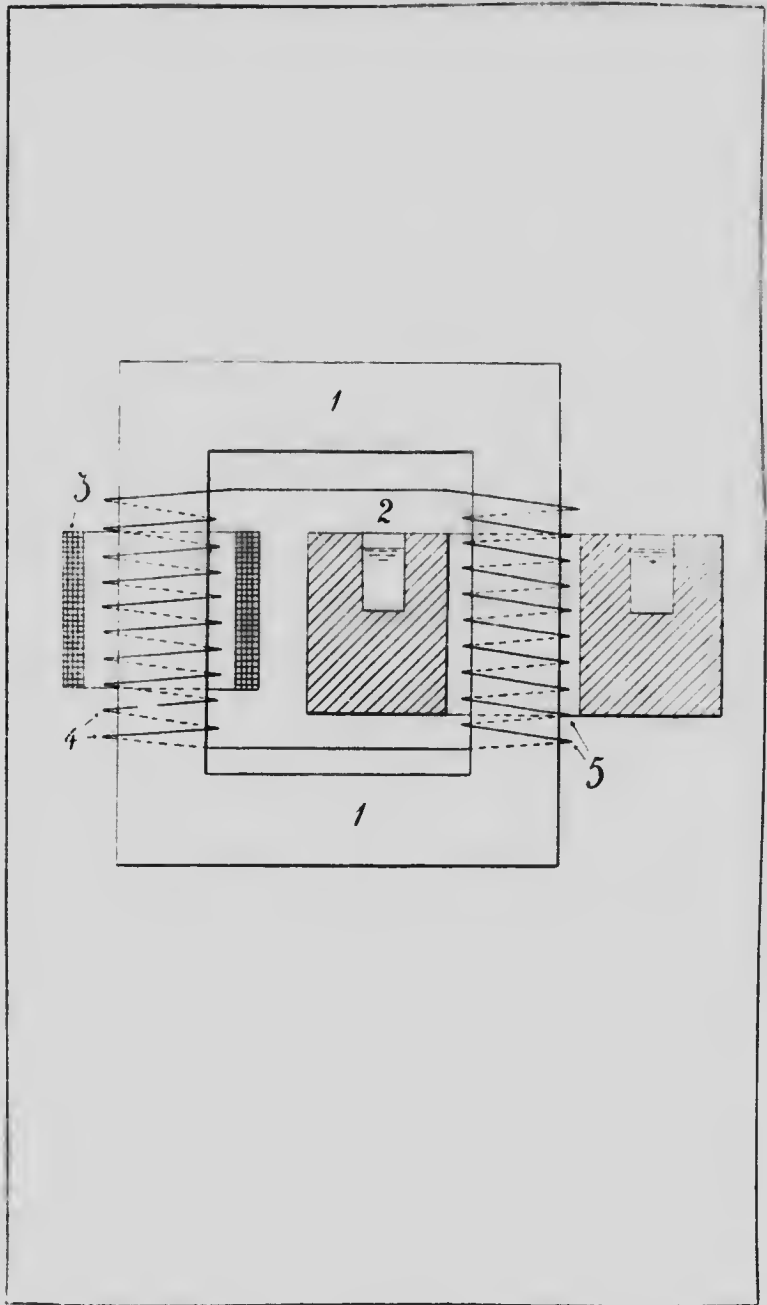

Specification No. 1a.

Improvements in Transformer Furnaces relating to the arrangement of Compensation Coils for the decrease of the Magnetic Leakage.

One of the greatest difficulties with transformer furnaces has up to the present been the great phase displacement produced by the generally considerable magnetic leakage.

The principle of the invention previously made by the inventors for the decrease of the magnetic leakage (see patent Specification No. 1) consists of suitably placed coils, charged from the outside with the required current, in such a manner that their magnetomotive force compensates the magnetomotive force with which the leaking lines of force try to force their way out from the iron core of the transformer.

The present invention has reference to a certain modification of that invention, which in an essential degree facilitates its practical application, on account of the decrease in the required number of coils and consequently also the decreased amount of copper required.

The accompanying drawing shows this form of the invention. Fig. 1 is a vertical section of a transformer furnace provided with the said invention. Fig. 2 is also a vertical section of such a furnace provided with another form of the invention. 1 and 2 are the two vertically placed legs of the iron core of the transformer, united above and below by the two parts 3. 4 is the melting bath and 5 the primary coil with its two terminals 6 and 7. 8 and 9 are two other coils designed in accordance with the present invention to counteract the primary leakage.

Fig. 1 shows the terminal 10 for coil 8, connected with the terminal 11 for coil 9. The other two terminals, 12 and 13, for these coils are intended to be connected with an outer source of current. The two coils 8 and 9 have such a winding, that the electromotive forces induced in same from the lines of force in the iron core are directed against each other.

If no primary leakage is produced, *i.e.*, if all of the lines of force produced by the primary coil 5 in the leg 1 pass also through leg 2, the electro-motive forces produced in coils 8 and 9 are equal, (providing the number of windings in the two coils are equal). There will be no difference of potential between the terminals 12 and 13. If, on the other hand, a primary leakage is produced, then a greater number of lines of force pass through leg 1 than through leg 2 and consequently the currents induced in coils 8 and 9 are no longer equal.

Assume that in leg 1 a number, a , lines of force are produced and in leg 2 a number, b ; in such a case the electro-motive force induced in coil 8 is proportional to a and in coil 9 proportional to b . On account of the two coils 8 and 9 being connected in such a manner that they counteract each other, a difference of potential is produced between the two terminals 12 and 13.

proportional to $a-b$, but $a-b$ represents the number of leaking lines of force around the primary coil 5 and, therefore, it is evident that the difference of potential produced between the terminals 12 and 13 by the primary leakage is equal to the difference of potential which would be induced in a coil with the same number of windings as coil 8 or 9, if all the primary leaking lines of force were forced to pass through it. The coils 8 and 9 act consequently as one coil, through which all the primary leaking lines of force are forced to pass. From this it follows that if a suitable current is passed through the coils 8 and 9 of such a strength that the magnetomotive forces in the said coils are made equal to the magnetomotive force with which the primary leaking lines of force try to force their way out of the iron core, the primary leakage is prevented.

It is to be noted that when this case happens the difference of potential between the terminals 12 and 13 is equal to 0, *i.e.*, the coil system 8 and 9 is a non-inductive winding and to force the required current through same only enough electromotive force is required to overcome the ohmic resistance.

This condition, that the coil system 8 and 9 is non-inductive, is a matter of great importance.

The current for the coil system 8 and 9 can, of course, be taken from the same source delivering current to the primary coil, providing the electromotive force is suitable. If that is not the case, the voltage can by means of a small transformer be made suitable. Evidently the coil system 8 and 9 can also be supplied from some other source of current, provided that the current is in phase or at 180° phase displacement from the current with which the primary is supplied and that the frequency is the same.

In case the coil system 8 and 9 is supplied with current from the same source as the primary coil, and a transformer is necessary to obtain a suitable voltage, instead of a separate transformer, the transformer coupling invented by Hick may then be used with advantage. The arrangements in this case are shown in Fig. 2.

The primary coil is as before supplied with current through the terminals 6 and 7, but the terminal 12 of coil 8 is now connected to the terminal 7 of the primary coil and the terminal 13 of coil 9 connected to such a point 14 on the primary coil that the prevailing difference of potential between terminals 7 and 14 will just be sufficient for the coil system 8 and 9.

It is evidently *not* necessary that the primary coil 5 be placed as shown in the drawing, since its position is indifferent in regard to the iron core. The primary coil can also be divided up in a number of arbitrarily placed parts. Evidently also the coils 8 and 9 can be placed in some other way than shown in the drawing and be divided up in different parts.

Fig: 1.

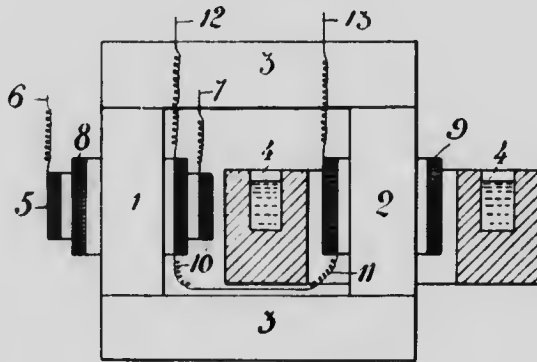
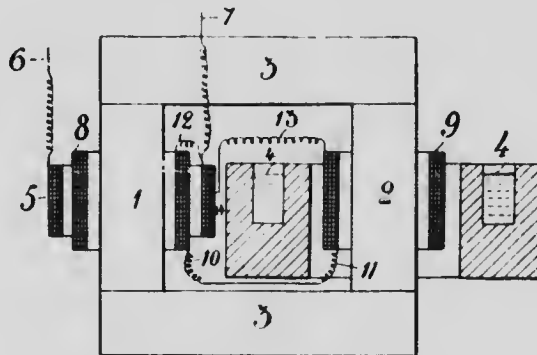

Fig: 2.



Specification No. 2.*Improvements in Transformer Furnaces relating to the Construction of the Iron Core of the Transformer for the decrease of the Magnetic Leakage.*

In electric smelting furnaces of the transformer type before known one of the greatest difficulties in practice has been the considerable electromagnetic leakage and the shifting of phases arising therefrom, which takes place on account of the position of the primary coil or coils with regard to the secondary coil, in this case consisting of the smelting bath.

In other transformers, for instance such as are used for the transmission of power, this difficulty does not arise, as in such transformers the primary and the secondary coil may without any inconvenience be placed near to each other, for instance in such a manner that the one coil be placed concentrically around and near to the other coil. In transformer furnaces, however, such an arrangement is, on account of the furnace construction, not possible, for even if the primary coil and the smelting bath be placed concentrically relatively to each other, the high temperature of the smelting bath makes it necessary that there should be a relatively great space between the primary coil and the smelting bath, in order that a sufficient insulation against heat may be secured. Therefore, in transformer furnaces other means must be used for reducing the leakage, so that the power factor ($\cos \varphi$) may not be too small, making the use of massive and expensive machinery necessary.

According to observations made by us in transformers of the constructions hitherto used, the leaking lines of force emanate chiefly from the edges of the sheets or lamellae of iron of which the transformer core is composed. Thus, when the transformer core is formed with rectangular cross section the most of the leaking lines of force emanate from those sides of the core which are formed of the edges of the said sheets or lamellae, while only a relatively small number of the leaking lines of force emanate from the other sides of the core, or, in other words, the leaking lines of force pass more easily along the side surfaces of the sheets of iron than across the same. This is also in accord with the theory, as the leaking lines of force which try to pass across the sheets of iron necessarily must be counteracted or restrained by the "screening action," which the iron sheets themselves exercise.

The present invention has for its object an iron core for use in transformer furnaces, which iron core is constructed on the base of the said observations for the purpose of reducing the leakage as far as possible.

The principle of the invention is, broadly speaking, as follows: The transformer core should be so formed that its surfaces, as far as possible, be formed not of the edges of the iron sheets of which the transformer core consists, but consist of the iron sheets or lamellae of which the transformer core

is formed and so arranged that wherever the leaking lines of force try to escape or emanate from the iron core they are forced to pass *across* a smaller or greater number of the said sheets of iron. In order to make our invention more plain, it is described in the following with reference to the accompanying drawing in which, as examples, different forms of the same are illustrated.

Fig. 1 is a front view of a rectangular transformer core, constructed in accordance with this invention and Fig. 2 shows a horizontal cross section of the same. Fig. 3 is a horizontal cross section of another form of a transformer core, also constructed in accordance with this invention.

According to the form of the invention illustrated by Figs. 1 and 2, the iron core is composed of a number of parts or sections, 1, of triangular section, said sections being put together to complete the iron core, so that the iron sheets, of which a certain section 1 is formed, will be parallel with that side-surface of the complete transformer core, which is formed of the same part or section. In order to prevent the production of disadvantageous currents within the iron ore, the several sections or parts 1 are separated from each other by means of a layer 2 of insulating material. To secure the effect aimed at by this invention, *i.e.* the "screening action" of the iron sheets, by which the reduction of the leakage is attained, the vertical legs of the transformer core may suitably be connected also at the corners with its horizontal parts in the manner shown in Fig. 1.

According to the form of the invention illustrated by Fig. 3, the sections 1 are formed with such cross sections that when said sections or parts 1 are put together, passages or canals 3 are formed, through which a suitable cooling medium may be led for cooling of the iron core.

Obviously it is not necessary that the transformer core be formed with rectangular cross section as shown in the drawing, but it may also be formed with any other suitable section and it ought also to be understood that the iron core may even be formed by another number of sections or parts than that shown in the drawing and that in such case all or a part of them may be formed with other cross sections than the triangular one. The iron core may also be composed of sheets of iron, placed concentrically or spirally around each other, in which case, however, the sheets must be insulated from each other in such a manner that no disadvantageous currents can develop within the iron core.

Fig:1

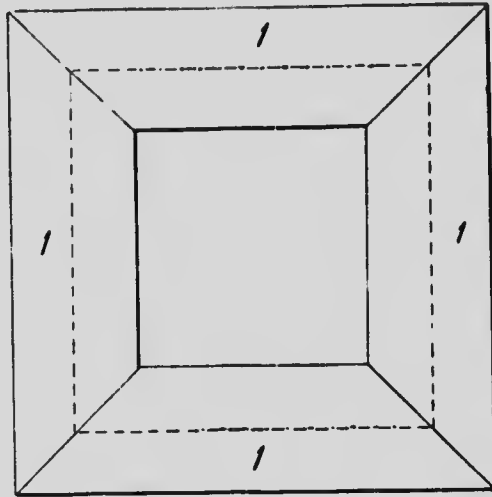

Fig:2.

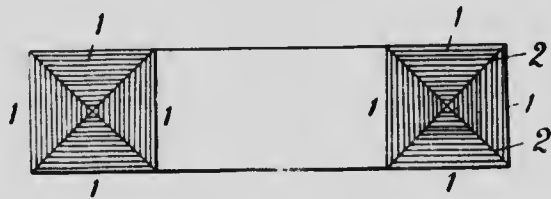
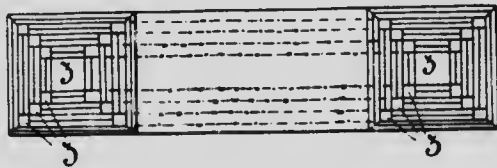

Fig:3.



Specification No. 3.*Improvements in Transformer Furnaces relating to the arrangement of Short-circuited Conductors for the decrease of the Self Induction.*

The present invention relates to improvements in electric furnaces of the type where the crucible is formed of an endless groove intended for the reception of the material to be treated, which material alone or together with other conducting materials placed in said groove forms the secondary coil of an electric transformer.

In transformer furnaces of the said type and of the construction hitherto known the disadvantage has appeared, that, owing to their construction, the self induction becomes very great and thus they work with a relatively small power-factor ($\cos \varphi$), which makes expensive machinery necessary.

The present invention consists in such improvements in transformer furnaces of the said type by means of which the self induction may be considerably reduced. For this purpose, according to this invention, a short circuited conductor or conductors of low resistance is placed in the way of the leaking lines of force but not in the way of the effective lines of force of the transformer, in which conductor or conductors by the action of the leakage flux currents are induced, which directly counteract the said flux. It is to be understood without further explanation that the said short circuited conductor or conductors may consist of an endless conductor or of annular discs or of mantels of conducting materials cut open in one or more places and formed and arranged in a suitable manner. This conductor or conductors may be located in non-insulated condition, at a little distance from the smelting bath, so that they may, without damage, be exposed to a high temperature. The less the ohmic resistance of these conductors is and the greater the number of the leaking lines of force that are caused to pass through the same, the more effective will the action of the same be.

In the following this invention is described with reference to the accompanying drawings, forming parts of this specification. In these drawings are shown as examples several different forms of the invention.

Fig. 1 is a vertical section and Fig. 2 a plan view of an electric smelting furnace embodying a form of the invention. Figs. 3, 4 and 5 are horizontal plan views of smelting furnaces embodying some other forms of the invention. In the different Figures corresponding parts are indicated with the same numbers of reference.

Referring to Figs. 1 and 2, 1 is the transformer core, which is surrounded by the groove 2, intended for the reception of the material to be treated (or the material forming the secondary coil) and by the primary coil 3. The said core, the whole or a part or parts of it, is further, according to this invention, surrounded by a mantel 4, of conducting material, which mantel is

cut open at one or several places, for instance at 5, in order that the effective lines of force of the transformer may not act inductively on the same. By means of this mantel 4, which may enclose the whole transformer core or only a part thereof, the primary leakage is decreased with increase of sectional area and conducting power of the mantel, and also with increase of length of the transformer core enclosed by the mantel. The said mantel or envelope may also be of the form illustrated by Fig. 3. According to this form of the invention, the said mantel 4, which is made of conducting material, is formed of two or more turns of the conducting material wound around each other spirally and insulated from each other. The said mantel may also be employed as a cooling device in such a way that a cooling medium is forced to flow between the said mantel and the transformer core. According to the form of the invention illustrated by Fig. 4, the short circuited conductor 4, enclosing a part or parts of the transformer core, is placed within the groove 2, intended for the reception of the material to be treated in such a manner that the leaking lines of force may act inductively on the same. According to the form of the invention illustrated by Fig. 5, the said short circuited conductor or conductors shown in Fig. 4 consist of or are replaced by one or more annular discs or plates 4 of conducting material, cut open at one or several places, for instance at 5, so that the effective flux of the transformer may not act inductively on the said disc or discs, while the diffused or leaking lines of force excite local eddy currents in the same, which counteract the said leaking lines of force. Obviously these conductors or discs or mantels may be placed either within the area enclosed by the smelting bath, or above, beneath, or around it, or simultaneously in two or more of these different manners.

Fig:1

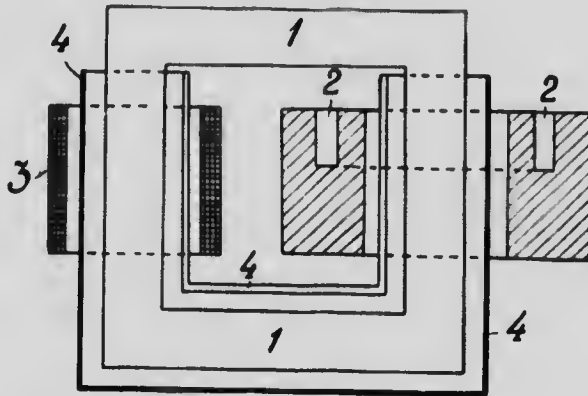

Fig:2

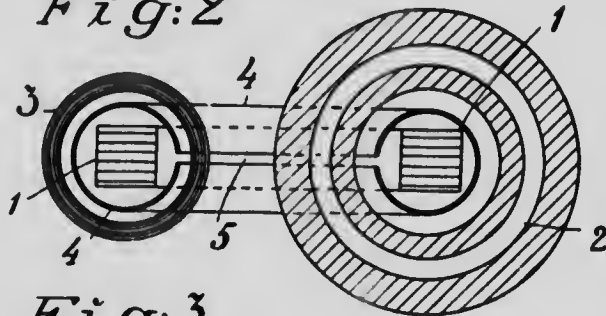
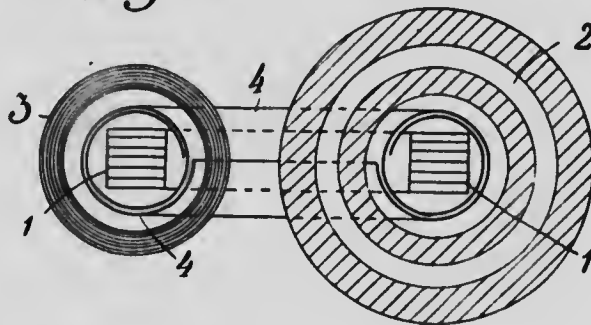

Fig:3





MICROCOPY RESOLUTION TEST CHART

(ANSI and ISO TEST CHART No. 2)

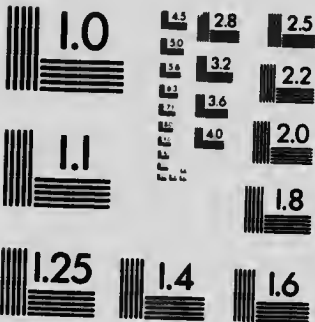

APPLIED IMAGE Inc

1653 East Main Street
Rochester, New York 14609 USA
(716) 482 - 0300 - Phone
(716) 288 - 5989 - Fax

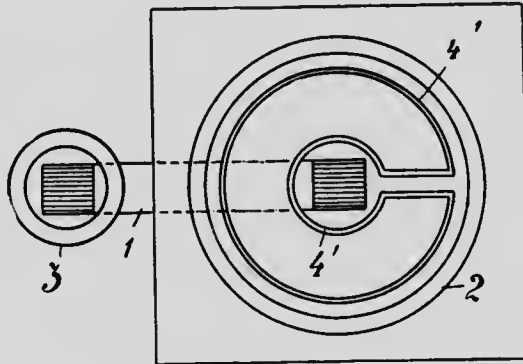
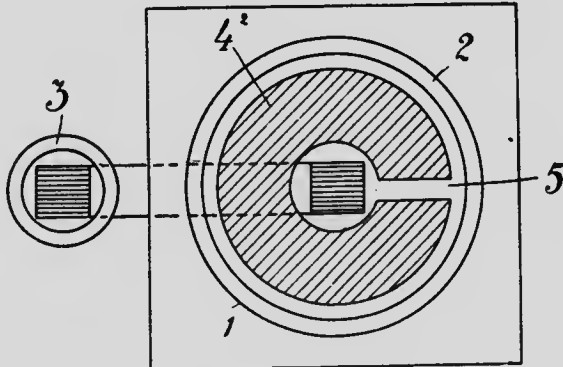
Fig: 4.*Fig: 5.*

Specification No. 4.*Improvements in Electric Transformer Furnaces and Transformer Furnaces
in connection with a Shaft Furnace.*

The present invention relates to improvements in electric furnaces of the type where the crucible is formed of an endless groove intended for the reception of the material to be treated, which material, alone or together with other conducting materials placed in said groove, forms the secondary coil of an electric transformer.

The invention consists of a special form of the said groove or canal, which is intended for the reception of the material to be treated, which material, as above said, during the smelting or heating process forms the secondary coil or conductor of the electric transformer. The invention further consists in the combination of two such grooves or canals with each other in such a way that the material may be tapped off from the one into the other for further treatment. The invention also consists in the combination of the smelting groove or canal with a blast furnace or other similar furnace and in a certain arrangement of the primary coil of the electric transformer or transformers used, and in certain arrangements of said transformers and grooves. In the use of electric smelting furnaces of the above mentioned type and of the constructions hitherto known certain difficulties have been experienced, consisting partly therein that a great phase-displacement takes place which becomes greater the greater the area is which is enclosed by the said groove forming the hearth or crucible and partly therein that only an electric current of relatively low voltage can be used.

Through the present invention these difficulties are overcome thereby, that the said endless groove (or grooves) intended for the reception of the charge to be heated or smelted and which as usual surrounds a part of the iron core of the transformer is partly bent around the said core but provided with one or more relatively long extensions formed in such a way that certain parts or branches of said groove (or grooves) are arranged parallel to each other and as near each other as is practically possible. These extensions are connected with each other in such a way that the same together with the parts bent around the core form an endless groove or canal. By giving the groove this particular shape, the advantage is gained that it will have a great volume, but enclose a relatively small area. Besides this the further advantage is gained that a higher voltage may be used than by any other construction. The voltage may be the greater, the longer the said extensions of the smelting groove are. On account of the relative smallness of the area enclosed by the said groove, the periods of the alternating electric current employed may be of greater frequency, hence the electric machinery necessary will be considerably less costly than with constructions before known.

An electric smelting furnace of this construction can suitably be combined with a blast furnace or another similar furnace in such a manner that the extensions of the groove of the electric furnace, or in general words, the parts of the groove arranged practically parallel to and near each other, are drawn into or through the hearth (the lower part) of the furnace. Thus, the hearth of the blast furnace will consist of a part of the smelting groove of the electric furnace and the material heated or smelted in the blast furnace will directly drop down into the smelting bath of the electric furnace and will there be submitted to further treatment by means of an electric current. Preferably two grooves of the form above stated may be combined with each other either in such a way that they belong to one and the same transformer, or in such a way that each of them is provided with its own transformer or transformers. These grooves are so located relatively to each other, that the one is placed higher than the other so that the smelted material may be tapped off from the former to the latter for refining treatment or puddling.

In order to facilitate the cooling of the primary coil of the transformer and to reduce its leakage, it is, according to this invention, placed not around the part of the iron core of the transformer which is enclosed by the smelting bath, forming the secondary coil, but around one of the other parts, preferably around the lower one of those parts, by which the vertical legs of the said core are connected with each other or a primary coil may at the same time be arranged both on said part and on the vertical leg not enclosed by the smelting bath, by which arrangement the leakage from these parts of the transformer is practically overcome.

In the accompanying drawings examples of some forms of construction of the invention are shown:—

Fig. 1 is a vertical section of a transformer furnace in accordance with the present invention. Fig. 2 is a plan view of the same seen from above. Fig. 3 is a vertical section through the line C-D in Fig. 4 of such an electric furnace combined with a shaft furnace. Fig. 4 is a plan view of the same seen from above and partly in section through the line A-B in Fig. 3 and Fig. 5 is a transverse section through the line E-F in Fig. 4. Figs. 6, 7 and 8 illustrate in the same manner a somewhat modified form of the furnace shown in Figs. 3-5. Fig. 9 is a vertical section and Fig. 10 a horizontal plan view of another form of the invention. Fig. 11 is a vertical section and Fig. 12 a horizontal plan view of still another form of the invention and Fig. 13 is a vertical section and Fig. 14 a horizontal plan view of still another form of the invention. In the several Figures the same parts are indicated by the same figures of reference.

Referring to the Figs. 1 and 2, 1 is the endless groove or canal arranged in a frame 2 of brick work or the like and is intended for the reception of the

material to be treated. Said groove encloses as usual a part, 3, of the core of the transformer and 4 indicates the primary coil of the transformer, which coil for the purpose stated above is placed on the lower one of those parts of the said core of the transformer that connect the vertical legs with each other. The groove 3 is partly bent around the one leg of the iron core and is provided with one or several relatively long extensions 5 arranged parallel (or practically parallel) and as near each other as possible, the said extensions being at their outer ends 14 connected with each other so that an endless groove is formed. In transformer furnaces where alternating electric two- or poly-phase current is used, the groove may also be provided with such extensions, in which case the ends of the same may be connected to a neutral point. When the groove intended for the reception of the material to be treated is given the form above stated the advantage is gained, as above said, that a part (for instance at 14) of the extension of the same may be placed within the hearth of a blast furnace or another smelting furnace. Such an arrangement is shown in the drawings, as for instance in Figs. 3, 4, 5, and in Figs. 6, 7, 8. In these Figures 5 indicates the parts of the groove that form the hearth. Said parts enter into the hearth of the blast furnace 6, where they are connected with each other in the manner shown in Figs. 4 and 7.

The material heated and reduced within the blast furnace may thus in smelted or heated condition directly drop down into the said groove of the electric furnace, where it is submitted to the action of the electric current. In this case the electric current will pass through the hearth or through the smelting zone of the blast furnace, thereby generating a quantity of heat sufficient to make up for all or at least a part of the quantity of coal or other fuel that otherwise would be necessary for the smelting of the ore within the blast furnace. The smelted iron may by means of these arrangements be brought to continuously flow out from the blast furnace into the melting bath of the electric furnace where it is further heated or refined.

The said arrangement of the electric furnace, viz.: that the groove is provided with extensions or parts arranged practically parallel and near each other may also be used in electric furnaces of the type called "contact furnaces" or "resistance furnaces."

In some cases another groove, 9, (which may be called "fining groove") similar to the mentioned one may be arranged at the side of this latter, which groove, in such cases, forms the "steel melting groove" proper. This groove, 9, is, as may be seen from the figures 5 and 8, arranged lower than the other groove, 1, so that the smelted mass may be tapped off from the groove 1 into the groove 9 through suitably arranged canals or the like (not shown). The said grooves 1 and 9 may have a common electric transformer (or transformers), as shown in the figures 3 to 5, or be provided each with its own transformer, as shown in the figures 6 to 8. The groove 1, which, to distinguish it from the groove 9 in this case, may be called the "blast furnace

groove," is suitably covered with a vault or with plates 7, of fire-proof or refractory material, so that a canal or passage 10 is formed, through which gases containing carbon monoxide or other oxidizable gases suitable for the reduction or heating of the material charged into the blast or smelting furnace may be introduced into this latter through the pipe 8. Such an arrangement permits the introduction of gases into the blast or smelting furnace in a very simple and practical manner. This construction has the additional advantage, that when the said gases pass through the passage 10 over the smelted mass in the groove 1, the gases absorb heat that radiates from the slag covering the smelted iron in the groove. This heat may be utilized for the process going on in the blast or smelting furnace. The said gases containing carbon monoxide, which are introduced into the blast or smelting furnace through the pipe 8, are preferably generated in the manner stated in another application filed simultaneously herewith, viz.: that the gases issuing from the said furnace, which gases are relatively rich in carbon dioxide, are continuously led through a heating device and there heated to a sufficiently high temperature and thereafter in a heated condition led through or over a layer of carbon, whereby the carbon dioxide through the reducing action of the carbon is reduced to carbon monoxide while at the same time carbon is oxidized to carbon monoxide. The gases thus received, or a part of them, which are relatively rich in carbon monoxide, are then led through the pipe 8 and passages 10 into the smelting furnace, where the carbon monoxide either by means of air introduced in said furnace or principally by means of the oxygen contained in the material to be treated is oxidized to carbon dioxide, which together with the other gases are, in the manner above stated, led from the blast or smelting furnace through the heating device and over or through the carbon for regeneration of carbon monoxide, which latter gas is then again introduced into the furnace and so forth in a continuous circulation with alternate oxidation of carbon monoxide to carbon dioxide and decomposition or reduction of this latter by means of carbon to carbon monoxide. Canals or passages 12 are also provided for conveyance of air to the transformer for the purpose of cooling the same.

It must be understood that in the case illustrated by the figures 1 and 2, *i.e.* when the electric furnace is not combined with a blast furnace or another similar smelting furnace, a special "fining groove" may also be provided in the same manner as shown in the figures 3 to 5 or 6 to 8.

In the figures 9 to 14 some other forms of the invention are shown.

According to the form illustrated by the figures 9 and 10, the furnace is provided with two transformers 3 placed each at the opposite ends of the groove 1 intended for the reception of the material. This groove may have the form shown in figures 10 and 12, *i.e.*, its end portions partly bent concentrically around a leg of the cores of the transformers and its middle portions arranged substantially parallel to and as near each other as possible. The

last named parts may be straight, as shown in Figures 10 and 12, or they may be curved for instance, as shown in Figure 14, or in any other suitable way.

In Figures 13 and 14 there is shown a form of the invention where two legs of the core of the transformer are surrounded by the groove in a manner that may be seen from Figure 14. By these arrangements the advantage is gained, that the core of the transformer may be of smaller dimensions than if only one transformer is used or a transformer of which only one leg of the core were enclosed by the smelting bath, besides which the area enclosed by the groove is with regard to its capacity relatively small. If the electric furnace is to be combined with a blast furnace or a similar furnace, these latter may suitably be placed at the middle, 15, of said groove.

In some cases it may be useful to expand a certain part of the groove into a well for collecting the smelted iron or material in question, in which also the temperature may be kept lower than in other parts of the groove. Such an arrangement may suitably be provided in the forms illustrated in Figures 9-14 in such a manner that said well for collecting the smelted material be made a neutral point, for instance at 15. (See Figure 10). These latter forms also of the electric furnace may be combined with a blast furnace in the manner before stated, in which case the blast furnace or smelting furnace is placed over the neutral point (see Figures 11 and 12). The employment of two transformers for the same smelting bath or groove has the advantage that if a fault occurs in one of the transformers this transformer may be cut out and repaired while the smelting bath is kept heated with the aid of the other transformer. The electric furnace, as illustrated for instance by Figures 3 to 5, or 6 to 8, works in the following manner:—

The ore charged into the blast furnace and there reduced by the action of the carbon monoxide is, in that part of the groove of the electric furnace which extends into or is placed within the blast furnace, heated to the smelting temperature by the passage of the electric current, reaching a temperature of about 1600° C. Into the smelted iron bath contained in said groove drops from the blast furnace both smelted iron and also partly reduced pieces of ore. These latter pieces when they have fallen into the iron bath are very rapidly reduced and melted. The smelted iron which fills the groove of the blast furnace is tapped into the other groove (the fining groove) which, as before stated, is placed for this purpose somewhat lower than the first groove. Some smelted iron must, however, be retained within the "blast furnace groove" in order that the electric current may not be broken. The fining process is carried out as usual by adding scrap iron or ore to the smelted pig iron. The fining work may conveniently be carried out in those parts of the groove that are arranged parallel to each other. When the fining work of a charge is finished, all the charge may be tapped off and the "fining groove" again charged from the "blast furnace groove." Evidently a very high de-

gree of efficiency may be obtained in an electric smelting furnace, constructed as above described. In the blast furnace itself the smelting zone where the highest temperature takes place may be restricted to a small space, for the high temperature is, as described, obtained in the iron and the heat is led from the interior of the mass outwards. This electric transformer furnace is, as before stated, from an electric point of view of a most advantageous construction.

It ought to be understood that even more than two grooves, each surrounding a leg of a transformer core, may be combined with each other in the manner described, by means of grooves arranged parallel to and near each other.

Fig:1.

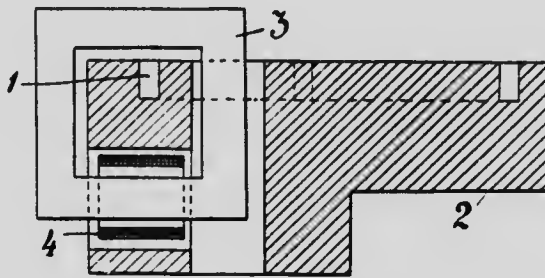

Fig:2.

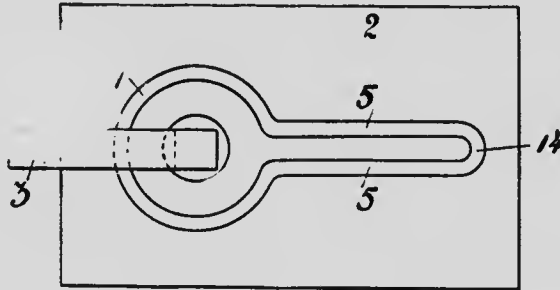

Fig: 3.

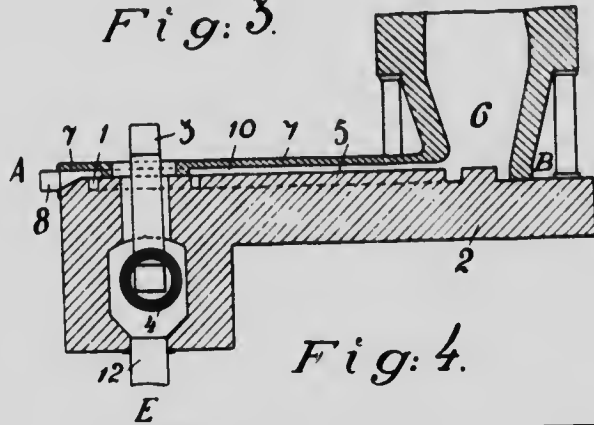

Fig: 4.

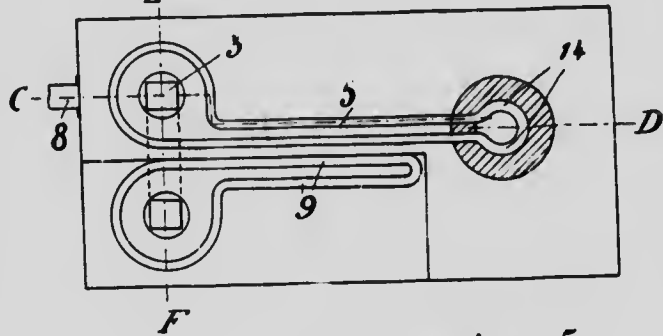

Fig: 5.

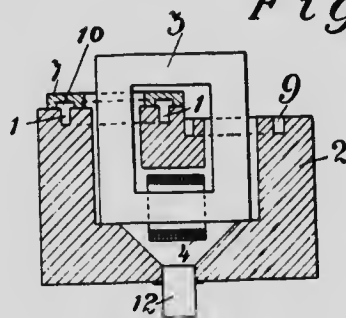

Fig:6.

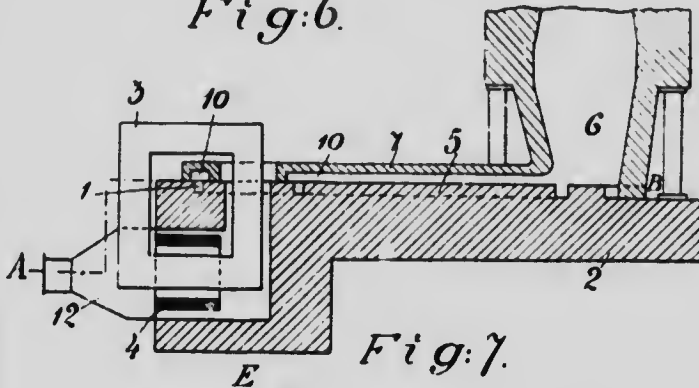
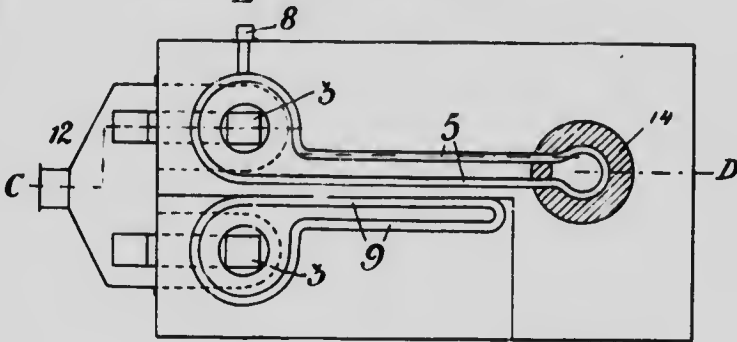

Fig:7.



F

Fig:8.

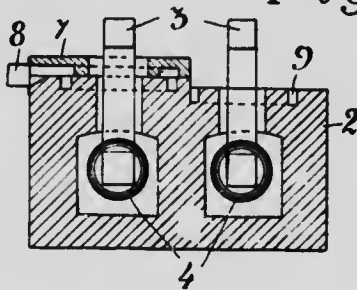

Fig: 9.*Fig: 10.*

Fig: 11.*Fig: 12.*

Fig: 13.*Fig: 14.*

Specification No. 5.*Electric Contact Furnace for the Production of Metals from their Ores.*

For the production of metals from their ores by means of the electric current, as for instance for the reduction of iron ores, furnaces have been used in which the electric current is brought by means of contacts to the material which is to be heated or melted. The heat developed by the electric current is produced in the material through its electric resistance.

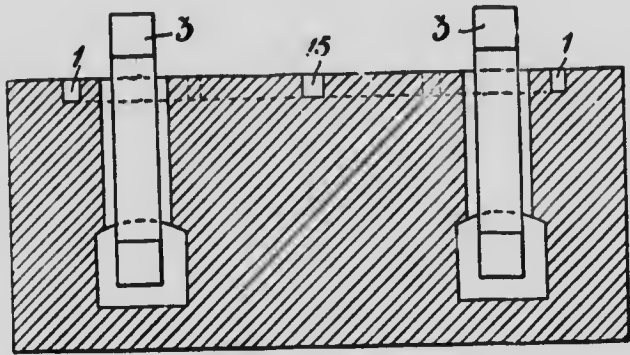
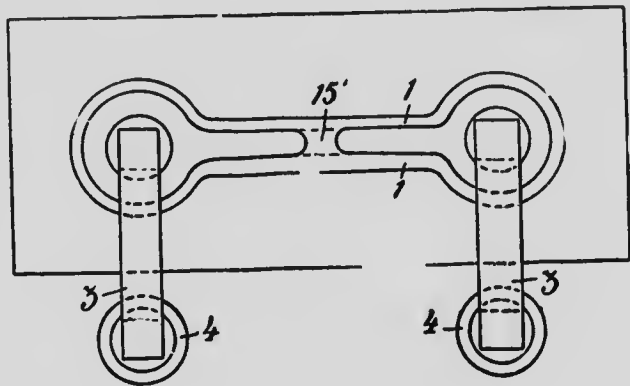
One difficulty with these furnaces has been the conveyance of the current, *i.e.*, in the arrangement of the contacts themselves. Up to the present the contacts have generally been so arranged that either both or at least one of the electrodes have been placed inside the furnace shaft (in a vertical or more or less inclined position) and surrounded by the charge. The gases produced by the reduction in combination with the high temperature have in such cases led to destructive corrosion of the contact.

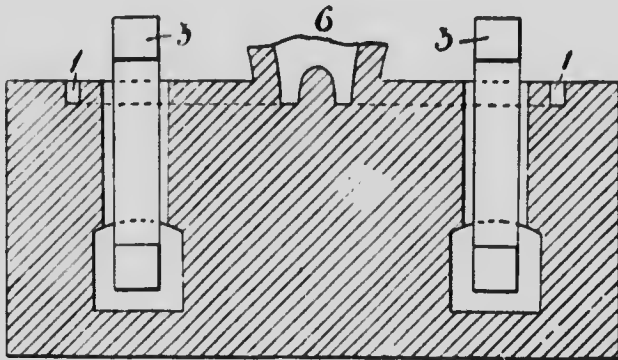
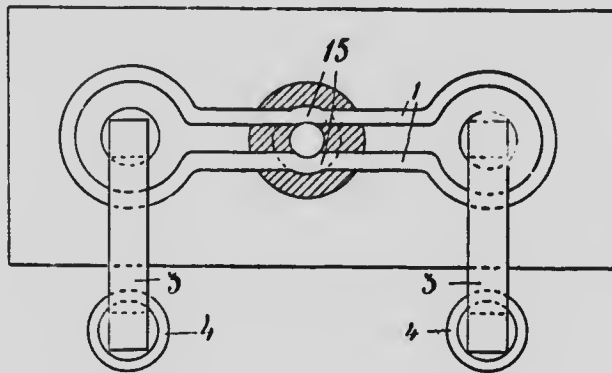
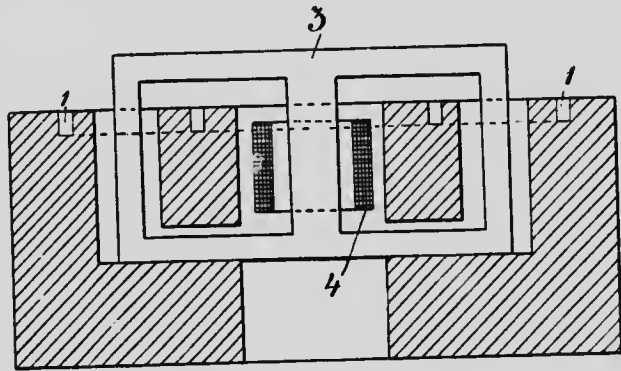
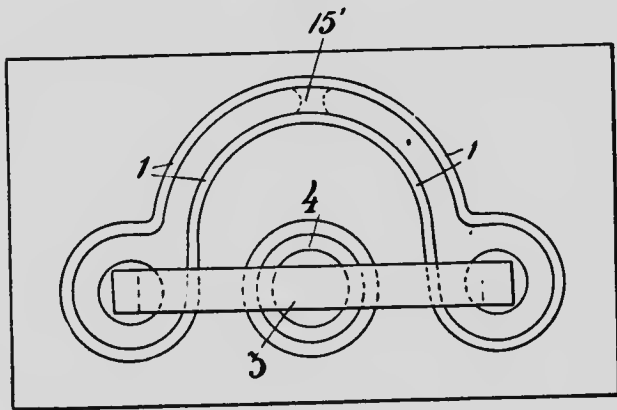
This present invention has in view a furnace-construction in which the above mentioned difficulty is eliminated.

The accompanying drawing shows, as an example, a furnace according to this invention. Fig. 1 is a vertical section through line E-F in Fig. 2. Fig. 2 is a horizontal section through line C-D in Fig. 1 and Fig. 3 is a vertical section through line A-B in Fig. 1. 1 is the furnace shaft, in which the material to be smelted is charged. The lower part of the shaft is divided into two parts by means of a wall of fire-proof material, so that two grooves, 6, are formed, in which the melted materials collect. These grooves extend through the openings, 2, in the brick work outside the shaft. The material forming the conductors in the parts of the grooves extending outside the shaft is in a molten or half molten condition and in some suitable manner connected with the terminals of the electric current, for instance, as shown in the drawing, by two carbon blocks, 5, which are placed at the ends of the grooves, which here are widened out and made deeper.

In order to keep the molten bath inside the furnace at a constant level, the molten product, as shown in the drawing, can continuously be run out through openings 7 into a fore-hearth 8, from which it can be tapped through the tap-hole 9.

For a furnace of above described construction the continuous working from an electrical point of view will be as follows:—

The electric current passes from one of the terminals 5 through the molten product of the furnace in groove 6 and across the wall 3 through the charge to be smelted and out to the other terminal through the material in the other groove. The charge in the furnace through its resistance to the current is heated and melted.

The molten material in the grooves 6 inside the furnace performs consequently the function of electrodes. The parts of grooves 6 outside the furnace can be made of such cross section that the temperature will be comparatively low, which enables the contacts to be made more easily.

When starting the furnace a suitable electrode material of the same kind as the product to be produced is placed in the grooves 6.

This class of furnace construction can, of course, be adapted for poly-phase currents. For a three-phase current, for instance, the grooves are arranged as shown in Fig. 4 and if the shaft is circular as shown in Fig. 5.

Fig: 1.

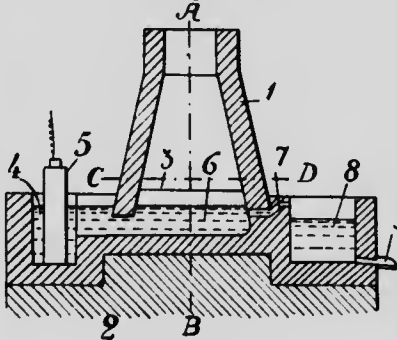

Fig: 3.

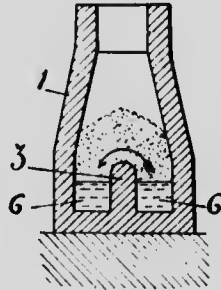

Fig: 2.

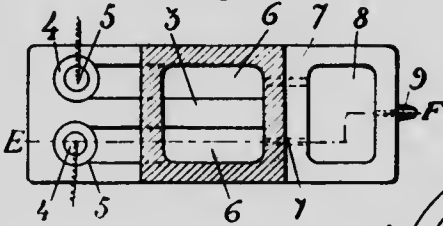

Fig: 5.

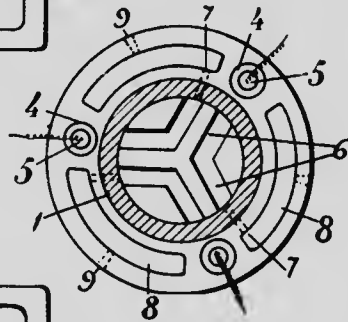
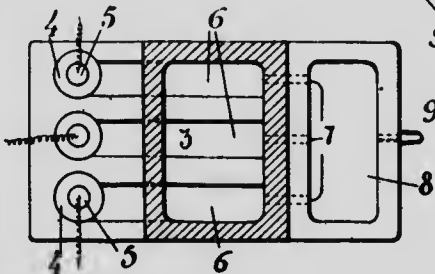

Fig: 4.



Specification No. 6.*Rotating Smelting Furnace.*

Experiments with rotating furnaces have been made during late years at several places for roasting ores, for cement fabrication and also for the production of pig iron.

The construction used has consisted of one or more inclined or horizontal rotating cylinders, into which the ore is charged and slowly brought forward, gradually meeting gases of continuously increased temperature, and at last melted down in a special part of the furnace, or in a separate chamber, arranged at the side of or in the lower part of the rotating cylinder. In this part of the furnace the heat is generated by the combustion of generator gas by means of an air blast.

The difficulty, however, has been the sintering together of the ore before it gets down to the smelting chamber, on account of the impossibility of preventing the heat, when gas firing, from rising to the higher parts of the furnace, and the consequent clogging of the relatively narrow cylinders.

This difficulty can be altogether avoided by employing the construction constituting this present invention, which is based on an electric furnace in combination with a rotating reduction furnace and eventually also a rotating roasting furnace. Throughout the extent of the reduction and smelting chamber combustion by means of the oxygen from air is precluded.

In the accompanying drawings are shown as examples two different constructions of the invention.

Fig. 1 is a vertical section of a construction, including both roasting, reduction furnace and an electric furnace. Fig. 2 is a vertical section of a similar furnace construction, but in this the roasting furnace is omitted.

The furnace shown in Fig. 1 consists of a series of inclined rotating cylinders, 1, 2, 3, 4, communicating with each other, constructed of some suitable material. The two upper cylinders, 1 and 2, constitute the roasting furnace and the two lower ones, 3 and 4, the reduction furnace. The upper end of cylinder 1 communicates with a charging apparatus, 5, for the ore. The lower end of cylinder 2 and the upper end of cylinder 3 communicate with another charging apparatus 6 for the carbon and eventually for such material as may be required for the reduction and smelting processes. In the lower end of cylinder 2 a tuyer 7 (or eventually more than one) is inserted for the introduction of air into the roasting furnace.

The lower end of cylinder 4 communicates with a suitable chamber 8 constituting an electric smelting furnace, in which the charge is melted. In this chamber or in the lower part of cylinder 4 one or more tuyers, 9, are inserted for the introduction of reducing gases, which may be generator gas.

The electric furnace can be of any suitable construction, as, for instance, a transformer furnace or a contact furnace.

In the accompanying drawings the electric furnace is a contact furnace of the following construction:—

In the lower part, 10, of the furnace chamber, 8, are arranged two grooves, 11, (one only shown in the Fig.), extending outside the furnace and connected with the contact blocks, 12. The electrodes in this case are formed (during the continuous working) by the molten material in these grooves, which convey the electric current respectively to and from the furnace. The ends of the grooves connected with the blocks 12 are suitably made wider and deeper in order to obtain a lower temperature in these parts and in order to keep the molten material in the grooves at a constant level these grooves are provided with tap holes, through which the melted product continuously flows out into the fore-hearth 15 and from there is tapped through the tap hole 16. The rotating cylinders are on the inside provided with longitudinal projections 17, which during the rotation agitate the material and insure a better effect of the gases. These projections can be formed by bricks laid in the lining.

With this furnace the working process is as follows: Ore in suitable form is charged through the charging apparatus 5 and passes through the rotating cylinders 1 and 2, constituting the roasting furnace, and is there meeting hot air, pressed in in sufficient quantity through the tuyer 7.

The heat required for the roasting of the ore taking place in cylinders 1 and 2 is derived from the combustion of the combustible gases coming from the reduction furnace by the *previously* heated air passing into cylinder 2 through the tuyer provided for this purpose. The amount of air pressed in is regulated in such a manner that no sintering together of the ore can occur. The ore after being roasted drops from cylinder 2 down into the stationary hopper 18, where it is mixed with carbon and other required material. The mixture then passes through the cylinders 3 and 4, constituting the reduction furnace, where it is met by the hot reducing gases pressed in through the tuyer 9. In order to prevent too high a temperature in the reduction furnace, no air is here let in, but only reducing gases suitably preheated to a temperature of 800°—1000° C. The preheating of the gases can be accomplished in an electric heating apparatus, as shown in Fig. 2.

The highly heated material drops from cylinder 4 down into the furnace chamber 8 and is there smelted by means of the electric current, as previously described.

The electric furnace can also be used in combination with only a reduction furnace, as is shown in Fig. 2. The principal difference in this construction from that represented by Fig. 1 is that the cylinders 1 and 2 constituting the roasting furnace have been omitted.

The ore is charged together with carbon and other required material through the closed charging apparatus 18 and passes through the rotating

cylinders 3 and 4 down into the furnace chamber 8, as previously described. With furnaces thus constructed, a considerable saving in carbon can be effected, by forcing the gases developed to continuously circulate through the furnace system. This can be accomplished by means of an exhauster, 20, which draws the gases from the charging chamber 18, through pipe 19, and presses them through pipe 21 into a heating apparatus of suitable construction, where the gases are heated to a temperature of 800° — 1200° C. From the heating apparatus the gases (or only part of same) are pressed through pipe 23 and tuyer 9 into the smelting chamber 8 and further through cylinders 4 and 3 back to the charging chamber.

In this case only enough carbon to combine with the oxygen of the ore needs to be added. The excess of gases resulting from the reduction can be used for other purposes. The gases which circulate through the furnace system will, when the furnace has been in operation for some time, consist nearly entirely of carbon monoxide and dioxide. The carbon dioxide is reduced by the carbon in the lower parts of the furnace to monoxide, which in the upper parts of the furnace again is oxidized to dioxide by the oxygen of the ore. Possibly part of the carbon dioxide is also dissociated in the smelting chamber 8 into carbon monoxide and oxygen.

The heating apparatus for the gases can be of any suitable construction, but preferably such that the heating is done by electricity. Such an apparatus is shown in Fig. 2. In a chamber, 22, of a suitable material are a number of tubes, 25, of conductive and fire-proof material, arranged in such a manner that the gases which are to be heated are forced to pass first through and later around the tubes before being conveyed to the furnace.

Another method, which perhaps is preferable, is to let the gases first pass around the tubes and then through the whole length of the tube system, when a higher temperature can be obtained. The rotating cylinders, in order to facilitate the passage of the ore, can be made conical.

In the constructions shown, both the roasting and reduction furnace consist of two cylinders each, but it is evident that instead of two only one or a number of cylinders can be employed.

When treating a material which only needs roasting, for instance for the production of copper, the whole furnace system is arranged as a roasting furnace, *i.e.*, air is pressed in through tuyer 9 instead of reducing gases. (See Fig. 1).

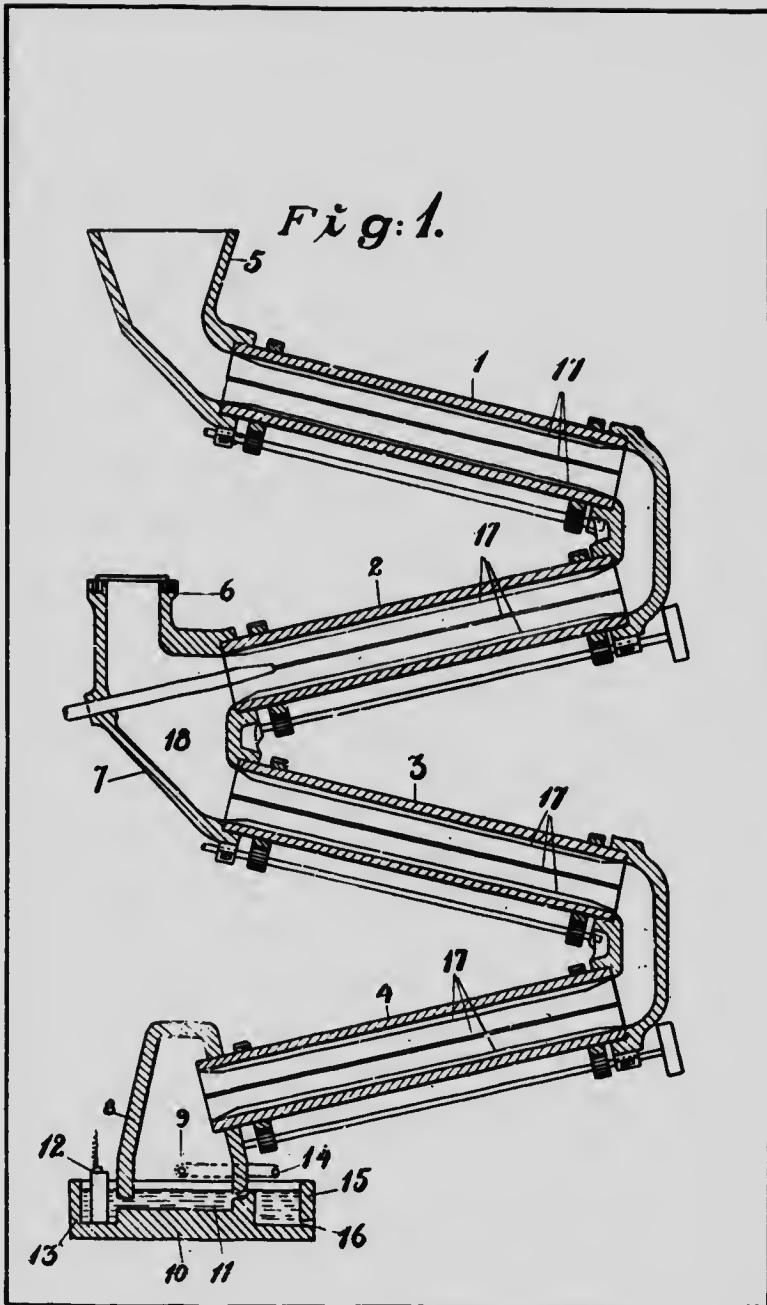
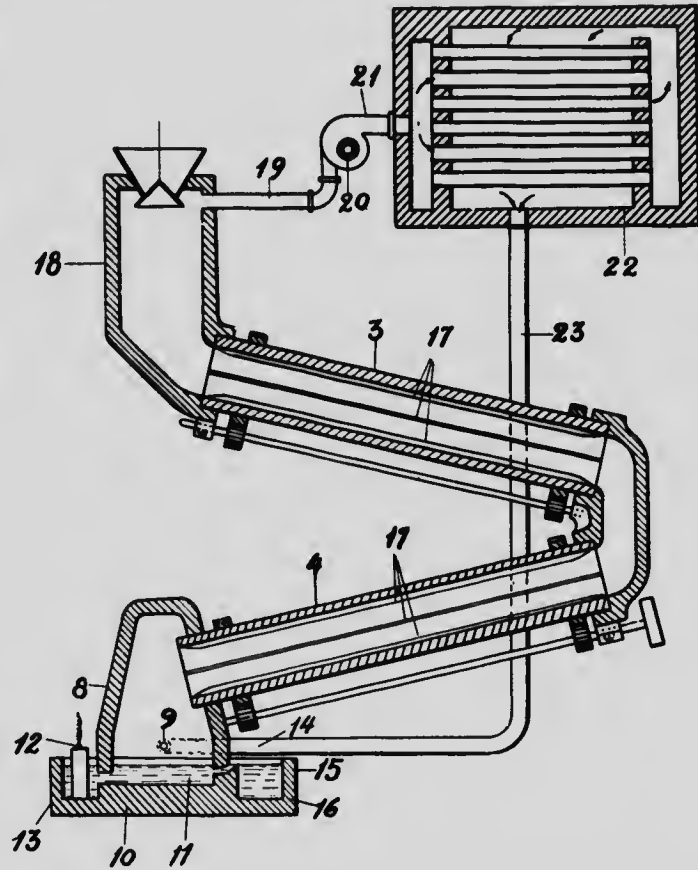

Fig. 2.



**Results obtained with the Héroult Steel Furnace at Remscheid
in Germany.**

At the meeting of the Verein Deutscher Eisenhüttenleute at Düsseldorf on the 9th of December, 1906, Professor Eichhoff, of Charlottenburg, read a paper* on the manufacture of electrical steel, in which he reviews in a general way the progress made in the application of electricity to steel-making, and describes and criticises the principal furnaces employed.

With regard to the Héroult system he gives the following statements:—

The plant at Remscheid was started on the 17th of February, 1906, and has, since the 22nd of March, been operated by the firm Richard Lindenberg, G.m.b.H.

The demand for the steel has been so great that it has proved necessary to double the plant and an additional furnace and rolling mill consuming 1,400 h.p. have been ordered. Up to the present the electric furnace has been running continuously without any interruptions for more extensive repairs. The Wellman furnace used for preheating and smelting of the raw material has caused some interruptions, which, however, when necessary experience has been obtained, will be avoided. No change of the hearth in the electric furnace has up to the present been required and the roof, which consists of one layer of small bricks, lasts over 100 charges. The electrodes last from 70 to 80 hours with a consumption in height of about 1 c.m. per hour. The average power consumption is about 250 K.W. and the consumption per ton steel, 385 K.W. hours.

Since up to the present the plant has been unable to meet the demand for steel, it has been impossible to experiment with other classes of steel and soft iron not included in the Firm's line of manufacture.

One experiment was made, however, with silicon steel and the results obtained showed that only a very small percentage of the silicon was lost.

On account of these few results obtained, the investigation made by the well known experimenter L. Guillet in Paris, the results of which were read by him at the Congress for Technical Chemistry in Rome, 1906, will perhaps be of interest.

* From Stahl und Eisen, 1907, No. 2.

EXPERIMENTS MADE BY L. GUILLET WITH HEROULT STEEL.

UNIFORMITY OF COMPOSITION IN THE INGOT.

	1. Soft Iron.				2. Steel.					
	Large Ingot.			Small Ingot.	Large Ingot.			Small Ingot.		
	Top	Mid- dle	Bot- tom.	Middle.	Top.	Mid- dle.	Bot- tom.	Top.	Mid- dle.	Bot- tom.
Carbon.	0.084	0.009	0.008	0.070	1.015	1.016	1.022	1.018	1.013	1.022
Silicon	0.036	0.034	0.038	0.030	0.103	0.101	0.103	0.098	0.100	0.101
Manganese	0.233	0.230	0.240	0.230	0.144	0.148	0.158	0.151	0.150	0.146
Sulphur	0.019	0.020	0.022	0.022	0.021	0.019	0.021	0.020	..	0.019
Phosphorus ...	0.008	0.008	0.009	0.008	0.010	0.009	0.010	0.011	0.011	0.010

EXPERIMENTS MADE BY L. GUILLET WITH HEROULT STEEL.

C	Mn	Si	S	P	Strength in $\frac{\text{kg}}{\text{mm}^2}$	Elongation in % of original length	Contraction in % of original cross section.
0.044	0	0.075	0.007	0.007	39.00	30.00	70.6
0.089	0.076	0.003	0.005	0.006	36.00	31.00	74.6
0.107	0.105	0.040	0.018	0.010	38.00	33.50	72.6
0.140	0.320	0.140	0.006	0.012	43.00	30.00	55.0
0.230	0.250	0.220	0.006	0.015	49.00	28.00	49.0
0.293	0.320	0.050	0.009	0.024	53.00	26.00	48.0
0.207	0.380	0.080	0.009	0.026	48.00	28.00	59.0
0.285	0.480	0.465	0.021	0.010	57.00	28.00	50.0
0.700	0.125	0.035	0.015	0.007	68.50	18.00	40.0
0.880	0.080	0.148	0.006	0.009	86.00	13.00	29.0
1.19	0.110	0.065	0.004	0.003	69.50	17.00	36.0
1.30	0.160	0.129	0.017	0.006	76.20	18.50	23.0
1.38	0.190	0.090	0.011	0.005	82.90	11.00	23.0
1.49	0.187	0.148	0.007	0.009	73.30	15.00	29.0

COMPARATIVE EXPERIMENTS WITH DIFFERENT CLASSES OF STEEL MADE BY L. GUILLET.

Produced in	Treatment of sample.	Chemical Anal. res.							Mechanical Tests.				Number of taps in tapping tests.
		C	Mn	Si	S	P	Cu	As	Strength in $\frac{3}{2}$ kg/mm	Elastic limit in $\frac{2}{2}$ kg/mm	Elongation in % of original length.	Contraction in % of original cross section.	
1 { Electric furnace Crucible	All samples uniformly heated to 875°C.	0.030	0.000	0.100	0.015	0.008	0.053	0.064	32.2	...	32.5	65.0	23
		0.050	0.256	0.178	0.023	0.015	36.5	24.5	39.5	50.0	22
2 { Electric furnace Basic open hearth Crucible		0.051	0.184	0.047	0.024	0.011	0.053	0.100	37.5	25.5	34.0	71.5	50
		0.062	0.325	0.095	0.018	0.021	35.3	21.2	29.0	54.3	23
3 { Electric furnace Basic open hearth Crucible		0.050	0.250	0.178	0.023	0.015	36.5	24.5	30.5	50.0	22
		0.136	0.297	0.070	0.007	0.016	0.040	0.082	40.8	23.5	34.0	69.0	48
4 { Electric furnace Basic open hearth Crucible		0.142	0.330	0.055	0.052	0.023	39.5	22.5	27.9	48.2	24
		0.139	0.225	0.125	0.028	0.010	39.9	23.3	29.0	52.4	25
5 { Electric furnace Basic open hearth Crucible		0.220	0.399	0.070	0.008	0.007	0.043	0.073	48.2	28.0	27.5	56.5	25
		0.205	0.445	0.152	0.062	0.091	47.5	26.3	26.0	43.6	20
5 { Electric furnace Basic open hearth Crucible		0.230	0.327	0.180	0.030	0.020	40.9	25.4	27.0	48.9	23
		0.218	0.385	0.360	0.012	0.017	0.043	0.073	50.4	32.7	27.0	61.7	28
5 { Electric furnace Basic open hearth Crucible		0.205	0.445	0.152	0.062	0.091	47.5	26.3	26.0	43.6	20
		0.230	0.327	0.180	0.030	0.020	46.9	25.4	27.0	48.9	23

The source of the materials for these tests is not stated, but very likely they were obtained from the works in France and date back to a time when the process had not reached its present development.

The investigations by Guillet correspond partly with the results obtained at Remscheid, viz.:—that by the Héroult process a steel can be produced fully comparable with and with the following advantages over crucible steel:—

- 1—With equal toughness it permits of a carbon content from 20 to 40% higher and consequently offers a greater resistance to wear.
- 2—Very high elastic limit and contraction.
- 3—Freedom from blow-holes.
- 4—Steel completely deoxidized and containing no emulsion of silica or manganous oxide.
- 5—The presence of copper and arsenic has no injurious effect, so long as practically no sulphur is present.
- 6—Segregations of phosphorus and sulphur do not occur.
- 7—The steel forges better and stands a higher heat better than crucible steel.
- 8—A cost of production far below that of crucible steel.
- 9—Independent of the raw material.
- 10—Manufacture coupled with less exertion for the workmen than that of crucible steel.
- 11—A purity excelling nearly all crucible steels.
- 12—The process makes it possible to produce any kind of alloy steels.

Steel produced may be kept for hours under a neutral slag without changing its quality and a part of the heat may be worked over to another grade—a matter which is of great importance to steel founders. The steel may be allowed to chill and be melted over again without hurting its quality.

Cost of Production.

The cost of production varies greatly according to conditions and the quality of the raw material.

Professor Eichhoff has compiled the following tables of the power and time required for the different operations, assuming the impurest raw material and the highest purity of product, taking a series of weights of charges:—

TIME REQUIRED FOR OPERATIONS, IN MINUTES.

No.	Weight of Charge in kg.	500	1000	1500	2000	3000	5000
1	Repair of hearth, cold charge	10	14	16	18	20	22
2	Repair of hearth, hot charge	8	10	12	14	17	20
3	Charging, cold charge	12	15	18	21	25	30
4	Charging, hot charge	15	15	15	15	15	15
5	Melting charge, cold charge	100	135	170	180	200	238
6	Drawing off first slag, cold charge	7	9	11	12	14	15
7	Melting slag, cold charge	12	14	16	17	19	20
8	Melting slag, hot charge	27	30	34	36	40	44
9	Drawing off second slag, cold, or hot charge	7	9	11	12	14	15
10	Melting slag, cold or hot charge	12	14	16	17	19	20
11	Drawing off third slag, cold or hot charge	12	13	14	15	17	20
12	Melting slag, cold or hot charge	18	20	22	24	28	30
13	Melting slag, hot charge	30	35	40	42	46	55
14	Converting slag to white slag, cold or hot charge	15	15	16	17	19	20
15	Smelting carbide	30	35	40	40	40	40
16	Smelting additions	5	8	10	10	10	10

No.		Weight of Charge in kg.					
		500	1000	1500	2000	3000	5000
		<i>Total time required for cold charge, in hours.</i>					
1	When drawing off slag 3 times 1, 3, 5, 6, 7, 9, 10, 11, 12, 14, 15, 16.....	4.00	5.00	6.00	6.38	7.08	8.00
2	“ “ “ twice 1, 3, 5, 6, 7, 11, 12, 14, 15, 16.....	3.68	4.63	5.55	5.90	6.53	7.42
3	“ “ “ once 1, 3, 5, 11, 12, 14, 15, 16.....	3.37	4.25	5.10	5.42	5.98	6.83
		<i>Time of current expenditure for cold charge, in hours.</i>					
4	When drawing off slag 3 times 3, 5, 6, 7, 9, 10, 11, 12, 14, 15, 16.....	3.63	4.55	5.43	5.78	6.40	7.22
5	“ “ “ twice 3, 5, 6, 7, 11, 12, 14, 15, 16.....	3.32	4.17	4.98	5.30	5.85	6.63
6	“ “ “ once 3, 5, 11, 12, 14, 15, 16.....	3.00	3.78	4.53	4.82	5.30	6.05
		<i>Total time required for hot charge, in hours.</i>					
7	When drawing off slag twice 2, 4, 8, 9, 10, 11, 12, 14, 15, 16.....	2.48	2.82	3.18	3.33	3.65	3.90
8	“ “ “ once 2, 4, 8, 11, 12, 14, 15, 16.....	2.17	2.43	2.73	2.85	3.10	3.32
9	With only one slag 2, 4, 13, 14, 15, 16.....	1.72	1.97	2.22	2.30	2.45	2.66
		<i>Time of current expenditure for hot charge, in hours.</i>					
10	When drawing off slag twice 8, 9, 10, 11, 12, 14, 15, 16.....	2.00	2.29	2.60	2.73	2.97	3.15
11	“ “ “ once 8, 11, 12, 14, 15, 16.....	1.68	1.91	2.15	2.24	2.42	2.57
12	With only one slag 13, 14, 15, 16.....	1.33	1.55	1.78	1.82	1.92	2.08

PRODUCTION PER YEAR OF 280 DAYS=6720 HOURS IN TONS.

No.	Weight of Charge in kg.	500	1000	1500	2000	3000	5000
1	Cold charge drawing off slag 3 times	811	1315	1680	2120	2860	4210
2	Cold charge, drawing off slag twice	914	1450	1820	2280	3080	4530
3	Cold charge, drawing off slag once	999	1585	1980	2480	3380	4920
4	} For consumption of energy see following table.						
5							
6							
7	Hot charge, drawing off slag twice	1358	2380	3170	4050	5520	8620
8	Hot charge, drawing off slag once	1550	2770	3700	4720	6500	10120
9	Hot charge, only one slag	1955	3420	4510	5810	8230	12620
10	} Consumption of energy, see following table.						
11							
12							

POWER EXPENDITURE.

Charge	COLD CHARGE (SCRAP).				HOT CHARGE (SOFT IRON).				
	Generator capacity in K.W.	Average power consumption in K.W.	Drawing off slag 3 times. Time of power expend. per charge 4 K.W. hours per ton steel	Drawing off slag twice. Time of power expend. per charge 5 K.W. hours per ton steel	Drawing off slag once. Time of power expend. per charge 6 K.W. hours per ton steel	Average power consumption in K.W.	Drawing off slag twice. Time of power expend. per charge 10 K.W. hours per ton steel	Drawing off slag once. Time of power expend. per charge 11 K.W. hours per ton steel	With only 1 slag. Time of power expend. per charge 12 K.W. hours per ton steel
500	250	3.63	3.32	3.00	175	2.00	1.68	1.33	465
1000	310	4.55	4.17	3.78	215	2.29	1.91	1.55	333
1500	375	5.43	4.98	4.53	250	2.60	2.15	1.78	286
2000	440	5.78	5.30	4.82	290	2.73	2.24	1.82	263
3000	550	6.40	5.85	5.30	365	2.97	2.42	1.92	253
5000	750	7.22	6.63	6.05	515	3.15	2.57	2.08	219

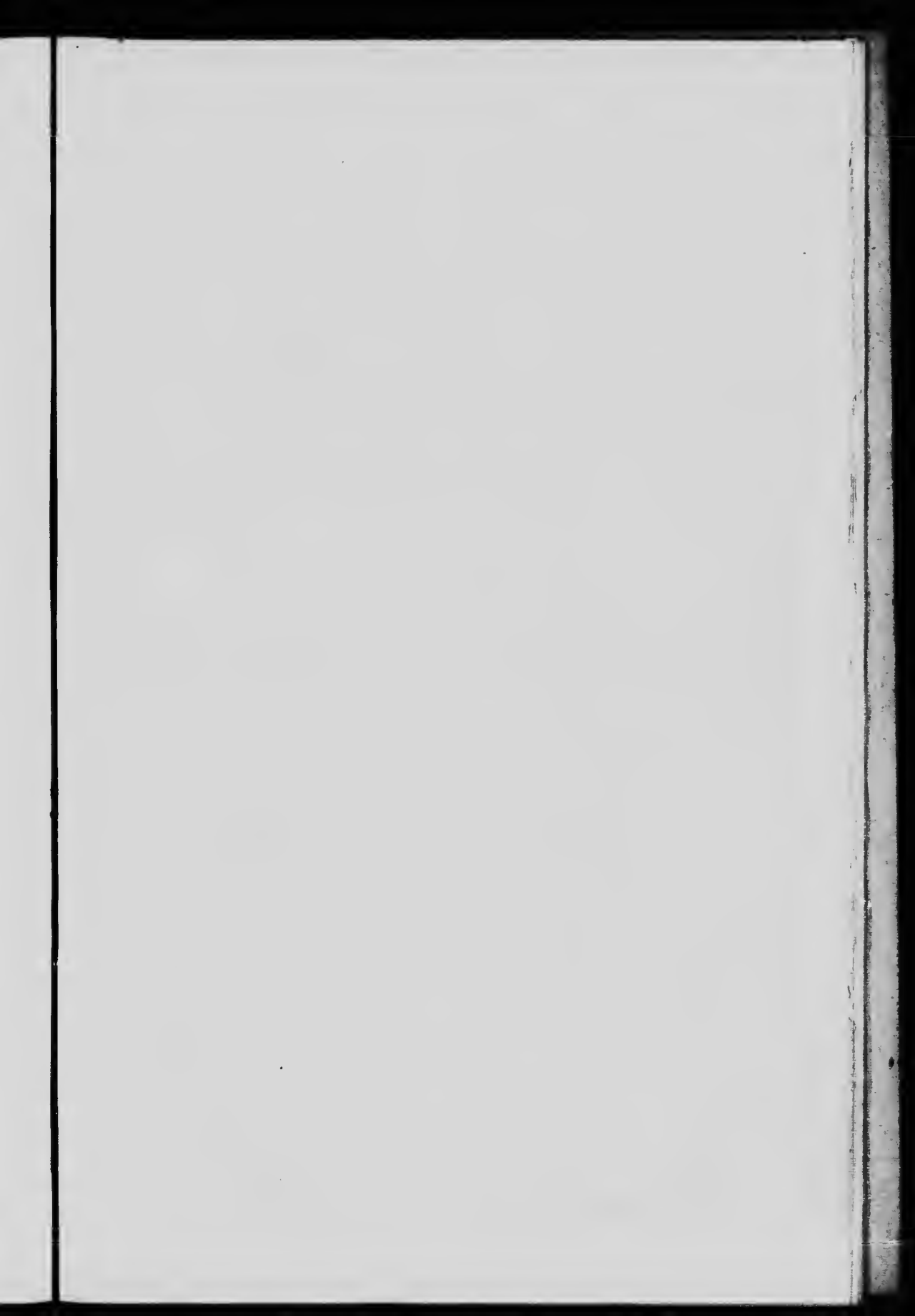

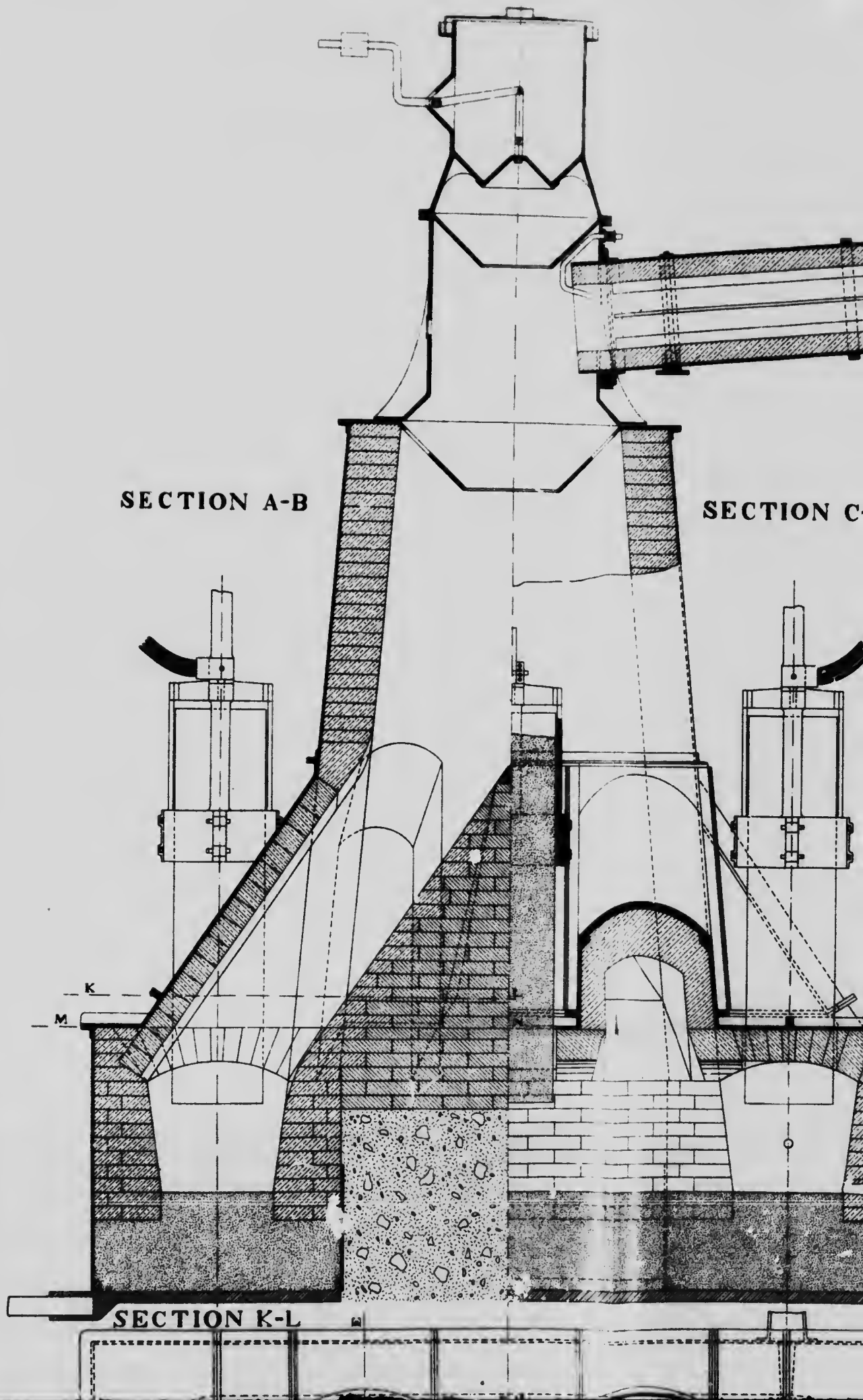

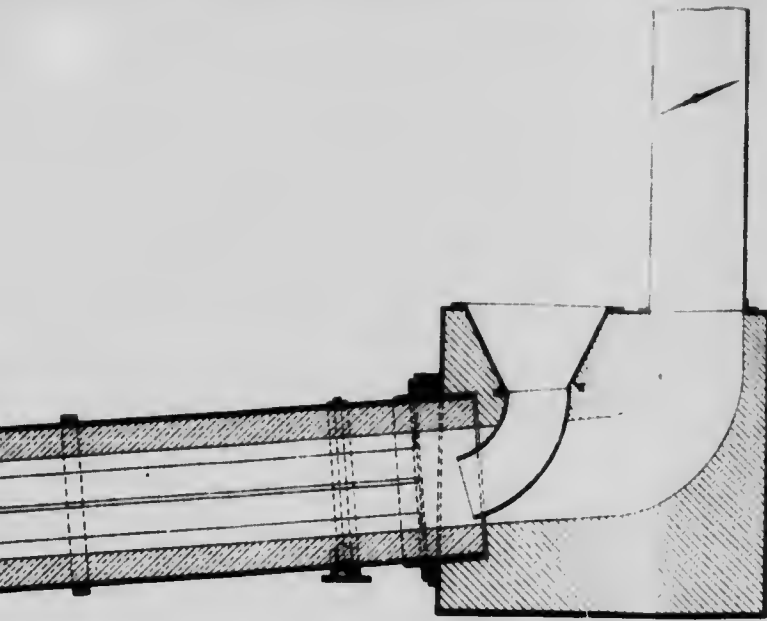

SECTION C-D

SECTION E-F

SECTION G-H

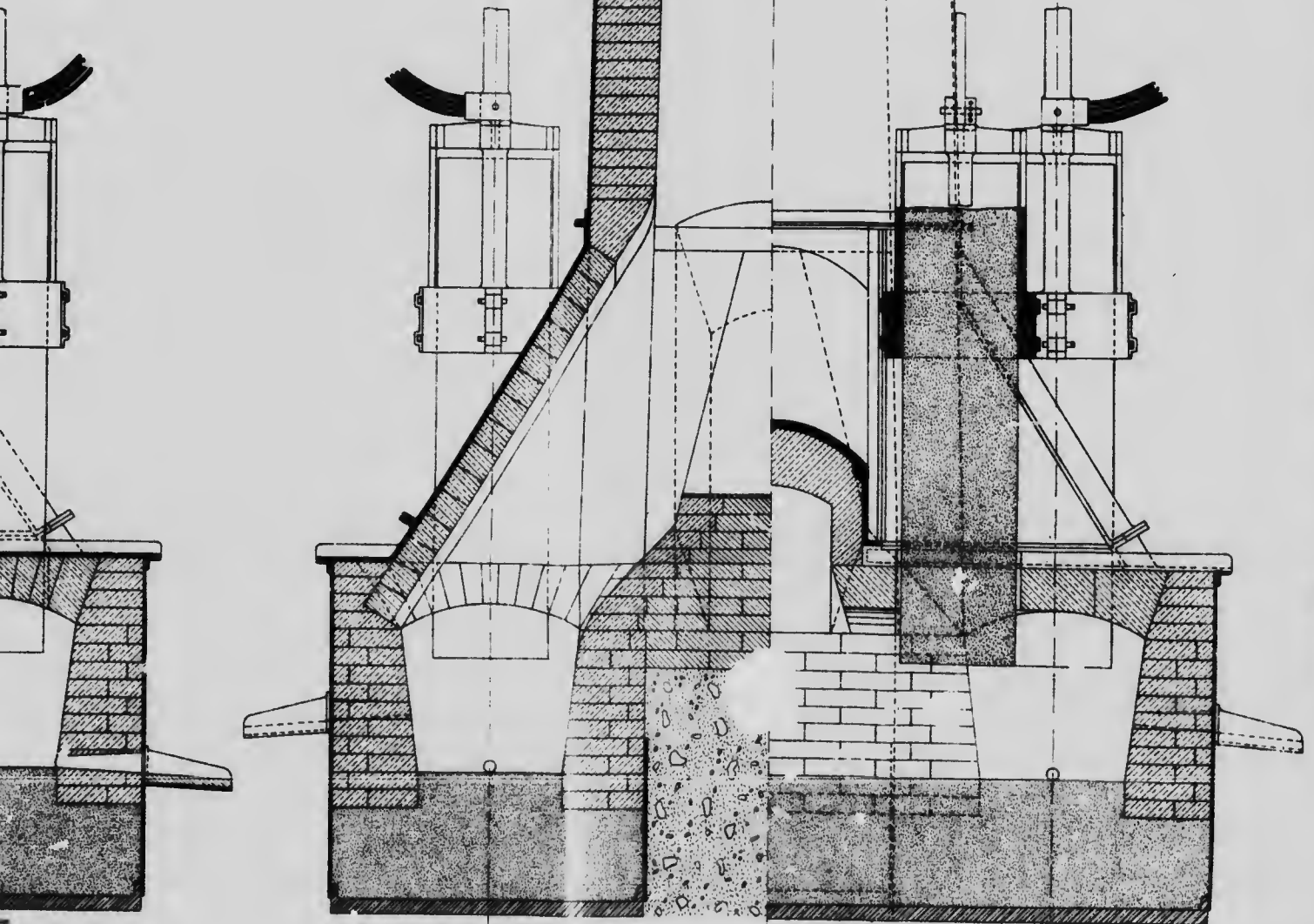

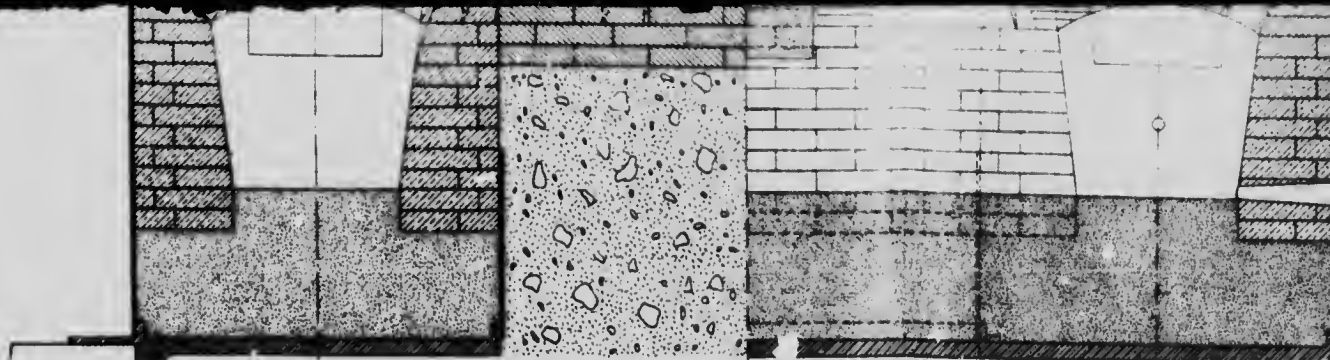

SECTION K-L

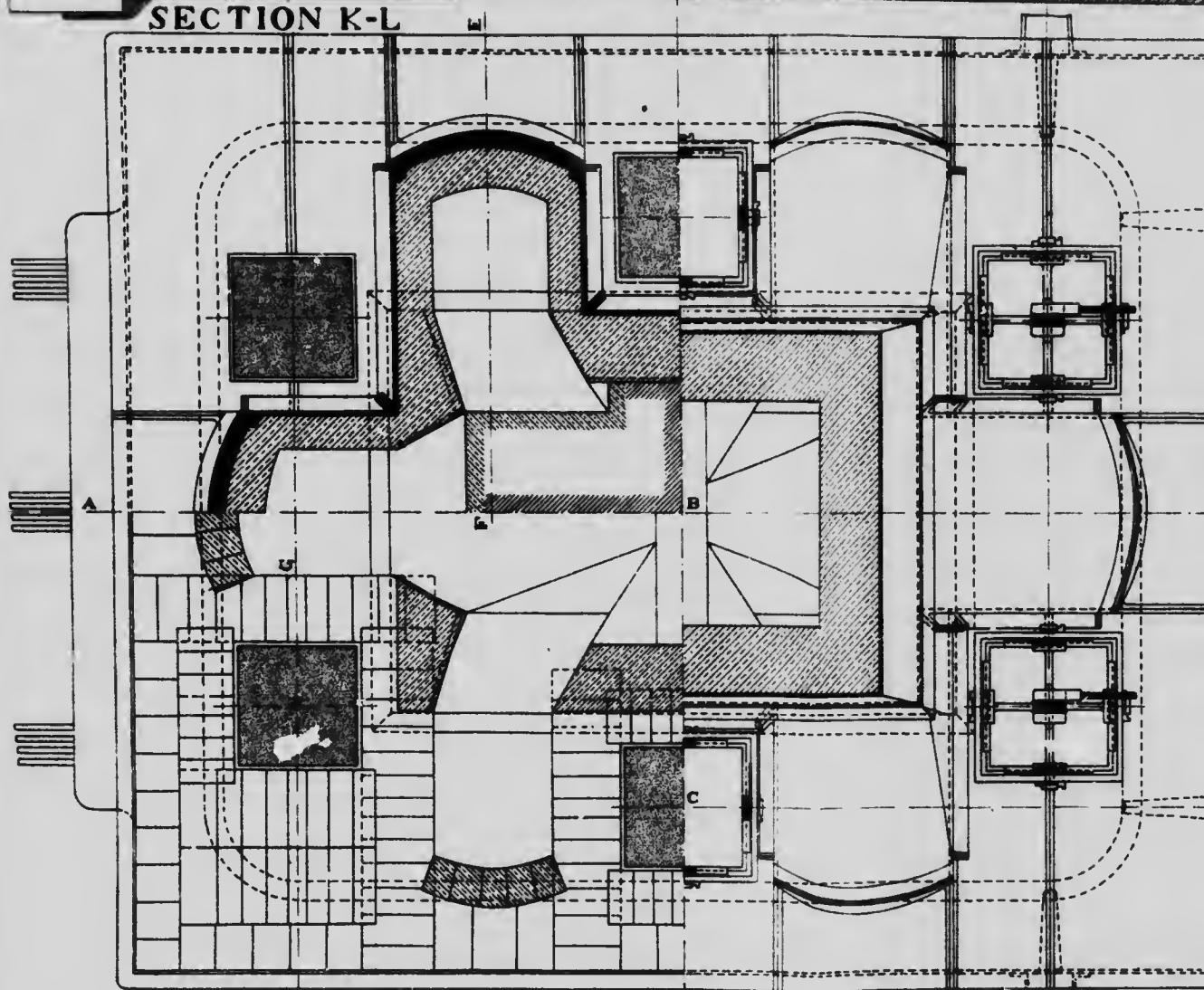

SECTION M-N

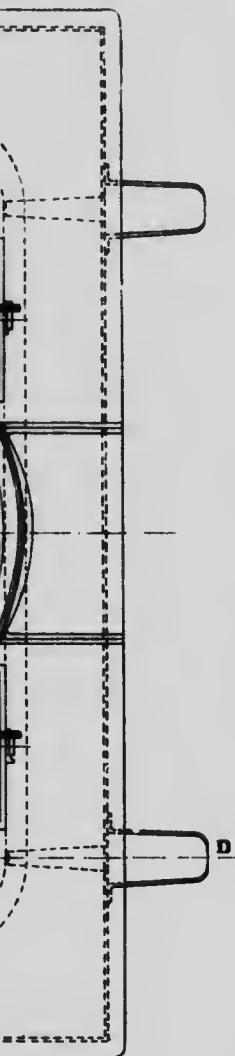
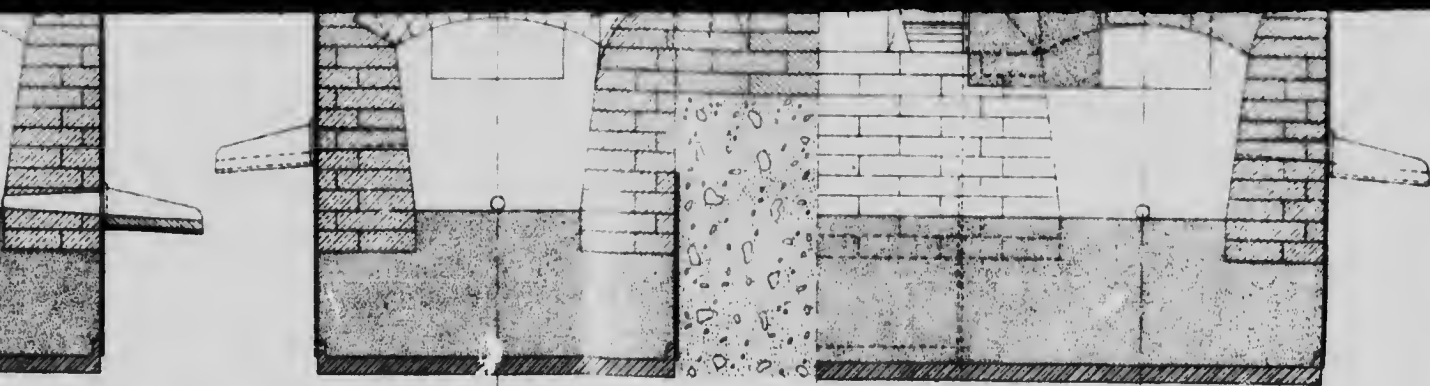

ELECTRIC FURNACE

[The page contains extremely faint and illegible text, likely bleed-through from the reverse side of the document. No specific content can be transcribed.]

The operation of the furnace calls for two men and one boy. When cold material is charged one or two charges are required, according to the size of the furnace.

The consumption of electrodes ranges between 75 cents, and one dollar with a cold charge, and 25 to 62 cents with liquid charge.

The waste, with the purest product, is 6% in cold charging and 3 to 2½% with liquid charge.

The consumption of lime and ore is not greater than by other processes and there is a saving in ferro-manganese and ferro-silicon.

The cost of repairs and the consumption of refractories are much lower than by the open hearth process.

Improvement in Electric Furnace Construction suggested by R. Turnbull.*

This furnace is shown in sections and plan in Plate XVIII and consists of a smelting groove communicating through shoots with a central shaft.

The electrodes carrying the current are suspended vertically between the shoots in the smelting groove, the bottom of which is made of carbon paste in communication with one of the terminals for the current.

The top of the central shaft is arranged in such a manner that the gases (or part of same) developed through the reduction of the ore are utilized for the preheating of the ore and the calcining of the limestone.

The ore, limestone and other required slag-building material are charged into a rotating cylinder, in which the gas is burnt by means of an air blast, the quantity of air being regulated so that a suitable temperature is obtained. The gases resulting from the combustion are drawn out through a chimney by means of which the pressure in the furnace is also to some extent regulated.

The carbon is charged through a closed charging apparatus and in the furnace shaft mixed with the ore and slag-building material.

The bottom of the shaft is made in such a manner that the charge has an easy descent through the shoots into the smelting groove.

Electric Smelting Plant in Canada.

The first electric smelting plant in Canada for the production of pig iron and later of high grade steel and steel castings is at present under construction.

This plant will be located at Welland, Ont., on a piece of ground facing the Welland Canal.

The first installation will consist of one 3,000 h.p. furnace of the latest type brought out by Dr. Héroult and his associates. This furnace is expected to produce 35 tons of pig iron per day, when not utilizing the gases produced by the reduction, and 40 tons when the gases are used for preheating

* Worked out and drafted by E. Nystrom, M.E.

and reduction. The power will be furnished by the Ontario Power Co., of Niagara Falls, at a voltage of 12,000 volts, and then transformed to the required voltage.

The transformers, furnished by the Packard Company, of St. Catharines, Ont., will be of the oil and water cooled type, of 750 K.W. each, and arranged with taps on the secondary side to allow a range from 30 to 40 volts on the secondary. The furnace is arranged in such a manner that a three-phase current can be employed.

This first furnace will be used for the purpose of demonstrating that pig iron can be commercially produced by the electro-thermic process even at such an unfavorable site as Welland, where the price of power is high and the nearest ore supply about 150 miles distant. Some of the ore used will be brought from Port Arthur, containing as high as 13% sulphur. Other ores of a very refractory nature will also be used, the intention of the promoters being to employ exclusively Canadian ores.

The first furnace will be followed by a second one of probably larger capacity. A Héroult steel furnace will be put down at the same time and the entire production of the second furnace will be used for the manufacture of high grade steel castings, which are at present not made in Canada, and also for a limited number of ordinary steel castings.

The electrodes will be manufactured by the Héroult secret process, a plant with a capacity of 18 electrodes per week being constructed.

The organization of this demonstrative plant is due to the efforts of Mr. R. Turnbull, Canadian representative of the Héroult processes and furnaces, and also to Mr. R. H. Wolff, American representative of same. These gentlemen, along with some friends also interested in the above processes, are investing their own private capital in the enterprise, thus proving that not only are they certain of the results that can be obtained by this new process, but are now leading the way for others by taking the first risk and building the first commercial plant.

Electric Smelting Plant in the United States.

At Baird, California, an electric smelting plant for the production of pig iron is at present under construction and is expected to be in operation in May, 1907.

The first installation will be a 2,000 h.p. furnace with a guaranteed output of 20 long tons per 24 hours. If successful, this plant is to be enlarged to a capacity of 600-800 tons per day.

The ore which will be employed is a very rich magnetite, containing only a very small percentage of sulphur and phosphorus. The reducing agent will be charcoal and for the production of the charcoal a plant has already been erected.

Electric Steel Works.*France.*

Société Electrométallurgique Française, at La Praz ; one 400 h.p. Héroult furnace.

Société des Hauts Fourneaux et Forges d'Allevard, Allevard ; two 500 h.p. furnaces built, two building.

Société des Hauts Fourneaux, Forges et Aciéries du Saint-du-Tarn, Saint Juéry ; one Héroult furnace building.

Jacob Holtzer & Cie, Uignex ; one Keller furnace.

Société Anonyme Electrométallurgique Ugine ; one Giroud furnace

Schneider & Cie, Creusot ; one induction furnace.

Spain.

Viuda de Frigoita e Hija, Araya ; one Kjellin furnace.

Germany.

Richard Lindenberg, Renscheid ; two Héroult furnaces.

A. Krupp, Essen ; one Gin furnace.

Roehling, Volklingen a. d. Saar ; one Gin furnace.

Switzerland.

Allgemeine Calcium Carbide Gessell, Gurtneuen ; one Kjellin furnace.

George Fischer, Schaffhausen ; one Héroult furnace building.

Italy.

Forni Termoelettrici Stassano, Turin ; one Stassano furnace.

Arsenal of Turin, Turin ; one Stassano furnace.

England.

Vickers, Sons & Maxim, Sheffield ; one Kjellin furnace.

Sweden.

Aktiebolaget Héroult's Elektriska Stal Kortfors ; one Héroult furnace.

Metallurgiska Patent Aktiebolaget Gysinge ; one Kjellin furnace.

United States.

Halecomb's Steel Co., Syracuse, N.Y. ; one Héroult furnace.

PLATE A.



Electric Furnace just after Metal has been tapped.

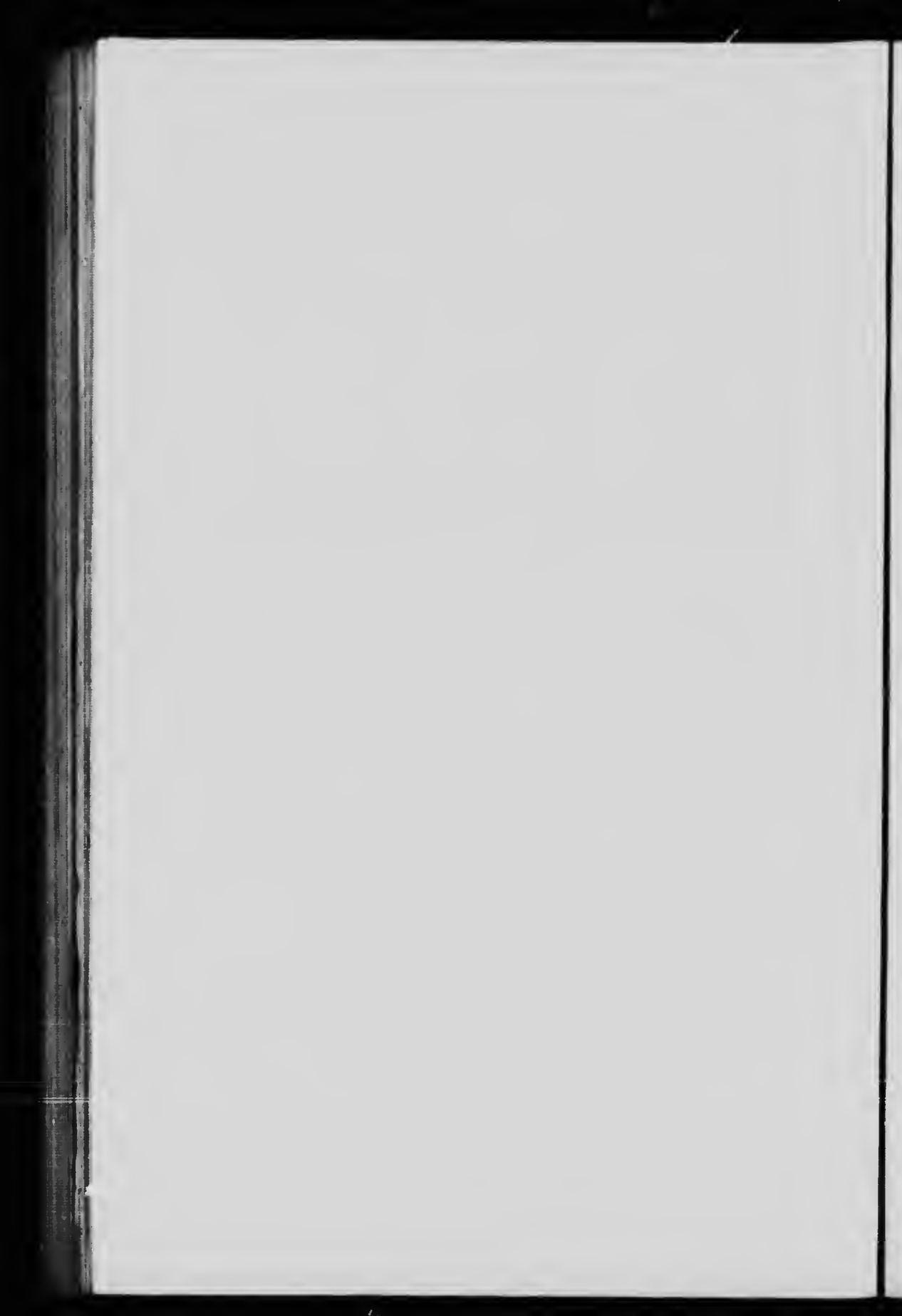

PLATE B.



Electric Furnace showing measuring instruments in place and method of regulating electrode.

PLATE C.

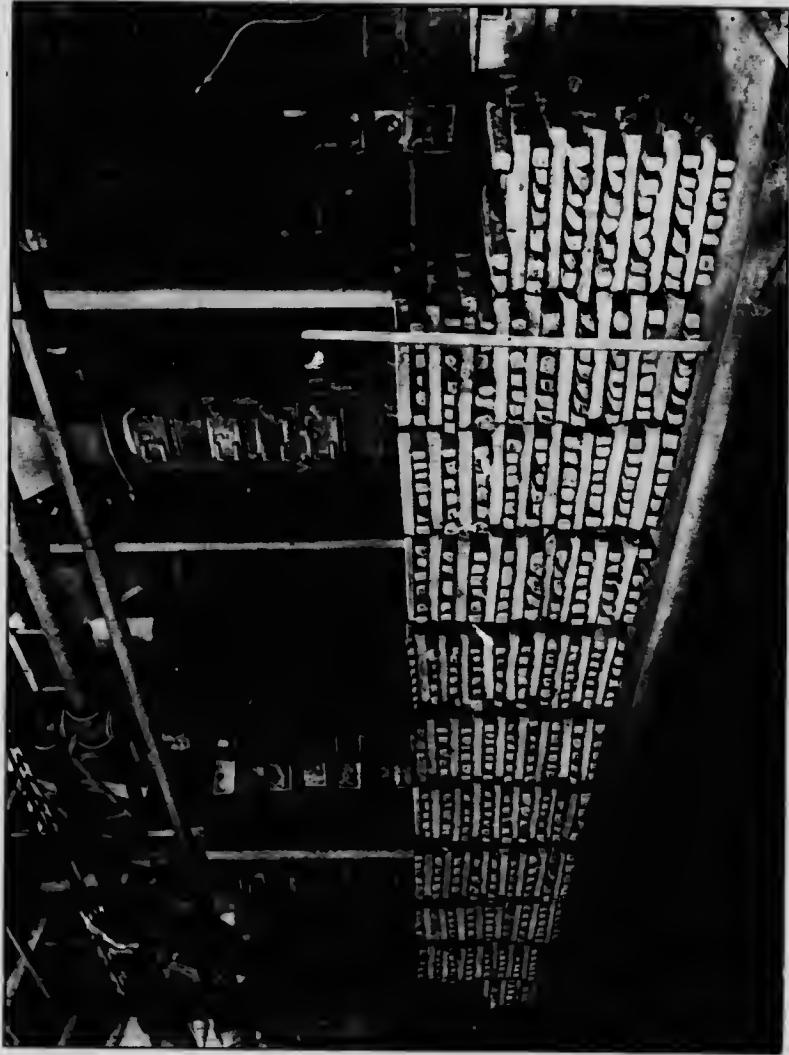

Exhibit of two-thirds of the pig iron produced during the Government experiments.

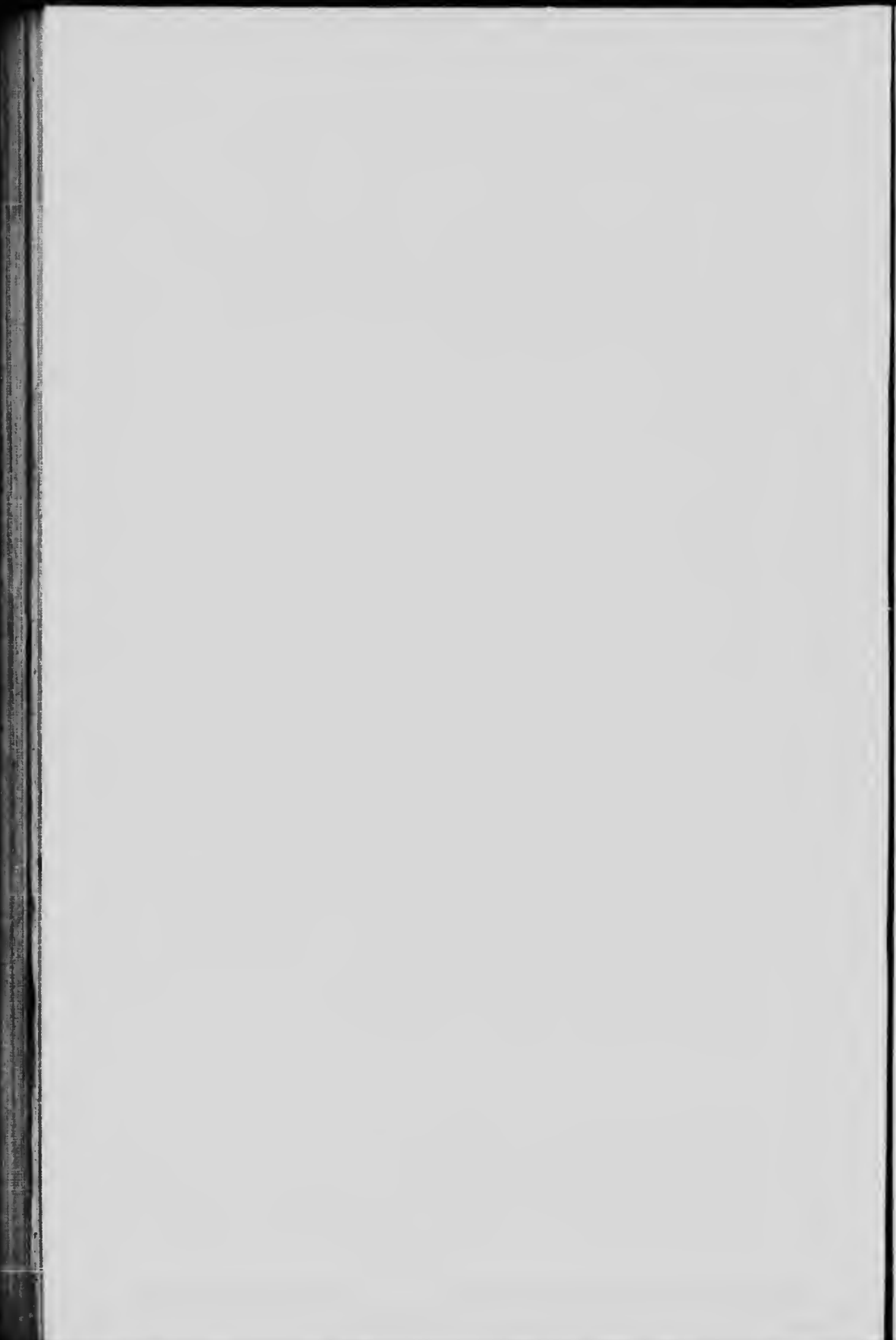
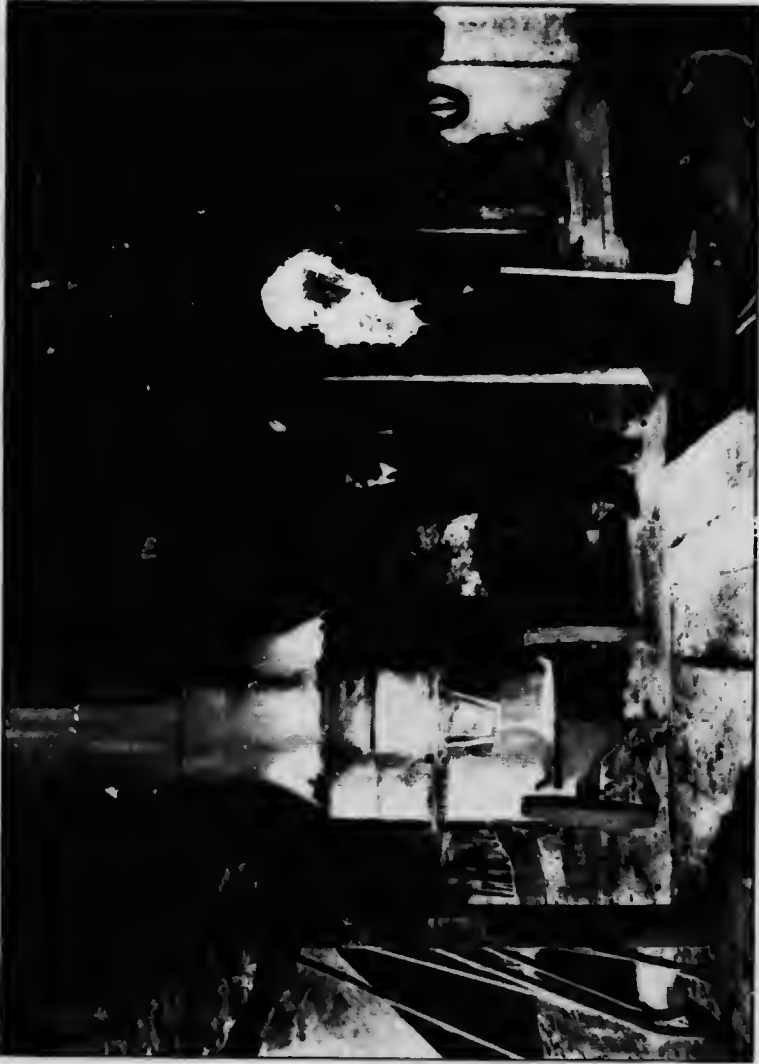

PLATE D.



Experimental Electric Furnace as modified by the Lake Superior Corporation
for the production of Ferro-Nickel pig.

PLATE E.



Ferro-Nickel pig produced by the Lake Superior Corporation during April-July, 1906 (168 tons).

