

**Please read and send in as full a
discussion as possible at earliest date**

The Canadian Society of Civil Engineers.

INCORPORATED 1887.

ADVANCE PROOF—(*Subject to revision*)

N.B.—This Society, as a body, does not hold itself responsible for the statements and opinions advanced in any of its publications.

A NEW WATER SUPPLY FOR THE CITY OF VANCOUVER, B.C.

By H. M. BURWELL, M. Can. Soc. C. E.

(To be read before the General Section, 8th December, 1910.)

The city of Vancouver, B.C., has heretofore depended on Capilano Creek for its water supply. This creek empties into the northerly side of Burrard Inlet at a point about a mile and a half from the city. The supply has been adequate up to the present time, but owing to the recent rapid increase in the population, the necessity of securing water from another source was apparent for the following reasons:

(1) Capilano Creek at its extreme low water stage would not afford a sufficient supply for the future population.

(2) Owing to the rapid fall of this creek and its narrow valley it would be impossible to create storage reservoirs at a permissible cost.

(3) The crossing of the supply main under the First Narrows (being the entrance to Vancouver Harbour) made a dangerous point in the system, several of the submerged pipes having already been broken by ships' keels.

The City Council therefore decided to secure an additional supply from Seymour Creek. This new system is now almost completed, and the following is a description of its chief features.

Seymour Creek empties into the northerly side of Burrard Inlet at a point about three miles east of the city. It is a beautiful, clear mountain stream (except once or twice annually, when it becomes a raging torrent), and has a fall at the lower part of about 65 to 70 ft. per mile. Its drainage area is about 80 square miles, and its mean annual run-off about 500 ft. per second. The extreme low water flow is about 80 cu. ft. per second. The source of the stream is a lake of from 400 to 500 acres, at an elevation of 3,200 ft. above sea level. In this neighbourhood there are also two glaciers, which help to maintain the supply of water during the summer months.

The waterworks intake is located seven miles above the mouth of the stream at an elevation of 465 ft. above sea level. Owing to the large amount of boulders, gravel, and finer sediment which the creek carries down during freshets, it was necessary to design the intake so that it would not become completely choked up under such conditions, and means had also to be provided to prevent the finer sediment entering the pipe.

The intake is formed by a hewn cedar crib with rock filling, 13 ft. high. It has two openings, each 5 ft. in width, and on the face of each opening is placed an oak rack, set in an iron frame. The water enters the intake at right angles to the direction of the stream, the faces of the racks being parallel with the axis of the stream. This allows boulders and most of the heavy sediment to be swept away, as the current of the stream is stronger than the current of water entering the intake.

About 50 ft. below the intake a low weir, composed of large, broken rocks, extends across the creek. This weir is only of such height as to keep a sufficient depth of water on the intake during extreme low water periods.

The water, after passing through the racks, enters an 11 x 14 ft. forebay. From this there is an open conduit 6 ft. in width, of hewn cedar cribwork. This conduit extends down stream along the bank of the creek for a distance of 300 ft. Its upper end is furnished with a 6 x 10 ft. head-gate. At the lower end of the open conduit is placed a scour-gate, discharging into the creek, to flush out the sediment which may enter the intake and deposit itself along the flume.

Just below are located two sediment tanks, designed to separate the finer sediment and floating matter from the water and prevent it entering the pipe. These tanks are built of 6 in. x 12 in. sawn cedar timbers, the sticks all being placed flat and drift-bolted together, with frequent tie-sticks extending into the bank. Each tank is 20 x 100 x 6 ft. deep, and is lined with 3 inches of concrete, fastened on the sides with expanded metal, spiked to the timber walls.

The floors of the tanks were made by first covering the ground (which consisted of a compact mass of boulders and gravel) with expanded metal, held in place by numerous $\frac{3}{4}$ -in. anchor bolts driven between the boulders. On this as a bed 3 in. of concrete was floated. The object of the anchor bolts was to withstand the upward pressure which occurred at extreme high water.

Each tank is supplied with a 4 x 5 ft. inlet gate, and there is also one of the same dimensions at the lower end, which admits the water to the supply main leading to the city.

A few feet in front of the lower gates are placed two rows of screens, extending across the entire width of both tanks. There are 16 screens in all, each 5 ft. square, having iron frames, backed with heavy steel wire netting, and fitted in front with light wooden frames on which the fine screens are fastened. The screens are operated by a hydraulic hoist, which lifts a row of 8 at a time, the



Seymour Creek Canyon.

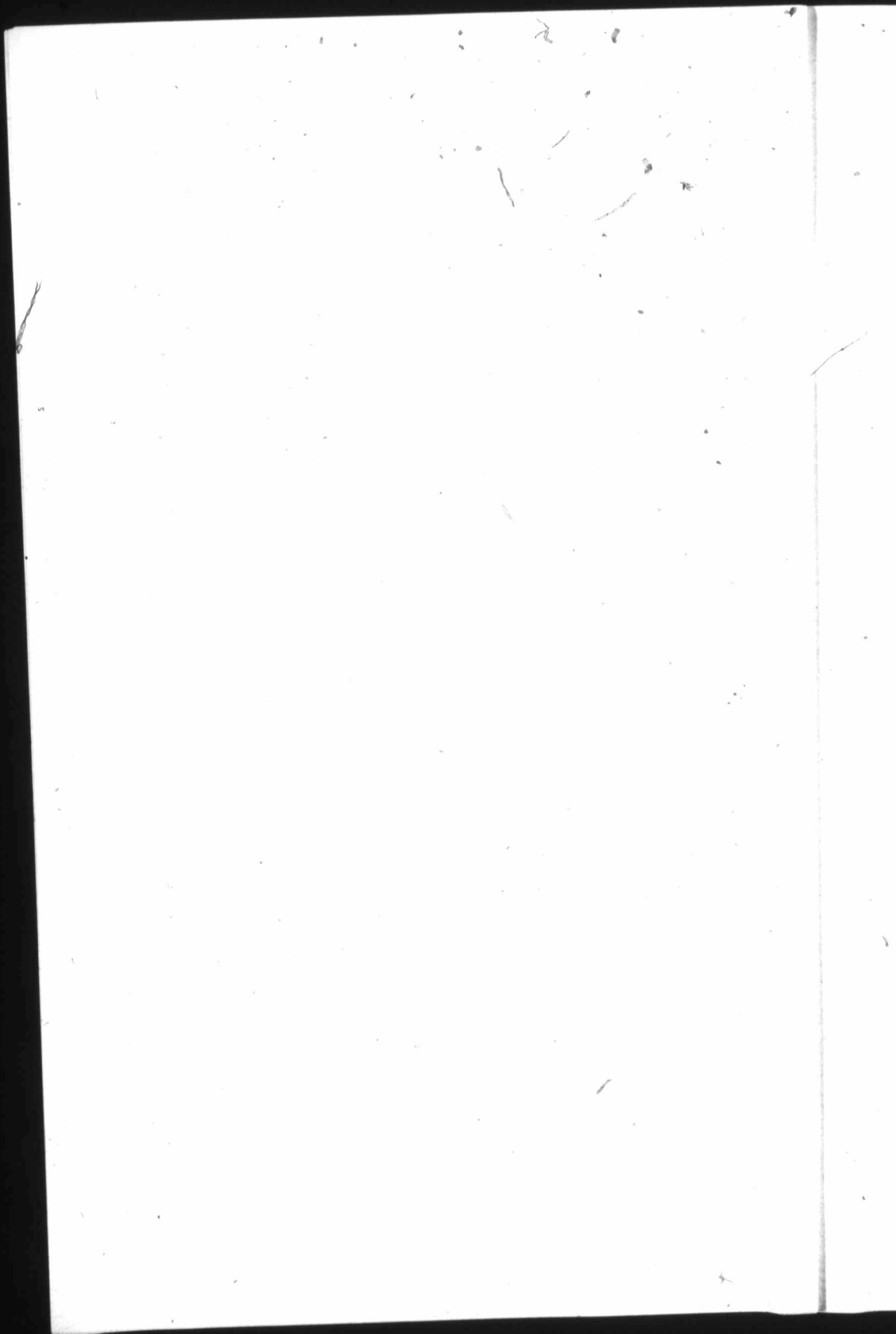



Building the Pipe, Seymour Creek.



Junction of Wood and Iron Pipe, Seymour Creek.

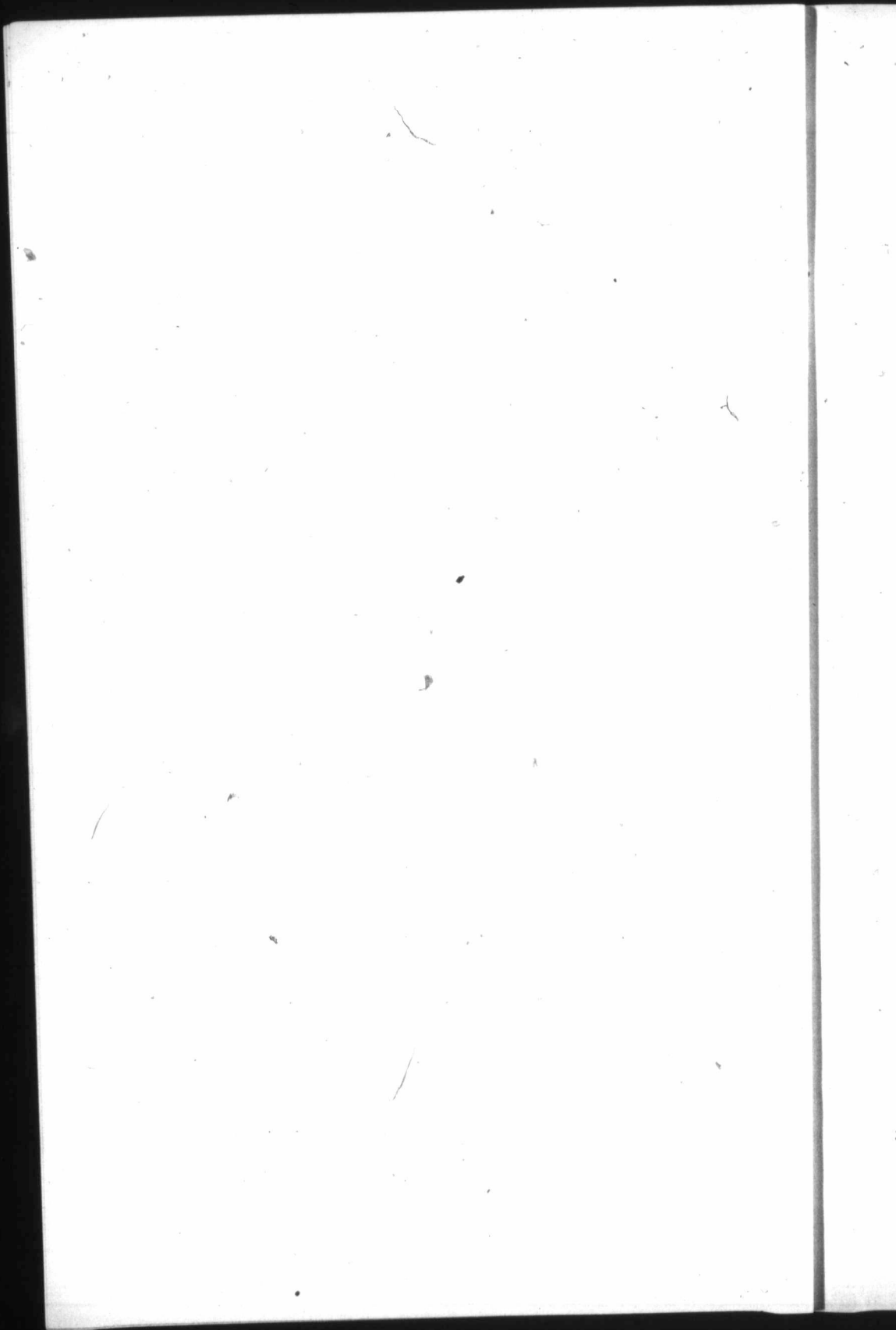

whole row being cleaned by means of a strong jet of water. The refuse falls into a cement trough in the floor and is carried out into the creek. The water for this work is supplied from a small mountain stream through a 4-in. pipe, under a 125 ft. head.

Across the bottom of both tanks is placed a weir or baffle, 18 in. in height, situated about 6 ft. in front of the screens. Its duty is to prevent the sunken matter and heavier sediment from coming in contact with the screens.

Just above the weir is built a skimmer, which crosses both tanks. This contrivance makes provision for the overflow and carries off all floating matter.

Each tank is provided with a scour-gate, 24 in. square, placed on the floor. A tank can thus be flushed out without interfering with the supply to the city.

The Supply Main.—Before constructing the supply main, a good wagon road was built along the pipe line. It has a maximum grade of $4\frac{1}{2}\%$ and a total length of 7 miles. For the first $3\frac{1}{2}$ miles below the intake it is located on the westerly side of Seymour Creek. It then crosses the creek on a steel bridge, and extends along the easterly side to the Second Narrows of Burrard Inlet. About half a mile below the bridge the creek passes through the Seymour Canyon, a deep cleft in the rock, having almost perpendicular walls. Here the road is excavated through rock along the edge of the canyon for some distance and is very picturesque.

Wood-stave Pipe.—The pipe line is along the side of the road farthest away from the creek. For the first 1,000 ft. it consists of a continuous wood-stave pipe, 36 in. inside diameter. From this point, where there is a slight summit in profile, the wood-stave pipe is 30 in. diameter. The total length of the wood pipe is $4\frac{1}{2}$ miles. The staves, of which the pipe is built, have a thickness of 2 in., and were chiefly fir timber, although some cedar was used. These staves were manufactured near the site of the work. The lumber used in the sediment tanks and intake buildings was also cut on the works, a portable sawmill and logging donkey engine having been procured for this purpose.

The price of the class of lumber required would have been \$40 per 1,000 ft. B.M. if purchased at the mills in Vancouver. The necessary haulage and handling would have increased the cost to at least \$50 per 1,000 ft. The actual cost of the lumber used in the pipe, including equipment, was \$28.50 per 1,000 ft.

The wood pipe is supplied with two 30-in. gate valves, one placed about $1\frac{1}{2}$ miles and the other about 3 miles below the intake. These positions were selected partly for use in case of emergency and partly to facilitate the construction of the pipe. The pipe in one place will be subjected to a pressure due to a static head of 210 ft., and on this portion (which is near the bridge) the steel bands are spaced $1\frac{1}{2}$ in. c. to c. The bands are of $\frac{1}{2}$ -in. steel, fitted with forged steel shoes, and have an average spacing of $3\frac{1}{2}$ in. c. to c.

Bridge Crossing.—The crossing of the bridge is made with a 32-in. continuous steel riveted pipe, with bends and special connec-

tions for wooden pipe at both ends. It rests upon the floor-beams of the bridge, and is provided with a 6-in. blow-off valve at the centre. The watertight connections between this steel pipe and the wooden pipes are made with ordinary lead joints. Where the pipe line crosses ravines or small hillside creeks, it is supported on substantial cedar trestles, and is enclosed in cedar cribwork filled in with sand and gravel.

In places where it is thought there might be danger from fires, the pipe line is supplied with 2-in. globe valves, with a length of hose and a nozzle in each place, enclosed in a small house.

Welded Steel Pipe.—From the canyon down to the Second Narrows the pipe line is constructed with 24-in. lap-welded steel pipe. The shell of the pipe has a thickness of $\frac{5}{16}$ in. (being the standard thickness of plate with which this kind of pipe of the above diameter is made). It is in about 19-ft. lengths, and is known as "Stewart's patent inserted joint lap-welded steel pipe," costing \$3.80 per ft. delivered at Vancouver.

At the upper end the pipe is supplied with a gate-valve and a 6-in. blow-off. At the Narrows it connects with the two 18-in. submerged mains by means of a Y special, and is supplied with a 6-in. blow-off placed within a concrete well, which also encloses the Y and two 18-in. gate-valves. This portion is covered with tidal water at times.

Submerged Mains.—The total distance across the Second Narrows is 2,600 ft., but only 1,000 ft. of the channel is deep water, the rest being tidal flats uncovered at low water.

In the central portion of the channel, which has a depth of 85 ft. at low water, two 18-in. flexible cast-iron pipes are used, in lengths of 9 ft., with a $1\frac{1}{2}$ -in. shell. Each pipe length weighs 3,300 lbs., and each joint is capable of a deflection of 19° . The pipe is of the ball and socket type. The ball is formed by running lead into the joint after the pipe has been placed.

The shore connections, amounting to 1,600 ft., are made partly of steel and partly of ordinary cast-iron pipes.

An interesting feature of the work was the placing of the flexible pipes along the bottom of the deep channel. This was accomplished by first building a wooden trough or shute on the tidal flat at the northerly shore, directly in line with the crossing, and extending out to the edge of the deep channel. The shute was made of 3 x 12-in. lumber, supported on trestles, and of a length equal to that of the flexible main. It was well greased on the inside, after which the pipes were placed and joined together, the bell ends each resting on a short board forming a sort of sled, used to keep the pipes in place and to reduce the friction in sliding them along.

A $1\frac{1}{2}$ -in. steel cable was then drawn through the pipe and fastened at each end to eye-bolts of 2-in. Norway iron of about 8 ft. in length. These passed through cast-iron caps placed at each end of the pipe. The rear bolt was threaded for about 6 ft. and provided with a large nut by which the cable inside of the pipe was made taut. The front end cap was provided with a stuffing box to permit



"The Finishing Touch," Seymour Creek Pipe Line.

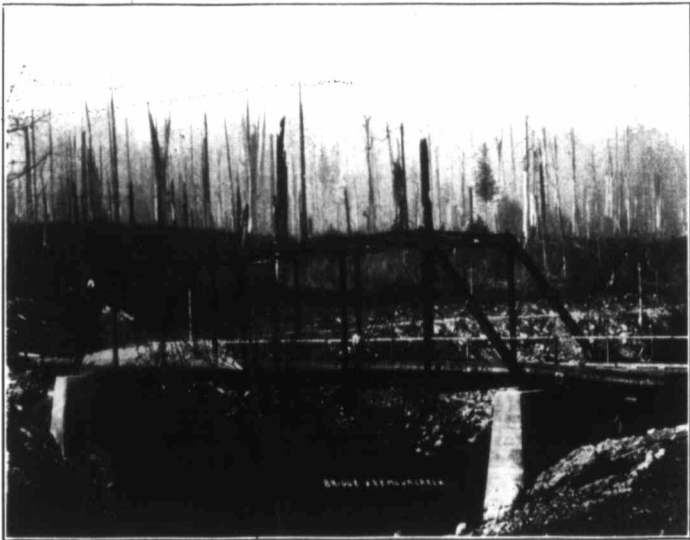

Bridge, Seymour Creek.

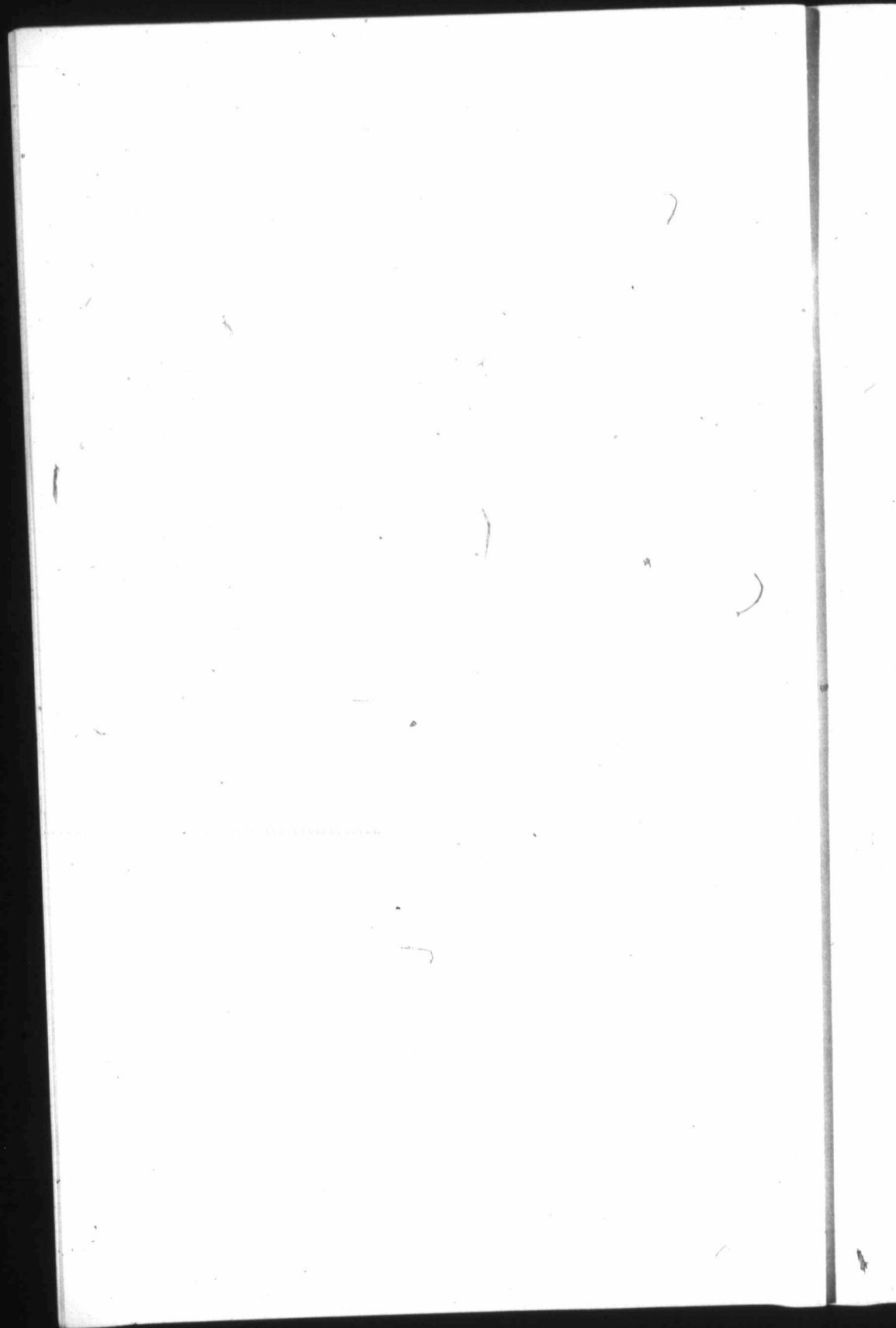

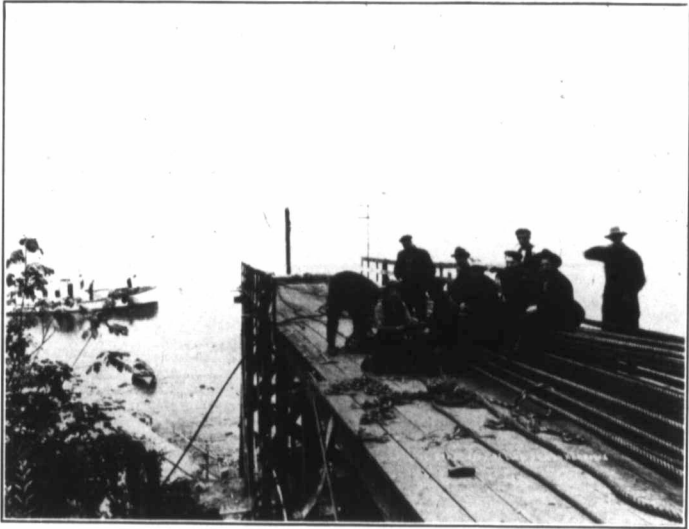

Hauling Stage for Pipe Line, Second Narrows.

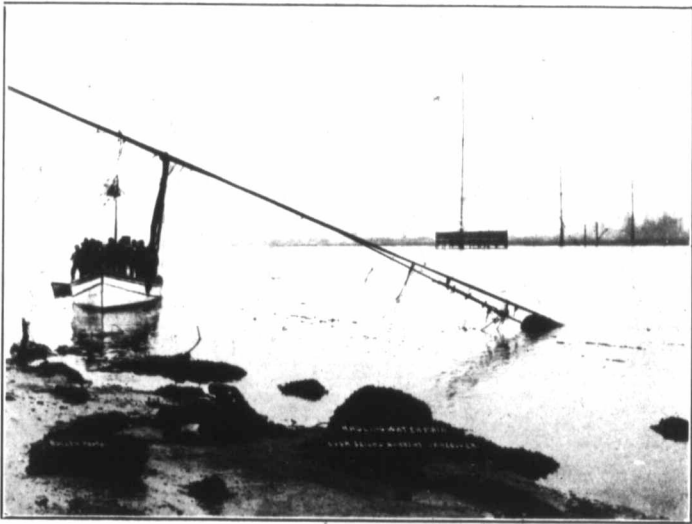

Hauling Water Main over Second Narrows, Vancouver.

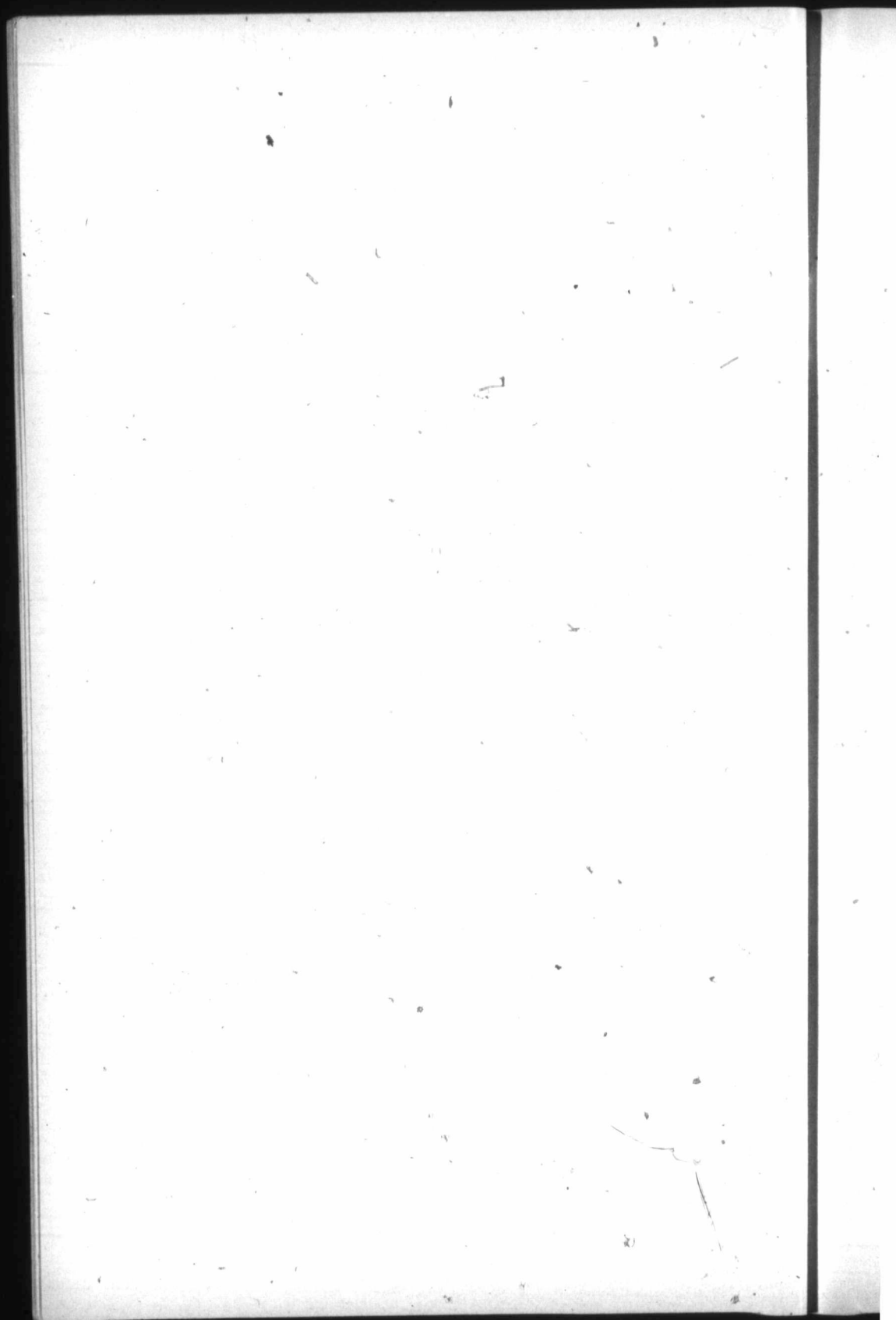

the movement of the eye-bolt outward as the strain came on the inside cable, without admitting water into the pipe.

Three 1½-in. steel hauling cables were then fastened to the pipe, one about one-third the distance back from the front end, one at the front end, and the other was fastened to the above-mentioned eye-bolt.

As the Canadian Pacific Railway passes along the southerly shore of the Narrows, close to the water's edge, a bridge had to be erected over the track to prevent interference with traffic. The cables were carried over on top of this bridge, which, owing to a high bank on the south side, was built on a slope of about 15°.

The platform was extended uphill to a large spruce stump, which was used as the chief anchor for handling the pipe. At the lower end of the platform, which was 85 ft. in length, there was a wooden roller, over which the hauling cables passed.

The hauling was performed by means of 5 capstans, operated with horses, transmitting a strain of 180 tons to the hauling cables.

In hauling the several 12-in. mains across the First Narrows, in the Capilano system, it was noticed that, owing to leaks at the joints, the pipes were always full of water before the ends reached the south shore. This added to the weight and made the hauling more difficult, especially as the last part of the haul was up a steep hill. The new main being much heavier than any previously hauled, it was decided, in order to avoid leakage, to instal an air-compressor and maintain a pressure of from 50 to 60 lbs. in the pipes while being hauled. The haulage was done by day labour without unusual difficulty.

The conduit from the Second Narrows to the city, where it connects with the Capilano system (a distance of about 3 miles), is a 24-in. lap-welded steel pipe, with the exception noted below. Its connection with the submerged pipe is made by means of a Y, the same as on the north shore, but, in addition, the two 18-in. gate-valves have two 18-in. check-valves bolted to them. The pipe passes under the railway tracks in a concrete-lined tunnel, in which is placed a special steel-riveted pipe, with the necessary T and bends, all riveted together and resting in concrete saddles and concrete backings at the bends.

The pipe line, after passing through the tunnel, follows the railway right-of-way for a distance of about half a mile, and, in accordance with an agreement with the railway company, this portion is made of ¾-in steel plates.

The total length of the main from the intake to the connection with the Capilano system in the city is about 10½ miles, and the capacity of the system 9,000,000 gals. per day, or about equal to that of the present Capilano system.

Cost Data.—The wagon road along Seymour Creek was built by contract at a cost of \$44,500. The work contained some very heavy side-hill cuttings and a considerable quantity of rock work.

The pipe trench for most of its length was excavated through a compact mass of large boulders and gravel, deposited by glacial

action. That portion along the edge of the canyon was excavated through granite rock.

The trench for the wooden pipe, 4 ft. in depth by 5 ft. in width, was excavated by contract, the price being 49 cents per lin. ft. The rock work was paid for per cubic yard, making the average cost of the trench 73 cents per lin. ft.

COST OF WOOD-STAVE PIPE.

	Per lin. ft.
Excavation of trench (contract)	\$0.73
Building pipe39
Steel bands, including haulage	1.38
Lumber, including haulage65
Tongues, including haulage02
Paint for bands, including haulage02
Inspection01
Back-filling over pipe (day labour)25
Total	\$3.45

COST OF THE STEEL PIPE.

Excavating trench (day labour)	\$0.85
Steel pipe	3.80
Laying and making joints, including lead23
Back-filling25
Haulage of steel pipes (day labour)07
Total	\$5.20

SUMMARY OF THE COST OF THE WHOLE WORK PERFORMED.

North Side of Burrard Inlet:

Wagon road (contract)	\$44,500
Wharf and approach at Narrows (contract)	6,000
Steel bridge	7,000
Warehouse and camp buildings	1,500
Intake and sediment tanks, including lumber, screens, gates, complete (day labour)	19,500
Wooden-stave pipe line	78,500
Steel pipe line (day labour)	76,500
Gate-valves, special steel pipe, bends, air-valves, etc.	3,500
Trestles and culverts (day labour)	3,500
Repair work to road, cutting out slides and corduroy work (day labour)	3,500
Protection work to pipe line, riprap, and crib work (day labour)	5,500
Telephone line	1,000
Portable sawmill	6,000
Logging donkey engine	3,000
Rough lumber in stock	9,000
Teaming	1,000

Total \$270,000



New Waterworks Intake.



General View, showing Excavation.

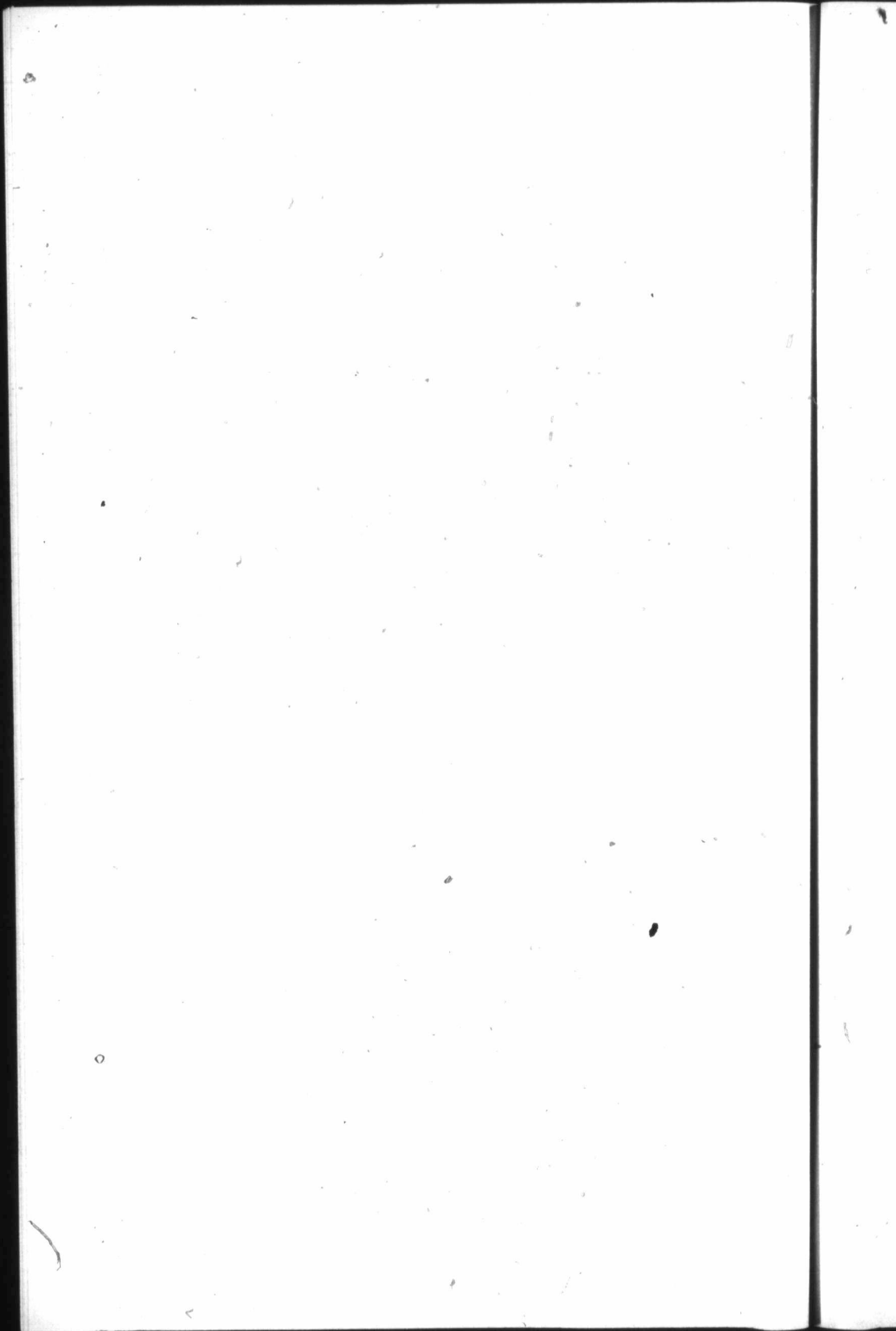

Submerged Main:

Flexible c.i. pipe, 1,000 ft.	\$8,500
Hauling flexible pipe (day labour)	4,000
1,600 ft. steel and c.i. pipe (shore connection)	7,500
Laying pipe and making shore connections, including delivery from city of all pipes	1,000
Gate-valves and specials	2,500
Lumber and tools	500
Protection work, riprap, and concreting	1,000
Lead	2,000
Total	\$27,000

South Side of Burrard Inlet:

Tunnel under railway track, concrete-lined, with 40 ft. shaft	\$2,000
Special steel riveted pipe, with concrete saddles and anchoring	2,000
Steel main to city, connecting with Capilano system, complete	86,500
Total	\$91,000

This brings the cost of the Seymour Creek system at the present date up to	\$388,000
For engineering and superintendence	11,000
Total	\$399,000

This amount does not include the cost of the land purchased for reservoir sites, foreshore land, pipe line right-of-way, and legal expenses. The cost of the ordinary labour varied from \$2.80 to \$3 per day of 10 hours.

The city of Vancouver holds records of water on Capilano and Seymour Creeks amounting to 2,900 B.C. miner's inches. This amount will be sufficient to supply a population of about 400,000. In order to make use of the water from any stream in British Columbia, it is first necessary to apply to the Government for a water record.

The combined water systems, as at present developed, are estimated to supply a population of 180,000.

Reservoir.—In addition to the above work there is now being constructed a 24,000,000 gallon distribution reservoir to be used for a high-level system. This reservoir is situated about 1 mile south of the city boundary on the top of a rocky hill, known as Little Mountain, and has an elevation of 395 ft. above sea level at high water mark. At present it is connected with the Seymour Creek system by a single lap-welded steel pipe, 18 in. in diameter, but it is the intention to have it also connected with a high pressure pipe from the Capilano Creek system. This will insure safety from interruption in the supply and render the system an ideal one.

The formation at the site of the reservoir consists of a top layer of very compact sand, gravel, and boulders, from 3 to 4 ft. in thick-

ness, overlying hardpan, which rests on trap rock. The material excavated was used to form the banks of the reservoir, the finer being placed on the inside slopes and the coarser material and rock on the outside. The total excavation was about 80,000 cubic yards, of which 18,000 cubic yards were from solid rock. This rock was placed around the outside of the earth-bank, forming a riprap extending from the bottom to the top of the bank for its entire length, and adding to its stability as well as greatly improving its appearance. The excavation was performed under contract by Mr. M. P. Cotton, of Vancouver, who received 54 cents per cubic yard for earthwork and \$1 per cubic yard for rock-in-place.

With the exception of the top layer of about 3 ft., the entire mass had to be drilled and blasted, after which it was excavated with a steam shovel and hauled to place by dump cars. For this purpose a track was carried around on top of the bank and shifted as the work advanced. The earthwork in the bank was completed last autumn, so that it might settle during the winter. The wages paid on the work ranged from 25 cents to 35 cents per hour.

Tenders are now being asked to construct the concrete lining, which will be proceeded with at once. The bottom lining will consist of concrete slabs not greater than 12 ft. square by $4\frac{1}{2}$ in. thick, with V-shaped joints, which will be filled with the best quality of clay or asphaltum.

The side slopes, which are 2 hor. to 1 vert., will be lined with reinforced concrete, with expansion or parting joints every 50 ft. This lining will have an average thickness of $4\frac{1}{2}$ in., and will be reinforced with Clinton electrically-welded wire. The reinforcement for the bottom half will weigh about 42 lbs. per 100 sq. ft., and the top half 24 lbs. per 100 sq. ft. This reinforcement will be held in place during the construction of the lining by flat anchor rods, driven into the bank, and the concrete will be poured into the forms in a wet condition.

All concrete used in the work will consist of the following ingredients: 1 part of Portland cement, 2 parts coarse, sharp sand, 2 parts broken rock, free from dust or dirt, which will pass through a ring half an inch in diameter, 2 parts broken rock, free from dust or dirt, which will pass through a ring 1 in. in diameter.

Inlet Pipe.—The inlet pipe is of continuous $\frac{3}{4}$ -in. riveted steel, having a diameter of 24 in. and a length of 175 ft. This pipe was placed in its trench and embedded in concrete before the excavation of the reservoir. It passes through two concrete bulkheads or cut-off walls, and is provided at the reservoir end with a balanced valve arrangement designed by the writer, and at the outflow end with a scour-gate, a swing check-valve, and an automatic regulating valve, as illustrated on the accompanying plan.

The second submerged main, with shore connections complete, cost about \$19,000, and the pipe line to the reservoir, including valves and specials, about \$75,000. The probable cost of the new reservoir will be \$80,000. This will bring the total cost of the Seymour Creek system up to about \$575,000, its capacity being about 9,000,000 Imperial gallons per day.

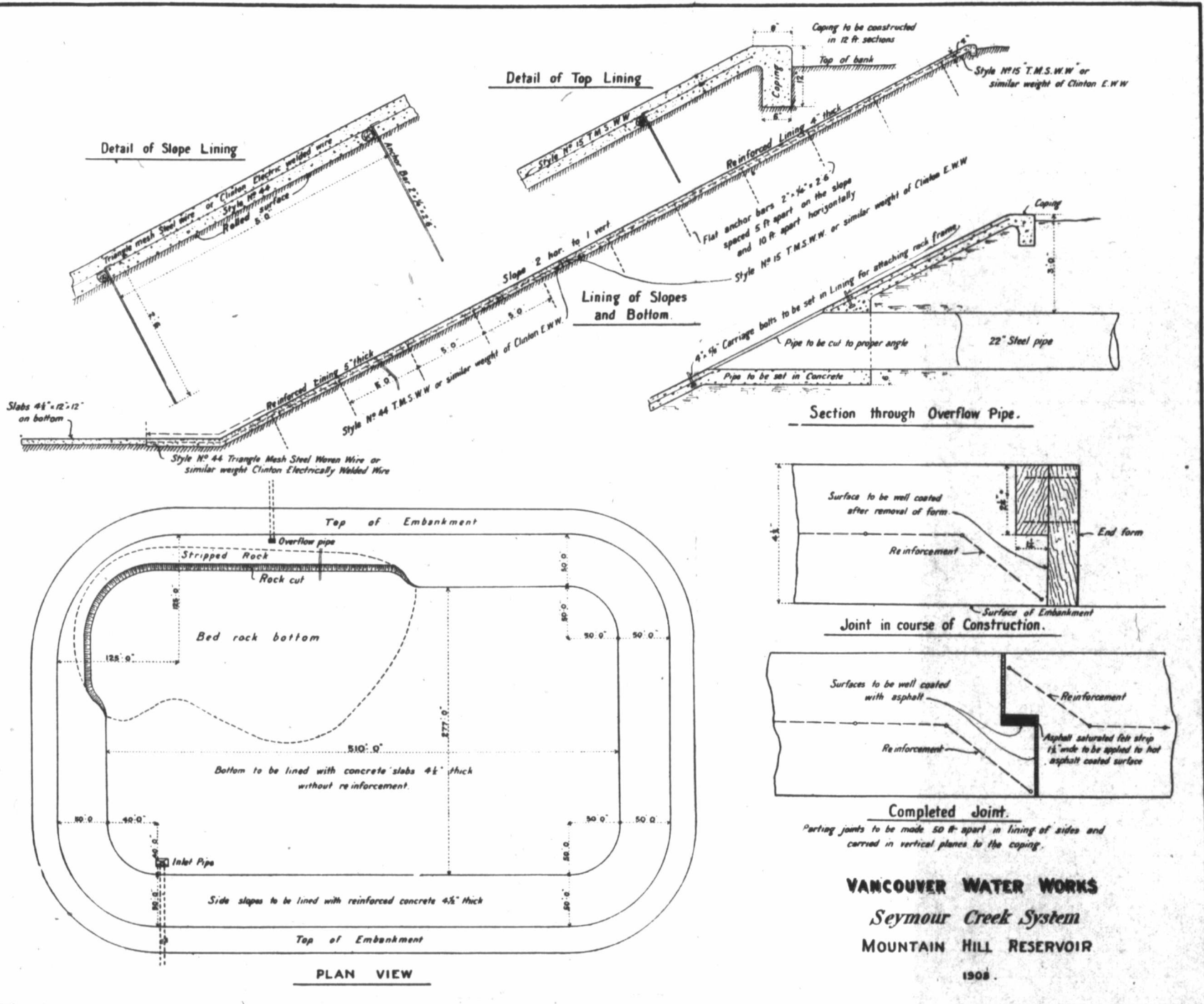

VANCOUVER WATER WORKS
 Seymour Creek System
 MOUNTAIN HILL RESERVOIR

1908.



100

11

U

12

13

14

15

16

17

18

19

20

21

22

23

24

25

26

View

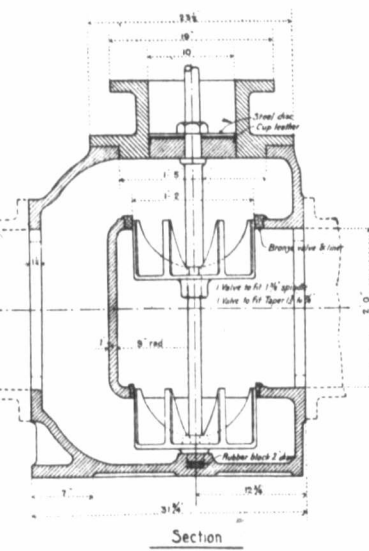
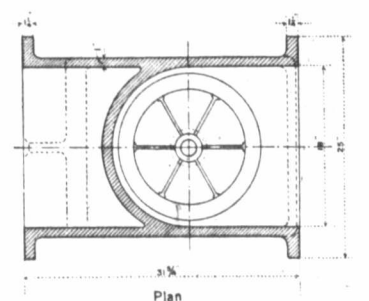
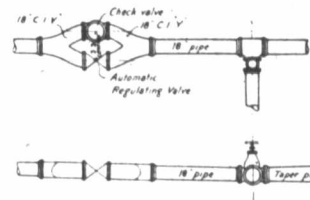
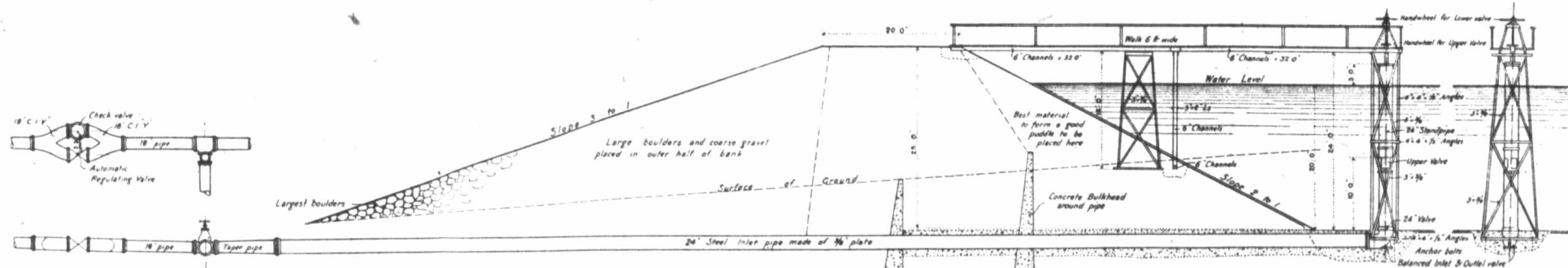

AUTOMATIC REGULATING VALVE

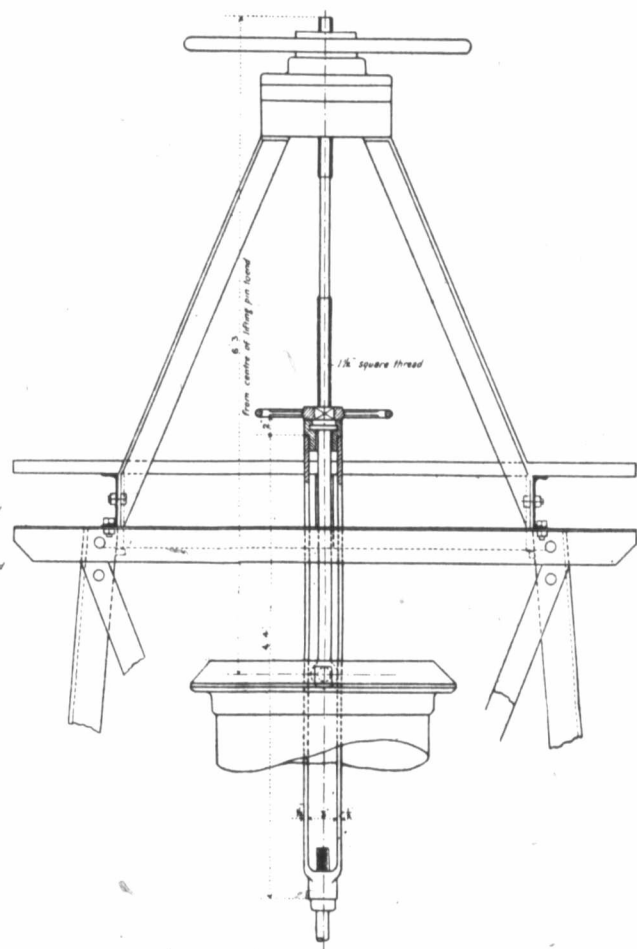
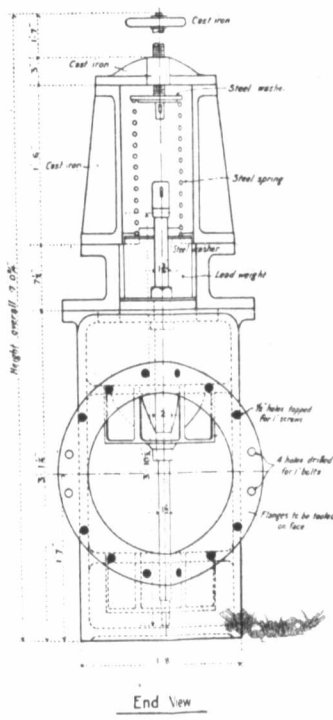

LIFTING GEAR FOR BALANCED VALVES

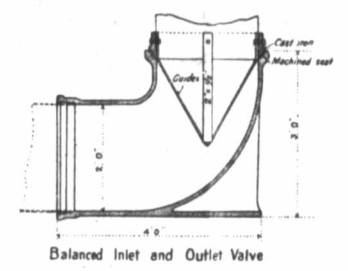

Balanced Inlet and Outlet Valve

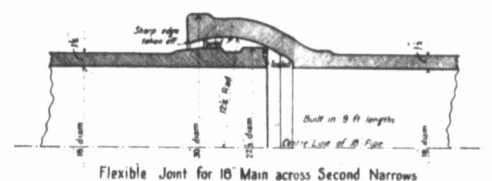

Flexible Joint for 18" Main across Second Narrows

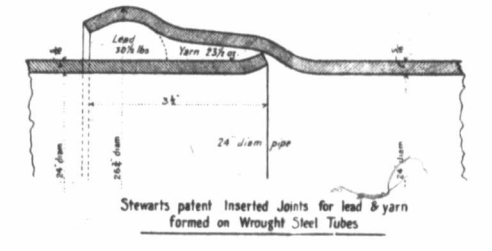

Stewarts patent Inserted Joints for lead & yarn formed on Wrought Steel Tubes

VANCOUVER WATER WORKS
 Seymour Creek System
 EMBANKMENT MOUNTAIN HILL RESERVOIR
 AND
 DETAILS OF VALVES AND PIPES.

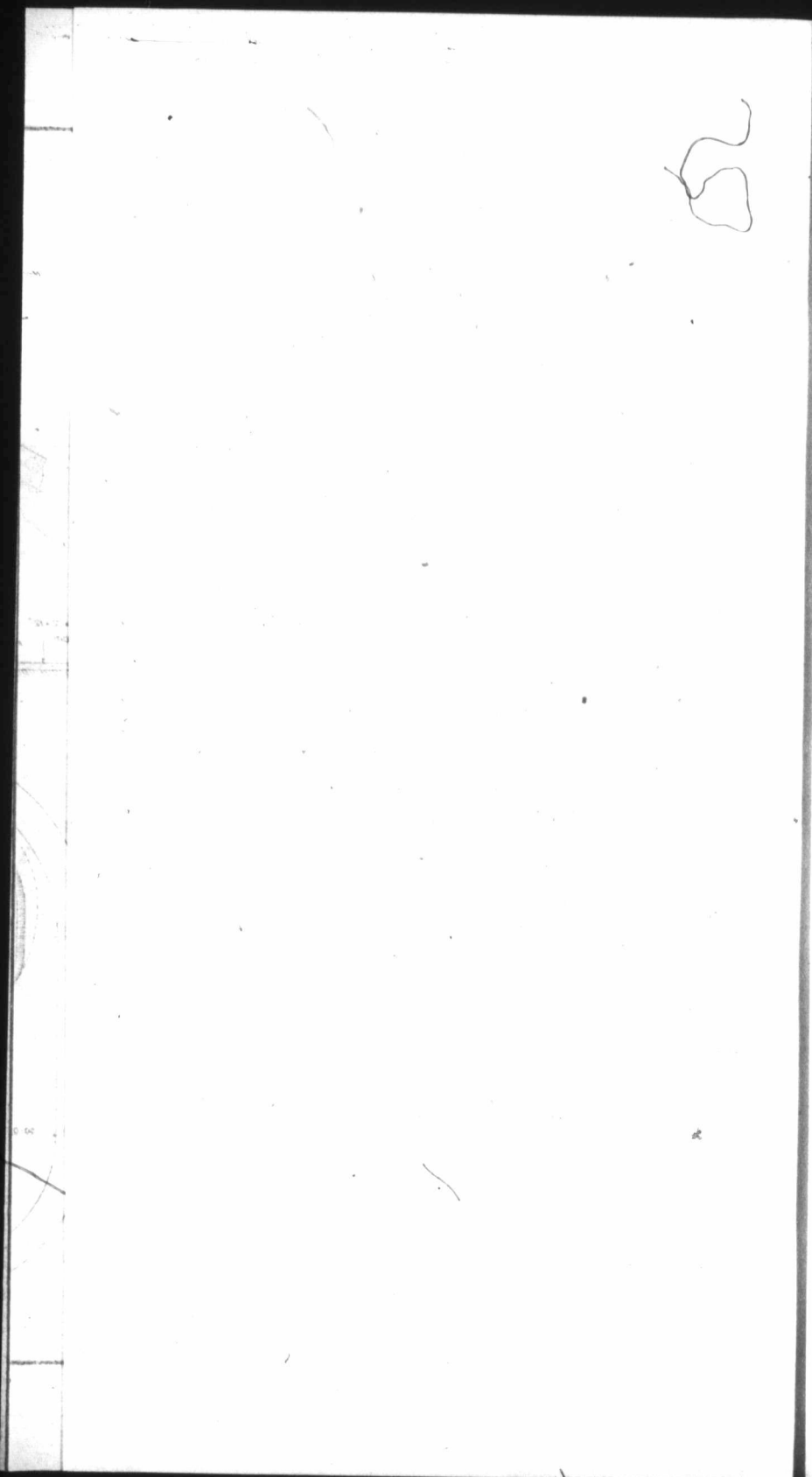

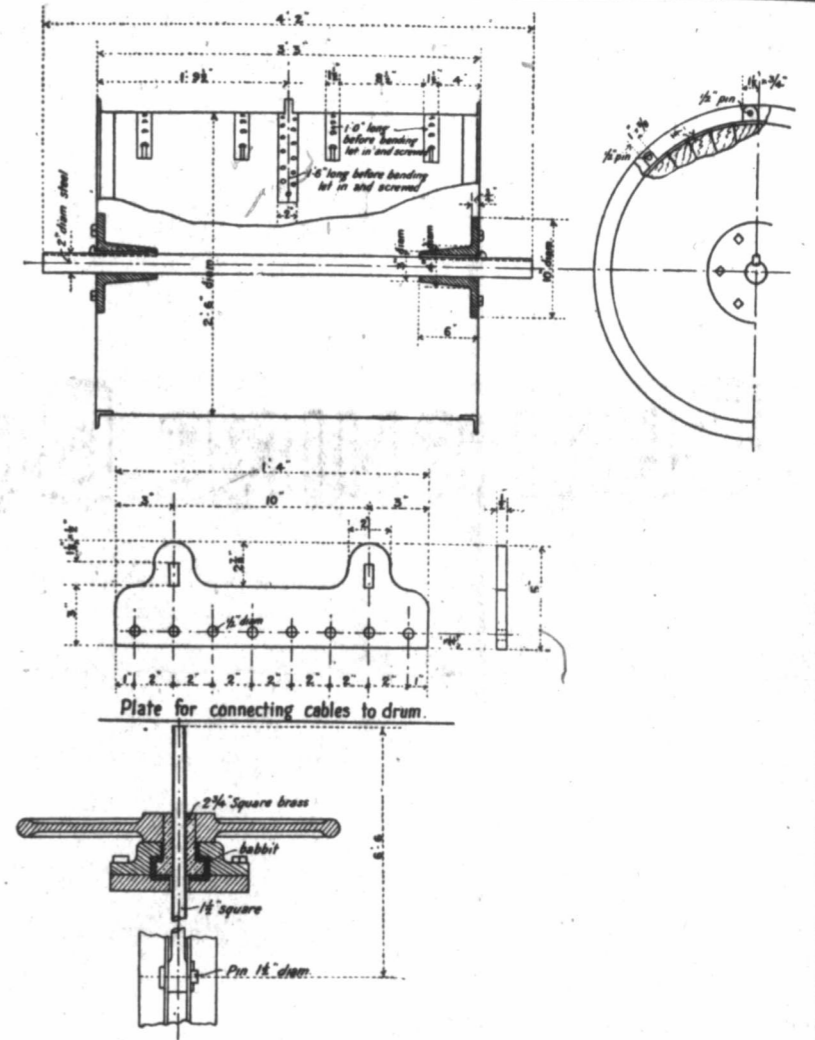
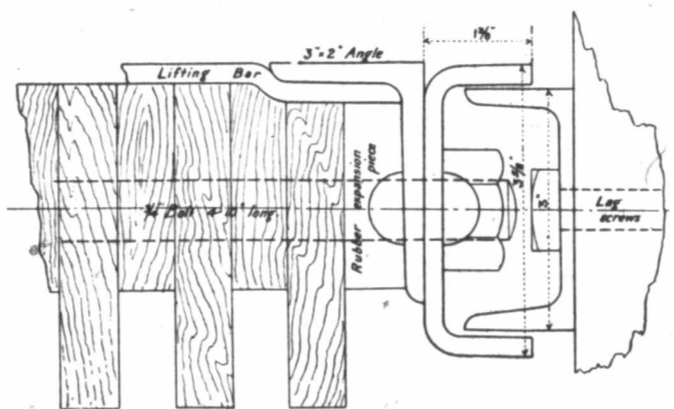
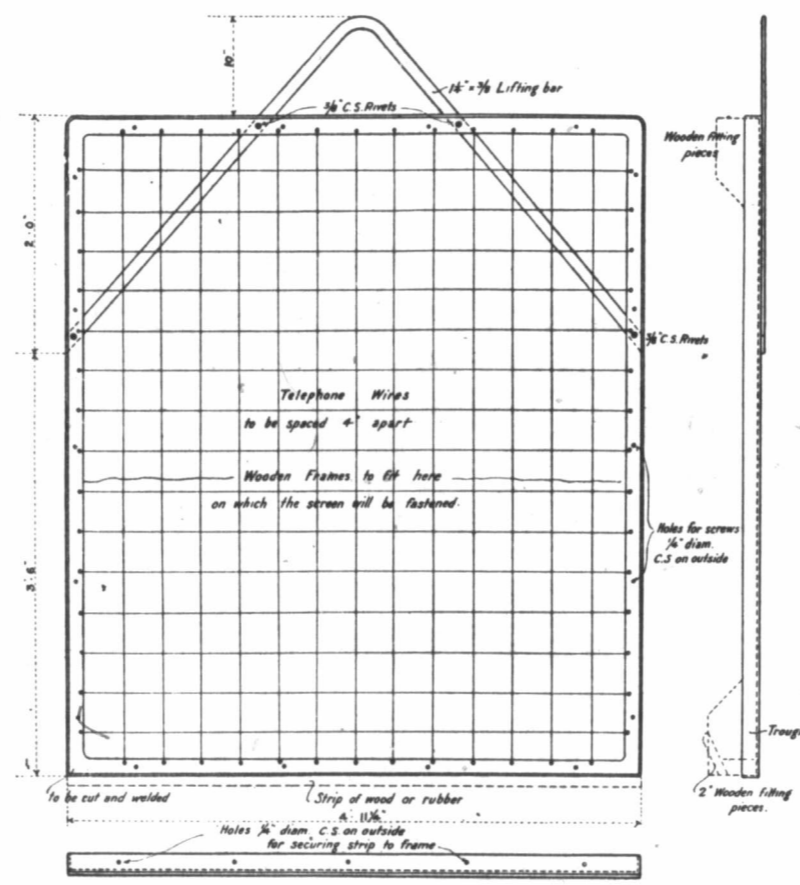
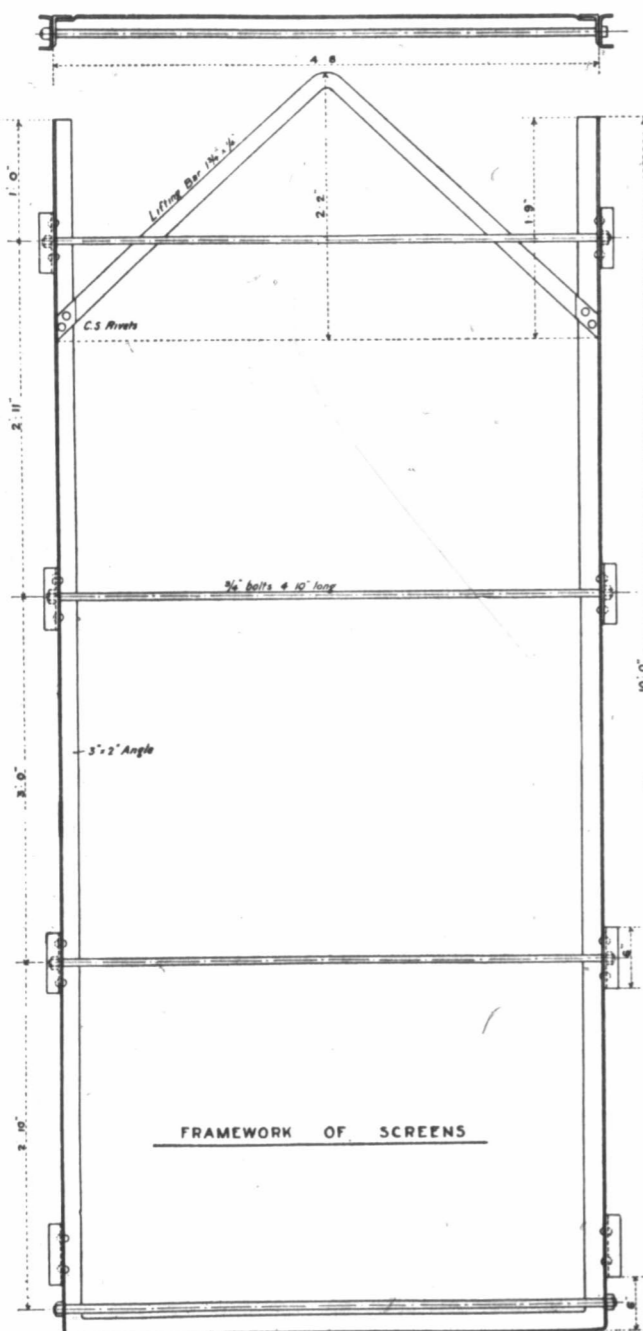

VANCOUVER WATER WORKS
 Seymour Creek System
 INTAKE SCREENS.

1908

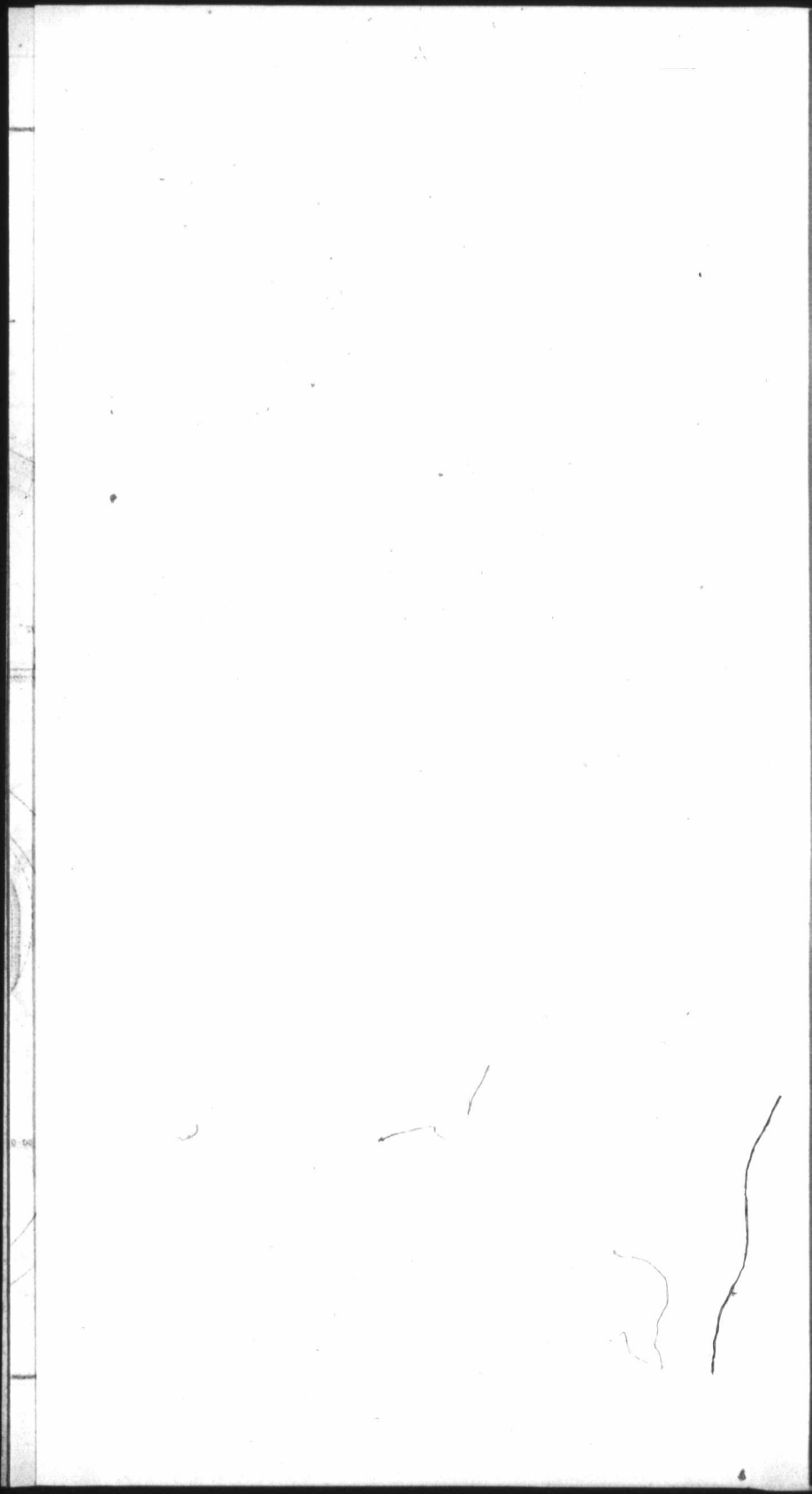

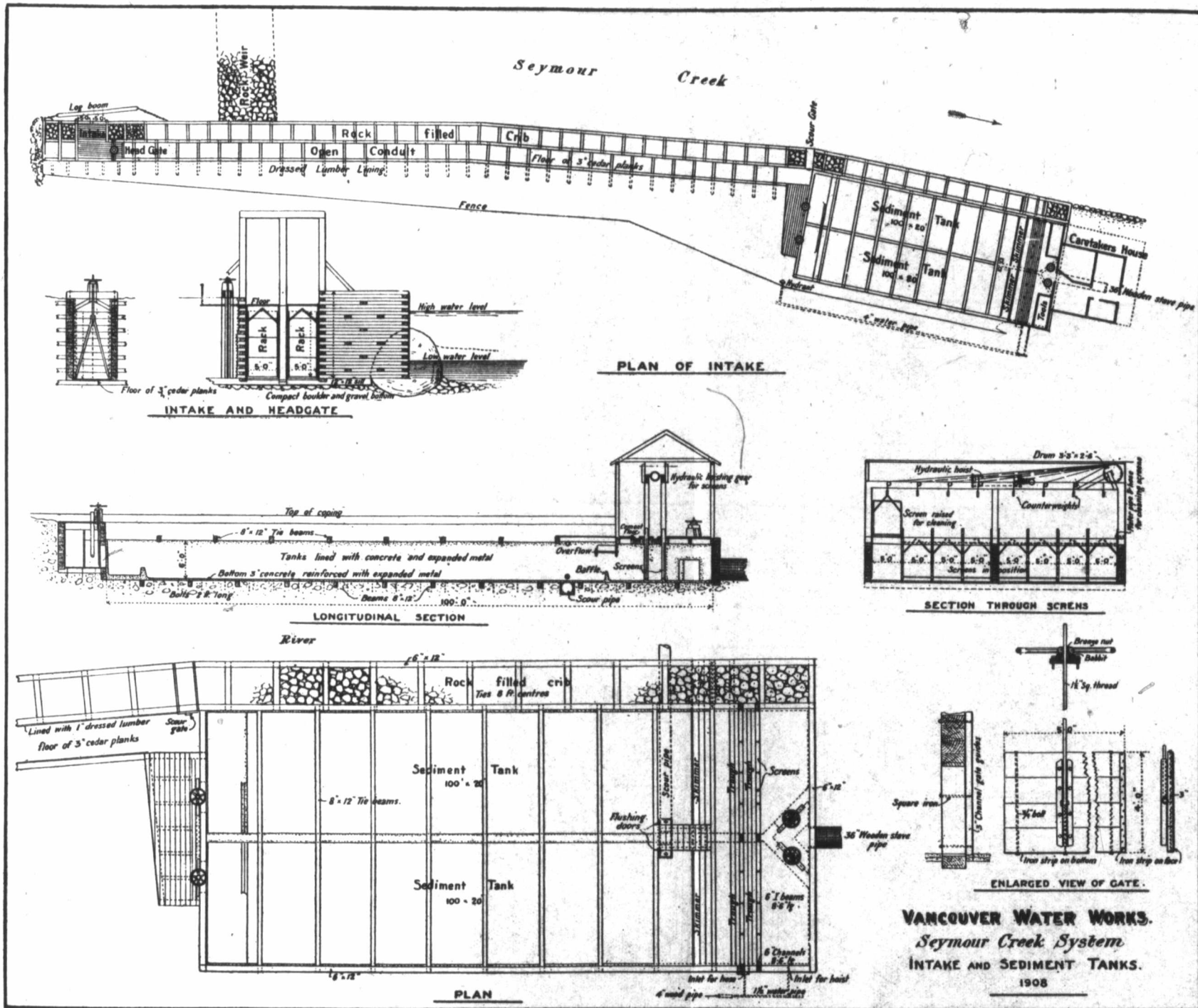

Seymour Creek

PLAN OF INTAKE

INTAKE AND HEADGATE

LONGITUDINAL SECTION

SECTION THROUGH SCREENS

PLAN

ENLARGED VIEW OF GATE

VANCOUVER WATER WORKS.
Seymour Creek System
INTAKE AND SEDIMENT TANKS.
 1908