

78.

Library of Parliament Jan 97

THE FARMER'S ADVOCATE

AND HOME MAGAZINE

PERSEVERE
WILL
SUCCEED
FOUNDED 1877

AGRICULTURE, STOCK, DAIRY, POULTRY, HORTICULTURE, VETERINARY, HOME CIRCLE.

REGISTERED IN ACCORDANCE WITH THE COPYRIGHT ACT OF 1875.

VOL. XXXI. LONDON, ONT., AND WINNIPEG, MAN., MAY 1, 1896. No. 405.

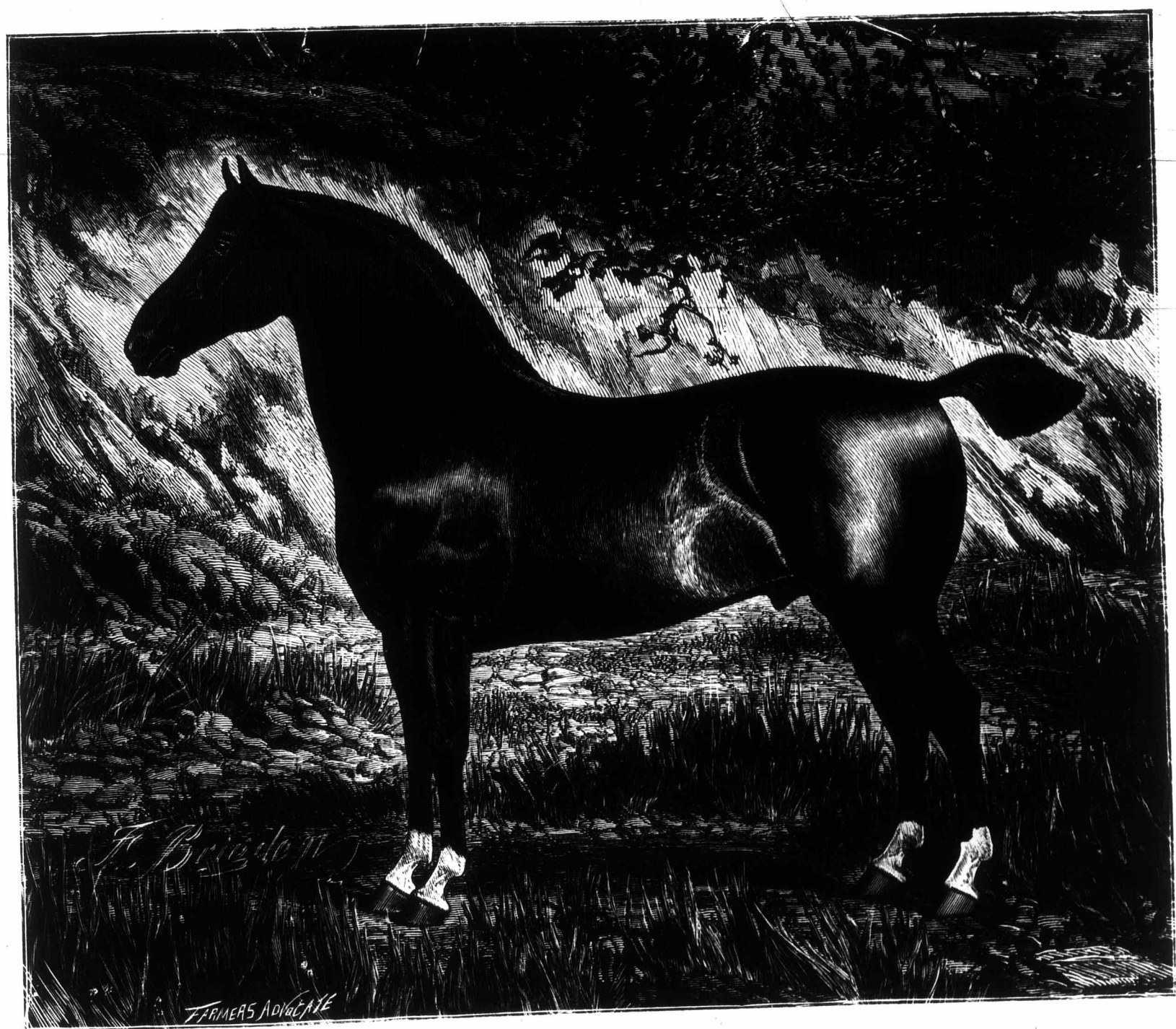

THE GREAT HACKNEY, JUBILEE CHIEF,
 WINNER OF 1ST PRIZE IN CLASS FOR "STALLION AND THREE OF HIS GET," CANADIAN HORSE SHOW OF 1894.
 THE PROPERTY OF R. BEITH & CO., BOWMANVILLE, ONT.

EDITORIAL.

Horse and Sheep Breeding.

"Horses and sheep have fallen into neglect," writes Mr. A. McNeill, who, in another column, favors our readers with some thoughtful and practical observations as the result of a recent farmers' institute tour through a portion of the Province of Ontario. A visitor at the late Canadian Horse Show in Toronto, witnessing the magnificent cavalcades of saddle horses, and the still more attractive and varied exhibition of driving horses and equipages, both of the English and American type, might be disposed to discredit the former part of Mr. McNeill's statement were it not known to be the fact, especially as it relates to draft horse breeding. This would also be gathered from the preponderance of the lighter type of equines at the show referred to. But while the current of popular favor has strongly been set in that direction—the demand from the well-to-do civilian classes for really choice animals keeping clearly ahead of the supply—it is well not to forget how constant and substantial is the call for the heavy draft. Years ago, with the advent of the steam engine, the extinction of the horse was predicted more confidently than to-day; but the railway only created work for him; nor is there yet any more real prospect of his displacement. Canadian horse shipments to England increased enormously last year, and the Governor-General, Lord Aberdeen, in opening the show at Toronto, took an optimistic view of the future of horse breeding, remarking that in the motherland would always be found a profitable market for good horses. We doubt if there is really any more salable stock to-day than good heavy horses; we emphasize weight because that is perhaps more loudly called for than any other essential. Recently there was also a revival of shipments from Ontario to Manitoba and the Northwest, where farmers now realize that during the three or four years past they have, shortsightedly, allowed the industry to "fall into neglect."

The bicycle and the electric car have dealt a blow to the "general purpose" nag, but our safe plan of operations is not to rush pell mell out of horse breeding, but, rather, to breed with greater discrimination both in the choice of mares and mating, and then giving the progeny such an upbringing as will properly prepare them for the harness, heavy or light, or the saddle. Some years ago officers from England visited Canada on the lookout for suitable cavalry remounts, but they were not to be found here in sufficient supply. We have improved a bit in that direction since, but horse stocks generally in Canada are now lower than they have been for many years, and we are glad to notice a distinct and intelligent revival of interest in that direction, which we hope to see characterized with steadiness of purpose. A salable horse is not produced in a hurry, and it will be several years before any material addition can be made to the stock of the country. The greatest obstacle for some time to come will, we apprehend, be the securing of suitable brood mares of the various types.

A few words now with regard to sheep, which in his travels Mr. McNeill has also found fallen into neglect, for which the low price of wool and lambs and the ravages of dogs will probably be blamed. When we deliberately think over the many characteristics that commend the peaceful sheep to our best care on the farm, we must certainly deplore the occasion of such a statement. As good an authority (if we need to quote authorities) as Prof. John Wrighton, himself a thoroughly practical and successful sheep raiser, whose penchant is for the early-maturing Hampshire, observes that the whole world produces sheep, but the whole world, with its steadily increasing population, consumes them—fleece and all. The extension of sheep farming, he points out, keeps up the price of ewes, and sheep breeding stimulates the trade in rams. Natural vicissitudes often decimate flocks so that years are required to recover lost ground. Lately we notice that millions have actually been dying from the effects of drought on the Australian plains. Sheep are not to be increased by simply "writing them up" or decreased by writing them down. Climatic fluctuations and epidemics have more to do with the sheep population than the effusions of literary agriculturists. Sheep are in themselves profitable. What stock are so easily cared for, subsist on so little, and give so good returns therefor? Two crops a year they yield us. These columns have borne testimony from time to time

to the satisfactory condition of the British sheep breeder during past years. To the wail of agricultural depression going up he has not been a contributor. The unassuming sheep has helped its owner to withstand the evil times. "Why," asks Prof. Wrighton, "are sheep profitable?" and he answers his own question: "It is because the price of mutton always rules higher than the price of beef, while the wool at least pays for the labor expended on the flock. Again, sheep make better use of their food than cattle. They benefit light, arable lands in a two-fold sense; first, by manuring, and, secondly, by consolidating it."

There is no question about the natural adaptability of Canada for sheep husbandry. The winnings of Canadian flocks at the Columbian Exhibition and the phenomenal sweep made by Canadian fat sheep at the great Madison Square Garden Show last fall will not soon be forgotten. For years United States breeders have drawn their main supply of breeding stock from the healthy, high-class flocks of Canada. The remarkably varied soil, climate, and foods of the Dominion all suggest variety in breeds used and in management, and our nearness to great markets, in contrast with New Zealand and Australia, all suggest the possibility of greatly extending the scope of our sheep breeding operations. Last season witnessed a slightly improved price for wool and an immense increase in the exports of Canadian sheep to England, the numbers being 217,768 in 1895 as compared with 139,763 in 1894. In England the outlook for wool is that prices for some time to come will range better than the average of the past ten years. Breeding stocks were sold down very low the past season in Canada, and in no department of breeding is there a more hopeful tone, which, if not positively buoyant (for the halcyon days of high prices have not yet returned), is at all events, to put it mildly, one of steady security and well deserving of the very best attention instead of neglect.

A Famous Stud.

The famous stud of Robert Beith & Co., situated at Bowmanville, Ont., has been before the public as the home of the highest class of Clydesdales for a great number of years, but lately it has been more noted for its world-renowned Hackneys.

Our frontispiece represents the famous Jubilee Chief, who has been winning first prizes ever since he came to this country, some five years ago, fittingly crowning his honor-roll of triumphs by capturing first for Hackney stallion and three of his progeny in Toronto at the Canadian Horse Show a fortnight ago, thus demonstrating his potency as a stock getter.

Jubilee Chief was bred by Wm. Martin, Scoreby Grange Gate, Helmsley, Yorks., Eng.; foaled 1887, and having for his sire Pilot 1323, his dam being Queen of the Forest by the celebrated stallion, Fireaway (Griffith's). He is a beautiful dark velvet-brown of grand conformation, great style and action. He is proving a wonderful sire, and in the show ring is hard to surpass, having to his credit, previous to 1896, first at Toronto Industrial, 1891, 1892, 1893; first at spring stallion show, 1893; first and world's championship at Chicago, 1893; first in Toronto on three occasions with three of his get, the last one of which was at the recent Canadian Horse Show.

In Mr. Beith's stud may also be seen a number of other grand specimens of the Hackney breed. Lord Roseberry, by Jubilee Chief, dam Florence, is a horse of beautiful mold, a dark brown in color, and possessing good action, like his sire. Lord Roseberry's winnings were second as a three-year-old at the horse show at Toronto in the spring of 1895, third at Toronto in the fall of 1895, also second as a two-year-old same place, and fourth at the recent show.

The four-year-old stallion, Banquo, also by Jubilee Chief, and from Mona's Queen, is a handsome brown of superb form and action, with a flash and style about him that will always find him ready admirers and make him a favorite. His winnings are second at Toronto as a foal and first at all leading Canadian fairs since (except at the late show, when he came second), also champion at Toronto spring fair in 1885 and second as yearling and first as a two-year-old at the great New York show.

The two-year-old filly, Jessica, is a particularly handsome mare, also sired by Jubilee Chief and foaled by Mona's Queen. Her conformation is difficult to fault and her knee and hock action would be hard to surpass. She has carried off the first honors wherever shown and won the sweepstakes prize at the Toronto Fair last spring, in competition with two and three-year-olds. The above individuals would indicate the grand breeding and transmitting powers of the sire, Jubilee Chief.

Other choice productions of the stud are Portia, a beautiful chestnut yearling filly out of imported Florence and by the beautiful stallion, Ottawa, sold at a long price from the stud to F. C. Stevens,

Attica, N. Y., where, unfortunately, he died some time ago, as mentioned in the *ADVOCATE*.

The breeding mares include some grand individuals, such as Mona's Queen, by Lord Derwent 2nd, by Denmark, a handsome chestnut and the dam of Jessica and Banquo. Lady Aberdeen, also by Lord Derwent 2nd, was a winner of second money as a three-year-old at Chicago, and first at Toronto and Detroit the same year; she and her mate, Mona's Queen, always carrying first and second wherever shown. Imported Florence, a half-sister to Banquo, is producing some grand stock, and is one of the valued members of the stud. The grand mare, Winnifred (imp.), sold to F. C. Stevens, of Attica, N. Y., won first and championship at the Chicago World's Fair, and has a grand record as a winner; a foal of hers won first at Philadelphia last summer with competition of the keenest.

A careful perusal of the report and prize list of the Canadian Horse Show, published in this issue, will show that this stud carried away a number of very good prizes in the keenest sort of competition. In addition to those mentioned above, the three-year-old Clydesdale colt, Locksley, succeeded in winning first in good company. He is a solidly built bay with four white feet. He is out of imported Maria [977], and got by Sir Walter (imp.) [1131].

What Induced Me to Begin Underdraining-- Profits from Tile Draining.

BY R. G. SCOTT.

Three things induced me to begin underdraining: (1) A sense of need; (2) unfairness of others; and (3) increase of knowledge.

1. I have a good farm of 150 acres. Visitors from districts better handled than my land was handled a few years ago told me in a kindly manner that I was not getting from my fields what they were capable of producing. I had not been satisfied with returns from my seeding and tillage. Every new comment by intelligent friends who came to my farm made me more suspicious that I was wanting in some of the first principles of successful farming. I wanted to know the better way, and I came to rejoice over the promise to him who seeks along agricultural lines as well as others. Weeds, thistles, cotton, bleached blades, thin yields, unrewarding threshings for a number of years, set me out to inquire why these things? I plowed carefully, I put in clean seed, I attended to my work, but things were not turning out well. I had begun to farm like a man to build at the chimney instead of at the foundation. By a series of leadings, which space will not permit me to explain here, I came to realize that drainage is the foundation of all successful farming. I began on new lines, and from the year of the new beginning until to-day I have delighted in my calling, and, without egotism, I counted myself a prosperous farmer. All land may not require the exact treatment mine does, but I declare, with a knowledge that I prize, that underdraining constitutes the most important line of thought in agriculture in the Dominion to-day, and I emphatically assert, from an understanding of farming operations in Ontario, Quebec, New Brunswick, and Nova Scotia particularly, that the main cause of nine-tenths of the unprofitable farming in these Provinces is due to the want of the underdrain.

2. The unfairness of others was a factor in setting me out on a better way with my farm operations. I heard not a few, who were working on the old lines, blaming the Almighty for wet fields, emptying clouds, and poor harvests; others laid the blame at the door of the Government. Sometimes the "Grits" got it, sometimes the "Tories." "This infernal Canada," said a friend of mine; "I can't make things pay in it by farming, and I'm going to the States." He did not go, however. He was dissuaded from the change by hearing me say, "They cultivate oysters under water, but not wheat and potatoes." Here is one who would sell his farm if he could and try the city; and there was another who would quit the soil and speculate in cattle. I writhe at blames cast upon God. I dislike to hear the Government charged with ills belonging to other men. I think Canada, all in all, the best country on this planet. I prefer the country to the city, and I honor the world's oldest occupation of agriculture more than the speculating of modern times. I was of the same opinion years ago in these respects as I am to-day; hence, when some of my fellows were planning to go elsewhere and do otherwise, in days gone by, I was being taken along a better way. Things were brightening up with me, because I was coming to appreciate foundation principles. While others raved, I worked the spade. They cursed when the water came on; I rejoiced as I let it off, and rejoicing turned to better profit than cursing.

3. Increase of knowledge on my part makes me an enthusiast in underdraining. Thanks to the publishers of the best farm papers, to agricultural colleges, to men of common sense who talk at institutes, to those who use the pen to give others valuable information on the science and art of successful farming, for what they have done, I am indebted to them. I have gone from home to get knowledge for farm work. I have brought knowing ones to my place to give me information. I wish all fellow farmers would prize these twelve things: (1st) That we must get surplus water away from the soil if we are to succeed on the farm; (2nd) that the best way to get it off is to let it go down the tile in the underdrain; (3rd) that manure is turned to advantage in clay soils only when they

are underdrained. It has put in a network its way (5th) that there work water and get the soil; (6th) fertility; (7th) drained land rust; (8th) reduced to a well drained of summer of the season of as compared ground pasture feed upon is and (12th) the

4. In the underscore of day, before costly that boards, etc., of setting my judgment the drains were replaced. Material for draining are being up to lines: (1) I no longer a ment. One Drained soil the way for asks for ad boon. (3) An undrain is herewith debt to buy quickest was testimony investment is the invest tiles, and i rejoicingly, laid under the rate of

Th A FLATTER

The lead U.S. refer picture, wh by sending Here are a equally goo

AN A very horse bree "Farmer's nipeg, Man engraving, the publish styled "C the finest great bree bred, and C uals depict to the far popular pie panion pic cate" issue home of ev and town, be an orna taste in th and other high ideal Globe, Tor

With t street car digious sc invention that the u business o be profit class hors in as muc the marke ness is as is still "C lithograph Advocate, of the fin companio Weld Co inches in

A Rumor evidently of London tenor of i and bree horse pict uly the have yet subscribe ave tha

are underdrained; (4th) that the fertility nature has put in rain and snow is utilized when water will work its way from the surface soil to the tile bed; (5th) that the fertility which is in the atmosphere works down through the pores made by water and gives additional richness to the roots in the soil; (6th) that underdraining prevents loss of fertility; (7th) that the conditions brought about in drained lands are preventives against blight and rust; (8th) that loss from heavings through frost is reduced to a minimum by underdraining; (9th) that well drained and well tilled ground resists the heat of summer better than undrained land; (10th) that the season of tillage is lengthened on drained land as compared with undrained; (11th) that the underground pasturage for the roots of plants and trees to feed upon is enormously enlarged by underdrainage; and (12th) that the draining with tiles pays.

4. In these closing sentences about profits I underscore the word *tile* in tile draining. In their day, before tiles were manufactured, or were so costly that but few would invest in them, stones, boards, etc., served a purpose. I would not think of setting timber or stone in a drain now. In my judgment, it will be but a matter of time until the drains would have to be re-dug and the bottoms replaced. Round tiles are the best and cheapest material for underdraining. The profits from tile draining are certain, other conditions on the farm being up to the mark, and are reaped along these lines: (1) Pleasure. Farming on prepared soil is no longer a drudgery, but a delight. (2) Encouragement. One good thing paves the way for another. Drained soil encourages better tillage; tillage opens the way for profits from the manure heap; clover asks for admission, and with admission comes a boon. (3) Money making. If a man is in debt on an undrained farm that needs drainage, testimony is herewith given that it pays to go further into debt to buy tools and tiles to underdrain for the quickest way to get out of debt, and thus further testimony is given that the best known permanent investment for a man with a farm needing drainage is the investment in drainage implements, round tiles, and instruction. I speak of what I know rejoicingly, that for every dollar invested in a well-laid underdrain, comes invariably an interest at the rate of 25 per cent. per annum, and often more.

(TO BE CONTINUED.)

The Judgment of Journalists.

A FLATTERING RECEPTION ACCORDED "CANADA'S GLORY" BY THE PRESS.

The leading public journals of the Dominion and U.S. refer in the highest terms to our new premium picture, which any present subscriber can secure by sending in only one new yearly subscriber. Here are a few specimen comments out of scores equally good:—

AN OBJECT LESSON IN BREEDING.

A very decided service has been rendered the horse breeding interests of the Dominion by the "Farmer's Advocate," of London, Ont., and Winnipeg, Man., in issuing a magnificent new premium engraving, a copy of which we have received from the publishers, the Wm. Weld Co. It is fittingly styled "Canada's Glory," and includes eleven of the finest light horses on the Continent. The four great breeds—Thoroughbred, Hackney, Standard-bred, and Coach—are all represented; the individuals depicted being from Nova Scotia, in the East, to the far Northwest. It should be even a more popular picture with the masses than its old companion piece, "Canada's Pride," which the "Advocate" issued a few years ago. It should be in the home of every lover of a good horse in both country and town, because wherever it goes it will not only be an ornament, but a real educator of the popular taste in that direction, and in these days farmers and others cannot devote too much attention to high ideals in breeding stock of any kind.—*The Globe, Toronto, Ont.*

A VALUABLE PICTURE.

With the general introduction of electricity for street car propulsion; the use of bicycles on a prodigious scale, by every sort of people, and the invention of horseless carriages, fears had arisen that the usefulness of the horse had waned, and the business of producing these animals would cease to be profitable. No such result has happened; first-class horses of nearly every breed are found to be in as much demand as ever, at high prices. In fact, the market for light horses fit for saddle and harness is as good now as it ever was. That the horse is still "Canada's glory" is suggested by a valuable lithographic picture just issued by the "Farmer's Advocate," giving portraits of no less than eleven of the finest light horses on the Continent. It is a companion picture to the one issued by the William Weld Company several years ago, and is 36 x 24 inches in size.—*London (Ont.) Free Press.*

A STUDY IN HORSE PORTRAITURE.

Rumors of the coming "horseless age" have evidently not disturbed the "Farmer's Advocate," of London, Ont., and Winnipeg, Man., in the "even tenor of its way." That enterprising old farmers and breeders' journal has just issued a new light horse picture, designated "Canada's Glory," decidedly the most ambitious effort in that direction we have yet noticed. It is awarded for obtaining new subscribers to the "Farmer's Advocate." We believe that the outlook for good horses, such as this

group portrays, is rapidly improving, and the "Advocate" people very happily discerned the signs of the times, and their effort to properly educate popular taste for the highest type of light horses will assuredly be appreciated by breeders, both of America and the Old Country. The longer we study this beautiful engraving the more we see in it to admire, and no doubt it will soon adorn the walls of many homes where art and the horse are at once deservedly admired.—*Christian Guardian.*

A WORK OF ART.

The "Farmer's Advocate," of London, Ont., and Winnipeg, Man., has signalized the great Canadian Horse Show of 1896 by issuing a companion piece to its much-admired draft horse premium group, "Canada's Pride," issued some years ago. The production is fittingly named "Canada's Glory," as it portrays an artistically arranged group of the finest individuals of the noblest race of animals extant. The design and the perspective of the picture and the life-likeness of the superb light horses portrayed are worthy of the very highest commendation. We recommend it as a piece of high-class art in animal portraiture, suitable alike for the adornment of the walls of the dining-room, sitting-room, or drawing-room. One cannot study a picture of this sort without being more strongly impressed than before with the nobleness of the equine race, while the thought that the gasoline motor will displace the horse becomes the climax of absurdities.—*Rider and Driver, New York.*

UNE ŒUVRE D'ART.

Le "Farmer's Advocate," journal agricole publié à London, Ont., et Winnipeg, Man., vient de publier une magnifique gravure, représentant un groupe des chevaux qui ont obtenu les premières récompenses à l'exposition chevaline tenue, l'été dernier à Toronto. Cette gravure mesure trois pieds sur deux et a pour titre: "Les gloires canadiennes"; elle est d'un fini parfait, et fait honneur à notre confrère. C'est une prime qui vaut la peine d'être conservée.—*Le Cultivateur, Montreal, Que.*

CANADA'S GLORY.

Under this title, the "Farmer's Advocate," of London, Ont., and Winnipeg, Man., has just issued a magnificent engraving, the subject matter of which is a group of celebrated light horses, gracefully disposed over a picturesque landscape. No more appropriate picture for the home of an agriculturist could well be imagined, though the intrinsic merit of this particular production admirably qualifies it to adorn the most refined of drawing-rooms. It is in itself an education in horsemanship and a noble example of what may be accomplished by the energy and enterprise of our Canadian live stock and agricultural publications, among which the "Farmer's Advocate" justly occupies a prominent position. [Then follows a list of the horses portrayed.] It will, perhaps, be remembered that the William Weld Co.—the publishers of the "Advocate"—formerly issued a draft horse picture, entitled "Canada's Pride," which was greatly admired. It is safe to say, however, that "Canada's Glory," designed as a companion piece, indicates an unmistakable advance in artistic workmanship, and will, we think, prove more generally popular.—*Nanaimo Free Press, Nanaimo, B. C.*

Word from One of Manitoba's Successful Farmers.

Valuable testimony was contributed to the Winnipeg Immigration Convention by Mr. Thos. Sissons, of Portage la Prairie; an unassuming, upright, honest man, whose word will carry greatest weight where his personality is best known. As might be expected, Mr. Sissons has been a reader and a careful student of his own business—farming. He gave first a most interesting account of his departure from Western Ontario, in August, 1871, and his trip by rail to St. Paul, Minn., and thence by wagon northward to Portage la Prairie, which they reached on September 25th. "We secured," he went on to say, "a few hundred acres of land, secured a home for the winter and settled down to work, preparing for the coming years by getting out logs for house, stables, and granary, fencing and firewood. The following summer we began to improve our farm, feeling our way, taking one step at a time, as circumstances would warrant. No spasmodic effort to repent of, but a gradual adding to, a comfortable home being our ambition, and I am happy to say that we have succeeded more fully than we ever expected.

"I remember when I thought, 'Oh, if I can only raise 1,000 bushels of wheat in one year, surely my fortune will be made.' Well, I soon had my wish in the first respect, but did I have a fortune? Well, probably I did; but did not realize it. The fact is, last year I raised 10,000 bushels of wheat, and still am not overwhelmed with the thought of my greatness; but I am truly thankful to the Giver of all good for a bountiful supply of all needful things.

"You may say, 'What cause have you really to claim the position of a successful farmer?' Well, what has your success amounted to? Well, when we arrived at the Portage and succeeded in realizing our goods and chattels from the Transport Company, being taxed some \$4 to \$5 per 100 pounds, and paying our living for the first year, we had very little money left. Now we make the modest

claim of assets to the value of forty or forty-five thousand dollars, as follows:—

"Landed estate, without encumbrance, \$20,000.
"Buildings—house, barn, grain barn, implement house, and sheds, \$10,000.
"Stock and implements, \$4,000 to \$5,000.
"Other stocks and securities, \$3,000 to \$10,000.
"Our liabilities, love to God and all mankind.

"Some may ask, 'To what cause do you attribute your success?' My answer is, to no one cause, but to many. Some of these causes are as follows: A good country, a rich and productive soil, a careful attention to one business or calling in life. And this latter has been my salvation in times of discouragement. If I don't know how to farm, I don't know how to do anything else, so I must stick to the farm. A careful adherence to the principle, 'pay as you go.' A careful attention to the housing and handling of all valuable machinery and implements. To plowing and working my farm in the very best way I could. To raising our own potatoes and vegetables, and having some to sell. To producing our own butter, and having some to sell. To raising our own beef, and pork; and poultry, and having some to sell. To raising our own wheat, oats, and barley, and having some to sell. To raising our own horses, and having some to sell. To raising our own hay, and having some to sell. To threshing our own grain, and that of some of our neighbors. To crushing our own cattle and horse feed, and some for others. To prudence and economy in all things. And last, but by no means least, to the fact of having gained the affections and the hand in marriage of a thrifty, industrious and amiable Scotch lady, to share my joys and sorrows. And to the blessing of God and good health.

"You will probably say my case is an exceptional one. I do not think so; there are many who have done as well, and even better than I. All my success comes within the ordinary possibilities of an ordinary man. Certainly, we have all to admit the fact of a great many failures, the causes of which are numerous. Some of them may be cited as follows:

"Some men cannot endure prosperity and bountiful crops, but run wildly into all manner of extravagance. The result is failure. Can we blame the country for that?

"Many come to this as to every new country, who have been failures in some other place, thinking they can gather a fortune here without persistent effort, and they likewise fail. But this is no fault of the country.

"Again, carelessness is a fruitful cause of failure. Some men use their horses, machinery, and all farm implements as if the present were the only time they would be required. As soon as plowing is done, they toss their plows aside to rust and be broken in various ways, and when next wanted they have to waste valuable time and money in cleaning and mending them. The same with binders; they are left in the field, or run down into some slough for eleven months of the year after being used less than one month, thus reducing the longevity of the machine, and rendering it unfit for successful work. It is the same with everything. Wagons stand out all winter to rot or be trampled and broken by stock. Sleighs stand out all summer, where sun and wind do them more harm than the winter's work; thus creating a continuous leak from the bucket, reducing or exhausting the profits of each year, and the end is failure. But surely here again no fault can be laid to the country.

"There is a class of men, especially young men from the Old Country, who have had no experience in farming, but who are promised help from their friends as soon as they are sufficiently taught to start farms of their own. They come here and engage with a farmer for one year, for little more than their board and instruction in farming; but the farmer soon finds he requires many additions to his previously simple and inexpensive household. He will require an extra laundress, another cook, a bootblack, a barber, etc., etc. In a few months he will find that his pupil knows more about farming than he does himself, and that it is not knowledge, but a good time, he is looking after. At the end of the year the young man sends a letter home, full of a glowing account of the progress he has made in the art of farming, and gets money to set him up in the business, and now he believes that perfect success is just at his finger-ends and he has nothing to do but grasp it. But can you wonder if this bubble bursts before he gets any closer to it?

"And now, a word of advice to young men and others who have come, or are about to come, to this country. Don't be in too great a hurry to make a fortune. Remember Rome was not built in a day. Be cautious, industrious, ready to receive advice from those who have had experience. Don't be easily discouraged at reverses, but keep steadily on, with a fixed purpose in mind. Avoid, as much as possible, the evil of running into debt. Learn, at whatever sacrifice, to bring down your wants to all your means. Be honest and straightforward in all your dealings, and your efforts will be crowned with success."

In handling colts, kindness is essential. It is often good policy to keep in front of a colt that is not thoroughly broken and is not used to handling. Too much freedom with the hind legs often ruins a colt, and sometimes the owner as well, if he is in range. It is only the naturally vicious colt that cannot be subdued by kindness, and if this will not subdue it, whipping is not likely to avail.

THE FARMER'S ADVOCATE & HOME MAGAZINE

THE LEADING AGRICULTURAL JOURNAL IN THE DOMINION.

PUBLISHED BY
THE WILLIAM WELD COMPANY (LIMITED),
LONDON, ONT., and WINNIPEG, MAN.
JOHN WELD, Manager.

1. The Farmer's Advocate is published on the first and fifteenth of each month.
- It is impartial and independent of all cliques or parties, handsomely illustrated with original engravings, and furnishes the most profitable, practical and reliable information for farmers, dairymen, gardeners and stockmen, of any publication in Canada.
2. Terms of Subscription—\$1.00 per year in advance; \$1.25 if in arrears; sample copy free. European subscription, 6s., or \$1.50. New subscriptions can commence with any month.
3. Advertising Rates—Single insertion, 30 cents per line. Contract rates furnished on application.
4. Discontinuances—Remember that the publisher must be notified by letter or post-card when a subscriber wishes his paper stopped. All arrears must be paid. Returning your paper will not enable us to discontinue it, as we cannot find your name on our books unless your Post Office address is given.
5. The Advocate is sent to subscribers until an explicit order is received for its discontinuance. All payments of arrears must be made as required by law.
6. The Law is, that all subscribers to newspapers are held responsible until all arrears are paid, and their paper ordered to be discontinued.
7. Remittances should be made direct to this office, either by Registered Letter or Money Order, which will be at our risk. When made otherwise we cannot be responsible.
8. Always give the Name of the Post Office to which your paper is sent. Your name cannot be found on our books unless this is done.
9. The Date on your Label shows to what time your subscription is paid.
10. Subscribers failing to receive their paper promptly and regularly will confer a favor by reporting the fact at once.
11. We Invite Farmers to write us on any agricultural topic. We are always pleased to receive practical articles. For such as we consider valuable we will pay ten cents per inch printed matter. Criticisms of Articles, Suggestions How to Improve the ADVOCATE, Descriptions of New Grains, Roots or Vegetables not generally known, Particulars of Experiments Tried, or Improved Methods of Cultivation, are each and all welcome. Contributions sent us must not be furnished other papers until after they have appeared in our columns. Rejected matter will be returned on receipt of postage.
12. Replies to circulars and letters of enquiry sent from this office will not be paid for as provided above.
13. No anonymous communications or enquiries will receive attention.
14. Letters intended for publication should be written on one side of the paper only.
15. All communications in reference to any matter connected with this paper should be addressed as below, and not to any individual connected with the paper.

Address—
THE FARMER'S ADVOCATE, or
THE WILLIAM WELD CO.,
LONDON, ONTARIO, CANADA.

CONTENTS.

EDITORIAL:—
181—Illustration, 182—Horse and Sheep Breeding; A Famous Stud; What Induced Me to Begin Underdraining; Profits from Tile Draining, 183—The Judgment of Journalists; Word from One of Manitoba's Successful Farmers.

FARM:—
184—Gleanings from Farmers' Institutes; Another Round Silo—How Built; Winter Feeding Swine; Sweet Corn, 185—How to Get the Picture; The Canadian Horse Show of 1896.

187—Stock Breeders' Meetings, 188—Our Scottish Letter, 189—A Mutton Test; Kill the Ticks; The Boston Horse Show; Hamilton Horse Show.

THE HELPING HAND:—
189—Dog Power—Three-Horse Whiffletree; Dog Power; Feed Box for Colts in the Field or Yard; Another Corn Marker; To Prevent a Cow from Kicking.

ENTOMOLOGY:—
189—Injurious Insects—No. 1. 190—Clothes Moths.

GARDEN AND ORCHARD:—
190—Setting Out an Orchard.

DAIRY:—
190—Dairying; More About Lucern Growing, 191—Small Size Factory Cheese.

POULTRY:—
191—Poultry House.

QUESTIONS AND ANSWERS:—
191—Veterinary; Miscellaneous.

LIVE STOCK MARKETS:—
192—Toronto Markets, 193—Chatty Stock Letter from Chicago; Montreal Markets; Horse Market.

APIARY:—
193—Transferring the Colony.

FAMILY CIRCLE:—193.

THE QUIET HOUR:—194.

CHILDREN'S CORNER:—194.

UNCLE TOM'S DEPARTMENT:—195.

STOCK GOSSIP:—196—A Day at Maple Shade; Tuberculosis in the Milk; etc.; 199—The New Waterous Engine Works; The Light Horse Engraving; 200, 202.

NOTICES:—200.

BOOK TABLE:—200.

ADVERTISEMENTS:—196 to 204.

How to Get the Picture.

A copy of our new premium engraving, "Canada's Glory," should adorn the walls of every agricultural home. The opinions of a few of the best judges in America, commending it in the very highest terms, appeared in our last issue, and in the present we give a few selections expressing the judgment of the press upon it. "A great picture," in conception, design, and execution, is the universal verdict. We have a supply now ready for sending out in strong tubes. Any present reader of the ADVOCATE may obtain a copy simply by sending us (inclosing \$1) the name of one new subscriber. This can easily be done in every neighborhood. A few moments' effort will secure what will afford benefit and satisfaction for a lifetime. We have done our part; we ask our readers to do theirs.

The Canadian Horse Show of 1896.

The second annual Canadian Horse Show, formally inaugurated amid great *eclat* by the Governor-General, Lord Aberdeen, on April 15th, was brought to a termination on the night of Saturday, April 18th, after four days of liberal patronage and pleasing entertainment. Toronto swelled with out in full force. The extra day over last year's show gave the judges, in most cases, plenty of time to decide where the respective ribbons should be placed. It also provided ample

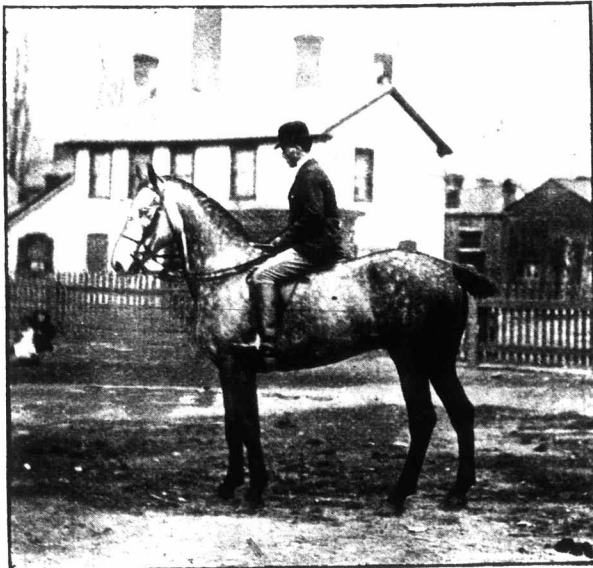

A GREAT SADDLE BEAST FROM MT. MORRIS, N. Y.

time for visitors to obtain comfortable seats in convenient locations without being crushed by inconsiderate crowds. Each day the afternoon and evening audiences were surprisingly large when the dollar admission and fifty cents for reserved seats are taken into consideration. The morning attendances were not large, owing to the fact that the exhibits at those sessions were least interesting to Toronto's citizens, being, in most cases, young stock and breeding animals shown on the halter. The rural attendance was not large, owing to the fact that the very busy season just opening prevented many from leaving the farm unless called by special business. This is to be regretted, however, as the exhibits were capable of teaching many lessons as to the sort of equines most in demand and for which fancy prices are paid.

THOROUGHBREDS.

Judges—E. W. Haggard, V. S., Kentucky; Capt. Massie, Kingston.

The section for stallions foaled previous to January 1st, 1893, contained five well-known horses. The noted world-beater, Mikado (portrayed in the FARMER'S ADVOCATE for April 1st), exhibited by Robert Davies, Toronto, attracted the attention of the judges and visitors from the first. His extraordinary quality, together with his useful size and gracefulness, placed him at the head, with S. B. Fuller's (Woodstock) Wyndham in 2nd place. He, too, has much to commend him as a first-class stock horse. A strong, handsome, and breezy horse, Tyrone, exhibited by T. H. Hassard, V. S., Millbrook, Ont., received the 3rd award, followed by Alex. Holmes' (Beachville) Pillarist, a very racy black. Robt. Davies' Parisian—a smallish horse, but a getter of speedy ones—was the highly commended contestant. Just two colts came out to be judged in the class for stallions foaled subsequent to or on Jan. 1st, 1893. They were Cinders by Cheviot, exhibited by John O'Neil, Toronto, and Disturbance 3rd by Morion, shown by John Dyment, Orkney. The former, a dark bay, and the latter, a chestnut, were very difficult to judge, being so nearly equal in general excellence. The red badge was ultimately placed upon the Toronto colt. Thoroughbred stallions qualified to improve the breed of saddle horses and hunters were out seven strong. The old gwinner, Wylie Buckles, owned by Quinn Bros., Brampton, was considered by the judges, as well as horsemen outside the ring, to be worthy of 1st place. He is a handsome, powerful horse with a grand set of cordy limbs. Graham Bros.' (Claremont) Chestnut Godard made a great showing and captured 2nd place. He, too, has size, beauty, and good action. Wm. Hendrie, Hamilton, showed Semper Rex, a horse of much character and snap. Such good horses as Monotony, St. James, and others were left out. The tug-of-war for sweepstakes brought Mikado and Wylie Buckles face to face, but the judge did not take long to place Robt. Davies' exhibit in the coveted position. The spectators thought no less of Wilev, however, as he made a worthy reserve number. A number of three-year-old grade fillies and geldings showed the get of Robt. Davies' Chicken to good advantage. A son of Dennison was placed second.

CARRIAGE OR COACH.

Judge—R. P. Sterrick, Springfield, Ill.
Perhaps the less said about this section the better, because out of two exhibits a horse worthy

of a prize could not be found. A very fine-looking German Coach horse, had he been sound, would have taken a creditable 1st prize, but the veterinary pronounced him a roarer and also possessing a curb, which disqualified him at both ends. He is handsome and a great actor. His opponent would have been more correctly placed in the roadster class, on account of his size. Carriage or Coach stallions three years old and under were represented by Prince George, shown by W. C. Brown, Meadowvale. He is a large, breezy animal, with a deal of action.

STANDARD BRED.

Judges—Jacob Erratt, Ottawa; C. E. Elliott, V. S., St. Catharines.

In stallions over three years old a nice half-dozen were forward. Some of the best movers here were rather ungainly, long-backed horses, but a combination of size, beauty, and speed was also present in Altoneer, shown by Edmund Taylor, Toronto, and Wiry Jim, exhibited by R. Robson, Brampton. Although the first named received the red badge, our choice was the Brampton exhibit, possessing more freedom of action, while his general make-up was quite up to the other horse. The 3rd prize horse was Harold Hamilton, a rather sweet bay shown by T. Boyes, Churchill, Ont. Colts three years old and under were just two strong, a two and a three-year-old. They were both good colts and were hard to judge, as the older, Uncle Bob, by Wildberries, shown by Hugh Smith, Claude, is a perfect beauty, with promise of speed, but his rather diminutive size scored against him as a stock horse. The other colt, Charity Bell, by Liberty Bell, owned by Harry Webb, Toronto, appeared a little raw, but he has a deal of substance and is nicely gaited. Should the two horses meet in good form in a couple of years, the reverse judgment may be expected. Two-year-old Standard-bred fillies had just three entries, all creditable mares. Pindus, by Wildbrino, exhibited by Thos. Hodgson, V. S., Toronto, was justly placed 1st. Harry Webb's pacing chestnut, Alecia Bell, by Liberty Bell, was placed next in order. Standard-bred mare any age had five entries of various ages. A superb mature mare, Bell Howard, owned by Edmund Taylor, Toronto, was ruled out because she was not registered. She would have been an easy winner had she been eligible. Harry Webb's Almira, by Bermuda, a three-year-old bay mare, received the 1st award, with her stable mate, Wiltonwood, by Wilton, the reserve number.

HACKNEYS.

Judge—R. P. Sterrick.
This is the breed most admired by the box occupants at the Canadian Horse Show. The beautiful conformation, the graceful action, the extraordinary intelligence and obedience of the various entries, excited enthusiastic bursts of applause upon several occasions. In the class for stallions foaled previous to January 1st, 1895, over 15 hands 2 inches, just one new comer was present among the five numbers shown, he being Royal Standard, a six-year-old horse bred in Ireland, and imported by Graham Bros., Claremont, last year. One turn



A WINNER IN THE SADDLE CLASS, OWNED BY S. B. FULLER, WOODSTOCK.

around the tanbark ring by each horse and the matter was settled for first place. The strange horse became a favorite by his fine appearance and wonderful action. He is strong, fine and rapid, while his knees and hocks flex enough for anyone. He appeared to be able to trot right over barrels without any danger of a touch. Had he gone a trifle closer behind we would not have seen a fault in him. He also won the sweepstakes award. The next to come was a well-known horse, and a good one: H. N. Crossley's Fireworks, no stranger to the show ring. He appeared this time in grand fix and going well. The Hamilton horse, Courier, exhibited by A. G. Ramsay, appeared well

among the others. He is a strong, compact horse, with good action. A son of Jubilee Chief, Lord Roseberry II., shown by Robt. Beith & Co., Bowmanville, might have been placed higher in the list without doing anything far astray. He is a graceful horse, well put up, and goes fairly well. A little more schooling would not be lost on him.

"Stallions foaled previous to January 1st, 1893, not exceeding 15 hands 2 inches," brought out a half-dozen entries. Here again a stranger met the approval of the judge—we refer to imported Moorland, a solidly built bay horse exhibited by Thos. Irving, Winchester, Ont. He is a very catchy horse while in motion, going very high and rapid. His closest competitor was the well and favorably known Banquo (Beith's), who might easily have been placed at the top had his manners been as good as formerly. His going is pleasing but spasmodic. A. G. Bowker, of Woodstock, had his black Shah in this contest. He has become a strong, smooth horse, but might have more snap than he exhibits. The Deer Park horses are too small.

Three-year-olds were three in number: Bartheleme Performer and Danish Prince, from Hillhurst Farm, and Rosseau Performer, from Crossley's stud. The first award went to Bartheleme Performer, a free-going, well-furnished colt. The chestnut-roan Rosseau colt put up the most flashy showing, but he works rather hard for the amount of ground he covers. He is a handsome colt, and a real Hackney. The third colt is a very strong, carriage-built fellow, pretty safe to cross with fine, snappy mares.

The same studs were represented in two-year-olds by the same number of entries as in the last section. Here Danish Duke and Gentility, from Hillhurst, scored 1st and 2nd. They are much alike in conformation and action. The son of Fireworks is a sweet colt with snappy action.

Hackney mares, three years old and under, had five entries from three studs. Robt. Beith & Co.'s Jessica is no stranger to the show ring; she has always been a winner, and is likely to remain at the top until something very extraordinary meets her. She is a credit to her sire, Jubilee Chief, and her dam, Mona's Queen. She has enough size and plenty of snap and dash for the most fastidious. Her white stockings flashed more like brilliant wheels than horse's legs as she strode round and round the ring. Her stable mate, Portia, by Ottawa, did not carry as much flesh as she might have to advantage, but her fine sweetness and fair action commended her to second place. H. N. Crossley's Victoria and Birdie, by Fireworks, are a sweet pair of yearling fillies, with nice action. They were placed 3rd and 4th.

The call for Hackney stallions with three of their get brought forward three beautiful quartettes. Jubilee Chief, with his winning offspring, had an easy victory. The head of the stud never appeared better, nor went more boldly and gracefully, than upon this occasion, while Banquo, Lord Roseberry II., and Jessica each did their part in pleasing a demonstrative audience. A. G. Ramsay's Courier, with Miss Courier, Vermont, and Trilby, were all nicely mannered and showy. They stood ahead of Fireworks and his followers, which were Victoria, Birdie, and Fireball. Whether they were correctly placed or not there is some room for doubt; perhaps the Rosseau fillies were too young to please the judge.

HARNESS HORSES.

High steppers, not under 15 hands sired by a Hackney stallion, were a cobby, bang-tailed lot of eight, all driven to carts with heavy harness. H. N. Crossley's noted mare, Althorpe Duchess, portrayed in our April 15th issue, was considered good enough to win. Her high quality and handsome action was closely resembled in some of the other competitors. A flashy, fine appearing chestnut with great action, shown by Mr. L. Meredith, London, Ont., was placed 2nd, and a wonderfully stylish brown gelding, shown by Mr. T. S. Weld, London, came next in order. John Holderness's Cherry Ripe was placed 4th, and Beith & Co.'s Mona's Queen 5th.

The class for mare or gelding over 14 hands 1 inch and not exceeding 15 hands, had 10 competitors present. They were judged by Orson Moulton, Batavia, N. Y.; R. P. Sterricker, and F. C. Underhill, Long Island, who judged all the following harness classes of the light-legged breeds. The class now in question exhibited a deal of the Hackney characteristics, being strong, low down, and cobby in action. The 1st and 2nd awards were secured by Shelah and Patriot, both owned by Mr. S. S. Howland, Mt. Morris, N. Y. We may mention just here that Mr. Howland's stables are under the able management of Dr. Greenside, formerly Professor of Veterinary Science at the Ontario Agricultural College. Shelah is a sweet little bay mare with a great amount of action, and has snap

from the ground up. The gelding, Patriot, is quite 15 hands, and is a real cob. A black mare, Jessie A., shown by W. A. Lawrence, Milton, the 3rd winner, is a very breedy beast, rather fine in the bone, high and rapid.

Mr. T. S. Weld's Conceit, a strong gelding, 15.1 hands, put up a very dashing show and captured the Highly Commended ribbon. He is a handsome horse, of the kind now in demand.

The mare or gelding class, between 15.1 and 15.3, contained a long string of bobtails. When such a mare as Althorpe Duchess came no higher than 4th place, it goes without saying that the class con-

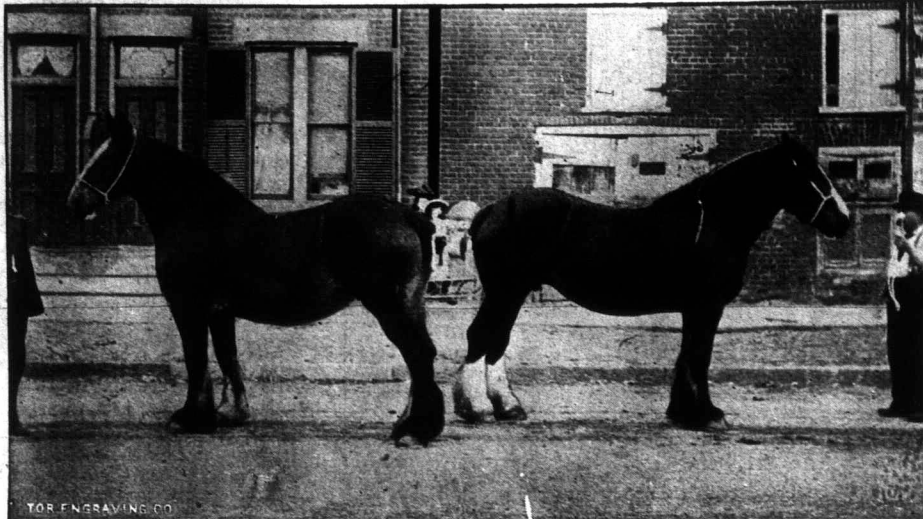

PRIZE-WINNING CLYDESDALE MARES FROM "THORNCLIFFE FARM."

tained some extra fine ones. Here again a couple of New Yorkers from S. S. Howland's stables secured 1st and 2nd. They are both brown geldings, of the strong, cobby type. The better, Puritan, is a bit more light and airy in his manner of going, but they are both A1 for their purpose. A very proud bay gelding, Quero, exhibited by A. R. Curzon, Guelph, was placed 3rd. He has a deal of snap and dash about him, but carried hardly enough middle to be a wearer.

There was a fine display of mares and geldings 15.3 and over, shown to dog carts, etc. The judges soon sent all but half a dozen out of the ring, all of which were of a most desirable type. Toronto Horse Exchange scored here with a big, handsome bay gelding over 16 hands. Howland again came in 2nd with a fast, high-acting chestnut 16 hands high. The 3rd went to Cid, a noble brown gelding shown by Robt. Beith & Co.

Pairs of horses over 14.1 and not exceeding 15.1 had just five competing teams. Beith & Co.'s Flirtilla and Fairy Queen were the favorites with the crowd, as they mated well, went well, and seemed to lack nothing. They were, however,



A STYLISH "UNICORN TEAM" FROM THE TORONTO HORSE EXCHANGE.

placed after a pair of six-year-old geldings shown by D. T. Lowes, Brampton, that were very nice and good actors, but not large enough. Mrs. J. H. Spink, Toronto, received 3rd on a span of good movers but poorly matched.

Pairs between 15.1 and 15.3 were strong in evidence, there being 10 entries present. Howland's Adonis and Patriot, already mentioned, could hardly be beaten in any show ring. They are just alike, highly educated and sensational steppers. Dallas and Dalson, shown by D. T. Lowes, Brampton, are high-class horses and well mated. T. S. Weld's Conceit and Confidence carried their heads and banged tails to perfection, while their action left nothing to be desired.

Pairs of horses 15.3 and over had 16 entries, and nearly all present. Geo. Gooderham, Toronto, won 1st on a bay pair of seven-year-olds, well matched, showy and useful. Howland's pair of six-year-old geldings, 16 hands, came 2nd, and D. T. Lowes 3rd on a black and bay of a good sort.

Limited space forbids our dealing with various classes of turnouts, tandems, four-in-hands, unicorn teams, etc. It will suffice to say that many of the horses already mentioned made up a number of them, and that the different events displayed a deal of horsemanship and wealth. The four-in-hands hitched to coaches and drags were lined with great skill.

ROADSTERS.

Judges—Jacob Erratt, Ottawa; Chas. Elliott, St. Catharines.

This class, for standard or non-standard, were shown with long, flowing tails, and, indeed, made a pretty contrast to the class after class having amputated coccygeal vertebrae. The mare or gelding section had 15 entries, more than half of which may be termed useful and handsome road horses. They were judged on conformation, style of going, manners, and hock and knee action. The numbers drawn by the judges were great beauties, breedy and active. The 1st prize was awarded to a six-year-old bay mare, 15.2, Bell Howard, exhibited by Edmund Taylor, Toronto. She was followed by a seven-year-old mare of C. A. Burns, Toronto, that would have matched her well. J. J. Burns, Toronto, won 3rd on a rangy chestnut gelding that any horseman would admire. A very pretty, nice-looking four-year-old black mare, 15.1, shown by H. Cargill & Son, Cargill, Ont., seemed worthy of a better place than 4th, had she a trifle more size.

Pairs of roadsters were few but nice, as just three entries were present. A pair belonging to C. A. Burns, Toronto, were given 1st position, which action had not the sympathy of the spectators outside the ring. While they had more substance than either of their opponents, they were longer backed and plainer. The two pairs of very handsome blacks shown by H. Cargill & Son were as much alike as peas in a pod, and they traveled fast and gracefully. Owing to the fact that they were not accustomed to band music and other excitement, they appeared a trifle high-strung, but they kept their feet well and pleased the audience beyond measure.

SADDLE HORSES.

The various classes of saddlers, hunters, etc., made up an interesting part of the show. In some of the classes as many as 30 entries were present. The Thoroughbred type was most in evidence, especially in the hunter classes. There were, however, a few prize winners of Hackney breeding. We would like to have seen far more of our farmer friends present to see the sort to breed for the hunter market. The prize winners were invariably strong weight-carriers, with good action and very breedy.

CLYDESDALES.

The Clydesdale men might well feel proud of the grand display made by the breed at the Armories. We think we are safe in writing that never has such a collection been seen together at a Canadian show: it only wanted Grandeur to round out the list. As it was, the two at head of the class were outstanding winners, but with Messrs. Sorby's horse, fit and well as we understand him to be, there would have been great excitement as to the placing. Mr. Ness judged alone, and his awards were well received.

In writing a report it can only be a superficial one, as it is impossible to describe each prominent winner, with any degree of accuracy from the view

from the stables have to our reing the severa the co merits

In t ary 1,1 ard, in lots of when upon c 2nd; h somest all the lackin to hav Erskir P. Cla very f feet, lo other and w locked Clyde. and is impro Craich showe In the fr Clark Vipom

The better exhibi ward. if he Graha from a make out-cl small.

In award by Jo typica the lig

The mares won 1 Lynced dwarf grand the ri cogno next The Q son su II. F hibite good

Sw was w of gele taste, deserv Wm. a we grand ings. won best s with Stand

Jud and J Con Clyde made ing, h a nd aged Hatf a po with lackin the g 2nd (o w r Cross nicer good have He sl qual nate the to th was years with 3rd v Ross with plain

Be hands Toron Pa Good

from without the ring, and as the horses were stabled all over town, it was impossible to find and have them moved. We are sorry we cannot give our readers who could not enjoy the treat of seeing them, a fuller description, as there were several there worthy of having the best talent on the continent paint a pen picture equal to their merits.

In the class for stallions foaled previous to January 1, 1893, Graham Bros. won with The Royal Standard, imported last year. He is a big horse with lots of quality. He catches the eye at first glance, and when one tries to find out his faults his merits grow upon one. Mr. Robt. Davies' Prince of Quality was 2nd; he is well named. This is one of the handsomest, truest made horses ever shown at Toronto; all that the veriest crank can say is, "He is a little lacking in substance." He was very fit, and seems to have thickened since last year. Third went to Erskine McGregor, four-year-old, exhibited by N. P. Clark, Minn., who had four entered. He was very fat, and has a short, thick neck, good legs and feet, looks like a wearer, but lacks quality. The other Minn. exhibit was overloaded with fat, and with his short, thick neck and pudgy frame, looked more like an improved Belgian than a Clyde. Fourth, J. Davidson's Lewie; looks well, and is generally a good horse. He has made great improvement since last year. T. Evans 5th with Craichmore Darnley, a son of that ilk, who also showed another good one, Uamvar.

In three-year-old class nothing especial was to the front. R. Beith 1st with Locksley, N. P. Clark 2nd with a very moderate one, and John Vipond 3rd.

The next class, two-year-old, contained much better metal; the winner, King's Owl, bred and exhibited by R. Davies, is a grand colt, very forward. There is in him the making of a great horse, if he is not thought too much of and overdone. Graham Bros. showed a good one by McGregor, from a Lord Erskine mare, that looks like wearing; from his conformation and breeding he ought to make his mark. Third, N. P. Clark; was completely out-classed. Fourth, Alex. Doherty; neat but, too small.

In Canadian-bred class five faced the judge, who awarded 1st to Ashburn Hero, a big horse owned by Job White; 2nd to Capt. Willie, a much more typical Clyde; 3rd, Alex. Holmes' Kingcraft, on the light side.

The next class, Canadian-bred or imported mares, dished up a hot lot for Mr. Ness. R. Davies won 1st with that grand mare, Nellie, by Lord Lynedoch; she is a big one, but her sweetness dwarfs her size. Second to Pride of Thorncliffe, a grand mare that had a great many friends around the ring, and she would not surprise some of the cognoscenti if she turned down her elder competitor next time they meet. Third to Graham Bros. on The Queen; she was rightly placed. Jas. I. Davidson succeeded in getting 4th with Boydston Lass II. Fifth, R. Davies with Candour. Empress, exhibited by Wm. Hendrie, Toronto, was quite a good pattern, as was R. Davies' Young Lilly.

Sweepstakes for best pair of mares or geldings was won by Geo. Moore with a rattling good pair of geldings, perhaps a trifle up-standing for present taste, but they well deserved the 1st. Wm. Hendrie 2nd on a well-matched, grand pair of geldings. Graham Bros. won gold medal for best stallion any age with The Royal Standard.

SHIRES.

Judges—R. Gibson and J. Y. Ormsby. Compared with the Clyde exhibit, Shires made a poor showing, both in quality and numbers. In aged class, Pride of Hatfield won. He is a powerful horse with good middle, lacking quality at the ground. Bravo 2nd was second (owned by H. N. Crossley), a much nicer horse, with two good ends, but might have better middle. He shows plenty of quality. Unfortunately, he bruised the sole of a foot traveling from Rosseau to the show—hence his position. G. Garbutt was third with old-timer Darnley, now 14 years old. Mares—Morris, Stone & Wellington, with a big mare, Lizzie, won premier position, also 3rd with Belle. H. N. Crossley was 2nd with Rosseau Pearl, and Wm. Hendrie, Hamilton, 4th with Midnight, a monster black mare, somewhat plain.

PRIZE LIST NOT MENTIONED IN REPORT.

Best and best-appointed gentleman's pair, not under 15 hands 2 inches—1, G. A. Case, Toronto; 2, John Macdonald, Toronto; 3, A. E. Gooderham, Toronto. Pairs of horses not under 15.2—1, John Macdonald; 2, A. E. Gooderham.

Tandems—1, Toronto Horse Exchange; 2, S. S. Howland; 3, Thos. A. Crow, Toronto. Best and best-appointed tandems—1, W. Beardmore; 2, Toronto Horse Exchange; 3, G. A. Stimson. Four-in-Hands—1, D. T. Lowes, Brampton; 2, Toronto Horse Exchange. Saddle Horses—Mare or gelding over 14.2 and not exceeding 15.2—1, S. B. Fuller, Woodstock; 2, S. S. Howland; 3, A. E. Osler, Toronto; 4, Hillhurst Farm, Hillhurst, Que. Mare or gelding over 15.2—1, John A. Gunn, Toronto; 2, S. S. Howland; 3, Frederick Wyld, Toronto; 4, Robt. Skinner, Toronto. Ladies' saddle horse not under 14.3—1, John A. Gunn; 2, A. S. Chisholm, Oakville, Ont.; 3, S. S. Howland. Best saddle and harness horse—1, Hillhurst Farm; 2, Fred Doane, Toronto. Hunters and Jumpers—Qualified hunters up to carrying

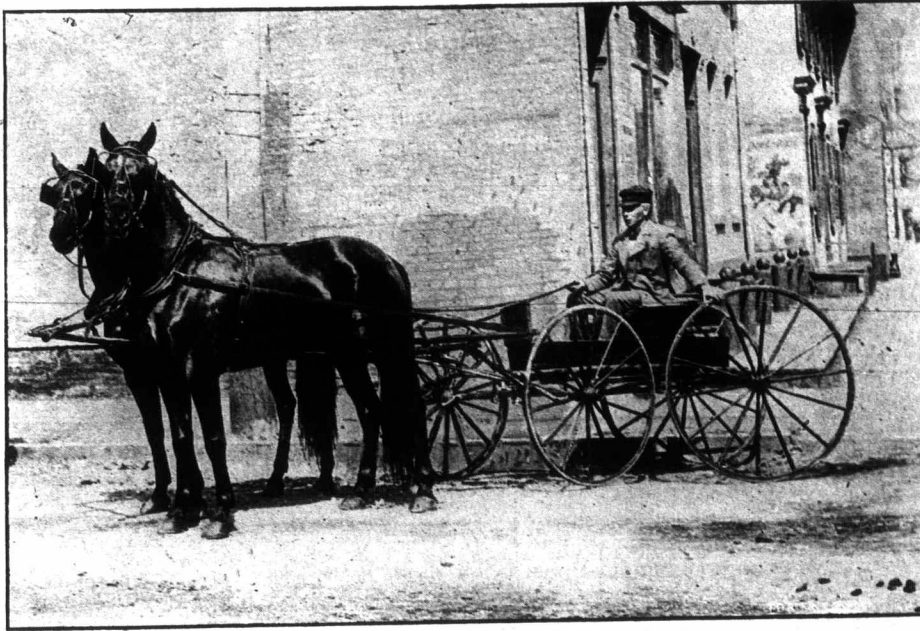

A PAIR OF H. CARGILL & SON'S PRIZE-WINNING ROADSTERS.

180 pounds—1, Geo. A. Carruthers, Toronto; 2, Geo. W. Beardmore; 3, J. F. Crean, Toronto. Green hunters up to carrying 180 pounds—1, Fred Doane; 2, S. S. Howland; 3, J. Phillips, Toronto. Green hunters up to carrying 150 pounds—1, Geo. W. Beardmore; 2, S. S. Howland; 3, Dr. Andrew Smith, Toronto. Best performance over six jumps—1, S. S. Howland; 2, J. F. Crean. High jump, limited to 6 feet, carrying 110 pounds—1 and 2, S. S. Howland; 3, Wm. Chambers, Currie's Crossing. Corinthian class; open to hunters ridden by members of hunt clubs—1, J. F. Crean; 2, S. S. Howland. Ponies—Under 13 hands—1, R. Davies; 2, V. Cawthra, Toronto. Pony over 13 and not over 14—1, Hillhurst Farm. Best pony turnout—1, Mrs. George Taylor, Toronto; 2, Mrs. O. M. Arnold, Toronto; 3, S. Nordheimer, Toronto. Unicorn or spike team—1 and 2, Toronto Horse Exchange. Best and best-appointed pair of horses to cab—1, P. Maher, Toronto; 2, Fred Doane, Toronto. Mare or gelding, single to delivery wagon—1, Harry Webb & Co.; 2, John Macdonald & Co. Pairs of mares or geldings to delivery wagons—1, A. & S. Nordheimer; 2, John Macdonald & Co. Best performance of professional private coachman—1, Walker Kuling; 2, Terrence Brady; 3, Walter Buddell; all of Toronto. Best amateur driving of pair—1, G. A. Case; 2, George A. Peters, Toronto.



A WINNING PAIR, EXHIBITED BY D. T. LOWES, BRAMPTON.

Best driving of tandem—1, G. A. Stimson, Toronto. Best riding by gentleman; open to members of recognized hunt or country clubs—1, G. A. Carruthers; 2, Geo. A. Peters. Best driving of pair by lady—1, Miss Edna Lee, Toronto; 2, Mrs. G. M. Davidson, Unionville, Ont. Best riding by lady, amateurs only—1, Miss Mabel Lee; 2, Mrs. Carruthers, Toronto. Best and best-trained police horses—1, Thos. Wiggin; 2, Sergt. Golding, Toronto.

Three first-prize winners at the Canadian Horse Show have graced in succession the portrait page of THE FARMER'S ADVOCATE, viz.: Robt. Davies' Thoroughbred Mikado, in April 1st; H. N. Crossley's beautiful Hackney mare, Althorpe Duchess, in April 15th; and Jubilee Chief, in the present issue.

Stock Breeders' Meetings.

THE DOMINION CATTLE BREEDERS.

The fifth annual meeting of the Dominion Cattle Breeders' Association was held at Shaftsbury Hall, Toronto, on Friday, April 17th, when many subjects of special interest to breeders and of great importance to the country were discussed. The meeting was fairly well attended, but there was an apparent lack of interest on the part of representatives of the several breeds other than Shorthorns, which were represented by many of the most prominent breeders of the country.

In the absence of the President, Hon. Thos. Ballantyne, of Stratford, the chair was ably occupied by Mr. John I. Hobson, of Mosboro, Ont. The annual address usually submitted by the President was therefore not on hand, and, by request, Dr. Mills, President of the O. A. C., gave an able and interesting address on the purposes and the work of the Association since its organization; also touching on the quarantine regulations existing between this country and the United States, and the embargo on Canadian live stock at British ports. Suitable acknowledgment was made by Dr. Mills of the \$1,500 grant to the Association from

the Provincial Government; and the idea of holding an annual exhibition of fat stock and dairy cattle was approved. He urged the Association not to rest till Canadian herd books were recognized by the United States, and the quarantine regulations changed. Reference was also made to a suggestion by H. J. Hill, Manager of the Industrial Exhibition, Toronto, in regard to the establishment of a live stock trade between Canada and the South American Republics. Mr. Hill's suggestion was that the Dominion or other government should invite these Republics to send competent representatives to spend two or three weeks in this country during the fall exhibitions to examine the stock of the country and report thereon to their governments; and it was suggested that \$1,500 or \$2,000 could not be better spent. What was now wanted was an outlet for the products of the cattle breeding industry. In the discussion which followed it was pointed out that the breeders of the Argentine Republic were England's best purchasers of pure-bred stock, both in numbers and prices, and that Canada might receive a fair share of their patronage if the proper means were employed to obtain it. It was also pointed out that the lack of direct steamship communication would prove a serious handicap to such a trade.

The annual report was then read by Mr. F. W. Hodson, Secretary, and in a few well-chosen remarks an earnest appeal was made to the cattle breeders of the country to unite with the Association for the promotion of their common interest. A hearty vote of thanks was next tendered to the press of Canada for their assistance in promoting the interest of breeders and the Association.

Transportation.—Mr. Robt. Miller, of Brougham, read an interesting paper (prepared by Mr. A. Johnston) on the subject of Transportation, dealing with freight rates levied by the railways, the necessity of better feeding and watering accommodation for stock in transit, and the appointment of better and more accommodating agents at stations, as several shippers have ample reason for complaint against many station agents.

The Hon. John Dryden then addressed the meeting, discussing a few of the most important matters brought forward in his usual clear and concise manner. The unfairness of charging three times as much for bulls from one to two years old as for those under that age was also brought up and discussed by members, resulting in a resolution being passed declaring that the Association was of the opinion that an estimate of 3,000 pounds was excessive for a bull between one and two years old.

Quarantine Regulations.—Mr. John I. Hobson read an interesting and instructive paper on the present quarantine regulations, dealing with the scheduling of cattle by Great Britain, the diseases existing among cattle in the several countries, and the freedom of Canadian stock from disease. He also touched upon the quarantine between Canada and the United States, and also between England and Canada, which should now be done away with, not only for our benefit in selling, but in securing new breeding stock from time to time.

This paper brought out an interesting discussion which finally led to the passage of the following resolution, introduced by Mr. Arthur Johnston: "That this Association wish to enter their protest against the publication to the world by the authorities of Great Britain that pleuro-pneumonia exists

among cattle in this country, which statement is made without proper investigation of the facts in this country, although our Government have frequently offered to bear the expense of a full investigation of the matter, while we know that the said disease does not exist and never has existed in this country."

It was considered an unfriendly act on the part of Great Britain to take her present course, and had Canada been disposed she could readily have found good reasons for scheduling British cattle.

Hon. Mr. Dryden protested against the action of the motherland towards her loyal colony. First they said our cattle had the pleuro-pneumonia, and now they claim our horses have the glanders. Some people did not understand why the Canadian breeders wanted access to the markets of the United States, but everyone present knew that they could not sell a pure-bred Shorthorn bull within ten miles of their homes, but that the American buyers would take all they had. If the quarantine was abolished it would be better for all concerned; that is, so long as there was no disease. But he would retain the power to impose the quarantine should disease at any time break out.

Mr. Russell, Richmond Hill, was also strongly in favor of the abolition of the quarantine. The Americans, he said, wanted all the pure-bred Shorthorn cattle they had, and more. Canadian breeders would be greatly benefited by an interchange of stock.

Mr. J. C. Snell, of Snelgrove, Ont., contributed a few well-chosen remarks on the question of quarantine and its many bearings, after which Mr. D. G. Hanmer, of Mt. Vernon, read an interesting and practical paper on the quarantine regulations and railroad rates as they affect the sheep and swine interests, showing the disadvantages and trouble to which shippers are often subject under the present system, with railroads and agents, and suggested that the quarantine between England and Canada be removed.

The speaker went on to show that under the present arrangement a lot of ten sheep, if shipped fifty miles, would cost \$18.40, while if it were allowed to pen those sheep in one end of a car and ship at a single first-class rate, the cost would be only \$5.72, and that the railway company would suffer no inconvenience.

With regard to the question of quarantine, Mr. Hanmer claimed that he saw no reason why it should be maintained, as it was useless to hope that Canadian cattle would be admitted without restriction into Great Britain, and he believed that an endeavor should be made to cultivate a more extensive trade with our neighbors across the line.

At this stage of the proceedings Lieutenant-Governor Kirkpatrick entered the room and was received with applause. He said that he felt a great interest in the Cattle Breeders' Association, for he believed their labors had had a considerable influence in adding to the prosperity of the Dominion. He complimented the Minister of Agriculture, Hon. Mr. Dryden, for the work he had done towards educating the farmers in the Province. In conclusion, His Honor wished for the Association even a greater scope of usefulness. On motion of Prof. Mills, a hearty vote of thanks was tendered to His Honor, who then withdrew.

Election of Officers.—Honorary President—Hon. Thos. Ballantyne, Stratford; President—John I. Hobson, Mosboro; Vice-President—J. C. Snell, Snelgrove; Secretary—F. W. Hodson, Guelph. Directors—Shorthorns, Arthur Johnston, Greenwood; Herefords, Alfred Stone, Guelph; Polled Angus, James Bowman, Guelph; Galloways, D. McCrae, Guelph; Ayrshires, Wm. Ballantyne, Stratford; Holsteins, G. W. Clemons, St. George; Jerseys and Guernseys, Capt. Rolph, Markham; Devons, J. W. Rudd, Eden Mills.

Ontario Agricultural College Representative—G. E. Day, B. S. A., Guelph.

These Vice-Presidents for the Provinces were elected—Quebec, H. D. Smith, Compton; Manitoba, John E. Smith, Brandon; N. W. T. and British Columbia, G. H. Greig, Winnipeg; Nova Scotia, Col. Blair, Government Experimental Farm; New Brunswick, Julius Inches, Fredericton; P. E. I., F. G. Bovier, Georgetown.

CLYDESDALE BREEDERS MEET.

A general meeting of the Canadian Clydesdale Association was held in Toronto, on April 17th, to consider the suggested amalgamation of the American and Canadian Clydesdale Stud Books. It was understood that a previous meeting was to have taken place between a committee from the Canadian Association and the Secretary and President of the American Association, who were to have attended the Canadian Horse Show, but they being in England, the meeting could not take place. A letter was read from Mr. Robert

Miller, Brougham, Vice-President of the American Association, stating the terms upon which they would amalgamate. After considerable discussion, it was decided to ask the committee to devise a more popular system of membership before the idea of amalgamation could be entertained.

**DOMINION HORSE BREEDERS' ASSOCIATION.
NO GLANDERS IN CANADA.**

At a meeting of the Dominion Horse Breeders' Association, held in the Armories, Toronto, April 18th inst., with President R. Davies in the chair (Secretary, H. Wade), it was resolved,—“That this



A WINNER IN COMBINED SADDLE AND HARNESS CLASS, FROM "HILLHURST FARM," P. Q.

Association of horse breeders for the Dominion desire to place on record the fact that glanders is not prevalent in Canada. They are satisfied, from their own knowledge, also from the assurance of Dr. Andrew Smith, Principal of the Ontario Veterinary College, that no Canadian horses have been exported suffering from that disease."

It was also resolved that the Hon. Dr. Montague, Dominion Minister of Agriculture, be requested to take such steps as may best protect our export trade in horses.

Our Scottish Letter.

Since last writing little has transpired on this side of the Atlantic to interest, in a special way, Canadian farmers. There have been no events in the agricultural world of a startling nature, and, with the exception of debates on the Cattle Diseases Bill, differences of opinion amongst farmers have been but rare. The opponents of the measure have practically abandoned their attitude of uncompromising hostility, and are endeavoring to go one better than the advocates of compulsory slaughter on this side: they are agitating for compulsory slaughter on the other side, and a foreign dead meat trade and nothing else.



A HIGH STEPPER, OWNED BY T. S. WELD, LONDON.

Butchers here are making rich, and the consumer is getting very little benefit from the abnormally low price of fat cattle. The butcher has the only occupation in this country which is not ruined with over-competition, and it is said that some of them acknowledge making a clear profit of £7 (that is about 35 dollars) per head on every bullock they kill and sell. Those who know something of the trade admit that a profit of at least £5, or 25 dollars, per head is being easily realized at present prices.

Another point in connection with cattle feeding and sale which is growing in favor is sale by weight and not per head. To an American or Canadian farmer it will doubtless appear absurd

that up to this time the British farmer is content to sell his bullock at haphazard, and without any definite idea as to its weight. The system of buying in this way is very popular with the butcher, and for obvious reasons. Weighing out every pound of the animal when dead, he comes to be an expert in its weight when alive, and never gives himself away when bargaining for a bullock. The farmer knows next to nothing about the weight of his animal, and is thus entirely at the mercy of his customer. Of late years, chiefly through the persistent advocacy of Mr. J. D. McJannet, a Fifeshire farmer and laird, the ignorance of the farmer on the subject, and the folly of this system of selling, has been brought prominently into view, with the result that at the Falkirk Mart, in the center of Scotland, most of the fat cattle recently sold have been disposed of at so much per cwt. live weight. There can be no doubt that this is the only rational method of procedure, and in Fifeshire especially there is a growing disposition to adopt it and no other. Some correspondence has taken place between the Windygates Club and the principal auctioneers in the midlands, and, with the exception of one or two, all express themselves as quite favorable to the proposed method of trading should their customers express a desire to have it so. My notion is that ere long no other system of buying and selling will be known than that advocated by Mr. McJannet and the Fife men.

The show season in the west of Scotland is now in full swing, and the famous Scottish dairy breed receives its full meed of attention. The season was inaugurated by a sale held at Burnhead, Darvel, in Ayrshire, when the herd owned by Major Steel was sold out without reserve: 21 cows made an average of £30 16s. 6d. each; 10 three-year-old grays made £36 9s. 9d. each; 7 two-year-old grays, £23 7s. 0d. each; 13 yearling grays, £14 13s. each; and 3 bulls, £61 19s. 0d. apiece. The average price of 54 head of all ages and both sexes was £23 12s. 3d. The sale is regarded as making a record in Ayrshire cattle breeding. The top price was £105 paid for a bull stirk by Mr. Hewetson, Auchencrainzie. The dam of this stirk, Wee Maggie, sold for £94 10s. The cattle were remarkably strong and healthy, with a good deal of style, but several of them had teats which were rather short. But for this the prices would likely have been even higher.

A perfect plethora of Clydesdale sales is in progress with us at present. The first was held on Wednesday, when a draft from the Lochburn stud, Glasgow, realized the respectable average of £43 for twelve animals. On the following day a draft from the famous Edengrove stud of Mr. William Graham was sold at Carlisle, when sixteen pedigree Clydesdales of the choicest breed made the fine average of £116 19s. 8d. apiece. The highest price was 450 gs., paid by Mr. Thomas Smith, Blacon Point, Chester, for the splendid mare Royal Rose 12494, got by Macgregor 1487, and unbeaten in the principal show yards. This is an extraordinary mare for quality, and her colt, just one year old, made £200 on the same day. Mr. Graham has been a great patron of the "Macgregor" tribe, and six females, including two yearling fillies, on the occasion in question, made the splendid average of £188 16s. 6d. each. It is doubtful whether any other sire of a draft breed could show a better record. Next week there is a sale at Professor McCall's, and in the end of the week the famous Keir stud, of world-wide renown, will be dispersed. The Professor's are grand, big, strong, sound horses, and the Keir lot includes the tribes of Samson 741, Prince of Wales 673, and Darnley 222, as well as Lochfergus Champion 449, in possibly greater numbers than any other stud at the present day.

Three very important shows have been held this week at Dublin, Castle Douglas, and Kilmarnock. Shorthorns were the strong point of the first, Galloways of the second, and Clydesdales and Ayrshires of the third. An Aberdeenshire bull, Sign of Riches, the property of the Earl of Caledon, was champion at Dublin. He beat a grand Aberdeen-Angus bull, Mick III., owned by Mr. A. J. Owen, Talbotstown. This gentleman owns one of the best herds in Ireland, and at the Royal last year his stock were well forward. The Shorthorn still holds the supremacy in the Emerald Isle, although the Aberdeen-Angus is making steady progress. The most successful exhibitor of Galloways at Castle Douglas was Mr. John Cunningham, Durhambill, Dalbeattie. He had four first prize winners, and the championship of the breed was conferred on his three-year-old heifer, Dora of Durhambill. Another successful exhibitor of the ancient blackskins was Mr. W. Parkin-Moore, of

White enthusiastic unbeaten milk, again. Ayrshire Mr. W. tige of Mr. Re. In the derry side wi male se 7155 a best fa Dougl 1487, a gomery Sir Ev

SIR, Yards, that w being t desira the cl seen by 15 lam were f

A s down \$4.25- averag other Thi know the S mann and c down S

SPR

Th and s lamb himse At the tende Whil of we is ver Whil reme the fl at cl and c The apply will p time after

T Apri socia From a show year ion v ians near almo awa How so p wall Bost here whic few

H hold was gust of t the eve age the pro and of a enc

Old sale foa

Whitehall, a Cumberland gentleman who is an enthusiast in stock breeding. He owns a splendid unbeaten two-year-old bull, Nonpareil of Castle-milk, and he bids fair to hold his own this season again. The supremacy of the Burnhouses herd of Ayrshires remained unchallenged at Kilmarnock, Mr. William Howie worthily sustaining the prestige of his father's herd. The champion bull was Mr. Reid's Royal Kyle, from Bonshaw, Stewarton. In the Clydesdale section the Marquis of Londonderry secured champion honors in the female side with the two-year-old filly, Kite, and in the male section, Mr. Kilpatrick's noted Prince of Kyle 7155 again triumphed. The first prize for the best family group of yearling Clydesdales at Castle Douglas was won by Mr. Montgomery's Macgregor 1487, and at Kilmarnock by the Messrs. Montgomery's young horse, Baron's Pride 9122, a son of Sir Everard 5353. "SCOTLAND YET."

A Mutton Test.

SIR,—The recent sale, at the Chicago Stock Yards, of lambs from the Iowa Experiment Station, that were fed for test purposes, the prime object being to ascertain what breed of sheep is the most desirable to feed for mutton purposes, fully justifies the claims of Southdown superiority, as may be seen by the following table; there being from 9 to 15 lambs of each breed, all of the same age, and all were fed the same:

Breed.	Average Weight.	Sold for.
Southdowns	123 pounds	\$4 75
Shropshires	133 "	4 62½
Oxfords	153 "	4 50
Lincolns	154 "	4 50
Cotswolds	158 "	4 50
Leicesters	165 "	4 25
Merinos	95 "	4 25
Suffolks	155 "	4 25
Dorsets	135 "	3 75

A study of these figures shows that the Southdown and Merino—123+95=218 pounds, at \$4.75+\$4.25=\$9.00—will average 109 pounds, at \$4.50, an average of less weight and greater price than any other combination that can be made.

This showing, taken in connection with the well-known hardiness, prolificacy, and fineness of wool of the Southdown, indicates in the clearest possible manner that the breed for muttonizing the Merino and common sheep of the country is the Southdown. JNO. SPRINGER, Secretary Southdown Breeders' Association, Springfield, Ill., April 20, 1896.

Kill the Ticks.

The farmer who goes to his sheep pen, day after day, and sees sheep ticks crawling about upon the young lambs, and does nothing to relieve them, stamps himself as a bringer of hard times to his own door. At this season the ticks leave the old sheep for a more tender and convenient feeding ground upon the lambs. While old sheep can withstand a moderate amount of worrying by vermin, the growth of young lambs is very much checked by even a few hungry, fat ticks. While dipping is altogether the most effective remedy, a more convenient method to adopt until the flock is shorn is to part the wool of the lambs at close intervals along the sides, breast, and belly, and dust in insect powder (pyrethrum) or hebeore. The former is more safe and more agreeable to apply. This will take only a few minutes, and will pay well for doing, even in the hurry of seeding time. Every flock should be carefully dipped soon after being shorn.

The Boston Horse Show.

The great Boston Horse Show, which lasted from April 6th till the 11th, was a success, financially and socially, beyond the most sanguine expectation. From an equine point of view, the show indicated a wonderfully improved condition since the first show was held in New York some twelve or more years ago. While the monstrous Mechanics' Pavilion was packed day after day with chiefly Bostonians, the contestants in the ring came from far and near. While Boston stables contributed horses in almost every section, New York horses carried away a deal of the premium money. Mr. S. S. Howland, Mt. Morris, N. Y., whose horses figured so prominently in the recent Canadian Horse Show, walked off with a number of the best awards at Boston. The entries in some of the sections numbered away up about 40, the larger proportion of which would have been considered prize winners a few years ago.

Hamilton Horse Show.

Hamilton is falling into rank in the matter of holding an annual horse show. Their first attempt was held on Saturday, April 11th—a rainy, raw and gusty day. Notwithstanding the unpropitiousness of the weather, the show was a decided success. In the afternoon the attendance was fair, and in the evening it was good. Great praise is due the management, as all arrangements were most complete, there being not a single hitch through the whole proceedings. The programme was well arranged, and the quality of the large number of entries was of a high order. The promoters will doubtless be encouraged to attempt a show on a more extended scale next year.

Clydesdale sales have been doing well in the Old Country. Our Scottish letter mentions the sale of one mare for 450 guineas and her yearling foal for £200.

THE HELPING HAND.

Dog Power -- Three-Horse Whiffletree.

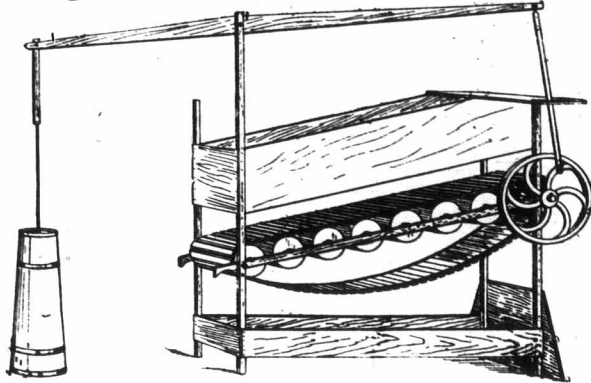

Dog Power.

THOS. MARTINDALE, Haldimand Co., Ont.:—"I inclose you a sketch and description of a dog power for churning, and also a three-horse whiffletree. Take four 2x2 oak posts, 4 feet long; put on with 2-inch screws the lower side-boards on the outside, and the upper ones on the inside of posts. Then make tread frame of 2x2 oak, bolting front end to frame 2½ feet from the bottom, leaving the hind end loose so that you can raise or lower with pins. Then get a wheel about 20 inches in diameter (I use an old cutting-box wheel). Drill a hole 7 inches from center, and put a bolt through to attach a lever. Make two front pulleys, 8 inches in diameter, with good flanges. Then run the shaft through the two front pulleys and the drive wheel, and fasten it to the front of the frame. For tread use two 2-inch straps fastened by small wrought nails to slats 12 inches long by 2x½ inches. The cut explains the rest.

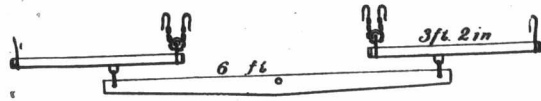

Three-Horse Whiffletree.

"Make a doubletree 6 feet long, and attach to either end of it a whiffletree 3 feet 2 inches long. Put common hooks on the long ends and a pulley on each of the short ends, putting a chain about a foot long, having a hook at either end, through them, to which the traces are to be attached. It will be noticed that the clevis is attached to single whiffletree, one foot from the inside end. This equalizes the draft among the three horses."

Dog Power.

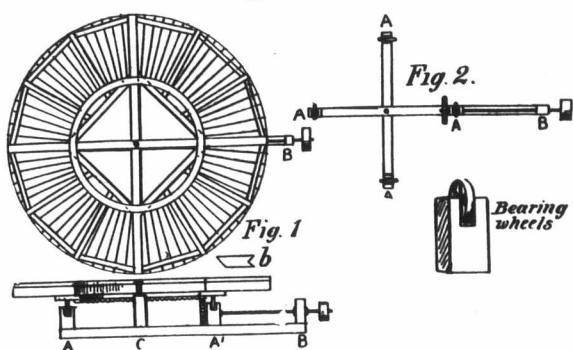

JOHN B. CRAIG, Lambton Co., Ont.:—"In your issue of March 16th a subscriber asks for a description of a dog power for churning, etc. One of my neighbors has one which enables a fair-sized dog to churn, as well as to pump water for the stock. To make one like it, make a wheel frame (Fig. 1), eight feet in diameter, of 2x4-in. scantling, with 1-in. hole in center. This frame is floored over, 2 ft. wide, all around outer edge with inch boards and light cleats nailed on about 6 or 8 inches apart. On the under side of the frame, about 2 ft. from center, nail a circle of boards 8 in. wide and on the inner edge of this place a flat, circular rack, which, with a small cog wheel to match, could be got at any good foundry. By using a number of notched blocks (b, Fig. 1) instead of cog rack, this power would work with a chain or rope belt, like a barn-floor horse power. Next make a cross (Fig. 2) of 3x4-in. stuff, with 8 in. uprights of 2x4 in. at A and B, and one of 4x4 in. at C. Those marked A have small wheels in top ends to support the large wheel, which is fastened to the center upright by a bolt, so that it revolves freely. The shaft of the cog wheel runs across uprights A and B, ending in a crank (or pulley) for driving churn or pump. The whole machine is held in an inclined position by legs of board nailed to the long center piece and a long one on one end of cross piece."

Feed Box for Colts in the Field or Yard.

J. D. MCGREGOR, of Brandon, Man.:—"The accompanying cut represents the sort of feed box used by many breeders of draft horses in England. It can be made six-sided or stand against a fence if only 3 colts are to be fed from it. There is very little danger of colts kicking one another when it is used."

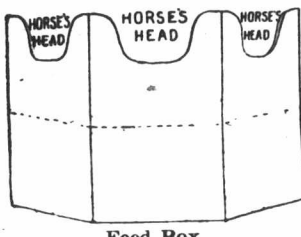

Feed Box.

Another Corn Marker.

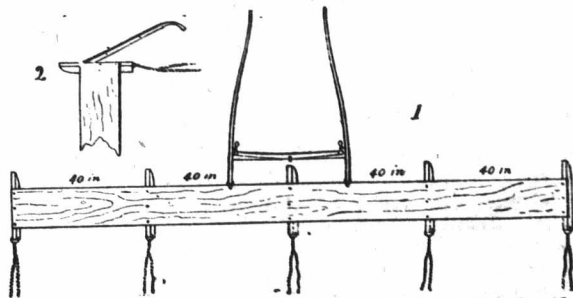

JOS. E. GOULD, Ontario Co.:—"I notice in the ADVOCATE, of April 15th, cuts of corn markers—all good; but as I like to have my rows perfectly straight, I prefer to have a boy to lead one horse and a man to handle the marker. Above is a machine used by me for three years, and was made in half an hour out of an inch board, 6 inches wide, 14 feet long, and one 2x4-inch scantling, 12 feet. Cut scantling 2 feet long and slope front ends; divide space (I prefer 40 inches between rows); nail runners to the board with 3-inch nails, down through the board into the runners. Take a pair of buggy shafts and fasten with wire. Fasten an old plow handle at each end, as in Fig. 2, to guide the marker. Hang a cow chain behind each runner so as to mark if any runner should not touch the ground. Boy leads the horse, man keeps the runner in the last mark made, and if a crook should occur he straightens it as he goes along. It is cheap, quickly made, and the marks can be made much straighter than a man can drive a team, and it will last for years."

To Prevent a Cow from Kicking.

MR. J. W. CLARK, Brant Co., Ont., recommends what many have long since found to be useful, that a half-inch rope drawn tightly around a kicking cow just in front of the udder and hips will prevent her from giving any further trouble with her feet so long as it remains on. It answers a good purpose, says Mr. Clark, in "breaking in vicious heifers." We believe, however, that if heifers are reared and handled as they ought to be there would be little "breaking in" required and fewer kicking cows.

ENTOMOLOGY.

Injurious Insects -- No. 1.

(BY JAS. FLETCHER, DOM. ENTOMOLOGIST, OTTAWA.)

SPRING WORK.

Year by year, as the season for spring work comes round, wise farmers and fruit-growers find it necessary, when making arrangements for the most profitable management and cultivation of their crops, to make suitable provision for the prevention of loss from the attacks of injurious insects and fungous diseases. No one can afford to neglect this matter. The study of the lives of injurious and beneficial insects has enabled those who have carried on these investigations to accumulate so much information concerning the habits of most of the kinds which are likely in an ordinary season to come before the notice of any farmer in Canada, that practical remedies are known by which injury can in all cases be lessened and in many instances avoided altogether. Among the most practical remedies we find many which are of a preventive nature, and where active measures, such as the use of poisons, are necessary, there are standard simple remedies for the different classes of insects which should be known by all who may require to use them. For all insects which have mandibles or jaws with which they bite their food, Paris green is a useful and effective material of wide application. For those insects, on the other hand, which have, instead of jaws, a tube-like mouth, by means of which they suck up their nourishment in a liquid form, some application is necessary which will kill by merely coming into contact with their bodies. There are several substances belonging to this class of remedies. The most convenient are decoctions of tobacco, soap or quassia; the standard remedy, however, for sucking insects is what is known as the kerosene emulsion—made of soap, coal oil, and soft water.

Paris green can be safely used upon all vegetation in the strength of one pound Paris green, one pound fresh lime, and 200 gallons of water. Moreover, this mixture is strong enough to destroy any insects which may eat foliage upon which it has been sprayed. It may be well to state that Paris green will not dissolve in water. The powder, too, is very heavy and will only remain in suspension for a short time; therefore any mixture containing it must be kept constantly stirred or the poison will stick to the bottom, when the upper part of the mixture will be too weak and that at the bottom will be so strong that it may injure foliage to which it is applied.

Spraying for insect enemies and fungous diseases is now universally recognized by progressive fruit-growers in Canada to be a necessary part of their annual operations. Remarkable success has attended the adoption of spraying as a regular

orchard practice by many growers, and great gain has resulted in both the quantity and the much improved quality of the crop reaped. It is certain that during the past season the number of fruit-growers who sprayed was far greater than it ever was before. This was largely due to the efforts made by the Dominion and Provincial Governments to disseminate accurate information as to the nature of the injuries to crops and the best means of preventing them.

This is the time of the year that the farmer should decide whether he can afford to do without a spraying outfit. If he has an orchard or garden which is liable to be attacked by insects, or if he wishes to grow potatoes free of potato rot, it certainly will more than pay him to procure a spraying pump with a proper nozzle. There are many kinds of these now made by Canadian firms, some of which advertise in the FARMER'S ADVOCATE and all of which will send price lists on application.

There is a new orchard pest which has lately appeared in Canada, and to which it would be well for Canadian fruit-growers to turn their immediate attention.

1. The New York plum-scale (*Lecanium cerasifer*). In many plum orchards in Western Ontario there have been observed, during the last two or three years, shining, dark brown, hemispherical, conspicuous scales about one-sixth of an inch long by one-eighth of an inch wide and one-twelfth of an inch high. These scales may now be found on the trees, clustered along the small branches, particularly along the lower sides. All of these specimens are empty and dead, but on the same branches may also be seen large numbers of minute, flat scales only about one-fiftieth of an inch in length, which are those to be feared by the fruit-grower, for on the return of warm weather they will revive and, inserting their tiny beaks through the bark, will suck out the life of the tree. They will grow rapidly until the middle of May, soon after which time eggs will be found under the scales. The young hatch about the end of June and crawl out on to the leaves, where they remain until autumn. About September most of them migrate back again to the twigs, where they pass the winter. In the State of New York this insect has proved very injurious, and although up to the present it is not known that it has done very serious damage in Canada, from its abundance there is no doubt that the loss is considerable and that the pest is becoming more numerous. From experiments carried out last summer at Queenston and Grimsby (Ont.), it is known that kerosene emulsion is an effective remedy. This is made according to the ordinary formula, which is as follows: Kerosene (coal oil), two gallons; rain water, one gallon; soap, one-half pound. Boil the soap in the water till all is dissolved, then, while boiling hot, turn it into the kerosene and churn it constantly and forcibly with a syringe or force pump for five minutes, when it will be of a smooth, creamy nature. If the emulsion be perfect it will adhere to the surface of glass without oiliness. As it cools it thickens into a jelly-like mass. This gives the stock emulsion, which for this pest must be diluted with four times its measure of warm water before using. The above quantity of three gallons of emulsion will make fifteen gallons of wash. Scale insects breathe through small openings along their sides. The effect of kerosene emulsion is to suffocate them by stopping up these breathing pores.

Trees which are found to be infested should be sprayed at once, before the buds burst, with the above mixture. Care must be taken in directing the spray. Remember that most of the scales are on the small branches, but there are also thousands of them in the crevices of the bark all over the tree. Thus, to hit all, the spray must be directed from beneath the tree and every part of it drenched. The best time to spray is now, with the stock emulsion diluted with four parts of water, as directed above; but if this cannot be done, for any reason, before the buds burst, there is another opportunity when good work can be done, viz., in the last days of June, when the young scales hatch.

Clothes Moths.

There are few who have not been annoyed by the injuries done by these little pests. If steps have not already been taken to protect winter clothes and sleigh robes against their depredations, no further time should be lost. The damage is done by small white caterpillars, which hatch from eggs laid by the tiny fawn-colored moths which are found flying in houses, particularly during May; not, as some suppose, by the large moths which fly around lamps at night when the windows are left open. The caterpillar can only originate from eggs laid by the moths, and only feed upon animal substances like wool, hair, feathers, etc. Paper is made of vegetable fibres, therefore clothes, etc., wrapped up securely in paper or put away in boxes made moth-proof by having old newspapers pasted securely over all cracks and openings, are safe from injury if they are put away before the moths appear. Should there be any doubt on this latter point the articles should be brushed or beaten well before being put away. Camphor, naphthaline, etc., are only partially effective, acting as deterrents to keep the moths from laying their eggs near where these substances are; they will not kill the insects if the eggs have been already laid. Any one can make a moth-proof box as advised above; any old box will answer, and newspapers and paste can always be obtained.

GARDEN AND ORCHARD.

Setting Out an Orchard.

I propose to explain, in connection with the accompanying diagram, an easy, simple and accurate way of marking out the ground and planting the

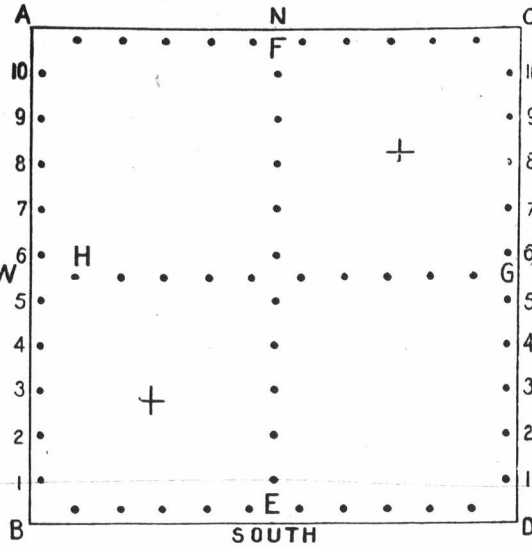

trees without putting any stakes where trees are to be planted or removing any while planting. The stakes not only show where to dig the holes, but when the planting is to be done, the same stakes indicate the precise place where the trees are to be planted, always sighting by the stakes only in setting, without any regard to the trees planted. Thus all the stakes will be standing when the last tree is planted, showing the accuracy of the work done.

The outside line of the diagram represents the ground to be planted; the dots are stakes, by means of which the location of each tree can readily be found without any measurements; but none of them stand where trees are to be planted.

The ground being properly prepared for one hundred trees, provide sixty laths as very suitable stakes—light, straight, and of proper length—lay them on the ground or a board and whitewash on each side about a foot or more at one end, by which they can readily be seen at a distance, and distinguished from any other stake or object. Let two men with a tape line start at the corner of the ground at D, and measure 25 feet along the east side to 1, and then set a stake; thence measure to 2, forty feet, setting a stake, and continue to 10, putting a stake every 40 feet to C, setting all stakes as perpendicular as possible.

Then with ten stakes start at B and measure the same distance toward A, sticking a stake first at 25 feet, and after that 40 feet to correspond with those on the east side. And on the same plan and in the same manner, stick ten stakes 40 feet apart along the north and south bounds of the orchard, and entirely outside of where any trees are to be planted, being particular that no trees shall be planted nearer than 25 feet to the fences surrounding the orchard, for the reason that when the trees become large, as much as 25 feet of space will be necessary to allow a spraying wagon and fixtures to pass in spraying the trees properly, and to place ladders about the trees for gathering the fruit.

The stakes being set around the orchard ground at proper distances, the tape line is no longer needed, as the cross intermediate rows of stakes are to be set by sight. Now let one man take ten of the white-top stakes and go about to E (at bottom of cut—E at right indicates point of compass), and another man go to the first stake north of D, and sight the man at E precisely where to stick a stake in line with the two stakes, on opposite sides of the ground; then move northward to 2, and stick a stake between 2 and 2; and thus continue from south to north and from east to west through, and not far from the middle of the field, being careful not to place either of these intermediate rows where a row of trees is to be planted. These rows need not be straight, but each stake must be in line with the corresponding stakes at the right and left.

With the stakes thus placed, a person moving anywhere about the ground to be planted, can readily find by looking in the direction of two stakes in two directions at right angles, precisely where a tree is to be planted. Thus a person standing at either + is at a point where a tree must stand, and at either of those points will see two stakes in a line with him in two directions at right angles; and so of every point where a tree is to be planted. If men are to be employed to dig the holes who are not capable of setting a stake in line with two other stakes already standing (there are such men), let some one who can do so go through the field, and with point of stake or other thing, mark where the holes are to be dug.

With this arrangement no stakes are placed where the trees are to be planted. Any number of men can go on with the work of digging the holes and planting in any part of the orchard without reference to any other trees in any other part. The writer has planted about 150 acres of apple and 100 acres of peach orchard on this plan, and has furnished many parties brief descriptions of same for planting; has planted rows 30 to 40 rods long of nice trees, so straight in line that a stake two inches in diameter set up in the row would hide every tree from view, looking from the end thereof.

—T. G. Y. in Country Gentleman.

DAIRY.

Dairying.

[From a Farmers' Institute paper prepared by S. P. Brown, O. A. C. Dairy School.]

In these years of keen competition—and that keenness ever steadily increasing—this seems to be one of those industries which offers the quickest and best returns to the farmers who participate therein. While it yields good returns, it does not impoverish the lands from which the products are marketed, but, on the contrary, enriches them, if properly managed.

Some one says: "We are held down by over-production now." No! We are held down by an excess of dairy and other products which cost more than the consumer is willing to pay, and a great percentage of which is a great detriment to the producer and the reputation of Canada, because of being quite inferior or far from prime articles. It is of this that our over-production consists. Even in the hard times of the past few years really prime articles of any class are quickly picked up at a handsome profit to the producer; hence, I say, we need to intensify our operations. How shall we do it?

I think I shall not exaggerate the facts when I claim that fully 20 per cent. of the cows in the country now are existing and producing what dairy products they do yield at a dead loss to their owners. This being a fact, the first step to take is to get rid of these cows at once. If they will pay for feeding send them to the shambles as quickly as possible; if they won't pay that way, take off the hide, feed the flesh to the pigs and chickens, and make fertilizers of the bones; but get that sort of a cow out of the dairy herd. Do so as soon as she ceases to make a profit for you in some way.

Keep no cows whose milk will not produce in a year 250 lbs. of butter, which means about 6,000 lbs. of 4 per cent. milk, or a corresponding increase in quantity as the quality decreases. Every herd that has one or more drones in it is being held back from making the record of profit for the owner that it should. While he may be showing a profit on the whole, still he may be losing money on part of the herd. One poor cow in a herd may make just the difference between profit and loss; the loss being not only in the feed and care bestowed upon this poor one, but also in robbing the good cows of so much good and valuable material from which they would make a profit to their owner.

Again, we must utilize every available means to increase the production of forage and grain crops per acre, which are most valuable, either as food for the production of the best milk or to exchange for that which promises to give even better results. In order to do this and reap the best results from those good cows we have retained, it is necessary that we should house our cows during the day in the hot, dry, fly season. I believe every one is willing to admit that pasturing is a very expensive way of feeding cows. There is no doubt that milking cows housed in well-ventilated stables, screened and darkened during this season, with but one feed a day of green fodder, will yield more profit on less acreage than if pastured. When they are put in to milk—which they should be—in the morning, there is no extra work connected with having them in, and when coming to dinner the time taken to put on a load of fodder is very little if a man calculates his work for it. By this method, the land which produces the early forage crops is always cleared early enough to get a crop of corn or millet or other fast-growing crop. This will almost or quite double the crop grown on the acreage under early forage crops.

More About Lucern Growing.

SIR,—Owing to numerous inquiries regarding lucern, I take the opportunity, through your valuable paper, of relating my experience with it. I was one of the first in this section to try lucern. About six years ago I sowed three acres as an experiment, with good results. Being beside a public road, I have been besieged with inquiries as to what it was and how to cultivate? It was green when all other pasture was dried up during the past very dry seasons. As a soiling crop I find it excellent, furnishing an abundance of very nutritious food. I have fed eight to ten cows, besides four work horses, from the time it was large enough to cut (about June 15th) till it was fit for hay, and then cut three tons of good hay from a little over two acres, the balance of three acres being fenced off for hogs. Just here let me say hogs should be changed quite often, as they will eat it so close as to weaken the vitality of the plant so much it may not recover. It makes the finest hay I ever fed for all stock, there being no waste whatever if properly cured.

How I seeded: I sowed the seed with oats at the rate of 15 lbs. per acre (barley preferred, and 20 lbs. per acre), lightly harrowed after sowing. Sow after danger of frost is over, as it is very tender when young. Sow on good, rich, mellow soil well drained, as water lying on it in the winter will kill it, as the crowns are above ground and not under the surface, as in red clover. Although it will succeed on poor, light soils, it will do on any soil well drained (the richer the better). Cut when about half the bloom is out; do not let it get too dry before raking; rake in small windrows, put in small hills, and let stand as long as weather will permit

very apt to heat in mow if put in too green. Here are a few things to do and not to do:—

Do put in plenty of seed; have ground in good condition; cut early, cure well, and you will have the best hay you ever fed.

Don't pasture first season, as tramping injures young plants; don't pasture too late in the fall; don't be alarmed if it causes looseness in bowels of animals, as no harm will come from it.

I find it a grand feed for the bull during service season, also for cows when breeding. I have had no difficulty in getting my cows in calf while feeding it, though some of the neighbors have had a great amount of trouble.
W. W. EVERITT.
"Dunedin Farm," Kent Co., Ont.

Small Size Factory Cheese.

In our report of the Ontario Agricultural and Experimental Union, held in Guelph, December last, mention was made of the successful experience of Mr. J. F. Beam, of Black Creek, Ont., in manufacturing and disposing of small cheese for patrons' use and local markets. It has frequently been urged in these columns that more attention should be paid to local cheese consumption and the making of fancy brands.

The practice of making small cheese was commenced by pressing the daily remnants of curds into small-sized hoops, for which the local demand was very good from the first. In fact, the demand could not be supplied for the cheese of ten inches in diameter weighing twelve to twenty pounds each. Mr. Beam claims that his 65 factory patrons nearly all made request for the small size cheese for their own home use and that of their neighbors. Some were made for special order, ten pounds and under. The more small cheese went out of the factory, the stronger became the demand for them from patrons, other farmers, and also from townspeople.

After a season or two of this increasing demand, Mr. Beam decided to try and supply it. A number of small hoops were therefore secured for the purpose. Such hoops can be made of galvanized iron by any good, careful tinsmith, and should be six or eight inches in diameter, and eight to twelve inches deep. But they must be very true to work well. In such hoops, cheese can be made of three, five, seven or ten pounds each, more or less, as desired. They are bandaged, and made in every way the same as the large cheese.

The best curds should always be taken for such small cheese. Gaseous curds or poorly made cheese will soon ruin the reputation of any cheese.

Some patrons prefer a moist, soft cheese, which can be obtained by salting lightly and using an extra quantity of rennet, and by hastening the curd into the press. Mr. Beam is of the opinion that many factories throughout the land may in this way increase their income by adding a small cheese department and making what has been called "truckle cheese." Farmers with good-sized herds can make up their own milk product by this plan, and dispose of it all in the local market, generally at a price considerably above the regular export rate. The home consumption could in this way be very largely increased.

POULTRY.

Poultry House.

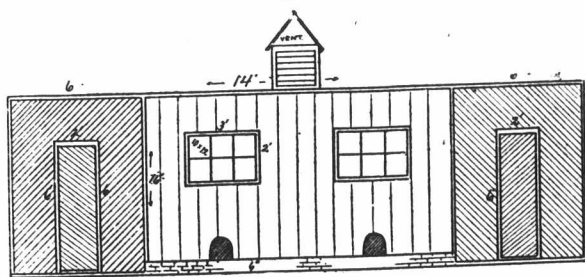

FIG. I.

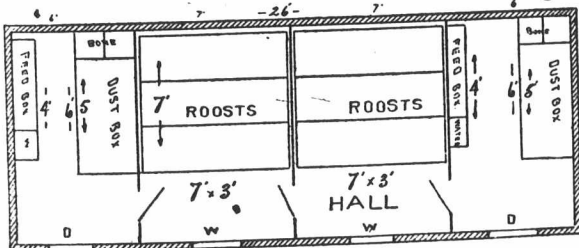

FIG. II.

At a farmers' institute meeting in Thorndale, Middlesex Co., a short time ago, Mr. J. E. Meyers, a poultry expert, was asked what sort of a hen-house was best, to which he replied: "Shelter is an important consideration in locating a house. For 100 hens, it should be 15 by 40 feet, having a 3-ft. entry. This allows six square feet for each hen, which is little enough to be profitable. This space should be divided into three compartments, as about 33 hens is all that should be in one flock. Build the house facing the south; five feet high on south side and six at north. One-third of the south side should be glass, doubled in winter, and shaded in summer. In building, put on an inside and outside coat of tar-paper and line the roof with heavy building paper to avoid sudden changes of inside temperature."

Figs. I. and II. (re-engraved from "Low Cost Poultry Houses," by Darrow), represent a house 38 x 10 feet, eight feet high in front and six feet in the rear. 1-1 represents a platform over which the roosts are placed. Over the platform, beneath which are the nests, nail-kegs, with one side out, will answer, or whatever else is thought better. The bone boxes are for gravel, bones, oyster shells, etc.

In building the house use either 2x4 or 3x4 scantling for posts, sills, and framework. Hemlock inch-lumber will answer for siding and roof-sheeting. The cracks should be battened with 1x3, and the roof should be covered with standard roofing paper, properly cleated and given two coats roofing paint. It will be necessary to line the house with common lumber, covered with tarred paper, fastened on with building laths. The platform should be about 2½ feet high and 7 feet long. In front of platform make a door 1 foot high and 7 feet long, through which to get the egg from nests. The top of platform should be on hinges, so as to be easily raised out of the way when it is necessary to clean behind it. No further explanation is necessary, as the figures are self-explanatory.

We would recommend that all poultry-houses face the south and have copious yards attached. It is well to plant one or two fruit trees in a poultry-yard, as they will furnish shade in summer, and the insects which visit the trees will be destroyed by the hens if they come within reach. The writer has seen plum trees in a poultry-yard so heavily laden that it was necessary to prop very many of the large limbs to save them from breaking.

QUESTIONS AND ANSWERS.

Veterinary.

LACERATED LEG AND CENURUS CEREBRALIS.

ENQUIRER, Wellington Co., Ont.:—"I. I have a young mare rising three years old. The hind leg was badly lacerated from the hock down to the hoof, about a year ago. The hair has grown over, but there are large scars left, and the leg is considerably swelled. Can the swelling be removed, also the scars?"

"2. What is the cause of grub in the head, in sheep? Can it be cured? If so, how? What measures could be taken to prevent it?"

[1. There is no method of removing scars, the result of wounds, but most of the swelling can, by constant application of dry flannel bandages every night. The bandage should be four yards long and four inches wide.

2. This disease is very common in some flocks—more especially in the winter months. It is known among flockmasters as sturdy, gid, turnside, grub in the head, hydatid in brain. We have heard a great many descriptions from shepherds, but all have reference to the many symptoms presented. This disease is dependent upon the presence of the hydatid form of parasites known as the *Cenurus cerebralis*. The ova are taken into the stomach, and being no larger than a blood globule or corpuscles, gain entrance to the circulation and find their way to the brain of the sheep, producing that form of disease which is characterized by such total helplessness and known by the name of sturdy. The symptoms are well-known as turnside—that is, turning round according to the side affected. If the hydatid or worm is situated on the left side of the brain, the animal will turn to the right; if on the right hemisphere of the brain, the animal will turn to the left. The earlier symptoms are a dull, moping appearance; the sheep separating from the flock, wandering, and blue appearance of the eye; partial or total blindness; ears slightly lopped. The sheep appears unsteady in its walk: will sometimes stop suddenly and fall down; at others, gallop across the field, or constantly move round in a circle. If the sheep sometimes makes a circle in one direction, and then in the other, we conclude that there is a hydatid in each hemisphere.

Treatment consists in removing the cause. Perhaps the best—it is certainly the simplest—mode of treatment consists in feeling for a soft place on the skull, puncturing with a trocar and canula, withdrawing the hydatid, after which a piece of cotton wool and bandage complete a cure.

Prevention.—It is surprising what a number of entozoa or worms infest the dog. It is also remarkable what a number of creatures are destined to play the part of intermediary bearer of the canine parasites in their juvenile stages of development. It would occupy too much space to describe the life-history of this parasite, but in order to make it partially known we will give the cycle of its life. The dog eats a sheep's brain containing a single hydatid; this becomes transformed into numerous tapeworms in the bowels of the dog, which are again dropped on the field, eaten by the sheep, becomes a grub in the head. The dog plays the part of intermediary host to the larval form. To clear the dog is the first line of treatment; remove the sheep to fresh pasture and salt the infected one.
DR. WM. MOLE, M. R. C. V. S., Toronto.

NOTE.—Our correspondent possibly refers to the sheep botfly (*Estrus Ovis*), which belongs to the same order as the horse botfly. It appears in May, June, and July, and becomes an intolerable nuisance to sheep. The fly deposits its eggs on the inner margin of the nostril, when they soon hatch and at once proceed to crawl up the nose until they reach the recesses of the frontal sinuses, where they remain until the following May without appearing to cause much mischief after they have

become lodged, but during the passage up and down the nostril they give great annoyance to the sheep. Occasionally the presence of a great number lodged in a sheep's forehead will set up inflammation and trouble which might be mistaken for grub in the head.

A preventive measure is to smear the sheep's nose occasionally with pine tar and also allow them access to loose earth into which they can rub their noses during the early summer months. A curative measure is to bore the frontal sinus and inject warm soft water containing a few drops of carbolic acid or turpentine. This will pass down and out of the nostril, carrying the grubs with it.—EDITOR.]

HEIFERS DRINKING IMMODERATELY LARGE QUANTITIES OF WATER.

Reply to "Farmer," P. E. I.:—As before expressed, we are doubtful if so young an animal suffers from disease of the kidneys. Do you know if she has been injured in any way—sudden fall, misstep, or from the feet sinking into holes on ice, etc? The symptom must be looked upon as indicative of some disease, the true nature of which we must try to find out. Obtain some of the animal's urine and have it tested by a qualified chemist, or if you will send us a sample, say about two ounces, securely packed and sealed in a bottle, to the office of this paper or direct to me, we will then test and report our opinion later.

DR. WM. MOLE, V. S.

ACTINOMYCOSIS.

WELLINGTON CO.:—"We have two cows with lumps on their jaws: the one on the upper jaw, under the eye, the other one on the lower jaw; can they be cured in any way?"

[The disease is generally described amongst farmers and drovers as big jaw or lump jaw; the scientific name is as above. We gave a lengthy description of this disease a few months ago. Treatment consists of first clearing out the bowels by a dose of purgative medicine and the daily administration of two-dram doses of iodide of potassium. In about six weeks you may expect to see partial recovery.
DR. WM. MOLE, V. S.]

WARTS ON TEAT.

J. B. C., Lambton Co.:—"I have a heifer, coming in this month, which has a lump of hard false growth in the side of one of her teats as big as a hazelnut; about the color and texture of the caslers on a horse's leg. What would be the best way to remove it? It is not sore, but would interfere with milking."

[These may be caused by any irritation, and when present in large numbers are unsightly and interfere with the process of milking. They are best removed by the knife; and afterwards the application of the actual cautery will stop the hemorrhage. Another method is to remove with a sharp pair of clipping scissors and touch the parts with a stick of lunar caustic. The daily application of castor oil will in time remove them.
DR. WM. MOLE, V. S.]

SURGICAL.

U. B. Thompson, Cumberland Co., Nova Scotia. [Had the replacement been very carefully made by a qualified veterinary surgeon, immediately after the accident, success might have followed the operation, but at this late date there would be no chance of growth taking place.]

Miscellaneous.

MILK AND BUTTER RECORDS.

CRAIG BROS., Portage la Prairie, Man.:—"We would esteem it a favor if you would publish in the ADVOCATE the best milk and butter records made by the following breeds: Jersey, Ayrshire, Short-horn, Holstein, and Hereford."

[Jersey.—From J. J. Hemmingway, Secretary of the American Jersey Cattle Club, we have received the following: "The Club does not keep records of milk as such, but only incidentally with butter records; so we cannot give highest milk record made. We keep no records of tests for shorter periods than seven days; tests for short periods, as one day, being considered valueless."

"Here are some of the highest official butter records for seven days: Princess 2nd 8046—Milk, 209 lbs. 8 ozs.; butter, 46 lbs. 12½ ozs.; owner, Mrs. S. M. Shoemaker, Baltimore, Md. Oxford Kate 13046—Milk, 248 lbs. 8 ozs.; butter, 39 lbs. 12 ozs.; owner, Andrew Banks, Baltimore, Md. Mary Ann of St. Lambert 9770—Milk, 245 lbs.; butter, 36 lbs. 12½ ozs.; owner, V. E. Fuller, Hamilton, Ont. Can. Little Goldie 38671—Milk, 251 lbs. 5 ozs.; butter, 34 lbs. 8½ ozs.; owners, Matthew & Humes, Huntsville, Ala.

"Highest yields for one year (private tests): Signal's Lily Flagg 31035—Milk, 11,330 lbs.; butter, 1,047 lbs. ¾ ozs.; owner, Samuel H. Moore, Huntsville, Ala. Bisson's Belle 31144—Milk, 8,412 lbs. 7 ozs.; butter, 1,028 lbs. 15½ ozs.; owner, Maury Jersey Farm, Columbia, Tenn."

Ayrshire.—From the American Ayrshire Breeders' report of their 21st annual meeting, we take the following records for 365 consecutive days' milking: Belle Temple, A. R. (3553), 9,624 lbs. of milk; Island Belle (1292), 9,982 lbs.; Ethel Douglas (2342), 10,006 lbs.; Manton Queen 4th (6100), 12,162 lbs. All the above were owned by Edward Brown, Providence, R. I. Alice Douglas (4308), owned by G. A. Fletcher, Milton, Mass., gave 12,671 pounds of milk; and Rena Myrtle (9530), owned by C. M. Winslow, Brandon, Vt., produced 12,172 pounds of milk in

UNCLE TOM'S DEPARTMENT.

MY DEAR NEPHEWS AND NIECES,—

"Taking the year together, my dear,
You'll always find the May."

says the old song, and very true words they are. Gone are "the uncertain pleasures of an April day," as Shakespeare terms them, but, after all, were not those self-same pleasures appreciated all the more for their very uncertainty, and now there is no more

"Waiting for the quiet rambles,
Where the fragrant hawthorn brambles,
With the woodbine alternating,
Scent the dewy way."

for dear old May, with her wealth of fair wild blossoms, is here. In the gardens the crocus and tulip have awakened from their long sleep, and each seems to vie with the other in making beautiful its surroundings. The plum trees are bowers of beauty, and the young, tender grass comes "creeping, creeping everywhere."

On every side we see countless things that make us give an emphatic affirmative to the question so often heard, "Is life worth living?" With so many blessings surrounding us, who can doubt it! Only those persons who misuse the gifts so beneficently given can think otherwise. Attracted this morning by the singing of a little bird, I stood for some moments watching him. He was perched upon a low branch of a lilac bush, singing his clear, sweet matin-song; then up higher he hopped and again poured forth the glad-some tune; up and up from spray to spray, singing as he went, till at last he reached the topmost twig, and then my tiny songster burst forth into a glorious morning anthem, his little throat swelling and his small body quivering, as if the very joy of existence so filled his heart that the tiny frame could scarcely contain it. Then down he flew from his lofty perch, his bright little eyes searching for tidbits of one kind and another till his breakfast was secured, and then up again he flew and once more the joyous song gladdened my ears. He was only a common, insignificant-looking graybird, but he faithfully and cheerfully performed the work which God sent him here to do, making the world seem brighter and better for his presence. I thought if so tiny a creature can add to the happiness of the world, how much more should we do, who are so much more gifted, to benefit our fellow-creatures? I think we cannot do better than follow the example of that little bird—keep going upward, singing as we go, and doing our duty, whatever it may be:

"Never looking beyond us,
Out of our little sphere;
If we could fill another,
God would not leave us here."

Dearie me, I wonder if that little bird was conscious of the long train of thought he aroused in your old uncle's mind!

Other songs are greeting my ear just now, for the curtains of night are closely drawn and the morning songsters are hushed, but the chatter of a rippling stream near by, and the many-toned chorus of the frog's band, make a melody not lacking in charms.

I believe one of my boys wants to know "if Uncle Tom is still interested in the Puzzle Department." Interested—I should say I am! Not only in the puzzle work, but also in the life-work of all who have been, are or will be members of his happy family. The hand that pens these lines may one day have to leave its pleasant task to someone younger, but whenever or wherever he hears of the success of any of his boys or girls, a thrill of pride and pleasure will fill the heart of
Your loving
UNCLE TOM.

Puzzles.

1—CONUNDRUM.

What applied to them?
When walking along our country road,
One hot and sultry day,
An old and well-respected friend
I met upon the way.
Among other things I asked my friend
If he had abundance of joys.
Said he, the same applies to them
As to the father of my boys.

T. W. BANKS.

2—ENIGMA.

My FIRST is a girl's name.
My SECOND is a plant.
My THIRD is a portion of what means "basket."
My FOURTH is the prevailing fashion.
My WHOLE is a young lady.

LILY DAY.

3—PUZZLE.

When 4 was walking 21 the 456
Others went 4132 the 523
32 5436 the beautiful 1236
Whose 3216 was so 1456 and free.
The 456 was so 1456 and smooth
That we thought 'twas 123 456 but glass,
And for 2156 41 our lives we didn't care
For any other laddie or lass.

So we just went 4132 our fun,
And we didn't TOTAL the time
But our pastime was such a cheerful 216
That we cared 123 a 5613 or a dime.

T. W. BANKS.

4—DOUBLE ACROSTIC.

An antithetical proverb; to ruin; to exalt; a metal; to flow gently; a messenger. The initials form the name of a fruit, which alone, of all vegetable productions, possesses the opposite qualities of extreme offensiveness to one sense and of the highest gratefulness to the other sense most closely allied to it. The initials form the name of a place where it grows.

CLARA ROBINSON.

5—AN ACROSTIC.

The first letter in each line is taken, and when transposed they give the answer.

Dear cousin, in this puzzle, greet
A youth who, story tells,
Each night across the Dardanelles,
Like Neptune, swam his love to greet;
Nor breasting wave his strength did tire;
Repaired and buoyed by love's hot fire;
Engulfed at last by storms was lo't.

CHARLIE S. EDWARDS.

6—NUMERICAL ENIGMA.

423 is a number.
4567 belongs to earth.
678 well-known animals.
9, 10, 11, 2 is a story.
6514 is a fog.
654978 is worn in winter.
WHOLE is given to emotion.

LOUISE MCLACHLAN.

7—GEOGRAPHICAL ENIGMA.

DEAR COUSIN (town on coast of Newfoundland).—
I (town in British Columbia) hope you will have a good time on your birthday. (City in Maine) says she will be up on (bay on coast of Newfoundland) Sunday, and will stay awhile, and I think young (town in Ohio) will be with her. I would like if you and (lake between Michigan and Ontario) could be here also. I am going to put a tent up at the river, at the (cape on the south-west of England). Father has just bought me a lovely (name of rocks near Lake Superior) of (group of islands off British Columbia), and has promised me one of Queen (city on Vancouver island). I will then have three pictures, for I now have a picture of (lake running through southern boundary of Quebec). My brother (city in New Brunswick) and (county in New Brunswick) are going to (strait between Prince Edward Island and New Brunswick county), and (river in north-east territory of Canada) is going to (forest city of Ontario).

Your sincere cousin,
(Town in British Columbia).
HARMOND BRADLEY.



TWO LITTLE GIRLS AND THEIR PONY AT THE TORONTO HORSE SHOW.

8—CHARADE.

Now that I am a puzzler too,
With pride I almost burst;
I offer this charade to you
To find where I am FIRST.

SECOND the letters count, I vow
When you have found the word;
I don't ask you to count them now,
For that would be absurd.

To sing a THIRD and clap the hands
For me is far from meet.
I join your happy little band
To swell its scant COMPLETE.

RICHARD JOHNSON.

Answers to April 1st Puzzles.

1—Carpet. 2—Bark, dark, hark, lark, mark, park.
3—"The best laid plans of mice and men gang aft a-glee."
5—Forgive.

6—(1) SPINE (2) THIGH
POLO HALLO
L L L L L
N O G O
E H

Care of Consumptives.

We read a great deal about the sickroom and the care of the sick; but there is one class of people about whose care little is heard. I refer to consumptives—those poor beings who move about among us like shadows, cheerful in their non-belief, and dumb in fits of melancholy.

Medicine is considered the proper thing for them, medicine, fresh air and good food; but let me say that while these are good, more especially the last two, there is something else which must go with them to obtain the best results.

Good nursing is as desirable in cases of this kind as in any other, but that fact is seldom realized. We see the sick one sitting for hours in the warm sunshine and wonder he does not move about more;

he used to be so active! We wonder, yet hardly expect it, for he has sat that way so long that we have grown used to it, as we have to his poor appetite, his complainings of pains and his restless nights.

The consumptive's room should be the sunniest and airiest room in the house; the furnishings should be plain, with as little of drapery and wool carpet as possible. If the patient uses a cuspidor in his room he should (being able) take care of it himself, thoroughly washing it in hot water every day. A little water should be kept in it with a few drops of carbolic acid. When out of doors, about the yard, or on the street, Japanese handkerchiefs should be used; then, when he returns to his room they can be burned—this is not only for the good of those about him, but his own as well, for it is acknowledged by the best authorities that many consumptives would recover if they did not retake the disease through their own carelessness.

Good food and plenty of it is of the most importance in treating this disease. Provide eggs, as many as one can take during the day. They must be perfectly fresh, and, if taken raw, directly from the shell, are best and most beneficial, because most easily digested. Beef in all ways, but especially rare, roasted or broiled and in soup, is in order. Mutton is the next best; pork should be avoided. Cream, if it can be taken, is preferable to codliver oil. Pastry should be shunned as of little use. The great point is not to eat a large quantity of everything or anything, but only such a quantity as the stomach can take care of, and it should be of the most easily digested and most nutritious food.

For fruit, grapes are the best, followed by figs (in certain cases), oranges (especially before breakfast), and dates. The value of grapes can hardly be over-estimated. Onions, in the vegetable line, if the stomach will allow, are excellent, also tomatoes and celery. If oatmeal is used it should be thoroughly cooked, and the plain Scotch oatmeal is the best. This kind made into a thick batter by adding water and a little salt, rolled as thin as a wafer, and baked thoroughly, is easily digested and very nutritious.

Don't think, when you have fed your invalid, and furnished him a room, you have done all there is to do. You must try to keep him cheerful, for one thing, and he can't be that if left to his own thoughts all day.

Aside from this, there is a further duty of the highest importance to the welfare of your patient. The temperature of his room should be kept not lower than fifty-five degrees during the night and as near seventy degrees as possible during the day. He should have a warm room to dress in. Before dressing he should bathe his chest in alcohol, rubbing thoroughly. Some one ought, also, to rub his back in the same way. During this time he sips a cup of hot water, slowly, which will relieve his cough and prepare his stomach for breakfast. A few drops of listerine in this water is beneficial.

About two o'clock he should be thoroughly rubbed again, in alcohol, for this not only strengthens but rests him, and allows him to breathe freer and deeper. It also keeps the lameness of the chest, and is a preventive against taking cold.

At night, on going to bed, he should take a sponge bath. Dissolve a small handful of sea-salt in a pint of hot water, add a little alcohol, use this as quickly and thoroughly as possible, then rub with a coarse towel until in a glow. Then he should be rubbed over chest and back with an emulsion composed of three parts sweet oil to one of ammonia. Shake it well before using. After this treatment, let him have a glass of pure, cool water, and he will get the maximum of sleep, which is a glorious thing in his case.

Half a dozen times during the day, while sitting or standing, indoors or out, he should take twenty as long, deep breaths as possible, filling his lungs with new air.

WALTER M. HAZELTINE.

Treatment for Catarrh.

In the first place you need an atomizer if you are in earnest in your decision to treat your catarrh at home. Ask your druggist for the best, or, better yet, have your physician recommend one. Then get two ounces of listerine and two ounces of Do-bell's solution, and put in a bottle together. When you wish to use it take two teaspoonfuls of the bottle mixture and put in the atomizer with two tablespoonfuls of warm water, and use it thoroughly in each nostril four or five times. If the throat is inflamed spray that also, using the tip which comes purposely for the throat. The relief will be great. This should be used night and morning. I wonder if all know what a valuable remedy listerine is? It is excellent for the teeth, and also to use as a gargle for sore throat, or in catarrhal affections. For a gargle take one teaspoonful of listerine to six teaspoonfuls of warm water. If you cannot afford an atomizer pour the mixture into the palm of your hand and snuff it so that it will pass through the nostrils into the throat. Don't swallow it.—Marion.

A Day at Maple Shade.

April sunshine had just swept away the snows from the broad, rolling fields of "Maple Shade," bringing into view the new "clover catch," and the refreshing greenness of as fine an area of winter wheat as the writer has seen anywhere this season.



A TYPICAL TRIO OF SHROPSHIRE LAMBS, AT "MAPLE SHADE," THE HOME OF HON. JOHN DRYDEN.

early last fall, and reproduced herewith, will give perhaps a better idea of their style than words. Some 35 breeding ewes are kept, and this spring's crop of lambs were strong, growthy, and very uniform, being from a ram of Maple Shade breeding.

But we must hasten from the sheep pens. The average visitor will probably find in the herd of some three score and ten Shorthorns his chief object of study and admiration.

BARGAINS FOR NEXT 30 DAYS!

Ayrshire bulls and heifer calves, Holstein bulls and heifers at \$12 each, crated and put on board cars, and registered in purchaser's name if taken before two weeks old.

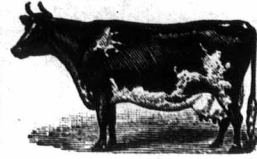

Visitors welcome. ALEXANDER WOOLLEY, Box 148, Springfield, Ont. Correspondence solicited. Putnam Sta., C.P.R.; Aylmer Sta., G.T.R.; Springfield, M.C.R.

THE WONDERFUL Ideal Spray Pump



DASH AGITATOR. FOR TOP OR SIDE OF BARREL. Thousands in Use. Always guaranteed. Trial given.



Manufacturers of Steel Wind Mills, Iron Pumps, Tanks, Grain Grinders, Beekeepers Supplies, and Maple Leaf Grinder. Mention this paper. 1-d-o

BUCHANAN'S (Malleable Improved) PITCHING MACHINE

For unloading hay and all kinds of loose grain.



Unloads on either side of barn floor without changing car. No climbing necessary. Malleable Iron Cars. Steel Forks. Knot Passing Pulleys. Will work on stacks as well as in barns. Satisfaction guaranteed.

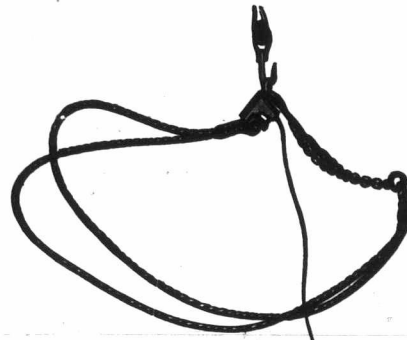

The Common-Sense Sheaf-Lifter

Works in connection with Pitching Machine, and is the most complete apparatus ever offered to the public for pitching sheaves. Sheaves left in the mow just as they come from the load.

RESPONSIBLE AGENTS WANTED

Circulars, Prices and Terms on application to J. W. CAMERON, Ingersoll, Ont. (Successor to M. T. BUCHANAN.)



Patented in Canada and U. S., Sept. 21, 1893; July 17, 1894, and Dec. 3, 1895.

"Spramotor Is First!"

THE REST NOWHERE.

At the test of spraying apparatus held at Grimsby on the 2nd of April, under the Judges Appointed by the Fruit Growers of Canada, and with 14 Competitors, Nine from Canada and Five from the United States, the "Spramotor" was awarded First Place, and the nearest competitor to it was more than Double the price.

357 Richmond Street, London, Ontario.

Peeling

of veneer machines are a very profitable investment. Requires small capital, quick turnover. The rapid increase of cheese factories makes a great demand for boxes at a paying price.

WATEROUS, BRANTFORD, CANADA.

dation for a herd. All the young bulls were gone save two or three, and if the others were any better than these, their new owners are to be congratulated.

If we mistake not, the first Shorthorn bull on the farm was brought there at the haller by Mr. Dryden when but a youth. He had "hankered" for a "Durham," and finally his father consented, and before the winter was over the young animal grew right away from his stall mate, showing plainly that there was "something in it."

In '65 a single female was purchased from Hon. Mr. Simpson, of Bowmanville; soon followed a cow with a heifer calf at foot. About 1870, attention was specially called to the Sittytan Shorthorns, a visit there resulting in the purchase of Stanley (52594); Mimulus, a three-year-old cow by Champion of England; and a yearling heifer, Queen of Beauty. In 1887 a bold stroke was made in securing for Maple Shade the entire herd—some forty head—of Mr. E. Cruickshank, nephew of the late Amos Cruickshank, and whose father, Anthony, was a partner as well as brother of the latter. The herd from Letheny was a valuable addition to the breeding stock of Canada, putting Maple Shade at once in the forefront.

STOCK GOSSIP.

In writing to advertisers, please mention the Farmer's Advocate.

It is said that a new breed of swine called "belled swine" has been propagated in Massachusetts. Several years ago Chester Whites, Berkshires and Duroc-Jerseys were crossed in the following proportion: one-half Chester, three-eighths Berkshire, and one-eighth Duroc-Jersey.

Mr. Edgar Silcox, Shelden, writes:—"My herd of Jerseys have wintered splendidly, and I have plenty of feed to the good. I have purchased from Mr. McIntyre, Lawrence, a granddaughter and great-granddaughter of Massena (Mrs. E. M. Jones' great Jersey cow), and two daughters of Rustler of St. Lambert stock from George Smith & Son, Grimsby, and three daughters of Ida's Romeo (bred by Mrs. E. M. Jones), also two daughters of St. Lambert of Coronora (bred by Capt. Ralph, Markham). I sold to George Smith & Son, Grimsby, a cow, Rose of Oak Grove; she is hard to beat in the show ring. I received a long price for her."

A GOOD WORD FOR THE DORSET-HORNS.

SIR.—My experience in sheep breeding in this country has been remarkably satisfactory. I have at the present time four hundred sheep at home; two hundred of these I am breeding, the rest feeding for mutton. Have also a number out on shares, some of which are very well; with others, it did not pay, as they were not properly cared for. I have in my flock pure-bred Dorset-Horns, Shropshires, Cotswolds, and Lincolns; also crosses of the above breeds, as well as Southdown crosses, and find the closer the wool, the better the sheep will do in this country.

Tuberculosis in the Milk.

The Iowa State Veterinary Department has conducted an exhaustive series of experiments to determine whether tuberculosis in cattle is hereditary. They conclude it is not. Calves from cows affected with tuberculosis when fed milk from healthy cows become healthy, and calves from healthy cows fed on milk from diseased ones contract the disease.

PLANT NOW!

May is a grand planting month, and we have a vast amount of Nursery stock, in a dormant condition, that can be safely planted throughout the month. Our Fruit Trees, Ornamental Trees, Norway Spruce and other Evergreens, all sizes; Shrubs, Climbers, Roses, hardy on own roots; Vines, etc., cannot be excelled. Our prices this spring are about one-half former years. Price lists free. Orders by letter have most careful attention.

Geo. Leslie & Son, NURSERYMEN, TORONTO.

Choice Shorthorn

COWS, HEIFERS, and HEIFER CALVES of good milking strain, for sale at very moderate prices. Also BERKSHIRE PIGS, of October and January litters; both sex.

Wm. Rivers, 13-1-y-om Springhill Farm, WALKERTON, ONT.

ADVERTISE IN THE ADVOCATE

IT PAYS TO ADVERTISE

IN THE

FARMER'S ADVOCATE

—AND—

HOME MAGAZINE.

HORACE N. CROSSLEY,
 PROPRIETOR OF THE
SANDY BAY STOCK FARM,
 Importer and breeder of
SHIRES, HACKNEYS, AND COLLIE DOGS.

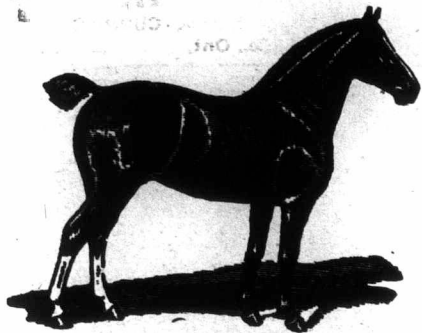

The above stud, though only commenced in 1890, has achieved unparalleled success at all the leading Canadian shows, such as Montreal, Toronto and London, also at the same year at the most notable in this stud are the Shire horse Bravo II, 1893, winner of first at Toronto, Montreal and London, and also beating all Clydes at the latter show in the sweepstakes. Hackney, Fireworks No. 3602, winner at Chicago, Toronto and London. Shires and Hackneys always on hand for sale. For further particulars apply to the Proprietor, ROSSEAU, Muskoka. 10-y-om

A. B. HOLBERT

IMPORTER AND BREEDER OF

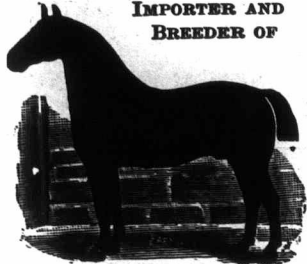

Shires, Clydes, Percheron, Royal Belgian, German Coach, French Coach, Hackney, Cleveland Bay, Yorkshire Coach, and Thoroughbred Stallions and Mares, and Shetland Ponies for sale.

He has the largest assortment of imported horses of any firm in America. Canadian distributing point, Woodstock, Ontario. Write

A. B. HOLBERT,
 GREELEY (Iowa),
 3-m-o or WOODSTOCK (Ont.).

THE GLEN STOCK FARM

Our stock comprises Clydesdales, Ayrshires, and Shropshires. High class Ayrshires a specialty. We are making a special offering of ten very promising young bulls, and a number of very choice cows and heifers of the heaviest and richest milking strains, any of which will be sold at very moderate prices. We also have Rough-coated Scotch Collies for sale, eligible for registry.

7-y-om **WHITESIDE BROS.,** INNERKIP, ONT.

FOR SALE!

4 YOUNG SHORTHORN BULLS

(fit for service; one roan and three reds) descended from Cruickshank cows. One Clydesdale stallion, four years old. Some brood mares and fillies.

James I. Davidson & Sons

3-a-o **BALSAM, ONT.**

THE SPRINGBURN HERD OF

SHORTHORNS for SALE

Five good yearling bulls, a few good cows and heifers, bull and heifer calves, all of the choicest breeding and descended from the best Scotch families; can supply a carload. Rock-bottom prices. Correspondence solicited.

R. R. Sangster,
 4-f-om Lancaster, Ontario.

WILLOW BANK STOCK FARM,
 Founded in 1855

by the late Wm. Douglas, has for sale a number of grand young Shorthorns, of both sexes; also the old stock bull, Baron Evenlode = 16705-. Prices to suit the times. Write for particulars. Address—**JAMES DOUGLAS,** Caledonia, Ont. 24-d-om

THOS. PUGH & SONS,

Breeders of Shorthorn Cattle and Shropshire Sheep of No. 1 quality. Young stock for sale at moderate prices. Write us or come and see our stock. **WHITEVALE P.O.** Locust Hill Station, C.P.R. Pickering, G.T.R. 151 L-o

MAPLE LODGE STOCK FARM.

We have for sale now, one very handsome young bull and a few choice heifers, all of the best breeding. **JAS. S. SMITH,** Maple Lodge P. O., Ontario. 9-1-y-om



The . . .
White Engine

HAS PROVED ITSELF, BY ITS RECORD, BEYOND DOUBT THE MOST DURABLE, AS WELL AS THE MOST SUITABLE FOR THRESHING AND FARM PURPOSES. SEE OUR MANY CONVENIENT ATTACHMENTS. BEST DOUBLE RING PISTON MADE, AND SPECIAL ADJUSTABLE BRASS GOVERNOR VALVE.

The **Detroit Ball-Bearing Disk Harrow.**



Write for Circulars and Prices.



Double Levers.
 Easy to Operate.
 The Genuine Ball-Bearing.
 Right Adjustment.
 Of the Best Material.
 Is light in Draft.
 Try It.

AMERICAN HARROW COMPANY,
 DETROIT, MICHIGAN. 6-d-o WINDSOR, ONTARIO.

CLYDESDALES AND HACKNEYS

A FEW FIRST-CLASS CLYDESDALE Stallions, Mares & Fillies for sale. Prices to suit the times. Come and see them, or write for prices.

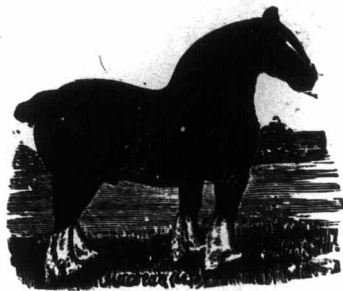

GRAHAM BROS.,

Claremont, Ontario.

25 miles east of Toronto, on C. P. R. 4-tf-om

ISALEIGH GRANGE STOCK FARM,
 DANVILLE, QUEBEC.

A CHOICE assortment of the following pure-bred stock always on hand: Ayrshire and Guernsey Cattle of the choicest breeding and most fashionable type and color. High-class Improved Large Yorkshires of all ages, "Sanders Spencer stock." Shropshires of the finest quality. Our breeding stock has been selected, at great cost, from the choicest herds and flocks of both England and Canada, and have been very successful winners in all leading show rings. Young stock supplied, either individually or in car lots, at the lowest prices. Prompt attention given to all correspondence. 9-y-om

J. N. GREENSHIELDS, Proprietor.
T. D. McCALLUM, Manager, Danville, Que.

A Great Bargain

IN THE REALLY HIGH CLASS **Holstein-Friesians!**

I now offer for sale every animal in my herd, than which there are none better in America, at prices to suit the hard times. The herd consists of mature cows with large milk and butter records, and their descendants; heifers in calf, others ready to breed, and heifer calves; bulls fit for service. Also several very choice bull calves; if taken at once will go at \$12. Write for particulars and breeding to **H. BOLLERT,** Maple Grove Stock Farm, Canad. Ont.

For Sale Cheap, That grand Ayrshire "HEATHER JOCK" — 1212 —

Stock Bull, Bred by D. Morton & Son, Hamilton; sire Royal Chief (Imp.) — 75 — (1847), dam Primrose (Imp.) — 1205 — (5507). This bull has proven a sure stock getter and can be purchased at a bargain if taken at once. Having a number of his progeny at breeding age, we cannot use him. Speak quick if you want a bargain. We have also some choice young Yorkshire Sows of breeding age from the stock of **J. E. Brethour.** Correspondence a pleasure. 1-1-y-o **A. & H. FOREMAN,** Collingwood, Ont.

Alex. Hume & Co., Importers and Breeders.

We still have several good **AYRSHIRE BULLS**, of DAIRY TYPE and breeding, fit for service; and bull calves. Also a number of heifer calves from cows of several crosses and extra heavy milkers. Write for prices and particulars. 5-1-y-o

N.B.—A few Yorkshire pigs of good quality, of different ages. Telephone and Station—Hoard's, G.T.R. Burnbrae P.O.

Arthur Johnston

NOW OFFERS

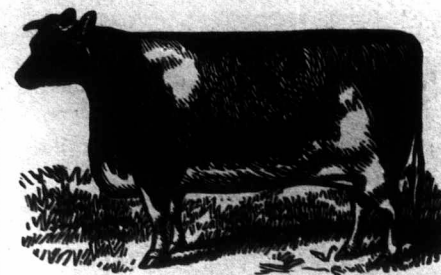

SHORTHORN BULLS
 SHORT-LEGGED, DEEP-BODIED, THICK-SET YOUNG
 ALSO A VERY CHOICE LOT OF YOUNG COWS AND HEIFERS.

We are breeding registered **BERKSHIRES** of the best English strains. Shorthorns or Berkshires shipped to order. Send for our 1895 catalogue.

GREENWOOD P. O. AND TELEGRAPH OFFICE. Claremont Stn. C.P.R. or Pickering Stn. G.T.R. Parties met on shortest notice at either station. 5-1-y-om

F. BONNYCASTLE & SONS,

CAMPBELLFORD, ONT.

Breeders of Shorthorn Cattle, Cotswold Sheep and Berkshire Pigs. Young Bulls, Heifers, and other young stock for sale at lowest living prices. 11-1-y-om



Shorthorn Bull

FIT FOR SERVICE; WON FIRST PRIZE AT MARKHAM FALL FAIR; HAVE ALSO SEVERAL HEIFERS. Write, or come and see.

JOHN MILLER, Markham, Ontario.

CARGILL HERD OF SHORTHORNS.

Have some good show material in Heifer Calves, also some grand Canadian-bred Cows and Heifers for sale. Write for catalogue. **CARGILL & SON,** CARGILL, Ont. 11-y-om

SIMMONS & QUIRIE.

Shorthorn Cattle, Berkshire Swine—Money-making Sorts.

The matchless bull, **ROYAL SAXON**—10587—(by Imp. Excelsior), 1st at Toronto, 1894, heads the herd, with **HARMPTON M.**—18940—, 1st, Toronto, 1895, by **Bampton Hero**—324—, in reserve. Female representatives of the celebrated **Mina, Strathallan, Golden Drop** and **Mysie** families. The Berkshires are choice prize-winning stock. Easy to feed, quick to sell. Stock for Sale. **C. M. SIMMONS, Ivan P.O., Ont.** 1-1-y-om **JAMES QUIRIE, Delaware, Ont.**

A. & D. BROWN,

BREEDERS OF

IONA, ONTARIO.

Three very choice young roan bulls, and also a number of good heifers for sale at very reasonable prices; bred from the noted stock bull **Warfare** (Imp.). 21-1-y-o



Shorthorns.

Four Bull Calves of finest Booth breeding. The dams are Imp. Lady Ann, daughter and g. daughter Lady Ann, sired by Mr. Booth's renowned **Paul Potter**; her daughter by a **Waraby** bull, her g. daughter by Booth bull. The sire of those calves is of finest **Polwarth** and **Waraby** blood. Two roan, two red and little white. Price, \$100 each. Also several Heifers. **D. ALEXANDER, Brigden, Ont.** 5-y-om

Shorthorns, Shropshires, and Berkshires.

Six young Bulls from 10 to 14 months old; 25 Shropshire Ewes, one, two and three years old, due to lamb in March; 15 ram and 20 ewe lambs. Twenty Berkshire Sows, from 5 to 12 months old, several of them due to farrow in March, April, and May. The above choice stock are all registered, and FOR SALE at GREAT BARGAINS. 15-y-om **W. G. Pettit, Freeman P.O., Burlington Stn., G.T.R.**

HAWTHORN HERD

OF DEEP MILKING SHORTHORNS.

FOR SALE—Several Heifers, got by the Golden Drop bull, **Golden Nugget**—17588—, by imported **General Booth**, and from A1 dairy cows. **WILLIAM GRAINGEE & SON,** 13-y-om **Londesboro, Ont.**

ADVERTISE IN THE ADVOCATE

Belvoir Stock Farm

SPECIAL MAY OFFERING.
One Yearling Shorthorn Bull, a good one.
One Shetland Pony, 4 years old. Make some child happy with it.

While the masses ride a bike, the classes are taking to the horse.

Get in the Swim.

Richard Gibson,
 51-om DELAWARE, ONT.

For Sale. Shorthorns

A fine 18-months old Bull; Heifers giving milk and younger ones. Also Fruit Farm, at Clarkson, 16 miles west of Toronto. Fifty acres of land, good house and outbuildings, 425 apple trees, 500 pear trees and other fruit. Possession immediately. Apply to
C. G. Davis,
 17 1-y-om FREEMAN P. O., ONTARIO.



Glenburn Stock Farm.

Three young Shorthorn bulls and several Berkshire boars and sows for sale at very low figures; also one yearling sow.
John Racey, Jr.,
 17 1-y-om LENNOXVILLE, QUE.

4 GRAND YOUNG BULLS and 20 HEIFERS

(Sired by the greatest living Cruickshank bull, Sittytton Stamp, and from pure Scotch cows)

For Sale.

We never offered such good animals at such low prices before.

John Miller & Sons,
 Brougham, Ont.

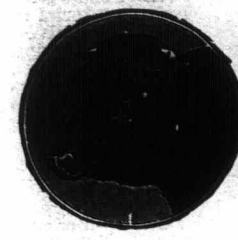

ORAGIEBURN Stock Farm.

BETHESDA P. O.
 G. A. BRODIE, breeder of Scotch Shorthorns. A few good young bulls for sale. Write me for prices and particulars. All orders and correspondence promptly attended to. Mention ADVOCATE. 21-1-y-om

"Gem Holstein Herd."

NAP! \$40.00 CASH
 For bull calf dropped March 4th, dam *Clarabel Sicut*, No. 18813, H.F.H.B.; she has averaged us five gallons of 3.8% milk every day during six months, and over 1,500 gallons in a calf per year. Prize winner at World's Fair, Chicago, and at Toronto Industrial Exhibition.

ELLIS BROTHERS,
 BEDFORD PARK P.O., ONT.
 Shipping Station, Toronto. 7-y-om

HOLSTEINS

None but the best are kept at **BROCKHOLME FARM, ANCASTER, ONT.**

Write me for prices if you want first-class stock at moderate figures. Holsteins in the advanced registry. Yorkshires all recorded.
 13-1-y-om **R. S. STEVENSON, Prop.**

MAPLE HILL HOLSTEIN-FRIESIANS.

Can still supply a few choice yearling heifers and heifer calves, but an entirely sold out of heifers in calf. Great individual merit, rich breeding, and reasonable price tell the story. Also a few excellent bull calves of Aagie and Netherland breeding. Correspondence solicited, and visitors welcome.
 G. W. CLEMONS, St. George, Ont.

Springbrook Stock Farm.—HOLSTEIN-FRIESIAN CATTLE and TAMWORTH SWINE. Four extra choice, rich-bred bulls ready for service. Write at once for bargains. Other stock for sale of best quality. A heavy stock of Tamworths on hand, bred from imported stock. 7-1-j-om
A. C. HALLMAN, New Dundee, Ont.

HOLSTEIN BULLS FOR SALE!

Four good two-year-olds, four yearlings, and a few good bull calves. The above stock are descended from imported cows, and will be sold at a bargain. Write for prices.
 5-1-f-o **JNO. McCULLOUGH, Deseronto, Ont.**

HOLSTEIN-FRIESIANS FOR SALE.—A few good young Bulls and Heifers of choicest breeding, being from imp. Cows from the famous herd of B. B. Lord & Son, N. Y., or directly descended therefrom. Address
JNO. TREMAIN,
 3-1-yo Forest, Ont.

ADVERTISE IN THE ADVOCATE



THE MAXWELL BINDER.

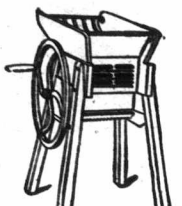

ROOT CUTTER.

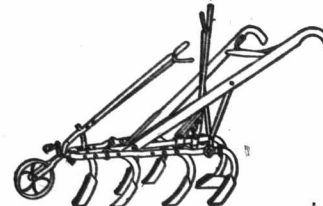

SCUFFLER.

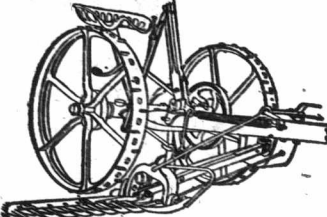

THE MAXWELL MOWER.



TEDDER.



STEEL HORSE RAKE.

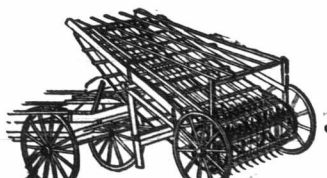

LOADER.

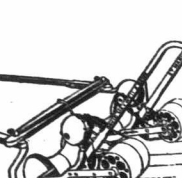

TURNIP SOWER.

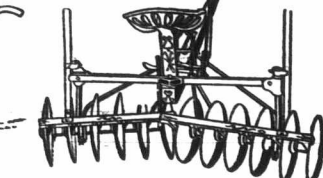

DISK HARROW.

David Maxwell & Sons
 ST. MARYS, ONTARIO, CANADA
 MANUFACTURERS OF BINDERS, MOWERS, REAPERS, HAY RAKES, HAY TEDDERS, HAY LOADERS, SCUFFLERS, DISK HARROWS, TURNIP SOWERS, ROOT CUTTERS, WHEELBARROWS, ETC.
 RESPONSIBLE AGENTS WANTED IN ALL UNOCCUPIED TERRITORY.

In the Kitchen
 The heat from cooking during summer months with an ordinary cook stove is very fatiguing.
Cooking Can be Done
 on a "Splendid Oil Cook Stove"
With Comfort
 at a small cost.
 No odor. Wicks easily replaced. Powerful 8-inch circular burners. Polished brass burners and oil tank. Steel top, tray and frames. Three sizes—1, 2 and 3 burners.
 "SPLENDID" FOR COAL OIL.
 BAKING, BROILING, AND ROASTING CAN BE DONE TO PERFECTION.
The McClary Mfg. Co., (London, Toronto, Montreal, Winnipeg, and Vancouver.)
 If your local dealer cannot supply, write our nearest house.

DAVIS CREAM SEPARATORS, DUPLEX FEED MILLS, LEVEL TREAD POWERS, HIGH-CLASS THRESHING OUTFITS, VICTOR CLOVER HULLERS.
THE JOHN ABELL ENG. AND MACHINE WORKS CO. (Limited), TORONTO, CANADA.



CATALOGUES FREE BY MAIL.

Get the Best!

FREEMAN BONE FERTILIZERS.
 Wide-awake farmers and fruit growers make money by using Fertilizer.
 It is a complete plant food. It is soluble in water and feeds the plant from start to finish. It will increase the yield of your crops and improve their quality. Ask for and use only Freeman's High Grade Bone Fertilizers.

The W. A. Freeman Co.,
 Limited,
 HAMILTON, ONTARIO.
 (Send for Catalogue.)

HOLSTEINS!

WE now offer young stock that have won prizes, and calves from our show herd, from one month to one year old, whose dams have large records—any age or sex—FOR SALE, at very low prices to quick buyers. Also some Poland-China Pigs, 1 and 6 months old; same quality (the best).

A. & G. RICE,
 Brookbank Stock Farms, CURRIE'S CROSSING, Oxford Co., Ont. 18-y-om



HAVE NOW 3 Young Ayrshire Bulls, ON HAND
 1, 2 and 3 years old, respectively; all prize-winners; the 3-year-old having won 1st at leading exhibitions. Write:
 19-y-om
MESSRS. ROBERTSON & NESS, Howick, Que.

J. YULL & SONS,
 MEADOWSIDE FARM, CARLETON PLACE, ONT.

We have a few young Ayrshire bulls left—2 two-year-olds, 4 yearlings, and a fine lot of calves of both sex; also Shropshire sheep and Berkshire pigs; pairs not sold for sale. Visitors met at Queen's Hotel. Give us a call before buying. 20-y-o

Ayrshires!

PURE-BRED, of different ages, and both sex. No inferior animals. Write for particulars.

A. McCallum & Son,
 Spruce Hill Dairy Farm, DANVILLE, QUE. 22-y-o

John Newman & Sons
 Box 221, Lachine, Que., breeders of Ayrshire Cattle and Carriage Horses.

We have a choice young two-year-old bull and a yearling, bred from imp. cows and from our grand stock bull *Glencoe*, fit to top any herd; also yearlings, bull calves, and heifers of all ages. Prices to suit the times. Write or call. 15-1-y-o

Dominion Prize Ayrshires

We have the oldest established, largest and best herd of Ayrshires in Canada. Choice young stock for sale at liberal prices. Satisfaction guaranteed.

JAMES DRUMMOND & SONS,
 1-1-y-o PETITE COTE, MONTREAL, P. Q.

WM. WYLIE, 228 Bleury St., MONTREAL, or Howick, P. Q.

Breeder of high-class AYRSHIRES. Young stock always for sale, bred from the choicest strains procurable. Breeding stock selected from the most fashionable strains and prize-winning stock of the day. Farm located at Howick, Que. 5-1-y-o

Maple Cliff Stock & Dairy Farm

Ayrshire Cattle, Berkshire and Tamworth Swine.

FOR SALE.—Four Ayrshire bulls of different ages, sons of such noted animals as *Nellie Osborne 538*, and *Gold King 1382*. They are good ones. Write for prices.
R. REID & CO., Hintonburg, Ont.
 One mile from Ottawa.

AYRSHIRE CATTLE

The bull *TOM BROWN* and the heifer *White Floss*, winners of sweepstakes at World's Fair, were bred from this herd. Young stock for sale. Also Leicester Sheep and Berkshire Swine. 5-1-y-o

DAVID BENNING,
 Glenhurst Farm, WILLIAMSTOWN, ONT.

WM. STEWART & SON,
 MENIE, ONT.

Breeders of high-class Ayrshire cattle; choice young stock of either sex and any age always on hand. Our herd contains a number of Columbian winners. 21-1-y-o

The Don Herd of Jerseys

Comprise the choicest strains obtainable, including *St. Lambert*, *Tennessee* and combination blood. A few now offering a few very choice bull calves from imp. and home-bred dams, and sires of best breeding obtainable. Address:
DAVID DUNCAN,
 DON P. O., ONT. 21-y-om

FOR SALE!

HALF THE FAMOUS BELVEDERE HERD OF JERSEYS, owing to most of my farm being sold. Not a Culling Out; but purchasers given their choice at Lowest Prices I ever offered. For many years I have taken everywhere

FIRST HERD PRIZE,

and some of these animals, with their descendants, are for sale. There is seldom such an opportunity to get together a superb Dairy Herd, that will also

SWEEP THE SHOW RINGS.

MRS. E. M. JONES,
Box 324, Brockville, Ont., CAN.

"Dairying for Profit,"

By Mrs. E. M. Jones.

Best book ever written. 50 cents by mail.
ROBT. BROWN, Box 107, Brockville, Ont., Can.

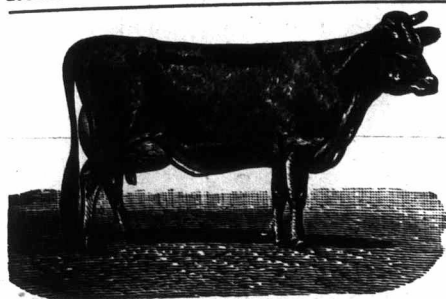

JERSEYS FOR SALE.—Young Cows and Heifers in calf, Heifer Calves and Bull Calves, richly bred, best testing strains, and good color. Also first-class Berkshire Boars and Sows, bred straight from imported stock. Come and see or write for prices.

J. C. SNELL, - Snelgrove P.O., Ont.
R. R. Station, Brampton, G. T. R., and C. P. R.
8-7-om

MAPLE CITY HERD OF JERSEYS.

For Sale.—Bull dropped July 20th, 1895; solid color, black points; sire Massena's Son 17608, dam Lady Lill 6164. Bull dropped Aug. 23rd, 1895; solid color, black points; sire Massena's Son 17608 (whose dam made 902 lbs. 3 ozs. of butter in one year), dam Forest Farm. 3-1-y-o
WM. W. EVERETT, Box 552, Chatham, Ont.

W. F. BACON,
Orillia, - Ontario,

—BREEDER OF—



CHOICE REGISTERED JERSEYS

Young bulls and heifers of the best blood for sale. Write me for prices and particulars. 19-1-y-om

JERSEYS FOR SALE

At the head of the herd is the grand young St. Lambert bull, Nabob, son of Nell's John Bull. Stock of both sexes and different ages, and of choice breeding, now on hand.

JONATHAN CARPENTER,

13-1-y-om

WINONA, ONT.



Jersey Sale!

The entire herd of A. J. C. C. H. R. Lee Farm Jerseys. Forty head of reg. bulls, cows, heifers, and calves; same number of high grade cows and heifers. Excellent chance to start a herd cheap, as they must be sold within the next 90 days. Come and see, or write

E. PHELPS BALL,

17-y-o

Lee Farm, Rock Island, P. Q.

GLEN ROUGE JERSEYS.

WILLIAM ROLPH, Markham, Ont., offers twelve Jersey Bulls and Heifers (pure St. Lamberts), out of tested cows. Grand individuals. Prices right. 21-1-y-om

FOR SALE A very fine-sexy Bull, fifteen months old. Very vigorous, and has grand form and quality.

ANDREW DRYSDALE, Goderich P. O.

MEADOWBROOK JERSEYS.

EDGAR SILCOX, Shelden, Ont.,

Breeder of high-class St. Lambert Jerseys. A couple of young Bulls for sale, grand individuals, nine and fourteen months old, from Rose of Oak Grove and Edna Hugo, sire Robin of Meadowbrook. 21-1-y-o

A. J. C. C. FOR SALE—Bull Calf, solid fawn, eight months; grandson of 100%, who was own brother to sire of Mary Anne of St. Lambert. One Heifer, 10 months, sire Baron Hugo of St. Anne's. Price, \$100 for pair, express prepaid.
H. E. WILLIAMS,
Sunny Lea Farm. 17-1-y-o KNOWLTON, P. Q.



Dana's Ear Labels for sheep, cattle, etc. Stamped with any name or address and consecutive numbers. This is the genuine label, used by all the leading record associations and breeders. Samples free. Agents wanted. C. H. DANA,
West Lebanon, N. Hamp.
11-om

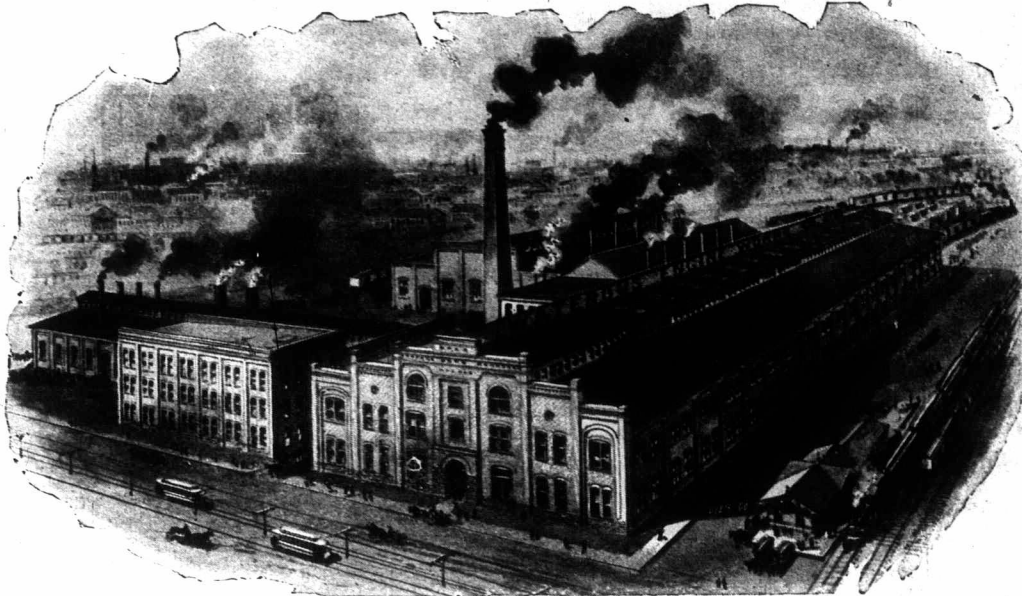

THE NEW WATEROUS WORKS AT BRANTFORD, ONT.

The New Waterous Engine Works.

The Waterous Engine Works Co. of Brantford, Ont., who have carried on business successfully for over fifty years, have outgrown their old premises, which have now been vacated to enter their new works, which are designed with a view to enable the Company to turn out the class of machinery that they build with the least possible expense for handling either the raw material or the finished machine. The buildings are extremely well lighted from the sides and the roof, there being no dark places, and the danger from fire is minimized from the fact that the walls of the different buildings extend through the roof. The raw material is taken directly from the car to the storehouse, or the place where it is to be worked up, and the finished article is delivered directly into the car. The business is that of manufacturing engines, boilers, sawmill and wood-working machinery, brick machinery, steam fire engines and fire department supplies. As the illustration given herewith indicates, the new works present a very fine exterior appearance and cover a large area of ground. We congratulate the Company on their advancement.

The Light Horse Engraving.

"A SERVICE TO THE COUNTRY."

Gentlemen,—New premium light horse engraving, "Canada's Glory," a companion piece to the popular draft horse picture, "Canada's Pride," is received. I thank you very much for sending me a copy of this admirable picture. I am sure you are doing a service to the country in bringing so prominently under the notice of farmers everywhere these choice examples of horses doing service throughout the Dominion. Yours very truly,

WM. SAUNDERS,
Director Central Experimental Farm,
Ottawa.

FROM THE PRESIDENT OF THE O. A. C.

Gentlemen,—I have pleasure in acknowledging the receipt of a copy of the light horse picture, "Canada's Glory," which you were so kind as to send me with the FARMER'S ADVOCATE a few days ago. Common or inferior horses are worth very little at the present time, but well-bred horses of a superior class still bring a good price; and I think your picture will be very much appreciated by all who are interested in improving our horses or are anxious to raise such animals as can be sold to advantage in either the home or the foreign market. I must compliment you on the general style of the picture and the information which it contains. I think it is a credit to the management of the ADVOCATE.

Very truly yours,
JAS. MILLS,
President Agricultural College,
Guelph, Ont.

A SOURCE OF PLEASURE.

Gentlemen,—Please excuse my delay in acknowledging the receipt of your very fine engraving, which you name with propriety "Canada's Glory." I think you can and should feel much pride in being able to produce so fine a picture. Your energy and efforts and the time and cost must have been very great, and I hope that you will not suffer loss; but that you were able to make it such a fine picture must be a great satisfaction. Please accept my thanks. It affords me great pleasure to own so fine a picture.
N. S. FISH,
Secretary Brown Swiss Cattle Breeders' Ass'n,
Groton, Conn.

WORTHY "THE BEST ROOM."

Sir,—Your handsome horse engraving, "Canada's Glory," is before me. It is certainly worthy of a nice frame and a place in our "best room." The other engraving, "Canada's Pride," which you issued a few years ago, has been admired by many visitors here, but I think this one will "take" better, because more of our people are admirers of the light horse and can better appreciate the fine work which has been done on this engraving. With best wishes for the ADVOCATE and thanking you for the picture.

W. A. SIAFOR,
Sec'y Am. Oxford Down Breeders' Association,
Middleton, O.

EXCEPTIONALLY GOOD OF "MISS BAKER."

Dear Sir,—I beg to acknowledge the receipt of a copy of your superb premium engraving, "Canada's Glory." I have seen several of the horses, and it is not flattery to say that Mr. Bridgen has surpassed anything hitherto attempted in this line. The portrait of Messrs. Sorby's great harness mare, Miss Baker, is exceptionally true to life. I feel sure that every subscriber of the ADVOCATE who loves a good horse (and who does not?) will be highly pleased with "Canada's Glory."

G. W. CLEMONS,
Sec'y Canadian Holstein-Friesian Association,
St. George, Ont.

[NOTE.—Any subscriber can secure a copy of "Canada's Glory" by simply sending us (inclosing \$1.00) the name of one new subscriber to the FARMER'S ADVOCATE.—EDITOR.]

WM. J. RUDD,

Eden Mills, Fairview Stock Farm, breeder of Choice Devon Cattle, Cotswold and Suffolk Sheep, Berkshire Pigs, and Plymouth Fowl. Young stock of the above, and of the best quality, always on hand. I can also furnish a car-load of Cotswolds, shearing rams and ewes of the choicest quality. Write me for particulars. Shipping—G.T.R. and C.P.R., Guelph 13-1-y-o



ADVERTISE IN ADVOCATE

ULRICH'S Illinois Mammoth Southern Sweet White Dent ENSILAGE

CORN is what you want for ensilage purposes. It stands more dry weather and will produce more ensilage on poor or good soil than any we know of. Ask your seed dealer there for it, and use no other. It is endorsed by some of the best seedsmen throughout Canada. Don't let them press you into using any other, but insist on having your

seed dealer show you our book of testimonials and invoice dated this season. It will pay you. Also ask for our Yellow Dent, which is very choice. Our sales this year have been very heavy.

E. R. ULRICH & SON,

Springfield, Ills.

WRITE FOR FREE SAMPLE. WE SELL TO DEALERS ONLY.

Tilsburg, Ont., 4-1-96.

Messrs. E. R. ULRICH & SON,
Springfield, Illinois:

Gentlemen,—In reply to your favor of March 27th, beg to say that the Mammoth Southern Sweet Seed Corn that we planted last spring, from which we grew such heavy crops of Ensilage, was seed we purchased from you, and I have no objection to your making use of the fact in advertising your corn. I inclose a printed circular. I had so many enquiries asking what seed I planted, and how I cultivated my corn and saved it in silos, I had not time to answer so many letters, and so had some printed. Also one on the silo.

Yours truly,
(Signed) E. D. TILLSON.

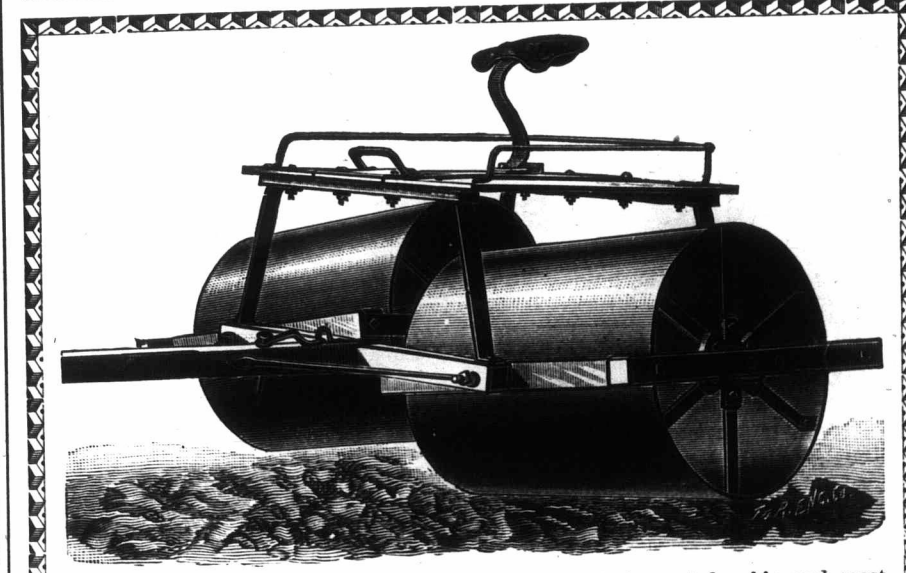

"The Dale Steel Land Roller is the strongest, heaviest, most durable and most economical roller for farming purposes at present made in the world."

SEAFORTH, ONTARIO.
THE ESTATE OF T. T. COLEMAN,

STOCK GOSSIP.

Write to advertisers please mention the Farmer's Advocate.

W. C. Shearer, Bright, Ont., makes a special offering in Plymouth Rock eggs in another column. Read it.

G. A. Brodie, Craigburn Farm, Bethesda, Ont., writes: "I have been exceedingly well pleased with my advertisement and am pretty well sold out, having only two young bulls left. One is a very handsome and thickly-fleshed roan two-year-old and the other a ten-month-old red calf of excellent quality. I have lately purchased two first-class sows of the large English Berkshire breed from 'Bow Park,' and expect soon to be classed as a swine breeder."

Capt. A. W. Young, Tupperville, Ont., has recently issued a catalogue and prize list of his Poland-China hogs and various breeds of poultry. The catalogue contains a number of cuts and a description of the different sorts of fowls in his yards. The Captain has recently written us that he has lately purchased a pure-bred Jersey cow and calf from J. C. Smith, of Snelgrove. The proprietor of Pine Grove stock farm evidently wants the best.

A. & D. Brown, Iona, Ont., write, under date of April 24th: "We never before had inquiries for stock so numerous as of late, but on account of feed being so scarce buyers are holding off. We sold one bull to John Carewell, Iona, of which he is very proud. We still have two left which should please anyone. Our young stock from imported Roy George are a grand lot, quite surpassing our expectations. Our cattle are coming out in good form, notwithstanding the great scarcity of feed."

Mr. Geo. Padget, of Buttonville, Ont., offers in our advertising columns a few fine young Berkshires of such blood as the famous boar, Enterprise, imp. Gladstone, and Oxford Daisy. A very fine litter of youngsters are now ready for shipment, out of Bella—471—by Royal Herbert—240— and sired by Dollar Lad (201), he by imp. Enterprise. He is also offering a couple of good young boars, about six months old and fit for service, at very low prices, considering their quality. Mr. Padget's Berkshires, as can be seen, are of the choicest blood, and should find ready sale.

Jas. S. Smith, Maple Lodge, writes us, under date of April 17th: "Fortunately, we have abundance of feed to last until the middle of May, and the stock are doing splendidly; calves and lambs are very numerous and thrifty. Our grand old cow, Constance of Maple Lodge, has recently given us a very handsome red heifer calf by Abbotford, and we also have our first set of the present stock bull, Calthness. It is a beautiful bull calf and very promising. His dam is now giving us over 50 pounds of milk per day, and her dam is giving rather more. Our stock is sold down pretty close at present, all being gone but one extra good one."

NOTICES.

"Ayer's Curebook," sent out in pamphlet form by that old reliable firm of J. C. Ayer & Co., Lowell, Mass., is an embodiment of a number of representative testimonials, and a plain presentation of the merits of the medicines to which the specified cures are attributed. It is a story of cures, told by the cured. The work can be secured for the asking.

Mr. Isaac Usher, of Thorold, Ont., manufacturer of Queenston cement, recently called at our office and reported that orders for cement are coming in so fast this season that he will be behind in supplying many of his customers. He is out on an instruction tour and will be on Lake Erie shore in Essex and Kent, the next week or two. He gives instruction as to building with cement free of charge.

Mr. G. J. Maulson, Manager of the London & Canadian Loan and Investment Co., 195 Lombard street, Winnipeg, informed one of our staff that sales of lands in Manitoba this year has been much greater than in the past. Several good parcels have been sold by him in the Dominion City district, 11 quarter-sections being sold in one block to Mononites. He also mentioned many sales made in Boissevain, Brandon, and Killarney districts. Mr. Maulson has been handling properties for a number of years and still handles a large amount of improved and wild lands in all parts of the Province. His advertisement, quoting low prices and easy terms, appears in another column. Any parties desiring to locate in Manitoba would do well to correspond or call on him before making purchase.

FAIR SECRETARIES PLEASE COMPLY.
Secretaries of all State and County fairs are requested to apply to us for copy for insertions in premium lists of a special premium we intend to present to every winner of a sheep premium at all the 1896 fairs. The special premiums will only be given where officially referred to in the premium list of the fair.
WILLIAM COOPER & NEPHEWS,
Galveston, Texas.

BOOK TABLE.

A book which will be a great convenience to every breeder of pure-bred sheep who uses it, is "Levering's Private Flock Register," for keeping records of imported and American-bred sheep in a short, concise method. The pages are ruled up and down, having the following headings: Name of Animal, Sex, No. of Ear Tag, Initials, Association No., Date of Birth, Ear Tag No. of Twin, Sire's Name and Association No., Dam's Ear Tag No., Served by Ram No., Time when Due, Lambered, Sex, Tag, Name and P. O. of Breeder, Date of Importation, Name of Vessel, Port of Entry, Name and P. O. of Purchaser, Date of Sale, Remarks, Death, Prizes Won. The register is published by Mortimer Levering, La Fayette, Ind., and sold for \$1.00.

GUERNSEYS

This is the Dairy breed for ordinary farmers. Large, vigorous and hardy, giving plenty of rich milk. Several fine yearling bulls and bull calves for sale at farmers' prices. A few heifers can be spared.

Address: SYDNEY FISHER,
17-y-o Alva Farm, Knowlton, P. Q.

Land for Everybody.

FREE GRANTS OF GOVERNMENT LAND. ——— CHEAP RAILWAY LANDS FOR SALE ON EASY TERMS.
GOOD SOIL! PURE WATER!! AMPLE FUEL!!!
The construction of the Calgary and Edmonton Railway, and the Qu'Appelle, Long Lake and Saskatchewan Ry. has opened up for settlement two new districts of magnificent farming land, viz., that between the North and South Saskatchewan Rivers, and that between Calgary and Red Deer.
Full information concerning these districts, maps, pamphlets, etc., free. Apply to
OSLER, HAMMOND & NANTON,
LAND OFFICE, 381 Main St., WINNIPEG.
Calgary and Edmonton Railway, Qu'Appelle, Long Lake and Saskatchewan Railway Company. 1-1-c

IMPROVED
Farms
FOR SALE in most of the best districts in Manitoba.

Cheaper than ever in the following districts:
Baldur, Belmont, Birtle, Russell, Brandon, Carberry, Deloraine, Emerson, Gladstone, Hamiota, Holland, Treherne, Killarney, Manitou, Melita, Morris, McGregor, Minnedosa, Rapid City, Neepawa, Pilot Mound, Plum Coulee, Steinbach, Souris, Virden, Winnipeg, East Winnipeg, Northwest. NO LAND SOLD ON COMMISSION. ALL OWNED AND CONTROLLED BY THE UNDERSIGNED.
Apply to H. H. BECK, 208 Main St., Winnipeg.

Choice Farm Lands
FOR SALE IN ALL PARTS OF
Manitoba.

IMPROVED AND WILD LANDS. |
Prices Low. Very Easy Terms. Write or call on
G. J. MAULSON, 195 Lombard St., Winnipeg, Man.

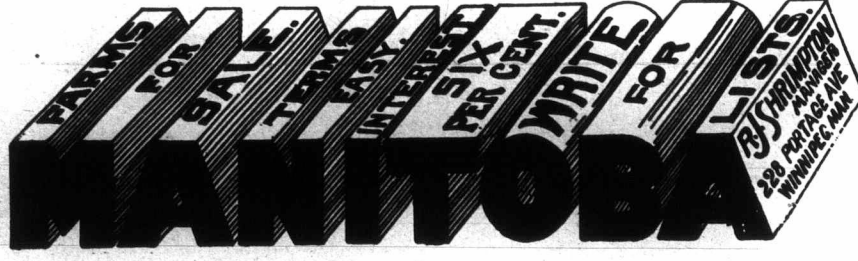

Keep Milch Cows In Good Health

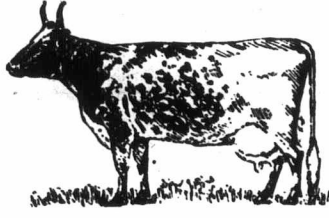

IT PAYS.—It is useless to expect a lean, run-down cow to have a good flow of milk, though she will eat more than an animal in good flesh. The difficulty is the nutriment is not all extracted from the food because her digestion is out of order.

Dick's Blood Purifier

will strengthen the digestion and make the food produce milk. It will cost but fifty cents to try it on the poorest cow you have and you will get back your money with interest in a few weeks.
For sale by Druggists, at general stores or sent post paid on receipt of 50 cts.
Dick & Co., P. O. Box 482, Montreal.

PURE OLD PROCESS
Ground Linseed Oil Meal.

The Best and Cheapest STOCK FOOD in the World!

Most SATISFACTORY, because it preserves healthy action at all times.
Most ECONOMICAL, because it fattens the quickest.
Most PROFITABLE, because best conditioned stock are secured.

MANUFACTURED BY THE
NATIONAL LINSEED OIL COMPANY,
Works: West Ganson Street, - BUFFALO, N. Y.
Send for CIRCULARS and PRICES. 12-y-o

A Set of Hustlers

are the PLANET JR. Farm Tools. They put farm work on a modern business basis,—a week's hoeing done in a day, three times the crops on the same land. The New No. 8 Horse Hoe is a dozen tools in one; width or depth changed instantly without stopping the horse. The PLANET JR. Book for 1896 tells all about these famous tools. Sent free if you write to
S. L. ALLEN & CO., 1107 Market St., PHILADELPHIA.

ADVERTISE IN THE FARMER'S ADVOCATE.

Ingleside Herefords.

UP-TO-DATE HERD OF CANADA!

Bull Calves
OF THE RIGHT SORT
For Sale.

Address—
H. D. Smith,
INGLESIDE FARM,
17-y-om Compton, Que.

"Best Quality with Greatest Quantity"
STILL THE MOTTO AT
MAPLE SHADE.

OUR Shropshire lambs are not numerous, but they are of good quality and good size. We still have left also a few strong, smooth, home-bred yearlings of good breeding and character. Our

Shorthorn Calves are developing finely, and present the characteristic quality and thick flesh of the typical Cruickshank Shorthorn. Prices moderate; if you doubt it, write and believe.

Address—**JOHN DRYDEN,**
Brooklin,
(30 miles east of Toronto.) 16-2-g-om

Henry Arkell,
ARKELL P. O.,
ONT.

Pioneer importer and breeder of registered Oxford-Down sheep. Won many honors at World's Fair. Animals of all ages and sexes for sale reasonable at all times. 9-y-om

To Stockmen & Breeders.

LITTLE'S
PATENT FLUID
NON-POISONOUS
SHEEP DIP
AND CATTLE WASH.

For the destruction of Ticks, Lice, Mange and all insects upon Sheep, Horses, Cattle, Pigs, Dogs, etc. Superior to Carbolic Acid for Ulcers, Wounds, Sores, etc.

Removes Scurf, Roughness and Irritation of the Skin, making the coat soft, glossy and healthy.

The following letter from the Hon. John Dryden, Minister of Agriculture, should be read and carefully noted by all persons interested in Live Stock:

"MAPLE SHADE" HERDS AND FLOCKS.
BROOKLIN, ONT., Sept. 4th, 1890.

DEAR SIR,—I cannot afford to be without your "Little's Sheep Dip and Cattle Wash." It is not merely useful for Sheep, but it is invaluable as a wash for Cattle, etc. It has proved the surest destroyer of lice, with which so many of our stables are infested. I have ever tried; it is also an effectual remedy for foul in the feet of Cattle. I can heartily recommend it to all farmers and breeders.
JOHN DRYDEN.

Seventeen Gold, Silver and other Prize Medals have been awarded to "Little's Patent Fluid Dip" in all parts of the world. Sold in large tins at \$1.00. Special terms to Breeders, Ranchmen and others requiring large quantities. Ask your nearest druggist to obtain it for you; or write for it, with pamphlets, etc., to
ROBERT WIGHTMAN, DRUGGIST, OWEN SOUND, Ont.
Sole Agent for the Dominion. 7-1-y-om

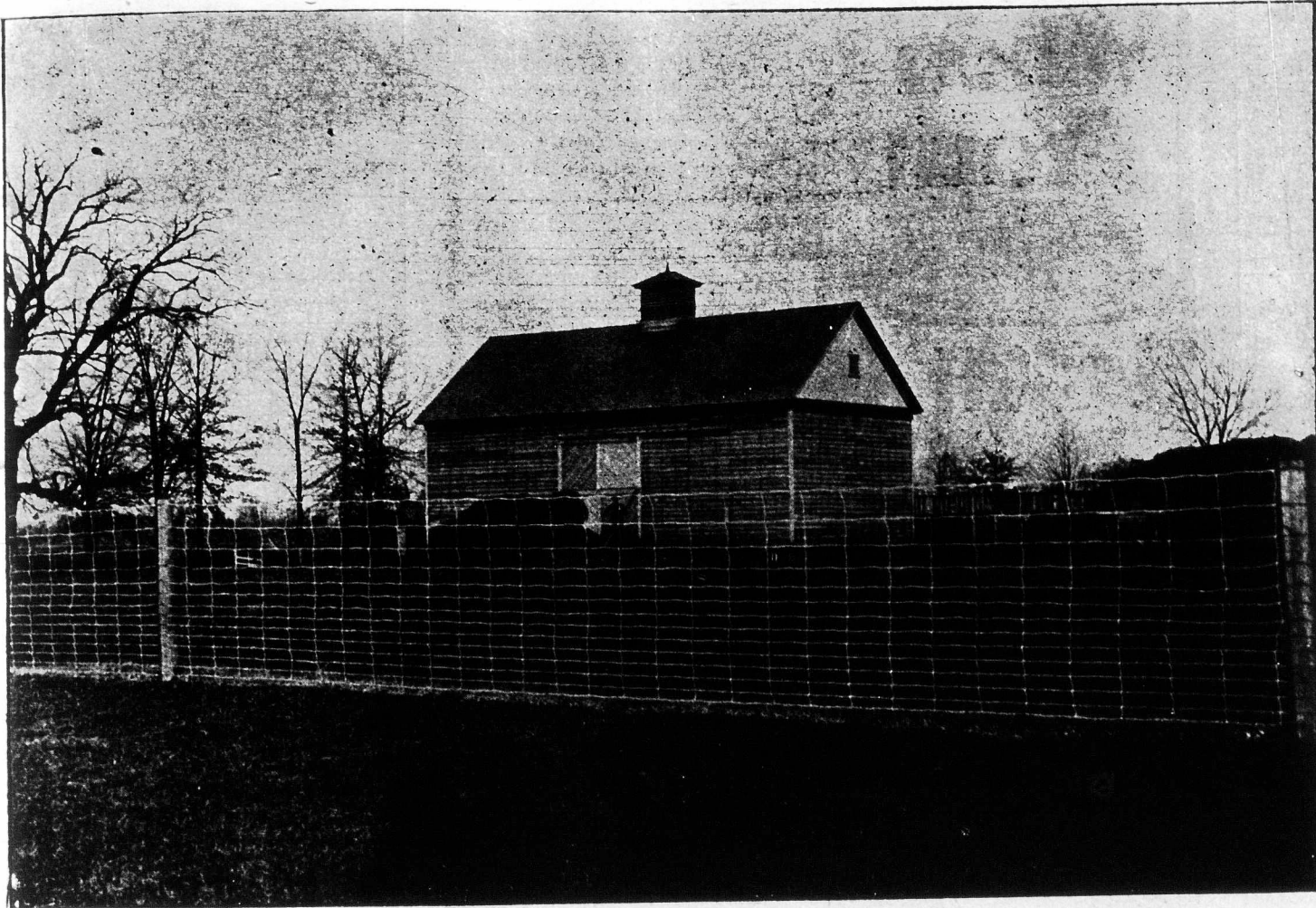

PAGE FENCE, AFTER NEARLY FOUR YEARS USE, ON THE FARM OF W. H. DUNNING, NEAR SANDWICH, ONTARIO.

PAGE FENCE

IS STRONGEST.
 IS NEATEST.
 IS MOST DURABLE.
 IS MOST EFFICIENT.
 IS PIG TIGHT.
 IS BULL STRONG.
 IS HORSE HIGH.
 IS ELASTIC.
 IS READY MADE.
 HAS MOST WIRES.
 HAS STRONGEST WIRES.
 HAS MOST CROSS WIRES.
 IS MOST ECONOMICAL.
 IS LIKED BEST.
 IS USED MOST,
 and
 IS THE CHEAPEST
 FIRST-CLASS
 FENCE.

FOR PARTICULARS
 WRITE THE

PAGE WIRE FENCE CO.,
 WALKERVILLE, ONT.

AMPLE SHADE STOCK FARM.
 SHORTHORNS
 AND LEICESTERS
Our Specialties.
 Choice young stock of the above breeds for sale.
E. GAUNT & SONS, St. Helen's, Ont.
 13-1-y-om

COOPER DIP

 KILLS AND PREVENTS
 TICKS, LICE AND SCAB.
 MAKES WOOL GROW.
 Dipping pamphlet free from
COOPER & NEPHEWS, Galveston, Tex.
 If druggist cannot supply, send \$2.50 for 100-gall. pkt. to **WILLIAM EVANS & SONS (Ltd.)**,
 Toronto and Montreal. Reduced prices on quantities.

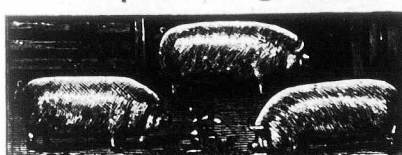
SHEEP BREEDERS' ASSOCIATIONS.
 American Shropshire Registry Association, the largest live stock organization in the world. Hon. John Dryden, President, Toronto, Canada. Address correspondence to **MORTIMER LEV-ERLING, Sec., Lafayette, Indiana.** 3-1-y-om

Specialty of Improved Large Yorkshires

I have now on hand a choice lot of young boars fit for immediate use. Prices very moderate. Orders for spring will receive careful attention. Pigs of the most desirable type and at reasonable prices.
 3-y-om **J. E. BRETHOUR, Burford, Ont.**

J. G. CLARK, Woodroffe Stock Farm, OTTAWA,
 BREEDER OF
 CLYDESDALE HORSES, Ayrshire Cattle,
 and IMPROVED LARGE YORKSHIRES.

I now have on hand a number of choice young Yorkshires, both sexes, which I will sell at prices to suit the times. Pairs supplied not akin. Correspondence solicited. 11-1-y-om

LARGE IMPROVED YORKSHIRES
 A choice lot of young pigs from four weeks to six months old, including boars fit for service and sows ready to mate. Prices to suit times. Satisfaction guaranteed. Apply to

WM. GOODGER & SON, Box 160, Woodstock, Ont.
 11-y-o

Binder Twine
CONSUMERS' CORDAGE COMPANY, LIMITED.
 Head Office, MONTREAL

NEW BRANDS FOR 1896:
Red Crown and Blue Crown

THESE TWINES ARE BEING MANUFACTURED WITH SPECIAL CARE, AND WE GUARANTEE THEM EQUAL TO ANY WE HAVE EVER MADE. BINDER WILL RUN ALL DAY WITHOUT ANY STOPPAGE EXCEPT TO CHANGE BALL.
 FARMERS WILL DO WELL TO USE THESE BRANDS FOR 1896.
 FOR SALE EVERYWHERE.
 ENQUIRE FOR PRICES.
 7-j-om

USE Queenston Cement
 FOR BUILDING... STABLE, SILO, AND OTHER WALLS, CISTERNS, STABLE FLOORS, HOG TROUGHS, ETC.
 As the building season has commenced, all parties using our cement, and where its use is not understood, kindly give us about ten days' notice and we will come or send an expert at our own expense. We shall be behind our orders this year; on this account order cement two or three weeks before you want to use it.
 SEND FOR OUR NEW PAMPHLET CONTAINING FULL INSTRUCTIONS, FREE.
 For prices of Cement and other particulars, apply,
ISAAC USHER & SON, Thorold, Ont.
 13-y-o

YORKSHIRE PIGS
 Of the best type and breeding. Pairs not akin for sale at all seasons.
J. M. HURLEY & SON
 Belleville, Ont. Box 448.

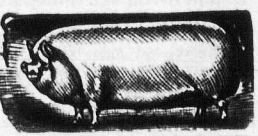

LARGE ENGLISH BERKSHIRES FOR SALE.
 Descended from imp. stock of the up-to-date type. Young pigs of all ages and either sex for sale, at prices in keeping with the times.
CEO. PADGET,
 Unionville St., G.T.R. **BUTTONVILLE, ONT.**
 9-1-y-o

ENTERPRISE STOCK FARM.
E. CAVERLEY, Sine P. O., Ont.
 Breeder of large English Berkshire and Poland-China Swine. Orders booked for spring pigs from February litters. Can supply pairs not akin. Prices lower than the lowest. 11-1-y-o

BERKSHIRES AND YORKSHIRES!
 Choice stock for sale at reasonable prices. Orders filled in rotation. Inspection invited. Write for prices.
THOMAS WATSON,
 Springvale, Ont.

ENGLISH BERKSHIRES
 The home of the famous imp. sires Baron Lee 4th and Star One. Young litters arriving every month out of matured sows. Highest quality, best breeding. Now is the best time to order spring pigs. Write for prices, or come and see us.
J. G. SNELL, Snelgrove P. O.,
 2-y-om **Brampton Station, Ont.**

LARGE ENGLISH BERKSHIRES.
 My herd won 246 prizes, 10 diplomas, 5 medals; also Prince of Wales prize, and sweepstakes over all breeds since 1888 at the leading fairs in the Dominion. Choice stock of all ages for sale. Pairs supplied not akin. **Geo. GREEN,**
 Fairview P. O., Ont.
 Stratford Station and Telegraph Office.

LARGE ENGLISH BERKSHIRES, IMPROVED LARGE WHITE YORKSHIRE SWINE, SHORTHORN CATTLE, AND SHROPSHIRE SHEEP.
 A choice lot of Boars of either breed, fit for service, for sale. Young Sows in pig, and a lot of very fine Boars and Sows three months old.
 Herd won 65 firsts and 45 second prizes at leading fairs, 1895. Inspection invited. Address,
H. J. DAVIS,
 Woodstock, Ont.,
 3-y-om

ADVERTISE IN ADVOCATE

STOCK GOSSIP.

In writing to advertisers please mention the Farmer's Advocate.

W. C. Edwards & Co., Rockland, Ont. (per J. W. Barnett), write:—"We have just sold three young bulls—one to Gaspard Massill, Butte Aux Vents, P. Q.; one to Gorman & Lynch, Douglas, Ont., and one to John McCallum, Cumberland, Ont. We have a few good ones left yet, including the two imported ones. Feed is plentiful, and the things will go to grass in good shape."

The annual meeting of the American South-down Breeders' Association will be held in the office of the Secretary, Mr. John G. Springer, at Springfield, Illinois, on Wednesday, May 27, 1896, at 10 a.m. The regular annual election of officers will be held, and other matters pertaining to the Association will receive attention. Volume VI. of the Record is now in the hands of the printers, and will contain 2,000 pedigrees; filed in a shorter time than any previous volume.

Mr. Arthur Johnston, of Greenwood, Ont., writes as follows:—"The Greenwood herd of Short-horns are now fully up to former April form and condition, with the exception of a few milking cows, which are unusually lean. Our young things, however, were never in better shape at this season of the year, especially our seven young bulls fit for service. They are thick, growthy, massive bulls; the two white ones look like being winners in any company. Indian Brave, the Toronto Industrial second prize winner in 1895 as a yearling, has improved in every respect. He thickened out immensely while making a steady growth and keeping his superb form, carriage, and character. Our calves, to the number of better than a score, are a good lot and in first-class condition. Some of the oldest will be fit for late service the coming season. Many of them are old enough to exhibit, and good enough too."

LINCOLN SHEEP.

The year 1890 was an auspicious period for this breed of sheep, as the preliminaries for the organization of the National Lincoln Association and Record occurred in that year. The Association was perfected in 1891, with nine members. Since that time Lincolns have made rapid strides in popular favor. The Association now has close to a hundred of the best breeders in North America, extending to Ontario, Manitoba, P. E. Island, S. Dakota, Indiana, Ohio, Illinois, Wisconsin, and are legion in Michigan. The breed has become popular on the vast ranches of Montana, Colorado, and New Mexico, and bids fair in a decade to be the most popular sheep in the United States. This has occurred in Australia and the Argentine. The majority of the sheep in the world are of Merino ancestry, and the Lincoln has proved the finest cross on the Merino, making a good length staple of wool (very lustrous and strong), and forming a large sheep of the best mutton qualities. The Argentine imported large numbers from England the past season, and the demand bids fair to exceed the supply. New Mexico and Montana are scouring Michigan and Ontario for all the Lincoln rams that can be found (this winter) for future use. Were the Lincolns gifted with speech, they might well exclaim, "Veni, vidi, vici." Lincoln rams sold the past season as high as \$600 each, and with the record season as high as the Smithfield (Eng.) show, of the greatest daily gain of any mutton breed, we consider them the best sheep to be found anywhere. As breeders, they have no superior; one ewe at Ilderton, Ont., having five lambs at a birth in 1895, two ewes at Elva having at a birth in 1895, triplets and twins are four each, while triplets and twins are very common. Breeders of Lincolns can use "Eureka" as their motto. H. A. DANIELS, Sec'y National Lincoln Ass'n, Elva, Mich.

MORE HACKNEYS FOR MAPLEWOOD. F. C. Stevens, the wealthy proprietor of the Maplewood Stock Farm, at Atlica, N. Y., owner of Langton Performer, and who purchased Ottawa (since dead) from Messrs. Beith & Co., last year, is bringing out a fresh lot of Hackneys from England—the selection of which was made by his manager, Mr. E. T. Gay, and Mr. Alex. Galbraith, of Janesville, Wis., one of the best all-round horsemen in America. It is said that several mares are to be shipped over by English breeders to be bred to Langton Performer, which expresses very well the high appreciation in which he is held. The new lot chosen are as follows:— Clifton II. 4688, chestnut, four years old, sire Danegelt, dam Lightsome, by Fireaway. Clifton II. won 2nd at Islington, in March, in the class for horses over 14 and under 15 hands, with 21 animals in the ring. Stella 7431, sire North Star, dam by Lord Derby. Stella was awarded 1st in her class, 19 entries, was also the adult cup winner and winner of the challenge cup. Applause 7612, chestnut, three years old, sire Saxton 2674, dam 1804 Lady Alliance, by Lord Derby II. 417. Applause took 4th in a class of 16.

The yearlings to be imported are:— Lady Valentine, sire Grand Fashion II. 3024, dam Lady Lillian by North Star. In a class of 31, she was awarded 1st. Miss Sutton, sire Chocolate Jr. (the sire of Lady Sutton), dam by Danegelt. Ding Dong, sire Danegelt 174, dam Mandoline, by Cadet. Golden Reef, a two-year-old, sire Royal Arthur, by Rufus, dam Gold, by Ganymede. She won 1st as a foal and won three times as a yearling. Lady Osbald 1659, sire Denmark 177, dam by Fireaway. She is now in foal to Langton Performer. She has taken over 40 prizes. Garton Lady Emille 6702, sire Connaught 1453, dam 2012 Dolly, by Young Fireaway. She is the dam of Langton Performer II., and is now in foal to Langton Performer. The pony stallion Tom Tit, sire Caxton 2389, dam Jennie Wren, by Lord Derby II., is a 2nd prize winner.

P. R. Hoover & Sons,

GREEN RIVER, ONT., BREEDERS OF CHOICE TAMWORTHS. We are now offering a few good young sows, ready to breed, at prices which should sell them. St., Locust Hill, C.P.R.; Markham, G. T. R. Correspondence solicited. 9-1-y-om

When Your CAKE Is All Dough When your cake is heavy, soggy, indigestible, it's a pretty sure sign that you didn't shorten it with COTTOLENE. When this great shortening is rightly used, the result will surely satisfy the most fastidious. Always remember that the quality of COTTOLENE makes a little of it go a long way. It's willful waste to use more than two-thirds as much as you would of lard or butter. Always use COTTOLENE this way, and your cake and pastry will always be light, wholesome, delicious. Genuine COTTOLENE is sold everywhere in tins, with trade-marks—"Cott lene" and steer's head in cotton-plant wreath—on every tin. THE N.K. FAIRBANK COMPANY, Wellington & Ann Sts., Montreal.



CANCER ON THE LIP CURED BY AYER'S Sarsaparilla. "I consulted doctors who prescribed for me, but to no purpose. I suffered in agony seven long years. Finally, I began taking Ayer's Sarsaparilla. In a week or two I noticed a decided improvement. Encouraged by this result, I persevered, until in a month or so the sore began to heal, and, after using the Sarsaparilla for six months, the last trace of the cancer disappeared." JAMES E. NICHOLSON, Florenceville, N. B.

Woodlands Herd of TAMWORTH SWINE. Choice young stock from imp. and home-bred stock. Pairs not akin. Write for prices. H. REVELL, Proprietor, Ingersoll, Ontario. ADVERTISE IN THE ADVOCATE.

BARTON HERD OF TAMWORTHS. Choice stock of all ages and either sex, descended from imp. stock. Pairs and trios not akin. 19-1-y-om. W. T. ELLIOTT, Hamilton Market.

OXFORD HERD OF POLAND-CHINAS. Our herd made a clean sweep of all the first prizes (30) at the late Toronto, Montreal and Ottawa Exhibitions. DARKNESS QUALITY, the unbeaten winner at the World's Fair, heads the herd. Stock for sale. Write for prices. W. H. JONES, 15-y-om Mount Elgin, Ont.

HERRON & DAFOE, AVON P.O. Importers and Breeders of Poland-China, Chester White and Tamworth Swine. Young stock of the above, any age and either sex, imp. and descended from imp. stock, for sale at hard-time prices. All stock registered. Mention ADVOCATE.

CANADA: WILKES. Boars fit for service, Sows of all ages, at lowest prices consistent with the times and quality of stock. Orders for spring pigs taken: trios and pairs not akin. Eggs for hatching: 15 for \$1.00, 30 for \$2.00. Any assortment of the following, except Pekin Ducks (Hallow strain), which are \$1.50 for 11 eggs, 25 eggs for \$3.00: Barred Rocks, Brown Leghorn, Black Spanish, and Silver-Gray Dorkings. Send for new illustrated catalogue of stock, free. Address, 17-y-om CAPT. A. W. YOUNG, Tupperville, Ont.

ESSEX HERD OF POLAND-CHINAS. R. B. McMULLIN, Goldsmith, Ontario, Importer & Breeder of Registered Poland-China Swine. Young stock for sale. Registered pedigrees furnished. Also eggs for hatching—B. P. Rock and Black Minorca varieties. 3-1-y-om.

THE FARGO HERD OF POLAND-CHINAS. Are of the choicest quality and breeding. I have young stock for sale from an imp. boar and imp. and home-bred sows, also a few choice sows in farrow to the imp. boar Black Joe. Those desiring a first-class article at the right price, should write at once or come and see my stock. OLIVER DRURY, 13-1-y-0 FARGO, ONT.

Duroc - Jerseys FOR SALE. Orders booked now for spring delivery. Three sows now due to farrow. Your choice of young pigs, \$5.00 each. BERDAN & McNEIL, STRATHBURN, ONTARIO. 21-1-y-0.

DUROC-JERSEY SWINE. We have the best and greatest prize-winning herd in Canada. Write for what you want. We have everything. TAPP BROWN, Ridgetown, Ont. 20-y-om

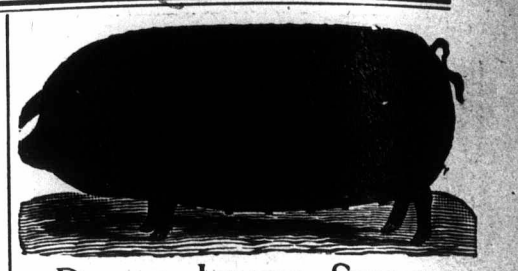

DUROC-JERSEY SWINE. For sale—Spring Pigs not akin, and eight fine fall sows to breed to order. Prices to suit the times. PETER LAMARSH, 5-1-y-0 Wheatley, Ont.

Summit Farm Duroc-Jersey Swine Herd of. I have a few choice young sows still for sale, which I am offering cheap. Orders taken for spring pigs. Write for particulars to 3-1-y-0 F. W. TERHUNE, Brantford, Ont.

IMP. CHESTER WHITE and TAMWORTH SWINE. Having won the sweepstakes for the best boar and two sows at Toronto Exhibition of 1895, we are booking orders for spring pigs from imp. stock in pairs not akin. Stock for exhibition purposes a specialty. Reduced rates by express. Drop a card for prices before buying elsewhere. H. GEORGE & SONS, Crampton, Ont., Middlesex County, 7-y-om.

E.D. GEORGE PUTNAM, ONT. Importer and Breeder of Ohio Improved Chester White Swine. The largest and oldest established registered herd in Canada. I make this breed a specialty, and furnish a good pig at a fair price. Write for prices. 15-1-y-om

CHESTER WHITES AND BERKSHIRES. Two one-year-old Berk. boars at \$12 each; three six months old Chester Whites at \$7 each; two litters of Berks. (soon ready to ship) at \$4 each pig; two litters of Chesters (soon ready to ship) at \$4 each pig. This is a special offering in order to reduce stock on hand. Pigs will be crated, put on board cars, and pedigrees furnished free of any extra charge. JAS. H. SHAW, Simcoe, Ont.

GIDEON SNYDER, Jr. Jarvis, - Ontario. Breeder & Importer of Ohio Imp. Chester & Berkshire Swine. Also Brick and Tile manufacturer. Junction of Air Line and Hamilton & North-western Ry.

SPECIAL OFFERING of Chester Whites. FOR APRIL. A large quantity to dispose of to make room. \$4.00 each. Male or female. Remember this only lasts during April. JOS. CAIRNS, 3-1-y-0 CANLACHIE, ONT.

SEEDS. YOU WANT THEM. CAN GET THEM FROM MERCHANTS OR DIRECT FROM US. CATALOGUE FREE. B - 8 Fuchsias, assorted, 50c. I - 6 Roses, ever-blooming, 50c. G - 8 Geraniums, good, 50c. V - 6 Canna Bulbs, as'd, for 50c. A - 8 Montretries, pretty, 50c. L - 30 Gladi's Bulbs, mxd., 50c. E - Sweet Peas, Coll. 30 var., 50c. U - Window Coll., 1 each (Ivy and Show Geranium Coleus, Manetta-Vine Mexican Primrose, Fuchsia Heliotrope & Tradescantia 50c) THE STEELE BRIGGS SEED CO. LTD. TORONTO ONT.

Our ABUNDANCE Plum and other Trees, Plants, Vines, Roses, Ornamentals, etc., are reliable and up to date; none better. Send for catalogue of 1896, giving variety and prices to suit the times. Special offers to buyers. Also choice Carman Seed Potatoes (Nos. 1 and 3), Am. Wonder, etc. No Agents. A. G. HULL & SON, Central Nursery, St. Catharines, Ont.

Fine FRUIT and GRAIN FARMS FOR SALE In the Grimsby and Niagara Districts. Address—G. F. BELL, Grimsby, Ont. 4-y-0

HOME COMFORT

ROLL OF HONOR.

**THREE GOLD
And ONE SILVER Medal**
World's Industrial and Cotton
Centennial Exposition, New Orleans
1884 and 1885.

HIGHEST AWARDS
Nebraska State Board of Agriculture, 1887.

DIPLOMA
Alabama State Agr'l Society at Montgomery, 1888.

AWARD
Chattahoochee Valley Expo., Columbus, Ga., 1888.

HIGHEST AWARDS
St. Louis Agricultural and Mechanical Asso'n, 1889.

SIX HIGHEST AWARDS
World's Columbian Exposition, Chicago, 1893.

HIGHEST AWARDS
Western Fair Association, London, Can., 1893.

SIX GOLD MEDALS
Midwinter Fair, San Francisco, Cal., 1894.

SILVER MEDAL
Toronto Exposition, Toronto, Canada, 1895.

ABOVE HONORS WERE RECEIVED BY

WROUGHT IRON RANGE CO.,

70 to 76 PEARL STREET, TORONTO, ONTARIO, and
Washington Avenue, 19th to 20th Streets, ST. LOUIS, MO., U. S. A.
FOUNDED 1864. PAID UP CAPITAL, \$1,000,000.

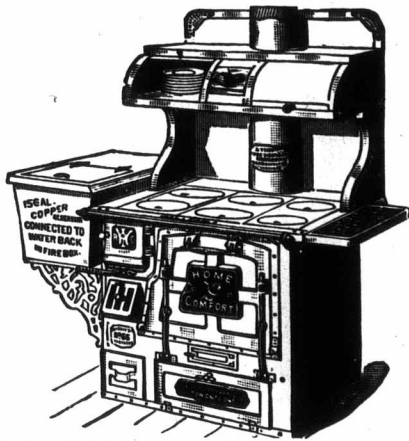

STEEL, HOTEL AND FAMILY RANGES.

Above Style Family Range is sold only by our
Traveling Salesmen from our own wagons
at one uniform price throughout
Canada and the United States.

Made of Malleable Iron and Wrought Steel,
and will last a lifetime with ordinary care.
Over 321,597 Sold to January 1st, 1896.

Eggs For Hatching

From three pens of Barred Plymouth Rocks,
selected from 300 birds, at \$1.00 per setting;
three settings, \$2.50. Reduced prices on larger
quantities. Also a few settings of Indian Games
at same prices. Pekin Duck Eggs at \$1 per 11.
These ducks are direct from Jas. Rankin's
yards, the greatest duck man in America.
W. R. GRAMM, Box 355, Bayside, Ontario.

Eggs for Hatching

From imported Barred Plymouth Rocks.
All choice, strong, healthy fowls. Price,
75 Cents per 13,
safely packed and delivered to Canadian Ex-
press Co.

W. C. SHEARER, Bright, Ont.

Breed for Eggs and Meat

FARMERS, breed Rose-combed White Leg-
horns—best layers, dress well, and combs never
freeze. Also eggs from Golden and Silver
Wyandottes, Single-combed Brown and White
Leghorns. All selected prize winners and high
scoopers. Eggs, \$1.50 per setting.

H. W. LAIRD, Cobourg, Ont.

EGGS from prize-winning pens: Black
Minorcas, Red Caps, Black Hamburgs,
Andalusians, Rose Comb Brown Leg-
horns, Single Comb White Leghorns, Light
Brahmas, and Barred Plymouth Rocks, \$1.00
per setting. Satisfaction guaranteed.
7-f-om W. L. BROWN, London West, Ont.

Salford Poultry Yards

Eggs from the following pure-bred stock:
B. Rocks, W. Rocks, W. Leghorns, B. Minor-
cas, B. Spanish, W. C. B. Polands; Indian,
Duckwing, B. B. Red, and Black Sumatra
Games, \$1.50 per 13. English Pheasant Eggs,
35c. each. Exhibition stock for sale in August.
8-f-om A. STEVENS, SALFORD, ONT.

Found.—A large fortune and an honor-
able title. This seldom hap-
pens, but, to a certain extent, both can be had by
buying from me your Golden and Silver Wyandotte
eggs at \$2.00 per 15, and Bronze turkey
at \$3.00 per 11. For further information send
for fine new catalogue. JAMES LENTON,
PARK FARM, OSHAWA, ONT. 8-d-o

EGGS FOR SALE from pure-bred stock—
E. B. P. Rocks, S. L. Wyandottes, W. and B.
Leghorns, B. Minorcas, S. S. Hamburgs, B.
Spanish, and Houdans. Write for circular.
-o J. E. MCCOMBS, Ridgeville, Ont.

Eggs for Hatching

FROM SILVER WYANDOTTES
(winners of silver medal at Toronto last fall) at
\$1.25 per 13, and Pekin ducks, headed by 2nd
prize drake at Toronto, \$1 per 11. 7-e-om
J. E. MEYER, Kossuth, Ont.

Preston Poultry Yards

L. and D. Brahmas, B. Langshans, B. and W.
Rocks, Blk. and W. Leghorns, and Silver Wyandottes.
Eggs, \$1.50 per setting, \$2.50 per two;
B. and P. Cochins, W. C. S. and G. Polish and
Games, \$2 setting, \$3.50 per two settings. 8-f-om
G. D. SMITH, Preston, Ont.

Jacob B. Snider, German Mills, Ont., Breeder of
choice Light and Dark Brahmas, Black Lang-
shans, Plymouth Rocks, Golden Wyandottes,
Black Minorcas, Red Cap and Indian Game.
Eggs, \$1.25 per 13. Correspondence solicited.

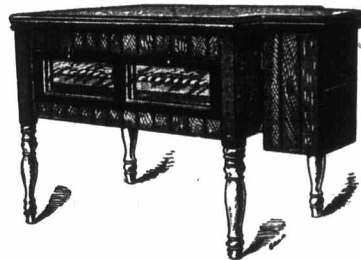

Don't Fail

To send for the Illustrated Circular
of the Safety Incubators and Brood
ers before placing your order. They
bear comparison with the best in the
land. Address J. E. MEYER, Kossuth,
Ont.

Pickle Your Eggs

when they are 7c. to 10c. per doz. for your own
use or sell them when they are 20c. to 25c. and
double your money. I have a recipe to make
a pickle that will keep eggs for two years if
necessary, which I have used for 15 years.
Will send it to any one sending me \$1.00 (regis-
tered letter). 8-f-om W. M. BUSH, Walkerton, Ont.

"Poultry Almanac" tells all about raising chick-
ens. 10 cents.
C. C. SHOEMAKER, Pub., Freeport, Ill.

MEN & WOMEN

Taught to make Creyon Portraits in spare hours at
their homes by a new copyrighted method. Those learn-
ing my method will be furnished work by me, by which
they can **EARN \$8 TO \$16 A WEEK.** Send for
particulars. H. A. GRIFF, German Artist, Tyrone, Pa.

THE Wall Paper King

OF CANADA.

IF YOU THINK OF PAPERING

a Residence, Church, Office, Lodge
Room, Public Hall, Hotel or Store

WRITE A POSTAL TO

C. B. Scantlebury,

Box 650. Belleville, Ont.

Mention the ROOMS you think of
papering, about the PRICE you
want to pay, and where you saw
this "ad."

You will get by return mail large
SAMPLE BOOKS of choice WALL
PAPER at the LOWEST prices
known to the Canadian trade, and
our booklet "HOW TO PAPER."

We pay express charges on all
orders and guarantee satisfaction
OF YOUR MONEY BACK.

References, Can. and Dom. Express Co's.
7-f-om

BEES AND SUPPLIES



6-d-om

WE make NEW
PROCESS and
Superior Comb
Foundation. Also
all other supplies of
best design. Cata-
logue of Bee Sup-
plies and sample of
Comb Foundation
free on application.
Address,
COOLD, SHAPLEY
& MUIR CO (Ltd.),
Brantford, Ont., Can.

**KEEP
YOUR
Engine
AT
WORK**

Run a shingle-mill, chopper,
lath-mill or small sawmill. A
12 horse-power threshing en-
gine will run a 44 to 48-inch
saw, cutting four thousand
feet per day.
Write for circulars to-day.

WATEROUS
BRANTFORD, CANADA. 9

NORTHERN Business College

IS THE PLACE TO ATTEND if you want
either a Business Education or a course in
Shorthand. The best in Canada. Full particu-
lars free. Address, C. A. FLEMING, Princi-
pal, Owen Sound, Ont.

**SHEET STEEL
BRICK
FIRE-PROOF**
WRITE FOR PRICES AND
CATALOGUE.
THE PEDLAR METAL ROOFING CO. OSHAWA ONT.

WM. WILKINSON, BRAMPTON, ONT.,
Manufacturer of the
FAVORITE
NOISELESS Steel Land Roller
and SMALLEY TREAD POWERS.
The best and cheapest made. Write for prices.
22-1-y-o

THE EXCELSIOR LIFE INS. CO. Issues the best
PROTECTION and INVESTMENT.
The Company is foremost in features essen-
tial to success, and the security is unsurpassed.
Agents wanted. E. F. CLARKE, President.
9-y-o



ADVERTISE IN THE ADVOCATE



THE HYSLOP WHEEL

BEST ON EARTH



REGENT
WHEELS
SECOND
ONLY TO
HYSLOP

FLEET
WHEELS
BEST \$75
WHEELIN
CANADA



THE SPARTAN WHEEL

\$50. COMPARE IT WITH
OTHERS AT \$75

HYSLOP, SON & M^CBURNEY.

THE
WHEELMEN OF CANADA.





Reasons Why It Pays

TO USE A CREAM SEPARATOR.

You realize from 15 to 25 per cent. more cream.
The quality of your butter will be 20 per cent. better, and
the price higher accordingly.

You dispense with hours of hand work and drudgery
every day, setting pans, skimming milk, etc.

You will have fresh, sweet, warm skimmed milk morn-
ing and night for rearing calves, saving the trouble
and expense of heating skimmed milk.

SEND FOR CIRCULARS. AGENTS WANTED.

Manufactured by
THE WATERLOO MFG. CO., Ltd.,

WATERLOO, ONT. om

(The only Cream Separator manufac-
tured in Canada.)

A Pension For Life!

FOR MEN AND WOMEN.

The Pension Bond Policy of the Manufacturers' Life guarantees an income for life of from \$100 to \$10,000 a year, from any age after 45. No medical examination required. Should death occur at any time before the Pension becomes payable, all the money paid by the assured to the Company will be returned to his or her beneficiaries.

This is the easiest, cheapest, simplest, and most convenient way of providing for old age. Same rates for both men and women. No medical examination required.

Write for particulars, etc.

The Manufacturers' Life Insurance Company,

Life Insurance Company,

HEAD OFFICE,

13-1-y-om Toronto, Can.

GALVANIZED STEEL WIND-MILLS



For POWER and PUMPING with PATENT ROLLER and BALL BEARINGS.

THE CELEBRATED "Maple Leaf Grinder"

Ten-inch reversible plates, Relief Springs, Ball-bearing Plates, Shake Feed, grinds fine and fast.



BRANTFORD CAN.

Send for Circulars, and mention this paper

Manitoba PORTAGE PLAINS FARMS FOR SALE.

NO FAILURES, CONVENIENT TO WOOD, Unlimited FIRST-CLASS WATER at from twelve supply of to sixteen feet. GOOD MARKETS.

It is safer to buy on the Portage Plains, at a reasonable figure, than to homestead West and gamble on reaping a crop. Within the last seven years young men have started with less than \$500 of this world's goods, and to-day are considered wealthy. The same opportunity is open to you. Write for particulars as to prices, terms of payment, and any other information you desire regarding these noble plains.

W. H. TRELEAVEN, Real Estate, Etc., 4-y-om PORTAGE LA PRAIRIE, MAN.

THE LATEST. The Jones Cheese Hoop

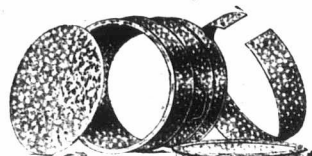

(Patented in Canada, Sept. 26th, 1895.) The body of the hoop is made of one piece, of sixteen gauge tinned steel, is flanged in at the bottom, and the loose perforated bottom rests inside upon the flange. The advantages are:—No rusting out at the bottom corners; cheese readily removed from the hoop; hoop easier to clean and keep clean; bandages after being put in place cannot drop down inside of hoop.

W. W. CHOWN & CO., BELLEVILLE, ONT. Write for prices. Also all cheese-factory supplies. 4-f-om

Potatoes,

Tomatoes, Melons, Cabbage, Turnips, Lettuce, Peas, Beets, Onions, and all Vegetables, remove large quantities of Potash from the soil. Supply

Potash

in liberal quantities by the use of fertilizers containing not less than 10% actual Potash. Better and more profitable yields are sure to follow.

Our pamphlets are not advertising circulars boomed special fertilizers, but are practical works, containing latest researches on the subject of fertilization, and are really helpful to farmers. They are sent free for the asking.

GERMAN KALI WORKS, 93 Nassau St., New York.

Purest and Best.

Windsor Cheese and Butter Salt

Has during the season of 1895 given the best satisfaction on account of Purity, evenness of crystal, and splendid working qualities.

It is now used in all the largest Cheese Factories and Creameries in Canada.

WINDSOR SALT WORKS, WINDSOR, ONT.

W. & F. P. Currie & Co.

WHOLESALE GENERAL MERCHANTS,

100 Grey Nun St., MONTREAL

IMPORTERS of Scotch Glazed Drain Pipes, Chimney Tops, Vent Linings, Flue Covers, Fire Bricks, Fire Clay, Portland Cement, Roman Cement, Canada Cement, Water Lime, Whiting, Plaster of Paris, Borax, China Clay, etc., etc.

MANUFACTURERS OF

Bessemer Steel Sofa, Chair and Bed Springs.

A LARGE STOCK ALWAYS ON HAND.

WM. CURRIE 7-y-o F. P. CURRIE

GRATEFUL-COMFORTING. EPPS'S COCOA BREAKFAST-SUPPER.

"By a thorough knowledge of the natural laws which govern the operations of digestion and nutrition, and by a careful application of the fine properties of well-selected Cocoa, Mr. Epps has provided for our breakfast and supper a delicately flavored beverage which may save us many heavy doctors' bills. It is by the judicious use of such articles of diet that a constitution may be gradually built up until strong enough to resist every tendency to disease. Hundreds of subtle maladies are floating around us ready to attack wherever there is a weak point. We may escape many a fatal shaft by keeping ourselves well fortified with pure blood and a properly nourished frame." *Civil Service Gazette.*

Made simply with boiling water or milk. Sold only in packets, by Grocers, labelled thus: JAMES EPPS & CO., Ltd. Homeopathic Chemists, London, England.

BOYS FOR FARM HELP

The managers of Dr. Barnardo's Homes will be glad to receive applications from farmers or others for the boys whom it is proposed to send out from England in several parties during the coming season. All the young immigrants will have passed through a period of training in the English Homes, and will be carefully selected with a view to their moral and physical suitability for Canadian life. Full particulars, as to the terms and conditions upon which the boys are placed, may be obtained on application to MR. ALFRED B. OWEN, Agent, Dr. Barnardo's Homes, 214 Farley Ave., Toronto. 4-v-o

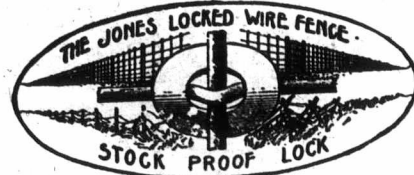

Read Its Advantages!

Our Fence contains all the claims made by other companies, besides having the following exclusive points:—

Highest award at the World's Fair; more weight; more strength; heaviest stay; greatest supporting qualities; the only diagonal brace (secured in the lock); no remnants; repairing of old fences; equal strain on all wires over grades; requires less capital; can build high or low, close or open; the "Missing Link," the Jones Flexible Clamp. Write for Catalogue. Agents wanted in unrepresented districts.

THE LOCKED-WIRE FENCE CO. (Ltd.), Ingersoll, Ont.

LIFE-GIVING COLIC DRAUGHT FOR HORSES.

Directions for Use.—As speedily as possible after the animal is attacked with COLIC, GRIPES, or SPASMS, give this draught in half a pint of cold water; if relief is not obtained in half an hour, repeat the dose, which proves effectual.

It is of the highest value in CHILL, a state of the animal which, if not prevented, frequently terminates in either INFLAMMATION OF THE LUNGS, BRONCHITIS, PLEURISY, or RHEUMATISM.

PRICE, 50c. AND \$1.00 PER BOTTLE. DR. WM. MOLE, 260 ADELAIDE STREET W., TORONTO, ONT.

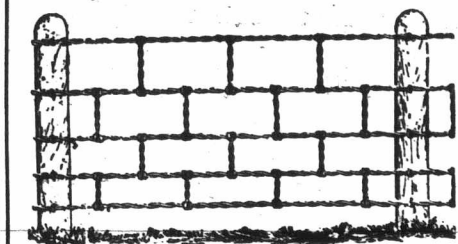

Four miles of our fence in use at Experimental Farm, Guelph. We claim we have the best and cheapest fence on earth. Send for prices.

TORONTO PICKET WIRE FENCE CO'Y, 221 RIVER STREET, TORONTO, 5-f-o ONTARIO.

E. Leonard and Sons, London, Ont.

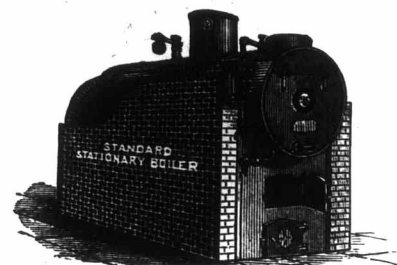

The largest manufacturers of ENGINES AND BOILERS for cheese and butter factories in Canada. We keep in stock, Steam Pumps, Injectors, Piping and Valves for complete plants. Write us for printed matter and prices.

MARINE BOILERS

Now is the time to order to secure prompt delivery. We make a specialty of boiler work, and are still taking orders at old prices notwithstanding the sharp advance in cost of material.

WATEROUS, BRANTFORD, CANADA. 1

EDMUND WELD, Barrister, Solicitor, Notary Public, Etc.

Moneys loaned on real estate, at lowest rates. Investments procured. Collections made. Address, 87 Dundas Street, London, Ont.

The Improved KNITER Family..... Will knit 15 pairs of socks a day. Will do all Knitting required in a family, homespun or factory yarn. SIMPLEST KNITER on the Market. This is the one to use. A child can operate it. We guarantee every machine to do good work. We can furnish Ribbing and Hosiery. Agents wanted. Write for particulars. Price, 98.00. Dundas Knitting Machine Co., 17-y-om Dundas, Ont.

The People's Supply

We want

All the good butter, fresh eggs, poultry, wool, etc., that the farmers of Ontario can send us; in return, we will send you either cash or goods as you may direct. We quote you a few prices; for balance, see our catalogue, sent to every farmer on application. Dried apples, 5c.; choice prunes, in 25-lb. boxes, 5c.; svp. peaches, 10c.; apricots, 15c.; pitted plums, 12c.; 5 lbs. of 25c. blend tea, \$1.00; choice Japan, 25c.; 40c. Ceylon tea for 25c.; Kaona tea, 35c.; special blend mixed, 30c. These are the best teas to be had in the city. 3-spring hair padded sweat pads, 25c.; No. 1 team harness, \$24; No. 2, \$22; single harness at all prices; 4-tug plow harness, \$16.50. For all kinds of goods see our catalogue—sent to every farmer on application.

The People's Wholesale Supply Co.

35 Colborne St., (Ltd.), TORONTO. R. Y. MANNING, Mgr.

6-f-o

The Haymaker

TRUE AS STEEL—NOTHING BETTER. SINGLE RAIL CARRIER.

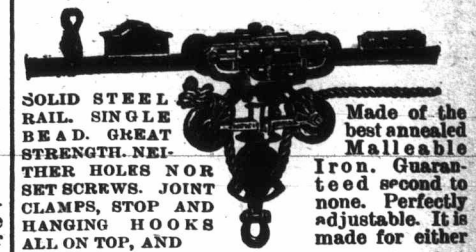

Made of the best annealed iron. Guaranteed second to none. Perfectly adjustable. It is made for either STEEL OR WOOD TRACK.

Are you going to get a WINDMILL? If so, you want THE BEST. We have them. THE GEM!!!—Solid steel wheel and tower, graphite bearings that require no oiling. Either painted or galvanized. Exceeds all others. THE CANADIAN AIR-MOTOR!!!—Solid steel wheel and tower. The best Mill for the money in Canada.

THE HALLIDAY STANDARD!—The best sectional wooden wheel ever built. Has been a complete success for 30 years.

Give us a chance to figure on your outfit. Estimates cheerfully furnished. Catalogues fully describing our Windmills, Horse Hay Tools, Spray and other pumps, etc., etc., sent free upon application.

ONTARIO WIND ENGINE & PUMP CO.

10-y-om 367 Spadina Ave., TORONTO, ONT.

STEEL SHINGLES

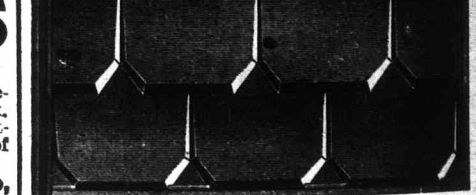

THE "EASTLAKE"—the old reliable shingle that others try to imitate. The only original shingle with a cleat! Others are imitations. Cut out and send this advertisement for price list and catalogue.

Metallic Roofing Co., Ltd.

SOLE MANUFACTURERS, TORONTO.

11-y-o

\$3 A DAY SURE. SEND your address and we will show you how to make \$3 a day absolutely sure; we furnish the work and teach you free; you work in the locality where you live. Send us your address and we will explain the business fully; remember we guarantee a clear profit of \$3 for every day's work absolutely sure; write at once. Address: IMPERIAL SILVERWARE CO., BOX D 3, WINDSOR, ONT.

ADVERTISE IN THE ADVOCATE