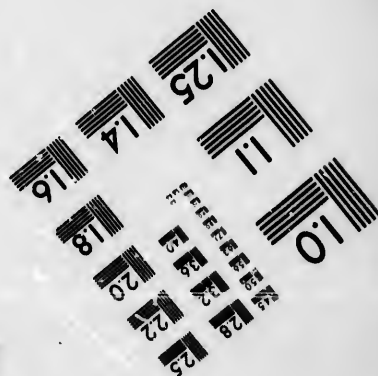
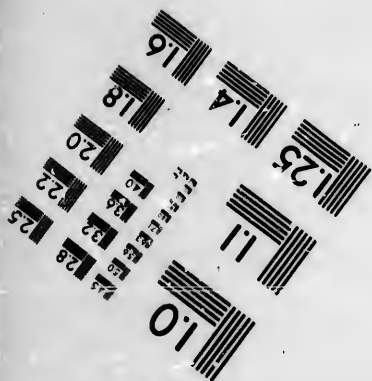
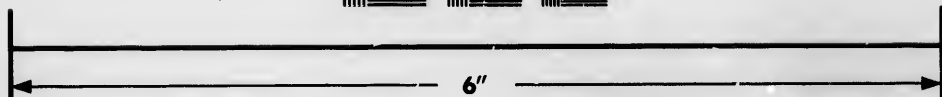
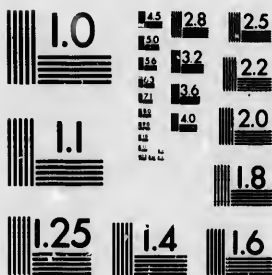

**IMAGE EVALUATION
TEST TARGET (MT-3)**



**Photographic
Sciences
Corporation**

23 WEST MAIN STREET
WEBSTER, N.Y. 14580
(716) 872-4503

**CIHM/ICMH
Microfiche
Series.**

**CIHM/ICMH
Collection de
microfiches.**



Canadian Institute for Historical Microreproductions / Institut canadien de microreproductions historiques

© 1985

Technical and Bibliographic Notes/Notes techniques et bibliographiques

The Institute has attempted to obtain the best original copy available for filming. Features of this copy which may be bibliographically unique, which may alter any of the images in the reproduction, or which may significantly change the usual method of filming, are checked below.

L'institut a microfilmé le meilleur exemplaire qu'il lui a été possible de se procurer. Les détails de cet exemplaire qui sont peut-être uniques du point de vue bibliographique, qui peuvent modifier une image reproduite, ou qui peuvent exiger une modification dans la méthode normale de filmage sont indiqués ci-dessous.

- Coloured covers/
Couverture de couleur
- Covers damaged/
Couverture endommagée
- Covers restored and/or laminated/
Couverture restaurée et/ou pelliculée
- Cover title missing/
Le titre de couverture manque
- Coloured maps/
Cartes géographiques en couleur
- Coloured ink (i.e. other than blue or black)/
Encre de couleur (i.e. autre que bleue ou noire)
- Coloured plates and/or illustrations/
Planches et/ou illustrations en couleur
- Bound with other material/
Relié avec d'autres documents
- Tight binding may cause shadows or distortion
along interior margin/
La reliure serrée peut causer de l'ombre ou de la
distorsion le long de la marge intérieure
- Blank leaves added during restoration may
appear within the text. Whenever possible, these
have been omitted from filming/
Il se peut que certaines pages blanches ajoutées
lors d'une restauration apparaissent dans le texte,
mais, lorsque cela était possible, ces pages n'ont
pas été filmées.
- Additional comments:
Commentaires supplémentaires:

- Coloured pages/
Pages de couleur
- Pages damaged/
Pages endommagées
- Pages restored and/or laminated/
Pages restaurées et/ou pelliculées
- Pages discoloured, stained or foxed/
Pages décolorées, tachetées ou piquées
- Pages detached/
Pages détachées
- Showthrough/
Transparence
- Quality of print varies/
Qualité inégale de l'impression
- Includes supplementary material/
Comprend du matériel supplémentaire
- Only edition available/
Seule édition disponible
- Pages wholly or partially obscured by errata
slips, tissues, etc., have been refilmed to
ensure the best possible image/
Les pages totalement ou partiellement
obscurcies par un feuillet d'errata, une pelure,
etc., ont été filmées à nouveau de façon à
obtenir la meilleure image possible.

This item is filmed at the reduction ratio checked below/
Ce document est filmé au taux de réduction indiqué ci-dessous.

10X	14X	18X	22X	26X	30X
<input type="checkbox"/>	<input type="checkbox"/>	<input type="checkbox"/>	<input checked="" type="checkbox"/>	<input type="checkbox"/>	<input type="checkbox"/>
12X	16X	20X	24X	28X	32X

The copy filmed here has been reproduced thanks to the generosity of:

Douglas Library
Queen's University

The images appearing here are the best quality possible considering the condition and legibility of the original copy and in keeping with the filming contract specifications.

Original copies in printed paper covers are filmed beginning with the front cover and ending on the last page with a printed or illustrated impression, or the back cover when appropriate. All other original copies are filmed beginning on the first page with a printed or illustrated impression, and ending on the last page with a printed or illustrated impression.

The last recorded frame on each microfiche shall contain the symbol \rightarrow (meaning "CONTINUED"), or the symbol ∇ (meaning "END"), whichever applies.

Maps, plates, charts, etc., may be filmed at different reduction ratios. Those too large to be entirely included in one exposure are filmed beginning in the upper left corner, left to right and top to bottom, as many frames as required. The following diagrams illustrate the method:

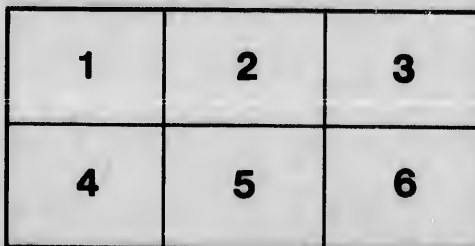
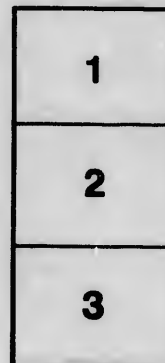
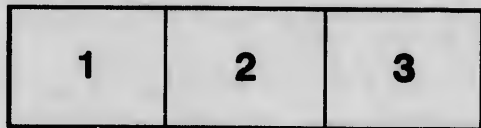

L'exemplaire filmé fut reproduit grâce à la générosité de:

Douglas Library
Queen's University

Les images suivantes ont été reproduites avec le plus grand soin, compte tenu de la condition et de la netteté de l'exemplaire filmé, et en conformité avec les conditions du contrat de filmage.

Les exemplaires originaux dont la couverture en papier est imprimée sont filmés en commençant par le premier plat et en terminant soit par la dernière page qui comporte une empreinte d'impression ou d'illustration, soit par le second plat, selon le cas. Tous les autres exemplaires originaux sont filmés en commençant par la première page qui comporte une empreinte d'impression ou d'illustration et en terminant par la dernière page qui comporte une telle empreinte.

Un des symboles suivants apparaîtra sur la dernière image de chaque microfiche, selon le cas: le symbole \rightarrow signifie "A SUIVRE", le symbole ∇ signifie "FIN".

Les cartes, planches, tableaux, etc., peuvent être filmés à des taux de réduction différents. Lorsque le document est trop grand pour être reproduit en un seul cliché, il est filmé à partir de l'angle supérieur gauche, de gauche à droite, et de haut en bas, en prenant le nombre d'images nécessaire. Les diagrammes suivants illustrent la méthode.

errata
to

pelure,
n à

32X

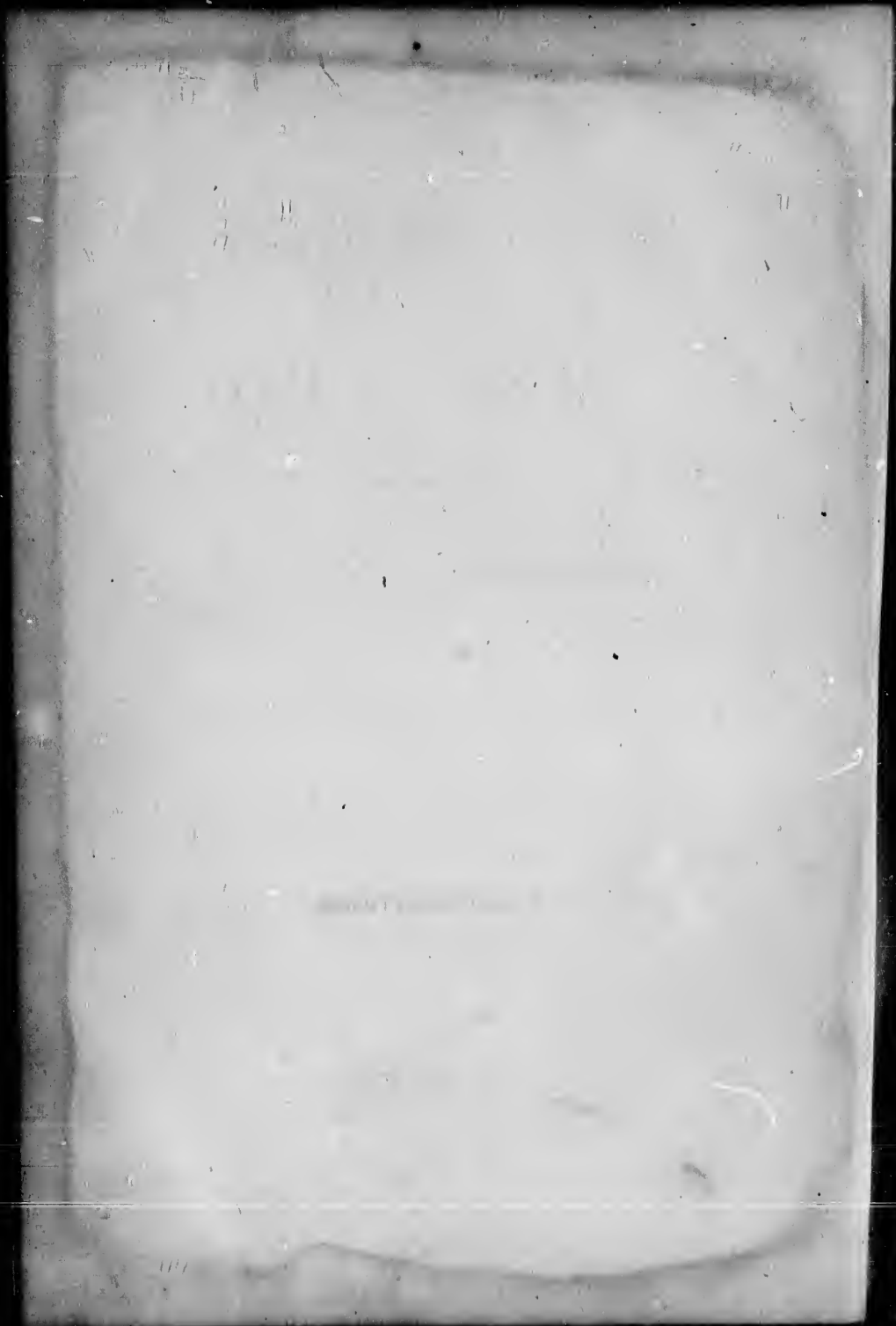

THE
SPEAKING TELEPHONE,
ELECTRIC LIGHT,

AND OTHER

RECENT ELECTRICAL INVENTIONS,

BY

GEORGE B. PRESCOTT.

WITH ILLUSTRATIONS.

NEW YORK:
D. APPLETON & COMPANY.

1879.

~~FROM THE LABORATORY OF
T. A. EDISON,
MENLO PARK, N. J.
U. S. A.~~

TK 145. P9

Entered, according to Act of Congress, in the year 1878, by

GEORGE B. PRESCOTT,

In the Office of the Librarian of Congress, at Washington.

v
v
d
e
o
p
s
m
p
g
th
sta
lea
giv
at
ev
sul
obt
we
wil
cre
hav
of
such

PREFACE.

THE object which we have had in view, in preparing this work, has been to furnish the public with a clear and accurate description of the more recent and useful improvements in electrical science, and especially to explain the principles and operation of that marvellous production, the Speaking Telephone. In giving particular prominence to this part of the subject, however, we have by no means lost sight of another matter in connection therewith, of considerable historical importance, and which has also elicited an unusual amount of general interest. The question as to whom we are indebted for the telephone is one which, in consequence of the conflicting statements that have appeared from time to time, is, to say the least, extremely puzzling. We have, therefore, endeavored to give it the attention its importance demands, in order to arrive at a true solution of the problem, and, in doing so, have taken every opportunity to consult all available authorities on the subject. No effort has been spared in our investigation to obtain all the facts as they are; and these are now given as we have found them, without favor or prejudice. The reader will thus be enabled to judge for himself just what measure of credit to accord to each of the different experimenters who have been engaged with the problem of electrical transmission of articulate speech, and whose labors have been crowned with such abundant success.

157467

Within a short time past, a very extended application of electricity to illuminating purposes has been made, both in this country and abroad, and just now public interest in this matter is very much excited. It was a long time after Davy's discovery, that the electric current was capable of producing the most brilliant light, before the thought was seriously entertained of putting this agency to practical use as a light producing power. But with the introduction of Nollet's improved magneto-electric machines the thing soon became an accomplished fact, by which the solution of the great problem is to be attained. Later and more efficient machines have rendered this application of electricity much more feasible, and to-day its field of usefulness for certain purposes is as clearly defined as that of steam itself. Whether the further introduction of electricity for domestic lighting will realize the expectations of many who are at present studying the subject, remains yet to be seen. The economical side of the problem is still a debatable subject, and one also of very general interest, so that it is not at all surprising, considering what has already been accomplished, that the public gives easy credence to many extravagant statements made with regard to it.

How much ground there may be for the anticipations of success which are so sanguinely indulged in by friends and promoters of the new light it would be difficult to say, as considerable secrecy is properly maintained in regard to the devices at present. What has been said on the general subject in the chapters on electric lighting will, however, give the reader a fair knowledge of what has already been done, and thus enable him to judge with some degree of confidence what probability of success there is in prospect in the immediate future.

FROM THE LABORATORY OF
T. A. EDISON
MENLO PARK, N. J.
U. S. A.

CONTENTS.

CHAPTER	PAGE.
I.—The Speaking Telephone.....	5
II.—Bell's Telephonic Researches.....	50
III.—The Telephone Abroad.....	83
IV.—History of the Production of Galvanic Music.....	110
V.—Gray's Telephonic Researches.....	151
VI.—Edison's Telephonic Researches.....	218
VII.—Electro-Harmonic Telegraphy.....	235
VIII.—Dolbear's Telephonic Researches.....	260
IX.—Improvements of Channing, Blake and others.....	274
X.—The Talking Phonograph.....	292
XI.—Quadruplex Telegraphy.....	309
XII.—Electric Call Bells.....	375
XIII.—The Electric Light.....	400
XIV.—The Electric Light.....	429
XV.—Edison's Recent Telephonic and Acoustic Inventions.....	526
XVI.—Duplex Telegraphs, Electro-Magnets and Electric Time Service....	588

u
m
th
G
ve
th
fo

en
su
gra
by
fro
cell
bet
dec
the
obs
the

In
defle

INTRODUCTION.

WHEN Franklin drew from the clouds the electric spark upon the cord of his kite, it seemed obvious that electricity might be made use of for the purpose of telegraphy; and more than one hundred years ago Lesage established a telegraph in Geneva by the use of frictional electricity. But this force had very little power when transmitted over a long distance, and that little was practically uncontrollable, and therefore useless for telegraphy.

When galvanism was discovered, at the beginning of the present century, and the voltaic battery invented, it was at once supposed that this new form of electricity might work a telegraph, and ten years later the chemical telegraph was invented by Coxe, in Philadelphia. Under this system, the two wires from a galvanic battery were made to approach each other in a cell of water. When the galvanic circuit was closed, the water between the opposite poles, which were near each other, was decomposed, and a bubble of hydrogen rose to the surface, as the bubble from champagne does in the wine cup; and the observer, seeing it, knew that a current was passing, and that the bubble was the signal. But it was evanescent

“—— like snow falls in the river,
A moment white, then melts forever.”

In 1820, Oersted discovered that an electric current would deflect a magnetic needle, and Arago and Davy simultaneously

discovered that a piece of iron, surrounded by a spiral wire through which a current of galvanism passed, would become magnetic. From this fact Ampère deduced the hypothesis that magnetism is the circulation of currents of electricity at right angles to the axis joining the two poles of the magnet. That was a brilliant deduction; but no practical result was produced from it until 1825, when the first simple electro-magnet was made by Sturgeon, who bent a piece of wire into the shape of a horseshoe, and wound a fine wire around it in a helix, through which the galvanic current passed; and he found that the horseshoe wire was magnetic as long as the current flowed. Then at once an attempt was made with Sturgeon's magnet to produce the electro-magnetic telegraph, but without success. The difficulty was that the magnetic power could not be transmitted from the battery for more than fifty feet with Sturgeon's magnet, which was, therefore, entirely useless for the purposes of a telegraph; and, in 1829, Professor Barlow published a scientific demonstration in England, which was accepted by the scientific world, that an electro-magnetic telegraph was impossible; which was true in the then state of knowledge.

In 1830, Professor Henry deduced from the hypothesis of Ampère the invention now known as the compound electro-magnet. He also answered the demonstration of Barlow, and proved that the electro-magnetic telegraph was possible. In the same year he set up an electro-magnetic telegraph in Albany, over a line of a mile and a half in length, using a polarized relay, the armature of which was pivoted so as to vibrate between its poles as the current of electricity was reversed, thus transmitting intelligence by sound.

In 1831, Professor Faraday made known his discovery of the phenomenon of magnetic induction.

In 1834, Gauss and Weber constructed a line of telegraph, containing about 15,000 feet of wire, which was operated by the magneto-electric currents generated in a coil of wire when the latter was moved up or down upon a permanent magnet, around which it was placed. The slow oscillations of a magnetic needle, caused by the passage of the current, and which were observed through a glass, furnished the signals for correspondence. Sir William Thomson has since greatly improved the latter apparatus, and thereby given us the beautifully sensitive mirror galvanometer which bears his name.

In 1837, Steinheil discovered the important fact that the earth would serve as a conductor, thereby saving one wire in forming a circuit: Cooke invented his electro-magnetic semaphore, known as the needle telegraph, in which needles swing upon the face of a dial, just as the vanes of the old semaphores swung on the hill tops: Morse invented his electro-magnetic telegraph, which he put in operation between Baltimore and Washington in 1844: and Page discovered that a musical sound accompanies the disturbance of the magnetic forces of a steel bar, when poised or suspended so as to exhibit acoustic vibrations.

In 1861, Reiss discovered that a vibrating diaphragm could be actuated by the human voice so as to cause the pitch and rhythm of vocal sounds to be transmitted to a distance, and reproduced by electro-magnetism.

In 1872, Stearns perfected a duplex system, whereby two communications could be simultaneously transmitted over one wire; and, in 1874, Edison invented a quadruplex system for the simultaneous transmission of four communications over the same conductor.

In 1874, Gray invented a method of electrical transmission by means of which the intensity of the tones, as well as their pitch

and rhythm, could be reproduced at a distance; and subsequently conceived the idea of controlling the formation of electric waves by means of the vibrations of a diaphragm capable of responding to all the tones of the human voice, thus solving the problem of the transmission and reproduction of articulate speech over an electric conductor.

In 1876, Bell invented an improvement in the apparatus for the transmission and reproduction of articulate speech, in which magneto-electric currents were superposed upon a voltaic circuit, and actuated an iron diaphragm attached to a soft iron magnet.

During the same year, Dolbear conceived the idea of substituting permanent magnets in place of the electro-magnets and battery previously employed, and of using the same instrument for both sending and receiving, instead of employing instruments of different construction, as had been previously done.

In 1877, Edison applied to the telephone the discovery made by himself a few years before, of the variation of resistance which carbon and certain other semiconductors undergo when subjected to a change of pressure. By this means he not only succeeded in varying the strength of the battery current in unison with the rise and fall of the vocal utterances, but, at the same time, also obtained louder articulation.

Did not Berliner
do this first?

THE
SPEAKING TELEPHONE AND ELECTRIC LIGHT.

CHAPTER I

THE SPEAKING TELEPHONE.

The Speaking Telephone, a recent American invention, which at the present moment is exciting the wonder and admiration of the civilized world, is a device for transmitting to a distance, over an electric circuit, and accurately reproducing at any desired place, various kinds of sounds, including those of the human voice. The function of the telephone is analogous to that of a speaking tube capable of almost infinite extension, through which conversation may be carried on as readily as with persons in the same room.

Before proceeding to give a description of the apparatus employed for communicating or reproducing articulate speech at a distance by the telephone, it will be well to devote some consideration to the process by which the ear distinguishes the vibrations of a particular tone, or the aggregate of the vibrations of all the tones which simultaneously act upon it, for by this means we may be enabled to ascertain the conditions under which the transmitting and receiving apparatus must act in order to effect the desired result.

It is well known that the sensation which we call sound is excited by the action of the vibrations of the atmosphere upon the tympanum or drum of the ear, and that these vibrations are conveyed from the tympanum to the auricular nerves in the interior parts of the ear, by means of a mechanical apparatus of wonderful delicacy and precision of action, consisting of a series of bones termed respectively the hammer, anvil and stirrup. In the process of reproducing tones by electro-magnetism, an artificial imitation of the mechanism of the human ear is employed, consisting of a stretched membrane or diaphragm corresponding to the tympanum, which by its vibrations generates and controls

an electric circuit extended to a distant station by a metallic conductor.

If we analyze the process by which the ear distinguishes a simple sound, we find that a tone results from the alternate expansion and condensation of an elastic medium. If this process takes place in the medium in which the ear is situated, namely, the atmosphere, then at each recurring condensation the elastic membrane or tympanum will be pressed inward, and these vibrations will be transmitted, by the mechanism above referred to, to the auricular nerves.

The greater the degree of condensation of the elastic medium in a given time, the greater is the amplitude of the movement of the tympanum, and consequently of the mechanism which acts upon the nerves. Hence it follows that the function of the human ear is the mechanical transmission to the auditory nerves of each expansion and contraction which occurs in the surrounding medium, while that of the nerves is to convey to the brain the sensations thus produced. A series of vibrations, a definite number of which are produced in a given time, and of which we thus become cognizant, is called a tone.

The action which has thus reached our consciousness, being a purely mechanical one, may be rendered much more easy of comprehension by graphical delineation. If, for example, we assume the horizontal line *a b* to represent a certain period of time, let the curves extending above the line *a b* represent the

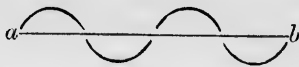

successive condensations (+), and the curves below the line the successive expansions (—), then each ordinate represents the degree of condensation or expansion at the moment of time corresponding to its position upon the line *a b* and also the amplitude of the vibrations of the tympanum.

A simple musical tone results from a continuous, rapid and uniformly recurring series of vibrations, provided the number of

complete vibrations per second falls within certain limits. If, for example, the vibrations number less than seven or eight per second, a series of successive noises are heard instead of a tone, while if their number exceeds forty thousand per second, the ear becomes incapable of appreciating the sound.

The ear distinguishes three distinct characteristics of sound:

1. The tone or pitch, by virtue of which sounds are high or low, and which depends upon the rapidity of the vibratory movement. The more rapid the vibrations the more acute will be the sound.
2. The intensity, by virtue of which sounds are loud or soft, and which depends upon the amplitude of the vibrations.
3. The quality, by which we are able to distinguish a note sounded upon, for example, a violin, from the same note when sounded upon a flute. By a remarkable series of experimental investigations Helmholtz succeeded in demonstrating that the different qualities of sounds depend altogether upon the number and intensity of the overtones which accompany the primary tones of those sounds. The different characteristics of sound may be graphically represented and the phenomena thus rendered more easy of comprehension.

In fig. 1, for example, let the lines \bar{c} 8 represent a certain length of time, and the continuous curved line the successive vibrations producing a simple tone. The curves above the line represent the compression of the air, and those below the line its rarefaction; the air, an elastic medium, is thus thrown into vibrations which transmit the sound waves to the ear. The ear is unable to appreciate any sensations of sound other than those produced by vibrations, which may be represented by curves similar to that above described. Even if several tones are produced simultaneously, the elastic medium of transmission is under the influence of several forces acting at the same time, and which are subject to the ordinary laws of mechanics. If the different forces act in the same direction the total force is represented by their sum, while if they act in opposite directions, it is represented by the difference between them.

In fig. 1 three distinct simple tones, *c*, *g* and *e* are represented, the rapidity of the vibrations being in the proportion of 8, 6 and 5. The composite tone resulting from the simultaneous production of the three simple tones is represented graphically by the fourth line, which correctly exhibits to the eye the effect pro-

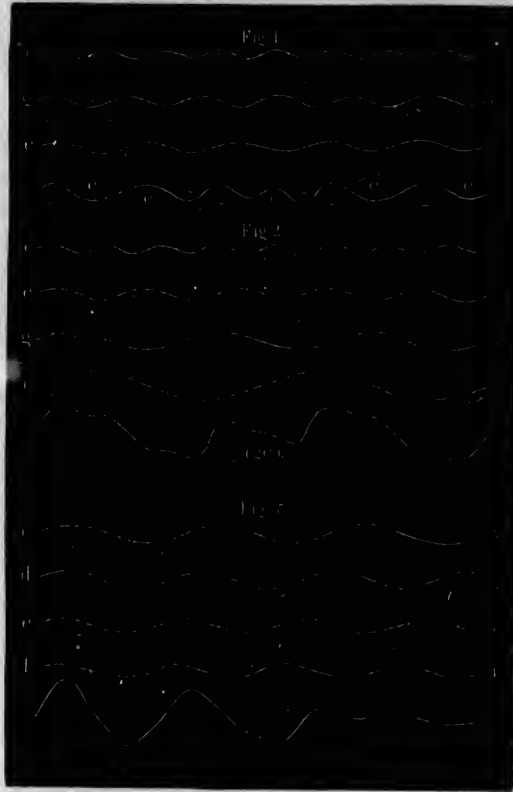

Figs. 1, 2, 3.

duced upon the ear by the three simultaneously acting simple tones.

Fig. 2 represents a curve formed of more than three tones, in which the relations do not appear so distinctly, but a musical

expert will readily recognize them, even when it would be difficult in practice for him to distinguish the simple tones in such a chord.

This method of showing the action of tones upon the human ear possesses the advantage of giving the clearest illustration possible of the entire process.

We may even understand by reference to fig. 3 why it is that the ear is so disagreeably affected by a discord.

It will be observed that the curves in the diagram represent the three characteristics of sound which have been referred to. The pitch is denoted by the number of vibrations or waves recurring within a given horizontal distance; the intensity by the amplitude of the vibrations—that is their comparative height above or depth below the horizontal line—and the quality by the form of the waves themselves. It is, therefore, easy to understand that if, by any means whatever, we can produce vibrations whose curves correspond to those of a given tone or a given combination of tones, the same impression will be produced upon the ear that would have been produced by the original tone, whether simple or composite.

The earliest experiments in the production of musical sounds at a distance, by means of electro-magnetism, appear to have been made in 1861 by Philip Reiss, of Friedrichsdorf, Germany. His apparatus was constructed in the manner shown in fig. 4.

A is the transmitting and B the receiving apparatus, which are supposed to be situated at different stations. For the sake of clearness, the appliances by which the apparatus is arranged for reciprocal transmission in one direction or the other have been omitted. Furthermore, it may be well to state that, as the apparatus was constructed merely for the purpose of making known to a wider circle the discoveries which had thus far been made, the possibility of extending the action of the apparatus to a distance beyond the limit of the direct action of the current had not been taken into consideration. This is a mere question of mechanical construction, and has no especial bearing upon the phenomena under consideration. The tone transmitter A, figure 4,

esented,
of 8, 6
ous pro-
ally by
ect pro-

simple

tones,
musical

is on the one hand connected by a metallic conductor with the tone receiver B at the distant station, and on the other with the battery C and the earth, or the return conductor. It consists of

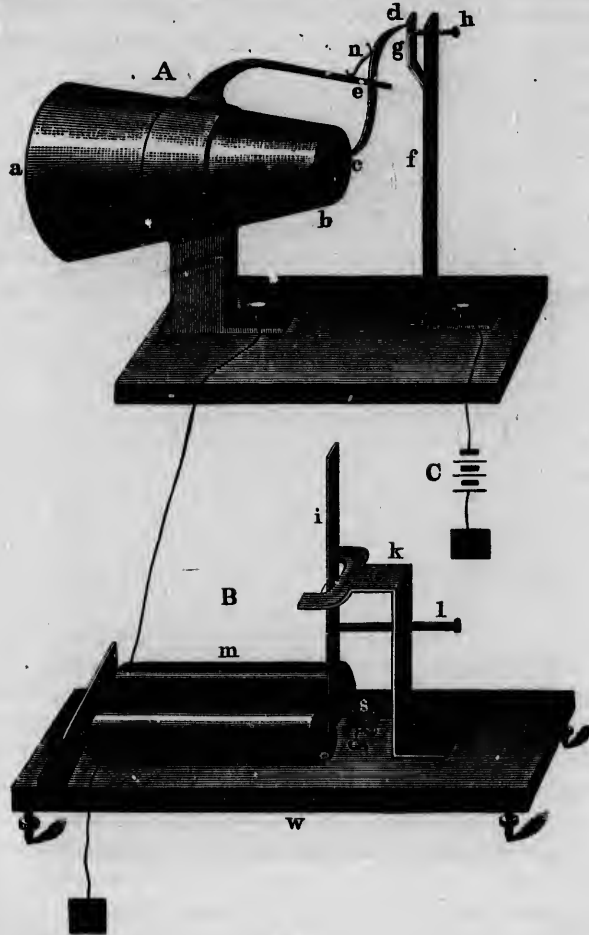

Fig. 4.

a conical tube, *a b*, about 6 inches in length, and having a diameter of 4 inches at the larger and $1\frac{1}{2}$ inches at the smaller end.

It was found by experiment that the material of which the tube was constructed had no influence upon the action of the apparatus, and the same is true as to its length. An increase in the diameter of the tube was found to impair the effect. The inner surface of the tube should be made as smooth as possible. The smaller or rear end of the tube is closed by means of a collodion membrane, *o*, against the centre of which rests one extremity, *c*, of the lever *c d*, which lever is in electrical connection with the metallic conducting wire through its point *e* and supporting bracket. The proper length and proportion to be given to the respective arms *c e* and *d e* of the lever *c e d* is determined by mechanical considerations. It is advisable that the length of the arm *c e* should be greater than that of *d e*, so as to produce the necessary movement at *c* with the least possible exertion of force at *d*. The lever itself should be made as light as possible; in order that it may follow with certainty the movements of the membrane, as any inaccuracy in this respect will give rise to a false tone at the receiving station. When the apparatus is in a state of rest the contact at *d g* is closed; a delicate spring *n* maintains the lever in this position. The metallic standard *f* is connected with one pole of the battery *C*, the other pole of which is connected to the earth, or to the return wire leading to the other station. A flat spring *g* is attached to the standard *f*, and is provided with a contact point corresponding to that at *d* upon the lever *c d*. The position of this contact point may be adjusted by means of a screw *h*.

In order to prevent the interference occasioned by the action of the sonorous vibrations of the atmosphere upon the back side of the membrane, when making use of the apparatus, it is advisable to place a disk about twenty inches in diameter upon the tube *a b*, in the form of a collar or flange, at right angles to its longitudinal axis.

The tone receiver *B*, fig. 4, consists of an electro-magnet *m*, mounted upon a sounding box or resonator *w*, and included in the circuit of the electrical conductor from the transmitting station. Facing the poles of the electro-magnet is an armature

which is attached to a broad but thin and light plate, *i*, which should be made as long as possible. The lever and armature are suspended from the upright support *k*, in the manner of a pendulum, its motion being regulated by the adjusting screw *l* and the spring *s*.

In order to increase the volume of sound, the tone receiver may be placed at one of the focal points of an elliptical chamber of suitable size, while the ear of the listener is placed at the other focal point.

The operation of the apparatus is as follows: When the different parts are in a state of rest the electric circuit is closed. If an alternate condensation and rarefaction of the air in the tube *a b* is produced by speaking, singing, or playing upon a musical instrument, a corresponding motion is communicated to the membrane, and from thence to the lever *c d*, by which means the electric circuit is alternately opened and closed at *d g*, each condensation of the air in the tube causing the circuit to be broken, and each rarefaction in like manner causing it to be closed. Thus the electro-magnet *m m*, of the apparatus at B, becomes demagnetized or magnetized, according to the alternate condensations and rarefactions of the body of air contained in the tube *a b*, and consequently the armature of the electro-magnet is thrown into vibrations corresponding to those of the membrane in the transmitting apparatus. The plate *i*, to which the armature is attached, transmits the vibrations of the latter to the surrounding atmosphere, which in turn conveys them to the ear of the listener.

It must however be admitted, that while the apparatus which has been described reproduces the original vibrations with perfect fidelity, so far as their number and interval is concerned, it cannot transmit their intensity or amplitude. The accomplishment of this latter result had to await the further development of the invention.

It was in consequence of this defect in the apparatus that the more inconsiderable differences of the original vibrations were distinguished with great difficulty—that is to say, the vowel

sounds were heard with more or less indistinctness, for the reason that the character of each tone depends not merely upon the number of the sonorous vibrations, but upon their intensity or amplitude also. This also accounts for the observed fact that while chords and melodies were transmitted and reproduced with a surprising degree of accuracy, single words, as pronounced in reading or speaking, were but indistinctly heard, although in this case, also, the inflections of the voice, interrogative, exclamatory, etc., could be distinguished without difficulty.

Figure 5 illustrates another form of Reiss's apparatus.

A is a hollow wooden box, provided with two apertures, one at the top and the other in front. The former is covered with a membrane S, such as a piece of bladder, tightly stretched in a

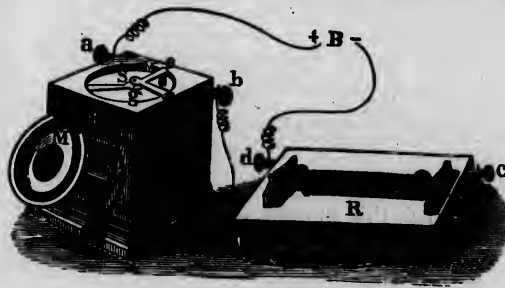

Fig. 5.

circular frame. When a person sings into the mouthpiece M, which is inserted in the front opening, the whole force of his voice is concentrated on the tight membrane, which is thrown into vibrations corresponding exactly with the vibrations of the air produced by the sound of the singing. A thin piece of platinum is glued to the centre of the membrane and connected with the binding screw *a*, in which a wire from the battery B is fixed. Upon the membrane rests a little tripod *efg*, of which the feet *e* and *f* rest in metal cups upon the circular frame over which the skin is stretched. One of them, *f*, rests in a mercury cup connected with the binding screw *b*. The third foot, *g*, consisting of a platinum contact point, lies on the strip of plati-

num which is placed upon the centre of the vibrating membrane and hops up and down with it. By this means the closed circuit which passes through the apparatus from *a* to *b* is momentarily broken for every vibration of the membrane. The receiving instrument R consists of a coil or helix, enclosing an iron rod and fixed upon a hollow sounding box, and is founded on the fact, first investigated by Professor Joseph Henry, that iron bars, when magnetized by means of an electric current, become slightly elongated, and at the interruption of the current are restored to their normal length. In the receiving instrument these elongations and shortenings of the iron bar will succeed each other with precisely the same interval as the vibrations of the original tone, and the longitudinal vibrations of the bar will be communicated to the sounding box, thus being made distinctly audible at the receiving station.

It will be seen that the result produced by these devices is not the veritable transmission of sound by means of the electric current, but is simply a reproduction of the tones at some other point, by setting in action at this point a similar cause, and thereby producing a similar effect.

It is obvious that **this apparatus**, like the one previously described, is **capable** of producing only one of the three characteristics of sound, viz, its pitch. It cannot produce different degrees of intensity or other qualities of tones, but merely sings the melodies transmitted with its own voice, which is not very unlike that of a toy trumpet. Referring to the graphic representation of the composite tone in fig. 1, this apparatus would reproduce the waves at properly recurring intervals, but they would all be of precisely the same amplitude or intensity, for the reason that they are all produced by an electric current of the same strength.

In the spring of 1874 Mr. Elisha Gray, of Chicago, invented a method of electrical transmission by means of which the intensity of the tones, as well as their pitch, was properly reproduced at the receiving station. This was a very important discovery—in fact, an essential prerequisite to the development of

the telephone, both in respect to the reproduction of harmonic musical tones and of articulate speech, as it enabled any required number of different tones to be reproduced simultaneously without destroying their individuality.

In this method the transmitters were so arranged that a separate series of electrical impulses of varying strength as well as rapidity passed into the line, thus reproducing at the distant end the intensities of the vibrations, corresponding to the graphic representation on the fourth or bottom line of fig. 1. By this means a tune could be reproduced at any distance with perfect accuracy, including its pitch and varying intensity as well as quality of sound. With a receiving instrument consist-

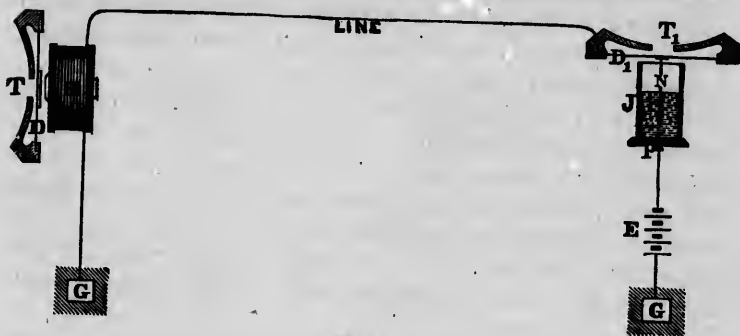

Fig. 6.

ing of an electro-magnet, having its armature rigidly fixed to one pole, and separated from the other by a space of $\frac{1}{4}$ of an inch, and mounted upon a hollow sounding box, which, like that of a violin, responded to all vibrations which were communicated to it, the tones became very loud and distinct.

Subsequently Mr. Gray conceived the idea of controlling the formation of what may be termed the electric waves, as represented in the diagram, figs. 1, 2 and 3, by means of the vibrations of a diaphragm capable of responding to sounds of every kind traversing the atmosphere, so arranged as to reproduce these vibrations at a distance. When this was accomplished, the problem of the transmission and reproduction of articulate speech over an electric conductor was theoretically solved.

The principle and mode of operation of Gray's original telephone are shown in the accompanying fig. 6. The person transmitting sounds speaks into the mouthpiece T¹. D¹ is a diaphragm of some thin substance capable of responding to the various complex vibrations produced by the human voice. To the centre of the diaphragm one end of a light metallic rod, N, is rigidly attached, the other extending into a glass vessel J, placed beneath the chamber. This vessel, whose lower end is closed by a metallic plug, P, is filled with slightly acidulated water, or some other liquid of the same specific resistance, and the metallic plug or end placed in connection with one terminal of an electric circuit, the other end being joined by a very light wire to the rod N, near the diaphragm. It will thus be seen that the water in the vessel forms a part of the circuit through which the current from a battery placed in this circuit will pass. Now, as the excursions of the plunger rod vary with the amplitude of the several vibrations made by the diaphragm to which it is attached, as well as with the rapidity of their succession, it will readily be seen that the distance, and consequently the resistance to the passage of the current, between the lower end of the rod and the metallic plug, must vary in a similar manner, and this produces a series of corresponding variations in the strength of the battery current.

The receiving apparatus consists simply of an electro-magnet, H, and armature, a diaphragm, D, and a mouthpiece, T. The soft iron armature which is attached to the diaphragm stands just in front of the electro-magnet; consequently, when the latter acts, it does so in obedience to current pulsations, which have all the characteristics of the vibrating diaphragm D, and thus, through the additional intermediary of the soft iron, the vibrations produced by the voice in T are communicated to the diaphragm T of the receiving apparatus, and thus sounds of every character, including all the tones of the human voice, are reproduced with absolute fidelity and distinctness.

In the summer of 1876 Professor A. G. Bell, of the Boston University, exhibited at the Centennial Exhibition, in Phila-

delphia, a telephonic apparatus, differing somewhat in its details from that just described, by which articulate speech could be transmitted over an electric circuit, and reproduced at a distance with some degree of distinctness.

The principle of his method is illustrated in fig. 7. A represents the transmitting and B the receiving apparatus. When a person speaks into the tube T, in the direction of the arrow, the acoustic vibrations of the air are communicated to a membrane tightly stretched across the end of the tube, upon which is cemented a light permanent bar magnet *n s*. This is in close proximity to the poles of an electro-magnet M, in the circuit of the line, which is constantly charged by a current from the battery E. The vibrations of the magnet *n s* induce

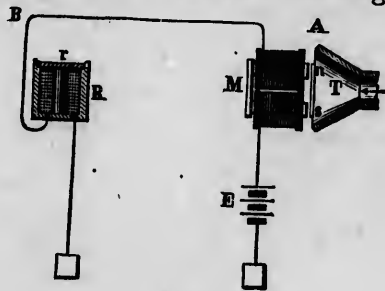

Fig. 7.

magneto-electric pulsations in the coils of the electro-magnet M, which traverse the circuit, and the magnitude of these pulsations is proportional to the rapidity and amplitude of the vibrations of the magnet; thus, for instance, when the small permanent magnet is made to move toward M, a current of electricity will be induced in the coils, which will traverse the whole circuit. This induced electricity will consist of a single wave or pulse, and its force will depend upon the velocity of the approach of *n s* to M. A like pulse of electricity will be induced in the coils when *n s* is made to move away from M; but this current will move through the circuit in an opposite direction, so that whether the pulsation goes from A to B or from B to A, depends simply upon the direction of the motion of *n s*.

The electricity thus generated in the wire by such vibratory movements varies in strength, as already observed, with the variations in the movement of the armature; the line wire between two places will, therefore, be filled with electrical pulsations exactly like the aerial pulsations in structure.

These induced electric currents are very transient, and their effect upon the receiver R is either to increase or decrease the power of the magnet there, as they are in one direction or the other, and consequently to vary the attractive power exercised upon the iron plate armature.

Let a simple sound be made in the tube, consisting of 256 vibrations per second; the membrane carrying the iron will vibrate as many times, and so many pulses of induced electricity will be imposed upon the constant current, which will each act upon the receiver, and cause so many vibrations of the armature upon it; and an ear held near *r* will hear the sound with the same pitch as that at the sending instrument. If two or more sound waves act simultaneously upon the membrane, its motions must correspond with such combined motion; that is, its motion will be the resultant of all the sound waves, and the corresponding pulsations in the current must reproduce at B the same effect. Now, when a person speaks in the tube, the membrane is thrown into vibrations more complex in structure than those just mentioned, differing only in number and intensity. The magnet will cause responses from even the minutest motion, and, therefore, an ear near *r* will hear what is said in the tube. Consequently, this apparatus is capable of transmitting both the pitch and intensity of the tones which enter the tube T. The receiving instrument consists simply of a tubular electro-magnet R, formed of a single helix with an external soft iron case, into the top of which is loosely fitted the iron plate *r*, which is thrown into vibrations by the action of the magnetizing helix. The sounds produced in this manner were quite weak, and could be transmitted but a short distance; but the mere accomplishment of the feat of transmitting electric impulses over a metallic wire which should reproduce articu-

late speech, even in an imperfect manner, at the farther end, excited great interest in a scientific as well as popular point of view, throughout the civilized world.

During the ensuing autumn some important changes in the telephone were effected, whereby its articulating properties were greatly improved. Professor A. E. Dolbear, of Tufts College, observing that the actual function of the battery current with which the line was charged in Bell's method had simply the effect of polarizing the soft iron cores of the transmitting and receiving instruments, or of converting them into permanent magnets, and that the mere passage of the constant voltaic current over the line had nothing to do with the result, conceived the idea of maintaining the cores in a permanently magnetic or polarized state by the inductive influence of a permanent mag-

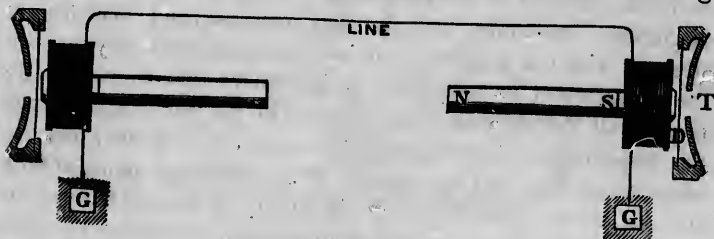

Fig. 8.

net instead of by a voltaic current. He therefore substituted permanent magnets with small helices of insulated copper wire surrounding one or both poles, in place of the electro-magnets and battery previously employed.

Another important improvement made by him consisted in using the same instrument for both sending and receiving instead of employing instruments of different construction, as all previous inventors had done.

The principle and mode of operation of the improved apparatus is represented in figure 8.

It consists of an ordinary permanent bar magnet, N S, a single helix, H, of insulated copper wire placed upon one end of the magnet, and a metallic diaphragm, D, consisting of a disk of thin

sheet iron, two and a quarter inches in diameter and one fiftieth of an inch thick, forming an armature to the magnet, N S. The vibratory motions of the air produced by the voice or other cause are directed towards and concentrated upon the diaphragm, D, by means of a mouthpiece, T. It will thus be seen that when vibrations are communicated to the air in front of the mouthpiece the impact of the waves of air against the elastic diaphragm will cause a corresponding movement of the latter. This in turn, by reacting upon the magnet, disturbs the normal magnetic condition of the bar, and since any change of magnetism in this tends to generate electrical currents in the surrounding helix, the circuit in which the helix may be placed will be traversed by a series of electrical pulsations or currents. Moreover, as these currents continue to be generated so long as the motion of the diaphragm continues, and as they increase and decrease in strength with the amplitude of its vibrations, thus varying with the variations of its amplitude, it is evident that they virtually possess all the physical characteristics of the agent acting upon the transmitting diaphragm. Consequently, by their electromagnetic action upon the magnet of an apparatus identical with the one above described, and placed in the same circuit at the receiving end, they will cause its diaphragm to vibrate in exact correspondence with that of the transmitting apparatus.

During the past year many ingenious persons have turned their attention to the subject of telephones, and by the introduction of various modifications have succeeded in greatly improving the invention, so as to make it available for practical application. Prominent among these is Mr. G. M. Phelps, mechanician of the Western Union Telegraph Company, to whose ability in the invention of valuable improvements, as well as in the scientific arrangement of details in the construction of the apparatus, the public is indebted for some of the most effective telephones yet introduced. The peculiar excellence of these instruments consists in their distinct articulation, combined with a loudness of utterance that is not often met with in the numerous other forms that have appeared up to the present time. Both of these

qualities, manifestly so desirable, are developed in these instruments in a very remarkable degree; while the distance over which they may be used is also another of their distinguishing characteristics, circuits of over one hundred miles having been worked by them with the most admirable results.

The most essential improvements introduced by Mr. Phelps consist in combining two or more vibrating diaphragms and two or more corresponding magnetic cores, enveloped in separate helices, connected in the same circuit, with a single mouthpiece or vocalizing chamber; in mounting two magnetic cores, when combined with separate diaphragms and coils, and a single mouthpiece, upon opposite poles of the same permanent magnet,

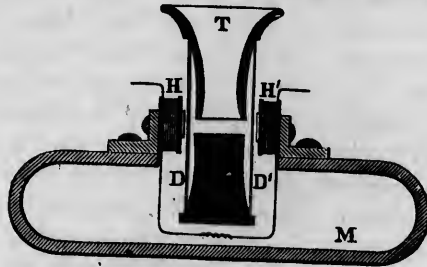

Fig. 9.

and in subdividing a single continuous induction plate into two or more separate and distinct areas of vibration, thus virtually forming two or more separate diaphragms, each of which acts or is acted upon by a separate magnetic core, to the consequent increased usefulness of the apparatus.

Figure 9 represents a form of the instrument constructed upon the above principles, which, both as regards distinctness of articulation and the facility with which it permits conversation to be carried on in consequence of the loudness of its tone, leaves little else to be desired. It consists of the permanent magnet *M* of hardened steel, which is bent into an oblong form, so as to occupy but little space, and also bring its poles conveniently near each other; two helices, *H* and *H*¹, of copper wire, placed respectively upon the north and south poles of the magnet; two

metallic diaphragms, D and D¹, and the speaking tube or mouth-piece T, which may be made of wood, metal, or such other substance as fancy may suggest. The diaphragms are placed upon opposite sides of a short cylindrical piece of hard rubber, provided with a lateral opening for the insertion of the mouth-piece, and, together with it, form a sort of chamber, within which the air is alternately condensed and rarefied, in consequence of the motion or impulses communicated to its particles by the voice when directed toward the opening of the tube. Hence, it will be seen that each condensation exerts an outward pressure of its own upon the diaphragm, while each rarefaction causes a corresponding pressure from the external air, and thus a vibratory movement is imparted to both diaphragms at one and the same instant; consequently, if the helices are so connected that the direction of the current pulsations, which are inductively produced by the vibrations of the diaphragms in the manner already explained, are similar when they become united in the line, the magnetic force, as exhibited in the receiving apparatus at the distant station, will be augmented considerably above that produced by the action of a single coil and diaphragm alone, and thereby a corresponding increase in the loudness of the sound will be produced. The best effects are obtained when instruments of this form are employed both in transmitting and receiving, the advantages they possess for the latter purpose being quite as marked as for the former, as will appear obvious enough when we consider that every time a current passes through the helices the attractive forces thereby imparted to the cores or magnet poles are such as to cause the centres of the two diaphragms to be drawn directly from each other, thus producing a much greater rarefaction of the air within the chamber than could be obtained by the action of a single diaphragm alone. A corresponding condensation, on the other hand, is produced at each cessation of the current, owing to the return of the diaphragms, in virtue of their elasticity to their normal position.

The greater the degree of condensation and rarefaction, however, the greater the amplitude of the sonorous vibrations—one

expression being the equivalent of the other—and, therefore, the greater will be the intensity or loudness of the sound produced. We might add, in this connection, that the introduction of a second helix in the line circuits presents in itself a slight disadvantage. This arises from the inductive action of the pulsatory currents upon themselves in the coils and the reactive influence of the core, whereby other and opposing currents are produced, which tend to delay; and, in part, neutralize the effects of the former. The latter are termed extra currents, to distinguish them from those produced in circuits exterior to that in which



Fig. 10.

the inducing currents are passing. As they are found to accompany all electro-magnetic action whenever one part of a circuit is brought in proximity to another, as is the case in magnet helices, it will readily be seen that they must become the more troublesome as the number of stations are increased—it being necessary to keep the vibratory bells at each station in circuits, in order that calls may be heard. By the use of condensers, consisting of alternate sheets of tin foil and paraffined paper placed around the bell coils, we are enabled to overcome the difficulty these currents would otherwise present. Con-

densers, therefore, become almost indispensable in cases where many telephones are employed in one circuit.

The instrument we have just described is made separate by itself, to be used as a transmitting or receiving instrument, or it is combined in a box represented below, with a call bell and the oval shaped telephone to be considered presently. In the latter case it is usually employed to transmit alone, while the oval form serves for receiving; it can, however, be used for either purpose.

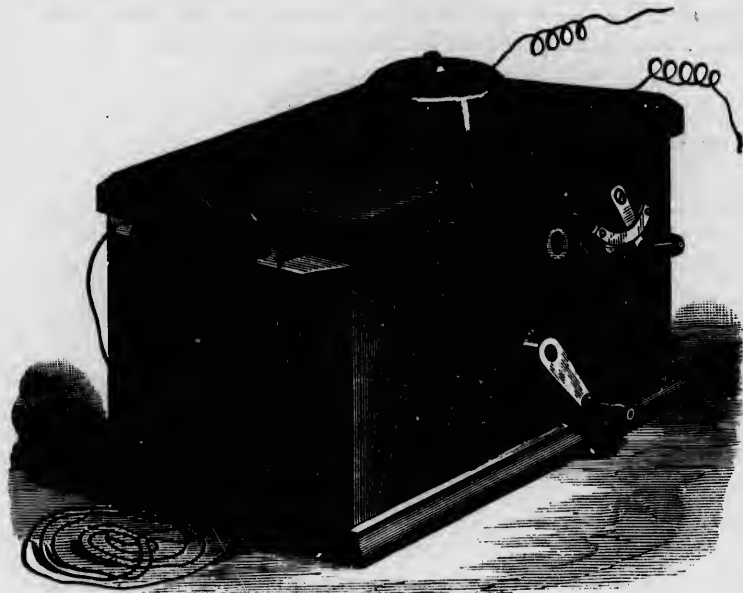

Fig. 11.

Mr. Phelps also found that the efficiency of the telephone for transmitting the human voice was much improved by reducing the cavity or chamber in which the diaphragm vibrates to the smallest practicable dimensions. Further gain was also made by cushioning the bearings of the diaphragm on both sides with rings of paper. In the form described below the diaphragms are still further cushioned on the side towards the magnets by a

ex
re
of
ne
co

number of small spiral springs, placed under a hard rubber ring which supports the diaphragm.

The value of these last named improvements lies not so much in increasing the loudness of tone as in eliminating the reverberatory quality characteristic of most of the early telephones, and which gave an unnatural and hollow sound to the voice transmitted by them.

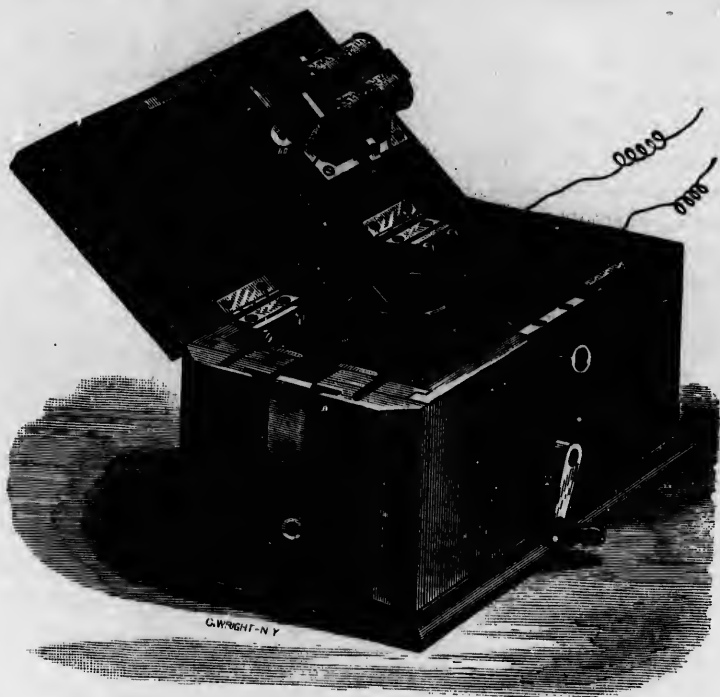

Fig. 12.

Another of the forms designed by Mr. Phelps, and now being extensively introduced by the American Telephone Company, is represented in fig. 10. It consists of a polished oval shaped case of hard rubber, with magnet, diaphragm and coils inside. In connection with this there is also a small magneto-electrical machine, contained in the oblong box shown in fig. 11, which is used for

operating a call bell when the attention of the correspondent at the distant station is required. The currents generated by this machine, when the crank is turned, are conveyed by the conducting wires through the helices of a polarized magnet, shown on the under side of the cover, fig. 12, and cause the hammer attached to the armature lever to vibrate against the bell, thus producing a violent ringing during the time the crank is turned.

By the use of polarized magnets—the latter so named on account of their armatures being permanent magnets—the armature levers are retained in a definite position, depending upon the direction of the current last sent into the line, and no retractile spring whatever is required. At the same time, also, the alternating currents produced by the magneto-electrical machine are permitted to act with their maximum power, as the repelling force exercised in one pair of coils urges the armature in the same direction as that of the attractive force in the other, and the two effects are thus added.

It is usual to supply two telephones with this apparatus—two being preferable to one—as then one can be held to the ear while the other is being used to speak into. By this means any liability of losing a word while the instrument is being passed from the mouth to the ear, supposing one only to be used, is entirely prevented, and consequently the necessity for repetition avoided.

When the telephone is not in use it is placed in a slide, as shown in fig. 11, which causes a spring, shown at the end of the box in fig. 12, to be pressed inward and cut out the instrument, leaving only the magneto machine and call bell in circuit. The spring, when in its normal position, on the other hand, cuts out the machine and call bell and leaves the telephone alone in circuit.

Fig. 13 represents a somewhat more expensive but at the same time also a more desirable combination of the telephone and its accessories. The box is intended to be fastened permanently to the wall. It contains, in addition to the extra loud telephone

with double diaphragms, which was described above, a call bell and a magneto-electric machine of improved construction. When not in use, only the call bell of this apparatus is in the main line circuit—the magneto machine, unlike that in the box just noticed, being cut out, so as to guard against accidental demagnetization of



Fig. 13.

the permanent magnet by lightning discharges, or by currents from telegraph lines when the latter are crossed or in contact with the telephone line, which is sometimes liable to occur. When we wish to send a signal, however, it is only necessary to turn the

crank of the magneto machine, shown in front of the case, and at the same time press upon the push button C, which is visible on the left. The latter movement, by a change of connection to be more fully described presently, puts the magneto machine in circuit, and thus allows the currents generated by it to pass into the line and act upon the distant call bells.

The switch near the top of the case serves for cutting the apparatus in and out of circuit. When it is turned to the right, and the telephone is in the fork or holder, as represented in the figure—in which case it presses against a button corresponding to the spring in the former box and cuts itself out of circuit—only the call bell is left in with the main line. When it is

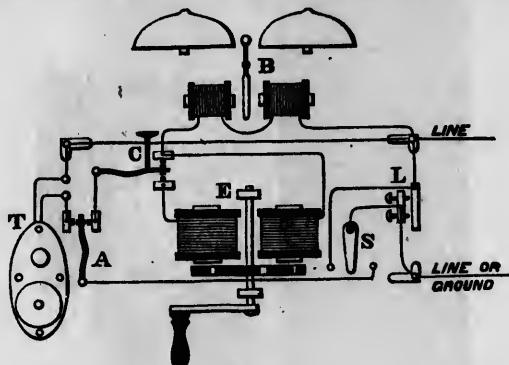

Fig. 14.

turned to the left hand or opposite side, which should always be done when left at night, all of the apparatus is cut out of circuit. A lightning arrester is provided in each box for the protection of the apparatus; but during thunder storms, and especially severe ones, it is best to cut the apparatus out of circuit altogether by means of the switch, as the best arresters sometimes fail. The accompanying diagrams, showing the internal arrangements of the different boxes, will give a much clearer understanding of the connections. Figure 14 represents the parts and connections of the improved apparatus, which is placed in a portable box, like the one shown in figure 11, without, however, the addition

of what we have called the extra loud Speaking Telephone. In the ordinary working condition of the apparatus the switch S should be placed on the button contact, shown just to the right of it, and the telephone hung in its fork, which causes the spring A to be forced against the inside contact point. The telephone and magneto machine are thus cut out of circuit, as will be seen on tracing the connections, but the call currents arriving from a distant station on the line, find a ready path

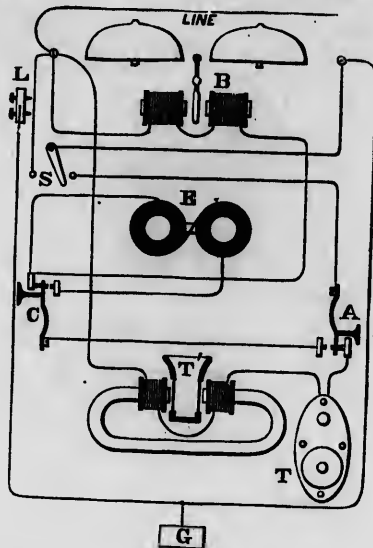

Fig. 15.

through the coils of the bell magnet B and spring below the push button C to the spring A, and thence by switch S to line again or ground, as the case may be, the final connection depending, of course, upon whether the station is located somewhere in the centre or at the terminal of the line. A call given by any one of the stations in the circuits will, therefore, be heard at all the others, as the connections at each are precisely similar. In giving the call, it is necessary, in addition to turning the crank of the magneto machine, to press against the push button

C, so as to bring the adjacent spring in contact with the little connecting piece which is metallically joined to the coils of the machine. Unless this is done no current will be sent into the line, because it is by this means alone that the inductive apparatus is placed in the circuit. When the button is down, the path opened for the current may be traced from the line terminal of the instrument by way of the bell and magneto coils to the spring beneath C; thence by way of spring A and switch S to line or ground.

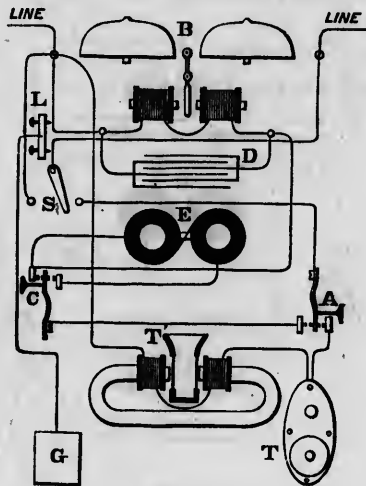

Fig. 16.

It will be obvious that the above arrangement supplies the means for giving a variety of calls in case there are several offices in one circuit; for, while turning the crank, the push button can be used, like a Morse key, to give different signals.

The removal of the telephone from its fork or holder puts it in circuit, and cuts everything else out, as will readily be seen by tracing the connections. The manner in which the apparatus is cut out of circuit, by turning the switch S on the left hand contact point, will also be seen on referring to the diagram.

Figures 15 and 16 show the internal connections and arrange-

ment of the large box, figure 15, being the arrangement for a terminal, and figure 16 that for an intermediate station. The loud speaking instrument is shown in both. Figure 16 also shows the manner of connecting the condenser D around the bell coils, so as to avoid the previously noticed inductive difficulties which present themselves when many sets of the apparatus are placed in one circuit. The lightning arrester is represented at L. It will hardly be necessary to say anything further in regard to the connections in the last two figures, as the same letters that were used in the preceding figure have been retained for corresponding parts in these, and have, therefore, been already considered.



Fig. 17.

Figure 17 represents a form of Gray's Speaking Telephone manufactured by the Western Electric Telegraph Company, of Chicago.

Figure 18 shows a section of the same, reduced to about one third the natural size, and designed to show the internal mechanism.

By referring to the latter it will be seen that the core C is fastened to the upper end of the curved metallic bar H, which serves as the handle of the telephone. The lower end of the handle is in like manner attached to the metallic brace B. To this brace is secured, by means of a stout screw, the iron rim

which holds the diaphragm; thus the core and the diaphragm form the two ends of a rigid metallic system, every part of which is of soft iron.

Around the core two helices of insulated copper wire are wound. One of these—the polarizing helix—is somewhat longer than the other, and contains wire of larger gauge. In using the telephone, this helix is connected in circuit with a local battery. The soft iron system is in consequence rendered magnetic, the end of the core exhibiting opposite polarity to that of the diaphragm confronting it.

By employing the battery current to charge the soft iron core,

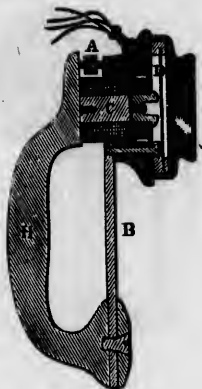

Fig. 18.

a greater degree of magnetism is thereby secured than could be obtained by the use of a permanent magnet of the same dimensions.

The difference also of magnetic potential existing between the diaphragm and the core is increased by making these respectively the opposite poles of the same magnet.

The other helix is made of very fine wire, and serves to convey to the line the undulating currents induced by the vibrating diaphragm. At any point on the line these currents may be reconverted into sound by introducing an instrument similar to the above.

In adjusting this telephone advantage is taken of the elasticity of the brace B, which has a tendency to approach the handle H. This tendency is checked and regulated by the adjusting screw A, a turn of which will cause the brace to move towards or recede from the handle; and, consequently, the diaphragm will also move to or recede from the core of the magnet.

Another of the forms devised by Mr. Gray is shown in fig. 19. In this there are two diaphragms, and no battery is used to charge the soft iron cores of the telephone, as is done in the original apparatus, the same result being obtained by the use of a permanent magnet, bent into a form like the letter U, as seen in the figure. The magnet also answers as a handle, by which



Fig. 19.

the instrument may be held conveniently. Two soft iron pieces are secured by screws to the poles of the magnet and carry helices of copper wire, which are joined together, and terminal-wires leading therefrom serve to put the instrument in circuit.

The mouthpiece, which is of metal, has two divergent tubes connecting with narrow chambers, within which separate diaphragms of thin sheet iron are placed, so as to stand just opposite the pole pieces of the magnet and in close proximity thereto. Whenever, therefore, any movement is produced in the air at the opening of the tube the resultant impulse is readily conveyed through it and its branches to the chambers, and thus communicates motion to the diaphragms. The principle of the action in

this apparatus is, of course, the same as that in the other forms of magneto telephones.

It will be observed that all the Speaking Telephones which we have described, possess certain common characteristics embodied in Mr. Gray's original discovery, and are essentially the same in principle although differing somewhat in matters of detail. All, for example, employ a diaphragm at the transmitting end capable of responding to the acoustic vibrations of the air; all employ a diaphragm at the receiving end capable of being thrown into vibrations by the action of the magnetizing helix, corresponding to the vibrations of the transmitting diaphragm; all depend for their action upon undulating electric currents produced by the vibratory motion of a transmitting diaphragm, which increases and decreases the number and amplitude of the electric impulses transmitted over the wire without breaking the circuit; and, finally, in all practically operative telephones, whether vocal or harmonic, the cores of the receiving instrument are maintained in a permanently magnetic state by the inductive action, either of a permanent voltaic current or of a permanent magnet. Repeated experiments have shown, also, that this permanent magnetic condition of the cores is absolutely essential, in order that the receiving magnet may become properly responsive to telephonic vibrations, especially when these are of great rapidity and comparatively small amplitude.

Mr. Thomas A. Edison, of Menlo Park, New Jersey, has invented a telephone, which, like that of Gray, shown in figure 6, is based upon the principle of varying the strength of a battery current in unison with the rise and fall of the vocal utterance. The problem of practically varying the resistance controlled by the diaphragm, so as to accomplish this result, was by no means an easy one. By constant experimenting, however, Mr. Edison at length made the discovery that, when properly prepared, carbon possessed the remarkable property of changing its resistance with pressure, and that the ratios of these changes moreover corresponded exactly with the pressure. Fig. 20 represents a convenient and ready way of showing the decrease in

resistance of this substance when so subjected. The device consists of a carbon disk, two or three cells of battery, and a tangent or other form of galvanometer. The carbon C is placed between two metallic plates which are joined with the galvanometer and battery in one circuit, through which the battery current is made to pass. When a given weight is placed upon the upper plate the carbon is subjected to a definite amount of pressure, which is shown by the deflection of the galvanometer needle through a certain number of degrees. As additional weight is added, the deflection increases more and more, so that by carefully noting the deflections corresponding to the gradual increase of pressure we can thus follow the various changes of resistance at our leisure. Here, then, was the solution; for,

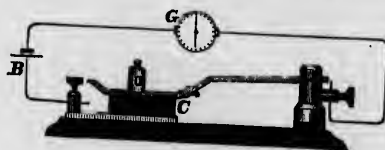

Fig. 20.

by vibrating a diaphragm with varying degrees of pressure against a disk of carbon, which is made to form a portion of an electric circuit, the resistance of the disk would vary in precise accordance with the degree of pressure, and consequently a proportionate variation would be occasioned in the strength of the current. The latter would thus possess all the characteristics of the vocal waves, and by its reaction through the medium of an electro-magnet, might then transfer them to another disk, causing the latter to vibrate, and thus reproduce audible speech.

Fig. 21 shows the telephone as constructed by Mr. Edison. The carbon disk is represented by the black portion, E, near the diaphragm, AA, placed between two platinum plates, D and G, which are connected in the battery circuit, as shown by the lines. A small piece of rubber tubing, B, is attached to the centre of the metallic diaphragm, and presses lightly against an ivory piece, C, which is placed directly over one of the platinum

plates. Whenever, therefore, any motion is given to the diaphragm, it is immediately followed by a corresponding pressure upon the carbon and by a change of resistance in the latter, as described above. The object in using the rubber just mentioned is to dampen the movement of the disk, so as to bring it to rest almost immediately after the cause which put it in motion has ceased to act; interference with articulation, which the prolonged vibration of the metal tends to produce in consequence of its

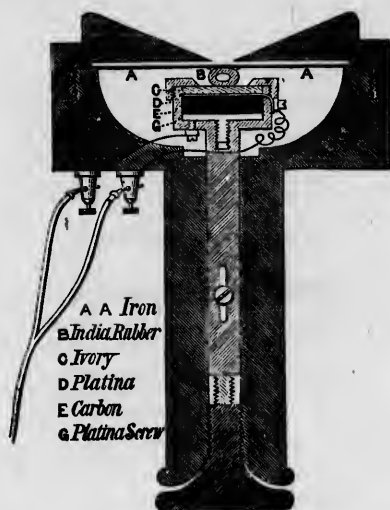

Fig. 21.

elasticity, is thus prevented, and the sound comes out clear and distinct. It is obvious that any electro-magnet, properly fitted with an iron diaphragm, will answer for a receiving instrument in connection with this apparatus.

Fig. 22 shows a sending and receiving telephone and a box containing the battery.

In the latest form of transmitter which Mr. Edison has introduced the vibrating diaphragm is done away with altogether, it having been found that much better results are obtained when a

rigid plate of metal is substituted in its place. With the old vibrating diaphragm the articulation produced in the receiver is more or less muffled, owing to slight changes which the vibrating disk occasions in the pressure, and which probably results from tardy dampening of the vibrations after having been once started. In the new arrangement, however, the articulation is

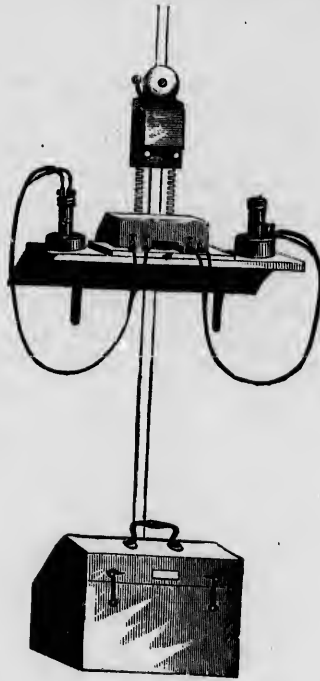

Fig. 22.

so clear and exceedingly well rendered that a whisper even may readily be transmitted and understood. The inflexible plate, of course, merely serves, in consequence of its comparatively large area, to concentrate a considerable portion of the sonorous waves upon the small carbon disk or button; a much greater degree of pressure for any given effort on the part of the speaker is thus

brought to bear on the disk than could be obtained if only its small surface alone were used.

The best substance so far discovered for these disks is lamp-black, such as is produced by the burning of any of the lighter hydrocarbons. Mr. Edison has found, however, that plumbago, hyperoxide of lead, iodide of copper, powdered gas retort carbon, black oxide of manganese, amorphous phosphorus, finely divided metals, and many sulphides may be used; indeed, tufts of fibre, coated with various metals by chemical means and pressed into buttons have also been employed, but they are all less sensitive than the lampblack, and have consequently been abandoned for the latter substance.

With the telephone, as with the ordinary telegraphic instruments, there is of course a limit beyond which the apparatus cannot be rendered practically serviceable, but in most cases this limit is sooner reached for the telephone than for other instruments that are employed for the transmission of telegraphic matter. One reason why this is so is probably due to the fact that the current pulsations generated by the vibrating diaphragm are made to follow each other with so much greater rapidity than those that are sent into the line by the ordinary hand manipulation, that less time is allowed for charging and discharging the line, and the phenomenon of inductive retardation thus becomes soonest manifest in the former case.

Another reason, however, and perhaps the principal one, is that the disturbances created by the inductive action of electrical currents in neighboring wires combine with the signals, and so confuse the latter in many cases, that it becomes altogether impossible to distinguish them. It is necessary, therefore, when we wish to speak over long distances, or over wires in close proximity to Morse lines, either to employ some means for neutralizing these disturbances, or to so increase the loudness of the articulation that it can be heard above this confused mingling of many sounds.

One of the best means so far suggested for overcoming the difficulty is the employment of metallic circuits throughout for the

telephone, placing the two wires forming a single circuit very close together, so as to render the inductive action practically the same in each. The resulting currents would thus neutralize each other and leave the telephone quite free.

It is claimed that the inductive disturbances just noticed are much less marked with Mr. Edison's telephone than with any of the other forms, owing to the fact that the signals or sounds in the former are produced by stronger currents, and the receiving instruments are made less sensitive to those fugitive currents that are always met with in telegraph lines.

Mr. Edison has recently invented a telephonic repeater, which is designed to be used in connection with his apparatus for increasing the distance over which it may be made available. The principal parts are shown in fig. 23. I is an induction coil, whose

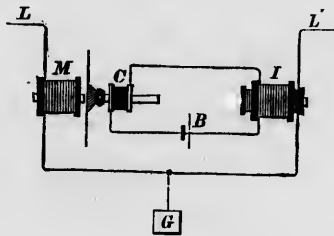

Fig. 23.

secondary is connected in the main line L' , into which the repeating is to be done; C is a carbon transmitter, included with battery B in the primary circuit, and operated by the magnet M instead of by the voice. The variations in the current produced by speaking against the disk of the instrument at the transmitting end of the line, cause this magnet to act on the repeater diaphragm, and thus produce different degrees of pressure on the carbon disk and thereby change its resistance. A corresponding change consequently takes place in the current of the primary coil, and thus gives rise to a series of induced currents in the secondary, which pass into the line, and, on reaching

the receiver at the opposite terminal, are there transformed into audible sound.

We have not yet personally experimented with this apparatus, but if it can be made only in a slight degree as effective as the ordinary carbon telephones, which already have permitted conversation to be carried on over five hundred miles of actual telegraph line, its advantage must sooner or later be made serviceable.

Instead of the magneto machine and call bell, which have already been described in connection with the telephone, a bat-

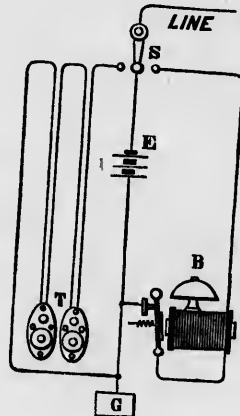

Fig. 24.

tery and vibrating bell may be, and sometimes are used for signaling purposes. Fig. 24 represents the connections for an arrangement of this kind. The line wire is joined to the back end of a four point button switch, S. The right hand front contact leads to one end of the helices which surround the bell magnet, and whose opposite end is in metallic connection with the armature lever. In its normal position this lever is held by a spiral spring against the back stop, which is joined to a wire leading to the ground. The middle front point of the switch communicates with one pole of a battery, E, whose opposite pole

is in connection with the ground wire, and the left hand point is connected to one or two telephones, T, also in communication with the ground.

When the apparatus is not being used the switch is left on the right hand contact, so that a current coming from the line has a free path through the helices, armature lever and back stop to earth. The soft iron core is thus rendered magnetic and attracts the armature, but after the latter has moved a short distance it leaves the spring forming part of the back stop, and in so doing breaks the circuit. The magnetism of the cores consequently disappears, and the armature is drawn back so as to complete the circuit once more, when another attraction follows, and so the process goes on alternating as long as battery is kept on at the distant station. Each attraction, therefore, occasions a distinct tap upon the bell, and as the magnetization and demagnetization are exceedingly rapid, the taps consequently succeed each other with sufficient rapidity to keep up a continuous ringing.

If the attendant at the distant station is wanted, the switch is placed on the middle contact, which allows the current from battery E to pass into the line, causing the distant bell to ring. The switch is then turned to the right again, when, if the signal has been observed, an acknowledgment to that effect is given by the distant correspondent placing his battery in circuit, and thereby in turn causing the bell at the station which originally gave the signal to ring. Both switches are then turned to the left hand side, by which means the telephones are put in circuit and made available for the interchange of correspondence.

Fig. 25 shows an arrangement for a Morse and telephone combination, which in many cases it is very convenient to have. When the switch is turned on to the right hand contact point the Morse apparatus is in circuit, and can then be used for the exchange of business in the ordinary way. The Morse apparatus answers also for a call to attract the attention of a correspondent when wanted; the local battery has been omitted in the diagram. When the switch is turned to the left the telephones alone are in circuit.

Before leaving the subject we must more particularly mention one point in connection therewith that is of too much interest to be overlooked. This is in relation to the various characteristics or forms of action that take place in the transmission of articulate speech, and which furnish us, in the operation of the Speaking Telephone, with a most beautiful illustration of the correlation of forces, or of their mutual convertibility from one form into another. When we speak into a telephone the muscular efforts exerted upon the lungs force the air through the larynx, within which are situated two membranes called the vocal chords. These can be tightened or relaxed at

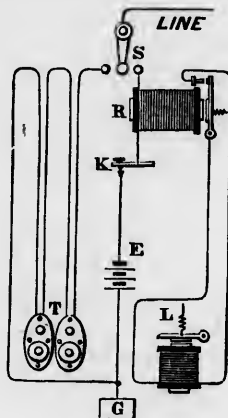

Fig. 25.

will by the use of certain muscles, and, being thrown into vibration by the passage of the air, give rise to a series of sonorous waves or aerial pulsations, varying in pitch with the tension or laxity of the chords. The impact of these pulsations against the metallic diaphragm produces, in turn, corresponding vibrations of the latter, which, as we have seen, is in close proximity to the poles of a permanent magnet. By this means, therefore, the inductive action of the diaphragm on the magnet is called into play, and there is consequently generated in the surrounding helix a series of electrical currents, which the intervening con-

ductor conveys to the distant station, where their further action is then spent in the production of magnetism. The receiving diaphragm, being then thrown into vibration by the resulting attractions, responds with faithful accuracy to the vibrations originally produced at the transmitting end of the line, and thus



Fig. 26.

also reproduces those sonorous waves which reach the ear and give us the sensation of sound. Here, then, we have, first, the mechanical effects of muscular action converted into electricity, then into magnetism, and finally back again into mechanical action. At each transformation, however, a portion of the

energy is lost, so far as its available usefulness is concerned ; and, therefore, the sound waves which reach the ear, although precisely similar in pitch and quality to those first produced by the vocal organs, are nevertheless much enfeebled—their amplitude, on which alone loudness depends, being diminished by the amount of energy lost in the transformation.



Fig. 27.

During the past year the articulating or Speaking Telephone has attracted very general interest and attention, not only in this country but also in Europe. It has already been extensively introduced here upon many of our short lines, and bids fair to become of almost universal application in a very short time, its

ex
it
in
gra
cov
pu

and
of in
T
appl
porta

concerned; and,
although pro-
duced by the
their amplitude,
ashed by the

extreme simplicity and the reliability of its operation rendering it one of the most convenient of the many electrical appliances in use. In Germany it has been adopted as a part of the telegraph system of the country, and there, as well as in other foreign countries, it is also being generally introduced for various private purposes, for establishing communication with the interior of coal

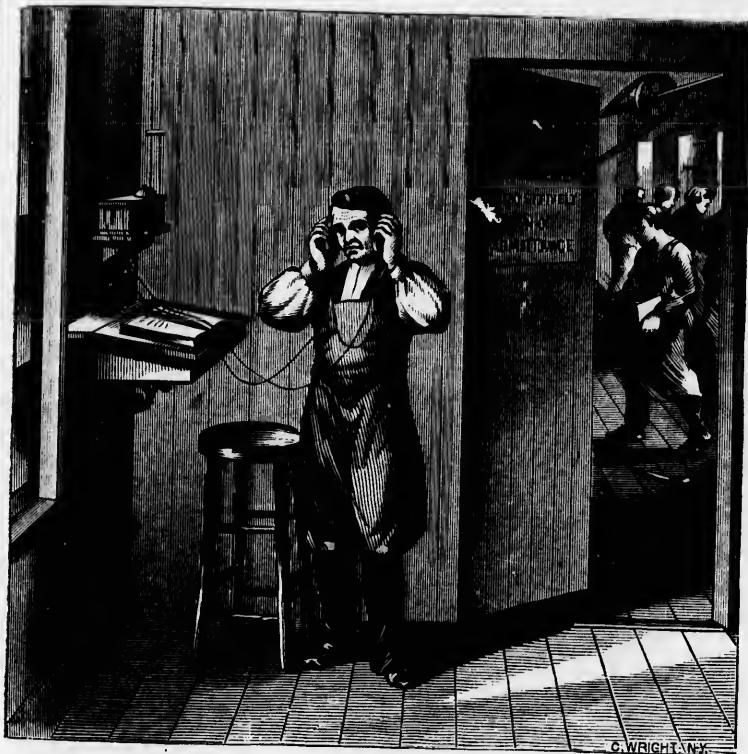

Fig. 28.

and iron mines, and for facilitating the carrying on of a multitude of industries of various kinds.

The innumerable uses to which the telephone has already been applied shows more forcibly than anything else its practical importance, and the advantages it affords for communicating

ing Telephone
t only in this
extensively
bids fair to
hort time, its

between places separated even by comparatively long distances ; no more convenient or serviceable instrument for this purpose has ever been produced, while at the same time it is capable of being used by every one. It can also be united with the District Telegraph system, so extensively developed here, and thereby the range of the latter system, which is now limited to a few special calls, such as police, fire, hack, etc., may be very much extended and improved. In addition to this again, its connection with the general telegraph system will soon greatly increase the usefulness of that service, by bringing many villages and hamlets that are now destitute of any telegraphic facilities whatever into communication with the rest of the world. Hitherto the great obstacle in the way of accomplishing this object has been the expense of keeping skilled employes at such places, where the business receipts are usually less than would be required to pay the salary of an operator. The application of the telephone, however, now provides the means of connecting these places to the nearest telegraph office with very little trouble and with little or no outlay for running expenses. We may therefore confidently expect that another year or two will suffice to establish telegraph communication with nearly every place in the country.

The apparatus, as at present furnished to the public by the American Speaking Telephone Co., is all contained in a neatly finished oblong box, which has already been described on pages 25 and 26. Figs. 11 and 12 show the outfit complete.

Fig. 26 gives a large size front view of the telephone, and also shows the manner of holding it when in use. Manufacturers and others, whose works are situated at some distance from their offices, will hardly need to be told of the advantages that may be derived from the use of the telephone, whereby they are at all times practically enabled to oversee and personally superintend the details of affairs at the works ; these must be evident to every one. It will also appear equally obvious that large and expensive warehouses may in many cases be dispensed with in cities where rents are always high, the telephone rendering it possible to fill orders at a moment's

notice directly from the factory or works quite as readily as from the warehouse, and at much less expense. Figs. 27 and 28 clearly illustrate the facility with which communication may be maintained between office and factory, and plainly show to what extent personal supervision may be exercised without at all necessitating the presence of the managing director at the place itself. In the former figure the manager at his desk in the city is seen giving instructions to his foreman, who is shown at the works in the latter, carefully noting everything that is being said.

As a matter of prophetic interest in connection with the telephone we feel constrained to reproduce here an extract from a popular little work, published a few years ago in France.¹ The author, as will be seen, strikingly foreshadows the realization of the Speaking Telephone as it exists to-day, complete in everything but loudness of articulation. Speaking of the marvels in telegraphy, he says:

"Wonderful as are these achievements, the inventions in telegraphy have gone still further. To be able to transmit thought to a distance is a triumph which was formerly astonishing; but we are now accustomed to it, and continue to practice it without its creating the slightest wonder. To be able to transmit handwriting, and even drawings, appeared to be more difficult; but this problem has also been resolved, and we now hardly wonder that this feat is accomplished by means so simple. Mankind ever requires a new stimulus to its curiosity, and already it is looking forward to the discovery of more marvels in telegraphy. Some years hence, for all we know, we may be able to transmit the vocal message itself, with the very inflection, tone and accent of the speaker. Already has the acoustic telegraph been invented; the principle has been discovered, and it only remains to render the invention practicable and useful—a result which, in these days of science, does not appear to be impossible.

Sound, of whatever kind, is produced by a series of vibrations, more or less rapid, which, setting out from a sonorous

¹ *Les Merveilles de l'Électricité*, par J. Baille. Paris, 1871.

body, traverse the air and reach our ear. Just as a stone, dropped into a pond, throws off a succession of circular undulations or water rings, so a concussion, acting on the air, produces analogous vibrations, though they are invisible, and it is when these vibrations reach the ear that we become sensible of sound. Helmholtz, an eminent German scientist, has analyzed the human voice and determined its musical value. According to him each simple vowel is formed by one or more notes of the scale, accompanied by other and feebler notes which are harmonics of these. He demonstrates that it is the union of all these notes that give quality to the voice. Every syllable is formed by the notes of the vowel accomplished by different movements of the organs of the mouth. Helmholtz, reflecting upon this, thinks it would be possible to construct a human voice by artificially producing and combining the elementary sounds of which it is composed. This is not the place to discuss such theories, but if we grant that there is any truth in them, we can understand that the acoustic telegraph can be invented and can transmit the living voice. Already experiments have been made in this direction.

A vibrating plate produces a sound, and, according to the rapidity of the vibrations, these sounds are sharp or flat. At each of the vibrations the plate touches a small point placed in front of it, and this contact suffices to throw the current into the line. When the plate ceases to vibrate and returns to its position of equilibrium, it no longer touches the metal point and the current is consequently interrupted. By this means is obtained a series of interruptions, more or less rapid, according to the sound, the current being thrown into the line and interrupted once for each of the vibrations.

At the extremity of the line the current enters an electromagnet, which attracts another vibrating plate of size and quality identical with the former. Attracted and repelled very rapidly, exactly, and as rapidly in fact as the plate mentioned above, this second plate gives forth a sound which will have the same musical value as that of the other, as the number of vibrations per second is the same in both cases.

Should this process be perfected it will be possible to transmit sound by means of the telegraph—to transmit a series of sounds, a tune, or spoken sentence and conversation. This consummation has not, however, been yet attained. Many experiments have been made, the principle has been applied in divers ways, and everything makes us hope that we will yet arrive at a perfect system of acoustic telegraphy. Advances have been made very far upon the road to success. A series of vibrating plates, answering to the strings of a harp, has been arranged, each of which vibrates when struck by a particular sound, and sends off electricity to create at the end of a line the same vibrations in a corresponding plate, or, in other words, to reproduce the same sound.

This system, it must be admitted, is at least very ingenious. Experiments have been made in laboratories, that is to say under conditions entirely favorable, and such as we would not often find in actual practice. Under these conditions a musical air has actually been successfully transmitted by this acoustic telegraph. All must admit that this is a promising beginning; but we must not make too much haste to exalt the miracle and to extol the advantages of the future machine, or to abandon ourselves to the indulgence in indiscriminate laudation on the strength of this new discovery. That would be a gross mistake and an injury to science. True scientific faith is doubt, until the truth appears in uncontrovertible clearness. Care must be taken not to take for reality that which is merely a desire on our part. We must guard against all premature exultation, because it weakens us in the search for truth, and because even one deception is cruel. Let us therefore give to doubt, to patience and to perseverance, the place which some too readily give to congratulation."

CHAPTER II

BELL'S TELEPHONIC RESEARCHES.

IN a lecture delivered before the Society of Telegraph Engineers, in London, October 31st, 1877, Prof. A. G. Bell gave a history of his researches in telephony, together with the experiments that he was led to undertake in his endeavors to produce a practical system of multiple telegraphy, and to realize also the transmission of articulate speech. As the subject has now become of great interest, both in a scientific and popular point of view, we feel warranted in reproducing the lecture in full. After the usual introduction, Professor Bell said :

"It is to-night my pleasure, as well as duty, to give you some account of the telephonic researches in which I have been so long engaged. Many years ago my attention was directed to the mechanism of speech by my father, Alexander Melville Bell, of Edinburgh, who has made a life-long study of the subject. Many of those present may recollect the invention by my father of a means of representing, in a wonderfully accurate manner, the positions of the vocal organs in forming sounds. Together we carried on quite a number of experiments, seeking to discover the correct mechanism of English and foreign elements of speech, and I remember especially an investigation in which we were engaged concerning the musical relations of vowel sounds. When vowel sounds are whispered, each vowel seems to possess a particular pitch of its own, and by whispering certain vowels in succession a musical scale can be distinctly perceived. Our aim was to determine the natural pitch of each vowel; but unexpected difficulties made their appearance, for many of the vowels seemed to possess a double pitch—one due, probably, to the resonance of the air in the mouth, and the other to the resonance of the air contained in the cavity behind the tongue, comprehending the pharynx and larynx.

I hit upon an expedient for determining the pitch, which, at that time, I thought to be original with myself. It consisted in vibrating a tuning fork in front of the mouth while the positions of the vocal organs for the various vowel sounds were silently taken. It was found that each vowel position caused the reinforcement of some particular fork or forks.

I wrote an account of these researches to Mr. Alex. J. Ellis, of London, whom I have very great pleasure in seeing here tonight. In reply, he informed me that the experiments related had already been performed by Helmholtz, and in a much more perfect manner than I had done. Indeed, he said that Helmholtz had not only analyzed the vowel sounds into their constituent musical elements, but had actually performed the synthesis of them.

He had succeeded in producing, artificially, certain of the vowel sounds by causing tuning forks of different pitch to vibrate simultaneously by means of an electric current. Mr. Ellis was kind enough to grant me an interview for the purpose of explaining the apparatus employed by Helmholtz in producing these extraordinary effects, and I spent the greater part of a delightful day with him in investigating the subject. At that time, however, I was too slightly acquainted with the laws of electricity fully to understand the explanations given; but the interview had the effect of arousing my interest in the subjects of sound and electricity, and I did not rest until I had obtained possession of a copy of Helmholtz's great work,¹ and had attempted, in a crude and imperfect manner it is true, to reproduce his results. While reflecting upon the possibilities of the production of sound by electrical means, it struck me that the principle of vibrating a tuning fork by the intermittent attraction of an electro-magnet might be applied to the electrical production of music.

I imagined to myself a series of tuning forks of different pitches, arranged to vibrate automatically in the manner shown

¹ *Helmholtz. Die Lehre von dem Tonempfindungen.* (English translation, by Alexander J. Ellis, *Theory of Tone.*)

by Helmholtz—each fork interrupting, at every vibration, a voltaic current—and the thought occurred, Why should not the depression of a key like that of a piano direct the interrupted current from any one of these forks, through a telegraph wire, to a series of electro-magnets operating the strings of a piano or other musical instrument, in which case a person might play the tuning fork piano in one place and the music be audible from the electro-magnetic piano in a distant city?

The more I reflected upon this arrangement the more feasible did it seem to me; indeed, I saw no reason why the depression of a number of keys at the tuning fork end of the circuit should not be followed by the audible production of a full chord from the piano in the distant city, each tuning fork affecting at the receiving end that string of the piano with which it was in unison. At this time the interest which I felt in electricity led me to study the various systems of telegraphy in use in this country and in America. I was much struck with the simplicity of the Morse alphabet, and with the fact that it could be read by sound. Instead of having the dots and dashes recorded upon paper, the operators were in the habit of observing the duration of the click of the instruments, and in this way were enabled to distinguish by ear the various signals.

It struck me that in a similar manner the duration of a musical note might be made to represent the dot or dash of the telegraph code, so that a person might operate one of the keys of the tuning fork piano referred to above, and the duration of the sound proceeding from the corresponding string of the distant piano be observed by an operator stationed there. It seemed to me that in this way a number of distinct telegraph messages might be sent simultaneously from the tuning fork piano to the other end of the circuit by operators, each manipulating a different key of the instrument. These messages would be read by operators stationed at the distant piano, each receiving operator listening for signals of a certain definite pitch, and ignoring all others. In this way could be accomplished the simultaneous transmission of a number of telegraphic messages along a single

wire, the number being limited only by the delicacy of the listener's ear. The idea of increasing the carrying power of a telegraph wire in this way took complete possession of my mind, and it was this practical end that I had in view when I commenced my researches in electric telephony.

In the progress of science it is universally found that complexity leads to simplicity, and in narrating the history of scientific research it is often advisable to begin at the end.

In glancing back over my own researches, I find it necessary to designate, by distinct names, a variety of electrical currents by means of which sounds can be produced, and I shall direct your attention to several distinct species of what may be termed telephonic currents of electricity. In order that the peculiarities of these currents may be clearly understood, I shall ask Mr. Frost

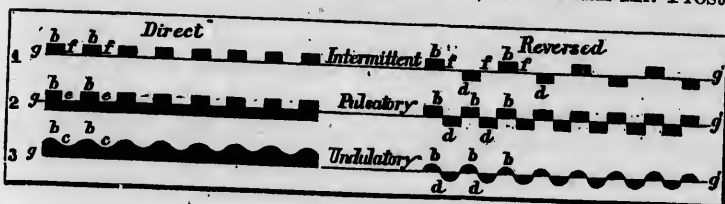

Fig. 29.

to project upon the screen a graphical illustration of the different varieties.

The graphical method of representing electrical currents shown in fig. 29 is the best means I have been able to devise of studying, in an accurate manner, the effects produced by various forms of telephonic apparatus, and it has led me to the conception of that peculiar species of telephonic current, here designated as *undulatory*, which has rendered feasible the artificial production of articulate speech by electrical means.

A horizontal line ($g g'$) is taken as the zero of current, and impulses of positive electricity are represented above the zero line, and negative impulses below it, or *vice versa*.

The vertical thickness of any electrical impulse (b or d), measured from the zero line, indicates the intensity of the electrical

current at the point observed, and the horizontal extension of the electric line (*b* or *d*) indicates the duration of the impulse.

Nine varieties of telephonic currents may be distinguished, but it will only be necessary to show you six of these. The three primary varieties designated as intermittent, pulsatory and undulatory, are represented in lines 1, 2 and 3.

Sub-varieties of these can be distinguished as direct or reversed currents, according as the electrical impulses are all of one kind or are alternately positive and negative. Direct currents may still further be distinguished as positive or negative, according as the impulses are of one kind or of the other.

An intermittent current is characterized by the alternate presence and absence of electricity upon the circuit;

A pulsatory current results from sudden or instantaneous changes in the intensity of a continuous current; and

An undulatory current is a current of electricity, the intensity of which varies in a manner proportional to the velocity of the motion of a particle of air during the production of a sound: thus the curve representing graphically the undulatory current for a simple musical tone is the curve expressive of a simple pendulous vibration—that is, a sinusoidal curve.

Telephonic currents of electricity may be	Intermittent	{ Direct	Positive 1	Positive intermittent current.
			Negative 2	Negative " "
			Reversed 3	Reversed " "
	Pulsatory	{ Direct	Positive 4	Positive pulsatory current.
			Negative 5	Negative " "
			Reversed 6	Reversed " "
	Undulatory	{ Direct	Positive 7	Positive undulatory current.
			Negative 8	Negative " "
			Reversed 9	Reversed " "

And here I may remark, that, although the conception of the undulatory current of electricity is entirely original with myself, methods of producing sound by means of intermittent and pulsatory currents have long been known. For instance, it was long since discovered that an electro-magnet gives forth a de-

cided sound when it is suddenly magnetized or demagnetized. When the circuit upon which it is placed is rapidly made and broken, a succession of explosive noises proceeds from the magnet. These sounds produce upon the ear the effect of a musical note when the current is interrupted a sufficient number of times per second. The discovery of Galvanic Music by Page,¹ in 1837, led inquirers in different parts of the world almost simultaneously to enter into the field of telephonic research; and the acoustical effects produced by magnetization were carefully studied by Marrian,² Beatson,³ Gassiot,⁴ De la Rive,⁵ Matteucci,⁶ Guillemin,⁷ Wertheim,⁸ Wartmann,⁹ Jannair,¹⁰ Joule,¹¹ Laborde,¹² Legat,¹³ Reis,¹⁴ Poggendorff,¹⁵

¹ *C. G. Page*. "The Production of Galvanic Music." *Silliman's Journ.*, 1837, xxxii. p. 396; *Silliman's Journ.*, 1838, xxxiii. p. 118; *Bibl. Univ.* (new series), 1839, ii. p. 398.

² *J. P. Marrian*. *Phil. Mag.*, xxv. p. 382; *Inst.*, 1845, p. 20; *Arch. de l'Électr.*, v. p. 195.

³ *W. Beatson*. *Arch. de l'Électr.*, v. p. 197; *Arch. de Sc. Phys. et Nat.* (2d series), ii. p. 118.

⁴ *Gassiot*. See "Treatise on Electricity," by De la Rive, i. p. 300.

⁵ *De la Rive*. "Treatise on Electricity," i. p. 300; *Phil. Mag.*, xxxv. p. 422; *Arch. de l'Électr.* v. p. 200; *Inst.* 1846, p. 83; *Comptes Rendus*, xx. p. 1287; *Comp. Rend.* xxii. p. 432; *Pogg. Ann.* lxxv. p. 637; *Ann. de Chim. et de Phys.* xxvi. p. 158.

⁶ *Matteucci*. *Inst.*, 1845, p. 315; *Arch. de l'Électr.*, v. 389.

⁷ *Guillemin*. *Comp. Rend.* xxii. p. 264; *Inst.* 1846, p. 30; *Arch. d. Sc. Phys.* (2d series), i. p. 191.

⁸ *G. Wertheim*. *Comp. Rend.* xxii. pp. 356, 544; *Inst.* 1846, pp. 65, 100; *Pogg. Ann.* lxxviii. p. 140; *Comp. Rend.* xxvi. p. 505; *Inst.* 1848, p. 148; *Ann. de Chim. et de Phys.* xxiii. p. 392; *Arch. d. Sc. Phys. et Nat.* viii. p. 206; *Pogg. Ann.* lxxvii. p. 43; *Berl. Ber.* iv. p. 121.

⁹ *Elie Wartmann*. *Comp. Rend.* xxii. p. 544; *Phil. Mag.* (3d series), xxviii. p. 544; *Arch. d. Sc. Phys. et Nat.* (2d series), i. p. 419; *Inst.* 1846, p. 290; *Monatscher. d. Berl. Akad.* 1846, p. 111.

¹⁰ *Jannair*. *Comp. Rend.* xxiii. p. 319; *Inst.* 1846, p. 269; *Arch. d. Sc. Phys. et Nat.* (2d series), ii. p. 394.

¹¹ *J. P. Joule*. *Phil. Mag.* xxv. pp. 76, 225; *Berl. Ber.* iii. p. 489.

¹² *Laborde*. *Comp. Rend.* l. p. 692; *Cosmos*, xvii. p. 514.

¹³ *Legat*. *Brix. Z. S.* ix. p. 125.

¹⁴ *Reis*. "Téléphonie." *Polytechnic Journ.* clxviii, p. 185; *Böttger's Notizbl.* 1863, No. 6.

¹⁵ *J. C. Poggendorff*. *Pogg. Ann.* xxviii. p. 198; *Berliner Monatsber.* 1856, p. 133; *Cosmos*, ix. p. 49; *Berl. Ber.* xii. p. 241; *Pogg. Ann.* lxxxvii. p. 189.

Du Moncel,¹ Delezenne² and others.³ It should also be mentioned that Gore⁴ obtained loud musical notes from mercury, accompanied by singularly beautiful crispations of the surface, during the course of experiments in electrolysis; Page⁵ produced musical tones from Trevelyan's bars by the action of the galvanic current; and further it was discovered by Sullivan⁶ that a current of electricity is generated by the vibration of a wire composed partly of one metal and partly of another. The current was produced so long as the wire emitted a musical note, but stopped immediately upon the cessation of the sound.

For several years my attention was almost exclusively directed to the production of an instrument for making and breaking a voltaic circuit with extreme rapidity, to take the place of the transmitting tuning fork used in Helmholtz' researches. I will not trouble you with the description of all the various forms of apparatus that were devised, but will merely direct your attention to one of the best of them, shown in fig. 30. In the transmitting instrument T a steel reed *a* is employed, which is kept in continuous vibration by the action of an electro-magnet *e* and local battery. In the course of its vibration the reed strikes alternately against two fixed points *m*, *l*, and thus completes alternately a local and a main circuit. When the key K is depressed, an intermittent current from the main battery B is directed to the line wire W, and passes through the electro-magnet E of a receiving instrument R at the distant end of the circuit, and thence to the ground G. The steel reed A is placed

¹ *Du Moncel*. Exposé, li. p. 125; also, iii. p. 83.

² *Delezenne*. "Sound produced by magnetization," *Bibl. Univ.* (new series), 1841, xvi. p. 406.

³ See *London Journ.* xxxii. p. 402; *Polytechnic Journ.* cx. p. 16; *Cosmos*, iv. p. 43; *Glösenner*—*Traité général*, &c. p. 350; *Dove*.—*Repert.* vi. p. 58; *Pogg. Ann.* xliii. p. 411; *Berl. Ber.* i. p. 144; *Arch. d. Sc. Phys. et Nat.* xvi. p. 406; *Kuhn's Encyclopædia der Physik*, pp. 1014-1021.

⁴ *Gore*. *Proceedings of Royal Society*, xii. p. 217.

⁵ *C. G. Page*. "Vibration of Trevelyan's bars by the galvanic current." *Silliman's Journal*, 1850, ix. pp. 105-108.

⁶ *Sullivan*. "Currents of Electricity produced by the vibration of Metals," *Phil. Mag.* 1845, p. 261; *Arch. de l'Électr.* x. p. 480.

in front of the receiving magnet, and when its normal rate of vibration is the same as the reed of the transmitting instrument it is thrown into powerful vibration, emitting a musical tone of a similar pitch to that produced by the reed of the transmitting instrument, but if it is normally of a different pitch it remains silent.

A glance at figs. 31, 32 and 33 will show the arrangement of such instruments upon a telegraphic circuit, designed to enable a number of telegraphic despatches to be transmitted simultaneously

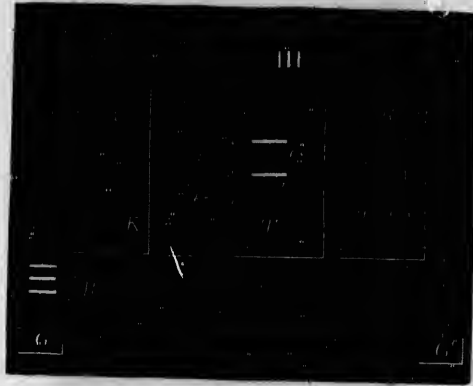

Fig. 30.

along the same wire. The transmitters and receivers that are numbered alike have the same pitch or rate of vibration. Thus the reed of T' is in unison with the reeds T' and R' at all the stations upon the circuit, so that a telegraphic despatch sent by the manipulation of the key K' at the station shown in fig. 31, will be received upon the receiving instruments R' at all the other stations upon the circuit. Without going into details, I shall merely say that the great defects of this plan of multiple telegraphy were found to consist, firstly, in the fact that the receiving operators were required to possess a good musical ear in order to discriminate the signals; and secondly, that the signals could only pass in one direction along the line (so that two wires would be necessary in order to complete communication in both direc-

to be men-
mercury,
the sur-
s; Page⁵
e action of
Sullivan⁶
n of a wire
The cur-
sical note,
and.

y directed
breaking a
ace of the
es. I will
s forms of
our atten-
the trans-
ch is kept
magnet e and
ed strikes
completes
key K is
battery B
e electro-
end of the
is placed

(new series),

Cosmos, iv.
; Pogg. Ann.
406; Kuhn's

rrrent." Silli-

Metals," Phil.

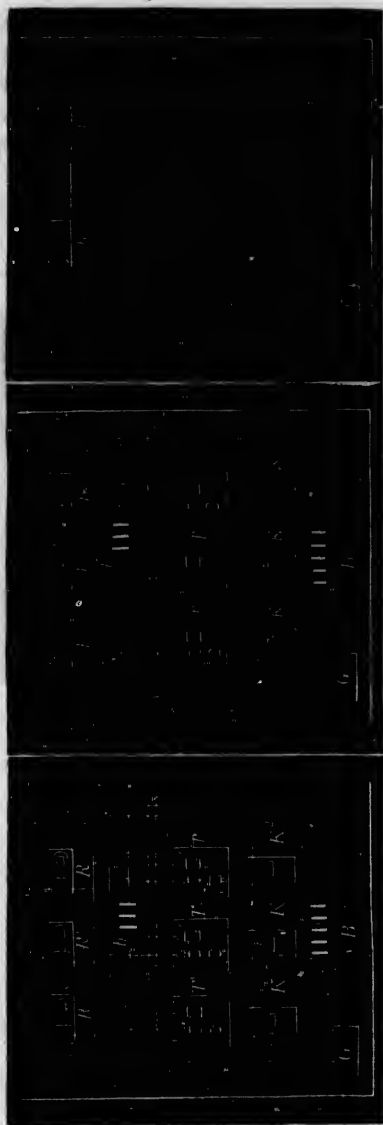

Figs. 31, 32, 33.

no
in
ce
of
m
gr
me
co
att
br
or
no
wit
up

tions). The first objection was got over by employing the device which I term a "vibratory circuit breaker," shown in the next diagram, whereby musical signals can be automatically recorded.

Fig. 34 shows a receiving instrument, *R*, with a vibratory circuit breaker *V* attached. The light spring lever *V* overlaps the free end of the steel reed *A*, and normally closes a local circuit, in which may be placed a Morse sounder or other telegraphic apparatus. When the reed *A* is thrown into vibration by the passage of a musical signal, the spring arm *V* is thrown upwards, opening the local circuit at the point *C*. When the spring arm *V* is so arranged as to have normally a much slower rate of vibration than the reed *A*, the local circuit is found to remain perma-

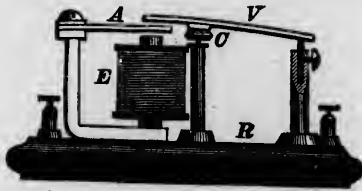

Fig. 34.

nently open during the vibration of *A*, the spring arm *V* coming into contact with the point *C* only upon the cessation of the receiver's vibration. Thus the signals produced by the vibration of the reed *A* are reproduced upon an ordinary telegraphic instrument in the local circuit.

Fig. 35 shows the application of electric telephony to autographic telegraphy. *q, q* represent the reeds of transmitting instruments of different pitch, *s, s* the receivers at the distant station of corresponding pitch, and *u, u*, etc., the vibratory circuit breakers attached to the receiving instruments, and connected with metallic bristles resting upon chemically prepared paper *w*. The message or picture to be copied is written upon a metallic surface, *p*, with non-metallic ink, and placed upon a metallic cylinder connected with the main battery, *c*; and the chemically prepared paper, upon which the message is to be received, is placed upon a

metallic cylinder connected with the local battery *d* at the receiving station. When the cylinders at either end of the circuit are rotated—but not necessarily at the same rate of speed—a *fac simile* of whatever is written or drawn upon the metallic surface *p* appears upon the chemically prepared paper *w*.

The method by means of which musical signals may be sent simultaneously in both directions along the same circuit is shown in our next illustration, figs. 36, 37 and 38. The arrangement is similar to that shown in figures 31, 32 and 33, excepting that the intermittent current from the transmitting instruments is passed

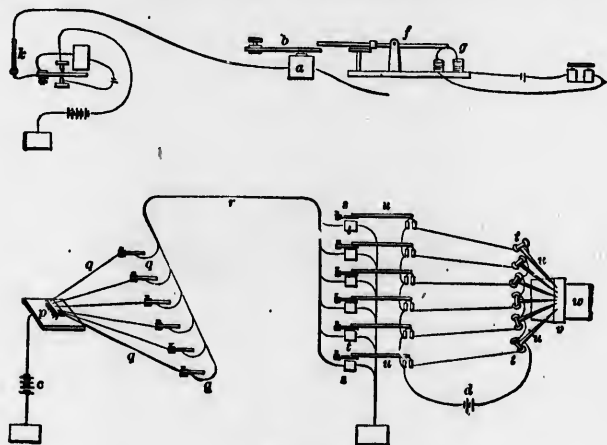
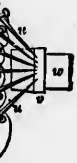

Fig. 35.

through the primary wires of an induction coil, and the receiving instruments are placed in circuit with the secondary wire. In this way free earth communication is secured at either end of the circuit, and the musical signals produced by the manipulation of any key are received at all the stations upon the line. The great objection to this plan is the extreme complication of the parts and the necessity of employing local and main batteries at every station. It was also found by practical experiment that it was difficult, if not impossible, upon either of the plans here shown, to transmit simultaneously the number of musical tones

ry d at the
d of the cir-
te of speed—
the metallic
er w .
may be sent
cuit is shown
rangement is
ting that the
nts is passed



he receiving
wire. In this
end of the
manipulation of
line. The
ation of the
batteries at
periment that
plans here
musical tones

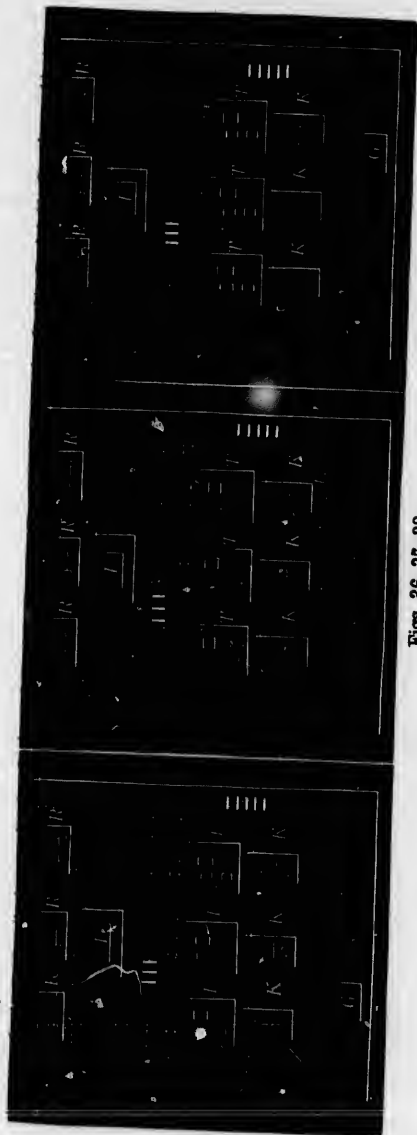

Figs. 36, 37, 38.

that theory showed to be feasible. Mature consideration revealed the fact that this difficulty lay in the nature of the electrical current employed, and was finally obviated by the invention of the undulatory current.

It is a strange fact that important inventions are often made almost simultaneously by different persons in different parts of the world, and the idea of multiple telegraphy, as developed in the preceding diagrams, seems to have occurred independently to no less than four other inventors in America and Europe. Even the details of the arrangements upon circuit—shown in figs. 31, 32, 33 and 36, 37, 38—are extremely similar in the plans proposed by Mr. Cromwell Varley, of London, Mr. Elisha Gray,

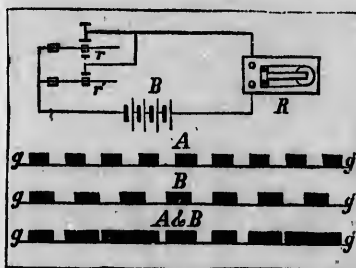

Fig. 39.

of Chicago, Mr. Paul La Cour, of Copenhagen, and Mr. Thomas Edison, of Newark, New Jersey. Into the question of priority of invention, of course, it is not my intention to go to-night.

That the difficulty in the use of an intermittent current may be more clearly understood, I shall ask you to accompany me in my explanation of the effect produced when two musical signals of different pitch are simultaneously directed along the same circuit. Fig. 39 shows an arrangement whereby the reeds r r' of two transmitting instruments are caused to interrupt the current from the same battery, B. We shall suppose the musical interval between the two reeds to be a major third, in which case their vibrations are in the ratio of 4 to 5, *i. e.*, 4 vibrations of r are made in the same time as 5 vibrations of r' . A and B represent the intermittent currents produced, 4 im-

pulses of B being made in the same time as 5 impulses of A. The line $A + B$ represents the resultant effect upon the main line when the reeds r and r' are simultaneously caused to make and break the same circuit, and from the illustration you will perceive that the resultant current, whilst retaining a uniform intensity, is less interrupted when both reeds are in operation than when one alone is employed. By carrying your thoughts still further, you will understand that when a large number of reeds of different pitch or of different rates of vibration are simultaneously making and breaking the same circuit, the resultant effect upon the main line is practically equivalent to one continuous current.

It will also be understood that the maximum number of

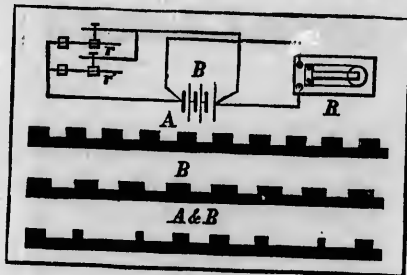

Fig. 40.

musical signals that can be simultaneously directed along a single wire without conflict, depends very much upon the ratio which the "make" bears to the "break;" the shorter the contact made, and the longer the break, the greater the number of signals that can be transmitted without confusion, and *vice versa*. The apparatus by means of which this theoretical conclusion has been verified is here to-night, and consists of an ordinary parlor harmonium, the reeds of which are operated by wind in the usual manner. In front of each reed is arranged a metal screw, against which the reed strikes in the course of its vibration. By adjusting the screw, the duration of the contact can be made long or short. The reeds are connected with one pole of a battery, and the screws against which they strike communicate

with the line wire, so that intermittent impulses from the battery are transmitted along the line wire during the vibration of the reeds.

We now proceed to the next illustration. Without entering into the details of the calculation you will see that with a pulsa-

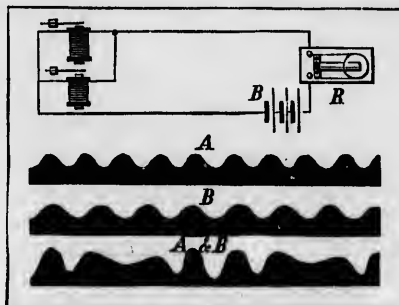

Fig. 41.

tory current the effect of transmitting musical signals simultaneously is nearly equivalent to a continuous current of minimum intensity—see $A+B$, fig. 40; but when undulatory currents are employed the effect is different—see fig. 41. The current

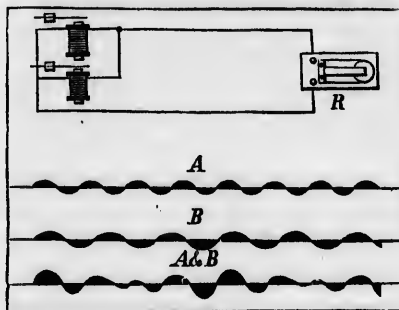

Fig. 42.

from the battery B is thrown into waves by the inductive action of iron or steel reeds vibrated in front of electro-magnets placed in circuit with the battery; A and B represent the undulations caused in the current by the vibration of the magnetized bodies,

and it will be seen that there are four undulations of B in the same time as five undulations of A. The resultant effect upon the main line is expressed by the curve A+B, which is the algebraical sum of the sinusoidal curves A and B. A similar effect is produced when reversed undulatory currents are employed, as shown in fig. 42, where the current is produced by the vibration of permanent magnets in front of electro-magnets united upon a circuit without a voltaic battery. It will be understood from figs. 41 and 42 that the effect of transmitting musical signals of different pitches simultaneously along a single wire is not to obliterate the vibratory character of the current, as in the case of intermittent and pulsatory currents, but to change the shapes of

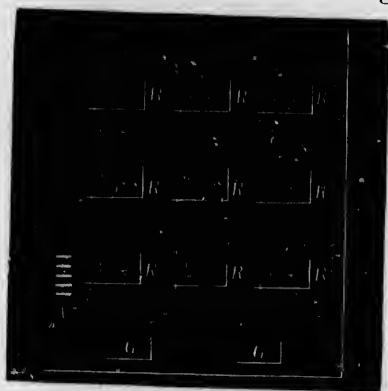

Fig. 43.

the electrical undulations. In fact, the effect produced upon the current is precisely analogous to the effect produced in the air by the vibration of the inducing bodies. Hence it should be possible to transmit as many musical tones simultaneously through a telegraph wire as through the air. The possibility of using undulatory currents for the purposes of multiple telegraphy enabled me to dispense entirely with the complicated arrangements of the circuit shown in figs. 31, 32, 33 and 36, 37, 38, and to employ a single battery for the whole circuit, retaining only the receiving instruments formerly shown. This arrangement is

represented in fig. 43. Upon vibrating the steel reed of a receiver R, R' , at any station by any mechanical means, the corresponding reeds at all the other stations are thrown into vibration, reproducing the signal. By attaching the steel reeds to the poles of a powerful permanent magnet, as shown in fig. 45, the signals can be produced without the aid of a battery.

I have formerly stated that Helmholtz was enabled to produce vowel sounds artificially by combining musical tones of different pitches and intensities. His apparatus is shown in fig 44. Tuning forks of different pitch are placed between the poles of electro-magnets (a', a^2 , &c.), and are kept in continuous vibration by the action of an intermittent current from the fork b . Reso-

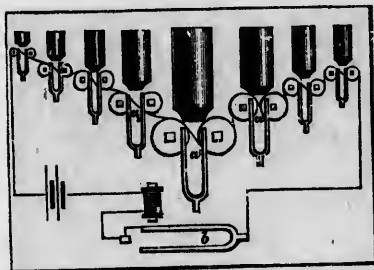

Fig. 44¹.

nators 1, 2, 3, etc., are arranged so as to reinforce the sounds in a greater or less degree, according as the exterior orifices are enlarged or contracted.

Thus it will be seen that upon Helmholtz's plan the tuning forks themselves produce tones of uniform intensity, the loudness being varied by an external reinforcement; but it struck me that the same results would be obtained, and in a much more perfect manner, by causing the tuning forks themselves to vibrate with different degrees of amplitude. I therefore devised the apparatus shown in fig. 45, which was my first form of articulating telephone. In this figure a harp of steel rods is employed,

¹ The full description of this figure will be found in Mr. Alexander J. Ellis's translation of Helmholtz's work, "Theory of Tone."

attached to the poles of a permanent magnet, N. S. When any one of the rods is thrown into vibration an undulatory current is produced in the coils of the electro-magnet E, and the electro-magnet E' attracts the rods of the harp H' with a varying force, throwing into vibration that rod which is in unison with that vibrated at the other end of the circuit. Not only so, but the amplitude of vibration in the one will determine the amplitude of vibration in the other, for the intensity of the induced current is determined by the amplitude of the inducing vibration, and the amplitude of the vibration at the receiving end depends upon the intensity of the attractive impulses. When we sing into a piano, certain of the strings of the instrument are set in vibration sympathetically by the action of the voice with differ-

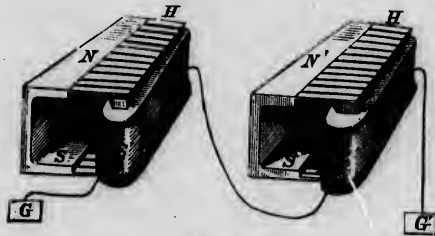

Fig. 45.

ent degrees of amplitude, and a sound, which is an approximation to the vowel uttered, is produced from the piano. Theory shows that, had the piano a very much larger number of strings to the octave, the vowel sounds would be perfectly reproduced. My idea of the action of the apparatus, shown in fig. 45, was this: Utter a sound in the neighborhood of the harp H, and certain of the rods would be thrown into vibration with different amplitudes. At the other end of the circuit the corresponding rods of the harp H' would vibrate with their proper relations of force, and the *timbre* of the sound would be reproduced. The expense of constructing such an apparatus as that shown in fig. 45 deterred me from making the attempt, and I sought to simplify the apparatus before venturing to have it made.

I have before alluded to the invention by my father of a sys-

d of a re-
the corre-
vibration,
ds to the
g. 45, the

to produce
of different
in fig 44.
the poles of
s vibration
t b. Reso-

e sounds in
orifices are

the tuning
y, the loud-
t struck me
much more
es to vibrate
devised the
of articulat-
employed,

ander J. Ellis's

tem of physiological symbols for representing the action of the vocal organs, and I had been invited by the Boston Board of Education to conduct a series of experiments with the system in the Boston school for the deaf and dumb. It is well known that deaf mutes are dumb merely because they are deaf, and that there is no defect in their vocal organs to incapacitate them from utterance. Hence it was thought that my father's system of pictorial symbols, popularly known as visible speech, might prove a means whereby we could teach the deaf and dumb to use their vocal organs and to speak. The great success of these experiments urged upon me the advisability of devising methods of exhibiting the vibrations of sound optically, for use in teaching the



Fig. 46.

deaf and dumb. For some time I carried on experiments with the manometric capsule of Koenig and with the phonautograph of Léon Scott. The scientific apparatus in the Institute of Technology in Boston was freely placed at my disposal for these experiments, and it happened that at that time a student of the Institute of Technology, Mr. Maurey, had invented an improvement upon the phonautograph. He had succeeded in vibrating by the voice a stylus of wood about a foot in length, which was attached to the membrane of the phonautograph, and in this way he had been enabled to obtain enlarged tracings upon a plane surface of smoked glass. With this apparatus I succeeded

in producing very beautiful tracings of the vibrations of the air for vowel sounds. Some of these tracings are shown in fig. 46. I was much struck with this improved form of apparatus, and it occurred to me that there was a remarkable likeness between the manner in which this piece of wood was vibrated by the membrane of the phonautograph and the manner in which the *ossiculae* of the human ear were moved by the tympanic mem-



Fig. 47.

brane. I determined, therefore, to construct a phonautograph modelled still more closely upon the mechanism of the human ear, and for this purpose I sought the assistance of a distinguished aurist in Boston, Dr. Clarence J. Blake. He suggested the use of the human ear itself as a phonautograph, instead of making an artificial imitation of it. The idea was novel and struck me accordingly, and I requested my friend to prepare

a specimen for me, which he did. The apparatus, as finally constructed, is shown in fig. 47. The *stapes* was removed and a stylus of hay about an inch in length was attached to the end of the incus. Upon moistening the *membrana tympani* and the *ossiculæ* with a mixture of glycerine and water the necessary mobility of the parts was obtained, and upon singing into the external artificial ear the stylus of hay was thrown into vibration, and tracings were obtained upon a plane surface of smoked glass passed rapidly underneath. While engaged in these experiments I was struck with the remarkable disproportion in weight between the membrane and the bones that were vibrated by it. It occurred to me that if a membrane as thin as tissue paper could control the vibration of bones that were, compared to it, of immense size and weight, why should not a larger and thicker membrane be able to vibrate a piece of iron in front of

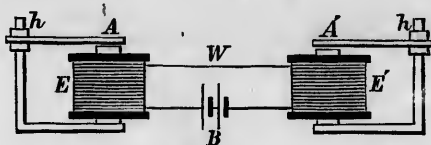

Fig. 48.

an electro-magnet, in which case the complication of steel rods shown in my first form of telephone, fig. 45, could be done away with, and a simple piece of iron attached to a membrane be placed at either end of the telegraphic circuit.

Fig. 48 shows the form of apparatus that I was then employing for producing undulatory currents of electricity for the purposes of multiple telegraphy. A steel reed, A, was clamped firmly by one extremity to the uncovered leg *h* of an electro-magnet E, and the free end of the reed projected above the covered leg. When the reed A was vibrated in any mechanical way the battery current was thrown into waves, and electrical undulations traversed the circuit B E W E', throwing into vibration the corresponding reed A' at the other end of the circuit. I immediately proceeded to put my new idea to the test of practical experiment, and for this purpose I attached the reed

A (fig. 49) loosely by one extremity to the uncovered pole h of the magnet, and fastened the other extremity to the centre of a stretched membrane of goldbeaters' skin n . I presumed that upon speaking in the neighborhood of the membrane n it would be thrown into vibration and cause the steel reed A to move in a similar manner, occasioning undulations in the electrical current that would correspond to the changes in the density of the air during the production of the sound; and I further thought that the change of the intensity of the current at the receiving end would cause the magnet there to attract the reed A' in such a manner that it should copy the motion of the reed A , in which case its movements would occasion a sound from the membrane n' similar in *timbre* to that which had occasioned the original vibration.

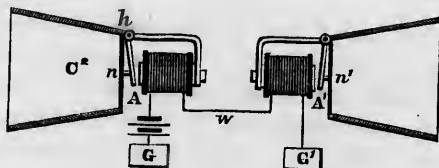

Fig. 49.

The results, however, were unsatisfactory and discouraging. My friend, Mr. Thomas A. Watson, who assisted me in this first experiment, declared that he heard a faint sound proceed from the telephone at his end of the circuit, but I was unable to verify his assertion. After many experiments, attended by the same only partially successful results, I determined to reduce the size and weight of the spring as much as possible. For this purpose I glued a piece of clock spring, about the size and shape of my thumb nail, firmly to the centre of the diaphragm, and had a similar instrument at the other end (fig. 50); we were then enabled to obtain distinctly audible effects.¹ I remember

¹ On the 14th of February, 1876, Mr. Elisha Gray, of Chicago, filed a caveat in the Patent Office at Washington, describing the Speaking Telephone shown in figure 6, page 15, and which, upon examination, will be found to be identical with that shown in figures 50 and 52. On the same day Professor Bell filed an application in the Patent Office at Washington, describing the apparatus shown in figure

an experiment made with this telephone, which at the time gave me great satisfaction and delight. One of the telephones was placed in my lecture room in the Boston University, and the other in the basement of the adjoining building. One of my students repaired to the distant telephone to observe the effects of articulate speech, while I uttered the sentence, 'Do you

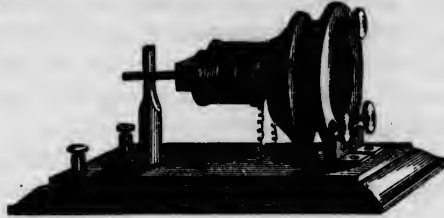

Fig. 50.

understand what I say?' into the telephone placed in the lecture hall. To my delight an answer was returned through the instrument itself, articulate sounds proceeded from the steel spring attached to the membrane, and I heard the sentence, "Yes, I understand you perfectly." It is a mistake, however, to suppose



Fig. 51.

that the articulation was by any means perfect, and expectancy no doubt had a great deal to do with my recognition of the sentence; still, the articulation was there, and I recognized the fact that the indistinctness was entirely due to the imperfection of the instrument. I will not trouble you by detailing the

49, which he here acknowledges would not work, and it was not until after he had substituted the apparatus shown in Mr. Gray's caveat in place of it, that he was enabled to successfully accomplish the grand object of reproducing articulate speech at a distance. See note, page 73.—G. B. P.

various stages through which the apparatus passed, but shall merely say that after a time I produced the form of instrument shown in fig. 51, which served very well as a receiving telephone. In this condition my invention was exhibited at the Centennial Exhibition in Philadelphia. The telephone shown in fig. 50 was used as a transmitting instrument, and that in fig. 51 as a receiver, so that vocal communication was only established in one direction.

Another form of transmitting telephone exhibited in Philadelphia, intended for use with the receiving telephone (fig. 51), is represented by fig. 52.

A platinum wire attached to a stretched membrane completed a voltaic circuit by dipping into water.¹ Upon speaking to the

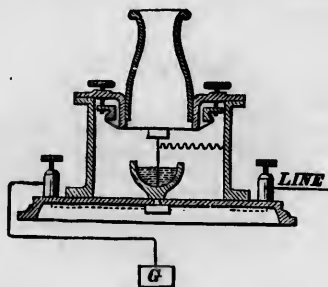

Fig. 52.

membrane articulate sounds proceeded from the telephone in the distant room. The sounds produced by the telephone became louder when dilute sulphuric acid, or a saturated solution of salt, was substituted for the water. Audible effects were also produced by the vibration of plumbago in mercury, in a solution

¹ From the reading of the text it might be erroneously inferred that the apparatus shown in figure 52 was invented by Professor Bell, and exhibited by him at the Centennial Exhibition. Professor Bell neither invented nor exhibited it. The above figure represents the transmitting portion of Elisha Gray's original Speaking Telephone—the first articulating telephone ever invented. The complete apparatus is shown in figure 6, page 15. Mr. Gray experimented with his telephone at the Centennial Exhibition at Philadelphia in 1876, and showed it to some of his friends, among others to Professor Barker, of the University of Pennsylvania, but did not exhibit it to the Judges.—G. B. P.

of bichromate of potash, in salt and water, in dilute sulphuric acid, and in pure water.

The articulation produced from the instrument shown in fig. 51 was remarkably distinct, but its great defect consisted in the fact that it could not be used as a transmitting instrument, and thus two telephones were required at each station, one for transmitting and one for receiving spoken messages.

It was determined to vary the construction of the telephone shown in fig. 50, and I sought, by changing the size and tension of the membrane, the diameter and thickness of the steel spring, the size and power of the magnet, and the coils of insulated wire around their poles, to discover empirically the exact effect of each element of the combination, and thus to deduce a more perfect form of apparatus. It was found that a marked increase in

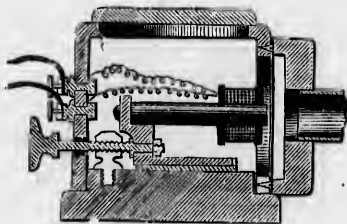

Fig. 52.

the loudness of the sounds resulted from shortening the length of the coils of wire, and by enlarging the iron diaphragm which was glued to the membrane. In the latter case, also, the distinctness of the articulation was improved. Finally, the membrane of gold beaters' skin was discarded entirely, and a simple iron plate was used instead, and at once intelligible articulation was obtained. The new form of instrument is that shown in fig. 53. and, as had been long anticipated, it was proved that the only use of the battery was to magnetize the iron core of the magnet, for the effects were equally audible when the battery was omitted and a rod of magnetized steel substituted for the iron core of the magnet.

It was my original intention, as shown in fig. 45, and it was

always claimed by me, that the final form of telephone would be operated by permanent magnets in place of batteries, and numerous experiments had been carried on by Mr. Watson and myself privately for the purpose of producing this effect.

At the time the instruments were first exhibited in public the results obtained with permanent magnets were not nearly so striking as when a voltaic battery was employed, wherefore we thought it best to exhibit only the latter form of instrument.

The interest excited by the first published accounts of the operation of the telephone led many persons to investigate the subject, and I doubt not that numbers of experimenters have independently discovered that permanent magnets might be employed instead of voltaic batteries. Indeed, one gentleman, Professor Dolbear, of Tufts College, not only claims to have

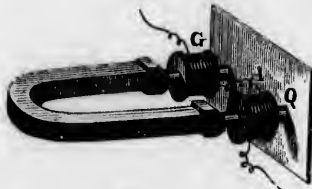

Fig. 54.

discovered the magneto-electric telephone, but, I understand, charges me with having obtained the idea from him through the medium of a mutual friend.

A still more powerful form of apparatus was constructed by using a powerful compound horse shoe magnet in place of the straight rod which had been previously used (see fig. 54). Indeed, the sounds produced by means of this instrument were of sufficient loudness to be faintly audible to a large audience, and in this condition the instrument was exhibited in the Essex Institute, in Salem, Massachusetts, on the 12th February, 1877, on which occasion a short speech shouted into a similar telephone in Boston, sixteen miles away, was heard by the audience in Salem. The tones of the speaker's voice were distinctly audible to an audience of six hundred people, but the articulation was

only distinct at a distance of about six feet. On the same occasion, also, a report of the lecture was transmitted by word of mouth from Salem to Boston, and published in the papers the next morning.

From the form of telephone shown in fig. 53 to the present form of the instrument (fig. 55) is but a step. It is, in fact, the arrangement of fig. 53 in a portable form, the magnet F H being placed inside the handle and a more convenient form of mouth-piece provided. The arrangement of these instruments upon a telegraphic circuit is shown in fig. 56.

And here I wish to express my indebtedness to several scientific friends in America for their coöperation and assistance. I would specially mention Professor Peirce and Professor Blake, of Brown University, Dr. Channing, Mr. Clarke and Mr. Jones. In Providence, Rhode Island, these gentlemen have been carrying on together experiments seeking to perfect the form of apparatus required, and I am happy to record the fact that they communicated to me each new discovery as it was made, and every new step in their investigations. It was, of course, almost inevitable that these gentlemen should retrace much of the ground that had been gone over by me, and so it has happened that many of their discoveries had been anticipated by my own researches; still, the very honorable way in which they, from time to time, placed before me the results of their discoveries, entitles them to my warmest thanks and to my highest esteem. It was always my belief that a certain ratio would be found between the several parts of a telephone, and that the size of the instrument was immaterial; but Professor Peirce was the first to demonstrate the extreme smallness of the magnets which might be employed. And here, in order to show the parallel lines in which we were working, I may mention the fact that two or three days after I had constructed a telephone of the portable form (fig. 55), containing the magnet inside the handle, Dr. Channing was kind enough to send me a pair of telephones of a similar pattern, which had been invented by the Providence experimenters. The convenient form of mouthpiece shown in

fig. 55, now adopted by me, was invented solely by my friend, Professor Peirce. I must also express my obligations to my friend and associate, Mr. Thomas A. Watson, of Salem, Massachusetts, who has for two years past given me his personal assistance in carrying on my researches.

In pursuing my investigations I have ever had one end in view—the practical improvement of electric telegraphy—but I have come across many facts which, while having no direct bearing upon the subject of telegraphy, may yet possess an interest for you.¹

For instance, I have found that a musical tone proceeds from a piece of plumbago or retort carbon when an intermittent current of electricity is passed through it, and I have observed the most curious audible effects produced by the passage of reversed intermittent currents through the human body. A rheotome was placed in circuit with the primary wires of an induction coil, and the fine wires were connected with two strips of brass. One of these strips was held closely against the ear, and a loud sound proceeded from it whenever the other slip was touched with the other hand. The strips of brass were next held one in each hand. The induced currents occasioned a muscular tremor in the fingers. Upon placing my forefinger to my ear a loud crackling noise was audible, seemingly proceeding from the finger itself. A friend who was present placed my finger to his ear, but heard nothing. I requested him to hold the strips himself. He was then distinctly conscious of a noise (which I was unable to perceive) proceeding from his finger. In this case a portion of the induced currents passed through the head of the observer when he placed his ear against his own finger, and it is possible that the sound was occasioned by a vibration of the surfaces of the ear and finger in contact.

When two persons receive a shock from a Ruhmkorff's coil by clasping hands, each taking hold of one wire of the coil with the free hand, a sound proceeds from the clasped hands. The

¹ See *Researches in Telephony*. Trans. of American Acad. of Arts and Sciences, vol. xii, p. 1.

effect is not produced when the hands are moist. When either of the two touches the body of the other a loud sound comes from the parts in contact. When the arm of one is placed against the arm of the other, the noise produced can be heard at a distance of several feet. In all these cases a slight shock is experienced so long as the contact is preserved. The introduction of a piece of paper between the parts in contact does not materially interfere with the production of the sounds, but the unpleasant effects of the shock are avoided.

When an intermittent current from a Ruhmkorff's coil is passed through the arms a musical note can be perceived when the car is closely applied to the arm of the person experimented upon. The sound seems to proceed from the muscles of the fore-arm and from the biceps muscle. Mr. Elisha Gray¹ has

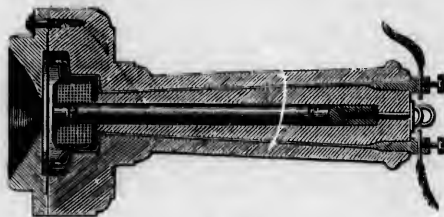

Fig. 55.

also produced audible effects by the passage of electricity through the human body.

An extremely loud musical note is occasioned by the spark of a Ruhmkorff's coil when the primary circuit is made and broken with sufficient rapidity. When two rheotomes of different pitch are caused simultaneously to open and close the primary circuit a double tone proceeds from the spark.

A curious discovery, which may be of interest to you, has been made by Professor Blake. He constructed a telephone in which a rod of soft iron, about six feet in length, was used instead of a permanent magnet. A friend sang a continuous musical tone into the mouthpiece of a telephone, like that shown

¹ Elisha Gray. Eng. Pat. Spec., No. 2646, Aug., 1874.

in fig. 55, which was connected with the soft iron instrument alluded to above. It was found that the loudness of the sound produced in this telephone varied with the direction in which the iron rod was held, and that the maximum effect was produced when the rod was in the position of the dipping needle. This curious discovery of Professor Blake has been verified by myself.

When a telephone is placed in circuit with a telegraph line the telephone is found seemingly to emit sounds on its own account. The most extraordinary noises are often produced, the causes of which are at present very obscure. One class of sounds is produced by the inductive influence of neighboring wires and by leakage from them, the signals of the Morse alphabet passing over neighboring wires being audible in the telephone, and another class can be traced to earth currents upon the wire, a curious modification of this sound revealing the presence of defective joints in the wire.

Professor Blake informs me that he has been able to use the railroad track for conversational purposes in place of a telegraph wire, and he further states that when only one telephone was connected with the track the sounds of Morse operating were distinctly audible in the telephone, although the nearest telegraph wires were at least forty feet distant.

Professor Peiree has observed the most curious sounds produced from a telephone in connection with a telegraph wire during the aurora borealis, and I have just heard of a curious phenomenon lately observed by Dr. Channing. In the city of Providence, Rhode Island, there is an overhouse wire about one mile in extent with a telephone at either end. On one occasion the sound of music and singing was faintly audible in one of the telephones. It seemed as if some one was practicing vocal music with a pianoforte accompaniment. The natural supposition was that experiments were being made with the telephone at the other end of the circuit, but upon inquiry this proved not to have been the case. Attention having thus been directed to the phenomenon, a watch was kept upon the instruments, and

upon a subsequent occasion the same fact was observed at both ends of the line by Dr. Channing and his friends. It was proved that the sounds continued for about two hours, and usually commenced about the same time. A searching examination of the line disclosed nothing abnormal in its condition, and I am unable to give you any explanation of this curious phenomenon. Dr. Channing has, however, addressed a letter upon the subject to the editor of one of the Providence papers, giving the names of such songs as were recognized, with full details of the observations, in the hope that publicity may lead to the discovery of the performer, and thus afford a solution of the mystery.

My friend Mr. Frederick A. Gower communicated to me a curious observation made by him regarding the slight earth connection required to establish a circuit for the telephone, and together we carried on a series of experiments with rather startling results. We took a couple of telephones and an insulated wire about 100 yards in length into a garden, and were enabled to carry on conversation with the greatest ease when we held in our hands what should have been the earth wire, so that the connection with the ground was formed at either end through our bodies, our feet being clothed with cotton socks and leather boots. The day was fine, and the grass upon which we stood was seemingly perfectly dry. Upon standing upon a gravel walk the vocal sounds, though much diminished, were still perfectly intelligible, and the same result occurred when standing upon a brick wall one foot in height, but no sound was audible when one of us stood upon a block of freestone.

One experiment which we made is so very interesting that I must speak of it in detail. Mr. Gower made earth connection at his end of the line by standing upon a grass plot, whilst at the other end of the line I stood upon a wooden board. I requested Mr. Gower to sing a continuous musical note, and to my surprise the sound was very distinctly audible from the telephone in my hand. Upon examining my feet I discovered that a single blade of grass was bent over the edge of the board, and that my foot touched it. The removal of this blade of grass

was followed by the cessation of the sound from the telephone, and I found that the moment I touched with the toe of my boot a blade of grass or the petal of a daisy the sound was again audible.

The question will naturally arise, Through what length of wire can the telephone be used? In reply to this I may say that the maximum amount of resistance through which the undulatory current will pass, and yet retain sufficient force to produce an audible sound at the distant end, has yet to be determined; no difficulty, has, however, been experienced in laboratory experiments in conversing through a resistance of 60,000 ohms, which has been the maximum at my disposal. On one occasion, not having a rheostat at hand, I may mention having passed the current through the bodies of sixteen persons, who stood hand in hand. The longest length of real telegraph line through which I have attempted to converse has been about 250

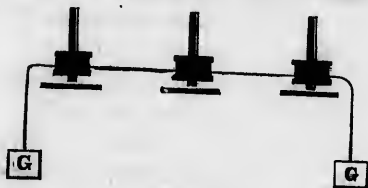

Fig. 56.

miles. On this occasion no difficulty was experienced so long as parallel lines were not in operation. Sunday was chosen as the day on which it was probable other circuits would be at rest. Conversation was carried on between myself, in New York, and Mr. Thomas A. Watson, in Boston, until the opening of business upon the other wires. When this happened the vocal sounds were very much diminished, but still audible. It seemed, indeed, like talking through a storm. Conversation, though possible, could be carried on with difficulty, owing to the distracting nature of the interfering currents.

I am informed by my friend Mr. Preece that conversation has been successfully carried on through a submarine cable, sixty miles in length, extending from Dartmouth to the Island of

Guernsey, by means of hand telephones similar to that shown in fig. 56."

At the conclusion of the lecture complimentary remarks were made by the President and various other members who were present, and a cordial vote of thanks was extended to Professor Bell for his very philosophical and entertaining discourse. We reproduce a portion of the remarks made by Mr. Preece :

"While on the one part Professor Bell has placed in our hands, to a certain extent, a new power, he has, on the other hand, thrown upon our shoulders an extra weight. The poor telegraph engineer has now to master many sciences. Not only must he know something of electricity and magnetism—not only must he know a good deal of chemistry—not only must he pass through various stages of mathematical knowledge, but now, thanks to Professor Bell, he is obliged to be master of the intricacies of acoustics. I do not blame him, because the study of sound is in itself a beautiful occupation, and when it becomes linked to one's profession it becomes almost a luxury.

Professor Bell alluded to the fact that expectancy led him in his first telephone to anticipate what was said. I will give you an illustration of the effect of expectancy. It was my pleasure, on a recent occasion, to exhibit the telephone before a very large audience. Many learned men were present. There is one very remarkable feature of a learned meeting. When you call upon a learned member to make a learned remark he frequently makes a foolish one. Now, I selected one of the leading scientific men of the day, and placed the telephone in his hand. It was in connection with a similar instrument fifty-five miles away. Of course we expected to hear from him some learned axiom, some sage aphorism or some wonderful statement; but, after some hesitation, he said: 'Hey diddle diddle—follow that up.' He rapidly put the telephone up to his ear and announced with much glee, 'He says, cat and the fiddle.' Fifty miles off my assistant was answering the question. I asked him next day if he understood 'Hey diddle diddle.' He said 'No.' 'What did you say?' 'I asked him to repeat!'"

CHAPTER III

THE TELEPHONE ABROAD.

¹ OF all modern inventions connected with the transmission of telegraphic signals, the telephone, devised by Mr. Alexander Graham Bell, has excited the most widespread interest and wonder. Wherever Mr. Bell has appeared before the public to give an account of his invention and the researches which have led up to it, crowds have assembled to hear him. Nor is this astonishing; for the telephone professes not only to convey intelligible signals to great distances without the use of a battery, but to transmit in fac-simile the tones of the human voice, so that a voice shall be as certainly recognized when heard over a distance of a few hundreds of miles as if its owner were speaking in the room by our side. And the telephone does not fall short of its profession. Scientific men have had their wonder and curiosity aroused even more than the unscientific public, since a scientific man appreciates the enormous difficulties to be overcome before such an instrument can be realized. Had any hardy speculator a few years ago proposed a telephone which should act on the principle, and be constructed in the form, of Mr. Bell's instrument, he would probably have been considered a lunatic.² The effects are so marvellous; the exciting causes at first sight so entirely inadequate to produce them. For a telephonic message differs as widely from an ordinary telegraphic message as a highly finished oil painting differs from a page of print. In the one you have only white and black—black symbols on a white ground—the symbols being limited in number, and recurring again and again with mere differences of order. The painting, on the other hand, discloses every variety of color and arrangement. No sharp lines of discontinuity offend the eye; on the contrary, the tints shade off gradually and softly

¹ From the *Westminster Review*.

² See Baille's prediction, page 47.

into each other, presenting tone and depth in endless variety. The page of print is unintelligible without the aid of a key; the painting tells its story plainly enough to any one who has eyes to see.

Let us inquire for a moment what is the nature of the apparatus which we have been using for the last thirty or forty years for the transmission of telegraphic signals. The instruments chiefly employed have been the single needle telegraph and the Morse instrument. In the former a coil of wire surrounds a magnetized needle, which is suspended in a vertical position. When an electrical current passes through the coil, the needle is deflected to right or left, according to the direction of the current. The sender, by means of a handle, can pass either positive or negative currents into the circuit. The right and left deflections of the needle are combined in various ways to form the letters of the alphabet, and the letters form words. Thus, at the sending station a message is broken up into little bits, each bit or part of a bit transmitted separately, and the process of building these up again performed at the receiving station. Some of the letters of the alphabet are indicated by a single movement of the needle, that is, by a single current; for others, as many as four are required.

In the Morse instrument only one current is utilized, which may be either positive or negative, and the requisite variety is obtained by allowing the current to pass through the circuit for a longer or shorter interval. The essential part of the instrument consists of an electro-magnet with an iron armature attached to one end of a lever. At the other end of the lever is a pointer or pencil, and a paper ribbon moves at a constant rate in front of the end of the pointer. When the coils of the electro-magnet are traversed by a current, the iron armature is attracted, and the pointer comes in contact with the paper ribbon, on which it makes a mark, long or short, according to the duration of the current. Thus are produced the dots and dashes. These are combined in a similar way to the right and left movements of the needle in the needle instrument. In some

of the more refined instruments letters are indicated and even printed directly at the receiving station. This is, of course, a great simplification; but with such arrangements we cannot have more than this. The page of print represents the limit of what such instruments and methods can do for us. It is true that a skilled operator with the Morse instrument can interpret the signals as they arrive without looking at the marks on the paper, simply by using his ears. Every time the circuit is made or broken a click is heard, and long practice has taught him to rely on the evidence of his ears with as much confidence as one less accustomed to the work would trust his eyes. Nevertheless, he hears only a succession of clicks, which must be interpreted before they become intelligible to any one but himself.

In these forms of apparatus, it will be observed, the currents are intermittent; each current, circulating through the coil, is followed by an interval of rest. They begin and end abruptly, and all perform the same kind of work; that is, they deflect a needle, or produce marks on a piece of paper. Telephonic currents, on the other hand, rise and fall, ebb and flow, change in intensity within comparatively wide limits, but preserve their continuity so long as continuous sounds are being uttered in the neighborhood of the telephone. They are called undulatory currents, to distinguish them from the intermittent currents of the ordinary telegraphic apparatus; and their peculiar character is an essential feature of the telephone.

No skill or training is required for the effective use of the telephone. The operator has merely to press the instrument to his ear to hear distinctly every sound transmitted from the distant end. For this, it is true, an effort of attention is required, and some persons use the instrument at the first trial with more success than others. Individuals differ in the facility with which they are able to concentrate their attention on one ear, so as to be practically insensible to what goes on around them. But this habit of attention is readily acquired, and when it is once acquired the telephone may be used by any one who has ears to hear and a tongue to speak. In sending a message, the instru-



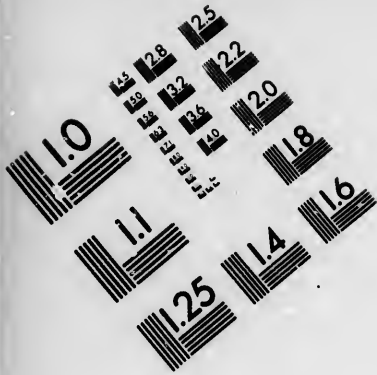

**IMAGE EVALUATION
TEST TARGET (MT-3)**

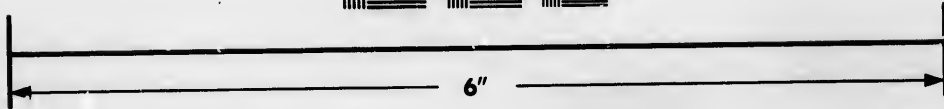
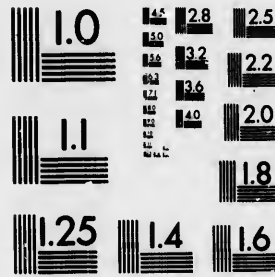

**Photographic
Sciences
Corporation**

23 WEST MAIN STREET
WEBSTER, N.Y. 14580
(716) 872-4503

15 12.8
18 12.5
22 20
25 18

10
12.8
15
18
22

ment is held about an inch in front of the mouth, and the sender merely talks into the mouthpiece in his ordinary, natural manner. The words are repeated by the instrument at the other end of the circuit with the same pitch, the same cadences, and the same relative loudness. But what strikes one the most is that the character of the speaker's voice is faithfully preserved and reproduced. Thus one voice is readily distinguished from another. No peculiarity of inflection is lost. Nor is this result effected over short distances only. No doubt a sentence will be heard with diminishing distinctness as it comes over an increasing distance. In this country experiments have not yet been made, so far as we know, over very long distances; but Mr. Bell states that he carried on a conversation without any difficulty between Boston and New York, two hundred and fifty-eight miles apart, through an ordinary telegraph wire. A man's breathing was distinctly heard one hundred and forty-nine miles away. At the Newport torpedo station, in Rhode Island, speaking was carried on through a line including five miles of submerged cable and an equal length of land wire. Resistance coils were added two thousand ohms at a time, until twelve thousand ohms were introduced into the circuit, without interfering with the transmission of speech. The importance of this test will be understood when it is remembered that the resistance of the Atlantic cable is equal to seven thousand ohms only.¹ The experiments at Newport were continued by the addition of a total resistance of thirty thousand ohms, but beyond twelve thousand ohms, the sound was found to diminish in intensity. Mr. Bell states that the maximum amount of resistance through which the undulating current will pass, and yet retain sufficient force to produce an audible sound at the distant end,

¹ It by no means follows, as the writer would lead us to infer, that the telephone can be used to transmit articulate speech through extended lengths of cable simply because it has served well, under very dissimilar circumstances, to communicate through an equivalent resistance of artificial line. The laws regarding the phenomenon of inductive retardation in long ocean cables, like those across the Atlantic, hold good for currents produced by the telephone as well as for currents derived from any other source whatever.

has yet to be determined. In the laboratory he has conversed through a resistance of sixty thousand ohms. There is a practical difficulty in transmitting telephonic signals through a telegraph wire running parallel to a number of other wires which are being used for ordinary telegraphic purposes. Induction currents are produced in the telephone wire, which greatly interfere with the distinctness of the sounds. The difficulty is said to be overcome by having an extra return wire, instead of utilizing the earth for a part of the circuit, as is ordinarily done. The two wires are put side by side in close proximity, and the detrimental effect of the inductive currents is thus partially or entirely disposed of. The following extract from a letter which appeared in the Daily News a few weeks ago shows that inductive action, when the parallel circuits are not numerous, does not seriously interfere with the transmission of speech:

The experiments with the telephone were made by me upon the cable lying between Dover and Calais, which is twenty-one and three-quarter miles long. Several gentlemen and ladies were present, and conversed in French and English with a second party in France for upwards of two hours. There was not the slightest failure during the whole time. I was only using one wire. The other three (it is a four-wire cable) were working direct with London and Paris, Calais and Lille. I could distinctly hear the signals by the three wires on the telephone; and at times, when but one of the three wires was working, I could decipher the Morse signals, and read a message that was passing from Glasgow to Paris. Yet when all the three wires were working simultaneously, the telephone sounds were easily and clearly distinguishable above the click of the signals: I happened to know several of the party in France, and was able to recognize their voices. They also recognized mine, and told us immediately a lady spoke that it was a female voice. When making some trials upon a line three fourths of a mile long, I arranged a musical box (the tones of which are very feeble) under the receiver of an air-pump, the top of the receiver being open. Upon this opening I placed the telephone, and every

note came out at the second end so clearly as to enable those who were present to name the tune that was played. Unfortunately we had not the same means in France, but simply held the mouth of the telephone close to the box, and some of the notes were audible, but not so perfect as on the short line. One young lady burst out laughing the moment she placed the instrument to her ear, and exclaimed, "Some one is whistling, 'Tommy, make way for your uncle!'" As my correspondent and myself had had a little practice, we were, without the slightest difficulty, able to talk in our usual manner, without any strain upon the voice or any unnatural lengthening of syllables. We were not able to hear breathing, in consequence of the continued pecking caused by induction from other wires.

The construction of the telephone (fig. 57) is remarkably simple.

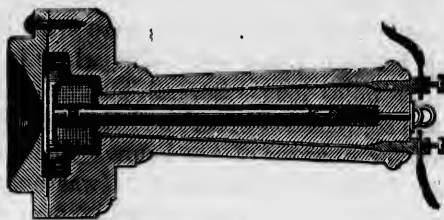

Fig. 57.

It consists of a steel cylindrical magnet, about five inches long and three eighths of an inch in diameter, encircled at one extremity by a short bobbin of wood or ebonite, on which is wound a quantity of very fine insulated copper wire. The magnet and coil are contained in a wooden cylindrical case. The two ends of the coil are soldered to thicker pieces of copper wire, which traverse the wooden envelope from one end to the other, and terminate in the binding screws at its extremity. Immediately in front of the magnet is a thin circular iron plate, which is kept in its place by being jammed between the main portion of the wooden case, and a wooden cap carrying the mouth or ear trumpet. These two parts are screwed together. The latter is cut away at the centre, so as to expose a portion of the iron plate,

about half an inch in diameter. In the experiments which Mr. Bell has carried out in order to determine the influence of the various parts of the telephone on the results produced, and their relations to each other when the best effects are obtained, he employed iron plates of various areas and thicknesses, from boiler plate three-eighths of an inch in thickness to the thinnest plate procurable. Wonderful to relate, it appears that scarcely any plate is too thin or too thick for the purpose, but the best thickness is that of the ferrotype plate used by photographers. Thin tin plate also answers very well. The iron plate is cut into the form of a disk, about two inches in diameter, and is placed as near as possible to the extremity of the steel magnet without actually touching it; the effect of this position being that, while the induced magnetism of the plate is considerable, it is susceptible to very rapid changes, owing to the freedom with which the plate can vibrate. The dimensions of the various parts of the instrument here given are found to be convenient, but they are by no means essential. Good results have been obtained by means of a magnet only an inch and a half long, and a working instrument need not be too large for the waistcoat pocket. There is no difference between the transmitting and the receiving telephone; each instrument serves both purposes. Nevertheless, in order to avoid the inconvenience of shifting the instrument backwards and forwards between the ear and the mouth, it is better to have two on the circuit at each station. The operator then holds one permanently to his ear, while he talks with the other.

It will not be supposed that the idea of this marvellously simple piece of apparatus was evolved ready formed from the inventor's brain: very far otherwise. It is the final outcome of a long series of patient researches carried out by Mr. Bell in the most skilful and philosophical manner, in which one modification suggested another, accessory after accessory was discarded, and finally the instrument was pruned down to its present form and dimensions. Telephones have been long known. A few years ago a simple arrangement whereby articulate sounds could be transmitted over a distance of fifty or sixty yards, or even fur-

ther, could be bought in the streets for a penny. It consisted of a pair of pill boxes, the bottoms of which were connected by a piece of string stretched tight, while over the mouth of each was pasted tissue paper. On speaking to one of the pill boxes the tissue paper and enclosed air were set in vibration. The vibrations so produced were communicated to the thread and transmitted to the distant pill box, which was held close to the ear, where they affected the air in such a way as to reproduce the original sounds. The simple apparatus was more effective than would be at first imagined. Electric telephones were devised in this country about the same time that the telegraph was introduced, but the best of them differed widely from the modern instrument. They were capable of conveying to a distance sounds of various pitch, so that the succession of notes constituting a melody could be reproduced many miles away, but the special character of the voice by which the melody was originated was entirely lost.¹ Now the great interest which attaches to Mr. Bell's telephone, and the intense wonder and curiosity it has aroused, are due to its power of conveying absolutely unaltered every peculiarity of voice or musical instrument. A violin note reappears as a violin note; it cannot be mistaken for anything else. And in the case of a human voice, it is not less easy to distinguish one speaker from another than it would be if the speakers were in the room close by instead of being miles or even hundreds of miles away. This is the charm of the new telephone; this it is which renders it immeasurably superior to any thing of the kind which preceded it.

Mr. Bell's researches in electric telephony began with the artificial production of musical sounds, suggested by the work in which he was then engaged in Boston, viz: teaching the deaf and dumb to speak. Deaf mutes are dumb merely because they are deaf. There is no local defect to prevent utterance, and Mr. Bell has practically demonstrated by two thousand of

¹ Reiss's telephone was the first invention which could accomplish the result here stated, and this was invented in Germany, in 1861. See description of Reiss's telephone, page 9.

his own pupils that when the deaf and dumb know how to control the action of their vocal organs, they can articulate with comparative facility. Striving to perfect his system of teaching, it occurred to Mr. Bell that if, instead of presenting to the eye of the deaf mute a system of symbols, he could make visible the vibrations of the air, the apparatus might be used as a means of teaching articulation. In this part of his investigations Mr. Bell derived great assistance from the phonautograph. He succeeded in vibrating by the voice a style of wood, about a foot in length, attached to the membrane of the phonautograph; and with this he obtained enlarged tracings of the vibrations of the air, produced by the vowel sounds, upon a plane surface of smoked glass. Mr. Bell traced a similarity between the manner in which this piece of wood was vibrated by the membrane of the phonautograph and the manner in which the ossiculæ of the human ear were moved by the tympanic membrane. Wishing to construct an apparatus closely resembling the human ear, it was suggested to him by Dr. Clarence J. Blake, a distinguished aurist of Boston, that the human ear itself would be still better, and a specimen was prepared. Our readers are aware that the tympanic membrane of the ear is connected with the internal ear by a series of little bones called respectively the malleus, the incus and the stapes, from their peculiar shapes, and that by their means the vibrations of the tympanic membrane are communicated to the internal ear and the auditory nerves. Mr. Bell removed the stapes and attached to the end of the incus a style of hay about an inch in length. Upon singing into the external artificial ear, the style of hay was thrown into vibration, and tracings were obtained upon a plane surface of smoked glass passed rapidly underneath. The curves so obtained are of great interest, each showing peculiarities of its own dependent upon the vowel sound that is sung. Whilst engaged in these experiments Mr. Bell's attention was arrested by observing the wonderful disproportion which exists between the size and weight of the membrane—no thicker than tissue paper—and the weight of the bones vibrated by it, and he was led to

inquire whether a thicker membrane might not be able to vibrate a piece of iron in front of an electro-magnet. The experiment was at once tried. A piece of steel spring was attached to a stretched membrane of gold beater's skin and placed in front of the pole of the magnet. This answered very well, but it was found that the action of the instrument was improved by increasing the area of metal, and thus the membrane was done away with and an iron plate substituted for it. It was important at the same time to determine the effect produced by altering the strength of the magnet; that is, of the current which passed round the coils. The battery was gradually reduced from fifty cells to none at all, and still the effects were observed, but in a less marked degree. The action was in this latter case doubtless due to residual magnetism; hence, in the present form of apparatus a permanent magnet is employed. Lastly, the effect of varying the dimensions of the coil was studied, when it was found that the sounds became louder as its length was diminished; a certain length was, however, ultimately reached, beyond which no improvement was effected, and it was found to be only necessary to enclose one end of the magnet in the coil of wire.

Such was the instrument that Mr. Bell sent to the Centennial Exhibition at Philadelphia. The following is the official report of it, signed by Sir William Thomson and others:

Mr. Alexander Graham Bell exhibits an apparatus by which he has achieved a result of transcendent scientific interest—a transmission of spoken words by electric currents through a telegraph wire. To obtain this result Mr. Bell perceived that he must produce a variation of strength of current as nearly as may be in exact proportion to the velocity of a particle of air moved by the sound, and he invented a method of doing so—a piece of iron attached to a membrane (fig. 58), and thus moved to and fro in the neighborhood of an electro-magnet, which has proved perfectly successful. The battery and wire of this electro-magnet are in circuit with the telegraph wire and the wire of another electro-magnet at the receiving station. This second electro-magnet has a solid bar of iron for core which is connected at one end by a

thick disk of iron to an iron tube surrounding the coil and bar. The free circular end of the tube constitutes one pole of the electro-magnet, and the adjacent free end of the bar core the other. A thin circular iron disk, held pressed against the end of the tube by the electro-magnetic attraction and free to vibrate through a very small space without touching the central pole, constitutes the sounder by which the electric effect is reconverted



Fig. 58.

into sound (fig. 59). With my ear pressed against this disk, I heard it speak distinctly several sentences. I need scarcely say I was astonished and delighted. So were others, including some judges of our group, who witnessed the experiments and verified with their own ears the electric transmission of speech. This, perhaps, the greatest marvel hitherto achieved by the electric



Fig. 59.

telegraph, has been obtained by appliances of quite a homespun and rudimentary character. With somewhat more advanced plans and more powerful apparatus, we may confidently expect that Mr. Bell will give us the means of making the voice and spoken words audible through the electric wire to an ear hundreds of miles distant. The present form of instrument, which is now being manu-

factured in large numbers by the Silvertown Company, does not essentially differ from that reported on so enthusiastically by Sir William Thomson. Only it is more simple in construction and more handy.

Before attempting any explanation of the action of the telephone, it may be well to draw the attention of our readers to the special characteristics of the human voice, and to those peculiarities which distinguish one musical note from another. Whatever the differences in question may depend upon, it is certain that they are transmitted and reproduced in the telephone with unerring fidelity, and it is, therefore, important that we should understand their nature and origin. Take a tuning fork and set it in vibration by striking or drawing a violoncello bow across its prongs. The fork yields its own proper note, which will be loud or the reverse, according as the fork has been struck energetically or lightly. So long as we use one fork only it is obvious that the only variation which can be produced in the sound is a variation of intensity. If the extent of vibration be small, the resulting sound is feeble; its loudness increases with the excursion of the prongs. What is true of the tuning fork is true of any other musical instrument, and hence, generally, the loudness of a musical sound depends upon the amplitude of vibration of that which produced it. Now, take two similar tuning forks of different pitch, and suppose that one is exactly an octave above the other. They may be excited in such a way that the notes emitted are of equal loudness, and then the only respect in which they differ from each other is in pitch. The pitch of a fork depends upon its rate of vibration. It is comparatively easy with suitable apparatus to measure the rate of vibration of a tuning fork, and were we to test the two forks in question, it would be found that that giving the higher note vibrates exactly twice as fast as the other. If the one performs a hundred oscillations in a second, the other which is an octave above, completes two hundred in the same interval of time. Thus, the pitch of a note yielded by a tuning fork depends upon its rate of vibration, and on nothing else, and the same is true of a piano-forte wire, the

air in an organ pipe, a harmonium reed, etc. We have now accounted for two of the characteristics of a musical note, its loudness and its pitch; but there is a third, equally, if not more important, and by no means so simple of explanation. We refer to what is usually spoken of in English books on acoustics as the quality of the note; the French call it *timbre* and the Germans *klangfarbe*. It is that which constitutes the difference between a violin and an organ, or between an organ and a piano-forte, or between two human voices; indeed between any two musical sounds which are of the same pitch and loudness, but are still distinguishable from each other. In order to explain the physical cause of quality, we will suppose we have a thin metallic wire about a yard long stretched between two points over a sounding board. When plucked at its centre the wire vibrates as a whole, the two ends are points of rest, and a loop is formed between them. The note emitted by the wire when vibrating in this manner is called its fundamental note. If the wire be damped at its centre, by laying on it with slight pressure the feather of a quill pen, and plucked at a point half way between the centre and one end, both halves will vibrate in the same manner, and independently of each other. That is to say, there will be two equal vibrating segments and a point of rest or node at the centre. But the rapidity of vibration of each segment will be twice as great as that of the wire when vibrating as a whole, and consequently the note emitted will be the octave of the fundamental. When damped at a point one third of the length from either extremity, and plucked half way between that point and the nearer extremity, the wire will vibrate in three equal divisions, just as it vibrates in two divisions in the previous case. The rate of vibration will be now three times as great as at first, and the note produced will be a twelfth above the fundamental. Similarly, by damping and plucking at suitable points the wire may be made to vibrate in four parts, five parts, six parts, etc., the rate of vibration increasing to four, five, six, etc., times what it was at first. Let us suppose that when the wire was swinging as a whole, and sounding its fundamental

note, the number of oscillations performed in a second was one hundred. Then we see that by taking suitable precautions the wire can be made to break up into two, three, four, five, six, etc., vibrating segments, the rates of vibration being respectively two hundred, three hundred, four hundred, five hundred, six hundred, etc., and the series of notes emitted being the octave above the fundamental, the fifth above the octave, the double octave, the third and fifth above the double octave, and so on. We now come to an important point, which is this—that, the wire being free, it is practically impossible to strike or pluck it in such a way as to make it vibrate according to one of the above systems only. It will vibrate as a whole wherever and however it be struck, but this mode has always associated with it or superposed upon it some of the other modes of vibration to which we have just referred. In other words, the fundamental note is never heard alone, but always in combination with a certain number of its overtones, as they are called. Each form of vibration called into existence sings, as it were, its own song, without heeding what is being done by its fellows, and the consequence is that the sound which reaches the ears is not simple but highly composite in its character. The word *clang* has been suggested to denote such a composite sound, the constituent simple sounds, of which it is the aggregate, being called its first, second, third, etc., partial tones. All the possible partial tones are not necessarily present in a clang, nor of those which are present are the intensities all the same. For instance, if the wire be struck at the centre, that point cannot be a node, but must be a point of maximum disturbance; hence all the even partial tones are excluded and only the odd ones, the first, third, fifth, and so on, are heard.

That characteristic of a musical note or clang, which is called its quality, depends upon the number and relative intensities of the partial tones which go to form it. The tone of a tuning fork is approximately simple; so is that of a stopped wooden organ pipe of large aperture blown by only a slight pressure of wind. Such tones sound sweet and mild, but also tame and spiritless. In the clang of the violin, on the other hand, a large number of

partial tones are represented; hence the vivacious and brilliant character of this instrument. The sounds of the human voice are produced by the vibrations of the vocal chords, aided by the resonance of the mouth. The size and shape of the cavity of the mouth may be altered by opening and closing the jaws, and by tightening or loosening the lips. We should expect that these movements would not be without effect on the resonance of the contained air, and such proves on experiment to be the fact. Hence, when the vocal chords have originated a clang containing numerous well developed partial tones, the mouth cavity, by successively throwing itself into different postures, can favor by its resonance first one overtone and then another; at one moment this group of partial tones, at another that. In this manner endless varieties of quality are rendered possible. Any one may prove to himself, by making the experiment, that when singing on a given note he can only change from one vowel sound to another by altering the shape and size of his mouth cavity.

Having thus briefly indicated the physical causes of the various differences in musical notes, and the production of sounds by the organ of voice, we will devote a few moments to consider how these sounds are propagated through the air and reach the plate of the telephone. When a disturbance is produced at any point in an aerial medium, the particles of which are initially at rest, sonorous undulations spread out from that point in all directions. These undulations are the effect of the rapid vibratory motions of the air particles. The analogy of water waves will help us to understand what is taking place under these circumstances. If a stone be dropped into the still water of a pond, a series of concentric circular waves is produced, each wave consisting of a crest and a hollow. The waves travel onwards and outwards from the centre of disturbance along the surface of the water, while the drops of water which constitute them have an oscillatory motion in a vertical direction. That is to say, following any radial line, the water particles vibrate in a direction at right angles to that in which the wave is propagated. The

distance between two successive crests or two successive hollows is called the length of the wave; the amplitude of vibration is the vertical distance through which an individual drop moves. In a similar manner sonorous undulations are propagated through air by the oscillatory motion of the air particles. But there is this important difference between the two cases, that, in the latter, the vibrating particles move in the same direction in which the sound is being propagated. Consequently such waves are not distinguished by alternate crests and hollows, but by alternate condensations and rarefactions of the air, the transmission of which constitutes the transmission of sound. The wave length is the distance between two consecutive condensations or rarefactions. It depends upon the pitch of the transmitted sound, being shorter as the sound is more acute, while the extent of vibration of the air particles increases with the loudness. Such are the peculiarities of the vibratory motion in air corresponding to the pitch and loudness of the transmitted sound. But what is there in the character of the motion to account for difference in quality? A little consideration will show that there is only one thing left to account for these, and that is the form of the vibration. Let us mentally isolate a particle of air, and follow its movements as the sound passes. If the disturbance is a simple one, produced, say, by the vibration of a tuning fork, the motion of the air particle will be simple also, that is, it will vibrate to and fro like the bob of a pendulum, coming to rest at each end of its excursion, and from these points increasing in velocity until it passes its neutral point. Such, however, is clearly not the only mode of vibration possible. If the disturbance be produced by a clang comprising a number of partial tones of various intensities, all excited simultaneously, it is obvious that the air particle must vibrate in obedience to every one of these. Its motion will be the resultant of all the motions due to the separate partial tones. We may imagine it, starting from its position of rest, to move forward, then stop short, and turn back for an instant, then on again until it reaches the end of its excursion. In returning it may perform the same series of to-

and-fro motions in the opposite direction, or it may move in a totally different way. Nevertheless, however complex its motion may be—and, as a rule, it will be exceedingly complex—its periodic character will be maintained. All the tremors and perturbations in one wave length will recur in all the others.

When sonorous undulations impinge upon the iron plate of the telephone, the latter is set in vibration. Its particles move to and fro in some way or other. The complexity of their motion will depend upon that of the air from which it was derived. But for the sake of simplicity we will assume that the plate has a simple pendulous motion. It will be remembered that the iron plate is placed quite close to, but not quite in contact with, the extremity of the steel magnet. It becomes, therefore, itself a magnet by induction; and, as it vibrates, its magnetic power is constantly changing, being strengthened when it approaches the magnetic core, enfeebled as it recedes. Again, when a magnet moves in the neighborhood of a coil of wire, the ends of which are connected together, an electrical current is developed in the coil, whose strength depends upon the rapidity with which, and the distance through which, the magnet moves. In the telephone then, as the plate moves towards the coil, a current is induced in the latter which traverses the whole length of wire connecting it with the distant instrument; the plate returning, another current with reversed sign follows the first. The intensity of these currents depends, as we have said, on the rapidity with which these movements are effected, but is largely influenced also by the fact that the plate does not retain a constant magnetic strength throughout its excursions. Under the assumption we have made with respect to the simplicity of the plate's motion, it follows that the induced currents, alternately positive and negative, follow each other in a uniform manner, and with a rapidity corresponding to the pitch of the exciting note. These currents pass along the circuit, and circulate round the coil of the distant telephone. There they modify the magnetic relations between the steel magnetic core and the iron plate in such a way that one current—say the positive—attracts the plate, while the other

—the negative—repels it. And since the arriving currents follow each other, first positive and then negative, with perfect regularity, the plate will also vibrate in a uniform manner, and will perform the same number of vibrations per second as did the plate of the sending instrument. Hence the sound heard will be an exact copy, except as to loudness, of that produced at the sending station. Having thus followed the sequence of phenomena in this simple case, we are enabled to extend our explanation to the case in which composite sounds of more or less complexity—vowel sounds and speech—are transmitted. We are compelled to admit that every detail in the motion of an air particle, every turn and twist, must be passed on unaltered to the iron membrane, and that every modification of the motion of the membrane must have its counterpart in a modification of the induced currents. These, in their turn, affecting the iron plate of the receiving telephone, it follows that the plates of the two telephones must be vibrating in an absolutely identical manner.

We can thus follow in a general manner the course of the phenomena, and explain how air vibrations are connected with the vibrations of a magnetic plate—how these latter give rise to electrical currents, which, passing over a circuit of hundreds of miles, cause another magnetic plate to vibrate, every tremor in the first being reproduced in fac-simile in the second, and thus excite sonorous undulations which pass on to the ear. We can understand all this in a general way, but we are not the less lost in wonder that the sequence of events should be what it is. That a succession of currents could be transmitted along a telegraph wire without the aid of a battery, that, by simply talking to a magnetic membrane in front of a coil of wire, the relations of the magnetic field between the two could be so far modified as to produce in the coil a succession of electrical currents of sufficient power to traverse a long circuit, and to reproduce a series of phenomena identical with those by which the currents were brought into existence, would have been a few years ago pronounced an impossibility. A man would have been derided who proposed an instrument constructed on such principles.

Nevertheless, here it is realized in our hands. We can no longer doubt, we can only wonder, and admire the sagacity and patience with which Mr. Bell has worked out his problem to a successful issue.

¹ The articulating telephone of Mr. Graham Bell, like those of Reiss and Gray, consists of two parts, a transmitting instrument



Fig. 60.

and a receiver, and one cannot but be struck at the extreme simplicity of both instruments; so simple, indeed, that were it not for the high authority of Sir William Thomson, one might be pardoned at entertaining some doubts of their capability of producing such marvellous results.

The transmitting instrument, which is represented in fig. 60,

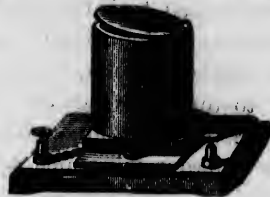

Fig. 61.

consists of a horizontal electro-magnet, attached to a pillar about 2 inches above a horizontal mahogany stand; in front of the poles of this magnet—or, more correctly speaking, magneto-electric inductor—is fixed to the stand in a vertical plane a circular brass ring, over which is stretched a membrane, carrying at its centre a small oblong piece of soft iron, which plays in front of the in-

¹ Engineering, 1877.

ductor magnet whenever the membrane is in a state of vibration. This membrane can be tightened like a drum by the three mill headed screws shown in the drawing. The ends of the coil surrounding the magnet terminate in two binding-screws, by which the instrument is put in circuit with the receiving instrument, which is shown in fig. 61. This instrument is nothing more than one of the tubular electro-magnets invented by M. Niçlès in the year 1852, but which has been reinvented under various fancy names several times since. It consists of a vertical bar electro-magnet inclosed in a tube of soft iron, by which its magnetic field is condensed and its attractive power within that area increased. Over this is fixed, attached by a screw at a point near its circumference, a thin sheet iron armature, of the thickness of a sheet of cartridge paper, and this, when under the influence of the transmitted currents, acts partly as a vibrator and partly as a resonator. The magnet with its armature is mounted upon a little bridge, which is attached to a mahogany stand similar to that of the transmitting instrument.

The action of the apparatus is as follows: When a note or a word is sounded into the mouthpiece of the transmitter, its membrane vibrates in unison with the sound, and in doing so carries the soft iron inductor attached to it backwards and forwards in presence of the electro-magnet, inducing a series of magneto-electric currents in its surrounding helix, which are transmitted by the conducting wire to the receiving instrument, and a corresponding vibration is therefore set up in the thin iron armature sufficient to produce sonorous vibrations, by which articulated words can be distinctly and clearly recognized. In all previous attempts at producing this result the vibrations were produced by a make and break arrangement; so that, while the number of vibrations per second, as well as the time measures, were correctly transmitted, there was no variation in the strength of the current, whereby the quality of tone was also recorded. This defect did not prevent the transmission of pure musical notes, nor even the discord produced by a mixture of them, but the complicated variation of tone, of quality, and of modulation, which

make up the human voice, required something more than a mere isochronism of vibratory impulses.

In Mr. Bell's apparatus not only are the vibrations in the receiving instrument isochronous with those of the transmitting membrane, but they are, at the same time, similar in quality to the sound producing them; for, the currents being induced by an inductor vibrating with the voice, differences of amplitude of vibration cause differences in strength of the impulses, and the articulate sound as of a person speaking is produced at the other end.

¹ The telephone has been regarded as a toy, or a curiosity to be played with; but, while it is undoubtedly extremely interesting as a novelty, it is very much more than this; it is, scientifically and practically, a great success. There are, undoubtedly, difficulties in its use, but, considering that it is a contrivance but of yesterday, the wonder is that it is so perfect.

When a telegraphist first gets into his hand this beautifully simple and electrically delicate instrument, his first inclination is to test its carrying power. This is, of course, a closet experiment, not working with actual telegraph line, but with a resistance coil equivalent to a telegraph line of stated length. An experiment of this nature gives better results than could be obtained by a veritable line, because the insulation is, so to speak, perfect. No leakage at undesigned points of contact, or disturbance from unfavorable atmospheric conditions, is felt, and the experiment is entirely under the observer's control. The apparatus used is designed to offer the same labor for the electric current to overcome as would be offered by a stated length of outside telegraph line. This artificial resistance is nicely graduated, and, as the method of testing was suggested by Ohm, a German electrician, the unit of resistance is termed an ohm. Removing the telephone to such a distance that the two observers were out of ear-shot, the test with resistance was tried, and with a resistance of 1,000 ohms—roughly speaking, equal to seventy miles of a well constructed line—the sound was perfect, although not very loud.

Every articulation of the speaker at the other end could be distinguished so long as silence was maintained in the room, or so long as no heavy lorry rumbling over the stones outside sent in no harsh noise which drowned the faint whisper of the instrument. The resistance was gradually raised to 4,000 ohms—nearly 300 miles—with like favorable results; and for some little distance beyond, articulation could still be made out. But by the time 10,000 ohms had been applied, putting the speaker at a distance of, say, 700 miles, sound only, but not articulate sound, reached the ear. The tone was there, and every inflection of the voice could be followed, but articulation was absent, although the listener strained every nerve to catch the sound, while the speaker, as was afterwards ascertained, was shouting in a loud, clear voice. The prolonged notes of an air sung could be heard with the resistance, but again no words could be distinguished.

The next experiment was to join up the telephones in the office with different line wires in succession going to various distances, and working with different kinds of telegraph instruments. When this was done, the real obstacle to telephonic progress at once asserted itself in the shape of induction. The first wire experimented with was partly overhouse and partly underground, and the offices upon it were working Wheatstone's step-by-step dial instruments. It is difficult to render clear to the person ignorant of telegraphic phenomena the idea expressed by the word induction. Briefly, it may be put thus: that, when an electric current is passing on a wire, it has the faculty of setting up a current of opposite character in any wire in its vicinity.

In various recent articles on the telephone, mention has been made of contact as the cause of disturbance. This word, however, although it has been used by telegraphists, is misleading, and can only be used as an endeavor to express popularly an electric fact. Actual contact of one wire with another would spoil the business altogether. A wire bearing an electric current seems to be for the time surrounded, to an undefined distance, by an electric atmosphere, and all wires coming within

this atmosphere have a current in an opposite direction set up in them. This is as near an explanation of the phenomena of induction as the state of telegraph science at present affords. Now, the telephone works with a very delicate magnetic current, and is easily overpowered by the action of a stronger current in any wire near which the telephone wire may come. To work properly, it requires a silent line.

In the place where the observations were made, there were a large number of wires travelling under the floor, along passages to the battery room, and to a pole on the outside, whence they radiate; or out to a pipe underground, where many gutta-percha covered wires lie side by side. On applying the ear to a telephone joined into a circuit working in such an office, a curious sound is heard, comparable most nearly to the sound of a pot boiling. But the practiced ear could soon separate the boiling into distinct sounds. There was one masterful Morse instrument—probably on the wire lying nearest the one on which we were joined up—whose peremptory click, cli-i-i-ck, click, representing dot, dash, dot on the printed slip we read from, could be heard over all. Then there was the rapid whirl of a fast speed transmitter sending dots and dashes at express speed by mechanical means; and, most curious of all, the rrrrr-op, rr-op, rrrrrrrrrrr-op, rrrrr-op, rrrrr-op, rr-op of the Wheatstone dial instrument, the deadliest foe to the telephone in its endeavors to gain admission into the family of telegraph instruments. There may be reason in this, for as the Wheatstone dial instrument is the instrument used for private telegraphy, or for the least important public offices, because it requires no code to be learned by the manipulator, so it would likely be the first to be displaced if an acoustic telegraph permanently took the field. So the sentient little Wheatstone dial opens its mitrailleuse fire on the intruder, on whose delicate currents, in the words of an accomplished electrician, it plays old Harry. The peculiar character of the sounds we borrow on the telephone from this instrument arises from the fact that, as the needle flies round the dial, a distinct current or pulsation passes for each letter, and the final op we have tried to

represent shows the stoppage of the needle at the letters as words were spelled out.

It must not be understood that the sounds of those various instruments are actually heard in the telephone. What happens is, that the currents stealing along the telephone wire by induction produce vibrations in the diaphragm of that instrument, the little metal membrane working on the magnet in ready response to every current set up by the latter. When it is remembered that the principle of the telephone is that the sound-caused vibrations in the filmy diaphragm at one end create similar but magnetically-caused vibrations in the diaphragm at the other end, and so reproduce the sound, it will be obvious why the rapid roll of the Wheatstone dial currents, or the swift sending of the fast-speed transmitter, when brought by induction into the telephone wire, cause disturbances in the sound vibrations, and thereby cripple the instrument. One instrument of either kind named would have a certain effect, but one Morse would not have any greatly prejudicial effect. But a number of Morses going together, such as were heard in our experiments, would combine to be nearly as bad as one Wheatstone dial or fast-speed Morse. So delicate is the diaphragm to sound (and necessarily so) that, in all experiments with the telephone itself, every sound from without broke in, giving effect like the well-known murmur of the shell.

Joining up our wire now to a more distant station at some miles along the railway, and having on its poles a number of what are known as heavy circuits, the pot-boiling sound assumed even more marked characteristics. The Wheatstone dial no longer affected us; but a number of Morse instruments were in full gear, and the fast-speed transmitter was also at work. While we were listening, the circuit to which we were joined began to work, and the effect was literally electrical. Hitherto we had only borrowed currents—or, seeing they were so unwelcome, we might call them currents thrust upon us—and the sounds, though sharp and incessant, were gentle and rather low. But, when the strong current was set up in the wire itself, the listener who held

one of our telephones nearly jumped from the floor when an angry pit-pat, pit-pat, pit-pat-pit assailed his ear, causing him to drop the instrument as if he had been shot. It was a result none of us had expected, for it did not seem possible that the delicate metal diaphragm and the little magnet of the telephone could produce a sound so intense. Of course, it was only intense when the ear was held close to the orifice of the instrument. Held in the hand away from the ear, the telephone now made a first rate sounder, and we could tell without difficulty not only the signals that were passing, but found in it a more comfortable tone than that given by the Morse sounder in common use.

Other experiments of a like character led to results so similar that they may be left unnoticed; and we proceed now to describe one of a different character, designed to test the telephone itself. At a distance of about half a mile, access was obtained to a Morse instrument in private use, and joined to the office by overhouse wire. Dividing our party and arranging a programme of operation, two remained with a telephone in the office, while other two, of whom the writer was one, proceeded with the second telephone to the distant instrument. By an arrangement which a practical telegraphist will understand, the key of the Morse was kept in circuit, so that signals could be exchanged in that way. It may be noticed, however, that this was hardly necessary, as the diaphragm of the telephone can be used as a key, with the finger or a blunt point, so that dot and dash signals are interchangeable, should the voice fail to be heard. As the wire in this instance travelled almost alone over part of its course, we were in hopes that induced currents would be conspicuous by their absence. In this we were, however, disappointed, for the pot was boiling away, rather more faintly, but with the plop-plop-plop distinctly audible, and once more a sharp masterful Morse click was heard coming in now and again. The deadly Wheatstone dial was, however, absent, so that our experiment proved highly successful. For some reason or another—probably an imperfect condition of the wire, or the effects of induction over and above

what made itself audible to us—the spoken sounds were deficient in distinctness; but songs sung at either end were very beautifully heard, and, indeed, the sustained note of sung words had always a better carrying power than rapidly spoken words. Every syllable and every turn of melody of such a song as “My Mother bids me Bind my Hair,” sung by a lady at one end, or “When the Heart of a Man,” sung at the other, could be distinctly heard, but with the effect before noticed, that the voice was muffled or shut in, as if the singer were in a cellar, while it was not always possible to say at once whether the voice was that of a man or a woman.

In the course of some domestic experiments it was remarked that, in playing the scale downward from C in alt on the piano, the result to the listener was a tit only for the four upper notes, although all below that had a clear ring, and the octaves below were mostly distinct, although at the low notes of the piano the sound was again lost. The ringing notes of a musical box were not so successful, but, with close attention, its rapid execution of “Tommy Dodd” could be well enough made out. An endeavor was made to catch the ticking of a watch, but this was not successful, and the experiment is not recommended, as the near presence of a watch to a magnet is not desirable; and the watch exposed to it in this instance was, it is thought, affected for a short time thereafter, although it received no permanent damage.

The observations made in the course of these experiments convinced those present that the telephone presents facilities for the dangerous practice of tapping the wire, which may make it useful or dangerous, according as it is used for proper or improper purposes. It might be an important addition for a military commander to make to his flying cavalry; as an expert sound reader, accompanying a column to cut off the enemy's telegraph connections, might precede the act of destruction by robbing him of some of his secrets. The rapidity and simplicity of the means by which a wire could be milked, without being cut or put out of circuit, struck the whole of the party engaged in the various trials that are described above. Of

course, the process of tapping by telephone could not be carried out if the instrument in use was a Wheatstone dial or single needle, or if the wire was being worked duplex or with a fast speed Morse, for in these cases the sounds are too rapid or too indefinite to be read by ear. The danger is thus limited to ordinary sounder or Morse telegraphs; but these still form the mainstay of every public system.

Since the trials here described were made, the newspapers have recorded a beautiful application, by Sir William Thomson, of the electric part of the telephone to exhibit at a distance the motions of an anemometer, the object being to show the force of air currents in coal mines. This is a useful application of an electric fact, and doubtless points the way to further discoveries. But it is to be noticed that the experiment, interesting as it is, hardly comes under the head of telephony, what is reproduced at a distance being not sound, but motion.

Obviously the invention cannot rest where it is; and no one more readily than the practical telegraphist will welcome an instrument at once simple, direct and reliable. Even in its present form the telephone may be successfully used where its wire is absolutely isolated from all other telegraph wires. But the general impression is that its power of reproducing the sound must be intensified before its use can become general, or come up to the popular expectation.

CHAPTER IV.

HISTORY OF THE PRODUCTION OF GALVANIC MUSIC.

This chapter will be devoted to the history of the production of galvanic music, and to the reproduction of sounds by electricity, from the experiments of Page, in 1837, to those of Gray, in 1874. The authorities quoted are given in chronological order.

¹ The following experiment was communicated by Dr. C. G. Page, of Salem, Mass., in a recent letter to the editor. From the well known action upon masses of matter, when one of those masses is a magnet and the other some conducting substance, transmitting a galvanic current, it might have been safely inferred (*a priori*), that if this action were prevented by having both bodies permanently fixed, a molecular derangement would occur whenever such a reciprocal action should be established or destroyed. This condition is fully proved by the following singular experiment. A long copper wire, covered with cotton, was wound tightly into a flat spiral. After making forty turns, the whole was firmly fixed by a smearing of common cement, and mounted vertically between two upright supports. The ends of the wire were then brought down into mercury cups, which were connected by copper wires with the cups of the battery, which was a single pair of zinc and lead plates, excited by sulphate of copper. When one of the connecting wires was lifted from its cup, a bright spark and loud snap were produced. When one or both poles of a large horseshoe magnet are brought by the side or put astride the spiral, but not touching it, a distinct ringing is heard in the magnet as often as the battery connection with the spiral is made or broken by one of the wires. Thinking that the ringing sound might be produced by agitation or reverberation from the snap, I had the battery contact broken in a cup, at considerable distance from the field of experiment; the effect was the same as before. The ringing is heard both when

¹ C. G. Page, *Silliman's Journal*, vol. xxxii., p. 396, July, 1837.

the contact is made and broken; when the contact is made, the sound emitted is very feeble; when broken, it may be heard at two or three feet distance. The experiment will hardly succeed with small magnets. The first used in the experiment consisted of three horseshoes, supporting ten pounds. The next one tried was composed of six magnets, supporting fifteen pounds by the armature. The third supported two pounds. In each of these trials the sounds produced differed from each other, and were the notes or pitches peculiar to the several magnets. If a large magnet supported by the bend be struck with the knuckle, it gives a musical note; if it be slightly tapped with the finger nail, it returns two sounds, one its proper musical pitch, and another an octave above this, which last is the note given in the experiment.

ON THE DISTURBANCE OF MOLECULAR FORCES BY MAGNETISM.

¹ A short article on this subject appeared in the last number of this journal under the caption, "Galvanic Music." The following experiment (as witnessed by yourself and others not long since) affords a striking illustration of the curious fact, that a ringing sound accompanies the disturbance of the magnetic forces of a steel bar, provided that bar is so poised or suspended as to exhibit acoustic vibrations. An electro-magnetic bar four and a half inches in length, making five or six thousand revolutions per minute, near the poles of two horseshoe magnets properly suspended, produces such a rapid succession of disturbances that the sound becomes continuous and much more audible than in the former experiment, where only a single vibration was produced at a time.

TONES PRODUCED BY ELECTRICAL CURRENTS.

² Mr. Page was the first to discover that an iron bar, at the moment it became magnetic through the galvanic current, gave a peculiar tone, and this fact has since been confirmed by Mr. Delezenne.

¹ C. G. Page, *Silliman's Journal*, vol. xxxiii., p. 118, October, 1837.

² W. Wertheim. *Annalen der Physik and Chemie*. LXXVII., June, 1849.

Without being aware of this discovery, I published, in 1844, a treatise in which I dealt with several questions relating to this subject. In this work I attempted to prove:

1st. That the electrical current causes a temporary weakening of the coefficient of the elasticity of iron.

2d. That likewise the magnetization is accompanied by a very slight decrease of the coefficient of the elasticity of the iron, which diminishes only partially when the magnetizing current is interrupted, and that this result does not manifest itself at once, but only upon the continued action of the currents.

The production of sound through the outside current (that is, a current which passes through a helix in whose axis is an iron bar or extended iron wire) was first accurately noticed by Mr. Marrian.

According to these physicists, the sound produced was identical with that obtained by striking the rod on either of its ends in the direction of its axis. Striking the rod sideways, however, did not give the same result.

Mr. Marrian also noticed that other metals, under the same conditions as iron, did not give any sound, and that the sounds from rods of the same dimensions, whether of iron, tempered steel or magnetized steel, were identical.

Mr. Matteucci has repeated these experiments with wires as well as iron bars, attempting especially to establish the relation between the strength of the current and the intensity of the sounds. He has, however, been in some doubt as to the character and value of the sounds.

Messrs. De la Rive and Beatson individually made the discovery that the current which passes directly through an iron wire produces a sound therein. In one of his later treatises, Mr. De la Rive has given a minute description of a series of experiments with various combined currents on different metals and under different conditions.

Mr. Guillemen made an interesting experiment, the result of which confirms my experiments already mentioned. He found that a weak iron bar which, surrounded by a helix, is fixed at

one of its ends in a horizontal position and at the other end is loaded with a light weight, visibly straightens itself when a current passes through the helix. Mr. Guillemen attributes this movement to a temporary increase of the elasticity of the iron effected by magnetization.

At the same time I delivered to the academy a short note, in which, without entering into the details of the experiments, I explained the results which I had obtained, and how, according to my opinion, the sounds were to be accounted for. The present treatise contains developments and proofs to sustain the opinions given by me at that time. It seems superfluous to repeat here the discussion which occurred at the time of writing this note, between Messrs. De la Rive, Guillemen and Wartmann. I desire simply to say that the last named scientist was the first to notice that a current passing through a wire may produce a sound without there being, in the wire, a resistance of any amount to oppose. Sound may therefore be produced as well in an iron bar as in an extended iron wire, heat having only an insignificant part to play in the phenomenon.

Later on Mr. De la Rive sent a treatise to the Royal Society, in London, which dealt with a part of this subject. After admitting that no sound is produced by a current passing through any metal, other than iron, he goes on to describe a new class of facts.

All conductors, when exposed to the influence of a powerful electro-magnet, give, at the moment of the passage of an interrupted electrical current, a very distinct sound, similar to that of Savart's cogged wheel. The influence of magnetism on all conducting bodies seems to consist in its imparting to the latter, similar properties to those possessed by iron in itself; thus developing in these conductors the property of emitting sounds which are similar to those given by iron and other metals without aid from the action of a magnet.

VIBRATIONS OF TREVELYAN'S BARS BY THE GALVANIC CURRENT.

¹ The vibrations of Trevelyan's bars by the action of heat is an experiment more interesting than familiar, and one which

¹ Silliman's Journal, 1850. Vol. ix., p. 105.

has been variously and vaguely explained by most authors. It will not be necessary for me to recapitulate the several descriptions and solutions of this phenomenon, as the novel experiment about to be detailed will embrace substantially the whole subject.

About a year since, while exhibiting to a class the vibration of these bars by heat, it became inconvenient to prolong the experiment, as the vibration ceases as soon as the temperature of the bar is somewhat reduced, and I was induced to seek for some method by which the vibratory motion could be produced and continued at pleasure without the trouble of reheating the bars for each trial. After various fruitless efforts, I obtained a most beautiful result by using the heating power of a galvanic

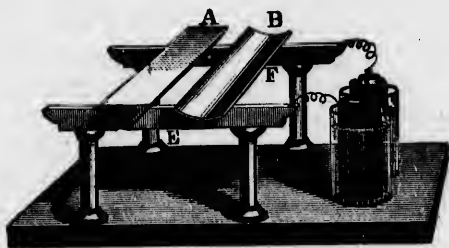

Fig. 62.

current. Fig. 62 shows the mode of performing the experiment with the battery. A and B are the two forms usually given to Trevelyan's bars, which, when to be vibrated by the action of heat, are made of brass, and weighing from one to two pounds, and after being sufficiently heated are placed upon a cold block of lead, as seen in fig. 63. The two bars may be placed upon the same block, though the vibrations are apt to interfere when two are used. When the bars are to vibrate by the galvanic current, they may be of the same size and form as shown, and of any kind of metal—brass, or copper, or iron, however, seeming to be most convenient. One or both of the bars may be placed at once, without reference to temperature, upon the stand, as in fig. 62, the bars resting upon metallic rails E F,

which latter are made to communicate each with the poles of a galvanic battery of some considerable heating power. Two pairs of Daniell's, of Smee's, or of Grove's battery of large size are sufficient. The battery I employ consists of two pairs of Grove's, with platinum plates four inches square. The vibration will proceed with great rapidity as long as the galvanic current is sustained.

In fig. 63 one pole of the battery is connected with the metallic block, and the other pole with mercury in a little cavity in the centre of the vibrating bar. The experiment succeeds much better with the rails as in fig. 62, and quite a number of bars may be kept in motion by increasing the number of rails, and passing the current from one to the other through the bars resting upon them.

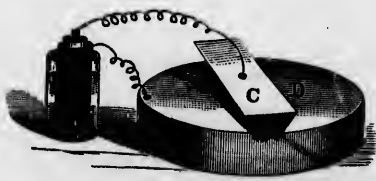

Fig. 63.

The rails are best made of brass wire, or a strip of sheet brass, though other metals will answer—the harder metals which do not oxidate readily, however, being preferred. A soft metal, like lead, is not so favorable to the vibrations in this experiment, although in Trevelyan's experiment lead seems to be almost the only metal that will answer to support the bar, which is usually made of brass.

Prof. Graham and other authors have attributed the vibration of Trevelyan's bars to the repulsion between heated bodies, and others have classed the phenomenon with the spheroidal state of heated bodies. I do not consider that any repulsive action is manifested or necessary in either of these cases, nor do I know of any instance in which a repulsion has been proved between heated bodies. It is obvious some other solution is required for this curious phenomenon, and it appears to me that the motion

is due to an expansion of the metallic block at the point of contact, and, upon this supposition, it appears plainly why a block of lead is required. That is, a metal of low conducting power and high expansibility is necessary, and lead answers these conditions best. In a future communication I will analyze this matter and explain more fully.

The size of the bars may be very much increased when the galvanic current is employed, and some curious motions are observed when long and large cylinders of metal are used. If they are not exactly balanced, which is almost always the case, they commence a slow rolling back and forth, until finally they roll entirely over, and if the rails were made very long they would

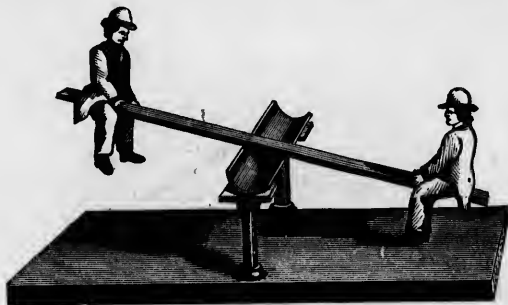

Fig. 64.

go on over the whole length. An inclination of the rails is required in this case, but it may be so slight as not to be perceptible to the eye.

If a long rod of some weight be placed across one of the bars, as shown in fig. 64, the vibrations will become longer, and by way of amusement I have illustrated this with a galvanic see-saw, as it may be termed.

It is well known that where mere contact (without metallic continuity) is made by metals conveying the galvanic current, the metals become most heated at the points of contact, and if the current be frequently broken the heat at these points is still more augmented. It is for this reason we are able to use various

kinds of metals for the experiment, without reference to their conducting powers and expansibilities.

VIBRATORY MOVEMENTS AND MOLECULAR EFFECTS DETERMINED IN MAGNETIC BODIES BY THE INFLUENCE OF ELECTRIC CURRENTS.

¹ Mr. Page, an American philosopher, had observed, in 1837, that on bringing a flat spiral, traversed by an electric current, near to the pole of a powerful magnet, a sound is produced.

M. Delezenne, in France, also succeeded, in 1838, in producing a sound by revolving a soft iron armature rapidly before the poles of a horseshoe magnet. In 1843, I myself remarked that plates or rods of iron give out a very decided sound when placed in the interior of a helix whose wire is traversed by a powerful electric current; but only at the moment when the circuit is closed, and when it is interrupted.

Mr. Gassiot, in London, and Mr. Marrian, in Birmingham, had also made an analogous experiment in 1844. Attributing this singular phenomenon to a change brought about by the magnetism in the molecular constitution of the magnetized body, I went through a great number of experiments, in order to study this interesting subject.

It is above all things important, in order to obtain a numerous series of vibrations, to be provided with a means of interrupting and of completing, many times in a very short space of time, the circuit of which the wire that transmits the current forms a part; in other words, to render a current discontinuous or continuous. With this view, I made use of one of the numerous apparatus called rheotomes, or cut-currents, and which are intended, when placed in the circuit, to render a current discontinuous. One of the most convenient (fig. 65) consists of a horizontal rod, carrying two needles, inserted perpendicularly and parallel with

¹ Treatise on Electricity in Theory and Practice, by Aug. De la Rive. 1853. Vol. 13; pages 300 to 321 inclusive.

each other, so arranged that when they are immersed simultaneously in two capsules filled with mercury, and insulated from each other, the circuit is closed; and when they are not immersed, it is open. A clock work movement, or simply a winch moved by the hand, gives a rotatory movement to the axis; whence it follows that, in a given time, a second for example, the circuit may be closed or interrupted a great number of times. The apparatus of fig. 65 presents four needles instead of two, and consequently four compartments corresponding with the four needles. We shall have occasion hereafter to see the use of the second system of two needles; for the present, a single one is sufficient; and, consequently, in all the experiments that will follow, in order to place it in the circuit, we shall employ indifferently either the one that is nearest to the clock work move-

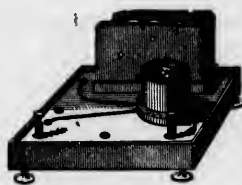

Fig. 65.

ment or the one that is most distant. There is a risk of the mercury being projected when the movement is too rapid; to prevent this inconvenience, we must cover the capsules, the needles, and the axis that carries them, with a small glass shade. When the current is very powerful, the mercury is oxidized by the effect of the sparks that occur at the moment when the needles emerge; in this case it is necessary to remove the oxide, or to change the mercury. We may do without mercury, and supply its place by two elastic metal plates resting on a cylinder, or on the circumference of a varnished wooden or ivory wheel, in the edges of which are inserted small pieces of metal, in metallic communication together. When the elastic plates, by means of the rotation of the cylinder or of the wheel upon its axis, come in contact with the metal part of the surface, the cir-

cuit is closed; when the contact with this metal part ceases, which occurs when the contact is with the wood or ivory, the circuit is open. It is necessary in this case that the two plates, as were the mercury cups in the preceding case, shall be in the course of the circuit, that is, to traverse the wire of the helix, and shall press strongly against the circumference.

We may also interpose in the course of the current merely a toothed wheel and an elastic metal plate, which presses upon the teeth of the wheel (fig. 66). By giving the wheel a movement upon its axis, we cause the plate to leap from one tooth to another; each leap produces a rupture in the circuit, which is closed again immediately afterwards. The musical tone given out by the plate, when we have no other means of measuring it, gives us exactly the number of times that the circuit has been opened and closed, that is to say, interrupted, in a second. I



Fig. 66.

have dwelt upon these several kinds of rheotomes because we frequently make use of one or the other of them. For the present, we shall apply them to the study of the vibratory movement experienced by magnetic bodies under the influence of discontinuous currents.

When we place a magnetic but unmagnetized body, such as iron or steel, in the interior of a bobbin, this body experiences very remarkable vibratory movements, as soon as we pass a series of discontinuous currents through the wire with which the bobbin is encircled. These movements are made manifest under the form of very decided and varied sounds, when the body has a cylindrical, or even an elongated form. The sound is less decided, but more sharp and more metallic, with steel than it is with soft iron. Whatever be the form or the size of the pieces of soft iron, two sounds are always to be distinguished; one a series of

blows or shocks, more or less dry, and very analogous to the noise made by rain when falling on a metal roof; these blows exactly correspond to the alternations of the passage and the interruption of the current; the other sound is a musical sound, corresponding to those which would be given by the mass of iron, by the effect of the transverse vibrations. We must take care in these sounds to distinguish those that are due to the simple mechanical action of the current upon the iron—an action which, being exercised throughout the entire mass, may deform it, and consequently produce, by its very discontinuity, a succession of vibrations. However, this is not sufficient for the explanation of

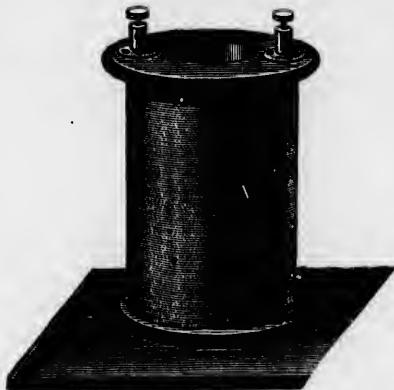

Fig. 67.

all the sounds; and we must admit that there is, in addition, a molecular action, namely that the magnetization determines a particular arrangement of the molecules of the iron, a rapid succession of magnetizations and demagnetizations gives rise to a series of vibrations. How, for example, can we otherwise explain the very clear and brilliant musical sound given out by a cylindrical mass of iron 4 inches in diameter, and weighing 22 lbs., when placed in the interior of a large helix (fig. 67), while traversed by a discontinuous current? Rods of iron half an inch and upwards in diameter, when fixed by their two extremities, also

give out very decided sounds under the same influence. But the most brilliant sound is that which is obtained by stretching upon a sounding-board well annealed wires, one or two twentieths of an inch in diameter and a yard or two in length. They are placed in the axis of one or several bobbins, the wires of which are traversed by electric currents, and they produce an assemblage of sounds, the effect of which is surprising, and which greatly resembles that to which several church bells give rise when vibrating harmonically in the distance. In order to obtain this effect it is necessary that the succession of the currents be not too rapid, and that the wires be not too highly strained. With a wire 5 feet 2 inches in length, and $\frac{17}{100}$ inches in diameter, I found that the maximum of effect occurs when it is stretched by a weight of from 57 lbs. to 117 lbs., if it is annealed; and from 64 lbs. to 126 lbs., if it is hardened. Beyond these limits, in proportion as the tension increases, the total intensity and the number of different sounds notably diminish; and, at a certain degree of tension, we no longer hear the sound due to the transverse vibrations, but simply that arising from the longitudinal vibrations. The reverse occurs when the wire is slackened.

Sounds entirely analogous to those we have been describing may be produced by passing the discontinuous electric current through the iron wire itself. We remark, in like manner, a series of dry blows, corresponding to the interruptions of the current, and stronger and more sonorous musical sounds, in some cases, than those that are obtained by the magnetization of the wire itself. This superiority of effect is especially manifested when the wire is well annealed, and of a diameter of about one twelfth of an inch; for greater or less diameters, the magnetization by the helix produces more intense effects than those which result from the transmission of the current. Moreover, the same circumstances that influence the nature and the force of the sound in the former case, exercise a similar influence in the latter. The transmission of the discontinuous current produces sounds only when transmitted through iron, steel, argentine, and magnetic bodies in general; but in different degrees for each,

depending on the coercitive force that opposes the phenomenon.

Wires of copper, platinum, silver, and, in general, any metals, except the magnetic, do not give forth any sound, whether under the influence of transmitted currents, or under that of ambient currents, such as the currents that traverse the convolutions of a wire coiled into a helix around a bobbin. The sound that is produced when a discontinuous electric current is made to pass in an iron wire, explains a fact that had been for a long period observed, and had been described as far back as 1785, by the Canon Gotton de Coma, a neighbor and a contemporary of Volta. This fact is, that an iron wire of at least ten yards in length, when stretched in the open air, spontaneously gives forth a sound under the influence of certain variations in the state of the atmosphere.

The circumstances that accompany, as well as those that favor the production of the phenomenon, demonstrate that it must be attributed to the transmission of atmospheric electricity. This transmission, in fact, does not occur in a continuous manner, like that of a current, but rather by a series of discharges. Now, Mr. Beatson has demonstrated that the discharge of a Leyden jar through an iron wire causes this wire to produce a sound, provided it does not occur too suddenly, but is a little retarded by passage through a moist conductor, such as a wet string.

The sounds given out by iron wire and by magnetic bodies, under the circumstances that we have been describing, seem to indicate, in an evident manner, that magnetism produced by the influence of an exterior current, as well as by the direct transmission of a current, determines in them a modification in the arrangement of their particles, that is to say, in their molecular constitution. This modification ceases and is constantly produced again by the effect of the discontinuity of the current; whence results the production of a series of vibrations, and consequently different sounds.

A great number of observations, made by different philosophers, have in fact demonstrated in a direct manner the influence

of magnetization upon the molecular properties of magnetic bodies. M. de Wertheim, in an extensive work on the elasticity of metals, had already observed, that magnetization produced by means of a helix whose wire is traversed by the electric current produces a diminution in the coefficient of elasticity in iron wire and even in steel; a diminution which, in the latter at least, remains in part even after the interruption of the current. M. Guillemin has also remarked more recently, that a bar of soft iron, fixed by one of its extremities whilst the other is free, and which, instead of remaining horizontal, is curved by the effect of its own weight, or by that of a small additional weight, immediately raises itself, when the current is made to pass in the wire of a helix with which it is surrounded, which helix is itself raised up with the bar, all the movements of which it follows, since it is coiled around it. This experiment possesses this important feature,—it shows the magnetization determines a modification in the molecular state of iron; for it cannot be explained by a mechanical action, which could only occur if the helix is independent of the bar.

Furthermore, an English philosopher, Mr. Joule, succeeded in determining the influence that magnetization can exercise over the dimensions of bodies. By placing a soft iron bar in a well closed tube, filled with water and surmounted by a capillary tube, he first satisfied himself that this bar experienced no variation of volume when it was magnetized by means of a powerful electric current, which traversed all the coils of an enveloping helix. In fact, the least variation of volume would have been detected by a change of the level of the water in the capillary tube; now not the slightest is observed, however powerful the magnetization may be. This result is in accordance with what M. Gay-Lussac had discovered by other methods, and with what M. Wertheim had also obtained by operating very nearly in the same manner as Mr. Joule. But if the total volume is not altered, it is not the same for the relative dimensions of the bar, which, under the influence of magnetization, experiences an increase in length at the same time as it does a diminution in

diameter, at least within certain limits. It was by means of a very delicate apparatus, similar to the instrument employed in measuring the dilation of solids, that Mr. Joule discovered that a soft iron bar experiences a decided elongation, which is about $\frac{1}{72000}$ th of its total length, at the moment when the current by which it is magnetized is established, and a shortening at the moment when it is interrupted. The shortening is less than the lengthening, because the bar always retains a certain degree of magnetism. It would appear that the lengthening is proportional, in a given bar, to the square of the intensity of the magnetism that is developed in it. When we make use of iron wires instead of bars, it may happen that it is a shortening, and not a lengthening, that is obtained at the moment of magnetization. This change in the nature of the effect is observed when the degree of tension to which the wire is subjected exceeds a certain limit.

Thus an iron wire, $12\frac{1}{2}$ inches in length by $\frac{1}{4}$ inch in diameter, distinctly lengthens under the influence of the magnetism, so long as it is not exposed to a greater tension than 772 lbs.; but the less so, however, as it approaches nearer to this tension. Setting out from this limit, and for increasing tensions, which in one experiment were carried up to 1764 lbs., the wire was constantly seen to shorten at the moment when it was magnetized. Tension exercises no influence over highly tempered steel; so there is never any elongation, but merely a shortening, which commences when the force of the current exceeds that which is necessary to magnetize the bar to saturation.

M. Wertheim, on his part, at the close of long and minute researches, succeeded in analyzing the mechanical effects that are manifested in magnetization. He found that, when an iron bar is fixed by one of its extremities, and the bobbin is so placed that its axis coincides with that of the bar, no lateral movement is observed, but merely a very small elongation, which rarely exceeds .00078 inch. This elongation is the greater as the bobbin is situated nearer to the free extremity of the bar, and diminishes in proportion as it approaches the point by which it is

fixed. When the bar ceases to be within the axis of the bobbin, the elongation still remains; but it is accompanied by a lateral movement in the direction of the radius of the bobbin. The bobbin that was employed by M. Wertheim was 9.84 inches long, and 7 inches in interior diameter; glasses of a magnifying power of about 20 diameters, and containing two steel wires, were used to measure the elongation and the lateral displacement. This displacement, or, what comes to the same thing, the versed sine of the curvature of the bar, measured at its extremity, was determined for different intensities of current; and it appeared that it was in general proportional to this intensity, but it varied for each position of the bar in the interior of the bobbin. However it may be, we are able to find for each of these positions the mechanical equivalent of the unit of the intensity of the current, namely, the weight which, when applied at the extremity of the bar, would produce the same versed sine. Thus, for example, by calling the length of the part of the radius, comprised between the axis of the bar and the axis of the bobbin D , the versed sine of the curve f , the weight that would produce the same versed sine P , the following results have been obtained by acting successively upon three bars of iron, the respective masses of which were 100, 40.5, and 25.5:

NO. OF BARS.	FOR D=80.		FOR D=50.	
	f	P	f	P
1.....	.4386 feet.	98.92 grs. Tr.	.2385 feet.	53.86 grs. Tr.
2.....	3.0632 "	41.28 "	1.5573 "	23.04 "
3.....	1.5249 "	22.57 "	.9360 "	12.55 "

We calculate P from the formula $P = \frac{f g b c^3}{44^3}$, in which f is the versed sine of the curvature, g the coefficient of elasticity, which is 27,122,653 lbs. avoirdupois per square inch for soft iron, b and c the width and thickness of the bar, and L its length from its fixed point to its free extremity. From the preceding table we deduce the value of the mechanical forces that are between

them : for $D=80$, as $100 : 41.71 : 22.81$; and for $D=50$, as $100 : 40.50 : 23.34$. So we may conclude, since the masses of the three bars are together as $100 : 40.5 : 25.5$, that the effect, which is here an attraction, is proportional to the mass of iron upon which the current is acting. We, in like manner, find that it is proportional to the intensity of the current ; which would render it an easy manner to construct upon this principle a very sensible galvanometer, by employing a prismatic bobbin and a wide and thin iron band.

Thus, all the experiments that we have been relating lead us to recognize that there is produced, by the effect of magnetization, a mechanical traction, due to a longitudinal component and to a transverse component ; that the latter becomes null when the bar is situated in the centre of the helix ; that they are both proportional to the intensity of the current and to the mass of the iron.

It is a more difficult matter to verify the effect of the transmitted current than that of the exterior current, by which magnetization is produced. In fact, in the former case, the mechanical effect of the current is very difficultly separated from its calorific effect. However, it follows, from some of Mr. Beatson's experiments, that an iron wire, at the instant it is put into the circuit, appears to undergo a small sudden expansion, and one very distinct from the dilatation that results in it, as in other metals, from the heating produced by the passage of the current.

These mechanical effects being once well studied, we can return, with greater knowledge of the cause, to the study itself of the sounds that accompany both magnetization and the transmission of currents.

M. Wertheim has in a perfectly accurate manner verified the existence of a longitudinal sound in an iron or steel bar when placed in the centre of helices traversed by discontinuous currents. This sound, which is similar to that produced by friction, is due, as is proved by direct experiment, to vibrations actually made in the direction of the axis. With wires substituted for bars the effects are the same, except that, when the tension

diminishes, we hear, in addition to the longitudinal sound, a very peculiar metallic noise, which seems to run along the wire, as well as other peculiar noises. With transmitted currents we also hear the longitudinal sound; and it remains nearly the same in intensity whether the current traverses only a part of the bar, or traverses the whole; a proof of the analogy existing between the action of the transmitted current and that of any other mechanical force, such as friction; equally a proof that the sound is not due to vibrations of a particular kind, engendered by the current. The longitudinal sound occurs equally in bars and in wires; but when we operate with wires, if they are not well stretched, the longitudinal sound is accompanied by the divers noises of which we have spoken. In fine, whether with bars or wires, every time the current is transmitted, but only in the parts where it passes, we hear a dry noise, a crepitation similar to that of the spark, and which is transformed into a distinct sound only in the stretched portion, if it is a wire that is in the circuit. Such are the facts established by M. Wertheim's researches: they are of a nature to confirm the deduction I had drawn before him from the simple study of the sonorous phenomena, namely, that magnetization on the passage of the electric current produces a molecular derangement in magnetic bodies, and that the sounds arise from the oscillations that are experienced by the particles of bodies around their position of equilibrium, under the influence of currents, whether exterior or transmitted. But what now is the nature of this molecular derangement? and how is it able to determine both the mechanical effects and the sonorous effects that we have described? When the action of exterior currents is in question we may form a tolerably exact idea of the nature of the molecular derangement brought about by magnetization. For this purpose we have merely to refer back to the experiment in which either fragments of wire or iron filings are placed in the interior of a helix whose axis is vertical. As soon as the current is made to pass through the wire of this helix the fragments of iron wire all place themselves parallel to the axis, that is to say, vertically, and the filings arrange themselves in small

elongated pyramids in the direction of the axis, which destroy themselves and rapidly form again when the current is intermittent. The action of the helix, therefore, upon filings, consists in grouping them under the forms of filaments parallel to the axis—filaments which gravity alone prevents being as long as the helix itself. This experiment succeeds equally well with impalpable powder of iron as with filings; it succeeds equally well with powder of nickel and cobalt; only if the current that traverses the helix is discontinuous, very different effects are observed with each of these three metals—effects that depend, as to their particular nature, upon the greater or less number of interruptions which the current experiences in a given time. The pyramids of filings are at their maximum of height when the disk that sustains them is in the middle of the helix. They turn under the influence of discontinuous currents, providing the succession of these currents is not too rapid, so that there are not more than 60 or 80 in a second. With 160 there is no longer any effect. These differences are indirectly due to the fact that the softest iron has still some coercitive force, and that it requires a certain time for magnetizing and demagnetizing. By comparing under this relation iron, nickel and cobalt, all reduced to an impalpable powder, and prepared by hydrogen, we find that nickel still manifests movements for a velocity of succession of currents, at which iron ceases to manifest any; and that cobalt, on the contrary, ceases to manifest them before iron, which is quite in accordance with what we know of the coercitive force of these three metals.

The following is an experiment of Mr. Grove's, which demonstrates in an elegant manner this tendency of the particles of magnetic bodies to group themselves, under the influence of magnetization, in a longitudinal or axial direction. A glass tube, closed at its two extremities by glass plates, is filled with water holding in suspension fine powder of a magnetic oxide of iron. On looking at distant objects through this tube, we perceive that a considerable proportion of the light is interrupted by the irregular dissemination of the solid particles in the water. But, as soon as an electric current traverses the wire of a helix,

with which the tube is surrounded, the particles of oxide arrange themselves in a regular and symmetrical manner, so as to allow the larger proportion of the light to pass. The particles in this case are not small fragments of iron wire, artificially disaggregated from a more considerable mass, but iron precipitated chemically, and consequently in its natural molecular state, such as constitutes a solid body by its aggregation.

This disposition of the particles of iron and of magnetic bodies to approach each other in the transverse direction, and to extend in the longitudinal direction, under the influence of an exterior magnetization, which is probably due to the form of the elementary molecules, and to the manner in which they are polarized, is now established in an irrefragable manner by direct and purely mechanical proofs.

It is easy to see that it accounts in the clearest manner for the production of sound in a bar or a wire subjected to the influence of the intermittent current of the helix. The particles contending against cohesion arrange themselves in the longitudinal direction when the current acts, and return to their primitive position as soon as it ceases: there follows from this a series of oscillations, which are isochronous with the intermittence of the current. All these effects are much more decided in soft iron than in steel or hardened iron, because the particles of soft iron are much more mobile around their position of equilibrium.

I have also remarked that both iron and steel, when they are already magnetized in a permanent manner by the current transmitted through a second helix, or by the action of an ordinary magnet, do not experience such strong vibrations when the discontinuous current tends to magnetize them in the direction in which they are already magnetized, but stronger ones in the contrary case. It is evident that, in the former case, the particles already possess, in very nearly a permanent manner, the position that the exterior action to which they are submitted tends to impress upon them; while, in the latter case, they are farther removed from it than they are in their natural position. Much more powerful oscillations, therefore, ought to occur to

them around their position of equilibrium in the latter case, and less powerful in the former, than when they are in their normal position, at the moment when the discontinuous current exercises its action.

The effects of the transmitted current are due to an action of the same order, but acting in a different direction. In order to analyze this action well, we must study the distribution of iron filings around a wire of iron, or of any other metal traversed by a powerful electric current. These filings always place themselves so as to form lines perpendicular to the direction of the current, and consequently parallel to each other. This is very readily perceived by fixing the conducting wire in a groove formed in a wooden plank, covered with a sheet of paper upon which the filings are placed. The latter arrange themselves transversely above the wire, whatever be the manner in which it is curved, forming small filaments of the sixth or eighth of an inch in length, which present opposite poles at their two extremities. When the conducting wire is free, these filaments, instead of remaining rectilinear, join together by their two edges, and envelop the surface of the wire, forming around it a closed curve, like a species of envelope composed of rings that cover each other and are pressed against each other. Now, the arrangement assumed by the particles of iron filings round any conducting wire, iron as well as every other metal, when it transmits a current, ought to be in like manner assumed by the molecules of the very surface of a soft iron wire itself traversed by a current, under the influence of the current transmitted by the entire mass of the wire. This, also, is equally demonstrated by the mechanical effects studied by Joule and Beatson. It follows, therefore, that when the transmitted current is intermittent the particles of the surface of the iron wire oscillate between the transverse position and their natural position, and that there is consequently, a production of vibrations. These oscillations ought to be the more easy, and consequently the vibrations more powerful, as the iron is softer; with hardened iron, and especially with steel, there is a greater resistance to be overcome;

thus the effect is less sensible. If the wire that transmits the discontinuous current is itself traversed by a continuous current moving in the same direction as the discontinuous one, the oscillatory movement ought to be annulled, or at least notably diminished, since the transmission of the continuous current impresses upon the particles in a permanent manner the position which the passage of the discontinuous current tends to give them in a temporary manner. Thus the sound in this case would completely disappear or notably diminish. If the wire is of steel or of well hardened iron, the continuous current is, on the contrary, favorable, by its presence, to the oscillating action of the discontinuous current, because it deranges the particles from their normal position, without, however, being able completely to impress upon them the transverse direction, on account of the too great resistance they oppose to a displacement, which is easily brought about in soft iron. The two currents united produce what a single current would not be able to accomplish, or would accomplish less effectually, and the sound is then reinforced, as is proved by experiment. In support of the explanation that I have just given, I have found that a copper wire, with a thin envelope of iron which is contiguous to it, gives rise to the same effects and of nearly the same intensity, when the discontinuous current traverses it as if it were entirely of iron; the sound is merely less musical; it resembles that which M. Wertheim designated under the name of "metallic" (*iron-y feraille*). As this result might be attributed to a part of the current traversing the iron envelope itself, instead of circulating exclusively through the copper wire, I insulated the latter by means of a thin covering of silk or wax, so that the iron cylinder that surrounds it is not able to communicate metallically with the copper. The effect is exactly the same as in the preceding case, that is to say, the discontinuous current that traverses the copper wire determines a series of vibrations in the iron envelope, which proves that we may admit that the same effect is produced upon the surface of an iron wire which itself transmits the current. With regard to the envelope, we can easily prove that it experiences a transverse magneti-

zation when the copper wire is in the voltaic circuit; for if we make in it a small longitudinal groove, we perceive that the iron filings are attracted upon its two edges, which have also an opposite polarity.

The detailed explanation that we have given of the molecular phenomena, which, in magnetic bodies, accompany the action of currents both exterior as well as interior, finds a further confirmation in the observation of several facts of different kinds. Thus I have remarked that permanent magnetization, whether impressed upon a soft iron rod by the action of an enveloping helix, or by the action of a powerful electro-magnet, increases, in a very decided manner, the intensity of the sounds that are given out by this rod, when traversed by a discontinuous current.

This reinforcement is, in fact, evidently due to the conflict that is established between the longitudinal direction that is impressed upon the particles of iron by the influence of the magnetization, and the transverse direction that the passage of the current tends to give to them. The oscillations of the particles ought necessarily to have greater amplitude, since they occur between more extreme positions. The effect is more decided with soft iron rods than with those of steel, and especially tempered steel. Mr. Beatson arrived at a similar result by quite another method. He observed, that if a continuous current traverses a wire, and if, at the same time it is subjected to the action of a helix in which a discontinuous current is passing, the wire will undergo a series of contractions and expansions which become inappreciable, if the continuous current ceases to be transmitted, even when the helix continues to act in the same manner. The author drew from this the same conclusion that I had deduced from the sonorous effects, namely, that the action of the helix impresses upon the particles of iron an opposite state to that which is produced by the transmitted current, and that one of these actions has the tendency to invert the arrangement which the other tends to establish.

A very curious fact is that magnetization tends to impress

upon the particles of soft iron an arrangement similar to that which they possess in tempered steel, even before it is magnetized. What confirms the correctness of this remark is, that the sound which magnetized soft iron gives out under the action of the transmitted current, is not only more powerful than it is when there is no magnetization, but it also acquires a peculiar dry tone, which makes it resemble that which steel gives out without being magnetized.

The very remarkable influence of tension, which, beyond a certain limit, diminishes in soft iron wires their aptitude to give sounds, is a further consequence of our explanation. In fact, the molecules, by the effect of tension, undergo a permanent derangement in their normal position, and are consequently found crippled in their movements, and are no longer able, under the influence of exterior or interior causes, to execute the oscillatory movements, and consequently the vibrations which constitute the sound.

Two facts, of a character altogether different from the preceding, still further show that the magnetization of iron is always attended by a molecular change in its mass.

The first of these facts was discovered by Mr. Grove. It is, that an armature of soft iron experiences an elevation of temperature of several degrees when it is magnetized and demagnetized several times successively by means of an electro-magnet, or even of an ordinary magnet set in rotation in front of it. Cobalt and nickel present the same phenomenon, but in a somewhat slighter degree; whilst non-magnetic metals, placed under exactly the same circumstances, do not present the slightest traces of calorific effects. This experiment can only be explained by admitting that the development of heat arises from the molecular changes which accompany magnetization and demagnetization. The second fact, which is no less important, is due to Dr. Maggi, of Verona, who proved that a circular plate of very homogeneous soft iron conducts heat with more facility in one direction than in the other when it is magnetized by a powerful electro-magnet; whilst, when it is in the natural state, its conduct-

ibility is the same in all directions, and, consequently, perfectly uniform. The plate is covered with a thin coating of wax melted with oil, and the heat arrives at its centre by a tube that traverses it, and in the interior of which the vapor of boiling water is passing. The plate is placed horizontally on the two poles of a powerful electro-magnet, several insulating cards preventing contact between it and the iron of the electro-magnet. So long as it remains in its natural state, the curves that bound the melted wax assume the circular form which indicates a uniform conductivity for heat in all directions. But, as soon as the electro-magnet is magnetized, the curves are deformed; and they are always elongated in a direction perpendicular to the line that joins the magnetic poles; which proves that the conductivity is better in the direction perpendicular to the magnetic axis than in the direction of the axis; a result in accordance with the fact that we have established, that the particles of iron approach each other, by the effect of magnetization, in the direction perpendicular to the length of the magnet, and recede in the direction of that length, which is always the magnetic axis.

INFLUENCE OF MOLECULAR ACTIONS UPON MAGNETISM
PRODUCED BY DYNAMIC ELECTRICITY.

We have seen that heat, tension, and mechanical actions generally facilitate magnetization.¹ M. Matteucci has found that torsion and percussive and mechanical actions, not only facilitate the magnetization produced upon soft iron by a helix that is traversed by a powerful current, but they also contribute, when the current has ceased to pass, to the destruction of magnetism in a very rapid manner. The same philosopher has likewise observed, that torsion, when it does not pass beyond certain limits, augmented the magnetization produced upon steel needles by discharges of the Leyden jar.

¹ M. Lagerhjelm observed that iron becomes strongly magnetic by rupture.

M. Marianini, who has made numerous and interesting researches upon magnetization, arrived at curious results upon the aptitude that iron bars may acquire of becoming more easily magnetized in one direction than in another, and even in being little or much magnetized by the influence of the same cause. When an iron bar has been magnetized by the influence of an instantaneous current that circulates around it, and when it has lost this magnetization by the action of a contrary current, it is more apt to be magnetized afresh in the former case than in the latter. We are able, by contrary currents, to give it even more aptitude to be magnetized in the latter direction than in the former. The augmentation of aptitude that it acquires of being magnetized in one direction is equal to the loss of aptitude that it experiences for being magnetized in the other direction. But, by reiterating the action of the currents upon the same bar, the increase of aptitude in one direction, and the corresponding diminution in the other, become always more and more feeble. The modifications of aptitude for acquiring magnetization are accompanied by modifications in the aptitude for losing this magnetization; but in such direction that the latter is the reverse of the former.

Willing to enter more deeply into the study of the effects that we have been relating, M. Marianini subjected iron to different physical and mechanical actions. First of all, he satisfied himself that neither elevation of temperature, nor especially the cooling by which it is followed, neither percussion nor torsion, nor a violent shock, nor any mechanical action, even the most energetic, are able of themselves to determine magnetization; nor, indeed, does the discharge of a Leyden jar through an iron bar magnetize it. But these various operators, incapable of magnetizing, may all serve to destroy the polarity of magnetized bodies; the quantity of magnetic force that they thus lose, when their aptitude has not been altered, is the greater, as the magnetization has been more feeble. But if, after having undergone one of these actions, the bar has still preserved a little magnetism, it can no longer lose it by this or by any similar action.

What is very remarkable is, that when the magnetism of a bar has been destroyed, on remagnetizing it in a contrary direction by a succession of instantaneous currents, so that its magnetization is null, we may restore to it its former magnetism by means of a violent shock, by letting it fall, for instance, on the pavement from the height of a couple of yards. The greater the height of the fall, the more powerful is the magnetism it recovers. Thus, a bar, that made a needle deviate 60° , having been brought by a succession of discharges to exercise no deviation beyond 0° , gave 14° on falling from a height of 12.8 feet, $15^\circ 30'$ on falling from a height of 15.0 feet, and $21'$ on falling from a height of 6.4 feet. This new polarity was in the same direction as the primitive one.

Even when, by destroying the primitive magnetization of the bar, we have actually imparted to it a new one in a contrary direction, we find on letting it fall upon the pavement that we restore to it the first that is possessed. M. Marianini would be disposed to believe from this experiment and other similar ones, that the bar had retained its former magnetization while still acquiring the contrary one, which neutralized the effect of the first and even surpassed it; and the shock merely destroyed the second, either in whole or in part, which permitted the former to reappear. Flexion, friction, heat, or an electric discharge traversing the iron directly, may take the place of the shock, particularly when very fine wires are in question.

The action that is exercised by an instantaneous discharge through the wire of a helix upon a body already magnetized, increases or diminishes the magnetism of this body according to the direction in which it is sent; but this increase or diminution is the less sensible as the iron is more magnetized. In any case, a given instantaneous current produces proportionately more effect when it is made to act with a view of diminishing the polarity in the magnetized bodies than when it is made to act with a view of increasing it.

M. Marianini, in order to explain the results of these experiments, admits a difference between what he calls polarity and

magnetism. Thus, the same magnet, although deprived of polarity, may very readily retain magnetism, when magnetized at one time in two contrary directions with an equal force. We must then suppose that contrary magnetic systems producing equilibrium are able to exist in iron, and that exterior forces, such as a current or a mechanical action, do not act with the same energy upon the opposite systems. This opinion, which does not as yet appear to us to rest upon facts sufficiently numerous, has, however, nothing in it that is inadmissible; nothing, in fact, opposes there being in the same bar a certain number of particles arranged so as to produce a magnetization in a certain direction, and others so as to produce magnetization in the opposite direction; as, for example, the interior particles may be found to have in this respect an arrangement the opposite of those on the surface; and that such exterior action operates proportionately with greater force upon the one than upon the other. This point would need to be made clear by further observations, and especially by comparative experiments made upon bars of different forms and different dimensions—upon hollow and solid cylinders, for example. But if some doubts still remain upon the conclusions that M. Marianini has drawn from his experiments, there are not any upon the new proof which they bring in favor of the connection that exists between magnetic and molecular phenomena. The different degrees of aptitude acquired by iron under the influence of certain actions, of becoming more easily magnetized in one direction than in the other, are all quite in harmony with the disposition with which the particles of bodies are endowed to arrange themselves more easily in one direction than in another. This loss of aptitude, after the multiplied repetition of the contrary actions, corresponds with the indifference to arrange themselves in one manner or the other, which is finally presented by the particles of bodies, after having experienced numerous derangements in different directions.¹ Finally the remarkable

¹We have a remarkable example of this in the fragility presented by iron when it has been for a long time subjected to rapid and frequent vibrations, as are the axles of locomotives.

effects of shock, flexion, heat, in fact, of all those actions that change the relative position of the particles, come in support of the relation that we have endeavored to establish.

The whole of the magneto-molecular phenomena that we have been studying, lead us to believe that the magnetization of a body is due to a particular arrangement of its molecules, originally endowed with magnetic virtue; but which, in the natural state, are so arranged, that the magnetism of the body that they constitute is not apparent. Magnetization would therefore consist in disturbing this state of equilibrium, or in giving to the particles an arrangement that makes manifest the property with which they are endowed, and not in developing it in them. The coercitive force would be the resistance of the molecules to change their relative positions. Heat, by facilitating the movement of the particles in respect to each other, diminishes, as indeed does every mechanical action, this resistance, that is to say, the coercitive force.

There remains an important question to be resolved. Are mechanical or other actions—disturbers, as they are, of the electrical state—able of themselves to give rise to magnetism? or do they only facilitate the action of an exterior magnetizing cause; for example, terrestrial magnetism, which, in the absence of all others, is ever present? M. Marianini's researches would seem to be favorable to the latter opinion; however, the facts that are known do not appear to us sufficient as yet to establish it in an incontestable manner. Let us remark that, even although it should be established, yet the non-existence of a previous and proper polarity of magnetic bodies, or of electric currents, circulating around them in a determinate direction, would not necessarily follow. We should merely conclude from it that, in the absence of an exterior acting cause, the particles when left to themselves, constantly arrange themselves so as to determine an equilibrium between their opposed polarities; whence results the nullity of all exterior action.

cov
a f
wh
of
Ma
cov
wh
pur
pas
thr
I
and
from
can
De
bot
zinc
sub
pow
T
the
pos
all
ther
reg
met
alth
curr
as th

A NEW METHOD OF PRODUCING TONES BY THE ELECTRIC CURRENT.

¹ In 1837 Dr. Page, of Salem, Mass., made the important discovery that a horseshoe magnet, before or between whose poles a flat spiral of copper wire was suspended, began to emit tones whenever he passed through the spiral the discontinuous current of a galvanic battery.

Other physicists, and especially Delezenne, Beatson, Marrian, Matteucci, De la Rive, and Wertheim, in following up the discovery, have shown us that it is the interrupted current only which generates this new formation of tones, and that for this purpose it can be applied in two ways, either direct, as when it is passed through the bodies themselves, or again, when conducted through a helical wire placed around these bodies.

In this manner tones have been produced in iron and steel, and in these metals only it would seem, as Wertheim has found from actual experiment, that bars and wires of other metals cannot be made to emit tones by either method; and although De la Rive says in his first treatise that he has obtained tones by both methods from platinum, silver, copper, brass, lead, tin, and zinc, it will be observed that he modifies this assertion in a subsequent work by saying that this took place only when a powerful electro-magnet was acting at the same time on the wire.

The method which we are now about to describe, and which the writer happened to discover accidentally in the fall of 1854, possesses the advantage of generalizing matters, as it shows that all metals can, under certain conditions, be made to emit tones; there are also other considerations which render it interesting as regards its connection with the theory of electricity. This method is based upon the interruptions of a battery current, although in reality it is not the latter, but rather the induced currents produced by the interruptions that must be considered as the generator of the tones. In place also of bars or wires as

¹ J. C. Poggendorf. Poggendorf's Annalen, xeviii., p. 193. Monatsberichten der Acad. März, 1856.

heretofore used for producing the tones, tubes formed of sheet metal are substituted, and surround the coils through which the current is passed.

The writer used in his experiments coils five inches in length and about one and one eighth inches in diameter. Both wires of the coils were connected, so that their united length was about 100 feet; the diameter of the wire was 1.4 millimetres. The coils were maintained in a vertical position by means of a stand provided for the purpose, and so placed that the lower ends could be connected to the battery, which, as a rule, consisted simply of a single Grove cell. The tubes to be examined, which were about five inches long and from two to four inches in diameter, were then placed over the coils. Some of them were left entirely open, some closed by soldering, and others bent together so that the edges just touched each other. The material of the tubes consisted of platinum, copper, silver, tin, brass, zinc, lead and iron.

A Wagener hammer of peculiar construction, so as to deaden the noise of its own vibrations, and thus prevent it from interfering with the investigations, was used for interrupting the current.

From the experiments made with this apparatus it has been found that none of the metals, except iron, can be made to emit tones when formed into either open or completely closed tubes and placed over the coils. If, however, the edges of the tubes just touch each other, then all metals can be made to emit a very audible tone, which will vary in loudness and quality of sound with the dimensions of the tubes, the elasticity and quality of the material employed, the strength of the current, and certain other minor considerations that will readily suggest themselves.

Iron is distinguished from the other metals by the fact, due no doubt to its magnetic properties, that it gives a crackling tone both when made into an open tube which surrounds the coil, and also when placed alongside of it. The tone in this case is similar to that heretofore noticed in sheet iron when laid in the coil, but it is much weaker than that heard when the edges of

the tube come in contact. In the latter case it seems as though a second tone appears with the former one.

The sounds obtained in this manner from metallic tubes whose edges just come in contact with each other, are evidently produced by the induced current generated in the mass of the tubes by the action of the intermittent current in the coil. They must evidently, therefore, become stronger or weaker as the conditions which give rise to them render the induced current stronger or weaker. For example, they are increased when iron wires are placed in the coils, as was done in the experiments made by the writer. They are also increased, but in a smaller degree, when the coil is connected with a condenser, which was also done in all of these experiments.

The weakening of the tones, however, may be still more strikingly shown. For this purpose it is only necessary to place between the tube producing the tone and the induction coil another metallic tube, completely closed and of somewhat smaller diameter. As soon as this is done, the tone of the wider tube ceases instantly, and when the smaller tube is withdrawn again the tone recommences at once.

Even two tubes of different diameters capable alone of giving out tones will show this weakening, but if placed simultaneously one within the other around the coil, they do not interfere with each other.

In place of the smaller closed tube, which, for example, may consist of zinc or any other non-magnetic metal, an open iron tube may be substituted. In this case also the action depends upon the length and thickness of the metal, and weakens or destroys the tones accordingly; not, however, because an induced current is formed in it, as in the case of the closed zinc tube, but because it becomes magnetized by the action of the coil, just as the core does, and the effects of the coil and core consequently oppose each other.

The proof of the connection of the tones with the induced current, if additional proof is necessary, is still further shown by the fact that they are quite independent of the diameter of the

tubes. The writer has obtained tones from tubes of two, four, and eight inches diameter without noticing any difference in the strength of the sound, other than what might be attributed to a change of proportion between the length and diameter of the tubes.

With proportionate length, a hollow cylinder of any diameter whatever would obviously be forced by the action of a single cell of battery to emit tones just as well as a tube of only an inch in diameter.

Now, while it may be considered sufficiently evident that the tones in question owe their origin to the induced currents which are produced in the tubes parallelly with the convolutions of the coil, and in this respect therefore correspond to the tones generated in steel or iron wires when an intermittent current is passed directly through the latter, we must by no means conclude that they are the result of a molecular action extending throughout the entire mass of the metal, as is certainly the case when iron wires or open iron tubes are used. On the contrary, as the writer is fully convinced, the development of tones first noticed by him, has its origin at the points where the edges of the tubes touch each other, and that, in consequence of this, slight concussions occur which set the tubes to vibrating and thus give out tones.

The tones, moreover, are only a secondary phenomenon, and may entirely fail when the material of which the tubes are made possesses but little elasticity, as, for instance, when lead is used. The real part of the acoustical phenomenon lies in the dull sound or kind of ticking, somewhat similar to that of a watch, which is heard at the points where the edges come in contact simultaneously with the strokes of the vibrating hammer.

It is consequently this ticking alone, and not the tone production, whose investigation properly comes within the province of electrical science, and which I consequently made the especial subject of study, but up to the present time I am obliged to say I have not yet succeeded in bringing about a complete solution of the problem.

The ticking tone is not audible in a tube whose edges have been soldered, and thus probably made to resemble more nearly a hollow cast-iron cylinder. Even a soldered tube, which has been so nearly cut in two that only a portion of metal of about a line in width remains, is found to give no ticking sound under the conditions I employed.

This shows that a certain separation of the edges is required for the production of the sound; it is furthermore perfectly clear that the adjacent edges of the tube do not come in so close contact as the particles within the mass, and is also proven by phenomena in other provinces of physical science. With apparently the very best contact, also, we must admit the existence of a thin air stratum between the edges of the tube, the same as exists even in the dark centre of Newton's rings.

The influence which distance between the edges of the tubes has on the ticking is shown by the fact that, the more the edges are pressed together the greater is the decrease in the sound, and it is not improbable therefore that if the compression were increased with force sufficient to press the particles of metal firmly against each other, the sound could be entirely destroyed. On the other hand, again, if a loud sound is wanted it is necessary to make the edges just touch each other loosely.

It might be thought an increase of pressure would increase the number of contact points also, and in this manner cause the decrease in the strength of the sound. This could only have been the case when I caused greater portions of the edges of the tubes that were not quite parallel to approach each other, so that in general such a conclusion will hardly be found to hold good. It has furthermore been found that when a short piece of wire or a sewing needle is placed between the edges of the tube, the ticking then becomes very loud, but decreases in like manner with increased pressure, although the needle is never made to touch at all points.

Portions of the tube edges may also be in close metallic contact without the entire disappearance of the ticking if only other portions make but slight contact with each other. Hence tubes

which have been partially cut in two, like those previously mentioned, will commence to give out sounds if a needle or wedge-shape piece of metal is inserted in the slit. This explains a phenomenon which is observed with tin. When a sheet of this metal is bent around the induction coil and its edges are brought close to each other, they immediately become fastened together as if soldered, and yet the ticking continues to be heard exceedingly well. If, however, the neighboring edges are melted together with a spirit flame or soldering iron, the sound ceases.

The principal question in this examination is of course this: What causes the ticking sound at the divided edges? On first consideration it might be attributed to the passage of sparks, but this certainly is not the origin of the sound. Sparks may generally be seen by separating the edges of the tubes from each other at the moment the hammer interrupts the battery current. They are also noticed, but in a lesser degree, with tubes which have been partially cut in two, when the wedge is allowed to drop into the opening. But so long as the edges remain quietly near each other no spark is observed, even in perfect darkness, and yet the ticking continues all the time without the slightest interruption. I further placed the induction coil with the metallic tube under the exhausted receiver of an air pump, but even there the ticking was heard without the least spark being visible between the edges of the tube.

The sparks, moreover, possess an exceedingly low potential, but this is not to be wondered at when we consider that they are produced in a metallic conductor of only a few inches in length.

With easily fusible metals, such as tin for example, sparks are often seen to be projected for a distance of several lines, but these cannot be considered as genuine electrical sparks; they are caused rather by the projection of particles of melted and glowing metal, and their direction also is generally contrary to that of the electrical current, being sometimes towards one side and sometimes towards another. In any case, however, they can never be real electrical sparks, since the electrical potential of the current, as already stated, is too low for their production. It

made no difference how near I brought the edges together without causing absolute contact, I could never perceive the passage of sparks between them. The slight space might also be closed by the moistened fingers, or the tip of the tongue even might be placed between the edges of the tubes without feeling the slightest sensation.

If sparks were the cause of the sound one would naturally suppose it would disappear in a fluid conductor, but while maintaining the tube in a horizontal position, I have dipped its edges in spring water, and even in diluted sulphuric acid, without being able to perceive any decrease in the sound. When, however, a thin piece of blotting paper, which has been saturated with diluted sulphuric acid, is placed between the edges, and consequently the metallic contact is broken, the sound disappears. It also disappears with zinc tubes when the edges are so thoroughly amalgamated that drops of mercury remain adhering thereto, obviously, however, because perfect metallic contact is thus established.

On the other hand, again, the sound did not cease when the edges were highly heated by the flame of a spirit lamp, but a decrease in its loudness was certainly noticeable.

The question therefore presents itself still more forcibly. If sparks do not produce the sound, what then is the cause that does?

We might attribute it to a kind of repulsion such as that which, as has been shown by Ampère, exists between different elements of a current for each other. It is possible that during the time the current is being generated this repulsion causes the edges of the tubes to separate a little, and on its disappearance allows them to approach each other again. This alone, however, is not sufficient; it seems hardly possible that these weak currents could produce such disproportionate mechanical results. I have noticed the sound in zinc tubes of two inches diameter and over two and a half lines thickness, which required considerable effort to bring the edges together. Besides, however much we may incline to the idea that the sound results from a me-

chanical knocking of the edges together, observation so far has given no proof that such is the case.

To the unassisted eye the edges seem to remain absolutely at rest, and even when viewed in the microscope, magnifying at least a hundred times, which would seem powerful enough to show any such motion if it existed, we are unable to perceive any change. In addition to this also, the liquids in which the ticking tubes were dipped showed no signs whatever of the slightest tremor or undulating motion, so that the ticking and toning vibrations, if such they *really* are, must be extremely small.

The most natural view of the phenomena is, that notwithstanding the apparent metallic contact of the edges of the tubes, no uniform flow of electricity actually follows, but that as the current is interrupted, a sudden discharge does take place, without, however, the appearance of sparks.

This assumption may seem to be a very extraordinary one, but at the same time it cannot be said to contradict the experience heretofore obtained; there seems to be no real ground for asserting that the passage of electricity through an exceedingly thin stratum of air should necessarily be accompanied by sparks, while, on the contrary, arguments may be adduced to show that the appearance of sparks under similar circumstances is somewhat doubtful. It still remains an open question whether, in the sparks as they appear, we really see the substantial transfer of electricity; these sparks may just as well be only accompanying phenomena of a dark invisible discharge of electricity, and their comparatively slow motion in certain cases would seem to render this view not altogether improbable.

I do not, however, purpose forming an hypothesis here, and additional light on the phenomena in question must be derived from future observations.

ELECTRICAL TRANSMISSION OF SPEECH.¹

I have not thought it desirable to give prominence in this chapter on the Electric Telegraph to a fantastic idea of a cer-

¹ Exposé des applications de l'électricité. Paris, 1857, par Le Cte. Th. Du Moncel.

tain M. Ch. Bourseilles, who believes that we shall be able to transmit speech by electricity, for it might be asked why I class amongst so many remarkable inventions an idea which is at present only a dream of its author. Nevertheless, as I am bound to be faithful to the duty I have undertaken of mentioning every electrical application which has come to my knowledge, I will give you some details which the author has already published on this subject. He says: I ask myself, for example, if words themselves cannot be transmitted by electricity; in other words, if one could not speak at Vienna and make oneself heard in Paris—the thing is practicable, and I will show you how.

Imagine that you speak against a sensitive plate, so flexible as to lose none of the vibrations produced by the voice, and that this plate makes and breaks successively the communication with an electric pile; you may have at any distance another plate, which will undergo in the same time the same vibration.

It is obvious that numberless applications of high importance would immediately arise out of the transmission of speech by electricity; any one who was not deaf and dumb could make use of this mode of transmission, which would not require any kind of apparatus,—an electric pile, two vibratory plates, and a metallic wire are all that would be necessary.

In any case, it is certain that in a future, more or less distant, speech will be transmitted to a distance by electricity. I have commenced experiments with this object; they are delicate and require time and patience for their development, but the approximations already obtained give promise of a favorable result.

PROPAGATION OF TONES TO ANY DISTANCE BY MEANS OF ELECTRICITY.¹

Previous to 1840, the attempts to transmit signals to great distances by means of electricity were not very successful. Since that time, however, great advancement has been made, and tele-

¹ Bottger's Polytechnical Notezblatt, 1863.

graph wires are now so generally erected throughout the country that it leaves little to be desired.

Experiments have been made to transmit tones to any desired distance by means of electricity. The first experiment which was in any degree successful was made by Philip Reiss, professor in natural philosophy at Friedrichsdorf, near Frankfort on the Main, and repeated in the meeting room of the Physical Society, in Frankfort, on the 26th of October, 1861, before a large number of members. One part of his apparatus was set up in the Civic Hospital, a building about three hundred feet distant from the meeting room, the doors and windows of the building being closed. Into this apparatus he caused melodies to be sung, and

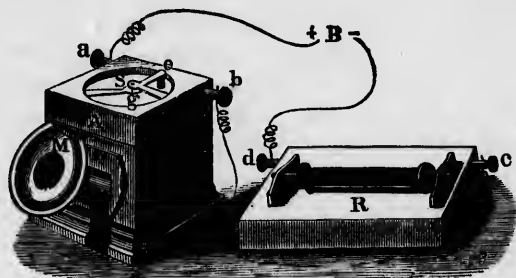

Fig. 68.

the same were rendered audible to the members in the meeting room by means of the second part of his apparatus. The apparatus used to obtain this wonderful result is shown in fig. 68, a small light wooden box in the form of a hollow cube, having a large and a small aperture at each end. Over the small opening was stretched a very fine membrane, *s*, against the centre of which rested a small platinum spring *e*, which was fastened to the wood. Another strip of platinum *f*, likewise fastened at one end to the wood, had a fine horizontal peg inserted in the other end, which peg rested on the platinum spring at the point of contact with the membrane. As is well known, tones are generated by the condensation and rarefaction of the air taking place in rapid

succession. If these motions of the air, called waves, strike the thin membrane they cause it to vibrate, which forces the platinum spring resting upon it against the horizontal peg, inserted in the second platinum strip, which hops up and down with it. Now, if the latter be connected by a wire with one of the poles of a galvanic battery, and the electricity conducted by a wire attached to the other pole of the battery, to any desired distance, then through a helix, R, six inches long, formed of very fine spun copper wire, and thence back to the platinum spring on the transmitting apparatus—then at every vibration of the membrane an interruption of the electric current will take place. Through the opening in the helix above described, an iron bar ten inches long is run, the ends of which project about two inches and rest upon two sticks of a sounding board.

It is well known that when an electric current passes through a helix enclosing an iron rod in the manner described, at each interruption of the current a tone, produced by the elongation of the rod, is audible. When the interruptions follow each other at a moderate rate, a tone is generated (owing to the change in position of the molecules of the rod) which is known as the longitudinal tone of the bar, and which depends upon its length and the strength of the current. If, however, the interruptions of the electric current in the helix take place more rapidly than the movements of the molecules of the iron bar, which are limited by its elasticity, then they are not able to complete their course, and the movements consequently become smaller and quicker in proportion to the rapidity of the interruptions. The iron bar then does not emit its longitudinal tone, but a tone whose pitch is dependent upon the number of interruptions of the current in a given time. It is a well known fact that higher and deeper tones depend upon the number of air waves which succeed each other in a second's time. We have seen heretofore that on these air waves depend the number of interruptions of the electric current of our apparatus, through the agency of the membrane and the platinum strips, and the iron bar consequently should emit tones of the same pitch as

those acting upon the membrane. Tones may thus be reproduced, with a good apparatus, at almost any distance.

It is evident, therefore, that it is by the electric impulses alone, and not by the transmission of the sound waves themselves through the wire, that the tones become audible at the distant end, for the tones are no longer apparent when the terminal wires of the helices are joined by a metallic conductor, and thus the instrument shunted out of circuit.

The reproduced tones are generally somewhat weaker than the original ones, but the number of vibrations is always the same. Consequently, while we may easily reproduce precisely the same pitch of the tone, it is difficult for the ear to determine the difference in the amplitude of the vibrations, on account of the gradually decreasing vibrations, which limit even the weaker tones. The nature of the tone, however, depends upon the number of the vibrations—that is to say—tones of the same pitch are produced by the same number of waves per second—at the same time each wave, as, for instance, the 4th, 6th, etc., may be stronger than any succeeding wave.

Scientists have shown that when an elastic spring is made to vibrate by being struck by the teeth of a cog-wheel, the first vibration is the strongest, and each succeeding one, less. If, before the spring stops, it is again struck, then the next vibration becomes equal to the first vibration of the first stroke—without the spring, however, making more vibrations on that account.

It may be that the time is still distant when it will be possible for us to hold a conversation with a friend at a distance, and to distinguish his voice as if he were in the same room with us. Still the probability of success in this has become as great as it was during the important experiments of Niepce for the reproduction of the natural colors by photography.

CHAPTER V.

GRAY'S TELEPHONIC RESEARCHES.

¹ WHILE engaged in studying the phenomena of induced currents, I had noticed a sound proceeding from an electro-magnet connected in the secondary circuit of a small Rhumkorff coil, which was at that time in operation. This, of course, was not new (it having been observed by Page, Henry and others that the magnetization of iron is accompanied with sound), but it helped to direct my mind to the subject of transmitting musical tones telegraphically. Subsequently I made a discovery that led to a thorough investigation of the subject, and I have devoted my whole time since then to the study which it suggested.

The circumstance was as follows: My nephew was playing with a small induction coil, and, as he expressed it, was "taking shocks" for the amusement of the smaller children. He had connected one end of the secondary coil to the zinc lining of the bath tub, which was dry at that time. Holding the other end of the coil in his left hand, he touched the lining of the tub with the right. In making contact, his hand would glide along the side for a short distance. At these times I noticed a sound proceeding from under his hand at the point of contact, which seemed to have the same pitch and quality as that of the vibrating electrotome, which was within hearing. I immediately took the electrode in my hand, and, repeating the operation, to my astonishment found, that by rubbing hard and rapidly, I could make a much louder sound than the electrotome was making. I then changed the pitch of the vibration, increasing its rapidity, and found that the pitch of the sound under my hand was also changed, it still agreeing with that of the vibration. I then moistened my hand and continued the rubbing, but no sound

¹ Experimental Researches by Elisha Gray. Read before the American Electrical Society, March 17, 1875.

was produced so long as my hand remained wet; but as soon as the parts in contact became dry the sound reappeared.

The next step was to construct a key board, with a range at first of one octave, similar in appearance to the cut shown in fig. 69, which has two octaves.

Each key has a steel reed or electrotome, tuned to correspond to its position in the musical scale. A better understanding of the operation of a key and its corresponding electrotome may be obtained by referring to the detached section shown in fig. 70.



Fig. 69.

a is a steel reed tuned to vibrate at a definite rate, corresponding to its position in the scale. One end is rigidly fixed to the post *b*, while the other end is left free, and is actuated by a local battery. The magnets *e* and *f* are arranged in the same local circuit, magnet *f* having a resistance of about thirty ohms and magnet *e* about four ohms. When the reed *a* is not in vibration the point *g* is in electrical contact with it, which throws a shunt wire entirely around the magnet *f*: thus, practically, the whole of the local current passes through magnet *e* at the instant of closing the key *c*. It is well known that when two electromagnets are placed in the same circuit, the one which has the

dro
an e
the
the
func
only
size
both
batt
It
vibr

higher resistance (other things being equal) will develop the stronger magnetism, and that if the magnet of higher resistance be taken out of the circuit the force of the other will be increased. When the key *c*, being depressed, closes the local circuit at *d*, the operation of the reed is as follows: The whole of the current from battery *l. b.* passes through the magnet *e*, which attracts the reed, say with a power of four. When the reed has moved towards *i*, far enough to leave the point *g*, the shunt circuit is broken and the current flows through both the magnets. Immediately the power in *f* rises from zero to five, and that of *e*

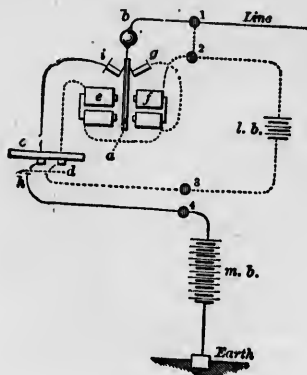

Fig. 70.

drops from four to one, and the reed is attracted towards *f* with an effective force of four, until contact is again established with the point *g*. The operation is repeated at a rate determined by the size and length of the reed, and which corresponds with the fundamental of the note it represents. The figures given above only approximate the facts. The relation of the magnets as to size and resistance, so as to give an equal impulse to the reed in both directions, was determined by actual experiment with a battery of a given size.

It will be observed that by this arrangement the centre of vibration coincides with the centre of the reed when at rest, so

that the pitch of the tone is not disturbed by any ordinary change of battery, as is liable to be the case when only one magnet is used or when the impulse is not equal in both directions.

A second battery, which we will call the main battery, is connected as follows: One pole is connected to the ground. The other runs to the instrument, and, entering at binding screw 4 (fig. 70), runs to point *h* of key *c*; from key *c* to point *i*, which makes contact with the reed *a*; from reed *a* to binding screw 1, and thence to line. It will be seen that when the key is at rest the batteries are open at the points *d* and *h*.

All the keys in the instrument, whether one or more octaves, have corresponding reeds and actuating magnets, the only difference being in the tuning of the reeds. There is but one main and one local battery used, and the connections to each key are run in branch circuits from the binding screws, as shown in fig. 69. But, since all these branches are open at the key points, neither of the batteries is closed unless a key is depressed.

If now the keys are manipulated, a tune may be played which is audible to the player. When any key is depressed, the local battery sets in vibration its corresponding reed, which sounds its own fundamental note according to the law of acoustics. So far the instrument is an electrical organ, the motive power being electricity instead of air. The main battery has had no part whatever in its operation.

If, however, the main circuit is closed by connecting the distant end to ground, and the point *i* is properly adjusted, so that it makes and breaks contact with the reed at each vibration, a series of electric impulses, or waves, will be sent through the line, corresponding in number per second to the fundamental of the reed.

Now, as the pitch of any musical tone is determined by the number of vibrations per second made by the substance from which the sound proceeds, it is clear that if these electrical waves can be converted into audible vibrations at the distant end of the line, whether it be one mile or five hundred miles from the player, the note produced will be of the same pitch as that of the sending reed.

be
cu
pr
tu
pla
cor
it i
zor
a c
Up

mad
thin
box
ties.
by m
If
grou
press
of th
at the
be ha

There are various ways by which these electrical waves may be converted into audible material vibrations. One of the most curious and novel is the one in which animal tissue plays a prominent part. Following out the idea suggested by the bathtub experiment, I constructed various devices with metallic plates for receiving the tune by rubbing with the hand. A very convenient method for doing this is shown in fig. 71.

This instrument has a metal stand of sufficient weight to keep it in position while being manipulated. Upon the stand a horizontal shaft is mounted in bearings, upon one end of which is a crank, with a handle made of some insulating substance. Upon the other end is centred a thin cylindrical sounding box,



Fig. 71.

made of wood, the face of which is covered with a cap made of thin metal, spun into a convex form to give it firmness. This box has an opening in the centre to increase its sonorous qualities. The metal cap is electrically connected to the metal stand by means of a wire.

If the operator connects the cap, through the stand, to the ground, and taking hold of the end of the line with one hand, presses the fingers against the cap, which he revolves by means of the crank with the other hand, the tune that is being played at the other end of the line becomes distinctly audible, and may be heard throughout a large audience room. If the conditions

are all perfect, the faster the plate is revolved the louder will be the music, and the slower the motion the softer will it become. When the motion stops the sound entirely ceases.

I have found that electricity of considerable tension is needed to produce satisfactory results, at least that of fifty cells of battery. The necessary degree of tension is most conveniently obtained by passing the line current through the primary circuit (adapted to the circuit wherein it is used) of an induction coil, and connecting the receiver in the secondary circuit.

The cause of this phenomena has been the source of much speculation and experiment. At first, I supposed it to be the quivering of the muscles of the hand, produced by the electric impulses and communicated to the plate and box, making an audible sound, and that the motion was produced through the medium of the nerves. This idea, however, had to be abandoned. While visiting England, in 1874, I called on Professor Tyndall at the Royal Institution, and exhibited to him a portion of my apparatus. He experimented with various substances, and found that the same result, in kind if not in degree, could be produced with dead animal tissue. For instance, a bacon rind that had been pickled and smoked until there could be no suspicion of a nervous influence left, would, when sufficiently pliable, produce the sound, the cuticle being used next the plate.

While Professor Tyndall's experiments did not explain what the cause of the phenomenon really was, they determined most conclusively that it was not due to nervous influence upon the tissues, acting in sympathy with electrical impulses. It was suggested by some that it might be caused by electrical discharges, in the form of a spark, from the hand to the plate; but if this is true, why should motion, as a gliding of the hand over the surface of the plate, be necessary to produce the result? Others have suggested that the molecules of the substance in contact were disturbed upon the passage of each electrical impulse, roughening the surface, and for the instant producing a sudden increase of friction. If this is true, why should wetting the parts in contact destroy the effect?

But to continue my experiments: I noticed that when revolving the plate with my finger in contact, the friction was greater when a note was sounding. I then connected a small Ruhmkorff coil to a battery, inserting a common telegraphic key in the primary circuit, instead of the self-acting circuit breaker. I connected one end of the secondary coil to the metal plate, and holding the other end in my hand, I rubbed the plate briskly, and had my assistant slowly make dots with the key. I noticed at each make of the circuit a slight sound, and at each break a very much louder one, owing to the fact that the terminal secondary wave is much more intense than the initial. I now held my hand still, and, while I could feel the shock just as distinctly as before, there was no audible sound, proving that the motion was a necessary condition in its production. The sensation when the sound was produced was as though my finger had suddenly adhered to the plate, and then as suddenly let go, producing a sound.

The next experiment was with one hundred cells of gravity battery. I connected one pole to the plate and held the other in my hand, pressing my finger against the plate and revolving it as before. I inserted a thin piece of paper between my fingers and the plate to prevent painful effects from the current, and my assistant made dashes with a key in the circuit. I was thus able to notice the effect of an impulse of longer duration. When the key closed there was a perceptible increase of the friction, so that my finger took a position farther forward on the plate, where it would remain as long as the circuit remained closed. As soon as the key was opened my finger suddenly dropped back on the plate, making the same noise I had before heard. This operation was repeated so often that there could be no question as to the effect it produced.

From the foregoing experiments, I find that the following conditions are necessary to reproduce musical tones through the medium of animal tissue, by means of electric waves transmitted through a telegraph wire.

1st. The electrical impulses must have considerable tension in order to make the effect audible.

2d. The substance used for rubbing the receiving plate must be soft and pliable, and must be a conductor of electricity up to the point of contact, and there a resistance must be interposed, very thin, neither too great nor too little.

3d. The plate and the hand, or other tissues, must not only be in contact, but it must be a rubbing or gliding contact.

4th. The parts in contact must be dry, in order to preserve the necessary degree of resistance.

It will be seen that we have here the conditions of a static charge, the plate receiving one polarity from the battery, and the hand the other polarity; the interposed resistance preventing in a great degree the dynamic effect. It is a well known fact, that



Fig. 72.

two bodies statically charged with opposite electricities, attract each other. May not this be the whole solution of the phenomenon, that each wave as it arrives at the receiving end becomes for a moment static, which results in a momentary attraction between the plate and the finger, and this immediately ceasing when the wave is gone, releases the finger with a noise or sound? If, then, sounds are repeated as fast as the sending reed vibrates, the production of a musical tone must follow, according to well known laws of acoustics, providing the waves are sent to line in musical order.

In the winter of 1873-4, I experimented very elaborately, and worked out many new applications of the principle, not only to the transmission of music, but to the transmission of telegraphic messages.

If, instead of the revolving plate and the animal tissue, we place in the circuit an electro-magnet, or a number of them, and have a tune played at the transmitting end, the tune will be heard from all these electro-magnets. The music produced will be loud or low; 1st, as the battery used is strong or weak; 2d, as the line offers more or less resistance; and 3d, as the magnets are mounted more or less favorably for acoustic effects.

In this case, as in that of the animal tissue, each impulse produces a sound; but it is produced differently in the two. It is a well known fact that an iron rod elongates when magnetized, and contracts again when demagnetized. The elongation and contraction are so sudden, that an audible sound is produced at each change. In order to convert this sound into a musical tone,

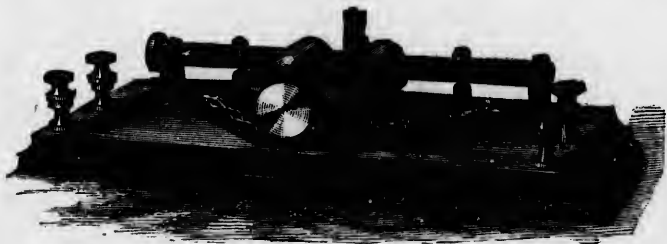

Fig. 73.

it is only necessary to repeat it uniformly and at a definite rate of speed, which shall not be less than sixteen nor more than four thousand per second.

When the electro-magnet is properly mounted the tone may be made very loud. Fig. 72 shows a very good form for mounting a magnet for receiving music. It is a common electro-magnet having a bar of iron rigidly fixed at one pole, which extends across the other pole, but does not touch it by about one sixty-fourth of an inch. In the middle of this armature a short post is fastened, and the whole mounted on a box made of thin pine, with openings for acoustic effects.

One of the earliest discoveries in connection with these experiments was the fact that not only simple, but composite tones

could be sent through the wire and received, either on the metal plate or on the magnet. Not only could a simple melody be transmitted, but a harmony or discord could be equally well. From that time, I have worked assiduously with the view of making a rapid telegraphic system embodying this discovery. The first step was to analyze the tones at the receiving end, which, if successfully accomplished, would open the way to a multiple Morse, a fast printing, an autographic and other systems.

It would be impossible to give in this paper all the experiments tried, for they were very many indeed. I accomplished the analysis in a number of ways. The method which seemed in all respects to give the best satisfaction is as follows:

Fig. 73 is a perspective of one form of a receiving instru-



Fig. 74.

ment called an analyzer. The construction of the instrument is very simple. It consists of an electro-magnet adapted to the resistance of the circuit where it is intended to be used, and of a steel ribbon strung in front of this magnet in a solid metal frame, and provided with a tuning screw at one end, so as to readily give it the proper tension. The length and size of the ribbon depends upon the note we wish to receive upon it. If it is a high note we make it thinner and shorter; if a low note we make it thicker and longer. If this ribbon is tuned so that it will give a certain note when made to vibrate mechanically, and the note which corresponds to its fundamental is then transmitted through its magnet, it will respond and vibrate in unison with its transmitted note; but if another note be sent which varies at all from

its fundamental, it will not respond. If a composite tone is sent, the ribbon will respond when its own note is being sent as a part of the composite tone, but as soon as its own tone is left out it will immediately stop. Thus I am able to select out and indicate when any note is being sent, in fact, to analyze the tones which are passing over the line.

This method of analyzing tones transmitted through a wire electrically is analogous to Helmholtz's method of separating tones transmitted through the air.

The transmitting instruments used in sending composite tones, are made similar in every respect to the one shown in fig. 70,

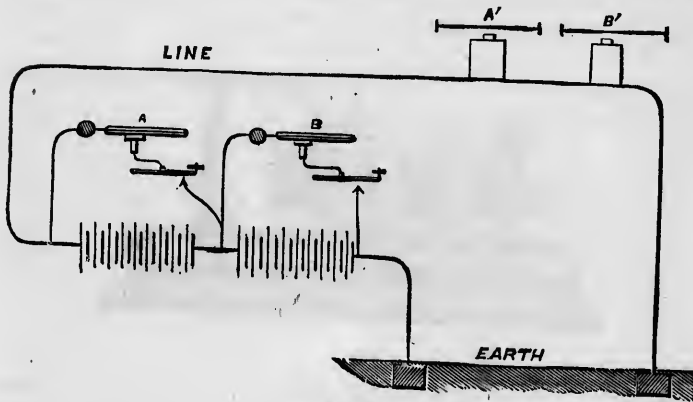

Fig. 75.

except that each reed is separately mounted. A cut of one of these transmitters, used in telegraph work, is shown in fig. 74.

Fig. 75 shows a diagram view of two transmitters and two receivers, with their connections. The local circuits, with their magnets, are left off to avoid confusion.

A and B represent two transmitters, placed at one end of a line, A' and B', two receivers at the other end. One end of the main battery is connected to line, and the other end to ground. Each transmitter is placed in a shunt wire, running from its main battery connections around one half of the battery. A

common open circuit key is placed in each of these shunt wires. Suppose now the two reeds of A and B to be sounding, A making 264 vibrations per second, and B 320, just two tones or a major third above A. So long as the keys remain open, all the battery is constantly on the line. If the key of transmitter A is closed, half of the battery is being thrown on and off the line, at the rate of 264 times per second. This causes a succession of electrical waves to flow through the line at the same rate. If now the steel ribbon of the analyzer A' has been tuned in unison with these electrical waves, it will respond and hum the same note as the transmitter; but, if it is not in unison, it will remain practically quiescent, so that the note can only be heard by submitting it to the most delicate test. To bring it in unison it is

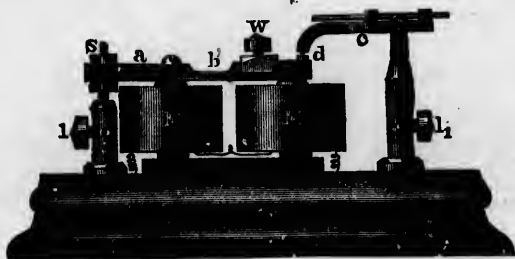

Fig. 76.

only necessary to turn the tuning screw up or down, as the case may be. When the fundamental of the ribbon corresponds with that of the sending reed, it announces the fact by sounding out loud and full. If (having the key of transmitter A still closed, and consequently its corresponding analyzer still sounding) we close the key belonging to transmitter B, the other half of the battery will be thrown on and off the line, at the rate of 320 times per second, and another succession of electrical waves will flow through the line, this one being at the rate of 320 times per second. If the analyzer B' is in proper tune, so that its fundamental is the same as that of its corresponding transmitter B, it will hum its note as long as the key is closed, making a chord

with A'. In the same way, a great number of different notes may be sounding at the same time, at one end of a telegraphic line, and be heard simultaneously at the other end, each note sounding upon a different receiving instrument.

The manner of making these vibrations of the analyzer operate a sounder, a register, or other recording instrument, is shown in fig. 76.

The light contact lever *c* is armed with a contact point at its free end, resting merely by the weight of the lever itself in the concave cup *d*, upon the extremity of the armature *a*. When the armature is thrown into vibration the contact lever hops up and down, and does not close the local circuit (which is connected to *l* and *l*₁) with sufficient firmness to actuate the sounder, but when the vibration stops the local circuit is closed. This reverses the writing upon the sounder, but it may be operated by means of a local relay, or arranged in various other ways which readily suggest themselves. The complete operation is as follows: When the operator, at the sending station, closes his key, the armature *a b d* is thrown into vibration, and remains so as long as the key continues closed, but comes to rest immediately when the key is opened. The lever *c*, not being able to follow the armature, rattles against it with a buzzing sound, disturbing the continuity of the local circuit by throwing in a great resistance at the point *d*. This resistance is sufficient to act upon the sounder the same, practically, as a dead break. By this means the sounder is made to follow the key of the operator who is sending the proper note. In the same manner all the other tones may be brought into service, each ignoring the other, and each seeking its own at the receiving end.

A simpler construction of the analyzer, and one which renders the sounder unnecessary, is shown in fig. 77. The electro-magnet *M M*, which has very short cores, is provided with an armature *a*, rigidly attached to the lower core, but separated from the upper one by a space of $\frac{1}{8}$ of an inch. This may be increased or diminished by moving the upper core in or out, by means of the screw *S*. The armature is made thinner at the

point *b*, being filed down until it vibrates to a certain note, the nicer adjustment being accomplished by adjusting the movable weight *W*. The whole is mounted upon a sounding box *B*, open at one end, which is termed a resonator. The principle involved in the action of the resonator is this: A volume of air contained in an open vessel, when thrown into vibrations, tends to yield a certain note, and consequently strengthens that note, when the latter is sounded in its neighborhood. By placing the instruments upon corresponding resonators, the sound is greatly strengthened, so that an operator may readily read by sound

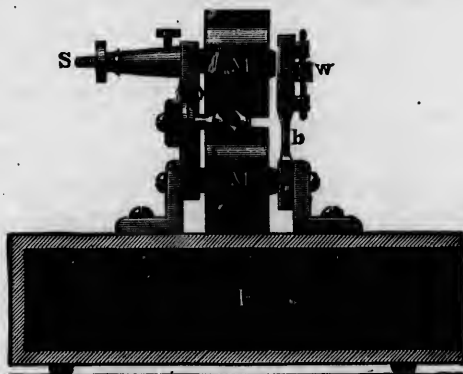

Fig. 77.

the telegraphic characters into which the continuous tone is broken by the transmitting key.

By this method not only may different messages be sent simultaneously, but a tune with all its parts may be sent through hundreds of miles of wire, and be distinctly audible at the receiving end.

¹ Gray's electro-harmonic telegraph is founded upon the principle that an electro-magnet elongates under the action of the electric current, and contracts again when the current ceases.

¹ American Mechanical Dictionary. Vol. iii. (The invention here described is a modification of that shown on pages 159 and 160.)

Consequently, a succession of impulses or interruptions will cause the magnet to vibrate, and if these vibrations be of sufficient frequency, a musical tone will be produced, the pitch of which will depend upon the rapidity of the vibrations.

By interrupting an electric current at the transmitting end of a line, with sufficient frequency to produce a musical tone by an instrument vibrated by said interruptions, and transmitting the impulses thus induced to an electro-magnet, at the receiving end of the line, the latter will vibrate synchronously with the transmitting instrument, and thus produce a musical tone or note of a corresponding pitch.

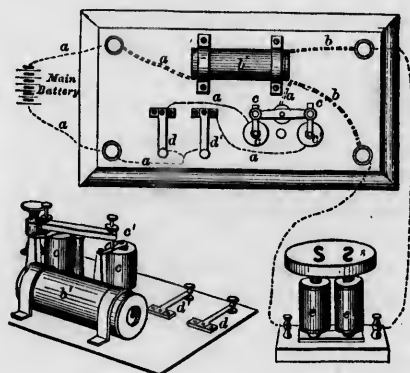

Fig. 78.

The instrument shown in fig. 78 consists of the transmitting apparatus, mounted on a base board, and a receiving apparatus, shown in a position beneath the former. The induction coil b^1 has the usual primary and secondary circuits. An ordinary automatic electrotome c has a circuit-closing spring c^1 , so adjusted as, when in action, to produce a given musical tone. A common telegraph key d is placed in the primary circuit a , to make or break the battery connection. The key being depressed, and the electrotome consequently vibrated, the interruptions of the current will simultaneously produce in the sec-

FROM THE LABORATORY OF

T. A. ERISON.

MENLO PARK, N. J.

U. S. A.

ondary circuit $b b$, of the induction-coil, a series of induced currents or impulses corresponding in number with the vibrations of the electrotome, and as the receiving electro-magnet e is connected with this circuit, it will be caused to vibrate by successive elongations and contractions, thus producing a tone of corresponding pitch, the sound of which may be intensified by the use of a hollow cylinder s , of metal, placed on the poles of the magnet.

When a single electrotome c is thrown into action, its corresponding tone will be reproduced on the sounder by the magnet. When electrotomes $c c^1$, of different pitch, are successively operated by their respective keys $d d^1$, their tones will be correspondingly reproduced by the receiver; and when two or more electrotomes are simultaneously sounded, the tone of each will still be reproduced without confusion on the sounder, so that, by these means, melodies or tunes may be transmitted. Another system is founded upon the alternate making and breaking of a telegraphic circuit by means of the vibration of tuning forks, or musical reeds, as in Helmholtz's apparatus for the production and transmission of vocal sounds. If a given fork be made to interrupt an electric circuit by its vibrations, and the intermittent current thus produced be passed through a series of electromagnets, each in connection with a fork of different pitch, and consequently different rate of vibration, only that fork will be thrown into vibration which is in unison with the first one. Practically, the time required to do this is a small fraction of a second. The advantages of this method are numerous. Not only may many receiving instruments at one station be operated, each by its own key, through a single wire, but many different stations in the same circuit may be operated, that one alone receiving the message which has an instrument with the requisite pitch, so as to vibrate in synchronism. Many signals may, in this way, be transmitted over the same wire at the same time, and many dispatches sent simultaneously to as many stations. All this may be done, too, without affecting the line for its ordinary use.

co
with
Eli
con
dir
the
me
bei
me
wa
tra
offi
tion
We
C
exp
of
cui
the
T
in
the
elec
con
vibr
ing
the
and
inte
incl
the
1 A
I., N
Gray

COMBINATION OF THE TELEPHONE AND MORSE APPARATUS.¹

The method of combining the telephonic, or electro-harmonic, with the ordinary Morse system of telegraphy, invented by Mr. Elisha Gray, of Chicago, has for its object a means whereby two communications may be simultaneously transmitted in the same direction, or in opposite directions, or, in other words, to double the capacity of a Morse circuit, having thereon several intermediate stations, so arranged that while a communication is being transmitted from one terminal station to the other by means of the telephonic system, either terminal station or any way station, may at the same time receive a message from or transmit one to either of the terminal, or any one of the way offices by means of the ordinary Morse apparatus. This invention has been subjected to a series of tests upon the lines of the Western Union Telegraph Company, with considerable success.

One of the several circuits upon which the system was tested experimentally extends from Chicago to Dubuque—a distance of 184 miles—with seventeen intermediate stations in the circuit, the total conductivity resistance of which, including all of the relays on the line, being about 5,000 ohms.

The principle and mode of operation of this invention is shown in fig. 79, which represents the instruments, in connection with the line, at a terminal station, including both the telephonic, or electro-harmonic, and the ordinary Morse apparatus, the former consisting of transmitter T, key K, local batteries e , e^1 and e^2 , vibrator or reed V, receiving instrument or analyzer A, repeating relay A^1 , sounder S, rheostat R^1 and main battery B; and the latter consisting of relay D, sounder S^1 , key K^1 , rheostat R and condenser C, the earth terminal of the line being at G. Each intermediate office is equipped with the Morse apparatus only, including the condenser and rheostat last mentioned; while at the distant terminal station both the telephonic, or electro-

¹ Abstract of an article from the Journal of the American Electrical Society, Vol. I., No. 2, entitled, A New and Practical Application of the Telephone, by Elisha Gray, Sc. D.

harmonic, and the Morse apparatus are arranged precisely as shown in the diagram.

To effect the object sought, viz., the simultaneous transmission of two communications in the same, or in opposite directions, it is obviously essential that sounder *S* (for example) should respond solely to the movements of key *K* and transmitter *T* of the telephonic apparatus; while in like manner the sounder *S*¹, which is connected with the Morse instruments at the distant terminal, and at the several intermediate offices, should respond solely to the movements of key *K*¹.

The manner in which this is accomplished will be understood by reference to the figure, and the following explanation thereof.

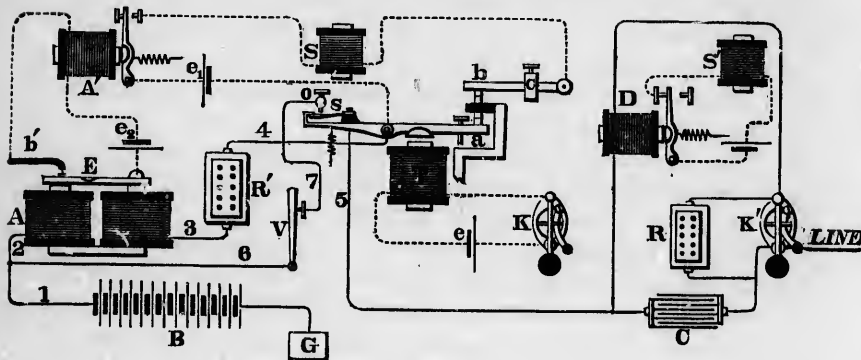

Fig. 79.

The transmitter *T*, which in principle is similar to that used in connection with the duplex and quadruplex systems, is operated by means of the key *K* and local battery *e*. The auxiliary lever *b*, one end of which rests upon a suitable fulcrum, while the free end rests upon the anvil of transmitter *T*, serves, in connection with the armature *a* of the latter, to control the local circuit of sounder *S* in a manner and for a purpose to be hereinafter described. The vibrator or reed *V* (which, with the receiving instrument or analyzer *A*, are fully illustrated and described on pages 153 and 162) is kept constantly in vibration by means of electro-magnets and a local battery (not shown in the figure),

and is tuned to a certain pitch, corresponding to the reed E of the receiving instrument or analyzer A. A small secondary lever b^1 , having one end pivoted, while the other end rests upon the free end of the armature or reed E of the analyzer A, serves to control the local circuit of the relay A^1 , which latter, in turn, operates the sounder S; and when thus arranged forms a well known device for reversing the signals of the receiving instrument A, in order that they may appear correctly upon the sounder S. The normal condition of the key K^1 of the Morse apparatus is closed as shown in the figure, in which position the rheostat R is cut out of the circuit, while that of key K and transmitter T is open. Disregarding for the present the apparatus at the distant terminal and several intermediate stations, the route of the circuit may be traced from the earth plate G to main battery B, by wires 1 and 2, to the receiving instrument or analyzer A; thence by wire 3 to rheostat R^1 , and wire 4 to the lever a and spring s of transmitter T; thence by wire 5 to relay D and key K^1 to the line. With key K closed, and the consequent operation of transmitter T, the route of the circuit is changed as follows: From earth plate G by wires 1 and 6 to the vibrator or reed V, and wire 7 to stop o and spring s of transmitter T; thence by wire 5 to relay D and key K^1 to the line and distant station, as before.

The amount of resistance employed in the rheostat R^1 , in addition to that of the analyzer A, should be equal to the apparent resistance caused by the vibration of the reed V, so that no variation in the strength of the current going to the line is manifested in the Morse relay D when the transmitter T is either open or closed. The rheostat R should be so adjusted, that when inserted in the line by opening the key K^1 , it will diminish the strength of the current to an extent sufficient to cause the armature of the Morse relay D to yield to the force of its retractile spring, thus opening the local circuit of sounder S^1 .

The condenser C is arranged with one set of its poles connected to wire 5 and the other to the front stop of key K^1 , so as to shunt the relay D and rheostat R, and thus, when the key is

opened and the resistance *R* introduced into the circuit, the full diminution of the current does not take place instantaneously, but only after an exceedingly brief interval of time and in a gradual manner while the condenser is charging. By this means the effect of a sudden change in the current on the receiving instrument or analyzer *A*, which would tend to make the latter give a false signal, is entirely avoided.

The condenser *C* also assists in maintaining a uniform condition of magnetism in the cores of the Morse relay *D*, by discharging through the electro-magnet, during the interval of time between the vibrations or when the potential is falling, and in this way the effects of the simultaneous operation of the telephonic apparatus are practically nullified.

The auxiliary lever *b*, which rests upon the anvil of transmitter *T*, serves to prevent a false signal being given upon the sounder *S*, which is sometimes an annoyance to the operator sending. The sudden release of the reed *E* from the attractive force of the magnets of analyzer *A* gives the lever *b*¹ a bound, which produces a "click" upon sounder *S*. The upper limiting stop of the lever *a* of the transmitter *T* is insulated from the anvil, and together with the armature *a* and auxiliary lever *b*, forms a portion of the local circuit of sounder *S*, so that when the armature *a* approaches the magnet *T* the local circuit of sounder *S* is broken, and when released from magnet *T*, the force with which it strikes against the upper limiting stop causes the lever *b* to vibrate enough to compensate for the vibrations of the reed *E*, of the analyzer *A*, caused by the latter being restored to its previous condition, thus preventing the signal above mentioned being given upon sounder *S* during the operation of key *K* and transmitter *T*. The sliding weight *C* is to regulate the movements of the lever *b*.

Thus it will be understood that by a depression of key *K* and the consequent operation of transmitter *T*, the electrical pulsations caused by the vibrating reed *V* will pass to the line and operate the analyzer *A* and reed *E* at the distant terminal, so as to record the desired signal upon sounder *S*, without producing

any
media
and r
mitted
equip

PHE

The
are at
ordina
closely
ession

It is
experim
well-de
takes
reader
facts pr

Amo
duction
than th
which
receiving

Very
of teleg
observed
through
flowing
simply

varying
To de
in my c

¹ By Ellis

any effect upon the Morse instruments at the several intermediate stations; while at the same time, by means of key K¹ and rheostat R and relay D, a communication may be transmitted to, or received from, any one of two or more way offices, equipped with suitably arranged Morse instruments.

PHENOMENA ATTENDING THE TRANSMISSION OF VIBRATORY CURRENTS.¹

The vibratory impulses used in electro-telephonic transmission are attended by certain phenomena which are not apparent in ordinary electric telegraphy. Their peculiarities seem to be closely connected with the short duration and the rapid succession of the single impulses.

It is my purpose in this paper to give the results of some experiments on this subject, without attempting to present any well-defined theory in regard to the molecular action which takes place under the conditions described, but leaving the reader to make such explanation as may be suggested by the facts presented.

Among the remarkable developments attending the introduction of the telephone there is, perhaps, none more striking than the effect upon the amplitude of the received vibrations which follows a change in the magnetic condition of the receiving electro-magnet.

Very early in the course of my experiments in the matter of telegraphically transmitting musical and other sounds, I observed that better effects were obtained when I operated through a closed circuit, having a constant current of electricity flowing through it, and transmitted the electric vibrations by simply superposing them upon this constant current without varying its power.

To define more clearly what I mean, I will give an instance in my experience which occurred in the winter of 1874-5.

¹ By Elisha Gray, Sc. D. Journal of the American Electrical Society, 1878.

While experimenting at Milwaukee, with my electro-harmonic or electro-acoustic multiple telegraph system, I had with me a set of my apparatus for receiving tunes, known as the musical telephone.

One evening, after the regular work of the day was closed, I transmitted a few tunes across the street from the telegraph office to the Newhall House, for the amusement of some friends. Instead of using an independent battery, I simply tapped one of the regular batteries of the North-Western Telegraph Company, which contained two hundred cells of the ordinary gravity form, by connecting my short line wire to the battery, twenty cells from the ground end, without in any way disturbing the other connections. This battery at the same time supplied three lines, which extended through Wisconsin in various directions to distant points. The few cells which I employed did not in the least interfere with the ordinary working of the lines.

A number of familiar tunes were played during the evening, and I was surprised next morning to learn from various offices in the State, through which the three lines ran that were supplied by the common battery, that the tunes played were all reproduced audibly and distinctly by the relays in the various offices along the line. Some of the operators being ignorant of the invention of the telephone at that time, were very much amazed at this new exhibition of the musical powers of their instruments, and I am told that one gentleman, sixty miles from Milwaukee, closed his office that night much earlier than he was accustomed to do.

The relation of the instrument to the various circuits is shown in the diagram, fig. 80. *E* and *e* represent the battery of two hundred cells used to supply the three telegraph lines *L*, extending through Wisconsin. *T* is a musical transmitter placed in the short wire running to the Newhall House, and attached to the battery, twenty cells from the ground end. *K* is a Morse key; *M* is the electro-magnet, and *R* the armature of the telephonic receiver at the Newhall House. It will be readily observed, that each time the transmitting vibrator closed, the

twent
receiv
ately
it ag
sendin
rent f
plied
batter
such r
tance
or mor

into act
matter.

At a
another
cumstan
length,
taneous
a system
cells of
wire, as
United

twenty cells of battery they would be short circuited through the receiver in the Newhall House and ground, thereby proportionately diminishing the power of the whole battery and restoring it again each time the vibrator opened the short circuit, thus sending a series of vibrations superposed upon the uniform current flowing from the larger battery throughout the lines supplied by it. I was well aware that twenty cells of this form of battery, connected to the three lines as shown, would not produce such marked effect upon so many magnets and at so great a distance; and I was naturally led to conclude that the one hundred or more cells of the additional battery, which were not thrown

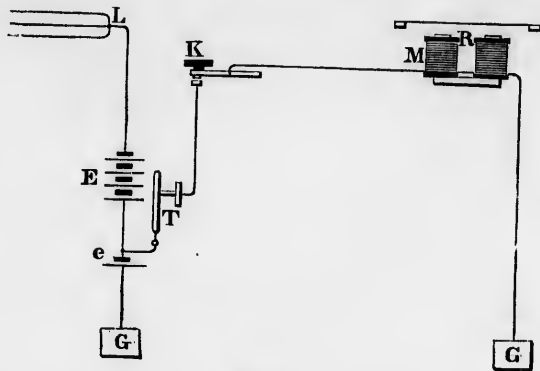

Fig. 30.

into action by the transmitter, in some way played a part in the matter.

At a later date—I think in the latter part of 1875—I made another experiment at the same place, under the following circumstances: I had been using a wire two hundred miles in length, and was engaged in transmitting a series of tones simultaneously over the same wire for the purpose of applying it to a system of multiple telegraphy. I had been using one hundred cells of battery, divided into four sections, upon each end of this wire, as shown in my patent for a multiple circuit, filed in the United States Patent Office, January 27, 1876, in which it will

be observed that the batteries are connected to the two ends of the line in the usual way for an American Morse circuit.

The two batteries were divided into four sections by shunt wires, in each of which was inserted a transmitter or a vibrator and a Morse key, which stood open except when used for transmitting signals while the vibrators were in operation. If the key belonging to any vibrator was depressed, it would throw in vibration the section of battery included in its short or shunt circuit. By this arrangement I had as many as eight receivers in operation simultaneously, each receiving a tone differing in pitch from the others, and each having a vibration strength of twenty-five cells.

One evening I wished to make an experiment with one tone

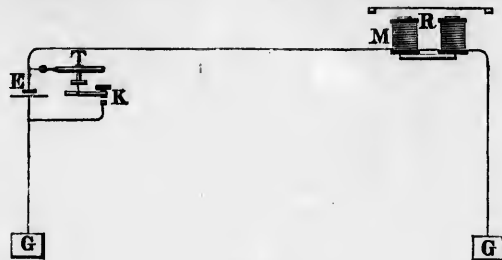

Fig. 81.

only, and for that purpose inserted only twenty-five cells in the circuit, leaving out the other one hundred and seventy-five, as it did not occur to me at first that the battery cells left out would play any part in a vibration not included in the shunt wires belonging to their particular tones. As twenty-five cells were all that were used in transmitting any one single tone, I supposed that amount of battery would be sufficient for the experiment that I wished to try. The position of the battery and instrument in relation to each other is shown in fig. 81. *E* is a battery of twenty-five cells. *T* is the vibrator and *K* the key inserted in a short or shunt circuit thrown around the twenty-five cells of battery. *M R* is the telephonic receiver. I was surprised at first to find that no perceptible effect could be felt on the receiver

wh
tion
ther
test
all
me
cells
arou
addi
M R
the
e tw
W

diffic
circu
receiv
was s
times
length
by stu
could
throw
circuit
It wou
or mor
in that

when the key was closed and the battery thrown into vibration. After working over it for some time, I concluded that there must be some fault in the connections, and proceeded to test the wires by inserting a Morse relay. I found the circuit all right, when a recollection of my former experience caused me to place in the circuit an additional battery of one hundred cells, leaving the vibrator and shunt wires as they were before, around the twenty-five cells only. The arrangement after the additional one hundred cells were inserted is shown in fig. 82. M R is the receiving telephone, T the telephonic transmitter, K the Morse key. E represents one hundred cells of battery, and e twenty-five cells.

When the key was now closed, the receiver responded without

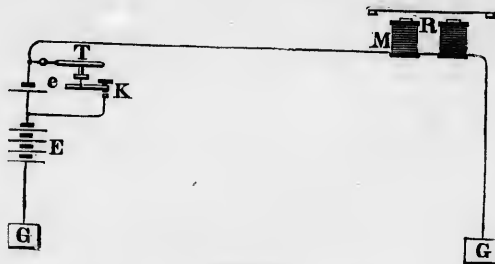

Fig. 82.

difficulty. By inserting an additional amount of battery in the circuit at the receiving end, the amplitude of vibration on the receiving reed, which was tuned in unison with the transmitter, was still greater. I have verified this experiment at different times since the above date, and on different lines, varying in length up to five hundred miles and over. It will be observed by studying the diagram in fig. 82, that the only effect the vibrator could have upon the circuit, when the key was closed, was to throw into vibration the twenty-five cells included in its short circuit, at a rate corresponding to the fundamental of the vibrator. It would seem that no effect could be had from the one hundred or more additional cells, inasmuch as they were simply inserted in that portion of the circuit which was never broken or opened,

except to produce a permanent magnetic effect in the receiving magnet corresponding to its current strength. In other words, if the magnetic effect produced by the one hundred cells is represented by twenty, twenty-five additional cells would increase the magnetic effect to a certain point above twenty, and when taken off it would fall to twenty, but not below.

If the power of the twenty-five cells is represented by five, why should it not be exerted with equal power without the one hundred cells inserted in the circuit, as described? This was the problem, and, in a measure it is a problem still, although I have satisfied myself in regard to certain facts which help to strengthen the theory which I then held in regard to the matter. I supposed at that time I could account for at least part of this effect, upon the theory that the speed of the signal was increased by the additional potential given by the larger number of cells. In other words, the value of any given cell, or number of cells, when forming part of a large battery, is greater, especially if used on long lines, than when used alone. This theory, however, is entirely inadequate to account for the whole effect, as will appear from what follows.

Some very interesting experiments bearing upon this matter were made by me while experimenting with the speaking telephone, known as the battery or supplemental-magnet telephone, a diagram of which is shown in fig. 83.

In this instrument no permanent steel magnet is used; nor is there connected with it a battery current flowing through the main line. Instead of a permanent steel magnet, such as is more commonly used in speaking telephones, I used an electro-magnet, B, which is held permanently charged by a local battery. The electro-magnet C, which is next to the diaphragm, and which connects with the line and ground, and a corresponding magnet at the other end of the line, are charged by induction from the core of the magnet B, which, as before mentioned, is charged from the local battery.

Before a battery current had been passed through the coils, and while the cores were perfectly neutral, I made the following

ex
lin
1, s
wit
tion
unc
C, v
tele
ton
batt
elec

actin
Alth
conso
get n
the c
medi
and c
ever
can n
of ste
hear t
faint
after

experiment: I connected the telephones to the two ends of the line, as shown in fig. 83, and put on a local battery at station No. 1, shown at the right hand of the diagram, connecting the battery with magnet B through the wires 4 4. The local battery at station No. 2, at the left of the diagram, was for the time left unconnected, so that the core of the magnet B, and also that of C, were both in a neutral state. I now placed my ear to the telephone at station No. 2, and had my assistant speak in a loud tone into the instrument at station No. 1, which had the local battery attached, and was therefore in condition to transmit the electrical vibrations produced by the motions of the diaphragm

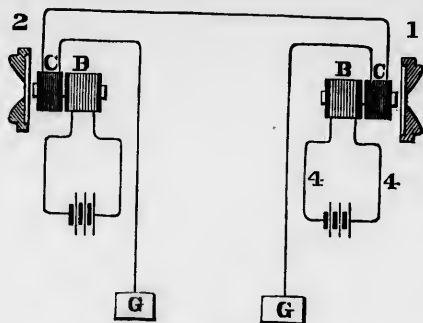

Fig. 83.

acting inductively upon the then magnetized electro-magnet C. Although the vibrations were passing through the circuit, and consequently through the coils of magnet C, at station 2, I could get no audible effect until I put on the local battery and charged the cores of the magnet at the receiving end of the line. Immediately after this was done I could hear every word loudly and distinctly, making in all respects the best telephone I have ever heard, due to the fact that by the aid of local batteries we can make of soft iron a much stronger magnet than can be made of steel. I then threw off the battery at station 2, when I could hear the words very faintly, and I was able then to transmit very faint sounds, due wholly to the residual charge left in the iron after the battery was taken off. It is easy to see why no sound

could be transmitted from the apparatus before it had been charged by the battery, because there was neither electricity nor magnetism present, nor had we any of the conditions necessary to produce either of these forces by simply speaking against the diaphragm. This was not true, however, of the No. 1 station, because the battery was connected and the magnet charged. No doubt there was some effect produced upon the receiving magnet, for the electrical impulses passing through the line must have been the same whether the magnets at the receiving end were charged or in a neutral condition. This one fact, however, was prominently brought out, that in order to make an electro-magnet, which is the receiver of rapid vibrations (such as will copy all the motions made in the air when an articulate word is uttered), sensitive to all the changes necessary in receiving sounds of varying quality, it must be constantly charged by some force exterior to the electrical vibrations sent through the wire from the transmitting station. We were well aware that this condition is unnecessary where the force transmitted is of sufficient magnitude, or where the signals are of sufficiently long duration. My experiments lead me to the conclusion that a soft iron core is far more susceptible to the slight changes in the electrical conditions of the wire surrounding it when it is already in a high state of magnetic tension. It is like an individual who, in his more calm and unruffled moments, may be surrounded by little waves of excitement without being affected by them; when on the other hand, if from any cause whatever, his nervous system is in a state of tension, he is readily affected by every disturbing influence, however slight.

It will be noticed that the above observations were made in regard to electrical impulses of very short duration; the longest several hundred per second, and the shortest many thousand.

The explanation of the above results may be partly understood when we fully consider the effects of the extra current which is induced in the primary circuit itself; especially when such circuit has included in it the coils of an electro-magnet.

The first effect from a current of electricity passing around

the coils of an electro-magnet is to develop magnetism in its soft iron core; but as soon as the core begins to magnetize, it sets up a momentary induced current in the opposite direction to the primary or inducing current, the effect of which is to retard the charge in the first instance.

It has long been known that this reactive effect of the induced current is strongest at the very beginning of the electrical excitement; while this effect is only momentary, its duration is still as great as that of the longest vibratory period of any of the tones of the voice.

When the magnet is already charged, the induced current is far less able to act as an opposing agent to the flow of the primary impulse. The constant charge given to an electro-magnet seems to have an opposite effect upon the secondary impulse from that which it has upon the primary. For I noticed when experimenting with the induction relay, that if I charged the primary coil with a battery power of, say five, the initial secondary impulse would be far greater than if I left a constant charge of five in the primary and suddenly raised it to ten.

I have thought that a further possible explanation of this phenomenon may be found on the supposition that, when the molecules of the iron are in a state of magnetic tension, that is to say, when they have moved from a neutral point up to a given position, there is then less molecular inertia to overcome in moving them forward. The principle here suggested finds an analogy in the superior resonating qualities of a sounding-board which is under mechanical tension, as compared with one in a neutral state.

It follows from the observations made above, in regard to the resistance to the passage of rapid vibrations through a helix having inserted in it an iron core, that any electro-magnet inserted in the circuit through which rapid vibrations are electrically transmitted, will either totally absorb them or greatly diminish their power. This is found to be true in practice, and it was a serious problem how to successfully use speaking telephones upon lines where more than two stations were necessary. In



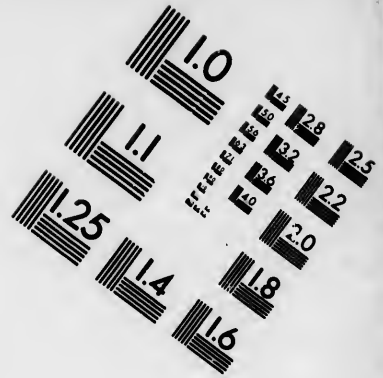
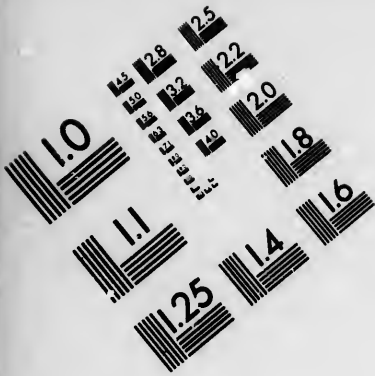

**IMAGE EVALUATION
TEST TARGET (MT-3)**

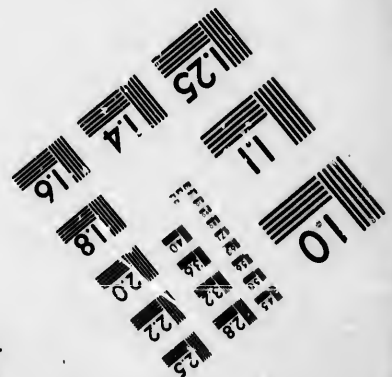
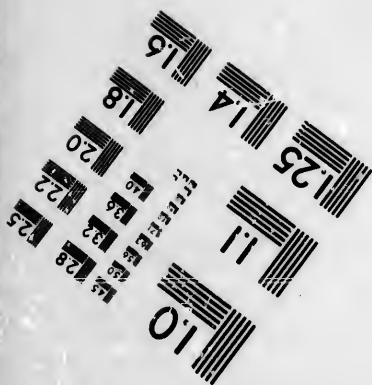
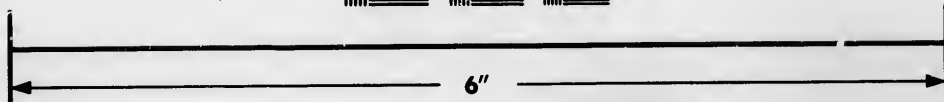
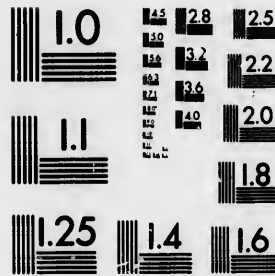

**Photographic
Sciences
Corporation**

23 WEST MAIN STREET
WEBSTER, N.Y. 14580
(716) 872-4503

28
25
22
20
18

10

order to be able to call the party with whom we wish to communicate, it is necessary to have bell magnets, or other signaling apparatus involving the use of an electro-magnet, and these magnets must be in circuit when the line is not in use, to be in position to receive a call from any station on the line. If A, B and C, have offices on the same line, and A should signal to C, they would both switch out their bell magnets and switch in their telephones; but B's bell magnet would still remain in circuit and act as a resistance to the passage of vibrations over the line. This difficulty is fully obviated by the use of a condenser, which is placed in a branch circuit passing around the bell magnets. So effectual is the remedy, that even five or six magnets may be inserted in the line without perceptibly diminishing the loudness of the tones over that of a clear wire of the same length. The action of the condenser in this case has been to some extent explained in an article published in the second number of this journal.¹

The effect of a condenser on impulses of short duration is just the reverse of that of an electro-magnet; the latter offering a momentary opposition to the passage of the impulse by creating a counter one, which to a great extent neutralizes it, while the former offers an easy passage to it so long as the condenser is filling, which occupies a very short space of time. The decrease in resistance effected by the use of the condenser is only momentary, and will be of no service whatever in prolonged signals. On the other hand, the increase of resistance caused by the insertion of an electro-magnet in circuit is also momentary, and does not act as a retarding influence, where the signal or impulse is sufficiently prolonged, more than the same amount of any artificial resistance.

I will mention another peculiarity which relates to the construction of the speaking telephone, with reference to its ability to accurately reproduce the characteristics of any voice or any sound that may be transmitted through it or received by it.

¹ For a description of the application of the condenser, see pages 80 and 81.

It is a well known principle in acoustics that that element of sound which we call quality or character is determined by the number of over-tones that accompany any given fundamental, and the position that they sustain with reference to the fundamental. For instance, a pure tone is made by a given number of vibrations per second, its vibratory periods occur at equal intervals, and it has no other tones accompanying it, of any pitch or intensity whatever. As a matter of fact, however, nearly all tones are composite in their character, and the nature of their composition, with reference to number and intensity, determines the character of the composite tone as a whole.

An approximately pure tone is obtained from a tuning fork constructed with great care, mounted upon a box whose cavity corresponds accurately to the pitch of the fork when the air column contained within it is thrown into vibration. When the fork is thrown into vibration, the sound of the vowel U will proceed from the cavity of the box. Hence, the characteristic of the vowel U is purity of tone, and may be likened to one of the positive colors, unshaded by the admixture of any other. On the other hand, if we add to this pure tone, or the vowel U, a tone whose vibrations are double the rate and very intense; also, two more tones of feeble intensity, one with a rate three times as great as the fundamental or lowest tone, and the other four times, we shall have a composite resultant sound whose character is that of the vowel O. And so by varying the composition with reference to number and intensity of tones, we produce in turn all of the other vowel sounds, and, in fact, every shade and variety of audible expression. Every change, however slight, in any single element of a composite tone, either in amplitude of vibration, rate or relation to the fundamental tone in the clang or composition, produces a change in the quality of the sound as a whole. From this it will be observed how important it is that the apparatus we use in transmitting and reproducing articulate speech shall copy with the greatest accuracy, both in the transmission and reproduction, all the motions made in the air by the speaker. Any attempt to reinforce the vibrations, by mounting

the diaphragm on resonant substances, such as wood, and over hollow air cavities, serves to mutilate the words transmitted, and destroy the peculiar characteristics of the sound. A few moments study of the laws of acoustics will suggest reasons why this is so.

Every solid substance of a resonant character—striking examples of which are wood and some of the metals—tends to assume a fundamental character when thrown into vibration. For instance, when we strike a bell of a given size, it gives a clang of the same character at every stroke. If the size of the bell is changed, the character of the sound or clang will change, so that everything of a solid or massive character may be said to be able to respond more readily to some tones than others. This characteristic increases as the body assumes the form of a vibratory reed or tuning fork, and it diminishes as the body is flattened into a thin shape, and assumes the form of a diaphragm, so that it ceases to vibrate more readily as a whole than in its equal parts. It has then more of the characteristics of the air with reference to its ability to take up simultaneously all forms of motion. If, then, the transmitting diaphragm of a speaking telephone is so constructed and mounted—with reference to whatever device is used to transform its mechanical movements into electrical movements of the same quality—that it copies accurately the motions of the air, it must transmit perfectly, and reproduce at the receiving end the same characteristics of sound that were transmitted, provided the receiving instrument is equally perfect in its construction. To secure this result, even after the diaphragm is as perfect as possible with reference to size, thickness and quality of material, it must be so mounted as not to excite the resonant qualities of the surrounding material which may be a part of the instrument. To this end, the instrument should be constructed, especially that portion which is immediately above and below the diaphragm, of some non-resonant material, and the diaphragm should be clamped at its edges by something in the shape of a pad or cushion.¹ The air space above

¹A device originally suggested by Professor A. E. Dolbear.

and
the
and
ph
eff
act
ver
rel
sou
or r
thro
dest

1
grap
desig
histo
been
this
has b
possi
justly
to th

At
the a
previ
with
Henry
an ele
also h
Reiss,
had n
I had
beside
A g

¹ Abst

and below the diaphragm should be the smallest possible. On the other hand, if the body of the instrument is made of wood, and an air cavity of considerable size is made under the diaphragm, or if any device is employed to reinforce the tones, the effect will be to mutilate the articulation, and change the character of the transmitted sounds. The reason for this will appear very plain when we consider the importance of preserving the relations of all the simple elements which make up a composite sound of a given character. These resonant devices will resonate or reinforce some of the tones of a clang and not the others, thus throwing the composition out of proportion, and consequently destroying its character.

¹ In the following pages, which relate especially to the telegraphic transmission of musical and other sounds, it is my design to give, with as much accuracy as possible, a concise history of my own experiments and observations, as they have been made from time to time since I began the investigation of this subject. It is not my intention to enter into the work which has been done by others; but to furnish as faithful a record as possible of my own, leaving the world to judge who is most justly entitled to priority of invention and discovery in respect to the various things hereinafter set forth.

At the time when I began my investigations in connection with the above subject-matter, I had no knowledge that any one had previously done anything in this field. I was, however, familiar with the general fact which had been made known by Page and Henry, in relation to the effect produced upon the iron core of an electro-magnet at the moment of its charge and discharge. I also had some general idea of the nature of the experiments of Reiss, of Germany, which were made about the year 1861, but had no knowledge at the time, or until more than a year after I had been actively engaged in telephonic research, that any one beside myself was devoting any attention to the same subject.

A glance at my antecedents may not be inappropriate at this

¹ Abstract of *Experimental Researches*, by Elisha Gray, Sc. D.

point, inasmuch as it will help to show how I came to be led into this particular field of physical research.

From my earliest recollection I was profoundly interested in all the phenomena of nature, and had an intense desire, whenever I saw any manifestation of physical force, to become acquainted with the secret of its operation. When I saw a piece of machinery of any character whatsoever, I usually attempted to reproduce it. Of course I was unsuccessful in most instances, owing to the fact that my facilities for constructing machines were very limited, and my experience as a mechanician at that early age was meagre. However, not all of my attempts were failures; for, I have in my mind the memory of the operation of many machines constructed by my own hands, ranging from a saw-mill run by water power to a Morse telegraphic apparatus.

Among all the phenomena throughout the domain of physics, nothing took such hold upon my mind as that exhibited in the various effects produced by the action of electricity. I read whatever I could find relating to this subject, with the same eagerness and interest that most boys would read Robinson Crusoe or the Arabian Nights; and many were the scoldings—to say nothing of stronger appeals that were sometimes made—that I received in consequence of my enthusiasm in experimental investigations in the various branches of physics. As I look back from this point, however, I feel no disposition to complain of what I then not unnaturally regarded as harsh treatment; for I can readily see that it was not altogether pleasant for my mother to find, as she sometimes did, that whole skeins of flaxen thread, which she had spun with her own fingers, had been used up in manufacturing belts to drive machinery which in her eyes promised very small results; or to discover that her best case-knife had been notched into saw-teeth, with which to equip a miniature saw-mill. Neither was it altogether agreeable to her feelings to find her only quart bottle—for quart bottles in those days were rare, and highly prized by the housewife—converted into a cylinder for an electrical machine; or to have the copper bottom of her wash-boiler cut up to make the plates

of a galvanic pile. I even think I would have invaded the sacred precincts of her handbox, which was only opened once a week, if thereby I could have made its contents subserve a purpose in connection with any of my boyish schemes.

While yet a boy I constructed a Morse register, all the parts of which were made of wood, with the exception of the magnet, armature and embossing point in the end of the lever (which latter I made by filing a nail down to a point). I had the magnet bent into a U form by a blacksmith, and then wound it with brass bell-wire, which was insulated with strips of cotton cloth wrapped around it by hand. For a battery I made use of a candy jar, in which I placed coils of sheet copper and zinc, with a solution of blue vitriol. With these materials I succeeded in making a very good electro-magnet, which would sustain nearly a pound weight, and which, when mounted as a part of the instrument, performed the work of actuating the armature with perfect success.

At quite an early age I was apprenticed to a blacksmith, and worked with him at that business about one year. Some of the edge tools which I made during that time are still in my mother's possession. I soon found, however, that this business was too laborious for me, as I was naturally of a rather frail constitution. I therefore relinquished it, and became an apprentice to a carpenter, joiner and boat-builder. I served a full apprenticeship, during which time I was employed in almost every department of wood-work.

The prime motive which actuated me through all these years that I had worked at the bench was my thirst for knowledge. I felt sure that, with my trade as my capital, I could work my way through a course of study. In pursuance of this idea, the time having expired for which I had apprenticed myself (three years and a half), I began a regular course of study, while by working a portion of each day and during vacation at my trade, I was enabled to pay my necessary expenses and keep up with my class. Here, as everywhere else, the capacity and ability to master everything relating to physical science was perhaps

the most prominent characteristic exhibited during my collegiate course. While studying natural philosophy, it was my custom to make and carry with me into the class such apparatus as could be readily constructed and would serve to illustrate the lesson. My habit of actually constructing everything which I saw or read of, so far as my facilities would allow, was the best possible method of fixing the principles of its operation firmly in my mind.

I have given this short autobiographical sketch simply to show the natural bent of my mind, and the characteristics which have been most prominent throughout my life.

My career as a professional electrician and inventor dates from the year 1865, since which time I have invented numerous electrical appliances, mostly relating to telegraphy. Some of these have gone into general use, but only a portion of them have been secured by letters patent. My time has been wholly occupied in the prosecution of electrical investigations and inventions, with the exception of that which has been required to secure and exploit certain of these inventions, and that which has been devoted to the science of acoustics, in connection with the telephone.

My first patent for electrical or telegraphic apparatus was granted October 1, 1867. Since that I have made a considerable number of electrical inventions, many of which have been patented. Including cases now pending, the number amounts to about forty in this country and thirty in foreign countries. Thirty of the United States cases and twenty-five of the foreign relate to the harmonic telegraph or telephone.

Fig. 84 shows the arrangement of the circuits and position of the operator when the bath-tub experiment was made, which is described on page 151.

This experiment produced a profound impression upon my mind, and determined me at once to take the matter up in earnest and see what might be in it.

I procured a violin, and taking off the strings, substituted in their place a thin metal plate provided with a wire connection, so that I could attach it to one pole of the induction coil or bat-



Fig. 84.

tery, thus placing it in the same position, with reference to the body, that the bath-tub was in the original experiment. By rubbing the plate in the same manner as before described, the sound of the electrotome was reproduced, accompanied by the peculiar quality or timbre belonging to the violin. I noticed, however, that the characteristics of the initial vibrations were faithfully preserved, and all that was needed was to sift out such foreign vibrations as were excited in the receiver, owing to its peculiar construction; in which case there would remain the exact character—nothing more nor nothing less—of the transmitted



Fig. 85.

vibrations. Fig. 85 shows the violin and the manner of holding it when in operation.

I subsequently substituted for the animal-tissue receiver an electro-magnet combined with a hollow box of tinned iron, having an opening in one side, while the other was held over the poles of the magnet at such a distance from it as would produce the best effect.

on
oth
the
a t
pos
tele
the
the
T
imp

mitte
tonic
W
demo
trans
receiv
resul
mind
that i
first p
A

With this apparatus I noticed that when I depressed two keys on my transmitter, if these were in the proper relation to each other, a composite tone would be received, thus demonstrating the general fact, that with a receiver properly constructed and a transmitter properly made and arranged in the circuit, composite tones of varying quality could be transmitted and received telegraphically. This apparatus is shown in fig. 86. In both of these cases I used an induction coil, placing the transmitters in the primary, while the line was connected to the secondary coil.

The above fact respecting composite tones was more strongly impressed upon my mind when I completed my musical trans-

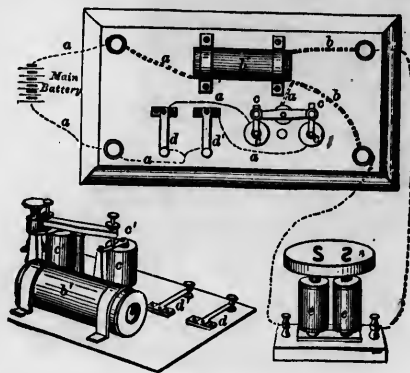

Fig. 86.

FROM THE LABORATORY OF

T. A. EDISON,

MENLO PARK, N. J.

U. S. A.

mitter, having a series of tuned reeds corresponding to the diatonic scale. This instrument is shown in fig. 87.

When the fact dawned upon me, and had been confirmed by demonstration, that sounds of a composite character could be transmitted through a telegraphic circuit and reproduced at the receiving end, and the possibilities of the invention and the great results to which it must eventually lead passed through my mind, I at once foresaw so many possible applications of it that it became a serious question which line of investigation to first pursue.

Among other conceptions of the probabilities of the invention

was that, at an early day, not only musical compositions of a complicated character, but even articulate speech would be transmitted through a single telegraph wire.

In addition to this, I could plainly see, also, how that musical tones, differing in pitch, could be simultaneously transmitted through the wire and analyzed at the receiving end, so that a transmitter and a receiver correspondingly tuned would transmit and receive a tone corresponding to their own pitch, rejecting all others; while at the same time a number of other tones

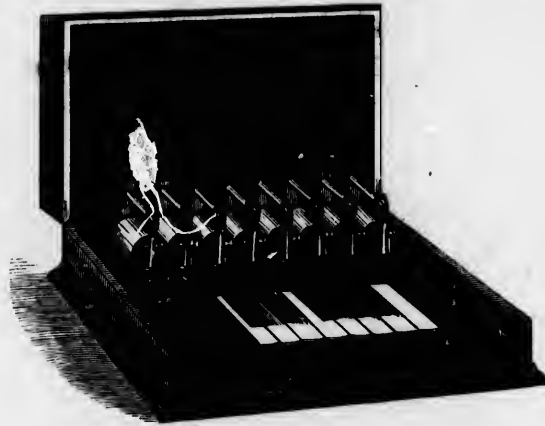

Fig. 87.

differing in pitch might be simultaneously transmitted and received through the same wire.

In truth, the general fact had already been demonstrated, but there was still needed that perfection in the details of apparatus and arrangement of circuits which were essential to success.

Another conception which occurred to me at this time was that of applying the invention to a printing telegraph, so that each type would be actuated by a tone of a particular pitch.

Having all these uses in my mind, and supposing I had secured in my first patent the fundamental principles that would underlie all the various applications that might be made in the

matter of transmitting sounds telegraphically, I pursued my investigations in a systematic way, placing each development to the credit of the particular application to which it seemed to belong.

Being well conversant with the facts, so far as they were then known in the sciences of electricity and magnetism, I was fully prepared to avail myself of what had already been done in that line. I was not, however, experimentally conversant to the same extent with the facts in the science of acoustics, but theoretically the subject was a familiar one to me. I devoted considerable time to familiarizing myself experimentally with that science, especially that branch which related to the qualities of composite tones; so that I was able to give the composition of the various vowel sounds, and determine in general the relation between the character of a sound as it seemed to the hearer and the physical fact as it existed in the form of motion, either in the air or any medium through which it was propagated. In this connection I made a number of experiments having reference to the transmission of sounds varying in quality.

I devoted myself principally to the construction of various devices for transmitting musical tones telegraphically, for this seemed to be the first fundamental step to take in the direction, either of musical or of multiple telegraphy.

I accordingly experimented with various forms of transmitting reeds, one of which consisted of an ordinary electro-magnet and a reed made of a piece of watch-spring, one end of which was fixed to one pole of the magnet, while the other or free end projected over the other pole, a short distance from it, so as to form an armature.

The circuit which actuated this reed, after passing from one pole of the battery through the helix, was connected to the magnet cores, thereby making the reed a part of the circuit, the pole being connected to a point resting against the reed one third of the distance from its fixed to its free end.

The transmitting reed above described, when adjusted very accurately, will give a musical tone of great purity; but the slightest

change in the adjustment, even a jar of the table, causes it to break into nodes, and give a note a third or an octave away from its fundamental. It was evident to my mind that there were inherent difficulties in the use of this form of reed which would render

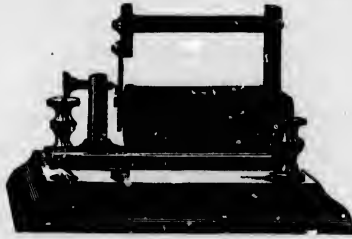

Fig. 88.

it impracticable for regular service. In the first place, it was too flexible throughout its whole length, partaking largely of the properties of a thin diaphragm, and thereby responding too readily to the harmonics of its fundamental. Another difficulty



Fig. 89.

was, that the free motion of the reed was impeded by its coming in contact with the break-point, where the current is interrupted.

To obviate the first objection, a reed was made of heavier material, and tuned by filing it at one point, near its fixed end, as shown in fig. 88. To obviate the second objection—the

solid
thin
of v
med
S
desc
T
meta
term
hoop

ing the
holding
audible
This I
be acc
plate an
Anot
It co
support

solid contact between the reed and break-point—a short and thin intermediate spring was mounted upon the reed, the free end of which came in contact with the break-point. This intermediate spring is shown in fig. 89.

Several forms of receivers invented by me have been already described. Another form is shown in fig. 90.

This consisted of a sheet of silver-foil paper stretched upon a metal hoop about four inches in diameter, like a tambourine, terminating in an insulated handle. Attaching the line to this hoop, by a connection which ran through the handle, and grasp-



Fig. 90.

ing the ground or return wire with one hand, at the same time holding the paper drum with the other, the tune would be audible not only to the one holding it, but to others near by. This I discovered to be wholly due to spark action, and not to be accounted for on the same principle as when the naked plate and rubbing were employed.

Another form of receiver is shown in fig. 91.

It consists of an iron pan mounted upon a wooden base, and supported by the standard, which is firmly secured to the base

and the rim of the iron pan. The bottom of the pan I used as a diaphragm for the receiver of musical and other sounds; and the rim answered as a frame in which the diaphragm was held in position. Upon another standard, mounted on the same base and near to it, was fixed an electro-magnet whose poles projected into the pan, and nearly, but not quite, touching its bottom. By means of a screw between the two standards, I was enabled to secure the proper position of the magnet with reference to the



Fig. 91.

diaphragm. I sometimes used a supplementary brace (not shown), which rested against the top of the rim, as an additional means of more rigidly holding the diaphragm in position.

This instrument I used in connection with various transmitters, especially with the one shown at fig. 87, and was the result of a series of experiments with thin iron and steel plates mounted over the poles of an electro-magnet. This I found to be a convenient way of mounting thin plates. It will be observed that

this instrument embraces all the substantial features in the mechanical construction of the speaking telephone of to-day. When used in connection with my articulating transmitter, articulate words have been received upon it, and when a duplicate of the instrument is inserted in a closed circuit, which includes a galvanic battery, it becomes a speaking telephone capable of acting both as a transmitter and as a receiver.

I designed another method of transmitting, which I called the organ-pipe transmitter, shown in fig. 92. The drawing shows a top and a side view of an ordinary organ pipe, with a space cut away at the centre, in length about equal to



Fig. 92.

the width of the pipe, and in depth just the thickness of the wall of the pipe, making an opening which was covered with a thin diaphragm *b*. A screw *D*, provided with a platinum point projecting through a metal brace *d* secured to the side of the pipe, was adjusted very near to the diaphragm *b*. The latter had glued to it a thin piece of platinum, to which was connected a small wire *c*, terminating in a binding post *C*.

It is a peculiarity of an organ-pipe with an open end, that when its fundamental note is sounded the waves are condensed most powerfully in a lateral direction in its centre. I took advantage of this fact to produce a vibration in the dia-

phragm *b*, which would make contact at each movement with the screw *D*. As the condensations and rarefactions of the air in the tube were synchronous with the vibrations necessary to produce a tone corresponding to the fundamental of the pipe, it is plain that the movement of the diaphragm would be the same. By connecting a battery and receiving instrument through the binding posts and the point *D*, when the organ-pipe is sounded its proper tone will be produced on the receiving instrument by electro-magnetic action.

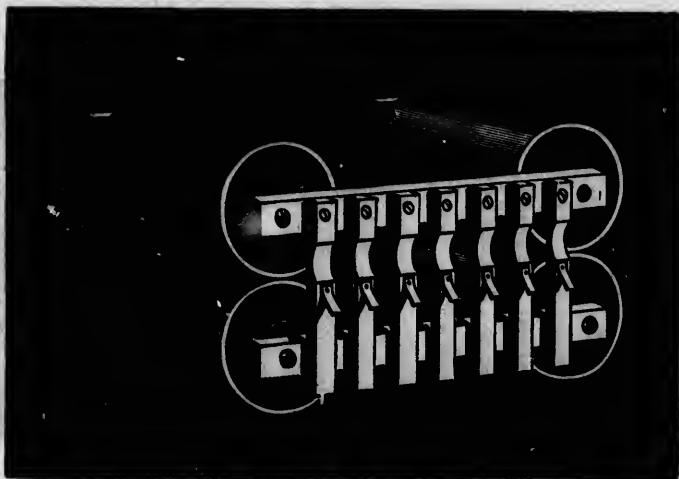

Fig. 93.

I made a series of these transmitters, operating them with a bellows, and when worked with uniform pressure of air, they produced splendid results. In fact, it makes a very good form of transmitter, and other things being equal, would be quite as good as the one we have most generally used. This method of transmission, however, involves the employment of a bellows, provided with some attachment for maintaining a uniform pressure, as well as with power to work it; so that it seemed, at least for telegraphic purposes, that some form of transmitter having electricity for its motive power would be more appropriate. I

therefore continued to prosecute my experiments in that direction.

In order to diminish the number of magnets in a transmitter having a large number of reeds differently tuned, I designed a compound magnet, as shown at fig. 93.

This consisted of two ordinary electro-magnets, with their poles far enough apart to give the proper length to the reeds. I connected the positive pole of each to the ends of a bar of soft iron about eighteen inches in length, and the negative pole to a similar bar, so that when the magnets were charged one bar would show



Fig. 94.

positive or north polarity and the other south. The magnetism was about equally distributed through the length of each bar. This arrangement enabled me to get a large number of reeds upon a small number of magnets. I found, however, that the power was too much distributed to produce good results upon any single reed, without increasing the battery to an undesirable extent, so I abandoned this form and subsequently constructed the one shown in fig. 94.

This is substantially the same as my transmitter shown in fig.

87, except that I use two and three reeds upon each magnet, all differently tuned.

Another form of transmitter invented by me is shown in fig. 95.

It consisted of a revolving shaft, upon which were mounted two eccentric cams, having one or more projections. These actuated two small levers, causing them to vibrate upon their respective break-points, through which points a battery current passed. From a pulley on this shaft I connected a belt to one of the wheels of a lathe which was driven by steam power, from which it derived a uniform motion and a definite rate of speed.



Fig. 95.

I refer to my experiments with this particular apparatus because, although simple in themselves, they were the means of giving my mind a new impulse in another direction, and one which soon conducted me to the solution of the problem involved in the transmission of articulate words. I employed, in connection with this transmitter, one of my common receivers which was adapted to the reception of all varieties of sounds. The pressure of the levers upon their contact-points was controlled by elastic springs.

When this apparatus was put in operation I noticed that a

sou
wh
E
han
inv
proc
By
tion
duce

Up
my r
comp
each
entire
could
that t
tion,
Du

sound of peculiar quality, not unlike that of the human voice when in great distress, proceeded from the receiver.

By altering the tension of the spring in various ways with my hand, I found that I was able to imitate many different sounds, involving the vowels only. I succeeded, among other things, in producing a groan, with all its inflections in the greatest perfection. By skilfully manipulating the spring in the manner before mentioned, a very great range in the quality of the sounds was produced, using only a single break-point.

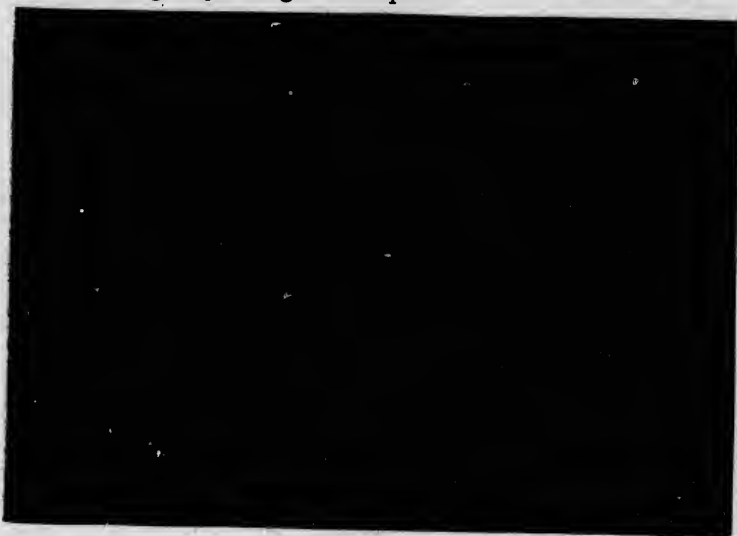

Fig. 96.

Up to the time of making this experiment I had associated in my mind, in connection with transmission of spoken words, a complicated mechanism involving a separate vibrating reed for each separate tone transmitted. This experiment produced an entire change in my views, and I came to the conclusion that it could all be done by means of a single transmitter; although, at that time, I did not carry my experiments farther in that direction, being too much absorbed in my multiple telegraph scheme.

During the latter part of the spring and early part of the sum-

mer of 1875, I was engaged in constructing and adapting my system to a type-printing telegraph, an idea which I had conceived early in 1874. I had it reduced to practice far enough to demonstrate the applicability of the principles involved. In January or February, 1875, I constructed an operative machine, at that time having three letters of the alphabet, together with the mechanism for controlling the printing and moving the paper. An outline view of this machine is shown in figs. 96 and 97.

The model of this machine was completed and forwarded to the Patent Office in October, 1875. The patent on it was issued



Fig. 97.

July 4th, 1876, to which I refer for a complete description. The general principle of operation may be briefly stated as follows: A particular tone actuates each particular type, so that there is a transmitting vibrator and corresponding receiver for each tone. A simple touch of a key prints the letter at the receiving end without the necessity of waiting for a type-wheel to come into position. The printing is executed upon a sheet instead of a long strip or ribbon, as in the ordinary step-by-step machine. It will not be necessary to describe the mechanism in detail in this place, as it is fully set forth in the specification of the patent itself.

D
call
over
the
T
long
other
previ
probl
physi
deter
reco
matt
I had
As
delph
tions
alread
I felt
sible t
and th
tiple t
feature
time.
Abo
where
tion of
months
I put n
ings an
determi
suggesti
telegrap
the mot
tudinal
diaphrag

During a visit to Milwaukee I saw for the first time a toy called the lovers' telegraph, consisting of a membrane stretched over the end of a tube, and having a thread attached to the centre, the other end of which was attached to a similar membrane.

The fact that spoken words were distinctly transmitted by the longitudinal vibrations of the thread from one membrane to the other, confirmed the idea that I had formed something like a year previous to this time; and it immediately solved in my mind the problem of making a transmitter that would copy electrically the physical vibrations of the air produced by articulate sounds. I determined to put this into practical shape and file it in the records of the Patent Office. I realized that this would be a matter of the highest importance in a scientific point of view; but I had no adequate conception of its value in a commercial sense.

As early as March, 1874, Dr. Samuel S. White, of Philadelphia, had purchased an interest in all of my telephonic inventions that I had made or might thereafter make; and, as he had already advanced considerable money in aid of their development, I felt it incumbent upon me to give as much of my time as possible to what seemed to be the most practical and useful feature, and the one promising the most immediate returns—that of multiple telegraphy. I therefore concluded to secure the articulating feature, and take it up and develop it more completely at another time.

About the 15th of January, 1876, I went to Washington, where I spent some time in assisting my attorney in the preparation of a number of cases which had been accumulating for several months. This required several weeks of time. While there I put my speaking telephone transmitter into the form of drawings and specifications, and, as my model was not yet ready, I determined to file the specification as a caveat. Following out the suggestion made by the diaphragm and string of the lovers' telegraph, I designed a transmitting apparatus which copied the motions of the diaphragm electrically, through the longitudinal vibrations of a light rod attached to the centre of the diaphragm. These electrical vibrations or undulations were the

result of the variations in the resistance of the circuit made by the longitudinal motions of the rod, moving in a yielding substance offering a considerable resistance to the passage of the electric current. The following is a verbatim copy of the specification, filed in the United States Patent Office, February 14, 1876:

GRAY'S SPECIFICATION, FILED FEBRUARY 14, 1876.

To all whom it may concern: Be it known that I, Elisha Gray, of Chicago, in the County of Cook, and State of Illinois, have invented a new art of transmitting vocal sounds telegraphically, of which the following is a specification:

It is the object of my invention to transmit the tones of the human voice through a telegraphic circuit, and reproduce them at the receiving end of the line, so that actual conversations can be carried on by persons at long distances apart.

I have invented and patented methods of transmitting musical impressions or sounds telegraphically, and my present invention is based upon a modification of the principle of said invention, which is set forth and described in letters patent of the United States, granted to me July 27th, 1875, respectively numbered 166,095 and 166,096, and also in an application for letters patent of the United States, filed by me, February 23, 1875.

To attain the objects of my invention, I devised an instrument capable of vibrating responsively to all the tones of the human voice, and by which they are rendered audible.

In the accompanying drawings I have shown an apparatus embodying my improvements in the best way now known to me, but I contemplate various other applications, and also changes in the details of construction of the apparatus, some of which would obviously suggest themselves to a skilful electrician, or a person versed in the science of acoustics, on seeing this application.

Fig. 1 represents a vertical central section through the transmitting instrument;

Fig. 2, a similar section through the receiver; and

Fig. 3, a diagram representing the whole apparatus.

ELISHA GRAY
INSTRUMENTS FOR TRANSMITTING AND
RECEIVING VOCAL SOUNDS TELEGRAPHICALLY
CAVEAT FILED FEBRUARY 14th 1876

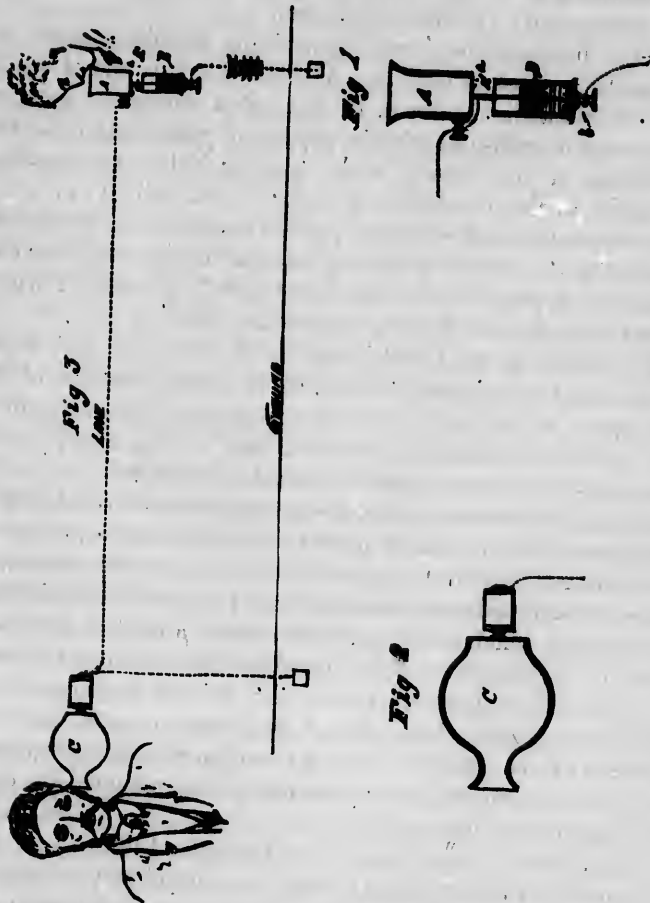

WITNESSES,
J. A. [unclear]
J. [unclear]

INVENTOR,
Elisha Gray

Fig. 98.

My present belief is that the most effective method of providing an apparatus capable of responding to the various tones of the human voice, is a tympanum, drum or diaphragm, stretched across one end of the chamber, carrying an apparatus for producing fluctuations in the potential of the electric current, and consequently varying in its power.

In the drawings, the person transmitting sounds is shown as talking into a box, or chamber, A, across the outer end of which is stretched a diaphragm *a*, of some thin substance, such as parchment or gold-beaters' skin, capable of responding to all the vibrations of the human voice, whether simple or complex. Attached to this diaphragm is a light metal rod, A', or other suitable conductor of electricity, which extends into a vessel B, made of glass or other insulating material, having its lower end closed by a plug, which may be of metal, or through which passes a conductor *b*, forming part of the circuit.

This vessel is filled with some liquid possessing high resistance, such, for instance, as water, so that the vibrations of the plunger or rod A', which does not quite touch the conductor *b*, will cause variations in resistance, and, consequently, in the potential of the current passing through the rod A'.

Owing to this construction, the resistance varies constantly in response to the vibrations of the diaphragm, which, although irregular, not only in their amplitude, but in rapidity, are nevertheless transmitted, and can, consequently, be transmitted through a single rod, which could not be done with a positive make and break of the circuit employed, or where contact points are used.

I contemplate, however, the use of a series of diaphragms in a common vocalizing chamber, each diaphragm carrying an independent rod, and responding to a vibration of different rapidity and intensity, in which case contact points mounted on other diaphragms may be employed.

The vibrations thus imparted are transmitted through an electric circuit to the receiving station, in which circuit is included an electromagnet of ordinary construction, acting upon a diaphragm to which is attached a piece of soft iron, and which

diaphragm
some

Th
into
and a

Th
to em
throu
presen
I ch
or con

Alt
raise t
other p
as I an
lating
voice t

In o
tion of
Mr. Ell
the for
on the
on whic

To a
ander C
certain
following

In let
have de
or more
by the e
occasions
the other

diaphragm is stretched across a receiving vocalizing chamber *c*, somewhat similar to the corresponding vocalizing chamber *A*.

The diaphragm at the receiving end of the line is thus thrown into vibrations corresponding with those at the transmitting end, and audible sounds or words are produced.

The obvious practical application of my improvement will be to enable persons at a distance to converse with each other through a telegraphic circuit, just as they now do in each other's presence, or through a speaking tube.

I claim as my invention the art of transmitting vocal sounds or conversations telegraphically through an electric circuit.

Although it is not my intention, as I said in the beginning, to raise the question of priority of invention as between myself and other parties, I will nevertheless state in this connection, that so far as I am aware, this is the first description on record, of an articulating telephone which transmits the spoken words of the human voice telegraphically by means of electricity.

BELL'S SPECIFICATION, FILED FEBRUARY 14, 1876.

In order that the claims of Professor A. G. Bell to the invention of the speaking telephone may be contrasted with those of Mr. Elisha Gray, we reproduce the specifications and drawings of the former as they were filed in the United States Patent Office, on the 14th February, 1876, the same day, it will be observed, on which Mr. Gray filed his caveat.

To all whom it may concern: Be it known that I, Alexander Graham Bell, of Salem, Massachusetts, have invented certain new and useful improvements in telegraphy, of which the following is a specification:

In letters patent granted to me April 6, 1875, No. 161,739, I have described a method of, and apparatus for, transmitting two or more telegraphic signals simultaneously along a single wire by the employment of transmitting instruments, each of which occasions a succession of electrical impulses differing in rate from the others; and of receiving instruments, each tuned to a pitch

at which it will be put in vibration to produce its fundamental note by one only of the transmitting instruments; and of vibratory circuit-breakers operating to convert the vibratory movement of the receiving instrument into a permanent make or break (as the case may be) of a local circuit, in which is placed a Morse sounder, register, or other telegraphic apparatus. I have also therein described a form of autograph telegraph based upon the action of the above mentioned instruments.

In illustration of my method of multiple telegraphy I have shown in the patent aforesaid, as one form of transmitting instrument, an electro-magnet having a steel spring armature, which is kept in vibration by the action of a local battery. This armature in vibrating makes and breaks the main circuit, producing an intermittent current upon the line wire. I have found, however, that upon this plan the limit to the number of signals that can be sent simultaneously over the same wire is very speedily reached; for, when a number of transmitting instruments, having different rates of vibration, are simultaneously making and breaking the same circuit, the effect upon the main line is practically equivalent to one continuous current.

In a pending application for letters patent, filed in the United States Patent Office February 25, 1875, I have described two ways of producing the intermittent current—the one by actual make and break of contact, the other by alternately increasing and diminishing the intensity of the current without actually breaking the circuit. The current produced by the latter method I shall term, for distinction sake, a pulsatory current.

My present invention consists in the employment of a vibratory or undulatory current of electricity, in contradistinction to a merely intermittent or pulsatory current, and of a method of, and apparatus for, producing electrical undulations upon the line wire.

The distinction between an undulating and a pulsatory current will be understood by considering that electrical pulsations are caused by sudden or instantaneous changes of intensity, and that electrical undulations result from gradual changes of intensity exactly analogous to the changes in the density of air

occasioned by simple pendulous vibrations. The electrical movement, like the aerial motion, can be represented by a sinusoidal curve or by the resultant of several sinusoidal curves.

Intermittent or pulsatory and undulatory currents may be of two kinds, accordingly as the successive impulses have all the same polarity or are alternately positive and negative.

The advantages I claim to derive from the use of an undulatory current in place of a merely intermittent one are, first, that a very much larger number of signals can be transmitted simultaneously on the same circuit; second, that a closed circuit and single main battery may be used; third, that communication in both directions is established without the necessity of special induction coils; fourth, that cable dispatches may be transmitted more rapidly than by means of an intermittent current or by the methods at present in use; for, as it is unnecessary to discharge the cable before a new signal can be made, the lagging of cable signals is prevented; fifth, and that as the circuit is never broken, a spark-arrester becomes unnecessary.

It has long been known that when a permanent magnet is caused to approach the pole of an electro-magnet a current of electricity is induced in the coils of the latter, and that when it is made to recede a current of opposite polarity to the first appears upon the wire. When, therefore, a permanent magnet is caused to vibrate in front of the pole of an electro-magnet an undulatory current of electricity is induced in the coils of the electro-magnet, the undulations of which correspond, in rapidity of succession, to the vibrations of the magnet, in polarity to the direction of its motion, and in intensity to the amplitude of its vibration.

That the difference between an undulatory and an intermittent current may be more clearly understood, I shall describe the condition of the electrical current when the attempt is made to transmit two musical notes simultaneously—first upon the one plan and then upon the other. Let the interval between the two sounds be a major third; then their rates of vibration are in the ratio of 4 to 5. Now, when the intermittent current is used, the circuit is made and broken four times by one transmitting

instrument in the same time that five makes and breaks are caused by the other. A and B, figs. 1, 2 and 3, represent the intermittent currents produced, four impulses of B being made in the same time as five impulses of A. *c c c*, etc., show where and for how long the circuit is made, and *d d d*, etc., indicate the duration of the breaks of the circuit. The line A and B shows the total effect upon the current when the transmitting instruments for A and B are caused simultaneously to make and break the same circuit. The resultant effect depends very much upon the duration of the make relatively to the break. In fig. 1 the ratio is as 1 to 4; in fig. 2, as 1 to 2; and in fig. 3 the makes and breaks are of equal duration. The combined effect, A and B, fig. 3, is very nearly equivalent to a continuous current.

When many transmitting instruments of different rates of vibration are simultaneously making and breaking the same circuit, the current upon the main lines becomes for all practical purposes continuous.

Next, consider the effect when an undulatory current is employed. Electrical undulations, induced by the vibration of a body capable of inductive action, can be represented graphically, without error, by the same sinusoidal curve which expresses the vibration of the inducing body itself, and the effect of its vibration upon the air; for, as above stated, the rate of oscillation in the electrical current corresponds to the rate of vibration of the inducing body—that is, to the pitch of the sound produced. The intensity of the current varies with the amplitude of the vibration—that is, with the loudness of the sound; and the polarity of the current corresponds to the direction of the vibrating body—that is, to the condensations and rarefactions of air produced by the vibration. Hence, the sinusoidal curve A or B, fig. 4, represents, graphically, the electrical undulations induced in a circuit by the vibration of a body capable of inductive action.

The horizontal line *a d e f*, etc., represents the zero of current. The elevation *b b b*, etc., indicates impulses of positive electricity.

2 Sheets—Sheet 1.

A. G. BELL,
TELEGRAPHY.

No. 174,465.

PATENTED MARCH 7, 1876.

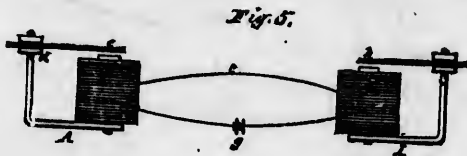
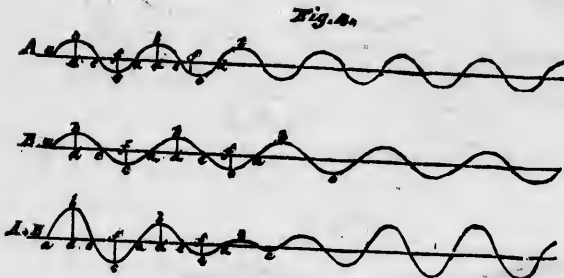
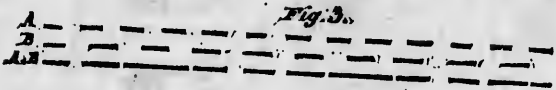
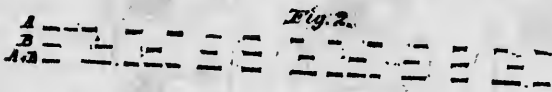
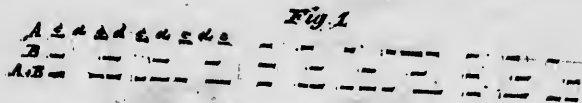

Witness:
Ewell A. Hart,
H. J. Huntman

Inventor:
A. Graham Bell
by Atty. P. H. P. P. P.

Fig. 99.

A. G. BELL.
TELEGRAPHY.

Patented March 7, 1876.

No. 174,465.

Fig. 6.

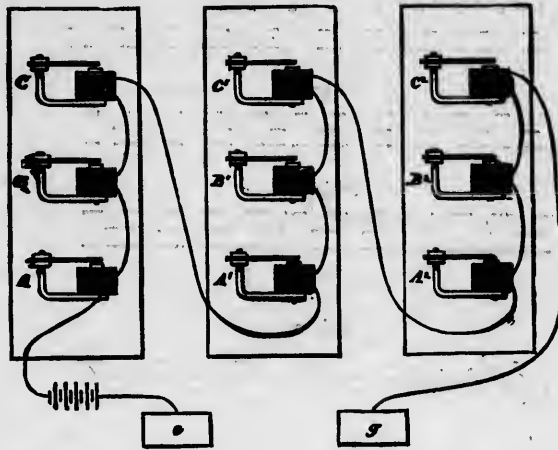
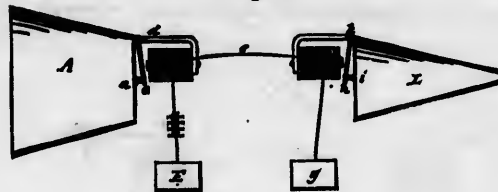

Fig. 7.



Witnesses
C. Wells
K. J. [unclear]

Inventor:
A. Graham Bell
by [unclear]

Fig. 100.

T
T
th
in
in
tic
th
ma

on
wh
Th
wh
tan
are
duc
of t
gra
feste
curr
latic
curv
T
elect
of b
that
throu
cause
latory
cylind
in fro
of ele
Un
vibrat
by the
hood

The depressions *c c c*, etc., show impulses of negative electricity. The vertical distance *b d* or *c f* of any portion of the curve from the zero line expresses the intensity of the positive or negative impulse at the part observed, and the horizontal distance *a a* indicates the duration of the electrical oscillation. The vibrations represented by the sinusoidal curves B and A, fig. 4, are in the ratio aforesaid, of 4 to 5—that is, four oscillations of B are made in the same time as five oscillations of A.

The combined effect of A and B, when induced simultaneously on the same circuit, is expressed by the curve A+B, fig. 4, which is the algebraical sum of the sinusoidal curves A and B. This curve A+B also indicates the actual motion of the air when the two musical notes considered are sounded simultaneously. Thus, when electrical undulations of different rates are simultaneously induced in the same circuit, an effect is produced analogous to that occasioned in the air by the vibration of the inducing bodies. Hence, the coexistence upon a telegraphic circuit of electrical vibrations of different pitch is manifested, not by the obliteration of the vibratory character of the current, but by peculiarities in the shapes of the electrical undulations, or, in other words, by peculiarities in the shapes of the curves which represent those undulations.

There are many ways of producing undulatory currents of electricity, dependent for effect upon the vibrations or motions of bodies capable of inductive action. A few of the methods that may be employed I shall here specify. When a wire, through which a continuous current of electricity is passing, is caused to vibrate in the neighborhood of another wire, an undulatory current of electricity is induced in the latter. When a cylinder, upon which are arranged bar magnets, is made to rotate in front of the pole of an electro-magnet, an undulatory current of electricity is induced in the coils of the electro-magnet.

Undulations are caused in a continuous voltaic current by the vibration or motion of bodies capable of inductive action; or by the vibration of the conducting wire itself in the neighborhood of such bodies. Electrical undulations may also be caused

by alternately increasing and diminishing the resistance of the circuit, or by alternately increasing and diminishing the power of the battery. The internal resistance of a battery is diminished by bringing the voltaic elements nearer together, and increased by placing them farther apart. The reciprocal vibration of the elements of a battery, therefore, occasions an undulatory action in the voltaic current. The external resistance may also be varied. For instance, let mercury or some other liquid form part of a voltaic circuit, then the more deeply the conducting wire is immersed in the mercury or other liquid, the less resistance does the liquid offer to the passage of the current. Hence, the vibration of the conducting wire in mercury or other liquid included in the circuit occasions undulations in the current. The vertical vibrations of the elements of a battery in the liquid in which they are immersed produces an undulatory action in the current by alternately increasing and diminishing the power of the battery.

In illustration of the method of creating electrical undulations, I shall show and describe one form of apparatus for producing the effect. I prefer to employ for this purpose an electro-magnet *A*, fig. 5, having a coil upon only one of its legs *b*. A steel spring armature *c* is firmly clamped by one extremity to the uncovered leg *d* of the magnet, and its free end is allowed to project above the pole of the covered leg. The armature *c* can be set in vibration in a variety of ways, one of which is by wind, and, in vibrating, it produces a musical note of a certain definite pitch.

When the instrument *A* is placed in a voltaic circuit, *g b e f g*, the armature *c* becomes magnetic, and the polarity of its free end is opposed to that of the magnet underneath. So long as the armature *c* remains at rest no effect is produced upon the voltaic current, but the moment it is set in vibration to produce its musical note a powerful inductive action takes place, and electrical undulations traverse the circuit *g b e f g*. The vibratory current passing through the coil of the electro-magnet *f* causes vibration in its armature *h*, when the armatures *c h* of the two instruments *A I* are normally in unison with one another; but the armature *h*

is unaffected by the passage of the undulatory current when the pitches of the two instruments are different.

A number of instruments may be placed upon a telegraphic circuit, as in fig. 6. When the armature of any one of the instruments is set in vibration, all the other instruments upon the circuit, which are in unison with it respond; but those which have normally a different rate of vibration remain silent. Thus, if A, fig. 6, is set in vibration, the armatures of A^1 and A^2 will vibrate also, but all the others on the circuit will remain still. So if B^1 is caused to emit its musical note, the instruments B B^2 respond. They continue sounding so long as the mechanical vibration of B^1 is continued, but become silent with the cessation of its motion. The duration of the sound may be used to indicate the dot or dash of the Morse alphabet, and thus a telegraphic dispatch may be indicated by alternately interrupting and renewing the sound. When two or more instruments of different pitch are simultaneously caused to vibrate, all the instruments of corresponding pitches upon the circuit are set in vibration, each responding to that one only of the transmitting instruments with which it is in unison. Thus the signals of A, fig. 6, are repeated by A^1 and A^2 , but by no other instruments upon the circuit; the signals of B^2 by B and B^1 ; and the signals of C^1 by C and C^2 —whether A, B^2 and C^1 are successively or simultaneously caused to vibrate. Hence by these instruments two or more telegraphic signals or messages may be sent simultaneously over the same circuit without interfering with one another.

I desire here to remark that there are many other uses to which these instruments may be put, such as the simultaneous transmission of musical notes, differing in loudness as well as in pitch, and the telegraphic transmission of noises or sounds of any kind.

When the armature *c*, fig. 5, is set in vibration, the armature *h* responds not only in pitch, but in loudness. Thus, when *c* vibrates with little amplitude, a very soft musical note proceeds from *h*; and when *c* vibrates forcibly the amplitude of the vibration of *h* is considerably increased, and the resulting sound

becomes louder. So, if A and B, fig. 6, are sounded simultaneously (A loudly and B softly), the instruments A¹ and A² repeat loudly the signals of A, and B¹ B² repeat softly those of B.

One of the ways in which the armature *c*, fig. 5, may be set in vibration has been stated before to be by wind. Another mode is shown in fig. 7, whereby motion can be imparted to the armature by the human voice or by means of a musical instrument.

The armature *c*, fig. 7, is fastened loosely by one extremity to the uncovered leg *d* of the electro-magnet *b*, and its other extremity is attached to the centre of a stretched membrane, *a*. A cone, A, is used to converge sound-vibrations upon the membrane. When a sound is uttered in the cone the membrane *a* is set in vibration, the armature *c* is forced to partake of the motion, and thus electrical undulations are created upon the circuit E *b e f g*. These undulations are similar in form to the air vibrations caused by the sound—that is, they are represented graphically by similar curves. The undulatory current passing through the electro-magnet *f* influences its armature *h* to copy the motion of the armature *c*. A similar sound to that uttered into A is then heard to proceed from I.

In this specification the three words, "oscillation," "vibration," and "undulation," are used synonymously, and in contradistinction to the terms "intermittent" and "pulsatory." By the term "body capable of inductive action," I mean a body which, when in motion, produces dynamical electricity. I include in the category of bodies capable of inductive action brass, copper, and other metals, as well as iron and steel.

Having described my invention, what I claim, and desire to secure by letters patent, is as follows:

1. A system of telegraphy in which the receiver is set in vibration by the employment of undulatory currents of electricity, substantially as set forth.

2. The combination, substantially as set forth, of a permanent magnet or other body capable of inductive action, with a closed circuit, so that the vibration of the one shall occasion electrical

un
per
cor
wir
ma
net
bor
g
vol
ind
wir
4
volt
sist
the

5.
other
electr
air ac
set fo
W
delive
Engin
ceding
in the
which
Speak

undulations in the other, or in itself, and this I claim, whether the permanent magnet be set in vibration in the neighborhood of the conducting wire forming the circuit, or whether the conducting wire be set in vibration in the neighborhood of the permanent magnet, or whether the conducting wire and the permanent magnet both simultaneously be set in vibration in each other's neighborhood.

3. The method of producing undulations in a continuous voltaic current by the vibration or motion of bodies capable of inductive action, or by the vibration or motion of the conducting wire itself, in the neighborhood of such bodies, as set forth.

4. The method of producing undulations in a continuous voltaic circuit by gradually increasing and diminishing the resistance of the circuit, or by gradually increasing and diminishing the power of the battery, as set forth.

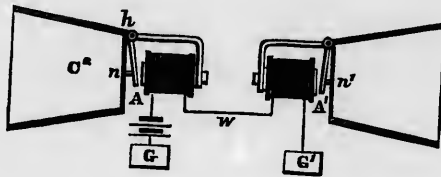

Fig. 101.

5. The method of, and apparatus for, transmitting vocal or other sounds telegraphically, as herein described, by causing electrical undulations, similar in form to the vibrations of the air accompanying the said vocal or other sounds, substantially as set forth.

We have given in Chapter II. a verbatim copy of a lecture delivered by Professor Bell, before the Society of Telegraphic Engineers, in London, October 31, 1877. On page 71 the preceding cut, fig. 101, is shown, which is the only instrument in the patent of March 7, 1876 (filed February 14, 1876) for which any pretence can be set up that it is a talking telephone. Speaking of this instrument, Professor Bell says, that Mr. Wat-

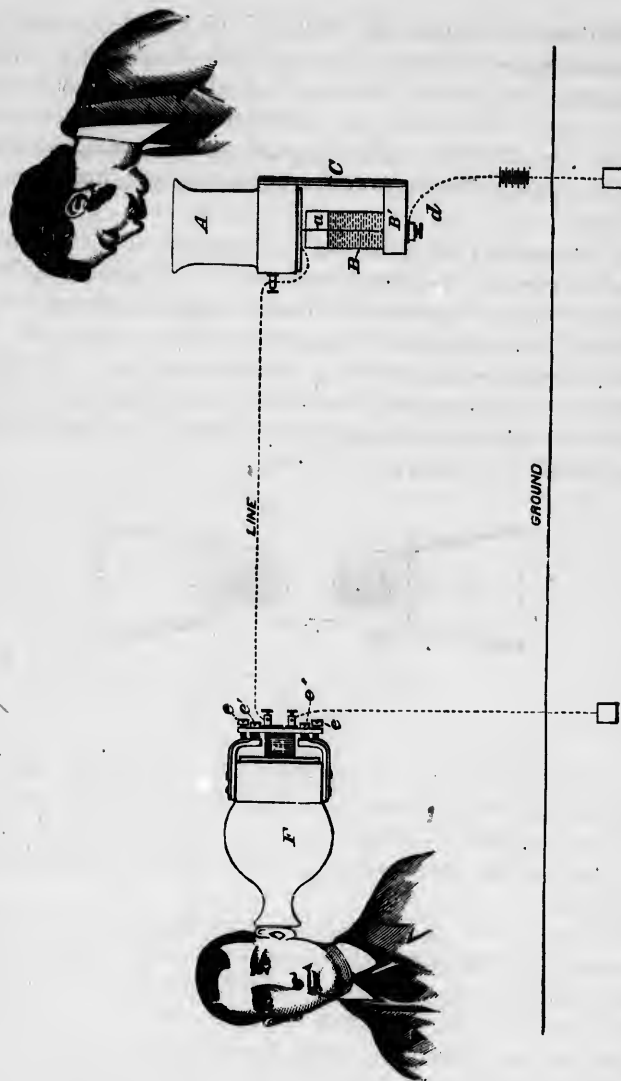

Fig. 102.

so
so
N
to
lat
ca
spe
per
gra
thr
I
me
wil
iden
and
Bel
spe
fact
spea
spea
sprin
duct
and
whic
in th
Whe
of M
the f
he be
not h
Mr. C

son, while trying it with him, declared that "he heard a faint sound" from it, but Professor Bell could not verify his assertion. Now, the "faint sound" heard by Mr. Watson cannot be claimed to be articulate speech, and the person who first obtained articulate utterance from the telephone is the discoverer. Mr. Gray's caveat of the same date shows means of producing articulate speech telephonically (fig. 102), and states that "it will enable persons at a distance to converse with each other through a telegraphic circuit, just as they now do in each other's presence, or through a speaking tube."

Referring to Prof. Bell's description, on page 71, of the instrument with which he first obtained audible effects (fig. 50), it will be seen that it is precisely the same in principle, and almost identical in construction, with the receiving instrument shown and described in Mr. Gray's caveat of February 14, 1876. Prof. Bell, it is claimed, obtained his first audible sounds of articulate speech in the spring of 1876. Here, then, are two important facts bearing on the question of priority in the invention of the speaking telephone. Mr. Gray described and illustrated his speaking telephone in the winter of 1876. In the following spring Prof. Bell obtained his first audible effects in the reproduction of articulate speech at a distance by electro-magnetism, and employed for this purpose an apparatus similar to that which was illustrated and described in Mr. Gray's caveat, filed in the United States Patent Office the preceding February. Whether or not Prof. Bell invented the apparatus independently of Mr. Gray, we have no means of judging; but that he was not the first inventor, we think the facts conclusively show. Had he been the first to invent it, is there any reason why he should not have described it in his application, filed simultaneously with Mr. Gray, on the 14th of February, 1876?

CHAPTER VI

EDISON'S TELEPHONIC RESEARCHES.

THE following communication from Mr. Thomas A. Edison gives a detailed account of his researches in telephony, and is a valuable contribution to the history of the development of the speaking telephone.

Some time in or about the month of July, 1875, I began experimenting with a system of multiple telegraphy, which had for its basis the transmission of acoustic vibrations. Being furnished, at the same time, by Hon. William Orton, President of the Western Union Telegraph Company, with a translated description from a foreign scientific journal of Reiss's¹ telephone, I also began a series of experiments, with the view of producing an articulating telephone, carrying on both series simultaneously, by the aid of my two assistants, Messrs. Batchelor and Adams.

With regard to the multiple telegraph I will say that many methods were devised, among which may be mentioned the transfer system. This consisted in combining a large tuning fork with multiple forks, so arranged at two terminal stations, with contact springs leading to different Morse instruments, that the synchronous vibrations of the forks would change the main line wires from one set of instruments to other sets at both stations, at a rate of 120 times per second. With this rate of vibration the wire would be simultaneously disconnected at both terminal stations from one set of Morse signalling apparatus, and momentarily placed in alternate connection with three other similar sets of apparatus, and then again returned to the first set, without causing the apparatus to mark the absence of the current otherwise than by a perceptible weakening of the same.

¹ Zeitschrift des Deutsch-Oesterreichischen Telegraphen-Vereins, herausgegeben in dessen Auftrage von der Königlich Preussischen Telegraphen-Direction. Redigirt von Dr. P. Wilhelm Brix. Vol. ix., 1862, page 125. (For a description of Reiss's apparatus see pages 9 to 13, inclusive.)

By this means, therefore, four perfectly independent wires were practically created, upon which signalling could be carried on with any system which was worked no faster than the ordinary Morse system. Each of these wires was also duplexed and found to work perfectly upon a line of artificial resistance, thus allowing, with the ordinary apparatus, of the simultaneous transmission of eight different messages.

Notwithstanding the perfect success of the system upon an artificial line, however, which possessed little or no electrostatic capacity, I have never, in practice, been able to produce a sufficiently perfect compensation for the effects of the static charge

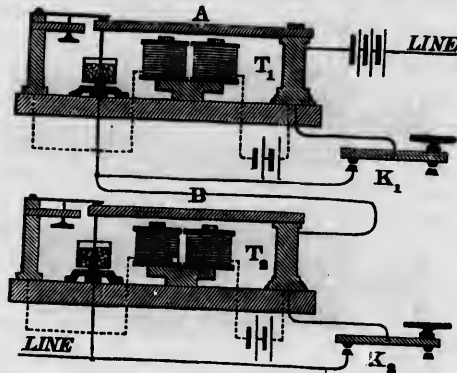

Fig. 103.

to allow of the successful use of the system on a line of over forty miles in length, although I have put the line to earth at both stations after it leaves one set of instruments and before it is placed in contact with another set; have sent reversed currents into it, and have also used magnetic and condenser compensation in various ways, known to experts in static compensation, but all without avail. By vibrating the line wire between two sets of apparatus, however, good satisfaction has been obtained on lines of about 200 miles in length.

In my system of acoustic transmission, which was devised in September, 1875, and is shown in fig. 103, two tuning forks, A

and B, vibrating from 100 to 500 times per second, were kept in continuous motion by a local magnet and battery, and the short circuiting was controlled by the signalling keys K_1 and K_2 .

As will be seen on reference to the figure, this system, like that shown in my patent of 1873, is dependent upon the varying resistance occasioned by employing a movable electrode in water, and which thus produces corresponding variations of the battery current in the line.

The receivers R_1 and R_2 , fig. 104, were formed of telescopic tubes of metal, by lengthening or shortening of which the column of air in either could be adjusted to vibrate in unison with the

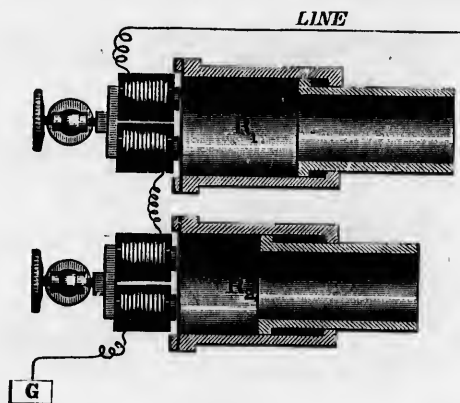

Fig. 104.

proper tone of the fork, whose signals were to be received by each particular instrument. An iron diaphragm was soldered to one end of these tubes, and the latter placed in such a manner as to bring the diaphragm of each respectively just in front of an electro-magnet, which, in action, would cause them to vibrate. When the column of air in either receiver was properly adjusted to a given tone, the signals due to stopping and starting the vibrations by the distant key were very loud, as compared to other tones not in harmony with the column of air. Flexible rubber tubes, with ear pieces, were connected to the receivers, so

that, in using the instruments, the head of the operator was not required to be held in an unnatural or strained position.

This system worked very well; but one defect in it was apparent from the first, and that was its continual tendency to give the operator what is termed the back-stroke, even from the slightest cause, such as the opening of a door or the moving of the head, and also occurred on the slightest inattention whatever.

With a Morse sounder, as is well known, every dot is made apparent to the ear by two sounds, the first being produced when the lever strikes the anvil, and the other when it strikes the upper or back contact. A dash, like the dot, is also composed of two sounds, but the interval of time between the production of the first, the downward stroke or sound and the upward stroke, is what determines its character. It frequently happens, however, when a sounder is so adjusted that the sound produced by the down stroke is of the same volume or loudness as the one given by the up stroke, that the order of reading becomes reversed on the slightest disturbance or inattention and the ear mistakes the up sound for the down sound, and *vice versa*. The signals consequently become unintelligible, and the operator can only restore the proper order by closing both ears and watching the motion of the sounder lever, or by deadening the back sound by placing the finger on the lever until the ear again catches a word or two.

Similarly with the musical signals, the dots and dashes are formed by the relative short or long duration of a continuous tone, but in this case the pitch is always the same, and this constitutes an element of confusion that is quite as bad as the back stroke of the sounder above referred to. I therefore arranged my keys so as to transmit two short tones close together to form a dot, and two tones separated by an interval to form a dash; but there was still so little distinctive difference between one and the other that I was led to defer further experiment with the apparatus for a time. It is probable that some means will be found for producing a greater degree of difference between the two elements of the signals, such, for instance, as the employment of two

forks of slightly different pitch, which, at least, promises well. When this is done the system will be of some value.

It will be noticed that the receiving instrument shown in fig. 104 contains the diaphragm magnet and chamber of the magneto-speaking telephone; and I may say here that I believe I was the first to devise apparatus of this kind, which I intended for use in connection with acoustic telegraphs. I can, however, lay no claim to having discovered that conversation could be carried on between one receiver and the other upon the magneto principle by causing the voice to vibrate the diaphragm.

Another system of multiple transmission consisted, partly, in the use of reeds for receivers, and has been exceedingly well developed in the hands of Mr. Elisha Gray, but I forbear explaining it here, owing to its complexity and lack of practical merit.

My first attempt at constructing an articulating telephone was made with the Reiss transmitter and one of my resonant receivers described above, and my experiments in this direction, which continued until the production of my present carbon telephone, cover many thousand pages of manuscript. I shall, however, describe here only a few of the more important ones.

In one of the first experiments I included a simplified Reiss transmitter, having a platinum screw facing the diaphragm, in a circuit containing twenty cells of battery and the resonant receiver, and then placed a drop of water between the points; the results, however, when the apparatus was in action, were unsatisfactory—rapid decomposition of the water took place and a deposit of sediment was left on the platinum. I afterwards used disks attached both to the diaphragm and to the screw, with several drops of water placed between and held there by capillary attraction, but rapid decomposition of the water, which was impure, continued, and the words came out at the receiver very much confused. Various acidulated solutions were then tried, but the confused sounds and decompositions were the only results obtained.

With distilled water I could get nothing, probably because, at that time, I used very thick iron diaphragms, as I have since

frequently obtained good results; or, possibly, it was because the ear was not yet educated for this duty, and therefore I did not know what to look for. If this was the case, it furnishes a good illustration of the fact observed by Professor Mayer, that we often fail to distinguish weak sounds in certain cases when we do not know what to expect.

Sponge, paper and felting, saturated with various solutions, were also used between the disks, and knife edges were substituted for the latter with no better results. Points immersed in electrolytic cells were also tried, and the experiments with various solutions, devices, etc., continued until February, 1876, when I abandoned the decomposable fluids and endeavored to vary the resistance of the circuit proportionately with the amplitude of vibration of the diaphragm by the use of a multiplicity of platinum points, springs and resistance coils—all of which were designed to be controlled by the movements of the diaphragm, but none of the devices were successful.

In the spring of 1876, and during the ensuing summer, I endeavored to utilize the great resistance of thin films of plumbago and white Arkansas oil stone, on ground glass, and it was here that I first succeeded in conveying over wires many articulated sentences. Springs attached to the diaphragm and numerous other devices were made to cut in and out of circuit more or less of the plumbago film, but the disturbances which the devices themselves caused in the true vibrations of the diaphragm prevented the realization of any practical results. One of my assistants, however, continued the experiments without interruption until January, 1877, when I applied the peculiar property which semi-conductors have of varying their resistance with pressure, a fact discovered by myself in 1873, while constructing some rheostats for artificial cables, in which were employed powdered carbon, plumbago and other materials, in glass tubes.

For the purpose of making this application, I constructed an apparatus provided with a diaphragm carrying at its centre a yielding spring, which was faced with platinum, and in front of this I placed, in a cup secured to an adjusting screw, sticks of

crude plumbago, combined in various proportions with dry powders, resins, etc. By this means I succeeded in producing a telephone which gave great volume of sound; but its articulation was rather poor; when once familiar with its peculiar sound, however, one experienced but little difficulty in understanding ordinary conversation.

After conducting a long series of experiments with solid materials, I finally abandoned them all and substituted therefor tufts of conducting fibre, consisting of floss silk coated with plumbago and other semi-conductors. The results were then very much better, but while the volume of sound was still great, the articulation was not so clear as that of the magneto telephone of Prof. Bell. The instrument, besides, required very frequent adjustment, which constituted an objectionable feature.

Upon investigation, the difference of resistance produced by the varying pressure upon the semi-conductor was found to be exceedingly small, and it occurred to me that as so small a change in a circuit of large resistance was only a small factor, in the primary circuit of an induction coil, where a slight change of resistance would be an important factor, it would thus enable me to obtain decidedly better results at once. The experiment, however, failed, owing to the great resistance of the semi-conductors then used.

After further experimenting in various directions, I was led to believe, if I could by any means reduce the normal resistance of the semi-conductor to a few ohms, and still effect a difference in its resistance by the pressure due to the vibrating diaphragm, that I could use it in the primary circuit of an induction coil. Having arrived at this conclusion, I constructed a transmitter in which a button of some semi-conducting substance was placed between two platinum disks, in a kind of cup or small containing vessel. Electrical connection between the button and disks was maintained by the slight pressure of a piece of rubber tubing, $\frac{1}{4}$ inch in diameter and $\frac{1}{2}$ inch long, which was secured to the diaphragm, and also made to rest against the outside disk. The vibrations of the diaphragm were thus able to produce the

req
resi
ind
A
elec
exc
tinc
mag
I
low
to v
subs
tial
blac
pres
A
phon
the v
work
inves
from
by pr
th
includ
disk i
Mr.
pany,
exper
wires
succe
and h
200 m
placed
sufficie
the art
has for

requisite pressure on the platinum disk, and thereby vary the resistance of the button included in the primary circuit of the induction coil.

At first a button of solid plumbago, such as is employed by electrotypers, was used, and the results obtained were considered excellent, everything transmitted coming out moderately distinct, but the volume of sound was no greater than that of the magneto telephone.

In order, therefore, to obtain disks or buttons, which, with a low normal resistance, could also be made, by a slight pressure, to vary greatly in this respect, I at once tried a great variety of substances, such as conducting oxides, sulphides and other partial conductors, among which was a small quantity of lamp-black that had been taken from a smoking petroleum lamp and preserved as a curiosity on account of its intense black color.

A small disk made of this substance, when placed in the telephone, gave splendid results, the articulation being distinct, and the volume of sound several times greater than with telephones worked on the magneto principle. It was soon found upon investigation, that the resistance of the disk could be varied from three hundred ohms to the fractional part of a single ohm by pressure alone, and that the best results were obtained when the resistance of the primary coil, in which the carbon disk was included, was $\frac{1}{10}$ of an ohm, and the normal resistance of the disk itself three ohms.

Mr. Henry Bentley, president of the Local Telegraph Company, at Philadelphia, who has made an exhaustive series of experiments with a complete set of this apparatus upon the wires of the Western Union Telegraph Company, has actually succeeded in working with it over a wire of 720 miles in length, and has found it a practicable instrument upon wires of 100 to 200 miles in length, notwithstanding the fact that the latter were placed upon poles with numerous other wires, which occasioned sufficiently powerful induced currents in them to entirely destroy the articulation of the magneto telephone. I also learn that he has found the instrument practicable, when included in a Morse

circuit, with a battery and eight or ten stations provided with the ordinary Morse apparatus; and that several way stations could exchange business telephonically upon a wire which was being worked quadruplex without disturbing the latter, and notwithstanding, also, the action of the powerful reversed currents of the quadruplex on the diaphragms of the receiver. It would thus seem as though the volume of sound produced by the voice with this apparatus more than compensated for the noise caused by such actions.

While engaged in experimenting with my telephone for the purpose of ascertaining whether it might not be possible to dispense with the rubber tube which connected the diaphragm with the rheostatic disk, and was objectionable on account of its tendency to become flattened by continued vibrations, and thus necessitate the readjustment of the instrument, I discovered that my principle, unlike all other acoustical devices for the transmission of speech, did not require any vibration of the diaphragm—that, in fact, the sound waves could be transformed into electrical pulsations without the movement of any intervening mechanism.

The manner in which I arrived at this result was as follows: I first substituted a spiral spring of about a quarter inch in length, containing four turns of wire, for the rubber tube which connected the diaphragm with the disks. I found, however, that this spring gave out a musical tone which interfered somewhat with the effects produced by the voice; but, in the hope of overcoming the defect, I kept on substituting spiral springs of thicker wire, and as I did so I found that the articulation became both clearer and louder. At last I substituted a solid substance for the springs that had gradually been made more and more inelastic, and then I obtained very marked improvements in the results. It then occurred to me that the whole question was one of pressure only, and that it was not necessary that the diaphragm should vibrate at all. I consequently put in a heavy diaphragm, one and three quarter inches in diameter and one sixteenth inch thick, and fastened the carbon disk and plate tightly together, so that the latter showed no vibration with the loudest tones.

Upon testing it I found my surmises verified; the articulation was perfect and the volume of sound so great that conversation carried on in a whisper three feet from the telephone was clearly heard and understood at the other end of the line.

This, therefore, is the arrangement I have adopted in my present form of apparatus, which I call the carbon telephone, to distinguish it from others. It is fully described in another part of this work.

The accessories and connections of this apparatus for long circuits are shown in fig. 105. A is an induction coil, whose primary

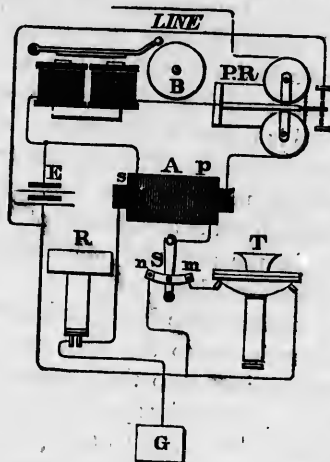

Fig. 105.

wire *p*, having a resistance of several ohms, is placed around the secondary, instead of within it, as in the usual manner of construction. The secondary coil *s*, of finer wire, has a resistance of from 150 to 200 ohms, according to the degree of tension required; and the receiving telephone *R* consists simply of a magnet, coil and diaphragm. One pole of the magnet is connected to the outer edge of the diaphragm, and the other, which carries the wire bobbin of about 75 ohms resistance, and is included in the main line, is placed just opposite its centre.

P R is the signalling relay, generally a Siemens' polarized instrument, which has been given a bias towards one side, and consequently is capable of responding to currents of one definite direction only.

The lever of this relay, when actuated by the current from a distant station on the line in which the instrument is included, closes a local circuit containing the vibrating call bell B, and thus gives warning when speaking communication is desired.

Besides serving to operate the call bell, the local battery E is also used for sending the call signal. S is a switch, the lever of which, when placed at *o*, between *m* and *n*, disconnects the transmitter T and local battery E from the coil A, and in this position leaves the polarized relay P R free to respond to currents from the distant station. When this station is wanted, however, the lever S is turned to the left on *n*, and depressed several times in rapid succession. The current from the local battery, by this means, is made to pass through the primary coil of A, and thus for each make and break of the circuit induces powerful currents in the secondary *s*, which pass into the line and actuate the distant call bell.

When the call signals have been exchanged, both terminal stations place their switches to the right on *m*, and thus introduce the carbon transmitter into their respective circuits. The changes of pressure, produced by speaking against the diaphragm of either transmitter, then serve, as already shown, to vary the resistance of the carbon, and thus produce corresponding variations in the induced currents, which, acting through the receiving instrument, reproduce at the distant station whatever has been spoken into the transmitting instrument.

For lines of moderate lengths, say from one to thirty miles, another arrangement, shown in fig. 106, may be used advantageously. The induction coil, key, battery, and receiving and transmitting telephones, are lettered the same as in the previous figure, and are similar in every respect to the apparatus there shown; the switch S, however, differs somewhat in construction from the one already described, but is made to serve a similar purpose.

When a plug is inserted between 3 and 4, the relay or sounder R' , battery E , and key K only are included in the main line circuit, and this is the normal arrangement of the apparatus for signalling purposes. The battery, usually about three cells of the Daniell form, serves also both for a local and main battery. When a plug is inserted between 1, 2 and 4, the apparatus is available for telephonic communication.

I have also found, on lines of from one to twenty miles in length, that the ordinary call can be dispensed with, and a simplified arrangement substituted. This latter consists simply

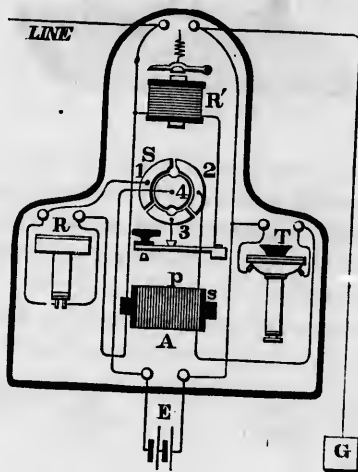

Fig. 106.

of the ordinary receiving telephone, upon the diaphragm of which a free lever, L , is made to rest, as shown in fig. 107. When the induced currents from the distant station act upon the receiver R , the diaphragm of the latter is thrown into vibration, but by itself is capable of giving only a comparatively weak sound; with the lever resting upon its centre, however, a sharp, penetrating noise is produced by the constant and rapid rebounds of the lever, which thus answers very well for calling purposes at stations where there is comparatively but little noise.

Among the various other methods for signalling purposes which I have experimented with, I may mention the sounding of a note, by the voice, in a small Reiss's telephone; the employment of a self-vibrating reed in the local circuit; and a break wheel with many cogs, so arranged as to interrupt the circuit when set in motion.

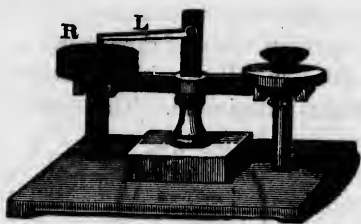

Fig. 107.

I have also used direct and induced currents to release clock work, and thus operate a call, and in some of my earlier acoustic experiments tuning forks were used, whose vibrations in front of magnets caused electrical currents to be generated in the coils surrounding the latter.

By the further action of these currents on similar forks at a distant station, bells were caused to be rung, and signals thus

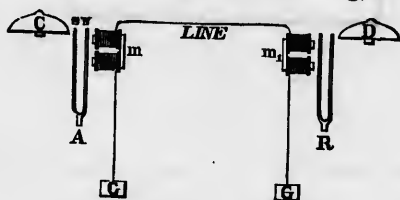

Fig. 108.

given. Fig. 108 shows an arrangement of this kind. A and B are two magnetized tuning forks, having the same rate of vibration and placed at two terminal stations. Electro-magnets m and m^1 are placed opposite one of the prongs of the forks at each station, while a bell, C or D, stands opposite to the other. The coils of the magnet are connected respectively to the line

wir
a st
by
mag
furt
to y
stru

For
oppo
of th
An
fig. 1
whos

separa
line ci
curren
of the
minal,
to vibr
Fig.

wire and to earth. When one of the forks is set in vibration by a starting key provided for the purpose, the currents produced by the approach of one of its magnetized prongs towards the magnet, and its recession therefrom, pass into the line and to the further station, where their action soon causes the second fork to vibrate with constantly increasing amplitude, until the bell is struck and the signal given.

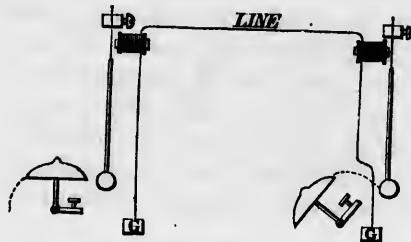

Fig. 109.

For telephonic calls the call bells are so arranged that the one opposite to the fork, which generates the currents, is thrown out of the way of the latter's vibrations.

Another call apparatus, which I have used, is represented in fig. 109. In this arrangement two small magnetic pendulums, whose rates of vibration are the same, are placed in front of

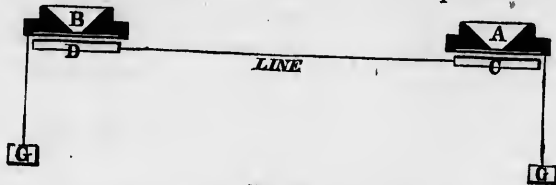

Fig. 110.

separate electro-magnets, the helices of which join in the main line circuit. When one of the pendulums is put in motion, the currents generated by its forward and backward swings in front of the electro-magnet pass into the line, and at the opposite terminal, acting through the helix there, cause the second pendulum to vibrate in unison with the former.

Fig. 110 shows a form of electrophorous telephone which acts

by the approach of the diaphragm contained in A or B towards or its recession from a highly charged electrophorous, C or D. The vibrations of the transmitting diaphragm cause a disturbance of the charge at both ends of the line, and thus give rise to faint sounds. Perfect insulation, however, is necessary, and either apparatus can be used both for transmitting and receiving, but the results are necessarily very weak.

Another form of electro-static telephone is shown in fig. 111. In this arrangement Deluc piles of some 20,000 disks each are contained in glass tubes A and B, and conveniently mounted on glass, wood or metal stands. The diaphragms, which are in electrical connection with the earth, are also placed opposite to one pole of each of the piles, while the opposite poles are joined together by the line conductor.

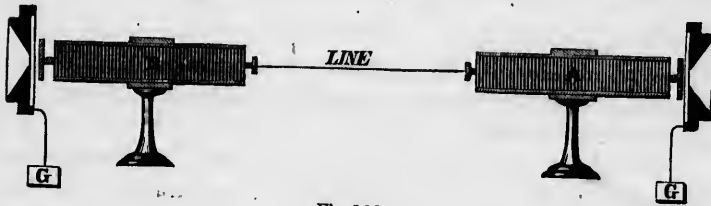

Fig. 111.

phragm is thus capable of disturbing the electrical condition of the neighboring disks, the same as in the electrophorous telephones; and consequently the vibrations, when produced by the voice in one instrument, will give rise to corresponding electrical changes in the other, and thereby reproduce in it what has been spoken into the mouthpiece of the former.

With this arrangement fair results may be obtained, and it is not necessary that the insulation should be so perfect as for the electrophorous apparatus. Fig. 112 shows a form of electro-mechanical telephone, referred to near the beginning of this communication, by means of which I attempted to transmit electrical impulses of variable strength, so as to reproduce spoken words at a distance. Small resistance coils—1, 2, 3, etc.—were so arranged with connecting springs near a platinum faced lever

B,
of
of
con
Inc
of
to

spring
ceed
the
Fi
ferre
sider

of the
unders
letter
its end
part of
and c.
I am

B, in connection with the diaphragm in A, that any movement of the latter caused one or more of the coils to be cut-in or out of the primary circuit of an induction coil C, the number, of course, varying with the amplitude of the vibrating diaphragm. Induced currents corresponding in strength with the variations of resistance were thus sent into the line, and could then be made to act upon an ordinary receiving telephone. By arranging the

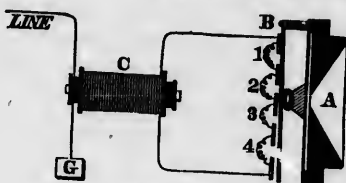

Fig. 112.

springs in a sunflower pattern about a circular lever, I have succeeded in transmitting articulate sentences by this method, but the results were very harsh and disagreeable.

Fig. 113 shows a form of the water telephone previously referred to, in which a double cell was used, so as to afford considerable variation of resistance for the very slight movements

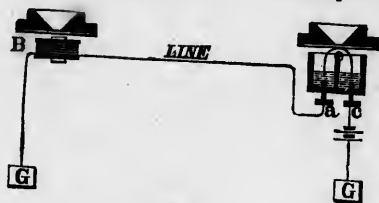

Fig. 113.

of the diaphragm. The action of the apparatus will readily be understood from the figure, where a wire in the form of the letter U is shown, with the bend attached to the diaphragm, and its ends dipping into the separate cells, and thus made to form part of the circuit when the line is joined to the instrument at a and c.

I am now conducting experiments with a thermo-electric tele-

phone, which gives some promise of becoming serviceable. In this arrangement a sensitive thermo-pile is placed in front of a diaphragm of vulcanite at each end of a line wire, in the circuit of which are included low resistance receiving instruments. The principle upon which the apparatus works depends upon the change of temperature produced in the vibrating diaphragm, which I have found is much lower as the latter moves forward, and is also correspondingly increased on the return movement.

Sound waves are thus converted into heat waves of similar characteristic variations, and I am in hopes that I may ultimately be able, by the use of more sensitive thermo-piles, to transform these heat waves into electrical currents of sufficient strength to produce a practical telephone on this novel principle.

Before concluding, I must mention an interesting fact connected with telephonic transmission, which was discovered during some of my experiments with the magneto-telephone, and which is this, that a copper disk may be substituted for the iron diaphragm now universally used. The same fact, I believe, has also been announced by Mr. W. H. Preece, to the Physical Society, at London.

If a piece of copper, say one sixteenth of an inch thick and three fourths of an inch in diameter, is secured to the centre of a vulcanite diaphragm, the effect becomes quite marked, and the apparatus is even more sensitive than when the entire diaphragm is of copper. The cause of the sound is due, no doubt, to the production of very weak electrical currents in the copper disk.

per
Ita
imp
arc.
the
by
sou
stat
grav
ing
swin
moti
W
so in
He h
but
that
or s
times
alrea
reflec
attrac
of the
—the
derive
discov

'A p
Chicago
trical So

CHAPTER VII.

ELECTRO-HARMONIC TELEGRAPHY.¹

LET us, in imagination, transport ourselves backward over a period of three centuries. It is a summer evening in the ancient Italian City of Pisa—a city whose curious leaning tower and imposing cathedral have been reckoned for centuries among the architectural wonders of the world. Beneath the lofty ceiling of the great cathedral a magnificent central chandelier, suspended by a slender silver chain, swings slowly to and fro in the gentle southern breeze that steals through the open arches. From his station in the chancel, idly at first, then eagerly and intently, a grave-faced choir-boy follows with his eyes the cluster of glittering lamps, as ever and anon a sudden current of air sets it swinging in a wide arc, and then, ceasing for a time, allows the motion to die away in gradually lessening oscillations.

What could there have been in this simple occurrence which so interested the youthful observer in the chancel? It was this: He had noticed, what doubtless many others had noticed before, but without in the least apprehending its significance, the fact that the oscillations of the suspended chandelier, whether great or small, were always, without exception, performed in equal times. Our choir-boy, although a mere youth, had nevertheless already become something of a philosopher, and his subsequent reflections upon the remarkable fact which had thus incidentally attracted his attention, led him directly to the discovery of one of the most comprehensive and far-reaching of all physical laws—the law of isochronous vibration (the word isochronous being derived from the Greek, and meaning “in equal times”). This discovery was but the first of a long and brilliant series, which

¹ A paper read before the annual meeting of the American Electrical Society, at Chicago, Ill., December 12, 1877, by F. L. Pope. *Journal of the American Electrical Society*, vol. 1, No. 2.

have justly rendered the name of Galileo forever immortal in the annals of science and of history.

In order that we may arrive at a clear understanding of the principles underlying the different varieties of the telephonic, or, in more general terms, the electro-harmonic system of telegraphy, and that we may be able to trace intelligently its origin and development, it is essential that we should first become somewhat acquainted with the laws and leading phenomena of vibratory or undulatory motion in general. Having done this, we shall find no difficulty in passing to the consideration of the special practical applications of these laws, which have recently been made in the domains of electro-telegraphy and electro-acoustics, and which have been attended with such remarkably brilliant and successful results.

Let us consider for a moment some of the peculiar properties of a body freely suspended from a fixed point—in other words, a pendulum. I suppose there are not many here present who do not treasure among the happiest memories of childhood the associations connected with the swing. It was simply a seat suspended by two ropes, perhaps from the horizontal branch of some overshadowing tree. I shall probably be safe in assuming that you all have a tolerably vivid recollection of most of the phenomena presented by this mechanical contrivance when in active operation; a very fortunate circumstance, inasmuch as it will enable me to place clearly before your minds some of the most important of the fundamental laws of vibration.

When our friend the school-boy, having seated one of his youthful favorites in the swing, and by a series of judiciously timed impulses gradually increased the amplitude of her oscillations from zero to perhaps 120° of arc, proceeds, in compliance with her breathless request, to discontinue his exertions, and, in the classic language of the play-ground, to "let the old cat die," it is hardly surprising that, not being another Galileo, our young friend has utterly failed to grasp the great physical truth that the vibrations of the little maiden are isochronous. Still less does he probably suspect that, even were he to subject the very

schoolma'am herself to the same conditions, the periodicity and the isochronism of her oscillations would not differ from those of her predecessor, notwithstanding the much greater weight of the oscillating body. Nevertheless, such is the fact. It is one which was experimentally demonstrated many years ago—by myself, although, of course, it would hardly be becoming for me to claim absolute priority over all others in making the experiment.

Another important property of the pendulum is that, by shortening it, it oscillates more rapidly. Thus, if we take two pendulums, one of which is three and the other twelve feet in length, the shorter pendulum will be found to make two oscillations to each one of the longer one, and if we continue the experiment with pendulums of different lengths, we shall arrive at the law that the time required in each case to perform an oscillation is proportional to the square root of the length of the pendulum.

I will also call attention at this point to a third property of the vibrating pendulum, which it will be very important for us to remember, in view of what we shall come to further on; a property which is very well illustrated by the suspended swing, to which I have just referred. It is this: A freely suspended body, even if it be very heavy, may be set in vibration by the repeated application of a comparatively insignificant force, provided the successive applications of the force be properly timed, but not otherwise. Of course you have all noticed this in the case of the swing, and therefore I need not enlarge upon it further than to say that the same effect is produced, though in a less degree, no matter whether the impulses are given at every vibration, at every alternate vibration, or even less frequently. The essential condition is, that the intervals of time between the successive impulses shall be exactly the same as the intervals between the vibrations, or else a multiple or submultiple of one of these intervals.

I have made use of the suspended pendulum to illustrate some of the principal laws of vibratory motion, for the reason

that its phenomena are familiar to you all, not merely because they are of every-day occurrence, but because they are very easy of comprehension both by the eye and mind. But the laws which govern the vibrating pendulum equally govern all the varied phases in which vibratory motion presents itself throughout the realm of physics.

All solid bodies exhibit the phenomena of vibration in various forms and degrees, according to the form of the body and the manner in which the force producing the vibration is applied. Cords and wires, as familiarly seen in stringed instruments of music, have their elasticity developed by tension so as to become capable of vibration. If the cord $a f b$ (fig. 114) be drawn out in the middle to $a c b$, upon being released its elasticity causes it to return to its former position. The velocity of this movement is constantly accelerated, and is at its maximum when the cord



Fig. 114.

has reached its line of equilibrium $a f b$; consequently, it passes with constantly decreasing velocity to $a d b$, where it comes to rest for an instant, and then returns to $a f b$, and so continues. You will at once perceive the analogy between the vibrations of the central point f of the string between c and d and that of the weight of the pendulum, and like those of the pendulum, the vibrations of the stretched string are isochronous. It may be regarded, in fact, as a kind of double pendulum, and is subject to the same laws as the ordinary pendulum. The tension and diameter being equal, the number of vibrations performed by a cord in a given time are inversely as its length. Elastic rods vibrate laterally like cords when fixed by their extremities. In consequence of their rigidity, however, they may be made to vibrate when fixed only at one extremity. Thus, a straight steel rod $n o$ may be clamped in a vice, as shown in fig. 115. If we draw

the
fro
The
dim
rest
pen
or s
num
tion

The
in the
acousti
charact
into th
at the r
When
sound i

the free end n aside and then liberate it, it will vibrate to and fro between the points p and p as shown by the dotted lines. The amplitude of the successive vibrations, however, constantly diminishes, until at length the rod returns to its original state of rest. Such a rod, when vibrating, follows the same law as the pendulum and the stretched cord, each vibration, whether greater or smaller, being performed in the same length of time, and the number of vibrations in a given time being inversely proportional to the square of the length of the rod.



Fig. 115.



Fig. 116.

The ordinary tuning fork, an almost indispensable instrument in the experimental investigation of the various problems of acoustics, consists virtually of a double vibrating rod of the above character. As actually constructed it is simply a steel bar, bent into the form of an elongated letter U, and supported or clamped at the middle of the bend, leaving the extremities free to vibrate. When such a fork is struck, and thrown into vibration so as to sound its deepest note, its free end oscillates, as seen in fig. 116,

where the prongs vibrate between the limits $b n$ and $f m$, p and q being points of no vibration, termed nodes.¹

Elastic plates are easily thrown into vibration, but the character of their vibrations depends upon the configuration of the plate, the manner in which it is supported or clamped, and the point at which the exciting or moving force is applied. For example, a circular plate, or a plate of any regular geometrical figure capable of being circumscribed about a circle, which is clamped or stopped at the edges, but otherwise free to vibrate, will have no decided tendency to any given rate of vibration, but will respond to any kind of vibrations which may be communicated to it. But if the plate be elongated, the normal rate of vibration is affected by the length of the plate, without reference to its breadth. The greater the length of the plate in proportion to its breadth, the more it partakes of the character of an elastic rod or a stretched string, according as it is supported at one or both ends, and thereby becomes capable of vibrating at one particular rate, and no other. You will see, therefore, that we may have a succession of plates of various forms, passing by degrees from the circular plate clamped at its edges, which will take any rate of vibration with equal facility, to the string or rod clamped at one or both ends, which will only take one particular rate, rejecting all others. These properties of plates of different forms, in respect to their modes of vibration, are of the utmost importance in harmonic telegraphy, as we shall hereafter see.

It remains to speak of the vibrations of membranes, which are in many respects analogous to those of plates. When loosely stretched over a circular hoop or frame, such a membrane, like the circular plate, has no decided tendency to vibrate at any particular rate. If strained more tightly, however, its tendency to vibrate at some particular rate is increased.

Omitting for the present a more particular consideration of the characteristics of vibrating solids, we will now examine the effects of vibratory motion upon fluids.

¹ Tyndall—"Lectures on Sound" (American edition), p. 138.

If
pool
follo
leng
a dep
there
liqui
circu
and c
wave
direct
the n
this k
rises a
over,
vertic
pende
stretch
have a
siderat
condit
The
waves.
a total
sation
disturb
then su
its exp
which
either s
this clas
a centre
This alt
medium
turbanc
which w

If we drop a smooth, round pebble into the bosom of a placid pool, a series of concentric undulations are produced. Wave follows wave, in ever-widening circles, until opposing forces at length cause an equilibrium to be regained. At the initial point a depression is produced by the fall of the pebble. Around this there first rises a circular elevation above the surface of the liquid when in equilibrium, and immediately beyond this is a circular depression, and so on, alternately, successive elevations and depressions. When we look at this progressive series of waves, the entire mass appears to advance progressively in every direction away from the point of excitation; but, if we watch the movements of some light, floating body, we shall see that this body is not carried forward over the surface, but merely rises and falls alternately as the waves pass beneath it. Moreover, we shall be able to observe an exact analogy between the vertical oscillations of this floating body and those of the suspended weight of the pendulum, or the central point of the stretched string, thus proving that the vibratory motion which we have already examined, and the undulatory motion under consideration, are manifestations of the same law under different conditions.

The undulations which we have just described are surface waves. All elastic mediums are also subject to undulations of a totally different character, which are termed waves of condensation and rarefaction, and are produced in air and gases by any disturbance of density. If any elastic fluid be compressed, and then suddenly released from compression, it will expand, and in its expansion exceed its former volume to a certain extent, after which it will again contract, and thus oscillate alternately on either side of its position of rest. It must be understood that this class of undulations extend equally in every direction from a centre toward every point of the circumference of a sphere. This alternate condensation and expansion of an elastic fluid or medium, extending spherically around the original centre of disturbance, is perfectly analogous to the series of circular waves which we have seen formed around a point of depression on the

surface of a liquid, the condensation of the elastic fluid corresponding to the elevation of a surface wave, and the phase of rarefaction corresponding to the phase of depression.

Suppose fig. 117 to represent a section of a sphere of air, or other elastic medium in which the waves of condensation and rarefaction have extended outward from the centre C, then the heavy lines *a e f g*, *b h i k* and *d l p q*, will represent the phases of greater condensation, the finer intermediate lines will represent the spaces of greatest rarefaction, and the distances *m n* and *n o*, between circles of greatest condensation, will be the length of the waves.

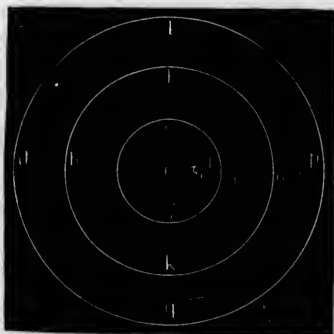

Fig. 117.

These waves of condensation and rarefaction in an elastic medium, like the waves on the surface of a liquid, are subject to the ordinary laws of vibration, and are capable of producing or of being produced by the vibrations of a solid body.

The mutual convertibility of vibrations and undulations may be shown by experiment. If a tuning fork is struck or excited by a violin bow and its motion allowed to gradually die away, its prongs oscillate backward and forward in the same manner and after the same law as a pendulum, except that they make many hundred vibrations for each single vibration of the pendulum. A particular tuning fork, therefore, will always perform a given number of vibrations in a unit of time. This number de-

depends solely upon the construction of the fork, and can, therefore, neither be increased nor diminished, unless the form or properties of the fork are in some way changed.

If we throw such a tuning fork into vibration the vibrations of the fork cause undulations in the surrounding air, which are propagated in every direction. How is this brought about? Each of the prongs beats the air in opposite directions at the same time. Let us try to picture to ourselves the physical condition of the air in front of one of these prongs. As the latter strikes outward the air in front of it will be driven outward, condensed, and on account of the elasticity of the air, the condensation will at once start to travel outward in every direction a wave of denser air; but directly the prong recedes, beating the air back in the



Fig. 118.

contrary direction, which will, of course, rarefy the air in front of the prong. But the disturbance we call a rarefaction is propagated in air with the same velocity as a condensation. We must therefore remember that just behind the wave of condensation there is a wave of rarefaction, each travelling with the same velocity, and therefore always maintaining the same position in relation to each other. Thus the fork vibrates a certain number of times in a second, and will consequently generate an equal number of these waves, all constituted alike and the same length. (See fig. 118.) Suppose a fork to make one hundred vibrations per second: at the end of the first second the wave generated by the vibration at the beginning of the second would have travelled, say, eleven hundred feet (which is known to be

approximately the distance traversed in a second by aerial vibration), and the intermediate waves would be uniformly distributed over the intervening distance; that is to say, in eleven hundred feet there would be one hundred waves, each of them evidently being eleven feet in length. If the fork made eleven hundred vibrations per second, each of these waves would be one foot long, for waves of all lengths traverse the air with precisely the same velocity.¹

Now, if we place in another part of the same room another fork, so constructed as to make exactly the same number of vibrations per second as the first one, and set the first one in vibration, the other one will soon begin to vibrate in sympathy, and it will even continue to vibrate after the first one had been stopped. Astonishing as it seems, it is nevertheless true that this heavy and rigid mass of steel has been set in motion merely by the successive impact of hundreds of tiny waves of air, each of such small motive power that it could not stir the weakest spring which was not adjusted in unison with the fork. The slightest disagreement in the respective rates of vibrations of the two forks sensibly diminishes, and a difference of one vibration in two or three hundred per second wholly destroys, the effect.

Thus we see that the isochronous vibrations of the first fork give rise to corresponding waves or undulations of condensation and rarefaction in the air, and these in turn reproduce isochronous vibrations in the second fork, and will also produce vibrations to a greater or less extent in every body which is capable of vibrating in unison with the first fork.

Thus far we have confined our attention solely to the nature and effects of simple vibrations. It remains to consider what effect is produced when a number of distinct sets of vibrations are simultaneously propagated through the same medium. Before attempting to explain this, it is desirable that we should understand the graphical method of delineating vibratory and other motions which mathematicians and physicists are accus-

¹ Dolbear—"The Telephone," p. 63.

tomed to employ in order to place the characteristics of these motions before the mind through the medium of the eye, in a manner much more intelligible than is possible even by the most minute verbal description.

Suppose we have a pendulum swinging from right to left and left to right with a uniform motion. In the vicinity of either end of its path it moves slowly, and in the middle much more rapidly. If we should attach a pencil to the end of the pendulum-rod so that it would mark upon a continuous slip of paper of sufficient width, moving uniformly beneath it at right angles to the plane of its oscillation, a wavy line would be produced. This wavy line once drawn would remain as a permanent record of the kind of motion performed by the pendulum during every part of its oscillation. Fig. 119 represents a line such as would be

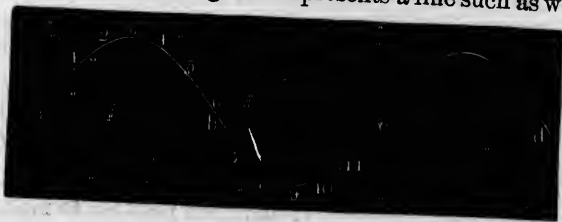

Fig. 119.

produced by the process we have just described. It is not difficult to comprehend the meaning of the curves which are thus formed. The marking point has passed relatively to the paper with a uniform velocity in the direction $a d$. Suppose it has described the section $a c$ in one second. Divide $a c$ into twelve equal parts, as in the figure, then the point has been one twelfth of a second in describing the horizontal length of any one of these divisions, and the curve shows us on which side and at what distance from the position of rest the vibrating point will be at the end one twelfth, two twelfths, and so on, of a second or generally at any given short interval of time after it has left the point a . We see in the figure that after one twelfth of a second it had reached the height 1, and that it rose gradually till the end of three twelfths of a second; then, however, it began to

descend gradually, till at the end of six twelfths of a second it had reached its mean position b , and then it continued descending on the opposite side till the end of nine twelfths of a second, and so on. We can also easily determine where the vibratory point was to be found at the end of any fraction of this twelfth of a second. A diagram of this kind, therefore, shows at a glance at what point of its path a vibrating particle is to be found at any given instant, and thus gives a complete image of its motion.¹

Although we are not yet able to make all vibrating bodies automatically record their movements on paper in this manner, yet we may ourselves construct curves which truthfully represent their vibration when the law of their motion is known; that is, when we know how far the vibrating point will be from its mean position at any given moment of time. We set off on a horizontal line, such as $a b$, fig. 119, lengths corresponding to the interval of time, and let fall perpendiculars, or, in mathematical language, ordinates to it, on either side, making their lengths equal or proportional to the distance of the vibrating point from its mean position, and then by joining the extremities of these perpendiculars, we obtain a curve such as the vibrating body would actually have drawn, if it had been possible to make it do so. Physicists, therefore, having in their minds such curvilinear forms, representing the law of the motion of vibrating bodies, are accustomed to speak as a matter of convenience of the form of vibration of such bodies,² a term which I shall hereafter employ when referring to the subject.

We are now ready to return to the consideration of the phenomena of compound vibrations. To illustrate in a general way the characteristics of this kind of motion, we conveniently refer again to the waves formed upon a calm surface of water. We have seen that if this surface is agitated by a pebble dropped upon it, that the agitation is propagated by concentric waves extending in every direction from the centre to a greater and

¹ Helmholtz—*Die Lehre von den Tonempfindungen* (English Translation, by A. J. Ellis), p. 31.

² *Ibid.*, p. 32

greater distance. Now, if we drop two pebbles at two points some little distance from each other, we shall produce two separate centres of agitation. Each will set in motion a separate set of concentric waves, and these two, gradually expanding, will finally meet and overlap each other. When this happens, it is easy to see that not only the water, but any floating body upon its surface as well, will be set in motion by both kinds of agitation at the same time, but this fact will in no wise interfere with the separate propagation of both sets of waves. Each of these will continue to advance further and further over the surface precisely as if the other had no existence. As they proceed, those parts of both rings which have just coincided appear again, distinct and unchanged in form. These little systems of waves may be accompanied by other and larger systems, caused by the action of the wind, but they will continue to spread out over the surface thus agitated, with the same systematic regularity that they did upon a perfectly calm surface.

The action of the vibrations or undulations of the atmosphere, which produce the sensation of sound, is strictly analogous to that of the waves of water. There is practically no limit to the number of distinct sets of vibrations which may be going on at the same time, without mingling with each other; but, in cases where there are many of these, the resulting motion of each separate particle of air is necessarily complex, almost beyond the power of the mind to conceive. The principle, however, may be understood perfectly well by studying the composition of two or three sets of simple vibrations, and this may be readily done by the aid of the method of graphic projection, which has been before explained.

Thus in fig. 120, we may suppose the horizontal length of the diagram to represent a unit of time. The curve A will then represent the undulation in the atmosphere caused by the vibrations of a tuning-fork in action. The horizontal distances measured on the straight line will represent the passing time, and the vertical heights the corresponding displacements of the particles of air. Now, suppose a second fork is set in action,

which is tuned an octave higher than the first, and, consequently, makes twice as many vibrations in the same time. The undulations produced by the second fork will be represented by the curve B. In such case, the curves above the horizontal line represent the compression of the air, and those below the line its rarefaction. Now, according to the laws of mechanics, if two different forces act in the same direction, the total force is represented by their sum, while if they act in opposite directions it is represented by their difference. If, therefore, we combine these two simple curves, according to this principle, we shall have a composite curve C, which represents the effect produced by the



Fig. 120.

superposition of one set of waves upon another. The line c_1 is the sum of the lines a_1 and b_1 , while c_2 is exactly equal to a_2 . On the other hand, the line c_3 represents the difference between the lines a_3 and b_3 , one being above the horizontal line and the other below it. Every point in the curve C may be found in the same manner, and, by the same method of construction, the resultant curve, corresponding to any number of simple curves combined together, may also be found, as you will readily understand.

The simple vibrational form is always the same. It is only

its v
time
tion
form
ositi
mat
vibr
Fou
grea
serie
the s
posit
of th
beau
after
in te
comp
TH
ment
maki
emph
in 18
to cor
telegr
and o
cation
more
In 1
of wh
at a d
1 For
see ibid.
2 See
3 Vail
p. 382.
4 Pres
same aut

its wave height or amplitude, and its wave length or periodic time, which is susceptible of change. But the number of vibrational forms which may arise from the composition of simple forms are mathematically infinite. The converse of this proposition is also true, which is, that any form of vibration, no matter how complex, may be expressed as the sum of simple vibrations. This was first mathematically demonstrated by Fourier, but its experimental proof is due to the labors of the great German physicist, Helmholtz, who, after a most elaborate series of investigations, succeeded in separating from each other the several simple sounds which form the constituents of a composite sound. It is not necessary here to enter into a description of the methods employed by Helmholtz in accomplishing this beautiful result,¹ although we shall have occasion to refer hereafter to some of the analogous means which have been employed in telegraphy for the same purpose, that is to say, the analysis of composite vibratory motions.

The idea of synchronizing the movements of the two instruments at widely separated points for telegraphic purposes by making use of the principles of isochronous vibration, was employed in telegraphy at a very early period. Thus Ronalds² in 1861, and Vail³ in 1837, employed isochronous pendulums to control their machinery, while at a later date the printing telegraph of Hughes,⁴ and the automatic telegraph of Casselli and others, have embodied most ingenious and beautiful applications of the same principle, with which I presume you are all more or less familiar, and therefore I need not dwell upon them.

In 1861, Mr. Philip Reiss, of Germany, made the first apparatus of which we have any account, for reproducing musical sounds at a distance, by means of electro-magnetism. His devices were

¹ For a full account of the apparatus and methods employed in these experiments, see *ibid.*, Chapter III.

² See Shaffner—"Telegraph Manual," p. 147.

³ Vail—"Electro-magnetic Telegraph," p. 159; Shaffner—"Telegraph Manual," p. 382.

⁴ Prescott—"History, Theory and Practice of Electric Telegraph," p. 139. Also same author's "Electricity and Electric Telegraph," p. 609.

very ingenious and beautiful, and it is evident, from descriptions and papers published at that time,¹ one of which has recently been reproduced in the *Journal of the Telegraph*, that Reiss had made a thorough study, both of the laws of electro-magnetism and of acoustics, and understood perfectly the conditions of the problem with which he undertook to deal.

Sound is simply a sensation resulting from the action of vibrations upon the nerves of the ear. If the same vibrations are felt by the touch, they produce a certain peculiar fluttering sensation; but this is not sound. Therefore, although all sounds are necessarily the result of vibrations, all vibrations do not necessarily produce sound. The vibratory motions proceeding from sounding bodies are usually conducted to the ear through the medium of the atmosphere. Therefore, to produce any given sound, of whatever character, at a distance, it is evidently only necessary to throw the atmosphere at this point into vibration precisely similar in every respect to those which would be produced by the action of the original source of sound, whatever it may be.

It is found that all the characteristics of sound which are appreciable by our senses depend upon three things: First, the rapidity of the vibrations, which determines what we call the pitch of the sound, whether, for example, it is high or low; second, the amplitude of the vibrations, which determines the loudness or power of the sound; and, third, the form of vibration, as represented by the curve corresponding to the movement of the vibrating body, which determines the quality of the sound.

The apparatus of Reiss consisted of a thin, stretched membrane, rigidly supported at the edges, and free to vibrate in the middle. The mathematical theory of the vibration of such a membrane, having a uniform tension in all directions, shows

¹ Reiss - *Dingler's Polytechnic Journal*, Vol. CLXVIII., p. 185; Legat - *Zeitschrift des Deutschoesterreichischen Telegraphen Vereins*, Vol. IX., p. 125. An excellent translation of this last paper may be found in the *Journal of the Telegraph*, Vol. X., p. 353.

that vibrations produced in any part of the membrane will produce nearly as strong vibrations (disregarding individual nodal lines) in all other parts of it. A thin, light membrane is not only susceptible of sympathetic vibration when vibrating air is allowed to act upon it, but this vibration is not limited to any particular pitch, and it is therefore capable of responding to sonorous vibrations of every character, traversing the atmosphere. A delicate circuit-breaker, attached to the membrane, was arranged to break the circuit of a telegraph line at the vibration, and thus the armature of an electro-magnet at the receiving station was easily adjusted to respond to those vibrations, and, when mounted upon a proper sounding-board, gave them out to the atmosphere, which conveyed them to the ear of the listener.

Now, if the form of vibration in this sounding-board could have been made to coincide in all respects with that of the membrane at the station from which the vibrations had been transmitted, Reiss would have had a perfect sound telegraph or telephone. But this was far from being the case. The pitch and rhythm of the sounds were perfectly preserved; their loudness or intensity, also, to a very small extent; but the quality was entirely lost. It is not difficult to understand the reason of this. Every vibration of the membrane caused a pulsation of electricity to traverse the wire and act upon the electro-magnet, but as each and every vibration of the armature was produced by a current of precisely the same strength, the only difference in the amplitude of these vibrations would be that due to the more complete magnetization or demagnetization of the electro-magnet, when the time allowed for the process was increased by the greater play of the circuit-closer, under the influence of stronger vibrations at the transmitting station. The form of the vibrations was of course altogether lost. Any simple musical tone, consisting of a regular succession of uniform vibrations, or any series of such tones, could, however, be reproduced with the greatest accuracy.

The next important step in the progress of invention was

obviously the discovery of some means whereby the proper amplitude of each vibration, or succession of vibrations, either simple or compound, could be directly reproduced by means of the electric current; and when this was once done, the general problem of harmonic telegraphy may be said to have been solved. This having been accomplished, it was not difficult to foresee that two important practical applications might be expected to follow, namely, multiple transmission, and vocal transmission. I believe that this discovery of the true method of transmitting composite vibrations was first publicly announced in the *Journal of this society*,¹ in a paper contributed by Mr. Elisha Gray, it having been made by him in December, 1874. It consists in causing the effective strength of the electric current, by which the transmission is effected, to rise and fall with the varying amplitude of the vibrations or waves which are to be reproduced. Nothing could be more simple and beautiful in a theoretical point of view, but the practical exemplification of the method, as is usual in such cases, presented considerable difficulty.

At the time of making this important improvement, Mr. Gray had already been engaged for more than a year in endeavoring to devise a practical means of transmitting and simultaneously reproducing a number of tones, so as to utilize them for the purpose of multiple telegraphy. Let us briefly glance at what he had already accomplished.

It was observed in 1837, by Dr. Page,² that a musical sound was produced by a magnet, between the poles of which a flat spiral was placed. The sound was heard whenever contact was made or broken between the coil and the battery. These observations were confirmed and extended by De la Rive, Wertheim³ and many others. The apparatus employed by these

¹ Gray, *Journal of American Electrical Society*, vol. 1., p. 13. This apparatus and its mode of operation will be found described in detail in Gray's patents, No. 1,874, of May 4, 1876 (Great Britain), and 186,340, of January 16, 1877 (United States).

² Page—*American Journal of Science* (first series), vol. xxxii., p. 389; *ibid.*, vol. xxxiii., p. 354.

³ De la Rive—" *Traité d'Electricité, théorique et appliqué*," (English Translation, by V. C. Walker, vol. i., p. 300); also, "Knight's Mechanical Dictionary," Articulating "Telephone."

⁴ *Ibid.*, vol. i., p. 307.

exper
magn
ture,
sound
and a
the in
When
second
a mus
accom
arrang
differ
line at
curren
numbe
adjust
alread
of the
cernin
words
purpos
self-int
tions i
now se
record
we sho
both an
in the
possibl
vibrati
interfer
is very

¹ Gray
further de
and 974, o
States); a

experimenters may be described in general terms as an electro-magnet with a self-interrupting break-piece attached to its armature, and another magnet in the same circuit for producing the sounds. The sounds proceed from the core of the magnet itself, and are caused by the molecular change which takes place in the iron at the moment of magnetization or demagnetization. When the current is interrupted a sufficient number of times per second, the successive sounds produce upon the ear the effect of a musical note. The method by which Gray at first sought to accomplish the desired result of multiple transmission was by arranging two or more self-interrupting magnets, adjusted to different rates of vibration, so as to close the circuit of the same line at the sending station, while at the receiving station all the currents passed through a series of electro-magnets, equal in number to the transmitters, and having armatures severally adjusted to their respective rates of vibration. As Mr. Gray has already described this apparatus at length in a preceding number of the *Journal*,¹ I need not enter into further particulars concerning its construction and arrangement, but will in a few words point out the reason why it failed to answer its intended purpose, except to a very limited extent. Suppose we have two self-interrupting transmitters, one of which, *a*, makes six vibrations in the same time that the other one, *b*, makes five. If we now set them in operation, first one and then the other, and record the pulsations on chemical paper at the receiving station, we should obtain the results shown in fig. 121 at *a* and *b*. But if both are set in operation simultaneously, we get the result shown in the third line of the figure, at *c*. Now, it is obviously quite possible, by insuring a proper relation between the times of vibration of two or even more transmitters, to avoid any material interference between the different sets of pulsations, but a limit is very quickly reached, because, as you will readily perceive,

¹ Gray—*Journal American Electrical Society*, vol. i, pp. 5, 6. For details and further description see specifications of Gray's patents, viz., 2,646, of July 29, 1874, and 974, of March 16, 1875 (Great Britain); also No. 166,095, of July 27, 1875 (United States); also, "Knight's Mechanical Dictionary," Articulating "Telephone."

any considerable number of transmitters, acting in this manner to open and close the same circuit, would produce a continuous current, and no analysis of the separate sets of vibrations at the receiving station would be possible.

I will now proceed to describe in general terms the nature of the improvement by means of which Mr. Gray was enabled to transmit an indefinite number of different series of vibrations, without destroying their individuality. The details of his system, and the particular application of it to multiple telegraphy, having been already made known in a preceding number of the Journal,¹ I shall not attempt to enter into them at any length.

The strength of current in any circuit may be varied in two ways: by employing a constant electromotive force, and varying

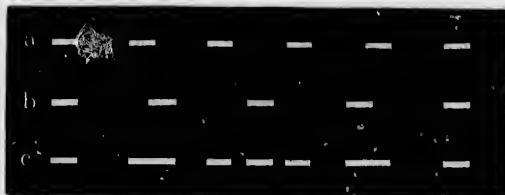

Fig. 121.

the resistance of the circuit, or else by varying the electromotive force, and allowing the resistance to remain constant. Gray employed the latter process in his method of multiple telegraphy. Each series of vibrations at the transmitting station, when added to the existing ones by the depression of its proper key, carried with it its own section of battery, and, therefore, its electromotive force was superposed upon that already in the circuit. The effect of this was to produce a resultant current of varying strength, which would be properly represented by a curve identical with that representing the resultant of the several sets of simple vibrations at the sending station. The analysis of the composite vibrations at the receiving station was effected by a

¹ Gray—*Journal American Electrical Society*, vol. 1, pp. 13 et seq.; also see patents of Great Britain and United States, referred to in note 2.

ser
bar
rate
arm
only
tion
par
is b
if it
fact
the
arm
imp
is, a
swin
imp
blow
alrea
T
depe
mult
comp
erati
the
acco
to de
ing t
the p
moni
or pa
four
The
tones
nants

¹ Hel

series of electro-magnets, the several armatures of which were bars or plates adjusted to a certain rate of vibration, the normal rate of each armature bar differing from that of the other. Each armature bar will respond to its corresponding set of vibrations only, and it makes no difference whatever whether these vibrations are transmitted alone, or whether they form a constituent part of a composite series of vibrations. Each set of vibrations is broken up into dots and dashes by the action of a key, just as if it was an ordinary continuous current. But as a matter of fact, the main circuit is never broken, although the strength of the current is constantly varied. The manner in which these armatures are thrown into vibration by the properly timed impulses of the electric current acting upon the electro-magnet is, as you will readily perceive, strictly analogous to that of the swing, which can only be set in action by properly timed impulses; or that of the tuning fork, set in vibration by the tiny blows of the little atmospheric waves, in the manner which has already been explained.

The reproduction of articulate vocal sounds at a distance, depends upon precisely the same fundamental principle as multiple harmonic transmission, namely, the transmission of composite vibrations. This will become evident from a consideration of the character of articulate sounds, such as those of the human voice. The analysis of vocal sounds was first accomplished by Helmholtz.¹ It would occupy too much space to detail the experiments by which he succeeded in establishing the fact that the different vowel sounds are produced by the presence of a fundamental note, mingled with higher harmonics in various proportions, a harmonic tone being a weak or partial tone, caused by a rate of vibration twice, three times, four times, and so on, greater than that of the fundamental. The several vowels, therefore, belong to the class of sustained tones which can be used in music, while the character of consonants mainly depends upon brief and transient noises. The

¹ Helmholtz—*Die Lehre von dem Tonempfindungen* (Ellis' Translation), Chap. III.

problem in this case was to reproduce at the receiving station precisely the same vibrations in the atmosphere as those produced by the voice of the speaker at the transmitting station. We have seen why Reiss was unable to accomplish this. Let us see wherein later inventors and discoverers have been more fortunate.

Some time prior to February, 1876, Gray conceived the idea of attaching to a stretched membrane, such as that used by Reiss, a resistance apparatus, which should be placed in a constant circuit, and caused to vary with the vibrations of the membrane in response to the sonorous waves traversing the atmosphere and impinging upon it. Of course, if this could be done, it would be easy to attach an electro-magnet with an armature formed of a circular plate, which would respond to vibrations of every character, and thus reconvert the waves of electricity into aerial sound waves.¹ A caveat, describing this invention, was filed by Gray in February, 1876, and himself and others have since been engaged in perfecting and elaborating it, with a very satisfactory degree of practical success.¹

We will now turn to the labors of another inventor in the same field, Mr. Alexander Graham Bell. Like Gray, he had been for some time at work upon the problem of multiple telegraphic transmission by means of harmonic vibrations, and when we consider that each of them appears to have been, at least as late as October, 1874, in entire ignorance of the labors of the other, the singular coincidence in the results which they finally attained was not a little remarkable. Gray had approached the

¹ Since the above was written, Mr. Thomas A. Edison, of Menlo Park, New Jersey, is said to have obtained very satisfactory results with a telephone constructed upon the general plan set forth in Gray's caveat, *i. e.*, a variable resistance controlled by the vibrations of a diaphragm. Edison made the discovery that plumbago possessed the curious property of altering its electrical resistance in proportion to the pressure to which it is subjected, and availed himself of this discovery in the construction of his telephone. More recently the same experimenter is said to have obtained still better results by the use of carbon in the form of lamp-black, from the smoke of an ordinary hydrocarbon lamp, compressed into a cylindrical button. No details of this apparatus have yet been made public.

sub
han
dire
beca
their
phys
His
1872
by K
ment
and
conn
For r
appan
tions
very
tinuo
missio
that a
from
to the
of 187
tion p
May 1
Mr. B
telegra
ing de
the fir
been r
interes
"Tw
ten ohm
carbon

¹ See p
which ma
² Bell-

subject from the stand-point of an electrician. Bell, on the other hand, was a physiologist, and so approached it from the opposite direction,¹ if I may use the expression. As early as 1867, he became interested in the researches of Helmholtz, because of their bearing upon the subject of his professional study, vocal physiology, or, in other words, the mechanism of human speech. His earliest experiments appear to have been made in Boston in 1872, but were substantially repetitions of those already made by Helmholtz. In November, 1873, he completed an experimental instrument with two self-interrupting transmitting reeds, and two corresponding receiving reeds, the transmitters being connected in multiple arc, exactly as in Gray's first method. For reasons which have already been given in speaking of Gray's apparatus, it is possible to transmit two separate series of vibrations without material interference in this manner, yet a limit is very soon reached, because the current becomes practically continuous. Bell continued his experiments in multiple transmission during the years 1874 and 1875, but it does not appear that anything of practical importance in that direction resulted from them. At length he seems to have turned his attention to the development of the speaking telephone, and in the spring of 1876 he arrived at some important results. In a communication presented to the American Academy of Arts and Sciences, May 10, 1876, and published in the proceedings of the society,² Mr. Bell gives a somewhat detailed account of his researches in telegraphy up to that date. I quote from this paper the following description of an experiment in vocal transmission, probably the first one in any degree successful, which appears to have been made by him early in the spring of 1876, and is of great interest:

"Two single-pole electro-magnets, each having a resistance of ten ohms, were arranged upon a circuit with a battery of five carbon elements. The total resistance of the circuit, exclusive

¹ See paper read by Prof. Bell before the Soc. of Tel. Engineers, an abstract of which may be found in the *Telegraphic Journal*, Vol. V., p. 276.

² Bell—*Proceedings of American Academy of Arts and Sciences*, Vol. XII., p. 1.

of the battery, was about twenty-five ohms. Drum-heads of gold-beaters' skin, seven centimetres in diameter, were placed in front of each electro-magnet, and a circular piece of clock-spring, one centimetre in diameter, was glued to the middle of each membrane. The telephones, so constructed, were placed in different rooms. One was retained in the experimental room and the other taken to the basement of an adjoining house. Upon singing into the telephone, the tones of the voice were reproduced by the instrument in the distant room. When two persons sang simultaneously into the instrument, two notes were emitted simultaneously by the telephone in the other house. A friend was sent into the adjoining building to note the effect produced by articulate speech. I placed the membrane of the telephone near my mouth, and uttered the sentence: 'Do you understand what I say?' Presently an answer was returned through the instrument in my hand. Articulate words proceeded from the clock-spring attached to the membrane, and I heard the sentence: 'Yes; I understand you perfectly.' The articulation was somewhat muffled and indistinct, although in this case it was intelligible. Familiar quotations were generally understood after a few repetitions. The effects were not sufficiently distinct to admit of sustained conversation through the wire. Indeed, as a general rule, the articulation was unintelligible, excepting when familiar sentences were employed. Occasionally, however, a sentence would come out with such startling distinctness as to render it difficult to believe the speaker was not close at hand."¹

There is reason to suppose that Bell had formed some idea of the possibility of this result as early as 1874, although its practical exemplification does not appear to have taken place until shortly before the date of the paper from which the above extract is taken. It will be observed that his method differs from that of Gray, inasmuch as the latter varies the resistance in the circuit without changing the electromotive force, while Bell varied the electromotive force, the resistance remaining constant. The bat-

¹ Ibid., Vol. XII., p. 7. See, also, *Telegraph Journal*, vol. V., p. 277.

ter
to
mag
Sep
ste
emp
goi
not
instr
the
to be
incre
best
voice
into
ism,
result
Mr. C
trollin
phrag
case is
It is n
exceed
pose t
ment
that of
advant
that th
efficient
the nec

² Dolb

tery current served no other purpose, in Bell's experiment, than to permanently magnetize the soft iron cores of the electro-magnet, while the magneto-inductive waves were superposed. In September, 1876, Prof. A. E. Dolbear substituted a permanent steel magnet for the electro-magnetic arrangement previously employed by Bell,² and the instrument thus improved is now going into very extensive use. Its articulation, while distinct, is not very loud, although sufficiently so in a well-constructed instrument to admit of lengthy sustained conversations, without the slightest misunderstanding or repetition. Of course, it is not to be expected that the loudness of this form of telephone can be increased very greatly beyond its present volume, for we can at best only get from it the mechanical equivalent of the human voice, deducting the loss inseparable from its conversion, first into mechanical motion, then into electricity, then into magnetism, and, finally, back again into motion. The most striking results are to be looked for in the direction first pointed out by Mr. Gray, for the reason that, if an effectual method of controlling the resistance of the circuit by means of a vibrating diaphragm can be discovered, the source of power, which in this case is the battery, may be augmented to any required extent. It is not to be denied that the problem thus presented is one of exceeding mechanical difficulty; but there is no reason to suppose that it may not be successfully solved. It is to the development of this variety of the speaking telephone, rather than to that of the magneto-instrument, that inventors will find it most advantageous to turn their attention, for I hazard little in saying that the latter has already reached such a surprising degree of efficiency as to leave comparatively little more to be done within the necessary limitations which have been pointed out.

² Dolbear—"The Telephone," p. 119. (See also preface of same work.)

CHAPTER VIII

DOLBEAR'S TELEPHONIC RESEARCHES.¹

DURING the year 1854, while at work in Allen & Thurber's pistol factory, in Worcester, Massachusetts, I began to make experiments in electricity and magnetism. I introduced at that time the use of a permanent magnet to pick up the small parts of the locks of pistols from the cases. This had previously been done by the employés with their fingers, which were often made sore by the nails being worn off too short. The magnet was adopted by those having that kind of work.

I also tried to make a perpetual motion machine, which should derive its power from permanent magnets. I also constructed a trough battery of six cells, with which I tried many experiments.

1855.—During this year I made a magneto-electric machine, of the common pattern. Was frequently with Henry M. Paine, who was then trying to construct a successful electromotor.

1859.—Made another magneto-electric machine. Also invented a steam whistle, which was designed to play any tune. This was while employed in Mason's locomotive works, at Taunton, Massachusetts.

1861.—Invented and constructed a gyroscope to run by electro-magnetism, consisting of a small electro-magnet revolving between the poles of a permanent magnet, shaped like the letter C.

1864.—Made for the Ohio Wesleyan College, at Delaware, O., a large compound permanent magnet; also an electro-magnet for lecture purposes. I invented a magneto-electric telegraph, in which the current of electricity was generated by the action of a permanent magnet when thrust into or withdrawn from a hollow bobbin. This was designed to move a needle. Also proposed to

¹ Abstract from "Researches in Telephony," by Professor A. E. Dolbear, of Tufts College.

have a like instrument at the receiving station, which I supposed would duplicate the movements of the first instrument. The receiving magnet was to be furnished with a pen, and thus register the movements of the transmitting one. I saw that the movements of the second would of necessity be precisely like those of the first, but did not at that time know that the movement of the second would be so feeble as it actually is. I tried to interest a number of persons in this invention, but did not succeed. As I had no means, and was working my way through college, I was compelled to abandon the project. It will be seen that the principle of the present speaking telephone is essentially involved in this invention of 1864.

1867.—Invented a gyroscope to run by electro-magnetism, and which demonstrates the rotation of the earth. This was while I was a student in Michigan University. This machine, constructed by Ritchie, was exhibited at the Centennial Exhibition.

1868.—Conducted a series of experiments to determine the quantity of matter transferred by the electric spark. The plan carried out was as follows: One thousand inch sparks from an electrical machine were received into chemically pure hydrochloric acid from a ball of copper. The liquid was made blue by the addition of ammonia, and then compared with a standard solution which was reduced until the colors of the two were judged to be alike. That gave approximately the transferred copper for that number of sparks. The same plan was tried with iron, silver, lead and some other substances, using, of course, different reagents with each.¹

1870.—Discovered that the so-called magnetic phantom was permanently magnetic; that it would place itself in the magnetic meridian, and in all respects comport itself like a magnet.

1871 and 1872.—Made quantitative measurements of the elongation of an iron rod when magnetized.

This was done by fixing a small mirror upon the long arm of

¹ A note of these experiments was published in the supplement to the *Chemical News*, in the winter of 1868-9.

a lever while the bar acted upon the short arm. A beam of light was projected upon the mirror, and reflected to a distance of fifty feet. The angle of its displacement then admitted of convenient measurement. Repeated experiments proved that the result of the magnetization of an iron rod was an average elongation of $\frac{1}{25000}$ part of its length.

I tried to cause a fine ratchet-wheel to revolve by a reciprocating motion derived from this slight molecular movement, making and breaking the circuit with an interrupter.

1872.—Made some very large forks, capable of vibrating strings twenty feet in length, for class demonstration.

1873.—Made some large tuning forks for projecting sound-curves upon a screen; also discovered a method of very much amplifying these vibrations.¹ A pair of these forks was exhibited at the Philadelphia Exposition. At the same time invented an attachment to the whirling-table, for accomplishing the same thing.²

Discovered convertibility of sound-vibrations into electricity. Using a tuning fork in connection with a thermo-pile and galvanometer, I noticed that when the fork vibrated the needle was deflected. Further observed the effect of a vibrating tuning fork, which was also a magnet, upon the current from a thermo-pile.

At the Portland meeting of the American Association, in 1873, read a short paper in regard to the first of these experiments, which I thought was new; but said nothing about the second, as I considered it was only a particular case of magneto-currents, which were well known. Nevertheless, it was precisely the same thing as the undulatory current which Professor Bell claims to have invented or discovered.

While engaged in making a manometric flame capsule, I invented the opeidoscope.³

I also proved that the sheet of air issuing from a sounding

¹ See *Journal of Franklin Institute*, 1873.

² See proceedings of American Association, 1873. Appendix I.

³ See *Journal of Franklin Institute*, 1873.

organ-pipe vibrates like a reed. This was done by filling an organ bellows with smoke, and examining it through a stroboscopic disk while escaping from the pipe.

1876.—Commenced my investigation and experiments in telephony, using at first a Helmholtz interrupter and electro-magnets. Among many experiments in transmitting speech I tried that of a conical point of iron fastened to the middle of an opeidoscope membrane, the point being attached to a fine wire in such a manner as not to interfere with its freedom of movement. This point dipped into a mercury cup, and the idea was, that inasmuch as the point was conical, when it was made to advance into the mercury it would present a notably larger surface, and thus lessen the resistance of an electric circuit of which it formed a part. A current of electricity passed through this arrangement and an electro-magnet caused the latter to sound loudly at times, but it was found that the mercury bounded away from the point when the latter was made to vibrate rapidly, and so the plan was abandoned.

Proposed to make a telephone with a permanent magnet having a coil about one pole and a piece of wire fixed to an opeidoscope membrane, to be vibrated by the voice in front of this pole. I used thin rubber for the membrane, and was troubled to keep the iron from clinging to the magnet when brought near it.

Tried paper diaphragm with iron on it, but did not have sufficient leisure to be able to accomplish my object. Meanwhile I had, while singing against a sheet of paper held in both hands, felt the force of the sound vibrations upon the paper, and concluded to construct the telephone vibrating armature entirely of iron, in the form of a complete plate fastened at the edges, instead of being attached to a membrane as before.

I measured the distance through which I could get a signal with such a current. I succeeded in doing so through a resistance of fifteen thousand ohms.

I now thought of obtaining a patent upon the speaking telephone with permanent magnets, and began constructing suitable

instruments to serve as a patent model, but before these instruments were completed, I was informed that Professor A. Graham Bell had declared that he had secured a patent upon the same thing two or three years before.

On the 12th of February, 1877, Professor Bell gave a lecture and exhibition, at Salem, Mass. Within a day or two I called upon him to see his fixtures. He was not in, but his assistant, Mr. Watson, showed them to me. They were substantially like mine. I invited Messrs. Watson and Bell to come to College Hill and see my apparatus.

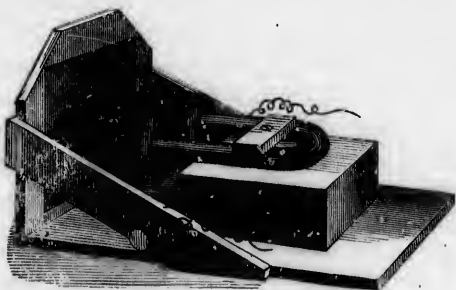

Fig. 122.

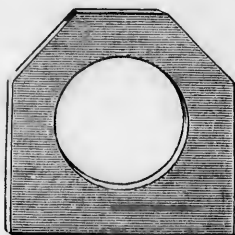

Fig. 123.

Mr. Watson said Professor Bell wished to know what the resistance of the human body was, and asked if I could measure it. I promised to do so, and in a few days sent him the measurement of the resistance of the bodies of about twelve students, for which I received a letter of thanks.

About the first of March, 1877, I chanced to see the official gazette of the Patent Office, containing Professor Bell's patent of January 30th, 1877, and found that I had been deceived in regard to his having patented the application of permanent magnets to the telephone previous to my invention, and accordingly went to consult a lawyer about it. I was considerably discouraged on account of his statement of the probable cost of an attempt to secure my rights. I tried to interest several persons in my case, but without success.

About the first of May Professor Bell lectured in Boston, and publicly declared himself to be without a competitor. I at once challenged his statement, informing him what I had done; yet he continued to reiterate his statement in all his subsequent lectures.

In July he wrote to me that, as he was going to Europe, he would like to have from me a statement of what I had done in telephony, since he desired to do justice to all. I met him at the house of Gardiner G. Hubbard, Esq., in Cambridge, and gave

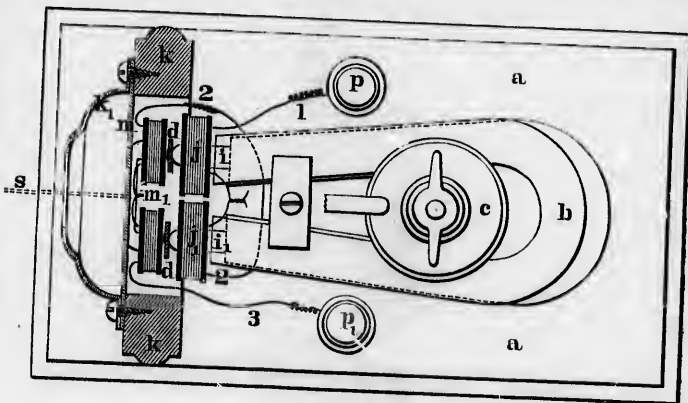

Fig. 124.

him the particulars of my work. He acknowledged that I had invented the telephone independently of himself.

In 1877, I was enabled to make further investigation into the conditions necessary for the telegraphic transmission of speech, and have the following discoveries and inventions to report as the result of these investigations:

A cushion for the vibrating diaphragm, by which greater amplitude of vibration is obtained, with increased sonorous effects. Telephones made in this way have been heard one hundred and fifty feet away.

The adaptation of the common string telephone (lovers' tele-

graph) to a Morse sounder or relay, by which speech may be transmitted, the same instrument acting either as receiver or transmitter.

That the strength of the sound is much more dependent upon the strength of the magnets and size of the plate than upon the diameter of the wire and number of turns upon the bobbin. Some of the loudest tones have been obtained with bobbins containing but two or three ohms of number 28 wire.

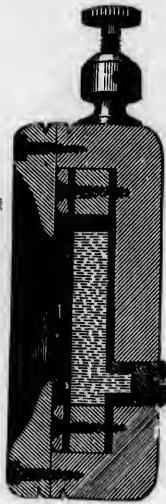

Fig. 125.

That compound magnets are much better in every respect than single magnets, and the compound U magnet is the best of all forms which have been tried.

The tuning fork call.

The devil's fiddle call.

The bell call—falling harmonic bell.

The paper diaphragm, with electro-magnet armature. See fig. 124.

The battery telephone, in which plates of two different metals

are separated by a non-conductor in such a way as to make a shallow cell. When a sound is made against one of these, as at I, fig. 125, the current from the cell is broken up into waves precisely like the movements of the sound waves, and speech is rendered remarkably distinct from the employment of such a sounder.

The electrophone or modified Reiss telephone (fig. 126). In this instrument a ring of wood, *a a*, has a plate of iron, *p*, screwed to one side of it, the plate being in metallic connection with a screw-cup leading to a battery. Upon the opposite side of the

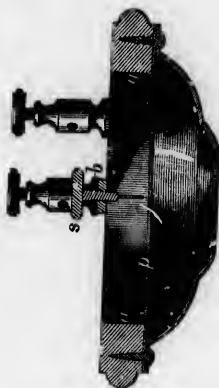

Fig. 126.

ring is a cross arm *b*, through which passes a screw *s*, carrying a point which may be adjusted at any required distance from the plate *p*. This screw *s* is also in metallic connection with the other terminal cup.

If a rather weak battery of two or three gravity cells be put in circuit with this, together with any form of receiving telephone, and the point be screwed down so as to touch the plate, and any kind of a sound be made in the cavity in front of the plate *p*, the circuit will be made and broken the number of times per second due to the pitch of that sound, and the like

pitch will be given out by the receiving telephone; the loudness of this sound will depend upon the ability of the receiver to respond to the pulsations. The tones will be quite loud from a Morse sounder, or from a relay.

If the point be drawn back, so as not to touch the plate at all, and a drop of water be inserted between the point and the plate, and talking or singing be resumed, the articulation becomes remarkably good, though the sound is not very loud.

If a strong battery of fifty cells, or more, be put in circuit, and the screw be turned down so as to have a jumping spark between the point and the plate, the vibrations of the latter introduce a variable resistance in the air. If at the same time there is a strong current, the result will be very loud talking. Indeed, it will be louder at the receiving than at the sending station. This has been used over the lines between Boston and New York, and between Milford, New Hampshire and Boston. In each case, every person in the room could hear the talking from the other end of the line. In this device it is found best not to use a very sharp point, but one having a surface like a sewing needle, with about one eighth of an inch broken off from the point. Such a one gives much better results than a sharp point, for the obvious reason that a greater quantity of electricity can pass from such a surface than from a fine point.

If electricity of high tension, like that from an ordinary electrical machine, be used instead of the current from a battery, the result is the same; talking is possible, the articulation is good, but the tones are not so loud.

Large plate for a call.

If the plate be made a foot or more in diameter, but mounted near the middle concentrically, the magnets and bobbins being the same as usual in size and strength, the plate may be struck with a billet of wood, or other material, and the thump will be very loud, as heard from an ordinary telephone; in fact, loud enough to be heard fifty feet away. It is also good as a receiver call.

A
L
in
pr
fo

7
opp
(fig
axi
the
plat
tion
mir
to d

1 B
ASSOC

AN ATTACHMENT TO THE WHIRLING TABLE FOR PROJECTING LISSAJOU'S CURVES.

¹ The costliness of the usual apparatus for the projection of Lissajou's curves has led me to devise a method for accomplishing the same results in a comparatively inexpensive way, which proves in other ways to be superior to the method with vibrating forks.

It consists of the following attachment to the whirling table:

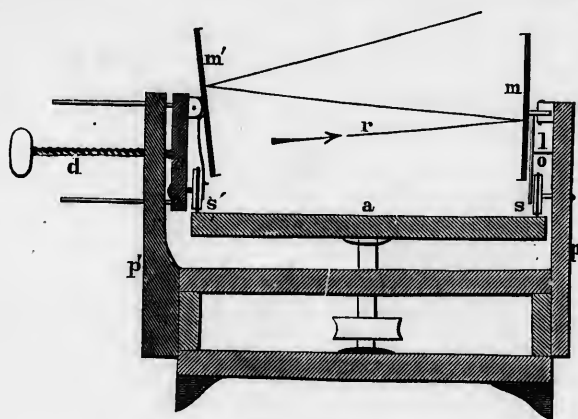

Fig. 127.

Two posts, p and p' , are made fast to the frame upon the opposite sides of the inertia plate a . A small wooden pulley, s , (fig. 127) about an inch in diameter, is made to turn upon an axis that is made fast in the post p , and with such adjustment that the pulley rests upon the plate a and turns by friction on that plate. It is best to have a thin india rubber ring upon the friction pulley, to insure it from slipping. Above the pulley, the mirror m is so mounted as to swing in azimuth, and is made to do this by a wire fastened to it at its hinge and bent into a

¹ By A. E. Dolbear, of Bethany, W. Va. From the Proceedings of the American Association for the Advancement of Science. Portland meeting, August, 1873.

loop l , at its lower end, which is opposite the face of the pulley s (fig. 128). Another twist in the wire at o will be needed, for a pin which is fast in the post p . This will make a lever of the wire l , with the fulcrum at o , and if it is properly fastened to the hinge of the mirror, will cause it to vibrate in a horizontal plane when the plate a revolves.

A somewhat similar arrangement is made for the other side, save that the friction pulley s' has its bearing made fast, in a separate piece c , which is so fastened to the end of a long screw d , that the whole fixture can be moved to or from the centre of the plate a . The piece c is furnished with two guides, which keep it steady in any place where it is put. The mirror m' is made to tilt in a perpendicular plane by an arrangement quite similar

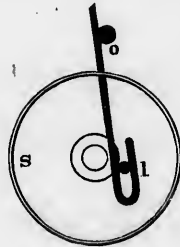

Fig. 128.

to the former one, save that the wire connection has its lower end bent into a horizontal loop, through which a pin in the face of the pulley s' is thrust. This is practically an eccentric, and being directly fastened to the hinge of the mirror m' , gives to it an angular motion proportional to the distance of the pulley face pin from the centre. The mirrors should be not less than two inches square. If then the pin is an eighth of an inch from the centre of the friction pulleys, they will have ample angular motion, much larger than can ever be got from forks.

It is evident that if the two friction pulleys have equal diameters, and they are at equal distances from the centre of the plate a , they will vibrate in unison in their respective planes.

Now let a beam of light r , from the porte lumière, fall upon the mirror m at such an angle as to be reflected first upon the mirror m' , thence to the screen. If the plate a is now revolved, the beam of light will describe a circle, an ellipse or a straight line, either of which can be made at will by simply adjusting the crank of one of the mirrors to the required angle. Thus, suppose the mirror m' is tipped back its farthest by bringing the pulley pin at the top, as indicated in the drawing, at the same time that the mirror m is at its maximum angular deviation. The beam of light will describe a circle.

If it moves slowly, the path and direction of the moving beam can be nicely observed. These two advantages are not to be had with forks; for, first, it is accidental if one gets a circle or any other desired resultant figures from forks in unison, for the obvious reason that the phases cannot be regulated: and second, the vibrations of the forks are so rapid that the analysis of the motion can only be made in a mechanico-mathematical way.

By moving the fixtures on the left side toward the centre of the plate a , the pulley s' will not revolve so fast. If moved half way, it will make one revolution while the other makes two, and the vibrations stand in the ratio 1 : 2, represented by forks in octave. Such ratio is shown upon the screen by a form very much like the figure 8, and known as the lemniscate.

Between these two places, every musical ratio in the octave can be got, and the resultant motions projected in their proper curves. More than that, while the mirrors are both vibrating, any of the ratios desired can be moved to at once by merely turning the thumb screw d , which is wholly impossible with any forks, which require stoppage and adjustment of lugs for each different curve.

Again, if the fixture c is moved still farther toward the centre than half way, the curves projected will be those belonging to the second octave, until the pulley reaches three fourths of the way, when the ratio will be 1 : 4, and the resultant figure will be like a much flattened double eight.

If one would show the phenomenon of beats, it will be neces-

sary to have the mirror m and its attachment so adjusted as to have it vibrate in a perpendicular plane like m' . This can be done by fixing its hinge at right angles, and the rest the same as for mirror m' . The reflected beam from the second mirror may be received upon a large mirror held in the hands, and thence reflected upon the wall or screen. All the phenomena of vibrations that can be shown by forks can be reproduced on a scale that is not approached by means of them, by any one possessing a turning table, and at less than the fifth of their cost.

ON THE CONVERTIBILITY OF SOUND INTO ELECTRICITY.

¹ I have found by experiment that if a vibrating tuning fork have its stem applied to the face of a thermo-electric pile which is in circuit with a delicate galvanometer, the needle will be deflected, showing that electricity has been developed in the pile. The question is as to its immediate origin. It may be asserted that the vibrations of the fork are competent to develop heat, which, in its turn, is converted into electricity, so that its appearance is a secondary phenomenon. To this explanation countenance is given by the experiment of Professor Henry, who found that the deadening effect of a rubber cushion, when the stem of a vibrating fork was put upon it, was due to the fact that the vibrations were converted into heat. But the vibrations are not noticeably deadened in the former case, and the junction of the metals is subject to definite and measurable vibrations.

The antecedent to the production of electricity is the contact, either mediate or immediate, of substances, which differ in composition or in condition, and if electricity is a mode of motion, it ought to appear whenever a motion may be set up at such point of contact as mutually to disturb the molecules of the differently constituted matter. That the vibrations of the fork are competent to do this without necessarily giving rise to the phenomenon

¹ By A. E. Dolbear, of Bethany, W. Va. From the Proceedings of the American Association for the Advancement of Science. Portland meeting, August, 1873.

of heat, may fairly be inferred, I think; so that, a priori, one should look for electric phenomena from such a combination of favorable conditions. At any rate, it will hardly be asserted by any one that because the electricity is generated in the thermo-pile its immediate cause must be heat. I do not know that it has ever been proved that heat motion was the only kind of motion that was capable of direct conversion into electricity in the so-called thermo-pair. It is probable that the more general statement is true, namely, that molecular disturbance at the junction of dissimilar metals will give rise to electricity.

We know that the molecular disturbance called heat will give rise to it, and it is not improbable that the disturbance caused by a regularly vibrating tuning fork, may do the same thing directly. My experiment does not prove that such is the case, but it hints at it, and I offer these considerations to meet the objections of some who take it for granted that it cannot be true that sound vibrations are really converted into electricity, except in an indirect way. This is capable of verification, I do not doubt, but I have not had time to apply the experimentum crucis, as the idea did not occur to me until a day or two ago, and I bring it to the association as an interesting experiment, whatever its rationale may be.



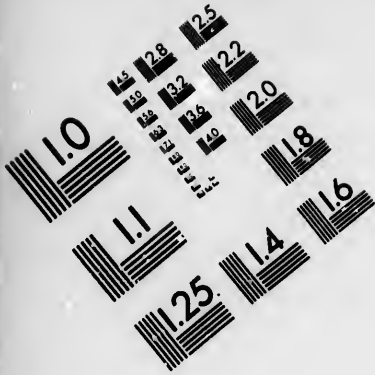

**IMAGE EVALUATION
TEST TARGET (MT-3)**

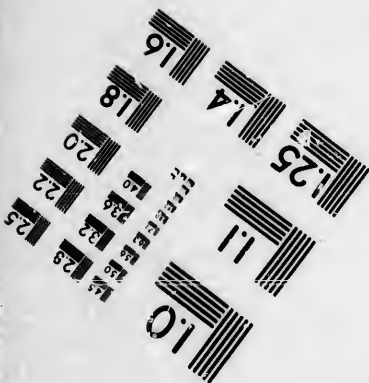
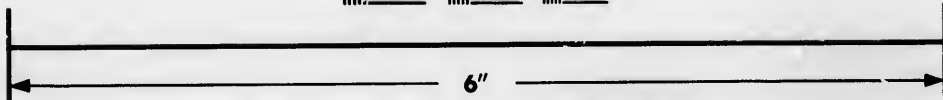
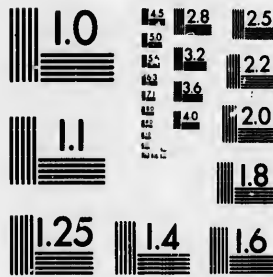

**Photographic
Sciences
Corporation**

23 WEST MAIN STREET
WEBSTER, N.Y. 14580
(716) 872-4503

1.5 2.8
1.8 3.2
2.2 3.6
2.5 4.0
2.8 4.5
3.2 5.0
3.6 5.6
4.0 6.3
4.5 7.1
5.0 8.0
5.6 9.0
6.3 10.0
7.1 11.2
8.0 12.5
9.0 14.1
10.0 16.0
11.2 18.0
12.5 20.0
14.1 22.5
16.0 25.0
18.0 28.0
20.0 31.5
22.5 36.0
25.0 40.0
28.0 45.0
31.5 50.0
36.0 56.0
40.0 63.0
45.0 71.0
50.0 80.0
56.0 90.0
63.0 100.0

10
11
12
13
14
15
16
17
18
19
20
21
22
23
24
25
26
27
28
29
30
31
32
33
34
35
36
37
38
39
40
41
42
43
44
45
46
47
48
49
50
51
52
53
54
55
56
57
58
59
60
61
62
63
64
65
66
67
68
69
70
71
72
73
74
75
76
77
78
79
80
81
82
83
84
85
86
87
88
89
90
91
92
93
94
95
96
97
98
99
100

CHAPTER IX.

IMPROVEMENTS OF CHANNING, BLAKE AND OTHERS.

IN the winter and spring of 1877 a notable series of experiments were made by a few scientific gentlemen in Providence, R. I., which resulted in making the telephone portable, and in giving to it distinct articulation. Every step leading to these important results was communicated to Prof. Bell, and the principal improvements thus originating, especially the handle instrument and the mouth-piece, were at once adopted by him, and form part of what is now commonly known as the handle telephone.

In March, 1877, the speaking telephone, in its most practical form, consisted of a box resembling a photographer's camera, with a two inch tube for mouth-piece, opening into a cavernous air chamber in front of a plate of sheet iron about $4\frac{1}{2}$ inches in diameter. Behind this plate was a large U magnet, with a soft iron core clamped to each pole, surrounded with a spool of fine insulated wire. These instruments were unwieldy, and their articulation defective, for three reasons: First, the mouth-piece did not converge the air on the centre of the plate, and the cavernous air chamber produced reverberation; second, the magnet did not react symmetrically with the centre of the plate, but the two poles or cores of the U magnet reacted with the parts of the plate which were opposite to them on each side of the centre; third, the plate was too large and heavy to respond perfectly and promptly to the average voice.

Experiments, commencing in the physical laboratory of Brown University, and continued several months by Prof. Eli W. Blake, Prof. John Peirce, and others, culminated, in April, in the construction, by Dr. William F. Channing, of the first portable telephone. This consisted of two small blocks of wood fastened to each other at right angles—one perforated for the mouth-piece and holding a ferrottype plate, $2\frac{1}{4}$ inches in diameter; the other

supporting a compound U magnet (made of two three inch toy magnets) with a single soft iron core, carrying a spool of fine insulated wire, clamped to one of its poles and opposed to the centre of the ferrotypc plate. The other pole of the compound magnet was either brought in contact with the outer edge of the plate or left free.

This little instrument, weighing about twelve ounces and easily held in the hand, especially when mounted on a handle, talked more distinctly than the large instruments, even over long circuits, though not quite so loud. It was followed later in April by a telephone made by Prof. Peirce, in which a small compound U magnet was enclosed in a cubical block of wood, on the top of which he placed for the first time his converging mouth-piece—an acoustic apparatus which deserves special description.

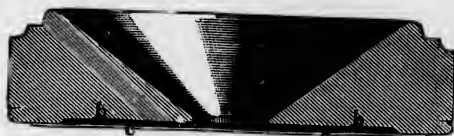

Fig. 129.

This is shown in section in fig. 129. The sound waves converge upon the centre of the plate through the aperture *a*, usually about $\frac{7}{16}$ inch diameter.

The sound waves also spread symmetrically from the centre, and act upon the plate through the very flat air chamber *b b*. To prevent resonance and ensure the prompt response of the plate, this air chamber is usually made only from $\frac{1}{32}$ to $\frac{1}{16}$ inch in depth, and about $1\frac{1}{4}$ inches in diameter when a ferrotypc plate (*c c*) is used. This mouth-piece made distinct and natural the previously obscure articulation of the telephone.

At the time Prof. Peirce's mouth-piece was made, Prof. Bell had arrived at the discovery that the instruments talked better if the air chamber, usually made deeper than that shown in fig. 53, was stuffed with paper. The reason will be sufficiently obvious from the above.

Prof. Peirce's upright block was followed naturally by the "handle telephone," now in general use, which was made by Dr. Channing early in May, 1877. Figs. 130 and 131 show both a sectional and perspective view of the instrument. In this a small straight magnet, simple or compound, carrying a single soft iron core and spool, is enclosed in a light and elegant handle, and the

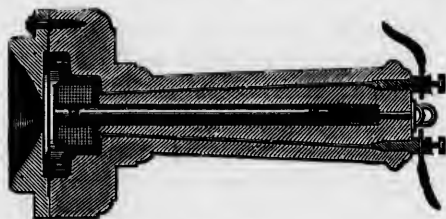

Fig. 130.

ferrotype plate is mounted in the circular head, of which the mouth-piece forms part. The design and style of the instrument is due to Mr. Edson S. Jones, another of the Providence experimenters.

After a competitive test with the box telephones, as at that time made, the handle telephone was adopted and sent out early

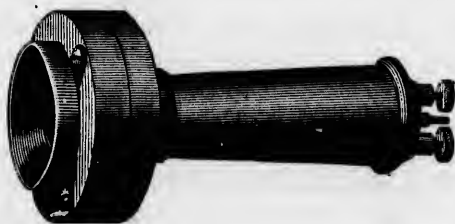

Fig. 131.

in June by the Telephone Company; and its portability, elegance and superior articulation contributed largely to the rapid diffusion of the telephone in this country and in Europe which immediately followed.

Prof. Bell was familiar with the preceding Providence experiments which had already made the telephone portable, and

in
g
st
in
pa
by
str
ha
so
me
Pr
of
has
he
thus
den
It
In t
men
show
effec

which suggested the handle form. In May, shortly after the construction of the handle instrument in Providence, and before it reached Boston, Prof. Bell, working in the same direction, had put a U magnet, each pole armed with a core and a spool, inside of a handle. The instrument was too cumbersome and inelegant for adoption, as well as defective in construction. Prof. Bell's desire to put both poles of the magnet to visible use was especially unfortunate in this case, as the smallness of the plates in the portable telephones makes it impossible that the two poles of the U magnet should act anywhere near the centre of the plate. The instrument was not adopted, and it could not have accomplished for the diffusion and commercial success of the telephone what was done by the original handle instrument.

Yet, with no other basis than this experiment, Prof. Bell, in his lecture in London, before the Society of Telegraph Engineers (see page 76), says: "Two or three days after I had constructed a telephone of the portable form, containing the magnet inside the handle, Dr. Channing was kind enough to send me a pair of telephones of a similar pattern, which had been invented by the Providence experimenters." As already stated, the instrument thus referred to is an accurate representation of the handle telephone of Dr. Channing and Mr. Jones, which has had so wide a career, and differs broadly in type from the experimental instrument of Prof. Bell, which never passed into use. Prof. Bell, in the above extract, not only claims the origination of the handle telephone, which has gone round the world and has a recognized place in the history of speaking telephony, but he also implies that he gave to the telephone portable form, thus ignoring one of the principal contributions of the Providence experimenters.

It happened with the telephone as with the Morse telegraph. In the beginning it was supposed that the power of the instruments was proportioned to their size. Later experiments have shown in both that more delicate instruments are the most effective.

It will be observed that Professor Bell is criticised here, not for claiming that he had made a straight magnet telephone, but for claiming this in combination with the handle, and figuring this combination, which constitutes the well known handle instrument, as his own. His real claim is to the independent experiment of putting a U magnet in a handle, subsequent to the construction of the genuine handle instrument in Providence.

Another practical result obtained in Providence as early as June, was the glass plate telephone of Henry W. Vaughan, State assayer. A disk of soft iron, about the size and shape of a nickel cent, was cemented with shellac to the centre of a very thin glass plate, $2\frac{1}{4}$ inches in diameter. This, with Peirce's mouth-piece and the usual magnets, gave the loudest and clearest articulation attained at that or at a later time, and may be the germ of important improvements. Mr. Vaughan also made, before the telephone had been seen in France, what has since been described as the multiple telephone of M. Trouvé. In this telephone, plates form the sides and ends of a cubical or polyhedral chamber, a magnet and coil being behind each plate.

Among other scientific observations with the telephone, Prof. Peirce heard the auroral sounds early in the summer of 1877, and Dr. Channing noticed the characteristic telephonic sound of lightning, even when distant, preceding the visible flash. Prof. E. W. Blake made the capital experiment, imperfectly reported in Prof. Bell's lecture, of substituting a soft iron bar for the magnet of the telephone. Whenever this bar was turned in the direction of the dipping needle, the telephone would talk by the earth's magnetism; but when swung up into a position at right angles with the dipping needle, the telephone became perfectly silent. Prof. Blake also talked with a friend by telephone for a short distance, using the parallel rails of the same railroad track as conductors, and hearing at the same time, by induction, the Morse operating from the telegraph wires overhead. This illustrates the apparent indifference of the telephone, at times, to insulation. Prof. Blake also originated the responsive tuning forks, in which two forks of the same musical pitch are magnet-

ized; a short iron core, surrounded with a spool of wire, is supported between the poles or prongs of each. The wires being connected, if one tuning fork is struck the other responds at a distance.

The names of Messrs. Louis W. Clarke and Charles E. Austin should be mentioned among the corps of Providence experimenters as contributors to this chapter of telephonic progress.

¹ With the object of stimulating inquiry into the means of improving the telephone, which is the most beautiful adaptation

FROM THE LABORATORY OF

T. A. EDISON.

MENLO PARK, N. J.

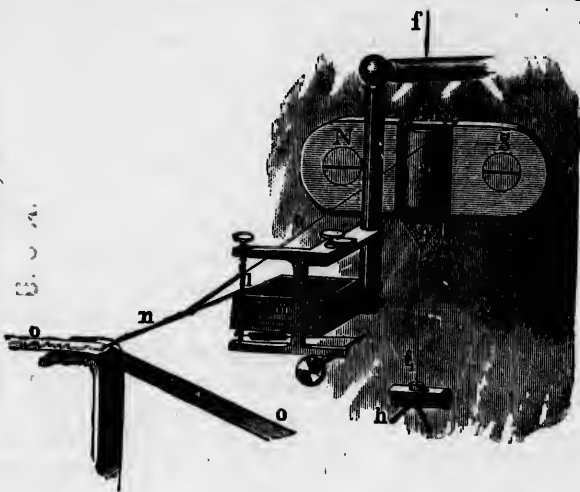

Fig. 132.

of telegraphy ever made, I desire to draw attention to a few simple methods by which any one may satisfy himself of its practicability; for no one having witnessed its performance can fail to see a great future before it.

The recorder of Sir W. Thomson, shown in fig. 132, affords a ready means of speaking, and gives out such clear tones as to make the listener at first involuntarily look behind the instrument for the speaker (who may be miles away). It suffices to

¹ John Gott. *Journal Society Telegraph Engineers*. Nos. XV. and XVI. 1877.

take a tube two inches in diameter, and stretch over one end a membrane of parchment or thin gutta percha (the latter is less affected by the breath, the former becoming somewhat flaccid after a time). To the centre of the membrane cement a straw, and fix the tube in front of the instrument, about six inches from the movable coil *b*; cement the other end of the straw to the coil at the point where the silk fibre *k* is usually fixed. This is all that is necessary for both speaking and receiving. Six or eight cells of battery connected in circuit with the electro-magnets suffice. A pair of these tubes may also be connected in a similar manner with the tongues of two polarized relays. The tube is to be fixed in a convenient position, at right angles to the tongue, and the free end of the straw cemented to the tongue, taking care that the latter is free from its ordinary contact points. No battery is required for speaking with this arrangement.

Or a pair of these speaking tubes may be connected with the ordinary armatures of any instrument or relay, and a current kept on the line. The armature should, however, not be too heavy, and should be carefully adjusted. The best adjustment gives the loudest sound. In sending, be careful that the armature in vibrating does not touch the cores of the electro-magnet.

A plate of thin iron, such as is used for stove pipes, fixed to an upright board, the latter hollowed out on the side on which the plate is fastened, and a hole made in the board in front for inserting a convenient tube for speaking, may be used as an armature, and a pair of coils placed in front of the iron plate through which a current from a battery is flowing, the cores to be adjusted as close as possible to the plate; this answers for sending and receiving. The battery need not be strong; if it be so, the armatures have to be removed further away from the coils. On a short line the resistance of the coils, with a suitable battery, is of little importance. I have spoken as well with small coils of three ohms as with 400 ohms.

If a pair of coils at the receiving end be placed on a violin, and connected to the line on which there is a permanent current

an
th
th
th
the
spe
the
and
adj
I
sen
V
com
Are
othe
T
vari
the
mag
air, c
T
thro
the s
the r
inser

Du
part
Unio
music

1 A
R. I., p

and a sending instrument as described, singing and speaking into the tube at the distant end can be heard by placing the ear to the violin. The effect is exalted by laying a plate of iron on the poles of the electro-magnet.

By these simple means—and they are selected as being within the reach of many—may be demonstrated the possibility of speaking over miles of telegraph line. The sound of the voice in the tube is not that of a whisper, but of a voice at a distance; and the nearer you seem to bring the sound the better your adjustment, and vice versa.

I have spoken through four knots of buried cable without sensible diminution of effect.

When the instruments are not well adjusted, some words will come clear when others do not; and I have found the sentence, Are you ready? pronounced deliberately, intelligible when others were not.

The object to be sought for is to augment the strength of the variations of current. At present it is limited by the power of the voice to move an armature or coil; and unless it can be magnified by putting in play a reserve of force, as compressed air, etc., improvement cannot go far.

The most hopeful field seems to be the effecting a variation, through a sensible range of resistance at the sending end, to vary the strength of current in a primary coil by shunting or varying the resistance of a battery circuit; as, for example, a fine wire inserted more or less in mercury.

REMARKABLE TELEPHONIC PHENOMENA. 1

During five evenings in the latter part of August and first part of September, 1877, performers stationed in the Western Union building in New York, sang or played into an Edison musical telephone, actuated by a powerful battery, and con-

¹ Abstract from a communication from Dr. William F. Channing, of Providence, R. I., published in the *Journal of the Telegraph*, December 16, 1877.

nected with one or more cities by a No. 8 gauge wire, with return through the ground.

In Providence, on the evening of the first of these concerts (August 28), Henry W. Vaughan, State assayer, and the writer, were conversing through magneto telephones over a shunt made by grounding one of the American District Telegraph wires in two places, about a quarter of a mile apart, through suitable resistance coils. At about half past eight o'clock we were surprised by hearing singing on the line, at first faint, but afterward becoming distinct and clear. At the same moment, apparently, Clarence Rathbone, talking with a friend through telephones over a private line in Albany, was interrupted by the same sounds. Afterward, during that and subsequent concert evenings, various airs were heard, sung by a tenor or soprano voice, or played on the cornet. The origin of these concerts remained a mystery for some time in Providence, and the lines were watched for music many evenings. The programmes heard proved to be precisely those of the Edison concerts performed in New York, the singers being Signor Tagliapietro, D. W. McAneeny and Madame Belle Cole.

The question how this music passed from the New York and Albany wire to a shunt of the District wire in Providence, is of scientific importance. The Edison musical telephone consists of an instrument converting sound waves into galvanic waves at the transmitting station, and a different instrument reconverting galvanic into sound waves at the receiving station. The battery used in sending the music from New York to Saratoga consisted of 125 carbon cells, with from 1,000 to 3,000 ohms resistance interposed between the battery and line connections in New York.

The wire used in these concerts extended from the Western Union building, corner of Broadway and Dey Street, through Park Row, Chatham Square, the Bowery and Third Avenue to One Hundred and Thirtieth Street, and thence via the Harlem Railroad to Albany. On the same poles with this Albany wire, for sixteen miles, are supported no less than four wires running

to Providence, three of them being on the same cross arm, and one of them being Boston wire No. 55 east, via Hartford and Providence; also for eight miles a fifth wire, Boston wire No. 32 east via New London and Providence. These wires, including the Albany wire, have a common ground connection at New York, and are strung at the usual distance apart, and with the ordinary insulation.

At the Providence end of the line, six New York and Boston wires, Nos. 55, 32, 2, 5, 27 and 28 east, run into the Western Union building, in company (on the same poles and brackets), for the last 975 feet, with an American District wire. This last runs especially near to wires 55 and 32, whose proximity to the Albany wire in New York has already been traced above. But here is a distinct feature. The District wire belongs to an exclusively air circuit of four and a half miles, having no ground connection. The New York and Albany and New York and Boston wires are, or may be, grounded at both ends. The District circuit referred to in Providence is geographically two circuits, but electrically one, both working through a single battery of fifteen cells. Mr. Vaughan and myself having District boxes a quarter of a mile apart, on this circuit, made a shunt for telephonic communication by ground connection at each house, including several hundred ohms resistance, so as not to impair the galvanic insulation of the line. The telephone talked through this perfectly, and the sounds of atmospheric electricity were heard in remarkable perfection.

It will be seen that the music from the Albany wire passed first to two or more parallel New York, Providence and Boston wires; second, from these to a parallel District wire in Providence; and third, through a shunt of that District circuit before reaching the listeners there.

This transfer of electric motion from one wire to another may have taken place by induction, by leakage, or, in the first instance, in New York, by a crowded ground conductor. In the transfer in Providence from the New York and Boston to the District wire, there was no common ground connection, and it is difficult

to suppose that sufficient leakage took place on the three brackets and three poles, which were common to the New York and the local wire, to account for the transfer in Providence. The magneto-telephone has also proved itself abundantly capable of picking up signals in an adjoining wire by induction alone. Without rejecting wholly, therefore, the other modes of transfer, I should ascribe to induction the principal part in the transfer of the concerts from wire to wire between New York and Providence.

What proportion, then, of the electrical music, set in motion in New York, could have reached the listeners on the shunt in Providence? Whether induction, leakage, or crowded ground was concerned, will any electrician say that the New York and Providence wires situated as described, could have robbed the Albany wire of one tenth or even one hundredth of its electrical force or motion? When this one tenth or one hundredth reached Providence, will any electrician say that the wires from New York, in the course of 975 feet, could have given up to the parallel District wire one tenth or one hundredth of their electrical wave motion? Lastly, when the District circuit had secured this minute fraction of the original music bearing electric waves, will any electrician say that the shunt as described (containing 500 ohms resistance, while the shunted quarter of a mile of District wire contained only 5 ohms resistance) could have diverted one tenth of the electric motion from the District circuit?

The music heard plainly in Providence did not, therefore, require or use one ten thousandth, hardly one hundred thousandth, of the electro-motive force originally imparted to the Albany wire.

This startling conclusion suggests, first, the wonderful delicacy of the magneto-telephone, on which point I shall venture to enlarge, and second, the as yet unimagined capacity of electricity to transport sound.

The magneto-telephone is probably the most sensitive of electroscopes for galvanic, magneto-electric, and atmospheric or free electricity, and will be used extensively in science and the arts, in this capacity. In the French Academy, on the 6th of Novem-

be
in
ele
tai
les
sin
bri
In
rea
ele
tele
fiel
A
ver
mag
the
wir
galv
tele
fere
P
tele
time
tele
there
mom
a cor
scopi
Brow
railro
At th
overh
Th
curio
of the
specia

ber, Mr. Breguet introduced the telephone as, of all known instruments, operating under the influence of the most feeble electrical currents. Prof. John Peirce, of Providence, has ascertained that the telephone gives audible signals with considerably less than one hundred thousandth part of the current of a single Leclanché cell. In testing resistances with a Wheatstone bridge, the telephone is more sensitive than the galvanometer. In ascertaining the continuity of fine wire coils it gives the readiest answers. For all the different forms of atmospheric electrical discharge—and they are constant and various—the telephone has a language of its own, and opens to research a new field in meteorology.

A magneto-telephone in Providence has been found, under very favorable conditions, to overhear the speech of another magneto-telephone on a parallel wire. But it will be noticed that the music and Morse operating so noisily overheard on other wires are not products of the magneto-telephone, but of powerful galvanic currents. The delicate magneto-electric current of the telephone is not generally exposed to eavesdropping, unless different sets of wires actually come in contact.

Prof. Peirce has observed that if one screw-cup of a magneto-telephone is connected with a ground wire, in use at the same time for Morse operating, the Morse signals will be heard in the telephone, although the other screw-cup is disconnected, and there is no circuit. Here the coils of the telephone seem to be momentarily charged by the passing signals, on the principle of a condenser. A still more striking illustration of the electroscopic delicacy of the telephone is this: Prof. E. W. Blake, of Brown University, talked with a friend for some distance along a railroad, using the two lines of rails for the telephonic circuit. At the same time he heard the operating on the telegraph wires overhead, caught by the rails, probably by induction.

The absence of insulation in this experiment recalls another curious observation. The telephone works better in some states of the atmosphere than in others. A north-east wind appears specially favorable. When a storm is approaching the sounds

are sometimes weak; but the talking is often loud and excellent in the midst of a storm, when insulation is most defective. I have just verified this by talking over a short line where the wire is without insulation, and its only support between two houses, the trunk of a tree, just now sheeted with water from falling rain. This apparent indifference to insulation in a telephone which will overcome a resistance of eleven thousand ohms is not easily explained. This is only one of a multitude of paradoxes presented by the telephone.

The sound produced in the telephone by lightning, even when so distant that only the flash can be seen in the horizon, and no thunder can be heard, is very characteristic, something like the quenching of a drop of melted metal in water, or the sound of a distant rocket. The most remarkable circumstance is that this sound is always heard just before the flash is seen—that is, there is a probable disturbance (inductive) of the electricity overhead, due to the distant concentration of electricity preceding the disruptive discharge. On Sunday, November 18, 1877, these sounds were heard and remarked upon in Providence the first time for several weeks. The papers on Monday morning explained it by the report of thunder storms in Massachusetts on the preceding day. Frequent sounds of electrical discharge similar to that of lightning, but much fainter, are almost always heard several hours before a thunderstorm. This has just been exemplified in Providence.

The sounds produced in the telephone by the auroral flashes or streamers were observed in Providence by Prof. John Peirce, in May or June, 1877.

I will give one further illustration of the delicacy of the telephone, this time in relation to magnetism. In June, 1877, Prof. E. W. Blake substituted for the magnet of the telephone a bar of soft iron, free from magnetism. When this was held in the line of the dipping needle, the telephone talked readily by the earth's magnetism. But when the telephone was swayed into a position at right angles with the line of the dipping needle (in the same vertical plane), it was absolutely silent; and the

vo
dir
I
ove
per
son
clai
Sar
wor
no r
the

M
on t

The t
simply
which
the po
The
open t
of vib
cury in
receiv
with th
tube of
through

voice increased or faded out in proportion as the telephone was directed toward or receded from the pole of the dipping needle.

It remains only to speak of the quality of the concert music overheard in Providence. The rendering of the music was very perfect, but articulation was deficient or absent, both in the songs and in some sentences which are said to have been declaimed in New York for the amusement of the audiences in Saratoga and elsewhere. The papers of the day report that the words were undistinguishable in Saratoga. There is, therefore, no reason to suppose that the sounds lost anything in quality in the course of their indirect transmission to Providence.

BREGUET'S TELEPHONE.

M. Breguet has invented an entirely novel telephone, based on the principle of Lippmann's electro-capillary electrometer.



Fig. 133.

The transmitter and receiver are exactly alike, and each consists simply of a glass vessel containing a layer of mercury, over which floats a layer of acidulated water. Into this water dips the point of a glass tube containing mercury.

The upper part of the glass tube contains air, and may be open to the atmosphere or closed by a plate or diaphragm capable of vibrating. The circuit is formed by connecting the mercury in the tube of the transmitting telephone with that in the receiver, and also the mercury in the vessel of the transmitter with that in the receiver. When one speaks over the top of the tube of the transmitter, the vibrations of the air are transmitted through the mercury to the point of the tube where the mercury

makes contact with the acidulated water of the vessel by the fine capillary bore of the tube. Here the electro-capillary action takes place, the vibratory motions of the mercury generating electro-capillary currents, which traverse the circuit to the receiver, and by a reverse process reproduce the air vibrations at the top of the tube of the receiver. M. Breguet says that this telephone, unlike Prof. Bell's, is capable of reproducing not only oscillatory motions of the air, but of reproducing the exact range of the most general movements of the vibratory plate. A portable form of this instrument, constructed by M. Lippmann, consists of a fine glass tube, several centimetres long, containing alternate drops of mercury and acidulated water, so as to form an electro-capillary series. It is sealed at the ends, by which two platinum wires make contact with the terminal mercury drops. A rondelle of firwood is fixed normally to the tube by its centre, and gives a larger surface for the voice to act against, so as to furnish more motion to the tube when it acts as a transmitter, and be easily applied to the ear when it is a receiver.

M. Breguet claims for this telephone that it will act through submarine cables with instantaneous effect, because it will only establish variations of potential at the sending end of the line, and, unlike other telephones, will not generate currents to flow through the line. But this claim does not appear to us to be justifiable, since currents must result in the line from the variations of potential set up; and, if there is to be any communication at all, they must travel throughout the length of the cable from end to end.

REMARKS ON THE THEORY OF THE TELEPHONE.¹

It is generally admitted that the audition of speech in the telephone is the result of repetitions, by the diaphragm in the receiving instrument, in consequence of electro-magnetic effects, of the vibrations produced in the transmitter when the voice is

¹ By Th. du Moncel. Extract from Comptes Rendus of the French Academy of Sciences.

directed against its diaphragm. If we consider the effects produced, however, a little reflection will show us that this explanation can hardly be admitted, and, in addition to this, all recent experiments, if not positively condemning it, seem at least to show that it is incomplete. It has, in fact, been demonstrated that not only can the vibrating diaphragm of the telephone receiver be replaced by a very thick and heavy armature without thereby altering the transmission of speech, but it has also been shown that the diaphragm may be made of some non-magnetic substance; and more recently Mr. Spottiswoode has ascertained that the vibrating plate even may be dispensed with without preventing telephonic transmission, if the polar extremity of the magnet is placed very near to the ear. If we consider, on the other hand, that different parts of the telephone may be made to transmit articulate sounds either directly or through the intermediary of a string telephone, as shown by Mr. A. Breguet, we are led to believe that the vibrations which reproduce speech in the receiver belong principally to the magnetic core within the bobbin, and, consequently, that they are of the same character as those studied by Messrs. Page, Henry, Wertheim and others, in electro-magnetic bars. These vibrations, as is well known, have been utilized since 1861 in Reiss's telephone, and more recently in the telephones of Messrs. Cecil and Leonard Wray, Van der Weyde and Elisha Gray. Under this hypothesis the vibrating diaphragm, when actuated by the voice, has no other role to fill than that of generating induced currents in the transmitter, and, when made to vibrate by the bar in the receiver, of reinforcing the magnetic effect of the latter by reacting upon its polar extremity.

Now, since the amplitude of these vibrations becomes greater as the diaphragm is made more flexible, and, on the other hand, the variations in the electro-magnetic state of the plate taking place with increased rapidity as its mass is reduced, it will be understood immediately why it is important to use very thin vibrating disks. In transmission, greater amplitude increases the strength of the induced currents, and in receiving, the varia-

tions of magnetization determining the sounds are rendered sharp and clear, and there is consequently an advantage in both cases. This hypothesis, it will also be observed, in no wise excludes the phonetic effects of such mechanical vibrations as may be produced, and whose action would therefore be added to that in the magnetic cores.

In the telephones of Messrs. Reiss, Wray and Gray, the magnetic cores have no armatures at all, sonorous boxes alone being used for increasing the sounds; but in Bell's telephone it is more particularly the vibrating disks in the receivers which determine the sound effect, and the permanent magnet is used solely for the purpose of rendering the apparatus capable of being used both as a transmitter and receiver. In the Bell model, shown at Philadelphia, the receiver consisted simply of a tubular magnet, whose cylindrical pole was provided with a vibrating plate.

We have now to ascertain what the physical effects are to which the vibrations of the magnetic core, under the influence of variations in the strength of the current in the bobbin, should be attributed, and for this purpose it is necessary to refer to the experiments of Messrs. Page, Henry and Wertheim. From these it would appear that they are due entirely to the contractions and dilations of the magnetic molecules of the core, under the influence of successive magnetization and demagnetization; and this assumption receives additional confirmation from the changes that have been observed to take place, by certain physicists, in the length of a bar of iron when submitted to energetic magnetic action.

As to the more efficacious action of induced currents in telephonic transmission, I do not find it difficult to believe that they owe this advantage directly to their instantaneous character or the suddenness of their production. For this reason, they are not, like voltaic currents, dependent upon the duration of the vibrations in the transmitter; and, as they do not have to pass through a variable period either, which increases as the square of the length of the circuit, their action simply depends upon

their strength alone. They are, consequently, much more favorable for the production of phonetic vibrations than voltaic currents; and the fact that the inverse currents which follow the initial pulsation tend to discharge the line promptly, contributes still more toward rendering their action sharper and more rapid.

If we consider, also, that the currents produced by the action of the voice on the diaphragm of an ordinary telephone do not exceed that from a single Daniell cell in a circuit of 100 megohms resistance, as has been shown by the researches of Mr. Warren de la Rue to be the case, we can readily understand that the greater or less strength of these currents is of little importance in the phonetic effects produced, and, under ordinary circumstances, would be incapable of producing mechanical movements or vibrations of sufficient magnitude in a plate like that of the telephone to produce the sounds we hear.

CHAPTER X.

THE TALKING PHONOGRAPH.

THE Talking Phonograph, invented by Mr. Thomas A. Edison, is a purely mechanical invention, no electricity being used. It is, however, somewhat allied to the telephone, for, like the latter, its action depends upon the vibratory motions of a metallic diaphragm, capable of receiving from and transmitting to the air sound vibrations.

The term phonograph, or sound-recorder, includes, besides Mr. Edison's, a large number of instruments, which, though they are not able to reproduce sound, are capable of graphically representing it.

Before treating of these instruments, it might be well to recall what has been said in an earlier part of this work on the nature of sound.

Bearing in mind that sound is and has for its origin motion, we will see that a vibrating body, situated in an elastic medium like our atmosphere, becomes the central source of a peculiar form of action, which is ever propagated outward. This is known as wave motion, and if the number of vibrations causing it be within certain limits, the wave motion becomes perceptible to the ear, and is called sound.

Any change in the original vibrations will cause a change in the nature of the sound emitted. Thus, if their amplitude be increased, the sound becomes louder, and can be heard at a greater distance, or, in other words, intensity is dependent on the extent of the vibrations.

Again, should the number of vibrations in equal portions of time be varied, the note will rise or fall in the musical scale; or, pitch depends on the number of vibrations occurring in a given time.

A third and, in this connection, more important characteristic

of sound is that, while an unchanging fundamental tone is emitted, other and more rapid vibrations may accompany it, on the same principle that the surface of large ocean waves is covered with smaller and independent ripples. It is the accompaniment and predominance of certain of these harmonics, as they are called, that gives to a note that peculiar property whereby it may be distinguished from another of equal intensity and pitch. This characteristic is often called the timbre or color of the note, but is known equally well as its quality.

The human voice is the most perfect of all musical instruments. Certain parts of its mechanism can at will be thrown into vibration, and these vibrations can be varied in amplitude and number at pleasure. Associated with the apparatus for effecting this, is a hollow cavity, which serves, as does the resonant chamber of an organ pipe, to reinforce the sound. The shape of this cavity may be so varied that it will resound to vibrations of any pitch. By means of this latter power we are able to produce the vowel sounds. Accompanying the original vibrations are others which are multiples of it, and it is by reinforcing one or more of these that the quality of each vowel is secured. Thus the forcible expulsion of air from the mouth may give rise to articulate speech or sounds, whose shadings and degrees of loudness vary with the number and pressure of the resulting impulses, and also with the degree of suddenness with which they commence and terminate.

So rapid are the vibrations of a body when emitting a sound, that the eye and ear cannot discern all the phenomena which accompany them. This has led students of acoustics to devise means of representing graphically the movements which the sounding body undergoes; and it is through the study of these drawings that much of our knowledge of the nature of sound has been obtained.

One of the simplest ways of producing what we shall hereafter call the record of a sound is to draw a vibrating tuning fork over a sheet of paper, so that a pencil attached to one prong of the fork shall leave behind it a waving line, as shown in fig. 134.

With this crude arrangement the energy is wasted in overcoming friction, and the fork soon comes to rest. To lessen the friction it is usual to employ paper covered with a layer of lamp-black. Instead of the pencil is substituted a small pointed bristle,



Fig. 134.

the weight of which is so slight that it will not modify the motion of the prong. With very little force the black can be removed, leaving a white line on a dark ground.

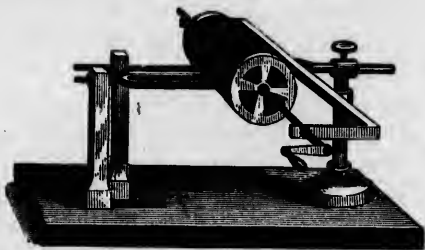

Fig. 135.

The use of a revolving cylinder, around which the paper is wrapped, early suggested itself, and in the hands of Duhamel the apparatus assumed the form shown in fig. 135. The axis upon which the drum revolves is a screw, which turns in a fixed nut,



Fig. 136.

causing the drum to advance at each revolution through the distance between two consecutive turns of the thread, which is sufficient to prevent one portion of the record from being super-placed upon that which precedes it. Fig. 136 shows the paper

after it has been removed from the cylinder and spread out. The dots, a, b, c, etc., are made by a clock which usually accompanies the apparatus. The distance between them represents the duration of one second. The amplitude and peculiar character of each vibration are clearly shown, and to ascertain the rate of vibration it is only necessary to count the number of undulations between two consecutive dots.

Devices have also been made by König, with which the resultant vibrations arising from two or more notes emitted simultaneously may be recorded directly from the vibrating bodies.

The phonograph invented by M. Léon Scott does not require that tracing shall be made at the place where the sound originates, but wherever it can be heard. It consists of a hollow chamber, made sufficiently large to respond to sounds of the lowest audible pitch, mounted before a cylinder, similar to that shown in fig. 135. One end of this resonator is left open, and the other is terminated by a ring, on which is fixed an elastic membrane. The air within the resonator is easily thrown into vibration, which is shared by the membrane. The latter carries a stylus, which also participates in the motion, and records it upon the blackened paper. The human voice, the tones from musical instruments, and even the rumbling of distant thunder are thus graphically presented on paper.

For recording vocal impulses one of the most sensitive instruments is the logograph, invented by W. H. Barlow, F. R. S.

The pressure of the air in speaking is directed against a membrane, which vibrates and carries with it a delicate marker, which traces a line on a travelling ribbon. The excursions of the tracer are great or small from the base line which represents the quiet membrane, according to the force of the impulse, and are prolonged according to the duration of the pressure, different articulate sounds varying greatly in length as well as in intensity; another great difference in them also consists in the relative abruptness of the rising and falling inflections, which makes curves of various shapes. The smoothness or ruggedness of a sound has thus its own graphic character,

independent both of its actual intensity and its length. The logograph consists of a small speaking trumpet, having an ordinary mouth-piece connected to a tube, the other end of which is widened out and covered with a thin membrane of gold beater's skin or gutta percha. A spring presses slightly against the membrane, and has a light arm of aluminium, which carries the marker, consisting of a small sable brush inserted in a glass tube containing a colored liquid. An endless strip of paper is



Fig. 137.

caused to travel beneath the pencil, and is marked with an irregular curved line, the elevations and depressions of which correspond to the force, duration and other characteristics of the vocal impulses. The lines thus traced exhibit remarkable uniformity when the same phrases are successively pronounced.

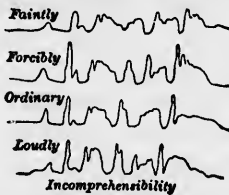

Fig. 138.

Fig. 137 shows curves obtained by the interposition of a light lever between the membrane and the smoked glass, which is drawn along beneath the style, whose excursions are much magnified by the lever. The curves show respectively the tongue trill or German *r* prolonged, the mark produced by the sound of a trombone, and by the sound of *oo* in mood.

Fig. 138 shows a tracing from the utterance of the word incomprehensibility, with different degrees of effort. It will be

vibr
hun
T
of a
vibr
glass
mois
attac

noticed that while a certain variation occurs, due to the energy, each sound preserves a specific character.

Fig. 139 shows in the upper portion the effect of words of quantity which require a large volume of air, and are maintained a relatively longer time than the more explosive or intense kind.

The lower diagram is what the tracer wrote when the familiar stanza from Hohenlinden was repeated.

A much more delicate instrument for recording sonorous

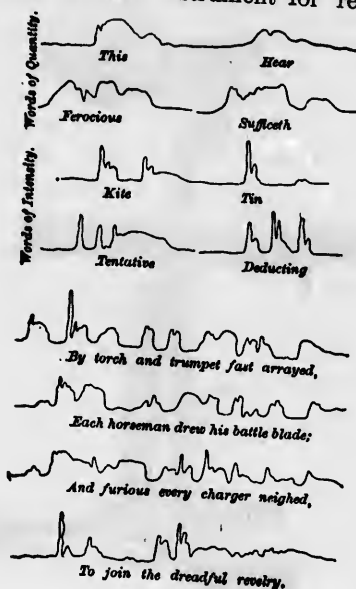

Fig. 139.

vibrations has been made by using the membrana tympani of the human ear as a logograph. This is represented in fig. 140.

The stapes was removed, and a short stylus of hay substituted, of about the same weight, so as to increase the amplitude of the vibrations and afford means of obtaining tracings upon smoked glass, as in the logograph experiments. The membrane is kept moist by a mixture of glycerine and water, and the specimen attached to a perpendicular bar sliding in an upright post, and

moved by a ratchet wheel. To the upright is attached, horizontally, a metallic stage six inches in length, upon which slides a carriage with a glass plate, and having a regular movement given to it by wheel and cord. A bell-shaped mouth-piece is inserted in the external auditory meatus and luted in position.

The vibrations of the membrane, due to a musical tone sounded in the bell, may be observed by means of a ray of light thrown



Fig. 140.

upon small specula of foil attached to the malleus, incus, or to different portions of the membrana tympani, or may be recorded on smoked glass by a stylus fastened to the descending process of the malleus or incus by means of glue, in a line with the long axis of the process, and extending downward, so as to reach the plate of smoked glass, which is moved at a right angle to the excursion of the stylus; the latter then traces a wave line cor-

res
sou

the
cur
am
em
to t
sem
way
and
carl
as t
upo
ordi
N
to t
kind
glas
they
they
Kön
by a
of w
front
from
part
of th
lengt
view
tinct
revol
lumin
of th
soun
Th

responding to the character and pitch of the musical tone sounded into the ear.

As the glass plates present plane surfaces, and as the point of the vibrating style sweeps through the segment of a circle, the curves obtained are apt to be discontinuous, especially when the amplitude is great. To obviate this difficulty a sheet of glass is employed, having a curved surface, the concavity being presented to the stylus. The sheet of glass is a section of a cylinder whose semi-diameter is equivalent to the length of the style. In this way the point of the stylus never leaves the surface of the glass, and the curve resulting from its vibration is continuous. The carbon film is preserved by pouring collodion upon it. As soon as this is dry, the film may be floated off with water, and placed upon a plane sheet of glass, or upon paper, and varnished in the ordinary way.

Numerous other methods of rendering sound-vibrations visible to the eye might be cited. In general these methods are of two kinds. They either aim at producing a lasting record on paper, glass, etc., which may be preserved and examined at leisure, or they present to the eye in a vivid way the sound vibrations as they are actually transpiring. Of the latter class, one devised by König deserves a passing notice. A hollow chamber is divided by a thin membrane of caoutchouc into two compartments: one of which communicates through a tube to the mouth-piece, in front of which the sounds are generated; the other is supplied from a pipe with ordinary coal gas, which issues from the compartment through a fine burner, where it is ignited. Any motion of the diaphragm will change the pressure on the gas, and either lengthen or shorten the jet. The movements of the flame when viewed directly are scarcely perceptible. To render them distinct, they are received on a four-sided mirror, which is made to revolve. The image of the flame is thus lengthened out into a luminous band. When the membrane vibrates, the upper edge of the band becomes serrated, each elevation being due to one sound-vibration.

The instruments thus far described, while able to produce

records undoubtedly correct, could go no farther. The records thus made suggested no way of reproducing the sound. Nor was this effected until Mr. Edison produced his wonderful talking phonograph.

In its simplest form the talking phonograph consists of a mounted diaphragm (fig. 141), so arranged as to operate a small steel stylus placed just below and opposite its centre, and a brass cylinder, six or more inches long by three or four in diameter, which is mounted on a horizontal axis, extending, each way, beyond its ends for a distance about equal to its own length.

A spiral groove is cut in the circumference of the cylinder from one end to the other, each spire of the groove being separated from its neighbor by about one tenth of an inch. The

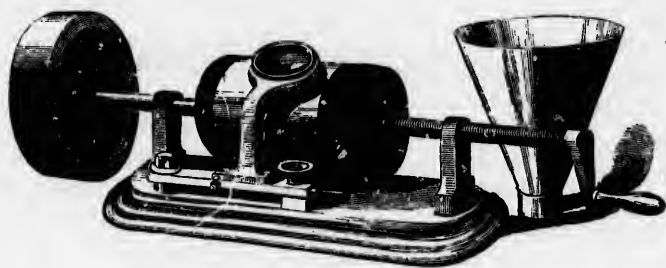

Fig. 141.

shaft, or axis, is also cut by a screw thread corresponding to the spiral groove of the cylinder, and works in screw bearings; consequently, when the cylinder is caused to revolve by means of a crank that is fitted to the axis for the purpose, it receives a forward or backward movement of about one tenth of an inch for every turn of the same—the direction, of course, depending upon the way the crank is turned. The diaphragm is supported by an upright casting capable of adjustment (fig. 142), and so arranged that it may be removed altogether when necessary; when in use, however, it is clamped in a fixed position above or in front of the cylinder, thus bringing the stylus always opposite the groove as the cylinder is turned. A small flat spring attached to the casting

ex
ric
pi
be
wh
ac
wh
tin
ing
be
pa
wh

the
as t
the
mar
of d
of t
mod
fore
they
the

extends underneath the diaphragm as far as its centre, and carries the stylus; and between the diaphragm and spring a small piece of india rubber is placed to modify the action, it having been found that better results are obtained by this means than when the stylus is rigidly attached to the diaphragm itself. The action of the apparatus will now be readily understood from what follows. The cylinder is first very smoothly covered with tinfoil, and the diaphragm securely fastened in place by clamping its support to the base of the instrument. When this has been properly done, the stylus should lightly press against that part of the foil over the groove. The crank is now turned, while, at the same time, some one speaks into the mouth-piece of

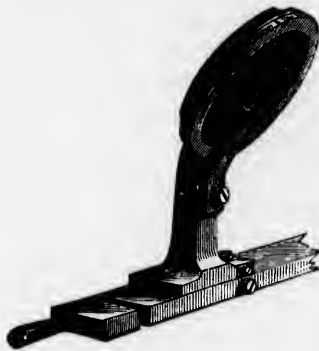

Fig. 142.

the instrument, which will cause the diaphragm to vibrate; and, as the vibrations of the latter correspond with the movements of the air producing them, the soft and yielding foil will become marked along the line of the groove by a series of indentations of different depths, varying with the amplitude of the vibrations of the diaphragm; or, in other words, with the inflections or modulations of the speaker's voice. These inflections may, therefore, be looked upon as a sort of visible speech, which, in fact, they really are. If now the diaphragm is removed by loosening the clamp, and the cylinder then turned back to the starting

point, we have only to replace the diaphragm and turn in the same direction as at first to hear repeated all that has been spoken into the mouth-piece of the apparatus, the stylus, by this means, being caused to traverse its former path; and, consequently, rising and falling with the depressions in the foil, its motion is communicated to the diaphragm, and thence through the intervening air to the ear, where the sensation of sound is produced.

As the faithful reproduction of a sound is, in reality, nothing more than a reproduction of similar acoustic vibrations in a given time, it at once becomes evident that the cylinder should be made to revolve with absolute uniformity at all times, otherwise a difference, more or less marked, between the original sound and the reproduction will become manifest. To secure this uniformity of motion, and produce a practically working machine for automatically recording speeches, vocal and instrumental music, and perfectly reproducing the same, the inventor has devised an apparatus in which a plate replaces the cylinder. This plate, which is ten inches in diameter, has a volute spiral groove cut in its surface, on both sides, from its centre to within one inch of its outer edge. An arm, guided by the spiral upon the under side of the plate, carries a diaphragm and mouth-piece at its extreme end. If the arm be placed near the centre of the plate, and the latter rotated, the motion will cause the arm to follow the spiral outward to the edge. A spring and train of wheel-work regulated by a friction-governor, serves to give uniform motion to the plate. The sheet upon which the record is made is of tinfoil. This is fastened to a paper frame, made by cutting a nine-inch disk from a square piece of paper of the same dimensions as the plate. Four pins upon the plate pass through corresponding eyelet-holes punched in the four corners of the paper when the latter is laid upon it, and thus secure accurate registration, while a clamping-frame hinged to the plate fastens the foil and its paper frame securely to the latter. The mechanism is so arranged that the plate may be started and stopped instantly, or its motion reversed at will, thus giving the greatest convenience to both speaker and copyist.

Mr. Edison has found that the clearness of the instrument's articulation depends considerably upon the size and shape of the opening in the mouth-piece. When words are spoken against the whole diaphragm, the hissing sounds, as in shall, fleece, etc., are lost. These sounds are rendered clearly when the hole is small and provided with sharp edges, or when made in the form of a slot surrounded by artificial teeth.

Beside tinfoil other metals have been used. Impressions have been made upon sheets of copper, and even upon soft iron. With the copper foil the instrument spoke with sufficient force to be heard at a distance of two hundred and seventy-five feet in the open air.

By using a form of pantograph, Prof. A. M. Mayer has obtained magnified tracings on smoked glass of the record on the

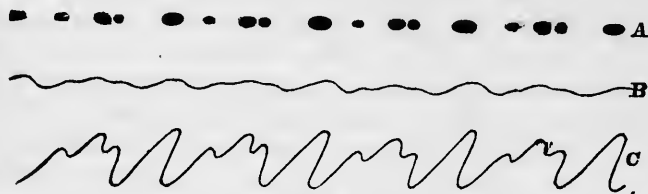

Fig. 143.

foil. The apparatus he used consisted of a delicate lever, on the under side of which is a point, made as nearly as possible like the point under the thin iron plate in the phonograph. Cemented to the end of the longer arm of this lever is a pointed slip of thin copper foil, which just touches the vertical surface of a smoked glass plate. The point on the short arm of the lever rests in the furrow, in which are the depressions and elevations made in the foil on the cylinder. Rotating the cylinder with a slow and uniform motion, while the plate of glass is slid along, the point of copper foil scrapes the lampblack off the smoked glass plate and traces on it the magnified profile of the depressions and elevations in the foil on the cylinder. In fig. 143, A represents the appearance to the eye of the impressions on the foil, when the sound of *a* in *bat* is sung against the iron plate of the phono-

graph. B is the magnified profile of these impressions on the smoked glass obtained as just described. C gives the appearance of König's flame when the same sound is sung quite close to its membrane. It will be seen that the profile of the impressions made on the phonograph, and the contours of the flames of König, when vibrated by the same compound sound, bear a close resemblance.

Mr. Mayer finds that the form of the trace obtained from a point attached to a membrane vibrating under the influence of a compound sound, depends on the distance of the source of the sound from the membrane, and the same compound sound will form an infinite number of different traces as the distance of its place of origin from the membrane is gradually increased; for, as you increase this distance, the waves of the components of the compound sound are made to strike on the membrane at different periods of their swings. For example, if the compound sound is formed of six harmonics, the removal of the source of the sonorous vibrations, from the membrane to a distance equal to $\frac{1}{4}$ of a wave length of the 1st harmonic, will remove the 2d, 3d, 4th, 5th and 6th harmonics to distances from the membrane equal, respectively, to $\frac{1}{2}$, $\frac{3}{4}$, 1, $1\frac{1}{4}$ and $1\frac{1}{2}$ wave-lengths. The consequence evidently is, that the resultant wave-form is entirely changed by this motion of the source of the sound, though the sonorous sensation of the compound sound remains unchanged. This is readily proved experimentally by sending a constant compound sound into the cone of König's apparatus, while we gradually lengthen the tube between the mouth-piece and the membrane.

The articulation and quality of the phonograph, although not yet perfect, is full as good as the telephone was six months ago. The instrument, when perfected and moved by clock work, will undoubtedly reproduce every condition of the human voice, including the whole world of expression in speech and song. The sheet of tinfoil or other plastic material receiving the impressions of sound will be stereotyped or electrotyped, so as to be multiplied and made durable; or the cylinder will be made of

a material plastic when used, and hardening afterward. Thin sheets of papier-maché, or of various substances which soften by heat, would be of this character. Having provided thus for the durability of the phonograph plate, it will be very easy to make it separable from the cylinder producing it, and attachable to a corresponding cylinder anywhere and at any time. There will doubtless be a standard of diameter and pitch of screw for phonograph cylinders. Friends at a distance will then send to each other phonograph letters, which will talk at any time in the friend's voice when put upon the instrument. How startling, also, it will be to reproduce and hear at pleasure the voice of the dead! All of these things are to be common, every-day experiences within a few years. It will be possible a generation hence to take a file of phonograph letters, spoken at different ages by the same person, and hear the early prattle, the changing voice, the manly tones, and also the varying manner and moods of the speaker—so expressive of character—from childhood up!

These are some of the private applications. For public uses, we shall have galleries where phonograph sheets will be preserved as photographs and books now are. The utterances of great speakers and singers will there be kept for a thousand years. In these galleries spoken languages will be preserved from century to century with all peculiarities of pronunciation, dialect or brogue. As we go now to see the stereopticon, we shall go to public halls to hear these treasures of speech and song brought out and reproduced as loud, or louder, than when first spoken or sung by the truly great ones of earth. Certainly, within a dozen years, some of the great singers will be induced to sing into the ear of the phonograph, and the electrotyped cylinders thence obtained will be put into the hand organs of the streets, and we shall hear the actual voice of Christine Nilsson or Miss Cary ground out at every corner.

In public exhibitions, also, we shall have reproductions of the sounds of nature, and of noises familiar and unfamiliar. Nothing will be easier than to catch the sounds of the waves on the beach, the roar of Niagara, the discords of the streets,

the noises of animals, the puffing and rush of the railroad train, of the rolling thunder, or even the tumult of a battle.

When popular airs are sung into the phonograph and the notes are then reproduced in reverse order, very curious and beautiful musical effects are oftentimes produced, having no apparent resemblance to those contained in their originals. The instrument may thus be used as a sort of musical kaleidoscope, by means of which an infinite variety of new combinations may be produced from the musical compositions now in existence.

The talking phonograph will doubtless be applied to bell-punches, clocks, complaint boxes in public conveyances, and to toys of all kinds. It will supersede the shorthand writer in taking letters by dictation, and in the taking of testimony before referees. Phonographic letters will be sent by mail, the foil being wound on paper cylinders of the size of a finger. It will recite poems in the voice of the author, and reproduce the speeches of celebrated orators. Dramas will be produced in which all the parts will be "well spoken—with good accent and good discretion;" the original matrice being prepared on one machine provided with a rubber tube having several mouth-pieces: and Madame Tussaud's figures will hereafter talk, as well as look, like their great prototypes!

¹ The phonograph has quite passed the experimental stage, and is now practically successful in every respect, and must be regarded as instrumental in opening a new field for scientific research, and making one more application of science to industry. Its aim is to record and reproduce speech, to make a permanent record of vocal or other sonorous vibrations, and to recreate these vibrations in such a manner that the original vibrations may be again imparted to the air as sounds.

The talking phonograph is a natural outcome of the telephone, but unlike any form of telephone, it is mechanical, and not electrical, in its action. In using the phonograph, it is found best to speak in a loud, clear voice, and with distinct enuncia-

¹ *Scribner's Monthly Magazine*, for April, 1878.

tion, that the vibrations may be sharply and deeply impressed on the foil. Attention must be also given to the movement of the handle, so that the passage of the foil under the stylus will be uniform and steady.

As the speed of the apparatus decides the distance between each dent marked by the sonorous vibrations, it must also decide the pitch of the tone when the sounds are reproduced. A bass voice will give only half as many vibrations as a soprano voice, one octave higher, and print half as many marks on the foil in a given space. If, in turning the instrument swiftly, the speed at which these marks pass under the stylus is increased, then the pitch of the resulting tones will be raised, and the bass voice may reappear as a soprano, or in a high, piping treble far above the pitch of any human voice. In a contrary manner, by turning the handle slowly, a soprano voice may reappear as a very deep bass. This curious circumstance, in connection with the speech of the phonograph, will undoubtedly make it necessary to employ clock work to move the apparatus, in order that an absolutely uniform rate of speed, and, consequently, rate of vibration, may be preserved while the machine is in operation. The foil, after having been impressed with the vibrations, presents a regularly lined or scored appearance. But so minute are the indentations stamped in the groove that they can hardly be seen without a glass. The foil is quite soft, and is liable to injury, and it is proposed to make stereotype copies of the proper size to fit the cylinder of the phonograph. Such cylinders will be permanent and durable, and can be used many times over without injury, or can be duplicated by electrotyping. The tone of the phonograph is usually rather shrill and piping, but this defect will undoubtedly be corrected by improved instruments. It must be observed that, marvellous as this instrument is, it is still quite new, and it is impossible to say to what degree of perfection it may yet be carried. It has already opened the door to an entirely new and untried field in the physics of sound. It is a new instrument in the hands of science wherewith to search out yet unknown laws in nature. Already it has sug-

gested many valuable uses in trade, manufactures and social life, and it will be the aim of this department to report the progress of this, one of the most remarkable inventions of this century, and its applications to science and industry.

FROM THE LIBRARY OF

T. A. MASON

MENLO PARK, N. J.

U. S. A.

**FROM THE LABORATORY OF
T. A. EDISON.
MENLO PARK, N. J.
U. S. A.**

CHAPTER XI.

EDISON'S QUADRUPLIX TELEGRAPH.

THE quadruplex system of telegraphy, by means of which four communications, two in each direction, may be simultaneously transmitted over a single wire, has, within a few years, found very extensive practical application upon the lines of the Western Union Telegraph Company, and is at the present time operated upon sixty lines, between almost all of the principal cities in the country.

The distinguishing principle of this system consists in combining at two terminal stations, two distinct and unlike methods of single transmission, in such a manner that they may be carried on independently upon the same wire, and at the same time, without interfering with each other. One of these methods of single transmission is known as the double current system, and the other is the single current or open circuit system. In the double current system the battery remains constantly in connection with the line at the sending stations, its polarity being completely reversed at the beginning and at the end of every signal, without breaking the circuit. The receiving relay is provided with a polarized or permanently magnetic armature, but has no adjusting spring, and its action depends solely upon the reversals of polarity upon the line, without reference to the strength of the current. In the single current system, on the other hand, the transmission is effected by increasing and decreasing the current, while the relay may have a neutral or soft iron armature, provided with a retracting spring. A better form, however, for long circuits, is that of the polarized relay, especially adapted to prevent interferences from the reversals sent into the line to operate the double current system. In this system, therefore, the action depends solely upon the strength

of the current, its polarity being altogether a matter of indifference

It will thus be apparent that by making use of these two distinct qualities of the current, viz., polarity and strength, combined with the duplex principle of simultaneous transmission in opposite directions, four sets of instruments may be operated at the same time, on the same wire. This method possesses, moreover, the important practical advantage that the action of each of the receiving relays is perfectly independent. Each receiving operator controls his own relay, and can adjust it to suit himself without interfering with the other.

Fig. 144 shows the quadruplex apparatus, as arranged upon the bridge plan, which was at first employed by the Western Union Telegraph Company in 1874, when the system was placed upon its lines.

T_1 is a double current transmitter or pole-changer, operated by an electro-magnet, local battery e_1 and finger key K_1 . The office of the transmitter T_1 is simply to interchange the poles of the main battery E_1 , with respect to the line and ground wires, whenever the key K_1 is depressed; or, in other words, to reverse the polarity of the current upon the line by reversing the poles of battery E_1 . By the use of properly arranged spring contacts, $s_1 s_2$, this is done without at any time interrupting the circuit. Thus the movements of the transmitter T_1 cannot alter the strength of the current sent out to line, but only its polarity or direction. The second transmitter, T_2 , is operated by a local circuit and key K_2 in the same manner. It is connected with the battery wire 12, of the transmitter T_1 , in such a way that when the key K_2 is depressed, the battery E_1 is enlarged by the addition of a second battery, E_2 , of two to three times the number of cells, by means of which it is enabled to send a current to the line of three or four times the original strength, but the polarity of the current with respect to the line of course still remains, as before, under control of the first transmitter T_1 .

At the other end of the line are the two receiving instruments R_1 and R_2 . R_1 is a polarized relay with a permanently mag-

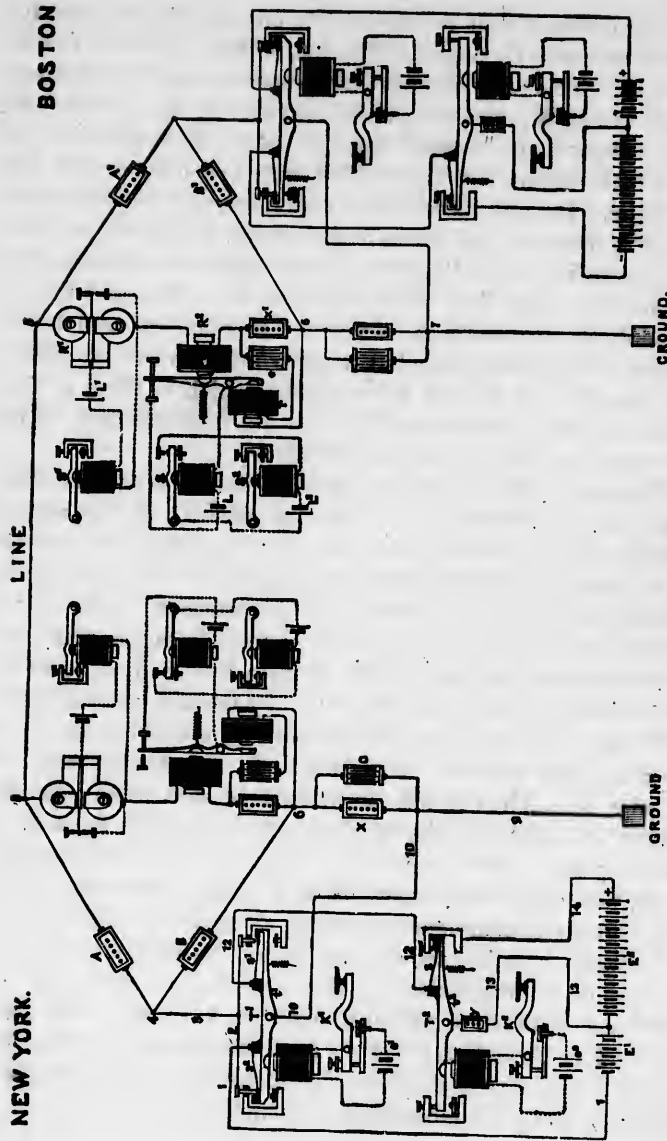

Fig. 144.

netic armature, which is deflected in one direction by positive, and in the other by negative currents, without reference to their strength. This relay consequently responds solely to the movements of key K_1 , and operates the sounder S_1 by a local circuit from battery L_1 in the usual manner. Relay R_2 is placed in the same main circuit, and is provided with a neutral or soft iron armature. It responds with equal readiness to currents of either polarity, provided they are strong enough to induce sufficient magnetism in its cores to overcome the tension of the opposing armature spring. The latter, however, is so adjusted that its retractile force exceeds the magnetic attraction induced by the current of the battery E_1 , but is easily overpowered by that of the current from E_1 and E_2 combined, which is three or four times as great. Therefore, the relay R_2 responds only to the movements of key K_2 and transmitter T_2 .

The same difficulty which troubled former inventors arises again in this connection. When the polarity of the current upon the line is reversed during the time in which the armature of R_2 is attracted to its poles, the armature will fall off for an instant, owing to the cessation of all attractive force at the instant when the change of polarity is actually taking place, and this would confuse the signals by false breaks if the sounder were connected in the ordinary way. By the arrangement shown in the figure, the armature of the relay R_2 makes contact on its back stop, and a second local battery L_2 operates the receiving sounder S_2 . Thus it will be understood that when relay R_2 attracts its armature, the local circuit of sounder S_2 will be closed by the back contact of local relay S ; but if the armature of R_2 falls off, it must reach its back contact, and remain there long enough to complete the circuit through the local relay S and operate it before the sounder S_2 will be affected. But the interval of no magnetism in the relay R_2 , at the change of polarity, is too brief to permit its armature to remain on its back contact long enough to affect the local relay S , and through the agency of this ingenious device the signals from K_2 are properly responded to by the movements of sounder S_2 .

By placing the two receiving instruments R_1 and R_2 in the bridge wire of a Wheatstone balance, and duplicating the entire apparatus at each end of the line, the currents transmitted from either station do not affect the receiving instruments at that station. Thus in fig. 144 the keys K_1 and K_2 are supposed to be at New York, and their movements are responded to only by the receiving relays R_1 and R_2 at Boston. The duplicate parts which are not lettered operate in precisely the same manner, but in the opposite direction with respect to the line.

In applying this system of quadruplex transmission upon lines of considerable length, it was found that the interval of no magnetism in the receiving relay R_2 (which, as before stated, takes place at every reversal in the polarity of the line current) was greatly lengthened by the action of the static discharge from the line, so that the employment of the local relay S was not sufficient to overcome the difficulties arising therefrom. A rheostat or resistance X_1 was therefore placed in the bridge wire with the receiving instruments R_1 and R_2 , and shunted with a condenser c of considerable capacity. Between the lower plate of the condenser and the junction of the bridge and earth wire an additional electro-magnet r was placed, acting upon the armature lever of the relay R_2 , and in the same sense. The effect of this arrangement is, that when the current of one polarity ceases, the condenser c immediately discharges through the magnet r , which acts upon the armature lever of relay R_2 , and retains it in position for a brief time before the current of the opposite polarity arrives, and thus serves to bridge over the interval of no magnetism between the currents of opposite polarity.

It will be seen that the combination of transmitted currents in this method differs materially from any of those used in previous inventions. They are as follows:

1. When the first key is closed and the second open, + 1
2. When the second key is closed and the first open—3 or—4
3. When both keys are closed..... +3 or +4
4. When both keys are open..... -1

Here we discover another very important practical advantage in the system under consideration, which is due to the fact that the difference or working margin between the strengths of current, required to produce signals upon the polarized relay and upon the neutral relay, respectively, may be increased to any extent which circumstances render desirable. Within certain limits, the greater this difference the better the practical results, for the reason that the range of adjustment of the neutral relay increases directly in proportion to the margin. The ratio of the respective currents has been gradually increased from 1 to 2 to as high as 1 to 4, with a corresponding improvement in the practical operation of the apparatus.

From what has been said, therefore, it will be seen that before it became possible to produce a quadruplex apparatus capable of being worked at a commercial rate of speed upon long lines, it was essential that its component parts should have arrived at a certain stage of development. When, in the early part of 1872, simultaneous transmission in opposite directions was for the first time rendered practicable upon long lines by the combination therewith of the condenser, the first step was accomplished. It now only remained to invent an equally successful method of simultaneous transmission in the same direction, which, as we have seen, was done in 1874. The application of one or more of the existing duplex combinations to the new invention, to form a quadruplex apparatus, soon followed as a matter of course.

The following method of simultaneous transmission in the same direction was invented in December, 1875.

Fig. 145 is a diagram of the apparatus as arranged for quadruplex transmission. The lever t_1 , with its appendages, constitutes the first or single-point transmitter, which is the same as that of the Stearns duplex, being operated by an electro-magnet T_1 , local battery t and key K_1 . The second or double-point transmitter consists of a quadrangular plate of hard rubber, E , mounted upon an axis, and capable of being oscillated by the arm e , which is rigidly attached to it. By means of a spring e_1 , the

arm e presses upon a roller fixed upon one end of the lever d , which forces the other end of the lever against the stop d_1 . The lever d carries the armature of the electro-magnet T_2 , which, like the single point transmitter, is operated by a local battery and key K_2 . The oscillating plate E has four insulated contact points f, g, f_1, g_1 , upon its respective angles. The contact levers F and G are mounted on axes at each end of the plate E , and

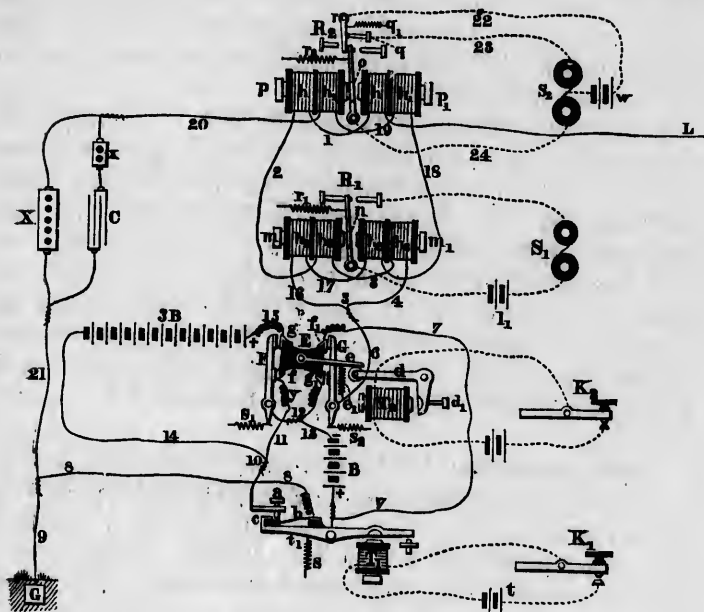

Fig. 145.

are pressed against it by springs $s_1 s_2$. When the transmitter is in a position of rest, as shown in the figure, F is in contact with f and G with f_1 , and the parts are kept in this position by the action of the spring e_1 . When key K_2 is depressed, the arm e is raised by the action of the electro-magnet T_2 upon the bent lever d ; this turns the plate E upon its axis, and brings F into contact with g and G with g_1 .

In this apparatus, as in the one previously described, there are four different electrical conditions possible when transmitting two simultaneous despatches in the same direction, as follows:

1. *Both keys in a position of rest.* This position is represented in fig. 145. Disregarding for the present the receiving instruments and their connections, the circuit may be traced as follows: From the earth at G through wires 9 and 8, contact spring *b*, lever *t*₁, wire 7, contact point *f*₁ and lever G, wires 6 and 5, and thence through the receiving instruments to the line L. Thus the line wire is connected to earth without any battery, and there is no current upon the line.

2. *The first key closed and the second key open.* The route is the same as before from the earth at G to contact spring *b*. From this point it now diverges through contact lever F, wires 12, 13, and battery B to wire 7, and thence to the line as before. The battery B is now in circuit and sends a + current to line.

3. *The second key closed and the first key open.* The route is now from the earth at G, through wires 9 and 8, contact spring *b* and lever *t*₁, as in the first instance, thence through battery B, wires 13, 12, contact lever G, wires 6, 5, and through the receiving instruments to line. The same battery B now sends a — current to the line.

4. *Both keys closed.* The route is now from the earth at G, by wires 9 and 8 to contact spring *b*; thence by contact point *a* and wire 14 to battery 3B; thence by wire 15, through *g* to lever F, wire 12 and *g*₁ to contact lever G, and finally through wires 6 and 5 to the line. The battery 3B, which contains about three times as many elements as B, now sends a + current to the line. It will thus be seen that the two batteries B and 3B are never thrown together on the line at the same time, as in the previous arrangement.

The receiving apparatus consists of two sounders, S₁ and S₂, which are controlled by two relays, R₁ and R₂, fig. 145. The line wire L, on entering the receiving station, passes through the coils of both relays, and thence to earth through the transmitting apparatus. Both relays are provided with polarized armatures,

and are preferably constructed with two electro-magnets m m_1 , arranged with their poles facing each other, with a permanently magnetized armature between the opposite poles.

The arriving current, entering the relay R_1 , passes through the wire 2 and coil h_3 of magnet m and h_3 of m_1 , which are so arranged that a + current will cause the polarized armature n to be attracted by m_1 and repelled by m , while with a — current the opposite effect will be produced.

The armature of relay R_1 is provided with a retracting spring r_1 , and operates the sounder S_1 by means of a local battery l_1 , in the ordinary manner. The relay R_2 consists of two electro-magnets p and p_1 , and its armature is also provided with a retracting spring r_2 ; but it differs materially from the other relay in the arrangement of its local connections. The polarized armature o is held by the tension of the spring r_2 , not against a fixed stop, but against the free end of a movable contact lever r , the opposite end of which turns upon an axis. The contact lever r is itself held against a fixed stop q by a spring q_1 , the tension of which considerably exceeds that of spring r_2 . The local battery w is placed in the wire 22, leading from the contact lever r to the differential sounder S_2 .

The manner in which the receiving instruments operate in each of the four different electrical conditions of the line is as follows:

1. *No current.* The local circuit of sounder S_1 is kept open by the action of spring r_1 on armature n , and it remains inactive. The opposing branch circuits 23 and 24 of sounder S_2 are both closed by relay R_2 , which render it also inactive.

2. *Current of + B.* The relay R_1 (which is affected by positive currents of any strength) operates sounder S_1 . The armature of relay R_2 is pressed more strongly against contact lever r , but not with sufficient power to overcome the spring q_1 . Sounder S_2 is therefore unaffected.

3. *Current of — B.* The armature of relay R_1 is attracted toward its back stop, and S_1 is not affected. The armature of R_2 is attracted to the right, and opens wire 24, which permits

the local battery w to operate the sounder S_2 by way of wires 22 and 23.

4. *Current of + 3B.* The armature of relay R_1 operates as in the second case. The increased power of the current from the battery of many elements causes the armature of R_2 to overcome the resistance of spring q_1 , and break the local circuit of wire 22, leaving the sounder S_2 free to operate by way of wires 22 and 24. Thus the + 3B current operates both sounders.

In order to adapt this system to quadruplex transmission, additional helices h h_1 and h_2 h_3 are placed upon the receiving relays R_1 and R_2 , which are placed in the circuit of an artificial line, arranged according to Stearns's differential duplex method, which diverges at the point 5 and goes by way of 16, 17, 18, 19, 20 and 21 to the earth at G , and is provided with the usual rheostat X and condenser C . The small rheostat α is employed to regulate the time of discharge from the condenser.

By the arrangement of the contact lever r , in connection with the armature lever o of relay R_2 , and the local circuits as above described, the reversal of polarity upon the line takes place without interrupting the signal upon sounder S_2 , for the reason that when the armature o is acted upon by the reversal it goes directly over from one extreme position to the other, without stopping at the intermediate position long enough to affect the sounder S_2 , even if there is a considerable interval between the successive currents.

An improvement upon the above arrangement was subsequently invented, in which an entirely novel combination of currents upon the line was employed, and which does not require the polarity of the current to be reversed during the transmission of a signal. In fig. 146, T_1 is a local electro-magnet, which operates the single point transmitter t_1 , under control of the key K_1 . The key K_2 in like manner controls the double point transmitter t_2 . The four electrical conditions of the line in the different positions of the keys are as follows:

1. *Both keys open.* This is the position represented in the figure. The route of the current is from the earth at G , through

wire 1, spring b , lever t_1 , wires 2 and 3, contact point o , spring O , wires 4 and 5, battery B , wires 6 and 7, contact point n , and spring N , thence by wire 8 to line L . The battery B sends a + current to line.

2. *First key closed and second key open.* The route is now

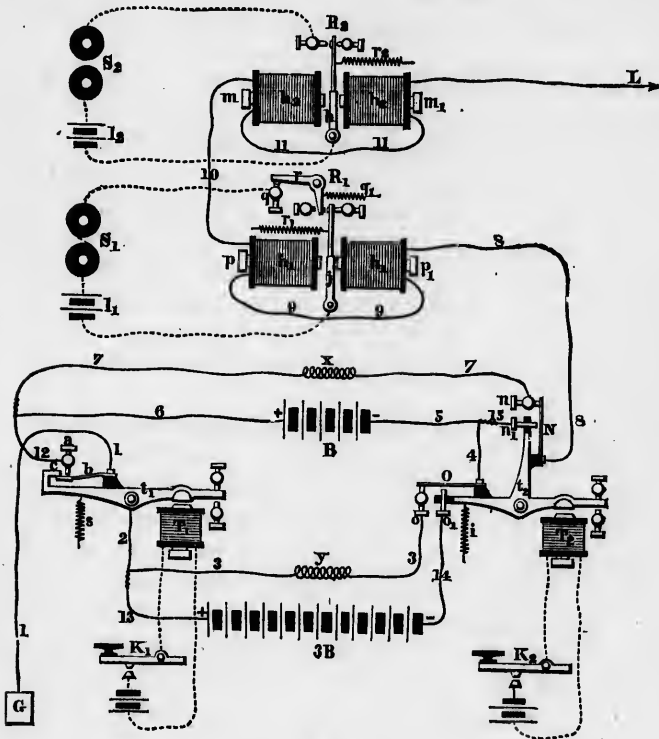

Fig. 146.

from earth at G , by wire 1 and spring b to point a , wires 12 and 7 and thence as before to the line. In this case there is no battery in circuit, and no current goes to line.

3. *Second key closed and first key open.* The route is now from earth at G by wire 1, spring b and lever t_1 , wires 2 and

13, battery 3B, wire 14, point o_1 , spring O, wires 4 and 15, contact point n_1 , spring N and wire 8 to the line. The large battery 3B sends a — current to the line.

4. *Both keys closed.* The route is from earth at G by wire 1, spring b , contact point a , wires 12 and 6, main battery B, wires 5 and 15, contact point n_1 , spring N, and wire 8 to line L. In this case the lesser main battery sends a — current to line.

The receiving apparatus consists of two sounders S_1 and S_2 , controlled by two relays R_1 and R_2 , both of which have polarized armatures, and are constructed in the same manner as those described in connection with the last method. The armature of relay R_2 is provided with a retracting spring r_2 , and operates the sounder S_2 by means of a local battery l_2 , in the usual manner. The polarized armature j , when no current is passing through the line, is held by a spring r_1 against the free end of a contact lever r , which is in turn held against the fixed stop q by the tension of a spring q_1 , which considerably exceeds that of the spring r_1 .

The manner in which the receiving instruments operate in each of the four conditions of the line is as follows: 1. *Current of + B.* The local circuit of sounder S_1 is kept open by the action of the positive current upon the polarized armature of relay R_1 , which is sufficient to overcome the tension of spring r_1 , and it therefore remains inactive. The local circuit of sounder S_2 is kept open by the action of the positive current upon the armature h of relay R_2 , in addition to the action of spring r_1 . 2. *No current.* The armature j of relay R_1 is drawn by the tension of spring r_1 over against the contact lever r , thus completing the local circuit of sounder S_1 . The armature of R_2 is held back by spring r_2 , thus breaking local circuit of S_2 . 3. *Current of — 3 B.* In this case the action of the negative current from the greater battery causes the polarized armature to press against the contact lever r and overcomes the tension of spring q_1 , and thus, although the local circuit is still closed between the armature j and contact lever r , it is now broken

between the latter and the fixed stop q , and hence sounder S_1 remains inactive. On the other hand, the negative current carries the armature h of relay R_2 to the left, closing the local circuit and actuating the sounder S_2 . 4. *Current of — B.* This current is not sufficient to overcome the tension of spring q_1 , and, therefore, the contact lever r continues to rest against stop q , and the local circuit of S_1 is completed. Relay R_2 , which operates by negative currents of any strength, closes its local circuit through the sounder S_2 .

In this arrangement it will be seen that a reversal of polarity upon the line cannot occur while a signal is being given by either key. This method may be readily united with any suitable duplex method to form a quadruplex combination.

Fig. 147 is a diagram illustrating a quadruplex method, based upon that shown in fig. 144, but embodies several important modifications and improvements not shown there. This arrangement was extensively employed for some time upon the Western Union lines, especially upon the longer circuits, and was found to be, in many respects, far superior to that first introduced. It will be seen that no changes were made in the principle of the transmitting portion of the apparatus, or the combination of currents sent to line in the different positions of the keys, but portions of the receiving apparatus were materially altered.

In fig. 147 the polarized relay R_1 , and its accompanying sounder, are placed in the bridge 5, 6, as before. The neutral relay, which was formerly placed in the bridge wire also, is discarded altogether, and is replaced by a compound differential polarized relay R_2 . This is inserted, not in the bridge wire, but in the line and earth wires; these respectively form the third and fourth sides of the bridge, of which A and B are the first and second sides. Thus, when the resistances A and B are made equal, the outgoing currents will divide equally between the line and the earth, and will neutralize each other in their effect upon the relay R_2 . The latter consists of two electro-magnets facing each other, with a polarized armature between them. When no current is passing, the polarized armature is held in a central

position between two spring contact levers $N N_1$, and the circuit of the local relay S is completed through these and the armature lever. The springs of the contact levers $N N_1$ are adjusted with sufficient tension to prevent them from responding to the current of the small battery E_1 at the sending station, but the additional current from battery E_2 will overcome the spring

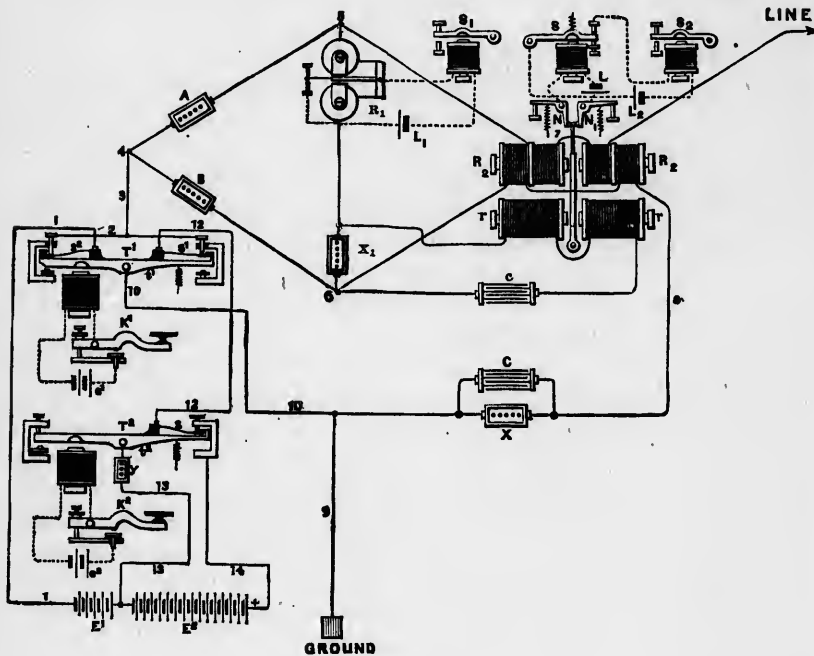

Fig. 147.

of N or of N_1 , according to its polarity, and thus break the circuit of the local relay S , which by its back contact will operate the sounder S_2 . The electro-magnets $r r$ are arranged to act in conjunction with $R_2 R_2$ upon the same armature lever, and are connected with a condenser c and a rheostat X_1 in the bridge wire, for reasons which have been fully explained on page 313.

Fig. 148 shows the connections of another form of quadruplex apparatus, embodying several important improvements that are not found in the apparatus heretofore described. Both receiving relays R_1 and R_2 are provided with differential helices and polarized armatures, and in general the differential method is employed

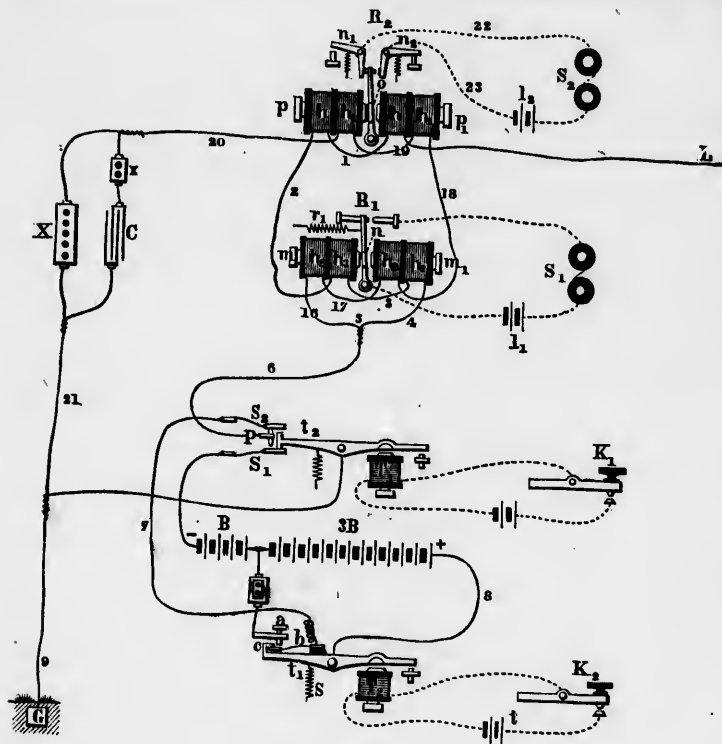

Fig. 148.

throughout in place of the bridge. The relays R_1 and R_2 may be constructed as shown in the figure, or according to Siemens's pattern. Experience has shown that the latter form gives, on the whole, the most satisfactory results, and it has therefore been adopted in all the more recent apparatus. The combination of

the outgoing currents differs from that employed in the original quadruplex, and is as follows:

K_1 open and K_2 open, current traversing line.....	+ 4 B
K_1 open and K_2 closed, " " "	+ B
K_1 closed and K_2 open, " " "	- 4 B
K_1 closed and K_2 closed, " " "	- B

As in the original quadruplex, key K_1 controls the polarity of the current going to line, but the depression of K_2 decreases the outgoing current, irrespective of its polarity, from 4 B to B; or, in other words, cuts off the battery 3 B altogether.

The only matter requiring detailed explanation is the action of the relay R_2 . When both keys are at rest, the positive current of both batteries (+ 3 B + B) is passing over the line, and the polarized armature is pressed against the contact lever n_1 , which yields, thus allowing it to separate from the contact lever n_2 , and the circuit of the sounder S_2 is broken. When K_1 is closed, the polarity of the entire battery upon the line is reversed, and the armature passes over to the other side and presses against n_2 in the same manner, so that the sounder S_2 cannot be operated by the stronger currents of either polarity. But the depression of the key K_2 in either case decreases the current, until it is unable to withstand the tension of the springs of the contact levers n_1 n_2 , and thus the local circuit through the sounder S_2 is completed, and the latter consequently responds to the movements of key K_2 .

On circuits exceeding 200 miles in length, the sounder S_2 is preferably operated through the medium of a local relay, arranged as in fig. 147. The combination of the outgoing currents in different positions of the keys is also rearranged, so as to conform to the original plans (figs. 144 and 147), and is as follows:

K_1 open and K_2 open, current traversing line	+ B
K_1 open and K_2 closed, " " "	+ 4 B
K_1 closed and K_2 open, " " "	- B
K_1 closed and K_2 closed, " " "	- 4 B

Figs. 149 and 150 comprise a plan view and diagram of a quartette table, arranged for quadruplex working on a long circuit, showing the relative positions of the different parts of the apparatus. In fig. 149 the compartment at the top of the figure is for receiving, and the other for sending; while in fig. 150 the sending operator occupies the upper compartment and the receiving operator the lower one. The letters and figures of reference indicate the same parts as in fig. 148. Additional letters of reference will be explained elsewhere. The main circuits are indicated by broken lines, and the local circuits by dotted lines.

In all of the methods of multiple transmission hitherto known, whereby two distinct communications may be simultaneously transmitted over one conductor in the same direction, or combined with any suitable one of the several known methods of simultaneous double transmission in opposite directions, so that four distinct communications may be transmitted simultaneously, without interfering with each other, it has been necessary to make use of a double-acting receiving instrument or relay at the receiving station, composed of a single electro-magnet having two or more armatures, or else of two or more independent receiving instruments.

The practical objection to the first mentioned arrangement is that the effective attraction of the electro-magnet for any one of two or more armatures is materially lessened whenever one of the others is already in contact, or nearly in contact, with its poles. Thus the movements of the separate armatures necessarily interfere with each other, which interference tends to confuse the signals. The second arrangement, viz., the use of two independent receiving instruments, although being free from the above mentioned objections, is liable to certain other defects, the principal of which are as follows: When the apparatus is arranged for the simultaneous transmission of four communications, two in each direction, it is found difficult to adjust the equating resistances and condenser capacities, so that neither of the two receiving instruments are affected by the variations in

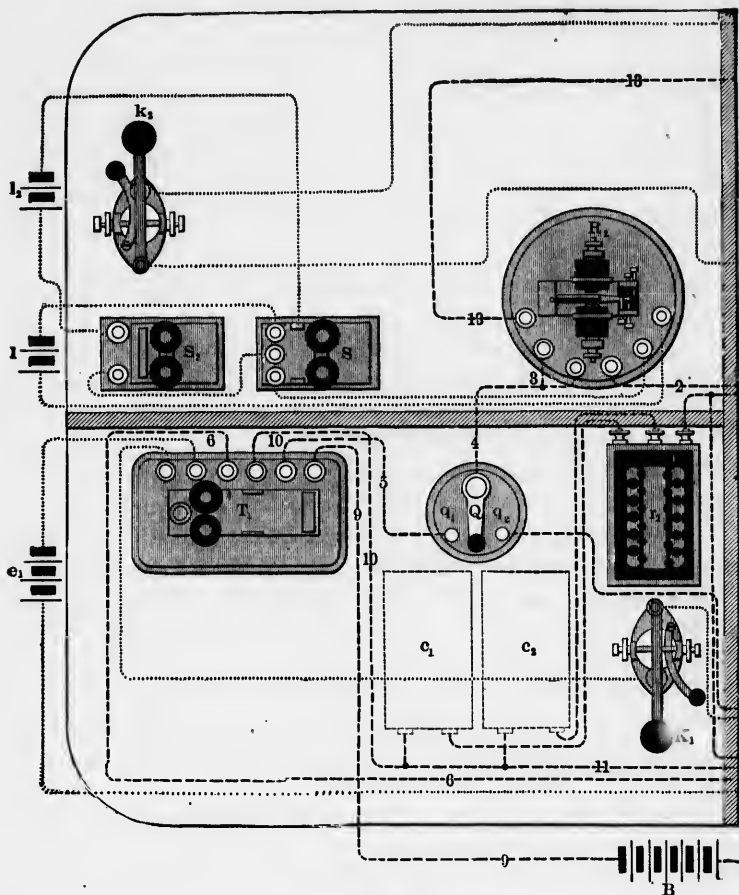

Fig. 149.

EXPLANATION OF FIGS. 149 AND 150.

K₁, Key of No. 1 sending operator.
T₁, Double current transmitter, operated by **K₁** or **k₁**.
e₁, Transmitter local, of three cells.
K₂, Key of No. 1 receiving operator.
R₂, Single polarized relay.
S₁, Receiving sounder operated by ditto.
L₁, Sounder local, of two cells.
K₂, Key of No. 2 sending operator.
T₂, Single current transmitter, operated by **K₂** or **k₂**.
e₂, Transmitter local, of three cells.

k₂, Key of No. 2 receiving operator.
R₂, Compound polarized relay.
S, Local relay or repeating sounder of ditto.
L, Local of repeating sounder (two cells).
S₂, Receiving sounder, operated by **S**.
L₂, Sounder local, of two cells.
B, Smaller division of main battery.
8 B, Larger division of main battery.
Q, Switch for cutting out main battery and connecting line to earth while balancing.
X, Large rheostat for balancing resistance of line.

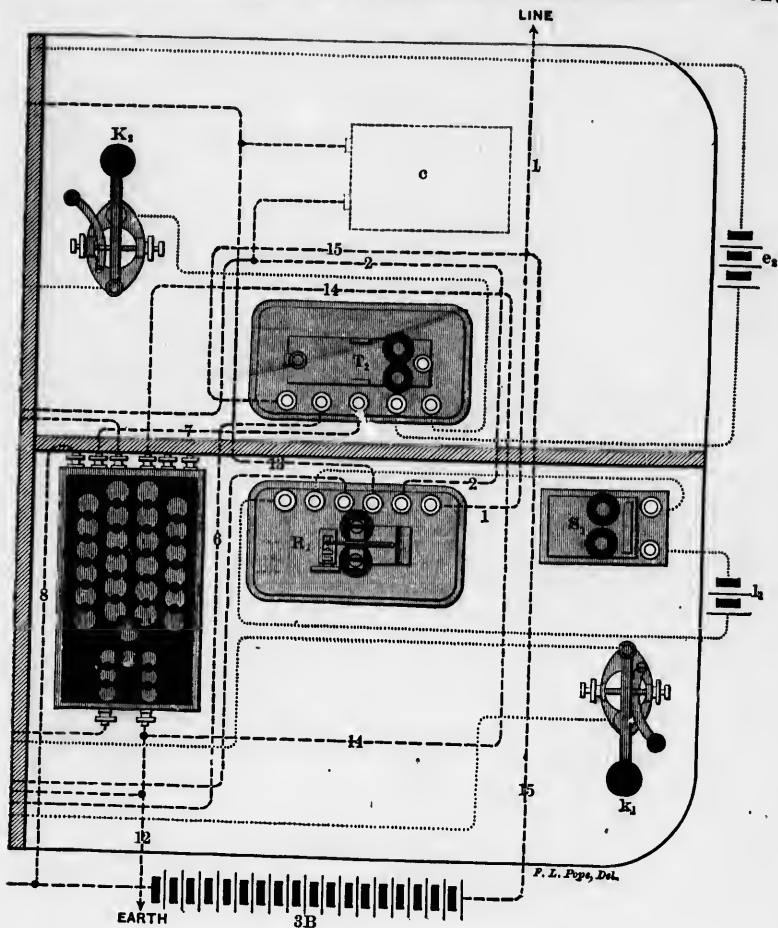

Fig. 150.

- y, Rheostat for compensating resistance of battery 3 B.
 z, Rheostat for compensating resistance of entire main battery 3 B + B.
 c, Equalizing condenser placed between main and artificial line.
 c_1 c_2 , Condensers for compensating static discharge from main line. The quantity and duration of the condenser discharge are regulated by means of the adjustable rheostats r and r_1 . The arrangement shown is employed only on lines

exceeding 400 miles in length. When a static balance is obtained, c_2 should have about twice as many sheets as c_1 (both being adjustable). The condenser c_2 should receive its charge through about half the resistance required for both. For example, if the number of sheets required in c_1 were 30, and in c_2 60 (total 90) and the resistance required for both were 2,000 ohms, c_1 would require 1,000 and c_2 1,000. On lines of less than 400 miles the arrangement shown in fig. 148 answers every purpose.

the strength or polarity of the outgoing currents; as the changes necessary to effect the proper adjustment or balance of one receiving instrument destroy the balance of the other, and much care and skill are, at times, required to accomplish the desired result.

Again, when two receiving instruments are used, one must be sufficiently sensitive to respond readily to weak currents. The other must be much less sensitive, responding only to cur-

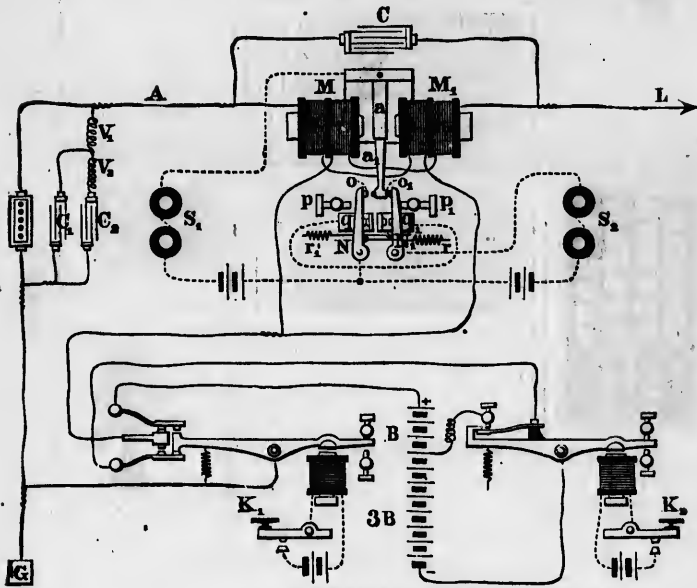

Fig. 151.

rents of greater strength. The current required to actuate the latter instrument sometimes affects injuriously the working of the more delicate one.

To meet these difficulties, a somewhat novel and ingenious arrangement has been devised, which is shown in fig. 151. The principal part of the improvement consists in the use of a new form of double acting relay, composed of a double electro-magnet

and a single armature, the latter capable of being placed, by the action of the former, in four different positions corresponding to the four possible positions of the two keys at the sending station. By means of suitably arranged contact-levers, two independent local circuits are brought into action by the same armature in its different positions, so as to actuate two independent sounders.

The diagram shows the receiving instrument or relay at one terminal station, combined with other well known apparatus, in order to effect the simultaneous transmission and reception of two communications, in the same or in opposite directions, or both, upon one conductor.

With the exception of the arrangement of contact-points and their respective local connections with the levers N and N_1 , and armature a_1 , by means of which the latter controls the local circuits which operate the sounders S_1 and S_2 , the construction of the receiving instrument is precisely the same as that used in the quadruplex system, which we have just considered, and which is fully described on page 324. As shown in the figure, the contact-levers N and N_1 of the receiving instrument turn freely upon suitable fulcrums at their lower ends, while their free upper ends, when at rest, are held against the adjustable contact points $q q_1$ by the tension of the adjustable springs $r r_1$. A contact point o is upon the upper extremity of the contact lever N ; and o_1 is an insulated stop occupying a corresponding position upon the lever N_1 . The contacts $q q_1$ are so adjusted as to allow the arm a_1 , which is rigidly attached to the armature a , to play between the stops o and o_1 upon the contact levers, which limit its motion in each direction, except at such times as the armature a moves with sufficient power to overcome the retractile force of springs $r r_1$, in which case the lever N or N_1 is pressed away from the contact q or q_1 until it strikes against the adjustable stop p or p_1 .

The operation of the two independent transmitters or keys K_1 and K_2 , at the sending station, gives rise to four different electrical conditions of the line, according to their respective positions with reference to each other, as follows:

1. First and second keys both open. This is the position of the apparatus shown in the figure. In this position of the keys both main batteries are in circuit, sending to line a positive or + current of $+ B + 3 B = + 4 B$.

2. First key closed and second key open. In this position both main batteries are also in circuit, sending to line a negative or - current of $- 3 B - B = - 4 B$.

3. Second key closed and first key open. In this position the smaller of the two main batteries only is in circuit, sending to line a positive or + current of a strength of + B.

4. First and second keys both closed. In this position the smaller battery only is in circuit, sending to line a negative or - current of a strength of - B.

At the distant terminal of the line L, the apparatus is arranged precisely as shown in the figure.

It is essential that one sounder (for example, S_1) should respond solely to the movements of the key K_1 , and the other sounder, S_2 , in like manner to the movements of the key K_2 ; while both should respond when both keys are simultaneously depressed. The manner in which this result is accomplished will be understood by the following explanation of the effect of each of the above mentioned electrical conditions of the line upon the receiving instrument.

1. Positive current from both batteries (+ 4 B). The local circuit of sounder S_1 is open between the point o and arm a_1 , and that of S_2 between the lever N_1 and the stop q_1 , because the action of the current upon the armature a , tending to attract it toward M_1 , is strong enough to overcome the tension of the spring r_1 , and force the lever N_1 against the stop p_1 .

2. Negative currents from both batteries (- 4 B). The local circuit of sounder S_1 is closed at the point of contact between arm a_1 and contact lever N ; but that of sounder S_2 is broken between the contact lever N and the stop q , because the strength of the current upon the line is so great as to overcome the tension of the spring r , and force the lever N against the stop p .

3. Positive current from battery B only (+ B). The local circuit of sounder S_1 is broken between the arm a_1 and the contact o on the lever N, but that of sounder S_2 remains closed, because the power of the current upon the line, though sufficient to move the arm a_1 away from the stop o , is not able to overcome the spring r_1 , and separate the lever N_1 from the stop q_1 .

4. Negative current from battery B only (- B). The local circuits of both sounders S_1 and S_2 remain closed, because the strength of this current is sufficient to bring the arm a_1 into contact with the stop o upon the contact lever N, but is not enough to overcome the spring r , and thus separate the lever N from the stop q .

Thus it will be understood that the armature a is caused to assume four different positions corresponding to the four different electrical conditions of the line.

When the armature is in either of its extreme positions the local circuit of the sounder S_2 is broken. When the armature passes directly over from one extreme position to the other, it, of course, closes the local circuit for an instant as it passes the middle point, but not long enough to produce any effect whatever upon the sounder S_2 , which remains inactive.

Condensers C_1 and C_2 are connected to the artificial line A for the purpose of compensating the static discharge of the line. The adjustable rheostats V_1 and V_2 are used in order to regulate the action of the condensers and render their charge and discharge nearer the same duration as that of the line.

An independent condenser C is arranged with one set of its poles in connection with the main line L, and the other set with the artificial line A.

No effect is produced upon this condenser by the outgoing current, as the potential of the latter is substantially the same on each side.

The incoming current from the distant station, meeting with the resistance of the helices $M M_1$, flows into and charges the condenser, which remains charged until a reversal of the current takes place upon the line, when it instantly discharges itself and

sends a momentary pulsation through the electro-magnets $M M_1$, thus tending to hasten the action of the receiving magnet upon its armature at each reversal, thereby improving the signals upon long lines.

The effective action of this condenser may be much increased if desired, by augmenting the resistance of the helices $M M_1$, or by inserting additional resistances between these and the junction of the wires leading to the condenser on each side.

The double acting receiving instrument here described, and shown in the figure, is equally serviceable in connection with the arrangement of main batteries illustrated and described on pages 314 and 318.

The apparatus has been tested in practical service upon all of the longest circuits on which the quadruplex system is worked from the Western Union Telegraph Company's New York office, and continued in constant use for one week on the New York and Albany circuit with very satisfactory results. In regular practice, however, it has been found preferable to use two independent relays, thus enabling each operator to adjust his own instrument.

On February 7, 1877, a test was made on a direct circuit between New York and Chicago, via Pittsburgh, Pa., a distance of 913 miles, and the simultaneous reception of two communications in the same direction was accomplished at a speed of thirty words a minute on each of the respective sounders S_1 and S_2 .

Fig. 152 shows a general plan of the quadruplex apparatus now in use on the lines of the Western Union Telegraph Company, and which embodies the more recent improvements.

The transmitting devices, both in construction and mode of operation, are precisely similar to those referred to in connection with fig. 151, so that it will be necessary here to refer only to the effect produced by the operation of the two independent transmitters or keys, which is as follows:

1. Key K_1 and K_2 both open. In this position the entire battery is in circuit, sending to the line a negative or — current of — B — 3 B — 4 B.

2. Key K_1 open and K_2 closed. In this case battery B only is in circuit, sending to the line a negative or $-$ current of $-B$.

3. Key K_1 closed and K_2 open. The entire battery is again in circuit, but in this case with the positive or $+$ pole to the line, sending a current of $+3B + B = +4B$.

4. Key K_1 and K_2 both closed. In this position the battery

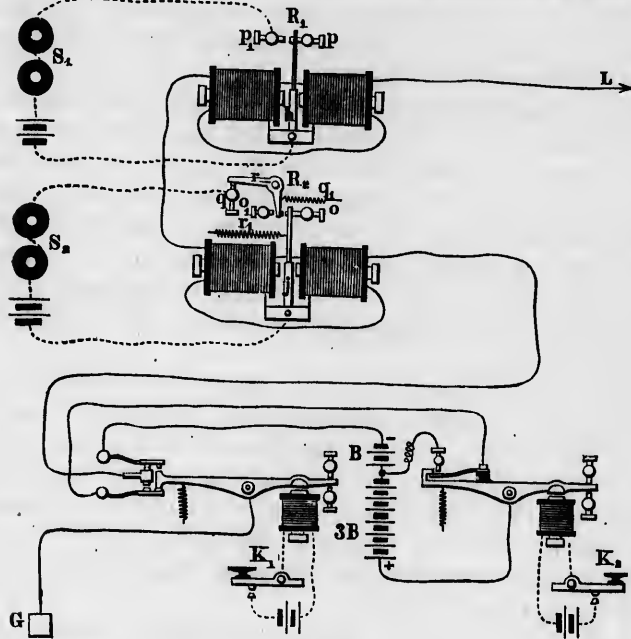

Fig. 152.

B only is in circuit, sending to the line a positive or $+$ current of $+B$.

Thus it will be understood that the line is caused to assume four distinct electrical conditions, corresponding with the four possible positions of the keys at the transmitting station.

The receiving apparatus consists of two sounders, S_1 and S_2 , which are controlled by relays R_1 and R_2 . The construction of R_1

is the same in every particular as that heretofore described ; it being, in fact, simply a polarized relay capable of responding to positive and negative currents.

The relay R_2 , however, differs materially from relay R_1 in the arrangement of its local circuit connections, by means of which the sounder S_2 is operated ; and the improvement upon the form of relay heretofore used consists chiefly in dispensing with one of the supplementary contact levers, whereby the apparatus is not only simplified, but made to work with greater facility and certainty through long circuits.

The normal position of the apparatus, when neither key at the transmitting station is depressed, is that shown in the diagram.

The manner in which the relays R_1 and R_2 operate in each of the four electrical conditions of the line mentioned, so as to cause the sounder S_1 to respond solely to the movements of key K_1 , and the sounder S_2 in like manner to the movements of key K_2 , and both in response to a simultaneous depression of keys K_1 and K_2 , will be understood by reference to the following explanation:

1. K_1 and K_2 both open. A negative or — current from both batteries (— 4B). The local circuit of sounder S_1 is kept open, because the polarity of the line current tends to hold the armature h of relay R_1 , on its back stop p . The local circuit of sounder S_2 is also open between armature j and lever r , because the current on the line is sufficiently powerful to overcome the spring r_1 , and hold armature j against stop o ; thus sounder S_2 remains inactive.

2. K_1 open and K_2 closed. A negative or — current from battery B only (— B). The local circuit of sounder S_1 remains open between stop p_1 and armature h , because the polarity of the current is such as to hold the latter against stop p . The action of this current upon relay R_2 is to cause its armature j , assisted by spring r_1 , to move to the left and make contact with the lever r , but not with sufficient force to overcome the retractile spring q_1 , thus leaving armature j in a central position between stops o and o_1 , thereby closing the local circuit and operating sounder S_2 .

3. K_1 closed and K_2 open. A positive or + current from both batteries (+ 4 B). This current causes the armature h of relay R_1 to move to the left, thus closing the local circuit at stop p_1 and actuating sounder S_1 . The armature j of relay R_2 is also strongly attracted toward the left, pressing against the yielding lever r with sufficient force to overcome the spring q_1 , and press the former against the stop o_1 , thus opening the local circuit of sounder S_2 .

4. Keys K_1 and K_2 both closed. Positive or + current from battery B only (+ B). Relay R_1 , which is arranged to close its local circuit by positive currents of any strength, actuates the sounder S_1 precisely as in the third case. The current upon the line in this case is not of sufficient strength to hold the armature j of relay R_2 against stop o_1 ; consequently it moves, together with lever r , assisted by spring q_1 , to a central position, thus closing the local circuit between armature j and stop q through lever r , thereby operating sounder S_2 . When the armature j of relay R_2 passes directly over from one extreme position to the other: for example, from stop o to o_1 , it will be observed that the local circuit is closed for an instant, but not long enough to produce any effect whatever upon the lever of sounder S_2 .

It is therefore obvious that, with the apparatus as arranged above, two communications may be simultaneously transmitted over a single conductor, and the signals recorded with facility and accuracy.

In order that four communications may be made to pass simultaneously over a single conductor, it is only necessary to combine the apparatus here described with any one of the several known methods of simultaneous transmission in opposite directions. The arrangement in general use for the accomplishment of this purpose upon the Western Union Telegraph Company's lines is that known as the differential method. A system of duplex telegraphy known as the bridge method may be used instead of the differential, or, instead of either of these, a combination of the differential and bridge methods. In practice the latter has been found preferable, more especially on the longer

circuits, where the signals have to be retransmitted automatically over an adjoining circuit, in which case it is absolutely essential that the signals should be recorded perfectly at the repeater station.

The last named plan is in operation on the New York and Chicago quadruplex circuit, arranged so that signals from New York and Chicago are at Buffalo automatically retransmitted in either direction. Before considering the arrangement for repeating from one circuit into another, however, it will first be well to describe the different instruments more in detail than we have yet done. A few words also regarding the setting up and adjustment of the apparatus will not be out of place here.

DIRECTIONS FOR SETTING UP THE QUADRUPLEX.

The diagram, figs. 149 and 150, will sufficiently explain the manner in which the instrument should be set up and connected.

The smaller section of the battery B usually contains about one third the number of cells that the larger section $3B$ does. The rheostat z should be as nearly as possible equal to the internal resistance of $(B + 3B) = 4B$. The resistance of y should be equal to the internal resistance of the portion $3B$ of the battery.

THE DOUBLE CURRENT TRANSMITTER.

This is represented at T^1 in figs. 148, 149 and 150, and is operated by the key K_1 and a local battery e_1 , usually of three cells. The double current transmitter is sometimes constructed as shown in fig. 153, but a simpler and far better arrangement has been recently introduced, which is shown in fig. 154. The drawing is an end view of the transmitter, and shows the pole changing apparatus distinctly. The adjustable contact screws a and a_1 are supported by and are in electrical connection with the post P, which is in turn connected with the line wire. The post also supports two contact springs S_1 and S_2 , which are insulated from it and connected by wires 1 and 12 with the zinc and copper

poles of the main battery, respectively. The lever t_1 of the transmitter is connected with the earth.

The proper adjustment of this transmitter is a matter of the

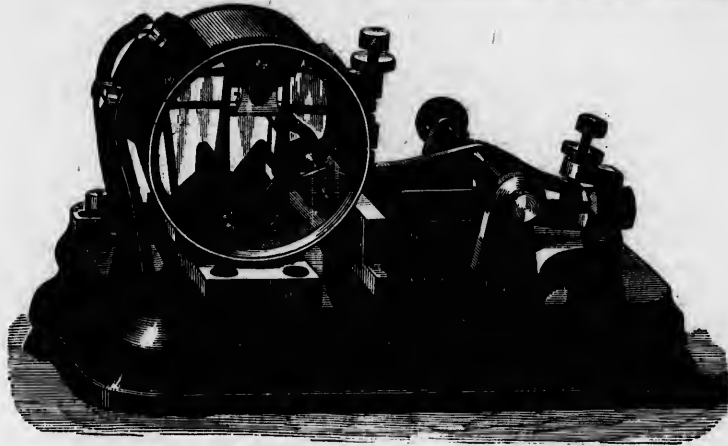

Fig. 153.

greatest importance to ensure the successful working of the apparatus. In order that it may follow the movements of the

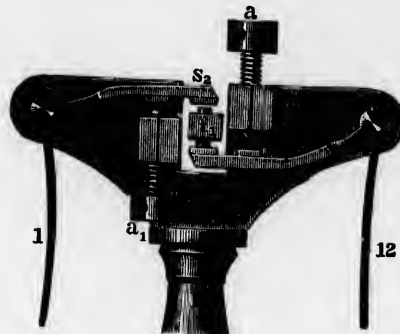

Fig. 154.

key with promptness, the play of the lever t_1 between its limiting stops near the electro-magnet should not exceed $\frac{1}{32}$ of an inch. The contact screws must be so adjusted that at a point

FROM THE LABORATORY OF
T. A. EDINON.
MENLO PARK, N. J.
U. S. A.

about midway of the stroke of the lever t_1 the springs S and S_2 will both be in contact with it at the same time, but for the shortest possible period. The easiest way is to first temporarily adjust the upper limiting stop at the opposite end of the transmitter lever t_1 , so as to reduce the play of the lever to $\frac{1}{4}$ of an inch, or about half the ordinary distance allowed for a sounder. Then gradually raise the contact screw a until the spring S_1 barely touches the lever t_1 , being careful to move the screw no further than is necessary to do this. Then lower the contact screw a_1 , and adjust the spring S_2 in the same way. Finally, raise the limiting stop at the other end of the lever, so as to give it the usual play of about $\frac{1}{2}$ of an inch. In its vibration the lever t_1 should touch one of the springs S_1 or S_2 at the same instant that it leaves the other. If the springs are adjusted too far apart there will be a break in the circuit, as the lever will break contact with one spring before it touches the other; if too near together, the battery will be placed on short circuit too long, from one contact being made before the other is broken. By careful adjustment this period can be reduced to almost nothing, and the more accurate this adjustment the better will be the performance of the apparatus.

THE SINGLE CURRENT TRANSMITTER.

This is similar to the transmitter of the Stearns duplex. The play of the lever of the transmitter should be about $\frac{1}{2}$ of an inch between the limiting stops and the contact screw A , fig. 155, adjusted so that when the key is closed and the transmitter in the position represented, the spring B will be slightly separated from the contact point on the end of the lever D .

THE COMPOUND POLARIZED RELAY.

This relay is represented by R_2 , in figs. 148 and 149, and the sounder connected with it responds to the signals given by the double current transmitter at the sending station. The relay consists of four separate electro-magnets, arranged, in pairs, with their poles facing each other, upon opposite sides of a double

polarized armature. The connections and principle of operation have already been explained in connection with fig. 148. The proper adjustment of the armature and local contact levers of this relay is a matter of much importance, and the following directions should be carefully observed :

Fig. 156 is a perspective view of the compound relay, showing the contact levers and their adjustment. The electro-magnets *M M* should be adjusted by means of the check nuts at the back, so that their poles are at equal distances from the opposite faces of the polarized armature *a*. The play of the armature lever

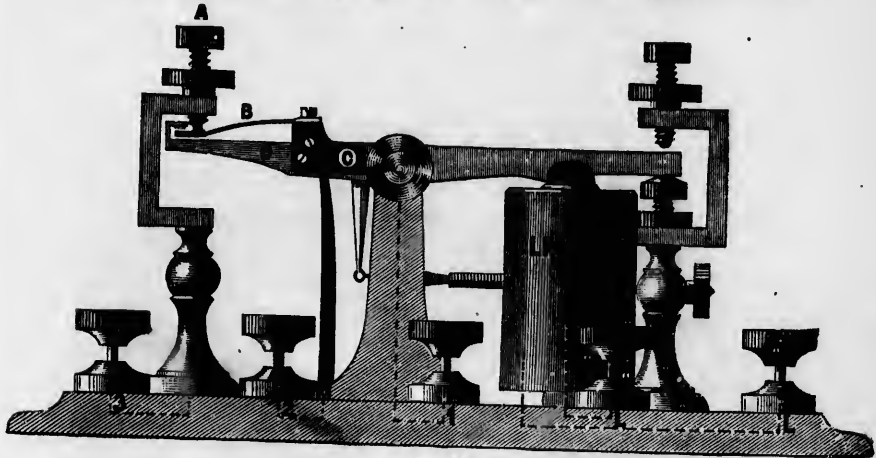

Fig. 155.

is regulated by the screw stops p_3 and p_4 , which limit the movements of the contact levers $N N_1$ in one direction, while the stops p_1 and p_2 limit them in the other direction. To adjust these levers, the screws p_1 and p_2 should be withdrawn until the contact points upon the armature lever *a* are touched by those upon the levers $N N_1$ upon each side, so that the local circuit can pass through the lever from *N* to N_1 when the armature is in a middle position, but will be interrupted by its slightest movement in either direction. The play allowed to the contact levers by the stops p_3 and p_4 may be, with advantage, consider-

ably less than that of an ordinary relay. The proper tension of the springs n and n_1 depends upon the condition of the line current, and will be referred to hereafter.



Fig. 166.

THE SINGLE POLARIZED RELAY.

This is shown at R_1 , in figs. 147, 148 and 150, and is simply a Siemens polarized relay, which should be adjusted with a play about the same as that of the ordinary Morse relay. This may

be, and usually is, constructed in the same form as fig. 156, but without movable contact levers $N N_1$.

ADJUSTMENT OF THE APPARATUS FOR WORKING.

The said arrangements having been properly made at both stations, one station, which for convenience we will call station A, commences by sending signals from the pole changing transmitter T_1 , having been careful to leave key K_2 or k_2 of transmitter T_2 open. Station B then signals to station A in the same manner, which signals will be received upon the polarized relay R. If the signals come reversed, or on the back stroke, the direction of the incoming current through the relay must be reversed. Station A next instructs B to ground. B complies by turning the arm of the switch Q (fig. 149) from q_1 to q_2 , which sends the incoming current direct to the earth through the resistance Z, which has already been adjusted to equal that of the entire battery ($E_1 + E_2$). Station A then grounds by placing his own switch in the same position, and adjusts his polarized relay R_1 , so that the armature will remain at rest indifferently upon either its front or back contact stop, when placed by the finger. Next, station A closes the single current transmitter T_2 by means of K_2 or k_2 ; turns the switch Q back to its original position, that is, to the left, sending the entire battery to line. The resistance X (fig. 150) should now be altered, until the armature of the polarized relay R_1 remains indifferently on either side when placed by the finger as before. When this is accomplished, the line resistance and rheostat resistance in X will be equal.

To obtain the electro-static balance, station A transmits dots or dashes by means of transmitter T_1 , and at the same time alters the capacity of the condenser $c_1 c_2$ (fig. 149), until it neutralizes the discharge which takes place at the end of each signal, and is manifested upon the relay R_1 . The electro-static balance of this relay insures that of relay R_2 without further precaution. Finally, station A again turns switch Q to the right, upon point q_2 , and station B now proceeds to obtain

a balance in the same way. Having accomplished this, he notifies A.

Station B is then requested to send from transmitter T_1 , leaving T_2 open or at rest. The signals are received at A on relay R_1 , and at the same time the springs $n n_1$ (fig. 156) of the compound relay R_2 should be pulled up sufficiently to hold the armature a at rest in a central position, with the local relay or repeating sounder S (fig. 149) closed. Next, B is requested to leave transmitter T_1 at rest and send signals on T_2 . These signals should be received at A upon the compound relay R_2 only. With currents of one polarity the armature a will move to the left, and with currents of the other polarity to the right, but in either case it should operate the sounder S_2 by means of the local relay S. When the armature passes from one extreme position to the other by a change of polarity upon the line, the relay should not give a false dot as it passes the central position. The contact points of the local relay or repeating sounder S should be adjusted as close as those of an ordinary relay.

The above described apparatus is suitable for use upon lines from 300 to 600 miles in length. For lines under 300 miles in length, the modification of the apparatus, shown in fig. 148, and which is of somewhat simpler construction, is usually employed.

Simultaneous transmission in opposite directions, at the rate of fifty-eight words per minute each way, is now carried on between New York and Washington, by the application of this quadruplex method to the Phelps electro-motor printer. This leaves two sides free for exchanging service signals, or for carrying on two separate communications by the Morse apparatus.

The arrangement for repeating from one quadruplex circuit into another is very simple in principle, and consists in placing the two transmitters of one line in the same local circuits with the corresponding receiving sounders of the other line. The details are more fully described on page 355. By this arrangement New York is enabled to carry on four distinct communications simultaneously with St. Louis, a distance of about 1,100

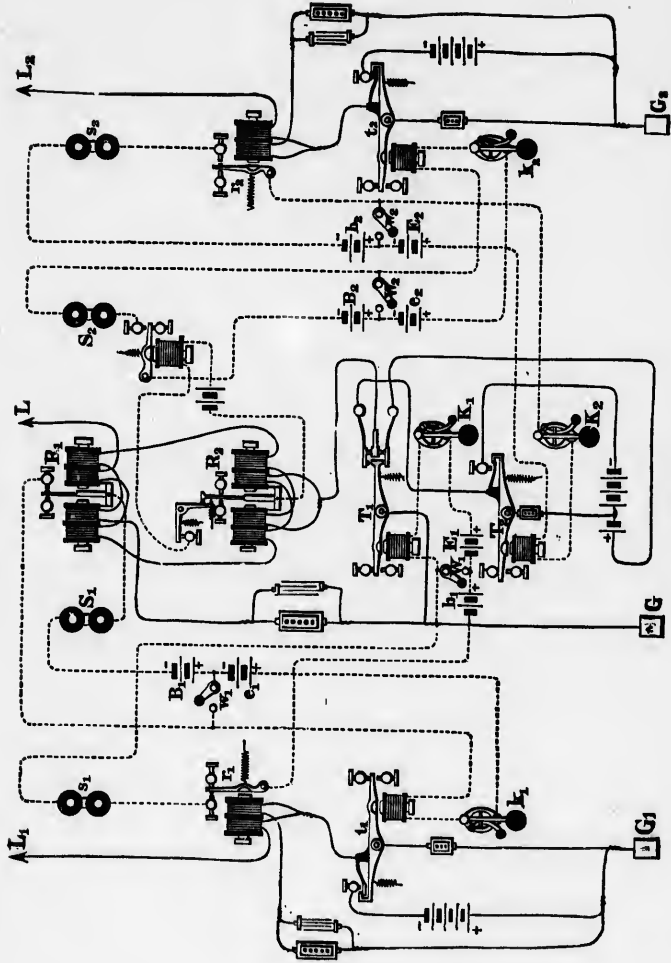

Fig. 157.

miles, by means of a quadruplex repeater at Pittsburg; and with Chicago, 1,000 miles, by means of a repeater at Buffalo.

Although the quadruplex has, in a great measure, taken the place of the duplex upon many of the lines between the more important telegraphic centres, the latter system is, nevertheless, still employed to a considerable extent between points of less importance where the business is not sufficient to keep the quadruplex constantly employed; and in numerous cases it forms, in connection with this system, both a convenient and valuable auxiliary for supplying direct communication between several different stations at one and the same time.

There are various ways in which these two systems may be combined so as to meet the numerous requirements of the service, but it will be necessary to describe and illustrate here only such as are now in actual operation and by experience have been found serviceable.

A plan of the apparatus as arranged at repeating station, forming the common terminus of one quadruplex and two duplex circuits, is shown in fig. 157. By this combination two independent communications passing in the same direction over the quadruplex circuit may be automatically retransmitted from the repeating station over two separate and independent duplex circuits extending to different points, while at the same time two communications passing in the opposite direction over the duplex circuits may be repeated into and over the quadruplex circuit.

For convenience of explanation we will take an actual case, and suppose the repeating apparatus to be placed at Boston, which is in connection with New York, 240 miles distant, by quadruplex, and with Duxbury and St. John, respectively 40 and 469 miles distant by duplex.

In order to effect the desired retransmission of the different sets of signals passing through the apparatus, it is necessary to form separate connections between the several receiving instruments and the transmitters of the different lines into which the signals are to be repeated.

This is done by means of the local circuits, in a manner which will now be explained.

As ordinarily arranged for single circuit working, the relay R_1 (fig. 157) of the New York line L , operates the sounder S_1 by means of the local battery B_1 ; and key k_1 , the transmitter t_1 , of the Duxbury line L_1 , by means of the local e_1 . For direct through working, however, and in order that the received New York signals may be communicated from the relay R_1 to the transmitter t_1 , and thus be repeated into the Duxbury line, a switch or button w_1 is so arranged that it forms, when closed, a part of each of the two separate local circuits containing the relay R_1 and the transmitter t_1 , but when open throws the two circuits into one, so that relay R_1 operates the transmitter t_1 as well as the sounder S_1 .

In a similar manner the circuit, including sounder s_1 of line L_1 is combined with that containing the transmitter T_1 of line L , by means of the button W_1 , while the button W_2 connects the local circuit of R_2 in line L with that of the transmitter t_2 in the St. John's line L_2 .

Another button w_2 in like manner also connects the local circuit of relay r_2 in line L_2 with that containing the transmitter T_2 of line L .

When, therefore, the buttons W_1 , W_2 , w_1 and w_2 are all closed, the three main lines L , L_1 and L_2 may be operated independently; the New York line as a quadruplex and the Duxbury and St. John's lines as separate duplex circuits.

When, on the other hand, the buttons are all open and the switches of keys K_1 , K_2 , k_1 , k_2 closed, New York is able to transmit simultaneously two independent communications over the line L to Boston, where one of them will then be automatically retransmitted by the relay R_1 and transmitter t_1 over line L_1 to Duxbury, and the other by relay R_2 and transmitter t_2 over line L_2 to St. John's. While this is being done Duxbury and St. John's may also send communications simultaneously over lines L_1 and L_2 respectively to Boston, where relays r_1 and r_2 will then repeat them into line L and to New York. It will thus be seen that New York has practically separate duplex circuits to Duxbury and St. John's, and that any or all of the correspondence may be read at Boston.

By properly arranging the buttons W_1 , W_2 , w_1 and w_2 , either line of communication may be worked through direct or be divided at Boston without reference to what is being done on the other. The manner of effecting this will be sufficiently obvious without further explanation.

We have thus far considered that the signals transmitted from New York and retransmitted at Boston into line L_2 , were copied at St. John's, N. B. It is proper to state, however, that in practice New York and North Sydney, C. B., work the line together duplex, a distance of 1,159 miles, by means of a second duplex apparatus at St. John's, constituting with the first a duplex repeater.

A modification of the plan shown in fig. 157, and just described, has developed a much wider field for practical operation. This consists in dispensing with one duplex circuit. Thus, for example, if the Duxbury line L_1 , and the apparatus connected therewith be removed, it will readily be understood, from what we have already said, that New York and North Sydney would still be able to work duplex, while, at the same time also, New York and Boston could work duplex together without regard to what is passing between the two former.

Before describing the manner of working the quadruplex in connection with the contraplex or diplex systems, it will first be well to devote a few words to the consideration of these systems alone.

The terms contraplex and diplex are here applied as specific names for designating clearly the way in which the particular simultaneous double transmission to which we wish to refer is effected. Thus, for instance, two messages may be sent over a single wire in the same or in opposite directions, and when we do not care to particularize either, we simply allude to them under the more common generic name of duplex transmission, which includes both. When, however, we wish to speak of either method by itself, we use the term diplex for simultaneous transmission in the same direction, and contraplex for that in opposite directions. As these terms are not in very general use, this explanation here will not be out of place.

Figs. 158 and 159 show the application of a contraplex system, in which one set of signals are made by a series of changes in the polarity of the current, and the other by changes in its strength.

In fig. 158, t_1 is the lever of a double current, or pole changing transmitter, which is operated by an electro-magnet T_1 , local battery and key K_1 .

The construction and operation of this transmitter is fully described on pages 337 and 338.

At station B, the receiving instrument R_1 , having a polarized armature, is placed in the circuit of the line, and in consequence of the polarity of its armature, will respond to each reversal of

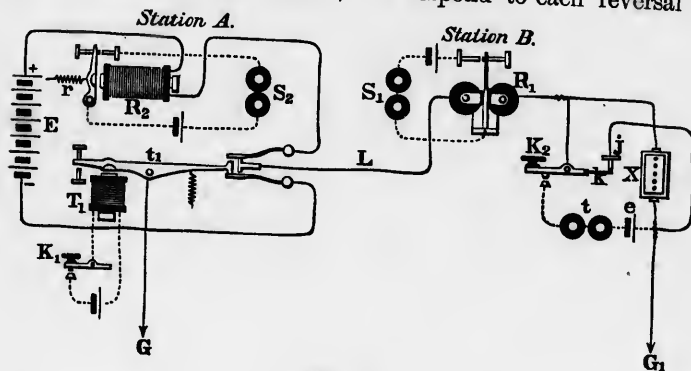

Fig. 158.

the current upon the line, produced by the movement of the double current transmitter t_1 , and will open and close the local circuit of the sounder S_1 , giving signals corresponding to the movements of the key K_1 at station A.

The line at station B, after passing through the receiving instrument R_1 , is conducted to the earth at G_1 .

A rheostat X is inserted between the receiving instrument R_1 and the earth, the resistance of which may be, say, from two to four times as great as that of the line. A key K_2 is connected with the line in such a manner as to shunt the rheostat X by a circuit of practically no resistance each time the key is depressed.

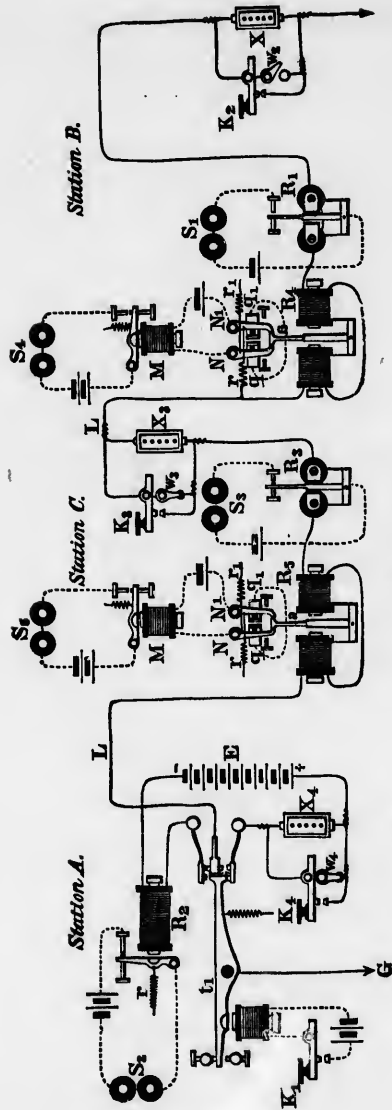

Fig. 159.

In order that the operator may be able to hear his own signals, the key K_2 is provided with a spring contact arm k , which, when the key is depressed, is brought in contact with the stop J , thus shunting the rheostat X , and giving the signal at station A. The ordinary contact point of the key at, or nearly at, the same time, strikes upon its anvil, and closes the circuit of the local battery e through the sounder t , and thus duplicates the signal sent to the other station.

At station A a receiving instrument, R_2 , having a neutral armature and adjustable spring r , is placed in one of the wires leading from battery E to the double current transmitter. The armature of the receiving instrument R_2 opens and closes the local circuit of the sounder S_2 , in the ordinary manner. The retractile spring r of the receiving instrument R_2 , should be strained up to a sufficient tension to withstand the attraction of the electro-magnet when the rheostat X is in circuit at the other station, while it will be easily overcome by the increased force of the line current, which results from the shunting of the rheostat X , and the consequent removal of its resistance from the circuit whenever the key K_2 is depressed.

By placing the receiving instrument R_2 in one of the wires leading from the battery to the pole changing transmitter t_1 , the direction or polarity of the current traversing its coils is never changed, and consequently its armature has no tendency to fall off when the current is reversed upon the line.

It is obvious that any required number of receiving instruments similar to R_1 , accompanied with the other apparatus shown and described at station B, may be placed in the circuit of the line at way or intermediate stations, all of which will simultaneously respond to the signals given by the key K_1 and transmitter t_1 .

Fig. 159 is a modification and extension of the system, so arranged as to be capable of either transmitting two communications simultaneously in the same direction, or one in each direction, at pleasure.

If the keys K_1 and K_4 are operated at the same time, the

former will control the polarity and the latter, the strength of the current going to line from the battery *E*.

At the terminal station *B*, as well as at the intermediate station *C*, receiving instruments R_4 and R_5 are made use of, the construction and operation of which are fully described on pages 338 and 340.

The polarized armature *a* plays between two contact levers *N* and N_1 , which are held against the stops *q* and q_1 by springs *r* and r_1 ; these springs being strained up to a tension sufficient to resist the electro-magnetic action of the weak current, which traverses the line when the rheostat X_4 is put in circuit by the opening of key K_4 , but which will readily be overcome by the stronger current which passes when the rheostat is cut out, by the depression of key K_4 .

The local relays *M M*, between the receiving instruments R_4 and R_5 , and their respective sounders S_4 and S_5 , at stations *B* and *C*, when arranged in this manner, is a well known device for reversing the signals of the relays, in order that they may appear correctly upon the sounder.

Thus it will be understood that the sounding or recording instruments S_4 and S_5 at stations *B* and *C*, will respond each time the key K_4 , at station *A*, is depressed, while in like manner the sounders S_1 and S_3 , at stations *B* and *C*, will respond each time the key K_1 , and transmitter t_1 , at station *A*, is operated.

The rheostats X , X_3 , and X_4 , are cut out of the circuit when the operators at the respective stations are not using the line by means of the switches W_2 , W_3 and W_4 , precisely as in the case of the ordinary closed Morse circuit.

In order to transmit communications in opposite directions at the same time, the operator at station *A* will use key K_1 , and the operator at station *B* or *C* will use key K_2 or K_3 .

With the apparatus constructed and arranged as in fig. 159, the operation may be briefly summed up as follows:

When key K_1 is operated sounders S_1 and S_3 will respond.

When either K_2 , K_3 , or K_4 is operated by first opening the switches attached, sounders S_2 , S_4 and S_5 will respond.

It will, therefore, be readily understood that the following results may be obtained :

1. Station A may send a message to C, and C at the same time send one to A, both of which may be read at B.
2. A may send a message to B, and B at the same time send one to A, both of which may be read at C.
3. A may send a message to C, and at the same time B may send one to A, which latter may also be read at C.
4. A may send a message to B, and at the same time C may send one to A, which latter may also be read at B.
5. A and C may simultaneously send messages to B, the latter of which may be read at A.
6. A and B may simultaneously send messages to C, the latter of which may be read at A.
7. A may send messages to B and C at the same time.
8. A may send two messages simultaneously to B, both of which may be read at C.
9. A may send two messages simultaneously to C, both of which may be read at B.
10. B and C can work together singly, precisely as in the ordinary closed circuit, Morse system ; and,
11. When it is not required to work duplex, A can signal B or C with either of his two keys.

All the results which have been described are accomplished by means of a single main battery E, placed at one terminal station A.

Fig. 160 represents a combination of the above system with the quadruplex at a common terminal station, at which the connections are so arranged as to allow of the repetition of signals from one circuit into the other.

Taking an actual case, as before, we will suppose the repeating apparatus to be located at New London, which, for convenience, may be designated as station A. This is in communication with New York, 126 miles distant, by a quadruplex wire L, and with Norwich, Conn., and Worcester, Mass., by the line L₁, 73 miles in length, the former being an intermediate and the latter a

terminal office, which we will designate respectively as stations B and C.

The apparatus at station A consists of a complete set of quadruplex instruments and a set of the instruments shown in fig. 158, both of which have already been described; consequently, it will only be necessary now to show the manner in which they are worked conjointly.

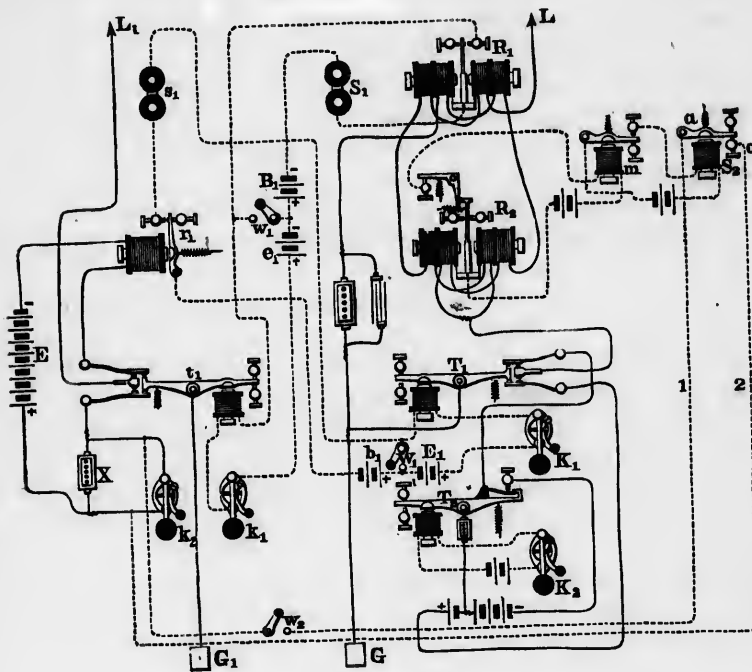

Fig. 160.

The switch or button w_1 is so placed between the local batteries B_1 and e_1 , that when closed it forms a part of each of the two local circuits containing the sounder S_1 and transmitter t_1 , but when open the separate circuits are combined into one; and if the key k_1 be closed, the relay R_1 then operates both sounder

S_1 and transmitter t_1 , and thus repeats the signals coming from line L into line L_1 , and to stations B or C.

The local circuit containing the sounder s_1 is, in a similar manner, separated from or combined with that containing the transmitter T_1 by means of the button W_1 . In the latter case, relay r_1 operates transmitter T_1 as well as sounder s_1 , and thereby repeats the signals from L_1 over line L to New York.

The sounder S_2 , which is operated by the relay R_2 of line L, may be arranged in connection with wires 1 and 2 and button w_2 , so that when the latter is closed and key k_2 opened the shunt around the rheostat X is thereby extended through lever a and contact o of sounder S_2 ; and thus a second set of signals, received from New York on relay R_2 at station A, may also be repeated into line L and to stations B and C.

The signals produced by the transmitter T_2 , when key K_2 is operated, are received at New York upon a sounder corresponding to that of S_2 in the figure.

It will, therefore, be seen that with the apparatus thus arranged the following results may be obtained:

1. New York may send a message to station C, and at the same time C can send one to New York, and both be read at A and B.
2. New York may send to B, B to New York, and both be read at A and C.
3. New York may send to C, and be read at A and B, while at the same time B may send to New York, and be read at A and C.
4. New York may send to B, and be read at A and C, while C may send to New York, and be read at A and B.
5. New York may send to B, and be read at A and C, while C also may send to B, and be read at A and at New York.
6. New York may send to C, and be read at A and B, while at the same time B may also send to C, and be read at A and New York.
7. New York may send to B, and be read at A and C, and at the same time A may also send to B, and be read at C and New York.

ations

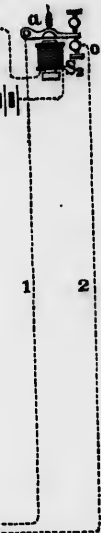
set of
own in
conse-
ner inlocal bat-
ch of the
mitter t_1 ,
one; and
a sounder

8. New York may send to C, and be read at A and B, and at the same time A may also send to C, and be read at B and New York.

9. New York and station A may work duplex continuously, without regard to what is passing between stations A, B and C.

10. New York may send two messages simultaneously to A, one of which may be read at B and C, and at the same time two communications may pass over the line to New York, one from A and the other from C, the latter of which may be read at A and B.

11. New York may send two messages simultaneously to A, one of which may be read at B and C, and at the same time two may pass simultaneously over line L to New York, one from A and the other from B, the latter of which may be read at A and C.

12. New York may send two messages simultaneously to B, both of which may be read at A and C, and at the same time receive two from A.

13. New York may send two messages simultaneously to C, both of which may be read at A and B, and at the same time receive two from A.

14. New York may send two messages simultaneously, one to A and the other to C, the latter of which may be read at A and B; and, at the same time, receive two, one from A and one from C, the latter of which may be read at A and B.

15. New York may send two messages simultaneously, one to A, the other to B, and the latter be read at A and C; and, at the same time, receive two, one from A and the other from B, the latter of which may be read at A and C.

16. New York may receive two messages simultaneously from A, and, at the same time, transmit two distinct communications, one to B and one to C, or both to either station separately, and both may be read at A. Finally,

17. Station A may, by properly arranging the buttons w_1 , w_2 and W_1 , divide the two lines L and L_1 , and operate each

separately; the former as a quadruplex wire to New York, the latter as contraplex or duplex to B and C.

Fig. 161 shows a plan of connecting the apparatus at a station forming the common terminus of two quadruplex circuits, so as to repeat from one into the other. We will suppose the station to be Cleveland, and that L_1 represents a quadruplex wire extending from that point to Buffalo, a distance of 183 miles, and L_2 a similar wire between Cleveland and Cincinnati, a distance of 250 miles. The apparatus comprises, in addition to two complete sets of quadruplex instruments, the four button switches, W , W_1 , W_2 and W_3 , which serve for giving direct communication between Buffalo and Cincinnati, or for dividing the wires and thus allowing each of them to be worked separately.

For clearness of illustration, the relays, as shown in the figure, are not wound differently, and the rheostats and condensers forming the artificial lines have been omitted.

The arrangement of the local circuits of the several relays R_1 , R_2 , r_1 and r_2 , so that they may be separated from or combined with those of transmitters t_1 , t_2 , T_1 and T_2 respectively, by means of the buttons W , W_1 , W_2 and W_3 , is precisely the same as that shown in fig. 157, for repeating from one quadruplex into two duplex circuits, and *vice versa*.

It will therefore be understood, from what has already been said, that when the buttons are all open, and the keys K_1 , K_2 , k_1 and k_2 closed, Buffalo may transmit two communications simultaneously over the line L_1 to Cleveland, where they will then be automatically retransmitted, one by relay r_1 and transmitter T_1 , the other by relay r_2 and transmitter T_2 , over line L_2 to Cincinnati. The latter station may also transmit two independent messages at the same time to Cleveland, where, in turn, they will be retransmitted, one by relay R_1 and transmitter t_1 , and the other by relay R_2 and transmitter t_2 , over line L_1 to Buffalo.

By simply closing the buttons W , W_1 , W_2 and W_3 , the two circuits may be divided at Cleveland, and worked separately.

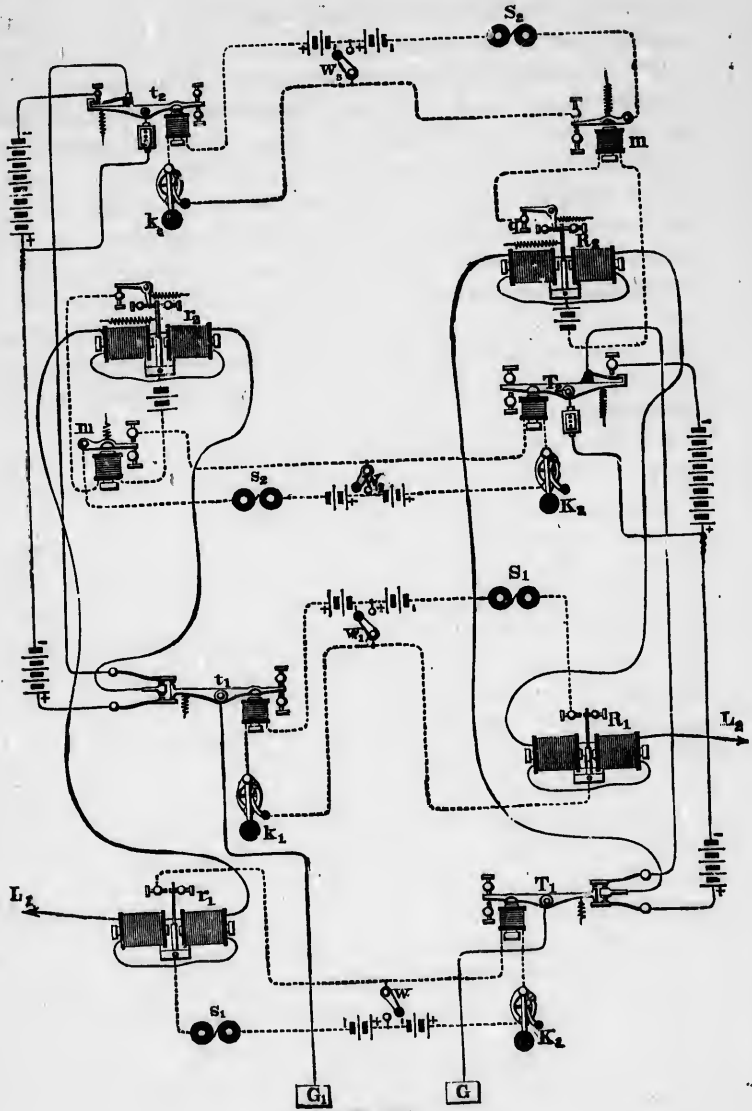

Fig. 161.

In regular practice, however, the circuits are worked in the following manner, so as to facilitate the exchange of business between the three points before mentioned :

The buttons W_2 and W_3 are closed and W and W_1 opened. When thus arranged, Buffalo and Cincinnati are enabled to work together duplex, and, at the same time, Cleveland may work duplex to Buffalo over line L_1 , and to Cincinnati over line L_2 . The transmitter t_1 and relay r_1 of line L_1 are so located on the desk or table, with regard to the corresponding apparatus of line L_2 , as to facilitate the adjustment of the several instruments.

Quadruplex repeaters are similarly arranged for facilitating the exchange of business between numerous other points on the lines of the Western Union Telegraph Company, among which may be mentioned Boston, Albany and Buffalo; Buffalo, Detroit and Chicago; and New York, Hartford and Providence.

A combination of the two methods of duplex telegraphy, known as the bridge and differential systems, but differing materially in arrangement from that shown on page 311, is also used in practice. At Buffalo two complete sets of quadruplex apparatus, on this plan, are arranged by connecting the local circuits in precisely the same manner as shown in fig. 161, for repeating signals from one circuit into another, and, by this means, New York and Chicago are enabled to exchange four communications simultaneously, over a single wire, between these points.

A second wire between New York and Chicago is equipped with the quadruplex apparatus, and precisely the same arrangement as the above is made at Buffalo for repeating from one circuit to the other. At New York, however, the connections are such, that while its office and Chicago are working duplex on one side, the latter may also work duplex on the other side with any one of two or more branch offices in New York. The manner in which this is done will readily be understood from fig. 162 and the following explanation, which relate to the arrangement for a Boston wire, where it was first used; the one for the Chicago line, however, is just the same :

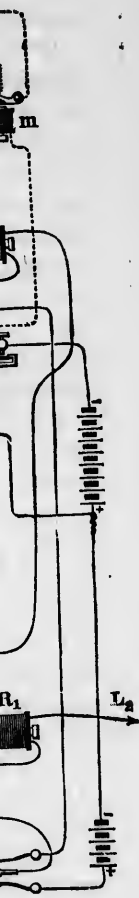

The complete quadruplex set in connection with the line L is supposed to be at the New York main office. Sounders s_1 and S_4 , and key k_1 , at a branch office in the city, which we will call station A; and the apparatus consisting of sounders s_2 and S_3 , repeating relay m_2 , key k_2 and local battery e_4 , at a second branch office, which we will call B.

In order to provide for the simultaneous reception of two independent communications over line L, from Boston, one of which shall be received upon relay R_1 and sounder S_1 , and, at the same time, also, upon sounder s_1 at station A, and that the other shall be received upon relay R_2 , sounder S_2 and upon sounder s_2 at station B as well, while separate communications are at the same time being sent to Boston from each of the two stations A and B, it is only necessary to connect the local or branch lines with the relays and transmitters of the quadruplex apparatus at the main office in the manner shown in the diagram (fig. 162). Here the route of the local or branch wire of the relay R_1 may be traced from the earth plate G_1 , at the main office, to battery e , wire 1 and armature of relay R_1 to sounder S_1 , and thence by wire 1_1 to sounder s_1 and earth G_2 at station A. The route of the branch circuit of relay R_2 is from earth plate G_3 to battery e_1 , wire 2, armature of repeating sounder M and sounder S_2 , and thence by line 1_3 to sounder s_2 and earth G_4 at station B. The routes of transmitters T_1 and T_2 may be similarly traced. It will be noticed, however, that the arrangement of the branch line, as well as local connections of transmitter T_2 , differ materially from those of T_1 , as in its normal position the former should remain open, and thus leave only the smaller portion of the main battery on the line. The keys K_2 and k_2 are not provided with circuit closing switches, and contact is made at the back point, instead of the front, as in the ordinary form. The normal position of these keys is that shown in the figure, in which they close the branch circuit and cause the armatures a and a_1 of repeating relays m_1 and m_2 to be attracted, and thus break the local circuits of transmitter T_2 at the main office, and sounder S_2 at B. By depressing K_2 or

k_2 , and consequently breaking the branch circuit, the armatures of the repeating relays m_1 and m_2 will be released, and the local circuits of transmitter T_2 and sounder S_2 will be closed simultaneously. The operator at B is thus enabled to hear his own or other signals that are being transmitted by the main or other office on the branch line.

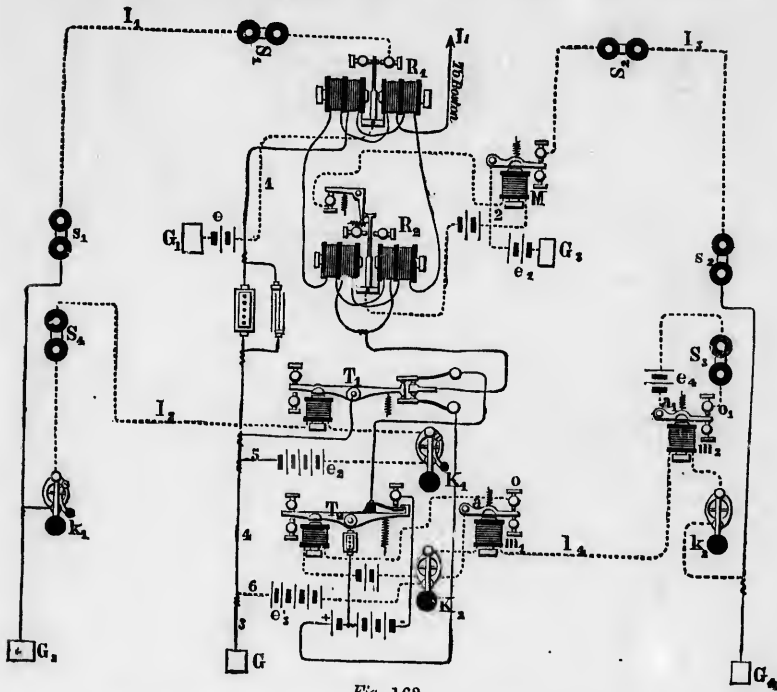

Fig. 162.

It will therefore be sufficiently obvious that the signals received from the line L upon relay R_1 and sounder S_1 at the main office can, with equal facility, be read from sounder s_1 at station A, while the latter office at the same time may, by depressing the key k_1 , and consequently operating sounder S_4 and transmitter T_1 , be sending signals to Boston or to some branch office at that place. In a similar manner and at the same time,

station B may work duplex with another branch office at Boston, of which at that place there are five on one side of the quadruplex and two on the other. The balancing and adjusting of the quadruplex, it will, of course, be understood, is all done at the main office.

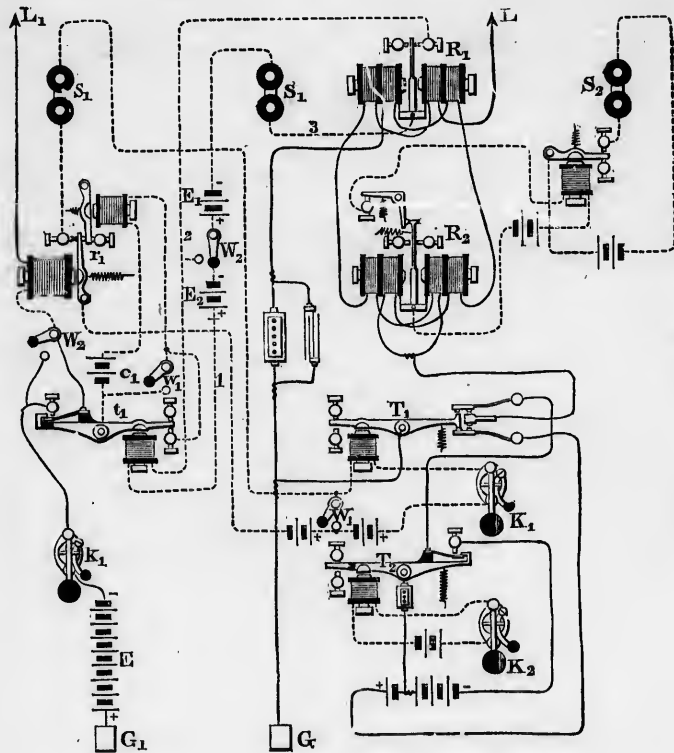

Fig. 163.

The quadruplex is also arranged to work in connection with a single direct circuit containing any number of offices, and the plan has been found to serve an excellent purpose in practice, as communication can thereby be maintained between a distant

office on the quadruplex circuit and any one of the number on the single wire line.

Fig. 163 shows the details of the arrangement as adopted at St. Louis, for automatically repeating from one circuit into the other, the outfit consisting of one complete set of quadruplex apparatus and portions of a Milliken repeater. The line L , extending to Chicago, 280 miles distant, is connected with the quadruplex relays; and line L_1 , extending to Kansas City, Atchison, Leavenworth and St. Joseph, with the Milliken relay r_1 . The local circuit of this relay is separated from or connected with that of the transmitter T_1 by means of the switch W_1 , in precisely the same manner as in the preceding cases, and by means of the switch W_2 , the local circuit of relay R_1 may be extended through the transmitter t_1 , or disconnected therefrom at pleasure. With the switch W_2 turned to the right, for example, as shown in the figure, the local circuit may be traced from the switch to local battery E_2 , wire 1, transmitter t_1 and wire 2 to relay R_1 , thence by wire 3, sounder S_1 and battery E_1 back to the switch again. When it is turned to the left, battery E_2 and transmitter t_1 are thrown out of circuit and relay R_1 operates sounder S_1 alone. The local contact points at the front end of transmitter t_1 are shunted out when desired, by means of the button or switch w_1 ; and the main contact points at the opposite end of the lever are in like manner cut out by means of button W . When, therefore, the switches W_1 , w_1 and W are open, W_2 turned to the right and keys K_1 and k_1 closed, as shown in the figure, Chicago may exchange business with any one of the offices on L_1 , the signals being automatically retransmitted at St. Louis by relays R_1 , r_1 and transmitter T_1 and t_1 . At the same time St. Louis and Chicago may also work duplex, using key K_2 and R_2 for that purpose.

By closing switches W_1 , w_1 and W and turning W_2 to the left, the two lines L and L_1 , as will readily be seen, may be worked separately, the former as a quadruplex and the latter as a single Morse circuit.

Boston,
quadru-
g of the
e at the



ion with
and the
actice, as
a distant

CURRENT INDUCTION.

The interference between well insulated telegraph lines, known as current induction, has from the first done a great deal toward preventing the proper working of the quadruplex system, and the question as to how the disturbing effects due to this cause might be overcome has, therefore, become one of considerable importance.

Mr. Charles H. Wilson, of Chicago, who has given considerable attention to the subject, has devised a plan for diminishing the difficulties just referred to.

Mr. Wilson seeks to accomplish his object by establishing a counter current in the disturbed conductor at the same moment and of the same strength and duration as that of the induced cur-

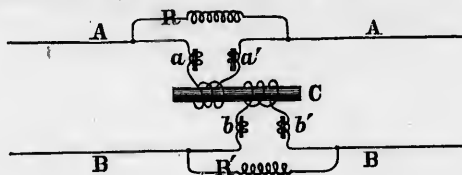

Fig. 164.

rent which is generated in it by the sudden change of potential in a neighboring wire.

Fig. 164 shows the application of the method to a single Morse line, but here it is of comparatively little practical importance, from the fact that these lines, as a general thing, can be supplied with strong currents, so that there is always sufficient working margin to cover the difficulties arising from induction. The primary wire of the induction coil C is in the circuit of one line, and the secondary coil in that of the other. The coils are so wound or connected to the lines that either will induce in the other currents of opposite direction to those induced by the remaining parts of the circuit. The electro-magnets represented at *a*, *a'*, *b* and *b'*, are employed for producing the proper retarding effect on the counter or neutralizing currents which are generated in the coils surrounding C, and the adjustable resist-

DUCTION.

, known
l toward
tem, and
is cause
siderable

consider-
inishing

lishing a
moment
uced cur-

potential

gle Morse
importance,
e supplied
t working
on. The
it of one
e coils are
induce in
ed by the
represented
er retard-
which are
ble resist-

INDUCTION BETWEEN PARALLEL LINES.

ance R R of the shunt circuit serve to still further modify these currents, so that their action is subject to complete control.

The manner in which the device is rendered effective will readily be understood from the diagram. Thus, for instance, if a current of any polarity is sent into the conductor A, a current of

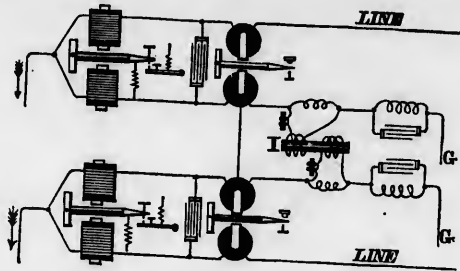

Fig. 165.

the opposite polarity will be induced in the line B, owing to its close proximity to the former, but at the same instant a similar current will also be induced in the coil to which it is joined, and, as the connection is so arranged that this current opposes that

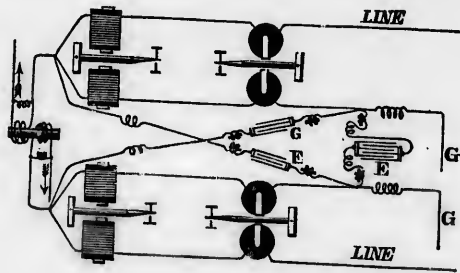

Fig. 166.

induced by the proximity of the two conductors to one another, the proper action of the instruments will not be disturbed.

The arrangement for accomplishing the same result between two quadruplex circuits is shown in fig. 165. It is evident that, with the bridge or differential principle, all that is required to effect the end in view, is to cause the two artificial lines to act

upon each other in a manner similar to the action of the actual lines, and for this purpose an induction coil and system of magnets, similar to that just described, is inserted in the path of the two artificial lines at I.

Fig. 166 shows an arrangement of condensers substituted for the induction coils, which has been in extensive use on some of the long lines in the central division of the Western Union Telegraph Company. If the inductive effect of the two wires are equal, the condenser E is alone necessary to effect the neutralization; but when unequal, the two condensers F and G are required in connection with E.

EARLY METHODS OF SIMULTANEOUS TRANSMISSION IN THE SAME DIRECTION.

In October, 1855, A. Bernstein, of Berlin, devised a plan for the simultaneous transmission of two messages in the same direction, which is shown in fig. 167.

The transmitting apparatus consists of two independent circuit preserving keys K_1 and K_2 in connection with batteries B_1 and B_2 , the former composed of, say 10, and the latter 20 cells, as shown in the figure at station A.

The movements of these keys produce three different electrical conditions in the line, according to their respective positions with reference to each other, as follows:

1. First and second keys open. The route of the circuit may be traced as follows: From the earth plate G, through wire 6, adjustable stops 5 and 4, wire 3, to adjustable stops 1 and 2 and line L. This may be considered the normal condition of the keys, in which position no current passes to the line.
2. First key closed and second key open. The route is from earth plate G to wires 6, 7, main battery B_1 , thence to lever l_1 of key K_1 , and wire 3 to stops 2 and 1 and line L to distant station as before. In this position of the keys the smaller battery B_1 only is in circuit, sending to the line a positive or + current of + 10.
3. Second key closed and first key open. The route now is

from earth plate G, wire 6, to stops 5 and 4; thence by wires 3 and 8, to main battery B₂, and lever *l*₂ of key K₂; thence by wire 9 to stop 1, and line L to distant office. In this position of the keys the larger battery B₂ only is in circuit, sending to line a positive or + current of + 20.

4. First and second keys both depressed. The route of the circuit in this case is from earth plate G, wire 6, 7, to battery B₁, lever *l*₁; thence to stop 4, and wires 3, 8, and battery

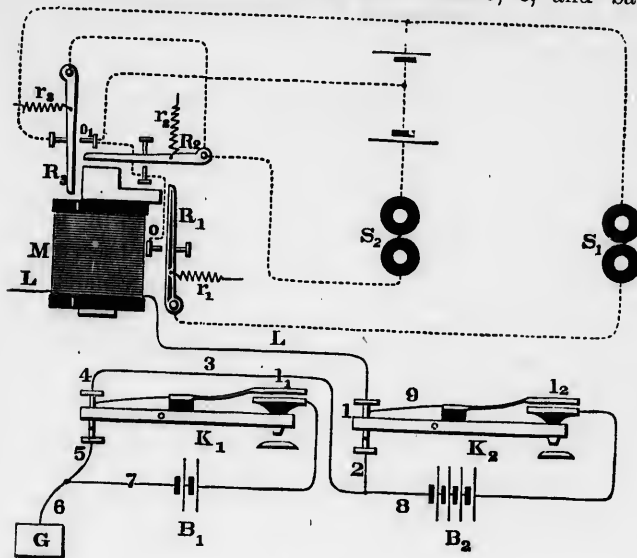

Fig. 167.

B₂ to lever *l*₂, wire 9 to stop 1; thence to the line L and distant station as before. In this position of the keys both batteries are in circuit, sending to line a positive or + current of + 30.

At station B a receiving instrument or relay is made use of, composed of a single electro-magnet M, having three armatures R₁, R₂ and R₃, to each of which are attached retractile springs *r*₁, *r*₂ and *r*₃ respectively, with local circuits and sounders S₁ and S₂, as shown in the figure.

Sounder S_1 should respond solely to the movements of key K_1 , and sounder S_2 , in like manner, to the movements of key K_2 , while both should respond when keys K_1 and K_2 are simultaneously depressed.

The manner in which this result is attained will be understood by reference to the following explanation of the effect of each of the previously mentioned electrical conditions of the line upon the receiving instrument M at station B:

1. The normal condition of the transmitting apparatus.

No current to line.

The local circuit of sounder S_1 is open at point o , armature R_1 being held against its back stop by the retractile force of spring r_1 .

Armature R_2 is, in a like manner, held against its back stop.

Armature R_3 rests upon its back stop, owing to the retractile force of spring r_3 , in which position it will be observed that a local circuit is completed, in which are included sounder S_2 and both local batteries, but as the two latter have like poles together, their effect upon sounder S_2 is substantially neutralized; consequently, the latter remains inactive.

2. Positive current from battery B_1 only = + 10.

The local circuit of sounder S_1 is closed between the point o and armature R_1 , because the action of the current upon the relay M is strong enough to overcome the spring r_1 , and force armature R_1 against the stop o .

Armature R_2 remains on its back stop, because the power of the current upon the line is not sufficient to overcome the tension of spring r_2 .

Armature R_3 rests upon its back stop because the current is not strong enough to overcome the spring r_3 . As in the first case, it will also be observed here that armature R_3 , in this position, completes a local circuit in which is included sounder S_2 . The latter, however, remains inoperative, for the reasons before explained.

3. Positive current from battery B_2 = + 20.

The local circuit of sounder S_2 is closed between the contact point and armature R_2 , because the power of the line current is sufficient to overcome the spring r_2 , and move the armature R_2 against its contact point. Armature R_3 still remains on its back stop, because the current upon the line is not of sufficient strength to overcome the tension of spring r_3 . In order to prevent a false signal from being given by sounder S_1 , it is obviously essential, in this case, that armature R_1 should make contact with the point o simultaneously with armature R_2 , by which means the local battery of sounder S_1 is short-circuited, thus leaving the latter inoperative.

4. Positive current from both batteries (B_1 and B_2) = + 30.

The current upon the line in this case is sufficiently powerful to overcome the tension of the retractile springs r_1 , r_2 and r_3 , and force the armatures R_1 , R_2 and R_3 against their respective front stops o and o_1 , operating the sounders S_1 and S_2 .

Thus will be understood the manner in which the respective armatures of the receiving instrument are made to assume their different positions with relation to the electrical condition of the line, so as to record the proper signals upon sounders S_1 and S_2 .

Instead of the receiving instrument as devised by Mr. Bernstein, viz.: a single electro-magnet, with three separate armatures, of different adjustments, three independent relays may be used, with local connections the same, without departing from the principle thereof.

A second method was also invented by Bernstein, in which he made use of both positive and negative currents.

Referring to the diagram, fig. 168, it will be observed that the transmitters, or keys, are circuit preserving, the sketch differing from the original in form, but not in principle.

The operation of the two keys gives rise to three strengths of current upon the line, according to their respective positions, with reference to each other, as follows:

The normal position of the keys is that shown in the figure, both being open.

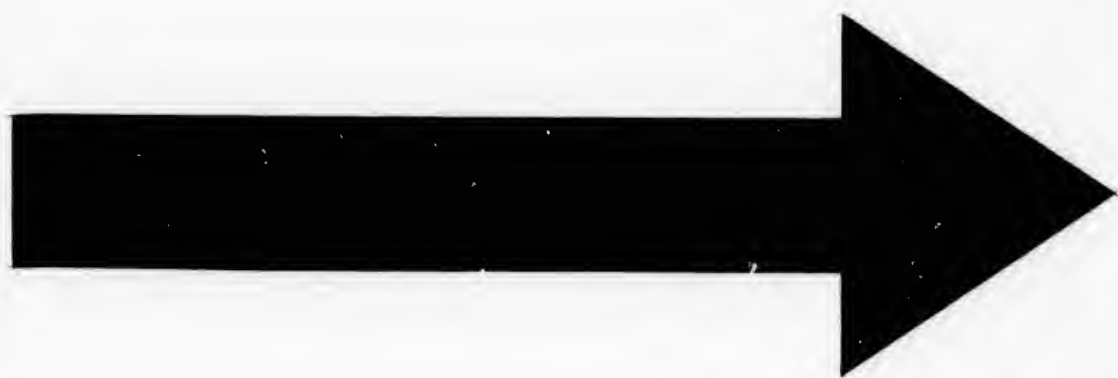

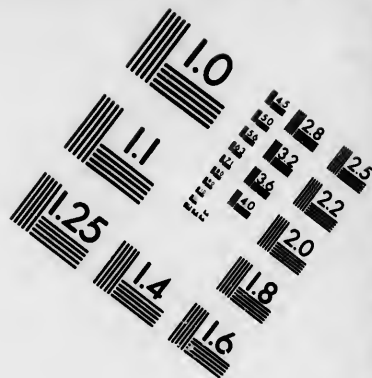
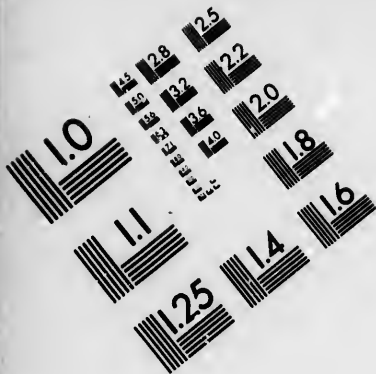

**IMAGE EVALUATION
TEST TARGET (MT-3)**

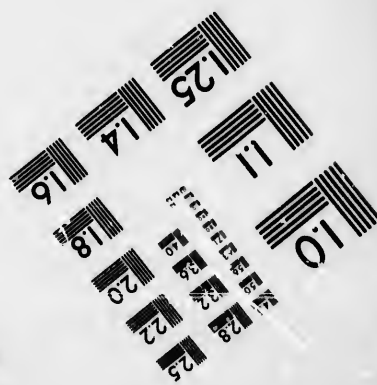
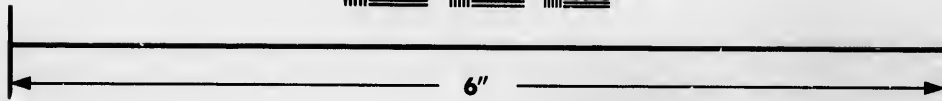
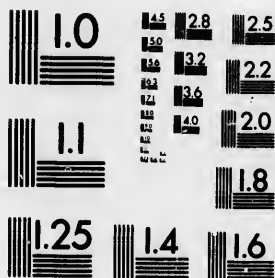

**Photographic
Sciences
Corporation**

23 WEST MAIN STREET
WEBSTER, N.Y. 14580
(716) 872-4503

0
18 28
16 32 25
14 22
12 20
10 18

10
11
12
13
14
15
16
17
18

368 DOUBLE TRANSMISSION IN THE SAME DIRECTION.

The route of the circuit, in each of the before mentioned positions of the keys K_1 and K_2 , may be readily traced by reference to the drawing.

Key K_1 alone sends a positive or + current of, say, 10 cells from battery B.

Key K_2 alone sends a negative or - current from the same battery =, - 10.

When both keys are simultaneously depressed, the negative

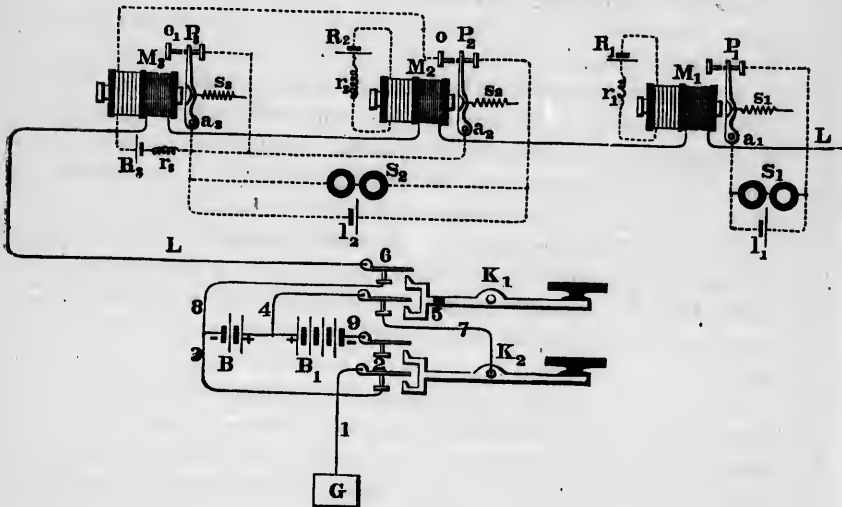

Fig. 168.

pole of the smaller battery is insulated, and the larger battery B_1 sends a positive, or + current =, + 20.

Bernstein's receiving apparatus, in this case, is composed of three independent relays, polarized by means of the auxiliary local coils R_1 , R_2 and R_3 , the two former being constant, and the latter controlled by the armature a_2 of relay M_2 , as shown in the figure at station B.

The sounders S_1 and S_2 are operated by shunting, instead of opening and closing the circuit.

The strength of the current in each of the auxiliary local circuits before mentioned may be changed at will, by varying the adjustable resistance coils r_1 , r_2 and r_3 . It should not, however, be of sufficient power to overcome the tension of springs s_1 , s_2 and s_3 .

The current from auxiliary local R_1 , circulating in M_1 , is, say, $= +10$, and that of auxiliary local R_2 , circulating in M_2 , $= -10$. That of relay M_3 is brought into action only when armature a_2 , of relay M_2 , makes contact with stop o , at which time a current of $+10$ circulates through M_3 .

Bearing this in mind, it will be readily understood by the following explanation how the armatures a_1 , a_2 and a_3 of the receiving instruments M_1 , M_2 and M_3 , respectively, are made to assume positions, with relation to the three electrical conditions of the line, so as to cause sounder S_1 to respond solely to the movements of key K_1 , and sounder S_2 , in like manner, to the movements of key K_2 , while both respond when K_1 and K_2 , at the sending station, are simultaneously depressed.

1. K_1 alone depressed, a positive or $+10$ current to the line of $+10$. The strength of this current, supplemented by that of the auxiliary local R_1 , is sufficient to overcome the spring s_1 , and move the armature a_1 forward, thus breaking the shunt between stop P_1 and armature a_1 , and leaving sounder S_1 to be actuated by local battery l_1 .

The action of the line current upon relay M_2 , in this case, tends to partially neutralize the effect of the auxiliary coil R_2 ; consequently, the armature a_2 is held more firmly by spring s_2 in the position shown.

Armature a_3 , of relay M_3 , also remains on its back stop P_3 , because the line current (viz.: $+10$) is not of sufficient strength to overcome the spring s_3 . Thus the shunt around sounder S_2 remains unbroken, and the latter is inoperative.

2. Key K_2 , depressed.

A negative or -10 current of -10 . In this case, the polarity of the line current is such as to partially neutralize the effect of the auxiliary local R_1 . The armature a_1 is, in consequence, held

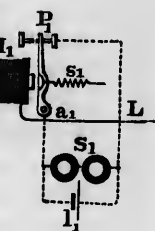

more securely by spring s_1 against stop P_1 , thus preventing a signal being given on sounder S_1 .

Armature a_2 of relay M_2 is carried from stop P_2 to o , because the strength of the line current, viz. : — 10, added to that of the auxiliary local (— 10), is sufficient to overcome the tension of retractile spring s_2 , thus breaking the shunt, and causing local battery l_2 to operate the sounder S_2 .

It will here be observed that when armature a_2 connects with stop o , the auxiliary local of relay M_3 is closed, the strength of which (viz. : + 10) being the same as that from the line, but of opposite polarity, it only serves to substantially neutralize the effect of the latter upon relay M_3 , and armature a_3 is held inactive by the retractile spring s_3 .

3. Keys K_1 and K_2 , both depressed.

A positive or + current of + 20.

Armature a_1 of relay M_1 is caused to move forward, thus breaking the shunt, and allowing a current from local battery l_1 to operate sounder S_1 . The line current in this case is of a polarity, and sufficiently powerful to completely neutralize the effect of the auxiliary local R_2 and exert a force upon relay M_2 , tending to attract its armature a_2 ; but the latter is held in the position shown, against stop P_2 , by the retractile spring s_2 .

The armature a_3 of relay M_3 is carried from stop P_3 to stop o_1 , because the line current is sufficiently powerful to overcome retractile spring s_3 , thus breaking the shunt and permitting sounder S_2 to respond.

Practically, the method of using one receiving instrument having three armatures is a very unsatisfactory one, for the reason that the effective attraction of the electro-magnet for any one of two or more armatures is materially lessened whenever one of the others is in contact, or nearly in contact, with its poles.

The manner of operating a register, or sounder, by closing and breaking a shunt, as in the system above described, would render it impossible to receive and record the signals with accuracy at any considerable degree of speed.

The use of three independent receiving instruments, though free from the objections just mentioned, does not obviate the difficulties which were inherent in the systems of simultaneous transmission in the same direction, invented by Stark and Siemens, in 1855, and which by the latter were considered insurmountable.

THE ELECTRO-MOTOGRAPH.

The salient feature in this discovery is the production of motion and of sound, by the stylus of the Bain telegraph instrument, without the intervention of a magnet and armature. By the motion thus produced, any of the ordinary forms of telegraph printing or sounding instruments or relays may be worked, thus making it possible to send messages by direct transmission over thousands of miles of wire, at the highest speed, without rewriting, delay, or difficulty of any kind.

More than this, the apparatus operates in a highly effective manner under the weakest electric currents, rendering it possible to receive and transmit messages by currents so weak that the ordinary magnetic instruments fail to operate, or even give an indication of the passage of electricity. Thus, when the common instruments stand still, owing to the feebleness of current, this telegraph will be at full work. The apparatus is shown in figs. 169 and 170.

In fig. 169 A is a lever pivoted upon a universal joint C, and is provided at its extreme end with a screw F, tipped with platina, resting upon a strip of moistened paper, which is carried forward (in the direction shown by the arrow) by the drum G. This drum G is continuously rotated by clock work. The spring S is used for the purpose of creating a pressure of the point F on the moistened paper.

The spring R is to draw the lever to the left and against the point X. L is a main battery, K a key. The zinc pole of the battery is connected to the point F, while the carbon pole is connected to the metallic drum G, through the key K. When K

is closed, the chemicals with which the paper is saturated are decomposed by the passage of the current through the paper, and the lever rests against the point X, closing the local circuit containing the sounder AX and local battery LB. If the key K is opened, the normal friction of the platina point F upon the paper is so great that the spring R is insufficient to keep it against the point X, and it is carried forward by the rotation of the drum to the point D, where it remains until the key K is again closed; then, by the passage of the current, the friction is reduced so as to be imperceptible, and the spring R easily pulls the lever against X, where it remains as long as the current is allowed to pass. As will be seen from this brief description, the

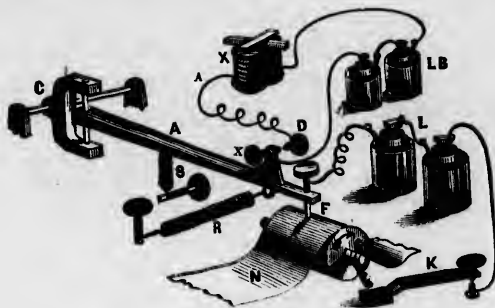

Fig. 169.

lever is moved backward and forward by a difference in frictions, caused by the decomposition of the chemicals (a solution of chloride of sodium and pyrogallic acid), with which the paper is moistened, by the passage of the current.

Why the paper becomes so extremely slippery on the passage of the current, the inventor is unable to state.

The apparatus is extremely sensitive, and can be worked over a circuit of two hundred miles with two cells of battery. Some idea of its wonderful sensitiveness may be formed from the statement that by employing a delicate construction of mechanism and using clock work to actuate the same, a movement of the lever has been obtained, sufficient to close a local circuit,

with a current that was incapable of discoloring paper, moistened with potassic iodide, or of moving the needle of an ordinary galvanometer.

Unlike a magnet, no secondary currents are set up, upon opening and closing the circuit, to delay the movements of the lever; neither has it cores to consume more time, in charging and discharging, but moves with a maximum effect instantly.

The plan shown in fig. 170 is called a polarized motograph.

The key K alternately connects the batteries A and B to the lever of the motograph, one sending a positive and the other a negative current. The current from the battery A passes to the

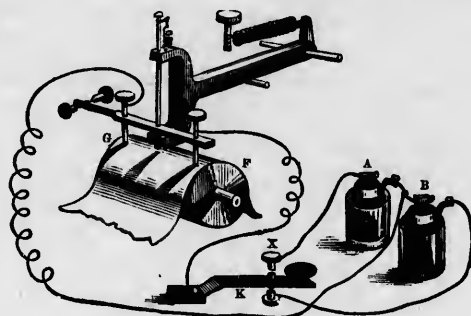

Fig. 170.

point X, thence through the paper to the point G, up through G back to the other end of the battery A. Thus hydrogen is generated on the point F, which becomes slippery, while oxygen is generated on the point G, which retains its normal friction; hence the point G is carried to the right by the rotation of the drum. If the direction of the current be reversed by putting on the battery B, hydrogen is generated on the point G, which becomes slippery, and oxygen on F, which retains its normal friction, and the lever is thrown to the left.

The diagram is arranged merely to illustrate the principle of the invention.

In practice, a single battery and reversing key are used.

Mr. Thomas A. Edison, the inventor of the electro-motograph, states that he has a machine in operation in his laboratory constructed upon the principle shown in fig. 169, with which he has succeeded in repeating automatic signals from one circuit into another, at the rate of one thousand two hundred words per minute, an average of six thousand letters, or twenty-four thousand waves per minute, compelling the lever A (fig. 169) to move backward and forward from the point on the left to the point D on the right four hundred times per second.

By attaching an ink wheel to the extremity of the lever, opposite a continuous strip of paper moved by clock work, messages transmitted at a speed of several hundred words per minute may be recorded in ink; and by attaching a local circuit to the repeating points and adding a sounder thereto, as shown in the figure, the apparatus may be used as a Morse relay to work long lines of telegraph.

CHAPTER XII

ELECTRIC CALL BELLS.

THE introduction of call bells or alarms, which have now become of such extensive application in hotels, factories, elevators, and wherever else their service has been desirable, or where it has been found convenient to employ electricity for operating them, followed, as a matter of course, with the early introduction of the electric telegraph. The invention of these instruments may, therefore, be said to date as far back as that of the telegraph itself.

It will readily be understood that, whatever may be the system of telegraphy employed for correspondence between places distant from or near to each other, it is important, first of all, to have some means at command by which the attention of the correspondent with whom we wish to communicate may be obtained; and this, of course, for cases under consideration, includes the means of producing a noise of some kind within his hearing. A wide field has thus been allowed for the exercise of man's constructive faculties; and the devices which have been successively introduced to meet the want have consequently been exceedingly numerous. Their general development, however, has been very much the same as that of the telegraph.

Professor Wheatstone, in his earliest telegraph experiments, made use of a call which was run by clock work, the movement of the latter being controlled by the action of an electro-magnet. This seems to have been about the first really practical instrument of the kind introduced, and even it was not considered altogether satisfactory in its operation at that time. Since then, however, the apparatus has been so much improved and simplified in one way and another, and the various domestic uses to which it has been applied have given rise to so many different forms, that a knowledge of their details becomes desirable. We

have, therefore, thought it worth our while to devote a chapter to the consideration of the more important of this class of instruments.

The push button or key used in short circuits serves to close the latter in a very simple and effectual manner. Its general plan will be made apparent by reference to figs. 171 and 172.



Fig. 171.

The former shows the case T of wood or other insulating substance, within which are secured the two metallic strips *p* and *g*, one above the other. In its normal state the upper strip is separated from the other by a steel or spiral spring. When, therefore, such a key is inserted in the circuit the latter remains open, but may be closed when desired by pressing upon the

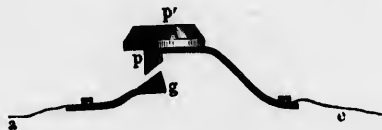

Fig. 172.

knob *p'*, which brings the points *p* and *g* together. Upon the removal of the pressure the circuit is again opened by the retractive force of the spring.

Various patterns of keys are made to suit the different purposes for which they are to be used. The form shown in fig. 171 is the ordinary one. Fig. 173 represents another form, used for electric door bells, in which the circuit closer is contained

within a hollow in the base, the latter being usually of marble, and provided with screws for securing it wherever desired.

Fig. 174 is a convenient form for combining a number of keys within a small compass; eight push buttons, corresponding to as many distinct circuits, are arranged at equal distances around a cylindrical case, within which the connections between the



Fig. 173.



Fig. 174.

metallic strips and wires are made. Each wire is separately insulated by a silk covering, and the whole wound together into a single strand, where they leave the case.

COMBINATION KEYS.

With the keys above described it is evident that the signals last only so long as the button is depressed by the operator; it will also be observed that the operator has no means of knowing with certainty that a signal has been given, and that he must therefore be still less sure of its having been noticed. To meet this defect, and provide a suitable arrangement for every requirement, a special combination is needed, such as is shown in fig.

175. This consists of a case containing a magnetic needle, an electro-magnet, and the metallic contact springs *a b* and *c d*. One end of the coil of the electro-magnet *E* is attached to the screw *e*, the other to the line wire by the insulated screw *V*. The spring *a b* is connected to the binding screw *r* leading to the battery, the other, *c d*, to the plate at *e*, by which communication with the line is made through the coil of the electro-magnet. To the axis of the magnetic needle, *A*, is fastened a pin *g*, which presses against the platinum contact *r*, when the lower pole is attracted by the electro-magnet, and the needle

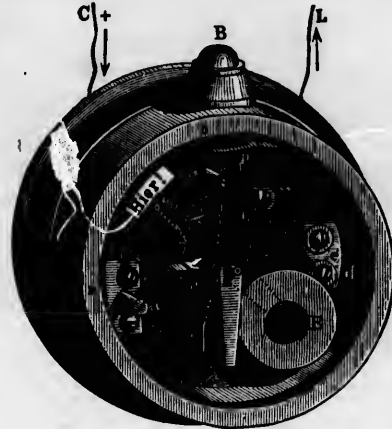

Fig. 175.

thus made to take up the position represented by the dotted lines opposite which, on the cover, is the word understood, or here. The axis of the needle is also in electrical connection with the metallic back of the instrument, to which are attached the metallic plate *p* and binding screw *g*, so that all three are electrically connected. The small plate connecting with *C*, *a* and *r* is insulated from the back, and a spiral wire *n m* joins *g* with the binding screw *e* and coil of *E*. In its normal position the pin *g* rests against a stop not shown.

The operation of the key will now be readily understood.

When the knob B is depressed the current from C passes along *ab* and *cd* to *e* and through the coil of E to V, thence to line L and other apparatus, where an audible or visible signal is to be given. The attraction of the needle A by the electro-magnet E, causing the former to point to the word here on the cover, enables the operator to see that the key has properly performed its office. At the same time the deflection of the needle brings the pin *g* in contact with *r*, so that the current now has a second route through springs *rr* and *g*, and the needle remains deflected after the finger has been withdrawn from B. Thus a continuous signal is given until noted by the person for whom it is intended, who then interrupts the circuit momentarily by such means as are provided for the purpose. With the interruption of the circuit the needle returns to its normal position, and thus shows that the signal has been received. When a vibrating bell, to be described presently, is used for the call apparatus, a continuous to and fro movement of the needle takes place as long as the circuit remains uninterrupted.

APPARATUS FOR GIVING THE SIGNALS.

The ordinary form of bells used for giving single taps is shown in figure 176.

It consists of an electro-magnet MM, opposite whose poles, *n s*, is placed the armature with its clapper, *k*. The latter, in its normal position, is held back from the bell G by a spiral spring attached to the movable upright *d*, which serves to regulate its tension. The stroke of the armature is limited by the set screw *r*. Another form devised by Breguet, in which the prolongation of the armature lever

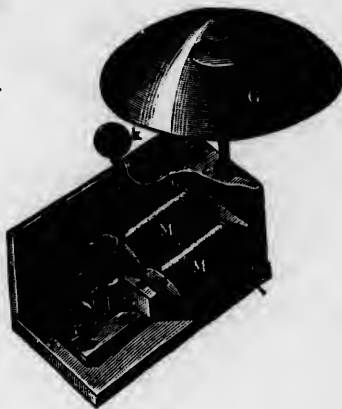

Fig. 176.

is a rather stiff spring, is shown in figure 177. When such an apparatus is placed in circuit with a battery and one of the push button keys already described, a ringing tap is given every time the button is depressed. By combining a certain number of taps, with proper intervals between them, it is possible to com-

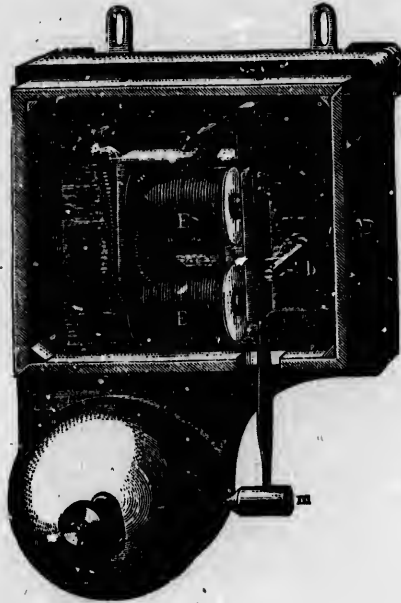

Fig. 177.

municate words and sentences, and thus, besides being a simple call, the apparatus becomes a veritable telegraph.

THE VIBRATING BELL.

The principle employed in this arrangement is shown in figure 178. MM are the coils of an electro-magnet, which are so connected that one end of the wire leads to the binding post B and the other to the post C. To the latter is also attached a straight spring which carries the armature *e*, and, when the current is not

circulating, tends to keep it withdrawn from the poles of the magnet and against another spring, r ; this again is in electrical communication with the binding post D, and both B and D are connected respectively to A and E by brass strips.

When such an apparatus is included in the circuit with the battery and push button, and the button is depressed, the current arriving at b passes through the coils to the post C and arma-

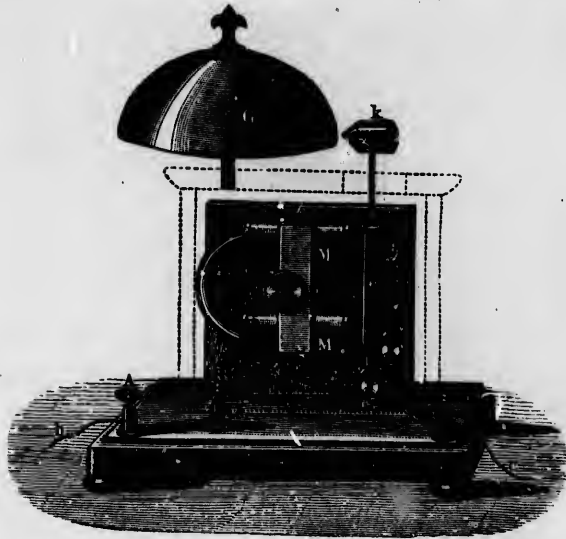

Fig. 178.

ture e , thence *via* the spring r to post E and wire c , completing the circuit. The soft iron cores consequently become magnetized and attract the armature which interrupts the current at r , this causes the cores to become demagnetized again and the armature falls back against the spring, when the circuit is once more established and an attraction follows as before. Thus a rapidly vibrating movement is set up and continued as long as the button is depressed or the circuit remains closed by the needle pin before referred to.

By a slight modification of the connections in the bell instrument the apparatus can be used both as a vibrator and as an instrument to give simple taps. The general plan is shown in fig. 179, in which M and *e* refer to the same parts as in the last. S is a switch which can be turned on B or E at pleasure. When it is on E the connections are precisely the same as those just described and the apparatus becomes a vibrating instrument; when turned on B there is no interruption of the current with

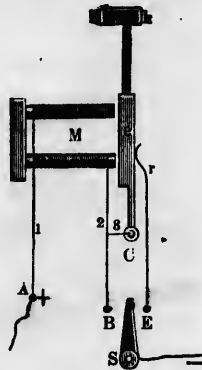

Fig. 179.

the attraction of the armature, and the instrument simply responds by single taps to each closing of the circuit by the push button. The path of the current, when the switch is on B and E, is sufficiently evident from the figure without further description.

DOUBLE BELLS.

When it is desirable to produce a very loud sound, double bells and double electro-magnets are usually employed in the vibrating apparatus. Figure 180 represents an arrangement of this kind. The current, arriving at the binding post C, follows the metallic strips in connection therewith to D and D', thence through the coils M M' and strips H V, H' V' to the contact springs R R' and armature A. From A the continuation of the circuit may be traced by way of B and binding post Z, which

leads back to the battery. One of the bobbins, *M* for instance, is wound so as to produce a greater magnetic effect than that produced by the other *M'*; this causes the armature *A* to be drawn towards *M* until the circuit of the latter is broken at *R*; *M'* now acts alone until interrupted in turn by the break at *R'*, when the same alternation is begun anew. Thus, at each

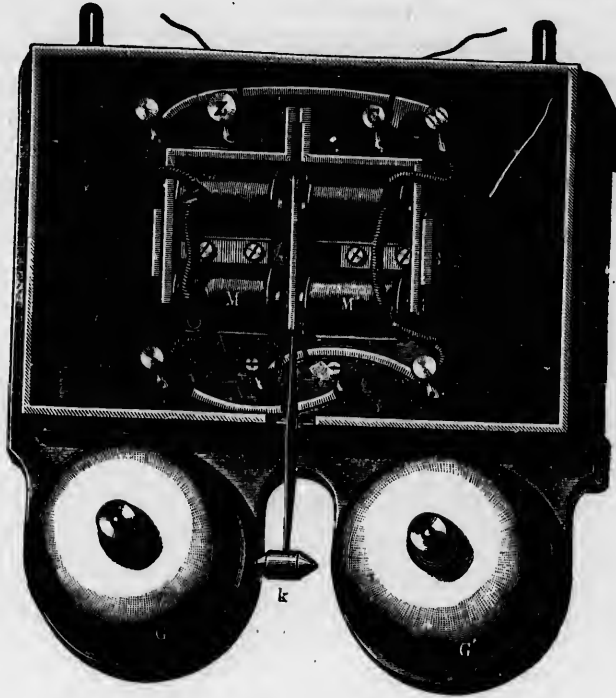

Fig. 180.

vibration of the armature, one of the two bells is struck with considerable violence, and the noise, with rapidly recurring strokes, is well calculated to arrest the attention.

In double bells of this kind the line circuit is never broken by the vibrating armature—the effect of this movement being merely to shift the current from one coil to the other. This, in

some particular cases, is an advantage of considerable importance.

In general, the principle of all vibrating bells is that of the self-acting make and break; but, when the contacts are rigid points, the vibrations of the armature take place only within narrow limits, and the arrangement cannot very well be utilized for ringing a bell. Siemens has devised a plan, in his dial instruments, which answers the purpose much better, by giving the armature a greater range of movement; but the adaptation of this device to the ringing of bells for simple calls is a little troublesome, and, in fact, for general use, would be altogether too complicated. By far the most preferable way of obtaining the desired range of stroke is that already described, in which a spring of some kind forms part of the path for the current, and

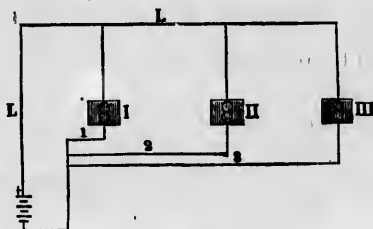

Fig. 181.

which, with the attraction of the armature, follows the latter for such a distance as may be required.

When one battery is to serve for operating several of the bells above described, the vibrators cannot all be placed in one circuit, as each one interrupts the circuit independently of the others; and it is impossible, or rather impracticable, to make the armatures of the various instruments so that they will all vibrate in exactly the same time, or always be in unison.

The plan generally adopted for such cases is shown in figure 181, where each bell, I, II, III, has a separate conducting wire of its own, as represented by the numerals 1, 2, 3, and a return wire, L L, serves for all. If, now, one of the bells is operated by the pressure of a push button in 1, 2 or 3, as the case may be,

it acts without in any way interfering with the others, as they are all quite independent of the circuit thus interrupted.

SINGLE BELLS TO BE WORKED WITHOUT INTERRUPTING THE CIRCUIT.

The fault just noticed in connection with the vibrating armature, causing a break at each vibration, may be remedied in a very easy manner simply by causing the armature to cut its own magnet out of circuit after each attraction. The principle works very satisfactorily, and will be readily understood by reference to figures 182 and 183, which represent two phases of its application. *m m* are the coils of the electro-magnet; *a*, the armature to which the clapper *k* is attached by means of a rather stiff

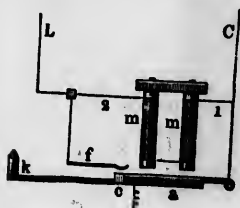

Fig. 182.

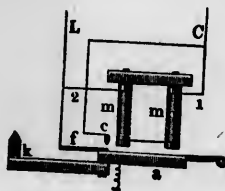

Fig. 183.

spring, and *f* an elastic steel spring, which readily follows the to and fro movement of the armature for a short distance. In figure 182, the armature itself forms part of a shunt circuit, by which the current is withdrawn from *m m*. As will be seen, a current arriving at *C* passes through the wire *1*, coils *m m* and wire *2* to the line *L*; the armature is thus attracted to the spring *f*, and a second route made for the current by way of *a c f*. As the resistance of this route is exceedingly small, compared to that of the helices, almost the entire current passes by the new path, and the cores become demagnetized. The retractile force of the spring now preponderates, and the armature falls against the back stop, breaking the shunt circuit on its way. By this means the magnetism of the cores is again renewed, and a con-

stant vibration kept up. In figure 183, the forward movement of the armature brings a spring *f* against a contact *c*, and forms the shunt quite independent of the armature.

As either of these arrangements does not break the main circuit, any desired number of them can be placed in the same line and worked without interfering with each other.

When the bell system is to be used for long distances, or when a very loud ringing is desired, for which purpose the main line current, as a rule, is not sufficient, a relay and local battery are

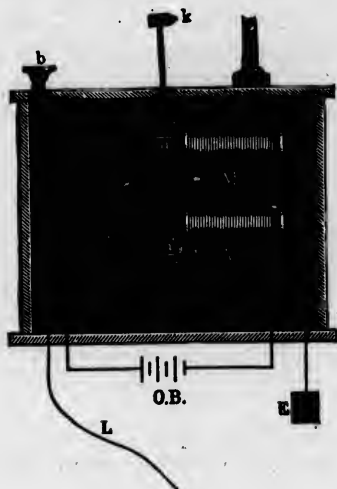

Fig. 184.

generally used; and with the heaviest apparatus, requiring still more power, the ringing is done by means of weights.

Figure 184 represents an arrangement devised by Aubine, in which a single set of electro-magnets, *M M*, serve both for the relay and the call. A small projection on the upper end of the armature *a*, when the latter is in its normal position, supports the lever *3*, keeping it from making contact with spring *4*, and, at the same time, holding it firmly against spring *2*. When now a current is sent into the line, it passes along the connection *1* to

spring 2, thence to lever 3 and its connecting wire to spring *f* and armature *a*, and from there on through the coils to earth. This causes an attraction of the armature; lever 3 falls down on spring 4 and closes the local circuit, which again results in a magnetization of the core. The armature is thus made to vibrate in the manner already described, and a violent ringing is set up, which continues until, by pressure on the knob *b*, lever 3 is again raised and supported by the armature projection.

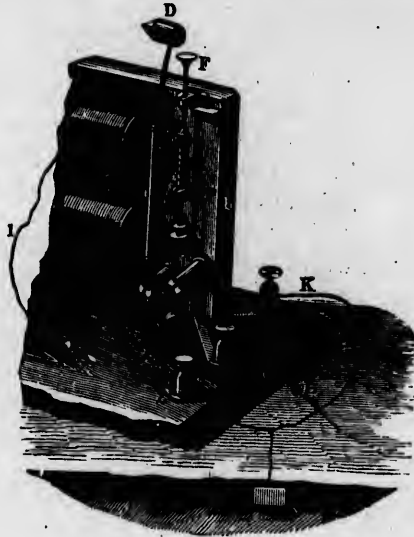

Fig. 185.

Figure 185 represents another relay based upon similar principles, and much used in France. The main line circuit is sufficiently apparent without further explanation. The local battery *O B* is inserted between the binding post *K* and *Z*. From *K* an insulated copper strip *b b* leads upward, and at the top is bent so as to catch the pin *e*, when the latter is carried upward by the spiral spring *d*. A projecting pin from the armature, when the latter is not attracted, serves to keep the rod *F M* depressed. With the arrival of the line current the armature is attracted and

the rod released; this allows the spring *d* to act, and close the local circuit at *eb* when the ringing is commenced. By pressing on the knob *F* the lower end of the rod is caused to engage with the projecting armature pin, and the apparatus is once more ready for another call.

SIEMENS AND HALSKE'S STATION ALARM.

This is shown in figure 186, and consists of an ordinary relay and bell magnet, with an automatic make and break arranged upon the same principle as Siemens' dial instrument. *m m* are the coils of the relay magnet, and *1¹* and *1²* its terminal wires, one of which leads to line, the other to earth. The poles only of the bell magnet are shown at *M M*, one of its coils is connected to the binding post *Z*, the other to a *V* shaped piece of metal, termed the shuttle, which, in its normal position, rests with one end against an adjustable screw in the plate *E*, the latter also in metallic connection with the relay lever *a*. The local battery is joined to the binding posts *Z* and *K*. When a current is sent into the main line the armature *a* is attracted and closes the local circuit; this charges the magnet *M M* and actuates armature *A*, but after passing a little distance the long projecting arm on the latter moves the shuttle against the stop *r* and breaks the local circuit; the spring *F*, being no longer restrained, now withdraws the armature, but in doing so causes the shuttle to close the circuit once more, and thus a constant ringing is maintained as long as the main line is closed.

BREGUET'S ALARM OR CALL.

With most of the apparatus heretofore described the call or alarm is only maintained for such a period of time as the circuit may be closed by the person giving the signal, or, as with the arrangement shown in fig. 184, until the messenger called stops the ringing by depressing the knob. Various other combinations have been suggested by Aubine, Breguet and others, by means of which a single signal is made to give any number of taps.

lose the
pressing
age with
be more

ry relay
arranged
m m are
al wires,
s only of
connected
f metal,
with one
r also in
attery is
t is sent
the local
ature A,
m on the
the local
ithdraws
e the cir-
d as long

e call or
be circuit
with the
lled stops
binations
by means
of taps.

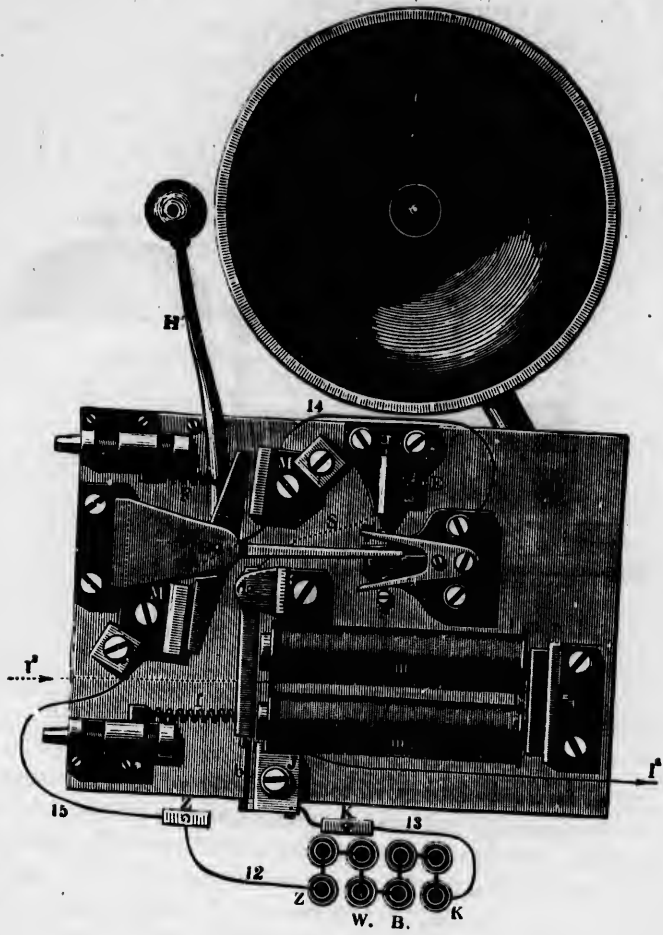

Fig. 186.

Breguet's arrangement is shown in figure 187, and its operation may be described as follows: The line current arriving at L in consequence of the key being depressed, passes to the contact screw S, thence by way of the lever C c, pivoted at C, through the coils of the electro-magnet E to the armature *a* and contact *b* to earth. The armature is thus drawn forward for a short distance, but returns immediately afterward, owing to the break in the circuit occasioned by the movement, and closes the circuit again. In this manner a vibratory motion is set up, and with each backward movement of the armature the toothed wheel R

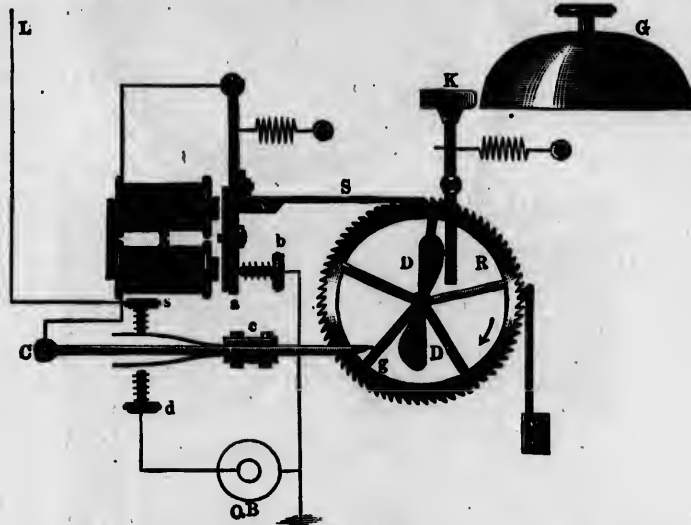

Fig. 187.

is forced forward one cog, so that the lever *c C* is soon released from the pin *g* and falls on the contact screw *d*, placing the local battery in circuit. The continued vibration of the armature keeps the wheel in motion, the arm *D* is thus brought against the hammer lever, and the latter carried forward a certain distance and then released, when the hammer strikes against the bell with considerable force. With the complete revolution of the wheel the pin *g* engages with the lever *C c* again, and once more closes the main current.

COMBINATION OF A SINGLE CALL BELL WITH TWO OR MORE RELAYS FOR SEVERAL LINES.

When two or more wires terminate at one place a single call bell may be made to answer for them all, but in such cases each relay must be provided with some arrangement such as the rod *F M* in fig. 185, to show on which of the lines the signal has been sent. Fig. 188 shows an arrangement of this kind. *A* is the electro-magnet of the relay, whose armature ends in a bent hook, *H*, which engages with the rod *F I*; *m* and *n* are two screws attached to the upright, *D K*, and serve to limit the play

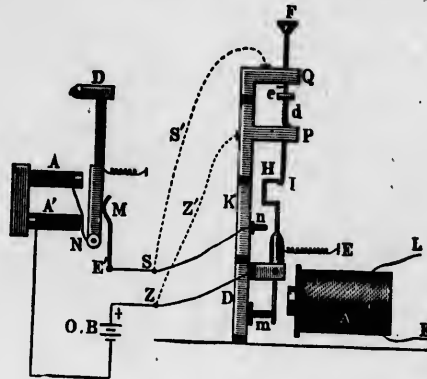

Fig. 188.

of the armature. This upright is made in two parts, insulated from each other; the one marked *D* is connected to one pole of the local battery; the other, *K*, is connected by a wire *S* to the interrupting spring *M*, of the vibrating bell already described. When the armature of the relay magnet is attracted, its upper part is brought in contact with the screw *n* and the local circuit is completed, at the same time the attraction of the armature part is brought in contact with the screw *m* and the local circuit is released, at the same time the attraction of the armature releases the rod *F I*, which is raised by the action of the spring *d*, and thus shows, when attention is called by the bell, which line has given the signal.

Each of the several relays are connected with the bell magnet in the manner shown in the figure, so that there are virtually as many distinct keys for closing the local circuit as there are relays. After the call has been observed the knob *F* is again depressed when it engages with the armature and is held until released by another signal.

It is frequently desirable that the bell should continue to ring after the main line current has ceased; and, in order that this may be the case, the upper part of the pillar *D K*, fig. 188, is made the same as its lower part, in two sections, *P* and *Q*, and each insulated from the other. Two wires, *S' Z'*, shown by the dotted lines, connect *Q* and *P* respectively to the wires *S* and *Z* when, therefore, the rod *F I* is released, the action of the spring *d* brings the small platinum tipped piece *e* against a similar contact on *Q* and forms a second closing of the local circuit, so that the bell continues to ring until the call has been observed and the knob depressed.

SIEMENS AND HALSKE'S RELAY WITH ANNUNCIATOR PLATE.

These instruments are made in a very perfect manner, and are much used on the German Fire Alarm Telegraph. Fig. 189 represents a perspective, and fig. 190 a sectional view of the relay, which does not differ materially from the ordinary forms, except in the addition of the annunciator disk and lever *b c d*, pivoted at *c*. The relays are made for both open and closed circuits, the one represented being designed for closed circuits. The line connections are made at 1 and 2. *K* and *B* connect with the Morse recording apparatus, while the alarm bell is joined to *A* and the metallic piece *W V*. In its normal state the lever of the disk is held in a horizontal position by the hook on the lever *a a*, but with any interruption of the main circuit the armature is drawn off by the action of spring *f* and releases the disk, which is now raised to a vertical position by the weight *b*; this closes the call circuit at *i* at the same time that the armature *a a*, falling on the back contact *m*, actuates the Morse recording

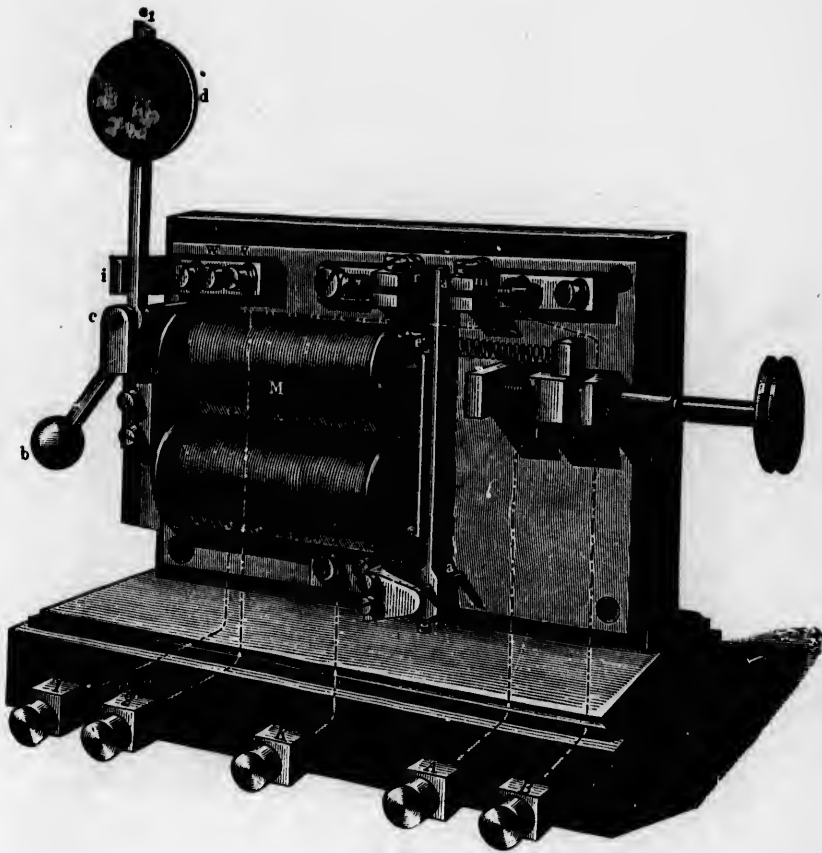

Fig. 189.

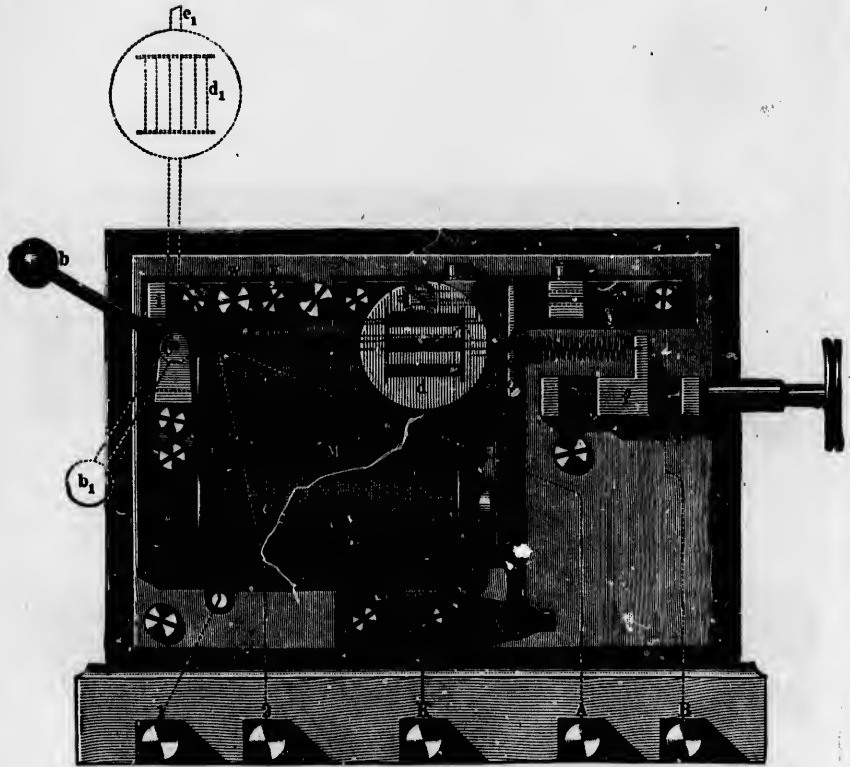

Fig. 190.

instrument. When the automatic vibrating bell is used the ringing is kept up until the lever and disk are returned to their horizontal position by the operator.

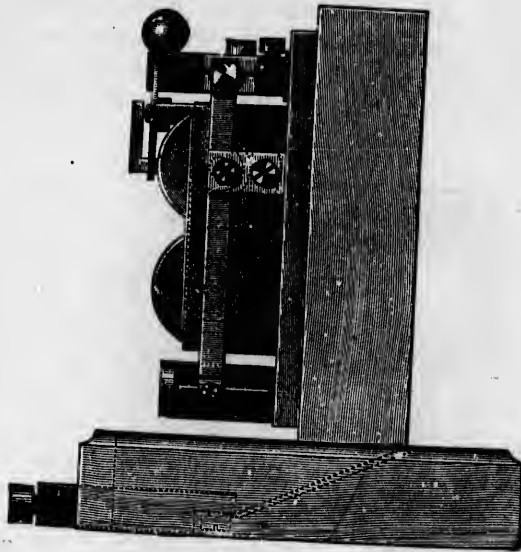

Fig. 190.

CLOCK WORK ALARM.

These calls are constructed in various ways, to suit the different purposes for which they are to serve; in some the hammer is operated by weights or springs, and made to give a single stroke for each impulse of current sent into the line; in others, the strokes are repeated a certain number of times; or again, the ringing is continuous; but in all cases the current has only one function to perform, that of releasing the train of clock work. This is usually accomplished by the action of an electro-magnet on its armature, and the weights or springs cause the signalling. An important and much used apparatus of this kind is that of Hagendorff's, which gives but a single stroke for each depression.

of the signaling key, and which is therefore preferable to the vibrating bells for many purposes, especially in places where the rattle of the latter is likely to be more or less annoying.

The use of weights or springs for causing the separate bell taps is also to be preferred to the tapping from a clapper carried by the armature lever, as with the latter arrangement, owing to an occasional tardy withdrawal of the hammer, the signals are not always very distinct.

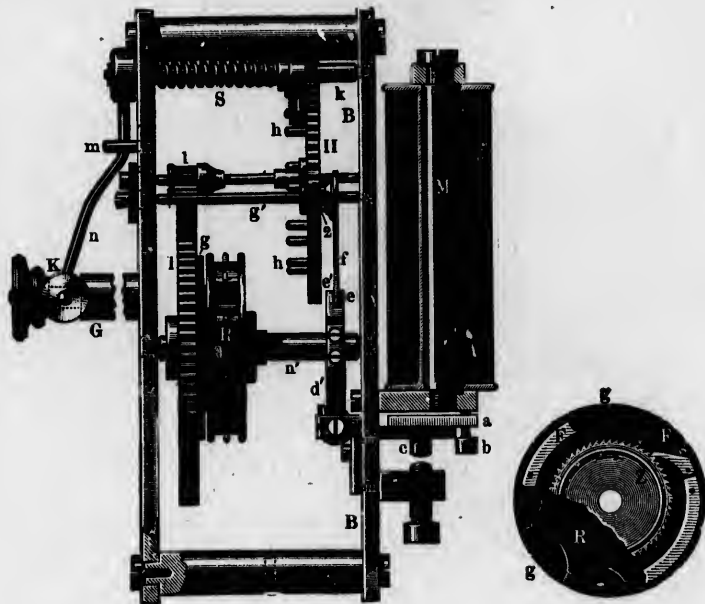

Fig. 191.

Fig. 192.

Figures 191 to 194, inclusive, show the principal parts of Hagendorff's apparatus; the letters refer to the same parts in each figure.

Figure 191 gives an interior view of the works. B B is part of the brass frame to the back of which is attached an electro-magnet M; fig. 193 represents the inside view of the same plate. The wheel I, fig. 191, is loose on the axis *n'* and carries a disk

g, better shown in figure 192; this is provided with a detent S and spring F F, which presses the former into the teeth of the ratchet wheel Z, thus preventing the latter, as well as the wheel R, which is fastened to it, from turning in the direction indicated by the arrow without at the same time causing the wheel 1 to turn with it. The wheel R is provided with radial pins which catch in a chain passing over it and attached to the weight P,

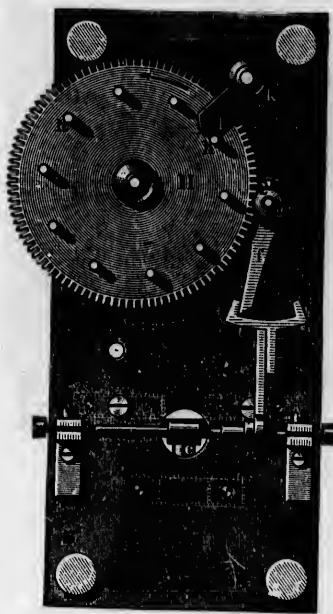

Fig. 193.

fig. 194, the pins serving to prevent the chain from slipping. As will be seen, the ratchet allows the wheel Z and R to be freely turned in a direction opposite that indicated by the arrow; this raises the weight P, which, in descending again, sets the whole train in motion, wheel 1 communicating its movement to wheel 11, and the latter, in turn, acting on axis g' and stop lever f connected to it.

ble to the
where the
g.
e bell taps
carried by
ring to an
ls are not



192.

l parts of
e parts in

B is part
an electro-
ame plate.
ies a disk

The wheel 11, fig. 193, carries near its circumference eight or ten projecting pins, *h h*, which raise the arm 1 on the axis *k*. A powerful spring, *S*, surrounding this axis and in communication with it and with the frame of the apparatus, tends continually to keep the arm depressed. When, therefore, the latter is raised by the revolution of the wheel the spring is subject to considerable tension, and as soon as a pin passes from under the arm, causes



Fig. 194.

the latter to descend, and the hammer *K*, attached to the axis *k* by the arm *n*, strikes the bell with some violence. The pin *m* serves to limit the play of the arm *n*.

Figure 191 represents the relay armature attracted. When no current passes in the coils of the magnet the armature remains down and the train work is arrested by the arm *f*, which catches in the escapement *d' e e'*. The ends *e e'* of the escapement are so made that the back one *e* is a little nearer than the front

one e' to the plate $B B$, but the two are attached to one piece, and move together with any movement of the armature. The operation of the apparatus will now be readily understood. When a current is sent into the line the armature of magnet M is attracted, the front point e' of the escapement, fig. 191, is moved to the left, and the arm f is carried forward by the action of the weight on the train work to e , and as soon as the circuit is broken e moves toward the back $B B$, and the arm makes one complete revolution, when it is stopped again by e' . Simultaneously with this movement the pins $h h$ pass under the arm l , and the hammer strikes against the bell, making one tap for each make and break in the circuit.

CHAPTER XIII.

THE ELECTRIC LIGHT.

WHEN the terminal wires of a battery containing a number of cells are brought together, and then separated slightly, there results, as is well known, an intense, bright light between them, and to this, on account of its curved form, the name electric arc has been given. If the circuit is not immediately broken, the ends of the wires rapidly become heated, and, in a very short time, melt and drop off in glowing globules. Portions are even volatilized and pass off as vapor, whose color varies with the kind of metals employed, and with the medium in which the experiment is made. The distance between the ends consequently increases rapidly, and a point is soon reached at which the light is interrupted, the electro-motive force of the battery being then no longer sufficient to maintain a current against the opposing resistance. If, however, the wires are again brought together, and then separated as before, the arc is once more established, but, as we have just seen, it will last only for the very short time during which the electro-motive force is sufficient to overcome the resistance between the points.

When two pointed pieces of hard, conducting carbon are used for the terminals, as shown in fig. 195, the light becomes of dazzling brightness, too intense, by far, if the number of cells is considerable, to be carelessly regarded by the unprotected eye alone. By viewing it through colored glass, however, or by projecting an image of it upon a screen, it may be studied without danger.

As the number of cells is augmented, the light becomes not only more intense, but the arc may be materially lengthened, while its temperature, at the same time, is still further increased.

In the brilliant experiments of Davy, which were performed at the beginning of the present century, with some 2,000 cells of

battery, and which were the first that were made on an extended scale, an arc of four inches in length was obtained in the open air, and in vacuo it increased to seven inches. Since then, more powerful elements, and greater numbers have been employed, and the resulting effects have been on a corresponding scale.

In temperature as well as brightness, the voltaic arc exceeds all other artificial sources of heat; by its means the most refractory substances are fused and volatilized, including even the diamond itself, which Despretz succeeded in reducing to vapor.

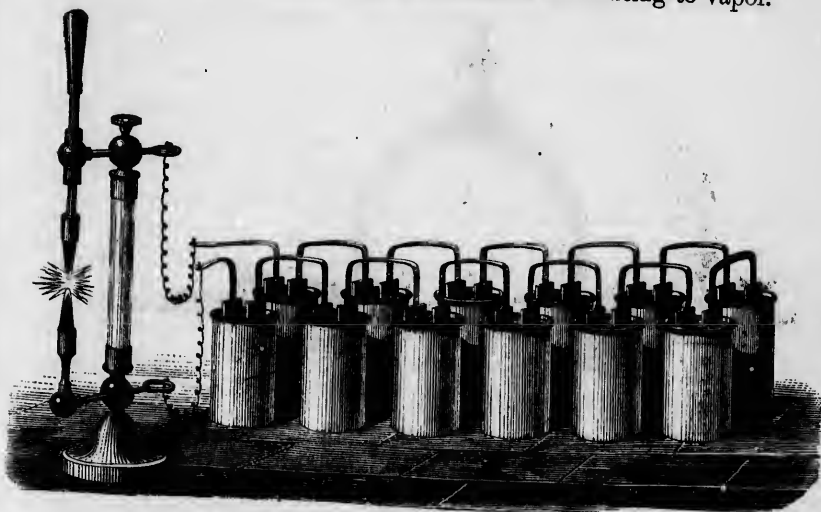

Fig. 195.

As the light continues, the positive carbon is found to waste away much more rapidly than the negative—a fact first observed by Silliman—and although the latter is first to become heated, its temperature in the end is less than that of the former, as may be seen when the light is interrupted, the positive carbon then continuing to glow for some time after the negative has become dark. In addition to this, it is also found that particles of the carbon are forcibly detached from the pencils and carried across the arc. This transport of particles can be rendered visible to a

large number of persons at one time by throwing an image of the heated points upon a screen, with the aid of a lens. On watching the image for a few minutes, incandescent particles will be observed traversing the length of the arc, sometimes in one direction and sometimes in the other, the prevailing direction being, however, that of the positive current. This circumstance, which appears to be connected with the higher temperature of the positive terminal, explains the difference between the forms assumed by the two carbons. The point of the posi-

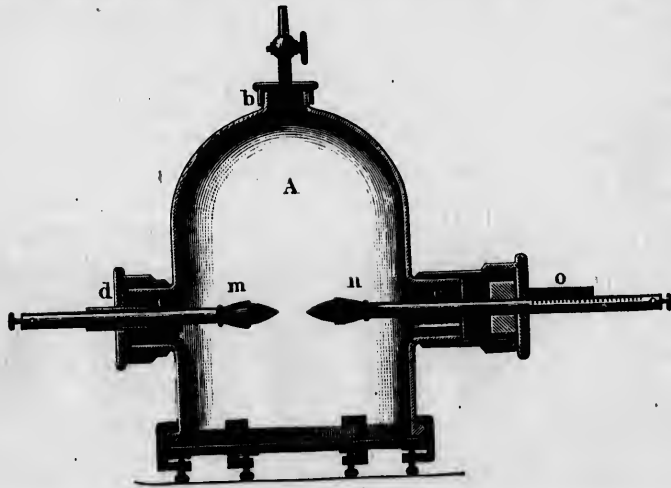

Fig. 196.

tive carbon becomes concave, while the negative remains pointed, and, as stated above, wears away less rapidly. In vacuo the difference is still more marked. A kind of cone then grows upon the negative carbon, while a conical cavity is formed in the positive.

Fig. 196 shows a convenient apparatus for experimenting with the light in vacuo and in various gases. It consists of a bell shaped receiver of glass, provided with three tubular openings, two, *d* and *o*, opposite each other, and the third, *b*, on top.

To the latter is fitted a stop cock and tube, which serve for connecting the apparatus with the air pump, and also for introducing various gases when necessary. The other two serve to bring the two electrodes opposite each other, inside of the receiver, and are provided with tightly fitting caps through which the electrodes pass. The one over the opening e allows the electrode n to be pushed in or out at pleasure, and carries, besides, a scale o , by means of which the length of the arc may readily be ascertained. A ground glass plate, clamped to the bottom of the receiver, completes the details for rendering the apparatus air tight.

With the arrangement shown in figs. 195 and 196, the light, as we have already seen, is soon extinguished, owing to the increased distance between the points by the burning or wasting away of the carbons; consequently, when we require to use it continuously for any considerable length of time, it becomes necessary to employ some mechanical means for keeping the pencils at the right distance apart, or for bringing them together again automatically, if from any chance cause they should become separated sufficiently to cause the light to go out. A great many forms of apparatus have been devised for this purpose, some exceedingly simple, and others more or less complicated.

Fig. 197 shows a form of lamp devised by Duboscq, and operated by the combined action of the current and a system of wheel work, driven by a spring in connection with one of the wheels.

On a circular brass plate A , is mounted a metallic tube B , to which is attached the binding post C . A metallic rod D , sliding in this tube, carries at its top the arm E , to which is also attached a rod and socket for holding the upper carbon. This rod is arranged to slide in the arm E , so that it may be moved up or down for a limited distance, and is held tightly in any position that may be given to it. The lower end of the rod D is provided with a rack F , which engages with the wheel G , and the latter again is pressed on to the axis of another wheel H , and

firmly held in place by friction. Within a barrel connected with wheel H there is a powerful spring, which serves as the motive force for actuating the mechanism of the lamp. A double rack J, terminating above in the rod O, which passes through an

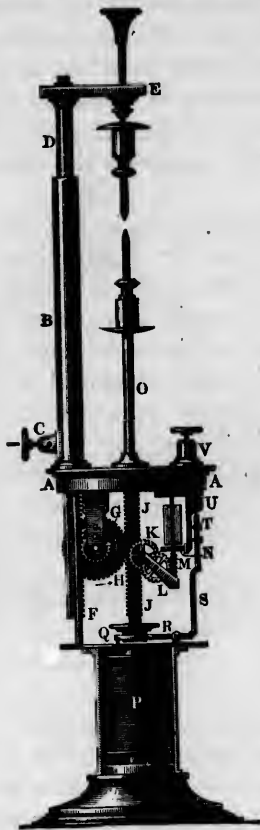

Fig. 197.

insulating guide in the cover, and is provided with a socket for holding the lower carbon, engages on one side with the wheel H, and on the other with the axis of wheel K. This wheel, in like manner, engages with the pinion of wheel L, better shown

in fig. 198, and the latter again, with an endless screw M on the prolongation of the axis, carrying the cog wheel N and fly X. An electro-magnet P, consisting of a hollow iron tube, with its helix of insulated copper wire, is placed in the base of the lamp; and one end of the wire of the helix is connected to the binding post V, insulated from the cover, the other to the lower end of the rack J, which moves up and down in the hollow of the core. A circular piece of iron Q, attached to the bent

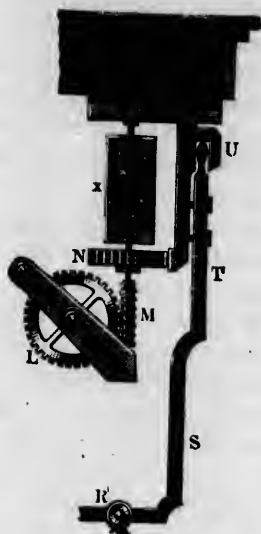

Fig. 198.

lever R S T, serves as an armature to the magnet, and when attracted by the latter, causes the pallet of the supplementary lever U, which is controlled by the long lever R S T, to catch in the wheel N, and thus arrest its motion and that of the train of wheels with which it is in connection. There is also a pin or rod in connection with the apparatus, that can be pushed in from the outside, and made to start or stop the train work when desired.

When the lamp is to be used, the rod D is raised. This causes

the wheels G and H to revolve, and thus at the same time lowers the rod O, so that the carbons can be inserted. If allowed to act now, the spring within the barrel connected with H will cause the carbons to approach and touch each other. The battery can then be connected; the positive pole to the post V, the negative to C. With the passage of the current through the coil surrounding the core, the armature will be attracted and the train thus locked; but the points may be properly separated again by raising the rod carrying the upper carbon, and the light will then shine out in all its brilliancy. As the carbons burn away the current necessarily becomes weaker, on account of the increased resistance of the arc, and a time soon comes when the magnet is no longer strong enough to retain the armature. The retractile spring then prevails, and releases the wheel N, and thus allows the spring in the barrel of H to act and bring the points once more near each other. With the decrease in the distance between the points, the current becomes stronger and the armature is again attracted. A moment more, it is again released and again attracted, and so its position continues to vary from time to time with the changes in the strength of the current. It therefore becomes possible, by the use of the lamp, to maintain the light for a very long time without interruption. As will be observed, the diameter of wheel H is double that of wheel G, and consequently the carbon connected with the holder O moves through twice the distance of that in the upper holder. The object of this is to compensate for the more rapid wasting away of the positive carbon, which, as has been found, consumes about twice as fast as the negative. The use of wheels of different diameters thus furnishes the means for keeping the light at a given point, which is a matter of considerable importance in almost all of the uses to which it is applied; and when a reflector is used, is absolutely necessary, as otherwise it would be all but impossible to keep the light properly focused.

Fig. 199 shows another form of lamp, devised by Foucault. In this there are two systems of wheel work, one for bringing the

ne time
ted. If
ted with
h other.
e to the
current
will be
properly
carbon,
As the
aker, on
me soon
tain the
eases the
H to act
With the
becomes
more, it
ion con-
strength
se of the
out inter-
el H is
connected
that in
e for the
h, as has
ve. The
means for
consider-
applied;
as other-
properly

Foucault.
aging the

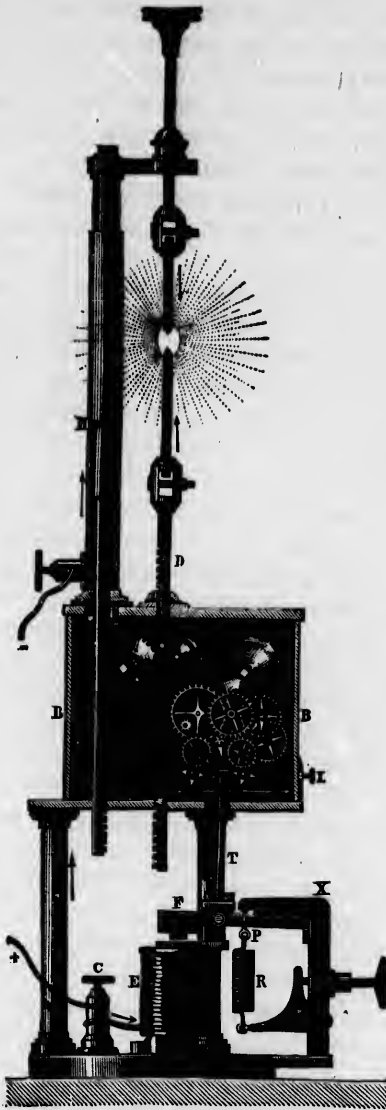

Fig. 199.

carbons together and the other for separating them, and it is principally in the addition of this last arrangement that the lamp differs from that of Duboscq, there being, in the latter form, no provision for automatically relighting the lamp in case it should accidentally go out. L' is a barrel driven by a spring inclosed within it, and driving several intermediate wheels, which transmit its motion to fly o . L is the second barrel, driven by a stronger spring, and driving in like manner the fly o' . The racks which carry the carbons work with toothed wheels attached to the barrel L' , the wheel for the positive carbon having double the diameter of the other, the same as in the Duboscq lamp. The current enters at the binding screw C , on the base of the apparatus, traverses the coil of the electro-magnet E , and passes through the wheel work to the rack D , which carries the positive carbon. From the positive carbon it passes through the voltaic arc to the negative carbon, and thence, through the support H , to the binding screw connected with the negative pole of the battery. When the armature F descends toward the magnet, the other arm of the lever $F P$ is raised, and this movement is resisted by the spiral spring R , which, however, is not attached to the lever in question, but to the end of another lever, pressing on its upper side and movable about the point X . The lower side of this lever is curved, so that its point of contact with the first lever changes, giving the spring greater or less leverage, according to the strength of the current. In virtue of this arrangement, which is due to Robert Houdin, the armature, instead of being placed in one or the other of two positions, as in the ordinary forms of apparatus, has its position accurately regulated, according to the strength of the current. The anchor $T t$ is rigidly connected with the lever $F P$, and follows its oscillations. If the current becomes too weak, the head t moves to the right, stops the fly o' and releases o , which accordingly revolves, and the carbons are moved forward. If the current becomes too strong, o is stopped, o' is released, and the carbons are drawn back. When the anchor $T t$ is exactly vertical, both flies are arrested, and the carbons remain stationary. The curva-

ture of the lever on which the spring acts being very slight, the oscillations of the armature and anchor are small, and very slight changes in the strength of the current and brilliancy of the light are immediately corrected.

Mr. Hart, of Edinburgh, Scotland, has invented a simple lamp, in which the weight of the rod in which the carbon is fixed supplies the place of the clock work in the lamp just described, and an electro-magnet lets it descend, or locks it, as the carbons are consumed.

Mr. Farmer, of Newport, R. I., has also invented an automatic lamp, containing but little train work, and whose action is controlled by a regulator or relay, consisting of an axial magnet, the coils of which are placed either directly in the main circuit or in a branch of the same, and a delicately poised lever, from one end of which the axis bar of the coil is suspended. The action of the current, when too strong, tips the bar in one direction, and when too weak a retractile spring tips it in the other. It is the employment of this relay to operate the mechanism of the lamp, through the intervention of local or branch circuits, which constitutes the principal difference between this and most of the other forms of lamps now in use. The train of wheel work, driven by a spring, tends to cause the carbons to approach each other, but the motion is arrested if the armature of a small electro-magnet, forming part of the apparatus, is attracted. The tilting bar of the regulator closes the local circuit of this releasing magnet whenever the current is of the proper strength, but as soon as the current weakens, by the burning away of the points, the retractile spring of the regulator causes the lever to open the branch circuit of the releasing magnet, and the armature of the latter then allows the train to move. The carbons, consequently, approach each other until the main current again becomes of such strength that the regulator closes the branch circuit of the detaining magnet, and thus, once more, stops the motion of the train.

When the points run into actual contact, after the arc has been broken, the light is again established by a third electro-

magnet, also in the main circuit, which withdraws the lower carbon from contact with the upper, and holds it in position until the arc is again broken. The movement of the carbon holders is caused by the action of two screws so geared together that one pencil, the positive, moves twice as rapidly as the other.

There are, besides, conveniences attached to each of the carbon pencil-holders, so that they can be disengaged from the screws and moved independently to any required position at pleasure. The holders, also, admit of separate adjustments on a vertical axis, so that by this means the carbons can be placed in a perpendicular line, one above the other. The spring does not need rewinding oftener than new carbons are supplied, and the performance of the lamp is very satisfactory. It has been run for hours when required, and no reason exists why it should not run continuously until the pencils are consumed, provided it be properly adjusted at first.

Within the last two years a new form of electric light apparatus has been introduced in France and elsewhere, which, from the remarkable properties that have been attributed to it, has attracted a great deal of attention. The invention is due to M. Jablochhoff, a Russian engineer, and is known as Jablochhoff's candle. It consists of two carbons placed side by side, and separated by an insulating and fusible substance. No clock work whatever is required, and the light is very soft and steady. Fig. 200 shows the arrangement as originally designed. The carbons *a*, *b*, some four inches in length and one quarter of an inch square, are imbedded in an insulating substance *c*; the carbon slips being also separated from each other some three sixteenths of an inch, and the whole moulded into the shape of a candle. In order to facilitate the early action of the current, a small piece of carbon, about the size of the lead of an ordinary lead pencil, is placed across the top of the electrodes. A series of experiments with candles of this description were carried out at Chatham some time since, and, it is stated, the power then obtained was some fifty per cent. greater than that obtained previously from the recognized electric light.

Since then, M. Jablochhoff has twice modified this arrangement, each modification being attended with success beyond that obtained by the preceding. His first proceeding was to divest the carbons of their outer covering, leaving nothing but the carbon slips *a, b* (fig. 201), and the intervening substance, kaoline, *c*. Each carbon is fixed in a small brass tube *d, e*, the lower portions of which are left vacant, so that they may fit over two metal pins, attached to which are the wires from the magneto machine. These tubes are insulated one from the other, and the whole bound together by a band of insulating material *f*.

The latest modification embraces the removal of the carbons



Fig. 200.



Fig. 201.

and the replacement of them by a carbon paste, a sort of priming, the object of which is to reduce the resistance which the kaoline, when cold, interposes to the passage of the current. With this arrangement a splendid band of light, constant, soft and steady, is obtained.

The principal advantages of the candle appear to be due to the fact that it is neither dazzling nor blazing, and does not, therefore, surround the various objects illuminated with the disagreeable haze and ghastly shadows that are observed when the ordinary electric light is used. It is, however, somewhat more expensive, but, as a compensation, is said to allow of a

greater subdivision of the current—as many as fifty lights having been maintained from a single source by its use.

A novelty in electric lamps has just been brought out by Mr. Wallace, and, we learn, will soon be placed in the market at a very low figure. It consists principally of a substantial metallic frame and an electro-magnet. There are two slides in the frame, each capable of holding, in a horizontal position, the two carbons, which are made in the form of plates, twelve inches long by two and a half wide, and half an inch thick. The upper and lower parts of the framework are insulated from each other, and in electrical connection with two binding posts, on the upper part, serving to connect them with the magneto machine. The electro-magnet, through whose helices the main current circulates, is placed in the centre of the frame above the carbons, and, by its action on an armature, serves to separate the upper carbon from the lower, to any distance desired.

When the lamp is joined with a magneto machine by means of the binding posts and conducting wires, the circuit is completed through the carbons, which touch each other, and the armature is attracted, thus separating and holding them apart so long as the current is maintained. The light burns toward the opposite end from which it started, then changes and burns back again, always burning toward the place where the carbons are nearest. If, from any cause, the light goes out, the circuit is broken, and, of course, the electro-magnet ceases to act. But the instant the upper carbon falls the circuit is again closed, and the carbons are once more separated and relighted.

The advantages of this lamp are that it contains no combination of wheels or springs, and, consequently, there is no winding up of the apparatus to look after. The carbons, again, are so large that they will last for ten nights, of ten hours each, and the lamp requires no care except for their renewal. The practical disadvantage that suggests itself is its lack of means for maintaining the light at a given point, so as to use it in connection with a reflector.

Figs. 202 and 203 show two forms of the Brush electric lamp, as

manufactured by the Telegraph Supply Company, of Cleveland. Fig. 202 is a hanging lamp, intended for factory use; fig. 203 an adjustable table lamp.

There are also a great many other lamps, such as Serrin's, Browning's, Siemens's, etc., and all of which are more or less employed when it is desired to maintain the constancy of the light for long continuous working; but the apparatus we have just described contain most of the principal characteristics and conveniences embodied in these, and it will, therefore, be unnecessary to give more attention to this part of the subject at present.

Instead of the battery, whose employment for light purposes is now almost exclusively confined to the illustration of lecture-room experiments, and physical demonstrations in class rooms, or to the production of luminous effects in theatrical exhibitions—places where it is seldom convenient to employ a steam engine—dynamo-electric machines are now almost universally used, and their advantages over the battery are very marked in a great many particulars. Of late years, dynamo machines have also been extensively introduced in electro-plating establishments, to take the place of batteries, but in such cases their construction is considerably modified, in order to adapt them to this particular kind of work. As ordinarily constructed for light purposes, the machines would have an electro-motive force far too high for plating, where, as a general thing, two or three volts are all that are required.

Large magneto-electric machines, for light purposes, appear to have been first suggested by Professor Nollet, of Brussels, in 1850, but since then a great many modifications and improvements have been introduced, so that the machines of to-day, although depending for their action, like the earlier ones, upon the same inductive principle by which mechanical force is transformed into electricity, are nevertheless far superior to them, both as regards economy and effectiveness when in action.

Fig. 204 represents one of the first forms of these machines as constructed by Holmes, of London, and the Compagnie l'Alliance,

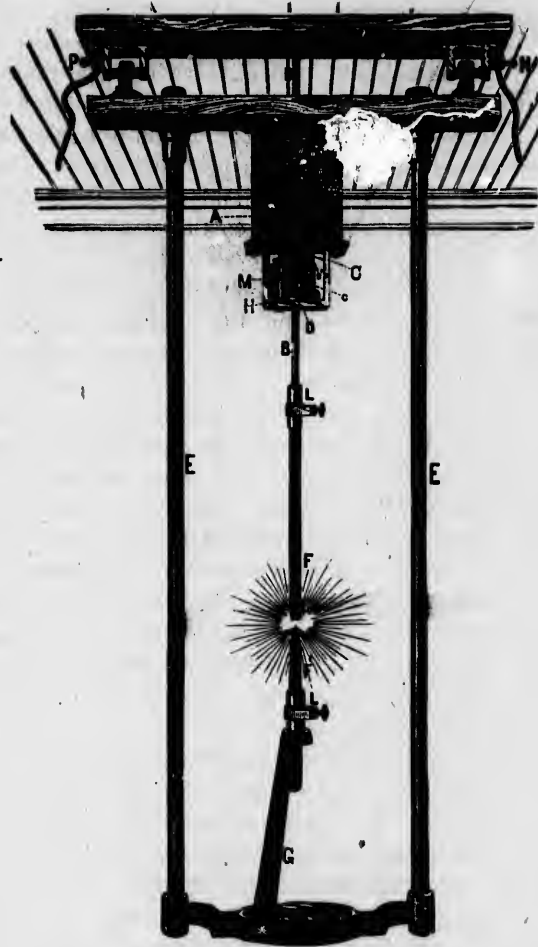
*Fig. 202.*

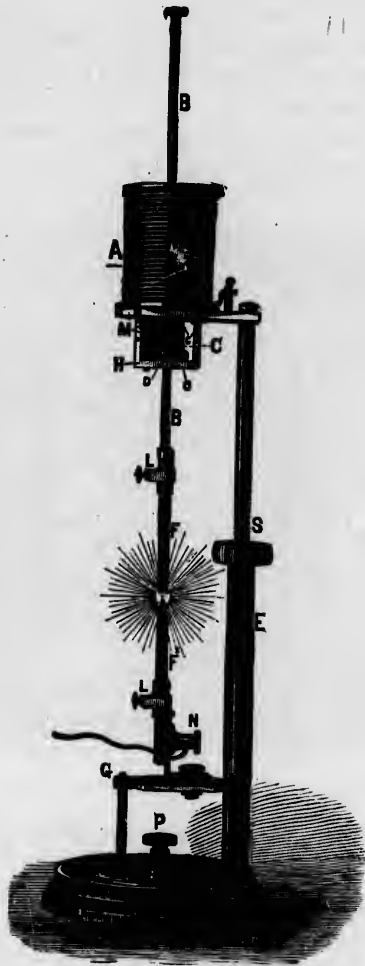

Fig. 203.

of Paris, and which at one time promised to become of very extensive application for light-house purposes.

In this machine there are eight rows of compound horseshoe magnets fixed symmetrically around a cast iron frame. They are so arranged that the opposite poles always succeed each other, both in each row and in each circular set. There are also seven of these circular sets, with six intervening spaces. Six bronze wheels, mounted on one central axis, revolve in these intervals,

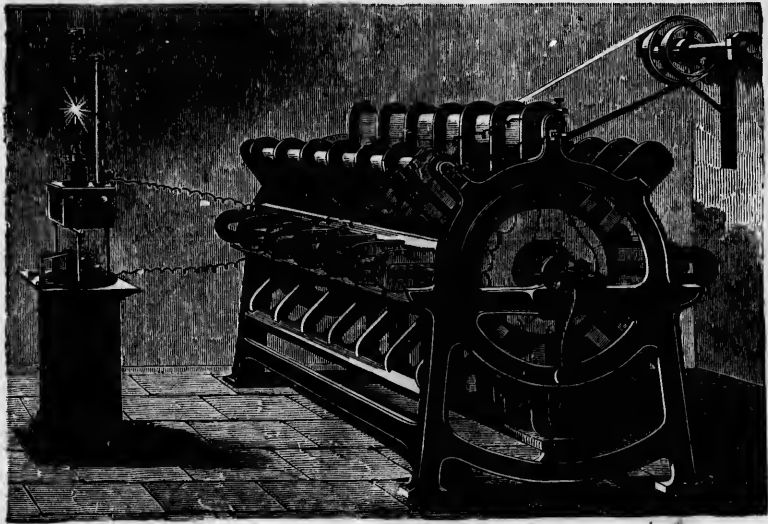

Fig. 204.

the axis being driven by steam power, transmitted by a pulley and belt. The speed of rotation is usually 350 revolutions of the axis per minute. Each of the six bronze wheels carries, at its circumference, sixteen coils, corresponding to the number of poles in each circular set. The core of each coil is a cleft tube of soft iron, this form having been found peculiarly favorable to rapid demagnetization. Each core has its magnetism reversed sixteen times in each revolution, by the influence of the sixteen succes-

sive pairs of poles between which it passes; and the same number of currents, in alternately opposite directions, are generated in the coils. The coils can be connected in different ways, according as great electro-motive force or small resistance is required. The positive ends are connected with the axis of the machine, which thus serves as the positive electrode; and a concentric cylinder, well insulated from it, is employed as the negative electrode.

In 1854 Siemens devised a very effective armature, which has since been much employed by other manufacturers in different forms of machines. The principal advantage of this armature results from its occupying but little space for rotation. Consequently, it can be kept in a very strong magnetic field; at the same time also its form renders it well adapted for rotation. It consists of a peculiarly shaped electro-magnet, such as would be formed by cutting two wide and deep longitudinal grooves opposite each other in a cylindrical bar of iron, and then continuing them around the ends. The wire is wound lengthwise around the core in the groove, like thread upon a shuttle, and brass caps, provided with axes and a pulley, are then screwed on to the ends of the magnet. When this armature is mounted between the poles of a series of permanent horseshoe magnets and rotated rapidly, very strong currents are produced. The two ends of the wire are connected with a commutator, formed by fastening two semicircular pieces of brass to an ivory ring on the axis, and springs bearing upon these brass pieces, and in metallic connection with the binding posts of the apparatus, supply the means for collecting and conducting away the electricity produced in the wire coils.

By employing two of these armatures and taking advantage of the property which soft iron possesses of receiving a much higher degree of magnetism than steel, and consequently, therefore, of its capability of producing stronger currents by induction in movable coils within its field, Mr. Wilde, of Manchester, England, has succeeded in constructing very energetic machines, and which are well adapted for producing the electric light.

of very
horseshoe
They are
ch other,
also seven
x bronze
intervals,



a pulley
ons of the
ies, at its
er of poles
be of soft
e to rapid
d sixteen
en succes-

The apparatus in reality consists of two machines combined in one. The current from one of the Siemens's armatures, produced by its rapid rotation in the strong magnetic field of a series of permanent magnets, is employed to charge a large and powerful electro-magnet, between whose poles the second armature is made to revolve, and the current from the latter is utilized for the light.

Two armatures for the electro-magnet are sometimes furnished

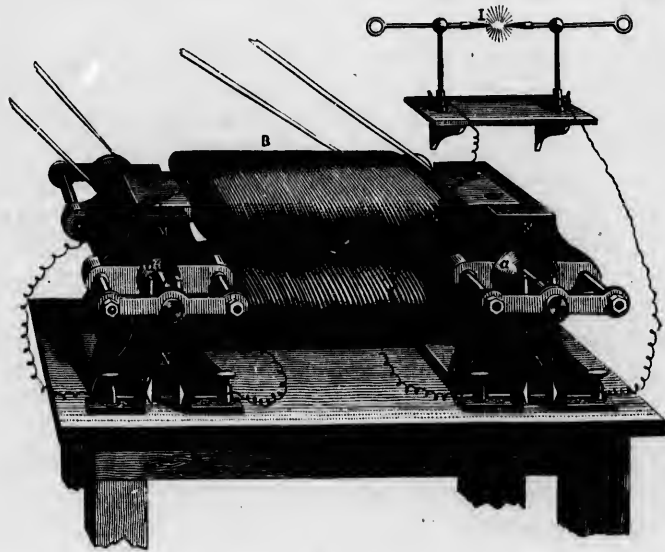

Fig. 205.

with the machine, one with wire coils for the production of currents of rather high electro-motive force, to be used for light purposes alone, and the other with coils of sheet copper strips, which give currents of less electro-motive force, but more especially adapted for plating. With the interchangeable armatures, which are driven by belts running on pulleys on their axis, the machines can be used either for lighting or for plating at pleasure, and this, in some particular cases, is a very desirable feature.

Numerous other machines are constructed with interchangeable armatures, on the same plan and for the same purpose.

Another form of magneto apparatus is that known, from the name of its inventor, as the Ladd machine. This was first publicly exhibited at the Paris Exposition of 1867. It is shown in fig. 205, and, as will be seen, employs, like the Wilde machine, two Siemens's armatures, but it differs from the latter principally in not having any permanent magnets whatever to charge the armature which supplies the horizontal field coils B B. Two long flat pieces of soft iron are placed within these coils and attached to the iron castings or pole pieces MM, NN, which are turned out just large enough for the armatures to fit inside of them and rotate without touching. Thick strips of brass or other non-magnetic metal are also placed between the upper and lower castings M and N, to keep them separate from each other, and thus subject the armatures between them to the full force of their inductive action.

The connections of the coils are such as to produce opposite polarities in M and N; and the armature at the left of the machine supplies the field coils, while that at the right furnishes the current for the light.

One of the most remarkable properties of these machines is that by virtue of which they become capable of producing exceedingly powerful currents from the smallest beginnings; the simple reactive effect of the very slight residual magnetism that remains in the cores after they have once been charged being, in fact, all that is required, on revolving the armatures, for their production; and to operate a new machine, it is only necessary to place it in such a way that the armatures will stand in the magnetic meridian, and then cause the one which supplies the field coils to rotate rapidly. This, of course, causes the convolutions of wire surrounding the latter to cut through the lines of force due to terrestrial magnetism, and produces in them electrical currents of greater or less magnitude, depending upon their velocity of rotation, which, on traversing the larger coils B B, render the cores and pole pieces M N slightly magnetic. The reactive

effect of the magnetism in the pole pieces on the armature is thus added to that produced by the earth's magnetism, and an increased current flows into the field coils. A greater degree of magnetism is consequently produced in the pole pieces, which causes the latter to react once more on the armatures, and the result of which is a corresponding increase in the current, and increased magnetism. By this means, therefore, the current, in an exceedingly brief interval of time, increases from nothing to a maximum of strength, at which it remains practically constant for a uniform velocity of armature rotation. It is usually better, however, and much more convenient in charging a machine for the first time, to use the current from a battery, or from another machine already charged, than to depend alone, for this effect, upon terrestrial magnetism.

The machines thus far described furnish only momentary currents of varying strength and polarity. If currents of but one direction are required, these intermittent currents must be rectified, as we have already seen, by means of a commutator, and this causes a diminution in the strength of current, and is frequently accompanied by the production of sparks. Mr. Z. J. Gramme has, however, invented a machine in which these objections are not met with, as the current obtained from it flows continuously, and in one direction only.

The magnetic field in this, as in other machines, is created by a powerful magnet, of such a shape that its poles confront each other, and its characteristic feature, therefore, lies wholly in the construction of the armature. This consists of a ring of soft iron, surrounded by an endless coil of wire, and is rigidly attached to an axis, so that it can be made to revolve; one half of the ring being under the influence of the north pole, and the other under that of the south pole of the magnet.

As the ring revolves, every portion of it changes position in the magnetic field; but no current is developed in the wire, considered as a whole, as the latter entirely surrounds the ring, and the magnetic state of this, as a whole, remains unchanged. A point on the ring considered by itself, however, changes polarity

twice during every revolution. As it recedes from one pole, it generates in the surrounding wire an electro-motive force, the same as that generated when it approaches the other pole, and the two electro-motive forces, consequently, oppose each other, but whenever an external conductor is provided between them, they unite and produce a current.

In practice, the ring consists of a bundle of soft iron wire, and the helix is made in sections, each one of which is connected to its neighbor, and also to a strip of brass forming the means of connecting with the external circuit. During a revolution, and when the electro-motive forces of opposite sections are at a maximum, the corresponding brass strips touch: a couple of metallic

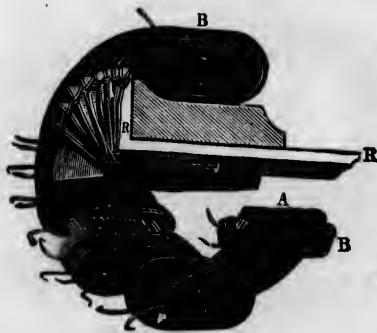

Fig. 206.

springs, and thus make connection with the external conductor. The peculiar construction of the ring will be seen by referring to fig. 206, where several sections of the wire B B are shown upon the ring A. The figure also shows the way in which connection is made with the brass strips R.

A convenient form of the Gramme machine, constructed especially for the laboratory and lecture table, is shown in fig. 207.

At the present time electric light machines and machines for plating purposes are made by numerous manufacturers in this country; but, perhaps, by none on a scale so large as that

FROM THE LABORATORY OF
T. A. EDISON,
MENLO-PARK, N. J.
U. S. A.

carried on by Messrs. Wallace & Sons, of Ansonia, Conn. This firm began the construction of these machines for the market in the spring of 1875, and since that time there is hardly any form of magneto machine that has not been built and tested at their works.

The machine which they finally decided upon manufacturing, as possessing the greatest merit, is the invention of Moses G. Farmer, formerly of Boston, but now and for the last three years electrician at the Government Torpedo Station, at Newport, R. I.

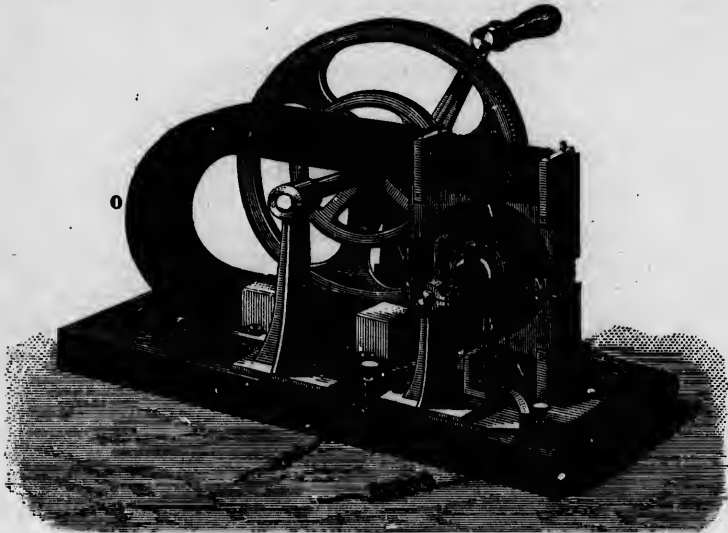

Fig. 207.

This machine, which has been somewhat modified and improved upon from time to time by Mr. William Wallace, is, in many respects, unlike any of the other forms that we have considered. It consists of two large electro-magnets, an armature, two commutators and four brushes, the latter forming part of the circuit, and serving, when the machine is in operation, to collect the currents generated in the armature coils. The two magnets are mounted upon a cast iron frame, similar to that of

a lathe, and are made to face each other, while the armature, which consists of an iron casting of varying diameter, according to the size of the machine, is mounted upon a shaft, and placed between the magnets. The shaft also carries pulleys at each of its ends, and is made to rest in bearings in the yokes of the electro-magnets. The armature disk carries on each side, and near its periphery, twenty-five wedge shaped projections, of which there are fifty in all, that face the poles of the electro-magnets, and on which coils of wire are placed. The terminals of these coils are joined together, and a wire, connected with the junctions, leads to the commutator, situated on the same side of the plate—all the coils on one side connecting with one commutator and all on the opposite side with the other.

The commutators are placed upon the shaft, between the legs of the two magnets, and consist of wood or other more durable insulating substance, on which strips of brass, connecting with the wires from the armature coils, are secured. The connections of the machine are so arranged that when the external circuit, which may consist of the light apparatus or depositing vats with their leading wires, is completed, the armature and field of force coils are combined with it in one—an arrangement for which Mr. Farmer obtained a patent in 1872, and which, when the external resistance is low, is of very great advantage.

The eight inch machine, so called from the length of its electro-magnet, and which is the one most commonly employed, will produce two lights of about two thousand candle power each, and is so arranged that the two may be combined in one if desired. It weighs six hundred pounds, and requires to drive it about one horse power for every twelve hundred candle light.

The machines made by Messrs. Wallace & Sons weigh from one hundred and twenty-five to three thousand pounds each, and are capable of producing a light equal to that of from one thousand to forty thousand candles. Some of them will even maintain the arc with the carbons three and a half inches apart. Fig 208 shows another form of the light machine, as constructed by the Telegraph Supply Co., of Cleveland, on a plan devised by Mr. C.

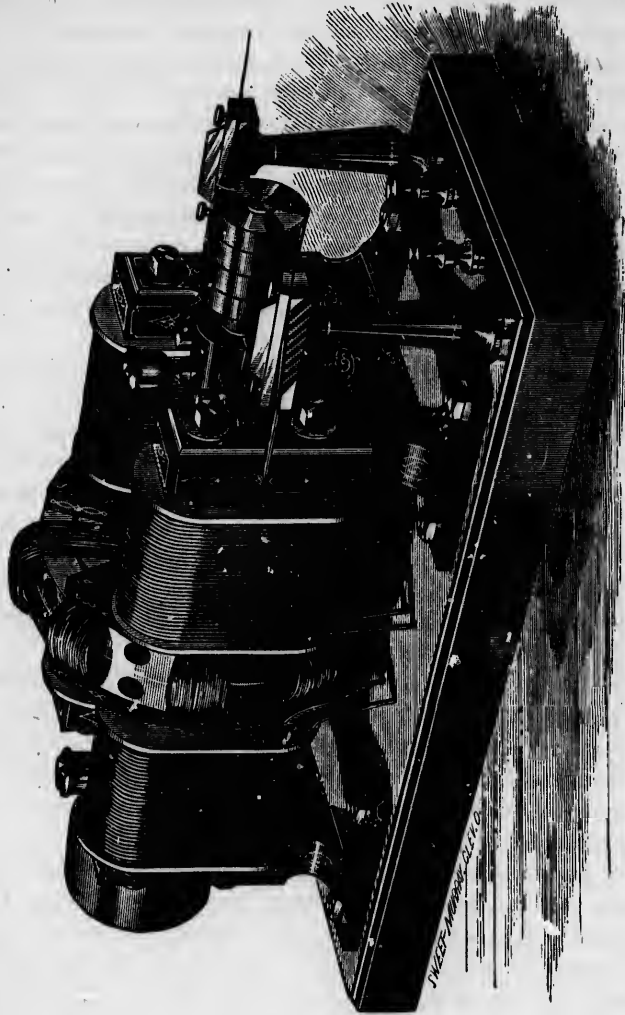

Fig. 208.

F. Brush. There are two marked differences between this and other machines, the first of which consists in the peculiar method adopted for winding the armature; the latter is composed of a ring or endless band of iron, but instead of having a uniform cross section, like that of the Gramme machines, is provided with grooves or depressions whose direction is at right angles to its magnetic axis or length. These grooves, which may be of any suitable number, according to the uses for which the machine is designed, are wound full of insulated copper wire. The advantage of winding the wire in grooves or depressions in the armature is twofold; first, the projecting portions of the armature between the sections of wire may be made to revolve very close to the poles of the magnets from which the magnetic force is derived. By this means the inductive force of the magnets is utilized to a much greater extent than is possible in the case of annular armatures as ordinarily used, which are entirely covered with wire and cannot, therefore, be brought very near the magnets; second, owing to the exposure of a very considerable portion of the armature to the atmosphere, the heat, which is always developed by the rapidly succeeding magnetizations and demagnetizations of armatures in motion, is rapidly dissipated by radiation and convection. In the case of armatures entirely covered with wire the escape of the heat is very slow, so that they must run at a comparatively low rate of speed, with corresponding effect, in order to prevent injurious heating. The second difference lies in the manner of connecting the armature coils to the commutator, this being such that only the particular coils which contribute to the production of the current are in circuit at once. During the time they are passing through the neutral points in the magnetic field they are cut out one after the other, and thus, while idle, do not tend to weaken the effects of the machine by affording a path to divert the current generated in the active sections from its proper channel.

It would be an interesting matter, if the efficiency of all the different machines employed in the production of the electric light could be obtained and published, so as to be readily avail-

able. A general comparison could then be made which would, in a measure, settle the ever-recurring question in regard to the superiority of this or that machine. Undoubtedly, this information exists for many of the machines, as numerous measurements of them have been made by different experimenters, but the results have in most cases never been made public, and are, therefore, to be found only in the hands of the individual experimenters themselves. It may be stated, however, from such information as we have found available, that the amount of energy obtainable as electricity from the best machines probably does not exceed, or if so, only in a slight degree, two thirds that of the mechanical force required to drive them.

The expense of maintaining the electric light is much less than that incurred by the employment of any of the ordinary methods of illumination. Mr. Farmer states that where a large amount of light, say from five thousand to ten thousand candle light, is required, it can be produced from a suitable machine at the rate of one thousand candle light per horse power; but, smaller amounts—say two hundred to three hundred candle light—are relatively more expensive, probably about one half horse power for two hundred to two hundred and fifty candle light.

This is much more economical than when produced from any of the ordinary forms of galvanic battery. One horse power may be reckoned as costing from two to six cents per hour, which would give the cost of ten thousand candle light as sixty cents per hour, simply for power. Of course some other items, such as oil, attendance, interest and depreciation, also cost of carbons consumed, would increase this amount somewhat, but even at twice or three times this cost it is still much less expensive than gas light at three candle light to the cubic foot per hour, at \$2.50 per thousand for gas.

The difficulty of procuring carbons that would burn uniformly has been a source of a great deal of annoyance. If the carbon is taken just as it comes from the gas retorts and sawed into shape, it is found to contain many impurities, and, when

burning, will frequently split and large pieces drop off. If it is first pulverized and then pressed into shape, as is done for battery plates, difficulties of one form or another still appear, and the long road of trial and failure has generally had to be pretty well trodden over by all who have given this part of the subject much attention. Mr. Wallace, who has studied it very closely, has, we believe, succeeded in producing very satisfactory carbons, but we are, as yet, unacquainted with the process.

The best illuminating effect appears to be produced from thin carbon pencils, but it has heretofore been found impracticable to use such pencils, on account of their high resistance and the rapid consumption of material due to the action of the air on their highly heated ends. Mr. Brush has sought to obviate these difficulties, and at the same time improve the illuminating power of the light, by the admixture of different foreign substances with the carbon and by surrounding the stick either mechanically or by electro-plating with various metals. By this means a free and ready conductor is afforded for the current and a good connection between the carbon and its holder secured, while the employment of longer and thinner pencils is also rendered practicable, and there is little or no liability to breakage.

In operation the intense heat of the arc melts and disperses the covering of the carbon sticks at their opposing points and for a proper distance beyond, but no farther. The balance of the carbons is entirely preserved, while as fast as they are burned, just so fast will their covering be removed, leaving the carbons exposed.

The subdivision of the light is another of the problems that have occupied the attention of inventors a great deal. No one doubts that the division can be effected, but to do this in a simple manner, and offer to the public a cheap and practical device for the purpose, has not been an easy task. It would appear, from some of the latest experiments made at the works of Messrs. Wallace & Sons, that there is scarcely any limit to the number of subdivisions that can be made, and, to a certain extent, most of the machines are now constructed to give

separate lights. One form of construction of the Brush machine is capable of producing four independent lights, of 3,000 candle powers each.

The best means, however, for obtaining a number of lights from a single source consists in the employment of thin strips of platinum or iridium, whose temperature is raised by the passage of the current to a point only slightly below the melting point of these metals. When strips or wires of either metal are rendered incandescent, a mild and pleasant light is emitted, much less contracted and glaring than the light obtained from carbon pencils; and with the additional advantage also, that no vitiation of the atmosphere occurs, and the amount of light, at any one point, can be made as small as may be desired.

Platinum, according to Mr. Farmer, affords about 100 candle light per square inch of incandescent surface, when within 220° of the point of fusion, and a bar or wire of this metal can be maintained at this temperature for any length of time by means of a suitable regulator and current. Iridium is even better adapted for illuminating purposes than platinum, as, in consequence of its higher melting point, it yields more light per square inch of heated surface.

While it is undoubtedly true that the light obtained in this way is not the most advantageous for light-house and steamship purposes, or for places where the dazzling light of the arc is required, it is none the less true that for many other, and especially for private or domestic uses, it possesses decided advantages over the carbon light, and on many accounts—among which the facility attending its regulation is not least—is far preferable.

FROM THE LABORATORY OF
T. A. EDISON
MENLO PARK, N. J.
U. S. A.

~~FROM THE LABORATORY OF
T. A. EDISON,
MENLO PARK, N. J.
U. S. A.~~

CHAPTER XIV.

THE ELECTRIC LIGHT.

The interest in electric lighting has increased so rapidly of late that we feel warranted, with the issue of a new edition of this work, in reconsidering the subject, and supplementing what has already been said in regard to it with such additional information as will tend to make the book still more valuable for those who desire to acquaint themselves with the progress that has been made in the application of electricity to lighting purposes. As the introduction of the new matter in its proper place in the old chapter would lead necessarily to some inconvenience, we have concluded to embrace what we now have to say in a new chapter, although in doing so the general arrangement will, by this means, be somewhat broken up.

It has been stated, on page 426, that much difficulty is experienced in procuring proper carbon pencils for light purposes—a fact that any one who has at all experimented with electric lighting cannot have failed to notice; and it will, therefore, be interesting to say a few words first in regard to the best means that have been devised by different experimenters, in the preparation of material, for remedying this defect.

Foucault certainly made a decided step towards the practical use of the light when he substituted gas retort carbon for the substance previously used. Before that time the arc was scarcely more than an interesting toy, and only rarely seen outside of the cabinets of schools and colleges; but, as intimated, the substitution partook more of the nature of an improvement than anything else, and did not solve the question completely, since, to this day, it occupies the attention of practical men.

One of the earlier methods of preparing carbons, and which to some extent is still used, consists in first reducing coke to a very fine powder and mixing it with syrup, with which it is thoroughly

incorporated. The mixture is then strongly compressed in moulds and baked, and afterwards placed in a concentrated solution of sugar or molasses until saturated. It is then placed in an oven and raised to a white heat, at which it is maintained for an hour or more. By this means moisture is all driven off and a compact mass is formed, which may be rendered still more solid by repeated saturation and baking. The disadvantage of carbons prepared in this manner, however, is that they contain all the impurities of the coke, no means being taken to exclude these injurious matters.

A purer material, capable of giving a very steady light, is made by placing pencils of gas retort carbon in caustic potash or soda, melted and raised to a white heat, and in which they are allowed to remain a quarter of an hour or more. The sticks are then washed in hot water, and placed in a porcelain or refractory earthen tube, through which a current of chlorine is passed, while the whole is maintained at a red heat for several hours. Many of the impurities that are not removed by the potash or soda are thus changed into volatile chlorides and driven off.

Another way of procuring very pure carbons, according to M. Fontaine, from whom we borrow liberally on this point, has been suggested by M. Jacquelin, a French chemist, of the Central School, at Paris. This consists in imitating the condition of things that is brought about in gas retorts during the manufacture of gas, which is the reduction of the material and contact of the heated and very dense hydrocarbon matter with the sides of the retort. Part of the matter is thus volatilized, while the rest is decomposed, and leaves a deposit of carbon. In the retorts of gas works the hydrocarbon matters carry with them much of the impurities contained in the coal; but, by taking tar, produced by actual distillation, which is consequently free from all non-volatile impurities, and reproducing the above conditions in specially prepared apparatus, it would seem possible to produce carbon of great purity, and such has actually been found to be the case. Plates obtained in this manner, and sawed into sticks of the proper dimensions, give a perfectly steady light that

is not only whiter, but more intense as well—something like twenty-five per cent. more so for a given current than that produced by carbons prepared in the ordinary manner. Considerable inconvenience, however, is experienced in preparing the sticks for use, as the carbon is so hard that it can only be cut with the greatest difficulty.

A composition for artificial carbons, consisting of powdered coke, calcined lamp black and a particular syrup formed of twelve parts of gum and thirty of cane sugar, has been introduced in France within a couple of years past, and is strongly recommended by the inventor, M. Carré. The proportions given in his patent are, fifteen parts of the purest coke, reduced to a very fine powder; five parts lamp black, and seven to eight of the syrup. The whole should be thoroughly ground together, and one to three parts of water added to compensate for the loss by evaporation, and give it the degree of consistency which it is desired the paste should possess. The latter is then pressed and passed through a die plate, by which process the proper form is given to the carbons. These are afterwards packed in crucibles and subjected to a high temperature.

The baking of the carbons really comprehends a series of operations. In the first place, the drawn or moulded sticks, while yet soft, are placed in a horizontal position on a bed of coke dust, in crucibles, each layer being separated from its neighbor by a sheet of paper between them, so as to prevent adherence of one to the other. A layer of powdered coke, of about four tenths of an inch in thickness, is then placed on top, between the last series and the cover, and over the joint of the latter is spread a like thickness of silicious sand.

After the first baking, which should be continued at a cherry red heat for four or five hours at least, the carbons are taken out and placed in a vessel of boiling hot and very concentrated syrup of sugar cane, or caramel, and left for two or three hours, allowing, also, two or three cooling intervals of some duration, so that the pores may become filled. The carbons are then drained by opening a stop cock at the bottom of the vessel, and

allowing the liquid to run out. They are then stirred a few moments in boiling water, to dissolve any sugar that may remain on the surface.

When dried, they are again replaced and baked once more, after which they may be packed in the crucible in a standing position, with sand between them, the above operation being repeated until they have acquired the density and solidity required. They are then dried slowly, the drying process being terminated in a drying oven, whose temperature gradually attains eighty degrees centigrade, in twelve or fifteen hours, and to prevent their change of shape in drying, the sticks are placed in V-shaped pieces of metal.

The Carré carbons are more tenacious and rigid than retort carbon, and are remarkably straight and regular. Sticks two fifths of an inch in diameter may be used, eighteen inches in length, without fear of breaking; and their cylindrical form, joined to their homogeneity, causes their ends to remain as perfectly sharpened as if they were turned. They are also better conductors than retort carbon. The only inconvenience that appears to accompany the use of carbons prepared in this manner, consists in their rapid wasting away, the production of small sparks and the irregularity of the luminous effect.

We learn from M. Fontaine's work, that the admixture of foreign substances with the carbon, of which mention has been made on page 427, has also been carefully studied by M. Carré, within a few years past, with very interesting results; and, from a large number of experiments made by him, he has been able to deduce the following important facts:

1. That potash and soda at least double the length of the arc, rendering it also free from the hissing sound so peculiar to it when carbon alone is used, while, at the same time, by combining with the silicates that are usually present, they eliminate these substances from the pencil points, causing them to fuse into clear, vitreous and often colorless globules just outside of the arc, and that they increase the illuminating power in the ratio of 1.23 to 1.

2. That lime, magnesia and strontium increase the light in the proportion of 1.40 to 1, and color it variously.

3. That iron and antimony enhance the illuminating effect to 1.60 and even to 1.70.

4. That boracic acid, forming a covering that excludes the material from the oxygen and the air, increases the durability of the carbon materially, though without augmenting the light.

Numerous experiments have also been made by M. Gaudoin with carbons containing borate, chloride, phosphate and silicate of lime, pure precipitated silex, borate of magnesia, magnesia, aluminum and silicate of aluminum, the proportions being calculated so as to give about five per cent. of oxide after the baking of the carbons; but, although the light is about double that obtained from gas retort carbons, the flame and vapor resulting from the use of carbons prepared in this manner, is, aside from the dangerous character of the fumes, a great obstacle to their practical introduction, and for this reason chemically pure carbons only should be employed where continuous light is desired.

The dust of retort carbon, although containing but a small proportion of foreign matters, is, nevertheless, not sufficiently pure for this use, and its employment presents some inconveniences, while washing in acids or alkalies, to which the carbonaceous matters may be submitted, with the aim of extracting the impurities they contain, is a costly and insufficient operation. Lamp black is pure enough, but its price is high and its management difficult.

M. Gaudoin, however, has found a solution of the problem in decomposing, by heat in closed vessels, the dried pitches, fats or liquids, tars, resins, bitumens, natural or artificial essences or oils, and other organic matters, capable of leaving behind sufficiently pure carbon after their decomposition by heat.

The apparatus employed for effecting this decomposition consists of closed retorts or crucibles of plumbago, and these are placed in a furnace capable of being heated to a bright red. The lower parts of the crucibles are furnished with two tubes,

one serving for the disengagement of gas and volatile matters, and the other for the introduction of the primary material. The volatile products of decomposition may be conducted under the hearth of the furnace and there burnt for heating the crucibles, but it is more advantageous to conduct them into a condensing chamber or into a copper still, and thus recover, after condensation, the tars, oils, essences and hydrocarbons that are produced in the operation.

M. Gaudoin also utilizes these different subproducts in the manufacture of his carbons, and he takes great care to avoid the use of iron, zinc, or any substances susceptible of being attached by these tars to the worms of the receiver, as the whole value rests in purity.

Whatever the primary material employed for the manufacture of this carbon may be, the decomposition by heat should be capable of being conducted either slowly or quickly, according to the nature of the subproducts to be obtained. For operating slowly, it is sufficient to fill the retort two thirds full and heat gradually up to a clear red, avoiding as much as possible the boiling over of the substances. For operating quickly, the empty retort is first heated to a deep red, and the primary material thrown into the bottom in small quantities, in a thin stream, if it is liquid, and in small fragments if it is solid. The slow distillation gives most tars and heavy oils and little gas. The quick decomposition more light oils and gas.

When, then, the primary material has been properly chosen, a carbon, more or less compact, remains in the retort. This is pulverized as finely as possible, and then agglomerated either alone or with a certain quantity of lamp black, by means of the carbides of hydrogen obtained as secondary products. The carbides thus prepared are completely free from iron, and much preferable to those found in commerce, not only for agglomerating the carbon, but also for impregnating or soaking the manufactured objects. The last operation, when effected with commercial products, introduces oxide of iron in the pores. Objects made in agglomerated carbon are, for the same variety of car-

bon, the more combustible as they are more porous, and more porous as the pressure in moulding is lessened. The inventor uses steel moulds capable of resisting the highest pressure of a strong hydraulic press.

Although the draw plate, or moulding apparatus, that has long been in use for the manufacture of ordinary graphite carbons may also be used in the manufacture of carbons for the electric light, M. Gaudoin has added certain important improvements, that make the apparatus more valuable and better adapted to the work. Thus, instead of causing the carbons to issue from top to bottom, vertically, he places the orifice or orifices of the mould upon the side, and in such a manner that the issuing carbons form, with the horizon, a descending angle of twenty to seventy degrees. The carbon is guided for the whole length by tubes or gutters. This arrangement allows emptying the whole of the matter contained in the mould without interrupting the work; and as the carbon is constantly supported, it does not break under its own weight, which frequently happens when issuing vertically.

We have made, at different times, says M. Fontaine, numerous trials with all kinds of carbons, and those of M. Gaudoin's manufacture have given the best results. It has, however, necessitated much time and considerable expense to remove this manufacture from the merely scientific domain to that of the practical, but success has crowned the efforts of the inventor. The results of some of these experiments, which include the tort, Archereau, Carré and Gaudoin carbons, are given in the accompanying table, No. 1.

No. 1.

TABLE OF EXPERIMENTS MADE NOVEMBER 6, 1876, WITH DIFFERENT KINDS OF CARBONS.

Name of Carbon.	Dimensions.	Consumption.					Mean of Two Experiments.	Regularity.	Observations.
		Speed of Machine.	Of Negative Carbons.	Of Positive Carbons.	Total per Hour.				
		m. m.	m. m.	m. m.	m. m.	m. m.			
Retort.	9m. m. square.	800	*19	36	56	63	Irregular. Sufficiently regular.	Scintillating, eclipsed for a short time, a slight disaggregation.	
"	9m. m. square.	920	23	48	71				
Archereau.	10m. m. diam.	800	20	60	80	85	Sufficiently regular. Sufficiently regular.	A slight disaggregation, a few sparks, cinders of oxide of iron in rather large quantities. White light. Cones good.	
"	10m. m. diam.	920	30	60	90				
Carré.	10 4m. m. diam.	800	18	60	78	92	Irregular. Regular enough.	A slight disaggregation, a few sparks, more cinders than the preceding, reddened for a greater length.	
"	10 4m. m. diam.	920	26	60	106				
Gaudoin.	11 3m. m. diam.	800	20	38	58	73	Very regular. Very regular.	Neither disaggregation nor sparks; less cinders than the Carré and Archereau carbons.	
	11 3m. m. diam.	920	38	50	88				

The light produced with the retort carbons was equal to one hundred and three burners, that by the artificial carbons varied between one hundred and twenty and one hundred and eighty burners for the Archereau and Carré carbons, and between two hundred and two hundred and ten for the Gaudoin carbons. The mean of one hundred and fifty burners may be applied, without appreciable error, to the Archereau and Carré carbons, and that of two hundred and five to the Gaudoin carbons.

Reduced to a uniform section of 0.0001 square mètre, the consumption of the carbons was, respectively:

For the retort carbons.....	51 millimètres (about 2 inches).
" Archereau carbons.....	66 " " 2.6 "
" Gaudoin "	73 " " 2.87 "
" Carré "	77 " " 3 "

* To convert millimètres into inches, multiply by .03937.

In proportion to the light produced, the consumption was :

For the Gaudoin carbons, 35 millimètres (about 1.38 inch) per 100 burners.						
"	Archereau	"	44	"	"	1.73
"	Carré	"	51	"	"	2
"	retort	"	49	"	"	1.93

A Gramme machine, constructed by M. Bréguet, and a Carré lamp by the same maker, were used in conducting these experiments, and the carbons were taken at random from a lot of several mètres for each series.

At the request of one of the inventors, and with the coöperation of Messrs. Gramme and Lemonnier, some additional experiments were made with a more powerful Gramme machine and a Serrin lamp.

No. 2.

RESULTS OF A SERIES OF EXPERIMENTS MADE APRIL 4, 1877,
UPON SEVERAL DIFFERENT KINDS OF CARBONS.

Name of Carbon.	Form and Dimensions.	Section in square millimètres.	Total consumption per hour in millimétré.	Mean Light in Candel Burners.	Length of the arc in millimétré.	Revolutions per minute of the machine.	Regularity.	Observations.
Retort carbon, good quality.	Square, 9 m. m. in the side.	81	60	120	2.5	820	Passable.	Splinters numerous. Separation of small pieces. Scintillation. Carbons were shaped very irregularly.
Archereau's carbons, new specimen.	Round, 10 m. m. diam.	78	68	173	3	820	Null.	Disaggregation. Sparks. Light very variable in intensity at periods, shaping into small facets.
Carré's carbons, new specimen.	Round, 9 m. m. diam.	64	69	175	3	820	Middling.	Small sparks. Light running round. Very variable in intensity. Good shaping of the carbons.
Gaudoin's, Type No. 1.	Round, 11.2 m. m. diam.	98	80	205	3	820	Good.	Neither sparks nor splinters. Light a little red, but pretty constant.
Gaudoin's Agglomeration of wood carbon.	Round.	—	78	240	3	820	Sufficiently good.	Light very white. Less steady than with Gaudoin's carbons, No. 1. No sparks. Small variations.

The preceding table (No. 2) gives the mean of three series of these experiments, made with the greatest precision. The electric lamp was placed vertically and on the same level with the oil lamp and photometer, and every precaution was taken to prevent any sensible error in the measurements of the luminous intensity.

The rate of consumption of the carbons in these experiments, and reduced to a uniform section of .0001 square mètres, was respectively :

For the Carré carbons.....	*44 millimètres.
“ retort “	49 “
“ Archereau carbons.....	53 “
“ Gaudoin (wood carbon).....	61 “
“ Gaudoin, No. 1.....	78 “

In proportion to the light produced, the consumption was as follows :

For the Gaudoin (wood carbon).....	32 millimètres per 100 burners.
“ Archereau carbons.....	39 “ “ “
“ Carré carbons.....	40 “ “ “
“ Gaudoin, No. 1, carbons.....	40 “ “ “
“ retort carbons.....	50 “ “ “

The light given by the Gaudoin carbons was a little less regular than that observed on November 6, 1876. That given by the Carré carbons varied in less than a minute from one hundred to two hundred and fifty burners; the arc rotated positively round the points, the same as if alternating currents were being used. The Archereau carbons appeared to be less effective than at the first trial; they were consumed slowly, but produced a light so variable that it was difficult to take photometric measurements. Only the retort carbons maintained their durability, luminous intensity, and, unfortunately, also their irregularity.

We cannot do better, while on this subject, than describe the later improvements that M. Gaudoin has made in his process, and which were patented April 7, 1877.

* To convert millimètres into inches, multiply by .03937.

Instead of carbonizing wood, reducing it to powder, and then submitting it to mixture, the inventor takes dried and properly chosen wood, to which he gives the definite form the carbon is to possess, and then converts it into hard carbon, and finally soaks it in the manner before described.

The distillation of the wood is effected slowly, so as to drive out the volatile substances, and the final desiccation is made in a reducing atmosphere, at a very high temperature. A previous washing, in acids or alkalies, removes from the wood any impurities that it possessed.

M. Gaudoin points out also the means of filling up the pores of the wood, by heating to redness, and submitting it to the action of chloride of carbon and different carbides of hydrogen. He hopes by this means to produce electric carbons of small consumption, and giving an absolutely steady light.

Since the first edition of this work was printed, a series of experiments has been made by a committee of the Franklin Institute, with several of the machines now used for light purposes. Having also been conducted with the greatest care and skill, and including, as they do, accurate measurements of the various factors which affect the general question of electric lighting, these experiments will necessarily possess a great deal of interest for persons whose attention may be directed to the subject, and we, therefore, give a large share of the committee's report in regard to them complete.

Previous to the commencement of the labors of the committee, an invitation was extended to makers of dynamo-electric machines, with a request that they should furnish machines for competitive trial. The machines supplied were two each of the Brush and Wallace-Farmer types, and a Gramme machine which had formed a part of the exhibit of M. Breguet, at the Centennial exhibition.

In measuring the power used, indicator diagrams were taken from the engine, as a check on the dynamometer readings, although the latter were relied upon in making our calculations, except in the case of the large Wallace machine. This machine

requiring more power than could be supplied by the institute's engine, or safely transmitted by the dynamometer, it was taken to the works of the I. P. Morris Co., and driven by an engine of 9" bore and 18" stroke, and the amount of power consumed determined from the indicator diagrams. This determination was sufficient to demonstrate the fact that this machine possesses no economical advantages over the smaller one of the same make, but the power consumed is omitted from the table of results, as

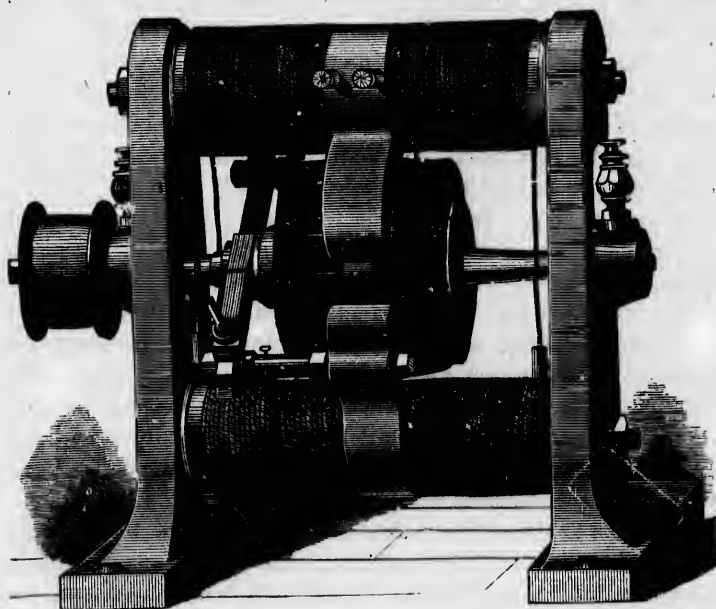

Fig. 209.

comparisons based on the different methods would be obviously unsatisfactory.

The following is a description of the machines submitted to examination. Their dimensions are given in Table III.

The Gramme machine, fig. 209, consists of two cylindrical electro-magnets, with their combined poles extended by pieces of such shape as nearly to envelop the armature which rotates

TABLE III.
 SHOWING WEIGHT, POWER ABSORBED, LIGHT PRODUCED, ETC., BY DYNAMO-ELECTRIC MACHINES
 TESTED BY A COMMITTEE OF THE FRANKLIN INSTITUTE, 1877-8.

NAME OF MACHINE.	COPPER WIRE IN				Revolutions of Armature per Minute.	Foot Pounds of Power Consumed.	Horse Power.	LIGHT PRODUCED IN STANDARD CANDLES.		Foot Pounds of Power Consumed per Candle Light.	Size of Carbons.	LENGTH OF CARBON CONSUMED PER HOUR.					
	ARMATURE.		FIELD MAGNETS.					Total.	Per h. p.			+	-				
	Size.	Weight.	Size.	Weight.													
Large Brush...	475	.081 in.	32 lbs.	.134 in.	100 lbs.	1340	107	606	3.26	1280	377	87	4	178	.34		
Small Brush...	390	.063 in.	24 lbs.	.096 in.	80 lbs.	1400	124	248	3.76	900	239	137	8	191	.58		
Large Wallace.	600	.042 in.	50 lbs.	.114 in.	125 lbs.	800	823		
Small Wallace.	350	.043 in.	18½ lbs.	.098 in.	41 lbs.	1000	128	544	3.89	440	113	292	1	2	.45	.073	
Gramme.....	366	.059 in.	9½ lbs.	.108 in.	57¼ lbs.	800	60	992	1.84	705	383	85	1	1	3	.15	.55

stitute's
 as taken
 engine of
 ument de-
 tion was
 sses no
 ne make,
 esults, as

obviously

mitted to
 IL
 cylindrical
 l by pieces
 which rotates

between them, figs. 210 and 211. The armature is composed of a ring of soft iron, with insulated copper wire wound over its entire surface. This wire is divided into sixty coils, connected successively at their ends, and the loops thus formed between each pair of coils are connected to the copper strips of the commutator. Fig. 211 represents the mode of winding this wire on the ring, only a few turns, however, being shown.

The commutator consists of copper strips equal in number to the armature coils, placed radially edgewise around the shaft of the machine, and insulated from each other and the shaft, thus forming a cylinder, the surface of which is composed of alternate strips of copper and insulating material. Upon the sur-

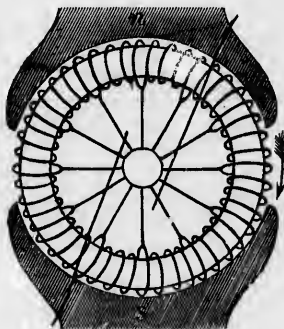

Fig. 210.

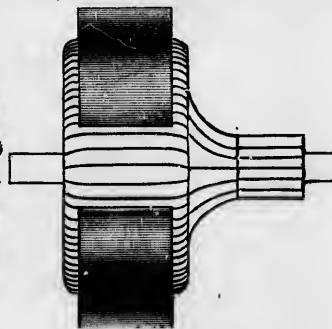

Fig. 211.

face of the commutator rest bundles of soft iron wire, by which the currents generated in the armature coils are conducted to the external circuit. As the armature is rotated between the poles of the field magnets, currents of electricity are generated.

These machines are also constructed with two commutators, each connected respectively to alternate armature coils, in which case the external circuit can be divided; but it is usual to pass both currents through the field coils, and then join them in the external circuit. This machine runs smoothly and very quietly, with few or no sparks at the commutator, and very little heating, the temperature of the armature being about 98° Fahr. after running nearly five hours.

The Brush machine, fig. 212, has, for its magnetic field, two horseshoe electro-magnets, with their like poles facing each other, at a suitable distance apart, the circular armature rotating between them.

In this machine the currents are generated in coils of copper wire, wound upon an iron ring, constituting the armature. This ring is not entirely covered by the coils, as in the Gramme armature, but the alternate uncovered spaces between the coils are almost completely filled by iron extensions from the ring, thus exposing large surfaces of the armature ring for the dissipation of heat, due to its constantly changing magnetism, as in the Pacinotti machine.

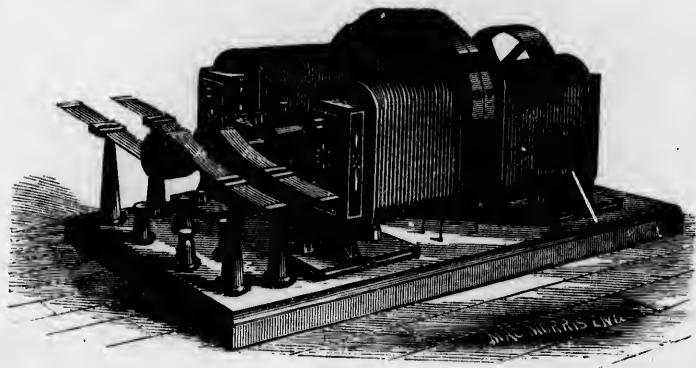

Fig. 212.

The ring revolves between the poles of two large field magnets, the two positive poles of which are at the same extremity of the diameter of the armature, and the two negative poles at the opposite extremity, each pair constituting practically extended poles of opposite character.

The coils on the armature ring are eight in number, opposite ones being connected end to end, and the terminals carried out to the commutator. Figs. 213 and 214 show this arrangement, only one pair of coils, however, being shown in fig. 213 as connected. In order to place the commutator in a convenient posi-

tion, the terminal wires are carried through the centre of the shaft, to a point outside the bearings.

The commutators are so arranged that, at any instant, three pairs of coils are interposed in the circuit of the machine, working, as it were, in multiple arc, the remaining pair being cut out at the neutral point; while in the Gramme machine, the numerous armature coils being connected end to end throughout, and connections being made to the metal strips composing the commutator, two sets of coils in multiple arc are at one time interposed in the circuit, each set constituting one half of the coils on the armature.

The commutator consists of segments of brass, secured to a

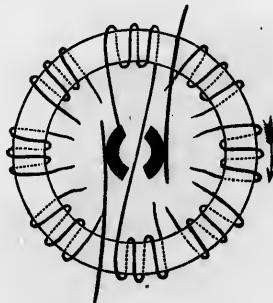

Fig. 213.

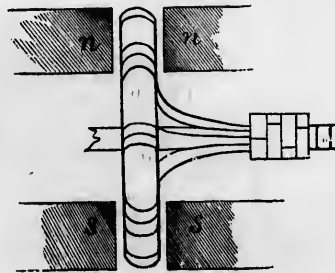

Fig. 214.

ring of non-conducting material, carried on the shaft. These segments are divided into two thicknesses, the inner being permanently secured to the non-conducting material, and the outer ones, which take all the wear, are fastened to the inner in such a manner that they can be easily removed when required.

The commutator brushes, which are composed of strips of hard brass, joined together at their outer ends, are inexpensive and easily renewed. The high speed at which these machines are run, together with the form of the armature, cause the rotation of the latter to be considerably resisted by the air, and produce a humming sound, but otherwise they run smoothly; the heating of the armature being inconsiderable, not exceeding

one hundred and twenty degrees Fahrenheit after four and three quarter hours' run. They are simple in construction, all the working parts being easily accessible, and the cost of maintenance low.

Fig. 212 represents the smaller Brush machine, which is identical in mechanical design with the larger, except that in the former there are two commutators, each of which is connected with alternate armature coils.

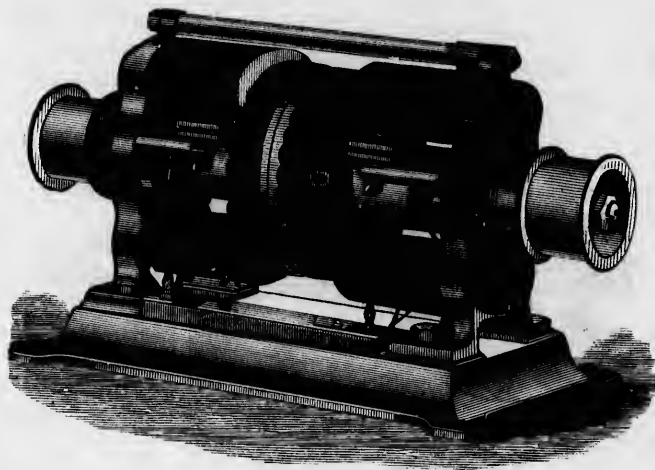

Fig. 215.

By this arrangement connections can be so made as to produce electric currents of high or low electromotive force (fifty-five to one hundred and twenty volts, as will hereafter be shown), or the conductor can be divided into two circuits, each of which can be utilized for producing its own light, or for performing other work.

In the Wallace-Farmer machine, fig. 215, the magnetic field is also produced by two horseshoe electro-magnets, but with poles of opposite character facing each other. Between the arms of the magnets, and passing through the uprights supporting them, is the shaft, carrying at its centre the rotating armature.

This consists of a disk of cast iron, near the periphery of which, and at right angles to either face, are iron cores, wound with insulated wire, thus constituting a double series of coils. These armature coils (figs. 216 and 217) being connected end to end, the loops so formed are connected in the same manner, and to a commutator of the same construction, as that of the Gramme. As the armature rotates, the cores pass between the opposed north and south poles of the field magnets, and the current generated depends on the change of polarity of the cores. It will be seen that this constitutes a double machine, each series of coils, with its commutator, being capable of use quite independently of the other; but in practice the electrical connections are so

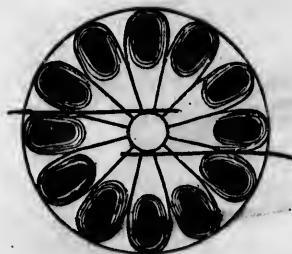

Fig. 216.

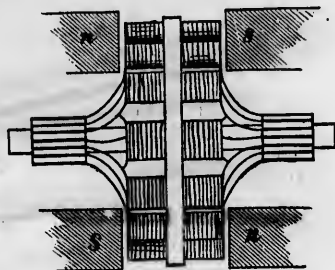

Fig. 217.

made, that the currents generated in the two series of armature coils pass through the field magnet coils, and are joined in one external circuit. This form of armature also presents considerable uncovered surface of iron to the cooling effect of the air, but its external form, in its fan-like action on the air, like that of the Brush, presents considerable resistance to rotation. In the Wallace-Farmer machine there was considerable heating of the armature, the temperature being sufficiently high to melt sealing wax.

The Brush and Wallace-Farmer machines were accompanied by lamps, or carbon holders, which were thought by their makers to present advantages, if not for all machines, at least to be espe-

cially adapted to the requirements of their own. The usual Serrin lamp, which is made by M. Breguet for the Grammè machine, did not accompany the latter. The result of experiment, however, quickly established the suitability of the Brush lamp as the source of light for all the machines, and the same lamp, with carbons properly adjusted as to size, was used for the several trials.



Fig. 218.

This lamp is shown in figs. 218 and 219, in which *a* is a helix of insulated copper wire, resting upon an insulated plate, *b*, upheld by the metallic post *c*. Loosely fitted within the helix is the core *d*, partially supported by the adjustable springs *e*. The rod *f* passes freely through the centre of the core *d*, and has at its lower end a clamp for holding the carbon pencil. A washer, *h*, of brass, surrounds the rod *f*, just below the core *d*, and has

one edge resting on the lifting finger attached to the latter, while the other edge is overhung by the head of an adjustable screw stop, *x*.

The metal post *c* is supported and guided by a tubular post, *i*, secured to a suitable base plate. Attached to the lower end of the post *c*, and passing out through a slot in *i*, is the arm *y*, supporting an insulated holder for the lower carbon.

If, now, one conducting wire, from the machine, be connected to the base plate, and the other to the lower carbon holder, the current of electricity will pass up through the posts *i* and *c*,

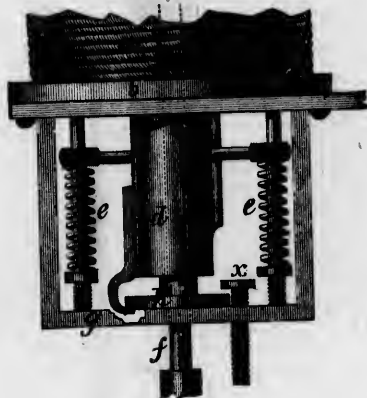

Fig. 219.

through the helix *a*, rod *f*, and the carbons *k*, thus completing the circuit.

The axial magnetism produced in the helix will draw up the core *d*, and it, by means of the lifting finger, will raise one edge of the washer *h*, which, by its angular impingement against the rod *f*, clamps and lifts it to a distance controlled by the adjustable stop *x*, but separating the carbon points far enough to produce the light.

As the carbons burn away, the increased length of the electric arc increases its resistance and weakens the magnetism of the

helix, and, therefore, the coil, rod and carbon move downward by the force of gravity, until, by the shortening of the arc, the magnetism of the helix is strengthened and the downward movement arrested. When, however, the downward movement is sufficient to bring the clutch washer *h* to the support *l*, it will be released from the clamping effect of the lifting finger, and the rod *f* will slip through until arrested by the upward movement of the core, due to the increased magnetism of the helix.

The normal position of the clamp washer is with the edge under the adjustable stop, just touching the support *g*, the office of the core being to regulate the slipping of the rod through it. If, however, the rod, from any cause, falls too far, it will instantly and automatically be raised again, as at first, and the carbon points thus continued at the proper distance from each other.

In the lamp used in these experiments, the helix was composed of two separate insulated wires wound together, so that, by means of suitable pin contacts, shown at the top of fig. 218, they could be connected either in couples or end to end, thus varying the intensity of the magnetism of the helix. This, in connection with varying the weight to be lifted by the magnetism of the helix, either by loading the core or increasing the upward thrust of the springs, enabled us to adjust the lamp to suit the varying qualities of the currents dealt with.

In order to make the measurements as accurate as possible, it was found necessary so to arrange the apparatus that no reflected or diffused light should fall on the photometer, and thus introduce an element of error. The arrangement of the apparatus to accomplish this is shown in fig. 220. The electric lamp was enclosed in a box, open at the back for convenience of access, but closed with a non-reflecting and opaque screen during the experiments. Projecting from a hole in the front of the box was a wooden tube, *b*, 6" square inside and 8' long, with its inner surface blackened to prevent reflection, thus allowing only a small beam of direct light to leave the box. This beam of light passed into a similar wooden tube, *c*, placed at a proper distance from the first, and holding in its further end the standard candle *d*.

This tube also held the dark box of a Bunsen photometer, mounted on a slide, so as to be easily adjusted at the proper distance between the two sources of light. A slit in the side of the tube enabled the observer to see the diaphragm. The outer end of the second tube was also covered with a non-reflecting hood, and the room was, of course, darkened when photometric measurements were taken. The rigid exclusion of all reflected or diffused light is believed to be the only trustworthy method of obtaining true results, and will, no doubt, account in a large measure for the lower candle power obtained by these experiments than that obtained by many previous experimenters.

The difficulties encountered in the measurement of the light,

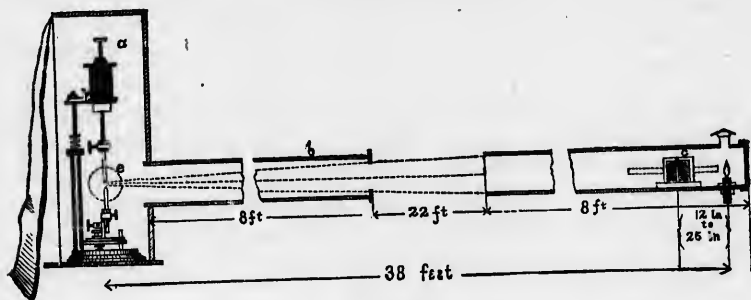

Fig. 220.

arising from the difference in color, were at first thought to be considerable, but further practice and experience enabled the observer to overcome them to such an extent that the error arising from this cause is inconsiderable, being greatly less than that due to the fluctuations of the electric arc.

The advantage to be derived from using a larger source of light than the standard candle, in measuring the electric light, was considered. A gas flame, giving twenty candles' light, and the oxyhydrogen light, so adjusted as to give seventy to one hundred and thirty-six candles, were carefully measured and used as a comparison. Both of these were found unsatisfactory, and the measurements relied on for our calculations were made

entirely with a standard candle, carefully corrected for any variation of consumption from one hundred and twenty grains per hour.

Were much higher intensities of light to be measured, it would be well to use, as a means of comparison, a large gas burner or a multiple wick lamp, such as are employed in light-house service, its power being constantly checked by measurements with the standard candle and separate photometer; but, with the volume of light dealt with in these experiments, the candle was sufficiently large, and its direct use greatly reduced the chance of error.

In the earlier experiments, measurements of light, current and power were made simultaneously, thus establishing standard references by which after experiments upon the different points were connected.

In determining the amount of light produced by each machine, it was run continuously for from four to five hours, and observations made at intervals, care being taken to maintain the speed and other conditions normal. One of the most important conditions necessary to insure correct results was the relative position of the carbon points. Great care was taken that the axes of the two sticks or pencils of carbon were in the same line, so that the light produced should be projected equally in all directions. Were the axes of the carbon pencils not in the same line, a much greater quantity of light would be projected in one direction, and the result of calculation of the light produced, based on the inverse square of the distance from the photometer, would be too great or too small, accordingly as this adjustment was in the one or the other direction.

To facilitate observations during the experiments, there was attached at *e*, to the side of the box *a*, holding the electric lamp, a focussing lens, with its axis at right angles to the beam of light, to the photometer, and an image projected upon a screen enabling the observer to see the condition and position of the carbon points without fatiguing the eye. Photographs were also taken, from time to time, at the moment of making the photometric

ometer,
pper dis-
le of the
uter end
ng hood,
tric mea-
ected or
ethod of
a large
e experi-
ters.
the light,

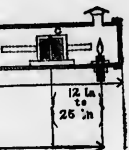

ught to be
enabled the
error arising
an that due

source of
electric light,
' light, and
ntly to one
asured and
atisfactory,
were made

observations—thus securing a permanent record of the condition of the carbon points.

Another difficulty in determining the exact photometric value of the electric light is the fluctuation, or rather, the moving from side to side, of the electric arc, and great care was taken so to adjust the conditions, that the arc or flame should be steady, and equally distributed about the ends of the carbon pencils.

Figs. 221 to 228 are full size, exact reproductions of the photographs taken, and fairly represent the average condition of the carbon when observations were made.

It was found, that although there was a slow consumption of the negative carbon, there was, at the same time, a constant "stalagmatic" growth of particles carried from the positive carbon by the action of the electric current. These stalagmites assumed different forms, as shown in the cuts, but no particular form seemed to be produced by the current from the different machines, except that the deposits on the negative carbon would become greater with increased current. These deposits would build up gradually until they had assumed the forms shown in figs. 226 and 228; then growing narrower near the base, until, by a weakening of the current by this and the consumption of the upper carbon, the lamp would readjust itself, and the piece would drop off. The effect of these growths on the intensity of the light was scarcely appreciable, except for a few seconds before and after the readjustment of the lamp.

Experiments were also made to determine what would be the effect on the amount of light produced by so adjusting the carbons, that the front edge of the upper one was in line with the centre of the lower one. Fig. 229 shows such an adjustment, and is from a photograph taken while measuring the light produced from the small Brush machine, running at twelve hundred and fifty revolutions per minute, and resulting as follows:

Front.....	2218	candles.
Side.....	578	"
".....	573	"
Back.....	111	"

$$3485+4=871.$$

The light produced by the same machine, under the same conditions, except the carbons being adjusted in one vertical line, was equal to that of five hundred and twenty-five candles. This would seem to indicate that nearly sixty-six



Fig. 221.



Fig. 222.



Fig. 223.



Fig. 224.



Fig. 225.*

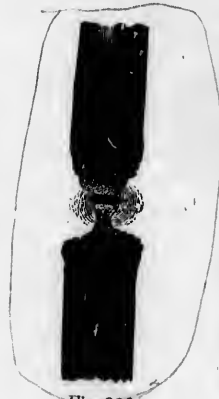

Fig. 226.



Fig. 227.



Fig. 228.

per cent. more light was produced by this adjustment of the carbons; but a close study of the conditions satisfies us that such is not the case, and that there is no advantage to be derived

* The voltaic arc should have been shown in fig. 225 as in fig. 227. All the carbons used were coated with copper.

onation

ic value
moving
taken so
e steady,
encils.

e photo-
n of the

ption of
constant
itive car-
alagmites
particular
different
on would
its would
shown in
, until, by
on of the
the piece
intensity
w seconds

ld be the
asting the
line with
adjustment,
light pro-
five hundred

ows:

es.

from such adjustment, except when the light is intended to be used in one direction only.

We would here call the attention of those who may compare our results with those obtained at the recent experiments at South Foreland, England, to the following statement upon this point, in the report of Mr. Jas. N. Douglas, engineer to the Trinity House, page sixteen of the official report:

I have found this arrangement of the carbons (the axis of the bottom carbon nearly in the same vertical plane as the front of the top carbon), and assuming the intensity of the light with the carbons having their axis in the same vertical line to be represented by one hundred, the intensity of the light in four

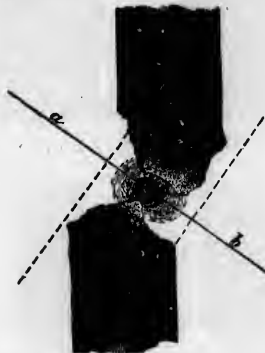

Fig 229.

directions in azimuth, say east, west, north and south, will be nearly as follows:

East or front intensity.....	287 to 100
North or side.....	116 to 100
South or ".....	116 to 100
West or back.....	38 to 100

$$\frac{557}{4} = 139 \text{ to } 100$$

* * * * *

In measuring the candle power of the light produced by each machine, I have given the mean intensity obtained in the direction of the photometer, the carbons in lamp working with

the Holmes and Alliance machines being always arranged with the axes in the same vertical line, and the carbons in the lamp working the Gramme and Siemens machine being always arranged with the front edge of the top carbon nearly on the centre of the bottom carbon.

It is, therefore, evident that the results given by Mr. Douglas must be divided by 2.87 in making a comparison with those obtained by us.

Thus, in the table on page 31 of the official report, in the column headed light produced by horse power in standard candles, he gives for the Gramme machine condensed beam twelve hundred and fifty-seven; but if this be divided by 2.87, we have four hundred and thirty-eight candles, which is, no doubt, still too high, our result of three hundred and eighty-three candles per horse power for the Gramme being obtained under the careful and rigid conditions before named.

In many battery circuits a high external resistance may be employed, and the electromotive force remain comparatively constant, while in dynamo-electric machines, in which the reaction principle is employed, the introduction of a very high external resistance into the circuit must be necessarily attended by decided variations in the electromotive force, due to changes in the intensity of the magnetic field in which the currents have their origin. Moreover, a considerable difficulty is experienced in the great variations in the behavior of these machines when the resistance of the arc, or that of the external work, is changed. Changes, due to loss of conductivity by heating, also take place in the machine itself.

The variations above mentioned are also attended by changes in the power required to drive the machine, and in the speed of running, which again react on the current generated.

There are certain normal conditions in the running of dynamo-electric machines designed for light, under which all measurements must be made, viz.:

1. The circuit must be closed, since, on opening, all electrical manifestations cease.

2. The circuit must be closed through an external resistance equal to that of the arc of the machine.

3. The arc taken as the standard must be the normal arc of the machine. This condition can only be fulfilled by noticing the behavior of the machine while running, as to the absence of sparks at the commutator, the heating of the machine, the regularity of action in the consumption of carbons in the lamp, etc.

4. The speed of the machine must be, as nearly as possible, constant.

5. The power required to maintain a given rate of speed must be, as nearly as possible, constant.

The machines submitted to us for determinations were, as already stated :

1. Two machines of different size, and of somewhat different detailed construction, built according to the invention of Mr. C. F. Brush, and styled respectively in our report as A^1 , the larger of the two machines, and A^2 , the smaller.

2. Two machines known as the Wallace-Farmer machines, differing in size, and in minor details of construction, and designated respectively as B^1 , the larger of the two, and B^2 , the smaller. In the case of the machine B^1 , the experiments were discontinued after the measurement of the resistances was made, insufficient power being at our disposal to maintain the machine at its proper rate of speed.

3. A Gramme machine of the ordinary construction.

All the above machines are constructed so that the whole current traverses the coils of the field magnets, being single current machines, in which the reaction principle is employed. In the case of the machine designated A^2 , the commutators are so arranged as to permit the use of two separate circuits when desired.

For the purpose of preserving a ready measure of the current produced by each machine, under normal conditions, a shunt was constructed by which an inconsiderable but definite proportion of the current was caused to traverse the coils of a galvanometer, thus giving with each machine a convenient deflection, which

could at any time be reproduced. As the interposition of this shunt in the circuit did not appreciably increase its resistance, the normal conditions of running were preserved.

As indicating the preservation of normal conditions in any case, the speed of running and the resistances being the same as in any previous run, it was found that when there was an equal expenditure of power, as indicated by the dynamometer, the current produced, as indicated by the galvanometer, was in each case the same.

Certain of the machines experimented with heated considerably on a prolonged run; most of the tests, therefore, were made when the machines were as nearly as possible at about the temperature of the surrounding air. It is evident that no other standard could be well adopted, as under a prolonged run the temperature of the different parts of the machine would increase very unequally; and, moreover, it would be impossible to make any reliable measurements of the temperatures of many such parts.

In measuring the resistance of the machines, a Wheatstone's bridge, with a sliding contact, was used in connection with a delicate galvanometer and a suitable voltaic battery. In taking the resistances of the machines, several measurements were made with the armatures in different positions, and the mean of these measurements taken as the true resistance.

It was, of course, a matter of the greatest importance to obtain a value for the resistance of the arc in any case, since upon the relative values of this resistance, and that of the machine, the efficiency would in any given case, to a great extent, depend. In each case, the arc of which the resistance was to be taken was that which was obtained when each machine was giving its average results as to steadiness of light and constancy of the galvanometer deflection.

The method adopted for the measurement of the arc was that of substitution, in which a resistance of german silver wire immersed in water was substituted for the arc, without altering any of the conditions of running. This substituted resistance was

afterwards measured in the usual way, and gave, of course, the resistance of the arc. It could, therefore, when so desired, serve as a substitute for the arc. No other method of obtaining the arc resistance appeared applicable, since the constancy of the resistance of the arc required the passage of the entire current through the carbons.

It may be mentioned, as an interesting fact in this connection, that when the current flowing was great, the arc corresponding thereto had a much lower resistance than when the current was small. This fact is, of course, due to increased vaporization, consequent on increased temperature in the arc.

In determining the true arc resistance, the resistance of the

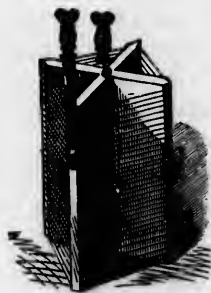

Fig. 230.

electric lamp controlling the arc was measured separately, and deducted from the result obtained with the german silver wire substitute.

For ease of obtaining a resistance of german silver wire equal in any case to that of the arc, a simple rheostat was constructed, by winding, upon an open frame, such a length of wire as was judged to be in excess of the resistances of any of the arcs to be measured. By means of a sliding contact, successive lengths of the wire were added, until the conditions as above stated were reproduced. Fig. 230 shows the arrangement of the rheostat. With this arrangement, no difficulty was experienced in reproducing the same conditions of normal running as when the arc

was used. The same conducting wires were used throughout these experiments. Being of heavy copper, their resistance was low, viz.: about .016 ohm.

Having thus obtained the circuit resistances, we proceeded to determine the value of the current. Here the choice of a number of methods presented itself. We selected two methods, one based on the production of heat in a circuit of known resistance, and the other upon the comparison of a definite proportion of the current with that of a Daniell's battery.

In the application of the first method, eight litres of water, at a known temperature, were taken and placed in a suitable non-conducting vessel. In this was immersed the german silver wire before mentioned, and the sliding contact so adjusted as to afford a resistance equal to that of the normal arc of the machine under consideration. This was now introduced into the circuit of the machine. All these arrangements having been made, the temperature of the water was accurately obtained, by a delicate thermometer, reading readily to quarter degrees Fahrenheit. The current from the machine running under normal conditions was allowed to pass, for a definite time, through the calorimeter so provided. From the data thus obtained, after making the necessary corrections as to the weight of the water employed, the total heating effect in the arc and lamp, as given in Table IV., was deduced.

Since the heat in various portions of an electrical circuit is directly proportional to the resistance of those portions, the total heat of the circuit was easily calculated, and is given in Table V., in English heat units. For ease of reference, the constant has been given for conversion of these units into the now commonly accepted units of heat.

Having thus obtained the heating effect, the electrical current is readily determined by the well known formula,

$$C = \sqrt{\frac{W h \times 772}{R t c}}$$

where C = the veber current per ohm, W the weight of water in,

TABLE IV.—RESISTANCES OF DYNAMO-ELECTRIC MACHINES.

From determinations by EDWIN J. HOUSTON and ELIHU THOMSON.

NAME OF MACHINE.	Temperature in Degrees F.	RESISTANCES		Resistance of Con-ducting Wire.	Resistance of Lamp, Exclusive of Arc.	CORRECTED RESISTANCES		Total Resistance of the Circuit. Ohms.	REMARKS.
		Of Machine + Conductor.	Of Arc + Lamp.			Of Machine + Conductor.	Of Arc + Lamp.		
A ₁ , large Brush.....	73½	.485	.57	-.016	-.032	.483	.54	1.055	At beginning of run. After running 25 min.
A ₁ , " ".....	88	.495	.82	-.016	-.032	.493	.79	1.315	
A ₂ , small Brush.....	74	1.255	1.70	-.016	-.032	1.239	1.67	2.955	Arranged for low resist. " " high "
A ₂ , " ".....	74	5.06	-.016	5.044	
B ₁ , large Wallace... ..	74	4.60	1.98	-.016	-.032	4.584	1.95	6.58	Machine cold. After 40 min. run.
B ₁ , " ".....	118	5.13	-.016	
B ₂ , small Wallace... ..	74	4.96	2.87	-.016	-.1025	4.944	2.77	7.83	At 844 rev. " 1000 rev.
B ₂ , " ".....	74	4.96	3.24	-.016	-.1025	4.941	3.18	8.24	
Gramme.	68	1.685	1.35	-.016	-.1025	1.669	1.25	3.04	Are not normal. Arc normal.
" ".....	68	1.685	1.97	-.016	-.1025	1.669	1.37	3.66	

Gramme.	68	1.685	1.35	0.16	0.1025	1.669	1.25	3.04
"	68	1.685	1.97	0.16	0.1025	1.669	1.37	3.66
"								

TABLE V.—THERMIC EFFECTS OF DYNAMO-ELECTRIC MACHINES.

From determinations by EDWIN J. HOUSTON and ELIHU THOMSON.

NAME OF MACHINE.	Galvanometer Deflection with Shunt.	HEATING EFFECT IN ARC AND LAMP.			Resistance of Calorimeter equal to arc.	Heat in arc and lamp, in pounds H ₂ O, 1° F.	Total heat of the circuit, H ₂ O, 1° F.	Heat per ohm, per second.	Speed of machine, Rev. per minute.	Dynamometer reading, including Friction.
		Lbs. H ₂ O.	Increase degrees Fahr.	Duration of run.						
A ¹ , large Brush.....	51½	18.64	23.35	10	8.2	43.338	69.49	.881	1340	107606
A ² , small Brush.....	34	18.63	9.09	5	1.70	33.87	58.87	.332	1200	117700
A ² , "	37	18.63	18.66	8	1.70	43.45	75.57	.426	1400	124248
B ² , small Wallace.....	25½	18.63	11.50	12	2.87	17.85	48.70	.104	844	97068
B ² , "	25½	18.63	4.92	6	2.87	15.28	41.69	.089	844	97068
B ² , "	24½	18.64	10.75	10	3.28	20.04	50.34	.102	1040	128544
Gramme.....	38	18.64	16.25	10	1.97	30.29	56.28	.256	800	60992

For conversion to new heat units—1 lb. water, 1° F., = 259.185 grammes of water, 1° C.

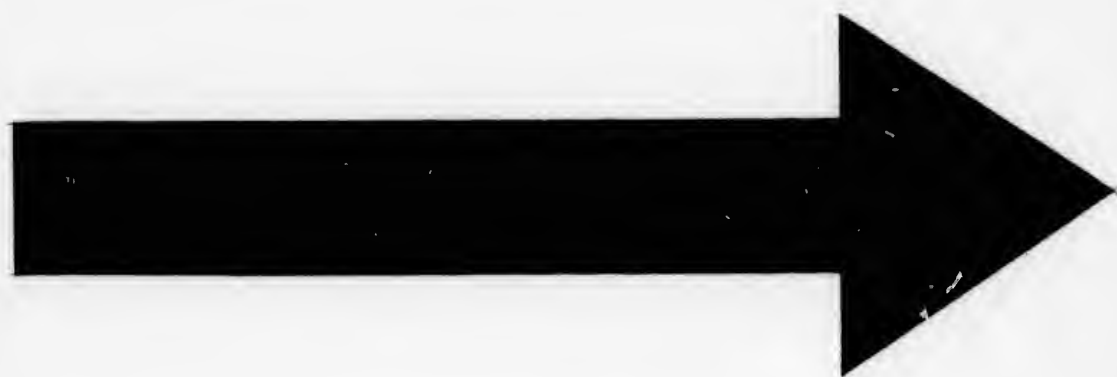

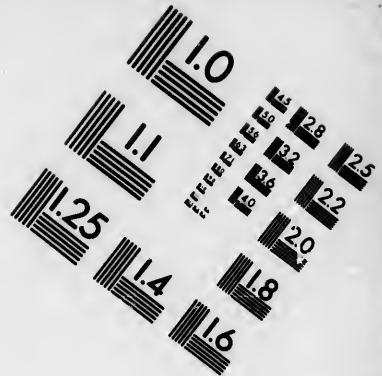
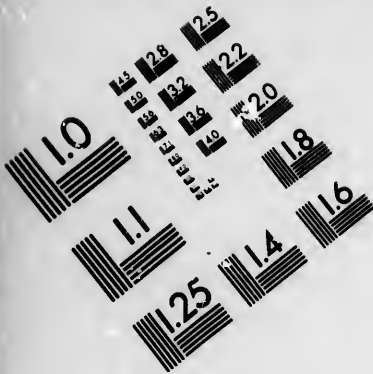

**IMAGE EVALUATION
TEST TARGET (MT-3)**

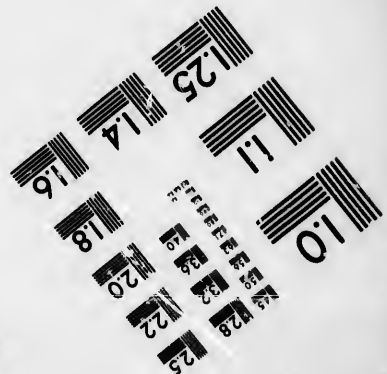
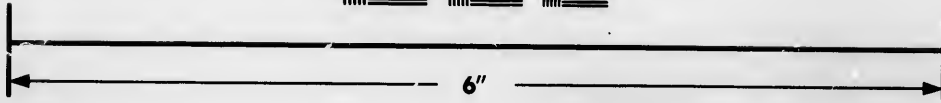
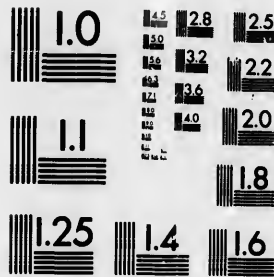

**Photographic
Sciences
Corporation**

23 WEST MAIN STREET
WEBSTER, N.Y. 14580
(716) 872-4503

0
1
2
3
4
5
6
7
8
9
10
11
12
13
14
15
16
17
18
19
20
21
22
23
24
25

26
27
28
29
30
31
32
33
34
35
36
37
38
39
40
41
42
43
44
45
46
47
48
49
50
51
52
53
54
55
56
57
58
59
60
61
62
63
64
65
66
67
68
69
70
71
72
73
74
75
76
77
78
79
80
81
82
83
84
85
86
87
88
89
90
91
92
93
94
95
96
97
98
99
100

pounds, h the increase of temperature in degrees Fahrenheit, seven hundred and seventy-two Joule's constant, R the resistance in ohms, t the time in seconds, and c the constant, 737335 the equivalent in foot pounds of one veber per ohm per second. The currents so deduced for the different machines are given in Table VI.

The other method employed for obtaining the current, viz., the comparison of a definite portion thereof, with the current from a Daniell's battery, was as follows: a shunt was constructed, of which one division of the circuit was 12 ohm, and the other three thousand ohms. In this latter division of the circuit was placed a low resistance galvanometer, on which convenient deflections were obtained. This shunt being placed in the circuit of the machine, the galvanometer deflections were carefully noted. To the resistance afforded by the shunt, such additional resistance was added as to make the whole equal to that of the normal arc of the machine. These substituted resistances were immersed in water, in order to maintain an equable temperature.

Three Daniell's cells were carefully set up and put in circuit with the same galvanometer used above, and with a set of standard resistance coils. Resistances were unplugged sufficient to produce the same deflections as those noted with the shunt above mentioned. The shunt ratio, as nearly as could conveniently be obtained, was $\frac{1}{25100}$. Then the formula,

$$C = \frac{s n \times 1.079}{R},$$

where C equals the veber current, s the reciprocal of the shunt ratio, n the number of cells employed, 1.079 the assumed normal value of the electro-motive force of a Daniell's cell, and R the resistances in the circuit with the battery, gives at once the current. In comparison with the total resistances of the circuit, the internal resistance of the battery was so small as to be neglected.

The results obtained were as follows:

Name of Machine.	Shunt Ratio.	Number of Daniell's Cells.	Resistances Unplugged.	Speed of Machine.
Large Brush.....	$\frac{1}{1000}$	3	2710 ohms.	1340 rev.
Small Brush.....	$\frac{1}{1000}$	3	3700 "	1400 "
Wallace-Farmer }.....	$\frac{1}{1000}$	3	8320 "	844 "
Gramme.....	$\frac{1}{1000}$	3	6930 "	1040 "
	$\frac{1}{1000}$	3	4800 "	800 "

The veber currents, as calculated from the above data, are given in Table VI.

From the results thus derived, the electro-motive force was deduced by the general formula,

$$E = C \times R.$$

The electro-motive force thus calculated will be found in Table VI.

Statements are frequently made, when speaking of certain dynamo-electric machines, that they are equal to a given number of Daniell's, or other well known battery cells. It is evident, however, that no such comparison can properly be made, since the electro-motive force of a dynamo-electric machine, in which the reaction principle is employed, changes considerably with any change in the relative resistances of the circuit of which it forms a part, while that of any good form of battery, disregarding polarization, remains approximately constant. The internal resistance of dynamo-electric machines is, as a rule, very much lower than that of any ordinary series of battery cells, as generally constructed; and, therefore, to obtain with a battery, conditions equivalent to those in a dynamo-electric machine, a sufficient number of cells in series would have to be employed to give the same electro-motive force; while, at the same time, the size of the cells, or their number in multiple arc, would require to be such that the internal resistance should equal that of the machine.

Suppose, for example, that it be desired to replace the large Brush machine by a battery whose electro-motive force and internal and external resistances are all equal to that of the

TABLE VI.—CURRENT AND ELECTRO-MOTIVE FORCE OF DYNAMO-ELECTRIC MACHINES.

From determinations by EDWIN J. HOUSTON and ELIHU THOMSON.

NAME OF MACHINE.	VEBER CURRENT PER OHM PER SECOND.		ELECTRO-MOTIVE FORCE IN VOLTS.		Per cent. of the work of current appearing in the arc.	Corresponding Dynamometric Values.	REMARKS.
	From heat developed.	By comparison with Daniell's batt.	Calc. from heat and resistance.	By comparison with Daniell's batt.			
A ¹ , large Brush.....	30.37	29.87	39.94	39.28	60.08	107606	Speed 1340 rev.
A ² , small Brush.....	18.63	55.05	117700	" 1200 "
A ² , " ".....	21.12	21.87	62.41	64.63	56.51	124248	" 1400 "
B ² , small Wallace....	10.42	9.73	81.59	76.19	35.38	97068	" 844 "
B ² , " ".....	9.64	75.48	" 844 "
B ² , " ".....	10.33	11.16	85.12	91.96	38.59	128544	" 1040 "
Gramme.....	16.38	16.86	59.95	61.71	51.09	60992	" 800 "

machine, and that we adopt as a standard a Daniell's cell, of an internal resistance of, say, one ohm. Referring to Table VI., the electro-motive force of this machine is about thirty-nine volts, to produce which about thirty-seven cells, in series, would be required; but, by Table IV., the internal resistance of this machine is about 49 ohm. To reduce the resistance of our standard cell to this figure, when thirty-seven cells are employed in series, seventy-six cells, in multiple arc, would be required. Therefore, the total number of cells necessary to replace this machine would equal thirty-seven by seventy-six, or two thousand eight hundred and twelve cells, working over the same external resistance. It must be borne in mind, however, that although the machine above mentioned is equal to two thousand eight hundred and twelve of the cells taken, that no other arrangement of these cells than that mentioned, viz., seventy-six in multiple arc, and thirty-seven in series, could reproduce the same conditions, and, moreover, the external resistances must be the same. The same principles, applied to the other machines, would, when the internal resistance was great, require a large number of cells, but arranged in such a way as to be extremely wasteful, from by far the greater portion of the work being done in overcoming the resistance of the battery itself.

The true comparative measure of the efficiency of dynamo-electric machines as means for converting motive power into work derived from electrical currents, whether as light, heat or chemical decomposition, is found by comparing the units of work consumed with the equivalent units of work appearing in the circuit external to the machine. In Table VII., the comparative data are given. In the first column the dynamometer reading gives the total power consumed; from which are to be deducted the figures given in the second column, being the work expended in friction, and in overcoming the resistance of the air; although, of course, it must be borne in mind, that that machine is the most economical in which, other things being equal, the resistance of the air and the friction are the least. The third column gives the total power expended in producing electrical effects, a

" 800

"

60992

51-09

61-71

59-95

16-86

16-38

Gramme.

portion only of which, however, appears in the effective circuit, the remainder being variously consumed in the production of local circuits in the different masses of metal composing the machines. This work eventually appears as heat in the machine. Columns four, five and six give respectively the relative amounts of power variously appearing as heat in the arc, in the entire circuit, and as heat due to local circuits in the conducting masses of metal in the machine, irrespective of the wire. This latter consumption of force may be conveniently described as due to the *local action* of the machine, and is manifestly comparable to the well known local action of the voltaic battery, since in each case it not only acts to diminish the effective current produced, but also adds to the cost.

We desire to call attention to the fact, that in all the determinations conducted by us, we have been particularly careful to insure a definite relation between the external and internal resistances in each case—a condition of paramount importance in the effective working of these machines. It is evident, indeed, that no determinations made with an unknown or abnormal external resistance can be of any value, since the proportion of work done, in the several portions of an electrical circuit, depends upon, and varies with, the resistances they offer to its passage. If, therefore, in separate determinations with any particular machine, the resistance of that part of a circuit of which the work is measured be, in one instance large, in proportion to that of the remainder of the circuit, and in another small, the two measurements thus made would give widely different results, since in the case where a large resistance was interposed in this part of the circuit, the percentage of the total work appearing there would be greater than if the small resistance had been used.

When an attempt has been made to determine the efficiency of a single machine, or of the relative efficiency of a number of machines, by noting the quantity of gas evolved in a voltameter, or by the electrolysis of copper sulphate in a decomposing cell, when the resistance of the voltameter or decomposing cell did not represent the normal working resistance, it is manifest that

the results cannot properly be taken as a measure of the actual efficiency.

In Table IV. it will be found, that in general, where the machine used had a high internal resistance, the arc resistance normal to it was also high, but they are not necessarily dependent upon each other. The arc resistance depends on the intensity of the current, the nature of the carbons, and on their distance apart. Other conditions being the same, the resistance of the arc is less when the current is great.

Since all the machines examined were built for lighting, it will readily be seen that, other things being equal, that machine is the most economical in which the work done in the arc bears a considerable proportion to that done in the whole circuit, and since, with any given current, the work is proportional to the resistance, we have in Table IV. the data for comparison in this regard. For example, in the second determination of A^1 , the large Brush machine, the resistance of the arc constitutes considerably more than one half the total resistance of the entire circuit, while in B^2 , the small Wallace-Farmer machine, it constitutes somewhat more than one third the total resistance. These relative resistances give, of course, only the proportion of the current generated, which is utilized in the arc as light and heat, the conditions of power consumed to produce the current not being there expressed.

During any continued run, the heating of the wire of the machine, either directly by the current, or indirectly from conduction from those parts of the machine heated by local action, as explained in a former part of this report, produces an increased resistance, and a consequent falling off in the effective current. Thus, in Table IV., at the temperature of 73.5° Fahr., A^1 , the large Brush machine, had a resistance of 485 ohm, while at eighty-eight degrees Fahrenheit, at the armature coils, it was 495 ohm. These differences were still more marked in the case of B^1 .

In A^2 , the small Brush machine, it will be noticed that two separate values are given for the resistance of the machine.

These correspond to different connections, viz., the resistance, 1.239 ohms, being the connection at the commutator for low resistance, the double conducting wires being coupled in multiple arc, while 5.044 ohms represent the resistance when the sections of the double conductor are coupled at the commutator in series.

Referring to Table V., the numbers given in the column headed "Heat in arc and lamp," are the measure of the total heating power in that portion of the circuit external to the machine. They do not, however, in the case of any machine, represent the energy which is available for the production of light, which depends also on the nature and the amount of the resistance over which it is expended. For example, the heat in arc and lamp are practically the same in each of the Brush machines, if the measurement of the smaller of these machines be taken at the higher speed. The amount of light produced, however, is not the same in these two instances, being considerably greater in the case of the larger machine. The explanation of this apparent anomaly is undoubtedly to be found in the different resistances of the arcs in the two cases. In the large Brush machine the carbons are nearer together than when the small machine is used. This suggests the very plausible explanation, that the cause of the difference is to be attributed to the fact, that, although the total heating effect is equal in each case, when the large machine is used, the heat produced is evolved in a smaller space, and its temperature, and consequent light giving power, thereby largely increased.

It would seem, indeed, that any future improvements made in the direction of obtaining an increased intensity of light from a given current, will be by concentrating the resistance normal to the arc in the most limited space practicable, thereby increasing the intensity of the heat, and, consequently, its attendant light.

It may be noted, in this connection, that in all the cases in which the resistance of the arc was low, the photometric intensity was high. This, indeed, might naturally be expected, since a great intensity of heat would, under existing conditions of the use of the arc, admit of increased vaporization, and consequent lowering of the resistance.

In the column headed "Total heat of circuit" are given the quantities of heat developed in the whole circuit, which numbers, compared with those in the preceding column, furnish us with the relative proportions of the work of the circuit, which appear in the arc and lamp.

The column headed "Heat per ohm per second," gives the relative work per ohm of resistance in each case, and these numbers, multiplied by the total resistance, give the total energy of the current expressed in heat units per second.

In Table VI. are given the results of calculation and measurement, as to the electric work of each machine. It is evident, to those acquainted with the principles of electrical science, that in the veber current and the electro-motive force, we have the data for comparing the work of these machines with that of any other machine or battery, whether used for light, heat, electrolysis, or any other form of electrical work.

As might be supposed, the values given in Table VI., of the veber current, approximate relatively to the photometric values, as will be seen from an examination of that part of the general report of the committee relating to photometric measurements.

The values of the veber current, as deduced from the heat developed, and from the comparison with a Daniell's cell, do not exactly agree; nor could this have been expected, when the difficulty of minutely reproducing the conditions as to speed, resistance, etc., is considered.

By comparison of the electro-motive force of the different machines, it appears that no definite unit seems to have been aimed at by all the makers as that best adapted to the production of light.

Table VII. is designed especially to permit a legitimate comparison of the relative efficiency of the machines, as well as their actual efficiency in converting motive power into current. The actual dynamometer reading for which we are indebted to the subcommittee on the measurements of power, is given in the first column. On account of differences of construction, and differences in speed of running, the friction and resistance of the

TABLE VII.—EFFECTS OF DYNAMO-ELECTRIC MACHINES IN FOOT POUNDS PER MINUTE.

From determinations by EDWIN J. HOUSTON and ELIHU THOMSON.

NAME OF MACHINE.	Dynamometer reading. R. P. consumed.	Friction and resistance of air.	R. P. consumed, after deducting friction.	R. P. appearing in arc as heat.	R. P. appearing in whole circuit.	F. P. unaccounted for in the circuit.	Per cent. of power utilized in arc.	Per cent. of effect after deducting friction.
A ¹ , large Brush.....	107606	17950	89656	35457	53646	36010	31	37½
A ² , small Brush.....	117700	12828	105872	26148	45448	59924	22	25
A ² , " ".....	124248	14976	109272	35543	58340	50932	27	31
B ² , small Wallace.....	99068	7800	89268	13780	37596	51672	14	15½
B ² , " ".....	128544	11072	117472	15469	38862	78610	12	13
Gramme.....	60992	4512	56480	23384	43448	13032	38	41

For conversion into Gramme metres — 1 foot pound = 138 Gramme metres, nearly.

and local action is the least, the speed being comparatively low. If the resistance of the arc is kept normal, very little heating of the machine results, and there is an almost entire absence of sparks at the commutator.

2. The large Brush machine comes next in order of efficiency, giving in the arc a useful effect equal to thirty-one per cent. of the total power used, or thirty-seven and one half per cent. after deducting friction. This machine is, indeed, but little inferior in this respect to the Gramme, having, however, the disadvantages of high speed and a greater proportionate loss of power in friction, etc. This loss is nearly compensated by the advantage this machine possesses over the others, of working with a high external, compared with the internal resistance, thus also insuring comparative absence of heating in the machine. This machine gave the most powerful current, and consequently the greatest light.

3. The small Brush machine stands third in efficiency, giving in the arc a useful result equal to twenty-seven per cent., or thirty-one per cent. after deducting friction. Although somewhat inferior to the Gramme, it is, nevertheless, a machine admirably adapted to the production of intense currents, and has the advantage of being made to furnish currents of widely varying electro-motive force. By suitably connecting the machine, as before described, the electro-motive force may be increased to over one hundred and twenty volts. It possesses, moreover, the advantage of division of the conductor into two circuits, a feature which, however, is also possessed by some forms of other machines. The simplicity and ease of repair of the commutator are also advantages. Again, this machine does not heat greatly.

4. The Wallace-Farmer machine does not return to the effective circuit as large a proportion of power as the other machines, although it uses, in electrical work, a large amount of power in a small space. The cause of its small economy is the expenditure of a large proportion of the power in the production of local action. By remedying this defect, a very admirable machine would be produced.

Within a short time past a new dynamo machine, invented

by Mr. Hiram Maxim, of this city, has been brought out, and is now being introduced by the United States Electric Lighting Company. This machine requires one and a half horse power to drive it. It weighs three hundred pounds, and produces a light of from 1,200 to 2,000 sperm candles, according to speed. The magnets are similar in form to those used by Dr. Siemens, of London, but the armature, or revolving portion, is a new design, which is said to be free from many objections common to other machines. The only point where any considerable wear takes place on these machines is in the commutator, in which a stationary copper brush takes the current from the revolving part.

In some machines this portion has been built into the machine, so that when it is worn the whole machine would require rebuilding in case of repair. Mr. Maxim has constructed his machine so that the removal of a nut loosens the parts subject to wear, so that they may be replaced in a few minutes, and at a trifling cost.

Mr. Maxim has also produced a new lamp, which is shown in the accompanying figures. Fig. 231 represents a vertical section, fig. 232, a perspective view of the same, and fig. 233, a detail. A is the positive carbon holder and B the negative. The operation of this lamp is as follows:

The negative carbon, which may be six inches long, being secured in the lower holder B, the top holder may be drawn up, as the pinion that gears into its rack is free to turn in that direction without driving the train of gears. A carbon eleven inches long may now be inserted in the top holder, and its point brought in line with the lower carbon by moving the lever on the back of the carrier.

The wires being connected to the binding post (one on each side of the lamp), the thumb nut G, being turned, will allow the weight of the positive carrier to rotate the train of gearing, and by winding up a cord, to draw the negative upward until the combined movement of both causes the points of the two carbons to meet. This will establish an electrical contact, the

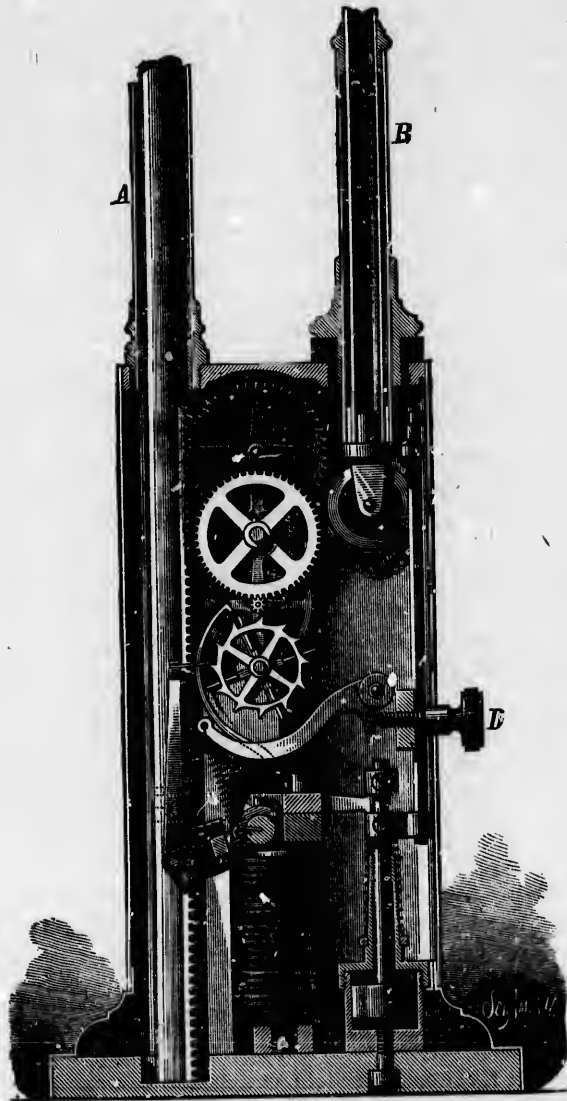
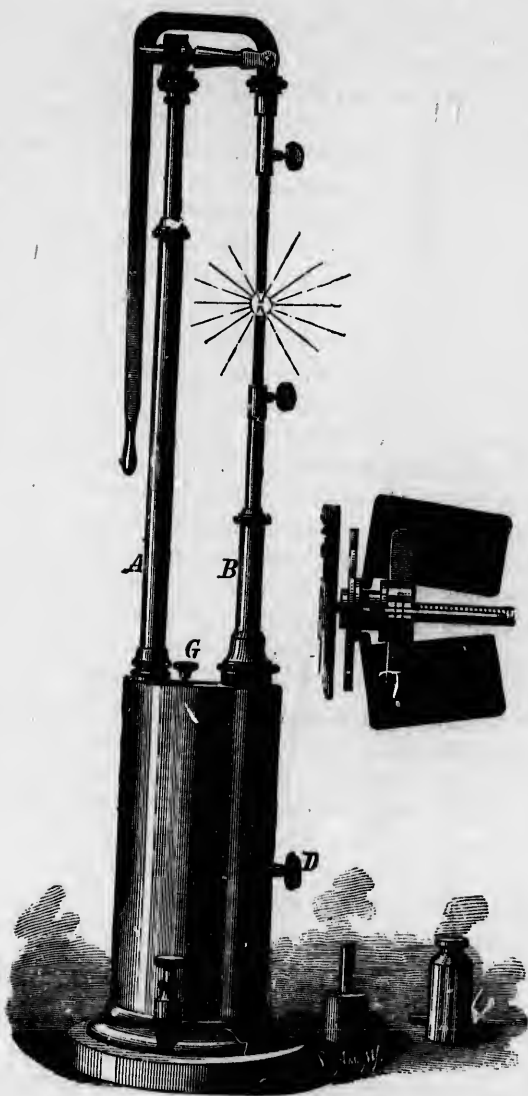

Fig. 231.



Figs. 232 and 233.

current will at once commence to pass, and the electro magnet in the bottom of the lamp will become excited and draw downward the two armatures, one of which draws down one end of the cord that supports the negative carbon, and the other locks the gearing. The separation of the carbons by this downward movement of the negative establishes the voltaic arc, when the light comes out in all its splendor. As the carbons waste away the arc becomes longer, and the resistance to the passing current becomes greater, its power to excite the electro magnet correspondingly decreasing. The armature E is drawn away from the magnet by a retractile spring, the tension of which is adjusted by thumb screw D. When the magnetism is so much reduced that the pull of the spring is greater than the pull of the magnet, the spring will force the armatures upward and remove the detent from the ratchet wheel F, thus allowing the train of gears to move so that the carbons slowly approach each other, until a point is reached where the arc is shortened sufficiently to again bring the magnet up to its original strength, when it will again pull down the armature and lock the gearing. A too rapid movement of the parts is prevented by a small fan, shown in fig. 233. When the carbons are drawn apart to a considerable distance and then allowed to approach, this fan will revolve with great speed, and its wings will be spread by centrifugal action to their fullest extent; but when the carbons touch, and the electrical current is established, its speed is much reduced, as the larger armature C is drawn down, and it remains in that position while the circuit is complete. The armature has an attachment which is brought within the field of the extended wings, but it cannot reach them when they are closed. The fan, when engaged by the attachment, can revolve only a quarter turn at a time and at a very slow speed.

When the ratchet F, on the fan shaft, is unlocked, it can revolve rapidly only when the current is broken, and when it is released to feed the carbons to an already established arc, it can only turn at a speed a little faster than the actual consumption of the carbons. Should the arc be broken, or the light be

extinguished, from a high wind or other cause, the large armature C will be liberated, and by bringing the lower carbon against the upper carbon, it reestablishes the arc instantly. A too rapid movement is prevented by a controlling chamber or dash pot in the bottom of the lamp. All the comparatively heavy work of separating the carbons and reestablishing the current is done by the armature C, while the smaller armature E has only to lock and unlock the train of gearing.

As the distance to be travelled is very slight, and the work to be done so light, but very little change in the electro-motive force of the current is required to stop or start the feeding of the carbons. The tension of the spring that opposes the magnetism can be adjusted from the outside of the case to balance its pressure against a current of any strength. Where great nicety and steadiness are required, this lamp seems well adapted to meet all requirements. It is small and compact, and appears a very substantial and beautiful piece of mechanism.

Fig. 234 is a side elevation of a less expensive kind of lamp, devised by the same inventor. In this lamp both carbon holders are supported by a cord. As the upper or positive holder descends it draws the cord over a pulley and raises the negative just one half the distance travelled by the positive. When the wires are properly connected and the carbons are in position, the top holder may be allowed to run down until the two carbons meet. This establishes the circuit and excites the axial magnet in the bottom of the case, when the core is drawn into the helix, and the two carbons, through the medium of levers, are drawn apart until the magnetism and tension of the spring balance each other; and as the carbon is burned away the arc is lengthened, the magnetism reduced, when the core is drawn out of the spool, thus feeding the carbons together as they are consumed until the parts have reached a position where the ratchet on the lower lever is beyond the reach of the pawl; then the core descends and the ratchet revolves, when the carbons take a new position, and the feeding goes on as before. The ratchet wheel is prevented from turning more than one tooth at a time by a spring at the

end of the lower lever. The pull of the rack is opposed to the spring, and when the pull is reduced by the disengagement of a ratchet tooth the lever, and with it the ratchet, are forced downward, and the succeeding tooth is caught on the pawl. The core on which the magnetism operates is connected with the rack by

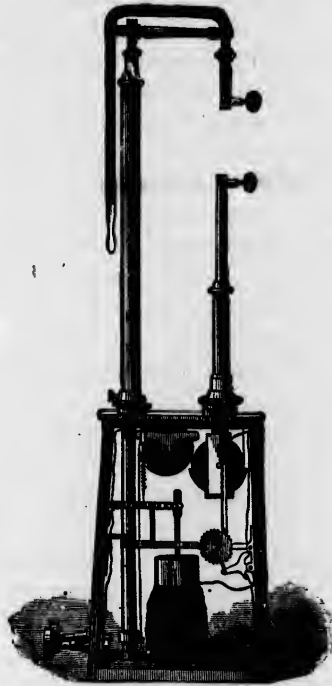

Fig. 234.

compound levers, so that by changing the position of the connecting link the leverage can be readily adjusted.

Adjustments may also be made with the thumb nut on the top of the case, which is attached to a retractile spring. While this lamp is not so susceptible of a very fine adjustment, still, for

some purposes, it is better than the more expensive one just described. In places where the speed of the dynamo machine varies much, or where the machine is of poor quality, it is better than the regular clock work lamp.

A new lamp, which is quite different from anything before made, is shown in fig. 235. This lamp is in two parts, connected by vertical tubes. The upper portion has a device for feeding the carbons, and the lower portion contains a device for separating them. The focus or source of light is always at the same place, as the two carbons feed exactly in proportion to the rapidity with which they are consumed. This lamp will accommodate itself to widely varying currents. Should a slackening of the speed allow the carbons to come completely together, they would at once draw apart on the increase of speed, and they will do this any number of times in succession; or the current may be broken and established any number of times without disarrangement of the parts. This feeding has positive movement, and is so nicely balanced that a very slight change in the length of the arc allows the carbons to feed, and should the current be broken, the lower carbon, by a very rapid movement, reestablishes it before the heat of the carbons is perceptibly diminished, and before the magnetism of the machine is discharged.

The light from the naked carbon points is dazzling to the eyes, and casts very distinct shadows. The light is of wonderful intensity. To diffuse the light without reducing it very much, and to make the small point appear as large as possible, have been the aim of the inventor in constructing this lamp. Above the focus is a silvered reflector, of suitable shape to throw the beams that would be wasted above in a horizontal or downward direction, and from this reflector two rows of prisms are suspended. One half of the prisms are arranged with their flat side to the light, and the other half have their angular side toward the light. Below the focus is a bowl shaped glass, having a zone ground just wide enough to be always between the eye of a near observer and the luminous arc. The point from which the light is emitted appears from a distance diamond

*Fig. 235.*

shaped and quite large. Thus modified, the light can be looked at with perfect ease, while its brilliancy does not seem to be at all impaired, the ground glass portion of the globe only being between the eye and the luminous point. The prisms and glass bowl enclose the light and protect it from the wind. The bowl is suspended by two cords that pass over pulleys and are attached to the reflector. By pulling the bowl downward the reflector is raised up, thus opening a space through which the carbons may be viewed. A pair of carbons $\frac{3}{8} \times \frac{3}{8}$ inch in these lamps last about three hours, and afford a very steady light. Carbons $\frac{5}{16} \times 1\frac{1}{4}$ inch last about ten hours.

Electric light may be utilized in two ways—either by powerful foci illuminating at great distances, or by less intense foci, giving a more diffused light, suitable for all kinds of night work; thus including lighthouse service, fortifications, maritime service, stores, armies in action; and for manufactories, show rooms, open air use, large workshops, railroad depots and yards, wharf work, steamboats, mines, theatres, large halls, reading rooms, streets, squares, and many other places. For these purposes electric light is superior to all others and much cheaper. Mechanical workshops have been among the first to make use of the electric light, also dyers and sugar refiners, who need a very pure and white light, and spinning mills and foundries have adopted it.

In the matter of street illuminating by electricity, Paris has recently taken the lead of the world, though the example is now being followed in other cities, and notably in St. Petersburg, Madrid and Brussels. The great development of the Paris system, however, gives it a degree of importance that has not yet been equalled elsewhere; and the following remarks by Mr. F. L. Pope, who has investigated the system during the past summer, will, therefore, not be without interest:

There are at the present time some three hundred electric lamps nightly in successful operation, illuminating the boulevards, gardens and public buildings of Paris, and arrangements for lighting all the principal boulevards and places are now in progress.

The magneto-electric apparatus employed is a Gramme machine, arranged for producing alternating currents, the field of force being fed by a smaller machine of the continuous current variety. The candle employed is the double carbon construction of Jablochkoff. Owing to the peculiar arrangement of this alternating machine, it is possible to divide the current so as to furnish sufficient electricity to sixteen, or more, separate candles. That this system, in a scientific and practical point of view, is literally a brilliant success is sufficiently evident to any one who has carefully watched its operation, night after night, in the streets and public places of Paris. The quality of the light is pure, soft and white, the general effect being not unlike that of an unusually powerful moonlight, but differs from the latter in the absence of the heavy, black shadows. These are avoided, partly by placing the candles within globes of opal glass, and partly by placing the lamps at a considerable elevation above the ground, perhaps twenty feet or more. The gas-lights in the vicinity of the Place de l'Opera present an unusually red, smoky and flickering appearance in contrast with the absolute clearness and steadiness of the electric light. That the system is equally successful in an economical point of view, in some of its applications at least, would seem to admit of very little doubt. It is possibly premature to assert that it is destined speedily to supersede the employment of gas for all purposes of public and general illumination on a large scale, yet it must be said that such a result seems exceedingly probable.

The construction of the alternating current magneto machine will be understood by reference to figs. 236 and 237, the former being a longitudinal vertical section taken in the plane of the dotted line *A B C*, in fig. 237 and the latter an end elevation (partly in section) of the same. An exterior induction ring or armature of soft iron is securely bolted to the frame of the machine, and is wound with insulated copper wire in eight sections, each of which consists of four coils or subsections, *a b c d* (see fig. 237). By reference to the figure it will be seen that the wire, although continuous, is wound in the reverse direction

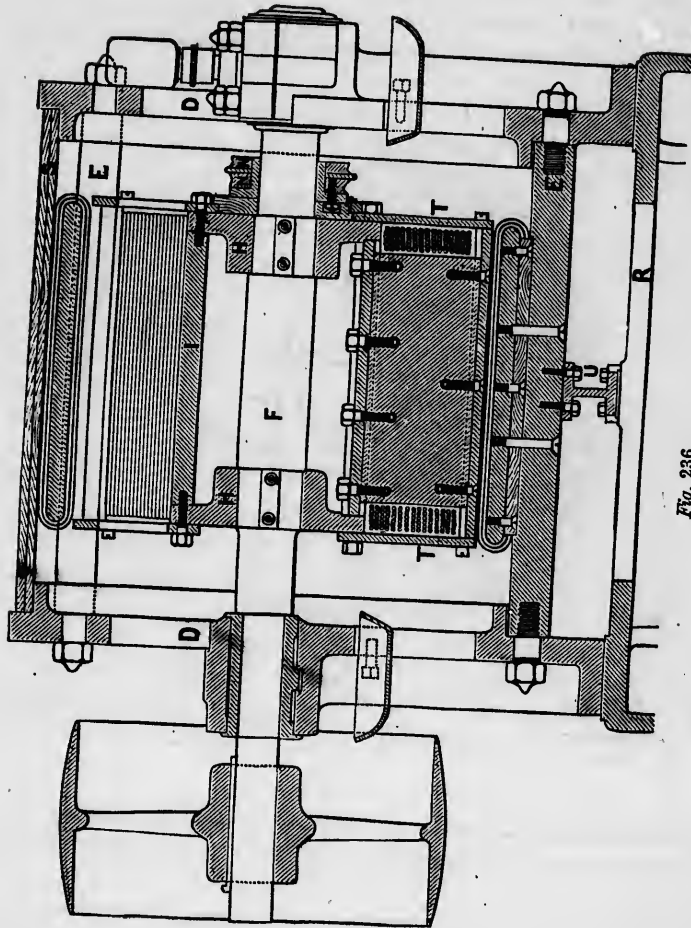

Fig. 236.

the ma-
field of
current
struction
s alter-
to fur-
andles.
view, is
ny one
ght, in
of the
not un-
s from
These
of opal
eleva-
the gas-
usually
e abso-
hat the
view, in
of very
destined
poses of
must be

machine
e former
e of the
levation
ion ring
e of the
ight sec-
s, *a b c d*
that the
direction

upon each alternate one of the eight sections. The inducing magnet *T* revolves within the induction ring, and consists of eight soft iron cores, *K K*, etc., projecting radially from a central hub, *H*, which is fixed upon a horizontal axis, *F*, revolving in bearings, and provided with a pulley, which receives its motion

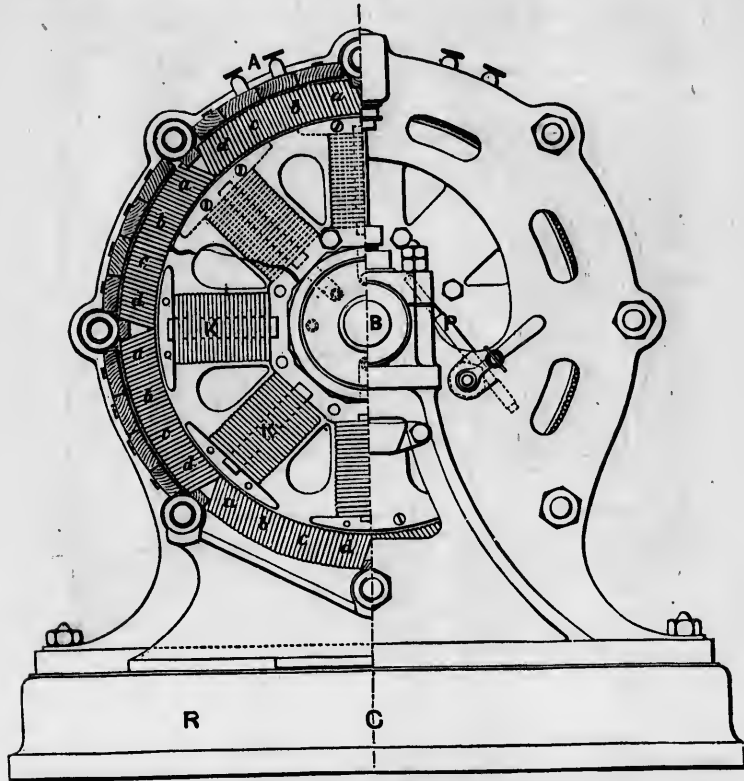

Fig. 237.

from a belt driven by steam or other power. Like the sections of the external ring, these radial cores are alternately wound with right and left handed coils. The outer poles of the cores are fitted with enlarged projecting pole pieces, as seen in fig. 237, in

order to increase the effective area of the magnetic field, by means of which the electric currents are generated. The revolving compound radial magnet, when the machine is in operation, is magnetized to saturation by the current from a small continuous current Gramme machine of the ordinary well known type, which is driven from the same motor. The same result might, of course, be produced by the action of a voltaic battery of sufficient power. This inducing current is conducted to the revolving magnet by means of brushes of silver plated copper wire, P, pressing upon insulated rings of copper upon the shaft to which the terminals of the magnet coils are connected. It will be observed that by this arrangement the pole changing commutator, which is the most fruitful source of electrical and mechanical difficulty in the ordinary magneto machines, is entirely done away with, and to this feature no doubt the practical success of this machine is very largely due.

It has been stated that the eight sections of the soft iron armature are each provided with four coils or subsections, *a b c d*, all wound in the same direction. The object of this arrangement is to enable a division of the current to be effected by connecting the coils in various ways, the ends of the latter being brought to terminals or binding screws on the outside of the machine. By properly connecting these terminals, the current produced by the machine may be divided into four, eight, sixteen or thirty-two circuits, as desired. For example, if it is required to obtain four currents for four different lamps, it is only necessary to connect in one series all the coils marked *a*, for the first circuit; all marked *b*, for the second circuit, and so of the other two.

The principle of operation of the machine is, of course, sufficiently obvious. When the shaft, with its radial magnet, is made to revolve, powerful alternating currents are induced in the coils surrounding the soft iron ring or armature, the electro-motive force of which depends upon the intensity of the magnetism in the revolving magnet and upon the rapidity of its revolutions.

There are at present three sizes of this machine made, of

ducing
ists of
entral
ing in
motion

sections
and with
ores are
. 237, in

which the one shown in the illustration is the largest. The weight, capacity, and other particulars of these are shown in the following table :

PARTICULARS OF MACHINE.	SIZE OF MACHINE.		
	1	2	3
Motive power required (horse power).....	16	6	4
Revolutions per minute.....	600	700	800
Weight of machine (kilogrammes).....	650	280	190
“ “ copper wire (kilogrammes).....	103	40	28
Number of Jablochhoff candles operated.....	16	6	4
Cost of machine, including small continuous current machine (frances).....	10,000	5,000	3,500

The dimensions of the machine shown in the figures are as follows: Length, including shaft and pulley, thirty-five inches, width thirty inches, and height nearly the same. The extreme size of the base plate is twenty-eight inches by thirty, and as the drawings are made to scale, the dimensions of any of the other parts of the machine may be estimated without difficulty.

It will be seen that the power required is one horse power for each electric candle, each candle being calculated to be equal to one hundred ordinary gas burners. I was informed that the results of the operation for one year, at the *Magazin du Louvre*, showed that this estimate is very nearly correct. Several hundreds of these machines have been at work in Paris during the past year, and so far as my inquiries extended, I could not learn that any of them had required repairs or had involved any expense whatever, except that of lubrication.

I was informed that M. Gramme was at work on another and still smaller machine, intended to supply two candles only, which is quite different in construction from those which have just been described, and from which he expects to realize a material saving in the relative expense both of first cost and power consumed in running. There is also a Gramme machine shown in the Exposition which weighs four hundred and forty-one pounds, and is

said to produce a light equal to thirty thousand candles, the cost of which is only about 1,500 francs. For practical purposes, however, this model is not considered a good one, as it is much more liable to get out of order than the standard pattern.

The electric candle of M. Paul Jablochhoff, which is so extensively employed in electric lighting in Paris, in connection with the magneto-electric apparatus of M. Gramme, is a very simple device; so simple, indeed, that, as is frequently the case with the most important and most original inventions, the first sensation upon seeing it is one of wonder that nobody ever thought of it before.

The invention consists simply in placing two carbon pencils side by side, and insulating them from each other by means of a thin plate of some refractory material inserted between them, which is a non-conductor at ordinary temperatures, but which becomes a conductor when fused by the action of a powerful current. The most suitable material yet discovered for this purpose is plaster of paris, which is used in all the candles now in operation. One of the results of the use of this material is to impart to the light a faint tinge of rose color, which is by no means unpleasant to the eye.

Referring to the illustrations, a description of the candles and the method of using them, as employed in Paris, will now be given. Fig. 238 is a representation, half in elevation and half in section, of one of the lanterns in the Avenue de l'Opera. Each lantern contains four candles, which are brought into operation successively, only one candle burning at a time. This is necessary in order to keep up the light for the required length of time each night, a single candle as now made lasting only one and a half hours. Fig. 239 is an enlarged sectional view, showing the candles and devices for holding them in position. These are mounted upon a circular base of white onyx, A, which serves not only to support the parts, but to insulate them from each other. The four candles are placed in a corresponding number of clips or candle-holders, arranged in the form of a cross. The candles are surrounded by a globe of white opal glass, sixteen inches in diameter.

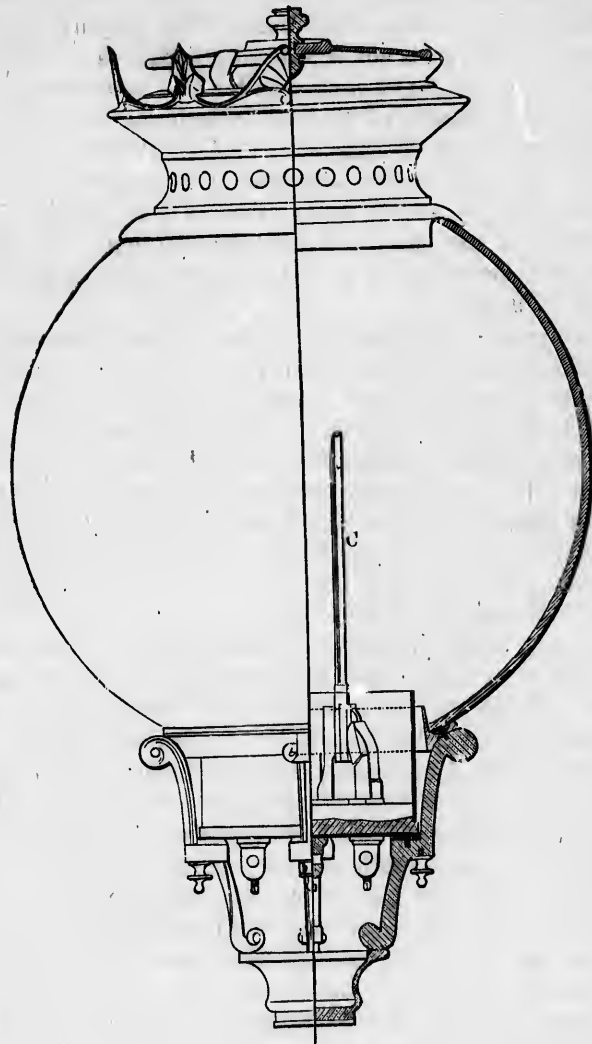
*Fig. 238.*

FROM THE LABORATORY OF
T. A. EDISON.
MENLO PARK, N. J.
U. S. A.



Fig. 239.

The candle itself is shown on a small scale in fig. 239. The two cylindrical pencils of compressed carbon, *cc*, are each two hundred and twenty-five mm. (8.8 inches) in length and four mm. (0.157 inches) in diameter. The distance apart is three mm. (0.118 inches). Fig. 240 shows the tip of a candle of its natural size, in elevation and in section. The candle holder or clip consists of two jaws, *B B*¹ (fig. 239), one of which, *B*, is fixed, and the other, *B*¹, is movable. The opposite faces of these jaws are provided with vertical grooves of semicircular form, for grasping the candle. The four fixed jaws, *B*, in each lantern are mounted



Fig. 240.

upon a common metallic base plate, *A*², to which the positive pole of the circuit is connected by means of a binding screw, *a*. Each movable jaw, *B*¹, is jointed by means of a link, *b*, to a block, *A*¹, which is provided with a binding screw, *a*¹, to which the negative conductor is attached. A spring, *D*, presses the movable jaw *B*¹ against the candle *C*, and holds it firmly in position. A small metallic plate is attached to the lower end of each carbon pencil on opposite sides of the candle, in order to form a proper electrical connection with the holder. By this simple and effective arrangement the burned out candles may be

replaced by new ones almost in a moment. There are, of course, four of these movable jaws in each lantern, each having its separate binding screw.

The arrangement of the electric circuits is as follows: Referring to fig. 237, it was stated that four distinct currents might be derived from the alternating magneto machine. Each of these currents is capable of supplying four candles at a time, when placed in series in the circuit, for the reason that, at the high temperature produced by the action of the light, plaster of paris fuses and becomes a tolerably good conductor of electricity. A conductor leads from the positive terminal of the machine to an ordinary lever switch, placed in the base of the lamp post, and accessible by a small door. This switch turns on to five points, four of which are connected respectively with the four movable jaws B^1 , of the candle holders, while the fifth connects with the return wire leading from the central binding screw a . This switch thus serves to direct the current to any one of the four candles, or, if necessary, to cut out the whole arrangement. The return wire from the binding screw a leads to the next lamp post, and from that in a similar manner to the next, and so on through the four, after which it returns to the negative terminal of the machine. Three other circuits from the machine are arranged in the same way, so that when in operation there are four distinct circuits, with four lights in each circuit, or sixteen lights in all.

Fig. 241 will serve to give an idea of the general arrangement of the apparatus. The alternate current magneto machine, which supplies the current for operating the lamps, is seen at the lower right hand corner of the figure, to the left of which is the continuous current machine which supplies the field of force. The arrangement of the switch in connection with the circuits leading to the four candles will be readily understood from the figure.

The conductors used are constructed of a strand of seven No. 18 B. W. G. wires, of tinned copper, twisted together, and have a resistance of about one ohm to one thousand four hundred feet. These conductors are insulated with strips of india

rubber, several thicknesses of which are wound on spirally and united by india rubber cement. These are placed underground, in tubes similar to the vitrified drain tile used in this country. Some arrangement of insulators (which was not seen) is employed to keep the wires from touching the interior of the pipes.

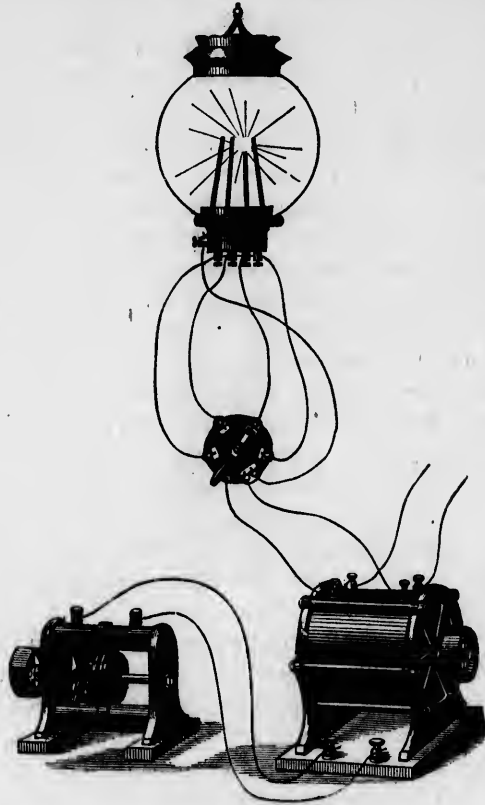

Fig. 241.

It should have been mentioned in its proper place, that each candle is provided with a conducting tip, as shown at c_1 in fig. 240, consisting of a piece of powdered plumbago and gum, com-

pressed into a little cylinder about as large as a No. 18 wire, and attached to the candle by a strip of asbestos. The object of this is to complete the circuit when the machine starts, and maintain it until the fusion of the plaster of paris commences, when the latter becomes sufficiently conducting, as before mentioned.

The number of lamps now in operation in the Place de l'Opera and the avenue of the same name is forty-six; but as the two lamps directly in front of the opera house are arranged to burn two candles at a time, in order to increase the brilliancy of the illumination, it will be seen that forty-eight candles are in operation at once. The average distance apart of the lamps on each side of the avenue is about one hundred and fifteen feet. These forty-eight candles are fed by three separate machines of the kind which has been described. The greatest distance to which the current of any one machine is transmitted is said to be two hundred metres (about six hundred and fifty feet). At first it was necessary to employ a man to go round to the different lamp posts at intervals of an hour and a half, and switch the current to a fresh candle as the old one burned out; but an automatic apparatus has been invented for doing this, which is now being applied, and which will be understood by reference to fig. 242. A and A_1 are two candle holders, in which are placed the candles C C_1 . An upright angular lever, L , is pivoted to a standard, l_1 , upon the base. A spring, s , presses against this and tends to throw it into such a position as to bring the short arm l of the lever into contact with the metallic block m , but this movement is prevented by a platinum wire, w , which is attached to the top of the lever L , and rests against the insulating portion of the candle C , at a point near its socket. This arrangement forms an automatic shunt, for when the candle C is burned down far enough to release the wire w , the spring s throws the lever L over, making contact between l and m , and thus bringing the candle C_1 into circuit. This is in like manner arranged to bring the third candle into circuit at the proper time, and so on. The substitution of one candle for another produces scarcely any visible interruption of the illumination.

A few words in reference to the cost of illumination by this system may be of interest by way of conclusion. The items of expenditure, other than that of interest on first cost, are almost entirely for motive power, candles and attendance. The cost of Jablochhoff candles is given as about fifteen cents each. Mr. Stayton, who examined the apparatus and system in Paris, in behalf of the vestry of Chelsea, a parish of London, gives the total running expense of thirty-two candles as sixteen shillings (nearly four dollars) per hour. His estimate includes wages, coal,

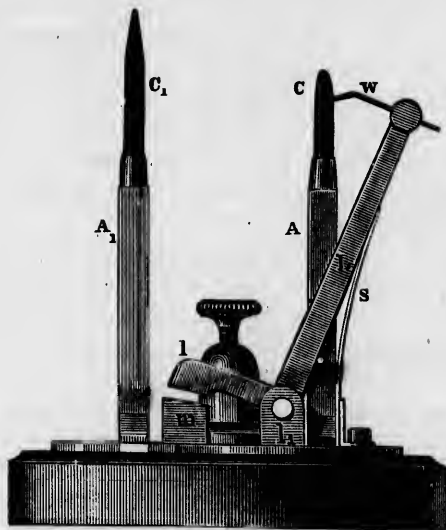

Fig. 242.

oil, waste, etc., as well as electric candles. This would make the expense per light per hour about twelve cents.

The system now in operation in the Place and Avenue de l'Opera was put up under a contract with the director of public works in Paris, by the General Electricity Company, which undertook to provide all the apparatus, and light the lamps for a term of six months, covering the period of the Exposition, for one franc and forty-five centimes (twenty-nine cents) per light per

hour. The amount of light produced by each electric candle is variously stated from five hundred to seven hundred wax candles.

The principal difficulties in the way of the general adoption of this light for street purposes, aside from the original outlay, which is a pretty serious item, is the amount of power required for each lamp, and the difficulty of conveying the current to any considerable distance from the machine without seriously reducing its strength. These are really the same difficulties in two different forms. At present, however, it certainly seems admirably adapted for lighting large squares, places and public buildings, and it does not seem unreasonable to expect that it will ere long be utilized for other purposes, when we consider what a number of inventors, some of them of exceptional ability, are now at work upon the problem.

Another machine for use in electric lighting, and somewhat resembling the Brush machine in construction, has just been brought out in France, and is highly spoken of there. One of these machines, with eight magnets only (of the same dimensions as those in the Alliance machines), will, it is said, illuminate from three to four of the Jablochhoff candles with an expenditure of but little over one horse power for driving purposes. This is considerably better than the Gramme. It gives reversed currents and experiences scarcely any heating. Its dimensions, besides, are very small, and the elementary parts simple in construction and easy of adjustment. A description of this machine, for which we are indebted to the Telegraphic Journal, is given below:

The enhanced effect of this class of machines is due to the fact that to the induction currents produced in the coil of the Gramme machines are added those produced in ordinary magneto-electric machines.

In order to understand this, let us imagine a Gramme ring, fig. 243, divided, for example, into four sections, insulated magnetically the one from the other, and forming, consequently, four electro-magnets, placed end to end. Let us suppose that

the iron core of each of these sections is terminated at each end by a piece of iron, A B, forming expanded prolongations of the poles; and let us suppose all these pieces to be joined by pieces of copper, C D, to form one solid ring, around which are placed permanent magnets, N S, with poles alternating with each other.

Let us examine what will take place when this ring accomplishes a revolution upon itself; and let us see, in the first place, what will happen on the approximation of the expanded pole B, as it travels from left to right, to the pole N. At this moment it will develop in the electro-magnetic helix an induced current,

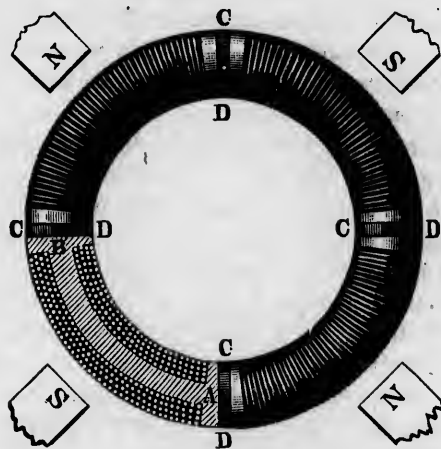

Fig. 243.

as in the Clark machine. This current will be instantaneous, and in a contrary direction to the Amperian currents in the inducing magnet. It will be very powerful, by reason of the proximity of B to the pole N; but the ring, in passing on, causes a series of magnetic displacements between the pole N and the core A B, which give rise to a series of currents, which may be called currents of polar introversion, from B to A. These currents will be direct in relation to those in N, but they are not instantaneous, and they increase in energy from B to A.

To these currents will be joined simultaneously the currents (of dynamic induction) resulting from the passage of the helix before the pole N. When A leaves N a demagnetization current is produced, equal in energy, and in the same direction, as the magnetization current due to the approximation of B to N. Thus we get reverse induced currents through the approach and recession of B and A; direct induced currents during the passage of the core A B before the inductor; direct induced currents resulting from the passage of the helix in front of N. All these inductive effects are thus accumulated in this combination; there are also currents resulting from lateral reaction of A B upon neighboring poles.

To still further augment the effects of induction, M. de Méritens, the inventor, makes the core and appendages of thin plates of iron, cut out and placed together, to the number of fifty, each one millimètre thick. The coils are so arranged that they can be connected in series or for quantity.

In fig. 243 we have considered only four sections, but there are, in fact, more than this; the model to which we have referred possessing sixteen, which are mounted on a bronze wheel, centred on the motor shaft. The inductor magnets are placed above the wheel and strongly fixed horizontally to two bronze frames.

A little consideration will show that the ring is constructed under the best possible condition. In fact, as each section is separate, it may be dismantled singly, and consequently, the wire can be wound on without difficulty. Those who know the difficulty of winding a Gramme ring will readily appreciate this advantage. On the other hand, the core being composed of plates which can be at once removed by releasing the key piece is an enormous advantage, for it obviates the precision necessary to the construction of solid rings, which are always difficult to keep perfectly true. Lastly, there is neither commutator nor collector, and, consequently, no loss of current.

We have said that this machine can feed three or four Jablochhoff candles applied to an electric light regulator; but

it has also been found competent to illuminate regulators, even when the carbons were separated by a distance of three and a half centimètres. It is certain that these results are very important, and we may safely argue a future for this machine.

As is well known, when an electrical current, which flows through a conductor of considerable length, is suddenly broken, a bright flash, called the extra spark, appears at the point of separation. The extra spark will appear, although the current is not sufficient to sustain an arc of any appreciable length at the point of separation.

In the system proposed by Professors Thomson and Houston, one or both of the electrodes, which may be the ordinary carbon electrodes, are caused to vibrate to and from each other. The electrodes are placed at such a distance apart that in their motion towards each other they touch, and afterwards recede a distance apart which can be regulated. These motions or vibrations are made to follow one another at such a rate, that the effect of the light produced is continuous; for, as is well known, when flashes of light follow one another at a rate greater than twenty-five to thirty per second, the effect produced is that of a continuous light. The vibratory motions may be communicated to the electrodes by any suitable device, such, for example, as mechanism operated by a coiled spring, a weight, compressed air, etc.; but it is evident that the current itself furnishes the most direct method of obtaining such motion, as by the use of an automatic vibrator or an electric engine.

In practice, instead of vibrating both electrodes, it has been found necessary to give motion to one only; and since the negative electrode may be made of such size as to waste very slowly, motion is imparted to it in preference to the positive. The carbon electrodes may be replaced by those of various substances of sufficient conducting power.

In this system, when desired, an independent battery circuit is employed to control the extinction and lighting of each lamp.

The following is a description of one of the forms of the electric lamp devised to be used in connection with the system.

A flexible bar, *b*, of metal, fig. 244, is firmly attached at one of its ends to a pillar, *p*, and bears at its other end an iron armature, *a*, placed opposite the adjustable pole piece of the electro-magnet *m*. A metal collar, *c*, supports the negative electrode,

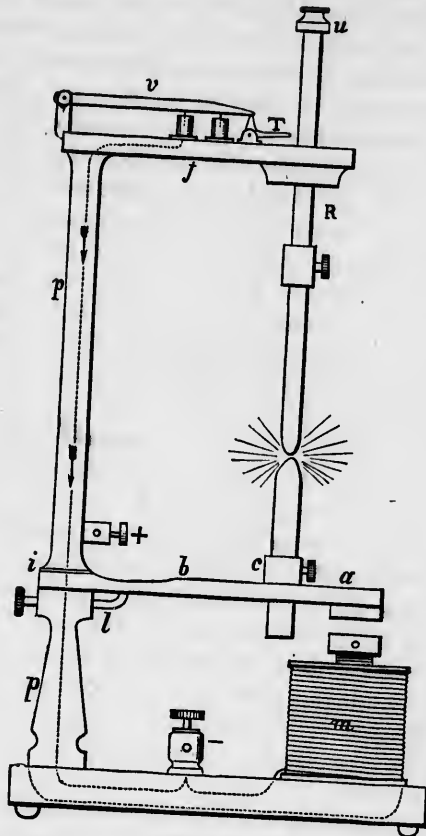

Fig. 244.

the positive electrode being supported by an arm, *j*, attached to the pillar *p*.

The pillar *p* is divided by insulation at *i* into two sections, the

upper one of which conveys the current from the binding post marked +, to the arm *j*, and the rod *R*, supporting the positive electrode. The magnet *m* is placed, as shown by the dotted lines, in the circuit which produces the light. The pillar *p* is hollow, and has an insulated conducting wire enclosed, which connects the circuit closer *v* to the binding post marked —. The current is conveyed to the negative electrode, through *b* and the coils of the magnet *m*. When the electrodes are in contact, the current circulating through *m* renders it magnetic and attracts the armature *a*, thus separating the electrodes, when, on the weakening of the current, the elasticity of the rod *b* again restores the contact. During the movement of the negative electrode, since it is caused to occur many times per second, the positive electrode, though partially free to fall, cannot follow the rapid motions of the negative electrode; and, therefore, does not rest in permanent contact with it. The slow fall of the positive electrode may be insured either by properly proportioning its weight, or by partly counterpoising it. The positive electrode thus becomes self-feeding.

The rapidity of movement of the negative carbon may be controlled by means of the rigid bar *l*, which acts, practically, to shorten or lengthen the part vibrating.

In order to obtain an excellent, but free contact of the arm *j* with the positive electrode, the rod *r*, made of iron or other suitable metal, passes through a cavity, *s*, fig. 245, filled with mercury, placed in electrical contact with the arm *j*. Since the mercury does not wet the metal rod *r*, or the sides of the opening through which it passes, free movement of the rod is allowed without any escape of the mercury. We believe that this feature could be introduced advantageously into other forms of electric lamps.

In order to prevent a break from occurring in the circuit, when the electrodes are consumed, a button, *u*, fig. 244, is attached to the upper extremity of the rod *R*, at such a distance that when the carbons are consumed as much as is deemed desirable, it comes into contact with a tripping lever, *t*, which then allows two

conducting plugs, attached to the bar *v*, to fall into their respective mercury cups, attached, respectively, to the positive and negative binding posts by a direct wire. This action practically cuts the lamp out of the circuit.

Another form of electrical lamp, devised recently by M. Reynier, is shown in figs. 246 to 249. The action of this lamp is based upon the well known principle that if a very intense current of electricity be led through a resisting and refractory conductor, such as a pencil of carbon, the temperature of this conductor may rise to a dazzling white heat, and it will then emit a vivid light. The principal difficulty to be overcome in

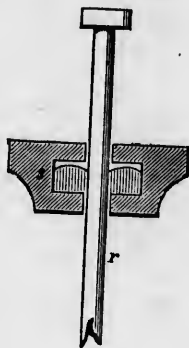

Fig. 245.

the electrical lamp is to limit the undue waste of the luminous conductors—a waste which is very rapid, even in an enclosed space, on account of the volatilization and disaggregation of the carbon pencils; and which is greatly accelerated in the open air by the rapid combustion of the incandescent carbon.

In the various systems of electrical lamps with continuous conductors heretofore proposed, the renewing of the carbon points is performed in the following manner: The incandescent pencil is placed in the circuit, with fixed contacts, and remains part of the same until broken by being consumed. The light is then extinguished. The current now suddenly passes from this

carbon to another, which is consumed, the circuit broken in its turn, and so on.

This method is open to many objections; there is an interruption of the current, accompanied by an extinction of light at every rupture of the pencil. The luminous intensity varies continually on account of the gradual thinning of the carbon. The conductor only gives its maximum of light at the moment next to that of rupture. Finally, the proposed apparatus can scarcely work except in an enclosed space.

In the new system here referred to the renewal of the carbon is progressive. The carbon, incandescent a part of its length, advances almost continuously, till the whole available part has been consumed. The system can operate in the open air. The following is the principle: A cylindrical or prismatic pencil of carbon, C, fig. 246, between *i* and *j*, forms part of an electrical circuit (continuous or alternate), sufficiently intense to render this part incandescent. The current enters or leaves at the point of contact *l*; it leaves or enters at the point of contact B. The contact *l*, which is elastic, compresses the pencil laterally; the contact B touches it at its end. Under these conditions the carbon is consumed at its extremity sooner than at any other place, which tends to diminish its length. Consequently, if the carbon is steadily forced in the direction of the arrow, it will gradually advance as it is consumed, sliding through the lateral contact *l*, so as to press continuously on the point of contact at B. The heat developed by the passage of the current is greatly increased by the combustion of the carbon.

In practice, a revolving contact, B, fig. 247, which carries off the cinders of the carbon, is substituted for the fixed contact. The rotation of the contact is made dependent on the progressive movement of the carbon, so that the weight of the latter, exerted at its end, acts as a brake on the mechanism of the motion.

The principle of this new system once established, simple apparatus to realize it could easily be devised. The specimens submitted to the Society of Physics may be understood at the first glance. The advance of the carbon C, fig. 248, and revol-

ing.
heav
this
any
alwa
TH
elem

lamps o
of the e
The
Physics
centimè
were op
repeated

ing contact at B, are obtained by means of the descent of the heavy rod P. To wind up the lamp it is only necessary to raise this rod. The carbon pencil is placed in its position without any adjustment. The luminous point remains fixed, which is always advantageous, and particularly so in optical experiments.

This apparatus gives a clear white light with four Bunsen elements. With a more powerful electrical source, several

Fig. 246.

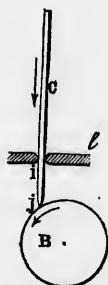

Fig. 247.

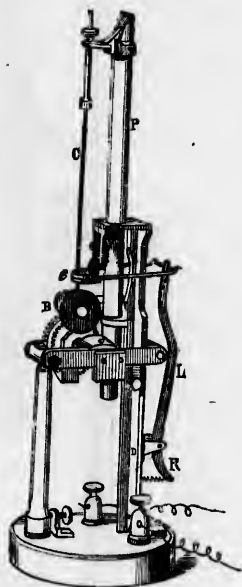

Fig. 248.

lamps of this system may be operated, and thus "a subdivision of the electrical light may be obtained."

The following experiments were made before the Society of Physics: With a battery of thirty-six elements of eighteen centimètres, grouped in two series of eighteen each, four lamps were operated when placed in a single circuit, and all four were repeatedly extinguished and relighted at will. Each of the four

lamps could be extinguished and relighted "individually," the three others continuing unaffected. Light was also obtained

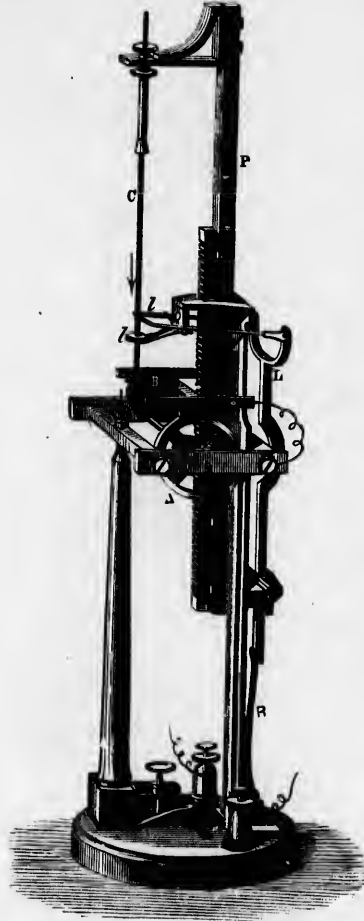

Fig. 249.

from one of these lamps by means of the current of a small Gramme machine, for the laboratory, with treadle attachment.

Finally, a light was obtained with a battery of three Planté (secondary) elements, which were charged during the afternoon, at the establishment of M. Bréguet, and carried, charged, to the hall of the society. This experiment may be considered as a step towards the application of the electrical light to domestic purposes.

The following is a more recent arrangement of the apparatus:

In this arrangement the revolution of the turning contact is obtained from the tangential component of the pressure of the carbon pencil on the circumference of the disk. Thus the end of the pencil never leaves the revolving contact, and all causes of irregularity in the light are obviated.

The brake, always indispensable, is operated, fig. 249, in the following manner: The disk B is carried by a lever swinging from O. The pressure exerted by the carbon on the disk B causes the shoe S to press on the face of a wheel, A, which is revolved by means of the weight of the heavy rod P through its rack and the pinion *a*. Accordingly as the point of the luminous conductor presses more or less heavily on the disk, the brake will retard, more or less, the descent of the heavy column, which occurs at almost inappreciable intervals.

A great deal has been said lately about the substitution of the electric light for gas, and from the frequent remarks which we hear on this subject it would appear that no small portion of the popular mind inclines to the belief that the realization of this event on an extended scale is not far distant. It should, however, be remembered that the great advantage of the electric light, so far at least as economy is concerned, can be obtained in the highest degree only where a large quantity of light is wanted, and that the circumstance under which the light is to be used has a modifying influence in regard to its application. A place already provided with power, or in such a position as to receive it without necessitating extra provisions for the purpose, would, of course, be served more economically than another requiring the special introduction of machinery and the employment of help to look after it. As the amount of light required decreases, the economy also becomes very much less marked.

7," the
tained

small
ment.

Platinum and iridium, as already explained on page 428, and gas retort, or other carbon pencils when rendered incandescent by the passage of sufficiently powerful currents, serve very well for illuminating small spaces and apartments, but the difficulties attending the use of these substances are considerable, and no extended practical application of them, so far as we are aware, has yet been made. The subject has, however, been taken up anew by Messrs. Edison, Sawyer and Man—the former working independently and the two latter together—and the results so far obtained, it is said, promise very well for their ultimate success.

Considered from a theoretical standpoint alone, carbon is even better adapted for lighting purposes than platinum or iridium, since its radiating power for equal temperatures is greater and its capacity for heat, referring, of course, to equal volumes, is less than that of either of these metals; thin sticks of this material would consequently be raised to a much higher temperature for a given current than equal volumes of the metals. Carbon also possesses the advantage of remaining intact at the highest temperature, while the metals become fused and are even deflagrated; its disadvantage, on the other hand, aside from a tendency to volatilize at high temperatures, is the ready combination of its heated particles with the oxygen of the air, but this in a measure has been overcome by confining the incandescent carbon in an atmosphere of some non-oxidizing gas, such as nitrogen. The Sawyer-Man lamp comprehends the use of this gas for the above mentioned purpose, but the idea is certainly not a new one. We shall refer to this lamp again presently.

It has been announced quite recently that Mr. Edison has discovered a means for subdividing the electric current indefinitely, thereby making it possible to use electricity for lighting small areas, and the statement has had a marvellous effect in bringing down the value of gas stock abroad.

It is somewhat remarkable, too, that although gas shares depreciated greatly and suddenly in England, on this announcement, few persons in that country had the slightest idea of what the alleged improvement consisted; they had, however, seen the light,

and already knew what wonderful things the American inventor had done in other directions, and that seemed quite sufficient.

In the application of Mr. Edison for a patent on his electric light invention, as it now appears on the records of the English commissioners of patents, bearing date of Wednesday, October 23, 1878, nothing at all is said about the subdivision of the current. The title which expresses the purport of the invention, and which will appear on the face of the patent, is as follows: "Method of, and means for developing electric currents and lighting by electricity." We may, however, assume that the idea is included therein. It will not be out of place in this connection to note, as well, that an application was also filed in the English patent office on October 26, just three days later, by Mr. Charles E. Shea, for a "Method of dividing and distributing the current produced by magnetic batteries and magneto and dynamo electric machines into an indefinite number of separate currents, equal or relatively unequal to each other in quantity or force." How many other persons are engaged upon the same problem it would be difficult to state, but the number is certainly very large. But leaving out of consideration the practicability of the infinite subdivisions of the current, regarding which scientific electricians have well known views that are not likely to be much affected now, we come to the principal part of the invention. More than a quarter of a century ago a good deal was done by inventors in this and other countries toward securing an electric light, by causing a current to pass through a platinum wire, and so raising its temperature as to make it self-luminous. The results at that time fell far short of the expectations of the sanguine experimenters. One obstacle to success was the liability of the wire to fuse. This Mr. Edison now claims to have overcome by so applying a small bar that it will expand the instant the wire reaches within a few degrees of the fusing point, and intercept the flow of the current through the wire sufficiently to prevent fusing.

This automatic arrangement secures, it is said, an even temperature in the wire or thin strip of platinum, and consequently a

steady glow of pure light. If this is done economically, and the practical limit of the subdivision is sufficiently extended, it is obvious that a marked advance has been made in artificial illumination. Actual trial, however, must determine whether the action of the automatic bar regulator will do all that is claimed for it.

A somewhat similar arrangement, or one which, at first sight, might be thought to involve the same principle, was exhibited before the Royal Society in June, 1878, by Dr. Siemens; and the method with which Mr. Farmer experimented some years since might not appear altogether dissimilar. As early as 1859—nineteen years ago—Mr. Farmer also demonstrated the possibility of subdividing the electric current for illuminating purposes, and at the same time showed its application to private dwellings by actually lighting one of the dwelling houses in Salem, Mass., every evening during the month of July of that year. This was undoubtedly the first private dwelling ever lighted by electricity. The current used for the purpose was supplied by three dozen six gallon battery jars. In 1875, he carried the subdivision still further, by making forty-two divisions in the current from a single dynamo-electric machine, and producing as many separate lights. The machine used in this case did not weigh over eight hundred pounds, and was driven by a small steam engine. While, therefore, a casual observer might discover a marked similarity between the invention of Mr. Edison and those of Messrs. Farmer and Siemens, a more careful one would scarcely fail to note the difference which, in one sense, is quite distinctive. In both of the latter it is the current which is regulated, while in the former it is the temperature of the incandescent substance, each lamp being entirely independent of the strength of current above a certain amount, and each also independent of the other.

The new form of electric light produced by what is known as the Sawyer-Man lamp, has been publicly exhibited in New York lately by the Electro-Dynamic Light Company, and its appearance alone certainly impresses the observer very favorably. We have, however, no reliable data in regard to the photometric value

of the lights, the current required for each, nor the practical limit to the subdivision of the principal current. Undoubtedly, subdivision can be carried as far with this form of lamp as with any other that has been brought out—it may be further. But there is a limit for the best—the press to the contrary notwithstanding—as will readily appear when we consider that a certain amount of current, and not a very inconsiderable one either, is required for each lamp. The division of the current itself to almost any extent is no difficult problem for small amounts, it being only necessary to lead off a number of branch circuits from the main conductor, and the current, following Ohm's well known law, will divide between them in the inverse ratio of their resistances; if all are equal, the currents in each will be alike. But when a current sufficient to maintain carbon pencils at a white heat is required in each branch, the practical limitations begin to appear. It is said that by the use of M. Rapieff's system, which has been practically introduced into the London Times' composition rooms, twenty lights from a single machine are obtained, and that the distributing principle has proven a great success.

One great advantage of this light is that it can be sustained for a whole night, if necessary, without change of carbons, or any attendance, and the intensity remains always the same, however much the carbons are consumed. Four carbon pencils instead of two, as in the ordinary form of regulator, are used with the system. These are opposed to each other in pairs, and so placed that the plane of one is at right angles to that of the other. At first the carbons are together, but when the current is sent through them they are drawn apart by an electromagnetic apparatus, which forms part of the lamp, and as the points consume, are made to approach each other slowly. This is effected by means of a lead weight or counterpoise. With carbons twenty inches long and two tenths of an inch in diameter the light is maintained for seven or eight hours, and with carbons twenty-four hundredths of an inch thick it is kept up for nine or ten hours. The light is equivalent to from one hundred to one hundred and twenty gas flames, or about one

thousand candles, but a smaller form of the lamp is made which is estimated to give five gas flames. The resistance of the arc is only two or three ohms.

The Sawyer-Man lamp consists of two conductors enclosed in a sealed glass vessel of about eight inches in height by two and a half in diameter, containing nitrogen, and a very thin carbon pencil, probably one tenth of an inch thick and three quarters long, which is the source of the light when rendered incandescent by the passage of the current. Every precaution has been taken in the construction of the lamp to modify or remove even the slightest thing that could tend to interfere with its use in a practical way. The glass is made very clear, to prevent undue absorption both of light and heat; the wires are large and long, so as to form ready conductors for the dissipation of useless heat that is always generated, and, finally, a diaphragm of some non-absorbing substance is placed immediately below the carbon pencil to prevent radiation downward, which, if allowed to take place, might seriously interfere with the sealing. The conductors are also wound in a spiral form to economize space. Considerable secrecy has been maintained by the inventors in regard to some substance contained in the base of the lamps; but this is believed to be metallic potassium, placed there to absorb any oxygen that may chance to leak through.

We have seen five or more of these lamps in operation at one time, and were much pleased with their performance. Our investigation of the various details connected with their construction and practical maintenance was, however, too limited to enable us to judge of them from an economical standpoint. One or two things which came under our observation did not impress us quite so favorably as we had reason to anticipate from what we had heard of them. Possibly a poor adaptation of means to ends, which is so often noticeable with new and hastily introduced apparatus, is in part responsible for this, but it is certainly remarkable that the continuance of the light on the occasion of our visit was not prolonged beyond five minutes at the most; and this fact, taken in connection with the sound from the dynamo-

electric machine, which indicated both a high rate of speed and the production of a powerful current, was not calculated to greatly astonish any one familiar with the subject of electric lighting. The particular advantages of this light, however, are its steadiness and the ease with which it can be controlled, both very desirable qualities, and it will no doubt meet with considerable success.



Fig. 250.

At present we have very little reliable data, beyond that given on page 426, regarding the cost of lighting shops and factories in this country, or the use of the light in a small way. What we have there said, however, shows under what conditions the employment of the electric light may be both advantageous and economical.

Messrs. Wallace & Sons, of Ansonia, Conn., have been among

the first here to introduce the light in a practical way, and their extensive rolling mills have been very successfully lighted with four lamps for months together. Fig. 250 shows one form of the lamp which they use; it has already been described on page 412. Various other applications of the light have also been made elsewhere in this country, but we are, unfortunately, not in possession of any detailed statement of the cost of the same, compared with that of gas used under similar circumstances.

Mr. Schuyler informs us, however, that the cost of lighting one of the corridors in the Equitable building, New York, by two Maxim lamps, like that shown in fig. 235, and one of the Farmer-Wallace machines, is a trifle over fifteen and a half cents per hour for running expenses alone, as against fifty-one cents per hour for gas, and that the quantity of light furnished by the two lamps, which replace fifty-one gas burners, is three times greater. It is confidently hoped by Mr. Schuyler and his associates that the advantages of the electric light will be even more marked, both as regards steadiness and economy, when the Farmer-Wallace machine is replaced by one of the new Maxim machines, as is proposed to be done shortly. This machine is shown in fig. 251, and, it is claimed, will furnish a very large amount of current for the comparatively small amount of material used in its construction. Its tendency to become heated is, at the same time, very small, on account of the manner of arranging the armature and field magnets, whereby a constant circulation of air among all the parts is secured.

The Maxim machine and lamp, we understand, have been adopted by the Russian government for the steamships which are being constructed for it in this country, the trial on one of the vessels having given so much satisfaction that all will now be similarly equipped.

In England, the Lontin machine and lamp have been somewhat extensively introduced, but it is difficult to get really accurate statements in regard to the cost of operating them. The machine, which has not been noticed in the preceding pages, is constructed in two parts, one of which supplies the current for

magnetizing the iron cores of the second, on the principle of the Wilde machine, while the latter is arranged to supply several different circuits containing separate lamps. The lamp is a modified form of the Serrin regulator, though in what the improvement introduced in it by M. Lontin really consists we are not informed. Like the Serrin lamp, it is, doubtless, rather costly. No reliable

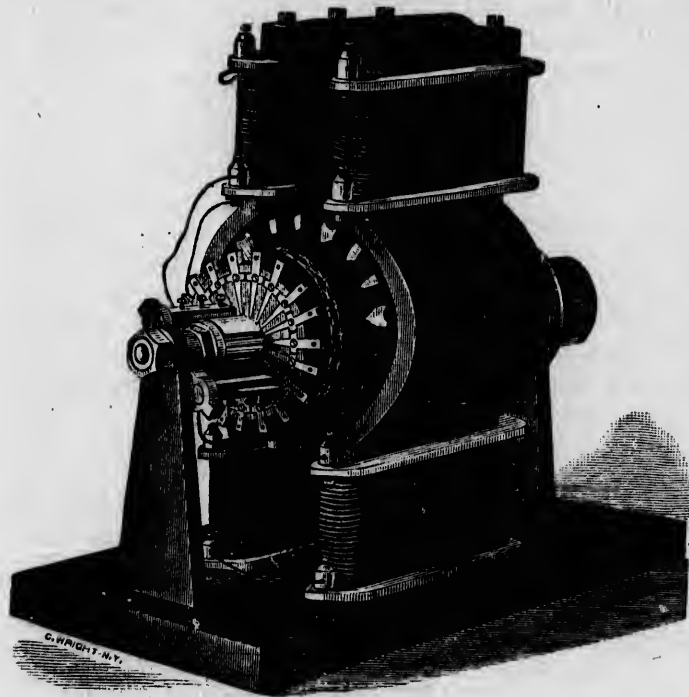

Fig. 251.

figures have been published, so far as we can learn, concerning the cost of producing light by this system, but it is believed to be somewhat less than that of the Jablochkoff candle supplied by the Gramme machine, which we have already given as about twelve or thirteen cents per light per hour, not including expense of repairs, depreciation and interest upon original outlay.

It is stated that the lighting of the Gramme workshop, in Paris, a room about forty feet square and sixteen feet high, has been maintained during four or five years past by a single light taking the place of twenty-five burners, and at a cost not exceeding twelve cents per hour.

The Ducommun foundries, at Mulhouse, among many other places abroad, have also been lighted with electricity for the past three years or more, and we refer to them here because of the details which have been made public in regard to the application and use of electricity in this case. One enclosure, about one hundred and eighty-four feet long and ninety-two broad, is lighted by means of four Serrin lamps, supplied from a like number of Gramme machines. The lamps are placed about sixteen feet above the floor, seventy feet apart in the direction of length, and forty-six feet in the direction of width. Scarcely any shadows are given, as the cross rays of the lamps are such, when placed as above, as to illuminate the different parts of the room almost equally well. The total cost of the complete equipment, including machines, lamps and placing of the same for service, amounted to about two thousand dollars, which is near what it would have cost to put in two hundred and fifty gas burners, while the light produced with the present arrangement really exceeds that from four hundred burners.

A comparison of the cost of lighting this foundry by gas and electricity is here given, on the authority of M. Fontaine.

LIGHTING BY MEANS OF GAS OBTAINED FROM OIL.			LIGHTING BY MEANS OF THE ELECTRIC LIGHT.		
Power of light expressed in gas burners.	COST PER HOUR.		Equivalent of the power of the Electric Light from four Regulators, expressed in number of gas burners.	COST PER HOUR.	
	Without Interest or Deterioration.	With Interest and Deterioration.		Without Interest and Deterioration.	With Interest and Deterioration.
Burners.	Francs.	Francs.	Burners.	Francs.	Francs.
442	11·05	15·03	442	1·54	6·64

From the preceding table it would appear, that with equal light emission, the electric light in this case costs less than gas, in the ratio of about 1 to 2.26, with interest and deterioration, and of 1 to 7.17 without interest and deterioration.

Before concluding the chapter, we should say that the relative cost of gas and electric lighting given above, and which does not appear to differ materially from the cost under similar circumstances in this country, is, after all, only another example of lighting on a large scale, in which case, as before stated, the electric light can be employed to the greatest advantage. For the illumination of small apartments and for private houses, however, where, comparatively speaking, a small light only is wanted, and that at the lowest cost, the foregoing advantages are not so apparent. It would, however, be premature, considering the number who are devoting their attention to this subject, and the consequent rapidly increasing application of electricity as a source of illumination, to assert that this agency may not ultimately be made to yield corresponding advantages on a small scale, though it is none the less evident now that other improvements will first have to be made.

Since the foregoing was put in type we have received a very interesting communication from Mr. Moses G. Farmer, on the subject of electrical lighting, which we give herewith. Its importance in this connection is amply shown in the amount of general information it contains, and which Mr. Farmer's large experience renders him so eminently able to give.

In the summer of 1838, while reading of the very interesting experiments of Prof. Draper on the heat and light evolved by a platinum wire, which was traversed by an electric current, I was struck by the rapid increase in the amount of light given out as the temperature of the wire approached the point of fusion, and it struck me that, if the temperature of the wire could be steadily maintained quite near the melting point, a useful light could be obtained from it. I was not long in devising a combination of electro-magnets, rheostats and batteries that would give the desired result, and early in 1859 I put the idea into successful

and practical execution, and we had a beautiful light in use in my house in Salem.

I at once entered upon a protracted investigation of the conditions which govern the management of the current, the construction of rheostats, the arrangement of lamp, etc., and the best proportion of length, width and thickness of the illuminator. I tried various substances in the course of my investigation, such as copper, aluminum, platinum, iridium, palladium, iron, nickel, carbon, etc.

Pure iridium gave the best results of any of the metals. Alloys of iridium and platinum gave next best results, and next to this, platinum and palladium. Carbon, when inclosed in an atmosphere free from oxygen, also gave satisfactory results. Nitrogen, carbonic oxide and hydrogen are all suitable gases to surround the incandescent carbon. A vacuum is, perhaps, better, were it not for the difficulty of maintaining it.

The important point is, that the higher the temperature of the incandescent substance, the greater the amount of light; and it is very noteworthy, that it requires nearly half as much current to make platinum shine in the dark as it does to fuse the wire or ribbon. Three quarters of the fusing current will not give one half the light that will be given off by seven eighths of the fusing current. A flat ribbon of platinum will give nearly one hundred candle lights per square inch, if it be maintained within two hundred degrees Fahrenheit of the melting point, and I have been able to keep it at this temperature for hours and days. A bar of pure iridium, owing to its higher melting point, will give several times as much light as an equal and equally exposed surface of platinum; but, since pure iridium is neither malleable nor ductile when cold, it is costly to work it into convenient shape; hence, I have had recourse to alloys of platinum and iridium, which, although they do not give so much light as pure iridium, are yet superior to pure platinum. The platinum does not seem to waste perceptibly, yet I think I have detected a tendency to volatilization.

The resistance of platinum, at the melting point, is nearly

seven times its resistance at thirty-two degrees Fahrenheit. A very simple empirical formula expresses the relation between the strength of current needful to melt, and the dimensions of the wire, and this formula serves as well for other substances as for platinum, when the proper constants are supplied.

I found no difficulty in subdividing the current into as many branches as I pleased, and in maintaining as many lamps as I desired in each branch, provided I had, at my control, sufficient electro-motive force and conductivity. I found that less than two hundred foot pounds per minute would maintain one candle light, if the piece of platinum were of suitable form and dimensions. It was easy to supply current to any desirable number of branches, and to so adjust the regulator that, if one, two or three of the branches were removed or cut off, the supply of electricity would be so curtailed as to maintain, at the proper temperature, the lamps in the remaining branches.

My regulator, as I used it in 1866, 1867 and 1868, was so sensitive as to feel the current of air arising from the opening and shutting of a door of the room in which the apparatus was placed.

I had this apparatus on exhibition at 109 Court Street, in Boston, during the years 1865, 1866, 1867 and 1868, until it was destroyed by fire. Since that time I have been almost continuously engaged in making further researches in this direction; have studied the conditions under which incandescent bars of carbon can be used in sealed globes, and have studied the construction of magneto-electric machines best adapted to this purpose.

There are four principal methods of producing electric light, on which I have bestowed much attention:

The first method is that in which an electric arc is maintained between carbon points. It is well known that a counter electro-motive force, or polarizing force, is encountered in the passage of the current between the electrodes, and this polarization is often as great in amount as twenty or thirty volts.

The resistance to conductivity in the arc varies also, being less

as the cross section of the arc increases, less as the temperature increases, also as the length of the arc diminishes, following the laws of conduction in fluids and liquids. With carbon, one quarter inch square, and a current of from twelve to twenty vebers, the resistance of the arc may be set down at ten to thirteen ohms per linear inch of arc, varying, however, between wide limits.

With carbon one half inch square, and current of fifty or more vebers, it is much less. The best prepared carbon weighs more than an avoirdupois ounce per cubic inch.

The resistance of carbon, unlike that of metals, does not vary greatly with the changes of temperature. The resistance of some specimens, which I have tested, is about fifteen hundred or sixteen hundred times that of pure copper, at thirty-two degrees, while the specific resistance of other specimens is at least twice as great.

The light evolved is due in considerable measure to the oxidation of the carbon by the atmosphere. Much of the light is, however, due to the energy of the current, and this depends on the density of current in the arc.

A second method of producing electric light is by rendering a continuous bar of carbon incandescent in the air by the passage of a current of sufficient density to raise its temperature to a white heat. Here much of the light is due to the superficial oxidation of the carbon bar, and this may perhaps prove to be the most economical method of producing it.

The third method is by enclosing the carbon bar in a closed transparent globe free from oxygen. In this case the carbon is not consumed, but the light is wholly due to the energy (RS^2) of the current acting on the bar.

The fourth method is that of rendering some of the metals, with high melting points, incandescent by the passage of a current of great density.

This is the method to which I have given most attention, and which promises to be the most convenient for minutely subdividing and widely distributing electric light, especially for

do
nee
led
I
exp
nat
cur
E
in
bee
ven
galv
four
of d
in 1
Berl
thre
this
my
mach
the c
of fo
in th
so fa
accou
Engla
was p
recol
Fro
duced
thousa
dred t
expen
machin
Now
or thro

domestic illumination. An entirely new field for electric engineers is thus opened, in which our accumulated stock of knowledge will be most usefully employed.

Previous to my investigations, Gardiner and Blossom had experimented on and patented a signal lamp, which was illuminated by a coil of platinum wire, heated by the passage of a current of electricity from a galvanic battery.

King, Staite and others had studied the use of carbon bars in sealed globes, and had proposed methods that would have been applicable and useful had there been any cheap and convenient source of electricity. I found that a current from a galvanic battery increased the cost of electric light to three or four times the cost of light from gas; and to remove this source of difficulty I turned my attention to the thermo-electric battery in 1864-5, just then being brought into notice by Marcus, of Berlin. I was, however, never able to utilize more than one three hundredth of the energy possessed by a pound of coal in this form of electro-motor; and so, in 1865-6-7-8, I turned my attention to the perfection of a form of magneto-electric machine which I had conceived of in 1859, namely, one in which the current derived from the armature should maintain the field of force in which it revolved, and also perform the useful work in the external part of the circuit. I succeeded, in 1866, in so far perfecting this apparatus as to be able to give some account of its performance to Mr. H. Wilde, of Manchester, England, in October, 1866, and an extract from my letter to him was published in the Manchester Philosophical Magazine, if I recollect rightly.

From all my researches, I conclude that when light is produced in large amounts—say, five thousand, ten thousand, fifteen thousand candle lights—from one lamp, as much as eight hundred to twelve hundred candle lights can be obtained from the expenditure of one horse power upon a suitable dynamo-electric machine and properly prepared and utilized carbon.

Now, while it is remembered that as much as two thousand or three thousand foot pounds of energy per minute per candle

light is consumed in the production of light from ordinary illuminating gas, it will be apparent that a large field is opened for the introduction and utilization of the electric light, which often requires the expenditure of less than one hundred foot pounds of energy per minute per candle light.

A great deal has been said and written about the difficulty of subdividing the electric light. Now, there is really no difficulty except that which arises from inexperience and the lack of skill.

If a wire of pure platinum five inches long and one hundredth of an inch in diameter be traversed by a current of electricity somewhat more than five and less than six vebers in strength, it can be maintained at a temperature quite near to the point of fusion, and while in this condition, it will, in the common atmosphere, emit something more than three candle lights, and just below the melting point the light will be between four and five candle lights.

If the light be enclosed in a glass globe and surrounded by hydrogen gas it will radiate less light. The resistance of the wire at the melting point will not be far from one and a quarter ohms if the platinum be pure; hence the energy active in the wire with a current of five and a half vebers (which it will ordinarily withstand) will not be far from $44\frac{1}{4} \times (5\frac{1}{2})^2 \times 1.25 = 1678$ foot pounds per minute, and if it give four and a half candle lights, which it will do if the surface of the platinum be highly polished, we should require $1\frac{1}{2} \cdot 7^3 =$ say 370 foot pounds of energy per minute per candle light.

Now, if one hundred such wires be put in series in a circuit, the sum of this resistance would be one hundred and twenty-five ohms, and it would require a difference of potential equal to $125 \times 5\frac{1}{2} = 687\frac{1}{2}$ volts to maintain this strength of current of five and a half vebers and we should get in the aggregate five hundred or more candle lights.

If, further, we should arrange ten such circuits in multiple arc, having one hundred lights in each of the ten branches, we should find the joint resistance of this part of the circuit reduced to twelve and a half ohms; but it would now require

a current of fifty-five vobers' strength to keep the lamps all shining, and the difference of potential required to maintain the one thousand lights, each from three to five candles, would still be six hundred and eighty-seven and a half volts; but we should now have five thousand candle lights instead of five hundred, and the energy absorbed in this part of the circuit would be equal to $\frac{44.25 \times 12.5 \times 55^2}{33,000}$ = more than fifty horse power to

maintain the five thousand candle lights or one hundred candle lights per horse power. But it must be remembered, that this is not all the energy consumed in the production of the light; this is only the useful energy.

Besides this, there is the $R S^2$ consumed in heating the leading and distributing wires, also that consumed in the magneto-electric machines or whatever source be employed.

This may be represented by $B S^2$, wherein B represents the internal resistance of the electro-motor, and can be made as small as one's purse will allow.

On this basis, let us suppose a city of five hundred thousand inhabitants to be furnished with electric light from platinum lamps, one of, say ten candles to each inhabitant. The aggregate amount of light would be five million candles; and if only one hundred candle lights were obtained from one horse power, we should then require fifty thousand horse power to furnish this amount of light, leaving alone the energy consumed in its production and distribution, which would, without doubt, exceed this amount, or nearly so, with the best machine now in use.

If you turn to the account of the experiments on the Brush light, as executed at the Franklin Institute, you will find that the cost of production was, on the average, in excess of one three hundredth of a horse power per candle light; and this, too, with carbon points, and with light in greater amount than ten, fifteen or fifty candle lights per lamp. Now, it is well known that the greater the amount of light at any source, the greater the economy, and so a five or ten thousand candle light costs less per candle than does a ten, fifteen or twenty candle light.

If next we consider the incandescent carbon, in an atmosphere free from oxygen, as in King's, Staité's, Kosloff's, and other lamps of this class, we shall find that a carbon rod three eighths of an inch in length and one thirtieth of an inch in diameter will offer a resistance of not far from half an ohm, whether it be cold or hot, and such a bar will bear a current of from ten to fifty vebers' strength for a time, without injury, and will give a soft, mild and very pleasant light, not too concentrated, but very desirable; and, as with the platinum lamp, many of these lamps can be put in one circuit, and many branch circuits in multiple arc can be heated simultaneously by one source of electricity, provided it have sufficient electro-motive force and conductivity, and the light will be more economical than from platinum, because the carbon, when thus protected, will withstand a higher temperature than will the platinum.

Next, we will consider the electric light produced by the arc between carbon points. If we have two suitable carbon rods, each, say, five sixteenths of an inch diameter, and separated to the distance of about one sixteenth of an inch, and apply to these electrodes a source of electricity, which has an electro-motive force of, say seventy volts, and an internal resistance of, say three ohms, we shall, after establishing the arc, find a current developed of about eight or ten vebers, and a light produced equal to from one hundred to four hundred candle lights.

If the resistance (four ohms) of the circuit were all metallic, the current developed would be in amount equal to sixteen or seventeen vebers; but the electric arc behaves like an electrolyte, and offers a counter electro-motive force, and so the actual electro-motive force in the circuit may be thus represented: $E - e$, where E is the electro-motive force of the machine, and $-e$ the counter or polarizing force of the arc. If, now, l represent the resistance to conductivity of the arc, B the internal resistance of the battery or machine, and r that of the leading wires, then the strength of current active in the circuit will be

$$C = \frac{E - e}{B + r + l}$$

The value of e varies, and all the conditions of its variation

are
pur
vol
as h
muc
fifte
W
vani
and
betw
exce
good
dred
not r
ohms
circu
tion,
such
If,
seven
ten a
would
rende
curren
Sup
force
reduc
such c
the ai
in one
I ha
the sam
I fin
circuit
machin
the stre

are not yet well understood. It is sufficient for our present purpose to know that it is sometimes as high as twenty or thirty volts, and that the resistance to conductivity in the arc is often as high as fifteen or sixteen ohms per lineal inch of arc, being much smaller when the light is very great, say when it is ten or fifteen thousand candles.

With this basis, suppose our magneto-electric machine or galvanic battery possesses an electro-motive force of seventy volts, and an internal resistance of three ohms, it will maintain an arc between carbon points, and, with care, this arc can be made to exceed one sixteenth of an inch in length, if the carbons be of good quality. Now, let us construct a machine with one hundred and forty volts intensity, and with an internal resistance not much greater than three ohms, at least not so great as six ohms. We can now maintain two short arcs in series in this circuit, each giving considerable light. With careful manipulation, even three arcs could be simultaneously maintained with such a machine.

If, now, our electro-motive force were raised to or in excess of seven hundred volts, we might maintain, possibly, as many as ten arcs in one circuit; but the feeding mechanism of the lamps would need to be well constructed, accurately adjusted, and rendered sensitive to slight variations in the strength of the current.

Suppose, further, that our machine has still an electro-motive force of seven hundred volts, but now its internal resistance is reduced to one tenth of an ohm, I doubt not that five or more such circuits of ten lamps each could be run in multiple arcs by the aid of this machine, as it is not probable that all the lamps in one branch would go out at once.

I have maintained three or four branch circuits in action at the same time, each branch having one lamp in it.

I find it much more difficult to run a few lights in each branch circuit than it would be to run several, if the construction of the machine be suitable and the power ample, as the laws governing the strength of current in branch circuits show would happen.

To sum up, then, the electric light question, there are many good and well known magneto-electric machines free to the public to use, for instance, the Saxton, the Siemens, Carpenter, Shepard, and many others; then, too, there is the platinum lamp of Gardiner and Blossom; the incandescent carbon lamps of King, Staite, and others.

Besides these there are the carbon point lamps of Browning, Dubosque, Serrin, Siemens, and many more, which are all free to the public, and hampered by no patents; no carbon point lamp need be better than the Serrin, when properly constructed, as it can be run for hours without flickering, or going out, if the carbons be good, the lamp well made and properly adjusted, and if the machine, which supplies the current, be of ample power.

Light to the amount of from one hundred to one thousand candles per horse power can be obtained from some of these machines and lamps, while at best not more than twenty-five or thirty candle light can be obtained from one horse power's worth of gas.

So let me here repeat what I in substance published in the *Scientific American*, a few years since, namely, that one pound of coal, if used for making gas, would yield enough to supply a candle light or its equivalent for about fifteen hours.

One pound of the gas, when made and burned, yields a candle light for seventy-five hours. Further, one pound of coal, burned in a good furnace under a good boiler, will furnish sufficient steam to drive a good steam engine, and if a magneto-electric machine, for a sufficient length of time, to furnish an electric light, which in intensity and duration shall be the equivalent of one candle light for one thousand hours.

But if all the energy locked up in one pound of carbon could be liberated and converted wholly into light, it would be equivalent to that given by one candle during one and a half years, if all concentrated in one source.

Hence, let experimenters take courage, and try to fill this chasm between one thousand hours and one and a half years!

When we shall see the electric light distributed in our dwell-

ings
this
Pear
1855
dwe
A
conv
when
light
butte
Th
light
was c
in the
equiv
electr
better
A v
from
gas w
illumi
it to g
heat, c
work.
hundr
thirty-
A v
consum
candle
need n
ute per
pect th
able fu
boiler
which s
light th
of illum

ings it may prove a source of pride to Salem to call to mind that this boon met with its first success in that city, where a parlor, in Pearl Street, was lighted every evening during the month of July, 1859, by the electric light, and was undoubtedly the first private dwelling house ever lighted by electricity.

A galvanic battery furnished the electric current, which was conveyed by conducting wires to the mantel piece of the parlor, where were located two electric lamps. Either lamp could be lighted at pleasure, or both at once, by simply turning a little button.

This light was soft, mild, agreeable to the eye, and more delightful to read or sew by than any light ever seen before. It was discontinued, for the reason that the acids and zinc consumed in the battery made the light cost about four times as much as an equivalent amount of gas light. Now that we can have cheap electricity from the dynamo-electric machine, we may soon expect better things of it.

A word as to the cost of electric light as compared with light from gas. Perhaps on the average, one pound of illuminating gas will give seventy-five candle lights per hour. One pound of illuminating gas possesses a sufficient store of energy to enable it to give out by combustion, about twenty thousand units of heat, or the equivalent of about sixteen million foot pounds of work. This, if burned in an hour, would average about two hundred and fifty thousand units of work per minute, or about thirty-five hundred foot pounds per minute per candle light.

A very large electric light, say ten thousand candles, does not consume more than twenty foot pounds of energy per minute per candle light, and even a small electric light of twenty candles need not consume more than two hundred foot pounds per minute per candle light. So it might not seem extravagant to expect that one pound of gas per hour could be burned in a suitable furnace under a proper boiler, and steam be taken from the boiler to a steam engine to drive a magnetic electric machine, which should supply five electric lamps that would give more light than five gas lamps, each consuming one fifth of a pound of illuminating gas per hour.

CHAPTER XV.

EDISON'S RECENT TELEPHONIC AND ACOUSTIC INVENTIONS.

The most important advance that has been made in the application of the telephone to business, manufactures and medical science dates from the discovery of the varying electrical resistance of certain bodies when submitted to pressure. The carbon telephone is based on this fact, and more recent discoveries prove that any mass of metal that is not continuous, like a heap of shot, a coil of chain, or charcoal impregnated with iron, will produce changes in an electrical current when submitted to pressure. This pressure may be the impact of sonorous waves of all kinds, and thus such a mass of metal may become the transmitter of a telephonic circuit.

In Chapter VI. we have already described a few of the discoveries and inventions made by Mr. Edison in his researches which culminated in the invention of the carbon telephone. We now propose to present a more complete description of the important forms of telephone upon which he then experimented, as well as to describe his more recent acoustic inventions. The carbon telephone is only one of many contrivances for reproducing articulate speech at a distance, but owing to its clear and truthful articulation, its simplicity of construction, and the far greater volume of sound which it creates, it is likely to be the most extensively used. Other instruments of Mr. Edison's invention, however, are not far behind it, and may by improvement be made equally effective. As a rule, Mr. Edison has succeeded better with those telephones which produce a variation in the resistance of the circuit than with such as depend for their action upon a variation of the electromotive force or static charge.

An instrument very similar to the carbon transmitting telephone is shown in fig. 252 (devised November 19, 1877), the

esse
lous
the
pres
being
fig. 2
trans
whic
struc
the b



carbon,
The we
is varie
block r
have be
the clo
modified
255 (de
floated
of the m
diaphrag

essential difference being that the carbon is replaced by bibulous paper, moistened with water. This semi-conductor, like the carbon, changes its resistance under the influence of varying pressure. The paper is kept moist by capillary action, a strip being used, one end of which dips into a reservoir of water. In fig. 253 (devised June 27, 1877) is shown a form of the carbon transmitting telephone, requiring no adjustment whatever, and which operates well, notwithstanding the simplicity of its construction. It consists essentially of a plate of metal resting on the bottom of a hollow vessel, and carrying a block of prepared

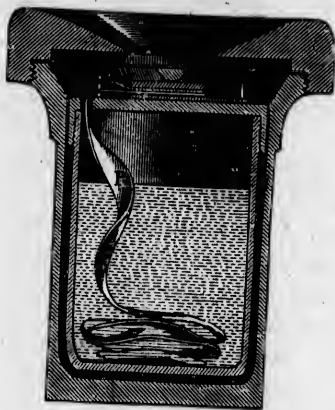

Fig. 252.

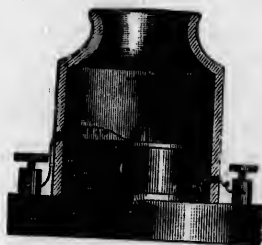

Fig. 253.

carbon, upon which a second and light metallic plate is laid. The weight of the upper plate affords an initial pressure, which is varied by speaking into the mouth of the vessel. The carbon block may be replaced by a disk of cloth, the pores of which have been filled with pulverized black lead. By this treatment the cloth becomes slightly conductive. The instrument thus modified is shown in fig. 254 (devised Sept. 20, 1877). In fig. 255 (devised August 12, 1877) the pulverized plumbago P is floated upon mercury, M, and is compressed between the surface of the mercury and a metallic block fastened to the centre of the diaphragm.

Still another form of the Edison transmitter is shown in fig. 256 (devised July 5, 1877). The carbon C rests upon the diaphragm, which, in this instrument, is a horizontal plate forming the top of a vocalizing chamber, the mouth piece being at the side. Three fine cords attach the carbon to the framework of the diaphragm, and prevent it from being displaced when the diaphragm is vibrating. In appearance this instrument resembles the Reiss telephone, and in principle it would be much the



Fig. 254.

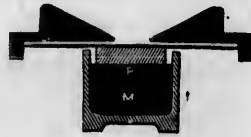

Fig. 255.

same were it not that, in vibrating, the carbon never actually leaves the plate upon which it rests, but simply, for an instant, releases its pressure. It is evident that the resistance of the circuit depends upon the electric connection between the carbon and the diaphragm, and that this connection depends upon the pressure of the carbon, which is constantly changing when the diaphragm is in vibration. This apparatus is too sensitive to extraneous sounds to be useful in telephony.



Fig. 256.

Another form acting on much the same principle is illustrated by fig. 257 (devised Sept. 30, 1877); it is called the inertia telephone, though it is hardly certain that its action is to be attributed solely to inertia. The carbon C is placed between two metallic plates, one of which is fastened to the diaphragm, and the other is held by a screw bearing in a framework, attached to the diaphragm by insulating supports. When vibrating, the

NTIONS.

in fig.
the dia-
forming
at the
work of
en the
resem-
ch the

ctually
stant,
he cir-
carbon
on the
en the
ive to

trated
tele-
attrib-
two
, and
ached
g, the

whole system moves, instead of the plate P alone, as in the ordinary carbon transmitter. Mr. Edison's explanation of its mode of action is, that the degree of pressure with which the carbon rests against the plates is varied during the vibration. Thus, after a movement toward the right, the diaphragm suddenly stops, and the carbon presses in virtue of its inertia on the plate P.

An advantage which the magneto-telephone has over the earlier forms of Mr. Edison's telephone is, that its diaphragm

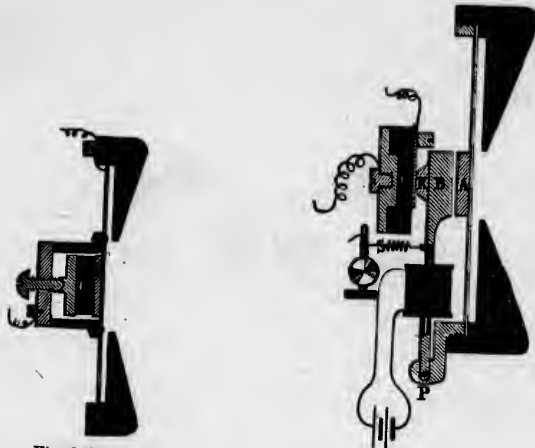

Fig. 257.

Fig. 258.

does not touch anything, and can therefore vibrate with perfect freedom. On the other hand, the diaphragm of the carbon telephone, used before his adoption of the present non-vibrating rigid plate, presses with considerable force upon the carbon, and thus causes it to make false vibration. In the form shown in fig. 258 (devised June 25, 1877), this difficulty is not encountered. The diaphragm carries an armature, A, of soft iron, which confronts but does not touch the magnet B. A and B are opposite poles of the same magnet, being connected at P, and polarized by a local circuit. The magnet B presses upon

the carbon at C, the pressure being regulated by the screw S. The attraction between A and B varies with the distance between them. When, in vibrating, A moves toward B, the attraction rapidly increases, and B lessens its pressure upon C. During a motion in the opposite direction, the attraction diminishes, and B, drawn by the spring S, increases its pressure upon C.

A similar contrivance is illustrated in fig. 259. (Devised April 10, 1877.) The diaphragm carries an armature, A, which, by its motion, changes the potential of two electro-magnets. These changes in magnetism cause a bar, situated in their magnetic field, to reproduce the original vibrations. The ends of the bar are held by the magnetic force against two pieces of carbon, *c* and *c*. These and the bar are included in the primary circuit of an induction coil. The resistance of the circuit

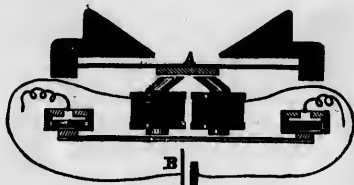

Fig. 259.

decreases when the bar is drawn up, and increases as the bar descends.

Of all substances which have thus been tested in the telephone for increasing and decreasing the resistance of the circuit by the effect of the sonorous vibrations, lamp black from the lighter hydrocarbons proves the best. It is very essential that the lamp black should be deposited at the lowest temperature possible, and the flame of the lamp should not be allowed to play upon the deposit; otherwise the product is of high resistance and wholly unsuitable for this purpose. Commercial lamp black of the best quality, scarcely allows a current to pass through it, while that obtained by the process herein described offers but slight resistance.

The lamp black as it comes from the burning apparatus is

laic
ting
a m
of s
pow
in d
butt
T
othe
of a
actio
cros
word
the i
finely
due c
ticles
Ag
tive t
a butt
in nu
the p
obtain
are br
ticles a
aggreg
pure is
present
points
of the
carbon
much s
the wav
points
minute,
we obta

laid upon a white slab, and those portions which have a brown tinge are picked from the mass; the remainder is then ground in a mortar and placed in a large mould and subjected to a pressure of several thousand pounds. The cake thus pressed is re-powdered and re-pressed several times. Finally, it is weighed out in divisions of three hundred milligrammes and moulded into buttons as seen in the telephone.

The reason why lamp black thus moulded is superior to any other material is satisfactorily explained, when we consider that of all finely divided substances obtained either by mechanical action or chemical precipitation, it is seen, when under the microscope, to have the greatest number of particles, or in other words, to be the most finely divided. Now it is well known that the increase and decrease of the resistance of any button of finely divided conducting matter, when subject to pressure, is due entirely to the contact of a greater or less number of particles at the junction or surfaces.

Again, it is known that the telephone is exquisitely sensitive to the slightest change of resistance in the circuit; hence, if a button of gas retort carbon composed of inelastic particles, few in number (as compared to lamp black), is used in a telephone, the production of a wave by gradually increasing pressure is obtained by the gradually increasing number of particles which are brought in contact with the surface plates. Now these particles are so few and large, and in many cases several particles aggregated in the retort carbon, that the wave instead of being pure is harsh and grating. This wave may be graphically represented by a serrated line inclined at an angle of 45° , the points representing the disturbance of the current by the effect of the particles themselves. Now if the button of gas retort carbon be replaced by one of graphite, which is composed of much smaller particles with no aggregations as with the first, the waves will be represented by the line as above, but the points will be scarcely perceptible, and these gaps being so minute, are beyond the power of the telephone to detect; hence we obtain a pure wave, but these gaps weaken the wave as

a whole, by their effect on the self-induction of the telephone receiver. But in the case of lamp black, the particles are infinitely finer than graphite, and, moreover, the button is somewhat elastic; hence the line representing the form of the wave will be perfectly straight, although theoretically there are gaps. They are infinitely small as compared to graphite or other conducting material, therefore we not only prevent harsh sounds, but obtain a stronger wave, owing to the absence of gaps and their effect on the self-induction of the magnet. Lamp black when moulded into buttons possesses another property differing from all other conducting material, and that is its elasticity. For instance, if we subject buttons of different materials to pressure, the greatest difference of resistance with a given weight will be produced on the lamp black button; again, if we increase the weight on all the buttons, a point will be reached where any additional weight ceases to reduce the resistance appreciably, except in the case of the lamp black, which continues to show decrease of resistance by additional weight placed upon it long after the other buttons cease to be affected, as all the particles that can come in contact will be brought in contact by a slight weight owing to the inelastic nature. Mr. Edison has endeavored to obtain an approximation as to the number of points of contact on the lamp black button now used. In order to accomplish this purpose he first placed a Rutherford diffraction grating under the microscope having 17,291 lines ruled on speculum metal within a space of one inch, and by the side of this a button of lamp black, then by changing from one to the other, he calculated that there were not less than 10,000,000 of points upon the surface of the button, nearly all of which were constantly in use when subjected to the sonorous vibrations. Had the Rutherford grating been ruled both ways there would have been 298,000,000 of points, and there is little doubt that a button of platina ruled double in this manner would give good results in the telephone, but would not equal the lamp black, owing to its want of elasticity.

The elasticity of the lamp black button has another advantage,

in
pl
th
th
mu
adj
cir
spa
ren
in t
but
is n
und
but
cont
the
ham
the
being
even
Mr. I
the l
moul
ature
far su
The
the te
and th
Lan
Hy
Iod
Gra
Gas
Plat
Fine
as osm

insomuch that it allows a considerable initial pressure to be placed upon it without materially reducing its sensibility; hence the apparatus is not so liable to be thrown out of adjustment as those employing an inelastic button, where the initial pressure must be exceedingly light to retain its sensibility. When adjusted in this manner, a loud sound causes a break in the circuit, and the sounds are harsh and disagreeable, and allow sparks to occur, which in time coats the metallic armature and renders it unfit for use. The only defect, if so it may be called, in the button made of lamp-black, is that it is somewhat friable; but Mr. Edison's experience goes to prove that if the telephone is made in a proper manner, so that no part of it will, when under the effect of the sonorous waves, vibrate and hammer the button, it will last for months, and as far as can be seen, will continue to last as long as the instrument that holds it; but if the instrument is so devised that the armatures are allowed to hammer the button, or if the initial pressure is very light and the instrument receives a violent concussion (for instance, by being dropped on the floor), the button is liable to crack, but even in this case the volume of sound is not materially lessened. Mr. Edison has attempted to harden these buttons by mixing the lamp-black with sugar, tar and other substances previous to moulding, and after moulding subjecting them to a high temperature. This treatment makes them hard but inelastic, and yet far superior to any other substance which he has tried.

The value of different substances to be used as buttons in the telephone are given below, the first mentioned being the best, and the others in the order given :

- Lamp-black,
- Hyperoxide of lead,
- Iodide of copper,
- Graphite,
- Gas carbon,
- Platinum black.

Finely divided materials which do not oxidize in the air, such as osmium, ruthenium, silicon, boron, iridium and platinum,

give results proportionate to this minute division, but many of them are such good conductors that it is necessary to mix some very fine non-conducting material with them before moulding. All the conducting oxides, sulphides, iodides, and nearly every metal finely divided has been tried by Mr. Edison, in various states of divisibility and mixed with various substances. Liquids in porous buttons of finely divided non-conducting material, render these particles conducting, and they, consequently, act in the same manner, but, of course, owing to the formation of gas, polarization, etc., they are objectionable.

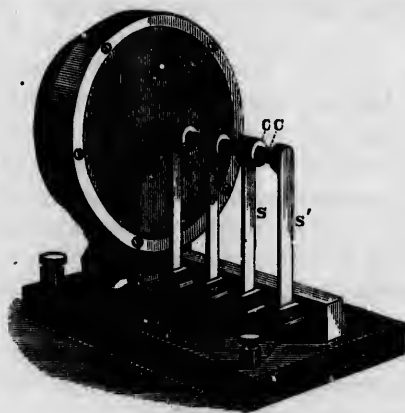

Fig. 260.

THE MICROPHONE.

The device of using several pieces of the semi-conductor instead of one was early tried by Mr. Edison. He found, in general, that the loudness of the sound was increased by thus multiplying the number of contact surfaces, but also that the articulation was impaired. Instruments of this nature have since become known as microphones, though it is not probable that faint sounds were ever augmented through their agency so that they could be easily recognized at a distance from their source. Fig. 260 shows one of the first forms, invented by Mr.

Edison
etc., ea
piece o
of carb
The pri
phragm
the sem
Other
two carb
contigu
Fig. 2

having te
having be
In fig.
protoxidiz
A nove
periments
semi-cond
with plum
The instru
both as a
covered b
solid carb
coated wit

Edison, April 1, 1877. Four pieces of charcoal are used, C C, etc., each supported by an upright spring, as at S and S'. The piece of charcoal nearest the diaphragm impinges upon a disk of carbon, which is fastened to the centre of the diaphragm. The primary wires of an induction coil are attached to the diaphragm and the spring S. The circuit is then completed through the semi-conductors.

Other forms are shown in figs. 261 and 262. The former has two carbons, separated by a plate of metal. The latter has three contiguous pieces of carbon.

Fig. 263 (devised Sept. 21, 1877) illustrates a microphone,



Fig. 261.



Fig. 262.

having ten plates of silk; a mixture of dextrine and lamp-black having been previously worked into the pores.

In fig. 264 (devised June 7, 1877), fifty disks, D, with iron protoxidized on the surface, are shown inclosed in a glass tube.

A novel form of transmitter used by Mr. Edison in his experiments is shown in fig. 265 (devised Aug. 12, 1877). The semi-conductor is a collection of small fragments of cork covered with plumbago. It can be used with or without a diaphragm. The instrument shown in fig. 266 (devised Aug. 24, 1877) acts both as a transmitter and receiver, the latter fact being discovered by Mr. Chas. Batchelor, Mr. Edison's assistant. The solid carbon of the transmitter is here replaced by silk fibres coated with graphite. Its action as a receiver is probably due

to the attraction of parallel currents; the volume of the whole being contracted during the passage of a current through F.

In May, 1878, Mr. Hughes, of London, published some interesting experiments, based upon Mr. Edison's discovery of the variable resistance of solid conductors when subjected to pressure.



Fig. 263.



Fig. 264.

In fig. 267, A is a glass tube filled with a mixture of metallic tin and zinc, commonly known as white silver powder. This powder is slightly compressed by two plugs of gas car-



Fig. 265



Fig. 266.

bon inserted at the ends, to which are attached wires, having a battery, B, and galvanometer, G, in circuit. The plugs are cemented in their place by being covered over with ordinary

sealing,
giving
tions,
is defl
one an
of the
tion.
the cor
tion by
tion of
increas
the sec
vanome

deflection
which re
coils whe
would be
of the tel
force, for
that takes
three inch
this sensit
named exp
up sonor
influence i
phone, un

sealing wax. Upon grasping this tube by the two ends, and giving it a tensile strain by pulling them in contrary directions, but in a line with its length, the galvanometer needle is deflected in one direction, and on pushing the ends towards one another, so as to put on a strain of compression, the needle of the galvanometer is instantly deflected in the opposite direction. In this case the finely divided metallic particles forming the contents of the tube are brought into more intimate connection by compression, and are more separated during the operation of extension, and thus the resistance of the circuit is varied, increasing the current in the first instance, and decreasing it in the second. If this view be correct, the movement of the galvanometer needle in the reverse direction cannot be called a



Fig. 267.

deflection, but a returning to zero, stopping at that position which represents the strength of the current flowing through its coils when the tube is being extended. This experiment alone would be a remarkable example of the marvellous sensitiveness of the telephone as a detector of minute variations of electrical force, for it is hardly possible to conceive the minute increment that takes place in the length or capacity of a glass tube, some three inches long, when extended by pulling with the fingers. But this sensitive tube is far more delicate than is shown by the last named experiment. So sensitive is it, that it is capable of taking up sonorous vibrations, and by its own vibrations under their influence it transmits through an electric wire to a distant telephone, undulatory currents capable of reproducing therein all

the sounds by which they were produced, and with even greater perfection than would be attained if a telephone were the transmitting instrument. By attaching one of these tubes to a small resonating box, as shown in fig. 268, we have one of the very simplest electric articulating telephones that has ever been produced. It consists of nothing more than a tube of glass filled with a powder whose electric conductivity can be varied by variations of compression, wires being led from the two ends, and this little apparatus attached to a little box opened at one end, which serves as the mouth piece of the instrument. The wires are attached to a distant telephone, and have a battery of three

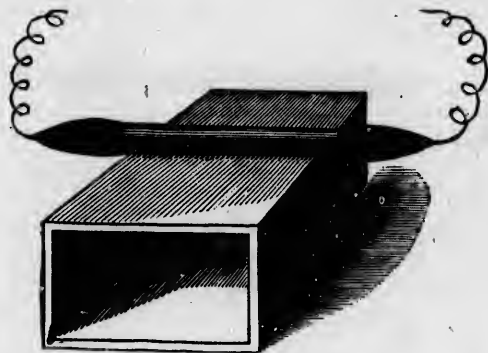

Fig. 268.

small Daniell cells in circuit. With this simple telephone the sounds are so loud that it is possible to sing into one instrument, and hear at the same time singing from a distant station in another. This duplex arrangement with a single circuit works perfectly, the one communication in no way interfering with the other.

When a stick of pure vegetable carbon, such as is used by artists, is employed instead of the tube, no effect is produced, because of its very high resistance making it to all intents and purposes a perfect non-conductor; but by heating it to incandescence, and suddenly plunging it into a bath of mercury, it

becom
in tha
compo
with p
in the

Mr.
arrived
ployed,
increas
distant
of vary

an undu
will exhi
an insulat
ceases to
in a non-c
be remedi
be found

Fig. 268
open at on
tuning for
long and
open at bo

becomes impregnated with minute particles of that metal, and in that state can be used almost as well as the tube of compound metallic powder. Similarly, charcoal impregnated with platinum perchloride may be used with advantage, whether in the form of a stick or as powder contained in a tube.

Mr. Hughes, in experimenting with various substances, arrived at the conclusion that whatever conductor is employed, it must not be homogeneous in its nature, so that increase or decrease of pressure, by producing closer or more distant union between its conducting particles, has the property of varying the strength of the current transmitted, giving to it

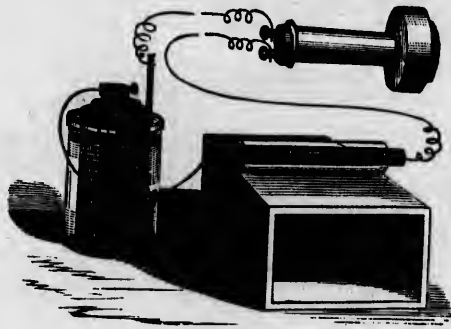

Fig. 269.

an undulatory character. A tube containing clean lead shot will exhibit the phenomena, but after a time, in consequence of an insulating oxide being formed on the surface of each shot, it ceases to convey the current. Possibly by immersing the shot in a non-oxidizing medium, such as naphtha, the defect might be remedied, but far better substances for the experiments can be found than shot.

Fig. 269 represents a perspective view of a small wooden box open at one end, and resembling the boxes used as resonators for tuning forks. A convenient size is ten inches wide, eighteen inches long and seven inches deep. On this is a small glass tube open at both ends, and fastened down with sealing wax. In the

tube are a number of pieces of willow charcoal that have been metallized with iron. To prepare this charcoal, take sticks (pencils) of charcoal and pack them loosely in an iron box with a loose cover, and bring the box slowly to a white heat. This tends to drive out the water that may be held in the pores of the charcoal, and it is replaced by the vapor of iron, so that, when cool, the sticks of charcoal are loaded with iron and have a decided metallic ring. Small pieces of the metallized charcoal are placed in the glass tube and closely pressed together till it is full and a portion of the charcoal projects at either end, as shown in the figure. The wires of a telephonic circuit are wound round these projecting ends, and the ends of the tube

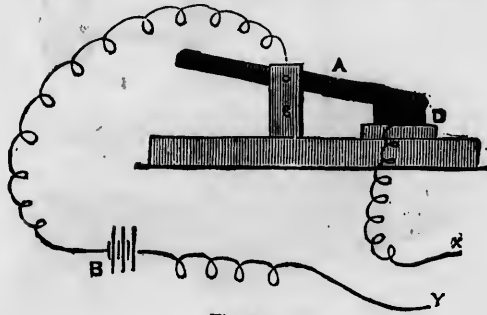

Fig. 270.

are then closed with sealing wax. This apparatus, simple as it is, makes a telephonic transmitter of most remarkable sensitiveness. On holding an ordinary magneto-electric telephone to the ear (with a battery in the line), the mere rubbing of the finger on the box, the trace of a pencil, or the footsteps of a house fly walking on or near the box will be heard with perfect distinctness. So sensitive is this instrument that sounds that cannot be heard by the ear become clear in the telephone.

A watch placed on the box gives all the sounds of its works—the grinding of the wheels, the sonorous ring of the spring and the minutest tick of the gearing. Words spoken in the box sound with the power of a trumpet in the telephone, and the blowing of the breath resembles the roar of the wind in a forest.

Fig. 2
same pri
used in t

the upright
wooden pla

a small block
(sealing wax)

Fig. 270 represents another form of transmitter based on the same principles. A is a short piece of a carbon point, such as is used in the electric light, mounted by a metallic arm pivoted on

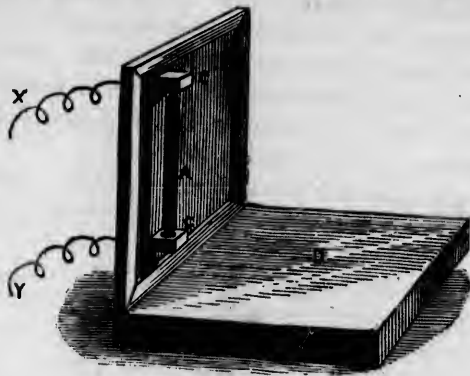

Fig. 271.

the upright C. There are two of these uprights secured to the wooden plate, one on each side of the stick of carbon. At D is

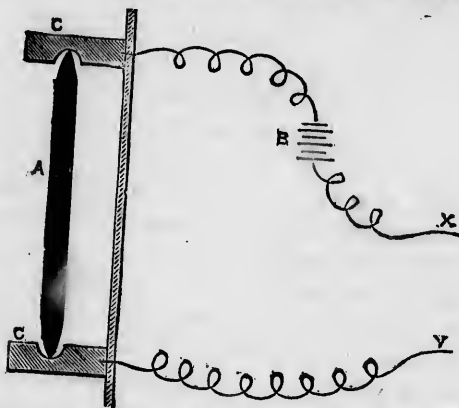

Fig. 272.

a small block of the metallized charcoal resting on an insulator (sealing wax). X and Y are the two wires of a telephonic line.

This apparatus shows the effect of varying pressure on electrical resistance. On lifting the lower end from the mass of charcoal the circuit is broken. On pressing it down on the charcoal the electrical resistance will vary with the pressure, however minute it may be. The pressure exerted by sonorous vibrations, even though they may be caused by the tread of a fly or the pressure of a finger, cause so great changes in the electrical status of the line that when the telephone receiver is placed at the ear these minute movements are distinctly heard.

Fig. 271 represents a thin pine board about six inches square, placed upright on a suitable support. To this are attached, by

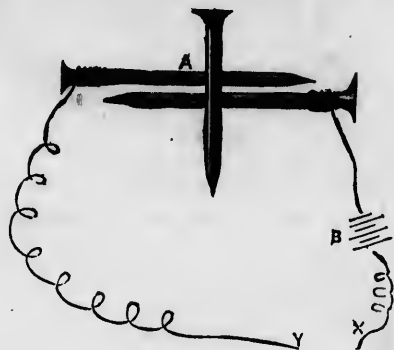

Fig. 273.

means of sealing wax, two pieces of common gas carbon, C, C. (See detail sketch, fig. 272.) In each piece is hollowed out a shallow cup, and supported between them is an upright spindle of gas carbon, A, the pointed ends just touching the cups. This spindle is placed in a telephonic circuit by twisting the wires round the carbon cups, as shown in the drawing. Words spoken before this sounding board, even at a distance of several yards, are distinctly heard in the telephone. These transmitters, rough and crude as they may appear, plainly show that a most important advance has been made in telephony. With instruments of more delicate construction, even more remarkable results may

yet be
a good
made
which
are pro
an und
circuit
would
through
conduct
theless
circuit
third na
mitter is
nail, wil
ness. F
are fast
attached
a manne
can be c
When a
(as a cyl
parallel v
imperfect
and it is
arrangem
In the
with the
that minu
sense that
little refle
in the acti
the receiv
walking ad
not the sou
a powerful

yet be obtained. Ordinary mechanical structures which contain a good many joints, such as a small machine or a small chain made into a little heap, act almost as well as the substances to which we have referred. In these special cases the phenomena are probably due to the electric current having imparted to it an undulatory character through being transmitted through a circuit containing a number of what the telegraph engineer would call faults, which are variable in their faultiness, through variations of pressure between the separate parts of the conducting structure. It must seem strange, and yet it is nevertheless a fact, that if we place two common nails in a telephonic circuit and insulate them from each other, and then place a third nail upon them so as to close the circuit, a capital transmitter is at once made. The sonorous vibrations, falling on the nail, will be reproduced in the telephone with startling distinctness. Fig. 273 shows such a transmitter. Two common nails, A, are fastened down to a horizontal board; wires X and Y are attached to them, leading to a battery, B, and a telephone in such a manner that the nails form the only break in the circuit, which can be closed by laying any conducting material across them. When a third nail is laid across the other two, it is clear that (as a cylinder can only touch another cylinder whose axis is not parallel with it in a single point) the electric circuit has a very imperfect connection at the points of contact between the nails, and it is to this faulty connection that the sensitiveness of this arrangement is due.

In the accounts which have been published of experiments with the microphone, the statement has frequently been made, that minute sounds are actually magnified by it, in the same sense that minute objects are magnified by the microscope. A little reflection will show, however, that there is no real analogy in the action of the two instruments. The sound that is heard in the receiving instrument of the microphone, when a fly is walking across the board on which the transmitter is placed, is not the sound of the fly's footsteps, any more than the stroke of a powerful electric bell, or sounder, is the magnified sound of

the operator's fingers tapping lightly and, it may be, inaudibly upon the key. This view of the subject readily explains why the microphone has failed to realize the expectations of many persons, who, upon its first exhibition, enthusiastically announced that by its aid, we should be able to hear many sounds in nature which had hitherto remained wholly inaudible.

SHORT CIRCUITING TELEPHONES.

A number of the telephones invented by Mr. Edison may be classed together as short circuiting, or cut out telephones. The principle upon which they act might thus be briefly stated: In vibrating, the diaphragm cuts from the circuit resistances, which

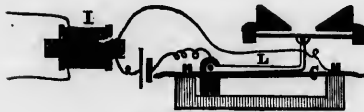

Fig. 274.

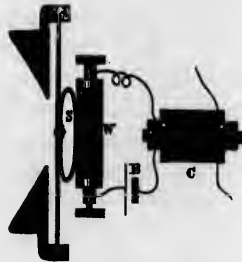

Fig. 275.

are proportional to the amplitude of the vibrations. A transmitter constructed upon this principle is shown in fig. 274 (devised March 20, 1877). A lever, *L*, of metal, vibrating in a vertical plane, rests at one end upon a strip of carbonized silk, *C*, which is part of the primary circuit of the induction coil *I*. In the course of its vibrations the lever cuts from the circuit parts of the silk, the current passing temporarily through the lever.

Another, acting on the same principle, but differing considerably in construction, is shown in fig. 275 (devised August 21, 1877). A fine wire, *W*, of high resistance, is wrapped around a cylinder in a spiral groove. The wire forms part of the primary circuit of the coil *C*. A spring, *S*, of metal, in the form of an

ellipse
side p
The d
making
it wou
sistanc
the cen
ment is
pressed
mittent

In fi
upon a

The film
of the si
metal ha

The ac
ment sho

Still a
fig. 277 (
around a
so that, in
each other
to cause t
number o
the amplif

ellipse, is fastened at one side to the diaphragm, while the other side presses against the uninsulated wire upon the cylinder. The diaphragm, in moving toward the right, flattens the spring, making it impinge upon a greater number of convolutions than it would if the motion were in the opposite direction. The resistance of the circuit depends, therefore, upon the position of the centre of the diaphragm. The disadvantage of this arrangement is, that either a whole convolution or none at all is suppressed from the circuit, rendering the current rather more intermittent than pulsatory.

In fig. 276 (devised October 21, 1877), a similar spring rests upon a narrow strip of metal, on the surface of a glass plate.



Fig. 276.

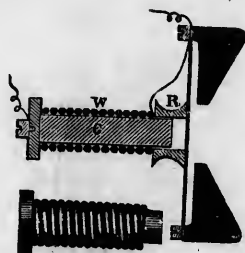

Fig. 277.

The film is shown in perspective at F, and consists of a fine strip of the silvered surface of a mirror; the rest of the burnished metal having been removed.

The action of this instrument is similar to that of the instrument shown in fig. 274.

Still another form of short circuiting telephone is shown in fig. 277 (devised Nov. 1, 1877). A spiral spring, W, is wrapped around a cylinder, the diaphragm pressing against the last turn, so that, in vibrating, the convolutions approach or recede from each other. A very slight motion of the diaphragm is sufficient to cause the first few coils to come together; and, in general, the number of coils that thus touch each other is dependent upon the amplitude of the diaphragm's motion. The wire is included

in the primary circuit of an induction coil, so that the resistance of the circuit fluctuates as the diaphragm vibrates. This wire has also been used as the primary of the induction coil itself with better results.

CONDENSER TELEPHONES.

Telephones in which static charge, instead of current strength, is made to vary in unison with the vocal utterances, have also been tried with success by Mr. Edison. The forms shown in figs. 278 and 279 (devised February 9 and December 10, 1877) differ only in construction, not in principle.

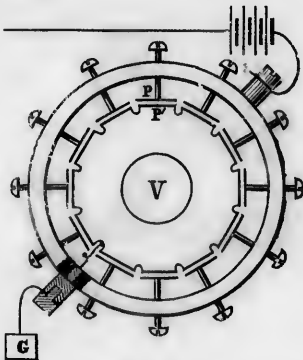

Fig. 278.

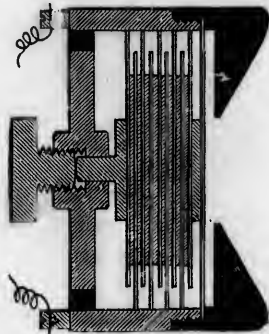

Fig. 279.

The former consists of a circular vocalizing chamber with mouth piece at V. The chamber is surrounded with plates, which are connected with each other and with the ground. These plates are free to vibrate, and are shown in the figure in section, as at P'. Immediately behind each of these stands a similar plate as at P, held at its centre by an adjusting screw. The outside row of plates are electrically connected with each other and with the battery which goes to line. When the inside row of plates vibrates under the influence of a sound, the distance between the plate varies and changes their static capacity.

In
of con
bearing
in vib
their s
The
If an
sistanc
basis o
The
exceed
rests u
the dia

slightly
exceedin
phonic c
It is a
changes
through i
ena in th
10, 1877)
a conduct
a transmi
the mercu
which is f

In fig. 279 the plates are arranged as in the ordinary form of condenser. An initial pressure is put upon them by a screw bearing in the solid frame of the instrument. The diaphragm, in vibrating, varies the distance between the plates; this alters their static charge and affects also the electric tension of the line.

The resistance of a conductor is dependent upon its shape. If an isometric block of metal be drawn out into a wire, its resistance may be indefinitely increased. This fact lies at the basis of several ingenious telephones invented by Mr. Edison.

The one shown in fig. 280 (devised August 17, 1877) is of exceedingly simple construction. A globule of mercury, *M*, rests upon a slightly concave plate of metal. A needle from the diaphragm indents its upper surface, and as it vibrates



Fig. 280.



Fig. 281.

slightly alters the shape of the globule. This alteration, though exceedingly small, is sufficient to vary the resistance of the telephonic current considerably.

It is a peculiar characteristic of a globule of mercury that it changes its original shape during the passage of a current through it. Mr. Edison has made an application of this phenomena in the telephone receiver shown in fig. 281 (devised August 19, 1877). The globule of mercury, *M*, is placed, together with a conducting solution, in a U shaped tube. The currents from a transmitter, passing through the contents of the tube, elongate the mercury. This agitates the liquid and vibrates the float *F*, which is fastened to the centre of the diaphragm.

THE VOLTAIC PILE TELEPHONE.

We have shown in fig. 282 (devised August 25, 1877) an instrument known as the pile telephone. A piece of cork, K, fastened to the diaphragm, presses upon a strip of platinum which is attached to a plate of copper. The latter is one of the terminal plates of an ordinary voltaic pile. The other terminal plate presses against the metallic frame of the instrument. When the pile is included in a closed telephonic circuit it furnishes a continuous current. The strength of this current depends upon the internal resistance of the pile and its polarization, and these are varied by vibrating the diaphragm.

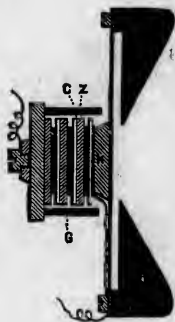

Fig. 282.

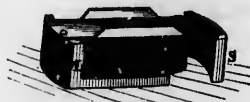

Fig. 283.

A convenient and peculiar form of receiver used by Mr. Edison is shown in fig. 283 (devised August 30, 1877). It is like the ordinary magneto telephone, except that the circular diaphragm is replaced by a strip of thin iron, the edges having been bent so as to render it stiff. We mention it simply because it demonstrates the fact that it is not essential that a circular diaphragm be used.

A novel and purely mechanical telephone is illustrated by fig. 284 (devised August, 1877). In place of a line wire, the illuminating gas contained in gas pipes is used. It is calculated

for
com
pipe.
repr
ened
large
tions
medi
Th
strum
vised
phon
being
traver

The ob
at the
desired

The
to hear
fication

It w
transmi
ber 23,
moved,
tained t
the drum
tallic sp

for short distances only, as it is essential that the gas used in communicating offices should be drawn from the same main pipe. In the figure, P is the main pipe. The telephones are represented at T and T'. The instrument is merely a cone fastened by its apex to the gas pipe in place of the burner. The larger end is closed by a thin circular diaphragm. The vibrations are conveyed from one diaphragm to another through the medium of the gas.

The phonograph and telephone, when combined, form an instrument known as the telephonograph, of which fig. 285 (devised August 17, 1877) is a representation. The drum of the phonograph is shown in section. The diaphragm, instead of being vibrated by the voice, is vibrated by the currents which traverse the helix H, and which originate at a distant station.



Fig. 284.

The object of the instrument is to obtain a record of what is said at the distant office, which can be converted into sound when desired.

THE MOTOGRAPH.

The motograph receiver, from which we have been accustomed to hear sounds almost destitute of quality, has by a little modification become an articulating telephone.

It works quite well in conjunction with the Edison carbon transmitter. In fig. 286 (the form shown was devised November 23, 1877) the back of the motograph receiver has been removed, showing its construction. Within the drum D is contained the decomposing solution, and the covering surrounding the drum is kept constantly moist by capillary action. A metallic spring attached to the centre of the diaphragm rests upon

the drum. While receiving, the drum is revolved by turning the milled screw at A.

Mr. Edison's musical transmitter is shown in fig. 287. The

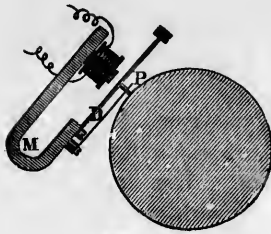

Fig. 285.

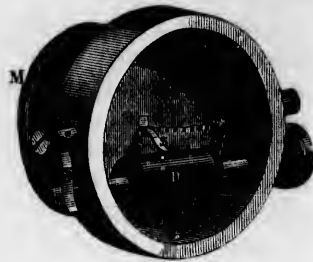

Fig. 286.

point P, projecting from the centre of the diaphragm, impinges upon a wrapping of platina foil covering a small drum of rubber, capable of adjustment by a thumb screw.

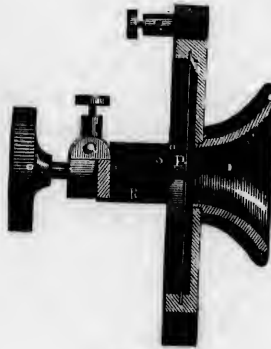

Fig. 287.

THE CARBON RHEOSTAT.

A very important application of the property possessed by semi-conductors, of changing their resistance under varying pressure, is shown in fig. 288. The cuts represent the new Edison

carbo
ordin
insert
quadr
Fig
vulca
with s
are su
lower



subject
in the
desired
hundred

The
with h
phragm
results

carbon rheostat. The instrument is designed to replace the ordinary adjustable rheostats whenever a resistance is to be inserted in a telegraph line, as, for example, in balancing quadruplex circuits, and where accuracy is not required.

Fig. 239 is a vertical section. It shows a hollow cylinder of vulcanite, containing fifty disks of silk that have been saturated with sizing, and well filled with fine plumbago and dried. These are surmounted by a plate of metal, C, which can be raised or lowered by turning the screw D. The carbon disks can thus be

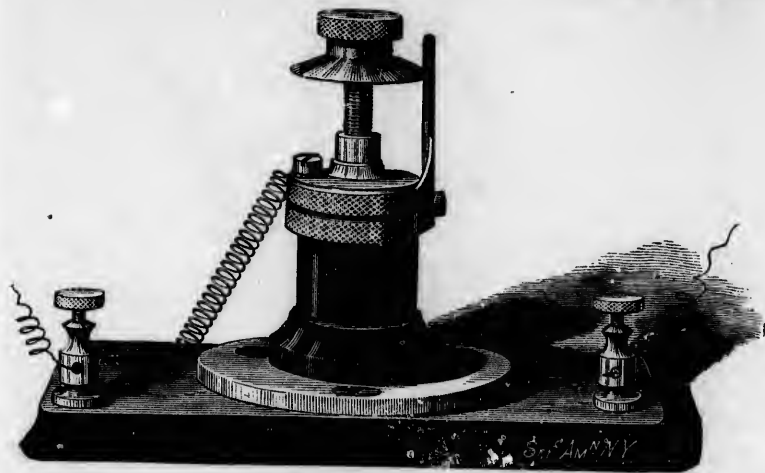

Fig. 288.

subjected to any degree of pressure at pleasure. When inserted in the line, it is a matter involving no loss of time to obtain any desired resistance. The resistance can be varied from four hundred to six thousand ohms.

THE MICRO-TASIMETER.

The micro-tasimeter is the outcome of Edison's experiments with his carbon telephone. Having experimented with diaphragms of various thickness, he ascertained that the best results were secured by using the thicker diaphragms. At this

stage he experienced a new difficulty. So sensitive was the carbon button to changes of condition, that the expansion of the rubber telephone handle rendered the instrument inarticulate, and finally inoperative. Iron handles were substituted, with a similar result, but with the additional feature of musical and creaky tones distinctly audible in the receiving instrument. These sounds Edison attributed to the movement of the molecules of iron among themselves during expansion. He calls them molecular music. To avoid these disturbances in the

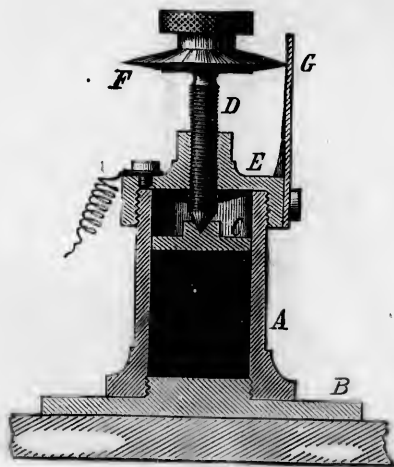

Fig. 289.

telephone, the handle was dispensed with, but it had done a great service in revealing the extreme sensitiveness of the carbon button, and this discovery opened the way for the invention of the new and wonderful instrument.

The micro-tasimeter is represented in perspective in figs. 290 and 291, in section in fig. 292, and the plan upon which it is arranged in the electric circuit is shown in fig. 293.

The instrument consists essentially in a rigid iron frame for holding the carbon button, which is placed between two platinum surfaces, one of which is fixed and the other movable, and in a

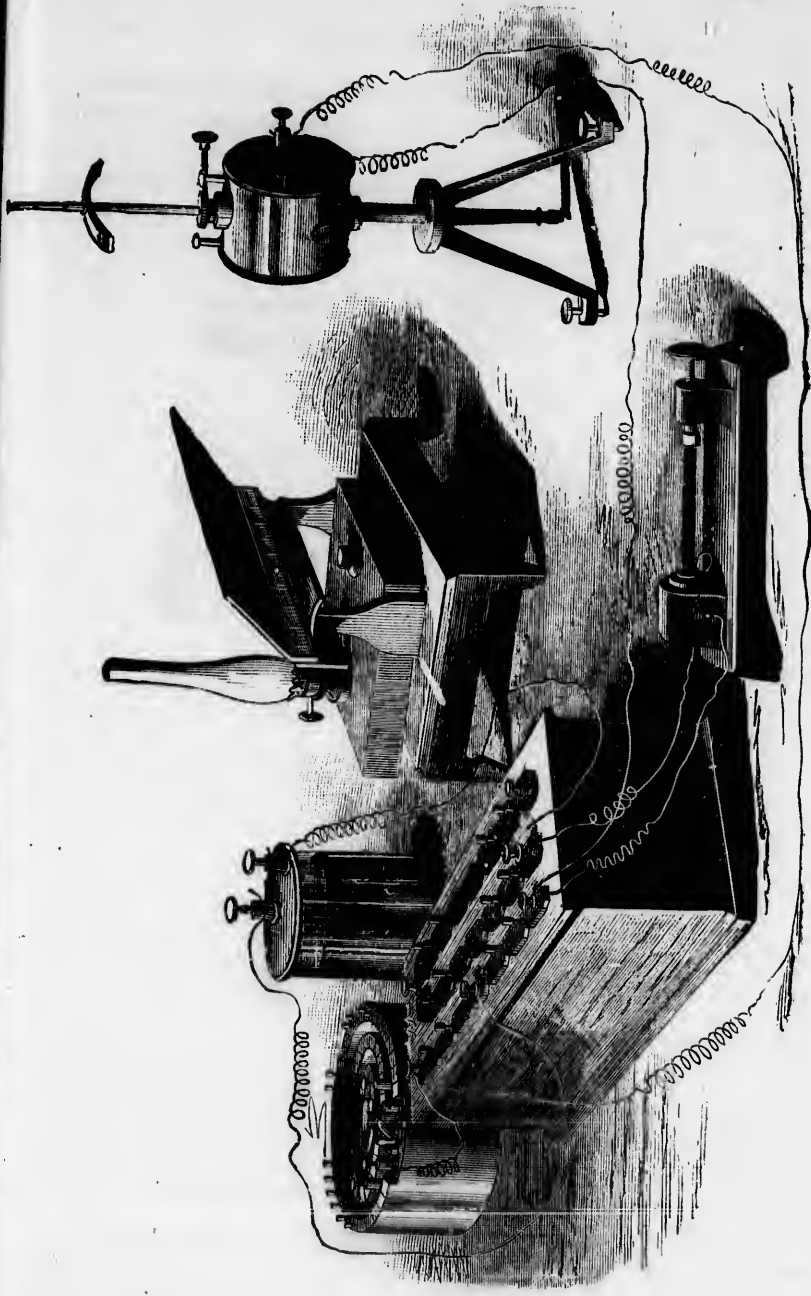

Fig. 290.

IONS.
s the
of the
ulate,
with a
and
ment.
mole-
calls
the

ne a
bon
a of
290
t is
for
um
n a

device for holding the object to be tested, so that the pressure resulting from the expansion of the object acts upon the carbon button.

Two stout posts, A, B, project from the rigid base piece C. A vulcanite disk, D, is secured to the post A, by the platinum

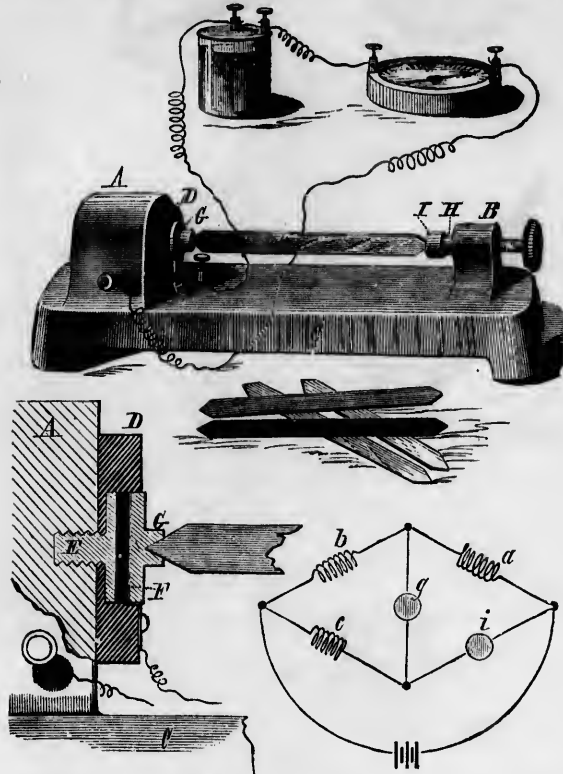

Figs. 291, 292, 293.

headed screw E, the head of which rests in the bottom of a shallow circular cavity in the centre of the disk. In this cavity, and in contact with the head of the screw E, the carbon button F is placed. Upon the outer face of the button there is a disk

of
bat
num
emp
T
tain
whic
expa
comm
conn
teste
galva
Whe
est s
indica
strip
sensit
move
galvan
therm
experi
of mic
of gel
moistu
inches
For
291, b
Thoms
by a W
on both
from th
shown i
fig. 293
which i
At a, b
nution

of platinum foil, which is in electrical communication with the battery. A metallic cup, G, is placed in contact with the platinum disk to receive one end of the strip of whatever material is employed to operate the instrument.

The post B is about four inches from the post A, and contains a screw acted follower, H, that carries a cup, I, between which and the cup G is placed a strip of any substance whose expansibility it is desired to exhibit. The post A is in electrical communication with a galvanometer, and the galvanometer is connected with the battery. The strip of the substance to be tested is put under a small initial pressure, which deflects the galvanometer needle a few degrees from the neutral point. When the needle comes to rest, its position is noted. The slightest subsequent expansion or contraction of the strip will be indicated by the movement of the galvanometer needle. A thin strip of hard rubber, placed in the instrument, exhibits extreme sensitiveness, being expanded by heat from the hand, so as to move through several degrees the needle of a very ordinary galvanometer, which is not affected in the slightest degree by a thermopile facing and near a red hot iron. The hand, in this experiment, is held a few inches from the rubber strip. A strip of mica is sensibly affected by the heat of the hand, and a strip of gelatine, placed in the instrument, is instantly expanded by moisture from a dampened piece of paper held two or three inches away.

For these experiments the instrument is arranged as in fig. 291, but for more delicate operations it is connected with a Thomson's reflecting galvanometer, and the current is regulated by a Wheatstone's bridge and a rheostat, so that the resistance on both sides of the galvanometer is equal, and the light pencil from the reflector falls on 0° of the scale. This arrangement is shown in fig. 290, and the principle is illustrated by the diagram, fig. 293. Here the galvanometer is at g , and the instrument which is at i is adjusted, say, for example, to ten ohms resistance. At a , b and c the resistance is the same. An increase or diminution of the pressure on the carbon button by an infinitesimal



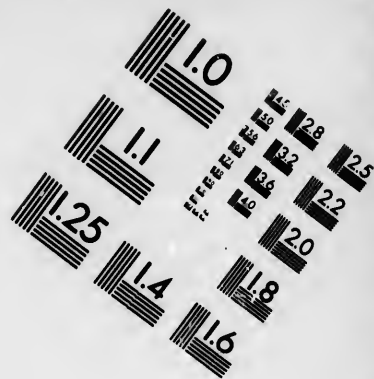
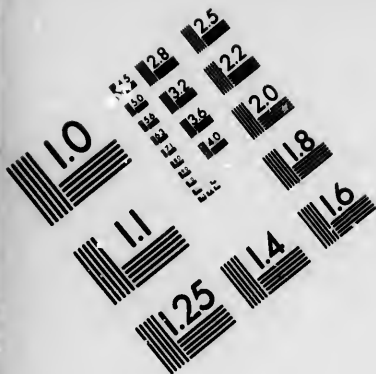

**IMAGE EVALUATION
TEST TARGET (MT-3)**

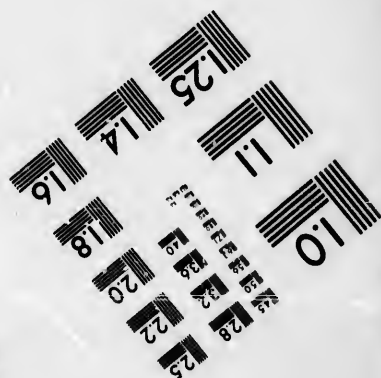
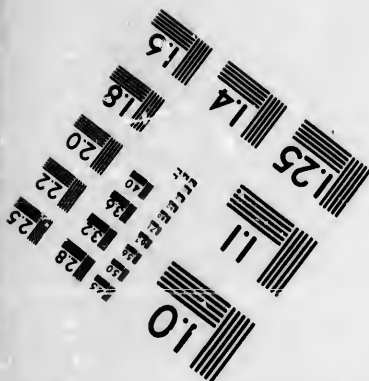
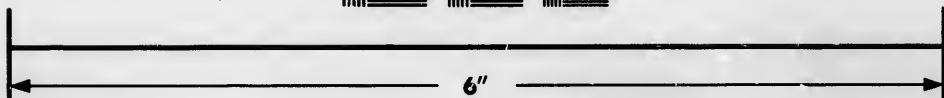
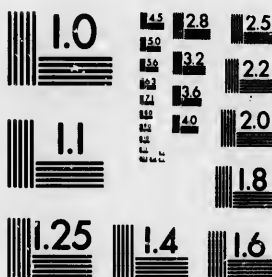

**Photographic
Sciences
Corporation**

23 WEST MAIN STREET
WEBSTER, N.Y. 14580
(716) 872-4503

14 28
16 32
18 36
20 40
22 44
24 48
26 52
28 56
30 60
32 64
34 68
36 72
38 76
40 80
42 84
44 88
46 92
48 96
50 100

10
11
12
13
14
15
16
17
18
19
20
21
22
23
24
25
26
27
28
29
30
31
32
33
34
35
36
37
38
39
40
41
42
43
44
45
46
47
48
49
50
51
52
53
54
55
56
57
58
59
60
61
62
63
64
65
66
67
68
69
70
71
72
73
74
75
76
77
78
79
80
81
82
83
84
85
86
87
88
89
90
91
92
93
94
95
96
97
98
99
100

expansion or contraction of the substance under test is indicated on the scale of the galvanometer.

The carbon button may be compared to a valve, for, when it is compressed in the slightest degree, its electrical conductivity is increased, and when it is allowed to expand it partly loses its conducting power.

The heat from the hand, held six or eight inches from a strip of vulcanite placed in the instrument—when arranged as last described—is sufficient to deflect the galvanometer mirror so as

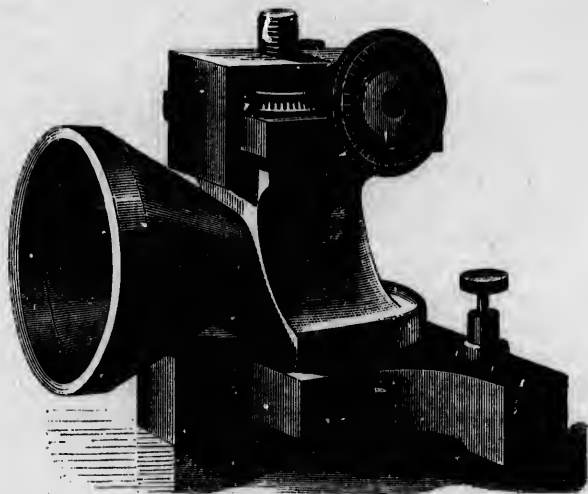

Fig. 294.

to throw the light beam completely off the scale. A cold body placed near the vulcanite strip will carry the light beam in the opposite direction.

Pressure that is inappreciable and undiscoverable by other means is distinctly indicated by this instrument.

Mr. Edison proposes to make application of the principle of this instrument to numberless purposes, among which are delicate thermometers, barometers and hygrometers.

Fig. 294 shows in perspective the latest form of the Edison

micro
value
tions
Th
cause
mater
varyi
the ci
it suc
It is
subst

In fi
affordin
The
at A.
in the r
latter is
vanome
pressur
This car
in one

micro-tasimeter, or measurer of infinitesimal pressure. The value of the instrument lies in its ability to detect small variations of temperature.

This is accomplished indirectly. The change of temperature causes expansion or contraction of a rod of vulcanite, or other material which changes the resistance of an electric circuit, by varying the pressure it exerts upon a carbon button included in the circuit. During the total eclipse of the sun, July 29, 1878, it successfully demonstrated the existence of heat in the corona. It is also of service in ascertaining the relative expansion of substance due to rise of temperature.

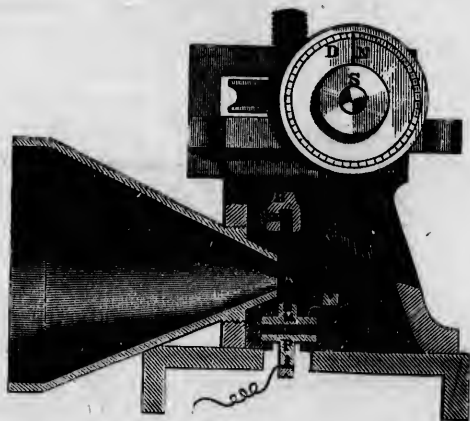

Fig. 295.

In fig. 295 the important parts are represented in section, affording an insight into its construction and mode of operation.

The substance whose expansion is to be measured is shown at A. It is firmly clamped at B, its lower end fitting into a slot in the metal plate M, which rests upon the carbon button. The latter is in an electric circuit, which includes also a delicate galvanometer. Any variation in the length of the rod changes the pressure upon the carbon and alters the resistance of the circuit. This causes a deflection of the galvanometer needle; a movement in one direction denoting expansion of A, while an opposite

motion signifies contraction. To avoid any deflection which might arise from change in strength of battery, the tasimeter is inserted in an arm of the Wheatstone bridge, while the galvanometer is used in the bridge wire of the same.

In order to ascertain the exact amount of expansion in decimals of an inch, the screw S, seen in front of the dial, is turned until the deflection previously caused by the change of temperature is reproduced. The screw works a second screw, causing the rod to ascend or descend, and the exact distance through which the rod moves is indicated by the needle N, on the dial.

The instrument can also be advantageously used to measure changes in the humidity of the atmosphere. In this case the strip of vulcanite is replaced by one of gelatine, which changes its volume by absorbing moisture. The delicacy of the apparatus to heat is remarkable, and far exceeds that of any other apparatus. When adjusted moderately delicate, the heat of the hand placed in line with the cone of the tasimeter thirty feet distant, causes the spot of light of the galvanometer to leave the scale.

THE AEROPHONE.

The aerophone, an invention of Mr. Edison's for amplifying sound, has already attracted considerable attention, though as yet it has not been perfected.

Its object is to increase the loudness of spoken words without impairing the distinctness of the articulation.

The working of the instrument is as follows:

The magnified sound proceeds from a large diaphragm, which is vibrated by steam or compressed air. The source of power is controlled by the motion of a second diaphragm vibrating under the influence of the sound to be magnified.

There are three distinct parts to the instrument:

A source of power.

An instrument to control the power.

A diaphragm vibrating under the influence of the power.

The first of these is usually compressed air, supplied from a

tank
The
phra
holl
phrag

with t
comm
outlet
which
vibrati

pipe C,
An upw
The t
consists
ordinary

It is necessary that it should be of constant pressure. The second, shown in section at fig. 296, consists of a diaphragm and mouth piece like those used in the telephone. A hollow cylinder is attached by a rod to the centre of the diaphragm. The cylinder and its chamber E will, therefore, vibrate

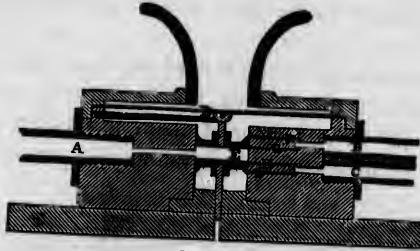

Fig. 296.

with the diaphragm. A downward movement lets the chamber communicate with the outlet H, an upward movement with the outlet G. The compressed air enters at A and fills the chamber, which in its normal position has no outlet. Every downward vibration of the diaphragm will thus condense the air in the

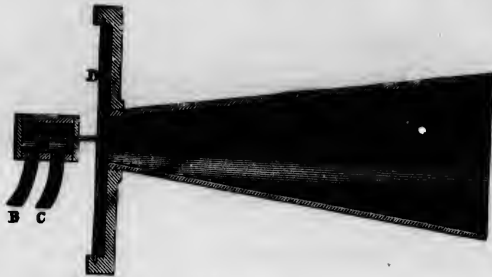

Fig. 297.

pipe C, at the same time allowing the air in B to escape via E. An upward movement condenses the air in B, but opens I.

The third and last part is shown in section in fig. 297. It consists of a cylinder and piston, P, like that employed in an ordinary engine. The piston rod is attached to the centre of a

large diaphragm, D. The pipes C and B are continuations of those designated in fig. 34 by the same letters. The pipe C communicates with one chamber of the cylinder and B with the other. The piston, moving under the influence of the compressed air, moves also the diaphragm, its vibrations being in number and duration identical with those of the diaphragm in the mouth piece.

The loudness of the sound emitted through the directing tube F is dependent on the size of the diaphragm and the power which moves it. The former of them is made very large, and the latter can be increased to many hundred pounds pressure.

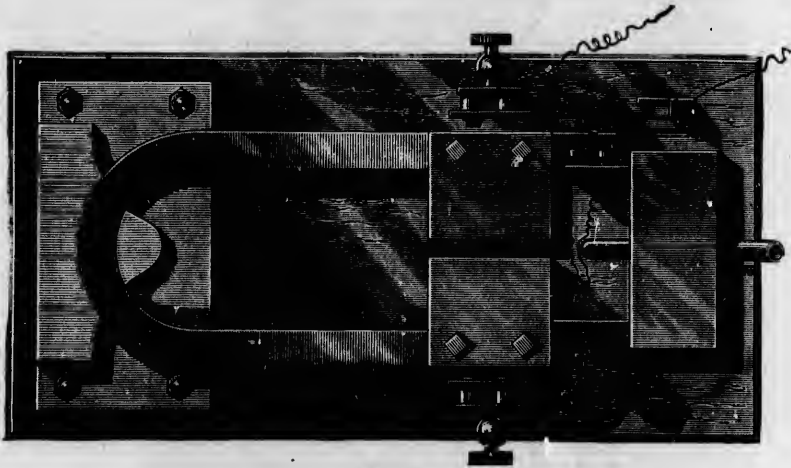

Fig. 298.

THE HARMONIC ENGINE.

This instrument is shown in fig. 298. Mr. Edison claims that ninety per cent. of the power derived from the battery is utilized through its agency. The chief part of the machine is a tuning fork of large dimensions, vibrating about thirty-five times a second, and carrying on each arm a weight of thirty-five pounds. The amplitude of the vibration is about one eighth of an inch, and the vibrations are sustained by means of two very small

electr
are co
work
Sm
tainin
each
tity o
stroke

monic e
chines a
in adva
electrici

One o
in his r

IONS.

ns of
pe C
h the
essed
ruber
mouth

tube
power
e, and
re.



that
lized
ning
es a
nds.
inch,
small

THE MEGAPHONE.

electro-magnets placed near the end of each arm. These magnets are connected in circuit with each other and with a commutator worked by one of the arms.

Small branches extend from the fork arms into a box containing a miniature pump having two pistons, one attached to each arm. Each stroke of the pump raises a very small quantity of water, but this is compensated for by the rapidity of the strokes. Mr. Edison's proposal is to compress air with the har-

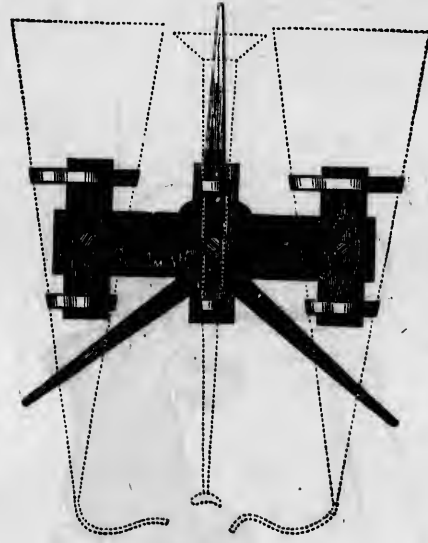

Fig. 299.

monic engine, and use it as a motor for propelling sewing machines and other light machinery. It appears to be considerably in advance of other electric engines, and through its agency electricity may yet become a valuable motive power.

THE MEGAPHONE.

One of the most interesting experiments made by Mr. Edison in his researches on sound is that of conversing through a



Fig. 300.

dis
tha
ph
sim
fee
dia
flex
T
from
bell
on t
nary
spea
sand
a m
M
of th
and l
to th
size o

By
the fe
heard
cate in
it has
Two
a micr
of the
T, and
ness of
microp
of plur
the rec

distance of one and a half to two miles, with no other apparatus than a few paper funnels. These funnels constitute the megaphone, figs. 299 and 300, an instrument wonderful both for its simplicity and effectiveness. The two larger funnels are six feet eight inches long, and twenty-seven and a half inches in diameter at the larger end. They are each provided with a flexible ear tube, the end of which is placed in the ear.

The speaking trumpet in the middle does not differ materially from the ordinary ones. It is a little longer and has a larger bell mouth. With this instrument conversation has been carried on through a distance of one and a half to two miles in an ordinary tone of voice. A low whisper, uttered without using the speaking trumpet, is distinctly audible at a distance of a thousand feet, and walking through grass and weeds may be heard at a much greater distance.

Mr. Edison is experimenting upon an apparatus for the benefit of the deaf. The results thus far have been quite satisfactory, and he hopes soon to have a practical apparatus for introduction to the public. The principal drawback at present is the large size of the apparatus.

NEW STETHOSCOPIC MICROPHONE.

By means of this apparatus of MM. Ducretet & Co., of Paris, the feeblest pulsations of the heart, pulse and arteries may be heard in several telephones placed in circuit. It is a very delicate instrument, and exquisitely sensitive, and this is its fault, if it has any.

Two tambours, such as devised by M. Mavey, are coupled to a microphone (fig. 301); one of these, T, acts, through the medium of the india rubber tube which unites them, upon the tambour T, and, consequently, on the lever microphone L, the sensitiveness of which can be regulated by the counterpoise P O. The microphone terminates in a pencil, C, formed of retort carbon or of plumbago, which rests on a disk of the same material fixed on the receiving tambour. The whole forms a complete circuit, in

which is a Daniell or Leclanché battery of one to three elements, and the telephones through which are heard the pulsation from the searching tambour T.

This microphone is susceptible of modification, and will undoubtedly be the means of more extended physiological observations. By substituting a small funnel for the tambour T, speech may be transmitted.

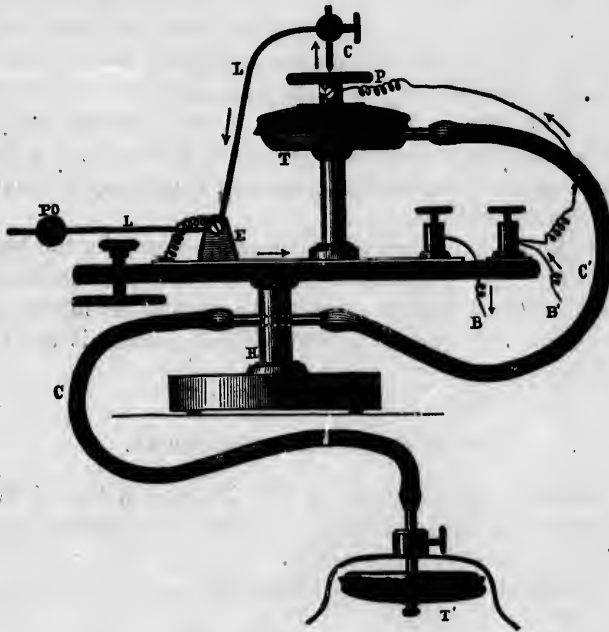

Fig. 301.

Mr. Edison, in his telephonic experiments, discovered that the vibrations of the vocal organs were capable of producing considerable dynamic effect. Acting on this hint, he began experiments on a phonometer, or instrument for measuring the mechanical force of sound waves produced by the human voice. In the course of these experiments he constructed the machine

shown in fig. 302, which exhibits the dynamic force of the voice. The instrument has a diaphragm and mouth piece similar to a phonograph. A spring, which is secured to the bed piece, rests on a piece of rubber tubing placed against the diaphragm. This spring carries a pawl that acts on a ratchet or roughened wheel on the fly wheel shaft. A sound made in the mouth piece creates vibrations in the diaphragm, which are sufficient to propel the fly wheel with considerable velocity. It requires a surprising amount of pressure on the fly wheel shaft to stop the machine while a continuous sound is made in the mouth piece.

We have already referred, on page 36 and elsewhere, to the later improvements made by Mr. Edison in the carbon telephone. The subject, however, has by no means been exhausted, and we, therefore, return to its reconsideration the more willingly now, as the opportunity thus afforded enables us to say a few words also in regard to the improved magneto telephones which Mr. Phelps constructs for working in connection with the carbon transmitter.

The continued use of these improved transmitters, in a practical way, for a number of months past, has shown them to be the best adapted of any of the forms now in use for real effective service; and if the necessary use of a battery in connection with them is, after all, so much of an inconvenience as some would imagine, their rapid introduction, in spite of this fact, and to the exclusion of other instruments, is sufficient evidence that the above mentioned drawback is fully compensated for by corresponding advantages in other directions.

On page 36 it has been stated that in the more recent forms of the carbon telephone Mr. Edison had done away with the vibrating diaphragm altogether, replacing the same by an inflexible plate of metal, whose sole function was to collect and concentrate a larger portion of the sonorous waves upon the limited carbon surface.

This form of transmitter is shown in fig. 303. The prepared carbon, represented at C, is contained in a hard rubber block, open clear through, so that one side of the former is made to

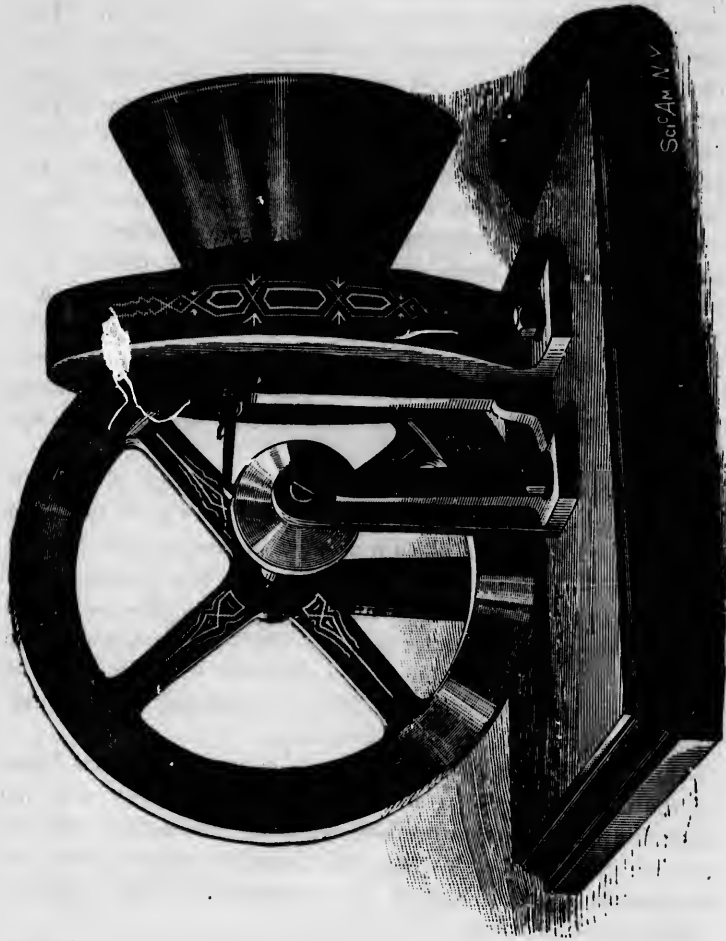

Fig. 302.

rest
conn
cover
a bit
conn
G, u
glue
knob
press
the
again
is th

The
moun
one o
the a
in fig
in a
a conv
rende
variou

rest upon the metallic part of the frame which forms one of the connections of the circuit. The opposite side of the carbon is covered with a circular piece of platinum foil, P, which leads to a binding post insulated from the frame, and forming the other connection for placing the instrument in circuit. A glass disk, G, upon which is placed a projecting knob, A, of aluminum, is glued to the foil; and the diaphragm D, connecting with the knob, serves, when spoken against, to communicate the resulting pressure to the carbon. A substantial metallic frame surrounds the carbon and its connections, and their complete protection against injury, to which they are liable from careless handling, is thereby secured.



Fig. 303.

The same instrument, in perspective, is shown in fig. 304, mounted upon a projecting arm with a joint at each end, only one of which, however, is shown in the cut. The lower end of the arm is secured by means of the joints to a desk shown in fig. 305, and thus, as will readily be seen—the motion being in a vertical direction—permits of placing the telephone in a convenient position for speaking purposes, and, consequently, rendering it easily adapted for the accommodation of persons of various heights.

The Edison telephone, it should be distinctly understood, relies wholly upon the battery for its power, and not upon the voice, as is the case with other telephones. Consequently, it is unnecessary to shout into the apparatus, and thus destroy the privacy of conversation. All that is required is that the words should be spoken distinctly and in an ordinary tone of voice.

One great drawback to the universal introduction of the telephone, that has thus far been experienced, is the disturbing influence of current pulsations in neighboring conductors when the latter are in use, and which produces a rattling noise within the telephone. This phenomenon, to which we have before



Fig. 304.

referred, under the head of induction, page 23, and elsewhere, is effectually overcome by using the Edison telephone, as the power of this instrument is so great that it can be operated with perfect success on lines having the greatest amount of inductive action, and where no other form could be used.

Figs. 306 and 307 represent two forms of the magneto telephone, as devised by Mr. Phelps, which give surprisingly good results, both when used singly and in combination with the Edison transmitter. In shape they somewhat resemble a single and double crown, and owing to this fact, have been designated respectively single and double crown instruments.

The
nary
sever
magn
magn
place
phone
core w

as many
the perip
case of h
The d
will be s
together,
coils on e

The single crown telephone, fig. 306, is composed of the ordinary diaphragm, electro-magnet, or soft iron pole piece, and several steel bars that have previously been rendered permanently magnetic. Six (being the usual number) of these permanent magnets, bent into a circular form, are used in this instrument in place of the single magnet employed in other magneto telephones. These have their like poles joined to one end of the core which carries the magnetizing helix, and radiate from it in



Fig. 305.

as many different directions. The opposite poles are joined to the periphery of the diaphragm, which is contained in a polished case of hard rubber, and faces the free end of the soft iron core.

The double crown instrument is shown in fig. 307, and, as will be seen, consists of two single crown telephones joined together, with a common vocalizing chamber between them. The coils on each of the cores are connected in such a way that the

currents generated in them, when the diaphragms are made to vibrate, mutually strengthen each other, or, when used in combination with the Edison transmitter, that the action of the pulsating current in each coil contributes to a single result, and thus enhances the effectiveness of the apparatus.

Some idea of the performance of these improved instruments will be conveyed by mentioning the results obtained at a recent exhibition of them in the Sunday school room of Dr. Wells' church, Brooklyn. Mr. Edison's carbon transmitter was used for sending and Mr. Phelps' single crown telephone for receiving.

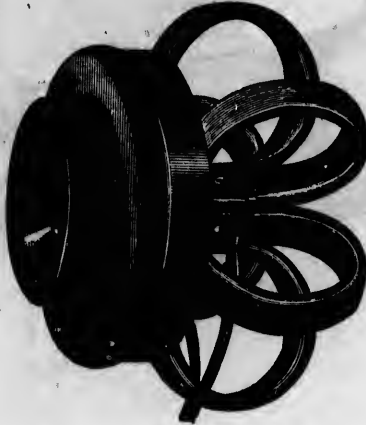

Fig. 306.

The sound was also reënforced at the receiving end by the use of a large paper cone, whose smaller extremity was held to the mouth piece of the instrument. The circuit extended from the residence of Dr. Wells, near the church, to the lecture room. Speech from the telephone was distinctly heard in all parts of the room by an audience of about three hundred persons, while the singing of a vocal quartette, solo singing, and guitar playing were transmitted with surprising clearness and loudness. It should be observed, moreover, that the performance in this case was very different from the so called musical telephones, by means of

which
the to
instan
was ex
magne
Wells
phone,
also in
Fig.

apparatu
An Edis
to be cap
operator,
ment as
graph sou
The sw
in and ou
apparatus

which only the pitch and rhythm of the notes are distinguished, the tone always resembling that of a penny trumpet. In this instance, the quality of the tone, which is the real life of music, was exactly reproduced. This is one of the characteristics of the magneto telephone—everything is faithfully reproduced. Dr. Wells addressed the audience from his parlors through the telephone, and not only was he clearly understood, but his voice was also instantly recognized.

Fig. 308 shows a convenient way of arranging the telephone

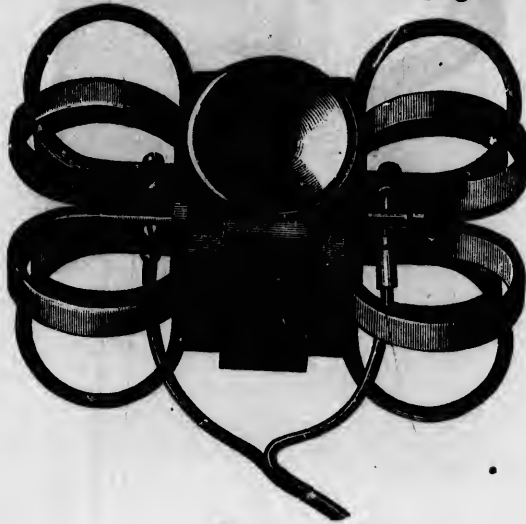

Fig. 307.

apparatus for shop, counting room, and various other purposes. An Edison carbon telephone jointed to a projecting arm, so as to be capable of movement in different directions to suit the operator, serves as the transmitter, and the Phelps crown instrument as the receiver, the call being given by an ordinary telegraph sounder and a key for interrupting the circuit.

The switch shown at the back serves for putting the telephone in and out of circuit. The small induction coil used with the apparatus is placed beneath the desk and in a position where it

is not liable to damage. When the switch is turned as represented in the cut, the apparatus is in the proper condition for speaking purposes. When it is turned to the opposite buttons, which is its normal position when not in use, the telephones are cut out of circuit, the sounder, battery and key alone being then included. By depressing the key now, which in the normal position keeps the circuits closed through a back contact, the battery current is interrupted and the sounder armature released,

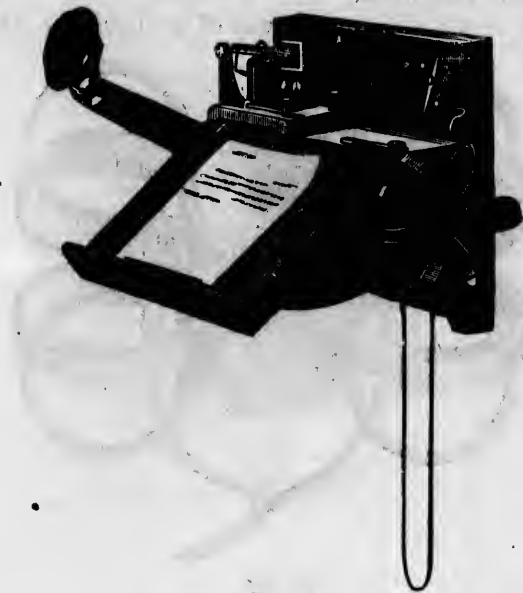

Fig. 308.

thus furnishing the call, to indicate that telephonic communication is desired.

It will be understood, of course, that the same battery is used both for signalling and talking purposes. In the former case the battery current traverses the line and produces the signal directly, while in the latter it merely passes through the telephone and primary wire of the induction coil and the induced currents, produced in the secondary coil by the variations of the battery

current
produ
station
in fac
to whi

The f
short lin
not be s
miles av
generate

TIONS.

s rep-
on for
attons,
es are
y then
ormal
ct, the
eased,

current when the telephone is spoken into, traverses the line and produces the articulation heard in the receiver at the distant station. This apparatus, mounted as in fig. 308, is much used; in fact, almost universally, in the merchants' exchange system, to which we shall refer presently.



Fig. 309.

The form of call here shown, however, is intended only for short lines, as the current from the small battery employed would not be sufficiently powerful to operate a sounder placed some miles away. For long lines the magneto machine is used to generate the call currents. The combination shown in fig. 309,

muni-

used
se the
ectly,
e and
rents,
attery

and which contains a machine of this kind, is somewhat similar in arrangement to the one given on page 27, but of a more improved pattern. The call bell and duplex telephone are the same, and the principal difference consists only in the arrangement of circuit connections, within the box, and in the addition of the single crown instrument, by which greater effectiveness is obtained. The switch at the upper right hand side of the box is used to put the apparatus in and out of circuit, as desired, while that on the left serves for connecting or disconnecting the bell magnets. When placed as represented in the figure, the latter is in circuit, and will cause the bell to ring both at the home and distant stations, if the button marked C is pushed in repeatedly, while the crank shown in front, and which operates the magneto machine, is turned at the same time.

Fig. 310 represents the same form of call box, with an Edison transmitter attached to replace the duplex instrument in the combination just described. The internal connections are the same in both, so that it will be unnecessary to describe them again.

Fig. 311 shows a call box, devised by Mr. Gray, and much used in the Western States in combination with the bipolar telephone.

A still later form has been arranged by Mr. Phelps. This also contains the magneto call apparatus and switch connections of the combinations referred to above, and in addition to these it is provided with an ingenious device, first suggested and applied by Mr. Henry Bentley, of Philadelphia, by means of which the carbon telephone, and, consequently, the battery also, is cut out of circuit at all times, except when actually in use for transmitting purposes. This device consists of a small spring placed on top of the handle of the instrument, or at the side, as the case may be, and which, in its normal position, keeps the telephone circuit disconnected, but immediately establishes it whenever the handle is grasped by the hand, being then pressed down upon the contact button, and thus allowing the battery current to pass through the telephone and primary wire of the induction coil. As the result of this arrangement, Mr.

Bent
spea
grav
for
syste

consum
at the o
except
most ec
brought
be all b

Bentley has been enabled to introduce the Leclanché battery for speaking purposes in the telephone system, in place of the gravity battery heretofore used, and thereby has paved the way for greatly reducing the expense of maintenance in larger systems, like that of which we intend to speak directly, as the



Fig. 310.

consumption of battery material may be reduced to a minimum at the outset and no expense need be incurred for attendance, except at very long intervals. Altogether this seems to be the most economical and practical combination that has yet been brought out, and its very general introduction would appear to be all but assured.

576 EDISON'S RECENT TELEPHONIC AND ACOUSTIC INVENTIONS.

During the past summer the Gold and Stock Telegraph Company have organized a merchants' exchange system in New York and elsewhere, which, besides being of great convenience to subscribers, has also been the means of giving a marked impetus



Fig. 311.

to the already widely extended and continually increasing application of the telephone to business purposes. In this system a central office is connected by wires with the house, office, counting room or other place of business of each of the subscribers,

a sep
indiv
scribe
muni
notif
wires
estab
alway
to att
is ma
A l
witho
frame
the sy
what
are ar
or mo
venier
ring to
line w
switch
in elec
carries
its nor
is simp
establi
the lin
and a l
throug
current
which
with ar
long as
conditi
into the
of a ke

a separate wire, as a general thing, being used for each one. Each individual subscriber is also provided with a list of all the subscribers to the system, and when at any time desiring to communicate with any particular one of the members, has merely to notify the central office of the fact, when the two corresponding wires are immediately connected and direct correspondence is established. Attendants sufficiently numerous are, of course, always kept on duty at the central office during business hours to attend to this work of switching and to see that everything is maintained in proper working condition.

A brief review of the arrangement in this office may not be without interest. Near the centre of a large room an oblong frame is erected, and enclosed and within this all the wires of the system are connected and separately led to small sections of what collectively may be called a switch board. These sections are arranged alongside of each other, facing outwards and in two or more parallel rows, one above the other, but all within convenient reach of an attendant standing upon the floor. Referring to a single section, as the connections are similar in all, the line wire after its introduction within the frame or back of the switch is connected to a screw passing through the section and in electrical connection with a metallic piece in front, which also carries a key provided with both front and back contacts. In its normal position the key is held on the back contact, which is simply a slight projection from a metallic plate, and thus establishes a good electrical path for a current arriving from the line to this plate, and when a plug is inserted between this and a brass disk beneath it, which is also in electrical connection through a small relay with the earth, the circuit for the call current is completed. A catch on the end of the armature lever, which extends through the wooden part of the section, engages with an annunciator disk and keeps it in a vertical position so long as the armature remains unattracted or during the normal condition of the line when idle. If, however, a current is sent into the line from the other terminal station, by the depression of a key like the one shown in fig. 308, the armature lever is

attracted, and thus releases the annunciator disk, which, being hinged below, now falls by its own weight, and indicates not only that a call has been sent, but also at what particular station it originated. This the attendant acknowledges by pressing upon the proper key and causing it to touch the front contact, which is connected to a battery of two or three cells, and by means of which a current is sent to line to actuate the correspondent's sounder or bell. The telephones are then placed in circuit and verbal communication established, when the wants of the calling station may be made known. The central office acquaints the station asked for that correspondence is desired and then switches the two lines together. It may also be added, in further explanation of the system, that some one in the central office always takes the precaution to see that communication is really established after the switching has been done. To facilitate this and provide for the contingency of simultaneous calls, telephone desks with their complete outfits are arranged along the sides of the room and connected by wires with the switch board. The number of desks, of course, varies somewhat, a certain number being always provided for a given number of lines, and these are continually increasing.

Heretofore, when through communication had been established it has been necessary for an attendant at the central office to listen from time to time, so as to know when to disconnect the lines again; but a device is now being introduced which will render this proceeding unnecessary. This consists of a short core relay, which is placed in the telephone circuit and adjusted so that its armature remains unattracted or upon the back stop while the telephones are in circuit, but immediately responds to the increased strength of current occasioned by the withdrawal therefrom of one or the other of these instruments. A local battery and call bell are connected with the relay, and serve to attract the attendant's attention when the armature is attracted. A single bell in conjunction with the annunciator disks is also used for some of the sections of the switch at the central office, but it has been found in practice that the fall of the disks alone

make sufficient noise to call attention to them, and the bell for this purpose will, therefore, be dispensed with for any new wires that may hereafter be added to the system.

Printing instruments, to a very limited extent, are likewise used on some of the wires of the exchange system, but their employment is attended with considerably more complication than that of the telephones, and correspondence is, at the same time less expeditious, so that the number of these instruments is confined to the few that were introduced before the telephone was made practical.

We are indebted to Professor George F. Barker, of the University of Pennsylvania, for the following interesting particulars in relation to the experiments made with the Edison carbon telephone, between Philadelphia and Washington, in April, 1878.

These experiments originated in the following way: While making plans to exhibit to the National Academy of Science, at its spring session, in Washington, the collection of telephones which the kindness of my friends, Messrs. Bentley, Edison, Gray and Phelps, had placed at my disposal for my lecture of April 15, it occurred to me that it would be a pleasant thing if the occasion could be made an opportunity of affording Professor Joseph Henry, the distinguished president of the academy, who had watched with so much interest the progress of the telephone, the means of carrying on actual conversation with some distant point, and thus of personally verifying the latest triumph of electrical science. The matter meeting with the cordial approval of Mr. Henry Bentley, of Philadelphia, I suggested it in a letter I was then writing to Hon. William Orton, president of the Western Union Telegraph Company. As this great and good man has now passed from among us, I may be permitted to quote that part of his letter in which he replies to my suggestion, because it shows the kindliness of his nature and the warm appreciation which he had of Professor Henry's scientific investigations. In his letter, which is dated April 11, he says:

"I note what you say concerning the meeting of the Academy of Science, at the Smithsonian Institution, on Tuesday, and I

sympathize most warmly with you in your desire to exhibit to Professor Henry the latest wonders of that science to which he has devoted so much of his priceless life, and for which he has received so little reward. But if the world is slow, as it often seems to be, in doing justice to those who have done most to promote the interests of science, and thereby the welfare of mankind, I believe that justice is sure to be done in the end, and so believe that the time will come when all men everywhere will recognize his services in connection with the grand results of his noble life. Any service that I can render toward making the occasion to which you refer interesting to all who may participate in it will be rendered most cheerfully." In pursuance of this kind offer, I received, a few days afterward, an official letter from Mr. James Merrihew, the superintendent of the Western Union Telegraph Company, at Philadelphia, saying that he would be glad to do anything in his power to facilitate the proposed plan. Manager Robinson, too, was equally courteous.

On reaching Washington and reporting on Wednesday morning to Manager Whitney, of the Western Union office there, I learned that Superintendent Merrihew had himself come on to assist at the experiments, and that they would be ready for the preliminary tests that evening. Early in the evening the wires worked badly, and it was with some difficulty that we could get Menlo Park. But about ten o'clock the induction lessened, and I carried on a conversation with one of Mr. Edison's assistants with considerable ease, the distance being two hundred and five miles. For the experiments at the Smithsonian Institution, on Thursday, April 18, it was judged best not to attempt conversation beyond Philadelphia. Mr. Edison and Mr. Bachelor had arrived that morning, and had brought with them some improved instruments. In the morning Mr. Edison exhibited the phonograph to Professor Henry in his own parlor. At three in the afternoon the telephonic apparatus was arranged in the same place. Mr. Edison being absent, Professor Henry, Mr. Merrihew and myself seated ourselves at the table, upon which, beside the Edison transmitter and induction coil, were the

magneto telephones of Phelps, Gray and Bell, to be used as receivers. The Morse instrument in circuit told us when all was ready; and, on cutting in the telephone, we recognized at once Mr. Bentley's well known voice, calling "Hallo! hallo!" Ordinary conversation was then carried on with perfect ease, and Mr. Bentley's elocutionary efforts, detailing the personal characteristics of the little girl whose forehead was adorned with a curl in its centre, were most highly appreciated, the articulation being clear and distinct. Professor Henry said he heard every word, and expressed to Mr. Bentley, through the transmitter, the pleasure and gratification which he deeply felt, and which his manner showed to every one present. Doubtless, his memory carried him back to 1830, when in the laboratory of the Albany academy he made the early researches of which the interesting experiments he had now assisted at, and which showed that men could converse through one hundred and forty miles of intervening distance, were the outcome. The friends who had gathered to witness the trials were now afforded an opportunity to test the question for themselves, Mr. Bentley most generously assisting them in every way.

At four o'clock, the hour which the academy had fixed for the phonograph and telephone experiments, the apparatus was taken down stairs into the office of the secretary, where the meeting was in progress. Mr. Edison was presented to the academy, and was welcomed by the chairman, Vice-President Marsh. Mr. Bachelor then exhibited the phonograph. I then read my communication on the telephone, exhibiting and describing the various forms, and closed by placing them on the Philadelphia wire, so that the members could hear the words spoken one hundred and forty miles away. The academy expressed itself highly gratified, and passed a resolution of thanks to the Western Union Telegraph Company, and especially to Mr. Edison, Mr. Bentley, Mr. Merrihew and Mr. Whitney for the courtesies shown.

The result of this experiment, the most important made in telephony up to that time, showed that it was entirely possible.

to converse with ease between stations one hundred and forty miles apart, and this over a wire surrounded by twenty or more wires, all in active use, and carried under three rivers in its course, in insulated cables. The first proof of this fact must ever be a source of gratification to all who were concerned in establishing it; and to none, I am sure, more than to Mr. Henry Bentley, through whose intelligent and well directed efforts the carbon telephone, the conception of Edison's genius, first became practically successful.

In a work which has been so largely occupied in considering the discoveries recently made by Mr. Edison, it does not seem inappropriate to add a few words in regard to the man himself, and to this end the concluding portion of the present chapter will be devoted. For the information respecting the early years of the great inventor we are indebted to an interesting paper, entitled "A Night with Edison," written by William Bishop, and published in Scribner's Monthly, November, 1878.

Thomas Alva Edison was born at Milan, in Erie County, Ohio, February 11, 1847. An obscure canal village of the smallest size, it was not the place where the advent of a genius would be looked for, if this elusive spark had the habit of appearing anywhere according to prescribed formulas. The village of Port Huron, Michigan, to which his family removed soon after, and where the greater part of his youth was passed, could not have afforded a better prospect. His family was an average one of the humbler sort. There was no unusual talent in any of its members upon which a claim to heredity of ability could be based. Of a number of brothers and sisters, none have shown an inclination towards pursuits like the inventor's own. He may have taken from his father—who was in turn tailor, nurseryman, dealer in grain, in lumber and in farm lands—some of the restlessness which has impelled him to activity in so many different directions. He took, also, from him a good constitution. This parent of Dutch descent, a hale old gentleman, still living at the age of seventy-four, had two immediate ancestors who lived, one to the age of one hundred and two, the other to one

hundred
note
course
progr
comp
paren
and h
parted
ever
month
not r
recor
who
plays
tions
involv
herit,
an ear
tories
ing H
and ev
the res
While
were c
educat
is by
early
has be
this ma
dicatio
mous
his car
time h
library
human
of volu

hundred and three. It is a point not altogether unimportant to note in passing, since it holds out the prospect, in the ordinary course of time, for the matured completion of the wonderful programme the inventor has laid out for himself already, at the comparatively youthful age of thirty-one. His mother, of Scotch parentage, though born in Massachusetts, was of good education, and had formerly been a school teacher in Canada. She imparted to him about all the instruction from outside sources he ever received. Of regular schooling he had no more than two months in his life; and his school mates of this brief period do not remember him as brilliant, nor are there preserved family records of phenomenal infantile doings. But he was a child who amused himself much alone, and doubtless, if his quiet plays had been noted, there would have been detected indications of the faculty in which his extraordinary future career was involved. He had the intense curiosity about the world we inherit, and its great names and great deeds, which will be found an early trait in common in almost all the lives that have histories of their own to leave behind them. At ten, he was reading Hume's *England*, Gibbon's *Rome*, the *Penny Encyclopædia*, and even some books of chemistry, which came in his way, with the rest, and gave, as it seems, the direction to his future action. While it will thus be observed, that his school opportunities were of a very limited nature, the statement that he is an uneducated man, which has appeared in some of the daily journals, is by no means true. During the whole of his life the habit, so early acquired, of reading everything that came within his reach has been continued, and much has, consequently, been gained in this manner, as he possesses a most retentive memory. As an indication of his thirst for knowledge, the *naïve* ignoring of enormous difficulties and the completeness with which the shaping of his career was in his own hands, it may be stated that at one time he formed the project of reading through the whole public library of Detroit! There was no one to tell him that all human knowledge may be found in a certain moderate number of volumes, nor to point out to him approximately what they are.

T. A.

Edison
died
in
1933

Each book was, in his view, a distinct part of the great domain, and he meant to lose none of it. He began with the solid treatises of a dirty lower shelf, and actually read, in the accomplishment of his heroic purpose, fifteen feet in a line. He omitted no book and skipped nothing in the book. The list contained, among others, Newton's Principia, Ure's Scientific Dictionaries and Burton's Anatomy of Melancholy.

When Edison was fourteen years old he entered the telegraph service, and remained in it until he was twenty-three, becoming in the meantime an accomplished operator. His experience as a practical telegraphist has been of the greatest value to him in the prosecution of his electrical inventions, particularly those relating to telegraphy.

The great number and variety of subjects to which Mr. Edison has given his attention is scarcely less surprising than the marked success with which his labors have been crowned. Electricity alone, although receiving the most attention, has furnished but a single field for the display of his versatile powers. His path has been through extended portions of physics and chemistry, and is clearly marked by characteristic inventions in these vast domains. Not less remarkable, too, is the originality of his ideas. Many of his inventions, to be sure, are but improvements upon the methods of previous investigators, but many others have been produced while pursuing a line quite outside of that followed by these earlier pioneers, and in some instances, also, without any knowledge whatever that the subjects had been considered by them. As illustrations of this faculty for original research, we have only to mention his chemical system of telegraphy, the electro-motograph, the system of double transmission in the same direction, the quadruplex telegraph and the carbon telephone, in all of which this faculty is conspicuously displayed. Stark, it is true, invented a method of simultaneous transmission in the same direction, in 1855, and at that time had the idea of quadruplex telegraphy in mind. Kramer, shortly afterwards, improved upon this method, and subsequently the idea was also taken up by Bernstein, Schreder,

War
lowe
ceed
Mr. I
equiv
done,
missi
meth
signa
duce
by pr
tive b
selves
telegr
a prac
Sim
the fi
fully
impro
whate
His
tion o
occupi
means
able el
idea o
ciple,
object
true so
the bes
discov
produc
subject
in the
instrun
We

Wartman and others; but all, with only slight modifications, followed a similar line of investigations, and in the end only succeeded in working imperfectly upon lines of very short length. Mr. Edison, however, instead of employing three relays, or their equivalent, for accomplishing this object, as his predecessors had done, confined himself solely to two, one for receiving each transmission. He also avoided, without employing previously used methods, but one quite original with himself, the mutilation of signals which a change in the polarity of the battery current produced; and by the addition of a simple device, never thought of by previous experimenters, and which was made directly operative by the line current, and independently of the relays themselves, succeeded in completely solving the question of multiple telegraphy for all cases, making the quadruplex, in consequence, a practical apparatus for the longest circuits.

Similar original and beneficial results attended his labors in the field of chemical telegraphy. With this system, after carefully studying the problems involved, he succeeded in vastly improving the speed of transmission for circuits of any length whatever.

His originality is also shown to good advantage in the invention of the carbon telephone. During the time that Gray was occupied with the problem of transmitting articulate speech by means of variations in the current strength, produced by a movable electrode in a liquid conductor, and Bell sought to realize his idea of reproducing speech at a distance by the magneto principle, Edison directed his attention to the attainment of the same object in quite another way, and soon succeeded in furnishing the true solution of the difficulties to be overcome, and of securing the best practical results, by following out a principle previously discovered by himself, and in which the current variation was produced by the variable resistance of solid conductors when subjected to pressure. The result of this novel departure is seen in the carbon telephone, justly considered the best transmitting instrument yet introduced.

We might thus go on and enumerate other inventions scarcely

less calculated to show his manner of investigation in the line of original research, but enough has already been said to make this point apparent; we will, therefore, conclude our very brief sketch with a few words regarding his great capacity and still greater inclination for work. Without doubt, Mr. Edison is more than usually endowed with what the world terms genius. His intellectual powers are of no ordinary kind, and the potentiality of his brain is very much above the average; but it should be clearly understood that his great success is the result, not so much of the divine gift of genius alone as of his ceaseless activity and indomitable perseverance under all circumstances. These are unquestionably the most remarkable characteristics of his nature and the real elements of his success. The author can state from personal knowledge what is now becoming more generally known regarding Mr. Edison's extraordinary propensities for work. No person with whom he has ever met has exhibited anything like it, and very few, if favored with like power of endurance, would be found willing to apply themselves so assiduously in any given direction. During the early experiments with the quadruplex system of telegraphy, which took place under his own supervision, and which required a vast amount of time and application for its perfection, it was a very common thing to find Mr. Edison working through the entire night, his only rest being such as a brief interval of sleep just before day might afford, taken in the experimental rooms. Night after night he has worked in this manner, and been found in the morning with nothing but his coat for a pillow and the table or desk for a couch, making thus a lame apology to nature for the most reckless disregard of her requirements.

Mr. Edison still keeps up the habit of working long into the night, at his laboratory in Menlo Park, and probably will continue to do so as long as his physical powers will sustain him. The accompanying fig. 312 represents him after a night spent in some absorbing work, as he takes his solitary way homeward through the surrounding darkness that precedes the dawn of another day. Entreaty and remonstrance with him on this point

are a
or stu
subje

upon it
for him
too often

are alike in vain; not that he is unmindful of friendly counsel or studiously neglects it, but because, when engaged upon any subject, his whole energies for the time being are concentrated



Fig. 312.

upon it and devoted to it, and the flight of time thus becomes for him a matter of secondary importance, but little noted and too often unheeded even then.

CHAPTER XVI.

DUPLEX TELEGRAPHS AND ELECTRO-MAGNETS.

In Chapter XI., page 364, we have described the methods of simultaneous transmission in the same direction, devised by A. Bernstein, of Berlin, in 1855. During the same year, Dr. J. Boscha, Jr., of Leyden, was engaged in the solution of the same problem. Boscha at first made use of three receiving instruments, two of them having polarized armatures, and the other a neutral armature.

To obviate a defect in this arrangement, caused by a reversal of the current upon the line, when a signal was being received upon the neutral relay, he subsequently devised the plan shown in fig. 313, in which all three relays are polarized. The operation of the transmitters K_1 and K_2 gives rise to three distinct electrical conditions of the line.

First: K_1 and K_2 both open. No current.

The armatures of the relays R_1 , R_2 and R_3 remain in the position indicated in the figure, the local circuit of battery e_1 is open, and a shunt being closed around the battery e_2 , sounders S_1 and S_2 are consequently inoperative.

Second: K_1 closed and K_2 open. Current = - 2.

This current causes R_1 and R_3 only to respond; the former, immediately after breaking the shunt around battery e_2 , closes the local circuit of battery e_1 , thus operating sounder S_1 . A signal upon S_2 is prevented by R_3 opening the local circuit of battery e_2 , at the same time that the shunt around the latter is broken by R_1 .

Third: K_1 open and K_2 closed. Current = + 1.

This current causes R_2 alone to respond, thus breaking the shunt around local battery e_2 , and recording the signal upon sounder S_2 .

Fourth: K_1 and K_2 both closed. Current + 1 - 2 = - 1.

This
ing th
battery
In 1
descrip
mission
The
keys, I
tinct el



First
Second
Third
Fourth
At the

of which

¹ Zeitsch
in dessen
Redigirt vo

This current causes R_1 only to respond, which, by first breaking the shunt around battery e_2 , and then closing the circuit of battery e_1 , causes the respective sounders S_2 and S_1 to respond.

In 1861, Edward Schreder,¹ of Vienna, published the following description of his improved method for the simultaneous transmission of two messages in the same direction (fig. 314):

The transmitting devices consist of two continuity preserving keys, K_1 and K_2 , the operation of which gives rise to three distinct electrical conditions of the line, as follows:

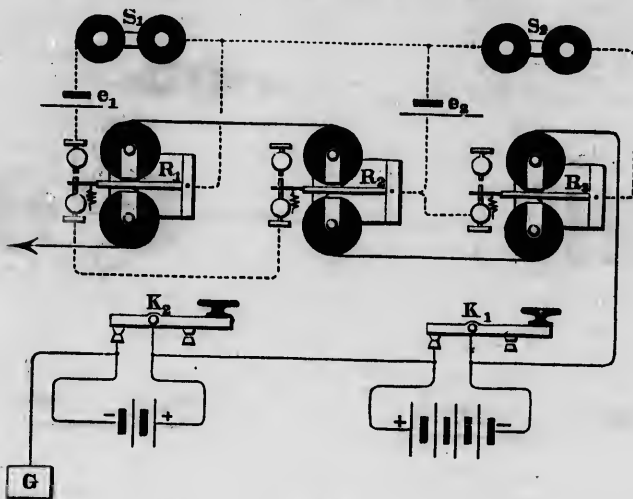

Fig. 313.

First: Keys K_1 and K_2 , both open. No current.

Second: K_1 closed, and K_2 open. Current = - 2.

Third: K_1 open, and K_2 closed. Current = + 1.

Fourth: K_1 and K_2 both closed. Current = - 1.

At the receiving station Schreder makes use of two relays, one of which is provided with two polarized armatures, and the other

¹ Zeitschrift des Deutsch-Oesterreichischen Telegraphen-Vereins, herausgegeben in dessen Auftrage von der Königlich Preussischen Telegraphen-Direction. Redigirt von Dr. P. Wilhelm Brix. Vol. VIII. Berlin, 1861. Page 85.

a single neutral armature, the former being known as the Stöhrer relay, illustrated and described on page 542 of "Electricity and the Electric Telegraph."

Schreder also used a recording instrument, or sounder S_2 , wound differentially, which, together with the sounder S_1 were controlled and operated by the relays R_1 and R_2 , as hereafter explained.

It is obviously essential that sounder S_1 should respond solely to the movements of the key K_1 , and sounder S_2 to the move-

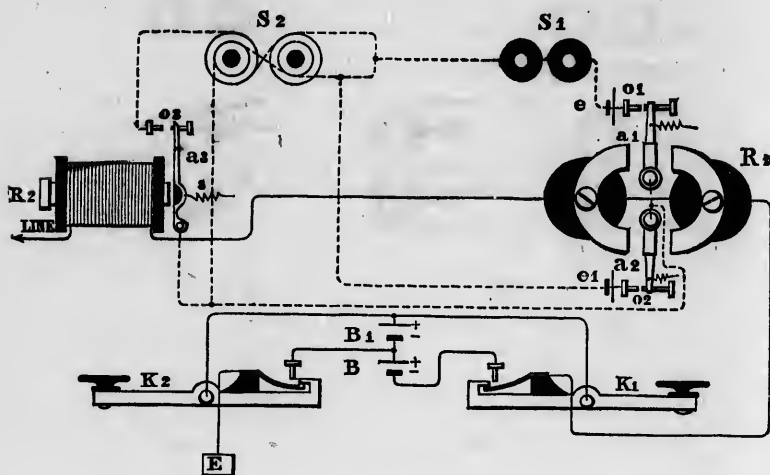

Fig. 314.

ments of key K_2 , while both S_1 and S_2 should respond when K_1 and K_2 are simultaneously depressed at the sending station. The manner in which this is accomplished will be understood by reference to the drawing, and the following explanation of the effect of the before mentioned electrical conditions of the line, upon the relays, at the receiving station :

First: K_1 and K_2 open. No current.

The armatures a_1 and a_2 , of relay R_1 , and armature a_3 of the relay R_2 , rest in the position shown. The local circuits being open, sounders S_1 and S_2 are consequently inoperative.

Second: K_1 closed, and K_2 open. Current = - 2 B.

The current in this case is of the right polarity, and of sufficient strength to actuate the relays R_1 and R_2 , causing armature a_1 of the former, and armature a_3 of the latter, to make contacts with their respective stops o_1 and o_3 , thus closing the local circuit of battery e , and sounders S_1 and S_2 . In order, however, that sounder S_1 alone should respond, it is essential that armatures a_1 and a_3 , of relays R_1 and R_2 , should move simultaneously, that is to say, a_3 should make contact with its front stop o_3 at the same time that a_1 , of relay R_1 , makes contact with its front stop o_1 , otherwise a false signal will be recorded upon sounder S_2 , around the cores of which two paths are provided for the current to pass, but by a simultaneous movement of the armatures a_1 and a_3 the current passing through sounder S_2 is divided, each half passing around its cores in opposite directions, thereby rendering the latter inoperative. Armature a_2 , or relay R_2 , is held more firmly in the position shown in the figure, the local circuit of battery e_1 remaining open between a_2 and stop o_2 .

Third: K_1 open, and K_2 closed. Current = + B_1 .

The polarity of the current in this case is such as to cause the armature a_2 , of relay R_1 , to make contact with stop o_2 , thus closing the local circuit of battery e_1 , which, passing around one half only of sounder S_2 , causes the latter to respond.

Armatures a_1 and a_3 , of relays R_1 and R_2 respectively, remain in the position shown, thus rendering S_1 inoperative.

Fourth: K_1 and K_2 closed. Current = - B.

In this case armature a_2 , of the relay R_1 , remains in the position shown, the local circuit of battery e_1 being open at point o_2 . This current not being of sufficient strength to overcome the retractile force of spring s , of armature a_3 , the latter also remains upon its back stop. Armature a_1 , of relay R_1 , is, however, caused to move forward, and make contact with its front stop o_1 , thus closing the local circuit of battery e , which, circulating through sounder S_1 and one half of sounder S_2 , causes them both to respond.

*The electro-magnet is composed of a magnetic core, or cylinder of iron; a helix, which consists of an insulated conductor, wound upon a bobbin, and surrounding the core, and an armature, a piece of iron, usually of prismatic form, placed transversely in front of the ends of the core, which ends are termed the poles of the electro-magnet.

If the core is composed of a straight cylinder the electro-magnet is termed a bar magnet, and usually acts by means of one of its poles only, but if the core is bent in such a manner that both its extremities may act upon the same armature, it is termed a horse shoe or U magnet. The same result may also be obtained by uniting several pieces together. Thus two cores of iron connected together by a yoke or bridge piece of the same metal, each core being surrounded by a bobbin, constitutes an



Fig. 315.



Fig. 316.

electro-magnet with two branches, this being, in fact, the form in which electro-magnets are usually constructed, but many other forms are also employed, to a greater or less extent. When the electro-magnet just described is without a helix or coil upon one of its cores, it is termed a single coil magnet. Figs. 315 and 316 represent two forms of this kind of electro-magnets.

The earliest experiments which were made with the view of improving and perfecting the electro-magnet, demonstrated that the effective force of an electro-magnet is proportional to the strength of the magnetizing current and to the number of convolutions in the magnetizing helix; and that in order to produce the most advantageous effect, the resistance of the helix should

¹ Abstract from *Exposé des Applications de l'Electricité*, by Ct. Th. Du Moncel.

be e
the h
Su
tible
in ce
to th
to th
matur
velop
prop
the c
prop
A sti
that t
the di
the le
ever,
of the
The
exerte
to the
The
proves
the ma
its for
which
of the
which
retaini
Wh
of soft
the fir
force o
strengt
square
rent.

be equal to that of the portion of the circuit not included in the helix.

Subsequent experiments proved that a mass of iron is susceptible of a certain maximum of magnetization only, and only within certain limits is the force of the electro-magnet proportional to the square root of the diameter of the iron cores, or simply to the diameters, if we take into account their action on the armatures. These experiments also proved that in order to develop in two electro-magnets of different diameters the same proportional part of their maximum magnetism, the product of the current multiplied by the number of evolutions must be proportional to the square roots of the cubes of the diameters. A still later series of carefully conducted experiments showed that the magnetic force not only increases as the square root of the diameter of the core, but is also proportional to the square of the length. The attraction which results from this force, however, diminishes in the ratio of the square root of the distance of the middle or neutral point of the core from the armature.

The result of these experiments shows that the attractive force exerted by an electro-magnet upon its armature is proportional to the diameter of the core and to the square root of its length.

The investigation of the question of magnetic saturation proves that the maximum of saturation depends solely upon the mass of iron contained in the electro-magnet, irrespective of its form; and that the maximum degree of magnetization, of which a mass of soft iron is susceptible under the influence of the electric current, is more than five times as great as that which a corresponding mass of hardened steel is capable of retaining.

When the electro-magnet exerts its attraction on an armature of soft iron, it creates a new magnet, which, reacting in turn on the first, induces a similar action, thus proving that the attractive force of electro-magnets is proportional to the square of the strength of current for a like number of convolutions, and to the square of the number of convolutions for like strength of current. This law can, however, only be considered as rigorously

exact when the electro-magnet and the armature contain about the same mass, and their magnetic state is near the point of saturation; that is to say, that which these magnetic pieces would retain if, being of tempered steel, they were magnetized to a maximum. We will only add, that it follows from the preceding law, that if the strength of current (acting on the electro-magnet), and the number of convolutions in the helix vary at the same time, which is nearly always the case, since by increasing the number of convolutions without changing the battery, we increase the resistance of the circuit, the attractive force of the electro-magnet becomes proportional to the square of the strength of current multiplied by the square of the number of convolutions. When the electro-magnet, instead of acting on an armature of soft iron, exerts its action upon another electro-magnet, the attraction is proportional to the sum of the products of the strength of current by the number of convolutions in the two helices. Finally, when the electro-magnet acts upon a steel armature magnetized to saturation, the attractive force is simply proportional to the product of the strength of current by the number of convolutions. It will be observed at the same time that the nature and diameter of the wire of the magnetizing helices exert no influence, provided the strength of current does not vary.

In the laws of the electro-magnet which have thus far been summed up, the armature has been assumed to be of sufficient dimensions to render it capable of receiving the same amount of magnetism as the core itself—a condition which is necessary in case the attraction exerted upon the armature is represented by the square of the force proper of the electro-magnet. In order that the law may hold good in the case of an electro-magnet which has arrived at its maximum point of saturation, it is evidently necessary that this armature should present a mass nearly equal to that of the core which is directly magnetized by the helix, while in order to satisfy the conditions of the law of proportionality of the forces, with respect to the diameters and lengths, the armature should be of about the same dimen-

si
th
co
wh
an

the
ma
arm
ma
con
wit
ma
oug
is a
sys
foll

I
that
the
the
resu
lish
mag
proj
favo
beco
unde
caus
enve
helix
tro-n
num
term
in len
maxi

sions as the electro-magnet. Hence we arrive at the conclusion that the maximum of force of which an electro-magnetic system, composed of a helix, core and armature, is capable, is developed when the dimensions of the two latter in respect to their length and surface are equal.

The proportion of the forces to the diameters indicates that the former depends more upon the surfaces than upon the magnetic masses. It follows from this principle, that if a second armature is attached to the inactive pole of a straight electro-magnet, the effective force of the combined system ought to be considerably augmented; for the reason that the electro-magnet with its first armature constitutes, in point of fact, an electro-magnet of double length. Therefore, the maximum of force ought to be developed when the length of the second armature is also equal to that of the electro-magnet. If we consider the system with reference to the first armature, we arrive at the following general law:

In a straight electro-magnet, the length of whose core exceeds that of the magnetizing helix, at the end opposite the armature, the force progressively increases with the length of the core, until the total length becomes three times that of the bobbin. This result is confirmed by experiment. We are now able to establish other conditions of maxima in respect to double electro-magnets. In fact, since the length of the magnetic core which projects beyond the magnetizing helix becomes more and more favorable to the development of magnetic force until the core becomes three times the length of the helix, we can readily understand that the force can be still further augmented by causing this mass of iron to react on the armature, and by enveloping the latter in a second helix. Now, if this second helix is of the same length as the first, we then have two electro-magnets, each of which is placed in its condition of maximum, and of which the part without the coils—which is usually termed the yoke—of the double electro-magnet should be equal in length to one of the cores, if it is desired to keep it within the maximum conditions already established. We may, therefore,

lay down the equality of the four constituent parts of the system, as the condition of maximum of double electro-magnets. This conclusion, which experience has shown to be correct, explains several phenomena exhibited by electro-magnets, to which we shall have occasion to refer in another place. The problem now under consideration is that of determining the best construction of the armature. If we only take into consideration the question of force without concerning ourselves with practical requirements, which are sometimes directly opposed to the conditions of maximum—as in cases where the utmost rapidity of motion is required, for example, when the mass of the armature should be as small as possible—it is obvious that the flat prismatic form is the best; for, inasmuch as the centre of the magnetic action in the armature coincides with its axial line, it is clear that the greater the thickness in the normal direction of the action of the magnet, the greater will be the distance between the latter and the middle point of the armature, and, therefore, the less the force. Consequently, the cylindrical form and the prismatic form of equal dimensions should be rejected. The best results will be attained by means of the thinnest possible armature placed broadside in front of the poles of the electro-magnet, for the reason that in that case the distance from the magnetic centre of the armature to either pole of the electro-magnet will be at its minimum. In fact, experiment shows that with an armature one inch in breadth and one eighth of an inch in thickness, the difference in the respective forces resulting from the position of the armature, whether flat or edgewise, is the ratio of ninety-two to fifty-nine.¹

¹ The form and mass of the armatures should depend upon several considerations, but principally upon the functions which they are required to fulfil. In respect to force alone, these armatures ought always to be a little broader than the poles which act upon them; the length ought to exceed by four or five lines the polar extremities of the magnet, and their thickness ought to vary according to the force of the magnet. It is even asserted that for a given magnetic force, this thickness is susceptible of a maximum, beyond which there is a loss of power when the thickness is still further augmented. It is easy to understand that this condition of force cannot always be realized, for if we require a very rapid movement of the armature, we ought to make the latter as light as possible.

On the other hand, it is easy to understand, that in order to allow the greatest possible amount of play with the least loss of power, it is preferable to pivot the armature in such a way that one of its extremities is in contact with one of the magnetic cores, and the other end alone movable. In this manner the armature moves angularly, and the force which is developed, compared with that which is obtained from the same armature moving parallel to the axis of the cores, is nearly double, being in fact, in the ratio of one hundred and twenty-five to sixty-four. The reason of this is obvious, when we consider that the distance through which the attractive force is exerted is by this arrangement diminished nearly one half. From the comparison which we have already made, with the yoke uniting the cores of the double electro-magnet with its armature, we can readily see that when these four parts are equal to each other they constitute a double system, in which each one of the magnetic cores composing a special electro-magnet has a distinct armature, which armature being of the same length and surface as the magnetic core which acts upon it, may give rise to a magnetic reaction under conditions analogous to those of the action produced by the magnetic core itself. But this is no longer the case when the armatures as well as the yokes are of greater or less dimensions. In this case it may happen, either that these armatures cannot furnish the sum of magnetism necessary to enable them to respond to the action, or, on the other hand, that the cores themselves do not possess sufficient magnetic mass to respond fully to the reaction which would otherwise be produced. In this case the forces depend upon the shortest parts constituting the magnetic system, but as the proportion of the total force which they are individually able to furnish is proportional to the square root of their length, and as one of these parts cannot vary in length unless the other also does, the result is, that when the different parts of a double electro-magnet are not equal, the force is proportional to the length of the shortest part. This fact was long since discovered and made known by Dub. As corollaries to this law, the latter gives the following deductions, which may be readily comprehended without further explanation :

1. The attractive force of an electro-magnet is proportional to its length, when the lengths of all the different parts of which it is composed increase in the same ratio.

2. The maxima of attractive force are proportional to the various lengths of the systems, of which the component parts are respectively of equal length.

3. The attractive force remains constant when the shortest parts are equal to each other, whether these are represented by the electro-magnet or the armature.

According to the British Association committee, electro-magnetic forces should be measured by the method of repulsion, and the unit of electro-magnetic force is represented by the repulsion exerted between two like magnetic poles placed at a distance of one mètre apart, and acting on each other with a force represented by $\frac{1}{1000000}$ (gramme-mètre). Nevertheless, as the greater part of the experiments which have been made up to the present time with electro-magnets have been made by means of a balance and weights, the existing ratio between the two systems of measures still remains to be ascertained.

The accompanying plate shows the various forms of electro-magnets generally used for electrical purposes. Figs. 1, 2, 3, 4, 5, 6 and 7 are electro-magnets, whose poles are straight, bevelled, tapering or flattened, according to the purpose needed. In fig. 3 the copper disks or end pieces are soldered to the core of the electro-magnet. In fig. 4 the core is hollow, with two iron disks at the extreme ends to increase the polar surfaces, and to serve as end pieces for the bobbins. Fig. 6 represents Bonelli's electro-magnet, in which the armature forms a part of the magnetized core, and by receiving from the helix a direct magnetization, makes the attraction between the two parts more powerful.

Fig. 7 represents an electro-magnet provided at both ends with two iron pallets. This plan is used to advantage as an armature of an electro-magnet, in which case the pallets correspond to the poles of the electro-magnet. This arrangement has been adopted by Mr. Maroni for the Italian Morse instruments. Figs. 8, 9, 10, 11, 12, 13, 17, 18 and 20 show the various forms which have been

given
the h
an el
core
woul
to th
use o
whic
extre
cores
with
such
is sho
magn
same
A sim
adopt
his te
fig. 1

If a
solder
this c
presen
the en
which
Manu
superi
magn
being

If v
in fig.
towar
we sha
on ea
acting
or circ

given to the double branched electro-magnets. Fig. 9 represents the best known and more generally used form. Fig. 10 shows an electro-magnet in which the helix is wound around the iron core without retaining disks at the ends; the various spirals are wound so as to form two truncated cones in opposite direction to their base. This form of electro-magnet is especially made use of in Clark's instruments, to favor the effects of induction, which is more energetic in the centre of the cores than at the extreme ends. Fig. 12 represents an electro-magnet with hollow cores and iron end pieces. Fig. 11 represents an electro-magnet with one coil. By bringing near together the two branches of such an electro-magnet, and bending the free branch around, as is shown in fig. 13, we may bring the two poles of the electro-magnet very near together, and hence make them react at the same time on an armature placed endwise, and of very small size. A similar form, and devised for the same purpose, has been adopted by Mr. Hughes for the two bobbin electro-magnets of his telegraphs, the branches, however, being bent back, as in fig. 17.

If a soft iron cylindrical case is placed around the bobbin and soldered to the circular end piece of a straight electro-magnet, this cylinder will share the magnetism of the end piece, and will present a like pole to its free end; hence there would be at one of the ends of the electro-magnet a circular pole, in the centre of which the other pole would be found, as shown, in fig. 15. Manufacturers of these tubular electro-magnets claim a great superiority for them in strength over the other forms. Electro-magnets of this style have been used in electro-motors, the poles being oblong instead of circular, as shown in fig. 21.

If we place over an iron tube electro-magnet like that shown in fig. 4, two soft iron cylindrical cases, leaving between them, towards the middle of the electro-magnet, a small open groove, we shall obtain a circular electro-magnet having a different pole on each of the two iron cases which surround it, and hence acting through its two poles at the same time on a longitudinal or circular armature, on which it rests. This form of magnet, as

shown in figs. 16 and 28, has been proposed for magnetizing the wheels of locomotives on railroads, and as an electro-transmitter of motion to supply gears.

By bending the yoke at right angles the two opposite poles of an electro-magnet may be made to face each other, as shown in fig. 18; and by cutting the yoke in two, and sliding the two free parts in a groove made in a plate of soft iron, the distance of the poles from each other may be regulated at will. When it is desired that an armature should oscillate between the two poles of an electro-magnet, in which case magnetic armatures are usually employed, there are three ways that may be followed: the poles of the electro-magnet may be bent in such a way as to stand opposite to one another at any desired distance apart, or the two cores are brought sufficiently near each other to allow the oscillation to take place between them; or, lastly, the cores themselves are inclined at the proper angle to bring the poles near to each other. The latter method possesses a slight advantage over the others, in not requiring any marked lengthening of the cores, which is always detrimental; and at the same time it allows a direct attraction on the armature, which is more powerful than lateral attractions. Fig. 20 represents a magnet of this description.

Electro-magnets, with multiple poles, as shown in fig. 19, are sometimes employed for large electro-motors. These magnets consist of an iron bar, carrying eight, ten and twelve, or even more, iron cores, on which the magnetizing helices are placed; the even branches are all magnetized alike, or are of the same polarity, while the uneven are of the other. The result is, that any one of these poles always stands between two poles, whose magnetism is opposite to that of the one considered. Electro-magnets of this construction are very powerful, and consequently of considerable importance in the construction of electro-motors. Attempts have also been made to magnetize iron plates in different ways. Fig. 22 shows one arrangement of this kind constructed by Joule, in which the plate is rolled into a cylindrical form, and the wire wound around it in the direction of the length of the cylinder

By
ing
fig.
mag
Wit
ful;
be n
the
seve
incre
this
verm
of m
consi
twent
separ
this f
havin
give g
eighth

The
tempo
may b
which
the ele
hood,
paralle
quently
both en
in whic
with res
poles or
one of
articulat

By cutting a series of grooves in an iron plate, and introducing therein an insulated wire, bent back upon itself, as shown in fig. 23, Mr. Pulvermacher has succeeded in making electro-magnets, with multiple poles, similar to those of Mr. Froment. With a single wire, however, these magnets are not very powerful; but, as they occupy but very little room, their number may be multiplied considerably. By making the grooves larger and the projection thicker, the wire may be turned back on itself several times, and the magnetic effect thereby be correspondingly increased. Among the various other methods of constructing this style of electro-magnets, there is one suggested by Mr. Pulvermacher which is worthy of note, as giving a large amount of magnetic power within a comparatively limited space. It consists in making the plate itself of sheet iron bands, one twenty-fifth of an inch thick, placed one next to the other, and separated only by sheets of card board. An electro-magnet of this form, when compactly enclosed within its copper frame, and having projections of only one fourth of an inch, will, it is said, give good results, although but a single conductor of about one eighth of an inch diameter is wound in the grooves.

ARRANGEMENT OF ARMATURES.

The armature of an electro-magnet, whether consisting of a temporary or permanent magnet, or simply of a soft iron bar, may be arranged in various ways relative to the electro-magnet, which acts upon it. It may be hinged to the two bobbins of the electro-magnet, or other suitable fixture in their neighborhood, as in fig. 33, in which case its movement is effected parallel to the axial line of the electro-magnet; and, consequently, the attraction of the two poles on the iron is equal at both ends. It may be articulated by one end, as in fig. 33, bis, in which case the movement takes place in an angular manner with respect to the axial line; and hence the action of the two poles on the iron is unequal, but, nevertheless, very efficacious, as one of the poles acts nearly in contact; or, lastly, it may be articulated between the poles of the electro-magnet by means of

a pivot parallel to the branches of the latter, as in fig. 36. The movement then partakes of a tilting motion, and the attraction is effected in a lateral direction. This arrangement of armatures, however, applies only to the direct action of electro-magnets, which may be either normal or lateral. When we desire to employ the force of the latter on their armatures, through their reciprocal magnetic reactions, the arrangement of the armatures may be modified in three different ways.

They may be fixed flatwise, with regard to the poles of the electro-magnet, to the end of a lever, whose opposite end is hinged near the yoke of the electro-magnet, and whose motion is, consequently, in a direction at right angles to the line joining the poles. The armature, being then placed about one twenty-fifth of an inch above the polar ends of the electro-magnet, is carried over the poles by the magnetic action of the latter until its centre coincides with the axial line of the magnet. This is, as remarked elsewhere, one of the best means of obtaining a large excursion of the armature; but, when the magnet is somewhat powerful, there is some risk of bending the supports. Fig. 37 sufficiently indicates this arrangement. The second way of arranging armatures to obtain a similar magnetic reaction is to pivot them so as to tilt, as shown in fig. 36, above the ends of the magnet, which is provided with soft iron pole pieces. Siemens employed this method, in 1848, for his dial telegraph.

The third arrangement consists in pivoting them in such a way as to allow of their turning between the poles of the electro-magnet, the edges of which have been hollowed out in order that the armature may turn freely through nearly half of a circumference, as in fig. 38. This is evidently the best arrangement, as the normal attraction of the poles, which is not concerned in the angular displacement of the armature, is in this case exerted at the two extreme ends of the armature, and in opposite directions. There is, consequently, no injurious results to be apprehended either to the pivoting or from any flexion of the armature or pieces that support it.

One advantage in employing electro-magnetic arrangements of

this
with
elec
stro
men
syst
insta
ture
doubl
were
1855
so as
magn
axis
also
arran
this c
and t
action
ing to
inner
simpli
figs. 3
magne

In
it is w
for wh
in the
used i
retract
been in
advanta

¹ Exper
at the edg
vince our
the polar

this description, besides the greater armature excursions, is that with the armature at but a little distance from the poles of the electro-magnet, the direct magnetic action, which is always the strongest,¹ reacts from the first instant of the armature's movement, which is precisely opposite to what takes place in other systems of attraction, and hence it is that its advantages in many instances are so marked. Two methods of arranging the armatures, and allowing the use of bar electro-magnets in place of double branched magnets, are shown in figs. 29 to 31. These were first employed in a couple of electro-motors exhibited in 1855. In one, the armature is bent twice at right angles to itself, so as to bring its extremities opposite the two poles of the electro-magnet; the piece which supports it stands perpendicular to the axis of the electro-magnet, and passing through the latter, may also carry another armature, as shown in fig. 29. In the other arrangement, the electro-magnet is hollow, and the armature in this case, a straight bar of iron, is placed inside the iron cylinder, and the armature support passes through the electro-magnet; the action of the latter is manifest in one direction or another, according to the proximity of the armature to one or the other of the inner sides of the cylinder. Preferable forms, on account of the simplicity of the arrangement of the various parts, are shown in figs. 30 and 31, in which an oblong shape is given to the electro-magnets.

In using any of the different combinations here referred to, it is well, whenever practicable, to pivot the armatures on points, for which purpose it is only necessary to employ screw supports in the framework. Sometimes, however, spring supports may be used instead, in which case they are also made to serve as retractile springs to withdraw the armature after the current has been interrupted. (See fig. 34.) This arrangement is especially advantageous when a continuous vibration of the armature is

¹ Experience shows that the electro-magnetic force of an electro-magnet is greater at the edges of the poles than at its centre, a fact of which we can readily convince ourselves by suspending a piece of soft iron and exposing it normally over the polar centres. The iron will be drawn from the vertical towards the edges.

desired, as in electric bells and electro-medical instruments. When two different mechanical effects are to be obtained from a single electro-magnet, without the employment of magnetic armatures, two soft iron armatures, placed parallel to and alongside of each other, are required; but in such cases the retractile springs must be unequally stretched.

By arranging two separate batteries in connection with a transmitter corresponding to an electro-magnet of the previous description, and adjusting the springs properly, it is possible to actuate either one of the armatures at will without the other taking part in the movement.

In the arrangement shown in fig. 27, in which the armature plunges into the magnetizing helices, we have another form of electro-magnet, whose action is similar to that of a piston in a steam engine. Each part is composed of two cylinders of soft iron, united by a yoke of the same metal, and thus really forming a double electro-magnet, although but a single pair of helices are employed.

Various other arrangements of electro-magnets with permanently magnetized armatures are also employed. The simplest arrangement for this kind of magnets is that represented in fig. 39, which is nothing more than a bar electro-magnet provided with one or two armatures jointed at one end. The arrangement, however, is not well adapted for use, except when it is desired to produce a double mechanical effect by means of a single wire. When greater force is required two bar electro-magnets may be employed, placed side by side, as shown in fig. 42. The armatures are then pivoted at their centres, and their limiting contacts are placed on opposite sides of a connecting lever, or of the ends of the armatures themselves, the adjustment being so regulated that the magnetic reaction of the electro-magnet on the latter, or *vice versa*, at the moment of attraction, will not interfere with the desired mechanical effects, notwithstanding the similarity of the poles which stand opposite to each other. It must not be understood, however, with two bar electro-magnets arranged so as to present unlike poles on the same side of an armature, that the

latter
con
the
than
to th
addi
in fi
W
of el
the
made
W
tracti
plove
and h
of a t
is a t
so as
magn
of the
the c
weigh
equid
at its
magn
double
form
armat
rapidit
combin
in whic
the ad
magnet
The
quadru
magnet

latter can be applied as shown in fig. 39 with advantage; on the contrary, such is not the case, as the increased attractive effect of the pole nearest the pivoting of the armature is far less marked than the decrease in the magnetizing power of the current, due to the increased resistance of the circuit by the introduction of an additional helix. But by combining the armatures, as shown in fig. 40, almost equally good results might be obtained.

With the foregoing arrangements combined with other forms of electro-magnets, such, for instance, as that shown in fig. 42, the application of permanently magnetized armatures is easily made, and the magnetic energy somewhat increased.

When magnetic armatures are to be acted upon by both attraction and repulsion, double electro-magnets should be employed. Figs. 40 and 41 show the more frequently used forms; and both present the advantage of allowing the additional action of a third force, which may be gravity. In fig. 40 the armature is a thin magnetized piece of steel, suspended from two pivots so as to oscillate between the four poles of two double electro-magnets, whose helices are connected in such a way that the ends of the magnets facing each other are of opposite polarity when the current circulates. When the current is interrupted, the weight of the armature keeps the latter in a vertical position, equidistant between the poles. In fig. 41 the armature is pivoted at its centre, so as to vibrate between the poles of two electro-magnets, but it will, of course, be understood that a single double electro-magnet may be employed. Fig. 43 represents a form in which the electro-magnet itself is movable while the armature is fixed, but the arrangement is not a good one where rapidity of movement is desired. Fig. 44 shows still another combination, somewhat similar to that represented in fig. 41, but in which the armature is of soft iron and rendered magnetic by the addition of a surrounding coil, instead of being permanently magnetic itself.

The same principle has also been tried in connection with the quadruplex system, in the earlier experiments, when an electro-magnetic, instead of a polarized, armature was used.

STANDARD TIME, NEW YORK CITY.

The standard time of New York City has for some months been determined by the dropping of a ball above the Western Union Telegraph building, at the corner of Broadway and Dey Street, precisely at noon each day, by an operator seated in the National Observatory, at Washington.

The upper portion of fig. 315 shows the time ball raised a little above the supports on which it is received when it falls, and also the structure of the iron pole on which the ball slides. The plan of the ball is shown in fig. 316. Though from a distance the ball appears to be solid, it is in reality composed of a dozen thin vanes of sheet copper disposed radially, half of them semicircles, the rest crescents. By this device the visual effect of a solid ball is secured with the least possible resistance to the wind or to the air when falling. The man in the figure stands two hundred and eighty-seven feet above the street, and the ball rises twenty-eight feet higher. The ball falls twenty-three feet, and is received by the six plungers already mentioned, which enter the closed cylinders attached to the ball, providing as many air cushions for the arrest of the motion of the ball without the shock. The moment the ball begins its downward course is noon.

Five minutes before noon the officer in charge of the station climbs to the room in the tower, shown in fig. 317, and raises the ball nearly to the top of the pole. This is done by means of a drum fixed at the right hand end of the table; the cord from the drum passing upward through a box to the foot of the tower, thence through the air to the top of the pole, where it passes over a pulley and is attached to the ball. Two minutes before noon a signal is received from Washington that all is ready, whereupon the ball is raised to the top of the pole, and the crank removed. The ball is now held in position by means of the lever shown in the cut, one end of which engages the ratchet wheel of the drum, the other being caught in the notch in the little standard to the left. The latter is attached to the armature of an electro-magnet, which is placed in telegraphic connection



and th
pole t
the ele

with the National Observatory, at Washington. At the moment of noon, New York time, the officer in charge at Washington closes the circuit; the armature is retracted, the lever disengaged,

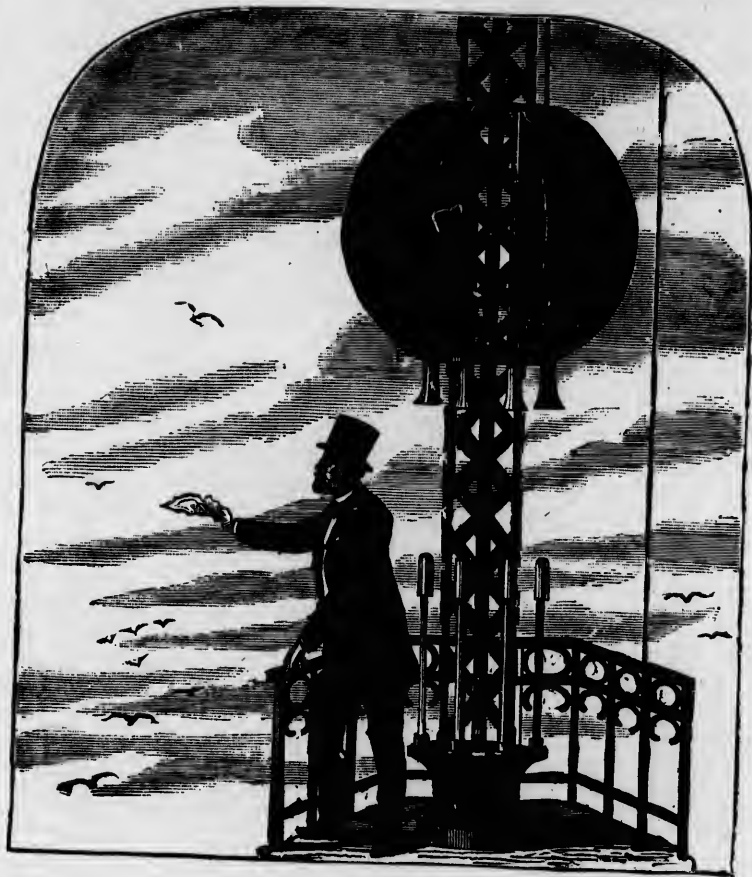

Fig. 315.

and the ball drops. The instant the ball reaches the base of the pole the fact is automatically reported at Washington through the electric tell tale shown at the left end of the table, fig. 317.

Owing to the great height of the ball when raised, it is visible for many miles around ; and directly or indirectly the clocks and watches of some two millions of people are thereby kept from straying far from the true time. Even as far off as Bayonne, N. J., according to a local paper, the principal of a public school regulates his clock daily by the falling ball. The ball and its discharging apparatus were designed by Mr. George M. Phelps, superintendent of the Western Union manufactory. The public service thus rendered by the Western Union Telegraph Company is wholly gratuitous, and affords not only a notable illustration of the public spirit of this great corporation, but also an illustration of the far reaching indirect benefits which applied

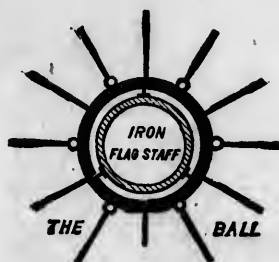

Fig. 316.

science is constantly conferring upon modern life, free of expense to the recipients.

But the time service does not end here. To reap the full benefit of the time ball, a great number of people must watch for its fall ; that takes time, and time is money. It is cheaper to employ one man with a little machinery to regulate the time of all, and the service is much more surely attended to. Accordingly, Mr. J. Hamblet has introduced a system of constant time service, by which our clocks may be kept constantly under the electrical control of a central regulator or standard clock, which is kept in exact time with the clock of the National Observatory, at Washington, due allowance being made, of course, for the difference in geographical position.



Fig. 317.

The central regulator is stationed in the Western Union Telegraph Company's building, and is so constructed as to keep time with the highest attainable accuracy. In addition, it is every day compared with the clock of the National Observatory, at Washington, and checked by the daily time observations made at the observatories at Allegheny, Pa., and Cambridge, Mass., with which it is in telegraphic connection. By this it must not be inferred that the clock in question is kept in exact accord with either or all of the observatory clocks, that being a mechanical impossibility. The range of variation, however, is kept within a few hundredths of a second. It is possible to measure and record the hundredth part of a second. Fig. 318 will make clear how it is done. It shows a section of the paper tape of the chronograph, which is used in comparing the standard clock with the clock of the Washington Observatory. The chrono-



Fig. 318.

graph is electrically connected with both clocks, and records the pendulum beats of each on the strip of paper. If the beats are exactly synchronous, the dots stand side by side. If the beats are not synchronous, the dots will be separated by an interval, long or short, according to the difference of the clocks—that is, the difference in time between the beginnings of corresponding beats—and the speed of the chronograph. Supposing the clock to be beating seconds, and the chronograph to discharge an inch of tape each second, it is obvious that the dots recording the beats of each clock will stand one inch apart. It is obvious, too, that the lineal space between the recording dots of two clocks not beating exactly together can easily be measured, as shown by the scale placed below the dots in the cut (fig. 318), and thereby the difference in time exactly determined.

The next step in the time service is to distribute the accurate

time thus maintained to such as want it, which is done through an electrical attachment to the standard clock. This controlling clock was constructed by E. Howard & Company, of Boston, from designs by Mr. Hamblet, and has a Dennison gravity escapement. The front clock plate and the electrical mechanism are shown in fig. 319. The wheel in the centre with the second hand revolves once a minute. One of its thirty teeth has been

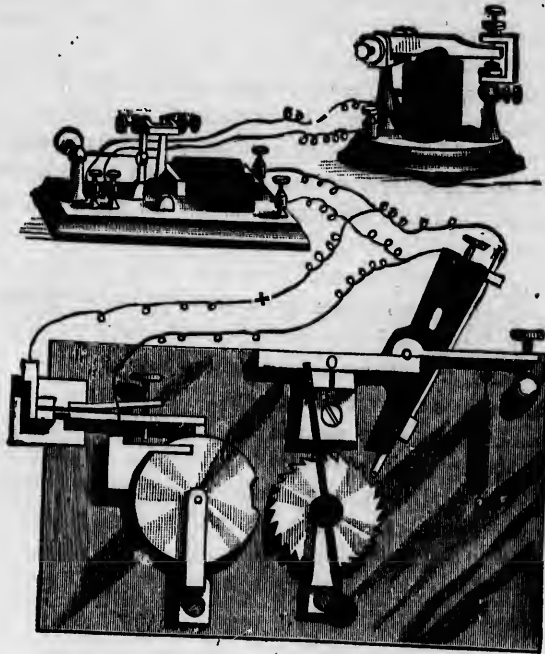

Fig. 319.

filed away, the vacant space causing the omission of the tick which would otherwise mark the fifty-eighth second of the minute. The remaining teeth act upon a delicate jeweled spring, which breaks an electric circuit at the passage of each tooth. The two wires connecting with this spring and its banking operate the relay, at the left of the figure, and through it the sounder,

which indicates the beginning of each minute by a pause of two seconds. The beginning of each five minutes is identified by a pause of twenty seconds, obtained through the agency of the five minute wheel to the left of the seconds wheel. At each revolution of the five minute wheel the lever at the top drops into the notch in the wheel, making electric connection between the two wires governing the relay, thus preventing the minute wheel from breaking the circuit for the space of twenty seconds. At the right, near the top of the figure, is shown a sounder, which may be located at any point on the lines. It is by means of these sounders, with which the recipients of the service are supplied, that their time pieces are regulated.

The practical advantages of this constant and trustworthy time service will appear to any one who has to do with important commercial or industrial affairs. One of the great sources of friction in social and business intercourse is time variation and uncertainty. The maintenance of a common and authoritative standard will go far to lessen such friction, to the great time saving of all classes, and the prevention of many mistakes and misunderstandings. Where thousands are engaged, delays of no more than a minute at a time amount in practical effect to the loss of hours, days, even months of individual labor. In a factory employing only three hundred men, a variation of one minute in the signal for starting and stopping means the loss of one man's work for a whole day.

A
Anv
Am
App
APP
App
Arti
Arti
Atm
Atlas
Auto
Audi
Aust
2

B
Bell
Bentl
P
Beaf
15
Blake
st
tr
Blake
pl
ea
Bours
Bottg
Bregu
ga

C
Cable
Center
Chan
tlo
Charac
gra
Conde
Comb
tel
Constr
Correl
Clarke
me
Curren
tral
Curren
lato
Curren

INDEX.

A **BROAD**, the telephone, 83.
 Accessories and connections of the carbon telephone, 237.
 Anvil, hammer and stirrup, 5.
 Ampère on the repulsion of different elements of a current for each other, 145.
 Applications of the phonograph, 305.
 Application of permanent magnets to telephone, 259.
 Apparatus for producing undulatory currents, 70.
 Articulating telephone, 86.
 Articulate speech, transmission of, 199.
 Atmospheric vibrations, 5.
 Atlantic cable, resistance of, 86.
 Autographic telegraphy, 60.
 Auditory nerves, 6.
 Anstin, Charles E., telephonic experiments, 279.

B**ELL**, Professor A. G., speaking telephone, 17; researches in telephony, 50, 256.
 Bell call, 24.
 Bentley, Henry, experiments with telephones, 225.
 Beaton's researches in telephony, 55, 112, 132, 133.
 Blake, Professor Ell W., contributions to the speaking telephone, 274; use of railway track for, 79.
 Blake, Dr. Clarence J., experiments with a phonautograph made out of a human ear, 69.
 Bonreilles, Charles, proposed telephone, 147.
 Bottger's Polytechnical Notizblatt, 147.
 Breguet's telephone and telephonic investigations, 287.

C**ARBON** telephone, 85; measuring resistance of, 85; invention of, 223.
 Cable, working telephone through, 87.
 Centennial exhibition of telephone, 73.
 Channing, Dr. William F., telephonic inventions, 78, 274.
 Characteristics of sound, 95; of the phonograph, 307.
 Condenser, application to telephone, 81.
 Combination of the Morse and harmonic telephone, 167.
 Construction of the telephone, 83, 293.
 Correlation of forces, 42.
 Clarke, Louis W., researches and experiments in telegraphy, 78, 279.
 Current induction, arrangements for neutralizing, 392.
 Currents, intermittent, pulsatory and undulatory, 54.
 Currents produced in the telephone, 291.

D**ELEZENNE's** researches in telephony, 56, 117, 139.
 De la Rive, researches in telephony, 55, 112, 131.
 Diaphragm, vibrating, 16.
 Discharge of a Leyden jar through an iron wire causes the wire to produce a sound, 123.
 Dolbear's, Professor A. E., speaking telephone, 19, 75; researches, 260; magneto-electric telephone, 263; electrophone, 267; projective apparatus, 269; convertibility of sound into electricity, 272.
 Du Moncel's researches in telephony, 53, 146; theory of the telephone, 283.

E**AR**, human, employed as a phonautograph, 69.
 Early experiments in telephony by Ellisha Gray, 135.
 Edison's telephonic researches, 218; Carbon telephone, 224; talking phonograph, 292; electro-static telephone, 233; electro-harmonic telegraph, 167; thermo-electric telephone, 233; quadruplex telegraph, 310; electro-motograph, 371.
 Effects produced by resonant devices, 193.
 Electrical rheotome, 119; transmission of speech, 145.
 Electro-magnetic piano, 52.
 Electro-motograph, 371.
 Electro-harmonic telegraphy, 235.
 Electro-static telephone, 231.
 Electric call bells, 375; combination keys, 377; apparatus for giving the signal, 379; the vibrating bell, 380; double bells, 382; single bells to be worked without interrupting the circuit, 385; electric alarm with relays, 387; Siemens and Halske station alarm, 388; Breguet's alarm or call, 388; combination of a single call with two or more relays for several lines, 391; Siemens's and Halske's relays with annunciator plate, 392; clock work alarm, 395.
 Electric light, 400; Brush's improved carbons, 427; Brush's dynamo-electric machines, 425; Brush's automatic regulators, 412; cost of the light, 428; Davy's experiments, 400; Duboscq's regulator, 403; Farmer's automatic lamp, 409; Farmer's dynamo-electric machine, 423; Foucault's regulator, 406; Gramme's machine, 421; Hart's lamp, 409; Jablockhoff's candle, 410; Ladd's dynamo-electric machine, 419; magneto-electric machines, 413; Siemens's armature, 417; subdivision of the light, 427; temperature of the arc, 401.

- Electric light, 429; arrangement of circuit for street lighting, 491; automatic switch for Jablochhoff candle, 498; alternating current machine, 432; Archereau's carbons, 435; armature of the Gramme machine, 442; Brush dynamo machine, 426, 443; Brush's automatic regulator, 412, 447; Bunsen's photometer, 450; cost of Jablochhoff's candle, 494; cost of electric light with Jablochhoff's candles per hour, 494; cost of the electric light, 496, 487, 510, 515; Carré's carbons, 431; comparison of different carbons, 437; comparative merits of different magneto-electric machines, 471; comparison with results obtained by Mr. Douglas, 455; current and electro-motive force of dynamo-electric machines, 464; condition of economical working, 467; current for illuminating houses first used, 503; Dnocomun foundries at Mulhouse lighted by electric lamp, 514; De Méritens' dynamo-electric machine, 495; Douglas' report on electric lighting, 454; electrical resistance of dynamo-electric machines, 457; efficiency of dynamo-electric machines, 463; energy of current in heat units, 469; effects of dynamo-electric currents in foot pounds per minute, 470; electric light in the Place de l'Opera, 493; electric lamps with continuous conductors, 501; experiments before the Society of Physica, 503; Edison's invention, 506; Electro-Dynamic Light Company, 506; Farmer, Moses G., subdivision of the electric current for illuminating purposes, 508; Farmer's magneto-electric machine, 423, 445; Farmer's automatic lamp, 409; first building illuminated with electric light, 508; Foucault's gas retort carbon, 439; Franklin Institute experiments, 489; Gramme ring, 496; Gramme machine, 440; Gramme's alternating current machine, 482-486; greatest distance to which the current of one machine is transmitted in Paris, 493; Gaudoin's carbons, 483; Gramme's machine and Carré's lamp, 437; incandescent pencil, 501; Jacquelin's carbon, 450; Jablochhoff's candle, 410, 487-490; light obtained from a small Gramme machine, 504; Lontin's machine and lamp, 513; measurement of current, 459; measurement of electro-motive force, 463; Maxim's machine and lamp, 473-480, 513; measure of the total heating power, 468; Planté's secondary elements employed for producing light, 505; platinum and iridium used for electric lighting, 506; photometric measurements, 451; power utilized in the electric arc, 470; Silliman's observation on the waste of carbon, 401; Sawyer-Man lamp, 508; Shea, Charles E., title of invention, 507; Siemens' arrangement for controlling the current, 508; Rapleff's system of electric lighting, 509; Reynier's electric lamp, 501; retort carbon, 436; revolving contact, 502; renewal of carbon, 502; street illumination by electricity, 481; table of resistances of dynamo-electric machine, 460; thermic effects of dynamo-electric machines, 461; table of mechanical details relating to electric lighting, 441; Thomson and Houston's machines and lamp, 498; variations in the amount of light produced, 453; Wallace-Farmer machine, 453; Farmer's electric light, 515; Edison's indefinable subdivision of, 506; Edison's application for patent for, 507; Edison's method of overcoming difficulty of fusion of platinum wire for, 507.
- Edison's recent telephonic and acoustic inventions, 526; aerophones, 556; action of microphone not analogous to microscope, 543; bibulous paper transmitting telephone, 527; button made of gas retort carbon, 531; carbon transmitting telephone requiring no adjustment, 527; carbon telephone with soft iron armature, 529, 530; carbon button, 531; charcoal microphone, 535; cork and plum-bago microphone, 535; condenser telephone, 546; Carbon rheostat, 551; carbon telephone, 222, 537; durability of the carbon button, 533; elasticity of lamp-black buttons, 533; experiment with a Rutherford diffraction grating, 532; electro-static telephone, 233; electro-harmonic telegraph, 167; electromotograph, 371; experiments with Edison's carbon telephone by Prof. Barker and Henry Bentley, 573; Gray's combination, 576; graphite buttons, 531; harmonic engine, 560; Hughes' experiments on Edison's discovery of the variable resistance of conducting substances under pressure, 531, 536; Inertia telephone, 528; lamp-black used in making carbon button, 530; mercury telephone, 527; modified Reiss telephone, 538; manufacture of carbon buttons, 531; microphone, 534; metallized charcoal transmitter, 540; mechanical telephone, 546; motograph, 549; musical transmitter, 540; micro-tasimeter, 557; megaphone, 561; phonometer, 565; phonograph, 293; Phelps' combination, 575; quadruplex telegraph, 310; pulverized black lead telephone, 527; number of points of contact on a carbon button, 530; nail transmitter, 543; carbon silk coated microphone, 536; short circuiting telephone, 544; stethoscopic microphone, 563; thermo-electric telephone, 233; telephone exchange system, 576; voltaic pile telephone, 543; undulatory current, 539; value of different substances to be used as buttons, 533.
- Edison's early life, 538; enormous capacity for work, 536; originality and genius, 535.
- Electro-magnetism and duplex telegraphy, 588; arrangement of armatures, 601; Boscha's duplex, 559; form and mass of the armature, 596; laws of the electro-magnet, 594; maximum of magnetization, 593; movement of the armature, 597; proportion of forces to diameter, 595; Schreder's duplex, 560; single coil electro-magnet, 592; various forms of electro-magnets, 599.
- Electric time service, 606; comparison of clock of the National Observatory, at Washington, with daily time observations made at observatories in Allegheny and Cambridge, 610.

- F**OURIER'S law of vibrational forms, 240.
- G**ALVANTO music, 110.
- G**ASSIOT'S researches in telephony, 55, 117.
- Galileo's observations, 226.
- Gay-Lussac's discoveries, 123.
- Gore's researches, 56.
- Gower's, F. A., experiments, 80.
- Gottin de Comma's observations, 122.
- Gray, Elisha, telephonic researches, 151, 171; electro-harmonic telephone, 167; early experiments in telephony, 185; bath-tub experiments, 187; violin experiment, 188; phenomena attending the transmission of vibratory currents, 171; discovery of the speaking telephone, 15; transmission of composite tones, 189; telephonic specifications filed in the United States Patent Office, February 14, 1876, 217.
- Graphical method of physicists, 245.
- Graham, Professor, theory of vibration of Trevelyan's bars, 115.
- Grove's experiment demonstrating the tendency of the particles of magnetic bodies to group themselves under the influence of magnetism in a longitudinal or axial direction, 128.
- Guillemin's researches in telephony, 55, 112, 123.
- H**ENRY, Professor Joseph, telephonic researches, 14.
- Helmholtz on the human voice, 48; analysis of the vowel sounds, 51, 63; of vocal sounds, 235; method of analyzing tones transmitted through a wire, 161.
- Humorous example of telephonic expectancy related by W. H. Preece, 82.
- I**NDUCTION currents, 87, 104.
- Influence of molecular actions upon magnetism, produced by dynamic electricity, 134.
- Induced currents, reactive effect of, 179.
- Invention of the speaking telephone, 201.
- Improvements by Channing, Blake, Peirce, Jones and Austin, 275.
- J**ANNIAR'S telephonic researches, 55.
- Joule's researches in telephony, 55; influence of magnetism over dimensions of bodies, 123.
- Jones, Edison S., invention of telephone handle, 276.
- K**NIGHT'S American dictionary, cuts from, 69, 296, 297.
- König's researches, 68; phonograph, 295; monometric flames, 299.
- L**A COUR'S telephone, 62.
- Laborde's telephonic researches, 55.
- Legat's telephonic investigations and publications, 55.
- Logograph invented by W. H. Barlow, F. R. S., 295.
- Logographic records, 297; with the human ear, 298.
- M**AGGI'S heat experiments, 133.
- Marianini's experiments, 135.
- Magnetic cores for telephones, 177.
- Magnetic speaking telephone, 221.
- Manometric capsule, 68.
- Maurey's experiments, 68.
- Matteucci's experiments, 55, 112.
- Marran's researches, 55, 112, 117.
- Magneto-electric machine, 23.
- Membrane, elastic, 6.
- Morse telegraph contrasted with the telephone, 84.
- Molecular forces disturbed by magnetism, 111; action of magnetic bodies, 117, 121.
- Multiple telegraphy, 57.
- Mayer's, Professor A. M., magnified tracings on smoked glass of the talking phonograph record on the foil, 303; what the form of the trace depends upon, 304.
- N**ICOL'S tubular electro-magnet, 101.
- O**HM, or unit of resistance, 103.
- On the disturbance of molecular forces by magnetism, 111.
- On the convertibility of sound into electricity, 272.
- P**AGE, Dr. Charles G., researches in telephony, 110, 117, 252.
- Peirce, Professor John, experiments and inventions, 76, 274.
- Peculiarities of vibratory currents, 173; of compound vibrations, 247.
- Phelps's telephone, 21.
- Phonograph, the talking, 292; mounting of the, 301; what clearness of articulation depends upon, 303.
- Phonautograph, Barlow's, 295; König's, 295; Scott's, 295; experiments with, 68.
- Phonographic records, tracings from, 303; dramas; letters, 305.
- Phil box telephone, 90.
- Plate, inflexible, 27.
- Poggendorf's researches in telephony, 55.
- Providence experiments, etc., 76, 274.
- Preece, W. H., observations on the telephone, 82.
- Production of vocal sounds, 181.
- Properties of the pendulum, 237.
- Producing the record of sound, 294.
- Q**UADRUPLEX telegraphy, 309; bridge method, 313; differential method, 315; combined differential and bridge methods, 321; arrangement of apparatus for long circuits, 325; double acting relay, 329; single current transmitter, 336, 339; adjustment of the quadruplex, 341; combined quadruplex and duplex circuits, 345; arrangement for contraplex transmission, 347; combined duplex and contraplex systems, 349; combined duplex and contraplex systems, 349, 351; combination of quadruplex and duplex systems, 353; quadruplex repeater, 355, 357; improved relay, 353; directions for setting up the quadruplex, 356; the double current transmitter, 356; the compound polarized relay, 338; the single polarized relay, 340; adjustment of the apparatus for working, 341; combination of quad-

- rux and diplex systems, 353; arrangement for branch offices, 359; quadrux and single circuit combination, 361; arrangement for neutralizing current induction, 362; induction between parallel lines, 363; double transmission in the same direction, 364; early methods of simultaneous transmission in the same direction, 364; Bernstein's method, 365.
- R**EACTION effect of induced currents, 179.
- Resonant devices, effects of, 183.
- Remarks on the theory of the telephone, 239.
- Receivers, telephonic, 219.
- Researches in telegraphy by Edison, 218; Reiss, 55, 251.
- Reiss's telephone, 251.
- Rheotome, 78.
- Rahmkorff's coil, 78.
- S**ALEM lecture reported by telephone, 76.
- Silvertown Company, 94.
- Scott's, Léon, phonograph, 63, 295.
- Signaling apparatus for telephones, 29, 239.
- Sound, characteristics of, 7, 95, 293; convertibility into electricity, graphic representations of, 9; velocity of, 243; Tyndall's lectures on, 240; sound waves converted into heat waves, 234; vibrations of, 5.
- Sounds of the human voice, 97; Helmholtz, analysis of vocal, 235; produced in iron wire by passage of electricity, 122; produced by molecular changes, 253.
- Sonorous undulations, 99.
- Specifications of telephonic inventions filed in the United States Patent Office, February 14, 1876; Gray's, 202; Bell's, 205.
- Speaking telephone, invention of, 201.
- Sympathetic vibrations, 87.
- T**ALKING phonograph, 232.
- Telephone, articulating, 15; audibility of, 38; American speaking company, 46; application of permanent magnets to, 259; accessories and connections of the carbon, 227; Bell's, 17, 50, 205; battery, 32; Baille's, 47; Breguet's, 237; Bourselle's, 147; Bendey's experiments, 225; correlation of forces illustrated by, 42; carbon, 34, 223; caveat for, 217; currents produced in, 291; conversation of English scientists about, 82; Channing, Dr. William F., inventions, 277; Dolbear's, 19, 75; double diaphragm, 33; duplex, 21; distance over which it can be worked, 81; Edison 35; Edison's researches, 218; electro-static, 231; electro-harmonic, 187; Gray's, 15, 73; Gray's telephonic researches, 152; Gray's electro-harmonic, 187; Gray's caveat, 217; handle, 276; innumerable uses of, 45; illustration of correlation of forces by the, 42; improvements by Channing, Blake, Peirce and Jones, 275; E. S. Jones, handle, 276; limit of audibility, 38; musical, 9; Morse combination, 41; magneto, 221; magnetic cores for, 177; Phelps's duplex, 21; Peirce's monthpiece for, 275; pill box, 90; Reiss's, 9, 142, 251; repeater, 39; receivers, 193, 219; remarkable phenomena, 281; siphon recorder, 279; signaling apparatus, 29, 239; sensitiveness of, 265; switch, 40; speaking, invention of, 201; Thomson's report, 93; tones produced by electric currents, 111, 139; theory of, 288; vibratory bell, 41; vibrating diaphragm, 16; vibratory plate, 48; working through cable, 81.
- Tone, 6; simple and composite, 8.
- Tracings of air vibrations, 91; from phonograph records, 303.
- Transmission of composite tones, 189.
- Transmitting reeds, 191.
- Tyndall's experiments, 156; lectures on sound, 240.
- U**SES of the phonograph, 303.
- Undulatory currents, 53, 83, 208.
- University, Boston, 72.
- V**ARLEY, Cromwell F., researches, 62.
- Various forms of transmitting reeds, 191; telephonic receivers, 193; transmitters, 197.
- Velocity of sound, 243.
- Vibrating plate, 48; rods, 239.
- Vibratory circuit breaker, 59; movements and molecular effects determined in magnetic bodies by the influence of electric currents, 117; currents, peculiarities of, 173; motions of fluids, 241.
- Vibrations, propagation of compound, 247; of Trevelyan's bars by the galvanic current, 113; of sound, optically exhibited, 68.
- Vibrational forms, Fourier's law of, 249.
- Visible speech, 68.
- W**AGENER's hammer, 140.
- Watson's, Thomas A., assistance in perfecting the speaking telephone, 71, 77.
- Wartmann's researches in telephony, 55, 113.
- Wertheim's researches in telephony, 55; on the elasticity of metals, 123; analysis of the mechanical effects manifested in magnetism, 124, 125, 139.
- Western Electric Manufacturing Company telephonic apparatus, 31, 32, 33.
- Working telephones over artificial lines, 108.
- Wheat-tone's instruments, 104.
- Wilson's, Charles H., method for overcoming current induction, 362.

; improve-
Pierce and
ndle, 276;
; Morse
, 9; magnetic
plex, 21;
; pill box,
er, 39; re-
phenomena,
signalling
ss of, 235;
n of, 201;
produced
theory of,
ating dia-
8; work-

n phono-

89.

ures on

08.

62.

g reeds,
; trans-

vements
In mag-
electric
titles of,

nd, 247;
nic cur-
hibited,

249.

ance in
71, 77.
55, 118.
55; on
analysis
sted in

mpany

es, 103.

ercom-

ELECTRO-MAGNETS.

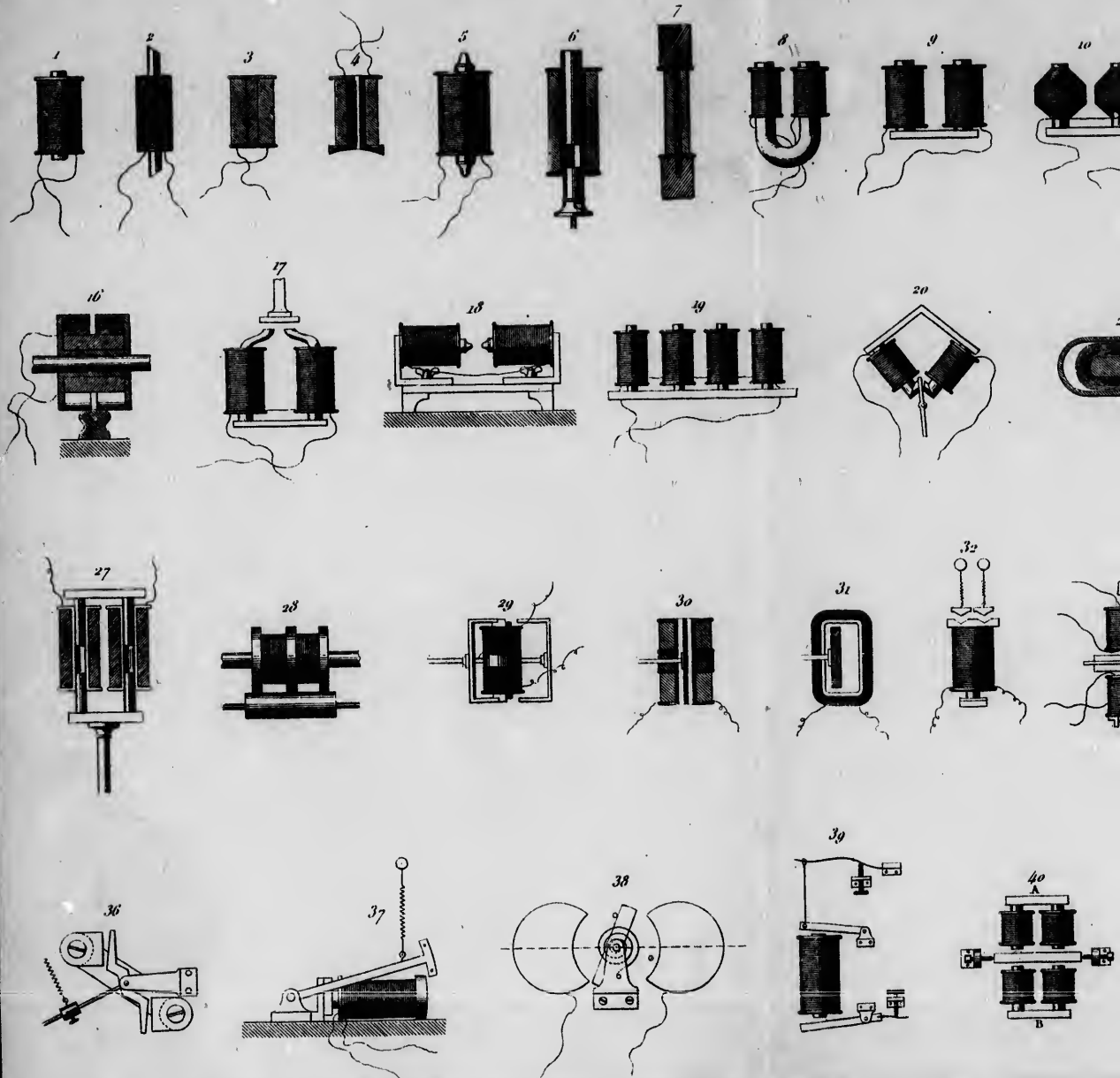

O-MAGNETS.

