

J. H. Grisdale  
Exp. Farm. June 15, 02

# THE FARMER'S ADVOCATE

AND HOME MAGAZINE

PERSEVERE  
SUCCEED  
FOUNDED 1866

\* AGRICULTURE, STOCK, DAIRY, POULTRY, HORTICULTURE, VETERINARY, HOME CIRCLE \*

REGISTERED IN ACCORDANCE WITH THE COPYRIGHT ACT OF 1875. PUBLISHED AT

Vol. XXXVII. LONDON, ONTARIO. APRIL 15, 1902. WINNIPEG, MANITOBA. No. 548

## Land for Everybody.

Free Grants of Government Lands. Cheap Railway Lands for Sale on Easy Terms.

**GOOD SOIL. PURE WATER. AMPLE FUEL.**

Take your choice in  
**Alberta, Assiniboia, Saskatchewan or Manitoba.**

Most desirable land can be obtained in Southern Alberta in close proximity to the Calgary and Edmonton Railway and the Crow's Nest Pass Railway, suitable for Mixed Farming and Ranching on both a large and small scale.

Most desirable land can be obtained in the Olds District, along the line of the Calgary and Edmonton Railway, about fifty miles north of Calgary.

In the Prince Albert, Duck Lake and Rosetern Districts, on the line of the Qu'Appelle, Long Lake and Saskatchewan Railway.

In the Beaver Hill District and along the line of the Manitoba and Northwestern Railway.

For full information concerning these Districts, Maps, Pamphlets, etc., FREE, apply to

**Osler, Hammond & Nanton,**  
LAND OFFICE,  
440 Main St. WINNIPEG, MAN.

**Windsor Salt Makes Fine Butter!**

Creameries that have gained a reputation for making the finest high-grade butter are the largest users of Windsor Salt. Can you have better proof of its purity, dryness, evenness, than this?

**BEST GROCERS SELL IT.**

**Catalogue Printing Our Specialty.**

Many of the best Catalogues in Canada are produced by us. Latest type faces, designs, ornaments, and modern machinery. — Best in America. Up-to-date covers designed by special artists without extra charge.

**London Printing & Litho. Company, Ltd.,**  
LONDON, ONTARIO.

**\$3 a Day Sure**

Send us your address and we will show you how to make \$3 a day absolutely sure; we furnish the work and teach you free; you work in the locality where you live. Send us your address and we will explain the business fully; remember we guarantee a clear profit of \$3 for every day's work, absolutely sure, write at once.

**REFERRAL SILVERWARE CO., Box 608, WINNIPEG, ONT.**

### CONTENTS OF THIS NUMBER. PAGE.

EDITORIAL.—USE OF GOOD SIRE; BUILDING PERMANENT SILOS	289
A CALL FOR HELP IN A WORTHY WORK	290
HORSES.—MR. INNES CLOSES THE HORSE JUDGING CONTROVERSY	290
THE "FARMER'S ADVOCATE" AS A MONEY SAVER	290
JUDGING A HORSE'S AGE BY HIS TEETH (ILLUSTRATED)	293
HIWATHA 1907 AT TEN YEARS OLD (ILLUSTRATION)	293
STROXTON TOM (ILLUSTRATION)	291
STOCK.—IMPROVED SIRE FOR IMPROVED STOCK	292
GALLOWAYS AT CASTLE-DOUGLAS; CASTOR OIL FOR RINGWORM	292
BLACK LAMBS: A REMARKABLE EXPERIENCE	292
THE BY-PRODUCTS GIVE THE PROFIT; IN THIS HOME SINCE 1866	293
OUR SCOTTISH LETTER; TO MAKE BOX MEASURES	294
THE ESTABLISHMENT OF CO-OPERATIVE PORK-PACKING HOUSES	294
VALUE OF WHEAT FED TO HOGS	294
SELECT THE BEST MILKING EWES	294
DR. RUTHERFORD APPRECIATED	294
FARM.—CORN THE MOST PROFITABLE CROP; A BEAVER COLONY	294
HAZZARD MINES (ILLUSTRATION)	295
A WESTERN INDUSTRY OF GROWING IMPORTANCE	295
A COMMON MISTAKE REGARDING WORK	295
THE FARMER AS A THINKER; AN ESSENTIAL IN A GOOD POTATO	295
HEDGE PLANTING IN DECEMBER: A SINGULAR EXPERIENCE	295
THE ROCHE PERCEE, OR PIERRED ROCK	296
HOW CAN THE FARMER EDUCATE HIMSELF	296
AN EASY METHOD OF GROWING POTATOES	296
STYLE OF WINDOWS AND VENTILATION FOR BASEMENT STABLES	296
PROVIDE FOR A DRY TIME; ROOT GROWING	297
A COMFORTABLE HOMESTEAD, A. W. KENT'S (ILLUSTRATION)	297
COLD STORAGE AS AN INVESTMENT	297
DESTROYING PASTURE WEEDS	297
HOW TO MAINTAIN SOIL FERTILITY	297
PIOWING ON THE FARM OF A. W. KENT (ILLUSTRATION)	297
CEMENT SILOS; HOW TO CONSTRUCT A CEMENT SILO—BUILT 19	298
CANNOT SAY TOO MUCH FOR SILAGE	298
ADVISES PLASTERING ROUND CEMENT SILOS INSIDE AND OUT	298
NEW CEMENT SILO NEEDS WATER—SATISFACTORY EXPERIENCE	298
CEMENT SILO ENTIRELY SATISFACTORY	299
ROUND CEMENT SILO A COMPLETE SUCCESS	299
CEMENT SILOS REPLACING WOODEN ONES	299
COST OF A LARGE CEMENT SILO; MR. R. ROBINSON (PORTRAIT)	299
GROWING AND SELECTION OF SEED GRAIN	299
EXPERIENCE WITH STONE SILO; DOUBLE CEMENT SILO	299
MR. JOHN ANDERSON'S CATTLE STABLE BASEMENT (ILLUSTRATION)	300
STABLE MANURE AND SUGAR BEETS	300
DAIRY.—DAIRYING IN BRITISH COLUMBIA	300
THE CHEESE FACTORY SECRETARY'S REVERIE	300
CARE OF CREAM ON THE FARM	301
GOLDEN LAD, P. 122, H. C. J. H. B. (ILLUSTRATION)	301
THE CARE OF MILK FOR BUTTERMAKING	301
CREAMERIES: CO-OPERATIVE OR PROPRIETARY	301
SOWING MANGELS AND SUGAR BEETS	301
IN DEFENSE OF THE CREAM-GATHERED SYSTEM	301
LADY BUTE OF MID-ASCOG—9188—(ILLUSTRATION)	302
AGAINST THE CREAM-GATHERING SYSTEM	302
THE PRODUCTION OF MILK BY THE AVERAGE COW	302
APIARY.—ON THE PREVENTION OF SWARMING	303
GARDEN AND ORCHARD.—ORCHARD INSTITUTE MEETINGS	303
PLEASED WITH HIS PRESENT—TREATING APPLE TREES—MILLET FOR FODDER; FERTILIZER IN ONION GROWING	304
REACHES GOOD MEN; CONSTANCY	304
POULTRY.—THE BUFF ORPINGTON AS A GENERAL UTILITY FOWL	304
IMPORTED BARRED PLYMOUTH ROCK COCKEREL (ILLUSTRATION)	304
BUFF ORPINGTONS (ILLUSTRATION)	304
CARNEGIE'S ADDRESS: SUCCESSFUL POULTRY RAISING	305
QUESTIONS AND ANSWERS	305
VETERINARY: LYMPHANGITIS; WIND SUCKER AND COLT WITH WEAK FETLOCKS; PECULIAR TROUBLE IN COW; COW WITH A COUGH; HORSE SORE IN FRONT; OBSTRUCTION TO MILK DUCT; CATARRH OR GRUB IN THE HEAD IN EWES; LICE ON CATTLE AND SKIN DISEASE IN MARE; COLT THAT GOT HIS STIFLE HURT; IMPACTION OF THE THIRD STOMACH, OR FARDEL-BOUND; PARALYSIS IN SOW; WORMS IN HORSE; CONTUSED WOUNDS—RINGWORM; BLACK QUARTER; DISLOCATION OF PATELLA; ECZEMA IN COLT; INFLAMMATION OF THIRD STOMACH; PHYSIC FOR CATTLE	305, 306
MISCELLANEOUS: DEFAULTING DRIVER; CARROTS FOR COWS; SOWING RAPP FOR HOGS; CURE FOR COLIC; INFORMATION WANTED RE CIRCULAR BARN BUILDING; CORN LITERATURE—CHESTER WHITE HOGS—DRIED BLOOD FOR CALVES; CORN RATIONS; REPAIRING A SILO; TAMWORTH ORIGIN—A READER FOR 35 YEARS; FACTS ABOUT SPELT—BARNYARD MANURE IN SUMMER—MANURING SPRING GRAIN; VENTILATING A STABLE (ILLUSTRATED); ENSILAGE AND COWS' TEETH: A WORK ON POULTRY; PRESERVING EGGS; LINE FENCE DIFFICULTY; KEEPING VICIOUS DOGS; CATTLE ON ROAD; REMOVAL OF MANURE; COST OF REGISTERING CATTLE; PROPERTY IN SWARMS OF BEES; PRUNING—RAPE FOR COWS; PERMANENT PASTURE; NUTRITIVE BATHS; COAL ASHES AS A FERTILIZER; TWO-HORSE TREAD POWER; BRICK PIG-HOUSES; CLOVER SEEDING TO PLOW DOWN FOR CORN	306, 307, 308
MARKETS.—FARM GOSSIP: PLANT FOOD; TAXING OLEOMARGARINE; A CANADIAN RAILWAY COMMISSION; KENT CO., ONT.; STRATHROY DAIRY SCHOOL; GUELPH DAIRY SCHOOL GRADUATES; ORIGIN OF THE EXPERIMENTAL UNION; BETTER THAN REPRESENTED: THE HORSE SHOW A SUCCESS; MIDDLESEX CO., ONT.; WANT CANADIAN EGGS; COMING TO CANADA; P. E. ISLAND; ABOUT "BUG DEATH"; OTTAWA NOTES; PORTABLE NET FENCE	308, 309, 310
TORONTO MARKETS; MONTREAL MARKETS; BUFFALO MARKETS; CHICAGO MARKETS	310
GOSSIP	315, 318, 319, 323, 324, 327, 328
BOOK REVIEWS	326
NOTICES	315, 325
ADVERTISEMENTS	285 to 288, 315 to 328

**A GOOD BREAKFAST**

Is what you need if you want to do a good day's work; such a breakfast is to be got from

## SHREDDED WHEAT BISCUIT

which contains all the nutriment needed to sustain you in your work. Shredded Wheat Biscuit is made from the Whole Wheat, thus making it a natural food. Everybody who wants to be in good health should eat Shredded Wheat Biscuit for Breakfast, Dinner and Tea. It is just what growing children need to keep them in health.

ONCE USED ALWAYS USED.

Have you tried it? If not, you should do so at once. Don't delay. Send a postal for our Neat Booklet, setting forth various ways of preparing the Biscuit. Address:

**THE NATURAL FOOD CO.,**  
61 Front Street, East,  
TORONTO, ONT.

## Cheese and Butter

Makers of these articles, in many instances, do not pay the necessary attention to the quality of the Salt they use. Some people think that "Salt is Salt," and it does not matter where it comes from or who makes it. This is a great mistake, for it is essential that to produce the best Butter or Cheese nothing but the purest Salt should be used.

## RICE'S DAIRY and TABLE SALT

STAND UNRIVALLED.

FOR PRICES, ETC., ADDRESS:

**R. & J. Ransford, Clinton, Ont.**  
ESTABLISHED 1868.

## DOMINION LINE STEAMSHIPS

**FOUR PASSENGER SERVICES:** Montreal to Liverpool, Portland to Liverpool, Boston to Liverpool, Boston to Mediterranean.

These services are maintained by large and fast steamers with midship saloons, electric lights and every convenience to make the voyage enjoyable. Rates of passage are very moderate, and we would ask intending travellers to apply for all information to a local agent of the company, or to

**RICHARDS, MILLS & CO.,**  
77 STATE ST., BOSTON. 69 DEARBORN ST., CHICAGO.

**DAVID TORRANCE & CO.,**  
17 ST. SACRAMENT ST., MONTREAL. 10 COMMERCIAL ST., PORTLAND.

ADVERTISE IN  
**THE FARMER'S ADVOCATE.**



## FITS EPILEPSY

**FREE SAMPLE OF LIEBIG'S FIT CURE.**

If you suffer from Epilepsy, Fits, Falling Sickness, St. Vitus Dance, or have children or relatives that do so, or know a friend that is afflicted, then send for a free trial bottle with valuable Treatise, and try it. The sample bottle will be sent by mail, prepaid, to your nearest Post Office address. It has cured where everything else has failed. When writing, mention this paper and give name, age and full address to THE LIEBIG CO., 179 KING ST. WEST, TORONTO, CANADA.

ESTABLISHED 1860.  
SUCCESSORS TO  
WM. EVANS SEED CO.

## Ewing's Seeds

SELECTED  
FARM  
AND  
GARDEN

are thought reliable, and better cannot be found. We mail Free our Illustrated Seed Catalogue for 1902, to all sending us their addresses. No seed house has a higher reputation nor can serve you better in regard to quality, extent of assortment or prices.

**WM. EWING & CO.,**  
SEED MERCHANTS,  
142 MCGILL ST., MONTREAL.

## Trees! Trees! Trees!

We have a full line of Fruit and Ornamental Trees for spring, 1902, at lowest possible prices. Headquarters for packing dealers' orders. Farmers wishing to buy first-class stock absolutely first hand and without paying commission to agents, should write to us at once for a catalogue and price list. Don't wait until the last minute, as you will be disappointed. Place order early and secure the varieties you want. Correspondence solicited.

**Winona Nursery Co.,** WINONA, ONT.



Good shorthanders are in demand among business men everywhere. In the Federated Business Colleges you get a thorough training in shorthand and typewriting, fitting you to occupy responsible positions.

These Schools are situated at Toronto, Hamilton, London, Ottawa, Sarnia, Berlin, Galt, St. Catharines.

**J. W. WESTERVELT,** London, President.  
**DAVID HOSKINS, C. A.,** Toronto, Vice-President.  
**O. R. McCULLOUGH,** Hamilton, Managing-Director.

Now is a good time to enter. No vacation.

### RIPPLEY'S COOKERS

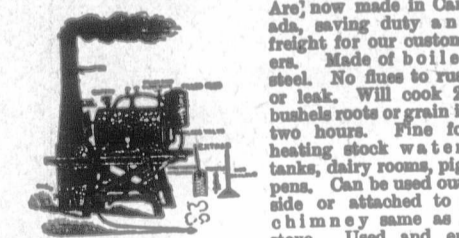

Are now made in Canada, saving duty and freight for our customers. Made of boiler steel. No fines to rust or leak. Will cook 25 bushels of grain in two hours. Fine for heating stock water-tanks, dairy rooms, pig-pens. Can be used outside or attached to a chimney same as a stove. Used and endorsed by the following Canadian breeders and many others: Brethour & Saunders, Burtford; W. D. Platt, Hamilton; D. C. Platt & Son, Millgrove; H. J. Davis, Woodstock; Ontario Agricultural College, Guelph; also James Boden, Graham Bros., Newton & Gosh, J. A. McDonald, J. P. Connely, Price, \$10 to \$45. Took first premium at Toronto and London fairs. Catalogue and prices mailed free. Address: **RIPPLEY HARDWARE COMPANY,** BOX 215, LONDON, ONT. U. S. Factory: Grafton, Ill.



**ROCK SALT** for horses and cattle, in ton and car lots.

**FARMERS, ATTENTION!**  
Concrete walls, floors, cisterns, cheese factory floors, built by an expert (12 years' experience). **London Cement Construction Company,** 419 Ridout St., London, Ont.

PLEASE MENTION FARMER'S ADVOCATE.

**NO CURE NO COST**



## REMOVE THE SPAVIN

Takes but one 45-minute treatment to take off most of the bad ones. Seldom known to fail. You think this claim strong because you think spavins hard to cure, but they are not. Splint, Ringbone, Curb, etc., just as easy. If Fleming's Spavin Cure ever fails it is free. Write today for our free spavin book.

R. B. McKee, Centerville, Pa., writes: "The druggist here sent to you for a bottle of Spavin Cure for a friend of mine. He took off one spavin with it, and I took off two with the rest. I think it wonderful."

### Cure Fistula and Poll Evil

Cure in two to four weeks. Not one failure, nor do we believe failure possible. A scientific cure that anybody can use with perfect success. Fleming's Fistula and Poll Evil Cure will make the existence of these diseases impossible. Write us today.

### Lump Jaw Will Disappear

Just as soon as all stock raisers learn what Fleming's Lump Jaw Cure will do; the disease will banish from the earth. Known and tried too long for any one to doubt its worth. Costs nothing if it ever fails.

C. L. Tamehill, Hebron, Ind., writes: "The one bottle I got from you cured four lump jaws."

Write today for instructive circulars on above. Mention this paper.

**FLEMING BROS.,** Chemists,  
36 Front Street, West, Toronto, Ont.

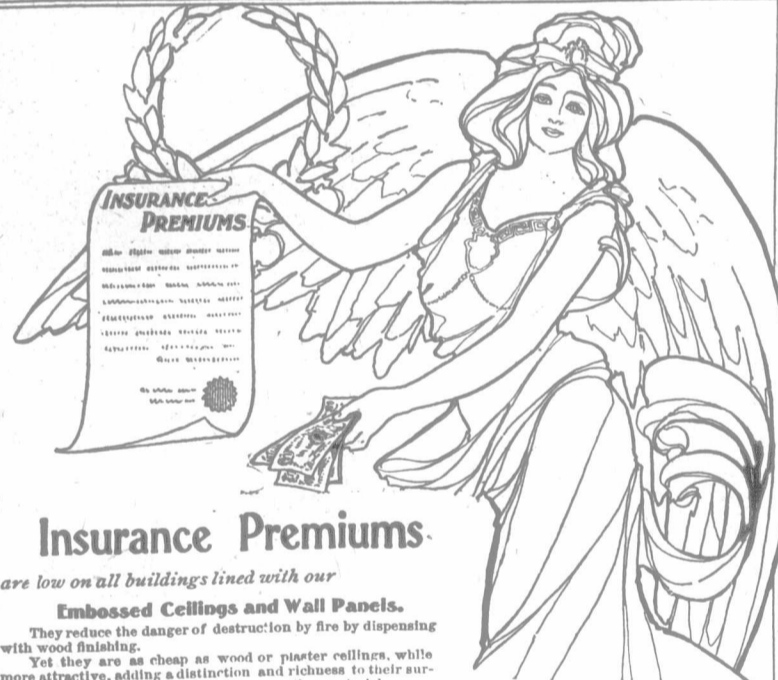

## Insurance Premiums.

are low on all buildings lined with our **Embossed Ceilings and Wall Panels.**

They reduce the danger of destruction by fire by displacing with wood finishing.

Yet they are as cheap as wood or plaster ceilings, will be more attractive, adding a distinction and richness to their surroundings that cannot be equalled by any other material.

We make a specialty of fitting up church interiors, including pillars, moulding, sculptured parts and plain work. Only closest inspection can distinguish our metal from marble and costly wood.

Write to us for catalogue and prices.

**THE PEDLAR PEOPLE, Oshawa, Ontario.**  
Eastern Branch: 22 Victoria Square, Montreal.

# Bug Death

Kills potato, squash and cucumber bugs; currant, gooseberry and tomato worms, and all bugs and worms that eat the leaves of plants.

**BUG DEATH is not poisonous.**

It prevents the blight. It FEEDS the plant. The increased yield of crop more than pays for the Bug Death used.

SEND FOR OUR BOOKLET: WE SEND IT FREE.

## BUG DEATH CHEMICAL CO., Limited,

ST. STEPHEN, N. B.

Please Mention the Farmer's Advocate.

## The Flow of Milk will be increased.

Why go to all the trouble of keeping cows and get only about half the milk they should produce.



### Dick's Blood Purifier

strengthens the digestion and invigorates the whole system so that the nutriment is all drawn from the food. It takes just the same trouble to care for a cow when she gives a pail as when she gives a pail. Dick's Blood Purifier will pay back its cost with good interest in a few weeks.

50 cents a package.

**Leeming, Miles & Co., Agents,**  
MONTREAL.  
Write for Book on Horses and Cattle free.

### THE VOCALION

"Is, in all respects, the most perfect of its kind." So said Frederic Archer, the renowned organist. Twice the amount of music for half the money usually spent. Write us for particulars. Catalogue on application.

**THE MASON & RISCH CO.,**  
211 DUNDAS STREET, LONDON, ONTARIO.

## TORONTO ENGRAVING CO.

**92 BAY ST**  
CUTS BY ALL PROCESSES  
LIVE STOCK A SPECIALTY.

### CENTRAL Business College

STRATFORD, ONTARIO.

This is the school whose graduates are in strong demand as teachers in business colleges, and as book-keepers and stenographers for prominent firms. Catalogue free. **W. J. ELLIOTT, Principal.**

### Family Knitter

Cheapest, Simplest, Best.  
Price, **\$8.00.**

Write for circular.

**Dundas Knitting Machine Company,**  
DUNDAS, ONTARIO.

### BOYS FOR FARM HELP.

The Managers of Dr. Barnardo's Homes invite applications from farmers, or others, for the boys who are arriving periodically from England to be placed in this country. The young immigrants are mostly between 11 and 13 years of age; all will have passed through a period of training in Dr. Barnardo's English Institutions, and will have been carefully selected with a view to their moral and physical suitability for Canadian life. Full particulars as to the terms and conditions upon which the boys are placed may be obtained upon application to Mr. Alfred B. Owen, Agent Dr. Barnardo's Homes, 214 Farley Ave., Toronto.

## Nitrate of Soda

THE STANDARD AMMONIATE FERTILIZER FOR

# MONEY CROPS

CORN, FRUIT, HAY,  
SUGAR BEETS, AND WHEAT.

Send post card for formulas and free bulletins.

**William S. Myers, Director,**  
Dept. A, 12 John Street, New York.

Our customers say that the King Washer is the best.

Before buying a washer, get prices of King Washer. We have agents in nearly every city, town and village in Canada handling our goods. If your dealer does not handle them, write direct to us for particulars.

**H. A. Clemens & Co.,**  
QUEBEC, QNT.





**DEERING TO THE RESCUE!**

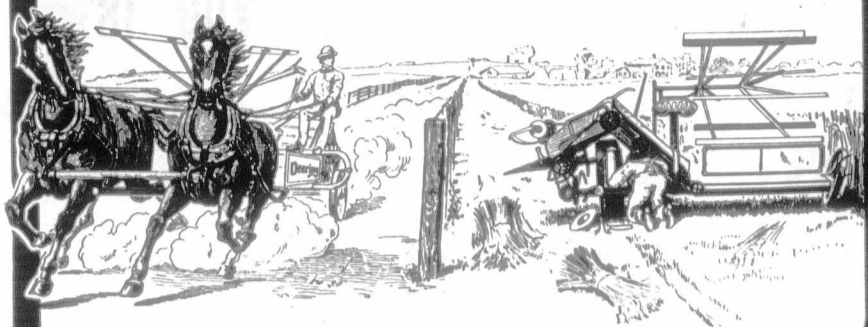

**WHEN SOMETHING GOES SNAP**

on that binder for which so much was promised, and there is an enforced halt in the midst of the busy harvest, the farmer instinctively turns to the Deering for succor.

No crop is beyond harvesting when there is a DEERING IDEAL BINDER on the ground. It will cut, elevate and bind any condition of grain. It is built to meet every requirement, and meet it satisfactorily. It is the all-round, ever-dependable machine.

Get a Deering Binder and you will be always ready for harvest.

The Deering Harvester Company controls the entire output of the Mann Manufacturing Co., Limited, of Brockville, Ont., and are prepared to supply the trade with the famous Mann line of Seeding and Tillage machines.

**DEERING HARVESTER COMPANY,**  
CHICAGO, U. S. A.

CANADIAN BRANCHES: TORONTO, LONDON, MONTREAL, WINNIPEG.  
World's greatest manufacturers of Binders, Headers, Mowers, Reapers, Corn Binders, Corn Shockers, Huskers and Shredders, Rakes, Twine, and Oil.

**CANADIAN  
PORTLAND  
CEMENT**



BRANDS:

(RATHBUN'S) STAR, BEAVER, ENSIGN.

MANUFACTURED BY

**The Canadian Portland Cement Co.**  
LIMITED.

Excels all other cements for durability and economy in building concrete silos, barn foundations, floors, hogpens, cisterns, etc.

Watch our advertisement in each issue. Write for prices and other information to our sales agents.

**THE RATHBUN COMPANY,**  
310-312 Front St. W., TORONTO, ONT.

**SUNLIGHT**

**SUNLIGHT SOAP**

If your Grocer cannot supply, write to LEVER BROTHERS LIMITED, Toronto, sending the name and address of your grocer, and a trial sample of Sunlight Soap will be sent you free of cost.

**REDUCES  
EXPENSE**

One woman will do more work than two will with impure soap.

Ask for the Octagon Bar

**"CANADA'S GREATEST SEED HOUSE."**

The Growers' Favorite

STEELE BRIGGS'

**"ROYAL GIANT"**

SUGAR BEET



**A Valuable Root Crop.**

Stock feeders and producers of milk will find that

"Royal Giant" is not only a good flesh maker, but also increases the flow and enriches the quality of milk, which enhances the value of butter and cheese by improving the quality and flavor.

**A TRUE SAYING  
"Imitation is Flattery."**

When an article has merit and becomes popular it is likely to be imitated.

To imitate is to impose upon the buyer thereof and mislead those wanting the genuine. Ask for **Steele, Briggs' "ROYAL GIANT" Sugar Beet**

It is supplied only in 1 lb. packages, as represented in above cut. See that their name is upon the package.

**PROTECT YOURSELF**

If your local dealer cannot supply you send order direct for "Royal Giant."

PRICE (Carriage Paid)  
5 lb. lots or more, 30 cts. per lb.  
In less quantity, 35 " "

No other class of roots is so desirable for feeding milch cows or more profitable for the grower as a crop producer.

**What Growers Say.**

"'ROYAL GIANT' gives a surprisingly heavy crop of clean, handsome roots, and easily harvested."

"It beats them all; wish I had planted all my sugar beet crop with your 'Royal Giant.' I shall do so this season."

"I never had a crop like 'Royal Giant' gave me; they are large, clean and easily taken up; keeps solid all winter."

"You recommended me to plant your 'Royal Giant.' I did so, and had the finest root crop I have ever grown; all animals, upon the farm eat it with relish."

Use Steele, Briggs' "ROYAL GIANT."

**The Steele, Briggs' Seed Company, Limited**  
TORONTO, ONTARIO.

PLEASE MENTION FARMER'S ADVOCATE.



A DOUBLE SILO  
BUILT WITH  
**Thorold Cement**

H. W. BROWN, OF RATHO P. O., GETS INTO LINE AS  
AN UP-TO-DATE FARMER.

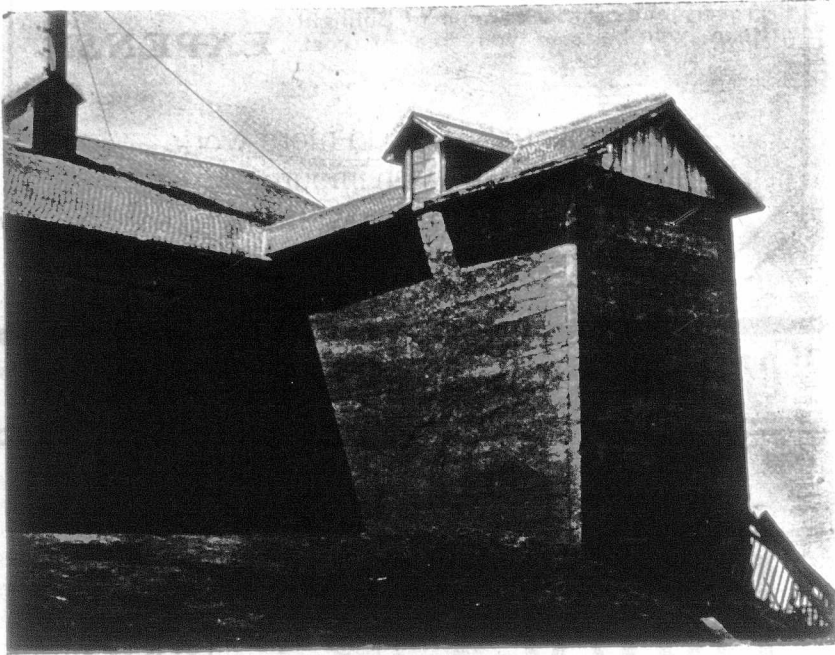

DOUBLE SILO OF H. W. BROWN, RATHO P. O.  
Outside dimensions, 24 x 13 feet, 24 feet high.

Mr. Marcus Ware, Instructor for Estate of John Battle, Thorold, Ont.:

Sir.—Yours of the 10th to hand, inquiring about my cement silo, which you built with Battle's Thorold Cement in 1898—a double silo, 24 feet x 13 feet, or 10 feet square inside, and 24 feet high.

We used 135 barrels of cement and 64 yards of gravel, besides the small stones. There is not a crack in the silo, and I am much pleased with it, and can recommend both yourself and Battle's Cement with pleasure.

Yours truly,

H. W. BROWN, Ratho P. O., Ont.

SALES AGENTS WANTED WHERE WE HAVE NONE NOW.  
Write us for free pamphlet and any information desired.

ESTATE OF JOHN BATTLE, THOROLD, ONTARIO.  
MANUFACTURERS OF THOROLD CEMENT.

"We do not place our cement to be sold on commission."

## To House Owners.

"Ill fares the land,  
To every ill a prey,  
Where Paints deteriorate  
And houses decay!"

The use of THE CANADA PAINT COMPANY'S PAINTS will preserve your buildings and add to their value and appearance.

## THE CANADA PAINT COMPANY (LIMITED),

The largest manufacturers in the Dominion of Canada of high-class PAINTS for interior and exterior use.

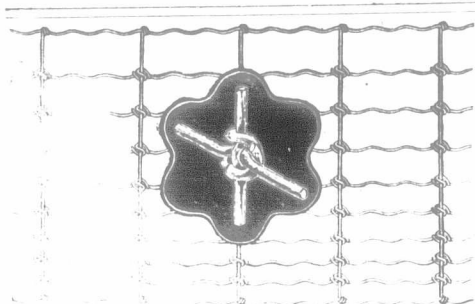

## Ideal Woven Wire Fencing

Complete in the roll. A heavy, one-piece stay that will not buckle up and cannot slip. Note the lock. No. 9 hard spring wire throughout. A fence that WILL LAST.

McGregor, Banwell Fence Co., Ltd.  
WINDSOR, ONT.

Coiled spring and other fence wires.

## Tell Me a Friend Who is Sick.

No Money is Wanted. Simply Let Me  
Send Him My Book.

You have a friend who is sick. Write me his name. That is all—just a postal card. Send it as an act of humanity.

Tell me which book he needs.

I will either cure that friend or pay all the costs of his treatment. I will at least do the utmost that medicine can do. I will give the best advice in my power. I may fail; but there will not be a penny of cost if I do.

I will do this at the start:

I will send the sick one an order of his or her druggist for six bottles of Dr. Shoop's Restorative. I will tell that druggist to let him test it for a month at my risk. If it succeeds, the cost is \$5.50. If it fails, I will pay the druggist myself.

I will leave the decision to you.

Don't say that this is impossible, for I do just as I say. I have done it for years—done it with hundreds of thousands.

I will do it in any case, no matter how difficult. I only ask the sick one to be fair with himself and me.

I cannot always succeed. There are conditions like cancer, for which I know no cure. But I alone am the loser when I fail.

My records for five years show that 39 out of each 40 who accepted my offer paid for the medicine taken. That means that 39 in each 40 are cured. That fact alone makes this offer possible.

There are 39 chances in 40 that I can cure your friend.

My success is due to a lifetime of effort, in learning how to strengthen the inside nerves. It is this nerve power alone that operates the vital organs. No organ is weak when it has sufficient power. I bring back the Nerve power—That is all. It is just like giving more steam to an engine that is weak.

My book will explain it all.

Every soul who reads this knows some sick friend. You know somebody who will never find another way to get well.

Let me tell that friend my way.

I must be successful. My remedy must do what I claim.

If it did not, such an offer as this would bankrupt me in a month.

The sick one is your friend—a stranger to me. If I am willing to do so much, won't you write a postal, that he or she may get well?

Simply state which book you want, and address Dr. Shoop, Box 52, Racine, Wis.

Book No. 1 on Dyspepsia.  
Book No. 2 on the Heart.  
Book No. 3 on the Kidneys.  
Book No. 4 for Women.  
Book No. 5 for Men (Sealed).  
Book No. 6 on Rheumatism.

Mild cases, not chronic, are often cured by one or two bottles. At all druggists.

## Fruit Growers!

IF YOU DON'T, YOU WILL.

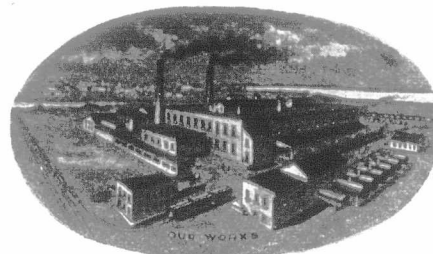

USE FREEMAN'S HIGH-GRADE FERTILIZERS. THEY PRODUCE LARGE PAYING CROPS.

John Carnochan, Niagara:—"Having used a ton of your BONE AND POTASH on my orchard of peach trees in the spring, I have much pleasure in recommending it to others, as in my opinion it is an excellent thing for peach trees, both for growth of trees and insuring an abundance of fruit; in fact, I have so much faith in its virtue that I have ordered two tons more for same orchard and another."

Prices, Catalogue and Information on Application.

A good thorough fruit grower wanted in every section to represent our high-grade FERTILIZERS in any territory not already taken up.

THE W. A. FREEMAN CO., LIMITED,  
HAMILTON, ONT.

Pure, Fragrant and Cleansing.  
**BABY'S OWN SOAP**  
IS UNRIVALLED FOR NURSERY AND TOILET USE.  
Don't risk imitations on Baby's delicate skin.  
ALBERT TOILET SOAP CO., MFRS.  
MONTREAL.



# The Farmer's Advocate

## and Home Magazine.

"PERSEVERE AND SUCCEED."

ESTABLISHED 1866.

REGISTERED IN ACCORDANCE WITH THE COPYRIGHT ACT OF 1875.

VOL XXXVII.

LONDON, ONT., AND WINNIPEG, MAN., APRIL 15, 1902.

No. 548

### EDITORIAL.

#### Use of Good Sires.

Never was the need for nor the encouragement to improvement of the beef and dairy cattle of the country and of our live stock generally greater than at present. The only available means of securing the best prices in the markets that are open to us is by producing the best quality, and this in live stock can only be done by means of the use of pure-bred males in grading up the general stock of the country to a higher standard and by liberal and judicious feeding, combined with good breeding to secure early maturity, which means quick returns. The produce of a good pure-bred bull will readily sell for two to five dollars a head more as calves or yearling stockers with ordinary treatment than the offspring of a scrub or grade bull at the same age and with similar care, while with better treatment of both, the difference in value will be greater, and the better-bred cattle will bring from \$15 to \$20 a head more as finished heaves and be ready for market a year earlier than the ill-bred class.

The reports of sales of fancy cattle at high prices are perhaps liable to discourage the average farmer from thinking of securing a pure-bred bull, but a little enquiry will satisfy him that one that will suit his purpose well may, even in these good times for the breeders, be had for a very reasonable price; in many cases, indeed, for less than it has cost to raise him, when it is considered that he has probably consumed the whole milk of a cow for one season, and been liberally fed otherwise. We do not advise buying the lowest-priced bull, even a pure-bred, for use in a herd of grade cows, believing that it pays well in the long run to use the best one can afford, but good, useful bulls can be bought for one hundred dollars, and even less, that will greatly improve the character of a grade herd and rapidly increase the value of the young stock. We know for a fact that there are hundreds of excellent young bulls in the hands of breeders, both of beef and dairy breeds, throughout the country that can be bought well worth the money to the average farmer, and we are quite sure that many farmers are standing in their own light by using inferior sires and squandering money by feeding good food to ill-bred beasts, which give but a poor return for what they consume. Those who have not the means or the accommodation for keeping a bull have little excuse for breeding to scrub sires, since in nearly every district the services of pure-bred bulls may be had for a moderate fee, and it will pay well to drive one's cows a few miles rather than to put up with inferior stuff. In some districts the stock of cattle has been greatly improved by the use of pure-bred sires brought in by the agricultural societies, using a part of their funds for this purpose, the members having the benefit of their services for a moderate fee. In other cases, neighbors have agreed to patronize bulls brought in by one of themselves, each pledging a certain number of cows at a stated fee. The syndicate system has in some cases worked quite satisfactorily, a number of farmers joining in the purchase of a sire to be kept by one of themselves, and standing the animal at a price for service that with good management may readily repay his cost while improving the stock of the district. This system is perhaps better adapted to the handling of stallions, but could

also very well be used for the introduction of good bulls. Private ownership is, however, more satisfactory as a rule, and with the use of good judgment in making selections, satisfactory sires can be secured on reasonable terms, and since it is largely a waste of time and money to feed inferior stock, the sooner a start is made in the line of improvement the better. It takes time to grow a horse or a steer to maturity, and the sooner advantage is taken of the use of good blood the sooner will the best returns be secured.

#### Building Permanent Silos.

On thousands of Canadian and American farms the silo is now recognized as an essential part of an outfit of buildings for the storage of fodder crops. The word silo is said to be derived from siros, a Greek term, descriptive of a pit for holding grain. Its purpose is the preservation of food for stock in a green and succulent form, the advantage of this being that it brings into winter feeding the summer condition of food calculated to promote digestion and healthfulness when animals are closely housed, and also large production of milk in case of dairy cows, and rapid gains in flesh when fed in conjunction with grain rations. In general practice it is also held that there is less waste than in the field-curing of corn, now conceded to be par excellence the crop for making ensilage. Extravagant claims have doubtless been made for the silo and ensilage, but the steady growth of the system and the extremely isolated cases in which silos have been discarded, go to show that the plan has substantial merit, because practical men, who have a keen eye to the cost of production, are not liable to persist in following a delusion.

This season is likely to see as many, if not more, new silos constructed and more corn grown in Canada than in any previous year. "What manner of silo shall I build?" is, therefore, a practical question with the farmer. In the first place, the walls must be sufficiently strong to resist (without spreading or cracking) the great pressure caused by the settling and heating of the contents when first put in; they must be smooth inside, to allow the mass to settle freely; and air-tight. When the green cut corn is put in, a degree of fermentation begins and the temperature rises, which expels the air within the mass, which settles and becomes firm. Further chemical changes practically cease. Providing air is not allowed to penetrate, the product—ensilage—may be preserved almost indefinitely. How can these conditions be secured, at a reasonable outlay?

The earlier silos, of stone or brick, plastered, were ponderous and costly. In the quest for a more economical structure, the square-shaped wooden silo came in vogue, but, as a rule, proved too short-lived, and was succeeded by a much simpler, more quickly constructed and less expensive form, the round stave silo, which is still, generally speaking, the most popular. Though not permanent and liable to collapse when empty in summer, without a roof, it has proved a great advance on previous styles. A medium-sized silo of that kind can be erected for about \$50.

With the advent of cement concrete as a building material on the farm, men have for a couple of years past been turning their attention in that direction. Many farmers felt that by the use of cement a permanent silo could be secured at a fair outlay that would fill the conditions necessary for making good ensilage. Learning that in the counties of Huron and Perth, cement silos had

been erected in large numbers, the "Farmer's Advocate" decided to begin an enquiry as to what the results had been in that district, in the hope that the investigation would bring to light facts that might prove generally advantageous. Last year reports from one or two quarters elsewhere had proved rather unfavorable, the porous character of the walls causing the ensilage apparently to dry out around the walls, and we also heard of silo walls cracking on account of defective foundations and being filled too soon after they were completed, so that the cement concrete had not time to "set" properly. Elsewhere in this issue we submit the results of our latest enquiry, which, we are bound to confess, are even more favorable than we had anticipated. We are greatly obliged, on behalf of our readers generally, to those who have so frankly stated their experience, which shows very clearly the conditions to be observed in cement-silo building, in order to secure thoroughly satisfactory structures, and what they will cost. In the minds of these men there appears to be no manner of doubt as to the utility of cement in constructing silos. Their statements will repay careful study, and will, we apprehend, have the effect of leading many others in the same direction. In this, and in a host of other ways, the use of cements, of which so many excellent brands are now produced in Canada, is only in its infancy. It is hardly necessary to add, in regard to cement silos, what the most casual reader can see, viz., that they must be constructed with very much greater care than the round wooden variety, and that they should not be filled so soon after completion.

#### A Call for Help in a Worthy Work.

To the Editor "Farmer's Advocate":

Sir,—For more than ten years the Ontario W. C. T. U. has had a Missionary Department, first called "Work Among Lumber Camps," later "Frontier Missionary Work." An expansion in the field of operations changed the name; for lumber camps led to the mining and railway construction camps also, and these to the scattered settlements away back in the bush of New Ontario, round the mouth of the mines, etc.

At first "comfort bags" and bales of literature were sent into camps on the freighting wagons, and committed to the foreman for distribution. The marked Testaments, leaflets and personal letters from the women were relied on to preach the gospel that prompted these gifts.

In time the call to send a missionary grew so loud that, notwithstanding the slim condition of the Provincial Union Treasury, a man was secured to go with the supplies and add the spoken to the written word.

Now there are two laborers engaged by the year, Mr. Leckie, of Huntsville, for Muskoka and Thunder Bay District, and Miss Agnes Sproule, of Fort William, for the 43,000 square miles of Algoma.

Miss Sproule has found in some parts of the Rainy River portion of her parish a great deal of destitution. Settlers coming in there with little funds, some of them in debt, and with a home to build, implements and seed to buy, and a family to support, have suffered greatly. Two years ago she visited a series of small settlements. The winter was coming on, the houses were mere huts and the floors of many of them would have been considered by "Advocate" readers too poor for a stable. The women and children were without flannel or warm clothing of any kind. Miss Sproule made the need known to the Ontario W. C. T. U., chose a faithful woman living near one of the settlements as the custodian and distributor of any gifts that might be sent, and went her way. By Christmas time, boxes and bales of clothing began to arrive. There were toys and



## THE FARMER'S ADVOCATE AND HOME MAGAZINE.

THE LEADING AGRICULTURAL JOURNAL IN THE  
DOMINION.

PUBLISHED SEMI-MONTHLY BY  
THE WILLIAM WELD COMPANY (LIMITED).

TWO DISTINCT PUBLICATIONS—EASTERN AND WESTERN.

EASTERN OFFICE:  
CARLING STREET, LONDON, ONT.

WESTERN OFFICE:  
MCINTYRE BLOCK, MAIN STREET, WINNIPEG.

LONDON (ENGLAND) OFFICE:  
W. W. CHAPMAN, Agent, Fitzalan House, Strand,  
London, W. C., England.

JOHN WELD, MANAGER.

1. THE FARMER'S ADVOCATE is published on the first and fifteenth of each month. It is impartial and independent of all cliques or parties, handsomely illustrated with original engravings, and furnishes the most profitable, practical and reliable information for farmers, dairymen, gardeners, and stockmen, of any publication in Canada.
2. TERMS OF SUBSCRIPTION—\$1.00 per year in advance; \$1.50 if in arrears; sample copy free. European subscriptions, 6s. ad., or \$1.50. New subscriptions can commence with any month.
3. ADVERTISING RATES—Single insertion, 20 cents per line, agate. Contract rates furnished on application.
4. THE ADVOCATE is sent to subscribers until an explicit order is received for its discontinuance. All payments of arrearages must be paid as required by law.
5. THE LAW IS, that all subscribers to newspapers are held responsible until all arrearages are paid and their paper ordered to be discontinued.
6. REMITTANCES should be made direct to this office, either by Money Order or Registered Letter, which will be at our risk. When made otherwise we will not be responsible.
7. THE DATE ON YOUR LABEL shows to what time your subscription is paid.
8. ANONYMOUS communications will receive no attention.
9. LETTERS intended for publication should be written on one side of the paper only.
10. WE INVITE FARMERS to write us on any agricultural topic. We are always pleased to receive practical articles. For such as we consider valuable we will pay ten cents per inch printed matter. Criticisms of Articles, Suggestions How to Improve the ADVOCATE, Descriptions of New Grains, Roots or Vegetables not generally known, Particulars of Experiments Tried, or Improved Methods of Cultivation, are each and all welcome. Contributions sent us must not be furnished other papers until after they have appeared in our columns. Rejected matter will be returned on receipt of postage.
11. ALL COMMUNICATIONS in reference to any matter connected with this paper should be addressed as below, and not to any individual connected with the paper.

Address—THE FARMER'S ADVOCATE, or  
THE WILLIAM WELD COMPANY (LIMITED),  
LONDON, CANADA.

dolls and candy for the children, to most of whom Christmas had been little more than a name, and warm garments and rolls of flannelet for the mothers. Next year the same good cheer, only more of it, poured in, enabling the good women who managed it to have five Christmas trees in as many neighborhoods. The story of the good times and the people's gratitude is too long to give here. The local agent of the Union says: "These things have kindled a great deal of love and respect for the W. C. T. U. It is almost impossible to tell you how much the clothing has helped these settlers." In a letter just received Miss Sproule says that she spent eight days at ..... (the settlement above referred to), travelled about through the country, in all sorts of wagons, jumpers, etc., covering 60 miles. The homes were visited and six meetings held, which, despite the wretched weather and almost impassable roads, were splendidly attended. She did not know where all the people came from, or how they managed to get there. They all seemed so thankful for the aid received. Two years ago, they almost prayed her to "depart out of their coasts." Now all this is changed, and they are, moreover, taking earnest measures to prevent the spread of intemperance.

Last year Miss Sproule travelled 3,400 miles, visited the homes in 70 localities, addressing meetings and distributing large quantities of useful literature.

Mr. Leckie's field of work is in the camps themselves, of which there are more than 600 in his district. Last year he travelled about 3,220 miles, nearly all of it by wagon, holding 281 meetings in 161 camps. About 20,000 men were addressed, either in the camps or on the lumber drives. Over 14,000 papers, magazines, etc., and thousands of song sheets and leaflets were distributed, besides 491 comfort bags. In 50 camps Sunday evening song services were established, that go on whether the missionary is there or not. In Nipissing there is no missionary.

Through all these camps there are thousands of men, young and old, away from the comforts and influences of home, exposed to known and nameless evils, yet all of them some mothers' sons, to whom this self-sacrificing work has been a boon and an encouragement. Another worker is greatly needed in the camps, but for want of funds our hands are tied. If people but realized the need, they would help.

The salaries of these two missionaries and a third, working in the Purity Department, together with the money expended for Testaments

and literature, amount to \$1,200 per annum. As this outlay represents but two of the twenty-seven departments under the care of the Provincial Union, the financial strain has been heavy, and we are falling behind. Anyone disposed to help can forward a contribution to

MRS. ANNIE BRITTON,  
Treas. Ont. W. C. T. U.,  
Gananoque, Ont.,

stating that they saw the appeal in the "Farmer's Advocate," so that amounts received may be acknowledged in its columns.

### HORSES.

#### Mr. Innes Closes the Horse Judging Controversy.

To the Editor "Farmer's Advocate":

I am sorry to have to spend time replying to the unknown E. J., who persists in writing slang for the public reading, which, I am sure, is neither instructive nor amusing. It is easy for anyone to place misstatements before the public that he dare not own, and try to justify his cowardly actions by claiming that the spirit of his former letter was misapprehended. His sarcastic "I tell you nay, sir," to a suggestion I made, and the further insinuation, "He does not know his business," proves plainly the fallacy of his whole contention. He is piteously playing for public sympathy. I am not going to spend time following his mysterious conglomeration of excuses, that are abusive but not instructive. I am well aware a judge is a public official, chosen by the committee. It is his duty to perform his functions to the best of his ability, and, let me emphasize this point, to do his work honestly, giving to the stranger his honest rights even though the judge has to forfeit the friendship of one who kicks because thereby he expected to gain unmerited awards. "I tell you nay, sir," that little game is played out so far as I am concerned. Reasons that do not suit his mysterious views he considers no reasons. He makes insinuations that are easy for his kind, as his opponent has no recourse. Either he is ashamed of his anonymous squeal or is doing the dirty work for someone else. I suspect the latter. I will give him credit, as evidenced in the latter part of his epistle, for having read and quoted weights of animals that prove my contention to the letter and his ignorance on the subject. He tries to enlighten the breeders of Clyde show horses, but by his own words he shows there are other faddists besides me. E. J. quotes points. Why does he not go further and say if he knows that Hiawatha and Prince Robert have what is required first, my fad: a foundation of grand quality, with enough weight to fill the bill. The Alexis stud and Col. Holloway were made famous the world over (referred to by him) by this ridiculed fad of mine—quality; quality first, with fair size added. Holloway is to America what Lawrence Drew was to Scotland—the greatest educator along horse lines the world has ever seen. The fad rule applies to each of them to the full. Nothing else will be tolerated at Alexis. In conclusion, I will say that having been asked on several occasions to write articles on horse matters, I did so, with instructions to the editor to curtail any part or all that did not appear to be in the interest of the horse business, being always willing to take part in any honest discussion and never ashamed of my own signature. If the initials used by my opponent be those of a minor and designed as a scapegoat for the genuine article, and the public is mistaken or accuse someone wrongfully, the fault is not mine. I suppose I made a mistake in not treating this cowardly (what the writer calls honest) criticism with silent contempt, but I suppose he likes to hear the sound of his own squeal. Now he is smarting under the sting of his own lash. I hope I am mistaken or wrongly informed as to his identity. If innocent, it does not apply; if guilty, he has gotten what he asked for or partly so. Good-bye for all, my little man. Be careful how you allow your initials to be used in future.

ALEX INNES.

#### The "Farmer's Advocate" as a Money Saver.

I commenced taking your paper last fall. As to its value to the farmer in every department, the following will show, at least re the hog industry. I had a bunch of hogs (five), averaging over 160 pounds, two weeks previous to the time I received the first issue; in it you said you had predicted in the previous issue a great decline in hogs. Had I received that paper and been governed by it, I would have shipped the lot at 160 pounds and received as much for them as I did when I fed them up to 210 pounds. In other words, I produced 250 pounds of pork at a total loss, waited longer on my money, and have been sorry ever since that I did not take your paper long before. Wishing you every success and a constantly increasing circulation.

E. C. BOYD.

Perth, Co., Ont., April 4th, 1902.

#### Judging a Horse's Age by His Teeth.

Dentition in the horse is more regular than in other animals. Still, it is liable to variations; and while deviations from certain rules are not common, we must recognize the fact that they occur, and even in a young horse the age cannot always be positively determined by the appearance of his teeth. In order that a person may become tolerably expert in judging the age of horses, it is necessary for him to pay particular attention to the appearances of the mouth at different ages. He should carefully examine the teeth of animals whose age he knows, and observe the general and special appearances and compare mouths of different ages. He must also note the differences that frequently exist in mouths of the same age; for while, as already stated, dentition is tolerably regular, it is not at all uncommon to observe several months' difference in dentition, especially in horses under five years. The student must not depend upon charts or lectures—he must have actual experience, and be able to recognize in the actual mouth what he has read, or been taught to expect. Some people profess to be able to tell definitely a horse's age until he is thirty or over, but experience teaches us that such is not possible, and that the most expert can only arrive at an approximate idea after the animal is well up in the teens, and to a certain extent it is guesswork after nine years. After that age the differences looked for year after year become harder to distinguish, and are not as regularly present as in younger animals. Still, the changes appear with sufficient regularity to enable a person who has given the subject considerable study to avoid grave mistakes.

The horse has two sets of teeth, viz., the temporary or milk teeth and the permanent or horse teeth. The temporary teeth differ from the permanent in being much whiter in color, much more constricted at the neck, and smoother from side to side, there being an absence of that depression or furrow noticed extending the whole length of the visible tooth in the permanent. The adult male animal has 40 teeth, classified as follows: 12 incisors, 4 canine or bridle teeth, and 24 molars. The female, with rare exceptions, has only 36, the canine teeth usually being absent. The incisors number six in each jaw; the pair in the center is called the central; the pair, one on each side of these, is called the lateral; and the pair, one on each side of these, is called the corner teeth. In male animals the canine teeth are seen in the interdental space (the space between the corner incisor and the first molar in each row); a small space exists between the corner and canine teeth. The molars are arranged in four rows, one on each side of each jaw, and are numbered 1st, 2nd, 3rd, 4th, 5th and 6th from before backwards. At birth the colt sometimes has four temporary incisors, the central pair in each jaw, but usually these do not appear for about 14 days, the laterals at about 9 weeks, and the corners at about 9 months. He always has 12 molars at birth, Nos. 1, 2 and 3 in each row, and he never gets any more temporary molars. At one year old the first permanent molar (which is No. 4) should be well up and in wear. At two years the second (No. 5) should be present. At three years Nos. 1 and 2 (temporary) should be shed and replaced by permanent ones, which should be well up; and at four years, No. 3 (temporary) should be shed and replaced by a permanent one, and No. 6 should be seen well up and in wear. Hence, at four years old a colt should have a full set of permanent molars, and until this age is reached the appearance of these teeth will aid in determining age when any doubt exists. After about nine months old, at which time he has a full mouth of temporary incisors, no change takes place in these teeth, except that they become larger and the wearing surface gradually wears down and the hollows become less marked, until he reaches about 2½ years; between this age and three years the central temporary teeth are shed and replaced by permanent ones; between 3½ and 4 years the laterals are shed and replaced by permanent ones; and between 4½ and 5 years the corner teeth are shed and replaced by permanent ones, and the canine teeth appear in males. Hence, a horse should have a full mouth at five years.

The permanent incisors are wide from side to side and shallow from before backwards, and the external surface of each presents a groove running the whole length of the tooth, the bearing surface shows a thin rim of a hard white substance called enamel, outside; internal to this is a portion of a darker substance called dentine, internal to which is a second ring of enamel, and within this is a hollow which shows a substance which becomes dark and is known as the mark. At six years the marks should be worn out of the central lower incisors and the bearing surface of the teeth almost level. At seven years the marks have disappeared in the laterals; and at eight years in the corners. At nine years the table or wearing surfaces of all the lower incisors should be level, and usually, if a side view be taken, with the teeth shut, a hollow will be noticed near the outer edges of the upper corner incisors, forming



a sort of hook. At ten years the marks are supposed to have disappeared from the central upper incisors; at eleven from the laterals; and at twelve from the corners. It must be remembered that while this is the rule, the changes taking place in the upper teeth are not as regular as in the lower. After eight years the general shape of the teeth gradually changes; they become longer, deeper from before backwards, and narrower from side to side; the table surfaces first assume a rather round form and afterwards become somewhat triangular. In some cases, after the teens are past, the teeth become shorter, but this is not by any means constant. My experience has taught me that, while set rules may be laid down as to the appearances of the teeth at certain ages until 35 years or older, no definite dependence can be placed upon these rules; the condition of the teeth in advanced age will depend to a considerable extent upon the quality of the teeth (some are harder than others, as anybody who is in the habit of dressing teeth can testify) and upon the nature of the food upon which the animal has subsisted. Below will be seen a few cuts representing the appearances the teeth should present at certain ages.

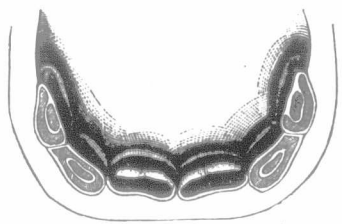

Fig. 1.—Lower jaw at 2½ to 3 years.

The central temporary incisors have been shed and replaced by a permanent pair, which should be up full and in wear at three years and sometimes are at 2½.

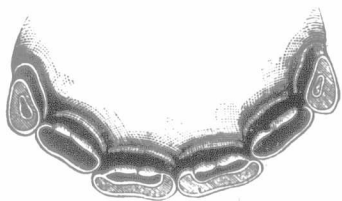

Fig. 2.—Lower jaw at 3½ to 4 years.

The lateral temporary incisors have been shed and replaced by a permanent pair, which should be well up and in wear at four years, and sometimes are at 3½. The central pair show a little wear on the outer edge.

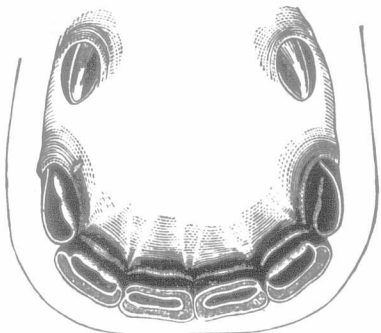

Fig. 3.—Lower jaw at 4½ to 5 years.

The corner temporary incisors have been shed and replaced by a permanent pair, which should be up full and in wear at five years, and sometimes are at 4½. The centrals show wear at both edges, and the outer edges of the laterals have begun to wear. In male animals the canine teeth have appeared, and at five should be fairly well grown. It is quite rare to notice these in females, but occasionally we see them either full-sized or rudimentary. Therefore, it will be seen that at five years a horse has a full mouth of permanent teeth.

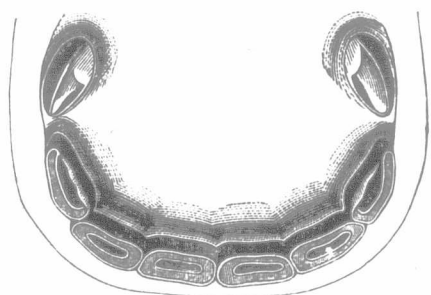

Fig. 4.—Lower jaw at 6 years.

The marks have disappeared from the centrals, the laterals are showing wear, and the inner edges of the corners are even with the outer.

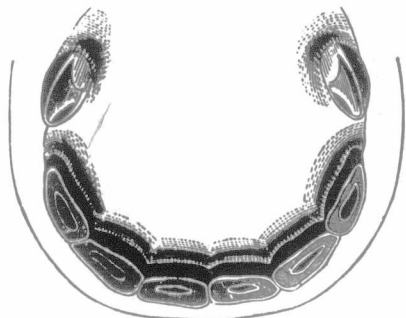

Fig. 5.—Lower jaw at 7 years.

The marks have disappeared from the laterals, the corners are showing wear, and both edges are worn to a smooth surface.

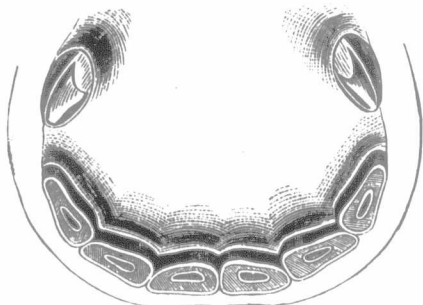

Fig. 6.—Lower jaw at 8 years.

The marks have disappeared from the corner teeth, and all the teeth are evenly in wear.

At nine years the lower incisors are all well worn down, with almost flat surfaces, there being little cavity left.

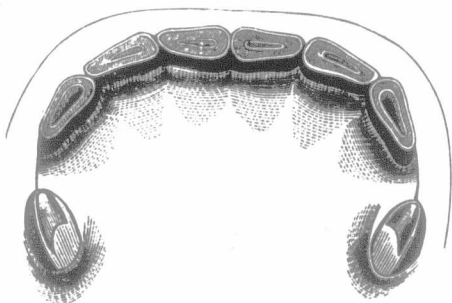

Fig. 7.—Upper jaw at 10 years.

The mark is almost gone out of the centrals, is still quite visible in the laterals, and clearly defined in the corners.

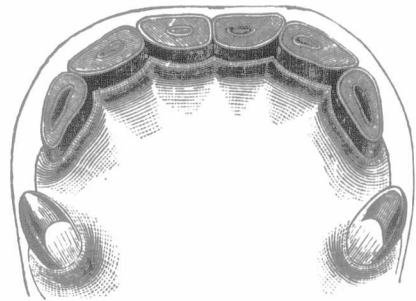

Fig. 8.—Upper jaw at 11 years.

The marks have disappeared from the laterals, but are still visible in the corners.

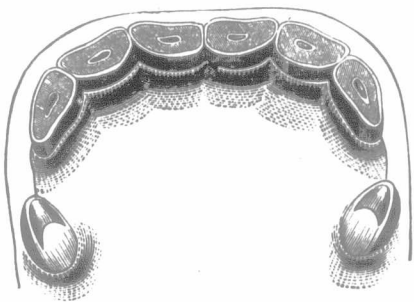

Fig. 9.—Upper jaw at 12 years.

The marks have disappeared from the corners, and the table surfaces of all are in wear.

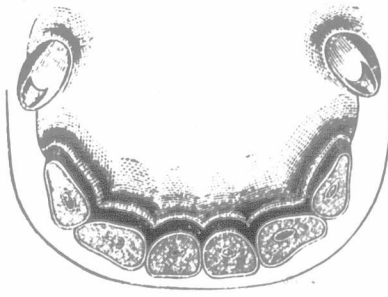

Fig. 10.—Lower jaw at 13 years.

The table surfaces of the central pair are nearly round, those of the laterals becoming so, and those of the corners gaining in thickness compared to width.

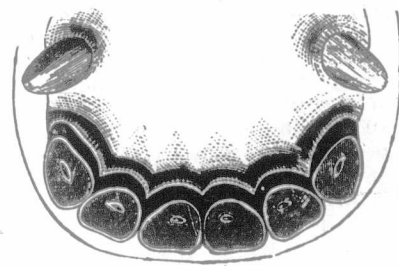

Fig. 11.—Lower jaw at 14 years.

The table surfaces of the laterals are almost round, and those of the corners becoming so.

At 15 years the surfaces of the corner lower incisors have become round, at 16 those of the central upper incisors, at 17 the lateral, and at 18 the corner. In the meantime the surfaces of the lower teeth have been gradually assuming a triangular form, and at about 20 those of the upper jaw gradually take on the same shape. At about 15 the points of the canine teeth begin to wear flat, and this gradually continues.



Fig. 12.—Lower jaw at 26 years.

The lower incisors are all somewhat triangular, and twice the depth from before backwards as from side to side. The canines have become quite flat on top.



Fig. 13.—Upper jaw at 29 years.

All the teeth are somewhat triangular, and twice as thick as they are broad. The canines are quite flat on top.

While these figures show what we expect to see, as already stated, they are not reliable after the animal has reached 12 years; and the age, after that, must be judged by the general appearance of the mouth and head, and it requires a great deal of observation and experience to acquire a reasonable degree of skill. "WHIP."

## STOCK.

### Improved Sires for Improved Stock.

If there is one thing more than another which pedigree breeding has taught, it is the value of using a good sire. It takes a long time before this lesson can be universally appreciated. There are some breeders whom nothing but adversity will teach; others are willing to profit by the experience of the many, and are ready to adopt the lessons which can be obviously deduced. It is a pity that in these times of enlightenment and advanced ideas the simplest of all lessons cannot be absorbed by small breeders. It is with the small breeder that the future lies, and the sooner he adapts himself to a more successful policy the better will it be for himself and for the breed which he favors. It is not enough to have a well-bred sire. That certainly is a primary consideration, for, as every breeder knows, there is nothing more perplexing in breeding than the frequency with which atavism occurs. It is satisfactory to note, however, that when characteristics have become more fixed by years of registered breeding, breeders are more and more coming to regard it as essential that the trumpeted merits of good back breeding should be displayed in the animal itself. The old principle that like produces like is truer now than it was fifty years ago, because of the increased prepotency of line-bred stock. Nothing condemns the policy of a breeder more effectively than the use of an indifferent horse on good mares, or, for that matter, a moderate bull on better cows. As a rule, the farmer is not deficient in useful breeding mares or rooey cows, but it would form painful reading to learn how often he had misused his trust by the use of an indifferent sire. It is a very safe rule to patronize a sire better than the females. There is everything to gain and nothing to lose. The initial cost is a mere bagatelle, compared with the difference in price of the progeny. It is a misfortune that many farmers expect too much of their mares or their cows. This, at all events, seems a reasonable deduction from their policy when they use very indifferent sires. The point we wish to accentuate is that it pays to use a good sire. It is short-sighted policy to expect too much of the dams.—Farmer and Stockbreeder.



### Galloways at Castle-Douglas.

We have just received a report of the annual sale of young Galloway bulls held at Castle-Douglas, on the 6th March. Castle-Douglas is in the heart of the home of the Galloway breed of cattle, and many of the best known herds are within easy drive of this ancient town. The annual sale is always looked forward to with interest by lovers of the black breed, and the judging in the prize ring, which precedes the sale, often settles the prize record of many an animal which in future heads the honor list at more widely-known shows. The champions at the Royal, of England, and the Highland Society, of Scotland, have, nine times in ten, got their first hall-mark at Castle-Douglas.

This year, owing, no doubt, to the extended interest in Galloways, the number of entries was larger than on most former occasions. The number of entries was a hundred and ninety-three, representing the produce of forty-eight breeders.

The entries are confined to bulls of two years old and under, and as a number such as were entered would be a heavy load for any sale, it is not to be wondered that many of the poorer animals brought somewhat low figures.

The good animals from the herds of the old and well-known breeders, however, brought good prices. The old reliable Castlemilk herd of Sir Robert Jardine was well up in front with the young bull, Scottish Chief 3rd of Castlemilk (8059), calved January 25th, 1901, whose sire, grandsire and great-grandsire were all champions at the great Scottish and English shows, and which promises to keep up the record, as he was placed first at this show, and sold afterwards for 54 guineas. Mr. David Brown, of Stepford, Dumfries, a new breeder, took second and fourth prizes with Crusoe of Stepford (8337), sired by a Castlemilk bull, and Chief 2nd of Stepford, sired by the first-prize two-year-old at the last Highland Society Show, Campfollower of Stepford (7476), and which sold at 36 and 41 guineas, respectively.

The veteran breeders, Messrs. Sherman, of Balig, took the third prize with Dreadnought (8122), sired by another Castlemilk bull, Norseman of Castlemilk (6395), and which sold for 53 guineas. It is worthy of note that of the four prizewinners in this class, bulls calved after 1st December, 1900, and before March 1st, 1901, three were sired by bulls from the Castlemilk herd.

In the class for younger bulls calved after March 1st, 1901, the first prize went to Mr. Brown, of Stepford, for the young Campfollower 3rd of Stepford (8407), which was sold for 40 guineas. Messrs. Biggar, of Chopleton, got second for an excellent youngster, Foundationer (8072), by Mackenzie of Lochenkit (7382), now at the head of the Hope Farm herd in Manitoba, and which brought 36 guineas, to go to the herd of the Countess of Carlisle.

The third and fourth prizes went to Mr. Fenwick, of Walsingham, Durham, for Iocobite (8228) and the Duke of Buccleuch, for Brucine 3rd of Drumlanrig. Fifth, sixth and seventh prizes were awarded, as well as several "commended" in each class, but the names might not interest our readers.

The principal interest in the show is in the great increase of breeders competing, and the rival distribution among new owners at the sale.

Ireland took quite a large proportion of the animals sold, while a great many found new owners in England and the United States, and Canada will add new blood to their Galloway herds from the Castle-Douglas sale.

Galloway breeders are becoming aggressive, and the increased interest in this breed as a hardy and handsome breed of cattle will rapidly extend the number of herds and bring them more into the eye of the public. The recent dispersion sale at Omaha of the Wavertree herd, where at a closing-out sale over 200 head, including many sucking calves, averaged \$184, speaks well for the interest taken in the Galloways, and the fact that not only in the United States and Canada, but in their native land, the number of enthusiastic breeders is increasing should encourage owners of Galloway herds to push harder than ever to the front.

Galloways may not look so large on their feet, but when the block test is applied, as at the fat show at Smithfield, they are all there, and while their number may not be so great as those of some other breeds, they occupy no insignificant place in the "best breeds" of cattle, and are justly becoming better and more favorably known.

### Castor Oil for Ringworm.

I received my premium knife all right, some time ago, with thanks. I find it useful, as it is strong and handy, as well as an ornament. Here is a sure cure for ringworm: Pure castor oil applied just three times, every other day, with finger tips.

JOS. LANKTREE.  
Grey Co., Ont.

### Black Lambs: a Remarkable Experience.

To the Editor "Farmer's Advocate":

In recent numbers of the "Advocate" have appeared timely and edifying comments upon the "black lamb" question. Will you, therefore, permit me to offer a few observations on the same subject? While I am not at present prepared to combat Mr. Campbell's views, it seems to me that his remarks go rather far towards implying a predisposition on the part of pure Shrops towards throwing black lambs. Though I have had no black lambs dropped by Shrop ewes, even when running with black ones of other breeds, yet I have found the Shrop ewe very pliable and responsive to the prepotency of the black sire when I have mated them with the object of securing black offspring. So marked have I found this weakness (may I call it), that at first I was surprised and pleased, yet I was subsequently disappointed, for I always found that they never retained their color, but at a very early age they became gray or white, except head and legs; while the blacks from a Merino cross gave "fast" color. Some years ago, I was called upon to deliver a Shrop ewe, and took three lambs from her, one of which was jet black, though both parents were registered. The owner of that flock has since told me that he had to get rid of all his black sheep (grades) because their presence tended to the discoloration of his registered flock, and just here I believe he discovered the true secret of the source of the black lambs in white flocks, namely, mental impression and environment, and here is my proof: Soon after coming to Brooke, in 1890, the dogs seem to have decided that a treat for them had arrived, for in two consecutive nights they cleaned out my flock of Downs so effectually that I became disgusted and discouraged for the time being. I soon grew lonesome without the nannies, and as I at the time had several flocks distributed among farmers on shares, among which were some fine black specimens, I resolved to beat the dogs by growing up a flock of black sheep, and as with me the distance between the resolve and the act is very brief, I soon had a charming home flock of blacks, and this flock in ten years has been known to have been meddled with by dogs only once, and that in daylight, when an exploded cartridge and a dead dog settled the matter. These I ventured to show at the fairs, and though, because of prejudice, I could not win in the breeding classes, yet as fat sheep I could spot them. Quite a demand sprang up for the use of my black sires, to test their powers of transmitting the color. I let them out quite freely. This I found an excellent way of fortifying myself against the home use of weak producers. I found that one particular ram that had cost me much time, thought and travel to produce for my own use was proving very impressive, and was bringing true to type. This fellow I carefully husbanded for myself, but a neighbor having a white flock desired to use him. To accommodate him, I must let my whole flock of ewes mix with his white ones during the coupling period. Against such a course my own better judgment rebelled, for, remembering Jacob and the water troughs, I knew that such procedure meant disaster to the color of my next crop of lambs; but there was another and an outweighing consideration, for now I had an opportunity of testing, without being suspected of my purpose, the influence of the black ewes in intensifying the power of the sire to impress his color and characteristics upon his offspring, as would undoubtedly be revealed in the next crop of lambs dropped by those white ewes, also the reflex influence of the presence of the white ewes against the same power to impress, as would with equal certainty appear in my own crop of lambs, and I yielded for the benefit of the experiment in its bearing upon this important question. The more I thought of the matter, the more intensely interesting it became to my mind. Indeed, so fascinating did the thought become that I was now on the highway to a marvellous discovery, the revelation of which would be of untold advantage to generations yet unborn, that I went myself with the flock and remained for some time to note results. It at once became very clear that the white ewes regarded the blacks as intruders and interlopers whose company was anything but acceptable; while, on the other hand, the blacks, with equal evidence, regarded their white sisters with jealousy and intense hatred, because they monopolized so much of the company of their sable consort; and there was war in the camp, there was battle and counter-battle, charge and re-charge, until I became alarmed as to the results to the physical being of the ewes thus engaged, but I knew also that all this would have a most telling effect upon the revelation that was to be evolved out of the experiment; hence, as the battle proceeded and the pairing progressed, now a white, then a black, was mated, my interest grew apace, and I finally returned home, convinced that I had in store something rich in the form of a to-be-revealed secret relating to fetal markings, etc. The next spring I was around early to receive the revelation in instalments. Out of nine lambs, from the white dams that survived, there were eight niggers, while some of the black dams that

never before had yeaned a white lamb, even from a white sire, that spring had two white lambs, and ever after gave one white one when there were twins. One of these black ewes I kept until eleven or more years old, and the result was always the same—a white lamb if two were born. It would be the height of unphilosophical folly to say that the black sire's blood had become stained or vitiated by his consorting with the white ewes, as some have affirmed. If such were the case (and I have in the past seen it put forward in even the "Farmer's Advocate"), we would never dare to pair a male with a grade or one of any other pure breed without his certain ruin; but enough for this time.

E. J. YORKE.  
Lambton Co., Ont.

### The By-products Give the Profit.

One of the reasons given for lower prices on the Canadian cattle marts than obtain on the U. S. cattle markets is that the packers on the American side of the line are enabled to use everything about the slaughtered animal; with them the word ofal, in the strict sense of the term, becomes obsolete. The late P. D. Armour, Jr., contributed a paper to a breeders' meeting, some time ago, in which he states that a 1,200-pound steer, live weight, will yield from 650 to 700 pounds of dressed beef. In the earlier history of the packing business most of the difference was lost, even the disposal of much of it being a source of actual cost to the packer. The blood was allowed to run into the river, but the heads, feet, tannage and other refuse generally had to be hauled out on the prairie and buried in trenches.

The horns of a slaughtered steer are cut off close to the head, and the pith is removed and sent to the glue pot, while the horns themselves are dried, sorted into various grades, and shipped to the manufacturer. After being pressed into flat plates, they are manufactured into combs, buttons and ornaments of many kinds. The tips of the horns are made into mouthpieces for pipes, and the scraps are utilized by florists as fertilizers.

The bones are used in many ways. The knuckles are removed from the feet and shanks of the animals, and, after boiling and cleaning, are used in the manufacture of knife handles, tooth brushes, buttons, and various articles in which ivory and bone are used. The hard bone is susceptible of a very fine polish and can hardly be distinguished from ivory. The scraps are used by manufacturers of bicycles and screws, for case-hardening steel; and are also used for poultry food.

From the blood the albumen is extracted by a chemical process and used for the fixing of colors in calico printing, and also in the finishing of leathers. The residue of the blood goes into the fertilizers. A new use for the first blood drawn from the animal is a food for live stock, for which purpose it is in the form of a dry powder.

The white hoofs are shipped to Japan and Europe, to be made into buttons and ornaments of many kinds. Glues, gelatins, isinglass, etc., are manufactured from that portion of the hide not used for leather, and from sinews, cattle heads, cattle feet, calves' feet, etc. Tallow and grease are made into various grades of soap. Glycerin, a part of the fat that will not saponify, is recovered from the soap kettle and made into crude glycerin, dynamite glycerin, and chemically pure glycerin.

The hair is manufactured into felt, the cheaper grades of which are used for the insulation of refrigerator cars and ice boxes, and for undercarpets, etc. The better grades are used in the manufacture of horse blankets, saddlery, felt boots, hats, etc. The tails of the cattle are used for manufacturing curled hair, in combination with horse hair, which is imported largely from Russia and South America. The hides are tanned, as is well known, and made into leather.

One of the most valuable products of the steer is oleo oil, which is pressed from the fat. It is chemically butter-fat. Much of it is shipped to Europe, where it enters into the manufacture of margarine, and is also used in the States in the manufacture of oleomargarine and butterine.

All the portions of the animal that may not be utilized for food or for commercial manufacture, find their way back to the farm in the form of fertilizer. Pieces of meat, bones, etc., not available for food, are boiled under high pressure to extract the grease and glue, and the residue is dried and enters into the composition of fertilizer.

### In this Home Since 1866.

It has not been altogether an oversight in not sending my renewal, as the Farmers' Institute wanted me to subscribe through them. However, I am sending you \$1 for my subscription for a paper which has been in the house ever since 1866, my father having taken it then.

Peel Co. GEORGE BLAND.



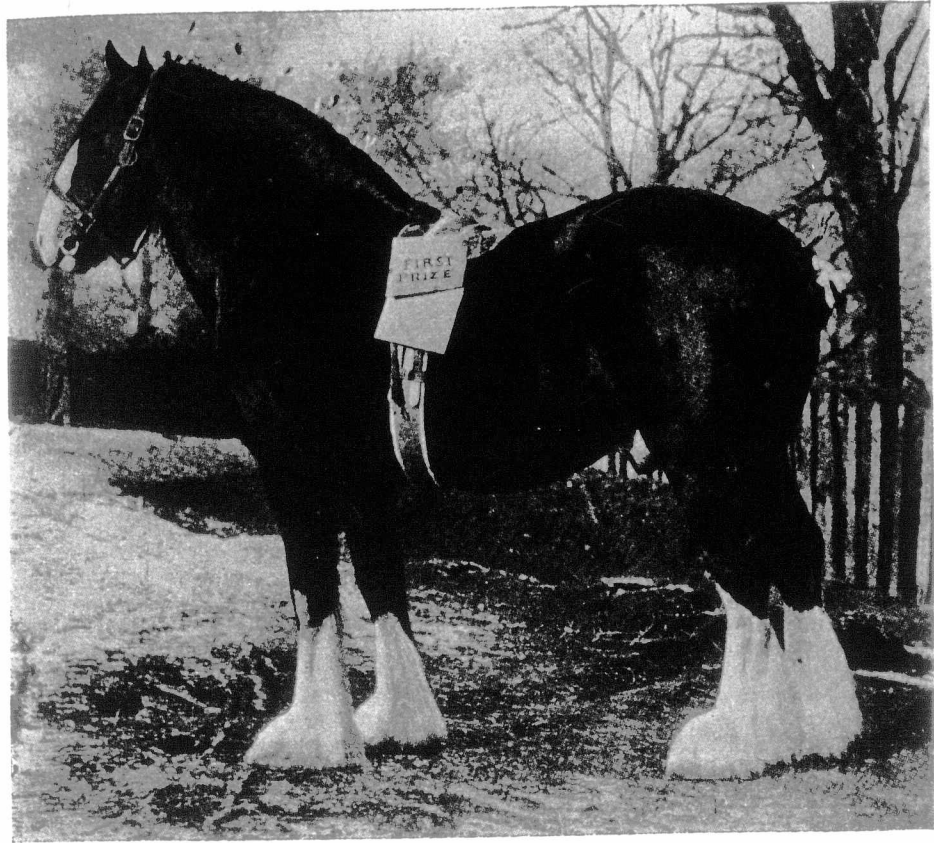

**HIAWATHA 10067 AT TEN YEARS OLD.**  
Winner of championship and Cawdor challenge cup for 1902, and for four years in succession at the Glasgow Stallion Show.

**Our Scottish Letter.**

Farmers in this country have not learned, as in Canada, the advantages of combination. There is, however, a sensible improvement in the direction of adopting the system, and all-around farmers are combining for the furtherance of their own interests. The Essex farmers, who are largely Scots from Ayrshire, have been the leaders in this movement, and their work has been attended with the best results. At first their motive was to counteract the combination of the London milk-dealers, who practically made their own price and paid the producers just what they pleased. In this the farmers largely succeeded. By insuring their members on the mutual-bonus system against loss should they be offered a lower price than the standard fixed by the combination, they were enabled to refuse to sell, and anyone who failed on this ground to make a market had his milk taken by his neighbors, or if he churned, the combination indemnified him for his loss. Similar institutions have sprung up over England, and now all are embraced in one federation. The parent society in Essex has meanwhile extended its business, and undertakes to do with much else that is of mutual interest beyond the price of milk. Through its agency farmers are buying their manures and feeding-stuffs. Guarantees are obtained from the merchants, and the goods are subjected to efficient tests. In this way better value is obtained for the money expended.

In Scotland several institutions of like nature have been founded. The dairy farmers of the West of Scotland are endeavoring to combine on the Essex plan, and so far good results have followed. The chief difficulty in getting such institutions into effective working order is the spirit of individualism and the determination of each one to fight his own battle. This is commendable, but it does not seem desirable that too much stress should be put upon it as a reason for combining for mutual defence. The farmer needs protection as much as any other business man, and this should come to him mainly through his neighbors, whose interests as producers are identical with his own. The West of Scotland Federation has not succeeded in convincing every farmer that he should join, but it has certainly secured a much greater degree of support than at one time could have been thought possible. The taking of samples of milk for analysis is one of the most practical ways in which these organizations can help the individual. When he knows by the best attainable means what the quality of his milk is, he can face the opposition with some good hope of success. Some of the branches are discussing questions of such vital interest to dairy farmers as the treatment to which cows near the calving are subjected. By the way, an extremely interesting lecture on this subject was lately delivered in East Kilbride by Mr. Begg, a local veterinary surgeon. The subject was handled in a practical way. Some of the points can hardly be appreciated where the auction-mart system does not prevail. Here cows within a few days of calving are bought by dealers as a speculation. They pass from hand to hand, and are taken to one auction mart after another so long as they are uncalved, provided a profit can be made on them, and when at length they pass to a permanent abode, they reach it in a condition easily understood but pitiable to a degree. Some-

times the poor animal enters her new quarters with the pangs of labor already on her. She may survive these, and perhaps generally delivers her calf, but in many cases she becomes feverish and dies. The rough usage of the previous fortnight or ten days was in all likelihood the main cause of the disaster, and much cruelty is inflicted and capital lost by this wasteful process.

The decision of the Supreme Court, that milk-blended butter is not technically adulterated, and may be sold as butter with impunity, has rather astonished the public. Milk-blended butter is cheap butter washed or churned anew in milk, thereby greatly increasing its content of moisture and leaving a substantial profit to the blender. The decision was based on the fact that in the label covering the butter a full disclosure was made of its constituents, and that, therefore, no one was deceived if he used his eyes. Simultaneously with this decision, a departmental committee has reported to the Board of Agriculture that genuine butter should not contain more than 16 per cent. of moisture, but if the seller makes a disclosure of the fact that any butter he sells contains more than this, he shall not be liable to prosecution. Butter, in other words, is declared to be genuine up to 16 per cent. of moisture, but beyond that point moisture indicates that the goods have been tampered with. Still, the seller is at liberty to sell these goods under the genuine name provided he informs the buyer that they contain what proves them not to be genuine. This funny recommendation has excited a good deal of comment, and, indeed, of consternation.

Shorthorns have been the scoring breed at the sales this spring. Curiously enough, the best price for a Shorthorn was got for a Beaufort bull at Birmingham. The anomalies of the auction system were never more strikingly displayed than in this transaction. The bull was bred by Lord Lovat at Beaufort Castle in Inverness-shire, was taken past all the Scotch sales to Birmingham, in the English midlands, and there was purchased by Mr. W. S. Marr, Uppermill, Aberdeenshire, for 335 gs. Lord Lovat sent four bulls to this Birmingham sale, and they made an average of £271 11s. each. The Beaufort cattle have scored splendidly of late years. Their success is due to a bull named Royal Star, bred by Mr. Reid, Cromleybank, sold to Mr. Duthie and by him to Lord Lovat. He was sired by Belvidere, of the Sittyton Butterfly tribe, and his dam a Marr Roan Lady. The second best average at Birmingham was made by a breeder from the other extremity of the British Isles—Mr. Hosken, Hayle, Cornwall. He sold five at £134 8s., which ought to be good enough business. A notable Shorthorn bull has recently been destroyed in Mr. Duthie's famous champion, Pride of Morning. This great sire was champion at the H. & A. S. Show at Aberdeen in 1894. He was not the most prolific of sires, or he may have been sparingly used, as the number of bull calves by him at any of the Collynie sales was never very high. What they lacked in quantity, they made up in quality. No sire of recent years left so many bulls which as calves sold for phenomenal prices. One went at 450 gs., another at 350 gs., and others at 200 gs. and 105 gs. More than once the highest-priced bull calf of the season has been got by Pride of Morning. When opened, the old bull was "sound as

a bell." In another connection, a notable Shorthorn-man has passed away. I refer to Mr. Cadwallader J. Bates, of Langley Castle, Northumberland. This gentleman was grand-nephew of Thomas Bates, of Kirklevington, and author of that admirably-written book, "Thomas Bates and the Kirklevington Herd." As a storehouse of information regarding what used to be the greatest of all the Shorthorn tribes, this book holds a unique place. Mr. Bates was more of an antiquarian than a farmer, and, indeed, took high rank in that respect. He had, however, stock-raising ambitions, one of them being the restoration of Bates cattle to their position of supremacy. It seems a somewhat idle ambition, and not worth realizing even if attained.

English breeders of Aberdeen-Angus cattle have a society of their own, its principal object being the holding of a spring sale of young bulls and heifers at Birmingham. The second of these sales recently took place, and a good average was secured. The leading herd in the south seems to be that of Mr. Bridges, Horley, Sussex. He led both for bulls and heifers, and deserved his average. The ranks of Scottish breeders of these cattle have been thinned by the untimely death of Mr. Hugh Wilson, Milton of Noth, a man well under 40 years, and universally respected as a painstaking, solid judge of black cattle. He frequently acted in that capacity at the leading shows.

Galloway breeders got a very sharp lesson at their bull sale at Castle-Douglas. About three times as many bulls were presented as were wanted, with the result that there was a decided slump in the market. There was, however, as usual, room at the top, and Messrs. Biggar & Sons cleared the way with a fine lot of eight, for which they got the substantial average of £31 19s. 11d. Mr. Brown, Stepford, Dumfries, improved on this, but with half as many animals, making £33 19s. 10d. The averages after these tapered down very low, and trade generally was completely demoralized. Galloways are grand cattle, but you can easily have too much of a good thing.

Horse movements are not numerous. The non-arrival on your side of the Allan liner "Huronian" is giving rise to serious misgivings. When the vessel left here she seemed light. She carried several good Clydesdale stallions, and also their owners. Let us hope she may be reported safe in a very few days. General shows begin next week, and until the end of August the country will have one of these events on an average every day.

"SCOTLAND YET."

**To Make Box Measures.**

A box 24 inches long by 16 inches wide, and 28 inches deep, will contain a barrel or three bushels.

A box 24 inches long by 16 inches wide, and 14 inches deep, will contain half a barrel.

A box 16 inches square and 8 2-5 inches deep, will contain one bushel.

A box 16 inches by 8 2-5 inches square, and 8 inches deep, will contain one peck.

A box 8 inches by 8 inches square, and 4 1-5 inches deep, will contain one gallon.

A box 7 inches by 4 inches square, and 4 1-5 inches deep, will contain one quart.

A box 4 feet long, 3 feet 5 inches wide, and 2 feet 8 inches deep, will contain one ton of coal.

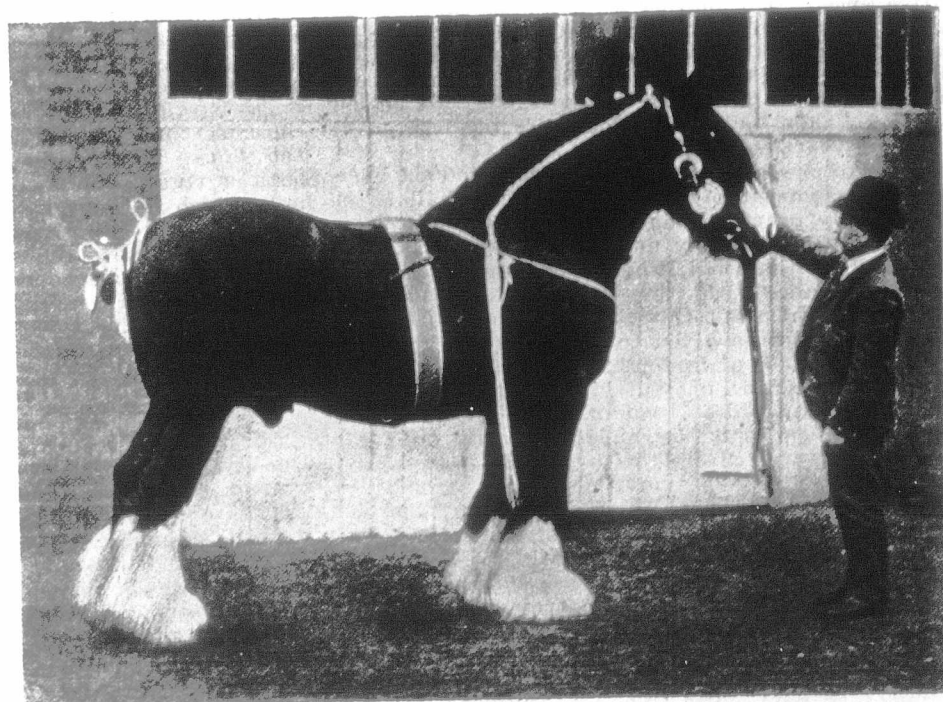

**STROXTON TOM.**  
Winner of first prize for stallion ten years old and upwards, the championship, challenge cup, and gold medal as best stallion any age at the Shire Horse Show, London, Eng., 1902.



### The Establishment of Co-operative Pork-Packing Houses.

[Contributed by J. W. Clark, Brant Co., Ont.]

Everyone is familiar with the history of the wonderful development of the export-bacon trade in Canada during the past ten or twelve years. In 1890 our export of bacon, lard, hams, pork, etc., amounted to less than 8,000,000 lbs.; in 1900 it had risen to about 136,000,000 lbs. The Province of Ontario has been the chief exporter, but the time has come when we may expect to see a change in this respect. Much of Quebec, New Brunswick, Nova Scotia, and Prince Edward Island is admirably adapted to dairying, a branch of farming which is rapidly extending from Montreal eastward, as well as in Ontario. The dairy districts produce the class of hog from which the finest Wiltshire bacon is made, and in these districts hogs are put on the market at as low a cost per pound as in any section of Canada. General dairying and hog-growing should go together, as neither will reach its highest paying condition without the other. The eastern and northern sections of Ontario produce a better class of hog than the corn belt of Western Ontario, or, in other words, the section of Ontario which more nearly resembles Quebec and the Maritime Provinces in climate and grain products produces the best class of bacon. In some respects these Provinces are better suited than Ontario for the development of this industry. Land is generally cheaper, pasturage surer, and roots and other crops easily raised. Two conditions are necessary in order to develop this industry in Quebec and the Eastern Provinces, especially the latter,—an abundance of coarse grains, which by attention to agriculture can be profitably produced, and the establishment of packing companies (or the extension of those already established), which will fully meet the requirements of the best markets both at home and abroad.

\* During the past year or two, I have had frequent requests from other Provinces for information regarding the establishment of co-operative packing factories, such as have recently been put up at several points in Ontario. The practical result of these co-operative movements has been demonstrated by the Danish farmers, who are becoming more and more interested in improving the quality and shape of the pig, as through this medium alone they have succeeded in placing their bacon and pork in a foremost position, both for quality and shapeliness of side, on the London market, while the fact of these co-operative factories being established all over Denmark shows to what a success they have been brought.

There are several points, however, that should always be observed in connection with the establishment of these pork-packing industries on the co-operative plan. In the first place, they should be installed as nearly as possible along the Danish lines, with only farmers as stockholders, and each one allowed to hold only a limited amount of stock. No speculators should be permitted to invest in the company. In the next place, it is absolutely necessary that the individual subscriber shall have faith in his own company. The practice of farmers subscribing stock in these movements and then selling their hogs to the highest bidder, often to firms competing against their own company, is all wrong and entirely different from the "modus operandi" in Denmark. The success of Canadian co-operative factories is absolutely regulated and controlled by the loyalty of the farmer, who has, as yet, scarcely realized the importance of operating along truly co-operative lines. Still another necessary feature is that all proxies should be concentrated in the hands of a council of not more than seven (preferably five) of the very best men among them, brainy, practical, business men, who are not likely to be led away by fads, or driven from wise business principles by factious opposition.

It is of the first importance that behind the business management of the concern there shall be a thoroughly practical and experienced curer, who will send forward only uniform goods of the highest quality, that will, when tested on the British market, grade with the best Irish and Danish bacon. To turn out this class of goods particular attention must be given to the sort of pig grown and the method of feeding the same. To produce the highest grade of Wiltshire sides the packers require a long, deep, smooth pig, possessing a light head and shoulder and even back, not too broad, but well covered with firm flesh, not fat; at the same time he must not be a razor-back. The sides from ham to back of shoulder must be long and deep, the underline straight and free from flabbiness; the ham smooth and tapering, with the greatest amount of flesh on the outside. The pig should be healthy, vigorous, and a good feeder, weighing when ready to market from 175 to 200 lbs. I believe that Yorkshires produce the greatest proportion of pigs of this type, with the Tamworths next. The thick fat American or lard types are not wanted by packers. Pigs should be fed good, wholesome and carefully-selected food—skimmed milk, potatoes, roots, green food, barley, peas, etc.—in a properly-balanced ration without

any undue stuffing. If the farmers do not intend to observe these conditions, they had better leave the business entirely alone, as otherwise they are only retarding the efforts of other Canadians who are striving to place our bacon on the market in the highest possible condition in competition with the Irish and Danish products. A good deal of money has been lost during the past year on hogs, the English market not justifying prices paid in Canada. For instance, we have had pigs for a whole year ranging in price from \$6.50 to \$7.50. Such a condition of affairs was never before known in the trade. The farmers have, however, received the benefit and the packing companies have suffered, largely because they have been climbing over one another to get pigs, irrespective of cost, doing no culling and taking undesirable animals just as quickly as they would the best. This kind of thing will right itself in course of time, but not before the packing houses lose a lot of money.

A co-operative packing factory should not be started until a capital of at least \$250,000 has been subscribed, which will be sufficient to ensure a killing capacity of two to three thousand a week. Small plants are objectionable because the refrigerating system costs very little less and the management and expenses are the same, minimum production always being the most expensive. Such a factory cannot be put up for less than \$100,000 to \$125,000. Farmers holding stock in such a company should deliver their hogs at the factory, take an advance of sixty or eighty per cent., have them slaughtered, cured, branded with the name of the factory, sent forward and realized on through the medium of a first-class English agency.

Eastern Canada has for some time shown a good deal of interest in the subject of co-operative packing-houses, but, so far as I am aware, Manitoba, the Northwest Territories and British Columbia have not given it much consideration. Possibly the information given above may prove of value to the people of the West as well as the East. Any community interested in the co-operative system outlined above should send a representative committee to visit and carefully inspect the operations of a working factory, such as the Farmers' Co-operative Packing Co., Ltd., of Brantford, Ontario. They will find the Manager, C. F. Hodges, or Mr. Joseph Stratford, Manager Farmers' Binder Twine Co., both able and willing to give the fullest information in regard to the co-operative movement in all its phases.

Brant Co., Ont.

J. W. CLARK.

### Value of Wheat Fed to Hogs.

Mr. Brennan, speaking at institute meetings in the Territories, gave the following personal experience in feeding wheat to hogs: In the year 1900 he had in his possession 500 bushels of inferior wheat which, if marketed, would have brought only 45 cents per bushel, or 500 x 45 = \$225.00.

He fed practically all of this to hogs, cattle, and poultry, and sold

\$162.00	worth of pork on local market.
110.50	" " pork to Indian Head Farm.
35.00	" " pork—private sales.
125.00	" " beef.
20.00	" " poultry.

\$452.50

There was also something over a bushel of the wheat unfed, which, if marketed at 45 cents, would have brought the proceeds up to \$453.00, or 90.6 cents per bushel.

### Select the Best Milking Ewes.

The importance of breeding from ewes which are known to belong to a good milking strain of sheep cannot be overestimated. The lamb which has for dam the heaviest-milking ewe in the flock is, as a rule, the first ready for the market when the time comes for disposing of the first fruits of the flock. Ewes, like cows, differ very largely both as regards the amount and the quality of the milk which they yield. During the early stages of their growth, lambs depend almost entirely for their sustenance upon the milk which they obtain from their dams, and it will be almost invariably found that the heaviest and plumpest lambs in the flock are those whose mothers are the heaviest milkers.

### Dr. Rutherford Appreciated.

At the recent annual meeting of the Veterinary Association of Manitoba, Dr. J. G. Rutherford, the newly-appointed Chief Veterinary Inspector of Canada, was unanimously elected an honorary associate. The following resolution was also carried without a dissenting voice:

"Resolved, that this Association rejoices in the elevation of one of its members to the most important post in the Dominion open to the veterinary profession—that of Chief Veterinary Inspector to the Dept. of Agriculture, and wishes to place on record its appreciation of Dr. Rutherford's work, as the founder of this Association and one of its most active members, and hereby tenders him its heartiest congratulations and wishes him the greatest possible success in his new sphere."

## FARM.

### Corn the Most Profitable Crop.

As to what spring grains I think most profitable for planting in this locality, I must say "corn" with all the emphasis that I can, and so would ninety-nine out of one hundred Essex farmers, for different reasons: First, because it is a cheap crop to seed with, as one bushel (price, 56 cents) will plant six acres. Second, the cultivation which corn receives, both before and after planting, leaves the ground in excellent condition for the succeeding crop; usually oats, which also pay well. Third, I cannot give you official returns as to the yield per acre of corn in this part of Ontario for the past year, but believe I am safe in saying an average of 100 bushels per acre on the ear, which will shell 67 2-3 bushels of shelled corn, at 57 cents—\$38.57 per acre. Now, sir, this is a market price, but we all believe we can make more than this per acre by feeding it to either hogs or cattle, and I might go into figures to show what we can make of our corn crop in this, but will refrain, as I might be making my letter too lengthy.

Some may say, "Oh, but corn takes so much time!" But I claim that it pays better for the time given to it than any other grain crop that we can grow in Ontario, and my experience is not limited to Essex County, as I formerly owned a farm in Wellington County jointly with my father. Corn may be grown and marketed without the expense of costly machinery for harvesting or threshing, or if we go to this expense, there is no more work with it than with wheat or oats, and we may be sure of a fair return every year, for we have had good crops of it here for thirteen years in succession, and for many years before that, I am told by the older farmers. As to the best mode of seeding, I would prefer a sod field, either that which had been meadow or pasture, and in good condition; if not in good condition, it should be manured well in the fall previous or through the winter and plowed about four or five inches deep early this spring and harrowed down, let lay awhile and then well worked with the disk harrow, and the better the cultivation before planting the larger will be the return. One bushel will plant six acres, but some prefer to put in more seed, especially if early planted or if the season be wet or cold, and if it comes too thick, to thin it out, leaving not more than three or four plants in a hill; some would plant one bushel on five acres, while others put it on six. Now, the time for planting would be from May 6th to 24th in this section. Use a 3- or 4-legged marker to mark field both ways, legs to be 3 ft. 6 in. to 3 ft. 10 in. apart. Plant with hand planter; one man will plant five acres per day. In about five days after planting, or as soon as you can see the first plants, harrow with light harrow. In two weeks after planting, cultivate both ways with two-horse riding cultivator or with single cultivator, and continue to cultivate every ten days until ears set. This will be a thorough cultivation and will pay both in corn crop and succeeding one.

The best varieties are the Dent varieties; Flint varieties do not yield as heavy a crop. Of those I would say Ohio White Cap Dent, Yellow Gord Seed, Bailey, Leaming, Gold Mine, are all good varieties. Where those varieties would be too late, plant Yellow Flint, White Flint, Compton. Now, sir, I cannot finish without saying that corn is food for everything, both man and beast, while the cured cornstalks are equal to hay, and will yield one ton per acre, worth at least \$3, which, with the market price of the grain (\$38.57), makes \$41.57 per acre, while the cob is also valuable for fuel or as manure.

Yours truly,

Essex Co., Ont.

J. F. BELL.

### A Beaver Colony.

Quite near Hartney, on the Souris River, there is a colony of beavers. The animals have selected for their home a place where the bank of the river is comparatively low and overhanging the deep water, which in winter is kept warm and open by the influence of strong springs. Young poplar trees selected from the grove along the shore afford plenty of food, and the chips from the freshly-cut green wood can be noticed scattered on the ground wherever the animals have been at work. It is said that the beavers have occupied this winter home for several years, and are increasing in numbers. The man on whose farm the interesting animals have located uses every means in his power to prevent the destruction of the creatures. This is perhaps the only family of beavers to be found within the settled portion of Manitoba.—Hartney Star.

Your premium knife to hand, and I find it a useful article; not too large to carry, and of first-class steel, and can recommend it to everybody as a splendid premium. JAS. SMITH, Lambton Co.



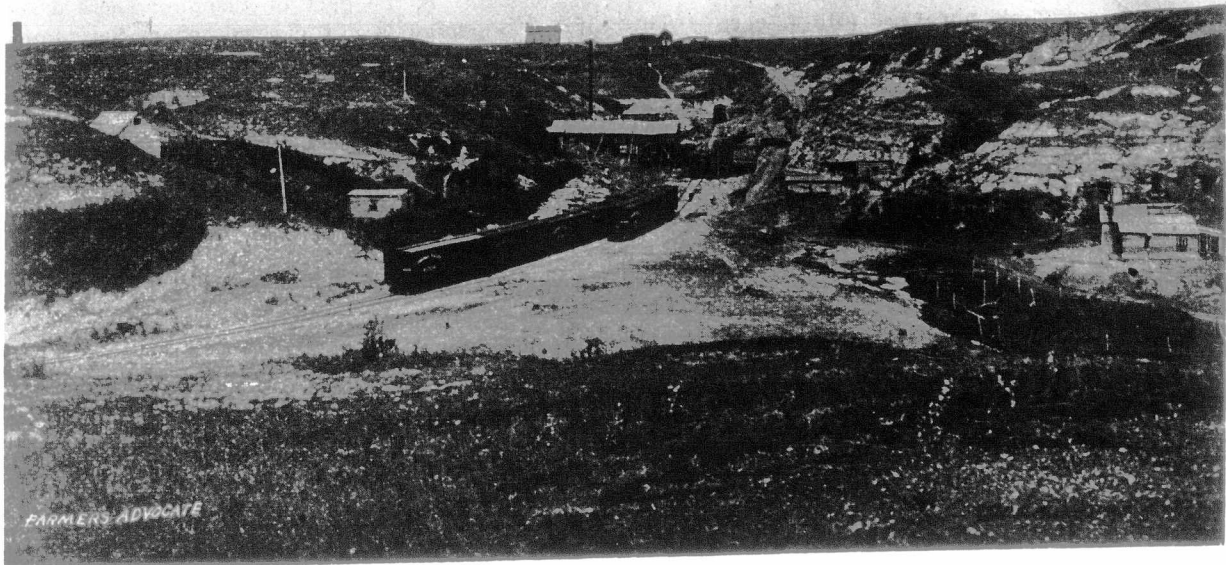

HAZZARD MINES.

**A Western Industry of Growing Importance.**

To the great majority of the settlers of the wheat-producing districts of the West the question of supply is one of greatest importance. As a necessity arises, however, a means of supplying it is generally found. In the south-eastern corner of Assiniboia, just west of the Manitoba boundary line, near the junction of the C. P. R. south-western branches with the Soo line, a large area of lignite coal was discovered some years ago. Engravings are produced on this page, one showing the mine mouth of the pit that is now being worked at Coalfields, the other the Roche Percee, or pierced rock, from which the mines take their name. These mines are the property of the Souris Coal Mining Co. (Ltd.), and the property owned by the Company, comprising 2,500 acres, is located in townships 1 and 2, range 6, west of the 2nd meridian, about 290 miles south-west of Winnipeg, where are the headquarters of the Company. There are two workable seams of coal. The upper, about 20 feet below the prairie level, is four feet thick; the other seam, 100 feet below the prairie level, is from 7 to 10 feet thick, and is the one that is being worked. The yield is estimated at 8,000 tons per acre, so that this property would give about nineteen million tons of coal. This lignite coal, while inferior to anthracite or bituminous, is a very useful fuel, and is rapidly increasing in favor as furnaces and stoves are being improved so as to be more adapted to its use. As an evidence of the increasing demand for the coal, the output for the years 1895 and 1896 was only about 10,000 tons, while last year about 40,000 tons were mined. This winter about 150 men are employed.

**A Common Mistake Regarding Work.**

The farmer is a busy man if he is worthy of his occupation. So is every other man, no matter what his business in the world may be. The idler and the trifler are like the sinner who "cannot stand in the judgment"; they cannot stand long in the stern trial which the world has for every business man. But too many men misunderstand the meaning of the word work. To many it means only manual labor; to many farmers it looms up as necessary and important above all other things. For the sake of their work they will neglect their business; for the sake of their work they will pass by opportunities of great value if they were improved. The wise man spoke of him who is "diligent in business" as worthy of the highest honor; not of the man who is a slave to his every-day work.

There is a nice problem confronting every business man. It is what and how much of the drudgery or detail of his business he shall attend to personally. We have known a man whose time was worth several thousand dollars a year to spend it on work that a cheap clerk could do as well. He was losing something. We know farmers and stockmen who are sticking at home and at labor all the time who ought to be attending to their business affairs instead of taking the place of a hired man. They are putting their ability in at too low a price, they are underrating themselves. Consider what work can be done most effectively, and do it. It may be that writing a letter will bring returns enough to pay for a laborer for several days. It may be that reading an article or an advertisement will be worth more money than a month's labor. No man can lay down a rule for another in such matters, but if some people would labor less and attend to business more they would be better off. Work is not all manual labor, it is the intelligent direction of energy to the furtherance of business.—Exchange.

**The Farmer as a Thinker.**

It is long since I heard it remarked of a certain farmer, well known for the successful management of his farm, that he "was always thinking." And, it was added, that is the first quality of a good farmer. Perhaps the same might be said of any other business or profession. To be so saturated with it that it is never out of one's thoughts means success. The person who made the remark went on to discourse of the change that has taken place in farming during the last fifty years, or thereabouts, in the relative importance of manual labor and thought. When one listens to the talk of elderly people—if those over sixty will pardon being called "elderly"—it is noticeable what emphasis they put upon the fact that in their "young days" farmers worked much harder than they now do. Hard labor, unceasing industry and thrift were the only gateways to success—at least among the class from which I sprang. No idling with reading, correspondence or half-holidays for them; no dabbling in science or theories or experiments or lectures; nothing but dogged persistence in rough, hard work from year to year. Such tales I have listened to of our forbears; of the prodigies they performed with scythe and hook and flail; of their zeal in cleaning sheughs, which was so great that such a one would never be seen to lift his head from the task for half a day! Indeed, it seemed to be a favorite pastime for the long summer evenings. One was telling me of the loneliness of her early bridal days on a moorland farm, and when I asked her if her man didn't keep her company in the evenings after the kye were milked, she replied, "Oh, no! He aye gaed out tae clean sheughs." It must have been because the land was insufficiently drained that they were constrained to spend so much of their time in dyke-backs.

It is not suggested that these farmers were not thinkers, but simply that necessity put hard manual labor in the place of first importance. Among them there would be, then as now, the thoughtful and the thoughtless. But while thrift and industry can never lessen in value, it becomes more and more important that the farmer, even of few acres, should use his brains—his thinking faculty. So much occasion is there for forethought, planning, and a constant alert supervision, not to speak of anxiety, about the rent and losses among the stock, that I have often thought a farmer's life would be too hard if it were not that the conditions of his work give him ample opportunity for quiet thought. Walking from field to field to inspect his stock or his crops he can mature his plans in peaceful surroundings without interruptions. If he puts forth his hand to milk, to sow, to lead a horse, or to build a stack, the work is not so absorbing that his mind is not free. And I have it on the testimony of more than one that a great amount of useful thinking can be done between the stils of the plow. A way has

been found through many a mental thicket as the skillful hand and eye made the furrows straight.—The Scottish Farmer.

**An Essential in a Good Potato.**

The tendency in agricultural lines is more and more towards knowledge of the products of the farm. It is not alone sufficient to produce things, but the article produced must be the best possible. To render such a result possible, it is incumbent on the producer "to know a good thing when he sees it." In potatoes, size, as far as is compatible with smoothness and soundness, is desired, as is also the mealy texture, about which the Farmer's Gazette has the following to say: "Why is it that the potato on being boiled becomes so floury or 'mealy' in texture? When cut up in the raw state the flesh or substance of the tuber is quite soft and juicy, whereas the same tuber after being boiled becomes quite crisp and mealy in texture. The explanation is that in the process of cooking the starch grains which are stored up in such large quantities in tubers become so acted upon by the heat that they burst the little cells or coatings in which they are enveloped, and in this way give the peculiar floury appearance so characteristic of a well-cooked potato of good quality. The higher the percentage of starch present the more mealy the appearance which the tuber will present after being cooked. A simple test of the quality of a potato may be applied by cutting it in two and then placing the cut edges against each other so as to get them into the positions which they occupied before cutting. One of the sections should then be taken hold of and the other allowed to depend or hang down. In almost all cases the lower portion will remain attached to the upper, but by jerking the hand slightly the two can be made to part company. The more difficult it is to shake them apart in this way the better the quality of the tuber, the explanation being that the pieces are held together by the adhesive nature of the starch, and that the more starch that is present the more difficult it will be to part them. On the other hand, the less starch there is present and the more water, the softer and less floury the flesh will be when cooked."

**Hedge Planting in December: a Singular Experience.**

To the Editor "Farmer's Advocate":

Sir,—I have been a reader of your valuable journal for years, and confess that I have learned many good lessons from discussions in it on different lines of farming. Having been benefited by others' experience, I am willing to help my brother farmers in return, especially when it comes in the line of beautifying our farms with ornamental and shade trees, thus increasing their value and making homes more attractive.

In your March 15th issue is a question and answer regarding lawn and hedges. I do not wish to dictate to those who should know more than myself, but in the last part of December, 1899, as the weather was mild, we planted over 400 cedars for hedge, from two to three feet high, and cut them back to 18 inches. Experienced men said I was wasting time, as they would not live, as May and 1st of June was the proper time to plant. In the following spring we planted some more in the first week in May and 1st of June. Of the 400 planted in December only two died. Of those planted in May not any lived, and of those planted on 1st of June, one lived. My lawn is clay loam. Nearly all the trees were taken from high land; a few from swamp, but they do not seem to do so well as the others. The cedar makes one of the prettiest hedges we have. Huron Co., Ont. G. LAITHWAITE.



THE ROCHE PERCEE, OR PIERCED ROCK.



### How Can the Farmer Educate Himself?

The education of the farmer is a question often discussed, but a few words as to its great advantages perhaps would not be amiss. It was considered at one time, and is considered yet, in parts of Nova Scotia, that the smartest boy in the family would make a good minister or doctor, but the dull son did not need much education, as he would probably be the farmer. Now, experience and proof has shown this to be a fallacy. Years ago, when the land was new and fertile, and insect pests were almost unknown, a farmer was sure of a good crop with hard work, and knowledge concerning the needs and cultivation of crops were seldom needed. But how is it to-day? The soil in most cases has lost much of its previous fertility; insects and diseases attacking crops have multiplied exceedingly in the land, and, owing to the growth of large cities and competition in the selling of farm produce, the sort of produce or variety of fruit or vegetable that was years ago looked for in most markets is now looked askance at. The fat pig and the scabby apple are not the best selling products to-day. The markets require fruit in the best of condition, meat and butter also of the best quality, and anything beneath the mark finds a slow sale and few purchasers. How is the farmer to know when he can produce the best quality of produce or stock which commands the highest price at a profit unless he has a knowledge of modern methods. He cannot depend altogether on what he learned from his father; times and conditions have changed. He would not use the scythe or the flail because his father or grandfather did. No more should he depend altogether on methods which, though best in their day, are now considered of little value. The bare fallow and high hilling of potatoes are examples of this class. Then he should have a knowledge of the elements contained in manures and fertilizers. I have known of some farmers who think they can determine the quality of a bag of fertilizer by smell (the stronger the better), and the same of manure, with only a vague idea of the meaning of the guarantee of the manufacturer. He may know what is the best food to feed his cattle for milk or meat, but little of the kinds of plant food he must apply in order to get results. What is the farmer to do if he is willing to learn? The best way is to subscribe for such a paper as the "Advocate," study what he can on these subjects in books written for his benefit by experienced men, get and read the experimental farm bulletins, and, still more important, try some of the modern methods on a small scale and compare the crop side by side with one grown on the same old plan he has always practiced, and if he finds it pays continue to improve and be up-to-date. The doctor or lawyer must study and read, as well as practice their profession, and the farmer's work, if carried on with the light of modern investigation, is more of a profession than either that of the lawyer or the doctor. The farmer who wishes to be successful in these modern times must know something of geology, chemistry, botany, etc., each one of which is a science in itself. The farmer who does not take any stock in modern ideas and methods would be surprised if he was told that growing a crop requires application of each of those sciences in combination. Of course, a good crop can be grown without this knowledge, but to obtain the greatest yield at the least expense, and to be enabled to take more interest and pride in his work, such knowledge is of much benefit. Much has been said of the great advantages of an agricultural-college training, but even if the teaching is free, the ordinary farmer, especially in this Province, could not afford to attend it, pay for books and board, or can he always afford to let his son take this advantage. Strange to say, that he can often afford to help his son through a law, medical, or business school, but when it comes to a school for farming, he hesitates. The institute and society system, as practiced in Ontario, is a great help to the farmer, but in some of the societies in this Province the improved methods of cultivation and fertilizing are often left in the background. Now, how can the best cattle be grown without proper attention paid to the primary question of producing food? Many of our agricultural society members depend on imported meal, grain, etc., when they could easily grow good substitutes if they were up-to-date in crop-raising, as they think they are in stock-raising. The Government lecturers are also great helps to the farmer who desires knowledge. Many of these men are experienced and practical farmers, who offer their suggestions to those willing to hear, but the only drawback is that they usually confine themselves to the richest farming districts, while those who need it most are neglected. Last, but not least, agricultural exhibitions, if conducted in a clean manner, encourage the farmer greatly. He sees samples of products and live stock which give him better ideas of his business and show him in a way to what perfection they can be produced if intelligence be combined with hard work,

and he should go home stimulated with the resolve to do better than he has in the past.  
Halifax Co., N. S. E. M.

### An Easy Method of Growing Potatoes.

In our rotation, potatoes follow corn. The corn is planted on clover sod, manured during the previous fall and winter, and plowed in May. In the past, we have planted and worked our potatoes as I am about to describe; this year I shall modify the system slightly. The corn stubble was plowed in the fall, usually during the month of November. In the spring, about May 1st, if the soil was fit, the surface was smoothed down with a harrow, marked out (the rows three feet apart), and furrowed with an ordinary plow. We use good sized, clean potatoes for seed, cutting to leave two eyes in each piece. The pieces are dropped by hand in the furrow, twelve to fourteen inches apart, and covered with the plow. This method of covering leaves the surface of the field rough, which is an advantage in the cultivation to follow, and which also helps the soil to absorb more heat from the sun. About two weeks after the potatoes are planted, we watch our chances for a dry, hot day—the hotter the better. By this time, every weed seed near the surface will be nicely sprouted, but very tender and easy to kill. During the hottest part of this dry day (which has never failed us) we run an iron drag cross-ways of the furrows, placing two pieces of scantling (about 6 ft. long) under the harrow, in the form of an A—a very broad A. These scantlings catch the crests of the furrows and level the field perfectly, upsetting every starting weed within sprouting distance of the surface. About a week later, or as soon as the potatoes begin to come through the ground, the drag (without the scantlings) is again run over the field, lengthways of the rows. This second harrowing will destroy any weeds that may have started since the first cultivation, and will leave the soil smooth and clean and mellow. The scuffer next comes into play. It is run through at intervals of a week, until the tops cover half the ground. Level cultivation is practiced all the way through.

Unless the ground is infested with thistles, which come up in the rows of potatoes, no hard work whatever is required to keep the field perfectly clean.

This coming season I will modify this system to the following extent: Our corn stubble was not, as in previous years, plowed in the fall. As soon as weather permits, we will go on with an Acme harrow, working the surface thoroughly to a depth of two or three inches. When the time comes for planting, we will simply plow the field in the ordinary way, dropping our seed in every third furrow. By so doing we will save three operations, namely, the marking, furrowing out, and covering. There will also be the advantage of having the well-ripened surface soil turned down in the furrow in close contact to the seed. Subsequent cultivation, with harrow and scuffer, will be practiced as in previous years.

Missisquoi Co., Que. CHAS. S. MOORE.

### Style of Windows and Ventilation for Basement Stables.

To the Editor "Farmer's Advocate":  
I see in the "Advocate," Feb. 15th issue, "Constant Reader" asking for best style of windows for basement, and, being a subscriber to your valuable paper and having received much knowledge and benefit from its columns, I will give "Constant Reader" my views. I built, last season, a barn 44x84, with basement wall 8 to 10 feet high, with 16 windows, 2 lights in each sash, 14x20 lengthwise, up and down, hanging on hinges at top, with hooks and staples to fasten up out of the way of stock. I think this style will give best satisfaction, as they do not swell like those hung on pivot in center. As to ventilation, I would say good height of wall or ceiling and plenty of light and ventilation are the three important points in building a basement barn. With low walls or ceiling, it is hard to get proper ventilation. My system of ventilation is 2-inch tile, one foot long, at top of wall, all around sides and ends, opposite on either side and end, which will admit plenty of fresh air and carry off all foul air, and for the above-sized barn I would use 20 of these tile; have only 15 in wall. Could not get in any more on account of bridging both sides of driveway, but can say this system has given perfect satisfaction, and at the same time is very cheap. One would be surprised in putting his hand over those holes to see what amount of fresh air is continually passing through, and not cold enough on the coldest days to be uncomfortable. Have not had to close them this winter to keep out frost, and no smell or foul odor was noticeable. My walls and floors were built with Battle's Thorold cement concrete, under supervision of Mr. Ware and Mr. Hagar, both competent men and great workers. Hoping this will not take up too much space in your valuable paper,  
Yours truly, A SUBSCRIBER.  
Haldimand Co.

### Provide for a Dry Time.

As in nearly every summer a time of drought occurs, which dries up the pastures, causing the cows to shrink in their milk-flow and all stock to lose flesh, it is the part of wisdom, where a supply of ensilage is not carried over for summer use, to provide some green forage or soiling crops to tide over such an emergency, and now is the time to make calculations for this. An acre or two saved from the corner or side of a grain-field, convenient to the barns, and sown early with a mixture of grains, or of oats and vetches, and another acre or two sown a few weeks later, is almost sure to be needed some time during the summer to keep the stock from failing, and if the season should happen to be so favorable, owing to frequent rains, as that the soiling crop is not needed, it will not be lost by any means, but may be cut and cured for winter feed. If corn for ensilage or for curing for winter use is not sown, a piece at least for feeding in the green state during a dry time should be provided, as it is but little trouble, is easily cut and carried, and will be found extremely helpful should the pastures fail. A few acres of rape sown any time in May or June will supply a large amount of excellent forage for sheep and pigs or young cattle in the late summer and the fall months. The seed is cheap (from 6 to 10 cents per pound), and two pounds is enough for an acre, if sown in drills, and it has the good quality of springing up again after being eaten down. The tendency among farmers to devote every possible acre to grain-growing is a mistake in these times, when the price of grain is low and the price of live stock and its products high in proportion. There is very little money in growing grain for sale, but a good return from feeding it to stock, and by feeding it, two profitable objects are effected: one from the sale of the stock and its products and one from the fertility added to the farm. The more stock we feed well, the better crops of grain we shall secure. It is not a question of less grain, but of fewer acres and more bushels per acre, and this result, by judicious management, can with reasonable certainty be secured. Forage and soiling crops and ensilage constitute a trinity of food supplies that goes far in solving the problem of successful farming, and the addition of clover and roots makes the provision for stock-feeding and soil fertility nearly complete.

### Root Growing.

The increasing favor with which corn ensilage is being received in most parts of the country as a winter feed for cattle and other stock may possibly have a tendency to lessen the area devoted to root-growing, as ensilage supplies, to a considerable extent, the succulence which is considered one of the principal virtues of turnips and mangels. While with ensilage fewer roots may be necessary, we are confident it would be a serious mistake on this account to abandon the cultivation of roots, as there is no really satisfactory substitute for them in the winter feeding of cattle and sheep in maintaining a healthy condition of the system and promoting the best growth and development in young stock. There is good ground for the belief that the signal success of British breeders of pure-bred stock in attaining and holding the pre-eminent position freely accorded them as leaders in the improvement and development of the various classes of live stock is very largely due to the free use of roots in the feeding ration, and if Canada holds second place to the Old Land in producing high-class stock, as we believe she does, it is in no small degree owing to the same system of feeding. In countries where corn is cheaply and plentifully grown, and is convenient for feeding purposes, the tendency is to feed it exclusively, or nearly so, with the inevitable result that an excess of fat is produced, lowering the value of the meat product, producing an undesirable type of animal, and impairing the procreative functions, thereby leading to uncertainty of reproduction, and in many cases to barrenness or sterility. The highest type of animals and the best quality of meat, it is safe to say, is produced where roots form a considerable proportion of the feeding ration, and Canadian breeders will certainly lose ground in the race for supremacy in livestock production of the best stamp if for any reason they abandon the cultivation of the juicy, succulent turnip or mangel, which has contributed so largely to the fame of the motherland in this respect. Mangels are found to be a cheap and healthful food for hogs in winter, and carrots for horses and cows, and it will pay the farmer well to raise a supply of each to carry his stock successfully through the year. These crops should be sown early, in order to secure best results, while turnips, as a rule, do best when sown about the middle of June.



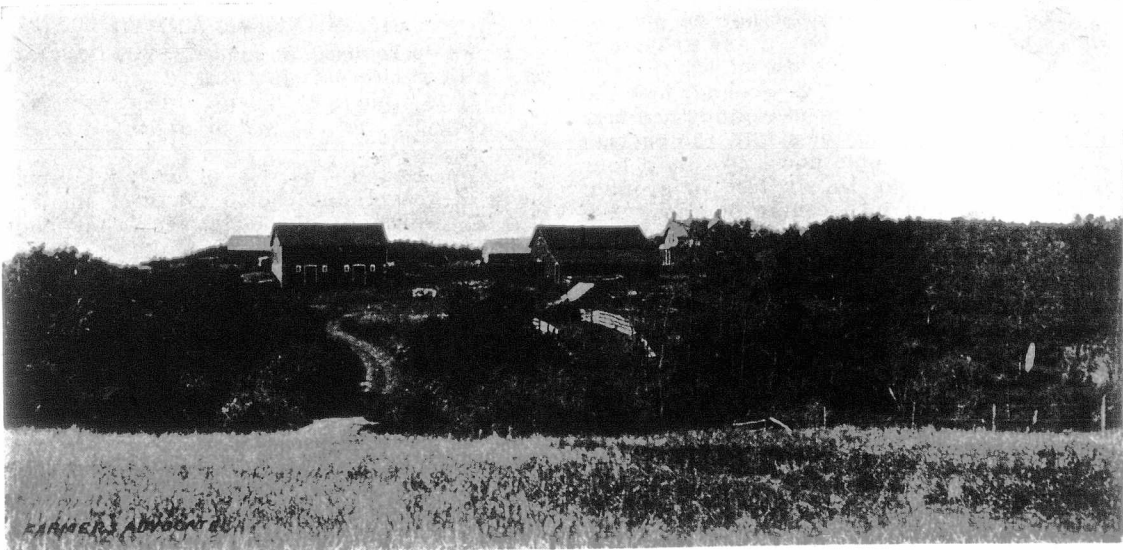

A COMFORTABLE HOMESTEAD, A. W. KENT'S, RALPHTON, MAN.

**Cold Storage as an Investment.**

While primarily we do not live to eat, we must eat to live; and a country gains its highest dignity in production where it cannot only feed its own population, but export all its surplus produce, at reasonably remunerative prices, to feed other nations. This is the justifiably proud position of Canada to-day. Less than a decade ago the Province of Nova Scotia paid annually \$100,000 to Ontario for butter and cheese; to-day, Nova Scotia does not import any cheese, and only a small quantity of butter during the winter, when the dairies are not working up to their full capacity. The dairymen of the Maritime Provinces are not only supplying their own markets, but are taking a share in the great foreign markets, as Ontario and Quebec have long been doing. The latest report of the Dominion Minister of Agriculture demonstrates that during the past six years Canada has exported \$332,036,319 worth of such farm produce as wheat, flour, oats, oatmeal, peas, cattle, cheese, butter, pork, bacon, hams, and eggs. We give the value of each product in 1896 and in 1901:

	1896.	1901.
Wheat.....	\$ 5,771,521	\$ 6,871,939
Flour.....	718,433	4,015,226
Oats.....	273,861	2,490,521
Oatmeal.....	364,655	467,807
Peas.....	1,299,491	2,674,712
Cattle.....	7,082,542	9,064,562
Cheese.....	13,956,574	20,690,951
Butter.....	1,052,089	3,295,663
Pork, bacon, hams.....	4,446,884	11,829,820
Eggs.....	807,086	1,691,640

Farmers in this Dominion have now the tide of prosperity with them, and even the South African war, by its constant demands for food and forage, has contributed to expansion, for up to a recent date the Imperial War Office had expended on this account over seven millions of dollars through our Department of Agriculture, and this is exclusive of horses which have been bought direct by an Imperial officer, and does not include wagons or saddlery.

Improved cold storage on ocean liners has increased the export of butter from the port of Montreal alone during the past three years by upwards of one hundred per cent. in quantity, with an increase in profit, owing to the superiority of the quality of the product now landed in Britain as compared with that under the older and less perfect cold-storage system, and before the improved creamery system became general.

Too much emphasis cannot be laid upon the necessity for owners of creameries to provide cold-storage accommodation at them, to protect the butter in cold storage from the day after it is made; and the Minister of Agriculture has induced the Government to grant a bonus of \$50 per creamery for every creamery at which the owner will provide and keep in use a refrigerator room according to plans and regulations which will be forwarded on application to the Department. This system of bonusing, commenced in 1897, has been taken advantage of by the owners of about 500 creameries; and, to the owners or lessees of creameries who have not hitherto obtained the bonus of \$50, the Government will grant a bonus of that amount per creamery, if and when its owner provides and keeps in use a refrigerator room according to the plans and regulations during the current year, and the further bonuses of \$25 each for 1903 and 1904, if and when the refrigerator room has been kept in use according to the regulations during these two seasons. Thus the owner of a creamery who provides the necessary refrigerator room and keeps it in use during the three years may receive altogether a bonus of \$100.

The cold-storage system has done much to expand Canadian commerce in food products. By preventing losses by deterioration in quality, it has increased the profits of the dealers and augmented the wealth of the country. Cold storage

in every phase has been tried and found effective. As at first the volume of trade might not have been sufficient to induce business men to put up cold-storage warehouses for the accommodation of products intended for export, a grant was offered by the Government to those who would provide cold-storage buildings at central points, such grant being in the nature of a guarantee that the earnings from the cold-storage business at these points would yield at least five per cent. on the cost of buildings and plant. Obviously, the rates to be charged were to be satisfactory to the Department of Agriculture, and the grants were not to be called upon except to make up any deficiency between the net earnings and the sum of five per cent. on the cost as mentioned. Advantage was taken of this offer at Quebec only. That capital put into cold-storage warehouses will prove a sound remunerative financial investment is not now open to doubt, for this system has passed far beyond the experimental stage, and without the realm of probable failure. In Great Britain, private enterprise has not been wanting in providing cold-storage warehouses for at least the last ten years, and substantial dividends have been declared upon working results. Here in Canada, with the greater need and the lesser working cost, such warehouses ought to form an attractive source for capital investment.

**Destroying Pasture Weeds.**

Eradication of weeds already present in pastures depends on the particular case. Annual weeds can be killed out by mowing before seeding during the growing season, as many of them will send up new sprouts. In the case of biennials or perennials with taproots, cutting the latter under ground and beneath the "crown" is effective. Perennials like the bindweed, which spread by underground stems, are extremely difficult to deal with, because every bud on such a stem is capable of growing into a new plant. Plowing under simply spreads the plant by cutting the propagating stems and scattering the pieces. No very satisfactory way of eradicating weeds of this kind can be given that will apply for all cases and conditions. A straw mulch, by excluding the light, will sometimes kill them. Common salt applied to the soil is effective, and arsenite of soda, one pound dissolved in eight quarts of cold water, is recommended. This can be obtained of wholesale druggists at ten cents per pound. Of course, any chemicals that will kill weeds will kill all the other vegetation for several months. Chemical methods of weed-extermination, then, should be used only as a last resort and under expert advice.

H. F. ROBERTS,  
Kansas Experiment Station.

**How to Maintain Soil Fertility.**

"We all know that it is very desirable to have a fertile soil in which to grow crops," says F. P. Peck, of Michigan, "for success in farming depends largely on the fertility of the land. Every one knows of many once-fertile farms which are not now producing half what they should—scarcely enough to pay for the labor necessary to produce a crop. It is more profitable to farm so as to maintain or improve the soil than it is to rob the soil of its fertility and in the end bring ruin to the owner of the farm."

How is this to be done? I believe our greatest loss of fertility is the loss of humus. A soil without humus will not carry a crop successfully through a drouth. A clay soil devoid of humus will be lumpy and hard, and will not retain moisture for very long. We all know the effect on the crop, and the great amount of labor required to prepare such a piece of ground for a crop. Hence our aim should be to farm so as to produce and leave as much humus in the ground as possible. This is best accomplished by a rotation of crops, and one crop in the rotation should be clover, which is our greatest soil renovator. We should aim to feed everything, or nearly everything, produced on the farm, and if we add a little bran or concentrated feed to the ration of each animal, and carefully save and apply all the manure, it is easy to see that we shall maintain and probably add to the fertility of the soil.

Many advocate the plowing under of green crops, but, unless a farm is very much run down, I would not practice this, unless it be to bury a second crop of clover, or a cover crop sowed to protect the ground during the winter. A cover crop should always be sowed whenever a piece of ground remains idle during the fall and winter. Many times we have a piece of stubble which we intend to plant to corn or potatoes. On this we can grow a crop of rye or peas and barley, either of which will make a large growth, and can be plowed under in time to plant to corn. This adds largely to the humus of the soil, and will tend to carry the crop through a drouth without injury.

As I said, it should be our aim to feed all, or nearly all, we raise on our farms, for the purpose of keeping up the fertility of the farm, and I believe it to be more profitable to sell our produce in the form of butter, beef, pork, etc., than to sell it in the rough. I believe our produce fed to good stock will bring us more than twice what it will sell for on the market. For example, I can feed a cow for 12½ cents per day, and have her bring in 25 cents per day for more for butter alone, and I believe the same to be true with all other kinds of stock.

Many advocate the use of commercial fertilizer. Of course, the basis of all our fertility is the amount of nitrogen, potash and phosphoric acid a soil contains. When we consider that an ordinary crop of wheat of 25 bushels per acre removes about \$8.75 worth of these elements from the soil, and a crop of corn nearly as much, we can readily see that when a soil is exhausted of these elements; it is quite expensive to replace them by using commercial fertilizers. Now, if we feed our crops on the farm, we can return about 80 per cent. of these elements to the soil in the manure, and at the same time get probably twice the market value of our produce. We can readily see that it is more profitable to farm so as to improve our soil than to sell our crops on the market and at the same time be losing heavily in the fertility of the soil.

I would not advocate the feeding of wheat, but would sell it and purchase bran or cottonseed meal, which is worth more for feed than wheat, and has double the manurial value. If I sold much wheat, I would use commercial fertilizers freely, for it is impossible to keep up the farm and sell grain without their use. If we grow all the forage crops we can and feed them on the farm, carefully save and return the manure, we need have but little fear.

F. W. HODSON,  
Live Stock Commissioner.



PLOWING ON THE FARM OF A. W. KENT, RALPHTON, MAN.



## Cement Silos.

## HOW TO CONSTRUCT A CEMENT SILO — BUILT 19.

I get more good from a careful study of the "Farmer's Advocate" than any other paper. It ought to be in every farmer's house, and I think that the back numbers should all be saved so that we could fall back on them at any time to get information, because they contain the ideas of practical men in every line of farm work. I have read almost everything published in regard to silos and ensilage, and have been helped in many ways. If what I can say will be of any benefit to others, I feel that I am obliged to give it.

We have had our cement silo in use two years, and it has given us the best of satisfaction. We follow a course of mixed farming, and find the ensilage very good feed for any class of cattle. We have never fed any of it alone. I don't think it would be wise to feed much of it alone. We find it is worth a great deal in summer when the grass gets dried up and the feed bad. We shut the gate in all day, and feed them a mixed ration of ensilage and cut straw or hay; a little grain will help a lot. We will have about six feet left for summer use. We cut the ensilage down in four blocks in the hot weather; that keeps it from spoiling.

Our silo is round, twenty-eight feet high, eleven feet nine inches in diameter, eighteen inches wide on hard clay bottom, tapers to nine inches on the first two feet, and finished at top about five inches; all the taper is taken off the outside; the inside is plastered very carefully. We also have one band built in the wall every three feet. One inch by one inch and a quarter band iron bolted together at the ends is very suitable. I think that the round cement silo is plenty strong enough without the bands. We have one in our neighborhood built without the band, which is standing all right.

We used eighteen barrels and one half Portland cement in building and plastering our silo, and about seven cords of gravel. We used some stone in the bottom, and up till wall was about six inches thick; also a little sand for plastering.

Cement—\$2.90 per barrel.....	\$53.65
Gravel—45c. per cord.....	3.15
Sand.....	10
Labor and board.....	51.00
Use of crib.....	3.00
Total.....	\$110.90

We think it is far better than the wood silo in many ways: 1st. A round cement silo properly built will be far more durable. 2nd. It will never blow down with the wind. We had about a dozen wood silos blow down in this locality in one night last summer. 3rd. The ensilage will keep better. We never have any waste after the top is taken off. I have been in a good many silos this last winter, but find the round cement silo the best every time. I was in one octagon silo. It was in very good shape; a little spoiled in corners. I think the round stave silo is the best wood silo to build.

I never heard of a crack in a round cement silo. We have built nineteen, and have yet to hear of a crack being in any of them. The ensilage will never dry out if inside the silo is properly plastered.

We have a double set of cribs. Each crib is eighteen inches deep, and in four sections, the inside crib hinged in three places and tightened at the fourth with a clamp. The outside one is bolted together, and two one-inch washers taken off every time you raise crib, so as to get the right taper on outside of wall. There is a rim around top side of each crib, one fitted into the other, so that they cannot get out of shape. We stand eight poles around outside of silo, and tie poles across from these and then lay planks across the corners, and that makes a good scaffold, on which you can wheel the cement around in wheelbarrow and shovel it into wall. We use two wheelbarrows, one getting filled while we empty the other. We draw all the cement up with a horse and swing pole; a good scaffold is worth a good deal in building a silo. In mixing cement and gravel, we use from one to nine to one to twelve, according to quality of gravel.

We just work one hundred acres, and keep about thirty to thirty-five head of cattle all the year round, a few pigs and five or six horses. I do not think we could do that without silo.

In regard to plastering the inside, it is done with Portland cement and clean, gritty sand (soft, fine sand is not so good), one part cement and two parts sand. The sand should be sifted so as to take out all stones and dirt. It should be handled very quickly and carefully, and one coat of plaster is all that is needed if properly put on. In plastering the outside, equal parts cement and lime to two parts sand—that gives it a fine white color, and then block it off and paint the joints black, and the silo looks finished.

There should be a solid bottom to start the wall on. The bottom of silo need not be put so far down as bottom of wall, but if the ground is dry, it is just as well to make use of all the silo wall. Our own silo is five feet in ground, and the ensilage is equally good. Ours is behind the barn, and the barn is built on side of a hill, the bottom of silo being level with stable floor. We built four silos last year, from four to six feet in ground, with an underdrain run into center of silo. Secure a good foundation for wall, anyway. If the bottom is a little risky, give the wall a good wide butt, and use good, big, clean stones with cement concrete to help to fill up. In building in the ground, we do not use outside crib until we get on top of ground. It will save a lot of digging just to have it the right size and a good circle. The ground should be levelled on top before starting to dig, and measure from center, and there will be no trouble in getting a good start.

I am sorry to say we are behind in the roofing. The most of our silos have no roof. Of course, we can get along without, but I have come to the conclusion that a roof is necessary. Some use flat roofs, but they are a hindrance. In filling you can't tramp your corn right at top of silo, and that is the main place for tramping—that is, if you fill to the top. We have one with a round, peaked roof, which answers very well. But the best plan that I have seen yet is on a silo we built for Mr. Paul Madge, last summer, at end of barn cement wall, thirty-six feet high. He then extended a frame from barn around silo, and closed it in, and roofed it straight with ridge of barn. He made a circle on top of silo six feet high, with one-inch lumber, so that he can fill forty-two feet. After settling, the ensilage will be down to cement. It also helps to keep frost out from silo. That plan is a good one, but a little expensive.

It is a good idea in finishing a silo wall to have it smooth and level all 'round, and have six or eight bolts put at equal distances around in center of silo wall to fasten a sill neatly around silo wall. That gives a good solid bottom to start any kind of a roof you may choose. The bolts should be down ten or twelve inches in cement. I think a few dollars extra in finishing and roofing a silo is well spent.

Huron Co., Ont.

William Moodie.

## CANNOT SAY TOO MUCH FOR SILAGE.

1. I have just had my silo one year, and I am well satisfied with it; in fact, better than I expected.

2. It is round, thirty feet high, eleven feet across, the first two feet twenty inches thick, then starts at nine inches and tapers to six at the top; perfectly straight on the inside.

3. Used twenty-two barrels of "Beaver Brand" Portland cement, and 24 loads of gravel, one of sand. The cement, iron and labor cost me one hundred dollars by contract.

4. I would recommend it in preference to wood. First, for its durability; second, for giving better quality of ensilage.

5. My walls are as free from cracks as they were when built. I have had no trouble with spoiled silage, from the top to the bottom. It has been as perfect on the outside as in the center. The only trouble I have is with the silage freezing. Mine has been worse than any I have heard of. At the thickest point it was two feet thick. One man told me it was because my silage was perfectly cured. As far as I could see the freezing did the silage no harm. The cattle ate it, and did as well after it was thawed out as before. It is a little trouble to get off if no thaw comes.

6. If I were paying to build another, I would hire two competent men with the rings, one for mixing and the other for building. My hired man and myself would do the other part, and I would find all the material myself, which I think will be cheaper this year than last. For a 100-acre farm, I would not build them less than twelve feet across.

I cannot say too much in regard to the feeding qualities of my silage this year. My cattle have done remarkably well, but a great deal depends on the stage of maturity of the corn when put in.

I have no stationary roof, and would not if a man would put it on for nothing; they are in the way at filling time. With a few boards and binder canvas, which I took out the next night, I filled mine 3½ feet above the cement wall, and that answered the same as that much wall. This year, if I have corn enough, I intend using all boards, about 8 feet long, and a band of wire around the top to keep them from spreading. I can fill it 6 feet above the cement, and then when it is settled I can take the boards away and my silo is full, and use the boards as a loose covering to keep the snow out. Rain will not hurt it. When they built the silo they set eight bolts in the cement, equal distances apart, to fasten a plank so as to nail on the covering. A man can put in tons more corn without a roof than he can with one. Three cement silos were built last year in my neighborhood, two without a roof and one with roof.

Huron Co., Ont.

Adolphus Hooper.

## ADVISES PLASTERING ROUND CEMENT SILOS INSIDE AND OUT.

1. We have used a concrete silo for two winters with entire satisfaction.

2. It is round, with wall 9 ins. at base and 5 ins. at top; is 11½ ft. in diameter, and 30 ft. high.

3. We used 45 barrels of Thorold cement, 27 loads of gravel, and 2 or 3 loads of small stones; also \$2 worth of old buggy tires for hoops. It took four men eight days to build it.

4. Would certainly recommend it in preference to wood, because it costs little, if any, more, and is so much more durable, and, also, I think, keeps the ensilage much better than any kind of wooden silo, and you don't have to build it over every few years, as many have to do who have tub silos.

5. We have not seen a crack or chip anywhere in ours, nor have we had any trouble with the contents drying or moulding around the edge, and see no reason why there should be if the wall is properly plastered on the inside.

6. I see no reason for giving any instruction about building them since so much has already been written about the round silo. The only difficulty to be met with is in trying to rush them up too fast. I know quite a few cases where they tried to build six feet a day, or more, and had it fall down. I think they should be plastered on the outside as well as the inside, to help keep the frost out. If the rock cement is used they should be built a good while before needed for use, but if Portland is used, it will not require more than a week.

Chas. E. Hackney.

Perth Co., Ont.

[Note.—To be on the safe side, it would be advisable not to delay building so late that there would only be a week between finishing and filling. Better leave two weeks for the wall to set.—Editor.]

## CEMENT SILO NEEDS WATER WHEN NEW — SATISFACTORY EXPERIENCE.

I have built two cement silos. I have had mine one year. It gives good satisfaction. Those that have stave silos say that my ensilage is far better than theirs.

Its shape is round, 14 feet in diameter, 30 feet high; walls 12 inches at bottom, 8 inches at top.

Fifty-five barrels cement, at \$2.85 a barrel, were used, and a number nine wire placed every twelve inches in the wall.

I would recommend it in preference to wood for two reasons: First, because it lasts for generations; second, because the ensilage is better than in a wooden one.

I have had no trouble with walls cracking, but I have heard of some that cracked, and not of those that were built last year, and the reason of it was they had no wire in the walls.

As for silage drying out and spoiling around the sides, mine was just as good against the wall as in the center, but I was told that there were some that were that way. The reason is, they were not watered enough. The cement needs to be well watered for about a month. Another reason is some were built too late in the season, when the water could not be put on before the corn was put in. In that case the cement drew the required dampness out of the corn, and that spoiled it, but if they are built in time, so that it can be watered enough, the corn will keep all right.

The best method to build them is to give a man the job that understands it. There is a man at Nile, Ont., that understands it thoroughly, and can be relied on to do the work right.

Huron Co., Ont.

Michael Schwanz.

## CEMENT SILO ENTIRELY SATISFACTORY.

My silo has been in use for two seasons, and has given entire satisfaction. It is round and is eleven feet nine inches in diameter, inside measurement, and twenty-five feet high. The walls are nine inches thick at bottom, and seven at top.

It took sixteen barrels of cement and twenty-five loads of gravel, and cost, when roofed, in the neighborhood of one hundred dollars.

I would recommend cement in preference to wood, because it will be cheaper in the long run. It seems to be difficult to keep wood silos in shape during the summer unless they are inside of a barn. A large number of them in this vicinity either fell down or were blown down during the past summer.

My walls are perfectly free from cracks; silage has never dried out or spoiled around the outside.

As to the best method of building, I may say I have only seen the one method in use: that is the use of cribs, two inside and two outside. The inside cribs are raised by a rope and pulley attached to a pole erected in center of silo. The outside ones can be raised from scaffold. There are two kinds of cribs in use here, wood and iron, but I cannot say which is the best. My silo was built with the wood cribs, and they made a good job. It would not pay a man to go to the expense of getting cribs made for one silo. It would be much better to employ a man in the business who has the cribs.

J. T. Morgan.

Huron Co., Ont.



**ROUND CEMENT SILO A COMPLETE SUCCESS.**

To the Editor "Farmer's Advocate":

We had a cement silo built in May, 1901, and it has given splendid satisfaction in every respect. It is round, and is eleven feet in diameter, inside measurement, and thirty feet high. The walls are ten inches thick at the bottom, and six inches at the top. The cement used was Beaver brand Portland, twelve parts of gravel to one of cement, and about two loads of good-sized stone built in the wall. There is also a quarter-inch iron rod built in the wall above and below each door, of which there are five. About thirty loads of gravel and twenty barrels of cement were used in building. It took four men and a boy five days and a half to build, and two men one half day to plaster the inside, and cost, when complete, about \$110.

I think a cement silo far ahead of a wooden one, and cheaper in the end. A wood silo may last eight or ten years, but I see no reason why a cement silo properly built should not last a hundred years or more. There is no danger of it being blown down or destroyed by fire. One in this neighborhood filled with corn withstood the heat of the burning barn and came through without a crack, only the doors being burned out. Other doors were put in, and the silage fed with very little waste.

We have had no trouble with wall cracking or ensilage spoiling. It is just as good around the sides as in the center. The only place where any spoil was about the doors; if they do not fit tight there will be a few forks found ensilage to be a very good and cheap food when fed with cut straw and a little meal or shorts, and I would not farm any more if I could not have a silo.

As to building, ours was built with two sets of rings made with boiler iron two feet deep and as large around as you wish to build your silo. While one set is filled and drying, the other set can be filled, and so on, until you reach the desired height.

The foundation for the silo was made by digging a trench 2 feet deep, or until we reached a good hard bottom; then fill in with cement and large stones. This wall is 18 inches wide and 2 feet high. The wall received one coat of plaster composed of three parts fine sand to one part cement. It took three barrels cement and one load sand. As far as a roof is concerned, I laid a few planks over to keep snow out; that is all that is necessary. Alex. A. Watt.  
Huron Co., Ont.

**COST OF A LARGE CEMENT SILO.**

I built a cement concrete silo in July, 1901, and I must say that it has given me perfect satisfaction, it being round and 14 ft. inside (clear) by 30 ft. high; walls 16 inches at bottom, tapered from outside to the top, which is 8 inches, and in top course are placed ten bolts 1/2 in. x 10, set 4 inches up, to which the rafters of roof are bolted, nuts up. The material used in building was cement—28 barrels of "Beaver" brand cement, this doing plastering and flooring complete, for which I paid \$2.90 per barrel off the car; gravel, 42 yards, and 2 loads of sand for plastering. Having the gravel and sand myself, I count it 10 cents per yard; and about 2 yards nice-sized field stone, and \$3 of 1/4-inch round iron, to be built in with cement. No. 9 wire would do, but the hardware men had none on hand, and the 1/4-inch round iron seemed to be easier to work with. I do not know the value of a wooden silo, but when I was building I thought the first expense would be the only one with cement. I have a complete silo, there being no cracks, and, I think, one of the first principles is to have a good foundation and a good drain, so there will be no water lie around to soften foundation. The silage in places seemed to be a little dry, but this is almost universal with every person the first year on account of the cement drinking in the sap from corn. I think the round silo the best, if a competent man puts them up. The reasons are, you have not so much material lying around when completed in the shape of plank braces, etc. and these, as every person knows, when done building, are almost useless. I will give a correct account of all the items of expense:

28 barrels cement.....	\$ 81 20
42 yards gravel.....	4 20
2 yards sand.....	25
1/4-inch iron.....	3 00
Rent of rings.....	6 00
Contractor, 8 1/2 days at \$2.....	17 00
Contractor's man, 8 1/2 days at \$1.25.....	10 65
Myself and hired man, \$1.....	17 00
Extra help.....	3 00
Scaffolding.....	5 00
Roof.....	15 00
<b>Total.....</b>	<b>\$162 30</b>

I have not counted in teaming material or digging foundation or board of men, which in all would bring the total cost close to \$175.  
Huron Co. Wm. Lockhart.

**CEMENT SILOS REPLACING WOODEN ONES.**

I have had a concrete silo for only one season, but thus far it has given good satisfaction. The silo is round, 12 feet in diameter, 30 feet high; wall 12 inches thick at base and 7 inches at top. The silo was built with the intention of making it 5 feet higher, if it was needed, and 5 inches is quite sufficient for thickness at top. It is built with a slight batter on the outside. Thirty good loads of gravel and 23 barrels of Portland cement were used in the wall. Flooring and plastering inside and out required about three barrels more of cement. It cost about \$100, but the cost will vary with situation as regards gravel pits, etc. I have never had a wooden silo, but several farmers in this locality have replaced wooden silos by cement. The cement silos are considered more durable, but as regards the preservation of the ensilage one is about as good as the other, as far as I know. I have had no trouble with the walls cracking, and the only places where the silage dried out and spoiled was immediately around the doors. I consider this to be caused by imperfectly air-tight doors, and think that it could be overcome by perfecting them. I think the best way to build one is by means of curbs on the inside and out. In mine I placed 5-16 iron rods about two feet apart and about two inches from the outside and hooked the ends of each together so as to form a solid band around the silo. I have three openings in mine, but if I were going to build again I would have four.  
Isaac W. Johns.  
Perth Co., Ont.

**Growing and Selection of Seed Grain.**

[Address given at Fredericton, N. B., by G. H. Clark, Chief of Seed Division, Department of Agriculture, Ottawa.]

The success or failure in the growing of profitable farm crops depends on several influences. When I speak of the importance of good seeds, I do not wish to be understood to say that good seed is the one and only essential to success. A great deal depends on climatic conditions, over which we have no control; perhaps more depends on soil and the cultivation given to it; but much depends on the productive capacity of the seed itself.

**PRODUCTIVENESS OF SEED.**—Perhaps the first quality to be sought after in securing seed is productiveness. Variations in the yield of our common farm crops are usually ascribed to the productiveness of varieties and to the productive capacity of the soil. That the productiveness of two strains of seed of the same variety may vary quite as much as varieties themselves is not fully recognized.

It is very important that such varieties of farm crops be selected as will fit into our particular conditions of soil and climate. But with the best variety and the best soil much can be done to increase the yield of grain. In a favorable season a soil may be capable of producing sixty bushels per acre of Banner oats, while the seed of that variety used may not be capable of producing a greater yield than fifty bushels per acre. By examining a sample of seed, we can only judge as to its purity and vitality. To be able to judge as to its productiveness we must have some knowledge of its previous history.

**HOW VARIETIES ARE BROUGHT OUT.**—Each year quite a list of new varieties are introduced. Each year we find in the catalogues of seed firms glowing accounts of new varieties of farm crops. Some of those varieties prove to be of real worth and are adapted to a wide range of conditions of soil and climate, but a very large percentage of them have a short history. The testing of these new varieties is too expensive an undertaking for the average farmer. Much better results would be obtained if our people would turn their attention a little more to improving the old standard varieties which they have found to be well suited to their farms. If they were to put into practice on their own farms some of the simple methods that are used in bringing out new varieties, the results would surprise them.

New and improved varieties are brought out largely by selection. By artificial cross-fertilization the desirable characteristics of two varieties may be combined, but such characteristics can be fixed only by constant and careful selection after cross-fertilization has been accomplished. This method of improving our varieties of farm crops may safely be left in the hands of specialists. It is too complicated a process to be undertaken by the average farmer.

But a great many of our new and improved varieties are brought out by simple methods of selection, by taking old standard varieties which have proved to be valuable, and raising them from a low to a high degree of productiveness.

For instance, at the Minnesota Experiment Station new and productive strains of the Fife wheat are brought out by selecting seed from vigorous plants which possess certain desirable characteristics, and planting a small plot of good land with five hundred seeds. From these five hundred plants ten or more of the most vigorous are selected as mother plants from which to get large, well-developed heads to produce seed for a similar plant for the succeeding year. This system of selection is repeated for a number of years or until the desirable improvement has been made.

Now, in bringing out these new or improved varieties, the chief object is to get pure seed that will produce vigorous plants and give large yields of grain of good quality. These results are obtained by forcing a vigorous growth in the plants and selecting to an ideal type. Those are, to a great extent, the same principles which are applied in the improvement of live stock.

**CAUSES FOR DECREASE IN PRODUCTIVENESS.**—Now let us consider how this seed, which has been raised from a low to a high state of productiveness, is used when it reaches our average farms. It is sown on impoverished fields, and at the rate of, in many cases, as much as three and one-half bushels per acre. The seed for the next crop will be taken from the grain that is harvested and threshed from that field without any selection except what can be made with a fanning-mill. The seed will be taken from a crop which is grown under conditions quite opposite to those made use of in improving the vigor and productiveness of the seed. By thick seeding we do not allow the plants room to stool. An impoverished soil will not produce vigorous plants. Such weaknesses are transmitted through seed to the succeeding crops.

**HOW TO PREVENT SEED FROM RUNNING OUT.**—If the farmers of Canada would make a practice of growing their seed grain on special plots of ground—on those portions of their fields



**MR. R. ROBINSON.**  
For some 35 years a reader of the "Farmer's Advocate," at Niagara Falls South, Ont.

**EXPERIENCE WITH STONE SILO.**

As to the best and cheapest kind of silo, it all depends upon what material is most convenient for a person to build with. I would prefer a square silo to a round one, as it is easier built and equally as good. I would also prefer stone or cement. I built mine seven years ago with stone, 12 ft. by 18 ft. inside, 26 ft. deep; 6 inches narrower and shorter at top than bottom, which is most important to keep the pressure off the walls. I plastered it; first coat with mortar, second coat with half water lime and Portland cement. The walls are 18 inches at the bottom and 10 inches thick at the top. There is no need for corner stones, as one can build them round with any kind of stone. The ensilage keeps perfectly good close to the walls built in this way. If the foundation is good, there is no better. Will write again, "Does it pay to build a silo?"  
Wellington Co., Ont. John Jones.

**Double Cement Silo.**

Mr. Jas. A. James (Middlesex Co., Ont.) has had in use for some six years a pair of cement concrete silos, 20 ft. x 9 ft. 3 in. each and 22 ft. deep, which have never shown a crack or a flaw. The outside walls are 18 inches thick at bottom and 12 inches at top, the partition wall being slightly heavier, though less would have done. The corners are rounded inside. The concrete was made of Queenston cement, 1 part to 6 parts sharp, coarse sand or gravel.



which they know to be well adapted for growing large crops of grain of good quality, and gather each year from those plots enough of the large heads of grain from the most vigorous plants to produce good seed for the succeeding seed-grain plot, they would not only overcome the tendency to run out, but they would increase the yield and quality of their grain crops sufficient to make a difference between profit and loss.

**MACDONALD SEED-GRAIN COMPETITION.**

—Two years ago arrangements were made by Prof. Robertson and Sir William C. Macdonald, of Montreal, so that cash prizes might be given to boys and girls living on Canadian farms, with a view to encourage them in the study of the benefits to be derived from a systematic continuous selection of seed grain.

The competitors in the Macdonald Seed Grain Competition have been operating a seed-grain plot of one-quarter of an acre, each year selecting seed for their plots according to instructions which were outlined for them by Prof. Robertson.

We now have in the neighborhood of eight hundred boys and girls who have been following up this very important branch of nature study. The results have been quite satisfactory. These young people have been depending largely on the encouragement and instructions which have been given them by their own people. It is hoped that in the near future they will have help from a well-trained teacher, and the work will be carried on in connection with our rural schools.

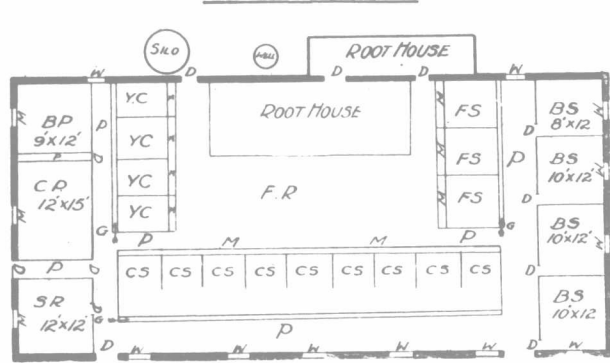

CATTLE-STABLE BASEMENT IN BARN OF MR. JOHN ANDERSON, SIMCOE CO., ONT.  
 B. P., bull pen; B. S., box stall; C. P., calf pen; C. S., cow stall; Y. C., young cattle; F. S., fattening stall; P., passage; M., manger; W., window; D., door; G., gutter; S. R., separator room; F. R., feed room. Size of building, 40x86 ft.

**Stable Manure and Sugar Beets.**

The common teaching is that sugar beets are injured in quality by stable manure applied the same season that the beets are sown. That this is not true, at least not on certain soils in New York, is proved in a bulletin of the Station at Geneva. Tests were made for four years—on two farms in widely-separated localities for one season—with results uniformly favoring rather than opposing the use of the stable manure.

**DAIRY.**

**Dairying in British Columbia.**

I beg to submit statement of business done in our creamery, "Eden Bank," in 1901. Our creamery is run on a combination of whole-milk and cream-gathering systems. Number of patrons, 70 in summer and about 40 during winter months. There were delivered at the creamery during the year, 114,168 lbs. of butter-fat, from which were made 130,180 lbs. butter. There has been credited to the patrons \$28,037, an increase of \$3,852.58 over the previous year. A comparative statement of the past five years shows a steady increase in the output and a yearly decrease in the cost of making, as follows:

	Lbs. butter.	Cash to patrons.	Cost of making.	Average price per lb. of butter.
1897	53,605	\$10,591.30	4.35c.	19.76c.
1898	81,212	16,763.91	4.02	20.64
1899	96,943	19,527.24	3.86	20.14
1900	107,615	24,174.42	2.95	22.46
1901	130,180	28,037.00	2.75	21.50

The trade account for the year ending Dec. 31, 1901, shows a net profit of \$2,033.53, being a marked proof of the progress of the company. Of this amount \$50 was donated to the managing director, \$210 was reserved for repairs and renewals, \$57.50 for insurance, \$574.57 was placed against bad debts (owing to the assignment of a commission house), and the balance, \$1,141.52, was returned to the patrons supplying cream or milk during the year. A large portion of our output was sold in the Coast cities, and during the year we have succeeded in opening up a very good trade in the Yukon, and also in the Kootenays. Our butter is all put up in one-pound prints, and that which goes to the Yukon is shipped in tin cans, which will hold 50 lbs. in prints, and filled with brine before being soldered. Our experience with this kind of package has been very satisfactory.

T. A. F. WIANCKS,  
 Creamery Operator.

N. Westminster District, B. C.

**The Cheese Factory Secretary's Reverie.**

Let me see now; how things do change! Twenty-seven years ago, patrons were charged \$2.25 per 100 lbs. of cheese for hauling milk and making cheese, and we got no whey returned. No, sir. The cheesemaker kept a piggery at the factory. He must have coined money in those days. The milk-drawer washed the cans at the factory and left them on the farmers' stands ready for the evening's milk. Yes, the milk was hauled twice a day, and the drawer did not generally get through until 8 or 9 o'clock at night. Now the milk is hauled only once a day and made up for \$1.55 (and by some factories for less), a difference of 70 cents per 100 lbs., and then the patron gets the whey returned in his can. Is that a good plan? Well, no, I scarcely think so. But the farmers think, like Col. Sellers, there are "millions" in it. The patrons who haul their own milk take a good supply of whey; the drawer who has a heavy load studies how little he can take and keep his patrons from growling. How does the whey go all 'round? Well, there is generally real good water at the cheese factory, and

of course, you cannot blame the cheesemaker. How long have I been keeping cheese-books? Last year must have been my 17th season; a good many changes in that period. I remember the first time the inspector came around with the lactometer. Our cheesemaker did not have much faith in it, and quietly slipped out and poured a pail of water in a patron's can of milk, which he marked. By and bye the inspector called him to the weigh porch, saying, "This patron has been watering his milk, we must prosecute him." The cheesemaker asked, "How much water do you think has been put into that can?" After again looking at the lactometer and noting the number of pounds of milk, the inspector said, "About 25 pounds of water."

"That is just the quantity that I poured into that can a few minutes ago. I merely wanted to find out if your lactometer was any good." We did not have a Babcock tester then, and when the cheesemaker suspected a patron of skimming, he took samples of the milk in glasses and allowed the cream time to rise. Yes, he could tell pretty correctly, but it was not easy to bring the delinquent to time. On one occasion the cheesemaker reported to a meeting of directors that a certain patron had been keeping the cream from the Sunday morning's milk which he sent to the factory on Monday mornings. After some abortive motions, it was finally carried that the secretary be instructed to write to the offending patron, and the meeting immediately adjourned. The secretary sat down and penned the following: "Dear Sir,—Our cheesemaker has reported to the directors that, while your milk is generally satisfactory, yet for the last three or four Monday mornings it has been found that a quantity of cream has been abstracted. Now, although the directors do not even wish to insinuate that you have been skimming your milk, yet it is possible that while you have been at church, your own cats or those of your neighbors' have been getting access to your milk and licking the cream off, and the directors wish me to state that they would feel obliged if you would see that this does not happen again." The milk came all right in future.

In course of time the inspector brought the Babcock tester and tested every patron's milk. On one of these occasions he said to the cheesemaker, "Your milk is all right except No. 9, and that appears to have been partly skimmed, and you must take me to his farm so that I can milk his cows and get a sample of his milk." On the cheesemaker looking at his milk-book to see who No. 9 was, he exclaimed, "There must be some mistake; No. 9 is the preacher, his milk is all right." But the inspector represented the majesty of the law, and he was obdurate, and so they went to the manse. It was found out that the minister and his housekeeper were from home, and the boy who was left in charge of the cow had that morning taken a liberal supply of cream with his porridge from the evening's milk, which had stood overnight. He naturally explained that he thought a patron had a right to take as much as he required for his own use. The inspector pointed out that patrons must set aside the quantity required for their own use immediately after the cows are milked. In this case, there being only one cow, the taking of all the cream that a growing boy could use for his breakfast would naturally make a great difference to the percentage of butter-fat. In next week's local news there appeared something like the following: "The inspector appointed by the Western Dairymen's Association called at our factory and the patrons' milk was weighed in the balance and one or two found wanting. This is a good text for every patron of every cheese factory. Be ye also ready, for in such an hour as ye think not the inspector cometh." The plan of paying for factory milk by the test now in vogue in our more advanced factories disposes satisfactorily of many of these old difficulties.

OLD DAIRYMAN.

**Care of Cream on the Farm.**

The care of the cream on the farm is getting to be a matter of supreme importance in our butter industry, on account of the number of "cream-gathering" creameries which are springing up all over our Province. A few years ago the tendency was strongly in favor of "separator" creameries, but the advent of the hand separator on the farm is gradually changing the aspect of the whole business, and whether for good or for evil, remains to be seen. The butter which has been made from "separator" creameries has undoubtedly built up the reputation of our butter abroad, and if that reputation is not sustained we are going to suffer heavily in consequence. That first-class butter can be made from "gathered" cream has been abundantly proven, and especially in the U. S., where large quantities of butter is made from "gathered" cream. Evidence is not wanting, however, to show that the average grade of "gathered" cream butter is not equal to that from the "separator" creameries, and we have to face this fact and apply a remedy if at all possible. Hauling the milk to the creamery to have the cream taken out and then hauling the skim milk back again to the farm is an expensive and, apparently, unbusinesslike method of handling the milk. The hand separator is undoubtedly the proper method of taking the cream from the milk and then hauling the cream only to the creamery, but the loose and careless methods of caring for the cream after it is separated is causing serious trouble in many creameries; whereas, the cream from the hand separator should reach the creamery in the pink of condition if properly cared for. All cream, whether from the hand separator or "gravity" method, should be kept in cold water, and if iced water all the better. Cream from the hand separator should never be mixed with a previous lot until it is cooled down, and to do this properly it should be placed in cold water by itself until the next milking. The can should then be thoroughly washed and scalded, ready for the next lot. "Deep-setting" cream is always, or should always be, cold when it is taken from the milk and it should be kept as cold as possible by placing the cream can in ice water. "Shallow-pan" cream should never be accepted at a creamery, because the milk is always too much exposed to taints and odors. The cream is liable to be tough and clotted, and it is almost impossible to get it to the creamery in a sweet condition. As a rule, the flavor of "gathered" cream butter is taken completely out of the hands of the buttermaker, because the cream is usually sour before it reaches the creamery. There is no excuse for this state of things if the equipments for handling the cream on the farm are what they should be. These are of the simplest kind and consist only of a tank of some sort to hold water and ice and a good cream can with a tight-fitting cover.

The great trouble is that we have so many persons who will not go to a dollar's expense to provide the crudest of appliances for the dairy, and they are the class of people who are keeping down the grade of butter, both creamery and dairy.

"Gathered" cream is collected not less than three times per week during the summer, and every patron should have the necessary apparatus to keep his cream sweet for that length of time, and until we can do that our "gathered" cream butter is going to suffer in quality.

There is a partial remedy in collecting the cream every day, but this adds to the expense. We may, however, have to come to this, and by using the hand separator exclusively we should then have ideal conditions, which ought to give us the finest of butter and which is giving the finest grade in sections where it is in vogue in the United States. Many people do not take proper care of their separators, which, in many cases, are covered with a stinking mess of milk and cream both inside and out.

Such people ought to be ashamed to use a valuable piece of machinery in such a manner, and especially a machine that has anything to do with milk. Anyone who is careless with their separator will be careless in the whole operation of getting and handling their cream, and they not only suffer in pocket themselves but they lower the product of their neighbors who take better care of their milk and cream.

Nothing but clean, bright tinware should be used in connection with the cream. A can with the tin worn off in spots is fatal to the good flavor of cream and should never be used. Stir the cream thoroughly when two lots are mixed together.

J. STONEHOUSE.

Of the eighty-one students who attended the Western Dairy School, Strathroy, this winter, twenty-five wrote on the examinations held at the close of the term.



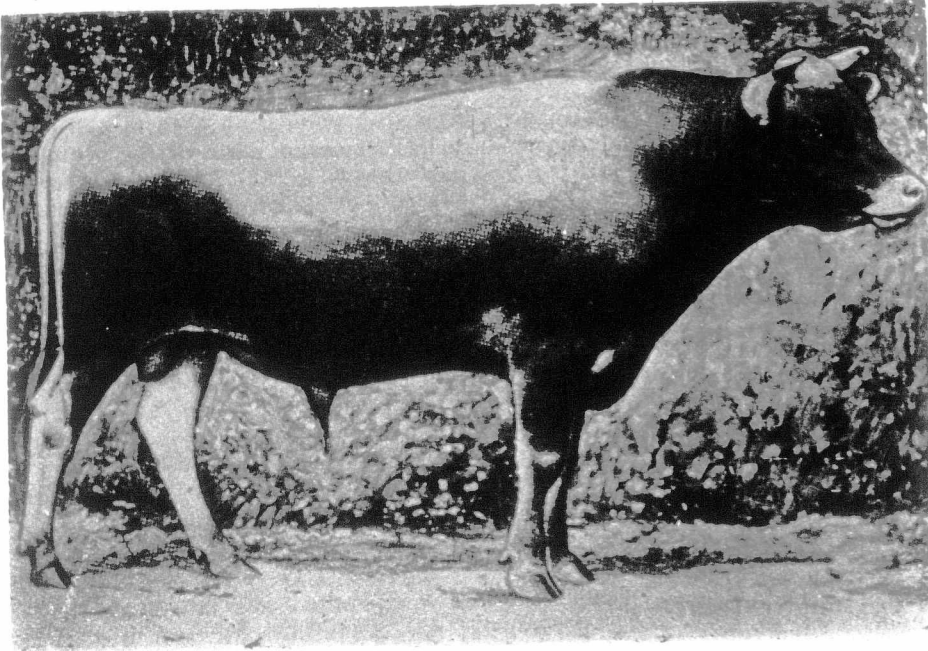

**GOLDEN LAD, P. 1242, H. C., J. H. B.**  
The great improver of latter-day Jerseys on the Island and in England.  
OWNED AT TIME OF DEATH BY MR. R. J. POPE, BERESFORD MANOR, PLUMPTON, SUSSEX.

**The Care of Milk for Buttermaking.**

To the Editor "Farmer's Advocate":

After milking, take the milk as soon as possible to a milk-house that is well ventilated and surrounded with pure air; here place your cans, pails or other vessels holding the milk, in a tank of good cold spring water and stir while cooling. If you have plenty of water, have your milk-house arranged so as to run this water off and refill occasionally. Cool the milk to a temperature of 55 or 60 as soon as possible, but under no consideration leave it any time after milking before doing so; cool immediately and drive off the animal heat. After you have the milk cool, place a cloth over the cans to keep out any dust or dirt that occasionally blows around in summer; a double piece of good cheese cotton is the best thing for this.

A word about the milk-house. It must be well ventilated. See that a good draft of pure fresh air is in circulation while cooling the milk to help drift away the gases, or they will likely stop around the walls of the house and cause trouble if not closely looked after. You know milk when drawn from the cow contains a certain amount of dissolved gases. These gases contain what is called animal odor, easily removed from the milk by exposure to the air while cooling, so see that your milk-house has lots of pure, fresh air. The cover you place over your cans to keep out the dust or dirt should be kept clean. Pails, strainers, and everything in connection with the milk-house and milking should be thoroughly clean. Washing cans and pails, etc., with one pail of lukewarm water is not the thing, and must be stopped if we are going to succeed in having good milk producers. First rinse them thoroughly in lukewarm water; second, wash them thoroughly with a good sal soda water as hot as possible, using only a brush for the purpose; third, thoroughly rinse with hot water and expose to the bright sunlight for several hours.

To have this milk delivered at the factory in prime condition, first when the milk-drawer comes along, if he take a thermometer and try the temperature it will be about 60 F., and look clean and sweet. Do not own a can that has a rust mark on it. If you do, see that it is used as a slop can, but in no case send it to a factory, for if you have a maker that knows his business, he will reject milk coming in such a can. Farmers and dairymen, this matter of good milk supply is laid at your door. If you have not the right man in charge of your factory, discharge him for one that is known to do the work. Milk for the creamery should be in such condition when it arrives at the creamery that a sample can be tested with the Babcock tester to allow the farmer his proper allowance. If his milk has not been aired and cooled (at the same time stirred, too) below the surrounding atmosphere, the cream will become tough and will not mix in with the milk and you will blame the buttermaker for not giving you the right tests. With milk aired, cooled and stirred immediately after milking, there will be comparatively little tendency afterwards for the cream to separate from the milk. If you are a farmer known to supply good, pure sweet milk, and your neighbor is not, see that something can be done to help him along. Have a maker that can show each farmer where he can improve on the quality of the milk supplied. I have found it a good plan to observe the different kinds of milk and write to each farmer as often as possible or go and see them, and in this way the farmer will soon appreciate the interest taken and will take better care of his milk and more interest in the factory and maker.

ROBT. IRELAND,  
Kingston Dairy School. Ins. in Buttermak'g.

**Creameries: Co-operative or Proprietary.**

In answer to the question, "Which is the most profitable—proprietary or co-operative ownership of creameries?" the New York Produce Review gives the following answer:

"Co-operation to be successful in any line must be co-operation in the true spirit.

"We presume the questioner means which is the most profitable to the milk producers, and in that case it depends so much on the conditions, there can be no doubt that wherever the milk producers have learned to co-operate in the true co-operative spirit, that system will be the most profitable to them.

"There is always human nature to be considered, and it is natural that when a milk producer sells to an individual creamery he is apt to forget that even then he co-operates and to be short-sighted in his reasoning.

"He will often say to himself, 'What do I care whether my milk is clean or not as long as it is received at the weigh-can. The creamery-man won't pay me any more.'

"Whereas, if he delivers to his own co-operative creamery, he will, as a rule, have a feeling of responsibility to his own pocketbook and to his neighbors', and, if he forgets the latter, they will be likely to remind him.

"This is in reality the main reason why co-operative creameries should be more profitable.

"The fact that the extra profit necessary to the individual owner, on account of the risk incurred in building a creamery, which is at the mercy of the milk producers, comes next, and last, as well as least, is the reduction in expenses by the farmer manager putting in \$1,200 worth of time, energy and ability for from \$50 to \$300, as well as cheap hauling, cutting ice, etc.

"It is a matter of education, and if the farmers have not attained it; if they are jealous of each other, instead of trusting the man among them whom they have chosen as manager; or if (but this is doubtful) there should not be a man among them with sufficient business capacity, then it will be better for them to sell their milk to an individual creameryman.

"If we ask the farmers of Denmark, New Zealand, or of Minnesota, the answer will be co-operation, but in many States it seems as if the farmers do not trust themselves; at any rate, they will say that co-operation is a failure!"

**Sowing Mangels and Sugar Beets.**

We have taken the "Farmer's Advocate" ever since I can remember, and I have received more benefit and help from it than from any other paper we have ever taken along the same lines. I would like an answer to the following questions in your next issue, if convenient. Which is the best way to sow sugar beets and mangels, on the flat or in raised drills? Can the seed be sown with an ordinary grain seed drill, and will it sow as even as a regular root drill?

J. M. B.  
Middlesex Co., Ont.

Ans.—If grown for stock food, it is generally considered preferable to sow on raised drills or ridges, 30 or 32 inches apart. Sow with a root drill, and flatten the ridges with a roller after sowing. Sugar beets, if grown for sale for sugar production, must be sown on the flat, and not more than 21 inches apart. The seed of either can be successfully sown with the grain drill and quite as regularly as with the root drill. We have

seen excellent crops of mangels that were thus sown on the flat. The only objection is that they are not so conveniently kept clean of weeds. It is said to be a good plan to pound the seed in a sack before sowing, to break off the rough shell, which makes the seed work out more freely.

**In Defense of the Cream-Gathered System.**

To the Editor "Farmer's Advocate":

Sir,—In your last issue appears an article from the pen of Mr. I. W. Steinhoff, in which he very strongly denounces the cream-gathered system of buttermaking, and to which I wish to refer very briefly. Mr. Steinhoff's article, if not fully discussed, would not only jeopardize the interests of the cream-gathered creameries now being organized, but would also seriously affect the welfare of those already established and that have been doing a profitable business for both the farmers and the manufacturers for many years. It would increase the difficulties with which the makers have to contend, as it would lead the farmers to believe that it is impossible to make a good quality of butter on that system, and that the system is detrimental to the butter industry. It would increase the tendency, which, unfortunately, is too prevalent, of being more careless in caring for their cream. Mr. Steinhoff's article refers to the fact that a large number of the cheese factories in the northern district are either lying idle or have been changed to cream-gathered creameries. There must have been a cause for these factories closing down which once did a profitable business, and this cause was no doubt a lack of patronage or sufficient milk, the farmers going in largely for stock-raising, and the quality of the stock being apparently of more importance to them than the quality or quantity of butter produced. It is undoubtedly true that the oldest and most successful creameries we have in Ontario are operated on the cream-gathered system. We must also consider the fact that where these creameries are being operated it would be impossible to operate a separator creamery or cheese factory with anything like the same degree of success where the farmers keep a small number of cows and a sufficient quantity of milk could not be obtained within a reasonable distance from the creamery.

Mr. Steinhoff considers the question from the buyer's standpoint, and does not consider that even if the farmers had to accept one cent per pound less for their butter than on the separator system (which should not be necessary), they would still be getting more money for their milk on account of the difference in the cost of manufacturing the butter, which is from two to three cents per pound less, and the skim milk being in very much better condition for feeding.

To make a creamery successful, the returns must be satisfactory to the farmer, and the success and extension of the cream-gathered system is sufficient proof of its popularity and stability, whereas the decline and gradual extinction of the separator system, not only in Ontario, but also in the Western Provinces and in the United States, or in any district or country where the farmers do not make a speciality of producing large quantities of milk, is proof that it has not been as profitable as we had hoped it would be.

It, unfortunately, is true that the greater portion of cream-gathered butter at the present time does not give satisfaction on the British market,

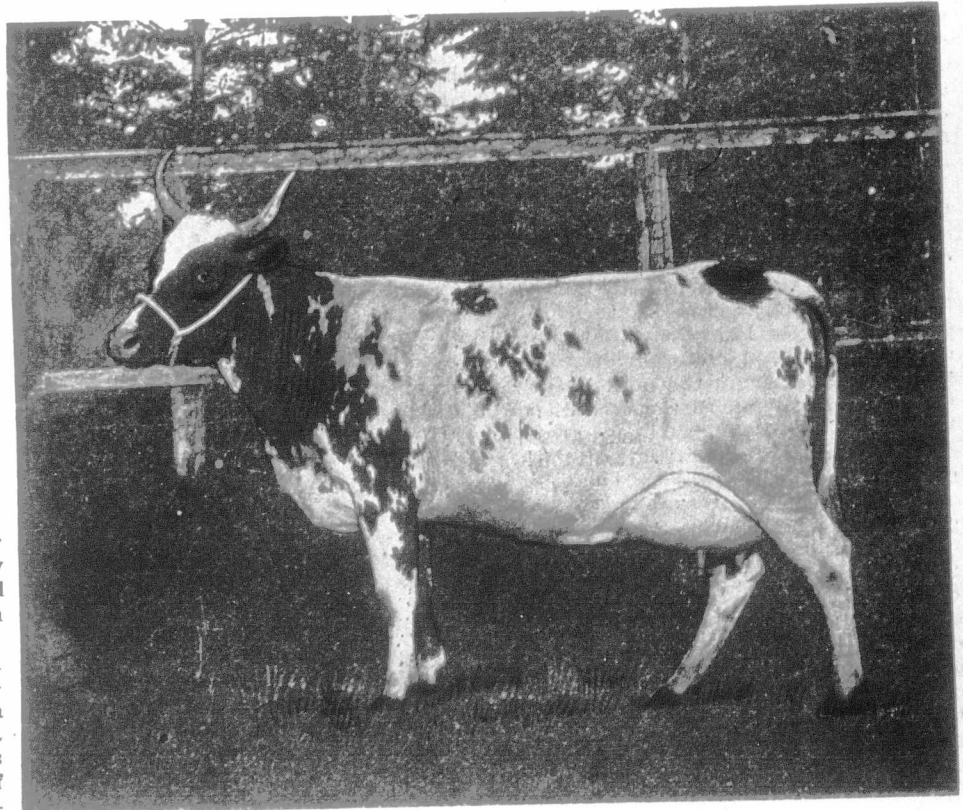

**LADY BUTE OF MID-AESCOG -9185-**  
Imported Ayrshire cow. (See Gossip, page 319.)  
OWNED BY MR. J. N. GREENSHIELDS, ISALEIGH GRANGE, DANVILLE, QUE.



and from my experience as instructor at the creameries for the past three years, I claim that the quality is not due to the system of making, but is injured largely by the same means by which the quality of our cheese is injured, the cream being improperly cared for at home and the butter held too long in unsuitable storages before being sold. It is quite customary to hold the butter at the creamery for three or four weeks, and often six or eight weeks, and the result is the flavor of the butter is wrong before it leaves the creamery, whereas at the separator creameries the butter in nearly every case is sold weekly and consumed while it is still fresh. I have recently interviewed three of the largest exporters of Western Ontario butter on this subject, and their experience is that when they can purchase the cream-gathered butter each week, while it is still fresh, and place it on the market immediately, in nearly every case it has given good satisfaction. They also give it as their opinion that if the butter at the separator creameries was held at the factory under the same conditions as at most of the cream-gathered creameries, there would be little or no difference in the quality of the butter. If you look up the records of the best expositions in Ontario for the past five or ten years, you will find that the majority of prizes have been taken by the cream-gathered creameries. At the July contest at the Pan-American, the Ayton creamery exhibited their butter (which was not specially made for the purpose, but was merely selected on shipping day, and was one month old) and received the highest score. The same creamery also won two firsts and the silver challenge trophy for the best butter at Toronto, and two firsts and gold medal at Ottawa Exposition last year, which goes to prove that if the farmers were educated properly in caring for their cream, the factories properly equipped, and the butter well made and properly cared for afterwards and put on the market while still fresh, we would have no difficulty in producing butter on the cream-gathered system that would compete successfully with the finest goods offered on the market.

To improve the quality of our butter by checking the extension of the cream-gathered creameries or converting the present ones into separator creameries would be as impossible as to improve the quality of our cheese by preventing the sour whey going home in the milk cans when the farmers demand it, and instead of a useless attempt to abolish the system and advocating a system which could not exist, we should unite our energies to improve the present conditions under which most of our butter is made. To see that the cream-gathered system is rapidly growing in favor, and is here to stay, we have only to note the prosperous condition of the majority of cream-gathered creameries and the enormous sale of hand separators, thousands of them being sold in Ontario last year. It is the only system which can be profitably adopted in the northern counties or the Western Provinces, where dairying is not a specialty, and in the United States it has largely replaced the separator system. Between 5,000 and 10,000 hand separators were sold in the State of Iowa alone last year. It is my opinion that the hand separator will effect a greater improvement in the quality of Western Ontario butter than any other means, for the reason that they deliver the cream in the best possible condition, and if it was properly taken care of by keeping it cold and sweet and free from bad odors, the finest quality of butter could be made at a minimum of cost.

If the manufacturers of hand separators could secure agents as well skilled in teaching the farmers the proper methods and the benefits of caring for cream, together with the literature they are already distributing, they would be more effective in improving the quality of cream-gathered butter than the dairy schools and travelling instructors combined, for the reason that the agent comes in contact with each individual patron, which is impossible on the part of the instructor, and if a farmer is at first taught to care for his cream properly, he is likely to continue doing so, and there is no good reason why the cream, after being skimmed from the milk by a hand separator, which tends to purify the cream, could not be delivered at the creamery in as good or better condition as a large quantity of milk, and at very much less expense.

The three greatest objections to the cream-gathered system are: 1. Cream is not collected often enough, and is frequently drawn too far. 2. It is often sour and tainted when it reaches the creamery. 3. The butter is usually held at the creamery too long before selling. Time will remedy the first difficulty. As the farmers engage more extensively in the business, which will increase the amount of cream and enable the factorymen to collect it oftener, a proper system of educating the farmers will improve the condition of the cream. Our experiments at the Western Dairy School indicate that sour cream can be pasteurized successfully, which will also free it from bad odors and greatly improve the flavor and keeping quality of the butter. The practice of holding the butter too long at creamery could

be largely overcome by appointing the maker salesman. The butter would then be sold at an early date, and before it was injured by age or heat in storage.

The plan we have adopted at creameries in which I am interested, is to send printed instructions to each patron on the benefits and use of hand separators, which we strongly advocate, and proper methods of caring for cream to keep it sweet and free from odors. Each patron is visited once during the season, if possible, and local meetings of the farmers are held at different points in the district. We are also arranging to ship our butter each week direct to the British market, where it will be consumed while it is still fresh. We are paying good salaries to expert makers, and I am positive that by these methods we can produce the quality of butter the market demands, and make the business much more profitable to the farmer than could possibly be done in the same districts under the separator system.

ARCHIBALD SMITH.

Middlesex Co., Ont.

### Against the Cream-Gathering System.

To the Editor "Farmer's Advocate":

Sir.—The letter of Mr. I. W. Steinhoff in your April 1st issue, on the subject of creameries under the cream-gathering system, is, to my mind, a timely warning. It takes the same ground upon which I have always stood in creamery matters, but I have held my peace for some one with a broader experience to open the fire, and I am glad to know that Mr. Steinhoff has made the onslaught. I think that every person interested in Canada and her reputation should raise his voice for the maintenance of a system in any line of Canadian production which will be the greatest credit. I do not think his statements are at all too strong. Previous to 1885 we had nothing in the butter line to send to England worth mentioning, and the great bulk of butter that was made and handled in country stores from farm dairies had to be used up as soap grease and the like. The gathered-cream creamery in those days did much good to reduce the bulk of butter disposed of as above mentioned. In 1891, the system of instruction inaugurated by the Government (travelling dairy), and followed for several years, did a grand work in the improvement of the dairy butter of our fair Canada, but it was not till the inception of creameries operated on the separator system that Canada's reputation as a producer of finest butter began to forge ahead, as did our reputation as cheese producers.

Now, if we are to hold and maintain this reputation, we must stay with the system that gave it to us, and lose no opportunity to improve and perfect it.

Let us look back in review of the position for a moment. When the great bulk of our butter was handled in the stores of our country, it was a difficult matter to get 1,000 pounds of butter of uniformly good quality. This was one of the worst features even after the goods were vastly improved by education.

Under the gathered-cream system this trouble still exists, because, while it is an improved method over the home-dairy system, the cream is managed under just as many systems (many of which are entirely unfavorable) as the butter was formerly, even though many times it may be separated by mechanical methods, as is the case.

One of the greatest difficulties we have to contend with in the dairy business is to get patrons to take proper care of the milk for either cheese or butter, and if the cream alone is cared for under these improper methods, how much worse the results will be may be measured to some extent by the fact that the cream is the essence of the milk from which the finished article is made, and much more easily contaminated after separated than when in the whole milk. Under the management of a separator creamery, the cream is all managed with the same express and the best methods for the production of the best quality possible.

The encouragement of cream-gathering creameries indicates to one the invitation for troubles to assail the export trade in butter in future years which will not be easily handled.

It is true that many prizes have been taken by butter made from gathered cream, but it is not made from the "pool of cream" taken in, but from carefully-selected cream from patrons who take especial care of the same. Patrons can take just as good care of it, if they will, as the creamery, but with more trouble. Patrons can also care for their milk in first-class style, if they will, and deliver a first-class raw material to the hands of the makers of cheese or butter, from which nothing but first-class goods would then be made. If this one condition could be obtained, without exception, for the current year, 1902, we should hear nothing at our conventions next winter about the poor cheese or butter made this season. Our friend, Mr. Dorbyshire, will not have the opportunity to say we produced the best and the worst cheese in 1902 that we ever produced, but simply stop when he has said the first

Lambton Co., Ont.

S. P. BROWN.

### The Production of Milk by the Average Cow.

BY PROF. E. H. FARRINGTON, CHIEF WISCONSIN DAIRY SCHOOL.

In discussing this important part of the dairy industry, I wish to make it plain at the beginning that I am not the champion of any particular breed of cows; my knowledge of the different strains or types of dairy cows is not sufficient for me to enlarge on the advantages of a long-horned cow over a short horn, neither do I pretend to say that a Guernsey, a Jersey, a Holstein or an Ayrshire is the best cow for a farmer to keep. My information on the cow question is confined to observations made at some of the ninety-five farms that are supplying milk to the Wisconsin Dairy School.

In visiting these farms in the past seven years I have not attempted to train myself so that I might become sufficiently expert to tell a farmer all about the different cows in his herd by simply looking them over while sitting in a buggy on the highway, but my efforts have all been directed towards trying to induce the farmer to keep a record of what his cows are doing. This, it seems to me, is going to help him, and I am afraid that if I ever tried to discuss the points of a cow with a farmer I would be in the plight of the professor of agriculture who was once talking with a young lady, and she suddenly turned on him and asked: "Professor, can you tell a good cow?" The professor, without any hesitation, replied: "Why, yes, I think I can." "Then what would you tell her?" said the young lady.

BY THEIR FRUITS YE SHALL KNOW THEM.

I did not wait to hear the rest of this interesting conversation, but without further delay I wish to say that my position on the cow question is expressed in the text, "By their fruits ye shall know them." If a cow gives milk and butter enough in a year to pay for her keep, and a profit besides, she is worth telling something of a story about; but if her food costs more than her milk brings, the less said about her the better. It is encouraging, however, once in a while to hear someone tell about an unprofitable cow that has been disposed of, and to know that such an animal is no longer being bought and sold among farmers.

The lack of exact knowledge regarding the annual production of each cow in a farmer's herd is in some cases rather surprising. It often happens that the cows are milked and fed in the same way every year, and if the check from the creamery or cheese factory is not large enough to suit the patron, and it never is, then a great many complaints are heard about the price of butter or the cost of feed, and very little, if any, effort is made to find out whether or not the cows are what they should be.

An illustration or two will serve to show the extent to which some farmers make an effort to think or how well informed they are about their cows and other business affairs. I once asked a farmer, who was bringing milk to the creamery, what breed of cows he kept, and he said: "Oh, I don't know, I guess they are Poland-China cows." Another farmer, who was drawing his own and some of the neighbors' milk to the factory, came to see me one day about the price he was receiving for his work. He said he had come to the conclusion that he could not afford to make the trip unless he was paid a dollar and a half a day. I asked him what he was getting, and he said he didn't know, but it wasn't enough. I looked up the records, showing how much he had received for several months, and found from his own creamery checks that he had been paid \$1.75 per day for drawing milk. This was twenty-five cents more than he said he wanted, but he had not taken the trouble to find out how much he was receiving before he came in to make his complaint and demand for \$1.50 per day.

It is too often the case that

### FARMERS KEEP NO RECORDS.

whatever, and do not have the slightest idea as to where they are at. They look at the amount of their creamery- or cheese-factory check without thinking that the size of their cows and their own size is responsible for the size of their monthly check. Many of them talk like a woman I met on the street, December 23rd. As I passed her I said, "Good morning, Mrs. Blank, I suppose you are out buying Christmas presents this morning?" "No," she said, "it's too hard times to buy Christmas presents this year; the creamery don't pay enough for the milk." Now, that woman keeps nine cows and the creamery paid her about \$250 in a year for the milk she sent to it. This is between \$25 and \$30 per cow per year that she receives, and she never once thinks that it is the cow's fault or her own fault that she does not get more money, but according to her way of thinking, and there are others that are of the



same opinion, the fault lies in the price of butter, the creamery management, or the hard times.

There is such a tendency in human nature "to look out and not in," as the Sunday-school teacher used to tell us—to think that the causes of our hard lot are all outside our own dooryard instead of in it—that we are sometimes helped by being reminded that a little investigation at home may be a profitable undertaking. This sort of an enquiry would be very helpful to many farmers if they can be led to realize what a difference there is in the earning capacity of the cows in their own herds, and then be induced to part with those that eat more than they produce; then the price of butter and "hard times" will not be continually worrying them. There's nothing like the inspiration of playing a winning game to make us forget our troubles, and, this being true, the most cheerful dairyman ought to be the one who knows the most about his cows.

It was with the hope of helping farmers, and of illustrating the condition of some dairy herds, that we undertook, some four years ago, to begin testing the cows of the patrons supplying milk to the Wisconsin Dairy School. These patrons keep cows and deliver milk to the factory in the same way as is customary at the creameries and cheese factories throughout the State. They do not have large herds, and it was observed during the past year that the cows owned by one hundred of them were probably similar to the one million in the State. Only eight out of the one hundred patrons kept more than twenty cows, and thirty-five owned from two to five cows only. This shows that the majority of our patrons do not pretend to be dairymen in the sense of making the production of milk a serious business, and I fear there are many farmers in so-called dairy districts who do not allow the cows to make much of an impression on their minds; other lines of farming crowd the cows out, so that they receive only a little attention at milking time.

WHY TEST THE COW?

During past years we have, like other creameries, urged our patrons to take samples of each cow's milk and allow us to test them, as this will aid in obtaining definite knowledge of the amount of milk and butter each cow produces. The patron's usual reply to these suggestions is that he "supposes it would be a good plan to test his cows," or he plainly states that it is too much bother to take samples. He is either so much attached to his cows that he does not care to part with any of them, even if it is proved that some cows do not produce milk enough in a year to pay for their feed, or he seems to think he knows enough about his cows without having their milk tested. Not one of our patrons during the past seven years has voluntarily brought samples of milk to us for any length of time with the request that we test them for him. This indifference to an exact knowledge of the profit or loss from cows is common among farmers, and on account of it they suffer annually very large financial losses. It was with the hope of convincing our patrons that cow records are valuable that a systematic testing of a number of herds was begun in August, 1897.

In preparation for these tests we had boxes made for carrying four-ounce sample bottles of milk from the farms to our creamery. Small books, in which might be recorded the weight of each cow's milk once a week, and accurate weighing scales were also provided. We offered this outfit to our patrons, and agreed to test all samples they would send us if these were taken for one day at regular intervals of one, two or four weeks during the year. We were able to test six herds the first year, beginning August 1st, 1897. These tests included the weighing, sampling and testing the milk of forty cows once every week through one complete period of lactation; eleven more cows were tested for a part of the year. Since that time the testing of patrons' herds has continued. During the year beginning April 1st, 1899, sixty-two cows on nine farms were tested through one complete period of lactation, and fifty-four cows for only part of the year. The following year fifty cows on six farms were tested, and up to the present time 217 cows on thirteen of our patrons' farms have been tested. These tests represent 135 complete and 98 partial periods of lactation. The cows in three herds were tested for three years consecutively, and four other herds were tested for two consecutive years.

During the first year of testing, the milk of each cow was weighed and tested once each week, but it was impossible to get this done so often after the first year. Some patrons were willing to weigh and sample the milk of each cow once in two weeks, and others could only be induced to do this "extra work" once a month.

The results obtained by this three years of testing have shown that farmers may gain a great deal of useful information by such work, and that it is one of the most profitable fields for careful observations in the whole domain of agriculture.

A description of our methods of making the tests and some of the results obtained may be of interest to you.

(To be continued.)

APIARY.

On the Prevention of Swarming.

BY MORLEY PETTIT.

In the "Farmer's Advocate" for February 1st, page 92, of the current volume, there were stated some of the conditions under which increase by natural division or swarming takes place. It is the purpose of the present article to consider ways and means of preventing such conditions and bringing the swarming impulse as nearly as possible under control. While this subject is not exactly "seasonable" in April, it is of the utmost importance that the apiarist be well prepared, both in plans and appliances, for the summer's work before the beginning of June. It must also be borne in mind that methods in bee-culture are peculiarly subject to the season and locality, the style of hive used, and the man. Hence the impossibility of laying down hard and fast rules and the necessity of taking time to carefully consider all methods proposed in bee literature before adopting them in their entirety. In view of these facts, this most important subject is introduced thus early in the season that it may receive due consideration.

In the article mentioned, the swarming impulse is said to depend partly on the race or strain of bees employed. "Other qualities being equal," then, "it is obvious" that the race with the least swarming propensity is preferable. Whether this be Carniolan, Italian or Black, the writer is not prepared to state. His experience with the first in this respect has been anything but encouraging; but others, in a different locality and perhaps with different management, prefer Carniolans and have very few swarms. For a general-purpose bee take a hybrid of Italian and Black blood, or, perhaps, substitute Carniolan for the latter. Much can be done towards improving one's stock by careful and scientific selection in breeding.

The other conditions as tabulated are: (a) "The super is crowded with honey." To prevent this condition give, at the beginning of the honey flow, what experience and the strength of the colony shows to be sufficient super room to afford the workers no prospect of being crowded. In the "locality" of Elgin County, colonies which have been wintered and "springed" well must have a super in May (preferably of half depth) to store honey from fruit bloom. Do not delay giving a super until the combs of the brood chamber are whitened, as many text-books recommend. By that time the bees have probably decided to swarm, and prevention is very much easier than cure. At the beginning of white clover, the fruit-bloom honey should be removed and super room given equal to one and a half times or even twice the capacity of the brood chamber. As soon as a little capping is done, extract about half of the super, choosing the best-capped combs, that storing may go on in these while the others are being capped. When these others are about half capped extract them; and repeat this, alternating from one side of the super to the other, as long as the honey flow lasts. The above method applies particularly to deep supers. With shallow supers the tiering-up system is best—that is, placing supers of empty combs, as they are needed, beneath those already on.

(b) The queen crowded in the brood chamber often, though not always following (a), is avoided either by removing some of the brood or by enlarging the brood chamber. Adopting the former plan, remove most of the brood and substitute empty combs or frames of wired foundation, at or shortly after the time of giving supers for the main honey-flow. The brood is used to build up weak colonies or to form nuclei for increase. It will be seen that this method prevents swarming by checking the growth of the colony and keeping it within the limits of a small hive, and while it answers the requirements of many men and localities it has its disadvantages for others. By the second plan the brood chamber is enlarged beyond the laying capacity of the queen, which accomplishes the same result, and has the advantage of allowing the colony to attain its utmost strength without any division of the working force. It is from such powerful colonies that big yields of extracted honey are obtained. The thoughtful apiarist will, no doubt, use either method, as the individual case requires. If increase is desired, form nuclei. If any are weak, help them from the strong. As soon as all are strong, enlarge the brood chambers—but not too much, lest the lower part fall into disuse except as a storeroom for pollen.

(c) A slow yield of nectar excites breeding, but does not wear out the workers, and the hive becomes overpopulated. This condition may, in a measure, be overcome in the same manner as (b).

(d) A negative condition, no ventilation nor shade, is answered positively. Give ventilation and shade, a large entrance and upward ventilation in the super, a non-conducting lining to the cover, and the shade of trees.

GARDEN AND ORCHARD.

Orchard Institute Meetings.

BY G. C. CREELMAN, SECRETARY.

At the last annual meeting of the Ontario Fruit Growers' Association, we were requested to arrange for a series of orchard institute meetings throughout Ontario. It was deemed best not to commence the series until the close of the Farmers' Institute meetings in March, it being a better time for practical demonstrations than when there was more snow on the ground. In all 49 meetings were held, reaching from Iroquois in the east to Leamington in the west, the Province being divided for this purpose into seven districts: 1st, the Ottawa and St. Lawrence Valley district; 2nd, the Lake Ontario district; 3rd, the Burlington district; 4th, the Niagara peninsula; 5th, the Georgian Bay district; 6th, the Lake Huron district; 7th, the Lake Erie district.

PLAN OF CAMPAIGN.—The object of the meetings was twofold: First, to give a practical demonstration of the best methods of pruning and grafting, and the general care of an orchard, together with a discussion on matters generally pertaining to fruit; secondly, the formation of local fruit-growers' associations in each place, for the purpose of giving the fruit-growers an object in meeting together once a month to discuss their business. This was the work of the evening meeting, and many associations have been formed and plans laid for regular meetings to be held, where the following subjects, among others, will be discussed: Methods of Cultivation; Picking, Packing, Grading and Handling of Fruits; Co-operative Shipping, and Co-operative Buying of Packages.

CO-OPERATIVE BUYING.—Already the Georgian Bay people have taken this matter up, and have sent out a circular to each of their five branch associations, containing the following information:

Believing it to be the general wish of the members of the Georgian Bay Fruit Growers' Association to do something in the co-operative buying of packages and chemicals, with the object of placing orders during the slack season, thereby obtaining a reduction in prices, we would be glad to have, at your earliest convenience, a return of the enclosed blank form properly filled out.

FORM.

I agree to take the following stock, to be delivered at the undermentioned place, and at prices not to exceed those mentioned below.

.....apple barrels, at.....each.	Delivered.....'	'02
.....apple boxes, at.....each.	Delivered.....'	'02
.....fruit baskets, at.....each.	Delivered.....'	'02
.....lbs. Paris gr., at.....per lb.	Delivered.....'	'02
.....lbs. bluestone, at.....per lb.	Delivered.....'	'02

Signed.....

Place of delivery.....  
Suggestions.—

The secretary, at the same time, asks for any suggestions that would be for the general welfare of the Association, and asks the ideas of each member upon the following subjects: Co-operative buying of supplies, trees; also what they think of establishing an information bureau for the purpose of collecting data on the transportation question, and also to keep the members informed as to fruit prices and other matters of special interest to fruit-growers.

LAKE HURON DISTRICT.—Reports from this district show a decided interest in the meetings, and the series closed with 108 paid members and the formation of six societies. These separate societies hope to join hands and send delegates to a central point, at an early date, when they will organize the Lake Huron Fruit Growers' Association. With Mr. Sherrington in charge of the fruit work at Walkerton, we have no doubt this Association will always be a useful organization.

ST. LAWRENCE VALLEY.—Here Mr. Harold Jones, Director of the Experimental Fruit Station, Maitland, held a series of five meetings. An association was formed at each place, and local parties have written to say they do not regret having travelled, some of them on foot, ten miles to the meeting. At each place an orchard meeting was held, and in many instances local men took an active part. This is especially true in Iroquois, where Dr. Harkness, who has always been an active worker for the fruit interests, met with the farmers and took part in the discussions. In this district, strange to say, it was necessary to clear up some superstitions. At one point, Mr. Jones was confronted with the statement that it was understood they had been sent there by the Ontario Government to cut down their trees, because they believed there was an insect called the San Jose scale working in their orchards. Mr.



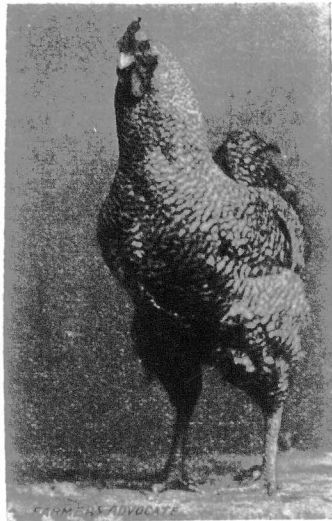

IMPORTED BARRED PLYMOUTH ROCK  
COCKEREL.

Sire of winners of sweepstakes at the Ontario Winter Fair, 1901.  
PROPERTY OF J. W. CLARK, ONONDAGA, ONT.

Jones was able to inform them that there was no scale in that part of the country, and took occasion to tell them how serious the pest was in other parts of the Province.

**LAKE ERIE DISTRICT.**—Here, again, a fruit experiment station man takes part in the work, Mr. W. W. Hilborn, Leamington. A fruit-man, writing to us after the meeting in Kingsville, says: "I was present yesterday at the meeting of the fruit-growers, and heard Mr. A. McNeill and Mr. W. W. Hilborn discuss the subject of 'Care of Fruit Trees.' We afterwards adjourned to an orchard, where they splendidly demonstrated how to prune the different kinds of trees and bushes. It was very instructive, and I wish it could be done in every neighborhood each season."

**HALTON COUNTY.**—Commencing at Bronte, on the lake front, and working back to Watford and Georgetown, a series of good meetings was held, Mr. Murray Pettit being the local director in charge. A full report of one of these meetings appeared in the Weekly Sun of March 26th.

**LAKE ONTARIO DISTRICT.**—Here good meetings were held, commencing in York County and working east to Prince Edward County. The series is not yet completed, but such reports as we have show—as we expected in this splendid apple-growing district—first-class meetings, and many strong local associations formed as a consequence. The local directors—Mr. Elmer Lick, Oshawa; H. J. Snelgrove, Cobourg; and Mr. W. H. Dempsey, Trenton—were assisted by Mr. G. C. Caston, of Craighurst, and Mr. G. H. Vroom, of Middleton, N. S.

#### PRACTICAL SUGGESTIONS THROWN OUT AT ORCHARD MEETINGS.

In planting, trees should be given a slight slant toward the prevailing wind. The main roots should be placed so as to brace the trees against the wind, and the tree should be so headed that the main branches would not when loaded bend directly away from the tree and so be apt to break off.

Trees, after they have grown crooked, may be straightened somewhat by the use of the spade early in the spring when the ground is soft.

In pruning the south side of the tree, it can be left a little thicker than the north side, as it receives more light and moisture.

It pays to thin overloaded trees at least 20 per cent., as the remaining fruit will be of better quality.

A man who does not know a fruit bud from a leaf bud should never be allowed to prune a tree.

You can hasten the development of fruit spurs and multiply the fruit buds by checking the growth of the wood. This can be done by pruning the roots with a spade, or by nipping off the ends of twigs. The latter method is preferable, as it does not impair the vitality of the tree, as does the root-cutting.

Where large wounds are made in the trees from cutting off large limbs, the wound should at once be painted over. A good paint mixture is made by mixing 2 pounds cement with 10 pounds of milk. For an old wound, where rotting has set in, further injury may be prevented by using two parts of cement and one of sand, completely covering the wound so as to exclude the air.

Orchards should be cultivated constantly until the middle of July; then a cover crop of clover, rape or rye, to be plowed under next spring.

Apples must be handled more like eggs than turnips, if we expect to realize good prices for our fruit.

The Baldwin, Ben Davis, Greening and Spy are at present the favorite commercial varieties.

Four years ago, Reeve Coyle, of Colborne, purchased an orchard containing ten acres. The price was \$2,600. The crop gathered from that orchard in 1900 netted, after all expenses were

paid, \$2,130. Mr. Coyle made the following statement at an orchard meeting in Colborne, last week: "I shipped 800 barrels of apples from my own orchard two years ago. The dealer to whom I consigned them said they were the best apples he had ever sold in the Liverpool market. There were not five barrels of wormy or scabby apples in the lot. The superiority of this fruit was due to the fact that I had persistently cultivated the orchard and pruned and sprayed my trees."

**Bordeaux Mixture.**—After the bluestone is dissolved, it should be put in twenty gallons of water, and the lime after it is dissolved should be put in another twenty gallons of water. The two mixtures may then be brought together. If the lime and bluestone are mixed together undiluted, they will curdle.

Mr. Gaston strongly advises the use of lye as a wash for trunks of trees. It should be applied every second year, after the old bark has been scraped off. It not only destroys all bark lice, but seems to have a tonic effect on the trees.

Mr. A. McNeill says: "Each bud has its own individuality apart from the variety to which it belongs, just as each man has his individuality apart from his race. No two buds, no two trees, are exactly alike. Hence, in budding or grafting, it is important we should select for the purpose."

Speaking at the Georgetown meeting, Mr. McNeill also made the following remark: "I do not think our fruit experiment stations could do more useful work than by developing good trees from which to supply cuttings for grafting on commercial orchards in their neighborhood. This would be more useful work than developing varieties of doubtful merit."

#### Pleased With His Present --- Treating Apple Trees --- Millet for Fodder.

To the Editor "Farmer's Advocate":

Sir,—This is the first year I have had the pleasure of reading the "Farmer's Advocate," which came to me, through a very kind friend, as a present, which I value very much. I think it the best agricultural paper I ever read, and every farmer ought to have one in his house for his family, giving them something that is worth reading.

I am just through pruning my fruit trees and whitewashing them. First, I scrape off all the old bark that will come off easily. It is astonishing what a number of insects hide under the old bark. I put a rug under the tree to catch the insects, and then burn them in the stove. I find the lime wash a splendid remedy for the bark-louse and other insects. In former years I washed my trees with potash, but the lime is much better.

A few words on raising millet for fodder, as asked about. I tried a small quantity of Japanese millet last spring. I sowed it in drills 20 inches apart, and it grew rather strong—over five feet in height, and my cattle ate it greedily. I cut it in its milky state, and it made splendid coarse hay. I am sowing a bushel this spring for fodder.

WILLIAM BICKERS.

Pictou Co., N. S.

#### Fertilizer in Onion Growing.

A Geneva (N. Y.) Experiment Station bulletin deals with a problem of particular interest to onion-growers, but also one which again enforces the lesson needed by many farmers, of economy in the purchase and use of commercial fertilizers. The experiments of four years, when different quantities of high-grade commercial fertilizer were used, show that 500 pounds per acre was the most profitable amount to apply. With good prices assured for onions, larger quantities of fertilizers might be used, but, considering all factors, the onion-grower "runs great risk of diminished profits when he uses 1,500 and 2,000 pounds of commercial manure per acre." In case of one set of tests on rich soil, it was found that even the smallest amount of fertilizer was unprofitable.

#### Constancy.

*The constant drop of water  
Wears away the hardest stone;  
The constant gnaw of Towser  
Masticates the hardest bone;  
The constant wooing lover  
Carries off the bashful maid;  
And the constant advertiser  
Is the man that gets the trade.*

#### Reaches Good Men.

Mr. John Bright, breeder of Clydesdale horses and Shorthorn cattle, Myrtle, Ont., writes us as follows: "The advertisement I have in your paper I must say gives me the best of satisfaction. Bringing me correspondence from good men from all parts of America. I think I am safe in saying that I make nine-tenths of my sales to readers of the 'Farmer's Advocate.'"

## POULTRY.

### The Buff Orpington as a General Utility Fowl.

To the Editor "Farmer's Advocate":

Sir,—The Buff Orpington fowl, though of comparatively recent introduction, has attained a position in the English show-pens which would indicate that it is likely to continue to be a general favorite as an all-round utility bird. It possesses a combination of the desirable characteristics of three distinct English breeds.

The object of William Cook, of Orpington House, England, who is the originator of the breed, was to produce a distinct type or strain of birds that would combine the good qualities of some of the breeds that are well known to be good egg producers and table fowls. In this he was most successful, as to-day the Buff Orpington is held to be the best general-purpose bird in England. They are especially suited to the requirements of the English market, and as a money-earning breed they lead all others.

Being connected with a company that has from time to time been forwarding poultry to the English market, I have had occasion to communicate with some of the leading dealers in dressed poultry in Great Britain, and have noted that special mention has frequently been made of the merits of this breed. They find the greatest demand for a white-fleshed bird having white legs and which will weigh from three to four pounds dressed when five months old. The color of the flesh or legs will frequently make a difference of one or two cents per pound. Such points do not generally appeal to Canadian poultry-raisers, but if we intend to continue to build up a trade in high-class dressed poultry with John Bull, we must place before him just what suits his eyes, while constantly remembering that, however much he may love us, pure sentiment will not induce him to violate his stomach. Our attention has repeatedly been called to the ideal type of bird for the export trade. We have been supplying too great a mixture, and unless we can succeed in improving our stock, with a view to curtail those vexatious variations and supply what the English market demands, we cannot expect to get the highest prices.

During the last three months I have visited the poultry departments at the Ontario Agricultural College, Guelph, and at the Central Experimental Farm, Ottawa, and found that the Buff Orpingtons were making an excellent record as winter layers. W. R. Graham, Superintendent Poultry Department, Guelph, had a pen which were all laying on 15th January. An April pullet usually commences to lay in October or November, and with proper care will continue to produce eggs throughout the winter and spring.

[Note.—The writer of this letter, Mr. Clark, encloses quotations from Liverpool and London (Eng.) dealers, who state that they prefer the Buff Orpingtons to any other breeds as market birds. Canadian dealers recommend them. From what we have seen of them, they are likely to prove a valuable addition to our list of excellent general-purpose fowls.—Editor.]

They are exceptionally hardy. During the past winter I have imported four crates of birds from England. They landed in the early part of March in the very best of condition. After being confined in the crates for 17 days and crossing the Atlantic in the roughest part of the year, they were healthy and bright, a number of the pullets were laying, and they have never required nursing a single day since they landed.

Their general characteristics may be summed up as follows: They are hardy, quite domestic in habit, mature early, are excellent egg-producers, their body is of the proper size and conformation, they have a fine-grained flesh, and they are well suited to our Canadian climate.

Brant Co., Ont.

J. W. CLARK.

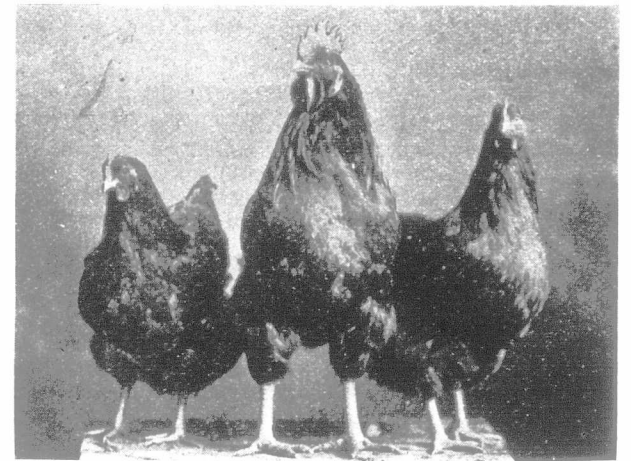

BUFF ORPINGTONS.

Sample of lot imported by J. W. Clark, Onondaga, Ont., from one of the best flocks in England; costing \$30 per trio.



## Successful Poultry Raising.

"HOW I DID IT."

BY MRS. YULL.

Having been very successful in raising poultry last year, and especially so in hatching and raising early chickens, I thought I would send you an article on "How I did it," for the benefit of such of your readers as it may interest.

Our henhouse is 20 feet long by 8½ wide, with double-brick walls plastered inside, and cement floor. The windows, which are 3x5 feet, are two feet from floor, two of them facing south, and one east. The ceiling is two-ply inch lumber. The roosts are round poles hung from ceiling, and are one foot from floor in front and two at the back. The droppings are scraped up each morning, and the floor sprinkled with wood ashes. The dust bath is composed of one ounce sulphur to every eight pails of road dust.

I feed in a V-shaped trough. The drinking fountain is a four-gallon covered tin can, with a strip 3x6 inches cut out of the side about 6 inches from the bottom. Our fowl are all Barred Plymouth Rocks. The best results we had in hatching were from eggs laid by pullets eight months old, fed on a little grain morning and noon, and in the evening a mash made as follows: Two handfuls of broken eggshells, 2½ lbs. cut clover, scalded with one quart of water, let steam for half an hour and mixed with bran and a little salt. Their supply of meat is prepared at butchering time. All the refuse meat is boiled until quite tender, then mixed with one part bran, two parts oats, one part barley, ground fine, and a little salt. Fill this mixture into small barrels or nail kegs, then set out to freeze. When frozen solid break two or three staves out of the barrel and roll it into the henhouse. As it thaws the hens will get all the meat they require. We also feed a little ground bone every day.

Seeing a number of articles in the papers on feeding poultry for egg production in winter, I tried a change of feed, but did not have so good results.

I filled my first incubator on the 14th of January, and had 86 live chicks out of 110 eggs. These chicks were left in incubator for 12 hours. In preparing brooder, I put about one inch of sand on the bottom, heat it to 90 degrees, then put the chickens in and let them remain 12 hours without food. For the first feed mix a hard-boiled egg, ground fine, shell and all, with quarter of a pound stale bread crumbs, put a clean paper over part of sand in brooder, then sprinkle two table-spoonfuls of this food on paper, and repeat in two hours; when the paper becomes solid, replace with a clean one. Continue this food for the first three days, being careful not to feed too much.

On the fourth day about a teaspoonful of ground meat may be fed. Also a little pin-headed oatmeal, mixed with small seeds, such as millet, still continuing the hard-boiled egg and bread, although a little oatmeal may be mixed with these. When about two weeks old split a small mangel, scrape a little out of the middle, mix with corn meal, replace, and feed. The mangel serves as a trough, and learns them to eat it. Give them a fresh one every day; by this time the chicks are ready to leave the brooder for food. Scatter a little wheat and seeds on henhouse floor. Boiled potatoes mixed with fine-ground oats and corn meal slightly dampened with skim milk may now be fed for breakfast. About ten o'clock give them ground cabbage, carrots, mangels or onions, mixed with fine-ground oats, corn meal or shorts. If possible, change this portion of their diet every day. When they are about three months old I feed them wheat for supper; at four months whole oats. While in the brooder give all the clean cold water they will drink, in saucers, with a teacup turned mouth down in each saucer. Do not give them any milk for two weeks. We raised all our February and March chickens in this way.

I disposed of very few of the February chickens, as the majority of them were pullets. What cockerels there were among them, and also those hatched in March, were sold to the Canada Produce Co., Toronto. The February chickens weighed, on an average, four pounds each at four months old, and the March ones weighed three pounds at three months old. The February pullets commenced laying in August, moulted the last of September, and commenced laying again soon after, and have been laying ever since.

I have used a Cyprus incubator for two years, and am having good success with them this year. Lanark Co., Ont.

## Carnegie's Address.

Would you kindly give me the address of Andrew Carnegie, the millionaire, as I am not sure where he resides?

CLIFFORD M. COLDWELL.

King's Co., N. S.

Ans.—He has, we understand, places of residence both in Great Britain and America. He was in New York a few days ago, and a letter forwarded, care of the "Carnegie Institute," New York City, would likely be forwarded to him.

## QUESTIONS AND ANSWERS.

1st.—Questions asked by bona fide subscribers to the "Farmer's Advocate" are answered in this department free.

2nd.—Our purpose is to give help in real difficulties; therefore, we reserve the right to discard enquiries not of general interest, or which appear to be asked out of mere curiosity.

3rd.—Questions should be clearly stated and plainly written, on one side of the paper only, and must be accompanied by the full name and address of the writer, as a guarantee of good faith, though the name is not necessarily for publication.

4th.—In veterinary questions, the symptoms especially must be fully and clearly stated, otherwise satisfactory replies cannot be given.

## Veterinary.

## LYMPHANGITIS.

My horse's left hind leg is swollen. The cord on the inside is swollen up to the body, and is very sore to the touch. The sheath and floor of the abdomen is also swollen. The first day he refused food. He was quite lame at first.

Nipissing, Ont.

G. F.

Ans.—Your horse has lymphangitis, often called weed, or Monday morning disease. He will doubtless be over his lameness, although swelling may still be present, by the time you see this. This disease is generally preceded by a day or longer of idleness, during which time the horse has been well fed. Horses that are exercised every day seldom suffer. Treatment consists in giving a brisk purgative of 8 drs. aloes and 2 drs. ginger, excluding all drafts, bathing the leg long and often with warm water, and after bathing applying camphorated liniment, which can be bought in any drug store. He should not be exercised until the lameness has disappeared, and then exercise dissipates the swelling, but it will return to some extent at nights for some time. Repeated attacks of this disease terminate in a chronically enlarged leg.

J. H. REED, V. S.

## WIND SUCKER AND COLT WITH WEAK FETLOCKS.

1. A four-year-old colt has acquired the habit of sucking. He works his jaws and makes a noise, but does not take hold of anything.

2. A colt now two years old was weak in the fetlock joints when foaled. He would go forward on them until the joint would touch the ground. He is much better now, but still weak, and sometimes stumbles.

A. C.

Wellington Co., Ont.

Ans.—1. Your four-year-old colt is a wind sucker. This is a vice, not a disease. As a rule, a horse addicted to this habit will catch the manger or other object, but occasionally we see one that does not. The habit is very hard to check. Buckling a strap studded with tacks around his throat so that when he commences to suck the enlargement of the throat causes the skin to come in contact with the tacks will check him. This will need to be worn for a long time, as the habit is likely to return if the strap be removed.

2. It is not probable your two-year-old colt will ever be very strong in the fetlocks or very sure-footed. Blistering the joints every five or six weeks during the spring and summer will benefit the case.

J. H. REED, V. S.

## PECULIAR TROUBLE IN COW.

A cow suddenly took sick in stable; showed great pain; turned purple on hind parts, udder and tongue; would bellow from pain; throw herself in a great many positions; diarrhea set in, with a yellow, frothy discharge; temperature normal; died in less than ten hours. Several cows have shown similar symptoms in this neighborhood within the last few years, but all recovered.

Prince Co., P. E. I.

Ans.—It would require a careful post-mortem examination to determine the cause of death. It somewhat resembles anthrax, but the fact that it is not usually fatal dispels that idea. It must be some disease due to local causes. The symptoms given indicate a stoppage of the circulation from plugging of an important artery. A condition of the arteries called embolism causes such symptoms, but nothing can be done to give relief.

J. H. REED, V. S.

## COW WITH A COUGH.

About a month ago a three-year-old cow began breathing heavily. She does not appear to have a cold, but coughs some in trying to get her breath. She was fed on hay, pulped turnips, and chop. Now she cannot eat either of the latter, but can eat hay and whole turnips. She drinks all right. She is getting thin. She stands with her head stretched out, and can be heard breathing for quite a distance. I think the trouble must be in her throat or windpipe.

Bruce Co., Ont.

A SUBSCRIBER.

Ans.—It is probable your cow has tuberculosis, either of the glands of the throat or the lungs. You had better have her tested with tuberculin, and if she reacts, destroy her. If she does not react, blister her throat well with the ordinary paste blister and give her one dram iodide of potassium twice daily. The fact that she can eat hay and whole turnips and cannot eat either pulped turnips or chop is peculiar. Try spreading the chop thinly over a large surface, so that she cannot get a mouthful, but will be compelled to eat slowly.

J. H. REED, V. S.

## HORSE SORE IN FRONT.

I have a six-year-old horse with some nervous disease. He stretches out like a foundered horse, and will shake. He is stiff when in the stable. He has good feet, and is in good order. Has been like this for a year.

J. McN.

Huron Co., Ont.

Ans.—Your horse has either navicular disease or chronic laminitis. Remove the shoes, pare the feet well down at the heels, clip the hair off the coronet for about 1½ inches above the hoof all round. Blister with 1½ drs. each biniodide of mercury and cantharides, mixed with 2 ozs. vaseline. Rub blister well in, tie so that he cannot bite the parts. In 24 hours rub well again, and in 24 hours longer wash off. Let his head down and apply some vaseline to the parts every day. Blister every month for five or six times, and turn him on soft ground as soon as the grass grows and the weather becomes fine enough. Cases of this kind require a long period of rest and treatment.

J. H. REED, V. S.

## OBSTRUCTION TO MILK DUCT.

When I took the calf from one of my cows I noticed that the milk did not come freely from one teat. It takes about four times as long to milk her as it should. There is a small growth at the lower end of the teat on the inside.

Give a recipe for worms about one inch long in a calf about 10 months old?

D. G. McK.

Pictou Co., N. S.

Ans.—There is a small tumor in the milk duct, and it will require an operation with an instrument called a concealed bistoury. It requires an expert to perform the operation, and unless you can employ a competent veterinarian you had better leave it alone, as unskillful interference will make matters worse by setting up inflammation of the udder.

The worms described are called pinworms, and are found in the rectum. Inject into the rectum 1 part turpentine to 16 parts raw linseed oil. Repeat in three days.

J. H. REED, V. S.

## CATARRH OR GRUB IN THE HEAD IN EWE.

A ewe with lamb about a month old has refused to eat for about a week. There is a discharge of matter from both nose and eyes. Should she be removed from the other sheep? Should sheep be kept in the same stable as other stock? The stable is cement and the sheep-house is in one corner, with a partition between; one half of the door is opened every fine day.

Huron Co., Ont.

SUBSCRIBER.

Ans.—It is not good practice to keep sheep in the same stable as other stock. Other stock require closer, warmer compartments than sheep, which should be kept in a wooden building with more ventilation. Your ewe has probably contracted catarrh as a result of too close quarters. Steam her nostrils by holding her head over a pot of boiling water, in which has been poured about a dram of carbolic acid, twice daily. Give her some boiled flaxseed and ¼ dr. powdered gentian as a drench several times daily until she will eat a little. See that the premises are well ventilated and dry. If she has grub in the head, benefit may be derived by causing her to inhale the fumes of burning sulphur.

J. H. REED, V. S.

## LICE ON CATTLE AND SKIN DISEASE IN MARE.

Our cattle have lice (white body and reddish head). Do the lice stay on the cattle or in the stable during the summer? We whitewashed our stalls last fall.

We have a mare that breaks out in spots on neck and body. The hair comes off, and in the center of bare place there will be seen a small pimple or scab. She had the same last summer.

H. H. Mc.

Ans.—Lice may remain on cattle continuously. They cannot remain in the stable if it has been thoroughly whitewashed. Get some stavesacre seeds, put an ounce to a quart of water and fetch it to a boil, then allow it to simmer for four hours; draw off and add water to make a quart. Wash the affected cattle with this once weekly for three applications. Any of the recognized sheep dips also destroy lice on cattle.

Your mare is predisposed to eczema. Give her a purgative of 8 drs. aloes and 2 drs. ginger. Then give 2 ozs. Fowler's solution of arsenic twice daily for a week or ten days. Wash her well with strong soft-soap suds; rub her until dry. Then apply twice daily: Creolin, 1 part; water, 70 parts.

J. H. REED, V. S.

## COLT THAT GOT HIS STIFLE HURT.

A two-year-old colt got his stiffler hurt last fall. I used a liniment for awhile, and then blistered three times, about three weeks apart. Is this good treatment?

A. H.

Simcoe Co., Ont.

Ans.—You do not state the nature of the injury received, nor yet the condition of the part at present, hence it is impossible for me to say whether your treatment is correct or not. If the colt is lame or has an enlargement, you are treating him all right; but if there is a raw surface or a discharge of pus, the treatment is wrong.

J. H. REED, V. S.



**IMPACTION OF THE THIRD STOMACH, OR FARDEL-BOUND.**

Two weeks ago a Shorthorn bull went off his feed. I treated him for indigestion, or clogging of the manyplies. On Wednesday I gave him a handful of salt dissolved in water, and also considerable water to drink. Next day he was no better, and I gave him a pound of Glauber salts, and another handful of salt and water to drink. Next day he passed nearly clear water, and I thought I had given him too much purgative medicine. I then gave him a tablespoonful of ginger, three of whiskey and one of laudanum to check purgation and act as a tonic. The same day I was in town and told the local veterinarian about the case. He did not condemn the treatment, but told me to be careful to not stop the action of the bowels too quickly. The bull continued to pass fluid at intervals of a few hours. On Sunday morning he appeared rather better, but would not eat. I boiled hay and gave him the liquid to drink, also burned flour; mixed it with water and drenched him with it. I continued the administration of ginger, whiskey and laudanum. The clear water stopped coming, but a colored fluid was passed. He died the next Friday night. A post-mortem revealed his liver much inflamed, and one end of the manyplies moist, but nearly the whole of it was dry, one layer after another packed with dry food. His stomach was nearly full. Now, the query is, where did the salt and Glauber salts go? They surely never went through the manyplies. It seems a mystery. There are more cattle die from this complaint than from all other diseases put together. A. M.

Ontario Co., Ont.

Ans.—Fardel-bound, or impaction of the third stomach, in the ox is a very hard disease to treat, and often proves fatal. My experience has taught me that it is not, as you say, very common. In this section it is comparatively rare, while in yours it must be quite common, as it causes more loss than all other diseases in cattle. It is caused by dry, indigestible food, a nonactive condition of the glands of the organ, or a partially paralyzed state of the muscular walls. The liver is not involved in cases of this kind, and the fact that in your case this organ was diseased indicates that that may have been the primary trouble. If the liver be diseased to such an extent as to materially interfere with the secretion of bile, digestion in the small intestines will be largely interfered with, and in such conditions the stomach cannot perform its normal functions. Impaction takes place from the fact that the inješta cannot pass backwards, and this is followed by a dryness of the contents, especially of the third stomach, which, under normal conditions, is only moderately moist. This condition of the liver is often not even suspected until symptoms of fardel-bound are exhibited, and even then there are no definite symptoms to indicate liver disease, and all that can be done is to treat for fardel-bound. If the condition be due to liver disease (and often when from other causes) the disease will be fatal. It has been the experience of all who have had experience with this trouble that it is not unusual for the administration of a purgative to be followed by the evacuation of a quantity of liquid feces, often as thin as water, such as you describe. It would take too long to describe the way in which medicines are believed to act in such cases, but the fact remains that we get this action, even though it may appear mysterious, as you state. I may say that the manner in which many medicines act is not well understood. We know that we may reasonably expect certain actions to follow the administration of certain drugs. We know this from experience, and the experience and experiments of others, but why or how a medicine should act in one way rather than another we do not know, but we do know how they act under normal conditions, and we also know that their actions are modified or in some cases entirely suspended by diseased conditions of the organs upon which they should act. As stated, a purgative given in a case of fardel-bound is often followed by the passage of liquid feces without materially altering the condition of the third stomach. You should not have tried to check purgation. Treatment consists in administering a purgative of one to two pounds Epsom salts, and about an ounce of ginger. It is good practice to add one ounce aloes, as aloes has a special action upon the third stomach. This should be followed by two-dram doses nux vomica three times daily. If the bowels do not act well in 24 hours, give a pint of raw linseed oil, and, if necessary, give this every day. If after about two days constipation continues, repeat the Epsom salts and ginger. In the meantime nourishment should be given by administering a drench—a few bottles full of boiled flaxseed three or four times daily. This treatment has given me the best results, but frequently is not successful. Fardel-bound will not occur as a primary affection if the food be of good quality. But where it occurs as a sequel to disease of some digestive organ, it cannot be averted or cured unless the primary disease be diagnosed and successfully treated before it has reached an advanced stage. J. H. REED, V. S.

**PARALYSIS IN SOW.**

About a week ago I noticed my sow staggering with her hind legs. She gradually got worse until she lost the use of them entirely. I gave her a dose of saltpetre without result. She has been running in the barnyard and been fed on corn, with water to drink. J. W. C.

Essex Co., Ont.

Ans.—Your sow has either paralysis caused by digestive derangement (probably due to feeding entirely on corn), else she has rheumatism caused by sleeping in heated manure and then being exposed to cold. Change her food entirely. Give raw roots, bran, and a little shorts. Purge her by giving from 4 to 12 ounces Epsom salts, according to size. Give  $\frac{1}{2}$  dram powdered nux vomica three times daily. Take her to a comfortable, dry pen and keep her well bedded.

J. H. REED, V. S.

**WORMS IN HORSE.**

A five-year-old horse passes fine, small worms, and also some 10 or 12 inches long. I cannot keep him in good condition. He scratches one hind leg with the other. C. N.

Lambton Co., Ont.

Ans.—Get the following prescription: Powdered sulphate of iron, powdered sulphate of copper, tartar emetic, and calomel, of each 1½ ozs.; mix well and divide into 12 powders. Give one every night and morning. Feed nothing for 12 hours after giving the last, and then give a purgative of 8 drs. Barbadoes aloes and 2 drs. ginger. Give nothing to eat but a little bran until purgation commences. He may work until he receives the purgative, but must have three days' rest then. J. H. REED, V. S.

**CONTUSED WOUNDS—RINGWORM.**

A mare got in the manger and bruised herself badly. It has broken out in places and leaves a raw hole in the flesh. After it has finished running, what should I do to heal it up?

Also, please give treatment for ringworm in calves. E. H. S.

Ans.—Keep the parts clean by bathing with warm water three times daily, and after bathing dress with carbolic acid 1 part, water 40 parts. Inject a little of the lotion into the holes mentioned. Continue this treatment until the parts are well healed.

2. Remove all scales and scurf by washing with warm water and soap, and apply tincture of iodine once daily for three or four applications. J. H. REED, V. S.

**BLACK QUARTER.**

We have been losing calves by sudden death for two years. About the beginning of October they get stiff and sometimes lame; seem very sick and die in about twelve hours. They have a slight bloody discharge from the rectum after death, and the under part of the body near the hind limbs turns dark. Our local veterinarian called it anthrax. The land is high and dry. Many in this district have calves in the same way. S. T.

Victoria Co., Ont.

Ans.—Your calves die from black quarter, or symptomatic black quarter. If seen in the very early stages of the disease, the administration of 1½ drs. iodide of potassium every four hours for three doses will sometimes effect a cure. Inoculation with blackleg vaccine, which can be procured from Parke, Davis & Co., Detroit, Mich., will render the cattle immune. The only other preventive is removal from affected pastures and feeding on fodder free from the virus. J. H. REED, V. S.

**DISLOCATION OF PATELLA.**

A three-year-old filly becomes helpless by spells on left hind leg. She has no power at all. Her leg is stretched backwards, drawing the foot on the ground, showing the sole from behind. It gets all right after awhile. E. S.

Wellington Co., Ont.

Ans.—The patella (stifle bone) becomes dislocated, and, as a consequence, the filly has no power in the affected limb. This condition occasionally occurs and will rectify itself. Put her in a roomy box stall with a level floor, and keep her well bedded, so that she will not slip when lying down or rising. Blister the front and inside of the stifle joint in the usual way once every month for three applications.

J. H. REED, V. S.

**ECZEMA IN COLT.**

A yearling colt bites his legs. He has been doing so for about two months. He is in first-class condition. Has been fed on hay, bran and chop all winter, but for some weeks has been fed nothing but bran and carrots. Our veterinarian treated him for worms, and he voided a few. Stanstead Co., Que.

SUBSCRIBER.

Ans.—Your colt has a skin disease, to which horses of the heavier breeds are especially liable, and it is occasionally noticed in the light breeds. Give him a purgative of about 4 drs. aloes and 1 dr. ginger. After his bowels regain their normal condition, give him  $\frac{1}{2}$  oz. Fowler's solution of arsenic in his bran twice daily. Dress the legs (being sure that the dressing reaches the skin) well once or twice daily with corrosive sublimate 1 part, water 1,000 parts. J. H. REED, V. S.

**INFLAMMATION OF THIRD STOMACH.**

Two-year-old heifer due to calve in May took suddenly ill; stamped and struck at her belly with her hind feet; would lie down and get up again; vet. said it was colic; gave her treatment, including a pint of raw linseed oil; after a few hours pain gradually subsided; physic did not operate; some pain still continuing, but not very severe; he gave her another pint of oil in about thirty hours, also some powders, to be taken at intervals; that dose did not physic; pain nearly, or quite, all gone; pulse all right; respiration the same; eyes bright and normal in appearance; voided urine several times while sick, also two or three lots (about a single handful) of a black, tarry substance, with a bad odor; blackness appeared to be caused by blood; fifth day had several passages from the bowels; not more lax than when on grass; frequently worked her tongue as though trying to spit something out of her mouth; would grind her teeth occasionally, but not very much; a small quantity of liquid came from her mouth once or twice, and that had a very bad odor; in five days she died; had not eaten anything and drank only three or four quarts during the five days; listless, but would coax to be petted; died without a struggle; the vet. and myself opened her; found a small spot of inflammation in one of the small intestines; no mortification, and bowel not closed up; third stomach (manyplies) filled with liquid, and the lining would slip off in the fingers in places; a large quantity of water in the other stomachs as well; she had been watered a few hours before we noticed her ailing; did not drink a very large quantity, and it is pumped from a deep well; vet. said it was inflammation of the third stomach; did not know what had caused it; I asked if the food would cause it, and he said not; feed was hay, cured corn fodder, and a few mangels every day; always appeared well and felt well until the day she took sick. 1st. What was the disease? 2nd. What would cause it? 3rd. Is there any remedy? If so, what is it, and how should she have been treated? J. K. D.

Lanark Co., Ont.

Ans.—1st. Your veterinarian was correct in diagnosing the disease as colic or indigestion, which resulted in inflammation of the stomach. This was proved by the post-mortem.

2nd. A change of food or water, or large quantities of either, will cause such diseases, and often they appear without any well-marked cause, due to an unexplained weakness of the digestive glands and organs.

3rd. The treatment adopted was quite correct. You should not blame your veterinarian if he fail to effect a cure in all cases. In this case he evidently understood the case, and acted intelligently. The post-mortem established the correctness of his diagnosis and treatment. J. H. REED, V. S.

**PHYSIC FOR CATTLE.**

Would a dose like the following be all right or not for a physic for a cattle beast: Epsom salts, 1 pound; brown sugar, half pound; common salt, 2 tablespoonfuls; ginger, 1 tablespoonful; common soda, 1 tablespoonful? If it is possible let me know in April 15th number of "Advocate," and oblige. WILLIAM DIXON. Wellington Co.

Ans.—For a full-grown adult animal, the dose is a good mixture, the other ingredients added tending to promote the action of the salts. For a smaller, younger beast, the quantity of salts should be reduced. Heavy (and repeated) dosing with salts alone is a mistake.

**Miscellaneous.****DEFAULTING DROVER.**

If I sell a batch of hogs to a drover and he pays me some money on them and I agree to take them to a certain shipping station, which I do at his appointed time, and when I get there he is not there and has not left any word for me about the hogs, and I have to bring them home again, can I sell the hogs to someone else and keep the money he paid on them, it not being more than enough to pay me for my trouble, or am I compelled to hold the hogs for him? W. H. B.

Ans.—We think you are not legally in a position to resell, and are obliged to hold the hogs for the drover a reasonable time. But you are entitled to payment forthwith of the balance of price and compensation for taking the hogs home and keeping them since the time fixed for delivery, and if upon demand made for payment the same should be refused or not complied with, it would be in order for you to sue and so compel payment.

**CARROTS FOR COWS.**

Please state, in the "Farmer's Advocate," whether white carrots make as good feed for a milking cow as mangels? SUBSCRIBER.

Ans.—Mangels are regarded as a preferable food for cows, and are much more easily grown and harvested than carrots.



**SOWING RAPE FOR HOGS.**

I have three-quarters of an acre of good, rich soil. I am thinking of sowing it to rape for hog pasture. What is the best variety, and how many hogs can I feed on it with grain? What would be the best kind of grain to feed, and in what way—dry or wet? What would be the best weight of hog to put on for best results? HARRY. Oxford Co., Ont.

Ans.—Dwarf Essex is the only true variety for this purpose. The number of hogs it will pasture will depend on the growth of the crop before commencing to feed it off. It should be allowed to grow 8 or 10 inches high before being pastured, in order to get the most feed off it. This applies especially to pasturing with sheep, which are fond of it. Hogs take to it slowly, and may be turned in while the rape is younger. We should judge that three-quarters of an acre would pasture twenty pigs that were getting other feed. Shorts and ground barley makes a good mixture, and may be fed either dry or wet. Pigs at any weight after weaning will do well on rape, with a light ration of meal as above.

**CURE FOR COLIC.**

I am a farmer and a breeder of horses and cattle, and have handled hundreds of horses, and never lost one with colic. The farmer cannot always have a vet. when the animals take sick. Colic must be seen to at once, as if it turns to spasmodic colic it is a doubtful case. I have brought horses around that have lain on their back against a wall for hours. Here is the cure: Tie the animal by the head in a wide stall. Now kick, with the instep of your foot, the under surface of the belly until your feet are really warm; take the other side and do the same. Be sure and hit with the instep of your foot every time. As soon as you notice the horse passing gas, you have mastered the ailment. I have used this with breeding mares within a short time of foaling. It can be used with cattle as well as horses. Wellington Co., Ont. JAMES H. STONE.

**INFORMATION WANTED RE CIRCULAR BARN BUILDING.**

In a recent issue of your paper there is a plan of a round barn, but the mode of placing the beams and rafters is not made very plain. A barn 75 feet in diameter would call for a rafter nearly 50 feet long, to have a good shingle roof. If the gentleman who gave the plan or any of your other readers would tell of the best mode to stay the upper portion of the rafters in the middle and at the top, I will be very much pleased; also, how the building is stayed at the plate to keep it from spreading; also, how the beams are best put in to lay the floor over the basement—if they radiate from the center, how are they supported in the middle? I believe the round barn the most economical if the above difficulties are disposed of. Shall await answers, as I feel very much interested. J. K. DARLING.

Ans.—Will some reader kindly supply the desired information?—Editor.

**CORN LITERATURE—CHESTER WHITE HOGS—DRIED BLOOD FOR CALVES—CORN RATIONS.**

1. Can you give me the address of some State Experimental Farm or College in the U. S. corn belt, as I would like to get their report on the different varieties of corn? 2. Last summer I saw in the "Advocate" that dried blood was good to stop scours in calves. Can you tell me in which issue it was? 3. Please give a short sketch of the origin of the O. I. C. hogs. Are they not a cross of the Chester White and some other breed? 4. I have not seen anything that suits us here for balanced rations where corn fodder and corn is the main crop raised. I am feeding corn, oats and barley, with corn fodder, to my milk cows and young cattle. Essex Co., Ont. NICODEMUS.

Ans.—1. Address Prof. C. F. Curtis, Ames, Iowa, and Prof. E. Davenport, Urbana, Ill., mentioning the "Farmer's Advocate." As a rule, cultivate the varieties of corn that are found to do best in your own locality.

2. July 15th issue, 1901, page 468.

3. In the United States there are five (at least) record associations in the interests of pure-bred Chester White swine, viz., the American Chester White Record Association, the National, the International, the Standard, and the Ohio Improved, the latter being the one to which our correspondent refers. Chester Whites, tracing to U. S. records in good standing, are also recorded in the Dominion Swine Breeders' Record. They are one of the oldest of American breeds. The foundation stock were large white hogs in Chester Co., Pennsylvania, which no doubt originally came from England. Their improvement seems to date from the importation of some white pigs from Bedford, Eng., by Capt. James Jeffries, of Westchester, Pa., from which they have been steadily improved and widely spread through the Northern, Middle and Eastern States, and Canada.

4. As a fattening ration corn is unexcelled, but is lacking in protein. Oats and wheat bran are good additions to corn meal and clover hay with corn fodder, these being richer in protein, which is a muscle-forming food.

**REPAIRING A SILO.**

My silo needs to be repaired at considerable expense, or else a new one built. I have been thinking about lining the old one with galvanized iron, which will not cost nearly so much as a new one. Through your valuable paper, would you please answer the following questions: 1. Would the acids in the ensilage be apt to eat through the galvanized iron? 2. If so, would painting prevent it? 3. How long would the paint last? 4. Would the paint be injurious to the ensilage, or cattle it is fed to, as I have heard it said that cattle have been poisoned by licking paint from painted doors? Middlesex Co., Ont. SUBSCRIBER.

Ans.—1. Yes, by softening the zinc coating of the galvanized iron.

2 and 3. Painting would be a benefit, but probably not permanent. A coating of "water glass" (sodium silicate) might be beneficial, or of paraffine wax melted and applied with a brush, but they would only be temporary at best.

4. Unless it were a paint containing much white lead or a green paint, it would not prove injurious to the stock, and, in any case, the chances are that the cattle would probably not get enough of it to do any harm.

To line a silo say 12 x 12 feet square and 25 feet deep with galvanized iron, would cost for material (not including nails, for it could not be soldered) about \$45, and if the present wooden structure is decaying, we question if it would prove satisfactory even temporarily.

**TAMWORTH ORIGIN—A READER FOR 35 YEARS.**

What is the origin of the Tamworth hog? Are they a distinct breed, or are they bred by crossing?

I believe I am one of your oldest subscribers, having taken the "Advocate" for 35 years without a break, and can truly say it gets better every year. R. ROBINSON. Welland Co., Ont.

Ans.—The Tamworths take their name from Tamworth, in South Staffordshire, England, where they have been extensively bred, and in adjacent counties, such as Leicestershire and Northamptonshire, as far back as the early part of the past century. Somewhat rough, though hardy, they were improved by infusions of Neapolitan blood, and about 20 years ago, when the bacon type form started, they were pushed to the front by enterprising English breeders, and were given separate classes at the Royal Show. They are certainly entitled to be described as a distinct breed, which is also apparent from their impressive character in crossing.

**FACTS ABOUT SPELT—BARNYARD MANURE IN SUMMER—MANURING SPRING GRAIN.**

With regard to the question of the York County farmer, asking as to how best to keep his barnyard manure over summer: by leaving it in the barnyard, drawing it out into a large pile in which to keep it till fall, I would suggest that if he cannot conveniently place barnyard manure in a fresh condition on the land, the best practice is to have a covered yard in which young cattle and pigs can tread the manure thoroughly so as to make it very compact. In this way it is prevented from heating violently, and the waste is much less.

In regard to the enquiry of one of your subscribers in Nipissing, Mr. J. A. Shiels, as to the best manner of cultivating spelt, how much seed should be sown per acre, and where the seed can be secured, I would say that spelt does not require any different cultivation from that needed by ordinary wheat. If the spelt used is clean from the chaff, the quantity required per acre would be about the same as with spring wheat, namely, 1½ bushels; but if the grain be still in the chaff, the quantity to be used should be two bushels per acre. Spelt wheat for seed can now be had from most of the large seed dealers. There is a consideration in connection with the growing of spelt which has been usually overlooked when the crops from this grain have been referred to—that is, the proportion of chaff in this variety of wheat. When comparing spelt with other wheat crops, it should be borne in mind that the chaff forms about 23 per cent. of the weight of the crop, and in making such comparisons with ordinary wheat, the crop of spelt should, therefore, be reduced to the extent of nearly one-fourth of the whole in order to reach correct conclusions. Some growers, when comparing the productiveness of spelt with that of other sorts of wheat, have taken the measured bushel of spelt as the basis of comparison. The measured bushel of wheat of standard quality weighs 60 pounds; that of spelt as usually threshed weighs from 40 to 46 pounds. To make a fair comparison between such varieties, the same weight should be taken in each case and 23 per cent. deducted from the spelt for the chaff. On such a basis, which is the only fair and just one, some of the phenomenal yields reported in connection with spelt would be greatly reduced.

In reply to your Middlesex reader, who you say asks if I would recommend manuring heavily in spring or winter for a grain crop such as barley, oats or peas, I beg to say that I would not

recommend a heavy dressing of barnyard manure for a grain crop to be followed by roots, as the crop would be almost sure to be weedy, especially if the manure were used in a fresh condition. It would be far better to use the manure for a root or corn crop. WM. SAUNDERS, Central Experimental Farm, Director.

**VENTILATING A STABLE.**

Would you describe for me, through your valuable paper, plans for ventilation of a stone stable, which is very damp. The ceiling and west side get very wet. Some readers of the "Farmer's Advocate" will no doubt have had similar experience. The stable is 40x60 feet, as per diagram enclosed, with 7-foot ceiling, and cement floors, except in box stall. N. GREENIANS. Peel Co.

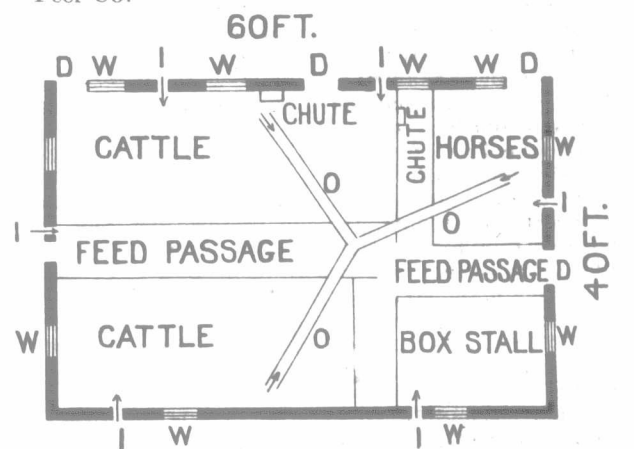

Ans.—First, to provide inlets at the points I, or thereabouts, shown in Fig. 1, the style of inlet being shown in Fig. 2. Each inlet begins near the base of the wall, runs through the wall from the outside, then up to the top of the wall inside, where the air is admitted into the stable. The box should be about 8x8 inches, or about 64 square inches, and should be made of thin lumber or galvanized iron.

For outlets, shown in Figs. 1 and 3, a straight pipe or box from the ceiling up through the roof is required. At the ceiling of the stable branches run in three directions to different parts of the

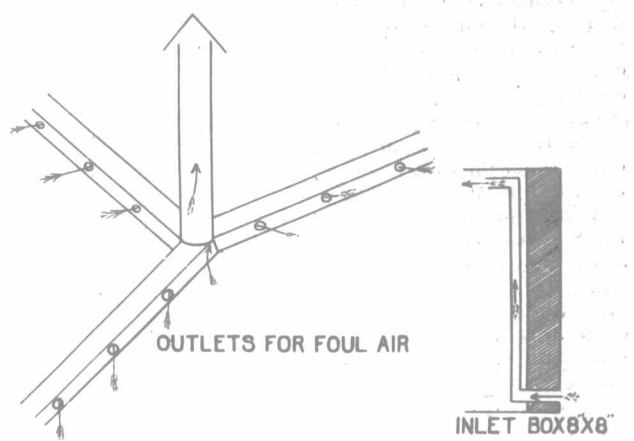

stable, these branches being provided with small openings at intervals for the purpose of drawing in foul air and moisture from all parts of the stable.

As we do not know exactly the interior arrangements of the stable or the barn above, we cannot give exactly the best placing of the inlets and outlets. The owner must depend on his judgment for that, placing these inlet and outlet boxes where they will do most good, and where they will be out of the way. J. B. REYNOLDS. Ontario Agricultural College.

**ENSILAGE AND COWS' TEETH.**

Having heard that silage is injurious to cows' teeth if fed to them for a number of years, I would be pleased to hear, through your valuable paper, if such is the case? Grey Co., Ont. DONALD McNIVAN.

Ans.—Some of our staff have been feeding ensilage for ten years, and have noted no ill effects of that kind, but we have frequently heard the objection raised. Among animals (as among men) there are doubtless differences in the natural preservative or resisting powers of teeth to the action of the acids in silage, lactic, we understand, being more prejudicial than acetic acid. The danger is more speculative than real, else more would have been heard of teeth troubles during all these years in which ensilage has been fed to thousands of herds of cattle.

**A WORK ON POULTRY.**

Kindly advise me as to the best book on poultry for a beginner? We have been taking the "Advocate" for a number of years, but mother has given all the back numbers away. HUMPHREY LOCKHART. Westmoreland Co., N. B.

Ans.—"Farm Poultry," by Watson, would probably suit your purpose best. Price, \$1.25. Order through this office.



## PRESERVING EGGS.

1. Will you kindly furnish me with a formula for pickling eggs? I am in the baking business and I would like to pickle my own eggs, if you think I can do it successfully. 2. What is the best kind of tubs, vats or barrels to use?  
York Co., Ont.

E. FRENCH.

Ans.—1. If good, freshly-burnt lime can be obtained, as much as two to three pounds to five gallons of water is used, though with such lime as is here referred to, one could rest assured that one pound to five gallons (50 pounds) would be ample, and that the resulting limewater would be thoroughly saturated. The method of preparation is to slake the lime with a small quantity of water, and then stir the milk of lime so formed into the five gallons of water. After the mixture has been kept well stirred for a few hours, it is allowed to settle. The liquid, which is now "saturated" limewater, is drawn off and poured over the eggs previously placed in a water-tight vessel. As exposure to the air tends to precipitate lime (as carbonate), the vessel containing the eggs should be kept covered. The air may be excluded by a covering of sweet oil or by sacking on which a paste of lime is spread. If after a time there is any noticeable precipitation of the lime, the limewater should be drawn or siphoned off and replaced with a further quantity newly prepared. Prof. F. T. Shutt, who made a special enquiry into the subject, says: "It is essential to notice the following points: 1. That perfectly fresh eggs be used. 2. That the eggs should, throughout the whole period of preservation, be completely immersed. Although not necessary to the preservation of the eggs in a sound condition, a temperature of 40° to 45° F. will no doubt materially assist towards maintaining good flavor, or, rather, in arresting the stale flavor so characteristic of packed eggs. Respecting the addition of salt, it must be stated that our experiments, conducted now throughout three seasons, do not show any benefit to be derived therefrom; indeed, salt appears to impart a limy flavor to the egg, probably by inducing an interchange of the fluids within and without the egg. Water glass (sodium silicate) has been extensively used, with solutions varying from 2 per cent. to 10 per cent. Although in the main the results have been fairly satisfactory, we are of the opinion that limewater is fully its equal, if not its superior, as a preservative; and that this latter preservative is both cheaper and pleasanter to use, there can be no doubt."

2. The size of the vessel or tank will depend upon the number of eggs to be preserved. An exporter who last year stored, treated and shipped 500,000 dozens of eggs to the English market, recommends a tank not more than 4½ feet deep in the cellar, made of brick and cement mortar, and plastered inside and out (with cemented bottom) to prevent leakage. The eggs are placed in this and the liquid poured on. A tank made of cement concrete, carefully constructed, would answer the same purpose. Put on a cover. If only a few eggs are to be stored, a good tub or barrel would, we presume, answer the same purpose.

## LINE FENCE DIFFICULTY.

1. A few years ago I built a straight-rail fence in place of the old snake fence between myself and my neighbor. As my neighbor's part was in bad repair, and his live stock keeps troubling me, I notified him to build his part or make it lawful. He refused to do so, and said that my part was several feet over the line on him, and if I made him build his part he would make me move mine. When building my fence there were considerable trees in its path, some of which we used for posts by wiring fence to them, and also to avoid cutting down too many. We went a little over the line on both sides, but in no case did we go further out on my neighbor than the old snake fence was. By building the fence on this plan we put several rods of it from a few inches to 1½ feet over on my neighbor, and vice versa. 1. Assuming that my neighbor will be as contrary as possible, can he compel me to move those few rods of fence off him? 2. Does the fact that said neighbor said nothing about it for several years make any difference? I do not reside on this farm, and this fact makes me more anxious to have the line fences in good repair.

Ans.—1. Yes. 2. No.

## KEEPING VICIOUS DOGS.

1. What can be done to a man who keeps a vicious dog and will not try to keep him off the road? He has bitten three people already. 2. Can I shoot him on the road when he comes out to tear me down?  
G.

Ans.—He could be sued for damages by the injured parties, and may also be prosecuted under municipal by-law, assuming that, as is probably the case, there is a by-law of the municipality providing for the case. 2. Yes.

## CATTLE ON ROAD.

Are persons allowed to herd cattle along your side of the road if you object, when there is no township by-law to prevent it?

Ans.—Apparently it cannot be prevented.

## REMOVAL OF MANURE.

I have one hundred and fifty acres of land. I have rented one hundred of it, and hold the other fifty. I had a sale last November. The barn was full of oat straw, so I bought up cattle through the winter and fed the straw. I want to draw 25 loads of manure to the fifty that I work yet, for roots, and there are about one hundred loads. I have for five years been drawing all from the fifty to the hundred. Can he stop me from taking it before he gets possession?

Ans.—No.

## COST OF REGISTERING CATTLE.

A advertises an auction sale of pure-bred Shorthorn cattle. B attends sale and buys two calves, paying fancy price for them. After sale B settles with A for calves, and demands register papers. A says he has not registered them yet, but for B to name them and he would register them at once. In course of time registers came to hand, also a bill of \$2.64 for registration papers and postage. Now, has B a right to pay this bill to A or not?  
FARMER.

Hants Co., N. S.

Ans.—We think so.

## PROPERTY IN SWARMS OF BEES.

A (a beekeeper) and B live on adjoining lots. A's bees swarm and cluster on B's shrub or tree. He is forbidden to come on the property for them. Can A get the swarm without being liable for trespass and damages, or must he lose his bees?  
FRED M.

Ans.—A is entitled to take possession of the swarm and to go upon B's lands for the purpose, but must notify B beforehand and compensate him for all damages. In so doing, A would not be rendering himself liable as for trespass.

## PRUNING—RAPE FOR COWS

I have an old orchard that has not been pruned for quite a number of years. When would be the best time to prune it, now or in June? 2. Does rape sown with spring grain make good fall pasture for milking cows?  
Frontenac Co., Ont.

THOS. I. ELLIS.

Ans.—1. In June. Dead limbs can be readily seen then, and the wounds will heal more readily. 2. No, owing to the vile odor which it imparts to the milk; but it is all right for other cattle or sheep.

## PERMANENT PASTURE.

Kindly give, in your April number, what quantity and variety of seed per acre should be sown for permanent pasture?  
SUBSCRIBER.

Perth Co., Ont.

Ans.—An Ontario County reader, who has had a good deal of successful experience with permanent pastures, recommends the following mixture: Three pounds timothy, 4 pounds Kentucky blue grass, 2 pounds white clover, 2 pounds alsike and 5 pounds orchard grass. If soil were wet, he would sow a little red-top also.

## NUTRITIVE RATIOS.

What is supposed to be the nutritive ratio of a properly-balanced ration for feeding to cows for milk; also for feeding for beef?  
J. D. Quebec.

Ans.—For milking cows, a good nutritive ratio, according to the Wolf-Lehmann standards, is 1:5.7; and for fattening cattle, 1:6.5; but successful feeders in practice do not rigidly adhere to these standards.

## COAL ASHES AS A FERTILIZER.

I wish to learn, through the "Advocate," if coal ashes are useful as a fertilizer?  
SUBSCRIBER.

Ans.—No; but they may benefit the mechanical condition of heavy clay soils. See April 1st issue, page 263.

## TWO-HORSE TREAD POWER.

Please let me know the price of a two-horse tread power?  
S. McCLINTON.

Simcoe Co., Ont.

Ans.—A postal card to the Thom Implement Works, Watford, Ont., will give the desired information.

## BRICK PIG-HOUSES.

Have any readers of the "Advocate" had any experience with brick pig-houses? How do they compare with wooden or scantling frame, from a sanitary point of view?  
SUBSCRIBER.

Bruce Co., Ont.

## CLOVER SEEDING TO PLOW DOWN FOR CORN.

I have a piece of blue-grass sod, from which I have taken two crops of hay. Plowed it last fall. Could I seed it down, by sowing oats this spring and clover seed, and get a crop of clover to plow under next spring for corn? My soil is in fair condition, and is a gravelly loam.  
Lincoln Co., Ont.

SUBSCRIBER.

Ans.—Securing a catch of clover with oats on sod plowed down last fall will be somewhat uncertain, owing to the probability that the oats will grow rankly and be liable to smother the clover plants. If a fair catch of clover is secured and left ungrazed in the fall, there might be sufficient growth to be very helpful to the corn crop when plowed in next spring, and if the land is in really good heart, a fair crop of corn may be had, but it would be better if the land were top-dressed with barnyard manure during next winter and spring.

## MARKETS.

Every reader is invited to write something for this department that other farmers ought to know. Do it while you think of it. Put it on a post card if you haven't time to put it in a letter.

## FARM GOSSIP.

## Plant Food.

We hear at times of plant food used in excess—rather, of one or more of the three elements of plant food used in excess. This must prove confusing to some readers, and I shall attempt to make it a little clearer. In the first place, all fertilizers, manures and other materials applied to soils to increase plant growth have been found, when of value, to have certain points of sameness—they all contained nitrogen, potash, and phosphoric acid. Further investigation proved that these three substances are true plant food, and not the great bulk of the material associated with them. For example, a ton of sulphate of potash contains 1,000 pounds of actual potash and 1,000 pounds of sulphur combinations, etc. It is only the 1,000 pounds of actual potash that is useful as plant food, the other 1,000 pounds having no value as such. The actual potash may be separated from this useless material (useless so far as the farmer is concerned), but to do so would greatly add to the cost of the actual potash. As a matter of fact, plants are as able to use the potash in the crude material as if in the refined condition, so that the cost of refining is a needless expense. In like manner, a ton of farmyard manure contains about 10 pounds of nitrogen, 10 pounds of potash and 5 pounds of phosphoric acid. This in all makes 25 pounds of plant food, and the remaining 1,975 pounds of the ton are not plant food at all, but add to the cost of the actual plant food by the expense of handling.

These substances—nitrogen, potash, and phosphoric acid—may not be used out of place—that is, nitrogen cannot do the work of potash, nor potash the work of nitrogen. Phosphoric acid, in like manner, alone can do the work of phosphoric acid. If, to illustrate, a soil contained nitrogen and phosphoric acid sufficient for 30 bushels of wheat per acre, but potash only enough for 5 bushels, the crop would not exceed 5 bushels. This is the very point making clear the meaning of "plant food in excess." In the illustration given, we evidently have five times as much nitrogen and phosphoric acid as we can use, there being no potash to go with it. This nitrogen and phosphoric acid is, therefore, in excess. It is of no value in crop-making, and suffers loss through the seepage (oozing or percolation of fluid or moisture) of winter, when there is little or no surface evaporation to draw materials to the surface.

Using particular plant-food elements in excess means more than the simple loss of these ingredients. Nitrogen in excess tends to favor a growth of immature wood, leaf and stalk; fruiting is shortened and blossoms prove sterile. Winter-killing becomes very severe. An excess of phosphoric acid has the effect of stimulating maturity to an unusual degree, causing a ripening of the crops long before a full growth has been reached. Potash in excess does no particular damage, and also persistently resists losses from leaching. We must, therefore, consider the probabilities of an excess of plant food in every manuring scheme we attempt to work out. Farmyard manure does not of itself contain an excess of any element of plant food, but the nitrogen in such manures becomes available long before the potash and phosphoric acid, which in effect is the same thing as an excess of nitrogen. This is noticed in the common lodging of grain where farmyard manures are used in large quantities, particularly in spring top-dressing wheat.

P. J. CHRISTIAN.

## Taxing Oleomargarine.

At the close of a lively debate in the United States Senate on April 3rd, the Oleomargarine Bill was passed by a vote of 39 to 31.

During the afternoon a perfect flood of telegrams poured into the Senate from all parts of the country, urging senators either to support or to oppose the measure.

The measure, as passed by the Senate, differs in some respects from that passed by the House of Representatives. It provides that oleomargarine and kindred products shall be subject to all the laws and regulations of any State or territory, or the District of Columbia, into which they are transported, whether in original packages or otherwise; that any person who sells oleomargarine and furnishes it for the use of others except to his own family, who shall mix with it any artificial coloration that causes it to look like butter, shall be held to be a manufacturer and shall be subject to the tax provided by existing law; that upon oleomargarine colored so as to resemble butter, a tax of 10 cents a pound shall be levied, but upon oleomargarine not colored, the tax shall be one-fourth of 1 cent per pound.

That upon adulterated butter a tax of 10 cents a pound shall be levied, and upon all process or renovated butter the tax shall be one-fourth of 1 cent per pound. The manufacturers of process, or of renovated, or of adulterated, butter shall pay an annual tax of \$600; the wholesale dealers shall pay a tax of \$480, and the retail dealers a tax of \$48 per annum. The measure provides regulations for the collection of the tax, and prescribes minutely how the various products are to be prepared for market.



**A Canadian Railway Commission.**

Hon. A. G. Blair, Canadian Minister of Railways, has introduced in Parliament, at Ottawa, a bill providing for the abolition of the Railway Committee of the Privy Council, and for the appointment of three commissioners to exercise the functions of that body, a change in accordance with modern requirements. The commissioners are to hold office during good behavior for a period of ten years, are eligible for re-appointment, and are removable only by the Governor-General on the address of both the Senate and House of Commons. The position will be quite as honorable and distinguished as a seat on the Bench, and will command sufficient salary, as well as prestige, to make it desirable to men of ability. The powers of the commission extend to all matters with which the Railway Committee is now authorized to deal. In the matter of rate regulation, these powers are far more extensive than were conferred on the Railway Committee. Freight is divided into three classes. On ordinary traffic, no greater, less or other tolls can be levied than those fixed by the commission, and no change can be made until it has been actually approved by that body. On freight classed by the commission as "commodity," a maximum and minimum toll is to be established. The railway companies will be allowed within these limits to fix a working tariff of charges, as is now customary with all freight, but every such working tariff must be filed with the secretary of the commission, and must remain in force until another within the same limits is filed. The commission has power to revise the working tariff so filed or to alter the maximum or minimum. The third class of traffic is that between competitive points. The commission may thus designate any cities, towns, places or districts in Canada, and permit between them lower rates for a long than for a short haul. The railway companies may make reductions between such points at any time by simply mailing the new schedules to the commission, but increases cannot be made without official approval. With regard to through rates and traffic arrangements, the bill gives the commission power to fix rates and apportion percentages between railway companies. The act provides that the commission may not only determine the reasonableness of rates submitted by the railway companies, but may specify rates, a power which the Interstate Commerce Commission is seeking to obtain in the United States.

The leading principle of the bill is the authority which will be conferred on the commission in supervising all dealings and deciding all disputes between the railways and their patrons. Similar authority is conferred in regard to expropriation, right of way, company organization, and other matters connected with railway construction and operation. In such matters, as well as in regard to unjust discriminations, the leading features of the existing law are retained, with the all-important difference that the machinery has been provided for carrying the law into effect. This legislation is a recognition of the right of the people to control their highways.

**Kent Co., Ont.**

Although we had but a couple of weeks' sleighing during the past winter, the ground was sufficiently covered to protect the fall wheat, and has been remarkable for its magnificent wheeling; cold, even temperature, and entire absence of cold rains. As a consequence, stock have wintered well and look splendid.

Warmer weather set in about the 1st of March, and the roads began to break up. Occasional rains helped matters along, until the middle of March found the frost out of the ground and the roads as bad as it is possible to imagine them. Fall wheat has wintered well, and should the weather continue favorable, the crop should be a good one. The entire absence of freezing and thawing, although favorable to the wheat crop, proved disastrous to the maple-sugar makers, who report an extremely poor year. The prices of farm products still continue high, horses especially in strong demand, farmers themselves being a strong factor in the market. Butchers' cattle are scarce and hard to buy. Beefsteak retailing at 15c. per lb.; all other meats and poultry have advanced in price in sympathy with the above. Eggs brought 20c. per dozen until lately, but suddenly took a slump to 12½c. per dozen; butter remains at 20c. per lb. Other market prices for farm products are: Wheat, 70c.; corn, 58c.; oats, 39c.; barley, per cwt., \$1; beans, 75 to 80 cents; red clover seed, \$4.80 per bushel; alsike, \$8.50; timothy, \$3.50; alfalfa, \$6.50. Baled hay is worth \$6.50 to \$7 per ton; loose hay about 50c. per ton less. Live hogs are \$5.50 per cwt., and the market for dressed ones is just about closed.

The prospects for fruit are excellent at present. Our annual sleet storm we have missed entirely, and should we be blessed with the absence of late frosts, a splendid fruit crop is assured. W. A. MCGEACHY.

**Strathroy Dairy School.**

Following is the list in order of merit of the successful students at the closing examinations of the Western Dairy School, at Strathroy, Ont.: David A. James, H. Goodhand, Jas. R. Burgess, Wm. D. Cousley, Robert Smith, T. H. McCormick, Fred Pratt, Thos. W. Tate, Fred A. Heilor, R. M. Durrant, R. A. Riesberry, Jas. Ross, Alex. Duff, H. J. Jeavons, W. A. Pickell, B. B. Crawford, Frank A. Smith, W. J. Shannon, J. F. Davis, J. D. Reynolds, Wm. Stewart, Lawrence Lorce, James Stewart, A. L. Graham, Arthur Cox.

**Guelph Dairy School Graduates.**

During the winter terms of the Dairy School at the College, 103 students have registered for the dairy courses, and 96 for the course in domestic science in connection with the School, making a total of 199 registered, besides a large number who were present for a short time or took some of the domestic science lectures, but did not register. The term closed on March 27th, with an "At Home" in the dairy building, given by the instructors to the students and their friends. Quite a number have signified their intention of coming back for a second term. Students who have a limited education find the work, which is crowded into three months, rather heavy, and it is a question whether it would not be advisable to extend the course to two terms instead of one, as at present. This would allow more time for advanced work. It is proposed next year to divide the class in cheesemaking into experienced and non-experienced men at the beginning of the term. Those who are able to take up advanced work in cheesemaking, dairy chemistry and dairy bacteriology, will find provision for such work, instead of having to take up elementary work along with experienced men. If this arrangement proves satisfactory in the cheese room, the principle will be extended to other branches of the School, and, if necessary, the term will be extended. A dairy school should meet the needs of a rapidly-growing dairy industry, and be able to furnish the strong meat of advanced work to those who have passed the milk-experience stage. The following are the results of the examinations:

**PASSED IN ALL SUBJECTS AND RANKED ACCORDING TO STANDING IN GENERAL PROFICIENCY.**

Factory Class.—1, J. F. Singleton, Newboro, Leeds, Ont.; 2, H. W. Parry, Compton, Quebec; 3, V. Hooper, Tyrone, Durham, Ont.; 4, W. Macdougall, Truro, Nova Scotia; 5, J. H. Brown, Unionville, York, Ont.; 6, J. D. Malcolm, Sheffield, Wentworth, Ont.; 7, J. R. Henderson, Cheltenham, Peel, Ont.; 8, H. E. Allen, New Durham, Brant, Ont.; 9, D. Bustamante, Jujuy, Argentine Republic; 10, R. N. Mitchell, Lennoxville, Quebec; 11, Miss G. Carter, Guelph, Wellington, Ont.; 12, G. S. Dobbie, Guelph, Wellington, Ont.; 13, J. H. Thomson, River View, Grey, Ont.; 14, Miss E. M. Hewson, Mayfield, Peel, Ont.; 15, J. E. Campbell, Linden Valley, Victoria, Ont.; 16, P. Rivara, Buenos Ayres, Argentine Republic; 17, S. Echeagaray, Santiago, Del Estero, Argentine Republic; 18, J. Weir, Hamilton, Wentworth, Ont.; 19, F. W. Culbertson, Benson, Vermont, U. S. A.; 20, Miss M. Hunter, Rockton, Wentworth, Ont.; 21, L. Winder, Guelph, Wellington, Ont.; 22, D. J. Dwyer, Norwich, Oxford, Ont.; 23, C. A. Metcalf, Red Wing, Grey, Ont.; 24, C. Ball, Guysboro, Norfolk, Ont.; 25, D. Strachan, Jamestown, Huron, Ont.; 26, W. B. Dinwoodie, Lyons, Middlesex, Ont.; 27, G. A. Miller, Castleton, Northumberland, Ont.

**GENERAL PROFICIENCY LIST IN SPECIAL COURSES.** Buttermaking—1, C. VanBlaricom, Belleville, Hastings, Ont.; 2, J. F. Cowell, Fruitland, Wentworth, Ont.; 3, G. Witter, Listowell, Perth, Ont.

Farm Dairy.—1, Miss G. McGill, Eramosa, Wellington, Ont.; 2, Miss J. Evans, Guelph, Wellington, Ont.; 3, H. M. Johnston, Islington, York, Ont.; 4, Miss M. S. Mortimer, Guelph, Wellington, Ont.; 5, Miss J. Glendinning, Manilla, Ontario, Ont.; 6, A. C. Calder, Lancaster, Glengarry, Ont.; 7, Miss R. McCreary, Rosemont, Simcoe, Ont.; 8, Miss K. Wolfe, Hespeler, Waterloo, Ont.; 9, Miss F. Hudson, Guelph, Wellington, Ont.

**Origin of the Experimental Union.**

Thinking many persons interested in the co-operative work of the Experimental Union would be pleased to know the truth concerning the origin and time of commencement, I contribute the following, knowing how it was first organized and for what purpose.

The Union was organized by the O. A. C. class of '78, the second-year class graduating that year. At the writer's suggestion, a meeting was called for the purpose of discussion and organization; quite well aware at that time that we were planting seed in fertile soil, and that the possibilities were favorable to growth. The organization of this Union was not an accident or simply boys' play—it was clearly discerned the good possible to accomplish. The fact, too, was taken into consideration that experience and experiment was the shortest road to practical agricultural knowledge. We soon after elected our officers and appointed a committee to draw up a constitution, which was done satisfactorily. The constitution, to my knowledge, has not been much changed to this date. The name is the same that we gave it, after considerable discussion, at that time. Our object was to plant it upon a broad, liberal basis, and membership was offered to all officers of the college and young men of the first year as well as the second, and we are glad to see its usefulness has been extended to any Ontario farmer choosing to comply with the conditions required by the Union. LEWIS TOOLE.

**Better Than Represented.**

F. W. Abbott, King's Co., N. S.: "Many thanks for the premium 'farmer's knife' received some time ago. It is a treat to get such a good piece of steel in this country, and, like all the other 'Advocate' premiums, it is first-class, and, if anything, better than represented."

**The Horse Show a Success.**

The annual Canadian Horse Show, held at Toronto last week, was a decided success, notwithstanding the weather was not specially favorable, the character of the exhibits of horses being well up to a high standard, and perhaps better on the whole than at any of the previous shows, while the attendance of city people was quite as large as usual, the afternoon and evening sessions being exceedingly well patronized. The attendance of farmers was not increased to the extent that was hoped for in response to the earlier date chosen, but the display of stallions in both the heavy and light classes was distinctly larger and of better quality than in former years. Thoroughbreds were not strongly represented, but in the classes for Standard-breds, carriage horses, Clydesdales and Shires, it was decidedly the best spring show seen here in the last ten years or more, while the saddle and harness classes were simply grand, showing a very marked improvement over those of former years.

In the class for mature Thoroughbred stallions, Mr. Wm. Hendrie's Versatile, in his 14-year-old form, was accorded first place, and he was also the championship winner. In Hackney stallions, Mr. Robert Beith's Alarm, a handsome and typical brown 5-year-old son of Wildfire, and recently imported from the Chestnut Hill stud of Mr. Mitchell Harrison, of Pennsylvania, was first in his class and the sweepstakes winner. Mr. Beith had also the sweepstakes female in the brown 4-year-old Hernia, by Royal Standard. Mr. H. G. Boag, Churchill, carried off the first prize in mature Clydesdale stallions with Lyon Stewart, a substantial bay 4-year-old, bred from imported sire and dam. The first-prize 3-year-old Clydesdale stallion, Strathcona, shown by Mr. J. M. Gardhouse, Highfield, was a popular winner of the championship of the class, combining sufficient size with high-class quality. He has since been sold to Wilkinson Bros. & Fyfe, Palmerston, Ont. The sweepstakes Clydesdale mare was Moss Rose 2nd, by Macqueen, shown by Graham Bros., Claremont. The first place in mature Shire stallions, and the sweepstakes of the class, was given to imported Blaisdon William, a magnificent bay 6-year-old son of Hitchin Conqueror, shown by Berry & Geiger, of Hensall, and the first-prize 3-year-old stallion was imported Newnham Duke, an exceptionally good horse, owned and exhibited by J. M. Gardhouse, Highfield. The first prize for mature carriage or coach stallion, not less than 16 hands, went to Performer, by Phenomena, shown by W. N. Scott, Milton, and second to J. L. Reid's (Derry West) Lord Roberts, by Wiley Buckles. An extended report of the show will appear in our next issue.

**Middlesex Co., Ont.**

Two weeks ago we had exceedingly fine weather, and a number commenced seeding, some putting in as much as 25 and 30 acres, mostly oats, but since then we had, and are having, typical March weather.

Wheat, although small in acreage, looked fairly well, and if we have good weather from now out, will be a fairly good crop.

Clover has stood the winter well. Choice export cattle are selling well, from \$5.35 to \$5.75, some extra choice for middle and last of May delivery selling for \$6, but only a few at this price.

Hired help is very scarce; good men getting all the way from \$20 to \$26 and board and washing for seven and eight months, and hard to get at that, as a great many have gone to the lakes for the summer.

There have been a number of auction sales in this locality, and prices of live stock have ruled high, cows supposed to be in calf selling from \$48 to \$53; yearlings, \$24 to \$28.

Horses are scarce and prices rule high, several two-year-old colts selling at \$125 and \$130—just ordinary Clyde crosses. J. M. B.

**Want Canadian Eggs.**

Buffalo, N. Y., April 9.—Negotiations have just been completed by Swift & Co., Chicago, meat packers, with the Treasury Department for the establishment here of a bonded warehouse for eggs. One story of the Buffalo Cold Storage Company's warehouse will be used for the purpose. According to the plans of the Chicago firm, it is the intention to buy up eggs in Canada and keep them in bond here until sales can be effected. By this plan the firm, of course, avoids paying duty on the eggs until sales are made. For the privilege, Swift & Co. will have to reimburse a Government inspector at the rate of \$3 a day. This inspector will be appointed by Collector Brendel from the civil service list. Swift & Co. have furnished a bond in the sum of \$15,000, which, being twice the value of the eggs to be stored, means that Canadian eggs with a duty value of \$7,500 may be warehoused here.

**Coming to Canada.**

The McCormick Harvesting Machine Company, of Chicago, are now contemplating the establishment in Toronto of works nearly as large as those of the Massey-Harris Company. They have decided to build a branch in Canada, and the other day their representative had surveys made of two sites in this city. The new move is intended to meet the requirements of their Canadian business, which they state doubled last year. If they decide to come here they will probably locate in the north-west section of the city.—Globe.



## P. E. Island.

This is the earliest spring we have had on the Island for half a century. The snow has been all off the fields for three weeks, and the ice went out of the bays and rivers before the 20th of March. This is four weeks earlier than usual. Plowing will soon commence, as the fields are getting quite firm, but not likely much seeding will be done till after the 20th of April. Clover is not much in evidence on the new meadows. The drouth last summer and fall left it so weak and puny that not much of it has survived the winter. The grass fields look well, and with a favorable season we will expect a good cut of timothy and good pasturage.

Cattle have wintered well, and we hear nothing about shortage of feed. Stall-fed cattle never were so well cleaned up at this time of the year. They have been selling high, and are most all gone out of breeders' hands. There was a very fine display of beef cattle at the Easter market. The heaviest steer weighed 1,990 pounds. There were quite a number weighing from 1,500 to 1,700 pounds. The Easter beef brought a little better than \$5 per hundred, live weight. The best cattle for the market were two heifers shown by Blake Bros.; one a pure-bred Aberdeen Angus, and the other a Hereford-Angus cross. The pair weighed 2,800. They were three-year-olds, and bred by John Richards, Bideford, who has an excellent herd of Aberdeen Angus cattle.

Our Farmers Institutes are going largely into importing seeds this spring. They think to get better quality by ordering from reputable Ontario seedsmen, and also save a little money that the jobbers would get. The Institutes are also purchasing quite a number of pure-bred bulls for the improvement of their stock. Horses are in good demand. Quite a lot of buyers have been here already, and have shipped a lot of good stock at very good prices.

Prices.—Oats have fallen to about 43c.; potatoes worth 30c.; hay, \$10 to \$12; timothy seed, \$4.25; horses, \$100 to \$150; best fat cattle, 5c.; hogs (bacon), 6½c.; butter, 25c.; eggs, 10c.

Our Provincial Government have at last decided not to give any grant for a provincial exhibition this year. They first decided to give \$4,000, but afterwards rescinded the order. The "P. E. Island Exhibition Association," on account of the refusal of a Government grant, have decided to sell their property. This, we consider, is the greatest calamity that could happen to our agricultural interests, as this is the best and most suitable exhibition site in Maritime Canada, and if once broken up, it will be difficult to find as suitable a site again. But we can't blame the company. They have gone to about \$30,000 expense to provide the Province with exhibition grounds, and so far have only realized about one per cent. per annum on their money. We feel that our Government have made a great mistake in not giving this company some encouragement and in denying us, year after year, a provincial exhibition.—Apl. 7. W. S.

## About "Bug Death."

Sir,—I saw in a recent issue of your paper, an article by Mr. Frank T. Shutt, giving the analysis of "Bug Death," from which he concluded that it was of no value in nourishing the plant. He makes the mistake that many scientific men do of thinking that chemical analysis will tell the whole story. Now, the manufacturers of the goods referred to claim that it prevents blight and increases the yield. If it prevents blight (and kills the bugs), it certainly has a chance to increase the yield by allowing the tubers to come to maturity. We have a scientific man here in Maine, who made a very adverse report upon Bug Death, and many believed it, myself among the number, so much so that when last spring Mr. E. A. Rogers, of Brunswick, Me., reported an increased yield by the use of Bug Death, I took occasion to poke fun at him, and when he challenged me to make a trial and report the results, I took him up and conducted a test on a small field that was already planted. One half the field was treated with Bug Death in a dry form. The bugs were very thick, and I applied about 100 pounds per acre. The other half was treated with ashes and Paris green, applied dry. I used more Bug Death than is recommended, but I was confident I was going to beat with the ashes and Paris green half, and I didn't want to give anyone a chance to squeal by saying I didn't use enough of the former. At digging time the Bug Death half was away ahead. The tops held green longer. There was less rot on that half. The total yield was larger. I have not the figures at hand, but I believe the difference in cost of treatment was about \$6 per acre in favor of Paris green, while the difference in yield was 30 bushels in favor of the Bug Death. Since I made this test I have talked with several who have used Bug Death extensively, and they all agree that the best way to use it is in Bordeaux mixture, about 15 pounds per acre each application, and that much better results will be obtained than by using Paris green. I shall try it this year, and I hope many of your readers will do the same and report, as I would give more for one short letter from an old farmer, based on actual experience, than I would for all the theories in existence. RALPH E. GOULD.

Andrascoggin Co., Maine.  
[Note.—We have received a similar letter to the above from E. A. Rogers, a seed-potato grower, of Cumberland Co., Me., who states that while Bug Death costs more to apply than Paris green per acre, it shows a favorable balance by giving a largely-increased yield.—Editor.]

## Ottawa Notes.

At the Experimental Farm, Ottawa, an experiment is being carried on with the work horses for the purpose of ascertaining the feeding value of the different kinds of grain. One lot are being fed ground oats and cut hay, while another lot are being fed two parts of oats to one of barley and cut hay. The third lot are being fed equal parts of barley, oats, and hay. The diet will be changed at the end of each and every month, and a new one substituted. Prof. Grisdale says that the experiment will last about a year.

The Ayrshire cattle that Prof. Grisdale imported last summer have all calved, and are milking remarkably well, giving in the neighborhood of fifty pounds of milk per day. One cow is doing a little better, giving 55 pounds, which tests 4½ per cent. of butter-fat. The Ayrshire heifers are giving about 30 pounds per day, which is considered fairly good.

One of the Large Tamworth sows, crossed with one of the Large Black boars which were imported last fall, has just farrowed. She had a litter of seven, and the officials intend to experiment with them as soon as they are weaned.

Mr. Thos. Bradshaw, who had charge of the feeding experiments in the piggery, under the herdsman, Mr. Brettell, has resigned his position, to accept charge of Mr. P. Clarke's farm at Lake Deschenes.

Dr. Rutherford, Dominion Veterinary Inspector, left for Fort McLeod on Saturday, 5th inst., to attend a meeting of the Western Live Stock Growers' Association. He will also meet Commissioner Perry, of the Northwest Mounted Police, while in the West, to discuss with him the administration of quarantine in the West. The Mounted Police look after this work throughout the Territories.

Mr. J. A. Ruddick, Chief of the Dairy Div. Dept. of Agriculture, has called a meeting of dairy experts and cheese instructors in the Dominion to meet in Ottawa on the 29th and 30th inst. The idea is to discuss prevailing systems of manufacture, and also to arrive at a more uniform method of dairying which may be carried on in the future. It is expected that fully fifty dairymen will be present.

## Portable Net Fence.

A Bruce County subscriber, who is going into sheep-raising, writes for information as to where he could obtain light nets for making portable fences for sheep, such as he has seen used in Yorkshire, England. Possibly some reader can give the information.

## Toronto Markets.

Light deliveries made business brisk at the cattle market. Prices advanced, and prospects still good for all classes of cattle. Export cattle touched \$6.30, the highest price for many years. Prices will likely remain steady, and probably advance in the next year on all classes of live stock. Export cattle, beef cattle, milk cows, and hogs have advanced from ten to fifteen per cent. all round, and those who have followed the advice of the "Farmer's Advocate" must be well satisfied at the efforts put forth on the readers' behalf to obtain exclusive and reliable reports of transactions. Within the last few months the writer has refrained from giving some extreme prices paid for cattle, as they were of exceptionally choice character, and have always been purchased previous to arrival, and were not actual sales on the market. Prices for butchers' cattle firm and unchanged, at recent advances. Sheep and lambs firmer, at quotations. Hogs again advanced to level money, \$6.25 per cwt. Cables report market steady; prices firm, or advanced.

Export Cattle.—Choice, well-bred export cattle were in demand, and worth from \$5.75 to \$6.30 per cwt.; good medium weight, \$5 to \$5.75; light weight, choice quality, \$4.60 to \$4.80. Mr. Geo. Adams, of Tilbury, sold 18 export cattle, 1,400 lbs. average, at \$5.90 per cwt. Mr. I. W. Elliott bought eight loads of export cattle at from \$5.40 to \$5.80 per cwt. Mr. D. O. Leary bought two loads of exporters, 1,220 lbs. average, at \$5.75 per cwt. Mr. W. H. Dean purchased four carloads of best export cattle at from \$5.75 to \$6 per cwt., average 1,250 lbs. each. Messrs. Rennie Bros., Scarborough, sold 7 exporters, 1,295 lbs. average, at \$6 per cwt. These animals were re-sold on the market to Messrs. Brown & Snell for highest price reported for many years, at \$6.30 per cwt. Messrs. Whaley & McDonald sold six carloads of export cattle at from \$5.35 to \$6.30 per cwt. Mr. Jos. Gould shipped 500 cattle. Mr. James Dunn bought from Mr. C. I. Brodie, of Markham, the best load of exporters at \$6.30 per cwt.

Butchers' Cattle.—Best butchers' cattle, weighing from 1,100 to 1,150 lbs., equal in quality to export, met ready sale, and sold at from \$5 to \$5.50 per cwt.; choice picked loads, steers, heifers and fat cows, \$4.60 to \$4.90; loads of medium butchers', \$4.50 to \$4.75; inferior butchers' thin cows, \$3.75 to \$4.25.

Bulls.—Export bulls in good demand; choice, well-bred animals sold at \$4.12½ to \$4.70; light export, \$3.40 to \$3.80. Messrs. Deall & Stone sold two export bulls at \$4.50. Mixed loads of export bulls and cows sold at from \$3.75 to \$4.40 per cwt.

Feeders.—Choice, well-bred steers weighing from 900 to 1,000 lbs. always meet ready sale. Very few on offer. One carload sold at from \$4 to \$4.60 per cwt. Messrs. Corbett & Henders bought one carload of steers at \$4.50 per cwt., average 1,050 lbs.

Stackers.—Choice, well-bred young steers weighing 600 lbs. average sold at \$3.25 to \$3.60; poor quality,

unthrifty Holsteins and mixed colors, \$2.75 to \$3.25.

Calves.—Only moderate supply; good demand for choice veals, at from \$4 to \$6 per cwt., or from \$2 to \$10 per head, according to size and quality. Milk fed and grain rations give veal calves a preference.

Sheep.—Prices rule steady, at from \$3.50 to \$3.75 per cwt. Mr. Westley Dunn bought 100 yearling lambs at \$5.65 per cwt. Twenty sheep sold at \$3.85.

Lambs in good supply. Yearling lambs, \$4.50 to \$4.75; spring lambs, \$2 to \$6 per head. Mr. Wesley Dunn purchased 20 spring lambs at \$3.75 each.

Milk Cows.—Milk cows of very inferior quality sold at from \$20 to \$40 per head. Choice milkers, newly calved, in good request, at from \$45 to \$55 per head. Mr. Jas. Armstrong bought 12 cows and springers at from \$30 to \$50 per head.

Hogs.—Best selected bacon hogs, singers, not above 200 lbs., not below 160 lbs., unfed or watered, sold at \$6.15 per cwt.; light and thick fats, too many offered; are culled at \$6 per cwt.; unculler car lots are worth \$6.10 per cwt. There is a disposition on the part of drovers to force the price of hogs above actual value, and our advice, as given two weeks ago, should be followed: Market hogs as soon as fit, not before, and do not wait for increased prices. Hogs are coming along too heavy, over 200 lbs. These are culled a quarter a hundred every time. The hog market is so erratic that it is difficult to follow. Prices have varied from day to day, and since our last report three changes have been recorded. Prospects are better for a firmer market at an advance. They will go to the quarter next week; that is, \$6.25 per cwt.

	Extreme comparative prices to-day, April 11th.	Two weeks ago.	Same date last year.
Export cattle.....	\$ 6 30	\$ 5 70	\$ 5 00
Butchers' cattle.....	5 50	5 50	4 40
Export bulls.....	4 70	4 50	3 25
Feeders.....	4 60	4 60	4 25
Stackers.....	3 60	3 90	3 25
Sheep (per cwt.).....	3 75	3 75	3 50
Lambs (per cwt.).....	4 75	4 25	5 00
Hogs.....	6 15	6 12½	6 87½
Milk cows.....	55 00	55 00	45 00

## GRAIN AND PRODUCE.

Wheat.—One hundred bushels of white wheat sold at from 72c. to 75c. per bushel. One load of Goose wheat sold at 66c. per bushel; one load of spring wheat at 68c. per bushel.

Oats.—Two loads of oats sold at 47½c. per bushel.

Hay.—Twelve loads of hay sold at from \$12 to \$13.50 per ton for timothy. Four loads of clover sold at from \$8 to \$9 per ton.

Straw.—Two loads of sheaf straw sold at \$8.

Seeds.—No. 1 alsike clover sold at from \$8.50 to \$10.50 per bushel of 60 lbs. Red clover seed sells at from \$5.25 to \$5.75 per bushel. Timothy seed is wanted, and worth from \$7 to \$8.50 per bushel.

Baled Hay.—Best baled hay, in car lots, sold at \$10.25 to \$10.50 per ton.

Straw.—In car lots, at from \$5 to \$5.75.

Dressed Beef.—Beef, fore quarters, cwt., \$5.50; beef, hind quarters, cwt., \$9.

Mutton, carcass, pound, 8c. Veal, carcass, pound, 9½c. Lamb, yearling, pound 9½c.; lamb, spring, each, \$6. Dressed hogs, cwt., \$8.

## Montreal Markets.

Montreal, April 10.—About 350 head of butchers' cattle, 350 calves, 40 sheep and 30 spring lambs offered to-day. Prices were higher than has been paid here for many years past, quality considered, and about ½c. per lb. all round above the very high prices prevailing on previous market. Mr. G. Martel paid 64c. per lb. for four prime steers. Other sales of prime heaves were made at from 5½c. to 6c. per lb.; pretty good cattle sold at from 4½c. to near 5½c., and the common stock, including a large number of milkmen's strippers, brought from 3½c. to 4½c. per lb. Calves sold at from \$1.50 to \$3 each. Sheep sold at from 3½c. to 4c. per lb., and yearlings at from 4½c. to 5c. per lb. Spring lambs sold at from \$2 to \$4.50 each. Fat hogs sold at from 6c. to 6½c. per lb., weighed off the cars.

## Buffalo Markets.

East Buffalo, April 11.—Cattle.—Good demand and higher; good steers, \$6.50; light, half fat to fair, \$4.75 to \$5.75; prime fat heifers, \$5.50 to \$5.90; veals, tops, \$6 to \$6.50; others, \$4 to \$5.75. Hogs active and 5c. to 10c. higher; closing easier for light and strong for heavy. Yorkers, \$7.15 to \$7.25; light, do., \$7 to \$7.10; mixed packers', \$7.25 to \$7.30; choice heavy, \$7.30 to \$7.40. Sheep and lambs—Sheep strong and lambs higher; choice lambs, \$7.15 to \$7.25; good to choice, \$7 to \$7.10; clipped, \$6 to \$6.40; sheep, choice handy wethers, \$6.15 to \$6.35; culls to extra mixed, \$3 to \$6; heavy export ewes, \$5.65 to \$5.85; clipped sheep, \$5.50 to \$5.75.

## Chicago Markets.

Chicago, April 11.—Cattle.—Good to prime steers, \$6.60 to \$7.35; poor to medium, \$4.50 to \$6.50; stockers and feeders, \$2.50 to \$5.25. Hogs mostly 10c. higher; good to choice heavy, \$7.05 to \$7.25; rough heavy, \$6.80 to \$7; light, \$6.80 to \$6.90; bulk of sales, \$6.95 to \$7.10. Sheep steady; good to choice wethers, \$5.25 to \$5.90; western sheep, yearlings, \$4.50 to \$5.90; native lambs, woolled, \$4.75 to \$6.85; Western lambs, \$5.25 to \$6.75.



to \$3.25.  
demand for  
from \$2  
ty. Milk  
erence.  
to \$3.75  
ing lambs  
3.85.  
\$4.50 to  
ad. Mr.  
3.75 each.  
ality sold  
ers newly  
per head.  
springers

not above  
ered, sold  
too many  
l car lots  
sition on  
gs above  
eeks ago,  
s fit, not  
s. Hogs  
These are  
The hog  
o follow.  
since our  
ed. Pros-  
advance.  
that is,

ame date  
last  
year.  
\$ 5 00  
4 40  
3 25  
4 25  
3 25  
3 50  
5 00  
6 87  
45 00

heat sold  
of Goose  
of spring

er bushel.  
n \$12 to  
lover sold

\$8.  
\$8.50 to  
seed sells  
seed is  
shel.

sold at  
5.  
\$5.50 :

s, pound,  
spring.

butchers'  
lambs of-  
been paid  
ered, and  
high prices  
rtel paid  
s of prime  
: pretty  
and the  
milkmen's  
b. Calves  
at from  
4c. to 5c.  
4.50 each.  
eighed off

mand and  
t fair,  
o \$5.90 ;  
to \$5.75.  
ing easier  
\$7.15 to  
packers',  
40. Sheep  
; choice  
to \$7.10;  
wethers,  
3 to \$6 ;  
ed sheep,

me steers.  
to \$6.50 ;  
gs mostly  
to \$7.25 ;  
to \$6.90 ;  
y ; good  
rn sheep,  
wooled,  
5.75.



Something About Women: Here and There.

[No. 1.]

Our happiness or unhappiness, our content or discontent with our lot in life, is more often than not a matter of temperament, a remark, however, which applies to both sexes alike. We find what we look for, mostly, but not always, for in spite of every desire to fit the back to the burden, to bear with philosophy or "sweet reasonableness" disheartening surroundings, in some lots there really is a crook which must remain a crook so long as life lasts. No two lots are ever quite alike, and no one woman can be a fair judge of how her sister woman is making the best or the worst of that state of life in which she has been placed. Amanda cannot see why Mary Jane should not be always in the mood to be singing as she scrubs the floor, or why Sarah Ann who carries her milking pail through the sweet clover meadows should be blind to the beauties of nature and not be able to see in them a compensation for hours of toil, while probably it is just as hard for Mary Jane or Sarah Ann to understand how Amanda can have any grievance whatever when she walks in silk attire and lives, as it were, in the very lap of luxury. But, nevertheless, unknown to one another, each may have a very real thorn in the flesh to test and try the mettle of which she is made.

Perhaps the best human antidote to the habit of introspection, which generally tends to magnify one's woes and worries, is, after having counted up and honestly acknowledged one's own mercies, to look at the many elsewhere of this terrestrial globe, where the lot of millions of our sister women is so incomparably worse than that of any woman in any corner of our own dear land. I do not dare to assert that amongst the readers

sign of advancing civilization. Many of the chieftains sit down to table like more civilized people, one of them actually going so far as to have his wife eat at table with him! It was an unheard-of thing until lately for a big chief's wife to eat in the same house as her lord. Another leading man (ordained) has gone the length of allowing his wife to walk down the street with him, even permitting her to take his arm; but few can muster up courage for this yet."

A writer in "The Contemporary," in discussing the native problem of South Africa, urges that the hope for the native is to induce him to work instead of living lazily while his wives do all the hard labor. In his proposition for "a judicious taxing of the population to make a proportion of labor compulsory," he advocates as a first step towards stopping polygamy and the sale and purchase of women, the imposition of a cumulative tax on every wife after the first.

Amongst the Hindoos, woman is held in complete subjection. Amongst their laws stand the following:

"Woman is unworthy of confidence, and the slave of passion." "One should not eat with his wife." "Whether of bad conduct or debauched, or even devoid of good qualities, a husband must always be served like a god by a good wife." "Day and night should women be kept by the male members of the family in a state of dependence." "It is the nature of women in this world to cause men to sin." A later code declares: "Woman is not to be relied on." Amongst the proverbs of these people, regarding our unhappy sex there, occur these questions and answers:

"What is that poison which appears like nectar? Woman."

"What is the chief gate to hell? Woman."

"What is cruel? The heart of a viper. What is more cruel? The heart of a woman. What is most cruel of all? The heart of a soulless, penniless widow."

"He is a fool who considers his wife as his friend."

"Educating a woman is like putting a knife into the hands of a monkey."

I would just stop here for a moment to take breath, then after thanking God for His many mercies, and without even one backward glance at any real or imaginary crook in our own lot, let us take a peep at some of our sisters amongst the civilized countries of Europe. "The sphere of women in Italy, France, and Germany," says a writer in the New York Churchman, "includes heavy field work, as we'll as all household drudgery. It would make the heart of every American woman ache to see the heavy loads which the poor, overworked old women carried on their backs in the rural districts. The haying in Italy was chiefly done by women. We saw one of them carrying bricks on her back from one end of a yard to the other, and knitting industriously as she walked. The men who were building a house would load and unload her much as if she were an animal. Indeed, both women and animals are sadly overworked in Italy. Surely discontented American women need to come over to Italy to appreciate their own greater advantages."

That there are still some lingering prejudices to be overcome before the native races of our own land quite recognize the place in creation the Great Father has assigned to the "weaker vessels" is somewhat humorously told by a teacher in an Indian school, who, during a flag drill where the partners were a boy and a girl, instructed the latter to go first, the former to follow after her. Oh! the indignity of it! "Do you know, Miss B.," said Isaac Crane, in his solemn way, "you have struck at the root of an Indian national custom?" "How so, Isaac?" "Why, it is the custom for the man to go first, carrying his dignity, and for the woman to follow, carrying everything else."

There are two sides to every question, and, space permitting, I may have something to say in our next issue about the brighter and more hopeful prospects which, thanks to the growing enlightenment of this generation, await the womanhood of the new century. H. A. B.

Her Answer.

I studied my tables over and over, and backward and forward, too; But I couldn't remember six times nine, and I didn't know what to do, Till my sister told me to play with my doll and not to bother my head. "If you call her 'Fifty-four' for awhile you'll learn it by heart," she said. So I took my favorite, Mary Ann (though I thought 'twas a dreadful shame To give such a perfectly lovely child such a perfectly horrid name). And I called her my little "Fifty-four" a hundred times, till I knew The answer of six times nine as well as the answer of two times two. Next day Elizabeth Wigglesworth, who always acts so proud, Said "Six times nine is fifty-two," and I nearly laughed aloud! But I wish I hadn't when teacher said, "Now, Dorothy, tell, if you can," For I thought of my doll, and—sakes alive!—I answered, "Mary Ann!" —By Anna M. Pratt.



GOOD FRIENDS.

of the "Advocate" there are any to whom this little mental discipline may be necessary, but it may not be uninteresting to them to read some of the fragments about those other women which I have gathered together from time to time as a corrective to any attack of the "blues" which may come to any one of us from indigestion, from inherent crankiness, or from that veritable thorn in the flesh which tears it so cruelly.

We will take China to begin with: "There, if a woman murders her husband, she is chopped up into seven pieces and is thrown out without proper burial; but if a husband murders his wife, he is only imprisoned for three months. In China, a wife is never seen by her future master. Some relative bargains for the girl, the stipulated price is paid, and she is afterwards a submissive wife and slave."

"In Turkey, woman is kept in the most rigid seclusion. She must always appear veiled. With pigs and dogs, she is forbidden to enter a mosque, and the Koran declares a woman who is unmarried to be in a state of reprobation."

"Siberian women are raised as abject slaves, untidy in dress, and are bought with money or cattle. The most capricious whim of her husband is law to the Siberian woman, and should he desire a divorce he has only to tear the cap from her head."

"Among the Congo negroes, when a man wishes a wife, he secures one and keeps her on probation a year. If her temper and deportment are satisfactory, he at the end of the year formally marries her, but should she prove an incumbrance he sends her back to the parental roof."

In a report from the Uganda Mission we read: "The status of woman is improving, an invariable

"And, Robin, is it you whose song comes up the hollow?  
Trill upon trill, a song whose meaning I would follow;  
Again, as when a child, full wonderingly I listen,  
While o'er the timid grass the tears of April glisten."

Domestic Science.

HOW TO TREAT A WOUND.—In an emergency, to make a compress for a wound, if nothing better is at hand, clean tissue paper makes an excellent application. It is much to be preferred to a strip torn from clothing or a soiled handkerchief, which may be the only other choice.

FURNITURE POLISH.—A reliable furniture preparation for cleaning picture frames and restoring furniture, especially that somewhat marred or scratched, is a mixture of three parts of linseed oil to one part spirits of turpentine. It not only covers the disfigured surface, but restores wood to its original color, leaving a polish upon the surface. Apply with a woollen cloth, and when dry rub with woollen.

HOW TO STOP NOSEBLEED.—Where nose-bleed is unusually obstinate, refusing to yield to the ordinary remedies, a dernier resort is to plug the nose with a piece of cotton about the size of the first joint of the thumb, around which a bit of thread is tied. Oil the plug, roll to a point on one end and introduce in the nose with a twisting motion until it reaches the point where the bleeding comes from.

TO CLEAN CARPETS.—A method of cleaning carpets which has been pronounced in every way satisfactory is to make a suds of good white soap and hot water, adding enough fuller's earth to secure the consistency of thin cream. Then, after providing a number of clean cloths, a scrubbing brush, a large sponge and a bucket of fresh water, pour some of the cleaning mixture into a bowl, dip the brush into it and brush a small piece of the carpet at a time, washing it with the sponge and cold water and drying with the cloths. When it has all been gone over in this way, let it dry.

TO POLISH WINDOWS.—The best thing for polishing windows is a small hand mop made of scraps of chamois. Pieces no larger than a dollar can be used, and if well worn the mop will work so much the better. String them all together on a piece of strong twine, then tie together in a bunch. When dirty, wash it out, dry, and before using rub it soft between your hands.

CURRIED BEEF, MADRAS STYLE.—Melt in a saucepan two tablespoonfuls of butter, add two onions sliced, and fry until brown; then add two tablespoonfuls of curry powder. Cut the meat in pieces about an inch square, put in the saucepan and add half a cupful of sweet milk. Simmer for thirty minutes. Just before serving add the juice of a lemon. Send to the table on a platter bordered with boiled rice.

CHICKEN HASH ON RICE TOAST.—Chop the cold chicken fine. Have ready some cold boiled rice, which has been pressed in a mould. Cut into slices half an inch thick and toast a delicate brown. Lay the slices on a hot platter, butter them, then cover evenly with the minced chicken, and serve.

DISHES IN MOULDS.—To remove any dish from a mould when cold, wrap a hot cloth about the outside of the mould for a minute or two. To remove a hot dish, wrap a cold cloth about it.

ARTICLES OF FOOD THAT ARE DAMP or juicy should never be left in ordinary paper. Paper is made of wood-pulp, rags, glue, lime and similar substances, with acids and chemicals intermixed, and when damp is unfit to touch things that are to be eaten.

FOR GREASY DISHES.—A little soda in water for greasy dishes is a great help, and a bit of blue in the water in which glass is washed adds much to its brilliancy. Glass cloths must be free from all fluff.

DEVONSHIRE CREAM.—A subscriber has asked us to publish a good recipe for Devonshire cream. Here is an excellent one, given by a lady who is famous for the way in which she prepares this dainty: Use milk fresh from the cow; set the pan away in a cool place for 24 hours; then, taking care not to disturb the cream, put the whole pan, just as it is, over boiling water, until it is very hot, so that you can scarcely bear your finger in it, but be careful not to let it boil. Set it away again for another 24 hours, then skim off the cream.



## THE QUIET HOUR.

## Just an Ordinary Angel.

Sometimes I am tempted to murmur,  
That life is flitting away,  
With only a round of trifles  
Filling each busy day;  
Dusting nooks and corners,  
Making the house look fair,  
And patiently taking on me  
The burden of woman's care.

One day is just like another,  
Sewing and piecing well,  
Little jackets and trousers,  
So neatly that none can tell  
Where are the seams and joinings.  
Ah! the seamy side of life  
Is kept out of sight by the magic  
Of many a mother and wife!

And oft, when ready to murmur  
That life is flitting away,  
With the self-same round of duties  
Filling each busy day,  
It comes to my spirit sweetly  
With the grace of a thought divine:  
"You are living, toiling for love's sake,  
And the loving should never repine.

"You are guiding the little footsteps  
In the way they ought to walk;  
You are dropping a word for Jesus  
In the midst of your household talk;  
Living your life for love's sake  
Till the homely cares grow sweet,  
And sacred the self-denial  
That is laid at the Master's feet."

—Margaret E. Sangster.

I have heard of one of these "ordinary angels," who looked like an old farmer. He was sitting in a railroad station, waiting for his train.

"Pretty tired, marm?" he said, addressing a woman who came in, carrying a baby and innumerable parcels. Two small children were clinging to her dress. They teased and fretted as children will sometimes, and the poor mother would have been quite worn out before the long delay of two hours was over, if the farmer had not come to the rescue. Soon both children were hanging round him, eating peppermints and listening to lively stories about the lambs, calves and chickens at home. Then a piece of string came out of this "angel's" pocket and they were soon playing "cat's cradle" on the floor. Then the heavy baby was taken from the tired mother's arms, and tossed until he crowed with delight. Many another chance of helping other people did this real gentleman take advantage of on that day, and on other days, too.

Many definitions of the word "gentleman" have been offered to the world, and some of them are very unsatisfactory definitions too; but surely one who tries to carry out the golden rule of doing to others as he would they should do to him, has a right to the title. The old idea that a gentleman is a person who does no work, is quite out of date. We, in Canada, will hardly agree with the prince Lee Boo, who concluded that the hog was the only gentleman in England, because he was the only animal who did no work.

Once an English nobleman said to a fair American that there did not seem to be any gentlemen in America: "I mean, a leisured class, with nothing to do."

"Oh, yes," she replied, "we have lots of them, but over there they are called 'tramps.'"

I seem to have wandered from angels to gentlemen; but never mind, it is very much the same thing, don't you think? If an angel's business in this world is to minister to those who need, surely a gentleman's business is not very different. Anyone who is always looking after the interests of "number one" is certainly no gentleman. What a splendid specimen of a gentleman Moses was. Do you remember how promptly he stood up for the man who was being ill-treated by an Egyptian? Afterwards, as a matter of course, he insisted that the rights of the daughters of the priest of Midian should be respected. He evidently believed in the principle of "ladies first." Then how loyally he stood by his poor, downtrodden people, freeing them from the oppression of Pharaoh.

There is a legend in the Greek Church about two Saints, one of whom thought only about his own concerns—spiritual or physical—while the other forgot himself in lending a hand to others.

St. Cassianus enters heaven, and Christ says to him: "What hast thou seen on earth, Cassianus?"

"I saw," he answered, "a peasant floundering with his wagon in a marsh."

"Why didst thou not help him?"

"I was coming before Thee," said Cassianus, "and I was afraid of soiling my white robes."

Then St. Nicholas enters heaven, all covered with mud and mire.

"Why so stained and soiled, St. Nicholas!" said the Lord.

"I saw a peasant floundering in the marsh," said the Saint, "and I put my shoulder to the wheel and helped him out."

St. Nicholas was blessed with a fourfold blessing because he thought of others instead of being concerned only with his own affairs.

Does this legend remind you of our Lord's description of the Last Judgment? Those who minister to the sick, the hungry, the poor, will be placed on the right hand. Those who let their opportunities of helping slip past them, "shall go away into everlasting punishment." Every day we have opportunities of ministering to Christ. Are we taking advantage of them, or will He say to us, "Inasmuch as ye did it not to one of the least of these, ye did it not to Me"?

"We cannot see Thy face, Lord;

We cannot touch Thy hand;

The mystery of Thy being

We do not understand;

Yet beside us daily

Needy ones there be;

In succoring the helpless

We are helping Thee."

HOPE.

## A Sinner Unrepent.

"My, but your mornin' glories do look nice, Miss Pheme! Wish you'd save me some seed often that white one." It was Mrs. Ridley coming up the walk.

"I will, Mis' Ridley. Come in and set down. There's a pa'm leaf on the lounge, an' mebbe you'll take a glass of cool water. It's a scorchin' mornin'," said Miss Pheme.

"I would like a drink, thank you," responded Mrs. Ridley. "Seems like when anybody's fat as I am, they just get he't' up like a coal stove. My, that tastes good. You got a grand well, Miss Pheme."

The hostess smiled a flattered smile, but before she could speak, Mrs. Ridley went on: "I brought over three of Mr. Ridley's vests, Miss Pheme, to get you to mend 'em. He's bu'sted 'em ever' one right down the back, f'r all the world like a seven-year locust, I tell 'im, an' it seems like I got no time to fix 'em, with Emma May gittin' married next week. We're just livin' in a regular whirlwind, an' sorry as I'll be to see Emma May go—not that I don't like Charlie Foote, but you know what I mean—I cert'ney shall be glad when all this fuss is over."

"I expect it is trying," sympathized Miss Pheme. "But Emma May's always been a good daughter, an' she deserves a fine weddin'."

"Taint that I don't want her to have it," said Mrs. Ridley, hastily. "But I'm just dog-tired this mornin'—for the land sakes, it's half-past ten o'clock a'ready; I got to go. You bring them vests over when they're done, Miss Pheme, and I'll pay you f'r 'em. I'd send one o' the boys over, but Emma May wants you to come pertickler an' see her presents, so 't 'll be killin' two birds with one stone." She chuckled comfortably as she stepped outside the door.

Miss Pheme looked after her departing form with resentful stare. "Yes," she muttered, "she can get Miss Maxwell to make Emma May's weddin' clothes, but I'm good enough to mend up Jim Ridley's old vests. I'll charge her fifteen cents apiece, see 'f I don't; that'll be forty-five cents. Does seem a good bit to charge f'r mendin' three vests."

Miss Pheme went in and shut out the glare of the summer day. As she picked up the package of vests her thin little hands trembled. Tears sprang to her eyes and she burst out fiercely: "Taint right! I made Emma May Ridley's dress to be christened in, little twenty baby as she was, an' I made her a dress to be confirmed in, an' I made her a dress when she gragwated at the High School, an' she'd always said I should make her weddin' dress. That flauntin' city thing's got all my trade! I've sewed here all my life and dealt honest by all, an' it's not fair." The tears rolled down her withered cheeks and fell unheeded upon Mr. Ridley's second best pepper-and-salt vest. Presently her wrath flamed anew.

"Emma May wants you to come pertickler to see her presents! Taint no hint; oh, no! Sally Ridley needn't 'a'troubled herself to say that. I got a present for Emma May, an' I'm going to give it to her. I'd like to get even with them, the whole kit band of 'em. Jest as if I couldn't 'a'made Emma May's weddin' clo's! They tell me Miss Maxwell uses a chain-stitch machine. I always did say chain-stitch machines was made for the careless, an' I don't see no reason to change my mind. Well, 'pon my word, this vest ain't on'y bu'sted, but frayed int' the bargain." Miss Pheme fell briskly to sewing.

The next day, despite the threatening rumble of a distant storm, Miss Pheme dressed in her best and started toward the Ridleys, carefully carrying two packages. She was graciously received by Emma May, a fat, fair girl of pleasant mien and placid disposition.

"I brought home them vests," explained Miss Pheme; "and here, Emma May, is a little present I brought for you. It'll be nice f'r your dining-room table, I thought." She held out a small white paste-board box, with an expression of the heaping-coals-of-fire kind.

"Ma," called Emma May, "come here; Miss Pheme's brought me a butter knife! Wisht you'd look! That cert'ney is beautiful."

"It's solid silver," said the donor, proudly. "My niece down to New York got it for me." She received the thanks, delivered a trifle embarrassedly, of mother and daughter, with polite coolness.

When the bride-elect invited her to an inspection of the presents, Miss Pheme looked them over and made few comments. She turned the set of silver spoons, "presented by the groom's parents," so that the plate-mark was visible, and she tapped the globe of a gaudy china lamp with the remark that they were just two dollars and thirty-nine cents down to Beedham's. When she had looked at all, she said, cheerfully:

"Now I want to see your clothes, Emma May."

Mrs. and Miss Ridley exchanged glances of annoyance, but the latter led the way to the spare room, where, on bed and chair, lay the creations of Miss Maxwell, "City Modiste."

There was the white silk wedding dress, the tan travelling dress, some odd waists, a black satin, stiff with jet, and a "tea gown." No girl in a country town marries without these last indispensable garments; they are the real backbone of the trousseau.

Miss Pheme looked at the display, felt the quality of the material, and examined the despised chain-stitching, without a word. At last she said, pleasantly conscious of paying old scores:

"If I might peep into to criticize, I really do think it's a pity you got your wedding dress made with a p'inted overskirt. All the latest fashion books say they're not worn at all this season; and box-pleats, too, is kind of droppin' out. I was readin' only yesterday that 'twas just the cheapest goods was made up so any more. That black satin's real pretty, though. Did you see Lena Sullivan's black satin? Hers was a beauty—finest piece o' satin I ever cut into, an' all made up with these here pleated ruffles. Why, Emma May, seems if you'd be most afraid to leave all these fine things in here with the winder open, this room on the ground floor like it is. It's been a real treat to see such elegant clothes, an' I hope your married life 'll be happy. The Footes have all got terrible onreasonable tempers, they say; but I hope you'll be able to manage Charlie. Good-bye, all."

Miss Pheme walked home slowly. Even the thought of the darts she had planted in Mrs. Ridley's capacious breast brought her no real comfort, when the vision of the snowy wedding dress rose before her.

"Things ain't edge even yet," she murmured. A low growl of thunder startled her, and she hastened into the house to shut out the cutting flare of the lightning. When the kettle boiled she set her lonely table and made tea. The quick thump of heavy rain-drops on the roof made her start nervously. Night had come with the storm, and, after supper was over, Miss Pheme sat in the dark and meditated. About ten o'clock the rain ceased, and she flung the shutters open. The stars were shining now. The air outside was cool and damp and fragrant. She looked over toward the Ridley house, and as she did so their last light went out. Miss Pheme strained her eyes to no avail. All was darkness there.

"I'm agoin' to do it," she said aloud, determinedly. Rummaging over the table, she found a pair of scissors. She took a match from the box beside the window and unlocked the door. The moon was creeping up, a flat disk of pale yellow. Miss Pheme looked down at herself and saw that she still wore her best dress. "It'll be all drabbed," she thought; then recklessly, "I don't care, nohow."

She brushed against the dripping flowers beside the garden path, and held her breath as the gate gave a whining creak. Out on the road, walking noiselessly, she went. Once she heard a team coming and crouched in a corner of the worn fence, behind a little sweet-gum sprout, till it was past. She recognized the doctor's rig, and her heart came up in her throat and beat there, with great frightened leaps; but he passed by safely, and she crept on.

At last, after a seemingly unending journey, she reached the Ridley's gate. The maples threw deep shadows, and, so sheltered, she reached the house. Round to the left wing—slowly—slowly—and the window was still open! She stopped and looked in. The moonlight lay in patches on the floor, the dresses spread upon the bed, and there, within reach, it fell full upon the wonderful pearl beading of the wedding dress and made scintillating lights. Miss Pheme saw all this, and slowly—slowly—her hand went out toward those glistening beads. A quick jerk, and the waist of Emma May Ridley's wedding dress lay across her knees. She sought the seam in the middle of the back. She could feel the despised chain stitching, and she slipped her fingers deftly along the collar. What was this? A loose end of thread—a little pull—r-i-i-i-p—it was done! In a spasm of fear Miss Pheme hustled the waist through the window, back into place, and ran into the concealing shadow. Out to the gate, down the road again—she was almost home. Suddenly she stopped and gave a little chuckle.

"Them bastin's 'll hold it together so nobody 'll s'spect—lucky she left 'em in. But when Emma May puts it on, big an' fat as she is, it'll bu'st square up the back like a frog." She couldn't help laughing at the idea; it tickled her fancy so. She forgot her wet feet, her dragged, muddy skirts, and went to



bed with a smile still pulling at the corners of her mouth.

The next morning the exposure had done its work. She was hoarse and feverish, and there was a sharp pain that stabbed her at every breath. "Threatened with pneumonia," the doctor said, and commanded her not to stir from her bed, though she could not have done so had she so wished.

Mrs. Emerson, the town gossip, came in and brought a bundle.

"Jest as soon as you git able, Miss Pheme, I want you to make me a dress. It's one Mr. Emerson got me over to Bristol, an' he showed real good taste for a man, I must say. Look-a-ther, ain't that fern leaf real pretty?"

"It's just beautiful," assented Miss Pheme. "Seems if you'd have Miss Maxwell make it up, bein' she's from the city an' all."

"She'll never cut into a piece of goods f'r me, I c'n tell you," said Mrs. Emerson, with emphasis. "Ain't nobody told you how she made Emma May Ridley's weddin' dress and never sewed up the back, an' Emma May, not suspicionin', put it on an' bu'sted it clean wide open? O' course, you was sick an' didn't git to the weddin'; but I was there, an' the weddin' party was nigh an hour late jest on that account. Nothin' but a bastin' thread to hold it together; such shif'lessness! Course, bein' bad luck, Emma May never tried on the dress after it come home, like she did the others, an' I c'n tell you she was hoppin'. People at the church didn't know what on earth was the matter. No'ndeed, Miss Maxwell makes no clo's f'r me."

After her visitor was gone, Miss Pheme lay back on her pillows and looked out of the window a long time.

"'Twas an awful mean trick, I know," she said at last. "'Twasn't right; but I got this spell o' sickness to pay up fer it, an' that butter knife was solid silver and real expensive. I'm evened up all 'round—an' somehow—I jest can't care.—[Sophie Gates Kerr.

Ingle Nook Chats.

My dear Guests,—

"Nature as far as in her lies  
Imitates God, and turns her face  
To every land beneath the skies,  
Counts nothing that she meets with base,  
But lives and loves in every land."

So said Tennyson, sounding the praises of his own "Merrie England," while Balfe, the pleasant song-writer, expresses the same idea in other words, singing of Ireland's Killarney:

"Bounteous nature loves all lands,  
Beauty lingers everywhere,  
Footprints leaves on many strands,  
But her home is surely there."

Christian Reid grows ecstatic recounting the charms of Mexico, the "Land of the Sun," and thus on indefinitely; but this morning, while enjoying a drive along one of the picturesque roads which here abound, I felt disposed to question the veracity of any writer who should claim his country to be more fair than this, our own young Canada. It is but just that each should sound the praise of his native land, as "man's first, best country ever is—at home"; we have no word of commendation for him who should fail to do so.

We have just been celebrating the feast of the Resurrection, the glad Easter-tide, and Nature, in imitation, is also undergoing a thorough renovation—doing her spring housecleaning, so to speak. The first bright blades of green are just beginning to peep from beneath sere grass of autumn, and, although we still see the bright glitter of sap-buckets in the maple groves, and occasional remnants of snow in shaded nooks, the already-swell-ing buds proclaim that soon the enjoyable occupation of syrup-making will be over. The revived green of the fir trees, the merry croaking of the frogs, the busy twitter of birds seeking summer residences, and the warmth of the bright sun, combine to give one a feeling of exhilaration not easily portrayed in words.

A deep river in proximity to the roadway adds another charm, sweeping proudly on, as it does, in its haste to join the noble Ottawa. Its glassy breast is resplendent with myriads of diamonds as the bright morning sun beams down upon it, save at one point, where it is covered with logs en route to the sawmills some miles farther down.

These are but a small relic of the almost fabulous wealth of timber that in time past has been carried over this same river. The old lumbering days form an ever-interesting topic of conversation to old inhabitants, and many are the stories told of deeds of strength, daring and bravery in camp and on the "drive." Perhaps some of our younger guests may not understand the above term, so, although knowing I can but inaccurately do so, I shall attempt to explain it.

You all know how in winter large numbers of men went to the woods to cut the huge pines and other timbers; these logs were then hauled out to the rivers and lakes, and when spring came

were carried by the water to sawmills at various points. Sometimes the logs were hewn into square timber in the woods, and in this case a certain number of these timbers were formed into what is called a "crib," which was propelled by three or four men with oars; twenty-five or thirty of these cribs were then connected, forming what is called a "raft," and in smooth waters sailed along all together. In some places the river becomes narrow and very rapid; the raft was then disbanded and the oarsmen acted as steersmen only, the current being sufficient power of locomotion. Where the rapids are very dangerous, slides are constructed and the cribs went through them one by one, until, on reaching smooth water, they were again formed into a raft. When the Ottawa was reached the raft was tugged by a steamboat until rapids again intervened, and thus on to the great St. Lawrence; and on and on again until old gray Quebec, which was the usual market, was reached. This journey of four hundred miles or thereabout might be accomplished in twelve days did everything go well. Dangers in plenty attended those trips, yet the life was full of charm, and men willing and eager to embrace it were never wanting. Still more dangerous was the breaking up of "jams," where the loose logs that were simply allowed to float along became in any way obstructed and collected in jams.

Men became very expert in handling them, and, to inexperienced eyes, it seemed wonderful to see them step from log to log as unconcernedly as if on terra firma. A log-rolling contest was a favorite pastime with the drivers. In this trial of skill, two men stood on a log and caused it to



"THE NEWHAVEN FISHWIFE."

revolve with such rapidity that the water often splashed as high as their heads, they all the while maintaining their position. He who longest sustained his place without receiving a ducking was, of course, victor.

But these are stories of the past (since railroads have penetrated every recess of the country), and lose much of their merit in being told by one not an actual eye-witness of the scenes they describe.

I have widely digressed from my original subject, yet I trust some, at least, of my readers may find the latter part of my chat sufficiently interesting to condone the fault.

THE HOSTESS.

Ingle Nook Chats, Pakenham, Ont.

Humorous.

A certain minister lost his MS. one Sunday morning, so made this announcement:

"I am very sorry to have to inform you that I have—er—somehow or other, mislaid my sermon for this morning. I must—er—therefore, trust to Providence for inspiration. To-night I will come better prepared."

Recently in a Washington trolley, a colored dude was seated among the passengers. A young woman of his own color entered, and he immediately rose, and offered her his seat. She gracefully demurred, and said, "I do not like to deprive you, sir, of your seat." "Oh, no depravity, miss," was his reply: "no depravity at all; I prefer to stand."

"The Newhaven Fishwife."

Our Newhaven fishwife, as she leans against her well-filled creel, looks the embodiment of health and content, and if her face is a true index to her mental condition (as why should it not be?) she has not a carping care to worry her. Well and sensibly clad in her short striped-linsey skirts, woollen stockings and stout leather boots, what cares she for wind or weather! The salt air braces her for her daily labor, and she gladly takes her share in the family support by selling in the streets of New Haven what her husband and sons have caught in their nets at sea. She evidently knows she is being photographed, and apparently enjoys the process. If she could but bring that creel to our doors in Western Canada, where the sea is not nor the fruit thereof, would we not empty it before she could get to the corner of the first block?

H. A. B.

Nature's Te Deum.

We read so much about the awakening of a summer's morning. Now all nature joins in the opening of a new day. The first music of the morning is the whispering wind in the pines, playing a soft accompaniment to the glad worshippers, the birds. Then the animals in turn awaken and pay their tribute to the goddess of morning, while the flowers, too, open their cups and petals in greeting, and all nature joins in the morning music, heralding in the new day. Few of us ever hear this morning Te Deum of Nature; it is sung while the worries and cares of the world are sleeping, before man with his spirit of unrest is abroad, and so it seems profoundly solemn and sacred, as though the spirit of the great Creator must be there amid the purest and most beautiful of His handiwork, sinless, as in the morning "when the stars sang together."

What a different chord in our nature is touched with the awakening of a spring morning! The first note of a robin sends a thrill of new life and gladness through our veins, and with the smell of newly-plowed fields, we long to hunt the "folded green things in dim woods," and become "kith and kin to every wild-born thing that thrills and blooms." Perhaps the robin has found a resting-place in more hearts than any other of our birds. He has not only been designed by the Creator for ornament and pleasure, but is a positive blessing to man in protecting vegetation, destroying the larvæ of many insects in the soil, and living upon worms and insects, except for a month or two when he changes his diet to strawberries and cherries, but we can surely forgive a thief whose song is such a welcome prelude to the general concert of summer.

Thus far, the proverbial fickleness of April none of us shall question; her eyes have been full of both tears and snow, with enough sun to open the frogs' throats and shut them again for the third time. This, however, is a sure sign of spring! So the popular belief declares, and we shall trust it is so, for we want no more doubts about the germinating of our sweet-pea seeds, though I suppose having perfect faith in the efficacy of the flight of the first bluebird, we need fear neither frost nor cold to blight our flowers. Few of us have the faith of the man who will sow his cabbage seed Easter Sunday and his onion seed in the new of the moon. We prefer pinning our faith to something firmer than legendary omens, and rather say with the poet of the seasons:

"Be gracious, heaven! for now laborious man  
Has done his part. Ye fostering breezes, blow!  
Ye fostering dews, ye tender showers, descend!  
And temper all, thou world-reviving sun,  
Into the perfect year."

Some writer has suggested the idea of making a calendar of trees, but just now we perhaps turn more fondly to making our calendar of birds and flowers. It would be very interesting if we were to start with the month of May, making, we shall more appropriately call it, a diary, noting the appearance and disappearance of birds, for there is constant shifting among the feathered population; and so also with the blooming and passing of flowers. This would make a walk interesting, and keep us healthier—mentally and physically.

Our robin is a night as well as a morning bird. I hear one singing now a requiem for the dying sun, and as we follow that great brilliant orb towards the western world, does it not make us feel that beyond all, in some unknown space, is a greater world, of which, perhaps, this bit of the Heavenly Artist's picture is but a harbinger,



a picture hung out in Nature's gallery to show what lies beyond this world of change and selfish ends? And now I am going to say good-bye to you for some time. I feel I'm only taking up space which others better can fill.

We have not forgotten Clarissy Ann and her practical helpful hints, and I'm sure we all want to hear more from her. So, Clarissy Ann, we invite you to step into the shoes of

ONE OF THE GIRLS.

### Where?

"Why, where are you going, my dear?"  
 Asked the Seal of the white Polar Bear;  
 For he seemed just about on a trip to start out,  
 With luggage to last him a year.  
 He fastened his pack with a pin,  
 Then said, with a sorrowful grin,  
 "I'm sure I don't know, but somewhere I'll go  
 Where folks won't make rugs of my skin!"  
 "Good, I'll join you myself," said the Seal—  
 Her languor replaced by great zeal—  
 "Or the fur on my back may become a long sacque,  
 To which an objection I feel!"  
 "I'll go with you, friends!" cried the Mink;  
 "I don't need a moment to think;  
 Let me go where minks' tails don't command such  
 large sales—  
 A traffic from which I so shrink."  
 The Grey Squirrel tilted his head:  
 "The move is expedient," he said,  
 "For I learn from friend Wind, cloaks with squirrels  
 are lined—  
 A fashion I certainly dread!"  
 "My breast and my wings, I have heard,  
 Are coming in style!" screamed a bird;  
 "So let me go too, I shall not hinder you,  
 A Gull's not a troublesome bird!"  
 "Very well, then, let's start," growled the Bear,  
 "For we haven't a moment to spare;  
 There is no knowing when those terrible men,  
 With guns and harpoons will appear."  
 So led by the white Polar Bear,  
 The procession set forth. But oh, where  
 Will they find that new zone, where man is unknown?  
 Can any kind friend tell them where?  
 —A. L. H.

### What Not to Wear.

This is the advice—as good as it is briefly put  
 —which a writer in Leslie's Weekly gives on what  
 not to wear:

- White petticoats on muddy days.
- Cheap jewelry any time.
- Bright red with a florid complexion.
- Conspicuous bicycle costumes.
- A broad belt on a stout figure.
- A plain basque on a slim figure.
- Cheap trimmings on a good dress.
- Cheap lace on anything.
- Diamonds in the daytime.
- Linen collars with dressy frocks.
- Picture hats with outing costumes.
- Soiled white gloves on a shopping expedition,  
 or at any time.
- Worn shoes with an elaborate toilet.
- Dotted veils with weak eyes.
- A linen collar that is not immaculately fresh.
- Gloves with holes in, or boots with buttons  
 missing.
- Hair dressed high with a snub nose.
- Hair in a Psyche knot with a Roman nose.
- Pointed shoes while bicycling.
- Gaudy colors in cheap materials.
- The new tight sleeve on a long, thin arm.
- Tan shoes in midwinter.
- A long draggled skirt on a rainy day.
- Lace frills or chiffon ruches for work or  
 school.
- Elaborate toilets for church.
- Untidy frocks for breakfast.
- Horizontal stripes or tucks on a stout figure.

### Where Moths Originate.

The distracted housekeeper wages war against the little white-winged moths that fly around so industriously in the spring, usually near her most expensive carpets, draperies, and furs. She wonders where they can come from in such armies, and she spends a great deal of time and strength in scattering borax, insect powder and naphtha about her carpets, and uses every available newspaper and countless moth balls in stowing away her winter furs, John's best overcoat and numerous other garments that these little pests like to feed upon.

Now, I am quite sure if this same vigilant housekeeper were some day to go on a hunting expedition from attic to cellar, she would be more than likely to run across an old horse blanket or piece of fur which contained larvae enough to stock a whole neighborhood with these pests. Perhaps a skein of soft white wool might be pulled out of some corner not often peered into, which would literally drop to pieces when she touched it, so industriously had it been preyed upon by these busy workers.

If the search should be very thorough, and everything thus infested should be burned, she would be apt to find the next year, when she looked around her carpets and closets, that her labor had not been in vain. And if she should continue to destroy all useless woollen garments that prove such prolific breeding places, she would in time completely rid herself of the troublesome carpet moth.—(Helen M. Richardson)

## THE CHILDREN'S CORNER.

### Prize Competition: "Canadian Country Life."

This has been a very satisfactory competition, although a few of the young poets have strayed from the subject, and some others have very elementary ideas about rhyme and metre. The winners are: Class I., Lorne Tremain, Blair, Ont. (aged 14); Class II., Olive M. Sproule, Wexford, Ont. (aged 12); Class III., Wesley Scott, McIntyre, Ont. (aged 10).

The best poem was sent in by Charlotte Hunter, Norval, Ont., but, as she did not give her age, it could not be put into any class, although I hope to print it before long. Percy McDavitt also neglected to mention his age, which was a pity, as his lines were also well written. We must stick to rules, you know. Those deserving honorable mention are: Class I., Hilda Bowman, Gertrude Shannon, Isabella Mackenzie, Effie Letson, Gertie Cannon, Maud Jose, Alexander Nixon, Pearle Stacey, Christina Kitchen, Florence Usher, Annie Matheson, Georgina Matheson. Class II.—Lena Myles, Margaret Lockwood, Morley Scott, Elsie MacDonald, Jennie Cannon, Fannie Scott, Mildred Atwater. Class III.—Alda Sproule, James Scott.

#### Class I.—"CANADIAN COUNTRY LIFE."

Oh happy is the country life—  
 Full of toil, but free from strife,  
 Obeying simple rules of health,  
 Not selling souls for fleeting wealth,  
 But happy with an humble home  
 In which to dwell 'til life is done.

Living mid fresh and bracing air,  
 The red-cheeked boys and maidens fair  
 Play round the maples in the spring,  
 Or race with robins on the wing;  
 And then when time for summer comes,  
 They feast and live on pears and plums.

The peasant in his humble cot  
 Lives near the rich and envies not—  
 His harvest brings him untold joys,  
 He likes to sit among his boys,  
 Telling them tales of bygone years,  
 His youthful pleasures and his fears.

And now when winter comes with snow  
 The farmer is right glad to know  
 That he can rest for a short time  
 Until there comes a warmer clime.  
 He is the picture of health now—  
 No wrinkle mars his honest brow.

The winter brings the children out,  
 They laugh, they play, and sing and shout;  
 The skates and sleighs are all brought down,  
 The good mother will never frown  
 To see the children have good fun  
 When all the other work is done.

Guided by nature's skillful laws,  
 Taught in school, of verb and clause,  
 They grow up pure, with well-stocked minds  
 To pursue duties of all kinds;  
 So out into the world they go,  
 Some of Canada's stock to show.

Lorne Tremain.

#### Class II.—"CANADIAN COUNTRY LIFE."

Wouldn't you like to hear of the girls and boys  
 Who don't play in the nursery with toys,  
 But all day play in the pleasant fields,  
 'Mong the grain so tall, that the harvest yields?  
 And when they're tired of their play,  
 They go asleep in the new-mown hay.  
 But better still: did you ever taste  
 The golden honey, and sweet flaky bread  
 With milk? (and none to waste)  
 Eaten in the shade of the great willow trees,  
 Where their hot cheeks are fanned by the evening  
 breeze.

And in the autumn the nuts they come;  
 The leaves are heaped in the hollows deep,  
 And each one takes his turn in the fun,  
 To jump right into the big brown heap.  
 The skating and coasting are yet to come,  
 And then, oh then, the fun is begun.  
 Over the plains and down the hills,  
 The skaters and coasters skim along,  
 And don't you wish you heard their song?  
 In spring come the flowers,  
 And kites for the boys;  
 Fishing too, don't forget those joys.  
 The leaves grow green,  
 And the rain comes in showers,  
 Then the roses in June;  
 But I'm back to summer.  
 So I won't say more, but hope you'll come soon,  
 And then you'll forget 'bout city strife,  
 And enjoy "Canadian country life!"

Olive M. Sproule.

#### Class III.—"CANADIAN COUNTRY LIFE."

Spring comes the third month in the year;  
 I think the grass is, oh! so dear;  
 I like to gather pretty flowers,  
 And sit beneath the shady bowers.

I do not like to see the mud,  
 But like to see the trees in bud;  
 I like to hear the robin's song,  
 And could listen to it all day long.

I go up to a gravelly hill,  
 Me and my little brother Will;  
 Then we go down the other side,  
 And Pa will give us a horse-back ride.

I like to ride upon the roller,  
 And like to talk to Harry Bowler;  
 He is our hired man,  
 And he gives me all the rides he can.

I like in summer to see the sun,  
 In summer I have lots of fun;  
 I have not got to go to school,  
 But sometimes have to drive the mule.

I like to ride upon the binder,  
 Our hired man could not be kinder;  
 He lets me sit upon his knee,  
 Then all the binder I can see.

Wesley Scott.

When threshing comes the men work,  
 And I toe in like a little Turk,  
 I like to hear the whistle blow,  
 And see the men to their dinner go.

And when the autumn winds come  
 The bees put away their solemn hum;  
 When winter comes with all its snow,  
 To the southern part the birdies go.

Wesley Scott.

I am glad to find that so many of our children know how to appreciate the simple country pleasures within their reach. I was also agreeably surprised with the quality of most of the MSS. sent in. Perhaps you may make Canadian poetry famous some day—who knows! I hope you will respond as well when our next competition is announced.

COUSIN DOROTHY.

### Travelling Notes.

This time Mollie's message is a very short one. Just a mere mention, in a private letter, of her safe arrival at Grasse, "Alpes Maritimes," in the south of France, where her relatives had already established themselves in most pleasant surroundings, a fuller description of which will probably reach us for our next issue. "Fancy," says Mollie, "there are no less than ten of us Canadians from London, Ontario, in this delightful corner of the European continent. As a newcomer, I have not yet got over the charm of novelty, but to all appearance the rest of the party might have been here all their lives; at any rate, although they may be equally alive to the sweet scents and foreign sounds, they have passed through the first 'Oh!' and 'Ah!' and 'is not this charming?' stage, which finds almost involuntary expression until one has become accustomed to it all. I must slip into my envelope a few of the sweet-smelling violets, acres and acres of which surround us. Now is the harvest of the olives, and they are being gathered by the wagon-load; so also are the flowers, literally by the bushel for the perfumeries; indeed, the whole air is laden with perfume. Some day I must tell you of our outing at Cannes, where we witnessed a 'battle of flowers,' a sight not easily to be forgotten.

"There is a dear little English church about ten minutes from here; it is very pretty, with some beautiful windows given by wealthy English winter residents. Baroness Rothschild's place is near, and as she keeps fifty gardeners, you may guess how grand are her grounds and gardens. When Queen Victoria was at Grasse, ten years ago, she gave a tea for all the English residents, so, by one and another of our new acquaintances, we are constantly being told of some of her sweet ways. One old gentleman related that he apologized for his wife not coming, telling the Queen that she was blind. Two days afterwards Her Majesty drove up to their house to visit the blind lady, and remained some hours, bringing both herself and her husband a handsome present, which he showed me. Strange, too, to relate, this blind lady died the very same day as the Queen. In a few days we are all going to Nice, Monte Carlo, Monaco, and Mentone, none being far off from here. I shall then have more to tell you. Good-bye for this time.

MOLLIE."

Thomas—A fine soft mornin', Andra.  
 Andrew—Oo aye; but why dinna ye pit oop yer  
 umbrella?

Thomas (aghast)—Sosh; ye were always a waste-  
 ful mou, Andra; can ye no' see it's a new ane?



NOTICES.

"POTATO BUGS" AND PAINT.—As long as the Colorado beetle remains an unwelcome visitor, the use of Paris green will be continued. The range of insecticides, fungicides and other death-dealing drugs in the endeavour to completely annihilate the bug have been ransacked, but the bug remains. The Canada Paint Company, Limited, for a number of years have made a specialty in producing Paris green, and we are assured that their manufactures are first-class in every respect. The Paris green which they have been shipping for several years is guaranteed to be ahead of the Government standard, and is a most economical insecticide for growers of potatoes and fruit-raisers. We understand that this green is for sale by all the leading stores throughout the Dominion.

It has been well said that 'one touch of nature makes the whole world kin,' and to it may be added, 'a few dabs of paint will make the whole world bright.' The painting season is now upon us in full swing, and the Canada Paint Company have certainly one of the best reputations in Canada for making first-class stock. Ask for the handy paints and varnish made by this company.

AN OLD-TIME READER.

Mr. R. Robinson, of Niagara Falls South, whose portrait appears elsewhere in this issue, was born in 1848, at Drummondville, near the old battleground of Lundy Lane. His father was a native of Staffordshire, England, and came to Canada in 1840. His mother was a descendant of the U. E. Loyalists. He has always lived within sound of the Falls, and has been engaged in mixed farming since about thirteen years of age, but delighted in raising horses and other stock, of which he has been judge several times at fairs. For a few years he has been raising pure-bred Yorkshire and Tamworth swine. In a recent note he said he had been a subscriber to the "Farmer's Advocate" for 35 years, and found that it was improving every year.

A GOOD WAGON.—In the proper equipment of every farm, first-class wagons, racks, etc., are essential. There is no economy in trying to handle crops and produce on the farm or highway with inferior vehicles, when it is so easy to secure such as those manufactured by the Adams Wagon Co. of Brantford, Ont. The growth of this firm from 1863 to the present, is one of the marvels of industrial progress in Canada. A glance at their handsome new catalogue, which we have received, shows that they manufacture farm, freight and truck wagons, lorries, drays, carts, and sleighs. To become posted on the subject, get a copy of this catalogue.

WIRE FENCING.—The question of fencing on the farm is of stirring interest now that spring is here. The old rails are failing to do duty any longer, and as a result it is necessary to turn attention to wire fencing. Barb wire has proven to be damaging to stock, and unsatisfactory in other respects, but the Coiled Steel Spring woven-wire fence seems to have given general satisfaction. The London Fence Machine Company, of London, Ont., have sent us a copy of their spring catalogue, illustrating and describing the London fence machine, which certainly builds an excellent woven fence. From reports received, it is proving a thorough success. We take pleasure in complimenting the firm on the style of their new catalogue, a copy of which farmers should secure. It is very attractive, and contains a large amount of useful information in regard to bracing posts, etc., for farmers who require wire fencing. Their machines and goods are first class. Their advertisement may be found on the back cover of this issue.

HARDY SHRUBS

Are the best of all for decorating the home grounds and lanes. Once planted, they are good for a great many years. They require but very little care or cultivation, and they increase in size and beauty every year. We have the largest variety of any Canadian nursery. We sell direct and save all middle profits. Our handsome catalogue, "Canadian Plants for Canadian People," is our only salesman. We make the following remarkable offer to get you acquainted with our stock. One each of the following ornamental shrubs:

- FORSYTHIA VIRIDISSIMA, WEIGELIA ROSEA, PHILADELPHUS CORNARIA PL., SPIREA DOUGLASII, DEUTZIA GRACILIS.

A sturdy young plant of each mailed to your address for only 50 cents. We guarantee them to arrive in good condition. Do not fail to take advantage of this wonderful offer. Address:

WEBSTER BROS., HAMILTON, CAN. Leading Canadian Florists.

THE CURVE OF LONG LIFE. Stretch the fence till it sings. Then it lasts a lifetime. The tension curve gives elasticity. Ready made, ready to put up. THE AMERICAN FIELD FENCE & HOG WIRE. Saves Time, Money, Stock and Crops. Sold everywhere. If your dealer hasn't it write to Canadian Steel & Wire Co., Ltd. HAMILTON, ONT.

Corn Planting must be well and carefully done, as the future crop depends upon it. For all purposes, in any soil, on all kinds of ground nothing equals the SPANGLER CORN PLANTER. It saves time, labor, money and insures the crop. You know when it is working; you can see the corn on its way to the ground. Made with or without fertilizer attachment. New device for sowing peas, beans, castor, corn, etc. We also make the famous Spangler Low-Drop Grain and Fertilizer Drill. Write for catalog and circ. SPANGLER MANUFACTURING CO., 510 Queen St., York, Pa.

FARM FOR SALE IN PILKINGTON. THREE hundred acres in the Township of Pilkington, Lots 3, 4 and 5, Concession 3. This is one of the best farms either for stock or grain in Ontario. There are two sets of buildings, and it is suitable to be farmed as one, two or three farms. For particulars apply to the undersigned on the premises, or by letter to JAMES HUNTER, ALMA P. O., ONT.

Public Sale OF Jersey Heifers AND BULLS, MAY 28th, 1902, AT AMHERST VILLA, WILLIAMSVILLE, N. Y. On Main St., 3 1/2 Miles from Buffalo City Line

Buffalo and Williamsville Electric Railway connects with Buffalo Main St. city line cars, running direct to Amherst Villa. The sale will include: 11 daughters and 3 sons of Golden Blyth 49215 (imp.); 4 daughters and 1 son of Golden Blyth 2nd 54567; 18 daughters of Great Name 54245 (imp.). Catalogues now in preparation, for which write:

Estate of Charles Lautz, 704 D. S. Morgan Building, BUFFALO, - - - NEW YORK.

W. F. STEPHEN, Trout River, Que., breeder Klondike of St. Annes 8397, and from deep milkers with good udder and teats. Carr's Crossing, 1 mile, G. T. R.; Huntingdon, 5 miles, S. L. & A. R. O.

HORTICULTURE. Prof. F. C. Sears, Principal, has issued an attractive illustrated pamphlet from the annual report of the School of Horticulture at Wolfville, N. S., which was attended last year by 68 students—58 from Nova Scotia, 7 from New Brunswick, and 3 from P. E. Island. An admirable course of practical instruction is given at this excellent institution. Not only by his work in the school, but by addressing farmers' meetings, Prof. Sears is rendering the fruit interests of Nova Scotia and the adjoining Provinces good service.

Mr. W. F. Stephen, of Trout River, Quebec, the successful Ayrshire breeder, makes an announcement elsewhere in this issue which dairy farmers will read with advantage, as just now many are looking for good young sires to improve their herds.

The Sunnyside Herefords

ESTABLISHED 1895.

IMPORTANT ANNOUNCEMENT.

Having purchased an entire herd of reg. Herefords, we are prepared to offer some bargains. For the next 30 days we will offer 4 choice bulls from 10 to 30 mos. old, and 25 choice females, consisting of yearling and 2-yr.-old heifers, young cows bred and in calf or nearly due to calve, and cows with calf at side, either sex. Write us for what you want, or come and see. Visitors met when notified in advance.

O'NEIL BROS., Southgate, Ont. Lucan Station, G. T. R.; Ilderton or Denfield Station, L. H. & B.

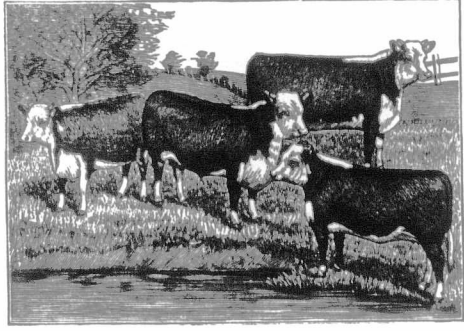

SEND FOR ILLUSTRATED PRICE LIST.

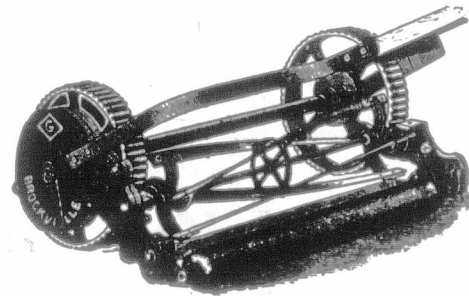

LAWN MOWERS.—12-in., \$3.50; 14-in., \$3.75; 16-in., \$4.00; 18-in., \$4.15, each. These are the best, fully guaranteed, lawn mowers.



DEEP WELL PUMPS.—Fully guaranteed, only \$6.50. HAMMERS.—Solid steel, only 35c. each.



We show a DOUBLE-BARREL BREECH-LOADING SHOTGUN, which we bought large quantities of. These guns are actually worth \$15, are all 12 bore. Our price while they last, only \$8.50.

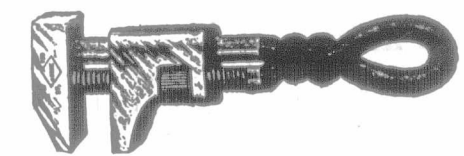

WRENCHES.—12-in., solid steel. Only 75c. each.

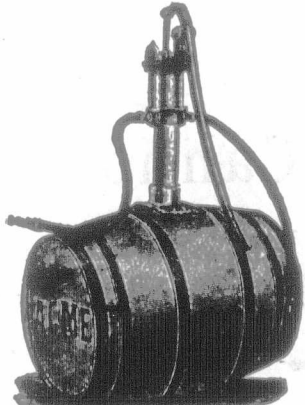

DOUBLE-ACTING SPRAY PUMPS.—Only \$8.25 each.

WILKINS & CO.

166 AND 168 KING ST. EAST.

TORONTO, - ONTARIO.



BREAD KNIVES.—Only 25c. each; postage, 5c. each extra.

THE WAGGONER LADDER CO. LONDON, ONTARIO, LIMITED.

MAKE THE BEST

EXTENSION LADDERS

In the world. They and our "Lindenwood" EXTENSION STEP ladders are indispensable for Pruning and Fruit Picking. In fact, they will save their price in a few days. For Painting, also Eav-straighting, Repairing, Stracking and general use, they have no equal. They are absolutely safe and reliable, and only half the weight of other ladders of the same strength.

OUR Folding Lawn Swings

Should be on every farmer's Lawn. They are Graceful and Ornamental, and a perfect delight to Young and Old. Very safe for children. No place to pinch their hands. Write for our

Free Illustrated Catalogue

and price list of all our goods—Ironing Boards, Clothes-horses, Curtain Stretchers, etc.



THE WAGGONER LADDER CO.'Y, LTD., LONDON, ONTARIO.



# VALUABLE PREMIUMS.

EXACT SIZE OF KNIFE.



**An Al Farmer's Knife**  
DIRECT FROM SHEFFIELD, ENGLAND.

**FINEST HAND-FORGED STEEL BLADES. STRONG AND DURABLE.  
BEAUTIFUL NICKEL HANDLE.**

Specially selected and ordered by the Manager of the ADVOCATE when in England last summer.

**Cannot be Duplicated.**

Every farmer and farmer's son should have one of these knives.

**How to Secure It.**

SEND

New Subscribers **2** New Subscribers

TO THE  
**FARMER'S ADVOCATE**

And we will send you the knife, postpaid.

START OUT FOR THE NAMES TO-DAY.

Another large consignment now on the way from England.  
*Made by one of the longest-established manufacturers of cutlery in Sheffield, England.*

**THE BIG FOUR** THE GREAT PREMIUM PICTURE OFFER, FOR OBTAINING NEW SUBSCRIBERS TO THE "FARMER'S ADVOCATE" AT \$1 A YEAR.

**"CANADA'S IDEAL"** Admitted by judges, breeders and artists to be the most magnificent engraving of high-class modern Shorthorns ever issued in any country. 24 x 36 inches. Twelve animals.

**"CANADA'S PRIDE"** Nine celebrated draft horses. Your choice of any two of these for 1 new subscriber, or all four beautiful pictures for only 2 new subscribers.

**"CANADA'S GLORY"** Eleven celebrated light horses.

**"CANADA'S COLUMBIAN VICTORS"** Thirteen celebrated Ayrshire cattle.

**BEGIN TO CANVASS AT ONCE** FOR NEW SUBSCRIBERS. The Christmas number for 1901 will be sent FREE to all who now subscribe for 1902. **Subscription Price, \$1.00 per Annum.**

**Our Self-Binder** HANDY, DURABLE and ATTRACTIVE. Made to contain the 24 issues of the year. We will forward this Binder, postpaid, to anyone sending us the names of TWO NEW SUBSCRIBERS and \$2.00.

**Bagster's** NEW COMPREHENSIVE **Teacher's Bible,**

Containing the Old and New Testaments, according to the authorized version, together with new and revised helps to Bible study—a new Concordance and an indexed Bible Atlas, with SIXTEEN FULL-PAGE ILLUSTRATIONS, PRINTED IN GOLD AND COLOR.

**HOW TO OBTAIN IT—**

Would retail at from \$3 to \$4. We will send (carefully packed, post paid) this Bible to anyone sending us the names of TWO NEW SUBSCRIBERS to the FARMER'S ADVOCATE at \$1.00 each.

**Handsome Curb-link Bracelet: Silver Filled**



For 2 new subscribers. Sterling silver for 3 new subscribers. For each additional new subscriber, two Sterling Silver Friendship Hearts.

Write for a sample copy of the Farmer's Advocate, and begin to work for these premiums. Cash must accompany new names.

**THE WM. WELD COMPANY, LIMITED, LONDON, ONTARIO.**



# FARM BOOKS.

The farmer's home without an Agricultural Library is lacking in one of the chief aids to pleasure and success. We have gone over the available first-class works on agricultural subjects, and have selected the best. See below for prices and how to obtain.

## SOIL AND CROP.

- THE FERTILITY OF THE LAND.—*Roberts*. 372 pages. \$1.25.
- A BOOK ON SILAGE.—*Woll*. 185 pages. \$1.00.
- SOILING, ENSILAGE, AND BARN CONSTRUCTION.—*F. S. Peer*. 247 pages. \$1.00.
- SOILING CROPS AND THE SILO.—*Shaw*. 386 pages. \$1.50.

## LIVE STOCK.

- VETERINARY ELEMENTS.—*A. G. Hopkins, B. Agr., D. V. M.* \$1.50. A practical book for stockmen and agricultural students.
- THE STUDY OF BREEDS (CATTLE, SHEEP, AND SWINE).—*Prof. Shaw*. 400 pages; 60 engravings. \$1.50.
- HORSE BREEDING.—*Sanders*. 422 pages. \$1.50.
- LIGHT HORSES—BREEDS AND MANAGEMENT. 226 pages. \$1.00.
- HEAVY HORSES—BREEDS AND MANAGEMENT. 219 pages. \$1.00.
- CATTLE—BREEDS AND MANAGEMENT. 270 pages. \$1.00.
- SHEEP—BREEDS AND MANAGEMENT. 232 pages. \$1.00.
- ANIMAL BREEDING.—*Shaw*. 406 pages. \$1.50.
- THE DOMESTIC SHEEP.—*Stewart*. 371 pages. \$1.75.
- THE SHEEP.—*Rushworth*. 496 pages. \$1.50.
- PIGS—BREEDS AND MANAGEMENT.—*Sanders Spencer*. 175 pages. \$1.00.
- FEEDS AND FEEDING.—*Henry*. 600 pages. \$2.00.
- FEEDING OF ANIMALS.—*Jordan*. 450 pages. \$1.25.

Vinton Series.

## GENERAL AGRICULTURE.

- AGRICULTURE.—*C. C. James*. 200 pages. 30 cents.
- FIRST PRINCIPLES OF AGRICULTURE.—*Voorhees*. 207 pages. \$1.00.
- AGRICULTURE.—*Storer*. 1,875 pages, in three volumes. \$6.00.
- CHEMISTRY OF THE FARM.—*Warrington*. 183 pages. 90 cents.
- FARMYARD MANURE.—*Aikman*. 65 pages. 50 cents.
- IRRIGATION FOR THE FARM GARDEN AND ORCHARD.—*Henry Stewart*. 1.00.
- SUCCESSFUL FARMING.—*Rennie*. 300 pages. \$1.50, postpaid.
- AGRICULTURAL BACTERIOLOGY.—*H. W. Conn*. 400 pages. \$2.50.
- PHYSICS OF AGRICULTURE.—*F. H. King*. 600 pages. \$1.75.
- THE FARMSTEAD.—*I. P. Roberts*. 350 pages. \$1.25.

## DAIRYING.

- AMERICAN DAIRYING.—*H. B. Gurler*. 252 pages. \$1.00.
- THE BOOK OF THE DAIRY.—*Fleischmann*. 330 pages. \$2.75.
- MILK AND ITS PRODUCTS.—*Wing*. 230 pages. \$1.00.
- TESTING MILK AND ITS PRODUCTS.—*Farrington & Woll*. 255 pages. \$1.00.
- DAIRYING FOR PROFIT.—*Mrs. E. M. Jones*. 50 cents.
- DAIRY BACTERIOLOGY.—*H. L. Russell*. 350 pages. \$1.00.

## POULTRY.

- FARM POULTRY.—*Watson*. 341 pages. \$1.25.
- ARTIFICIAL INCUBATING AND BROODING.—*Cypher*. 146 pages. 50 cents.
- PRACTICAL POULTRY-KEEPER.—*Wright*. \$2.00.
- AMERICAN STANDARD OF PERFECTION.—*Pierce*. 278 pages. \$1.00.
- THE POULTRY MANUAL.—*Sevell & Tilson*. 168 pages. 75 cents.

## APIARY.

- THE HONEYBEE.—*Langstroth*. 521 pages. \$1.50.

## FRUIT, FLOWERS, AND VEGETABLES.

- VEGETABLE GARDENING.—*Green*. 224 pages. \$1.25.
- FLOWERS AND HOW TO GROW THEM.—*Rexford*. 175 pages. 50 cents.
- THE PRINCIPLES OF FRUIT-GROWING.—*Bailey*. 514 pages. \$1.25.
- BUSH FRUITS.—*Card*. 537 pages. \$1.50.
- HORTICULTURIST'S RULE BOOK.—*Bailey*. 312 pages. 75 cents.
- SPRAYING OF PLANTS.—*Lodeman*. 399 pages. \$1.00.
- THE NURSERY BOOK.—*Bailey*. 365 pages; 152 illustrations. \$1.00.
- AMATEUR FRUIT-GROWING.—*Samuel B. Green*. 5x7 inches; 134 pages, with numerous fly leaves for notes; bound in cloth, and illustrated. 50 cents.

## PLANT AND ANIMAL LIFE.

- THE STORY OF THE PLANTS.—*Grant Allen*. 213 pages. 40 cents.
- THE STUDY OF ANIMAL LIFE.—*J. A. Thomson*. 375 pages. \$1.75.
- INSECTS INJURIOUS TO FRUITS.—*Saunders*. 436 pages. \$2.00.

## MISCELLANEOUS.

- THE HOME PHYSICIAN AND CYCLOPEDIA OF MEDICINE.—By seven eminent physicians, aided by specialists. 1,300 pages; illustrated. Cloth, \$4.75; leather, \$5.75.
- LANDSCAPE GARDENING.—*S. T. Maynard*. 338 pages. \$1.50.
- BIRDS THAT HUNT AND ARE HUNTED.—*Neltje Blanchan*. 360 pages. \$2.25.
- RURAL WEALTH AND WELFARE.—*Fairchild*. 381 pages. \$1.25.

## HOW TO OBTAIN THESE BOOKS:

We will furnish present subscribers any of the above books for cash or as premiums for obtaining new yearly subscribers to the FARMER'S ADVOCATE at \$1.00 each, according to the following scale:

Books valued at from	\$0.30 to \$0.65,	for 1 new subscriber.
"	.90 to 1.25,	for 2 "
"	1.50 to 1.75,	for 3 "
"	2.00 to 2.50,	for 4 "
"	2.75	for 5 "
"	6.00	for 12 "

We can furnish any of the above books at the regular retail price, which is given opposite the title of the book. By a careful study of the above list, any farmer can choose a select list of books suited to his needs, and for a small outlay in cash, or effort in obtaining new subscribers for the ADVOCATE, secure the nucleus of a useful library.

Cash to accompany names in every case. Subscriptions credited a year in advance from date received.

The WILLIAM WELD CO., Ltd., London, Ontario.

# Want a Good Watch?

WE have succeeded in procuring from one of the most reliable jewelers in Canada a complete list of Gents' and Ladies' Watches of sufficient variety to suit every one, and have no hesitation in recommending them to our readers as premiums worthy of an effort to secure. These are not by any means trashy goods, but first-class in every particular, and we assure you that you will be pleased with whatever of the above premiums you may obtain. Let us hear from you at an early date with a good list of new subscribers accompanied by the cash, and take your choice.

## Gents' Watches.

No.	Description	New Subscribers.
No. 1.	Yankee Nickel Watch	2
No. 2.	Trump Nickel Watch	4
No. 3.	Trump Gun Metal Watch	5
No. 4.	No. 14 Silver Watch	8
No. 5.	7 Jeweled Gent's Elgin in 3 oz. Nickel Case	10
No. 6.	7 Jeweled Gent's Elgin in Gun Metal Case	11
No. 7.	7 Jeweled Gent's Elgin in Sterling Silver Case	14
No. 8.	7 Jeweled Gent's Elgin in 20-year Filled Case	18
No. 9.	7 Jeweled Gent's Elgin in 25-year Filled Case	21
No. 10.	15 Jeweled Gent's Elgin in 3 oz. Nickel Case	15
No. 11.	15 Jeweled Gent's Elgin in Gun Metal Case	15
No. 12.	15 Jeweled Gent's Elgin in Sterling Silver Case	18
No. 13.	15 Jeweled Gent's Elgin in 20-year Filled Case	21
No. 14.	15 Jeweled Gent's Elgin in 25-year Filled Case	25

## Ladies' Watches.

No.	Description	New Subscribers.
No. 15.	Gun Metal Swiss Chatelaine	4
No. 16.	Sterling Silver Swiss Chatelaine	5
No. 17.	Nickel American O. F., large size	5
No. 18.	Gun Metal American O. F., large size	5
No. 19.	Nickel, small size	9
No. 20.	Gun Metal, small size	10
No. 21.	Sterling Silver, small size	10
No. 22.	7 Jeweled Elgin in 20-year Filled Hunting Case	20
No. 23.	7 Jeweled Elgin in 25-year Filled Hunting Case	22
No. 24.	15 Jeweled Elgin in 20-year Filled Hunting Case	23
No. 25.	15 Jeweled Elgin in 25-year Filled Hunting Case	25

## Description of Watches.

The accompanying cuts fairly well represent all the Ladies' and Gents' Watches, and a description of each as numbered is as follows:

No. 1. American Nickel Key-wind Boy's Watch that is absolutely guaranteed to keep good time and give satisfaction.

No. 2. Gent's Nickel American O. F. Watch; stem wind, and push-in stem and turn to set hands. This is a very strong, reliable Watch.

No. 3. Same as No. 2, excepting that it has Gun Metal case instead of Nickel case.

No. 4. Is a smaller-sized Gent's Watch, has sterling silver case, O. F. Screw Back and Bezel; stem wind, and push-in stem and turn to set hands. This is the lowest-priced and most reliable Boy's or small Gent's Silver Watch that is on the market.

No. 5. Is fitted with 7-Jeweled Nickel, first-quality Elgin movement. The case is a 3-oz. O. F. Nickel case; stem wind and set; screw back and bezel case.

No. 6. Same movement in Gun Metal or Black Steel screw back and bezel case.

No. 7. Same movement with Sterling Silver O. F. screw back and bezel case.

No. 8. Same movement in 20-year guaranteed Gold Filled O. F. screw back and bezel case.

No. 9. Same movement in 25-year guaranteed Gold Filled O. F. screw back and bezel case.

Nos. 10, 11, 12, 13 and 14 are fitted in the same style of cases as Nos. 5, 6, 7, 8 and 9; the difference is in the movement, and the movement is 15-Jeweled Nickel, first-quality Elgin movement.

No. 15. Is a small-sized Swiss O. F. Gun Metal Chatelaine Watch.

No. 16. Is the same, only with Sterling Silver case, which can be had nicely engraved.

Nos. 17 and 18 are a good-quality American Watch, O. F. stem wind, and push-in stem and turn to set hands. These are a little larger than the usual Ladies' Watches, and are smaller than the usual Boys' Watches, though can be used for either Boys, Girls or Young Ladies.

Nos. 19, 20 and 21 are small sized; in fact, are the exact size of cut. These are American Watches, O. F. stem wind, and push-in stem and turn to set hands, and are first-class timekeepers. Will give perfect satisfaction.

If a nice leather wrist case is desired with these watches, send two extra subscribers.

Nos. 22, 23, 24 and 25 are similar to the accompanying cut. These are regular Ladies' Hunting Watches. Nos. 22 and 24 are fitted in 20-year guaranteed Gold Filled cases, nicely ornamented, or to be had in plain or plain engine turned, and the same applies to Nos. 23 and 25, excepting that they are fitted in 25-year guaranteed Gold Filled cases, and 14k Gold Filled; 22 and 23 are fitted with 7-Jeweled Nickel, first-quality Elgin movements. Nos. 24 and 25 are fitted with 15-Jeweled Nickel, first-quality Elgin movements.

When making your choice of Watch as premium, be sure to mention its number as given in premium list, also whether Ladies' or Gents'.

The WM. WELD CO., Ltd., London, Ontario.

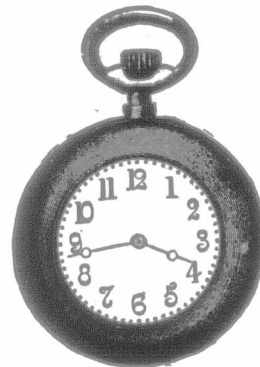
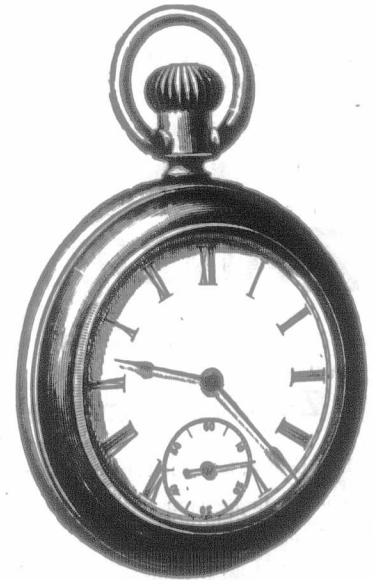



Horse Owners Should Use

GOMBAULT'S

**Caustic Balsam**The Great French Veterinary Remedy.  
A SAFE, SPEEDY AND POSITIVE CURE.

Prepared exclusively by J. E. Gombault, ex-Veterinary Surgeon to the French Government Stud.

**SUPERSEDES ALL CAUTERY OR FIRING**  
Impossible to produce any scar or blemish. The safest best Blister ever used. Takes the place of all liniments for mild or severe action. Removes all Bunches or Blemishes from Horses or Cattle.As a **HUMAN REMEDY** for Rheumatism, Sprains, Sore Throat, Etc., it is invaluable.**WE GUARANTEE** that one tablespoonful of **CAUSTIC BAL-SAM** will produce more actual results than a whole bottle of any liniment or spavin cure mixture ever made.Every bottle of **Caustic Balsam** sold is warranted to give satisfaction. Price \$1.50 per bottle. Sold by druggists, or sent by express, charges paid, with full directions for its use. Send for descriptive circulars, testimonials, etc. Address **THE LAWRENCE-WILLIAMS CO., Toronto, Can.****SITUATION WANTED**As manager or foreman on large farm, by capable married man, with thirteen years' experience in Canada. Best of references. Address: **P. F. R., FARMER'S ADVOCATE, LONDON, ONTARIO.****ZANZIBAR PAINTS.**Just ask your dealer for **Zanzibar Barn Paint,** and give it a trial.Low-priced, but good strong colors, and very durable. You can make your barns, roofs, silos, fences and all outbuildings waterproof and look clean and bright for a small outlay of money. **THEN, TOO:** Protect and brighten up your implements and wagons with**Zanzibar Agricultural Red, Green, and Black.**Made from the very best pigments. **BRILLIANT GLOSS, DURABLE COLORS, WEATHER AND RUST PROOF.****The Zanzibar Paint Co., Ltd., Toronto.** Write us if your dealer does not handle the goods.**Broadcast Seeders.**

THE LATEST AND BEST ON THE MARKET. ANYONE CAN USE THEM.

Price, **\$1.40** each**FRED HAMILTON, HAMILTON, ONT.** WHOLESALE AND RETAIL HARDWARE.DO YOU WISH TO OBTAIN **The largest and best crops** AT THE **smallest outlay?**

COMMUNICATE WITH

**G. Campbell Arnott, Agricultural Chemist,** Member Royal Agricultural Society of England, etc., 12 Richmond St. E. **TORONTO, ONT.**

Over 25 years' practical experience in the scientific manuring of soils and crops for profit, in Great Britain, Europe, and United States of America.

**SPRING BROOK POULTRY YARD.****EGGS FOR HATCHING.**

Barred Plymouth Rocks, from a pen of well-selected hens, mated with choice, typical cockerels of best strains, \$1 per setting, or 3 settings for \$2. Tamworths.—Young pigs ready to wean. A few Holstein calves to spare.

**A. C. HALLMAN, BRESLAU, ONT.** FORMERLY NEW HUNDER.**GOSSIP.**

The Battle Estate, of Thorold, manufacturers of the Thoroid cement, in writing regarding change of advertisement, mention that with them the season's cement business has opened up well, and that they are shipping several carloads of cement daily. A feature about this year's trade is that they are shipping carloads of cement to some points that they had not reached before, and with a steady continuation in this respect there will scarcely be a place or hamlet in Ontario where the well-known "Thoroid cement" will not have been used, and that they in no small measure give credit for this to the "Farmer's Advocate."

Mr. J. E. Casswell, breeder and exporter of Lincoln sheep, Shorthorn cattle, and Shire horses, Laughton, Folkingham, Lincs., England, who advertises in the "Farmer's Advocate," and who has one of the best flocks of Lincolns in England, writes: "I am glad to be able to inform you that so far the season has been most favorable to sheep-breeding. Both ewes and lambs are strong and healthy, so have been very little trouble. Up to February 12th I had 165 pairs, and 315 single lambs have gone away, which gives a little over one third pairs. My yearling rams are very even throughout, and look very promising; they were sired by the following rams: Laughton King-leader (6271), which won all the champion prizes he was eligible to compete for last season, including the Royal; also his sire Lincoln 130 Guineas (2783), which was the sire of Laughton 235 Guineas (4613), the champion sheep of the year 1899, also the sire of Laughton, which won 1st in a pen of five at the Lincolnshire Show, 1900. Pointon 105 Guineas (6409), Nocton Big Skin (3785), which cost 125 guineas as a shearing. Laughton Eclipse (5512), a son of Laughton Perfection. Laughton Vigor (3689), and others. This year's lambs are by the above rams, and others added to the flock as follows: Laughton Supreme ( ), which won 3rd prize in a pen of five at the Royal Show held at Cardiff; Laughton Rambler, which was highly commended at the same show; Pointon James, 1st in a pen of five at the above show and 1st at the Great Yorkshire Show.

"In Shire horses, of which I breed a good number, you will at once realize the quality of animals I keep when I tell you that I have been using for stud purposes such noted horses as Buscot Harold, Markeaton Royal Harold, Hury Victor Chief (all of which have won the championship in London two and three years together), Stroxtan Tom (champion, 1902), Meustrel, Hitchen Drayman (first-prize winners). The latter horse was purchased by myself and cousins for £600. If at any time you are in England, I shall be pleased to see you, or your friends, at Laughton."

The 23rd annual sale of Shorthorns from the Brandale herd of Mr. H. F. Brown, at Minneapolis, Minn., on March 25th, was very successful, the 35 head sold making an average price of \$750. The Canadian-bred bull, Royal Banner, bred by the Messrs. Watt, of Salem, Ont., and sired by the champion, Judge, brought \$1,500, being purchased by W. O. Carpenter, Pukwana, S. D. Imp. Juno, a red, four-year-old, by Star of Morning, sold for \$1,550, the highest price for a female, to W. H. Dunwoody, Minneapolis, Minn. Seven other females ran into four figures, bringing from \$1,000 to \$1,300, the former price being paid for the Canadian-bred cow, Minnie Benson 3rd, bred by David Birrell, Greenwood.

On March 26th, E. R. Strangland, Marathon, Iowa, sold 41 head of Shorthorns at auction at an average of \$185, the 37 females making an average of \$523, and the four bulls \$132.50 each. 20th Linwood Victoria, an American-bred cow, topped the sale at \$1,775.

On March 27th, Hector Cowan, Jr., Paulina, Iowa, sold 49 head for an average of \$512, the highest price, \$1,400, being realized for Dalmeny Princess 9th, by Scottish Sailor.

Mr. W. W. Chapman, Fitzalan House, Strand, London, the British agent of the "Farmer's Advocate," who is also Secretary of the Southdown Sheep Breeders' Association of Great Britain, has had large experience in selecting and shipping stock of all classes for export, and will be pleased to receive a call from Canadians visiting the Old Country in quest of stock and to afford any assistance in his power either in the purchase and selection of stock or in the shipping arrangements.

**THE "FARMER'S ADVOCATE" SELLS THEM.**

Mr. George G. Stewart, importer and breeder of Clydesdale horses, Rosebank Farm, Howick, Quebec, writes regarding his advertisement which appeared in our last issue: "With sixteen years' experience as an importer and advertiser in different papers in Ontario and Quebec, yours is the best and quickest returns I have made for all investments in that line, having disposed of Clydesdales 'Amphion' and 'Bucephalus' to Graham Bros., of Clarendon, Ont.; 'Voyageur' to John McTavish, of Killarney, Man., and 'Lord Gartley' to Wm. Hodgins, of Portage du Fort, Province of Quebec. Many farmers, the counties of Chateaugay and Huntington part with 'Lord Gartley' with regret, as he had gained a fine reputation, which will follow him. I leave for Scotland this month, and hope early in June to give you a list of my then importations."

1879—1901  
**ALWAYS PROGRESSING**

The original De Laval invention was followed by the "Alpha" Discs in the bowl, and later by the "Split-wing" shaft distributing device. The efficiency of the

**DE LAVAL CREAM SEPARATORS**

has been remarkably increased, the power required to operate them reduced, the prices alone have remained stationary. These machines started the procession and have kept at the head.

Send for new catalogue with full particulars.

**THE DE LAVAL SEPARATOR CO.**

NEW YORK 77 YORK ST. MONTREAL  
CHICAGO WINKFEG  
SAN FRANCISCO TORONTO PHILADELPHIA

**DON'T**

BUY A SEPARATOR UNTIL YOU HAVE SEEN THE

**National.**

**EXAMINE**

The simplicity of the design. All wheels and bearings protected, being perfectly safe in the hands of a child. It has anti-friction ball bearings. Few parts to wash—only two pieces inside the bowl. The National is made by The Raymond Mfg. Co. of Guelph, whose success with the celebrated Raymond Sewing Machine is sufficient guarantee of the high finish and workmanship. In 1901 five machines a day were manufactured. For 1902 the capacity is increased to 25 machines per day, showing the satisfaction given by the National in the past two years. The 1902 National contains all the strong points found in other separators, and is placed on the market with the guarantee of being the best and most up-to-date machine in every particular offered to the Western farmers to-day.

The National will well repay investigation by intending purchasers.  
National No. 1, capacity 330 to 350 lbs. per hour.  
National No. 1 A, capacity 450 to 500 lbs. per hour.

AGENTS WANTED IN UNREPRESENTED DISTRICTS.

**The Raymond Mfg. Co. of Guelph, LIMITED.**

GUELPH, ONT.

WE ALSO MAKE GOOD SEWING MACHINES.

**PURE SEED POTATOES.****PEARL OF SAVOY**, said by Prof. Zavitz, of O. A. C., to be one of the very best varieties for general use, 80c. per bag of 90 lbs. Bags free.  
**CLARK'S LEAMINGTON**, a new, good variety for general use, 50c. per peck.  
**GRASS PEAS**, \$1 per bushel. All f. o. b. Guelph, C. P. R. or G. T. R.**JAMES BOWMAN, GUELPH, ONT.****Real Estate Wanted**and for sale. If you want to sell or buy (no matter where located) send description and cash price and get (FREE) my successful plan. **W. M. OSTRANDER**, North American Bldg., Philadelphia, Pa.**BELGIAN HARES FOR SALE.**Address—\$3.00 PER PAIR.  
**W. C. STEARNS, PORT ROWAN, ONT.****4 Imp. Clydesdale Stallions 4**

Amphion, Vol. 24, 2 years old, bay; Bucephalus, Vol. 24, 2 years old, black; Voyageur, Vol. 24, 2 years old, brown; Lord Gartley, Vol. 23, 4 years old, brown. Representing the blood of Golden Sovereign, Sir Christopher, Montrave Matchless, and Royal Gartley.

**GEO. G. STEWART,** ROSEBANK FARM, P. O. and Station, Howick, Quebec.



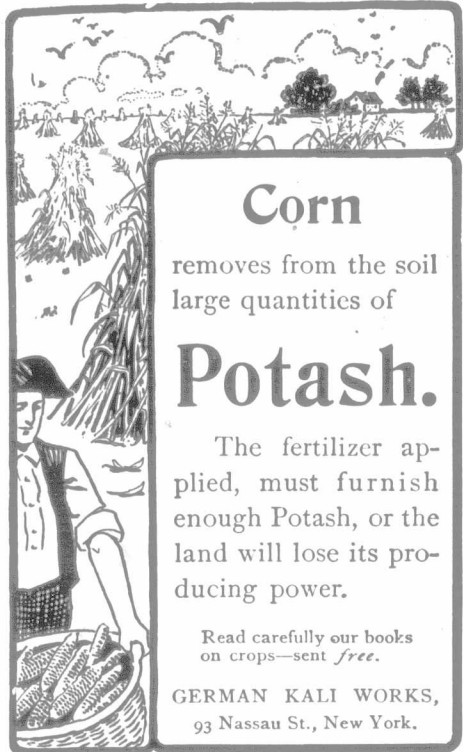

**Corn**  
removes from the soil large quantities of

**Potash.**  
The fertilizer applied, must furnish enough Potash, or the land will lose its producing power.

Read carefully our books on crops—sent free.

GERMAN KALI WORKS,  
93 Nassau St., New York.

**OAKLAWN FARM**  
THE GREATEST IMPORTING and BREEDING ESTABLISHMENT IN THE WORLD.

**PERCHERONS, FRENCH COACHERS.**  
On hand upward of **500 HEAD.**

Our late importations included the Principal Prize Winners at the Great Shows of France.

At the recent **INTERNATIONAL LIVE-STOCK EXPOSITION** at Chicago, the Oaklawn Percherons won every Championship, First Prize, and Gold Medal and every Second Prize in classes.

Notwithstanding the superior quality of our horses and the amply fair and certain terms of our breeding guaranty, backed by our well-known responsibility, it is a fact that our prices are lower than can be obtained elsewhere in America. Catalogue sent on application.

**DUNHAM, FLETCHER & COLEMAN,**  
WAYNE, DU PAGE CO., ILLINOIS.

**Standard-bred Trotting Stallion**  
FOR SALE: **ARKA 28725**

by J. I. Case 7511, dam Bell Royal, by O. A. C. 2072, second dam Maud A., by Bonair 1898, etc., etc. Arka is a seal brown, no white, stands about 16-2, weighed last spring (not fat) 1,260 lbs., and trotted last fall in 2:43 in a race, the second time he ever went a full mile at speed and the third time he was hitched to a trotting cart, but has no mark. He is one of the best horses I ever owned, which speaks volumes in his favor, but I have purchased the Standard-bred trotting stallion, Whitewood 7977, by Nutwood 600, dam by Cuyler 100, by Hambletonian 10, etc., etc., to breed principally to Arka's half-sisters, of which there are many, and circumstances prevent me from handling both, hence will sell very cheap. For particulars apply to

**O. A. COATES, BOTHWELL, ONT.**

**CLYDESDALE AND HACKNEY**  
STALLIONS AND MARES



FOR SALE: THE CLYDESDALE STALLION

**CHARMING LAD 2923**  
Rising 3; large size and very smooth; has won 6 prizes and a gold medal at Ottawa Exhibition. **LORD STANLEY 2537**, rising 2, also a prizewinner. **CLOTH OF GOLD 2959**, 5 years old; first-prize winner at Toronto and first and sweepstakes at London. Also brood mares and a number of very fine foals of both sexes. **TWO HACKNEY** stallions; also two mares rising 4 and 5 years old; large, handsome, high-steppers, well broken to drive. Size, action and quality combined in all. Inspection invited.

**O. SORBY, GUELPH, ONTARIO.**

**BRITISH COLUMBIA FARMS.**

IF you are thinking of going out to the Pacific Coast, try British Columbia. A delightful climate; no extremes of temperature; fertile land; ample rainfall; heavy crops, rapid growth, and splendid market for everything you raise, at good prices. The celebrated valley of the Lower Fraser River is the garden of the Province. Write for farm pamphlet telling you all about it, and containing a descriptive list of farms for sale.

**THE SETTLERS' ASSOCIATION OF B. C.**  
BOX 540, VANCOUVER, B. C.

**GOSSIP.**

Dentonia Park Farm, estate of the late Mr. W. E. H. Massey, Coleman post office, East Toronto, advertises eggs for hatching of five popular varieties of fowl, and also of Pekin ducks. Look up the advertisement if interested in this line. No expense has been spared in securing the best of each breed for the Dentonia breeding pens.

Colwill Bros., Newcastle, Ont., breeders of Lamworth swine, write: "We have sold nearly all our fall pigs, and our spring litters are fine strong fellows, as good as we ever had. Our customers can depend upon getting some choice stock this spring. The letters we are receiving from time to time from our customers are quite flattering. We are sending a boar to Manitoba this week by a Breeders' Association car."

Percheron Norman stallions, German Coach, Belgians, and large trotting stallions are advertised in this issue by Messrs. J. Crouch & Son, La Fayette, Indiana. This firm was very successful in winning prizes at the Pan-American and at the Chicago International Shows last year, their German Coach horse, Eulo, winning the \$300 gold medal sweepstakes at Buffalo. They state that they have Percheron stallions weighing from 1,800 to 2,400 lbs. Being large importers and having 200 stallions in their barns at present, they can sell as low as any firm in the United States. See their advertisement, and write for what is wanted.

H. Gee & Sons, Fisherville, Ont., breeders of poultry, in sending change of advertisement, say: "Commend the 'Advocate' as an advertising medium. Though we started in with a larger stock of Barred Rocks and Pekin ducks this year than any other, we are sold out of stock, not getting a single complaint from any customer. We have five pens mated up in both breeds, which our circular describes. It is free to 'Advocate' readers."

Mr. Henry Arkell, importer and breeder of Oxford Down sheep, Arkell, Ont., writes: "I have sold forty ewes in lamb this winter; sent them to the U. S., Quebec, N. S., and Ontario. Wintered 300 Oxford Downs, and they have come out of their winter quarters in great shape. It has been an exceptionally fine winter and spring in our part of the Province for stock. Have now seventy fine, strong, thrifty lambs, and expect a number more. Will have an extra fine lot of yearling rams and ewes for sale the coming summer. All sheep men are welcome at 'Farnham Farm'. It is always a pleasure to show them our Oxford Downs. Wishing the 'Advocate' continued and ever-increasing success."

The handsome imported Ayrshire cow illustrated by a photo-engraving on another page in this issue is representative of the high-class herd of Ayrshires maintained by Mr. J. N. Greenshields on his beautiful Isaleigh Grange Farm, at Danville, Quebec. Lady Bute was born April, 1895; bred by Messrs. R. & J. McAllister, Mid-Asco, Perth, Scotland; imported by Mr. Greenshields in 1898; sired by Yellow Chief of Castlehill; grandsire the noted Peter of Whitehill; dam Dandy S. of Mid-Asco, by Prince Duncan. She is a cow of grand constitution and large capacity for dairy work, and has a model milk vessel. A bull calf from this cow, and sired by the champion bull, Napoleon of Auchenbrain, is offered for sale in Mr. Greenshields' advertisement in this issue. Guernsey cattle are also bred at Isaleigh Grange, where a first-class herd of this breed is kept. In a note just received from Mr. W. Reid, Jr., the capable farm manager, ordering a change of advertisement, he says: "This last month has been a phenomenal one in the way of sales of young stock. We can attribute this chiefly to our advertisement in the 'Farmer's Advocate.'" Any one desirous of purchasing Ayrshires or Guernseys should write Isaleigh Grange Stock Farm for information.

Thos. Mercer, of Markdale, Ont., is one of the younger Shorthorn breeders that is rapidly coming to the front. His present herd of 60-odd head is made up of a number of each of the following families: Missies, Floras, Clarets, Princesses, Red Roses, Stamfords, Fashions, Matchlesses, and Crimson Flowers, and headed by that splendid stock bull, Village Squire 24993, sired by the champion, Abbotsford 19446, dam Village Flower 16865, by Prince Albert, by Barnpton Hero. Mr. Mercer's first venture in the Shorthorn arena was by the purchase of the prizewinning heifer, Dolly Stamford 29129, from the Messrs. Watt. Since then numerous purchases have been made, which have brought the herd to its present high standard. A glance at the stock bulls that have been used on the herd will show that Mr. Mercer has started right, and understanding as he does that the secret of success lies in the use of high-class sires, the public may rest assured that every care will be exercised to keep the herd at the front. Village Squire succeeds Aberdeen of Markham 23331 by Imp. Aberdeen, and Lovely Victor 22170, by Imp. Albert Victor. Mr. Mercer reports the demand for Shorthorns away ahead of any previous year. He also reports sales as being in every way entirely satisfactory. There is nothing in this herd reserved; everything can be bought worth the money.

**MAPLEWOOD HACKNEYS.**

PROPERTY OF **FREDERICK C. STEVENS,**  
ATTICA, N. Y.

Have won more challenge cups, more championships, more first prizes, and more value in prizes during the past seven years than all the other Hackneys of America combined.

**THIS IS THE PLACE TO BUY FOUNDATION STOCK.**  
Stallions of all ages, mares in foal, young mares and fillies. The best three carriage horse sires in America at the head of this stud: Langton Performer, Clifton 2nd, and Fandango.

SEND FOR CATALOGUE TO **E. T. GAY, MANAGER, ATTICA, N. Y.**

**Imported Stallions for Sale.**

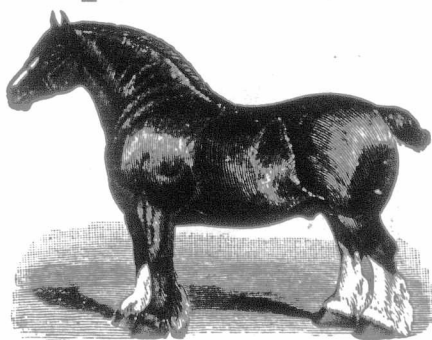

FOURTH consignment, per steamship from Glasgow, due to arrive end of February, 1902.

**DALGETY BROS., DUNDEE, SCOTLAND,** the largest importers and exporters of horses in Canada, have on hand just now a choice selection of above, including several prizewinners. Our fourth consignment this season. Largest and best lot from Glasgow show. They combine size, quality and action, and all good colors; age, from two years upwards; and will be for sale at

**BLACK HORSE HOTEL,**  
FRONT STREET, TORONTO, ONT., on Wednesday, March 5th, for one week; after that at our own stables, London, Ont. Any one in need of a good stallion should not miss seeing our stock before buying. Prices right. Apply to

**JAMES DALGETY, 229 HYMAN STREET, LONDON, ONTARIO.**



**SPECIAL OFFER IN BARCLAY'S PATENT ATTACHMENT**

FOR THE CONTROL AND CURE OF **BALKING AND KICKING HORSES.**

We will send our "Attachment," charges paid one way, to any part of Canada C. O. D., and subject to examination and approval of method. When satisfied it will do all we claim for it, pay the express agent our price, \$5.00. If not, the return freight will cost only a few cents. Our article will control any vice known to a horse, and is giving splendid satisfaction wherever used. Full illustrating splendid satisfaction wherever used. Full illustrating splendid satisfaction wherever used. Full illustrating splendid satisfaction wherever used.

THE **BARCLAY MFG. CO., BROUGHAM, ONTARIO.**

**TEN**  
**Choice Registered Fillies**

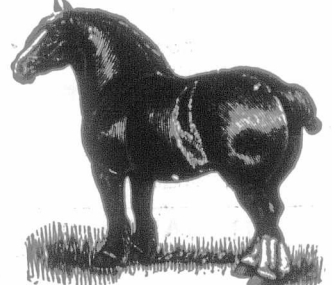

That I am now breeding to that noted stock horse, Lord Lynedoch (Imp.) (4530), also 4 young stallions under 2 years, and The Royal Arch [3171], rising 4 years old, sired by Erskine's Pride (Imp.) [1332], and a grand son of that prizewinning mare, Daisy (Imp.) 977.

**JOHN BRIGHT, MYRTLE, ONTARIO.**

**Lafayette Stock Farm.**

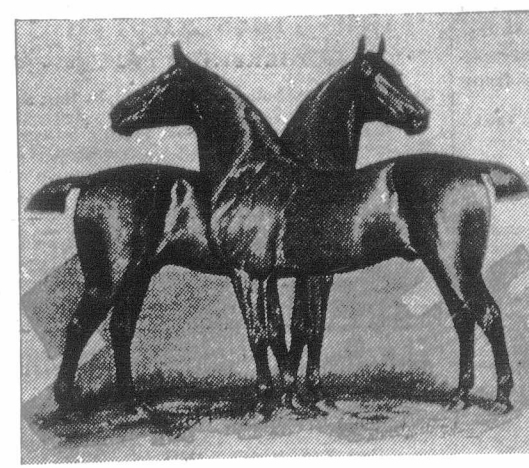

**LEADING IMPORTERS OF HIGH-CLASS HORSES OF AMERICA.**

One importation of German Coachers arrived January 9th, 1902; one of 42 head arrived March 9th, 1902, and our fourth importation so far this year, of Percherons and German Coachers, arrived March 30th. Our draft stallions, 3 to 5 years old, weigh 1,800 to 2,400 lbs. The great German Coach horse makes the best cross on small trotting-bred mares, producing horses that weigh from 1,100 to 1,400 pounds and stand 16 to 16 1/2 hands high, with finish and action. We give gilt-edge guarantee and terms to suit buyers.

**Oldenburg German Coachers, Black Percherons, Normans and Belgians.**

We import and sell more German Coach stallions than all others. We buy every horse ourselves direct from the breeder in Europe. Come to headquarters for high-class, serviceable stallions.

**J. CROUCH & SON, LAFAYETTE, IND.**

**PLEASE MENTION FARMER'S ADVOCATE.**



Clydesdale Stallions

FOR SALE. One seven-year-old. One three-year-old. Three two-year-olds. Also a few mares and fillies of good size and good quality. I. Devitt & Sons, Freeman P. O., Ont Burlington Junction Station 1/2 mile from farm.

WM. SMITH, COLUMBUS, ONT., IMPORTER AND BREEDER OF Clydesdale Horses & Shorthorn Cattle FOR SALE: One Imported Cleveland Bay Stallion Registered pedigree. Address: Hamilton Canning, Inverness, Que. Reedsdale, Que.

IMP. CLYDESDALES AND AYRSHIRE. The three imp. stallions, Copyright, Baron Frederick and Baron Laing, and the Canadian-bred stallion, Laurentin. Ayreshires all ages; and poultry, utility breeds. Eggs for sale. ROBT. NESS & SONS, Howick, Que., P.O. & Sta.

Smith & Richardson

COLUMBUS, ONT., IMPORTERS OF CLYDESDALE STALLIONS.

Our latest importation of 4 stallions is the best we ever made, weighing from 2,000 to 2,200 lbs., and of the well-known Darnley and Prince of Wales breeding. We have a number of pure-bred mares; also some young Canadian-bred stallions and fillies. Write for prices.

Railway Stations: Oshawa, G. T. R.; Myrtle, C. P. R. Long-distance telephone at Columbus.

4 Imp. Clydesdale Stallions

31 Imported Shorthorn Cows and Heifers. 7 Canadian-bred Cows and Heifers. 3 Imported Shorthorn Bulls. 5 Canadian-bred Bulls.

GEO. ISAAC & BROS., BOMANTON, ONT. OROUO STATION, G. T. R.

Shires, Shorthorns, and Leicesters. Young stock of both sexes for sale. Imported Prince Louis = 32082 = heads the herd. Write for prices or come and see them. John Gardhouse, Highfield P. O. Weston, G. T. R. and C. P. R.

FOR SALE: CLYDESDALES AND SHORTHORNS.

Stallions from sucking foals up. Brood mares and fillies of superior quality and breeding. A few grand young Shorthorn heifers, bred in the purple. Special mention, the great four-year-old stallion "Prince Lyon." THOS. GOOD, Richmond P. O., Ont. R. R. Station, Stittville, C.P.R.

DR. PAGE'S ENGLISH SPAVIN CURE

For the cure of Spavins, Ringbone, Curbs, Splints, Windgalls, Capped Hoof, Strains or Bruises, Thick Neck from Distemper, Ringworm on Cattle, and to remove all unnatural enlargements. This preparation (unlike others) acts by absorbing rather than blistering. This is the only preparation in the world guaranteed to kill a Ringbone or any Spavin, or money refunded, and will not kill the hair. Manufactured by DR. FREDRICK A. PAGE & SON, 7 AND 9 YORKSHIRE ROAD, LONDON, E. C. Mailed to any address upon receipt of price, \$1.00. Canadian agents: J. A. JOHNSTON & CO., DRUGGISTS, 171 KING STREET, EAST, TORONTO, ONT.

CLYDESDALE STALLION

Kinellar Stamp (3044). One-year-old bay. WM. BRASH, ASHBURN, ONTARIO.

HIGH PARK STOCK FARM. GALLOWSAYS of the choicest breeding and most fashionable strains. Inspection or correspondence invited. A. M. & ROBERT SHAW, P. O. Box 294, Brantford, Ont.

High-class Herefords

We have for sale the following choice young stock, which have been bred from imported and American sires. Intending buyers will do well to inspect the following: 18 young bulls, 2 sgd bulls, 20 young heifers. Correspondence invited.

A. S. HUNTER, DURHAM, ONT.

The Sunnyside Herefords.

Imp. Sunny Slope Tom 1st at head. The blood of Lord Willton, Garfield, Grove 3rd, Beau Real and Diplomat represented. Special offering: 5 bulls, good ones, ranging in age from 9 mos. to 2 1/2 years; 6 young cows and heifers. Inspection and correspondence solicited. 2 choice registered Berkshire boars, price \$10.00 each.

O'NEIL BROS., Southgate, Ont. Lucan station, G. T. R. Iderton station, L., H. & B.

The REID Hand Separator. gets from every milking the greatest quantity of cream available for churning; makes more and better butter possible. It is the only perfect hand Separator. Runs lightest, lasts longest. Sent anywhere on 10 days free trial. Send for our new catalogue and revised price list. A. H. REID 30th and Market St. Philadelphia, Pa.

INGLESIDE HEREFORDS.



A few choice heifers and young bulls by Mark Hanna, sweepstakes bull at Pan-American. Shropshire Sheep and Tamworth Swine. H. D. SMITH, Compton, Quebec.

JOHN DRYDEN, BROOKLIN, ONTARIO.

BREEDER OF CRICKSHANK SHORTHORNS AND CHOICE SHROPSHIRE SHEEP. Choice Young Bulls and Ram Lambs for sale. Write for prices.

J. R. McCallum, Iona Station, Ont. Offers young SHORTHORN BULLS and HEIFERS, of choice breeding, at reasonable prices. Iona Sta. on M.O.R., half a mile from farm.

BELLEVUE SHORTHORNS.

Both sexes. IMPORTED AND HOME BRED. All ages. Prizewinners at home and abroad.

EDWIN BATTYE, GORE BAY P. O. AND PORT.

"ORCHARD HILL" SHORTHORNS.

Herd comprises representatives of best Scotch-bred families, with Lord Lavender at head. Young animals of both sexes for sale. ARTHUR JOHNSTON, Vandeleur, Ont.

LAKE VIEW STOCK FARM. SCOTCH SHORTHORNS, both sexes, all ages. As good as the best.

Meaford Station, G. T. R. North. JAMES BOWES, Strathclair P. O.

FOR SALE: SHORTHORNS: 7 young bulls, from 8 to 10 mos. old, sired by Leta's Lad and out of deep-milking cows. H. E. HIND, Hagersville P. O. and Station, G. T. R. and, M. C. K.

SHORTHORNS AND LINCOLNS.

A. D. MCGUGAN, RODNEY, ONT. Herd headed by the great sire and sweepstakes bull, Abbotsford. Grand crop of calves from imported and home-bred cows. Bulls one year and under for sale - reds and dark roans. Ram and ewe lambs for sale at reasonable prices.

High-Class Shorthorns and YORKSHIRE PIGS.

2 GRAND show bulls, 16 months old, by Imp. Sirius; 8 bulls from 8 months old up; low-down, thick, fleshy fellows; all bulls of great substance. A few cows and heifers in calf. Yorkshires - A lot of young pigs 3 months old and down.

JAS. McARTHUR, Goble's, Ontario.

SPRINGBANK FARM. Shorthorn Cattle, Oxford Sheep, and Bronze Turkeys. Young bulls for sale.

JAS. TOLTON, WALKERTON, ONT.

Shorthorns and Leicesters.

Herd Established 1855. A number of young bulls, cows and heifers for sale. Imported Christopher = 28859 = heads the herd of large cows of grand milking qualities. Also a number of Leicesters of both sexes, from imported foundation.

JAMES DOUGLAS, OALEDONIA, ONT.

SHORTHORNS.

Fashionably bred, of both sexes and all ages. Nothing reserved. H. PARKEE, Durham P. O. and Station.

Shorthorn Bulls.

Good ones. Choicely bred. Moderate prices. Send for bull catalogue. Also Scotch-bred cows and heifers.

H. SMITH, HAY, ONTARIO.

Exeter station on London and Wingham branch of the G. T. R. adjoins the farm.

LESS LABOR AND MORE MONEY ON THE FARM.

BUY A LOW-DOWN, THICK-FLANKED

Hillhurst Shorthorn Bull,

Scotch-topped, from Cumberland, Gloucestershire, or Canadian dairy strain, and raise DEEP-MILKING, BIG-FRAMED COWS AND BABY BEEF in nature's way. Many cows that do not pay board at the pail will give a handsome return in growing beef. Four handsome young bulls, seven to nine months old, reds and roans, by the celebrated imported sires, "Joy of Morning" and "Scottish Hero," for sale at moderate prices. Low freights.

M. H. COCHRANE, COMPTON CO., P. Q., G.T.R., 117 MILES EAST OF MONTREAL. HILLHURST STATION.

Scotch Shorthorns

BREEDING FEMALES ALL IMPORTED.

Imp. Golden Drop Victor our present stock bull. Eleven young bulls and some young cows for sale at reasonable prices.

H. CARGILL & SON,

Cargill Station, G. T. R. CATALOGUE FREE. Cargill, Ontario.

DR. HESS' STOCK FOOD

Is the result of scientific study. It is formulated by Dr. Hess, a graduate of both veterinary and medical colleges. If the colleges of veterinary science know of nothing better it must be good.

What prominent Indiana stockmen say of it: - Evansville, Ind., Dec. 7th, 1901. DR. HESS & CLARK, ASHLAND, OHIO: GENTLEMEN, - We are feeders of Dr. Hess' Stock Food, and we will never do without it. We made a special test of it. We had a cow that was not doing well, little bit on the sick list. We began to feed Dr. Hess' Stock Food just as the directions stated, and in several days she showed an improvement in her appearance. A few days following we made a test of her milk, weighed it daily and in seven days she showed a gain of four pounds. We are feeding 60 head of cattle, 14 horses, 25 hogs, and our stock never did as well since we are in business. We cheerfully recommend Dr. Hess' Stock Food to the dairymen and stockmen. It will keep the cattle, horses and hogs in a fine condition. Yours truly, C. W. & C. KRATZ.

Dr. Hess' Stock Food is a Guaranteed Milk and Flesh Producer. It is not a stimulant, but a tonic. It builds up the system of the animal generally. Horses show greater ambition when fed Dr. Hess' Stock Food. They do more work and stand it better.

Feed Dr. Hess' Stock Food to your cows; if it doesn't pay, your money will be refunded. 7-lb. sack, 65c; 12-lb. sack, \$1.00. SOLD BY DEALERS GENERALLY, OR ADDRESS: THE GREIG MANUF'G CO'Y, CANAD'AN AGENTS, MONTREAL, QUE.

FREE - Dr. Hess' scientific veterinary work, giving the symptoms and latest treatment on stock diseases, will be mailed you for the asking. Address: DR. HESS & CLARK, ASHLAND, OHIO.

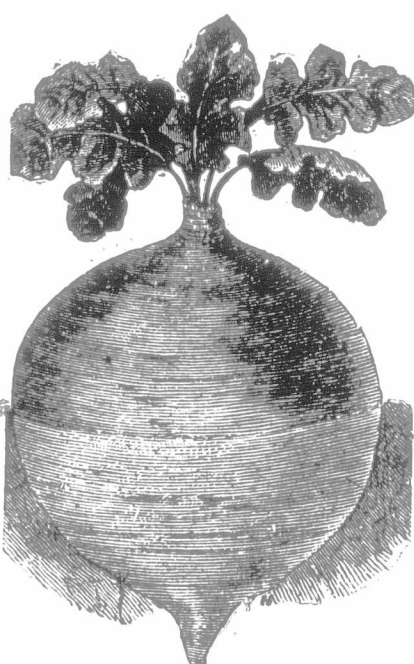

Bruce's New Century Turnip.

Bruce's New Century Swede Turnip.

After carefully testing this variety, we have no hesitation in offering it as one of the very best shipping varieties on the market, while for cooking purposes it excels all the ordinary swedes. It is a purple-top swede, resembling the Westbury, of handsome appearance, and splendid, uniform growth, and the roots are clean and well shaped. It is the best swede we know of to resist mildew, and is a heavy cropper. Price: 1 lb., 15c; 1/2 lb., 40c; postpaid.

Bruce's Giant Yellow Intermediate Mangel.

This is a distinct strain of the intermediate type, which, though a heavy yielder, on account of its shape is much more easily harvested than the long varieties. The enormous size of the roots, their handsome shape, bright, smooth, yellow skin, and flesh of the most solid texture and nutritious quality, all combine to make it the most valuable introduction of recent years. Since we introduced this variety in 1891, the sales of this grand mangel have grown by leaps and bounds, and we unhesitatingly recommend it. Price: 1 lb., 10c; 1/2 lb., 23c; postpaid.

Our beautifully-illustrated catalogue - 80 pages - mailed free to all applicants.

JOHN A. BRUCE & CO., Seed Merchants, HAMILTON, CANADA.

Established over half a century.



APRIL 15, 1902

**Maple Lodge Stock Farm.**  
ESTABLISHED 1854.

**SHORTHORNS.**—First-prize milking strains, best Scotch breeding. Young bulls and heifers for sale.  
**LEICESTERS.**—A grand lot of ewes, bred to our imported rams, and a few choice rams, now for sale.

**A. W. SMITH,**  
Alles Craig Station, Maple Lodge P. O., G.T.R., 3 1/2 miles. ONT.

**GREEN GROVE HERD OF SHORTHORNS.**

This herd is headed by the famous show bull, Spicy Robin = 28259 = (bred by J. & W. B. Watt), grandson of Imp. Royal Sailor, and of the noted English family, and contains such noted tribes as Nonpareils, Crimson Fuchsias, Mysies, Butterflys, and Langushes. Shorthorns of both sexes. Also a choice litter of Yorkshires, about 4 mos. old, for sale. Address: om  
**George D. Fletcher, Binkham P. O., Ont.**  
Erin Shipping Station, C.P.R.

**A QUICK, SHARP CUT**  
hurts much less than a bruise, crush or tear. Done with the **DEHORNING KEYSTONE KNIFE**. On the safest. Quick, sharp cut. Cuts from four sides at once. Cannot crush bruise or tear. Most humane method of dehorning known. Took highest award World's Fair, Write for free circulars before buying.  
Invented and Manufactured by R. H. McKenna, V. S., Picton, Ont.



**SHORTHORNS FOR SALE.**

Two good young bulls fit for service. Also females all ages. Herd headed by (imp.) Spicy Marquis. om  
**JAMES GIBB, Brookdale, Ont.**

**ROSEVALE SHORTHORNS**

Are of the up-to-date sort. We have for sale a number of young bulls and heifers of all ages. Marengo Heydon Duke (imp.) heads the herd. om  
**W.J. SHEAN & CO.**  
Owen Sound, Ont.

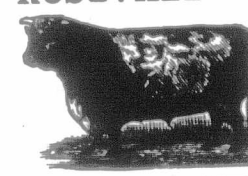

**Scotch Shorthorns**

Of both sexes, of the following noted families: Golden Drops, Rosebuds, Claras, Matchlesses, Strathallans, Vain Duchesses, Marr Beauties, Mayflowers, Crimson Flowers, and others; 56 head to select from. Herd headed by the imported Bracelet bull, Red Duke = 36084 = (77885). om  
**DAVID MILNE & SON, ETHEL P. O.,**  
Huron Co., Ont.

Ethel Station, G.T.R., half mile from farm. om

**JAMES A. CREERAR, Shakespeare, Ont.**  
BREEDER AND IMPORTER OF om

**HIGH-BRED SCOTCH SHORTHORNS**

**SHORTHORN BULLS FOR SALE:** A choice lot of Shorthorn bulls from 10 to 16 months old, sired by Imp. British Statesman (63729) = 20833 = ; and cows of the Mara family. They must be sold at once. Prices away down to suit customers. om  
**FITZGERALD BROS.,**  
Elmvale Station, G.T.R. Mount St. Louis P. O.

**A FEW CHOICE SHORTHORNS**

**YOUNG COWS AND HEIFERS**  
In calf to Imp. Prince of the Forest and Prince Ramsden; also a few young bulls fit for service. om  
**G. A. Brodie, Bethesda, Ont.**

**Shorthorns for Sale.**

6 heifers (all in calf), from Imp. British Statesman; also two young bulls, 18 months old. Write for prices. om  
**LOUIS ELLARD, Loretto P. O., Beeton Stn.**

**Bonnie Burn Stock Farm.**

40 rods north of Stouffville Station, Ont., offers Shorthorn bulls and heifers with calf. Shropshire ewes with lamb, and Berkshire pigs. All at farmers' prices. Inspection invited. om  
**D. H. RUSSELL, Stouffville, Ontario.**

**12 SHORTHORN BULLS.**

ALL UNDER TWO YEARS OLD.  
PRICE, FROM \$100 UPWARDS.

At the Toronto Industrial, 1900, the herd was awarded first for aged cows, three-year-old cows, two-year-old heifers, sweepstakes for female any age, first for herd (bull and four females), and first for breeder's herd.

Yonge Street trolley cars, from Union Station, Toronto, pass the farm several times a day.

**J. & W. RUSSELL,**  
RICHMOND HILL, ONT.

**SHORTHORNS.**

THORNHILL HERD. ESTABLISHED 27 YEARS.

Imp. Royal Member and Sailor Champion now at head of herd, which are all bred on straight Scotch lines, and are of the up-to-date kind. Present offering: some choice young bulls. om

**REDMOND BROS., Millbrook Sta. and P. O.**

**Mercer's Shorthorns**

Are represented by Missies, Stamfords, Floras, Claret Princesses, Red Roses, Fashions, Crimson Flowers, and Matchless families. Headed by Village Squire 24983, a son of Abbottsford. Stock of both sexes and all ages for sale. om

**T. MERCER, MARKDALE P. O., & STN.**

**J. & W. B. WATT,**  
SALEM, ONTARIO  
(POST AND TELEGRAPH OFFICE),

BREEDERS OF—  
Shorthorn Cattle, Clydesdale Horses, Leicester and Oxford Sheep, and Berkshire Pigs.

Our herd contains such families as Matchlesses, English Ladies, Mildreds, Village Buds, Missies, Stamfords, Mysies, Vanillas, Clarets, and Marthas. The imported bulls, Scottish Peer and Coming Star (a prizewinner at Chicago in 1901), now head the herd.

Farms 2 miles from Elora Stn., G.T.R. and C.P.R., 12 miles north of Guelph. om

**E. JEFFS & SON, BOND HEAD, ONT.**  
BREEDERS OF  
High-class Shorthorns, Leicesters and Berkshires.

Young bulls and heifers; young boars and sows for sale. Write, or come and see. om

**Shorthorns, Cotswolds & Berkshires**

**FOR SALE:** Nine young bulls from 6 to 18 months old, sired by Prince George = 28973 =, a Scotch-bred bull of the Miss Ramsden family, and from good milking dams. Cows, heifers and heifer calves. A choice lot of ewe lambs. Young pigs of the bacon type from 2 to 6 months old. om

**F. BONNYCASTLE & SON, CAMPBELLFORD, ONTARIO.**

**Centre Wellington Scotch Shorthorns**

Young bulls, heifers and young cows for sale. Farm adjoining town on G.T.R. and C.P.R. Correspondence solicited. om

**H. B. Webster,**  
Box 66. FERGUS, ONT.

**SHORTHORNS:**

We are offering 3 extra choice yearling bulls, all from imported sires, straight Cruickshank, with Lavendar and Miss Ramsden dams. om  
**THOS. ALLIN & BROS.,**  
Oshawa, Ont.

**HIGH-CLASS SCOTCH SHORTHORNS**

of the following families, for sale at moderate prices: Village Girls, Broadhooks, Beaufort Roses, Missies, Clarets, Marr Floras, Nonpareils, Minas and other choice families. Write for catalogue. Shropshire rams and ewes for sale as usual. om

**ROBERT MILLER, Stouffville, Ont.**

**SHORTHORNS (IMP.)**

Cows and heifers, imp. and home-bred. Bulls, imp. and home-bred—all ages. Representing the fashionable blood of Scotland. om

**EDWARD ROBINSON,**  
MARKHAM P. O. & STN.

**Charles Rankin**  
WYEBRIDGE, ONT.,  
IMPORTER AND BREEDER OF  
SHORTHORNS,  
OXFORD DOWNS  
AND  
BERKSHIRE PIGS.

Young stock always on hand. om

**10 SHORTHORN BULLS**

From 6 to 18 months old. Nearly all from imp. dams, and sired by the imp. Golden Drop bull, Royal Prince. Catalogue upon application. om

**John Miller & Sons, Brougham P. O.**  
CLAREMONT STATION, C. P. R. ONT.

**W. G. PETTIT & SON,**  
FREEMAN P. O., ONT.,

IMPORTERS AND BREEDERS OF  
**Scotch Shorthorns and Shropshire Sheep,**

Are offering 10 imp. bulls from 10 months to 2 years old; 10 home-bred bulls from imp. stock, 10 to 15 months old; 40 imp. cows and heifers, all ages. Home-bred cows and heifers all ages. Also a grand lot of ram and ewe lambs and yearling ewes for sale. om

**Burlington Jct. Stn. Tele. & Phone, G. T. R.**  
PLEASE MENTION FARMER'S ADVOCATE

**TROUT CREEK HERD OF Shorthorns**

Won first prize for herd and the championship for best bull and best female, any age, at Toronto Industrial and Pan-American Exhibitions, 1901. We keep constantly in our herd a choice lot of imported and Canadian-bred cattle of both sexes. Personal inspection invited. Parties desiring to see the herd will be met on arrival of trains if notice is given. Visitors always welcome. Address:

**JAMES SMITH,** **W. D. FLATT,**  
Manager, 378 HESS ST., SOUTH,  
MILLGROVE, ONT. Hamilton, Ontario.

**Queenston Cement.**

No better cement for durability and economy in building concrete houses, barn foundations and floors, silos, cisterns, etc. Estimates and all other information cheerfully given. Low prices. Write to this office, or see my agents before giving your order.

**Isaac Usher,**  
QUEENSTON, ONT.

**ARTHUR JOHNSTON, GREENWOOD, ONTARIO.**

BREEDER OF POST OFFICE AND TELEGRAPH OFFICE. IMPORTER OF  
**SHORTHORNS ONLY.**

**FOR SALE:** 9 imported bulls and bull calves. 11 home-bred bulls and bull calves, from imported cows and by imported bulls. 17 home-bred bull calves. A large and excellent lot of young cows and heifers of various ages. om

**RAILWAY STATIONS:** PICKERING, G. T. R., 22 MILES EAST OF TORONTO. CLAREMONT, C. P. R., 28 MILES EAST OF TORONTO.

**Spring Grove Stock Farm.**

**Shorthorn Cattle AND Lincoln Sheep.**

HERD prize and sweepstake at Toronto Industrial Exhibition, 1897 and 1898. Herd headed by the Marr Missie bull, Imp. Wanderer's Last, last of the get of the great sire, Wanderer, of the Cruickshank Brawith Bud tribe. High-class Shorthorns of all ages for sale. Also prizewinning Lincolns. Apply om

**Rapids Farm Ayrshires.**

REINFORCED BY RECENT IMPORTATIONS of 2 bulls and 20 cows, selected from noted Scotch herds, and including the male and female champions at leading Scotch shows last year. Imported Douglasdale Dam of Aber, champion at the Pan-American, heads the herd. Representatives of this herd won the first herd prize at the exhibitions at— om

Toronto, London and Ottawa in 1900, and at the Pan-American in 1901.

Come and see or write for prices. Young Bulls and Heifers for Sale, bred from High-class Imported Stock.

**Robert Hunter, Manager**  
for W. Watson Ogilvie, Lachine Rapids, Quebec.



**Mark Your Stock  
Dip Your Stock  
Cure Your Stock  
Shear Your Stock**



We make a specialty of Ear Labels and Buttons, Tattoo Markers, Milk Oil Sheep Dip, Cooper Sheep Dip (English), Worm Powders, Insect Powder, Rice's Lice Paint, Shears, Shearing Machines, Toxaline French Worm Cure, Crooks, Bells, Poultry Tonic, Poultry Bands, Shepherds' Cordial.

All Best and Cheapest.

Write for Illustrated Catalogue.

**F. S. BURCH & CO.,**  
178 Michigan St., Chicago.  
Mention this paper

**W. R. BOWMAN,**  
MOUNT FOREST, ONT.

Is offering two richly-bred Shorthorn bulls, 12 and 15 months old, at \$80 each; one Angus bull, 18 months, at \$85. Choice Plymouth Rock eggs, 5 settings for \$2. A number of York sows, bacon type, bred to our Toronto winners, at \$15 each.

**Shorthorns and Berkshires**  
Four young bulls, 6 to 12 months old. Pigs, 2 to 6 months old. Pairs supplied not akin.

**MAC CAMPBELL, NORTHWOOD, ONT.**

**Shorthorns, Berkshires, Leicesters**  
Am offering at present the grand stock boar, Crown Prince; also some young ones.

**ISRAEL GROFF, ALMA, ONTARIO.**

**MAPLE GROVE SHORTHORNS.**  
I am now offering 5 bulls from 10 months to 2 years old; imp. and home-bred; of the low, fleshy sort. Write for prices.

**W. B. CAMPBELL,**  
Campbellcroft P.O. Garden Hill Station.

**SHORTHORNS FOR SALE.**  
Three dark red bulls, 12 mos. old, got by Diamond Jubilee (imp.). One rich roan, 10 months old, got by Favorite 24690. For prices write—

**E. & C. PARKINSON,**  
Thornbury P. O. and station: G. T. R.

**10 SHORTHORNS FOR SALE**  
Sired by Scottish Chief and (imp.) Chief of Stars, and from prizewinning dams. Also cows, heifers, and Berkshire pigs.

**ALEX. LOVE, - EAGLE P. O.**  
Bismarck Station on M. C. R.

**SHORTHORNS:** We are offering for sale 8 bulls, from 8 months to 3 years old, by Mungo 2nd and Scottish Bard. Also a few cows bred to Baron's Heir.

**ROBT. GLEN, Owen Sound, Ontario.**

**Scotch-bred Shorthorns** For Sale—One 3 year-old Gloucester dam; three bulls from 9 to 16 months old, from Cecelia dams. Prices right.

**N. A. STEEN,**  
on MEADOWVALE STATION AND POST OFFICE.

**HAWTHORN HERD**  
of deep-milking Shorthorns for sale. Six young bulls of first-class quality and breeding and from A1 dairy cows.

**WM. GRAINGER & SON,**  
Londesboro, Ont.

**For Sale:** Very heavy, massive cows of Bates and Cruickshank breed. Two-year-old heifers in calf. Stock bull, Imperial 2nd, No. 28883. Bull calf, 11 months (Cancopper Boy 2nd = 39878=), dam Flora = 32974=; also dark red heifer calves. **John McFarlane, Dutton, Ont.**

**SCOTCH SHORTHORNS.**  
We are now offering a few young bulls, from 6 to 11 months; also a few heifers, from 6 months to 2 years; all showing No. 1 quality.

**W. G. HOWDEN, - om COLUMBUS P. O.**

**SHORTHORNS.**  
One bull, 1 year old; two bulls, 7 months old; a few heifers of choice breeding and superior quality.

**AMOS SMITH,**  
Listowel station, Trowbridge P. O., Ont.

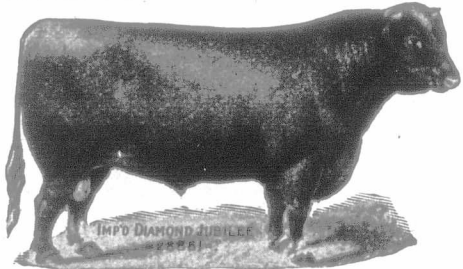

**T. DOUGLAS & SONS, STRATHROY, ONT.,**  
BREEDERS OF

**Shorthorns & Clydesdales**  
100 SHORTHORNS TO SELECT FROM.  
Herd bulls (imp.) Dian and Jubilee = 28861= and Double Gold = 37852=. April offering: Eight grand young bulls, and cows and heifers of all ages. Clydesdales: One 3-year-old stallion, and one 4-year-old mare in foal. Farm one mile north of town.

**FOR SALE:** 5 Scotch Shorthorn Durhams (bulls), 5 to 16 months; 5 young cows and heifers. Berkshire pigs, both sexes. Prices reasonable. "Camden View Farm."  
**A. J. C. SHAW & SON, Thamesville P. O.**

**HOLWELL MANOR FARM**  
SHORTHORNS,  
SHROPSHIRES,  
YORKSHIRES,  
SCOTCH COLLIES.

**D. G. GANTON, ELMSVALE, ONT.**

**SHORTHORNS FOR SALE.**  
Two bulls ten months old, two heifers one year old, one three years old in calf. Write for prices.

**JAS. RIDDEL, BEETON P. O. and STN.**

**R. Mitchell & Son, Nelson, Ontario.**  
**Scotch Shorthorns.**  
Twenty-five (imp.) bulls and heifers of following families: Jilt, Roan Lady, Augusta, Rosebud, Mayflower, Rosemary, Beauty, Victoria, Orange Blossom and Princess Royal. Also home-bred heifers in calf to imp. bulls and choice bull calves.

**Burlington Jct. Station and Tele. Office.**

**QUEENSTON HEIGHTS SHORTHORNS**  
SCOTCH AND SCOTCH TOPPED

In service: Derby (imp.) = 32057 = ; Lord Montalis, by Collynie Archer (imp.) = 28860 =. Some choice heifers and young cows with calf at foot or in calf to imported bull at moderate prices.

**HUDSON USHER,**  
QUEENSTON, ONT. om  
FARM 3 MILES NORTH NIAGARA FALLS

**SHORTHORNS.** FOR SALE: 2 choice bulls—one 20 months old and the other 11 months. Also Barred Rock eggs, \$1 per setting. Millar strain. Write: **C. & J. CARBUTHERS, Cobourg, Ont.**

**Shorthorn Cattle, Lincoln Sheep**  
Imp. Prime Minister at head of herd. Imp. Clippers, Miss Ramsdens, and other Scotch families. Lincolns won more than half the money and first for stock at the Pan-American; International, Chicago, 1901 and 1902.

**J. T. GIBSON, om DENFIELD, ONT.**

**Hillside Shorthorns and Shropshires.**  
Bulls, from 8 to 18 months old; heifers, various ages, of true type and fashionable breeding; also 25 ram lambs and 15 ewe lambs, from imp. sire. Will quote prices right for quick sales.

**L. Burnett, Greenbank P. O., Ont.; Uxbridge Sta., G. T. R.**

**SHORTHORNS (imported)**  
Two choice young imported bulls—one roan and one red. Write:

**THOS. RUSSELL, EXETER, ONT.**

**25 HOLSTEIN CALVES**  
For March, April and May delivery, from such noted strains as Homestead De Kol, Abbekerk Chief, and Corelia Ykema, imported, and others. We have spared no expense in getting the best pedigrees furnished. Express prepaid. Safe arrival guaranteed.

**H. GEORGE & SONS,**  
CRAMPTON, ONT. om

**4 HOLSTEIN BULLS 4**  
FOR SALE: From 4 to 7 months old, having sires in their pedigrees from such strains as Inka, Netherland, Royal Aggie, and Tritonia Prince, and out of imported females that have proven their worth at the fair.

**THOS. B. CARLAW & SON,**  
Warkworth.

**Brookbank Holsteins**  
16 to 25 lbs. of butter in 7 days' official test are the records of this herd of Holstein cows. Heifers of equivalent records. Bulls for sale whose sires and dams are in the Advanced Registry, with large official butter records.

**GEO. RICE, Currie's Crossing, Ontario.**  
OXFORD COUNTY.

**RIDGELING CASTRATION.**  
om- **DR. J. WILSON, V. S., WINGHAM, ONT.**, Specialist in the castration of ridgeling horses and colts. Terms and testimonials on application.

**Ridgedale Farm Holstein-Friesians for Sale.**  
2 yearling bulls; also bull and heifer calves; all of choice breeding. Prices always reasonable. Write, or come and see them. **R. W. WALKER, Utica P. O.** Shipping stations: Port Perry, G. T. R.; Myrtle, C. P. R. om

PLEASE MENTION FARMER'S ADVOCATE.

**A CULTIVATOR STORY**

**MASSEY-HARRIS Cultivator**

is undoubtedly the most satisfactory and the simplest Cultivator made.

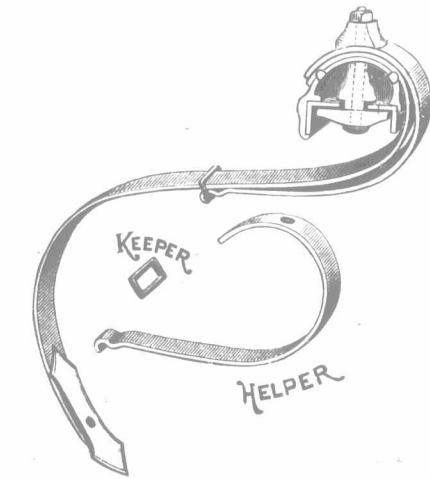

The "Keeper" and "Helper" shown are important features—they prevent the teeth breaking.

If you don't want continually to buy new teeth for your cultivator, obtain a

**"Massey-Harris"**

in the first place.

The Massey-Harris name is known in every farmhouse in the Dominion. It stands for Canadian industry, reliability, and fair usage to customers.

**Riverside Holsteins**

Five bulls, 9 to 11 months old, for sale. Victor De Kol, Pieterje and Johanna Rue 4th's Lad head the herd.

**MATT. RICHARDSON & SON,**  
HALDIMAND CO. CALEDONIA, ONT.

**Exmoor Jerseys for Sale.** Heifer calf. On bull calf by Sirda of St. Lambert. Also a registered cow four years old White Leghorn and Plymouth Rock hens' eggs, \$1 per setting.

**A. Norman Smith, Meaford P. O. and Stn**

**SUNNYLEA FARM.**  
For sale: Jerseys—6 yearling bulls; females any age. Tamworths—30 boars and sows, different ages. Shropshire sheep—rams and ewes of good breeding. Prices reasonable.

**H. E. WILLIAMS, Knowlton, P. Q.**

**FOR SALE: JERSEY BULL.**  
Carlo of St. Lawrence, A.J.C.C. 52387; four years old; weighs 1,400 pounds; solid color; strikingly handsome; gentle and kind. For pedigree, price and photo apply to

**ALEX. THOM, MORRISBURG, ONT.**

**CHOICE JERSEYS.**  
A offering 1 cow 5 years old, due to calve Feb. 6, very choice; bull calf 11 months old, registered, and cheap.

**WM. N. HASKETT,**  
Avon Manor, Markdale, Ont.

We have now on hand young females sired by **Nero of Glen Rouge 50241,** and cows and heifers bred to him.

**E. B. HINMAN & SON, GRAFTON, ONT.**

**BRAMPTON JERSEY HERD**  
Offers: 3 St. Lambert bulls from 6 to 14 months old, out of high-testing cows; 1 yearling and 5 bull calves, sired by Brampton's Monarch (imp.). Four young bulls sired by him won 1st, 2nd and 3rd prizes under one year, and 1st prize under six months, also 1st, 2nd and 3rd at London and Ottawa, in 1901. The best is none too good. These young bulls have never been beaten. Get one to head your herd.

**B. H. BULL & SON, BRAMPTON, ONT.**  
G. T. R. and C. P. R. Stations.

**FOR SALE: A SPLENDID LOT OF Jersey Cattle.**

41 HEAD TO CHOOSE FROM.  
Close descendants of my most noted prizewinners, and closely related to many animals I have sold that have won easily in the Northwest and all over Canada. My shipments last summer ranged from Manitoba to State of Delaware, U. S.

**MRS. E. M. JONES,**  
BOX 324, BROCKVILLE, ONT., CAN.

**LAWNRIIDGE STOCK FARM.**  
JERSEYS FOR SALE: Yearling bull, and bull 8 mos. old. Several fine registered and grade cows coming in every week. A few choice young heifers. Five Berkshire sows in pig. Finest strains.

**J. L. CLARK,**  
Norval station: G. T. R. Norval P. O.

**F. L. GREEN,**  
BREEDER OF  
Jersey Cattle and Yorkshire Pigs.  
Choice stock of each sex for sale.

**PICKERING STATION, G. T. R. GREENWOOD P. O.**  
CLAREMONT STATION, C. P. R.

**JERSEYS FOR SALE**  
A few choice Jersey bulls and bull calves for sale at very low prices. Choice breeding; good colors. Write for prices.

**W. W. EVERITT**  
CHATHAM, ONT.  
"Dun Edin Park Farm," Box 555. om

**Wm. Willis, Newmarket, Ont.**  
Breeder of A. J. C. C. Jerseys and registered Cotswold sheep. Have yet two fine young bulls from Count, fit for service; also Yorkshire swine.

**MILKING STRAIN**  
Young stock of either sex for sale. One fine Ayrshire bull out of the famous Lady Bute (imported sire), 8 months old. Guernseys, 6, 8 and 12 months.

**AYRSHIRES GUERNSEYS**  
When writing for descriptions kindly state age. Address:  
**Isaiah Grange Farm, Danville, Quebec.**

**"Here's Your Calf. Got Your Tag On."**  
No need to slit the ear of your animals to mark them. Mark all your stock with the Aluminum "Stay There" Ear Marker. Contains your name, address, and consecutive numbers on each tag. No rusting or wearing off, inexpensive, and perfectly easy and simple to attach. We send free sample and prices upon application.

**WILCOX & HARVEY MFG. CO., 194 Lake St., Chicago, Ill.**





**SWISS Cow Bells**  
Patented Design. Made from Finest Quality Swiss Bell Metal.  
We sell exclusively to the jobbing trade, but to introduce these delightfully musical Swiss Cow Bells more generally, offer them singly or in sets, tuned to accord. Made in 4 different sizes, with extra fine and substantial straps, or singly with or without straps. Send for circular of Cow, Sheep and Turkey Bells, etc. We are the oldest Bell Makers in America.  
BEVIN BROS. MFG. CO., EAST HAMPTON, CONN.



**"VIGILANT" NEST**  
SLIDING—ADJUSTABLE (Patented Can. & U.S.)  
The only nest in the World which positively prevents hens from eating their eggs.  
Simple—Effective—Durable  
No springs—Eggs cannot break. The inclined nest gathers them safely in lower section. Prevents fleas, or parasites, etc. Everlasting, never failing, comfortable. Thousands now in use. Ask your dealer for it or write to L. F. MORIN, Inventor, Mfr., 12 Antoine St., St. Hyacinthe, Que.  
Price 45c. each. AGENTS WANTED.



**NOTICES.**  
**BARN PAINT.**—Realizing the hesitancy on the part of farmers to buy high-priced oil paints, the Zanzibar Paint Co., Ltd., Toronto, have put on the market a barn and roof paint in several attractive colors, at a price which will enable almost every farmer to keep his buildings in a good state of preservation and well appearing. Zanzibar barn paints are smooth, durable, and bright, ready for the brush, and easily applied. See advertisement.

**A FINE COOK BOOK FREE.**—By sending your name and address on a post card to J. Hewitt, 61 Front street east, Toronto, and mentioning the "Advocate," you can get a fine cook book, containing 262 recipes, sent to your address, absolutely free of charge. Besides the recipes, this book contains much information valuable to the careful housewife. Send for it to-day. You will be delighted with it.

**SPECIALTIES FOR STOCKMEN.**—It is in a spirit of fair play that the old-established stockman's supply house of F. S. Burch & Co. (whose advertisement will be found in our columns) are soliciting the support of owners of live stock. Their leading specialties are sufficiently well known throughout the States, among the most important being their non-poisonous Milk Oil Sheep Dip, Summers Worm Powders, ear labels and markers. Many other articles are offered by this firm, and our readers should send for their new illustrated catalogue, in which, no doubt, will be found ample testimony of the value of the respective preparations.

**NEW VETERINARIANS.**—At the closing exercises of the Ontario Veterinary College in Toronto, on March 27th, Prof. A. Smith, B. Sc., D. V., principal, took the chair, and addresses were delivered by Mayor Howland, Prof. Mavor, and Prof. Lang, of the Toronto University; Mr. W. K. McNaught, President of the Toronto Industrial Exhibition, and Dr. Duncan, M. D., Mayor of Toronto, who congratulated the College upon his success in conducting the College, where were some seventy graduates, representing Great Britain, Newfoundland, the United States, and Canada.

**IDEAL FENCING.**—McGregor, Baerwell & Co., Windsor, Ont., announce that they have embarked in the manufacture of woven wire fencing, with ample up-to-date machinery. They have issued a catalogue which freely describes the excellencies of their fencing, with which readers would do well to familiarize themselves by obtaining a copy.

**SUCCESS WITH THE BLOWER.**—The Thom Implement Works, Watford, Ont., were pioneers in the introduction of the blower elevator in filling silos, demonstrating the practicality of doing so with farm power for two horses upward. It is very gratifying, therefore, to that firm to receive such letters as the following:

The No. 13 blower and ensilage cutter I purchased from you two years ago is giving the best of satisfaction. The first year I got a 10-horse-power steam engine to run it, as I thought it required steam power; but last year I could not get an engine, so had to resort to my two-horse tread power, and it handled it far above my expectations, having harvested 13 acres of heavy corn in a little less than five days, elevating to a height of 22 feet, and without chocking once in that time. I used a seven-inch-diameter leather-covered pulley. I might say we have been silo-filling for fifteen years now, and in that time we never handled the same amount of corn in so short a time and with so little help as we did last year with the two-horse tread power and the No. 13 blower.  
Yours truly,  
W. McCRIMMON,  
Glenroy, Ont., March 17th, 1902.

**GONE INTO OIL.**—Mr. Alonzo W. Spooner, of Toronto, who has had many years' experience in the oil business, has taken an active interest in the Grant-Hamilton Oil Co., of that city, who have large new factories and warehouses for the production and handling of lubricating oils, etc. We bespeak for Spooner and his enterprise every success.

**GOSSIP.**  
H. Bollert, of Cassel, writes, under date of March 24th, that he has now on hand two grandly-bred Holstein bulls, 15 and 18 months old. One of them is from a cow he considers capable of giving from 85 to 90 lbs. of milk in a day. She will shortly be tested by a representative of the O. A. College. Her dam has given 90 lbs. in 24 hours, and was a noted prizewinner.

**GOOD PRICES FOR HEREFORDS.**  
At the sale of 75 head of Herefords from the Weavergrace herd of Mr. T. F. B. Sotham, Chillingthorpe, Mo., held at Chicago, March 25th, good prices were realized, the entire disposal averaging \$454 per head! The two-year-old heifer, Galatea, by Corrector, topped the sale at \$1,650. Mr. Geo. E. Ricker, Quincy, Ill., being the purchaser. Lady Charming, a six-year-old daughter of Corrector, brought \$1,350, and two others sold for \$1,000 and \$1,005.

**CANADIAN PACIFIC RY**  
**SETTLERS' ONE-WAY EXCURSIONS**  
To Manitoba and Canadian Northwest will leave Toronto every TUESDAY during APRIL, '02. Passengers travelling without Live Stock should take the train leaving Toronto at 1:45 p. m. Passengers travelling with Live Stock should take the train leaving Toronto at 9:00 p. m. Colonist Sleeper will be attached to each train. For full particulars and copy of "Settlers' Guide," apply to your nearest Canadian Pacific Agent, or to  
W. FULTON, City Pass. Agent, 161 Dundas St., cor. Richmond, London, Ont.  
A. H. NOTMAN, Asst. Genl. Pass. Agent, 1 King St., East, Toronto.

**An Archipelago of 30,000 Islands.**  
Historic interest surrounds the locality, and health and life permeate the atmosphere among the 30,000 Islands of the Georgian Bay—that great eastern arm of Lake Huron which is visited by thousands of tourists each year. Splendid fishing, good boating and bathing, house-boat and camp life galore, immunity from hay fever, magnificent scenery among the tortuous windings of navigable channels, and good hotel accommodation are some of the attractions. Write for handsome illustrated descriptive matter, giving full particulars, list of hotels, rates, etc., to M. C. Dickson, Dist. Pass. Agt., G. T. R., Union Sta., Toronto.—Adv't.

**Settlers' Low Rates West.**  
Chicago & North-Western R'y; every day during March and April. Colonist one-way second-class tickets at very low rates from Chicago to points in Colorado, Utah, Montana, Nevada, Idaho, Oregon, Washington, California, Victoria, Vancouver, New Westminster, Nelson, Rossland, and other points in Kootenay District. Also special round-trip Homeseekers' tickets on first and third Tuesdays, March, April and May. Full particulars from nearest ticket agent, or B. H. Bennett, General Agent, 2 East King St., Toronto, Ont.

**To Rid Stock of Lice AND ALL SKIN DISEASES. Also to Keep Poultry Healthy**  
USE **WEST'S FLUID**  
Which is also a SURE CURE OF CONTAGIOUS ABORTION. STANDARD SHEEP DIP IS CHEAP AND GOOD. Pedigree forms free to customers. Manufacturers:  
**The West Chemical Co'y, TORONTO, ONT.**

**AYRSHIRE CATTLE AND POULTRY.**  
FOR SALE: Royal Star of St. Annes, 1st-prize bull at Toronto and London, also heifer calves, heifers and cows from dams with milk records from 40 to 64 lbs. per day. Price from \$35 to \$80 each. Barred Plymouth Rocks, Black Minorcas, Cornish Indian Games, \$1.50 each. Four pair Toulouse geese, \$4.00 per pair. For particulars write  
**WILLIAM THORN, Lynedoch, Ontario.**  
Norfolk Co., Front Run Stock Farm. —om

**FOR SALE:**  
Three grandly-bred Ayrshire bull calves, 12 to 15 mos. old. Also young calves, by Napoleon of Auchenbrain (imp.), whose dam has a record of 72 lbs. of milk per day. A few choice young Berkshire and Yorkshire sows could be served before shipping. Collie pups, from Perfection Queen. Address—  
**T. D. McCALLUM, Nether Lea, Danville, Que.**

**LIVE STOCK EAR LABELS REDUCED.**  
Send for a circular and order early, before the rush. Large and small lots and odd numbers supplied.  
**K. W. James, Bowmanville, Ont.**

**"PEERLESS" MACHINE**  
IT'S WORTH REMEMBERING. **OIL**  
**QUEEN CITY OIL CO., Limited, TORONTO.**  
SAMUEL BOGERS, PRESIDENT.

**AYRSHIRES AND YORKSHIRES.**  
We always have on hand choice individuals, male or female, of above breeds. Write us.  
**ALEX. HUME & CO., Menie, Ontario.**

**SPRINGHILL FARM.**  
Importers and breeders of choice, deep-milking **Ayrshires**  
Males and females for sale.  
**ROBERT HUNTER & SONS, Maxville, Ont.**

**NEIDPATH AYRSHIRES.** Four (4) August, 1901, bull calves. A number of heifer calves, yearlings and two-year-olds. Also a few March, 1902, bulls. **W. W. HALLANTYNE, Stratford, Ont.**  
Farm adjoins city, main line G.T.R. —om

**5 AYRSHIRE** bull calves for sale, from 6 to 12 months old. Sired by Klondyke of St. Ann's 8897. Their dams are heavy milkers, with good udders and teats. Inspection invited.  
**W. F. STEPHEN, Trout River, Quebec.**  
(Carr's Crossing, G. T. Ry.) —o

**Ayrshire Bulls** from 14 years to 6 months, from special milking stock, sired by the sweepstakes bull, Cock of the North—9997—also females all ages. Shropshire sheep. Berkshire pigs, either sex, and B. P. Rocks. For particulars write —om  
**J. YULL & SONS, Carleton Place, Ontario.**

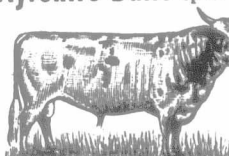

**NO HUMBUG!** PERFECT instruments in 3 one. Humane Swine V. Stock Marker and Calf Dehorner. Stops swine of all ages from rooting. Makes 48 different ear marks, large or small, with same blade. Extracts horns. Testimonials free. Price, \$1.50; or send \$1, get it on trial, if it suits send balance.  
Patented April 23, 1901, U.S.  
**FARMER BRIGHTON, Fairfield, Iowa.**

**HOMECROFT,** a farm for dairying and pure-bred stock: **AYRSHIRES, IMPROVED CHESTER WHITES, BARRED PLYMOUTH ROCKS. SOME FINE YOUNG BULLS.**  
**J. F. Parsons & Sons, Barnston, Quebec.**

**Tredinnock Ayrshires.**  
Imported bulls at head of herd: Glencairn 3rd, Napoleon of Auchenbrain, and Lord Dudley. Forty imported females, selected from leading Scotch herds, and their produce from above-named bulls. Size combined with quality and style, well-formed udders, good-sized teats, and capacity for large milk production. Bull calves for sale; also a few young cows and heifers. For prices and particulars address  
**JAMES BODEN, Mgr., St. Anne de Bellevue, Quebec.**  
Farm close to St. Anne Station, G.T.R. & C.P.R., 20 miles west of Montreal. —om

**DAVID A. McFARLANE,** Breeder of high-class **KELSO, P. Q. AYRSHIRES.**  
Young stock for sale from imported and home-bred foundation. Prices reasonable. —o

**FOR SALE:** IMPORTED AND HOME-BRED **AYRSHIRES,** including cows, heifers and young bulls out of our prize and sweepstakes cows. Foundation selected with due regard to quality and productiveness. Come or write.  
**WM. WYLIE, - HOWICK, QUEBEC.**

**AYRSHIRES.**  
Five bulls ranging from 11 to 23 mos., from such noted cows as Jean Armour, Lady Ottawa, Sprightly and Primrose (imp.), and from the best sires procurable. Also heifers and cows all ages, and poultry.  
**WM. STEWART & SON, MENIE, ONT.**

**I Will Cure You of Rheumatism**  
No pay until you know it.

After 2,000 experiments, I have learned how to cure rheumatism. Not to turn bony joints into flesh again; that is impossible. But I can cure the disease always, at any stage, and forever.

I ask for no money. Simply write me a postal and I will send you an order on your nearest druggist for six bottles of Dr. Shoop's Rheumatic Cure, for every druggist keeps it. Use it for a month, and if it does what I claim, pay your druggist \$5.50 for it. If it doesn't, I will pay him myself.

I have no samples. Any medicine that can affect Rheumatism with but a few doses must be drugged to the verge of danger. I use no such drugs. It is folly to take them. You must get the disease out of the blood.

My remedy does that, even in the most difficult, obstinate cases. No matter how impossible this seems to you, I know it and I take the risk. I have cured tens of thousands of cases in this way, and my records show that 39 out of 40 who get those six bottles pay, and pay gladly. I have learned that people in general are honest with a physician who cures them. That is all I ask. If I fail I don't expect a penny from you.

Simply write me a postal card or letter. Let me send you an order for the medicine. Take it for a month, for it won't harm you anyway. If it cures, pay \$5.50. I leave that entirely to you. I will mail you a book that tells how I do it.

Simply state which book you want and name of your dealer, and address  
**DR. SHOOP, Box 52, Racine, Wis.**

**ELECTRIC Handy Farm Wagons**  
make the work easier for both the man and team. The tires being wide they do not cut into the ground; the labor of loading is reduced many times, because of the short lift. They are equipped with our famous Electric Steel Wheels, either straight or stagger spokes. Wheels any height from 24 to 60 inches. White hickory axles, steel hounds. Guaranteed to carry 4000 lbs. Why not get started right by putting in one of these wagons. We make our steel wheels to fit any wagon. Write for the catalog. It is free.  
**ELECTRIC WHEEL CO., BOX 253, QUINCY, ILL.**



**WINDMILLS**

**THE CANADIAN AIRMOTOR TORONTO**  
You require one that will do your work satisfactorily. The



**Canadian AIRMOTOR**

**TERROR TO WORK.**  
WHY? **CAST-IRON CONSTITUTION, MECHANISM SO SIMPLE, MATERIAL THE BEST.**

**ONT. WIND ENGINE & PUMP CO. LIMITED. TORONTO, ONT.**

Fitzgerald Bros., Mt. St. Louis, Ont., offer, at farmers' prices, young Short-horn bulls sired by Imp. British Statesman. See their advertisement.



GOSSIP.

A St. Joseph, Missouri, horse dealer is reported to have got a contract for 12,000 horses, to be delivered at the rate of 500 per month, for use in the British army in South Africa.

J. & W. B. Watt, Salem, Ont., breeders of Shorthorns and Clydesdales, write: "Our cattle came through the winter looking their best. We have a very promising lot of calves, and although we have made a great many sales, the herd numbers seventy-five head. About the end of February we shipped our junior sweepstakes bull (at Toronto Industrial), Royal Wonder =34682=, to C. L. McClellan, Lowden, Iowa. Royal Wonder was never beaten in Canada, and when sold weighed 1,970 pounds, at 29 months. We recently purchased the three-year-old Clydesdale mare, Grace Darling 5th, from Mr John Isaac, Markham. She was the highest-priced mare at Mr. Isaac's sale, and weighs 1,650 pounds. The third-prize mare at Toronto Industrial last year, Moss Bank [3043], which we purchased from Mr. George Crawford, Oro, is looking fine, and weighs over 1,900 pounds. These mares are full of quality, and have the best of action.

The third international conference of sheep breeders will be held at Carlisle, England, on July 5th, during the week of the Royal Show, which is this year to be held in that city. Mr. A. Mansell, of Shrewsbury, will read a paper at the meeting on "The deleterious effect produced by the use of substitutes for wool in the manufacture of so-called woollen articles in England, America, and on the Continent; their injurious effect on the prices of wool, and the desirability of legislation to prevent the sale of such goods as woollen goods." The Secretary, Mr. W. W. Chapman, 32 Fitzalan House, Arundel St., Strand, London, will be pleased to have the names and addresses of breeders or representatives of societies who may intend to be present at the conference, so that any subsequent communication that may be needful can be made direct to them.

We are in receipt of the 1902 catalogue of the Ratcheugh herd of Shorthorns belonging to Mr. William Bell, Alnwick, England, whose advertisement is running in the "Farmer's Advocate." The catalogue contains the pedigrees of nearly one hundred animals, representing a number of excellent families and the blood of a long list of choicely-bred bulls from such noted herds as those of Messrs. Duthie, Cruickshank, Campbell, Marr, Shepherd, and of others bred in the herds of Her late Majesty Queen Victoria and Lord Polwarth. Among the stock bulls in service is Baron Abbotsford, first as a two-year-old at the Royal Show last year, by Baron Alnwick, out of Lady Clara 3rd, by the Duthie-bred Abbotsford, and her dam by Lord Lavender, bred by Mr. Cruickshank, grandam by William of Orange. A full brother is Baron's Pride, bred in the herd, a prizewinner at the Royal and many other leading shows, their dam, Lada Clara 3rd, having been a winner at the Royal three years, at the Highland Show three years, at the Yorkshire four years (including the Shorthorn dairy prize and the family prize with her two sons), and at Durham two years, including champion cup for best breeding animal among cattle. Canadian importers would do well to look over the Ratcheugh herd, where they will find quality, substance and symmetry combined with good sound breeding.

**LITTLE'S PATENT FLUID NON-POISONOUS SHEEP DIP AND CATTLE WASH**

**THE ORIGINAL Non-Poisonous Fluid Dip**  
Still the favorite dip, as proved by the testimony of our Minister of Agriculture and other large breeders.  
**For sheep.** Kills ticks, maggots; cures scab; heals old sores, wounds, etc., and greatly increases and improves growth of wool.  
**Cattle, horses, pigs, etc.** Cleanses the skin from all insects, and makes the coat beautifully soft and glossy.  
Prevents the attack of Warble Fly.  
Heals saddle galls, sore shouldered, ulcers, etc. Keeps animals free from infection.  
**No danger, safe, cheap, and effective**  
Beware of imitations.  
Sold in large tins at 75 cents. Sufficient in each to make from 25 to 40 gallons of wash, according to strength required. Special terms to breeders, ranchmen, and others requiring large quantities.  
**SENT BY ALL DRUGGISTS. SEND FOR PAMPHLET.**  
**Robert Wightman, Druggist, Owen Sound**  
Sole agent for the Dominion. —om

**STEWART'S SHEEP SHEARING MACHINE**  
Highest and Only Award at Pan-American Exposition.  
1902 Model, price including grinder, only **\$1850**  
Will be fitted with the wonderful Stewart Shear same as supplied with the \$65.00 Power Machine. No owner of 10 Sheep or more can afford to shear by hand even though the work be done for nothing. Don't butcher your sheep. Shear with this machine, and get ONE POUND WOOL EXTRA PER HEAD. Will more than cover the whole cost of shearing. Send today for valuable book on shearing. It is free and will save you money.  
**CHICAGO FLEXIBLE SHAFT CO., 150 La Salle Ave., Chicago, Ill.**

**E. T. CARTER, Wool TORONTO.**  
SUCCESSOR TO JOHN HALLAM 83 & 85 Front St. E., TORONTO.

EUROPEAN ADVERTISEMENTS.

**Ayrshire** HERD OF 150 cows and heifers, bred from deep milkers, with large teats, of a commercial stamp. Established over half a century. J. & A. Wilson, Boghall Farm, Houston, Renfrewshire, Scotland. —om

**PEDIGREE AYRSHIRES.** Cows and heifers, all bred from prizewinning stock at the leading shows. —om  
Robert Wilson, Mansurae, Bridge of Weir, Renfrewshire, Scotland.

**English Shorthorns.** Booth and Bates Shorthorns, topped with Cruickshank bulls. Young cows, bulls and heifers always on hand for sale. Eligible for the American herdbook. Royal and Highland prizewinners included for the last two years. Close on £400 won in prizes last year and this. —om  
WM. BELL, Ratcheugh Farm, Alnwick, Northumberland, Eng.

**JOHN BRYAN & SON, Southleigh, Witney, OXON.** — One of the oldest registered flocks of pure-bred Oxford Downs. Annual sale of rams. Oxford ram fair. Rams and ewes for sale at home. Inspection invited. —o

**FAMOUS ALL OVER THE WORLD ALFRED MANSELL & CO., LIVE STOCK AGENTS AND EXPORTERS, SHREWSBURY.**  
BRITISH STOCK selected and shipped to all parts of the world. Write for prices to ALFRED MANSELL & CO., Shrewsbury, England, or to our American representative, Robert Miller, Stouffville, Ont., Canada.

**HAMPSHIRE DOWN SHEEP GREAT ENGLISH PEDIGREE SALES, July, August & Sept., 1902**  
Waters & Rawlence, Salisbury, Eng., will sell by public auction, during the season, upwards of  
**50,000 PURE-BRED EWES, LAMBS, RAMS.**  
including both rams and ewes from the best registered prizewinning flocks in the country. Commissions carefully executed. Address—

**Waters & Rawlence, SALISBURY, ENGLAND.**

**WALTON HERD OF PEDIGREE PIGS.**  
The property of Sir Gilbert Greenall, Bart., Walton Hall, Warrington, England.  
This herd is unrivalled for its true type, large size and strong constitutional vigor. It is the premier herd in England at the present day. Its show-yard career is unique, the champion prize for the best Large White pig at the R. A. S. E. having been won by pigs bred in the herd in 1896, '97, '99 and 1901, besides leading prizes too numerous to mention at all the principal agricultural shows in England.  
A choice selection of boars and sows for sale. Inspection invited. All purchases carefully shipped. For particulars, apply to the Manager, MR. J. HALLAS, Higher Walton, Warrington, England. Railway stations:—Warrington (Bank Quay) per L. & N. W. Ry.; (Central) per Midland, G. N. or G. C. Rys. Telegrams, "HALLAS Higher-Walton."  
—om  
IN WRITING  
**PLEASE MENTION FARMER'S ADVOCATE**

**W. W. CHAPMAN, Secretary of the National Sheep Breeders' Association, Secretary of the Kent or Romney Marsh Sheep Breeders' Association, and late Secretary of the Southdown Sheep Society.**  
Pedigree Live Stock Agent, Exporter and Shipper. All kinds of registered stock personally selected and exported on commission; quotations given, and all enquiries answered.  
Address: FITZALAN HOUSE, ARUNDEL ST., STRAND, LONDON W. W.  
Cables—Sheepcote, London. —om

**J. E. CASSWELL'S LINCOLNS.** Laughton, Folkingham, Lincolnshire, England.  
Breeder of Lincoln Long-wooled sheep. Flock No. 46. At the Palermo Show, 1900, 25 rams bred by J. E. Casswell averaged £54 each; 14 of the best averaged £63 each, this being the highest sale of the season in the Argentine. Ram and ewe hoggs and shearings for sale; also Shire horses, Shorthorns, and fowls. Telegrams: "Casswell, Folkingham, Eng." Station: Billingham, G. N. R. —o

**Kent or Romney Marsh ANNUAL RAM SALE.**  
The annual show and sale of registered Kent or Romney Marsh rams, consisting of selected specimens from leading flocks of the breed, will be held on  
**FRIDAY, OCTOBER 3, 1902,** AT  
**ASHFORD, KENT, ENGLAND.**

Catalogues and full information from  
**W. W. CHAPMAN, Secretary Kent or Romney Marsh Sheep Breeders' Association, Fitzalan House, Arundel Street, Strand, London, Eng.**

**Robert W. Hobbs, Kelmscott, Lechlade, England.**  
One of the largest flocks in Oxford Down Flockbook. Numerous prizes obtained for ram lambs at principal shows. Rams and ewes always on sale. —o

**FARMERS! KEMP'S INSTANTANEOUS Sheep Dip**  
Contains more value for the money than any other Dip on the market. We will send a tin prepaid to any part of Ontario for ONE DOLLAR. Half gallon, imperial measure, in each tin. It is the cheapest disinfectant for outbuildings, drains, etc. —om  
**W. W. Stephen, MEAFORD, ONTARIO.**

**FAIRFIELD LINCOLNS** Imported ewes and lambs. Can supply show flocks. —om  
**J. H. PATRICK, ILDERTON, ONT., CAN.**

**COTSWOLD HILL STOCK FARM** Offers imp. and home-bred Cotswolds of both sexes and all ages, from the champion flock of Canada for the last six years.  
**JOHN PARK & SONS, Burgessville P.O. and Stn.** —om



To Farmers, Stock Dealers and Wool Growers: For Sheep, Cattle, and Horses.  
**Leicestershire Tick and Vermin Destroyer**  
It effectually destroys Ticks, Lice, Worms or Grub, to which sheep, horses and cattle are subject, and enables the animals to thrive. It will be found far superior to other preparations used for the similar purpose. The proprietors will guarantee perfect success when used according to directions, as will be found on each box. It prevents scurf and scab, and renders the wool bright and clear. It is put up in tin boxes, price 30 cents each. One box is sufficient for twenty ordinary-sized sheep. It only requires to be tried to prove itself all that is claimed for it. Sold by druggists and grocers. Manufactured by G. C. BRIGGS & SON, 31 King Street West, Hamilton, Ont. —o

**COOPER SHEEP DIP**  
STANDARD OF THE WORLD  
for 60 years. Used on 250 millions annually. Superior to all other kinds. No smell. Benefits while it cures. Keeps flock clean a long time. Increases growth and quality of wool. Used by large majority of sheep breeders in all countries.  
If local druggist cannot supply, send \$1.75 for \$2 (100 gal.) pkt. to  
**EVANS & SONS, Limited, Montreal and Toronto.**

**American Leicester Breeders' ASSOCIATION.**  
A. W. Smith, Pres., Maple Lodge, Ont. Pedigrees now being received for Vol. 4. For information, blanks, etc., address:  
**A. J. TEMPLE, Sec., CAMERON, ILL., U. S. A.**  
**JOSEPH FERGUSON, UXBRIDGE, ONT., BREEDER OF**

**Pure-bred Cotswolds—choice quality** —om  
**UXBRIDGE P. O. AND STATION.**

**IMPORTED COTSWOLDS**  
We are now offering some choice shearings of both sexes; also this season's crop of lambs, sired by Imp. Swanwick.

**BROOKS & LANGMAID, COURTICE, P. O.** —om  
SIX MILES FROM OHAWA STATION, G. T. R.

**CHAS. GROAT, BROOKLIN, ONT., OFFERS FOR SALE**

**Cotswold Ewes and Ewe Lambs** of good quality and breeding. Also a registered stallion, 1 year old, and one filly foal. Good ones. A Duchess of Gloster bull, 15 months old, for sale. Write for price and particulars. —om

**"FARMHAM FARM" Oxford Down Sheep**  
Am offering 40 choice yearling rams to head flocks. 50 superior yearling ewes. 70 ranch rams. 100 ram and ewe lambs of 1902. From imported sires, and a number from imported dams. All registered. Barred Rock eggs, 75 cents per setting. —o  
**HENRY ARKELL, ARKELL, ONT.**

**SUMMERHILL OXFORDS.**  
Present offering: A choice lot of ram lambs and ewe lambs. Also 50 extra nice yearling ewes.  
**PETER ARKELL & SONS, Teeswater P. O. and Station.** —om

**OXFORD DOWNS** Imported and home-bred, for sale. This flock has won more first prizes for Canadian-bred pens than any flock in Canada. **SMITH EVANS, Gourock (near Guelph), Ont.** —o

**BROAD LEA OXFORDS.**  
Can sell a few choice ewes of different ages; bred to our imported rams, May King 1st and Earl of Fairfield 2nd; also 75 good ewe and ram lambs, and an imported two-shear ram. Come and see our flock, or write us for prices, etc. —om  
**HENRY ARKELL & SON, TEESWATER, ONT. MILDMAY, G. T. R.; TEESWATER, C. P. R.**

**Linden Oxford and Shorthorns**  
Flock composed of selections from the best English flocks and their progeny. None but the best imp. rams used. Stock for sale. —om  
**R. J. HINE, Dutton, Ont.**

**HIGH-CLASS SHROPSHIRE.**  
A flock of 75, of good type. Two-shear rams, shearing rams, ram lambs, ewe lambs, fine lusty fellows. Flock headed by a fine imported ram. Write for prices. **Abram Rudell, Hespeler P.O., Ont.** —om  
C. P. R. and G. T. R.

**50 REG. SHROPS. 50**  
FOR SALE:  
Shearing and two-shear rams; also stock ram, bred by John Miller & Sons, and this season's crop of lambs ready for the fall trade. Foundation stock bred by Mansell, England. Prices moderate. A card will bring them. **ROWAT BROS.,** Phelpston station, G. T. R., 5 miles east. **Hillsdale, Ont.** —om  
Simcoe County.

**LARGE ENGLISH YORKSHIRES.**  
Sows due to farrow in May and June, bears fit for service, sows ready to breed, bears and sows 8 weeks old. Over 100 to choose from. All lengthy, deep, smooth type. Priors reasonable. Write:  
**Jas. A. Russell, Precious Corners, Ont.**  
**PLEASE MENTION FARMER'S ADVOCATE.**



# MICA ROOFING!

USE Mica Roofing on all your buildings.

IT IS CHEAPER THAN SHINGLES.

WATERPROOF. FIREPROOF.

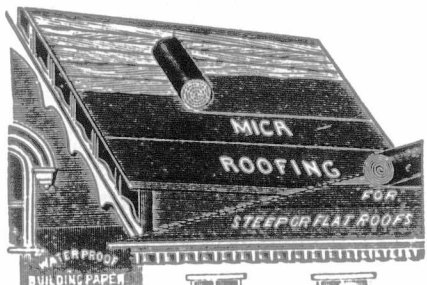

RAPIDLY TAKING THE PLACE OF SHINGLES. Is put up in rolls of one square each, 40 feet long by 32 inches wide, and costs only \$2.25, including nails, thus affording a light, durable, and inexpensive roofing, suitable for buildings of every description—especially flat roofs—and can be laid by any person of ordinary intelligence.

HAMILTON MICA ROOFING CO., OFFICE: 101 REBECCA ST., HAMILTON, ONT.

## SUMMERHILL HERD OF Large English Yorkshires.

HEADQUARTERS FOR THE IDEAL BACON HOG.

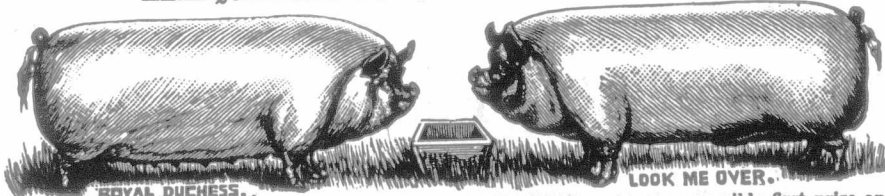

Our winnings at the large shows, for 1901, are as follows: At Toronto every possible first prize and five seconds, two silver medals, and first for pen of pure-bred bacon hogs, also sweepstakes on bacon hogs over all breeds; at London every possible first but two; while at the Pan-American, where our herd was divided, half going to Toronto, we won six out of ten possible firsts, also sweepstakes on boar any age. At the Pan-American (Buffalo), Toronto and London there were thirty-six first premiums and medals given: all the medals and every first prize but six won by the Summer Hill Yorkshires. When in need of the best write D. C. FLATT & SON, MILLGROVE, ONT. Telephone: Millgrove, Ont.

**Large English Berkshires.** My herd consists of sows imported from England; three of them (including a show sow) were selected from the herd of Geo. Green and were bred to his show boars. YOUNG STOCK FOR SALE (NOT AKIN). JNO. LAHMER, VINE, ONT.

### STOP! LOOK!! LISTEN!!!

**International Winnings:** Of the home-bred Fairview Shropshires in breeding classes. Of the \$551 offered they won \$204. Of \$301 by Shrop. Ass'n to American-bred, won \$156. They won 20 per cent. more money than any other flock. Had 15 of 32 first premium winners in both classes. All winners bred at Fairview except one third-prize ewe. All our first winners sired by "Newton Lord" but one. And sold out all surplus at the International, except three choice imported rams. Even placed orders for lambs not then dropped. JOHN CAMPBELL, Woodville, Ont., Can.

**W. S. CARPENTER, "MODEL FARM," SIMCOE, ONT.,** IMPORTER AND BREEDER OF

### Shropshire Sheep.

Ram and ewe lambs for sale. Well covered. Station One-half Mile from Farm, Wabash and G. T. R.

### BUCHANAN'S (Malleable Improved) PITCHING MACHINE

For unloading hay and all kinds of loose grain.

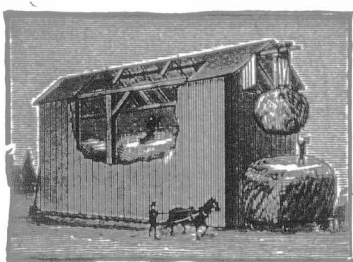

Unloads on either side of barn floor without changing car. No climbing necessary. Malleable Iron Cars. Steel Forks. Knot Passing Pulleys. Will work on stacks as well as in barns. Satisfaction guaranteed.

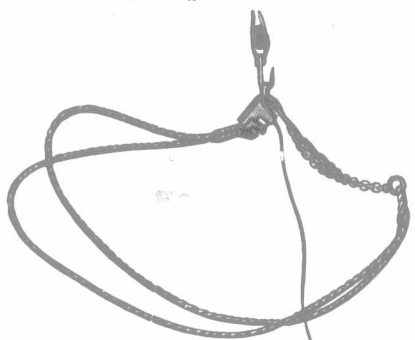

**The Common-Sense Sheaf-Lifter** Works in connection with Pitching Machine, and is the most complete apparatus ever offered to the public for pitching sheaves. Sheaves left in the mow just as they come from the load.

**RESPONSIBLE AGENTS WANTED** Circulars, Prices and Terms on application to M. T. BUCHANAN & CO., Ingersoll, Can.

USE MICA PAINT to repair leaky roofs.

Shingle, Iron or Tin Roofs painted with it will last twice as long.

# THE NOXON OPEN-BACK BINDER

Is Acknowledged by Practical Farmers to be the Best.

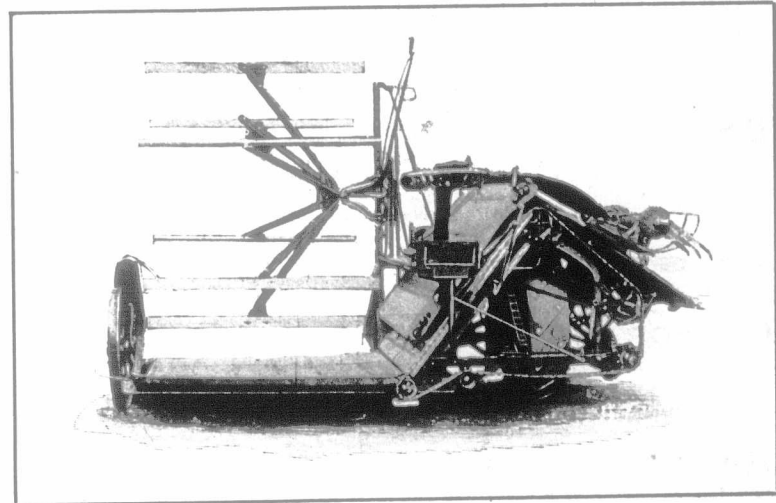

SOME SPECIAL FEATURES:

- Built of Steel Throughout, Open Back.
- Removable Dividers.
- Telescopic Packer Shaft.
- Three Packers.
- Weight Trip.
- The Lightest Made.
- A Pair of Ponies Can Handle It.
- Runs Without Noise.
- Always Reliable.
- No Neckweight.
- Handles Tangled Grain Perfectly.

EVERY PURCHASER GIVES A TESTIMONIAL.

THE NOXON CO., LTD., INGERSOLL, ONT.

### YORKSHIRES

Headed by Oak Lodge Prince 5071. Litters 15 weeks, either sex; 2 sows to farrow. WM. TEASDALE, Dollar, Ont. Northern branch G.T.R., 15 miles from Toronto. om

### YORKSHIRES AND POULTRY.

Young pigs, both sexes, extra choice. Eggs for hatching. No. 1 pens \$1.50, No. 2 pens \$1, from B. P. Rocks, W. Wyandottes, White and Brown Leghorns. A few Buff Orpington eggs at \$2.50 per setting. Choice pedigree collie pups. M. B. turkey and Pekin duck eggs. om A. B. ARMSTRONG, CODDRINGTON, ONT.

### Imported and Canadian-bred YORKSHIRES.

A number of good young sows in pig, boars ready for service and young pigs from 2 to 3 months old, direct from imported stock. Pairs and trios supplied not akin. H. J. DAVIS, WOODSTOCK, ONT. Box 290. Importer and breeder of Shorthorns and Yorkshires.

### FOR SALE: Yorkshires and Holsteins

Best type and quality. Young stock constantly on hand. Prices right. E. HONEY, Brickley P. O., instead of Warkworth.

### NEWCASTLE HERD OF TAMWORTHS

We are now offering a dozen boars fit to wean about 1st to the 10th May. A few young sows 3 months old, direct from Toronto Industrial winners. Prices right for quick sale. om COLWILL BROS., NEWCASTLE, ONT.

### Goldspring Herd Tamworths.

Offer choice Oct. and Nov. boars and sows. Also my stock boar, Advance. This is the spot for the best. Write for prices. They are moderate, quality considered. om NORMAN M. BLAIN, ST. GEORGE, ONT. BRANT CO.

### Tamworths and Berkshires.

A choice litter of young Tamworths, farrowed March 1st, \$6 each, registered. Berkshire sows four months old. Mammoth Bronze turkey eggs in season, \$3 per setting, large stock; order now. Safe arrival guaranteed.

D. J. GIBSON, BOX 38, BOWMANVILLE, ONT. HAZEL DELL STOCK FARM.

**Imported Poland-China Hogs.** We are offering something extra choice, of both sexes, any age (pairs not akin), from imported stock, and of the true type. Easy feeders, rapid growers. ROBT. L. SMYTH & SONS, FARGO P. O. and Station, M. C. R.

### SNELGROVE BERKSHIRES

We have for sale boars and sows 2 to 4 months old, and sows large enough to be bred. Now is the time to send orders for young pigs to be farrowed in March and April. Sired by the prize-winning boars: Colonel Brant—5950—, Crown Prince—5888—, and Normal Hero—5952—. Prices reasonable. om SNELL & LYONS, SNEGROVE, ONT.

### LARGE ENGLISH FOR SALE.

YOUNG boars and sows carrying the blood of Baron Lee 4th, Bright Star (Imp.), Enterprise and Higholders, on Bow Park, Teasdale and Snell females, with Allandale Boy 5875 and Royal Lad 3rd 4307 heading the herd. S. DYMENT, BARRIE, ONT.

### WILLOW LODGE BERKSHIRES FOR SALE

Two boars 11 mos. old; 4 boars 6 mos. old; 3 boars 5 mos. old; 4 boars 3 mos. old; also a number of sows from 3 to 5 mos. old. Now is the time to order spring pigs, which are arriving daily, sired by Longfellow Milton Lad (9660). Pairs supplied not akin. om WM. WILSON, SNEGROVE, ONTARIO.

### OHIO IMPROVED Chester White Swine.

OLDEST ESTABLISHED REGISTERED HERD IN CANADA. Choice young stock, 6 weeks to 6 months old. Pairs and trios not akin. Registered pedigrees. Express charges prepaid. Safe delivery guaranteed. om E. D. GEORGE, PUTNAM, ONT.

### PINE GROVE FARM HERD OF

### Large Yorkshire and Essex Swine.

The oldest established herd in America. We bred Hasket 3rd—1937—, sire of Oak Lodge Conqueror—2475—, and also sire of Look Me Over, the sire of Summerhill Victor, the champion boar at the Pan-American and the late Chicago Exposition, and sold there for \$700. Personal inspection and correspondence solicited. Nine imported and twenty home-bred sows breeding.

JOSEPH FEATHERSTON & SON, STREETSVILLE P. O., ONT. Streetville stn., C.P.R. Clarkson stn., G.T.R.

### YORKSHIRES.

TWO good 7-months-old, pure-bred Yorkshire sows, bred to a pure-bred Chester hog. For sale reasonable. om R. H. HARDING, Thorndale, Ontario.

### YORKSHIRES

One hundred Tamworth and Improved Chester White Spring Pigs of a true bacon type, our herd having won the best prizes offered at the leading exhibitions throughout Ontario and Quebec for the past ten years. Stock for exhibition purposes a specialty. We pay express charges between stations, and guarantee safe arrival of all stock shipped. Pairs furnished not akin. Write for prices. om H. GEORGE & SONS, Crampton P.O., Ont.

### Agents Wanted

for the New Pictorial Stock Doctor and Live Stock Cyclopedia, revised to 1901 with the assistance of the Professors of the Ontario Agricultural College, Guelph. The finest illustrated, cheapest and best book of its kind ever published. Large wages to agents. A full-page announcement of this book appeared in the ADVOCATE of the issue of June 1st. Particulars mailed free. Address WORLD PUBLISHING CO., Guelph, Ont.

### STRAWBERRY PLANTS

\$1.75 per thousand. Circulars free. om PINE HILL FRUIT FARM, Centre Brook, Conn.

### EGGS FOR HATCHING.

Barred Rocks (exclusively) bred from C. Mueller's noted prizewinners, carefully selected and mated as to color, shape and size, \$1 per 13. Give me a trial and be convinced that my stock is right. ALLEN SHANTZ, Waterloo, Ont.

### EGGS From prizewinning Brahmas, Cochins, Langshans, Rocks, Wyandottes, Minorcas, Leghorns, S. Dorkings, Spanish, Hamburgs, Red Caps, Pearl Guineas, Houdans, Polands, Games; Pekin, Rouen, Cayuga ducks. Eggs, \$1.00 per setting. om R. J. LAURIE, WOLVERTON, ONT.

### EGGS FOR HATCHING

Barred Rocks (exclusively). From two pens headed by two imported cockerels bred from a \$75 trio of A. C. Hawkin's Royal Blue strain: \$1.25 and \$1.50 per setting of 13. A. E. SHEPPINGTON, Box 100, Walkerton.

### Eggs

FOR SALE.—White Rocks of the finest strain in country; \$1 and \$1.50 per setting. J. McWEN, 266 St. James St., London, O.

### EGGS: Single-comb White Leghorns. Pens

headed with first-class male birds—"Hartford" and the Royal strains. Royal strain, \$1.00 for 13 eggs; "Hartford" or exhibition strain, \$1.50 for 13 eggs. J. E. HUSSEY, Melbourne, Ont.



**R. C. Buff Orpingtons.**

Only rose-combed flock known in Canada. \$2.50 per setting. One trio for sale, \$10.00. Also Rhode Island Reds, \$1.50 per setting.

CHAS. R. B. BRYAN, DURHAM, Nova Scotia.

**EGGS** BARRED ROCKS PEKIN DUCKS. Illustrated descriptive CIRCULAR free. See it before placing orders.

H. GEE & SONS, Haldimand County, Flahersville, Ont.

**EGGS FOR SALE.** B. P. Rock, W. Wyandotte, Buff Orpington, and Houdan; also Pekin ducks; \$1.25 per setting, om C. W. BEAVEN, Prescott, Ontario.

**EGGS FOR HATCHING.** Turkey eggs \$4 others \$1 per setting. Mammot Bronze turkeys, Barred Rocks and W. Rocks, and Red Caps. Chester White swine. Good bacon type. Write for prices. W. E. WRIGHT, GLANWORTH, ONT.

**Eggs for Hatching**

From a pen of choice Barred Rock hens, selected as persistent layers of large eggs, and mated with two large, strong, vigorous cockerels. Price, \$1 per setting, or three settings for \$2.

W. O. SHEARER, BRIGHT, ONTARIO.

**EGGS FOR HATCHING**

Barred Rocks (exclusively) from imported stock. \$2 for 13, or two settings for \$3.

J. H. FORDON, Maplehurst Farm, Beachville, Ontario.

**White Wyandotte Eggs.**

Large dark-egg strain, \$1.25 per setting.

A. M. MINTHORN, QUEENSTON, ONTARIO.

**EGGS:** from heavy-laying, prizewinning strains of S. C. Brown Leghorns, S. C. Black Minorcas, and Barred Plymouth Rocks. See "Gossip" column, Advocate, April 1st. Write for circular before purchasing elsewhere. JOHN B. PETTIT, Fruitland, Ontario.

IT'S THE MAN WITH

**Canadian Incubators**

THAT DOES THE WORK. CANADIAN INCUBATOR & BROODER CO., GRT CATALOGUE -om TORONTO, CAN.

**INCUBATORS AND BROODERS.**

Guaranteed to give satisfaction. Built to last a lifetime. Absolutely self-regulating, self-ventilating, and perfectly reliable in every way.

For circular giving prices, etc., write the manufacturer: J. E. MEYER, Shipping station: Guelph, Kossuth, Ont.

**SHOEMAKER'S BOOK ON POULTRY**

And Family Almanac for 1902. 100 pages 120 engravings, the finest work of its kind ever published. Gives recipes for making condition powders, remedies for all diseases of fowls, plans and diagrams for building poultry houses, tells you how to raise chickens profitably; gives description with illustrations of 48 leading varieties of pure bred fowls, also

**INCUBATORS AND BROODERS**

and poultry supplies at lowest prices. It is an encyclopedia of chicken information, worth many times its cost to anyone interested in poultry. You positively cannot afford to be without it. Sent postpaid, on receipt of price, 12 cents. Address: C. G. Shoemaker, Box 82, Freeport, Ill.

**The Daniels Incubator**

We can save our patrons 20 to 30 per cent, on

INCUBATORS, BROODERS, BONE MILLS, and all POULTRY SUPPLIES, CRAMMING MACHINES and POULTRY CRATES

Our aim for past 16 years has been satisfaction to every customer. Our large connection shows we have not failed in our aim. Send for our FREE catalogue. We don't sell catalogues, but straight, honest goods; this, or your money back.

C. J. DANIELS, 196-200 RIVER ST., TORONTO, ONT. Mention "Farmer's Advocate."

CRAMMING MACHINES, FATTENING COOPS, Incubators and Brooders POULTRY SUPPLIES. A. J. MORGAN, MFR., LONDON. Catalogue free.

**BOOK REVIEW.**

Any book reviewed in this department may be ordered through this office, at the price stated.

**A VALUED PUBLICATION.**

A publication of interest to stock-breeders the world over is the annual report of the U. S. Bureau of Animal Industry. The 17th annual report is just to hand, and contains the report of the Chief, Dr. D. E. Salmon, and his corps of assistants; such subjects as the free distribution of blackleg vaccine, a strong case being made out for the continuance of the scheme; some diseased conditions found as a result of meat inspection; and an interesting chapter on ocean transportation. Rabies is taken up by the Chief, who also contributes a useful article on "Poultry-raising on the farm." Other subjects of more or less strictly scientific nature, together with a number of fine plates and a lot of statistics, make up a bulky volume of 650 pages. The tardiness with which the report makes its appearance is its chief drawback. The front page contains the motto of the U. S. Department of Agriculture, viz., "Agriculture is the foundation of manufacture and commerce," which our legislators would at all times do well to remember.

**THE ART OF FEEDING.**

The Macmillan Co. have added another excellent volume to their Rural Science Series of books, so often mentioned favorably in the "Farmer's Advocate." It is entitled "The Feeding of Animals," and is written by a first-class authority, Prof. W. H. Jordan, Director of the New York Experiment Station. The aim of the work is to present the main facts and principles fundamental to the art of feeding animals as now understood, and the author, we are bound to say, has done his work with ample knowledge and a wise discrimination. Agricultural students and stockmen will alike find it valuable. He wisely intimates, we think, that it is time to break away from an indiscriminating adherence to mathematical doses of nutrients, the accuracy of which was long held by some to be the measure of successful feeding. Formulas are an aid, but must be used with discretion under the great variety of circumstances and conditions which arise in the course of the feeder's experience. In the chapter on corn ensilage and the silo, he records that the weight of evidence shows that the wastes in field-curing are greater than with the silo, besides which, of course, there is the gain in succulence and palatability. It is a well-printed book of 450 pages, convenient in size, and sells at \$1.25.

**A BOOK FOR STOCK-RAISERS.**

The World Publishing Company, of Guelph, Ont., has put upon the market a new work, "The New Cyclopaedia of Live Stock and Complete Stock Doctor." This is a work of over 1,400 pages and 800 illustrations. It treats at length with the different classes of domestic animals, viz.: Horses, cattle, sheep, swine, poultry and dogs, with a chapter on bees. The author of every article in the book is a specialist upon his particular subject. It deals briefly but comprehensively with the anatomy of the above-mentioned animals, furnishes cuts to illustrate points of the same, also to illustrate the desirable conformation, especially of the horse. It is replete with excellent illustrations of well-known high-class prizewinning individuals of all classes of stock. It deals at length with all animals in both health and disease, and describes the causes, symptoms and treatment for diseases. A chapter is devoted to the examination of a horse as to soundness; others to the education of a horse, how to buy and sell, etc. It deals with the origin and history of the different breeds of all classes, the characteristics and peculiarities of each breed, best methods of breeding, general care of stock, construction of stables, grooming, feeding, watering, etc. A chapter is devoted specially to the American trotter; one to the bacon hog; one to horse-breeding, giving tables on the points of excellence in each class; one to dairying and dairy buildings, and one to poultry. As far as possible there is an absence of technicality; all being written in plain English. This work should be a valuable

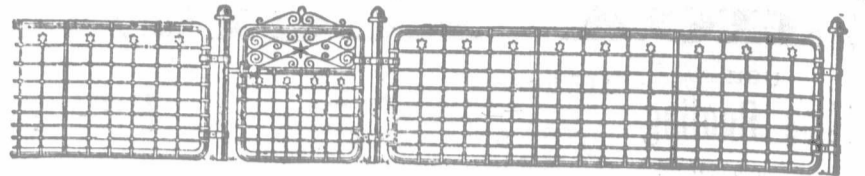

**Ornamental Gates and Lawn Fences**

are a specialty with us. Prices on application. THE FROST ornamental gates are the handsomest and best. Write for catalogue.

THE FROST WIRE FENCE CO. LTD., WELLAND, ONT.

**PAGE METAL GATES**



are so low in price no one can afford to use wooden ones. Light, and yet strong enough to support a heavy man on the end while he swings around the circle without causing them to sag. They are neat in appearance, will last a lifetime. Will not sag nor get rickety. They are supplied with latches which allow them to be opened either way and are self-acting. The only good metal gate that is low enough in price for general farm purposes. We also make Farm and Ornamental Fence, Poultry Netting, Nails and Staples. The Page Wire Fence Co. Limited, Walkerville, Ont.

THIS CUT ILLUSTRATES THE ONLY

**"Hinge" Stay Fence**

It will not sag, and is cheap, strong and durable. Write for circular and prices. Good Agents Wanted in every locality, to whom we guarantee good returns.

The Strathy Wire Fence Co. (LIMITED), OWEN SOUND, ONT.

**SHEWING HINGE**

MOVEMENT OF STAYS UNDER PRESSURE STAYS CANNOT BEND & WILL SPRING BACK TO PLACE WHEN PRESSURE IS REMOVED.



N#13

**THE CYPHERS INCUBATOR**

ON SALE BY RESPONSIBLE CANADIAN AGENTS.

Used with uniform success on twenty-six Government Experiment Stations in the U. S., Canada, Australia and New Zealand; also by America's leading poultrymen and many thousands of persons in every walk of life. Guaranteed to give satisfaction or price refunded. The original and only genuine non-moisture incubator, fully covered by patent. WRITE FOR NAME OF CANADIAN AGENT NEAREST YOU. Agents carry incubators in stock, duty paid, and can save you money. Complete 180-page catalogue for 1902, finely illustrated, free if you mention this paper. Ask for Book No. 110. Address: Cyphers Incubator Co., Buffalo, N. Y., Chicago, Ill., Boston, Mass., New York, N. Y.

**DENTONIA PARK FARM**

**EGGS** S. C. Leghorns—White, Buff and Brown - \$1.50 per 13. Andalusians, White Langshans, 1.50 per 13. White Wyandottes, 1.50 per 13. Pekin ducks (special matings), 1.50 per 11. 5.00 per 100.

S. C. White Leghorn breeding pens mated with cocks direct from Wychoff's stock, of Groton, N. Y. Stock for sale. Correspondence solicited.

O. REYNOLDS, Coleman, Ontario.

**100% a Year is Big Interest**

but that is what many users of THE IMPROVED U. S. SEPARATOR are receiving on the money invested.

It is nothing unusual to receive letters from users of the U. S. stating that it has produced enough more cream in a year to pay for the machine, to say nothing of the improved quality of the product and the saving of time and labor.

The U. S. Separator is not only

"The kind that gets all the Cream."

but it also wears the longest and saves its users much by not requiring repairs like other makes. Write for our latest illustrated catalogues.—Free.

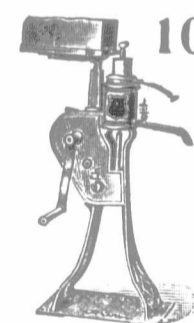

VERMONT FARM MACHINE CO., BELLOWS FALLS, VERMONT

**A BARGAIN! A LARGE CONSIGNMENT OF**

**Basic Slag**

FROM SCOTLAND, TO BE SOLD AT HALF PRICE. \$17.00 per ton, Toronto.

The best fertilizer for grasses, clover, roots, corn, etc. Used more in Great Britain than any other manure. Write for pamphlets.

GEORGE KEITH, Seed Merchant, TORONTO.

Send for Seed Catalogue and for samples of pure clover and timothy seed.

addition to the library of any person who breeds or owns stock.

J. HUGO REED, V. S. The price of the volume, which is handsomely and substantially bound and well printed, is: Cloth bound, \$3.75; half Russia, \$4.50.

"WORTH ITS WEIGHT IN GOLD." Mitchell, Ont.

The Lawrence-Williams Co., Cleveland, O.: I must congratulate you, gentlemen, on one of the best blisters in the world. It is your COMBAULT'S CAUSTIC BALSAM.



## LAMB FENCE

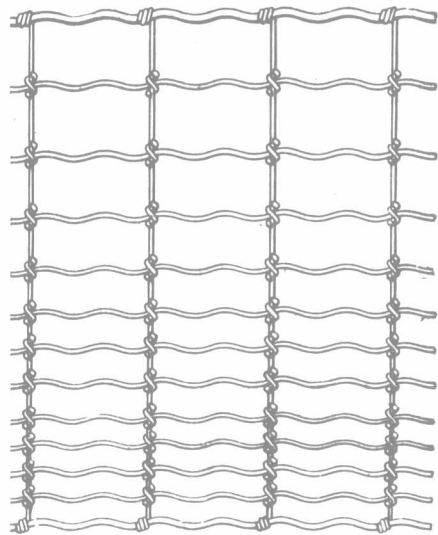

What is the difference between "LAMB FENCE" and a Bass Drum? You can beat the Drum, but you cannot beat "Lamb Fence." Heavy, hard wire cross-bar. High carbon laterals.

**H. R. LAMB,**  
LONDON, ONT.

## BINDER TWINE



### Farmers' Co-operative Binder Twine Co.

(LIMITED),  
BRANTFORD, - ONTARIO,  
Have set their prices on Twine for the harvest of 1902.

This co-operative movement, consisting as it does of nearly eight thousand farmer stockholders, has for ten years been a marvel of success, for the reason that the farmers, with determined loyalty and patronage, have said it shall be so. The Canadian agriculturist who buys a single ball of binder twine until he is entirely exhausted acts suicidal to the interests of himself and his home, while by such acts he encourages the possibility of combine and monopoly, that the country is rampant with at the moment, and is little better than the animal represented in the picture of this advertisement.

#### A PROUD RECORD.

For ten years we have not sold a single pound of twine representing to ourselves a greater profit than three-quarters of a cent a pound on its actual cost of production; while in 1898 we delivered to our patrons 1,500 tons—the mill's entire output—at 7½c., while for the same grade our opponents secured 14c. We divided all earnings and profits with our myriads of shareholders instead of passing it into the pockets of American millionaires. If we have not got a farmer agent representing us in your locality, write us at once.

**JOSEPH STRATFORD, General Manager.**

#### GOSSIP.

The Standard-bred trotting stallion, Arka 25, 25, by J. I. Case, is offered for sale in an advertisement in this issue by O. A. Coates, Bothwell, Ont. His breeding and performance speak for his merit, and those requiring such a horse should look up the advertisement and write for particulars.

D. A. Graham & Son, of Pine Hill poultry yards, Thedford, Ont., advertise eggs for hatching of a number of popular breeds of poultry, also of ducks and geese. They have erected all new poultry yards and hogen of up-to-date design, two poultry buildings 16x40, also incubator and brooder buildings, and are better prepared to furnish customers than ever, and guarantee good fresh, fertile eggs.

## NEW FIELD ROOT. Giant Sugar Mangel.

GREATEST YIELDING ROOT GROWN.  
OF HIGHEST FEEDING VALUE FOR  
PRODUCING MILK,  
OR AS A FLESH FORMER.

Since the introduction of the Danish Sugar Beet, an extraordinary demand has been created for a field root containing a higher percentage of nutritive value as well as producing the large weight per acre usually attained from the Mammoth Mangel. This new root, now offered for the first time, and which we have named "Giant Sugar Mangel," is really a full blooded Sugar Beet, growing to an immense size and producing a heavier weight per acre than any Sugar Beet now before the public. The magnificent roots (well shown in the accompanying illustration), are of the Giant Intermediate type, absolutely clean and free from the coarse and prongy roots so frequently found among Sugar Beets and certain classes of Mangel Wurzel. We have never seen a more handsome growing crop, the perfect shaped roots standing at least three-fourths out of the ground, with a rich pink and white skin contrasting with the upright deep green foliage cannot help but attract attention. The flesh, which is so exceptionally firm, is by far the sweetest of all roots, and greatly relished by all classes of stock. They are extra fine when cooked for the table. "Giant Sugar Mangels" are the easiest of all roots to harvest. "Push them over with your foot." No trouble to top them as the leaves grow upright and well together. The roots weigh heavier and will keep longer than either Carrots, Turnips or Mangels. Taking everything into consideration no better root for stock feeding has ever been placed before the public.

Every progressive farmer and dairyman will act wisely by giving Rennie's "Giant Sugar Mangel" a thorough trial.

PRICE.—Pound 35c.; 3 lbs. \$1.00 postpaid.

### Famous Waverley White Oats. From Europe.

Gives astonishing returns grown in Canada. Positively the Heaviest Weight and Finest in Appearance of any Oat now before the public. Thin in the hull with bright amber colored straw standing upright in almost all kinds of weather. Our crops have satisfied us that it is wonderfully adapted to both soil and climate of this country. Give it a trial.

PRICE.—lb. 30c.; 3 lbs. 75c. postpaid. Peck 60c.; ½ bushel \$1.00; bushel \$1.60; 5 bushels \$7.50 by freight at purchasers expense. Cotton Bags each 15c. extra.

ADDRESS ALL ORDERS TO

**WM. RENNIE, TORONTO.**

REMIT CASH WITH ORDER.



NEW GIANT SUGAR MANGEL.

## FENCING and GATES

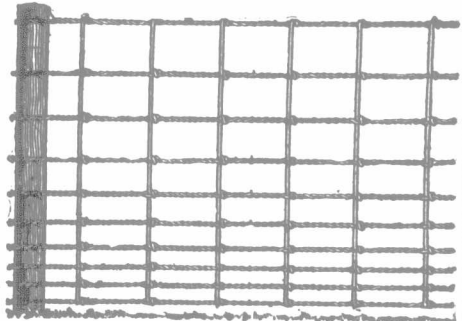

Buy your fencing and gates direct from the manufacturer. The Oshawa Wire Fence Co., Limited, are the largest manufacturers of different styles of fencing and gates in Canada. Send for catalogue and prices.

**OSHAWA WIRE FENCE CO., Ltd.,**  
OSHAWA, ONT.

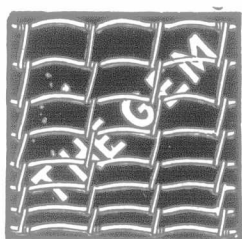

Latest and best devices for wire-fence building, including

#### GEM and McCLOSKEY

weaving machines, also Coiled Spring and other fence wire at lowest prices. Write to McGregor, Banwell Fence Co., Limited, Box 23, Windsor, Ont.

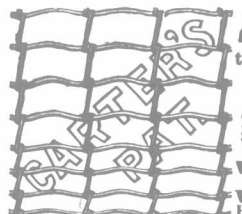

#### A MACHINE

to weave your own fence of Coiled Hard Steel Spring Wire. 52 inches high, at 25 Cts. per Rod. \$25 buys wire for 100 rod fence. Agents Wanted. Catalogue Free. GARTER Wire Fence Mach. Co. Box 4 Ridgetown, Ont.

**FRED SMITH, BRANDON, MAN., Gen. Agent.**

## THE ANCHOR WIRE FENCE

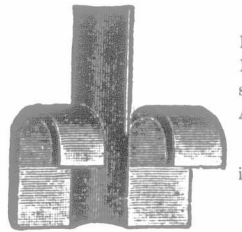

Is made throughout of No. 9 wire, all cross wires securely fastened with Anchor Clamp.

All kinds of fence wire in stock. Write for prices.

Agents Wanted.

**ESPLEN, FRAME & CO.,**  
MANUFACTURERS, - STRATFORD.

## THE FROST & WOOD

### WINDSOR DISC HARROW

The Best Made.  
A Perfect Cultivator.  
No Neckweight on Horses.

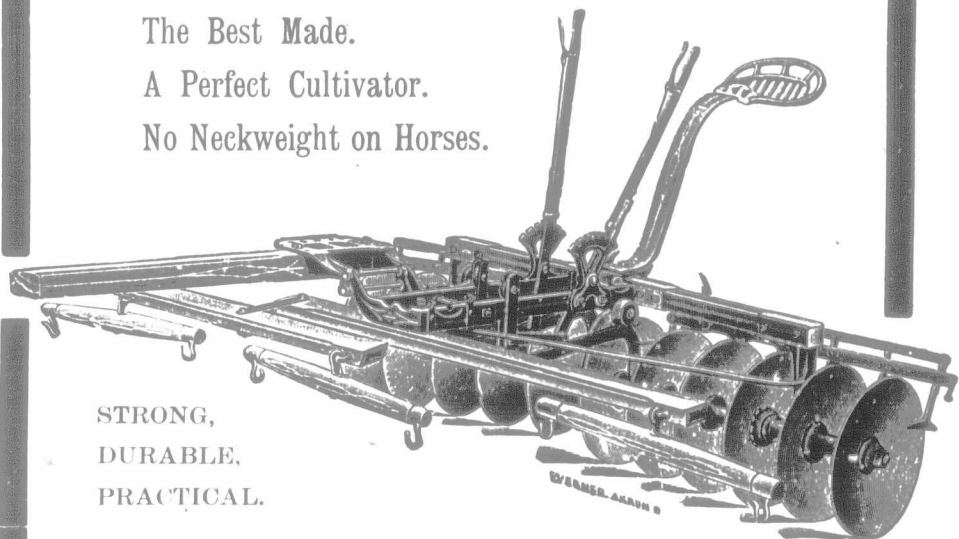

STRONG,  
DURABLE,  
PRACTICAL.

Does the hardest farm work in the easiest way for man and beast.

A labor saver. A time saver. A money saver.

The Frost & Wood full line of farm machinery is unexcelled.

See what we have to say in the next issue.

Head Office and Works:

**Smith's Falls, Ontario.**

**THE Frost & Wood Company LIMITED.**

Branch Offices and Warehouses:

Toronto, Ont.  
London, Ont.  
Winnipeg, Man.  
Montreal, Que.  
Quebec, Que.  
St. John, N. B.  
Truro, N. S.

#### GOSSIP.

##### CLOTH OF GOLD GOES WEST.

Mr. O. Sorby, Guelph, Ont., has sold to Messrs. Watson & Co., Oxbow, N.-W. T., the fine five-year-old Clydesdale stallion, Cloth of Gold 2959, 8962, by Lord Charming 7564, dam Madge III., by Cedric, by Prince of Wales. He is considered by competent judges to be one of the best horses in Canada. He has won the following prizes: In

1900, 1st prize at Illinois State Fair, 1st prize at Iowa State Fair; in 1901, 1st prize at Guelph Spring Stallion Show, and 2nd at Elora Spring Stallion Show; 2nd at Toronto Spring Stallion Show; 1st at Toronto Industrial, 1st and sweepstakes at London, second at Ottawa. He also sold to the same party a yearling stallion, Ornament, and a two-year-old filly, Princess Choice.



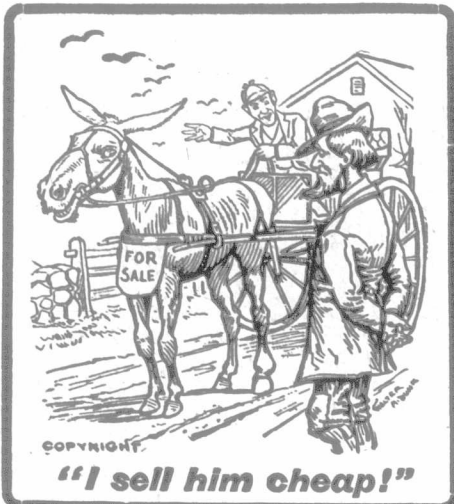

"I sell him cheap!"

YOU can judge the value of an animal and most articles in commerce by appearance and price. — With Seeds it is different. — Any Seed must be valued by what it will grow and not by a "cheap" price.

Poor Seeds are those of uncertain growth and product—they are as valueless as the broken-down mule. It is extravagant waste to use them. "Cheap" Seeds may give greater profit to the seller but the user is the loser.

"GOOD QUALITY" in Seeds is the foundation of worth—it is the result from selecting and improving strains, together with care and intelligence in growing and means success to the user.

**Steele-Briggs Seeds** are known for their "Good Quality" and "Worth." More of them are sold and used in Canada than any other kind.

Buy your Seeds from dealers who sell **Steele-Briggs Seeds** and insist upon having them. If you cannot get them from a local merchant send your order direct. Refuse substitutes or "Just as Good." Send for catalogue if you have not received it.

**The Steele-Briggs**  
Seed Co., Limited, Toronto.

"CANADA'S GREATEST SEED HOUSE."

**WOODSTOCK STEEL WINDMILLS**



Galvanized or Painted. For Power or Pumping.

**DANDY Windmill**

with Graphite Bearings, runs easy and controls itself in the storm.  
GRINDERS, PUMPS, WATER TANKS, DRINKING BASINS AND SAW BENCHES.

**WOODSTOCK WIND-MOTOR CO.,**  
WOODSTOCK, ONT. (Ltd.)



Buy the **NEW CENTURY AMERICAN CREAM SEPARATOR**

And have the best. Nothing as good. Simple, durable, easy to turn and clean. Five different dairy sizes.

WRITE FOR CIRCULARS AND INFORMATION. AGENTS WANTED.

**C. RICHARDSON & CO.,**  
P. O. Box 1048, - - St. Mary's, Ont.  
PLEASE MENTION FARMER'S ADVOCATE.



POWER AND PUMPING MILLS, STEEL TOWERS AND FLAG STAFFS, IRON AND WOOD PUMPS, MAPLE LEAF GRAIN GRINDERS, BEE SUPPLIES.

**BELL..**  
**PIANOS AND ORGANS**

Built to Last a Lifetime by the Largest Makers of Pianos and Organs in Canada.

**The Bell Organ & Piano Co., Ltd.,**  
GUELPH, ONT.

**London Fence Machines**

Build Fences that are worth more, pound for pound, than any factory or lock fence ever erected, because they can be well and evenly stretched, and will not rust or fall to pieces.

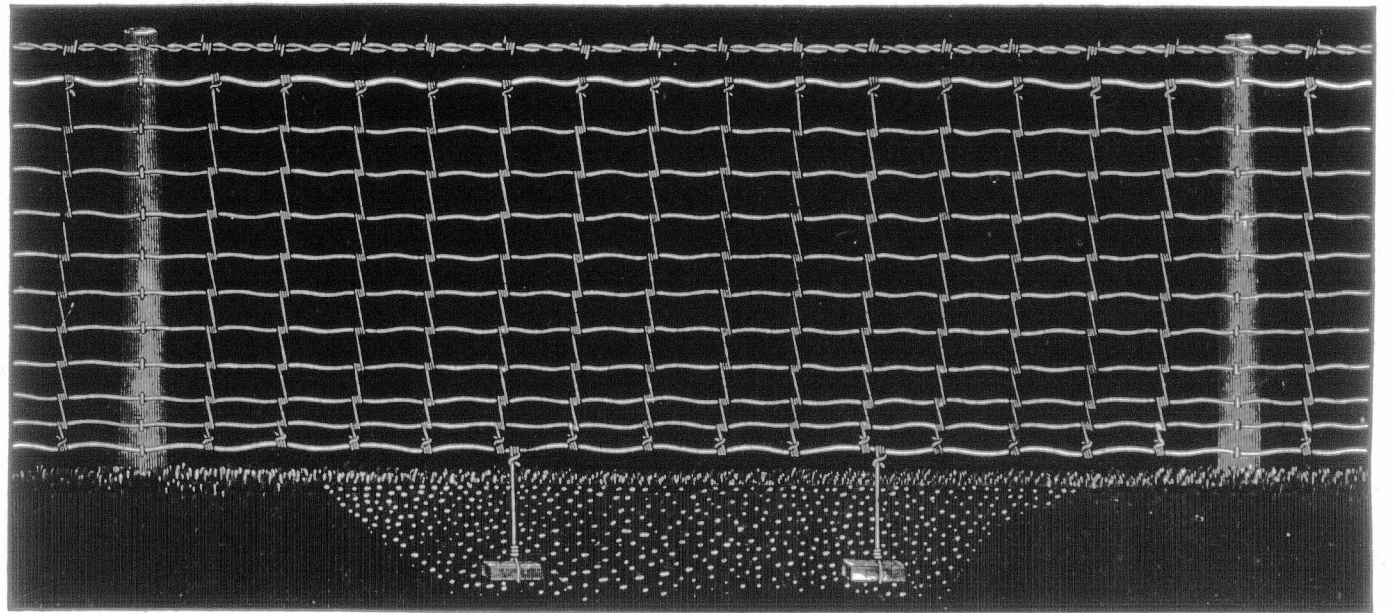

This 11-bar Coiled Spring Steel Woven Wire Fence, with a tensile strength of about 15,000 lbs., with No. 7 top, No. 12 body and No. 9 bottom wires, with No. 13 stays, 12 inches apart, will cost you 30c. per rod for the wire. We will furnish wire for 100 rods of the above, freight prepaid to any point in Western Ontario, for \$30 cash with order, or will pay partial freight to more distant points, or we will ship the above with same freight allowance, together with a London Fence Machine, a London Tackle Block Stretcher, and 60 ft. best 1/2-inch Rope, and a Wire Grip, also a Wire Reel and a Pair of Bernard's best Nickel-plated 6 1/2-inch Cutting Pliers, on receipt of \$45 cash. If the Barb Wire is desired, add \$3.25 to either of the above amounts. If preferred, we will ship C. O. D. for 50c. extra.

**LONDON FENCE MACHINE CO., LTD., LONDON, CAN.**

See article entitled "Wire Fencing," on page 315.

**\$400.00 CASH FOR LARGEST RAM IN THE WORLD**

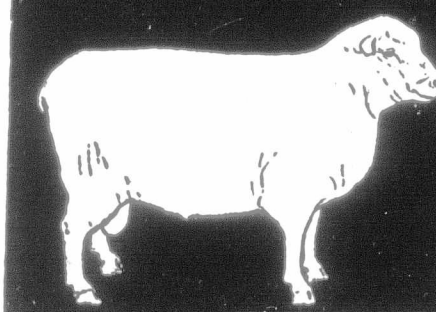

We hereby offer \$400.00 cash for Largest Ram of any breed or cross. Ram to be weighed November 20, 1902, and sworn statement of owner and weigher and three witnesses to be forwarded to the "American Sheep Breeder," Chicago, Ill. Ram winning this offer to be delivered in Chicago at the Live Stock Show in December, 1902, when the \$400.00 will be paid by International Stock Food Co.

**A \$3000.00 STOCK BOOK FREE**

This Book Contains 183 Large Colored Engravings of Horses, Cattle, Sheep, Hogs, Poultry, etc. It cost us \$2000 to have our Artists and Engravers make the Engravings. It contains a finely illustrated Veterinary Department that will save you Hundreds of Dollars. Gives description and history of the Breeds of Horses, Cattle, Sheep, Hogs and Poultry. The Editor of this Paper will tell you that you ought to have a copy of our finely illustrated Book for reference. We will ship you \$14.00 worth of "INTERNATIONAL STOCK FOOD" absolutely Free if our Stock Book is not exactly as represented.

**THIS BOOK FREE, Postage Prepaid, If You Write Us (Letter or Postal) and Answer 3 Questions:**  
1st—Name this Paper. 2nd—How much stock have you? 3rd—Did you ever use "INTERNATIONAL STOCK FOOD" for Horses, Cattle, Sheep, Hogs, Colts, Calves, Lambs or Pigs? Answer the 3 Questions and Write Us At Once for Book.

**INTERNATIONAL STOCK FOOD CO., MINNEAPOLIS, MINN., U. S. A.**

DEALERS SELL THESE ON A "SPOT CASH" GUARANTEE: INTERNATIONAL STOCK FOOD, INTERNATIONAL POULTRY FOOD, INTERNATIONAL WORM POWDER, INTERNATIONAL GALL CURE, INTERNATIONAL LOUSE KILLER, INTERNATIONAL COLIC CURE, INTERNATIONAL HEAVE CURE, INTERNATIONAL HARNESS SOAP, SILVER PINE HEALING OIL, ETC.

**ENGLISH JERSEYS SELL HIGH.**  
At Lady de Rothschild's annual sale of Jersey cattle, on March 20th, from The Rookery herd at Aston Clinton, Bucks, 210 guineas (\$1,050) was realized for the prize cow, Carol, purchased by Mr. A. Miller-Hallett. Mrs. Ratcliffe took Coralie at 115 guineas and Lady Rowena at 105 guineas, while Sir T. Coach took Wild Rose at 110 guineas. The 5c head sold averaged close to £40. It is worthy of note that last year 34 cows in this herd yielded an average of 569 gallons milk. In 1900, 34 cows averaged 591 gallons, and in 1899 25 cows averaged 563 gallons. The highest individual yield in one of the three years was made by Rosebud,

giving, in 1899, 8,037 lbs. or almost 804 imperial gallons. In the two succeeding years she gave 793 and 765 gallons, respectively.  
Two first-class imported Scotch-bred Shorthorn bulls, two years old and in fine condition, are advertised in this issue by Mr. Thomas Russell, Exeter, Ont., who is a well-known and reliable breeder and importer, who has for many years maintained a high-class herd of Shorthorns, Scotchman, a rich roan, of grand form and quality, beefy and level, has been pronounced by good judges one of the best bulls on the continent. He was two years old last month, was bred by Mr. Taylor, of Stonehaven, Kincar-

dineshire, sired by Lord Hampton, by Bapton Czar, a Sittytton Cicely bull by Gravensend, and out of a Missie cow by William of Orange. The dam of Scotchman, Strawberry Blossom, of the Bracelet tribe, was for five years in succession the 1st-prize cow at the Kincardineshire show, and was barred from showing any longer. The other bull, Fragrant Duke, is a smooth, straight, stylish bull by the same sire, and from the same herd, his dam being of the Lady Fragrant family, a choice tribe represented largely in the noted herds of King Edward and Lord Roseberry. Such bulls as these are needed, and should quickly find places at the head of first-class herds.