

**CIHM  
Microfiche  
Series  
(Monographs)**

**ICMH  
Collection de  
microfiches  
(monographies)**



**Canadian Institute for Historical Microreproductions / Institut canadien de microreproductions historiques**

**© 1995**

Technical and Bibliographic Notes / Notes techniques et bibliographiques

The Institute has attempted to obtain the best original copy available for filming. Features of this copy which may be bibliographically unique, which may alter any of the images in the reproduction, or which may significantly change the usual method of filming, are checked below.

L'Institut a microfilmé le meilleur exemplaire qu'il lui a été possible de se procurer. Les détails de cet exemplaire qui sont peut-être uniques du point de vue bibliographique, qui peuvent modifier une image reproduite, ou qui peuvent exiger une modification dans la méthode normale de filmage sont indiqués ci-dessous.

- Coloured covers/  
Couverture de couleur
- Covers damaged/  
Couverture endommagée
- Covers restored and/or laminated/  
Couverture restaurée et/ou pelliculée
- Cover title missing/  
Le titre de couverture manquant
- Coloured maps/  
Cartes géographiques en couleur
- Coloured ink (i.e. other than blue or black)/  
Encre de couleur (i.e. autre que bleue ou noire)
- Coloured plates and/or illustrations/  
Planches et/ou illustrations en couleur
- Bound with other material/  
Relié avec d'autres documents
- Tight binding may cause shadows or distortion  
along interior margin/  
Le reliure serrée peut causer de l'ombre ou de la  
distorsion le long de la marge intérieure
- Blank leaves added during restoration may appear  
within the text. Whenever possible, these have  
been omitted from filming/  
Il se peut que certaines pages blanches ajoutées  
lors d'une restauration apparaissent dans le texte,  
mais, lorsque cela était possible, ces pages n'ont  
pas été filmées.

- Coloured pages/  
Pages de couleur
- Pages damaged/  
Pages endommagées
- Pages restored and/or laminated/  
Pages restaurées et/ou pelliculées
- Pages discoloured, stained or foxed/  
Pages décolorées, tachetées ou piquées
- Pages detached/  
Pages détachées
- Showthrough/  
Transparence
- Quality of print varies/  
Qualité inégale de l'impression
- Continuous pagination/  
Pagination continue
- Includes index(es)/  
Comprend un (des) index

Title on header taken from: /  
Le titre de l'en-tête provient:

- Title page of issue/  
Page de titre de la livraison
- Caption of issue/  
Titre de départ de la livraison
- Masthead/  
Générique (périodiques) de la livraison

Copy has manuscript annotations.

- Additional comments: /  
Commentaires supplémentaires:

This item is filmed at the reduction ratio checked below /  
Ce document est filmé au taux de réduction indiqué ci-dessous.

10X	14X	18X	22X	26X	30X
<input type="checkbox"/>	<input type="checkbox"/>	<input type="checkbox"/>	<input checked="" type="checkbox"/>	<input type="checkbox"/>	<input type="checkbox"/>
12X	16X	20X	24X	28X	32X

The copy filmed here has been reproduced thanks to the generosity of:

University of Toronto,  
Science & Medicine Library

The images appearing here are the best quality possible considering the condition and legibility of the original copy and in keeping with the filming contract specifications.

Original copies in printed paper covers are filmed beginning with the front cover and ending on the last page with a printed or illustrated impression, or the back cover when appropriate. All other original copies are filmed beginning on the first page with a printed or illustrated impression, and ending on the last page with a printed or illustrated impression.

The last recorded frame on each microfiche shall contain the symbol  $\rightarrow$  (meaning "CONTINUED"), or the symbol  $\nabla$  (meaning "END"), whichever applies.

Maps, plates, charts, etc., may be filmed at different reduction ratios. Those too large to be entirely included in one exposure are filmed beginning in the upper left hand corner, left to right and top to bottom, as many frames as required. The following diagrams illustrate the method:

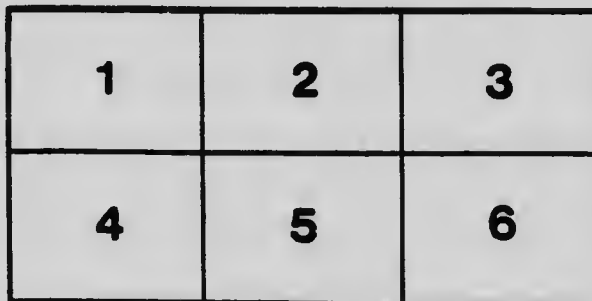
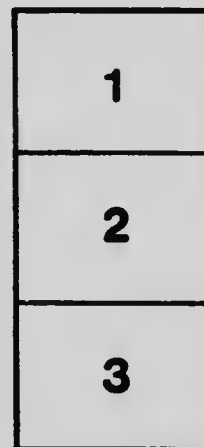

L'exemplaire filmé fut reproduit grâce à la générosité de:

University of Toronto,  
Science & Medicine Library

Les images suivantes ont été reproduites avec le plus grand soin, compte tenu de la condition et de la netteté de l'exemplaire filmé, et en conformité avec les conditions du contrat de filmage.

Les exemplaires originaux dont la couverture en papier est imprimée sont filmés en commençant par le premier plat et en terminant soit par la dernière page qui comporte une empreinte d'impression ou d'illustration, soit par le second plat, selon le cas. Tous les autres exemplaires originaux sont filmés en commençant par la première page qui comporte une empreinte d'impression ou d'illustration et en terminant par la dernière page qui comporte une telle empreinte.

Un des symboles suivants apparaîtra sur la dernière image de chaque microfiche, selon le cas: le symbole  $\rightarrow$  signifie "A SUIVRE", le symbole  $\nabla$  signifie "FIN".

Les cartes, planches, tableaux, etc., peuvent être filmés à des taux de réduction différents. Lorsque le document est trop grand pour être reproduit en un seul cliché, il est filmé à partir de l'angle supérieur gauche, de gauche à droite, et de haut en bas, en prenant le nombre d'images nécessaire. Les diagrammes suivants illustrent la méthode.

# MICROCOPY RESOLUTION TEST CHART

(ANSI and ISO TEST CHART No. 2)

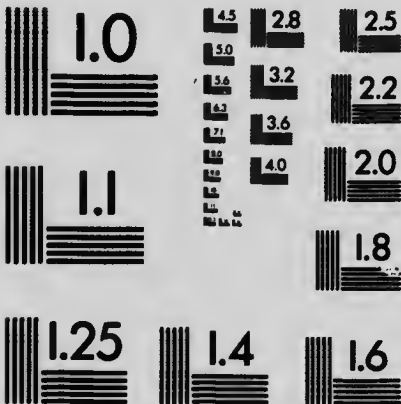

**APPLIED IMAGE Inc**

1653 East Main Street 14609 USA  
Rochester, New York  
(716) 482 - 0300 - Phone  
(716) 288 - 5989 - Fax

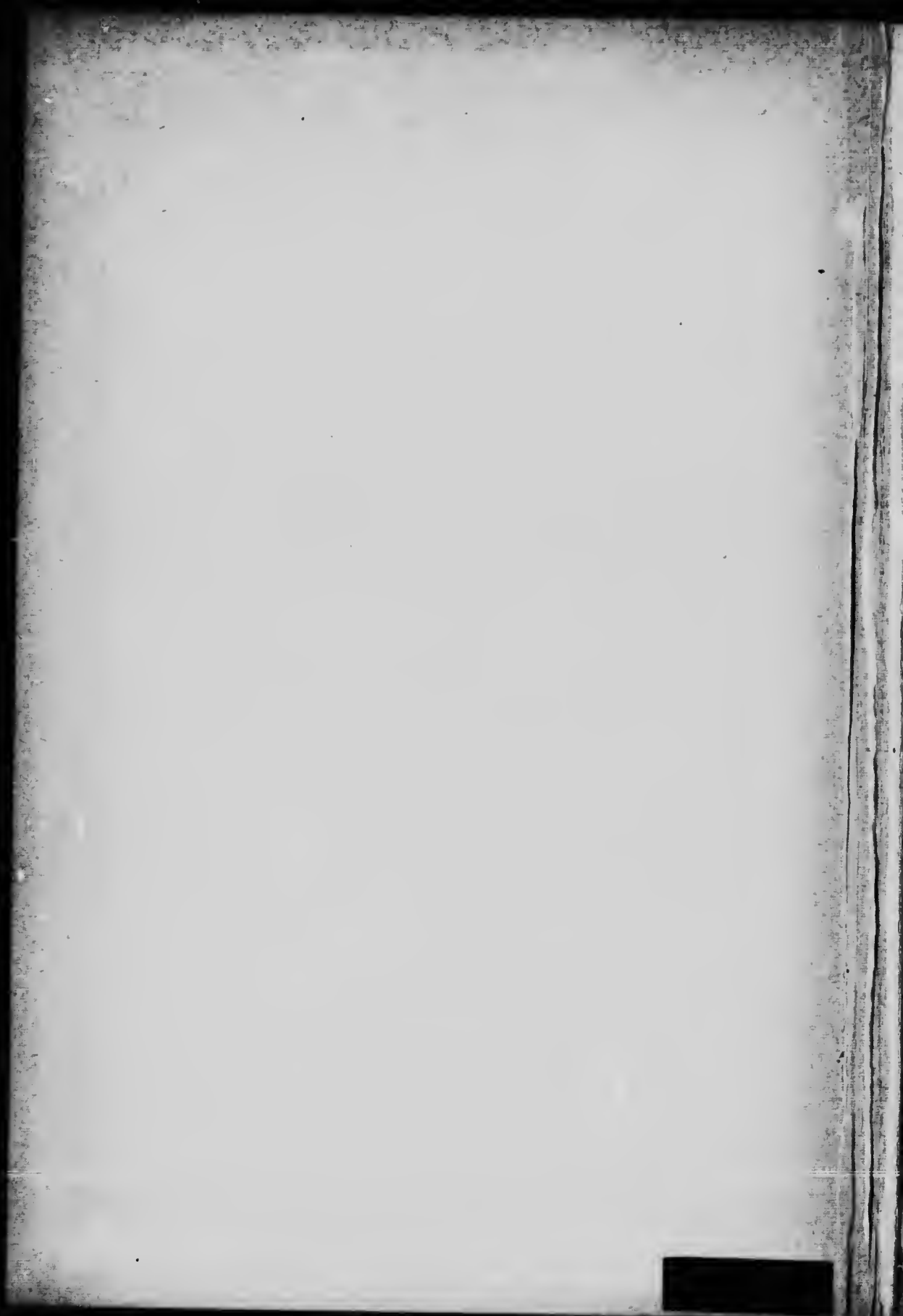

1  
Marie. A. De Lafontaine

40 Gloucester St

Toronto

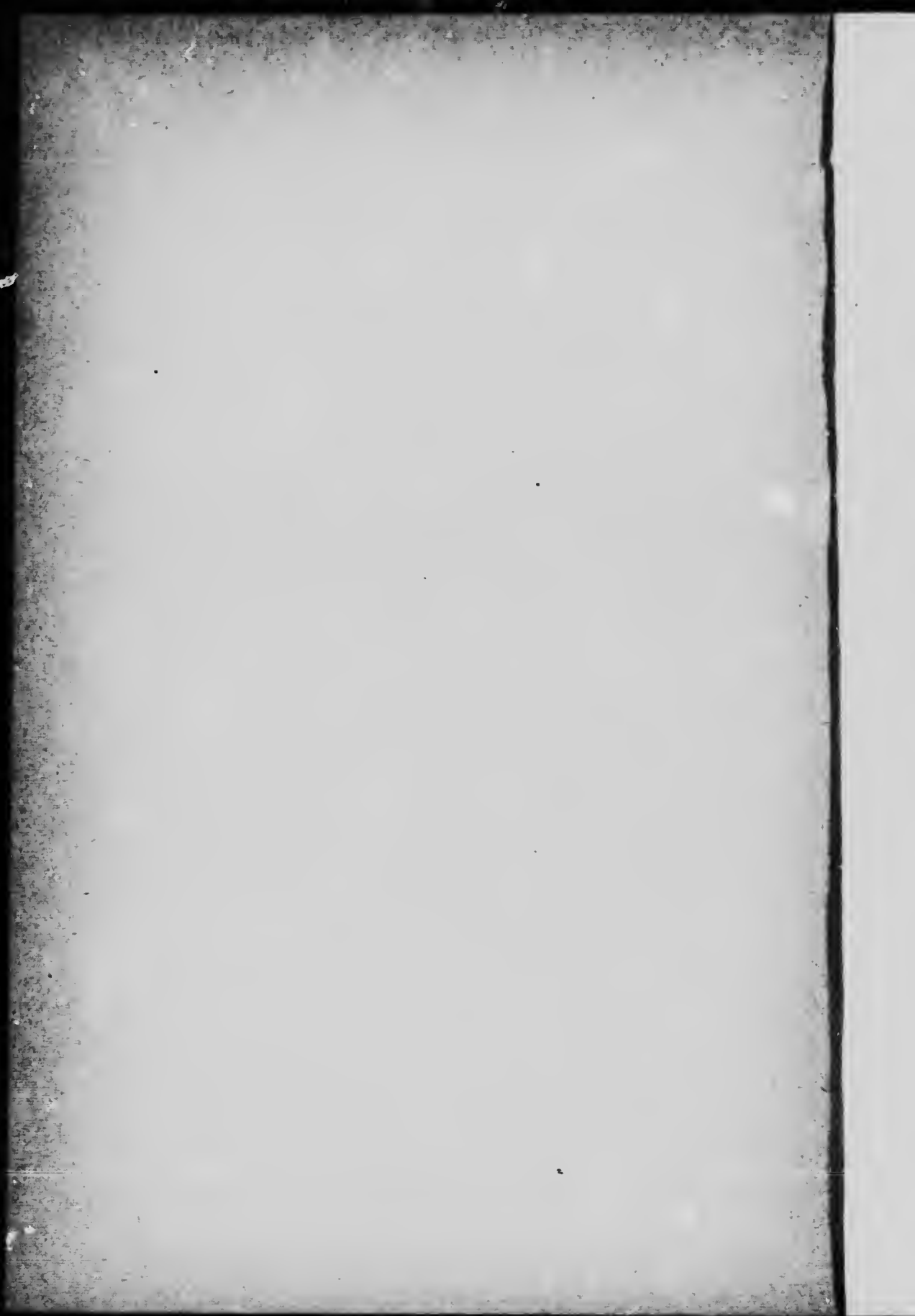

HALLIBURTON'S  
HAND-BOOK OF PHYSIOLOGY.





*Presented to the*  
LIBRARY *of the*  
UNIVERSITY OF TORONTO  
*h.*

MR. C.C. ROUS

*KIRKES' HAND-BOOK OF PHYSIOLOGY.*

HAND-BOOK  
OF  
PHYSIOLOGY.

By W. D. HALLIBURTON, M.D., F.R.S.

PROFESSOR OF PHYSIOLOGY, KING'S COLLEGE, LONDON.

SEVENTEENTH EDITION

WITH UPWARDS OF SIX HUNDRED AND EIGHTY ILLUSTRATIONS

INCLUDING SOME COLOURED PLATES.

NAU: )

TORONTO:

GEORGE N. MORANG & CO., LD.

LONDON: JOHN MURRAY.

1901.



**1124702**

## PUBLISHER'S NOTE.

---

THREE completely revised editions of Kirkes' Handbook have now been published since the editorship was first undertaken by Professor W. D. Halliburton in 1896. So extensive have been the changes made in these years, that but little remains of the original work, and the Manual has now obtained a higher reputation and a wider popularity than at any time before.

In these circumstances it has been suggested by several professional men and other readers of the book that it would be well to drop the time-honoured name of "Kirkes'," and to substitute for it that of the real author of the present volume—Professor Halliburton. Whatever prestige attached to the old title has now been rightly transferred to the new, and we have accordingly decided to adopt this suggestion, and to call the book in future "Halliburton's Physiology."

I must take this opportunity to call attention once more to the fact that for some years past a so-called edition of "Kirkes' Physiology" has been circulated in the United States, not only without the authority, but in spite of the repeated public protests, of the owners and editors of the genuine book. It is hoped that the adoption of a new name may enable the public to distinguish between the authorized and the unauthorized editions.

JOHN MURRAY.

*July, 1901.*

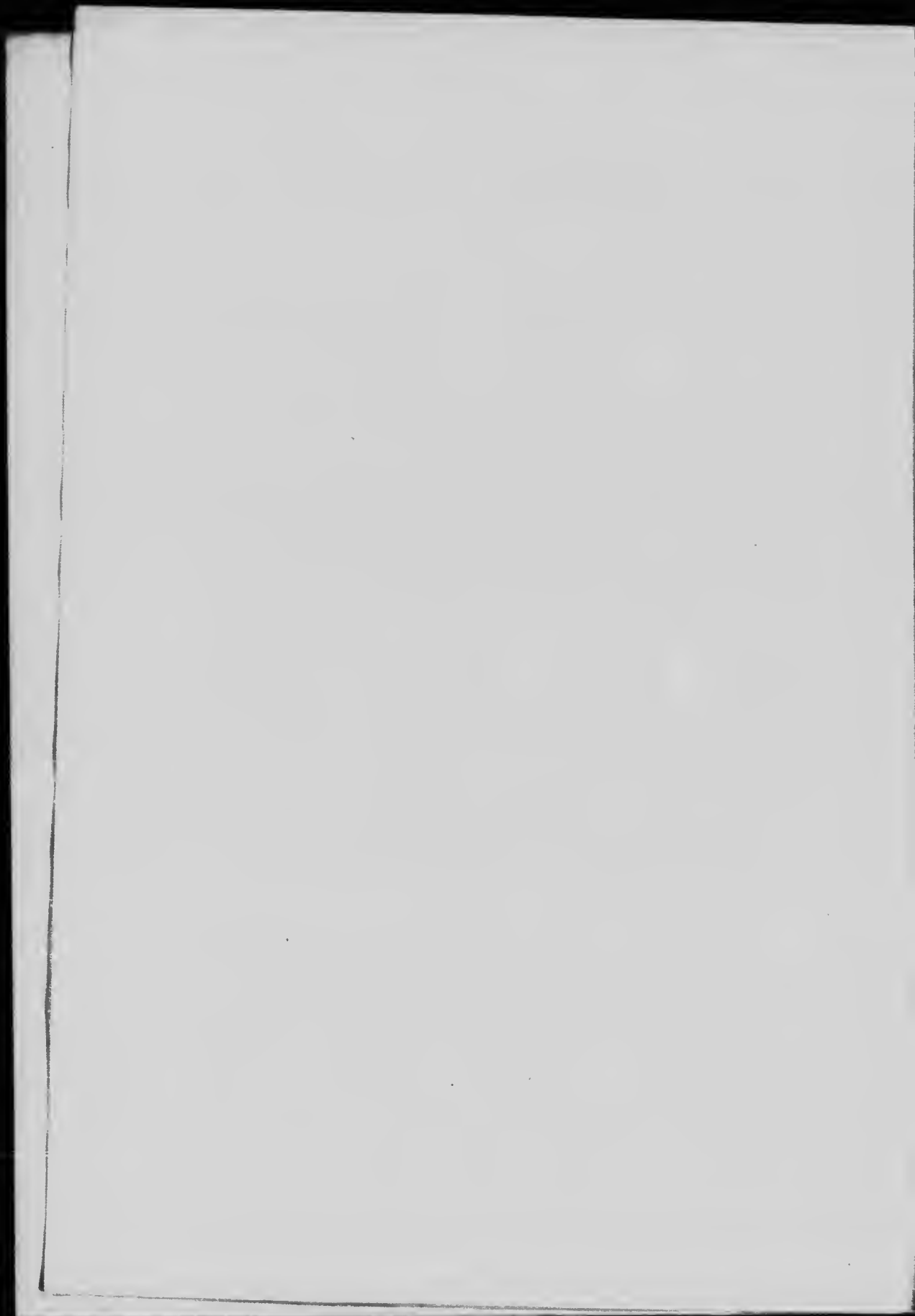

## AUTHOR'S PREFACE.

---

I HAVE once more subjected this book to a thorough revision, and endeavoured to incorporate in it the results of all important recent work in the widening physiological field. In so doing, I have tried to keep in mind that the book is a student's text-book, and that it is therefore necessary not to overwhelm its readers with a mass of unnecessary detail. The introduction of new matter entails the excision of what is antiquated or unnecessary, and so I have been able to keep the size of the work pretty much as it was. The present edition exceeds its predecessor by only fifteen pages, and this increase is largely due to the fact that about twenty new illustrations have been added. It is impossible to enumerate all the changes now introduced, for hardly a page has escaped some alteration. The principal additions are, however, as follows: New sections have been introduced on the significance of Nissl's granules, on Waller's work on the electrical currents of the eyeball, on Cannon's researches in connection with stomach movements, and on Waymouth Reid's investigation of the processes of absorption. The sections relating to the electrical phenomena of muscle, to the proteids, to the ductless glands, to the muscles of the larynx, to the cranial nerves, and to

respiration under altered conditions of pressure, have been almost entirely rewritten. I have to acknowledge valuable assistance given to me by Mr. Leonard Hill, F.R.S., and Dr. Pembrey, in the chapter on respiration, and by Mr. A. W. Cadman, F.R.C.S., in the new account given of the cranial nerves.

W. D. HALLIBURTON.

KING'S COLLEGE, LONDON,

*April, 1901.*

# CONTENTS.

## CHAPTER I.

	PAGE
INTRODUCTORY . . . . .	1
Definition of the Science of Physiology . . . . .	1
Physiological Methods . . . . .	3
The Organs, Tissues, and Cells of the Body . . . . .	4
Animal and Vegetable Cells . . . . .	6

## CHAPTER II.

THE ANIMAL CELL . . . . .	8
Protoplasm . . . . .	8
Nucleus . . . . .	10
Attraction Sphere . . . . .	12
Protoplasmic Movement . . . . .	12
Cell-division . . . . .	16
The Ovum . . . . .	22

## CHAPTER III.

EPITHELIUM . . . . .	23
Classification of Epithelium . . . . .	24
Pavement Epithelium . . . . .	26
Cubical, Spheroidal and Columnar Epithelium . . . . .	27
Ciliated Epithelium . . . . .	30
Ciliary Motion . . . . .	31
Transitional Epithelium . . . . .	33
Stratified Epithelium . . . . .	34
Nutrition of Epithelium . . . . .	36
Chemistry of Epithelium . . . . .	36



## CHAPTER IV.

	PAGE
THE CONNECTIVE TISSUES . . . . .	
Areolar Tissue . . . . .	37
Fibrous Tissue . . . . .	38
Elastic Tissue . . . . .	44
Adipose Tissue . . . . .	46
Retiform Tissue . . . . .	47
Adenoid or Lymphoid Tissue . . . . .	50
Basement Membranes . . . . .	51
Jelly-like Connective Tissue . . . . .	52

## CHAPTER V.

THE CONNECTIVE TISSUES— <i>continued</i> . . . . .	
Cartilage . . . . .	53
Bone . . . . .	53
Ossification . . . . .	58
Teeth . . . . .	64
The Blood . . . . .	70
	82

## CHAPTER VI.

MUSCULAR TISSUE . . . . .	84
Voluntary Muscle . . . . .	85
Red Muscles . . . . .	93
Cardiac Muscle . . . . .	94
Plain Muscle . . . . .	94
Development of Muscular Fibres . . . . .	95

## CHAPTER VII.

NERVE . . . . .	
Structure of . . . . .	96
Terminations of . . . . .	96
Development of . . . . .	102
	104

## CHAPTER VIII.

IRRITABILITY AND CONTRACTILITY . . . . .	105
--	-----

## CHAPTER IX.

CONTRACTION OF MUSCLE—Summary . . . . .	111
---	-----

## CHAPTER X.

	PAGE
CHANGE IN FORM IN A MUSCLE WHEN IT CONTRACTS . . . . .	112
Instruments used . . . . .	112
Simple Muscle Curve . . . . .	122
The Muscle-Wave . . . . .	125
Effect of two Successive Stimuli . . . . .	126
Effect of more than two Stimuli . . . . .	127
Tetanus . . . . .	128
Voluntary Tetanus . . . . .	128

## CHAPTER XI.

EXTENSIBILITY, ELASTICITY, AND WORK OF MUSCLE . . . . .	131
---	-----

## CHAPTER XII.

THE ELECTRICAL PHENOMENA OF MUSCLE . . . . .	139
--	-----

## CHAPTER XIII.

THERMAL AND CHEMICAL CHANGES IN MUSCLE . . . . .	153
--	-----

## CHAPTER XIV.

COMPARISON OF VOLUNTARY AND INVOLUNTARY MUSCLE . . . . .	161
--	-----

## CHAPTER XV.

PHYSIOLOGY OF NERVE . . . . .	163
Classification of Nerves . . . . .	163
Investigation of Nerve-Functions . . . . .	166
Degeneration of Nerve . . . . .	167
Roots of the Spinal Nerves . . . . .	169
Changes in Nerve during activity . . . . .	172
Nerve Impulses . . . . .	173
Chemistry of Nerve . . . . .	174

## CHAPTER XVI.

ELECTROTONUS . . . . .	175
------------------------	-----

## CHAPTER XVII.

	PAGE
NERVE-CENTRES . . . . .	188
Structure of Nerve-Cells . . . . .	191
The Significance of Nissl's Granules . . . . .	200

## CHAPTER XVIII.

THE CIRCULATORY SYSTEM . . . . .	203
The Heart . . . . .	203
Course of the Circulation . . . . .	211
Arteries . . . . .	213
Veins . . . . .	215
Capillaries . . . . .	219
Lymphatic Vessels . . . . .	222

## CHAPTER XIX.

THE CIRCULATION OF THE BLOOD . . . . .	226
--	-----

## CHAPTER XX.

PHYSIOLOGY OF THE HEART . . . . .	231
The Cardiac Cycle . . . . .	231
Action of the Valves of the Heart . . . . .	233
Sounds of the Heart . . . . .	235
Coronary Arteries . . . . .	238
Cardiographs . . . . .	238
Endocardiac Pressure . . . . .	241
Frequency and Force of the Heart's Action . . . . .	245
Innervation of the Heart . . . . .	247
Instruments for studying the excised Frog's Heart . . . . .	258

## CHAPTER XXI.

THE CIRCULATION IN THE BLOOD-VESSELS . . . . .	261
Velocity of the Blood-Flow . . . . .	261
Use of the Elasticity of the Vessels . . . . .	266
The Pulse . . . . .	267
Capillary Flow . . . . .	273
Venous Flow . . . . .	276
Local Peculiarities of the Circulation . . . . .	277
Blood-pressure . . . . .	281
Measurement of Blood-pressure in Man . . . . .	295
Vaso-motor Nervous System . . . . .	296

## CHAPTER XXII.

	PAGE
<b>LYMPH AND LYMPHATIC GLANDS</b> . . . . .	312
Composition of Lymph . . . . .	312
Lymphatic Glands . . . . .	313
Lymph Flow . . . . .	316
Relation of Lymph and Blood . . . . .	317
Formation of Lymph . . . . .	317

## CHAPTER XXIII.

<b>THE DUCTLESS GLANDS</b> . . . . .	320
Spleen . . . . .	322
Thymus . . . . .	328
Thyroid . . . . .	330
Supra-renal Capsules . . . . .	333
Pituitary Body . . . . .	336
Pineal Gland . . . . .	336
Coccygeal and Carotid Glands . . . . .	337

## CHAPTER XXIV.

<b>RESPIRATION</b> . . . . .	337
Respiratory Apparatus . . . . .	338
Respiratory Mechanism . . . . .	346
Nervous Mechanism of Respiration . . . . .	357
Special Respiratory Acts . . . . .	361
Effect of Respiration on the Circulation . . . . .	365
Asphyxia . . . . .	368
Effects of Breathing Gases other than the Atmosphere . . . . .	371
Alterations in the Atmospheric Pressure . . . . .	372
Chemistry of Respiration . . . . .	373

## CHAPTER XXV.

<b>THE CHEMICAL COMPOSITION OF THE BODY</b> . . . . .	384
Carbohydrates . . . . .	385
Fats . . . . .	390
Proteids . . . . .	392
The Polarimeter . . . . .	402
Ferments . . . . .	403

## CHAPTER XXVI.

	PAGE
THE BLOOD . . . . .	406
Coagulation of the Blood . . . . .	408
Plasma and Serum . . . . .	411
Blood-corpuscles . . . . .	414
Blood Platelets . . . . .	420
Development of the Blood-corpuscles . . . . .	422
Chemistry of the Blood-corpuscles . . . . .	426
Hæmoglobin . . . . .	430

## CHAPTER XXVII.

THE ALIMENTARY CANAL . . . . .	438
--------------------------------	-----

## CHAPTER XXVIII.

FOOD . . . . .	455
Milk . . . . .	457
Eggs . . . . .	462
Meat . . . . .	462
Flour . . . . .	463
Bread . . . . .	464
Cooking of Food . . . . .	465
Accessories to Food . . . . .	466

## CHAPTER XXIX.

SECRETING GLANDS . . . . .	467
----------------------------	-----

## CHAPTER XXX.

SALIVA . . . . .	471
The Salivary Glands . . . . .	471
Secretory Nerves of Salivary Glands . . . . .	474
The Saliva . . . . .	477

## CHAPTER XXXI.

THE GASTRIC JUICE . . . . .	479
Composition . . . . .	481
Innervation of the Gastric Glands . . . . .	482
Action of Gastric Juice . . . . .	484

CHAPTER XXXII.

	PAGE
DIGESTION IN THE INTESTINES . . . . .	486
The Pancreas . . . . .	486
Composition and Action of Pancreatic Juice . . . . .	487
Intestinal Digestion . . . . .	489
Leucine and Tyrosine . . . . .	491
Secretory Nerves of the Pancreas . . . . .	492
Extirpation of the Pancreas . . . . .	493

CHAPTER XXXIII.

THE LIVER . . . . .	494
Functions . . . . .	500
Bile . . . . .	501
Glycogenic Function of the Liver . . . . .	507
Nerves of the Liver . . . . .	511

CHAPTER XXXIV.

THE ABSORPTION OF FOOD . . . . .	512
----------------------------------	-----

CHAPTER XXXV.

THE MECHANICAL PROCESSES OF DIGESTION . . . . .	518
Mastication . . . . .	518
Deglutition . . . . .	519
Movements of the Stomach . . . . .	521
Vomiting . . . . .	525
Movements of the Intestines . . . . .	526

CHAPTER XXXVI

THE URINARY APPARATUS . . . . .	529
Nerves of the Kidney . . . . .	538
Activity of the Renal Epithelium . . . . .	541
Work done by the Kidney . . . . .	542
Extirpation of the Kidneys . . . . .	545
Passage of Urine into the Bladder . . . . .	545
Micturition . . . . .	546

## CHAPTER XXXVII.

	PAGE
THE URINE . . . . .	547
Urea . . . . .	549
Uric Acid . . . . .	556
Hippuric Acid . . . . .	558
Creatinine . . . . .	559
Inorganic Constituents of Urine . . . . .	560
Urinary Deposits . . . . .	563
Pathological Urine . . . . .	566

## CHAPTER XXXVIII.

THE SKIN . . . . .	570
--------------------	-----

## CHAPTER XXXIX.

GENERAL METABOLISM . . . . .	580
Discharge of Carbon . . . . .	583
Discharge of Nitrogen . . . . .	584
Balance of Income and Discharge in Health . . . . .	585
Inanition or Starvation . . . . .	587
Exchange of Material in Diseases . . . . .	591
Luxus Consumption . . . . .	592

## CHAPTER XL.

ANIMAL HEAT . . . . .	595
Regulation of the Temperature of Warm-blooded Animals . . . . .	600

## CHAPTER XLI.

THE CENTRAL NERVOUS SYSTEM . . . . .	602
--------------------------------------	-----

## CHAPTER XLII.

STRUCTURE OF THE SPINAL CORD . . . . .	604
--	-----

## CHAPTER XLIII.

THE BRAIN . . . . .	618
---------------------	-----

## CHAPTER XLIV.

STRUCTURE OF THE BULB, PONS, AND MID-BRAIN . . . . .	622
--	-----

CHAPTER XLV.

STRUCTURE OF THE CEREBELLUM . . . . .	PAGE 638
---------------------------------------	-------------

CHAPTER XLVI.

STRUCTURE OF THE CEREBRUM . . . . .	642
Histology of the Cortex . . . . .	647
The Convolutions . . . . .	652

CHAPTER XLVII.

FUNCTIONS OF THE SPINAL CORD . . . . .	657
The Cord as an Organ of Conduction . . . . .	657
Reflex Action of the Cord . . . . .	659
Reflex Action in Man . . . . .	661

CHAPTER XLVIII.

FUNCTIONS OF THE CEREBRUM . . . . .	667
Removal of the Cerebrum . . . . .	667
Localisation of Cerebral Functions . . . . .	668

CHAPTER XLIX.

FUNCTIONS OF THE CEREBELLUM . . . . .	681
---------------------------------------	-----

CHAPTER L.

SENSATION . . . . .	690
---------------------	-----

CHAPTER LI.

Tactile End Organs . . . . .	694
Tactile End Organs . . . . .	694
Localisation of Tactile Sensations . . . . .	700
Sense of Pressure . . . . .	702
Sense of Temperature . . . . .	703
Muscular Sense . . . . .	703

K.P.

l



## CHAPTER LII.

	PAGE
TASTE AND SMELL . . . . .	704
Taste . . . . .	704
Smell . . . . .	710

## CHAPTER LIII.

HEARING . . . . .	713
Anatomy of the Ear . . . . .	713
Physiology of Hearing . . . . .	722

## CHAPTER LIV.

VOICE AND SPEECH . . . . .	727
Anatomy of the Larynx . . . . .	727
Movements of the Vocal Cords . . . . .	734
The Voice . . . . .	735
Speech . . . . .	737
Defects of Speech . . . . .	738

## CHAPTER LV.

THE EYE AND VISION . . . . .	740
The Eyeball . . . . .	741
The Eye as an Optical Instrument . . . . .	755
The Ophthalmoscope . . . . .	770
The Perimeter . . . . .	774
Fovca Centralis . . . . .	774
Colour Sensations . . . . .	776
Changes in the Retina during activity . . . . .	780
Various Positions of the Eyeballs . . . . .	783
Nervous Paths in the Optic Nerves . . . . .	785
Visual Judgments . . . . .	787

## CHAPTER LVI.

TROPHIC NERVES . . . . .	790
--------------------------	-----

## CHAPTER LVII.

THE REPRODUCTIVE ORGANS . . . . .	792
Male Organs . . . . .	793
Female Organs . . . . .	798

## CHAPTER LVIII.

	PAGE
DEVELOPMENT . . . . .	803
The Ovum . . . . .	803
Changes in the Ovum previous to Fecundation . . . . .	804
Impregnation . . . . .	805
Segmentation . . . . .	806
Fœtal Membranes . . . . .	815
Development of the Decidua . . . . .	817
Development of the Fœtal Membranes . . . . .	818
Development of the Framework of the Body . . . . .	824
Formation of the Head . . . . .	826
Development of the Vascular System . . . . .	830
Development of the Nervous System . . . . .	841
Development of the Alimentary Canal . . . . .	851
Development of the Respiratory Apparatus . . . . .	854
Development of the Genito-urinary Apparatus . . . . .	855
-----	
INDEX . . . . .	863

**FAHRENHEIT  
and  
CENTIGRADE  
SCALES.**

F.	C.
500°	260°
401	205
392	200
383	195
374	190
356	180
347	175
338	170
329	165
320	160
311	155
302	150
284	140
275	135
266	130
248	120
239	115
230	110
212	100
203	95
194	90
176	80
167	75
140	60
122	50
113	45
105	40° 54'
104	40
100	37° 8'

98° 5'	36° 9'
95	35
86	30
77	25
68	20
50	10
41	5
32	0
23	- 5
14	-10
+ 5	-15
- 4	-20
-13	-25
-22	-30
-40	-40
-76	-60

1 deg. F. = 5/9° C.
1° 8' " = 1° C.
3° 6' " = 2° C.
4° 5' " = 2° 5' C.
5° 4' " = 3° C.

To convert degrees F. into degrees C., subtract 32, and multiply by 5/9.

To convert degrees C. into degrees F., multiply by 9/5, and add 32.

**MEASUREMENTS.  
FRENCH INTO ENGLISH.**

**LENGTH.**

1 mètre }  
10 décimètres } = 39°37 English  
100 centimètres } inches,  
1,000 millimètres } (or 1 yard and 3 3/8 in.)

1 décimètre }  
10 centimètres } = 3°937 Inches  
100 millimètres } (or nearly 4 inches)

1 centimètre } = °3937 or about  
10 millimètres } (nearly 3/8 inch.)  
1 millimètre } = nearly 1/32 inch.

OR,

ONE MÈTRE = 39°37079 inches.

(It is the ten-millionth part of a quarter of the meridian of the earth.)

1 Décimètre = 4 in.  
1 Centimètre = 1/10 in.  
1 Millimètre = 1/25 in.  
Décamètre = 32°80 feet.  
Hectomètre = 109°36 yds.  
Kilomètre = 0°62 miles.  
One inch = 2°539 Centimètres.  
One foot = 3°047 Décimètres.  
One yard = 0°91 of a Mètre.  
One mile = 1°60 Kilomètre.

The cubic centimètre (15°432 grains—1 gramme) is a standard at 4° C., the grain at 16°66 C.

**WEIGHT.**

(One gramme is the weight of a cubic centimètre of water at 4° C. at Paris.)

1 gramme }  
10 décigrammes } = 15°432349 grs.  
100 centigrammes } (or nearly 15 1/2.)  
1,000 milligrammes }

1 décigramme }  
10 centigrammes } = rather more  
100 milligrammes } than 1 1/2 grain.

1 centigramme } = rather more  
10 décigrammes } than 3/160 grain.

1 milligramme = rather more than 1/320 grain.

OR

1 Décigramme = 2 dr. 34 gr.  
1 Hectogr. = 3 1/2 oz. (Avoir.)  
1 Kilogr. = 2 lb. 3 oz. 2 dr. (Avoir.)

A grain equals about 1°16 gram., a Troy oz. about 31 gram., a lb. Avoirdupois about 454 Kilogrms., and 1 cwt. about 50 Kilogrms.

**CAPACITY.**

1,000 cubic centimètres } = 1 cubic  
1,000,000 cubic centimètres } mètre.

1 cubic décimètre }  
or } = 1 litre.  
1,000 cubic centimètres }

OR

ONE LITRE = 1 pt. 15 oz. 1 dr. 40.

(For simplicity, Litre is used to signify 1 cubic décimètre, a little less than 1 English quart.)

Décilitre (100 c.c.) = 3 1/2 oz.  
Centilitre (10 c.c.) = 2 1/2 dr.  
Millilitre (1 c.c.) = 17 mi.  
Décalitre = 2 1/2 gal.  
Hectolitre = 22 gals.  
Kilolitre (cubic mètre) = 27 1/2 bushels.

A cubic inch = 16°38 c.c.; a cubic foot = 28°315 cubic déc., and a gallon = 4°54 litres.

**CONVERSION SCALE.**

To convert GRAMMES to OUNCES avoirdupois, multiply by 20 and divide by 567.

To convert KILOGRAMMES to POUNDS, multiply by 1,000 and divide by 454.

To convert LITRES to GALLONS, multiply by 22 and divide by 100.

To convert LITRES to PINTS, multiply by 88 and divide by 50.

To convert MILLIMÈTRES to INCHES, multiply by 10 and divide by 254.

To convert MÈTRES to YARDS, multiply by 70 and divide by 64.

**SURFACE MEASURE.**

1 square mètre = about 1550 sq. inches. Or 10,000 sq. centimètres, or 10°75 sq. ft.

1 sq. inch = about 6°4 sq. centimètres.

1 sq. foot = " 930 " "

**ENERGY MEASURE.**

1 Kilogrammètre = about 7°24 ft. pounds.

1 foot pound = " 1381 kgm.

1 foot ton = " 310 kgm.

**HEAT EQUIVALENT.**

1 kilocalorie = 424 kilogrammètres.

**ENGLISH MEASURES.**

*Apothecaries Weight.*

7000 grains = 1 lb.

OR

437°5 grains = 1 oz.

*Avoirdupois Weight.*

16 drams = 1 oz.

16 oz. = 1 lb.

28 lbs. = 1 quarter.

4 quarters = 1 cwt.

20 cwt. = 1 ton.

Measure of 1 décimètre, or 10 centimètres, or 100 millimètres.



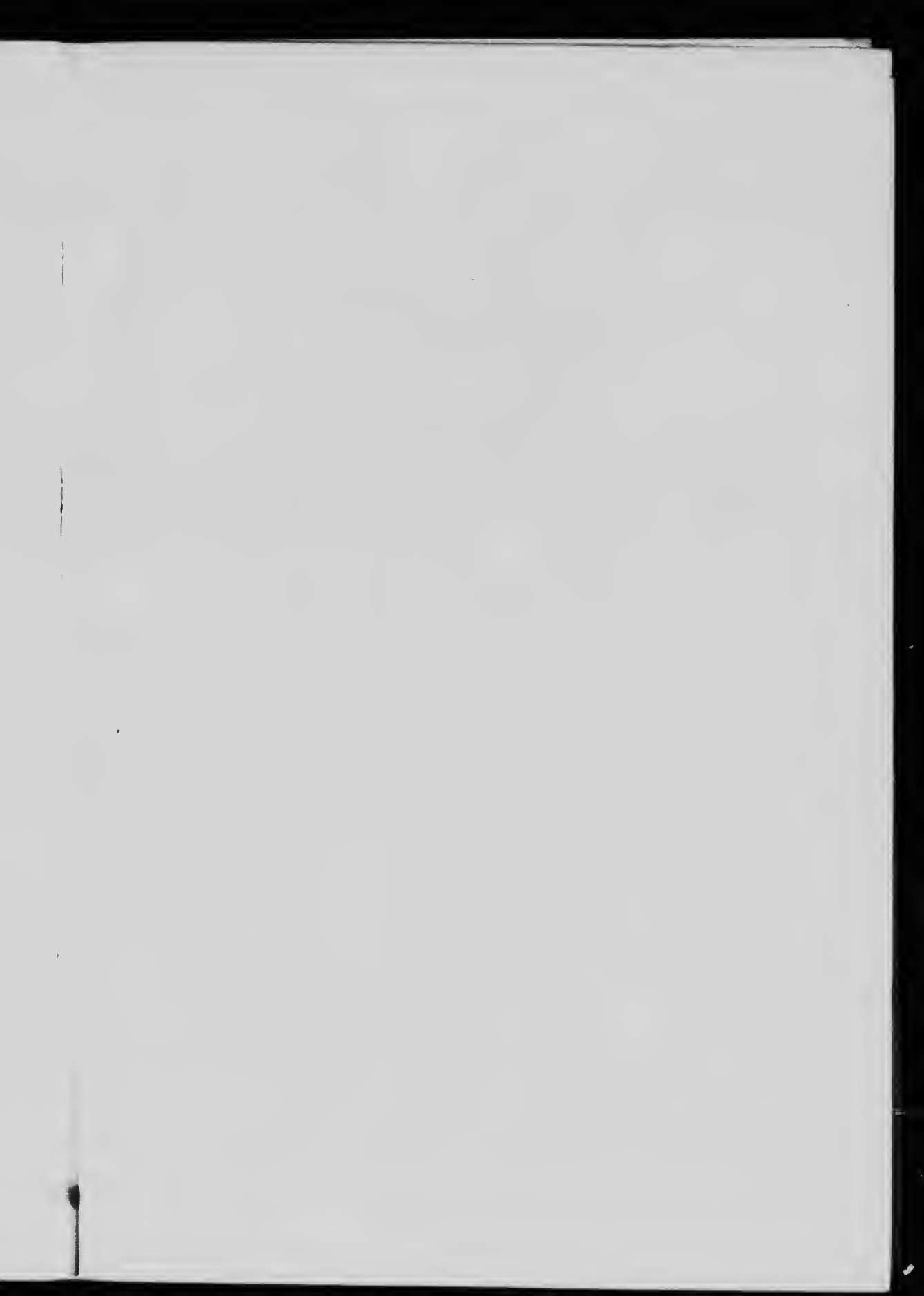

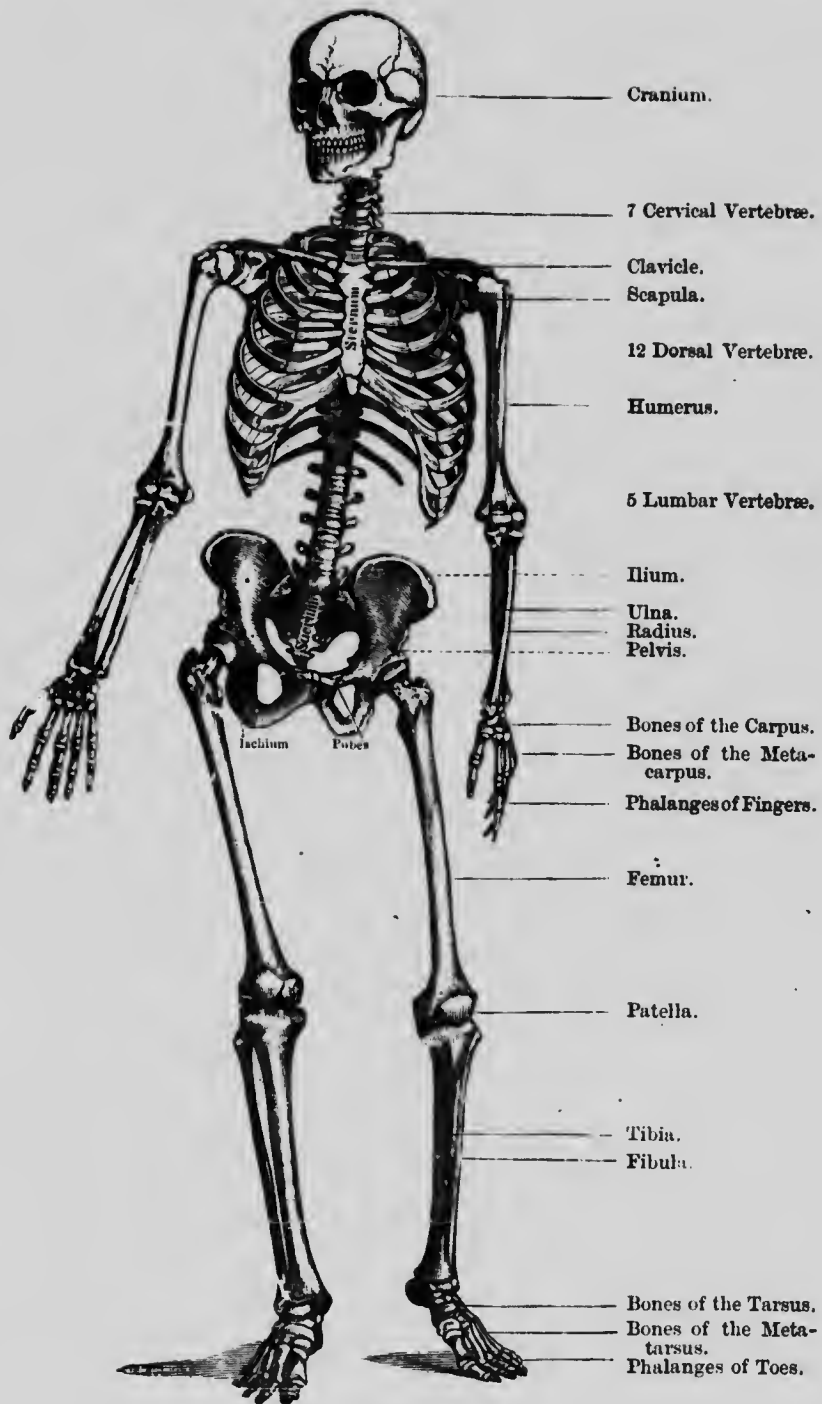

THE SKELETON (AFTER HOLDEN).

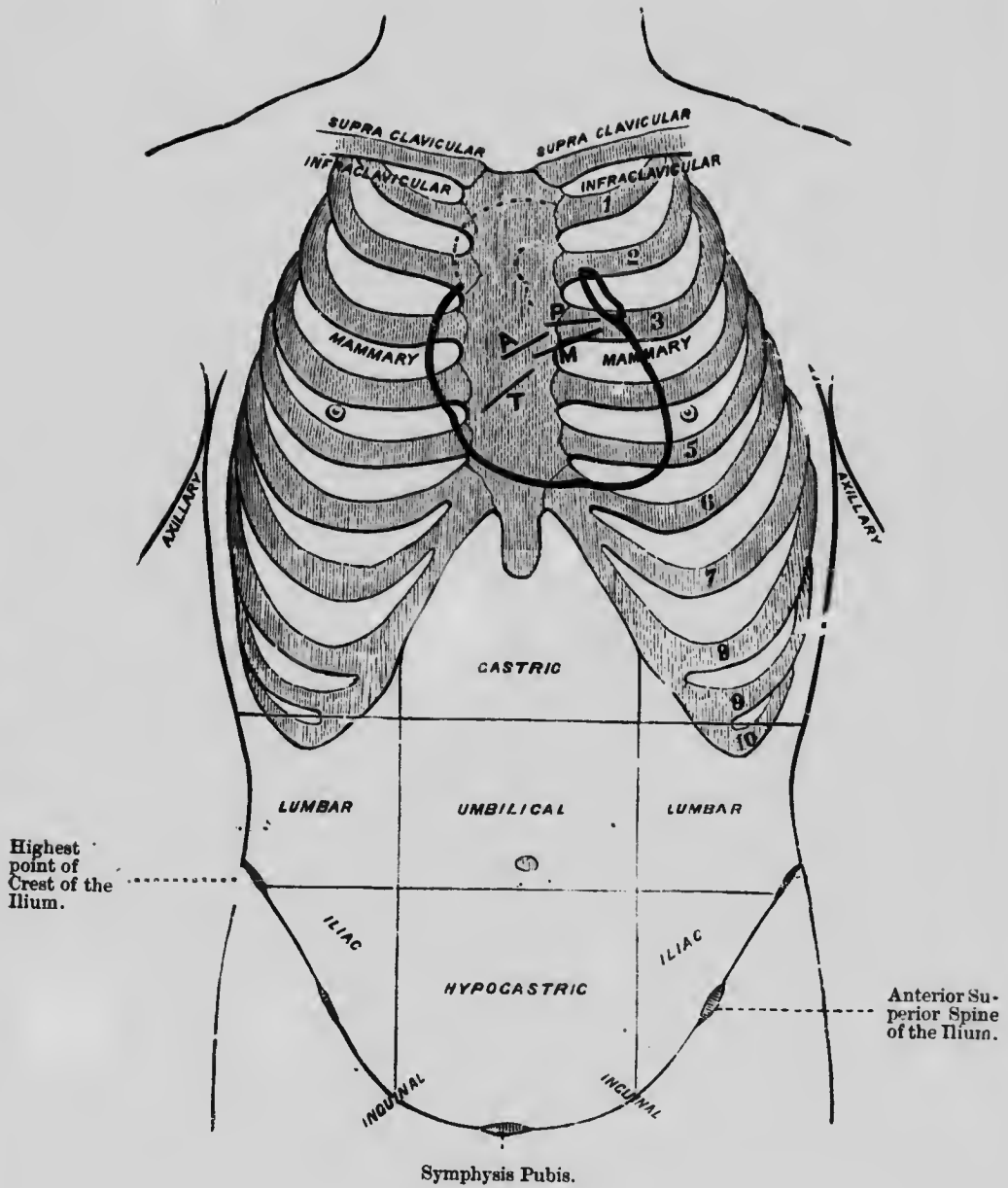

DIAGRAM OF THORACIC AND ABDOMINAL REGIONS.

A. Aortic Valve.  
M. Mitral Valve.

P. Pulmonary Valve.  
T. Tricuspid Valve.



# HANDBOOK OF PHYSIOLOGY.

---

## CHAPTER I.

### INTRODUCTORY.

*BIOLOGY* is the science that treats of living things, and it is divided into two main branches, which are called respectively *Morphology* and *Physiology*. *Morphology* is the part of the science that deals with the form or structure of living things, and with the problems of their origin and distribution. *Physiology*, on the other hand, treats of their functions, that is, the manner in which their individual parts carry out the processes of life. To take an instance: the eye and the liver are two familiar examples of what are called organs; the anatomist studies the structure of these organs, their shape, their size, the tissues of which they are composed, their position in the body, and the variations in their structure met with in different parts of the animal kingdom. The physiologist studies their uses, and seeks to explain how the eye fulfils the function of vision, and how the liver forms bile, and ministers to the needs of the body in other ways.

Each of these two great branches of biological science can be further subdivided according as to whether it deals with the animal or the vegetable kingdom; thus we get vegetable physiology and animal physiology. Human Physiology is a large and important branch of animal physiology, and to the student of medicine is obviously the portion of the science that should interest him most. In order to understand morbid or pathological processes it is necessary that the normal or physiological functions should be learnt first. Physiology is not a study which can be put aside and forgotten when a certain examination has been passed; it has a most direct and intimate bearing in its application to the scientific and successful investigation of disease. It will be my endeavour throughout the subsequent pages of this book to



point out from time to time the practical relationships between physiology and pathology.

Human physiology will be our chief theme, but it is not a portion of the great science that can be studied independently of its other portions. Thus, many of the experiments upon which our knowledge of human physiology rests have been performed principally on certain of the lower animals. In order to obtain a wide view of vital processes it will be occasionally necessary to go still further afield, and call the science of vegetable physiology to our assistance.

In another sense, human physiology is in no isolated position. Its study must go hand in hand with the study of anatomy. It is impossible to understand how the body or any part of the body acts unless we know accurately the structure of the organs under consideration. This is especially true for that portion of anatomy which is called Microscopic Anatomy or Histology. Indeed, so close is the relationship between minute structure and function that in this country it is usual for the teacher of physiology to be also the teacher of histology. Another branch of anatomy, namely, Embryology, or the process of growth of the adult from the ovum, falls also within the province of the physiologist.

But physiology is not only intimately related in this way to its sister science anatomy, but the sciences of chemistry and physics must also be considered. Indeed, physiology has been sometimes defined as the application of the laws of chemistry and physics to life. That is to say, the same laws that regulate the behaviour of the mineral or inorganic world are also to be found operating in the region of organic beings. If we wish for an example of this we may again go to the eye; the branch of physics called optics teaches us, among other things, the manner in which images of objects are produced by lenses; these same laws regulate the formation of the images of external objects upon the sensitive layer of the back of the eye by the series of lenses in the front of that organ. An example of the application of chemical laws to living processes is seen in digestion; the food contains certain chemical substances which are acted on in a chemical way by the various digestive juices in order to render them of service to the organism.

The question arises, however, is there anything else? Are there any other laws than those of physics and chemistry to be reckoned with? Is there, for instance, such a thing as "vital force"? It may be frankly admitted that physiologists at present are not able to explain all vital phenomena by the laws of the physical world; but as knowledge increases it is more and more abundantly

shown that the supposition of any special or vital force is unnecessary; and it should be distinctly recognised that when, in future pages, it is necessary to allude to vital action, it is not because we believe in any specific vital energy, but merely because the phrase is a convenient one for expressing something that we do not fully understand, something that cannot at present be brought into line with the physical and chemical forces that operate in the inorganic world.

It will be in connection with the nervous system that we shall principally have recourse to this convenient expression, for it is there that we find the greatest difficulty in reconciling the phenomena of life with those of the non-living.

Physiology proper may be conveniently divided into three main branches:—

1. Chemical physiology; or the application of chemistry to living processes.
2. Physical physiology; or the application of physics to living processes.
3. The physiology of the nervous system where the application of such laws is at present extremely difficult.

But just as there is no hard and fast line between physiology and its allies pathology, anatomy, physics, and chemistry, so also there is no absolute separation between its three great divisions; physical, chemical, and so-called vital processes have to be considered together.

Physiology is a comparatively young science. Though Harvey more than three hundred years ago laid the foundation of our science by his discovery of the circulation of the blood, it is only during the last half-century that active growth has occurred. The reasons for this recent progress come under two headings; those relating to observation and those relating to experiment.

The method of observation consists in accurately noting things as they occur in nature; in other words, the knowledge of anatomy must be accurate before correct deductions as to function are possible. The instrument by which such correct observations can be made is, *par excellence*, from the physiologist's standpoint, the microscope, and it is the extended use of the microscope, and the knowledge of minute anatomy resulting from that use, that has formed one of the greatest stimuli to the successful progress of physiology during the last fifty years.

But important as observation is, it is not the most important method; the method of experiment is still more essential. This consists, not in being content with mere reasonings from structure or occurrences seen in nature, but in producing artificially changed

relationships between the structures, and thus causing new combinations that if one had waited for Nature herself to produce might have been waited for indefinitely. Anatomy is important, but mere anatomy has often led people astray when they have tried to reason how an organ works from its structure only. Experiment is much more important; that is, one tests one's theories by seeing whether the occurrences actually take place as one supposes; and thus the deductions are confirmed or corrected. It is the universal use of this method that has made physiology what it is. Instead of sitting down and trying to reason out how the living machine works, physiologists have actually tried the experiment, and so learnt much more than could possibly have been gained by mere cogitation. Many such experiments involve the use of living animals, but the discovery of anaesthetics, which renders such experiments painless, has got rid of any objection to experiments on the score of pain.

We must next proceed to an examination of the general structure of the body, and an explanation of some of the technical terms which will frequently be used hereafter.

The adult body consists of a great number of different parts; and each part has its own special work to do. Such parts of the body are called **organs**. Each organ does not only its own special work but acts in harmony with other organs. This relationship between the organs enables us to group them together into what are termed **systems**. Thus, we have the *circulatory system*, that is, the group of organs (heart, arteries, veins, etc.) concerned in the circulation of the blood; the *respiratory system*, that is, the group of organs (air passages, lungs, etc.) concerned in the act of breathing; the *digestive system*, which deals with the digestion of food; the *excretory system*, with the getting rid of waste products; the *muscular system*, with movement; and the *skeletal system*, with the support of the softer parts of the body. Over and above all these is the *nervous system* (brain, spinal cord, nerves), the great master system of the body which presides over, controls, and regulates the functions of the other systems.

If we proceed still further on our anatomical analysis, and take any organ, we see that it consists of various textures, or, as they are called, **elementary tissues**. Just as one's garments are made up of textures (cloth, lining, buttons, etc.), so each organ is composed of corresponding tissues. The elementary tissues come under the following four headings:—

- |                        |                      |
|------------------------|----------------------|
| 1. Epithelial tissues. | 3. Muscular tissues. |
| 2. Connective tissues. | 4. Nervous tissues.  |

Each of these is again divisible into sub-groups.

Suppose we continue our anatomical analysis still further, we find that the individual tissues are built up of structures which require the microscope for their accurate study. Just as the textures of a garment are made up of threads of various kinds, so also in many of the animal tissues we find threads or *fibres*, as they are called. But more important than the threads are little masses of living material. Just as the wall of a house is made up of bricks united by cement, so the body walls are built of extremely minute living bricks, united together by different amounts of cementing material. Each one of these living units is called a **cell**.

Some of the tissues already enumerated consist of cells with only very little cement material binding them together; this, for instance, is seen in the epithelial tissues; but in other tissues, particularly the connective tissues which are not so eminently living as the rest, the amount of cement or **intercellular material** is much greater, and in this it is that the fibres are developed that confer the necessary strength upon these binding tissues.

If, instead of going to the adult animal, we look at the animal in its earliest stage of development, the ovum, we find that it consists of a single little mass of living material, a single cell. As development progresses it becomes an adherent mass of cells. In the later stages of development various tissues become differentiated from each other by the cells becoming grouped in different ways, by alterations in the shape of the cells, by deposition of intercellular matter between the cells, and by chemical changes in the living matter of the cells themselves. Thus in some situations the cells are grouped into the various epithelial linings; in others the cells become elongated and form muscular fibres; and in others, as in the connective tissues, there is a preponderating amount of intercellular material which may become permeated with fibres, or be the seat of the deposition of calcareous salts, as in bone. Instances of chemical changes in the cells themselves are seen on the surface of the body where the superficial layers of the epidermis become horny; in the mucous glands, where they become filled

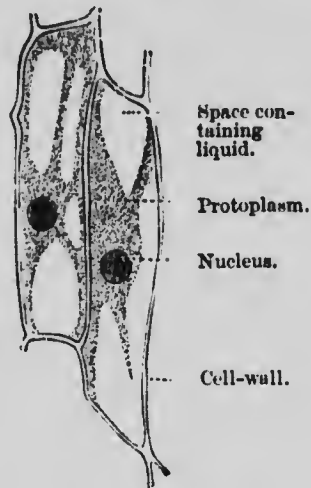

Fig. 1.—Vegetable cells.

with mucin, and in adipose tissue, where they become charged with fat.

The term cell was first used by botanists; in the popular sense of the word a cell is a space surrounded by a wall, as the cell of a prison, or the cell of a honey-comb. In the vegetable cell there is a wall made of the starch-like material called cellulose, within this is the living matter, and a number of large spaces or vacuoles filled with a watery fluid. The use of the term cell by botanists was therefore completely justified.

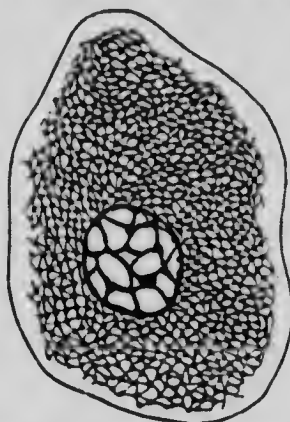

Fig. 2.—Animal cell consisting of protoplasm containing a nucleus.

But the animal cell is different; as a rule, it has no cell-wall, and no vacuoles. It is just a little naked lump of living material. This living material is jelly-like in consistency, possessing the power of movement, and the name **protoplasm** has been bestowed on it.

Somewhere in the protoplasm of all cells, usually near the middle in animal cells, is a roundish structure of more solid consistency than the rest of the protoplasm, called the **nucleus**.

An animal cell may therefore be defined as a *mass of protoplasm containing a nucleus*.

The simplest animals, like the amœbæ, consist of one cell only;

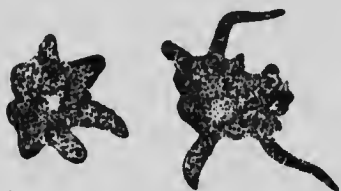

Fig. 3.—Amœbæ; unicellular animals.



Fig. 4.—Cells of the yeast plant in process of budding; unicellular plants.

the simplest plants, like bacteria, torulæ, etc., consist of one cell only.

Such organisms are called unicellular. In the progress of their life history the cell divides into two; and the two new cells separate and become independent organisms, to repeat the process later on.

In the case of the higher animals and plants, they are always unicellular to start with, but on dividing and subdividing the resulting cells stick together and subsequently become differentiated and altered in the manner already indicated. In spite of these changes, the variety of which produces the great complexity of the adult organism, there are certain cells which still

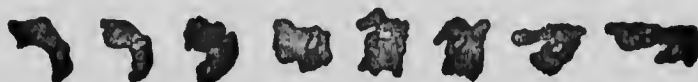

Fig. 5.—Human colourless blood-corpuscle, showing its successive changes of outline within ten minutes when kept moist on a warm stage. (Schofield.)

retain their primitive structure; notable among these are the white corpuscles of the blood.

It would appear at first sight an easy problem to distinguish between a living thing, and one which is not living. The principal signs of life are the following:—

1. Power of movement; this is seen in amœboid movement, ciliary movement, muscular movement, etc.
2. Power of assimilation, that is, ability to convert into protoplasm the nutriment material or food which is ingested.
3. Power of growth; this is a natural consequence of the power of assimilation.
4. Power of reproduction; this is a variety of growth.
5. Power to excrete; to give out waste materials, the products of other activities.

It should, however, be recognised that certain of these five characteristics may be absent or latent, and yet the object may be living. For instance, power of movement is absent in many vegetable structures; certain seeds and spores can be dried and kept for many years in an apparently dead condition, and yet will sprout and grow when placed in appropriate surroundings.

Of all the signs of life, those numbered 2 and 5 in the foregoing table are the most essential. Living material is in a continual state of unstable chemical equilibrium, building itself up on the one hand, breaking down on the other; the term used for the sum total of these intra-molecular rearrangements is **metabolism**. The chemical substances in the protoplasm which are the most important from this point of view are the complex nitrogenous compounds called *Proteids*. So far as is at present known, proteid material is never absent from living substance, and is never present in any thing else but that which is alive or has been formed by the agency of living cells. It may therefore be stated that **Proteid Metabolism** is the most essential characteristic of vitality.

## CHAPTER II.

## THE ANIMAL CELL.

AN animal cell is usually of microscopic dimensions, in the human body varying from  $\frac{1}{300}$  to  $\frac{1}{3000}$  of an inch in diameter.

It consists of—

1. *Protoplasm.* This makes up the main substance of the cell.
2. *Nucleus:* a vesicular body within the protoplasm, generally situated near the centre of the cell.
3. *Centrosome and attraction sphere:* these are contained within the protoplasm, near the nucleus.

These three portions demand separate study.

**Protoplasm.**

Until recent years, protoplasm was supposed to be a homogeneous material entirely destitute of structure, though generally containing minute granules of solid consistency, or globules (vacuoles) containing a watery fluid.

It has, however, now been shown with high powers of the microscope that in many cells the protoplasm consists of two



Fig. 6.—(A.) A colourless blood-corpuscle showing the intra-cellular network, and two nuclei with intra-nuclear network.

(B.) Coloured blood-corpuscle of newt showing the intra-cellular network of fibrils. Also oval nucleus composed of limiting membrane and fine intra-nuclear network of fibrils.  $\times 800$ . (Klein and Noble Smith.)

parts, a fine network of fibrillæ in which the more fluid and apparently structureless portion of the protoplasm is contained. (Sec figs. 2 and 6.)

The network or spongework is called the **reticulum** or **spongioplasm**, and the more fluid portion in its meshes the **enchylema** or **hyaloplasm**.

In order to study the microscopic structure of such transparent objects as cells, it is necessary to have recourse to various methods of fixing and staining. When one sees certain appearances after such treatment of the cells, the question arises whether they may not be due to the action of the reagents employed. Appearances which are undoubtedly produced artificially in this way are generally spoken of as *artifacts*. The network just described is regarded by some observers as an artifact, but it is impossible at present to state this positively. Hardy, in particular, has shown that a film of any colloidal substance like gelatin will, when it sets, present the appearance of a network, and he regards it as probable that the network seen in cells may be due to a similar setting or coagulation of the protoplasm which occurs either when the cell dies, or is fixed by hardening reagents.

The granules in protoplasm are partly thickened portions of the spongioplasm, but in addition to this there appear to be free granules, some fatty in nature (staining black with osmic acid), some composed of the substance called glycogen or animal starch (staining reddish-brown with iodine), and sometimes in a few unicellular animals they consist of inorganic (calcareous) matter. But by far the most constant and abundant of the granules are like the main substance of the protoplasm, proteid or albuminous in composition.

The chemical structure of protoplasm can only be investigated after the protoplasm has been killed. The substances it yields are (1) **Water**; protoplasm is semifluid, and at least three-quarters of its weight, often more, are due to water. (2) **Proteids**. These are the most constant and abundant of the solids. A proteid or albuminous substance consists of carbon, hydrogen, nitrogen, oxygen, with sulphur and phosphorus in small quantities only. In nuclein, a proteid-like substance found in the nuclei of cells, phosphorus is more abundant. The proteid obtained in greatest abundance in the cell protoplasm is called a **nucleo-proteid**, that is to say, it is a compound containing varying amounts of this material nuclein with proteid. White of egg is a familiar instance of an albuminous substance or proteid, and the fact (which is also familiar) that this sets into a solid on boiling will serve as a reminder that the greater number of the proteids found in nature have a similar tendency to coagulate under the influence of heat and other agencies. (3) Various other substances occur in smaller proportions, the most constant of which are **lecithin**, a phosphorised fat; **cholesterin**, a monatomic alcohol; and **inorganic salts**, especially phosphates and chlorides of calcium, sodium, and potassium.

The large quantity of water present should be particularly noted; the student when first shown diagrams of the reticulum in protoplasm is apt to imagine that it consists of a firm solid, like a system of wires pervading a jelly. The reticulum is only slightly more solid than the hyaloplasm.



### The Nucleus.

In form the nucleus is generally round or oval, but it may have in some cases an irregular shape, and in other cases there may be more than one nucleus in a cell.

The nucleus exercises a controlling influence over the nutrition and subdivision of the cell; any portion of a cell cut off from the nucleus undergoes degenerative changes.

A nucleus consists of four parts—

1. *The nuclear membrane*, which encloses it.
2. *A network* of fibres in appearance like the spongioplasm of the protoplasm but on a larger scale; that is to say, the threads of which it is composed are much coarser and much more readily seen. The name **chromoplasm** has been given to this network.
3. *The nuclear sap or matrix*, a more fluid and homogeneous substance which occupies the interstices of the spongework of chromoplasm.
4. *Nucleoli*; these are of two principal varieties; some are knots or thickened portions of the network and others, the true nucleoli, float freely in the nuclear sap.

These four parts of the nucleus are represented in the next diagram.

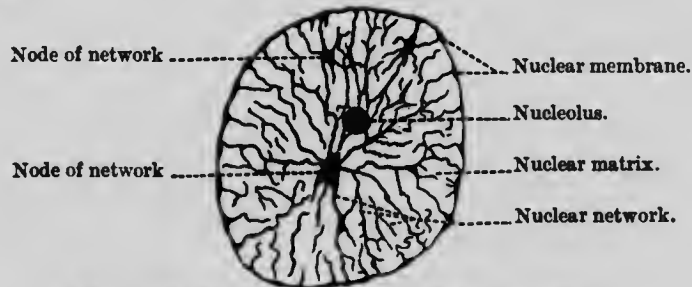

Fig. 7.—The resting nucleus—diagrammatic. (Waldeyer.)

The next figure (fig. 8) gives a view of the nucleus, according to the researches of Rabl. He considers that the fibres of the network may be divided into thick fibres which he terms primary, and thinner connecting branches which he terms secondary (shown only on the right-hand side of the figure). This observer also supposes that the primary fibres have the looped arrangement depicted in the diagram.

In the investigation of microscopic objects, a histologist is nearly always obliged to use staining agents; the extremely thin objects he examines are so transparent that, without such stains, much of the structure would be invisible. If such dyes as

hæmatoxylin or safranin are employed, it is the nucleus which becomes most deeply stained, and thus stands out on the lighter background of the protoplasm.

But the whole nucleus does not stain equally deeply; it is the chromoplasmic filaments and the nucleoli which have most affinity for the stain, while the nuclear membrane and the nuclear sap are comparatively unaffected. Hence the terms *chromatin* and *achromatin* originally introduced by Fleming. The network and the nucleoli are composed of chromatic substance or chromatin; it is so called not because it has no colour in the natural state, but because it has an affinity for colours artificially added to it. For a corresponding reason, achromatin or achromatic substance is the name given to the substances which make up the nuclear membrane and nuclear sap.

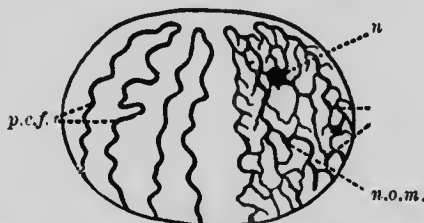

Fig. 8.—Diagram of nucleus showing the arrangement of chief chromatic filaments. Viewed from the side, the polar end being uppermost. *p.c.f.*, primary chromatic filaments; *n.*, nucleolus; *n.o.m.*, node of meshwork. (Rabl.)

To these general facts one or two details may be added. Balbiani first showed that the chromoplasmic filaments are apparently transversely marked into alternate dark and light bands; this is due to the existence of minute highly refracting particles imbedded in regular series in a clear homogeneous and unstainable matrix (see fig. 9). The term *chromatin* should properly be restricted to these particles. These particles have special affinity for basic dyes like methyl green, and safranin.

Coming next to the chemical composition of the nucleus, it is found to consist principally of proteid and proteid-like substances. The nuclei of cells may be obtained by subjecting the cells to the action of artificial gastric juice; the protoplasm is nearly entirely dissolved, but the nuclei resist the solvent action of the juice. No doubt the nuclei contain several chemical compounds, but the only one of which we have any accurate knowledge has been termed *nuclein*, and this is identical with the substance called *chromatin* by histologists. It is soluble in alkalis, but precipitated by acids; it is different from a proteid, as it contains in addition to carbon, nitrogen, oxygen, hydrogen and sulphur, an enormous quantity (7 to 8 per cent. or even more) of phosphorus in its molecule. In many cases nucleins contain iron also.



Fig. 9.—Part of a chromoplasmic filament, greatly magnified. (Carnoy.)

### The Attraction Sphere.

Recent research has shown that, in addition to the nucleus and protoplasm, most if not all living cells contain another structure ; it consists of a minute particle called a "*centrosome*," which has an attractive influence on protoplasmic fibrils and granules in its neighbourhood, the whole appearance produced being called an *attraction sphere* (fig. 10).

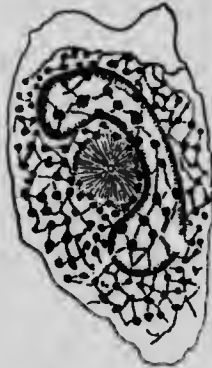

Fig. 10.—A cell (white blood-corpuscle) showing its attraction sphere. In this, as in most cases, the attraction sphere lies near the nucleus. (Schäfer.)

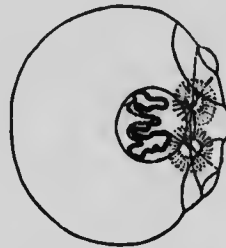

Fig. 11.—Ovum of the worm *Ascaris*, showing a twin attraction sphere. The nucleus with its contorted filament of chromoplasm is represented, but the protoplasm of the cell is not filled in. (v. Beneden.)

It is most prominent in cells which are dividing or about to divide. The centrosome, and then the attraction sphere, become double (fig. 11). It has been thought that the centrosome gives the primary impulse to cell-division, but a few cases have been described in which the nucleus divides before the centrosome, and it is now agreed that the division of chromatin and centrosome are two parallel events, the causal relation between which is not known.

### Protoplasmic Movement.

A cell possesses the power of *breathing*, that is, taking in oxygen ; of *nutrition*, of building itself up from food materials ; and of *excretion*, or the getting rid of waste material. But the most obvious physiological characteristic of most cells is their power of *movement*.

When an amœba is observed with a high power of the microscope, it is found to consist of an irregular mass of protoplasm containing one or more nuclei, the protoplasm itself being more or less granular and vacuolated. If watched for a minute or two, an irregular projection is seen to be gradually thrust out

from the main body and retracted; a second mass is then protruded in another direction, and gradually the whole protoplasmic substance is, as it were, drawn into it. The *Amœba* thus comes to occupy a new position, and when this is repeated several times we have locomotion in a definite direction, together with a continual change of form. These movements, when observed in other cells, such as the colourless blood-corpuses of higher animals (fig. 13), in the branched corneal cells of the frog and elsewhere, are hence termed *amoeboid*. The projections which are alternately protruded and retracted are called *pseudopodia*.

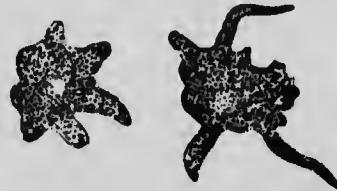
Fig. 12.—*Amœbæ*.

A *streaming* movement is not infrequently seen in certain of the protozoa, in which the mass of protoplasm extends long and fine processes, themselves very

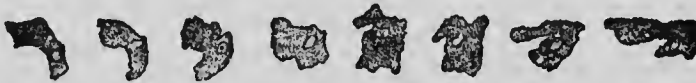

Fig. 13.—Human colourless blood-corpuse, showing its successive changes of outline within ten minutes when kept moist on a warm stage. (Schofield.)

little moveable, but upon the surface of which freely-moving or streaming granules are seen. A *gliding* movement has also been

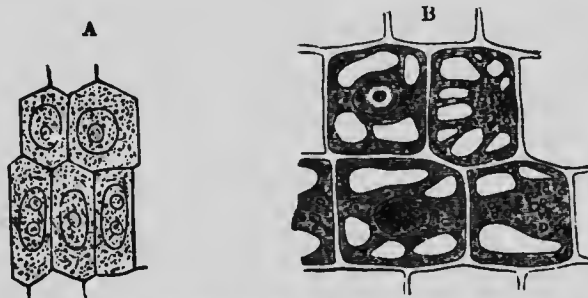

Fig. 14.—(A.) Young vegetable cells, showing cell-cavity entirely filled with granular protoplasm enclosing a large oval nucleus, with one or more nucleoli.  
(B.) Older cells from same plant, showing distinct cellulose-wall and vacuolation of protoplasm.

noticed in certain animal cells; the motile part of the cell is composed of protoplasm bounding a central and more compact mass; by means of the free movement of this layer, the cell may be observed to move along.

In vegetable cells the protoplasmic movement can be well seen

in the hairs of the stinging-nettle and *Tradescantia* and the cells of *Vallisneria* and *Chara*; it is marked by the movement of the granules nearly always imbedded in it. For example, if part of a hair of *Tradescantia* (fig. 15) be viewed under a high magnifying power, streams of protoplasm containing crowds of granules hurrying along, like the foot-passengers in a busy street, are seen flowing steadily in definite directions, some coursing round the film which lines the interior of the cell-wall, and others flowing towards or away from the irregular mass in the centre of the cell-cavity. Many of these streams of protoplasm run together into larger ones and are lost in the central mass, and thus ceaseless variations of form are produced. The movement of the proto-

plasmic granules to or from the periphery is sometimes called vegetable *circulation*, whereas the movement of the protoplasm round the interior of the cell is called *rotation*.

The first account of the movement of protoplasm was given by Röseler in 1755, as occurring in a small *Proteus*, probably a large freshwater amœba. His description was followed twenty years later by Corti's demonstration of the rota-

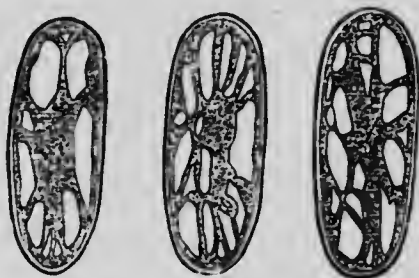

Fig. 15.—Cell of *Tradescantia* drawn at successive intervals of two minutes.—The cell-contents consist of a central mass connected by many irregular processes to a peripheral film, the whole forming a vacuolated mass of protoplasm, which is continually changing its shape. (Schofield.)

tion of the cell sap in *Characeæ*, and in the earlier part of this century by Meyer in *Vallisneria*, 1827, and by Robert Brown, 1831, in "Staminal Hairs of *Tradescantia*." Then came Dujardin's description of the granular streaming in the pseudopodia of *Rhizopods*; movements in other animal cells were described somewhat later (*Planarian* eggs, v. Siebold, 1841; colourless blood-corpuscles, Wharton Jones, 1846).

There is no doubt that the protoplasmic movement is essentially the same thing in both animal and vegetable cells. But in vegetable cells, the cell-wall obliges the movement to occur in the interior, while in the naked animal cells the movement results in an external change of form.

Although the movements of amœboid cells may be loosely described as spontaneous, yet they are produced and increased under the action of external agencies which excite them, and which are therefore called *stimuli*, and if the movement has ceased

for the time, as is the case if the temperature is lowered beyond a certain point, movement may be set up by raising the temperature. Again, contact with foreign bodies, gentle pressure, certain salts, and electricity, produce or increase the movement in the amœba. The protoplasm is, therefore, sensitive or irritable to stimuli, and shows its irritability by movement or contraction of its mass.

The effects of some of these stimuli may be thus further detailed :—

*a. Changes of temperature.*—Moderate heat acts as a stimulant : the movement stops when the temperature is lowered near the freezing point or raised above  $40^{\circ}$  C. ( $104^{\circ}$  F.); between these two points the movements increase in activity ; the optimum temperature is about  $37^{\circ}$  to  $38^{\circ}$  C. Though cold stops the movement of protoplasm, exposure to a temperature even below  $0^{\circ}$  C. does not prevent its reappearance if the temperature is raised ; on the other hand, prolonged exposure to a temperature of over  $40^{\circ}$  C. altogether kills the protoplasm and causes it to enter into a condition of coagulation or *heat rigor*. We have already seen that proteids, the most abundant constituents of protoplasm, are coagulated by heat.

*b. Chemical stimuli.*—Distilled water first stimulates then stops amœboid movement, for by imbibition it causes great swelling and finally bursting of the cells. In some cases, however (myxomycetes), protoplasm can be almost entirely dried up, but remains capable of renewing its movement when again moistened. Dilute salt-solution and very dilute alkalis stimulate the movements temporarily. Acids or strong alkalis permanently stop the movements : ether, chloroform, veratrine and quinine also stop it for a time.

Movement is suspended in an atmosphere of hydrogen or carbonic acid and resumed on the admission of air or oxygen ; complete withdrawal of oxygen will after a time kill protoplasm.

*c. Electrical.*—Weak currents stimulate the movement, while strong currents cause the cells to assume a spherical form and to become motionless.



Fig. 16.—Cells from the stamina hairs of *Tradescantia*. *A*, fresh in water ; *B*, the same cell after slight electrical stimulation ; *a*, *b*, region of stimulation ; *c*, *d*, clumps and nobs of contracted protoplasm. (Kühne.)

The amoeboid movements of the colourless corpuscles of the blood may be readily seen when a drop of blood from the finger is mixed with salt solution, and examined on a warm stage with the microscope. If a pseudopodium of such a corpuscle is observed under a high power, it will be seen to consist of hyaloplasm, which has flowed out of its spongy home, the reticulum.

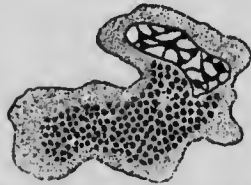

Fig. 17.—An Amoeboid corpuscle of the newt killed by instantaneous application of steam, showing the appearance of the pseudopodia. (After D. Gunn, Quain's Anatomy.)

Later, however, a portion of the reticular part of the protoplasm may enter the pseudopodium. The cells may be fixed by a jet of steam allowed to play for a moment on the surface of the cover glass. The next figure illustrates one fixed in this way.

The essential act in the protrusion of a pseudopodium is the flowing of the hyaloplasm out of the spongioplasm; the retraction of the pseudopodium is a return of the hyaloplasm to the spongioplasm. The spongioplasm has an irregular arrangement with openings in all directions, so that the contractility of undifferentiated cells may exhibit itself towards any point of the compass.

### Cell Division.

A cell multiplies by dividing into two; each remains awhile in the resting or, more correctly, non-dividing condition, but later it grows and subdivides, and the process may be repeated indefinitely.

The supreme importance of the cell, the growth of the body from cells, and the fact that cells are the living units of the organism, were first established in the vegetable world by Schleiden, and extended to the animal kingdom by Theodor Schwann. The ideas of physiologists depending on this idea are grouped together as cellular physiology, which under the guidance of Virchow was extended to pathology also: Virchow expressed the doctrine now so familiar as to be almost a truism in the terse phrase *omnis cellula e cellula* (every cell from a cell).

The division of a cell is preceded by division of its nucleus. Nuclear division may be either (1) *simple or direct*, which consists in the simple exact division of the nucleus into two equal parts by constriction in the centre, which may have been preceded by division of the nucleoli; or (2) *indirect*, which consists in a series of changes which goes on in the arrangement of the nuclear reticulum, resulting in the exact division of the chromatic fibres into two parts, which form the chromoplasm of the daughter nuclei.

The changes in the nucleus during indirect division constitute *karyokinesis* (κάρυον, a kernel), or *mitosis* (μίτος, a thread), and direct division is called *amitotic* or *akinetic* (κίνησις, movement). It is now believed that the mitotic nuclear division is all but, though not quite, universal. Somewhat different accounts of the stages of the nuclear division have been given by different authorities, according to the kind of cell in which the nuclear changes have been studied. The following will summarise the stages of karyokinesis as observed by Klein:—

The nucleus in a resting condition, *i.e.*, before any changes

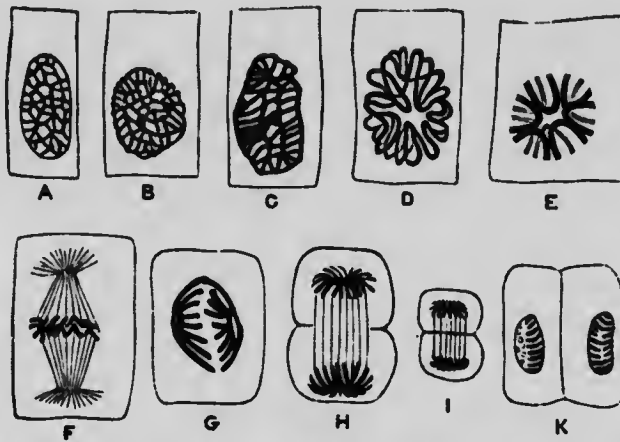

Fig. 18.—Karyokinesis. A, ordinary nucleus of a columnar epithelial cell; B, C, the same nucleus in the stage of *convolution*; D, the *wreath* or *rosette* form; E, the *aster*, or single star; F, a nuclear spindle from the Descemet's endothelium of the frog's cornea; G, H, I, *diaster*; K, two daughter nuclei. (Klein.)

preceding division occur, consists of a very close meshwork of fibrils, which stain deeply with carmine, embedded in a matrix, which does not possess this property, the whole nucleus being contained in an envelope. The first change consists of a slight enlargement of the nucleus, the disappearance of its envelope and an increase in the definition and thickness of the nuclear fibrils, which are also more separated than they were, and stain better. This is the stage of *convolution* (fig. 18, B, C). The next step in the process is the arrangement of the fibrils into some definite figure by an alternate looping in and out around a central space, by which means the *rosette* or *wreath* stage (fig. 18, D) is reached. The loops of the rosette next become divided at the periphery and their central points become more angular, so that the fibrils, divided into portions of about equal length, are doubled at an acute angle, and radiate in a V-shaped manner from the centre, forming a *star* (aster) (fig. 18, E), and later from two centres,



in which case a double star (*diaster*) results (fig. 18, G, H, and I). After remaining almost unchanged for some time, the V-shaped fibres being first rearranged in the centre, side by side (angle outwards), split longitudinally and separate into two bundles which gradually take up a position at either pole. From these groups of fibrils the two nuclei of the new cells are formed (*daughter nuclei*) (fig. 18, K), and the changes they pass through before reaching the resting condition are exactly those through which the original nucleus (mother nucleus) has gone, but in a reverse order, viz., the star, the rosette, and the convolution. During or shortly after the formation of the daughter nuclei the cell itself becomes constricted and then divides in a line about midway between them.

The changes as described are those which are most obvious; but they take little account of the formation of the spindle seen in fig. 18, F, nor of the part played by the attraction sphere (see p. 12).

The work of Waldeyer, Rabl, and others has shown that a more exact description is the following.

The process may be divided into the following stages:—

1. The non-dividing nucleus (fig. 19).

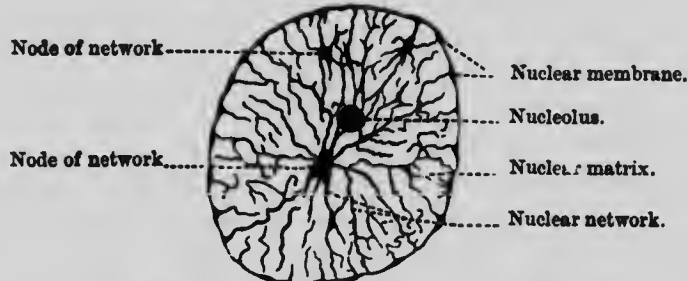

Fig. 19.—The resting nucleus. (Waldeyer.)

2. The spirem or skein stage: the nucleoli dissolve, the secondary fibres disappear, and the primary loops running from polar to anti-polar regions remain (figs. 8, 20).

In some cells there is at first one long, much twisted thread, which subsequently breaks up into segments.

3. Each loop becomes less convoluted and splits longitudinally into two sister threads, and the achromatic spindle appears (fig. 21, A and B).
4. The equatorial stage; monaster. The nucleus has now two poles, those of the spindle; and at each pole there is a polar corpuscle or centrosome. The division of the centrosome of the original cell, and then of the attraction sphere into two, usually precedes the commencement of changes in the

nucleus ; the two attraction spheres become prominent in cell division, and the connecting achromatic spindle is probably also formed from the  $n$  or from the achromatic material of the nucleus.

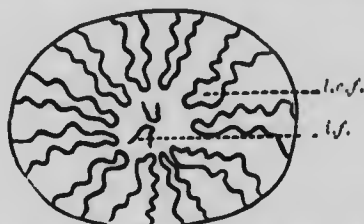

Fig. 20.—Early condition of the skein stage viewed at the polar end. *l. c. f.*, looped chromatic filament. *i. f.*, irregular filament. (Rabl.)

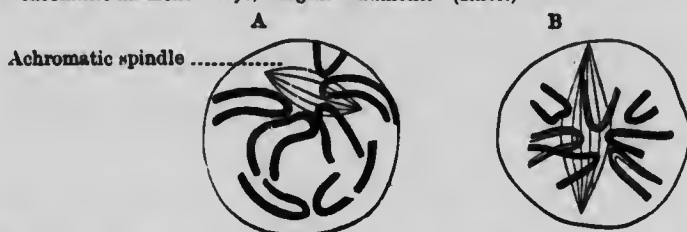

Fig. 21.—Later condition of the skein stage in karyokinesis. **A.** The thicker primary fibres become less convoluted and the achromatic spindle appears. **B.** The thick fibres split into two and the achromatic spindle becomes longitudinal. (Waldeyer.)

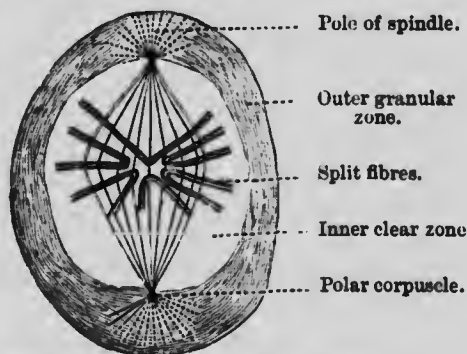

Fig. 22.—Monaster stage of karyokinesis. (Waldeyer.)

At this stage the nuclear membrane is lost, and thus cell protoplasm and nuclear sap become continuous ; the protoplasm immediately around the nucleus is clear ; outside this is a granular zone, and here the granules are arranged radially from the polar corpuscles. The star-like arrangement of these granules is much better marked in embryonic cells, indeed the lines present very much the appearance of fibrils (see fig. 23).

The term *amphiaster* often given to this appearance must not be confounded with the *diaster* to be immediately described. It

should further be noted that in all cells which are the result of the sexual process the number of chromosomes is always even, an equal number being contributed by each sex.

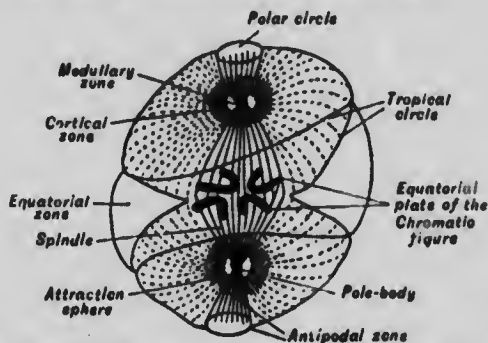

Fig. 23.—Ovum of the worm *Ascaris* in process of division. The attraction spheres are at opposite ends of the ovum; at the equator of the spindle which unites them, four chromosomes are seen. The protoplasm of the ovum, except in the equatorial zone of the cell, is arranged in lines radiating from the centre (centrosome) of the attraction sphere. (Waldeyer.)

The V-shaped chromoplasmic fibres or *chromosomes* sink to the equator of the spindle, and arrange themselves so as to project horizontally from it.

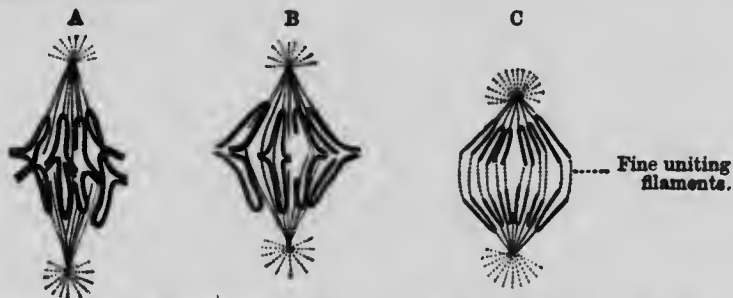

Fig. 24.—Metakinesis. A. Early stage. B. Later stage. C. Latest stage—formation of diaster. B. and C. show how the sister threads disentangle themselves from one another. (Waldeyer.)

5. *The stage of metakinesis.* The sister threads separate, one set going towards one pole, and the other to the other pole of the spindle (fig. 24): these form the two daughter nuclei. The chromosomes are probably pulled into their new position by the contraction of the spindle fibres attached to them.
6. Each daughter nucleus goes backwards through the same series of changes; the diaster or double star is followed by the dispirem or double skein, until at last two resting nuclei are obtained (fig. 25).

A new membrane forms around each daughter nucleus, the spindle atrophies, and the attraction sphere becomes less

prominent. The division of the cell protoplasm into two parts around the two nuclei begins in the diaster stage, and is complete in the stage represented in fig. 25.

The karyokinetic process has been watched in all its stages by more than one observer. The time occupied varies from half an hour to three hours; the details, however, must be studied in hardened and appropriately stained specimens. They are most readily seen in cells with large nuclei, such as occur in the epidermis of amphibians.

The process varies a good deal in different animal and vegetable cells; such as in the number of chromosomes, and the relative

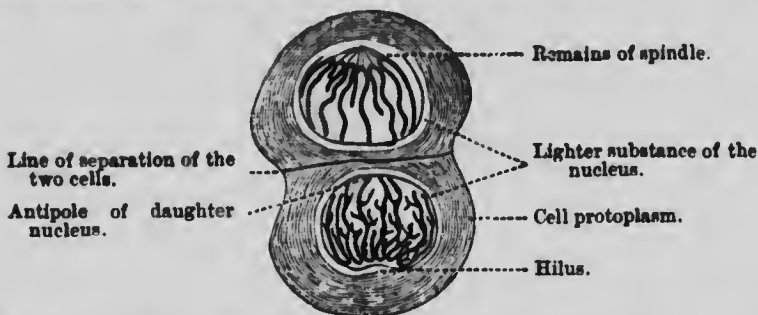

Fig. 25.—Final stages of karyokinesis. In the lower daughter nucleus the changes are still more advanced than in the upper. (Waldeyer.)

importance of the different stages. All attempted here has been to give an account of a typical case. The phases may be summarised in a tabular way as follows (from Quain's Anatomy):—

NETWORK OR RETICULUM . . . . .	1. Resting condition of mother nucleus (fig. 19).
SKEIN OR SPIREM . . . . .	2. Close skein of fine convoluted filaments (fig. 20). 3. Open skein of thicker filaments. Spindle appears (fig. 21 A).
CLEAVAGE . . . . .	5. Stellate arrangement of V filaments at equator of spindle (fig. 22).
STAR OR MONASTER . . . . .	6. Separation of cleft filaments and movement along fibres of spindle (fig. 24 A and B).
DIVERGENCE OR METAKINESIS . . . . .	7. Conveyance of V filaments towards poles of spindle (fig. 24 C).
DOUBLE STAR OR DIASTER . . . . .	8. Open skein in daughter nuclei. 9. Close skein in daughter nuclei (fig. 25).
DOUBLE SKEIN OR DISPIREM . . . . .	
NETWORK OR RETICULUM . . . . .	10. Resting condition of daughter nuclei (fig. 25).

### The Ovum.

The ovary is an organ which produces ova.

An ovum is a simple animal cell ; its parts are seen in the next diagram.

It is enclosed in a membrane called the zona pellucida or vitelline membrane. The body of the cell is composed of protoplasm loaded

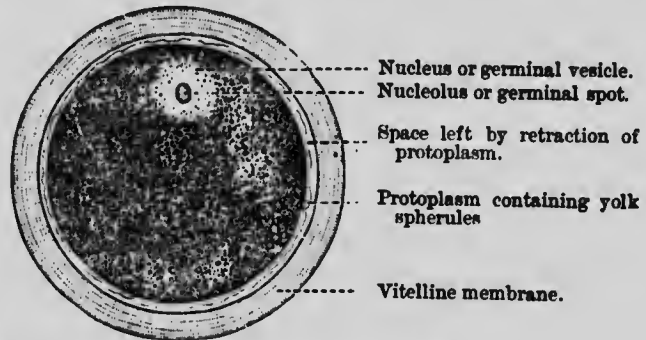

Fig. 26.—Representation of a human ovum. (Cadiat.)

with granules of food material, and often called the yolk or vitellus. The nucleus and nucleolus are sometimes still called by their old names, *germinal vesicle* and *germinal spot* respectively.

The formation of ova will form the subject of a chapter later on, but it is convenient here at the outset to state briefly one or two facts, and introduce to the student a few terms which we shall have to employ frequently in the intervening chapters.

The ovum first discharges from its interior a portion of its nucleus, which forms two little globules upon it called the polar globules.

Fertilisation then occurs ; that is to say, the head or nucleus of a male cell called a spermatozoon penetrates into the ovum, and becomes fused with the remains of the female nucleus.

Cell division or segmentation then begins, and the early stages are represented in the next figure.

Fluid discharged from the cells accumulates within the interior of the mulberry mass seen in fig. 27 *d*, and later, if a section is cut through it, the cells will be found arranged in three layers.

The outermost layer is called the **epiblast**.

The middle layer is called the **mesoblast**.

The innermost layer is called the **hypoblast**.

From these three layers the growth of the rest of the body occurs, nutritive material being derived from the mother in mammals by means of an organ called the placenta.

The *epiblast*, the outermost layer of the embryo, forms the epidermis, the outermost layer of the adult. It also forms the nervous system.

The *hypoblast*, the innermost layer of the embryo, forms the lining epithelium of the alimentary and respiratory tracts, that is, the innermost layer of the adult. It also forms the cellular elements in the large digestive glands, such as the liver and



Fig. 27.—Diagram of an ovum (a) undergoing segmentation. In (b) it has divided into two, in (c) into four; and in (d) the process has resulted in the production of the so-called "mulberry-mass." (Frey.)

pancreas, which are originally, like the lungs, outgrowths from the primitive digestive tube.

The *mesoblast* forms the remainder, that is, the great bulk of the body, including the muscular, osseous and other connective tissues; the circulatory and urino-genital systems.

## CHAPTER III.

### EPITHELIUM.

IN the introductory chapter will be found a list of the elementary tissues of which the organs of the body are built up. These may be arranged into the four groups, epithelial, connective, muscular, and nervous. The first of these, the epithelial tissues, follows naturally on a study of the animal cell, as an epithelium may be defined as a tissue composed entirely of cells united by a minimal amount of cementing material. As a rule, an epithelium is spread out as a membrane covering a surface or lining the cavity of a hollow organ.

These epithelia may be grouped into two great classes, each of which may be again subdivided according to the shape and arrangement of the cells of which it is composed. The following table gives the principal varieties:—

CLASS 1.—*Simple epithelium*; that is, an epithelium consisting of one layer of cells only. Its subgroups are as follows:—

- a. Pavement epithelium.
- b. Cubical and columnar epithelium.
- c. Ciliated epithelium.

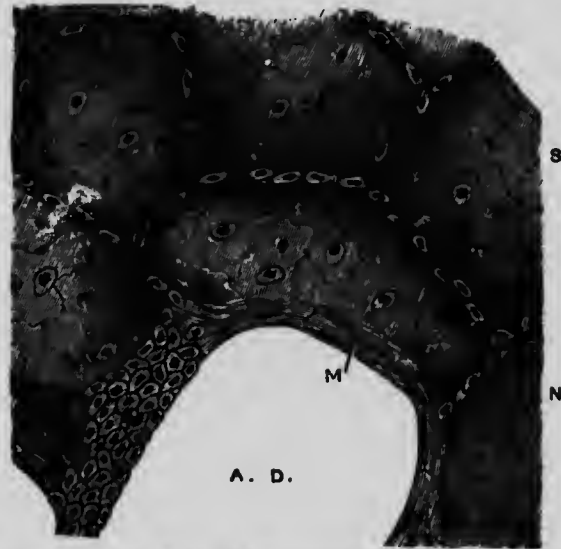

Fig. 28.—From a section of the lung of a cat, stained with silver nitrate. N. Alveoli or air-cells, lined with large flat, nucleated cells, with some smaller polyhedral nucleated cells. (Klein and Noble Smith.)

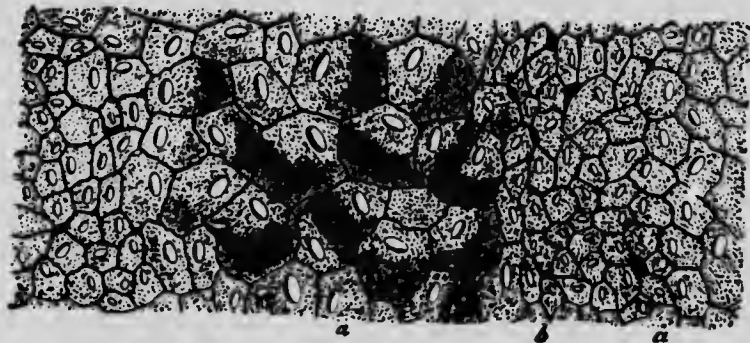

Fig. 29.—Abdominal surface of central tendon of the diaphragm of rabbit, showing the general polygonal shape of the endothelial cells; each cell is nucleated.  $\times 300$ . (Klein.)

CLASS 2.—*Compound epithelium*; that is, an epithelium consisting of more than one layer of cells. Its subgroups are as follows:—

- a. Transitional epithelium.
- b. Stratified epithelium.

This classification does not include the more specialised forms of epithelium found in secreting glands, or in the sense organs,

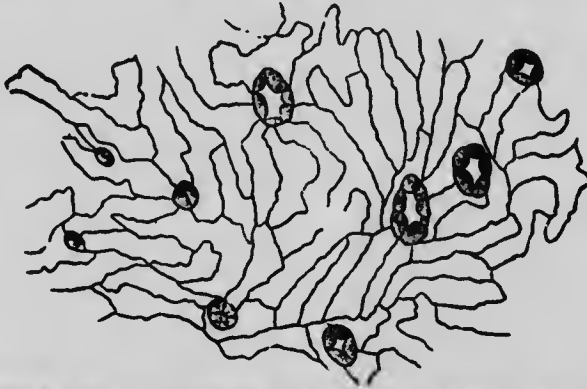

Fig. 30.—Peritoneal surface of a portion of the septum of the great lymph-sac of a frog. The stomata, some of which are open, some collapsed, are well shown.  $\times 160$ . (Klein.)

nor structures like hair, and enamel of tooth, which are epithelial in origin. These will be considered in their proper place later on.

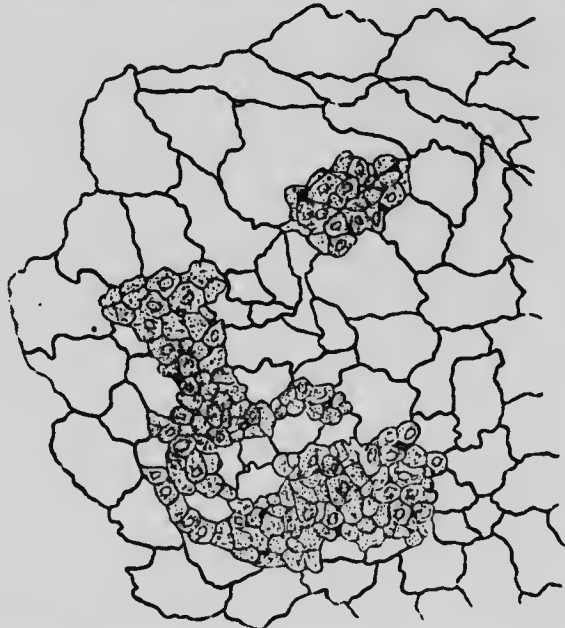

Fig. 31.—A portion of the great omentum of dog, which shows, amongst the flat endothelium of the surface, small and large groups of germinating endothelium, between which are many stomata.  $\times 300$ . (Klein.)

We shall for the present be content to study those already enumerated, and take them one by one.



### Pavement Epithelium.

This consists of a layer of flat cells, arranged like flat pavement-stones accurately fitting together and united by a small amount of cementing material. The structure of the cells and their outlines may be best demonstrated by a process of double

staining; one stain, silver nitrate, to show the cementing material, and another, like logwood, to show up the nuclei of the cells.

A portion of the fresh tissue is taken and immersed for a few minutes in a 1 per cent. solution of nitrate of silver; it is taken out, washed with distilled water, and exposed in water or spirit to sunlight. The silver forms a compound with the cement, which in the light is decomposed or reduced, leading to a fine deposit of silver, showing as black or brown lines between the cells, and accurately defining their outlines. The preparation may then be immersed in some stain like logwood to bring out the nuclei, and finally mounted in the usual way. The details of histological work can only be properly learnt in a practical class.

Fig. 28 shows the appearance presented in a preparation of lung. In the alveoli or air-sacs of the lung, pavement epithelium of a typical kind is found forming a lining membrane.

Fig. 32.—Surface view of an artery from the mesentery of a frog, ensheathed in a peri-vascular lymphatic vessel. *a*, The artery, with its circular muscular coat (media) indicated by broad transverse markings, with an indication of the adventitia outside. *l*, Lymphatic vessel; its wall is a simple endothelial membrane. (Klein and Noble Smith.)

**Endothelium.**—Epithelium of similar appearance is found lining the interior of the whole of the vascular system, heart, arteries, capillaries, veins, and lymphatics, and in the adjuncts of the circulatory system called the serous membranes (pericardium, peritoneum, etc.).

This epithelium is formed from the middle layer of the embryo, the mesoblast; most other epithelium is derived either from

epiblast or hypoblast. Hence it has received a distinct name, viz. : *endothelium*.

The general appearance presented by endothelium in serous membranes is shown in figs. 29, 30, and 31 ; in blood-vessels in fig. 32.

The stomata seen in some of the drawings are minute openings surrounded by more darkly staining cells, which lead from serous cavities into lymphatic vessels.

### Cubical, Spheroidal, and Columnar Epithelium.

In these forms of epithelium, the cells are not flat, but are thick ; if they approximate cubes or spheres in shape, the epithelium is called cubical or spheroidal respectively. *Spheroidal* epithelium is found in the alveoli of secreting glands, such as the salivary glands, liver, and pancreas (see figs. 33 and 34), and will

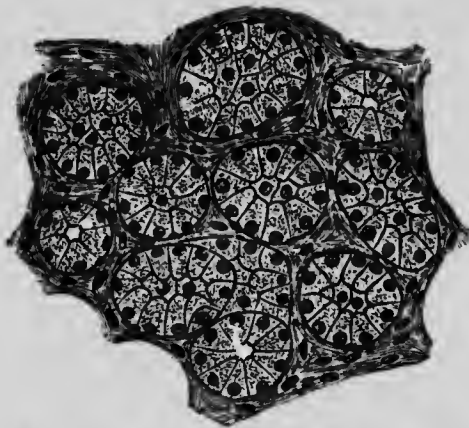

Fig. 33.—Glandular epithelium. Small lobule of a mucous gland of the tongue, showing nucleated glandular cells.  $\times 200$ . (V. D. Harris.)



Fig. 34.—A small piece of the liver of the horse. (Cadiat.)

be discussed at length in connection with those organs. *Cubical* epithelium is found in the alveoli of the thyroid (see fig. 35), in the tubules of the testis, and in the ducts of some glands.

In columnar epithelium the cells are tall, and form a kind of palisade or rows of columns. It is found lining the interior of the stomach and intestines, and the ducts of the majority of secreting glands ; it forms also the layer on the outer surface of the ovary

In the intestinal epithelium each cell has a distinct brightly refracting and striated border. Fig. 36 shows two isolated cells of this kind.

The nucleus with its usual network and the vacuolated condition of the protoplasm are very well seen. The attached border is narrower than the free edge. Amœboid lymph cells are found

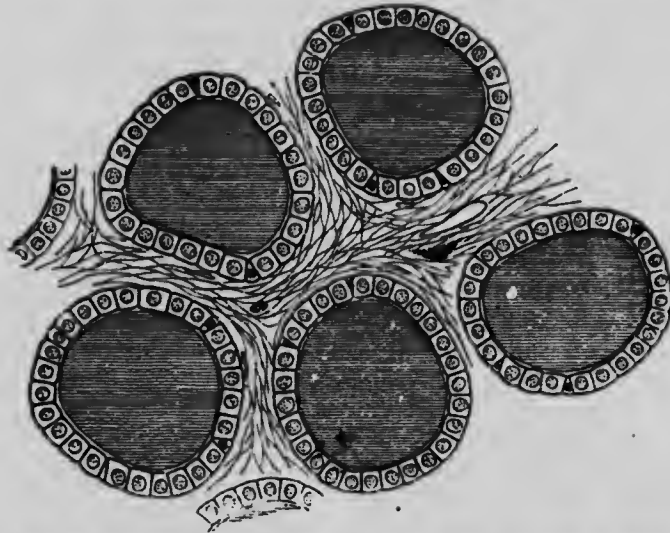

Fig. 35.—Section of human thyroid; the few vesicles shown are lined by cubical epithelium, and contain a colloid material. (After Schäfer.)

in the spaces that must necessarily be left when cells of such a shape cover a surface. Fig. 37 shows a row of columnar cells from the rabbit's intestine.

The next figure (fig. 38) shows the arrangement of these cells

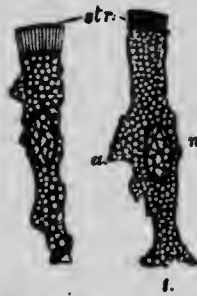

Fig. 36.—Columnar epithelium cells of the rabbit's intestines. The cells have been isolated after maceration in very weak chromic acid. The cells are much vacuolated, and one of them has a fat globule near its attached end. The striated border (*str.*) is well seen, and the bright disc separating it from the cell protoplasm. *n.*, nucleus with intranuclear network. *a.*, a thinned out winglike projection of the cell which probably fitted between two adjacent cells. (Schäfer.)

on the surface of a villus, one of the numerous little projections found in the small intestine.

The gaps seen there are due to the formation of what are called goblet cells. In some of the columnar cells, a formation

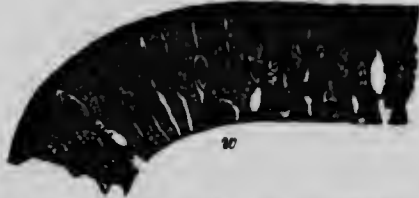

Fig. 37.—A row of columnar cells from the rabbit's intestine. Smaller cells are seen between the epithelium cells; these are lymph-corpuses. (Schäfer.)

of granules occurs which consist of a substance called mucigen; these run together, and are discharged from the cell as a brightly



Fig. 38.—Vertical section of an intestinal villus of a cat. *a*, the striated basilar border of the epithelium; *b*, columnar epithelium; *c*, goblet cells; *d*, central lymph-vessel; *e*, unstriped muscular fibres; *f*, adenoid stroma of the villus in which are contained lymph-corpuses. (Klein.)

refracting globule of mucin, leaving the cell with open mouth like

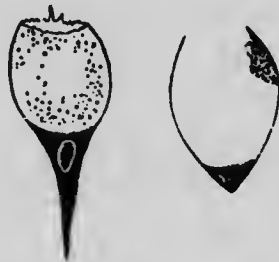

Fig. 39.—Goblet cells. (Klein.)

a goblet, the nucleus being surrounded by the remains of the protoplasm in its narrow stem (see fig. 39).

This transformation is a normal process continually going on throughout life, the discharged *mucin* contributing to form *mucus*. The cells themselves may recover their original shape after discharge, and repeat the process later on.

### Ciliated Epithelium.

The cells of ciliated epithelium are generally of columnar shape (fig 40), but they may occasionally be spheroidal (fig. 41).



Fig. 40.—Ciliated epithelium from the human trachea. *a*, large fully formed cell; *b*, shorter cell; *c*, developing cells with more than one nucleus. (Cadiat.)

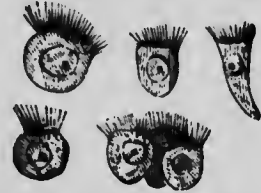

Fig. 41.—Spheroidal ciliated cells from the mouth of the frog.  $\times 300$  diameters. (Sharpey.)

Each cell is surmounted by a bunch of fine tapering filaments. They were originally called *cilia* because of their resemblance in



Fig. 42.—Ciliated epithelium of the human trachea. *a*, layer of longitudinally arranged elastic fibres; *b*, basement membrane; *c*, deepest cells, circular in form; *d*, intermediate elongated cells; *e*, outermost layer of cells fully developed and bearing cilia.  $\times 350$ . (Kölliker.)

shape to eyelashes. They differ from eyelashes in being extremely small, and in not being stiff; they are in fact composed

of protoplasm. During life these move to and fro, and so produce a current of fluid over the surface they cover. Like columnar cells, they may form goblet cells and discharge mucus.

In the larger ciliated cells, it will be seen that the border on which the cilia are set is bright, and composed of little knobs, to each of which a cilium is attached; in some cases the knobs are prolonged into the cell protoplasm as filaments or rootlets (fig. 43).

The bunch of cilia is homologous with the striated border of columnar cells.

Ciliated epithelium is found in the human body, (1) lining the air passages, but not in the alveoli of the lungs; these are lined by pavement epithelium; (2) in the Fallopian tubes and upper part of the uterus; (3) in the ducts of the testis known as the vasa efferentia and coni vasculosi; here the cilia are the longest found in the body; (4) in the ventricles of the brain and central canal of the spinal cord; (5) the tail of a spermatozoon may also be regarded as a long cilium.

In other animals cilia are found in other parts; for instance, in the frog the mouth and gullet are lined by ciliated cells; in the tadpole, the whole surface of the body and especially the gills are covered with cilia. Among the invertebrates one finds many protozoa completely covered with cilia; in many embryos the cilia are arranged in definite bands round the body; in the rotifers or wheel animalcules, a ring of cilia round the mouth gives the name to this particular group. The gills of many animals are covered with cilia; and the cells of the kidney tubules in some animals are ciliated.

#### Ciliary Motion.

Ciliary motion reminds one of amœboid movement, but it is much more rapid, and more orderly. It consists of a rhythmical movement of the cilia, a bending over, followed by a lessening of the curvature, repeated with great frequency.

When living ciliated epithelium, *e.g.*, from the gill of a mussel, or from the mouth of the frog, is examined under the microscope



Fig. 43. — Ciliated cell from the intestine of a mollusc. (Engelmann.)

in a drop of 0.6 per cent. solution of common salt (*normal saline solution*), the cilia are seen to be in constant rapid motion, each cilium being fixed at one end, and swinging or lashing to and fro. The general impression given to the eye of the observer is very similar to that produced by waves in a field of corn, or swiftly running and rippling water, and the result of their movement is to produce a continuous current in a definite direction, and this direction is the same on the same surface, being usually in the case of a cavity towards the external orifice.

There is not only rhythmicality in the movement of a single cilium, but each acts in harmony with its fellows in the same cell, and on neighbouring cells.

The uses of cilia can from the above be almost guessed; in the respiratory passages they create a current of mucus with entangled dust towards the throat; in the Fallopian tube or oviduct they assist the ovum on its way to the uterus; in the gullet of the frog they act downwards and resist swallowing; in the ciliated protozoa they are locomotive organs. Over the gills of marine animals they keep up a fresh supply of water, and in the case of the rotifers, which are fixed animals, the current of water brings food to the mouth.

Ciliary motion is independent of the will, of the direct influence of the nervous system, and of muscular contraction. It may continue for several hours after death or removal from the body, provided the portion of tissue under examination be kept moist. Its independence of the nervous system is shown also in its occurrence in the lowest invertebrate animals which are unprovided with anything analogous to a nervous system, in its persistence in animals killed by prussic acid, by narcotic or other poisons, and after the direct application of narcotics, such as morphia, opium, and belladonna, to the ciliary surface, or of electricity through it. The vapour of chloroform arrests the motion, but it is renewed on the discontinuance of the application. The movement ceases when the cilia are deprived of oxygen, although it may continue for a time in the absence of *free* oxygen, but is revived on the admission of this gas. Carbonic acid stops the movement. The contact of various substances, *e.g.*, bile, strong acids, and alkalis, will stop the motion altogether; but this seems to depend chiefly on destruction of the delicate substance of which the cilia are composed. Temperatures above 45° C. and near 0° C. stop the movement, whereas moderate heat and dilute alkalis are favourable to the action and revive the movement after temporary cessation. The exact explanation of ciliary movement is not known; whatever

may be the exact cause, the movement must depend upon some changes going on in the cell to which the cilia are attached, as when the latter are cut off from the cell the movement ceases, and when severed so that a portion of the cilia are left attached to the cell, the attached and not the severed portions continue the movement. The most probable cause of the movement is that it is part of the inherent power which protoplasm possesses, and that the cilia are but prolongations of the spongioplasm of the cell. It has been suggested by Engelmann that if this be the case, the contractile part of the protoplasm is only on the concave side of a curved cilium, and that when this contracts that the cilium is brought downwards; where relaxation occurs, the cilium rebounds by the elastic recoil of the convex border.

Schäfer has suggested that the flow of hyaloplasm backwards and forwards will explain ciliary as it will amoeboid movement. In an amoeboid cell, the spongioplasm is irregular in arrangement, hence an outflow of hyaloplasm from it can occur in any direction. But in the curved projection called a cilium, the hyaloplasm can obviously flow in only one direction into the cilium and back again. The flow of more hyaloplasm into the spongioplasm of the cilium will cause it to curve, the flow of the hyaloplasm back into the body of the cell will cause the cilium to straighten.

The action of dilute alkalis and acids on cilia is interesting. Dilute acids stop ciliary motion; and cilia, if allowed to act in salt solution for a time, get more and more languid and finally cease acting; in popular language they become fatigued. Now we shall find in muscle that fatigue is largely due to the accumulation of the acid products of muscular activity; remove the sarco-lactic acid and fatigue passes off. It is probable that the same occurs in other contractile tissues; the cilia gradually stop, due to acid products of their activity collecting around them; when these are neutralised with dilute alkali the cilia resume activity.

### Transitional Epithelium.

This term has been applied to cells which are neither arranged in a single layer, as is the case with simple epithelium, nor yet in many superimposed strata, as in stratified epithelium; in other words, it is employed when epithelial cells are found in two, three, or four superimposed layers.

The upper layer may be either columnar, ciliated, or squamous. When the upper layer is columnar or ciliated the second layer



consists of smaller cells fitted into the inequalities of the cells above them, as in the trachea (fig. 42).

The epithelium which is met with lining the urinary bladder and ureters is, however, the transitional *par excellence*. In this variety there are two or three layers of cells, the upper being more or less flattened according to the full or collapsed condition of the organ, their under surface being marked with one or more depressions, into which the heads of the next layer of club-shaped cells fit. Between the lower and narrower parts of the second row of cells are fixed the irregular cells which constitute the third row; sometimes a fourth row is present (fig. 44). It can be easily understood, therefore, that if a scraping of the mucous

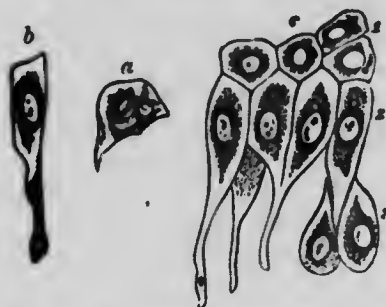

Fig. 44.—Epithelium of the bladder. *a*, one of the cells of the first row; *b*, a cell of the second row; *c*, cells *in situ*, of first, second, and deepest layers. (Obersteiner.)



Fig. 45.—Transitional epithelial cells from a scraping of the mucous membrane of the bladder of the rabbit. (V. D. Harris.)

membrane of the bladder is teased, and examined under the microscope, cells of a great variety of forms may be made out (fig. 45). Each cell contains a large nucleus, and the larger and superficial cells often possess two.

#### Stratified Epithelium.

The term *stratified epithelium* is employed when the cells forming the epithelium are arranged in a considerable number of superimposed layers. The shape and size of the cells of the different layers, as well as the number of the layers, vary in different situations; but the superficial cells are, as a rule, of the squamous, or scaly variety, and the deepest of the columnar form.

The cells of the intermediate layers are of different shapes, but those of the middle layers are more or less rounded. The superficial cells are broad and overlap by their edges (fig. 46). Their chemical composition is different from that of the underlying cells, as they contain keratin, and are therefore horny in character.

The nucleus is often not apparent. The really cellular nature of even the dry and shrivelled scales cast off from the surface of the epidermis, can be proved by the application of caustic potash, which rapidly causes them to swell and assume their original form.

The squamous cells exist in the greatest number of layers in the epidermis or superficial part of the skin; the most superficial of these are being continually removed by friction, and new cells from below supply the place of those cast off.

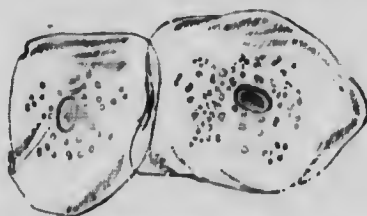

Fig. 46.—Epithelium scales from the inside of the mouth. 360. (Henle.)

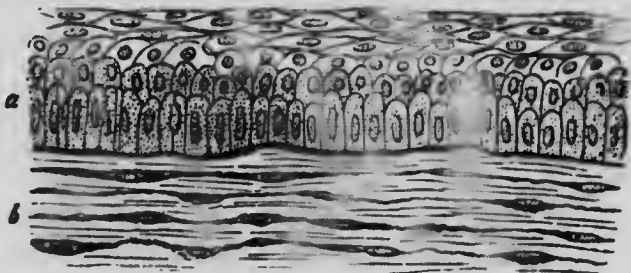

Fig. 47.—Vertical section of the stratified epithelium of the rabbit's cornea. a, anterior epithelium, showing the different shapes of the cells at various depths from the free surface; b, a portion of the substance of cornea. (Klein.)

The intermediate cells approach more to the flat variety the nearer they are to the surface, and to the columnar as they approach the lowest layer. There may be considerable intercellular intervals; and in many of the deeper layers of epithelium in the mouth and skin the outline of the cells is very irregular in consequence of processes passing from cell to cell across these intervals.

Such cells (fig. 48) are termed "ridge and furrow," "cogged" or "prickle" cells. These "prickles" are prolongations of the intracellular network which run across from cell to cell, thus joining them together, the interstices being filled by lymph and transparent intercellular cement

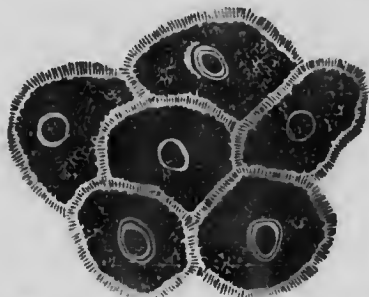

Fig. 48.—Jagged cells from the middle layers of stratified epithelium, from a vertical section of the gum of a new-born infant. (Klein.)

substance. When this increases in quantity in inflammation the cells are pushed further apart, and the connecting fibrils or "prickles" elongated and therefore more clearly visible.

The columnar cells of the deepest layer are distinctly nucleated; they multiply rapidly by division; and as new cells are formed beneath, they press the older cells forwards to be in turn pressed forwards themselves towards the surface, gradually altering in shape and chemical composition until they are cast off from the surface.

Stratified epithelium is found in the following situations:— (1) Forming the epidermis, covering the whole of the external surface of the body; (2) Covering the mucous membrane of the nasal orifice, tongue, mouth, pharynx, and œsophagus; (3) As the conjunctival epithelium, covering the cornea; (4) Lining the vagina and the vaginal part of the cervix uteri.

#### Nutrition of Epithelium.

Epithelium has no blood-vessels; it is nourished by lymph. When the blood is circulating through the thin-walled small blood-vessels in the tissues beneath the epithelium, some of its fluid constituents escape. This fluid is called *lymph*; it penetrates to all parts of the cellular elements of tissues and nourishes them. In the thicker varieties of epithelium, the presence of the irregular minute channels between the prickle cells (fig. 48) enables the lymph to soak more readily between the cells than it would otherwise be able to do. Epithelium is also destitute of nerves as a rule. But in stratified epithelium, particularly that covering the cornea at the front of the eye and in the deeper layers of the epidermis, a plexus of nerve fibrils is found.

#### Chemistry of Epithelium.

There is not much to add to what has been already stated concerning cells; protoplasm and nucleus have the same chemical composition as has been already described in Chapter II. Two new substances have, however, been mentioned in the foregoing chapter—namely, mucin and keratin.

*Mucin.*—This is a widely distributed substance occurring in epithelial cells or shed out by them (see goblet cells, fig. 39). It also forms the chief constituent of the cementing substance between epithelial cells. We shall again meet with it in the intercellular substance of the connective tissues. The mucin obtained from different sources varies in composition and reactions.

There are probably several mucins, but they all agree in the following points:—

- (a) Physical character: viscid and tenacious.
- (b) Precipitability from solutions by acetic acid. They all dissolve in dilute alkalis, like lime-water.
- (c) They are all compounds of proteid, with a carbohydrate material which has been provisionally called animal gum; by treatment with dilute mineral acid this is hydrated into a reducing but non-fermentable sugar-like substance.

The substance mucin, when it is formed within cells (goblet cells, cells of mucous glands), is preceded in the cells by granules of a substance which is not mucin, but is readily changed into mucin. This precursor, or mother-substance of mucin, is called *mucigen* or *mucinogen*.

*Keratin*, or horny material, is the substance found in the surface layers of the epidermis, in hairs, nails, hoofs, and horns. It is very insoluble, and chiefly differs from proteids in its high percentage of sulphur. Keratin is a member of a heterogencous group of proteid-like substances which are called albuminoids, and several more members of this group we shall have to consider in our next chapter on the connective tissues.

---

## CHAPTER IV.

### THE CONNECTIVE TISSUES.

The connective tissues are the following:—

1. Areolar tissue.
2. Fibrous tissue.
3. Elastic tissue.
4. Adipose tissue.
5. Retiform and lymphoid tissues.
6. Jelly-like tissue.
7. Cartilage.
8. Bone and dentine.
9. Blood.

At first sight these numerous tissues appear to form a very heterogeneous group, including the most solid tissues of the body (bone, dentine) and the most fluid (blood).

But on examining a little more deeply, one finds that the grouping of these apparently different tissues together depends on a number of valid reasons, which may be briefly stated as follows:—

1. They all resemble each other in origin. All are formed from the mesoblast, the middle layer of the embryo.
2. They resemble each other structurally; that is to say, the cellular element is at a minimum, and the intercellular material at a maximum.
3. They resemble each other functionally; they form the skeleton, and act as binding, supporting, or connecting tissues to the softer and more vital tissues.

An apology is sometimes made for calling the blood a tissue, because one's preconceived idea of a tissue or texture is that it must be something of a solid nature. But all the tissues contain water. Muscular tissue contains, for instance, at least three-quarters of its weight as water. Blood, after all, is not much more liquid than muscle. Blood, moreover, contains cellular elements analogous to the cells of other tissues, but separated by large quantities of a fluid intercellular material called blood-plasma.

Blood is also mesoblastic, and thus the two first characteristics of a connective tissue are present. It does not fulfil the third condition by contributing to the support of the body as part of the skeleton, but it does so in another sense, and serves to support the body by conveying nutriment to all parts.

We may now proceed to a consideration of this long list of tissues, one by one, in the order named.

### Areolar Tissue.

It is convenient to take this first, as it is a very typical connective tissue. It has a wide distribution, and constitutes the subcutaneous, subserous, and submucous tissues. It forms sheaths (*fasciæ*) for muscles, nerves, blood-vessels, glands, and internal organs, binding them in position and penetrating into their interior, supports and connects their individual parts.

If one takes a little of the subcutaneous tissue from an animal, and stretches it out on a glass slide, it appears to the naked eye like a soft, fleecy network of fine white fibres, with here and there wider fibres joining it. It is, moreover, elastic.

But in order to make out its structure accurately it is necessary to examine the thinnest portions of the film with the microscope, and

the action of staining and other reagents may then be also studied. By such means it is seen that this typical connective tissue consists

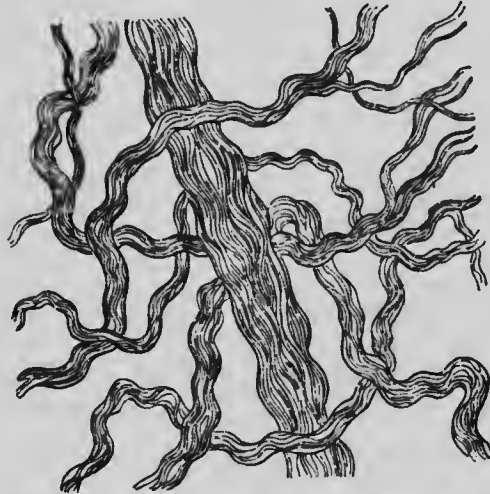

Fig. 49.—Bundles of the white fibres of areolar tissue partly unraveled.  
(After Sharpey.)

of four different kinds of material, or, as they may be termed *histological elements*. They are:—

- (a) Cells, or connective-tissue corpuscles.
  - (b) A homogeneous matrix, ground substance, or intercellular material.
  - (c) White fibres
  - (d) Yellow or elastic fibres
- } These are deposited in the matrix.

In considering these four histological elements we may first take the fibres, because they are the most obvious and abundant of the structures observable.

*The white fibres.* These are exquisitely fine fibres collected into bundles which have a wavy outline. The bundles run in different directions, forming an irregular network, the meshes between which are called *areolæ*; hence the name areolar. The individual fibres never branch or join other fibres, but they may pass from one bundle to another.

On treatment with dilute acetic acid they become swollen and

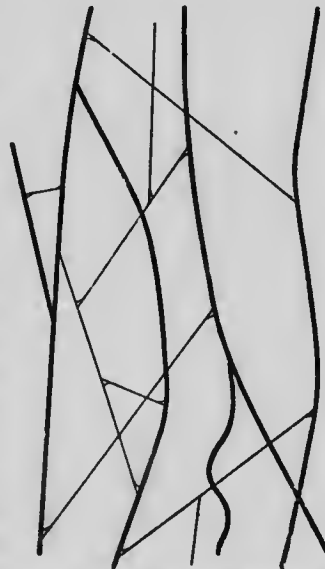

Fig. 50.—Elastic fibres of areolar tissue. (After Schäfer.)

indistinct, leaving the other structures mixed with them more apparent.

They are composed of the chemical substance called *collagen*. On boiling they yield *gelatin*; some chemists regard collagen as the anhydride of gelatin; but whether this is so or not, the gelatin is undoubtedly derived from the collagen. Gelatin is a proteid-like substance though not a proteid. It belongs to the class of albuminoids. Its most characteristic property is its power of jellying or gelatinising; that is, it is soluble in hot water, but on cooling the solution it sets into a jelly.

*The yellow or elastic fibres.* These are seen readily after the white fibres are rendered almost invisible by treatment with dilute acetic acid, or after staining with such dyes as magenta and orcein, for which elastic fibres have a great affinity. They are bigger than the white fibres, have a distinct outline, and a straight course; they run singly, branch, and join neighbouring fibres (fig. 50).

The material of which the elastic fibres are composed is called *elastin*; this is another albuminoid. It is unaltered, as we have seen, by dilute acid. It also resists the action of very strong acid, and is not affected by boiling water.

The bundles of white fibres which have been swollen out by dilute acetic acid sometimes exhibit constrictions as in fig. 51. These are due to elastic fibres or cell processes encircling them and preventing the swelling at those points.

*Connective-tissue corpuscles.* These are the cells of connective tissue: several varieties may be made out, especially after a preparation has been stained.



Fig. 51.—A white bundle swollen by acetic acid. (Toldt.)

1. Flattened cells, branched, and often united by their processes, as in the cornea.

2. Flattened cells, unbranched, and joined edge

to edge like the cells of an epithelium; these are well seen in the sheath of a tendon.

3. Plasma cells of Waldeyer, varying greatly in size and form, but not flattened. The protoplasm is much vacuolated.

4. Granule cells: like plasma cells, but containing albuminous granules (stainable by eosin) instead of vacuoles.

5. Wander cells: white blood-corpuscles which have emigrated from the neighbouring blood-vessels.

6. Pigment cells: these are seen in the subcutaneous tissues

of many animals, *e.g.*, the frog, and in the choroid coat of the eyeball.

Fig. 55 shows a highly magnified view of a small piece of subcutaneous tissue, and illustrates the irregular way in which the fibres and cells are intermixed.



Fig. 52.—Horizontal preparation of the cornea of frog, stained in gold chloride; showing the network of branched cornea corpuscles. The ground substance is completely colourless.  $\times 400$ . (Klein.)



Fig. 53.—Ramified pigment-cells, from the tissue of the choroid coat of the eye.  $\times 350$ . *a*, cell with pigment; *b*, colourless fusiform cells. (Kölliker.)

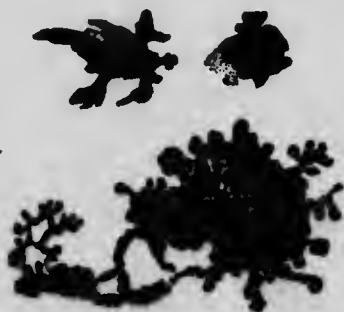

Fig. 54.—Flat, pigmented, branched connective-tissue cells from the sheath of a large blood-vessel of the frog's mesentery; the pigment is not distributed uniformly throughout the substance of the larger cell, consequently some parts of it look blacker than others (uncontracted state). In the two smaller cells most of the pigment is withdrawn into the cell-body, so that they appear smaller, blacker, and less branched.  $\times 350$ . (Klein and Noble Smith.)

We have now to consider the undifferentiated intercellular material which is called

*The ground-substance.* This may be represented in fig. 55 by the white background of the paper.

It may be readily demonstrated in a silver nitrate preparation; for the intercellular material has the same property of reducing silver salts in the sunlight that the cement-material



of epithelium has. It becomes in consequence dark brown, with the exception of the spaces occupied by the corpuscles.

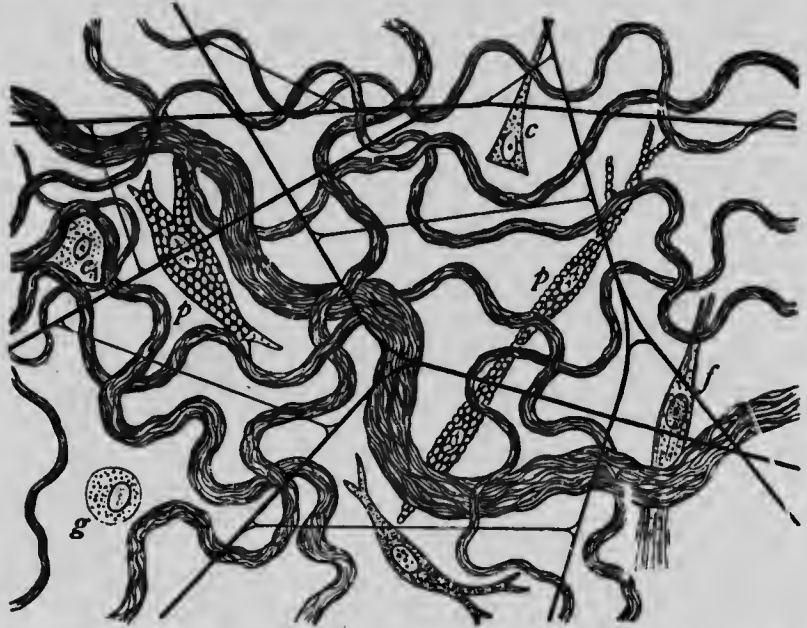

Fig. 55.—Areolar tissue. The white fibres are seen in wavy bundles; the elastic fibres form an open network. *p, p*, plasma cells. *g*, granule cell. *c, c*, lamellar cells. *s*, fibrillated cell. (After Schäfer.)

The spaces intercommunicate like the cells, and being considerably larger than the cells form a ramifying network of irregular channels, which were first termed by v. Recklinghausen

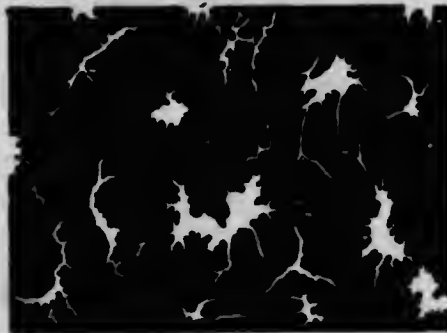

Fig. 56.—Ground substance of connective tissue, stained by silver nitrate. The cell spaces are left white. (After Schäfer.)

the *Saft Kanälchen*, or little juice canals. Areolar tissue is certainly provided with blood-vessels, but the tissue elements are, as in all tissues, provided with nutriment by the exudation from the blood

called *lymph*. The *Soft Kanälchen* enable the lymph to penetrate to every part of the areolar tissue.

### Development of Areolar Tissue.

The mesoblastic cells in those parts where the tissue is to be formed become branched and fusiform.

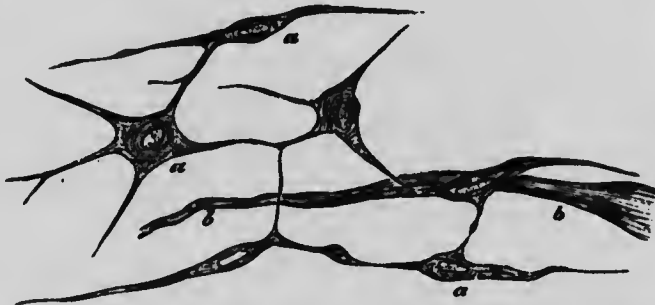

Fig. 57.—Portion of submucous tissue of gravid uterus of cow. *a*, branched cells, more or less spindle-shaped; *b*, bundles of connective tissue. (Klein.)

These ultimately become the connective-tissue corpuscles, and they get more and more widely separated by intercellular

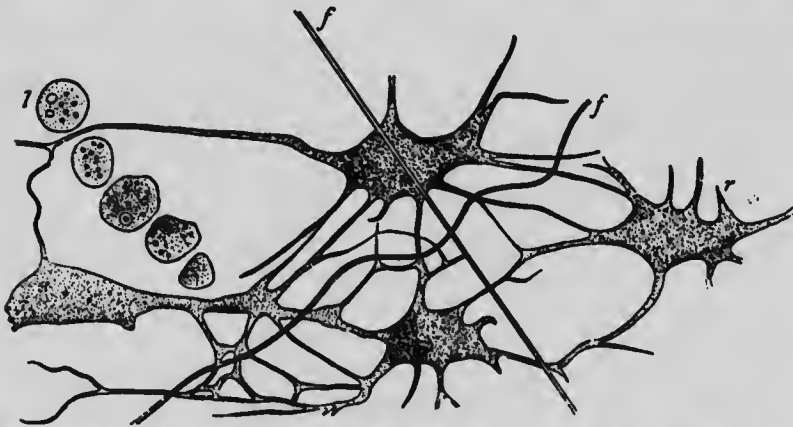

Fig. 58.—Jelly of Wharton. *r*, ramified cells intercommunicating by their branches. *l*, a row of lymph-cells. *f*, fibres developing in the ground substance. (Ranvier.)

material, partly shed out by the cells themselves, partly shed out from the neighbouring blood-vessels. This becomes the ground substance. The fibres form subsequently in this as crystals may be deposited by a liquid. At one time it was believed that the cells themselves became elongated and converted into fibres. No

doubt the cells do exercise a controlling influence on fibre-formation in their neighbourhood, but it is extremely doubtful whether they ever become fibres. The formation of fibres is now believed to be intercellular. Some of the fibres formed are of the white, others

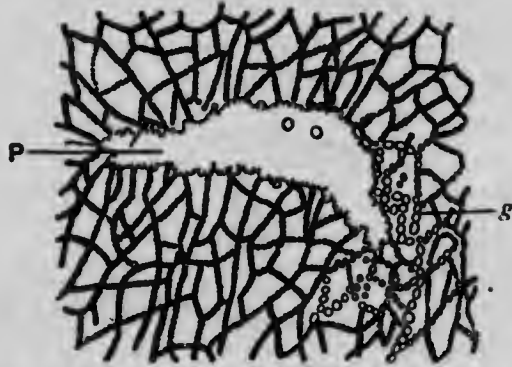

Fig. 59.—Development of elastic tissue by deposition of fine granules. *g*, fibres being formed by rows of elastic granules. *P*, platelike expansion of elastic substance formed by the fusion of elastic granules. (Ranvier.)

of the yellow variety. In the case of the elastic fibres, rows of granules of elastin are first deposited; these joining together in single or multiple rows form the long fibres: traces of this are seen in transverse markings occasionally noticeable in the larger elastic fibres.

#### Fibrous Tissue.

This is a kind of connective tissue in which the white fibres predominate; it is found in tendons and ligaments, in the



Fig. 60.—Mature white fibrous tissue of tendon, consisting mainly of fibres with a few scattered fusiform cells. (Stricker.)

periosteum, dura mater, true skin, the sclerotic coat of the eye, and in the thicker fasciæ and aponeuroses of muscle.

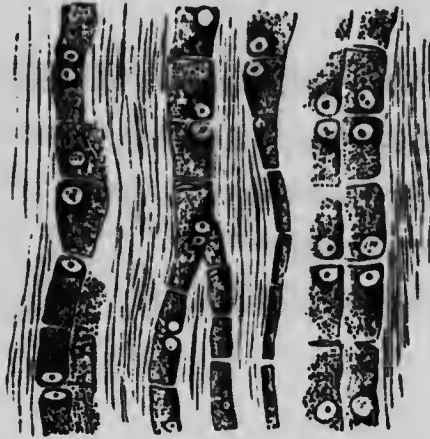

Fig. 61.—Caudal tendon of young rat, showing the arrangement, form, and structure of the tendon cells.  $\times 300$ . (Klein.)

The tissue is one of great strength; this is conferred upon it by the arrangement of the fibres, the bundles of which run parallel, union here, as elsewhere, giving strength. The fibres of the same bundle now and then intersect each other. The cells in tendons (fig. 61) are forced to take up a similar orderly arrangement, and are arranged in long chains in the ground substance separating the bundles of fibres, and are more or less regularly quadrilateral with large round nuclei containing nucleoli, which are generally placed so as to be nearly contiguous in two cells. Each of these cells consists of a thick body, from which processes pass in various directions into, and partially fill up the spaces between, the bundles of fibres. The rows of cells are separated from one another by lines of cement substance. The cells are generally marked by one or more lines or stripes when viewed longitudinally. This appearance is really produced by the wing-like processes of the



Fig. 62.—Transverse section of tendon from a cross section of the tail of a rabbit, showing sheath, fibrous septa, and branched connective-tissue corpuscles. The spaces left white in the drawing represent the tendinous bundles in transverse section.  $\times 250$ . (Klein.)

cell, which project away from the chief part of the cell in different directions. These processes not being in the same plane as the body of the cell are out of focus, and give rise to these bright stripes when the cells are looked at from above and are in focus.



Fig. 63.—Cell spaces of tendon, brought into view by treatment with silver nitrate. (After Schäfer.)

The branched character of the cells is seen in transverse section in fig. 62.

The cell spaces in which the cells lie are in arrangement like the cells; they can be brought into relief by staining with silver nitrate (see fig. 63).

#### Elastic Tissue.

This is a form of connective tissue in which the yellow or elastic fibres predominate. The yellow fibres are larger than those found in areolar tissue (see fig. 64), and are bound into bundles by areolar tissue. It is found in the ligamentum nuchæ of the ox, horse, and many other animals; in the ligamenta subflava of man; in the arteries and veins, constituting the fenestrated coat of Henle; in the lungs and trachea; in the stylohyoid, thyrohyoid, and cricothyroid ligaments; in the true vocal cords.



Fig. 64.—Elastic fibres from the ligamenta subflava.  $\times 200$ . (Sharpey.)

in colour, but individual fibres are not so distinctly coloured. The

*Structure.*—Elastic tissue occurs in various forms, from a structureless, elastic membrane to a tissue whose chief constituents are bundles of fibres crossing each other at different angles; when seen in bundles elastic fibres are yellowish

larger elastic fibres are often transversely marked, indicating their mode of origin (see p. 44), and on transverse section are seen to be angular (fig. 65).

Elastic tissue, being extensible and elastic (*i.e.*, recoiling after it has been stretched), has a most important use in assisting muscular tissue in a mechanical way, and so lessening the wear and tear of such an important tissue as muscle. Thus, in the ligamenta subflava of the human vertebral column it assists in the maintenance of the erect posture; in the ligamentum nuchæ in the neck of quadrupeds it assists in the raising of the head and in keeping it in that position. In the arterial walls, and in the air tubes and lungs, it has a similar important action, as we shall see when discussing the subjects of the circulation and respiration.

We now come to those forms of connective tissue in which the cells rather than the fibres are most prominent.

### Adipose Tissue.

*Distribution.*—In almost all regions of the human body a larger or smaller quantity of adipose or fatty tissue is present; the chief exceptions being the subcutaneous tissue of the eyelids, penis and scrotum, the nymphæ, and the cavity of the cranium. Adipose *tissue* is also absent from the substance of many organs, as the lungs and liver.

Adipose tissue is almost always found seated in areolar tissue, and forms in its meshes little masses of unequal size and irregular shape, to which the term *lobules* is commonly applied.

*Structure.*—Under the microscope adipose tissue is found to consist essentially of little vesicles or cells which present dark, sharply-defined edges when viewed with transmitted light: they are about  $\frac{1}{800}$  or  $\frac{1}{600}$  of an inch in diameter; each consists of a structureless and colourless membrane or bag formed of the



Fig. 65.—Transverse section of a portion of lig. nuchæ, showing the outline of the fibres. (After Stöhr.)



Fig. 66.—Ordinary fat-cells of a fat tract in the omentum of a rat. (Klein.)

remains of the original protoplasm of the cell, filled with fatty matter, which is liquid during life, but is in part solidified (or

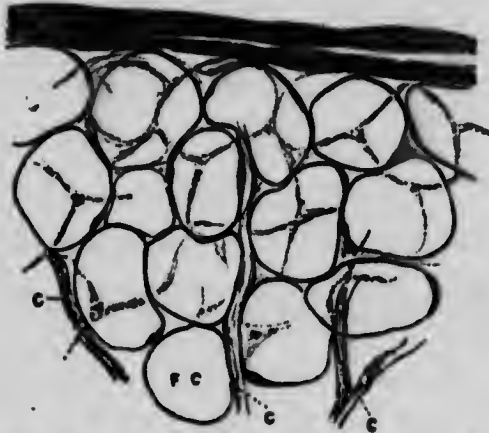

Fig. 67.—Group of fat-cells (*v c*) with capillary vessels (*c*). (Noble Smith.)

sometimes crystallised) after death. A nucleus is always present in some part or other of the cell-protoplasm, but in the ordinary condition of the cell it is not easily or always visible (fig. 67).

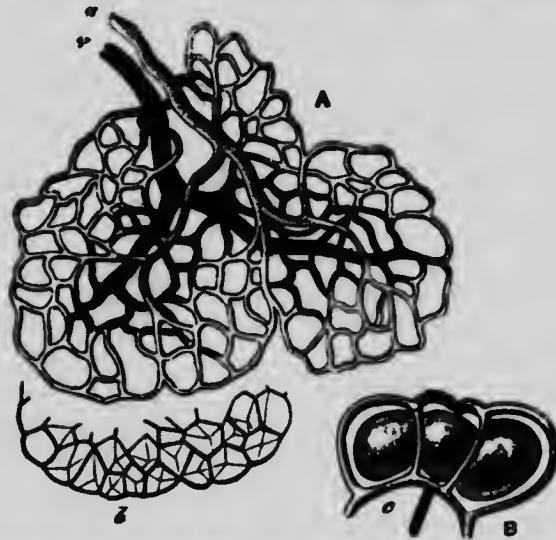

Fig. 68.—Blood-vessels of adipose tissue. A. Minute flattened fat-lobule, in which the vessels only are represented. *a*, the terminal artery; *v*, the primitive vein; *b*, the fat-vesicles of one border of the lobule separately represented.  $\times 100$ . B. Plan of the arrangement of the capillaries (*c*) on the exterior of the vesicles; more highly magnified. (Todd and Bowman.)

This membrane and the nucleus can generally be brought into view by staining the tissue: it can be still more satisfactorily

demonstrated by extracting the contents of the fat-cells with ether, when the shrunken, shrivelled membranes remain behind. By mutual pressure, fat-cells assume a polyhedral figure (fig. 67). When stained with osmic acid fat-cells appear black.

The cells are surrounded by capillary blood-vessels (fig. 68); the little clusters thus formed are grouped into small masses, and held so by areolar tissue.

The oily matter contained in the cells is composed of the compounds of fatty acids with glycerin, which are named *olein*, *stearin*, and *palmitin*.

**Development of Adipose Tissue.**—Fat-cells are developed from connective-tissue corpuscles; connective-tissue cells may be found exhibiting every intermediate gradation between an ordinary connective-tissue corpuscle and a mature fat-cell. The process of development is as follows: a few small drops of oil make their appearance in the protoplasm and by their confluence a larger drop is produced (figs. 69 and 70): this gradually increases in size at the expense of the original protoplasm of the cell, which becomes correspondingly diminished in quantity till in the mature cell it only forms a thin film, with a flattened nucleus imbedded in its substance (fig. 66).

**Vessels and Nerves.**—A large number of blood-vessels are found in adipose tissue, which subdivide until each lobule of fat contains a fine meshwork of capillaries ensheathing each individual fat-cell (fig. 68). Although nerve fibres pass through the tissue, no nerves have been demonstrated to terminate in it.

**The Uses of Adipose Tissue.**—Among the uses of adipose tissue these are the chief:—

a. It serves as a store of combustible matter which may be reabsorbed into the blood when occasion requires, and, being used up in the metabolism of the tissues, helps to preserve the heat of the body.

b. Part of the fat which is situated beneath the skin must, by



Fig. 69.—A lobule of developing adipose tissue from an eight months' foetus. a, Spherical or, from pressure, polyhedral cells with large central nucleus, surrounded by protoplasm staining uniformly with hæmatoxylin. b, Similar cells with spaces from which the fat has been removed by oil of cloves. c, Similar cells showing how the nucleus with enclosing protoplasm is being pressed towards periphery. d, Nucleus of endothelium of investing capillaries. (McCarthy.) Drawn by Treves.



its want of conducting power, assist in preventing undue waste of the heat of the body by escape from the surface.

c. As a packing material, fat serves very admirably to fill up spaces, to form a soft and yielding yet clastic material wherewith to wrap tender and delicate structures, or form a bed with like



Fig. 70.—Branched connective-tissue corpuscles, developing into fat-cells. (Klein.)

qualities on which such structures may lie, not endangered by pressure. As examples of situations in which fat serves such purposes may be mentioned the palms of the hands and soles of the feet and the orbits.

d. In the long bones fatty tissue, in the form known as yellow marrow, fills the medullary canal, and supports the small blood-vessels which are distributed from it to the inner part of the substance of the bone.

#### Retiform Tissue.

Retiform or reticular tissue is a kind of connective tissue in which the ground substance is of more fluid consistency than

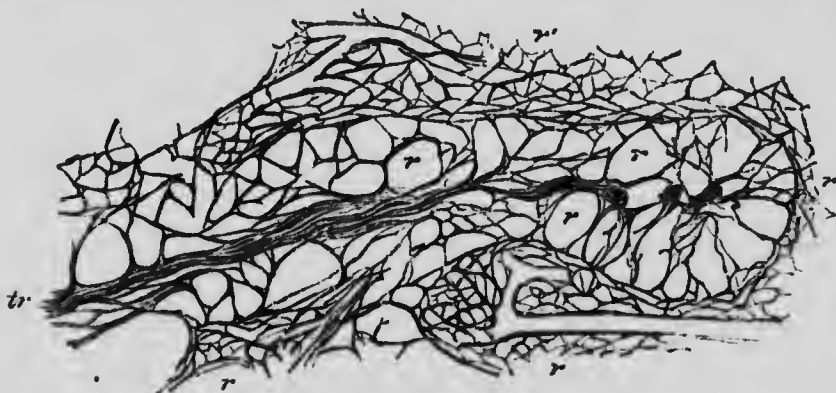

Fig. 71.—Retiform tissue from a lymphatic gland, from a section which has been treated with dilute potash. (Schäfer.)

elsewhere. There are few or no elastic fibres in it, but the white fibres run in very fine bundles forming a close network. The bundles are covered and concealed by flattened connective-tissue corpuscles. When these are dissolved by dilute potash, the fibres are plainly seen (fig. 71).

#### Adenoid or Lymphoid Tissue.

This is retiform tissue in which the meshes of the network are largely occupied by lymph corpuscles. These are in certain foci actively multiplying; they get into the lymph stream, which washes them into the blood, where they become the colourless

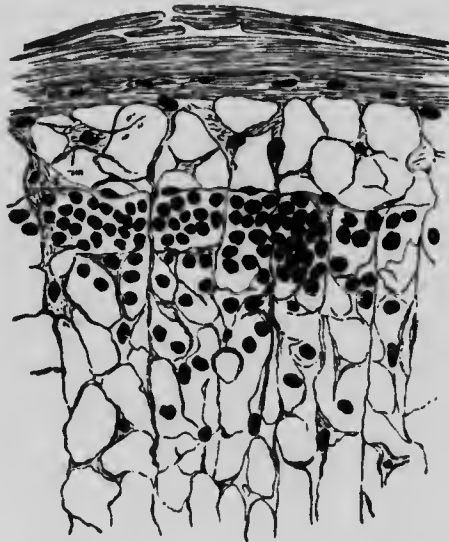

Fig. 72.—Part of a section of a lymphatic gland, from which the corpuscles have been for the most part removed, showing the supporting retiform tissue. (Klein and Noble Smith.)

corpuscles. It is found in the lymphatic glands, the thymus, the tonsils, in the follicular glands of the tongue, in Peyer's patches, and in the solitary glands of the intestines, in the Malpighian corpuscles of the spleen, and under the epithelium of many mucous membranes.

#### Basement Membranes.

These are homogeneous in appearance, and are found between the epithelium of a mucous membrane and the subjacent connective tissue. They are generally formed of flattened connective-tissue corpuscles joined together by their edges, but sometimes

they are made of condensed ground substance, not of cells, and in other cases again (as in the cornea) they are of elastic nature.

### Jelly-like Connective Tissue.

We have now considered connective tissues in which fibres of one or the other kind predominate, and some in which the cells

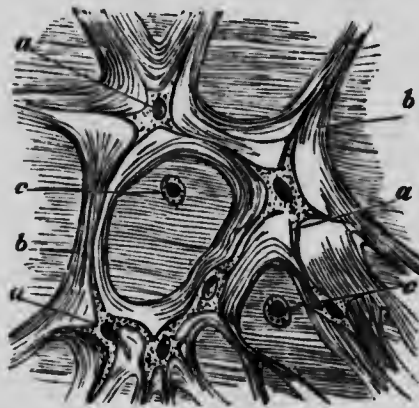

Fig. 73.—Tissue of the jelly of Wharton from umbilical cord. *a*, connective-tissue corpuscles; *b*, fasciculi of connective-tissue fibres; *c*, spherical cells. (Frey.)

are in preponderance. We come lastly to a form of connective tissue in which the ground substance is in excess of the other histological elements. This is called jelly-like connective tissue. The cells and fibres scattered through it are few and far between. It is found largely in the embryo, notably in the Whartonian jelly, which surrounds and protects the blood-vessels of the umbilical cord. In the adult it is found in the vitreous humour of the eye.

Various points in the structure of the tissue are illustrated in figs. 58 (p. 43) and 73.

The occurrence of large quantities of ground substances in such tissues has enabled physiologists to examine its chemical nature. Its chief constituents are water, and one or more varieties of mucin, with traces of proteid and mineral salts.

The foregoing tissues are sometimes called the connective tissues proper. The remaining members of the connective-tissue group we shall reserve for the next chapter.

## CHAPTER V.

THE CONNECTIVE TISSUES (*continued*).

## CARTILAGE, BONE, TEETH, BLOOD.

**Cartilage.**

**CARTILAGE** is popularly termed gristle. It may be divided into two chief kinds: *Hyaline cartilage*; here the matrix or ground substance is clear and free from fibres: *Fibro-cartilage*; here the

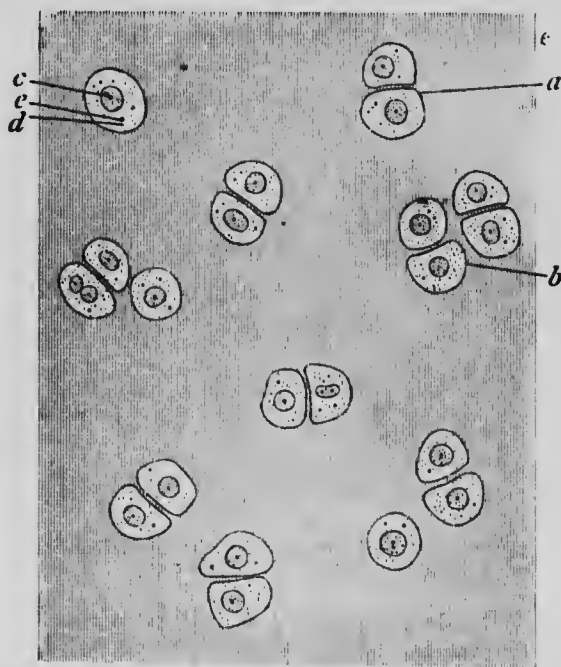

Fig. 74.—Section of articular cartilage. *a*, group of two cells; *b*, group of four cells; *d*, protoplasm of cell with *e*, fatty granules; *c*, nucleus. (After Schäfer.)

matrix is pervaded with connective-tissue fibres; when these are of the white variety, the tissue is *white fibro-cartilage*; when they are of the yellow or elastic variety, the tissue is *yellow or elastic fibro-cartilage*.

**Hyaline Cartilage** is found in the following places:—

1. Covering the articular ends of bones; here it is called *articular cartilage*.
2. Forming the rib-cartilages; here it is called *costal cartilage*.

3. The cartilages of the nose, of the windpipe, of the external auditory meatus, and the greater number of the laryngeal cartilages.

4. *Temporary cartilage* ; rods of cartilage which prefigure the majority of the bones in process of development.

*Articular cartilage* : here the cells are rounded and scattered in groups of two and four through the matrix, which is non-fibrillated (fig. 74), and much firmer than the ground-substance

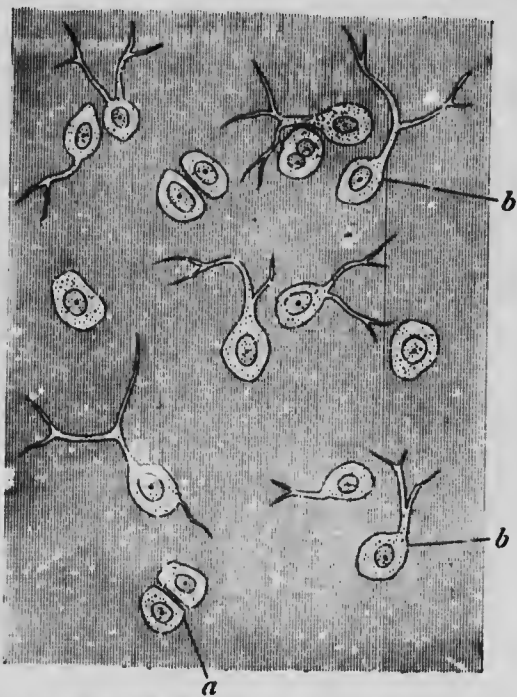

Fig. 75.—Section of transitional cartilage. *a*, ordinary cartilage cells; *b b*, those with processes. (After Schäfer.)

of the connective tissues proper ; but it is affected in the same way with silver nitrate.

In the neighbourhood of synovial membranes, the connective-tissue fibres of which extend into the matrix, the cells are branched (*transitional cartilage*) (fig. 75).

The next figure (fig. 76) shows the general arrangement of the cell-groups in a vertical section of articular cartilage. Cartilage is free from blood-vessels, and also from nerves. It is nourished by lymph, but canals connecting the cell-spaces are not evident.

*Costal cartilage* : here the matrix is not quite so clear, and the cells are larger, more angular, and collected into larger groups than in articular cartilage. Under the *perichondrium*, a

fibrous membrane which surrounds the rod of cartilage, the cells are flattened and lie parallel to the surface; in the deeper parts they are irregularly arranged; they frequently contain fat (see fig. 77).

The hyaline cartilages of the nose, larynx and trachea (fig. 78) resemble costal cartilage.

Hyaline cartilage in many situations (costal, laryngeal, tracheal) shows a tendency to become calcified late in life.

On boiling, the ground-substance of cartilage yields a material called *chondrin*. This resembles gelatin very closely, and the differences in its reactions are due to the fact that chondrin is

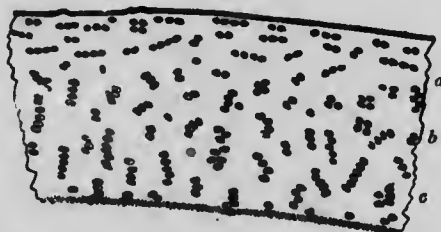

Fig. 76.—Vertical section of articular cartilage. *a*, cell-groups arranged parallel to surface. *b*, cell-groups irregularly arranged. *c*, cell groups arranged perpendicularly to surface.

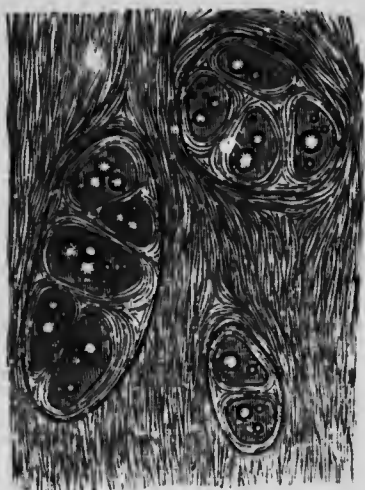

Fig. 77.—Costal cartilage from an adult dog, showing fat-globules in the cartilage-cells. (Cadiat.)



Fig. 78.—Ordinary hyaline cartilage from trachea of a child. The cartilage cells are enclosed singly or in pairs in a capsule of hyaline substance.  $\times 150$  diams. (Klein and Noble Smith.)

not a chemical individual, but a mixture of gelatin with varying amounts of mucin-like substances.

**White Fibro-Cartilage** occurs—

1. As *inter-articular* fibro-cartilage—*e.g.*, the semilunar cartilages of the knee-joint.
2. As *circumferential* or marginal cartilage, as on the edges of the acetabulum and glenoid cavity.

3. As *connecting cartilage*—*e.g.*, the inter-vertebral discs.
4. In the *sheaths of tendons* and sometimes in their substance.

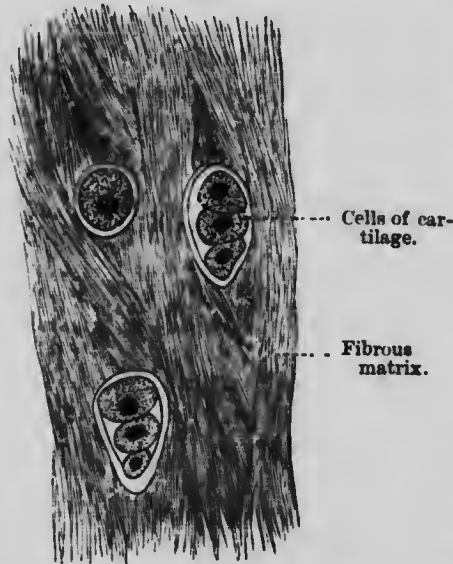

Fig. 79.—White fibro-cartilage. (Cadiat.)

in other parts continuous with these, cartilage-cells are freely distributed.

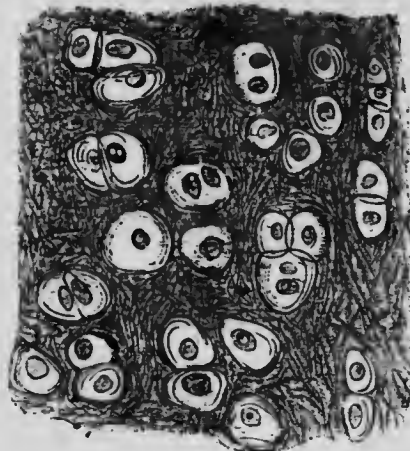

Fig. 80.—Yellow elastic cartilage. (Cadiat.)

intercellular substance is present around the cells.

**Development of Cartilage.**—Like other connective tissues,

In the latter situation the nodule of fibro-cartilage is called a *sesamoid* fibro-cartilage, of which a specimen may be found in the tendon of the *tibialis posticus* in the sole of the foot, and usually in the neighbouring tendon of the *peroneus longus*.

White fibro-cartilage (fig. 79) is composed of cells and a matrix. The latter is permeated by fibres of the white variety.

In this kind of fibro-cartilage it is not unusual to find portions so densely fibrous that no cells can be seen; but

**Yellow or Elastic Fibro-Cartilage** is found in the pinna of the external ear, in the epiglottis and cornicula laryngis, and in the Eustachian tube.

The cells in this variety of cartilage are rounded or oval, with well-marked nuclei and nucleoli (fig. 80). The matrix in which they are seated is pervaded in all directions by fine elastic fibres, which form an intricate interlacement about the cells: a small and variable quantity of non-fibrillated hyaline inter-

cartilage originates from mesoblast; the cells are unbranched, and the disposition of the cells in fully formed cartilage in groups of two, four, &c., is due to the fact that each group has originated from the division of a single cell, first into two, each of these again into two, and so on. This process of cell division is accompanied with the usual karyokinetic changes.

Each cell deposits on its exterior a sheath or capsule; on

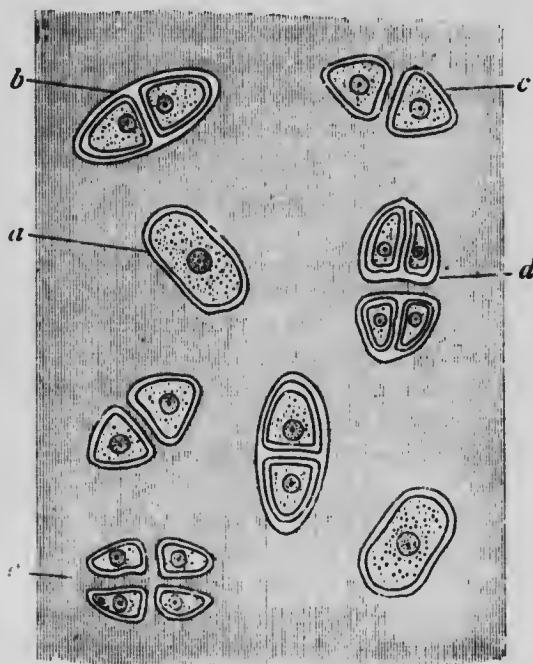

Fig. 81.—Plan of multiplication of cells in cartilage. *a*, cell in its capsule. *b*, divided into two, each with a capsule. *c*, primary capsule disappeared, secondary capsules coherent with matrix. *d*, tertiary division. *e*, secondary capsules disappeared, tertiary coherent with matrix. (After Sharpey.)

division each of the daughter-cells deposits a new capsule within this, and the process may be repeated (see fig. 81).

Thus the cells get more and more separated. The fused capsules form a very large part of the matrix, and indications of their previous existence may sometimes be seen in fully formed cartilage by the presence of faint concentric lines around the cells (see fig. 77).

In a variety of cartilage found in the ears of rats and mice called *cellular cartilage*, the cells never multiply to any great extent, and they are only separated by their thickened capsules.

But in most cartilages the cell-capsules will not explain the



origin of the whole matrix, but intercellular material accumulates outside the capsules and still further separates the cells.

By certain complicated methods of double staining this twofold manner of formation may be shown very markedly. We have seen that chondrin obtained by boiling cartilage is really a mixture of two substances; one is a mucinoid material, and comes from the capsules; the other is gelatin, which comes from the rest of the ground-substance which is collagenous. In hyaline cartilage, however, the collagen does not become precipitated to form fibres, but in white fibro-cartilage it does. In yellow fibro-cartilage the matrix is pervaded by a deposit of elastin, which results in the formation of a network of elastic fibres.

### Bone.

*Chemical composition.*—Bone is composed of *earthy* and *animal* matter in the proportion of about 67 per cent. of the former to 33 per cent. of the latter. The earthy matter is composed chiefly of *calcium phosphate*, but besides this, there is a small quantity (about 11 of the 67 per cent.) of *calcium carbonate*, *calcium fluoride*, and *magnesium phosphate*.

The animal matter is chiefly *collagen*, which is converted into *gelatin* by boiling.

The animal and earthy constituents of bone are so intimately blended and incorporated the one with the other that it is only by severe measures, as for instance by a white heat in one case and by the action of concentrated acids in another, that they can be separated. Their close union too is further shown by the fact that when by acids the earthy matter is dissolved out, or on the other hand when the animal part is burnt out, the shape of the bone is alike preserved.

The proportion between these two constituents of bone varies slightly in different bones in the same individual and in the same bone at different ages.

*Structure.*—To the naked eye there appear two kinds of structure in different bones, and in different parts of the same bone, namely, the *dense* or *compact*, and the *spongy* or *cancellous* tissue. Thus, in making a longitudinal section of a long bone, as the humerus or femur, the articular extremities are found capped on their surface by a thin shell of compact bone, while their interior is made up of the spongy or cancellous tissue. The *shaft*, on the other hand, is formed almost entirely of a thick layer of the compact bone, and this surrounds a central canal, the *medullary* cavity—so called from its containing the *medulla* or marrow.

In the flat bones, as the parietal bone or the scapula, one layer of the cancellous structure lies between two layers of the compact tissue, and in the short and irregular bones, as those of the *carpus* and *tarsus*, the cancellous tissue fills the interior, while a thin shell of compact bone forms the outside.

**Marrow.**— There are two distinct varieties of marrow---the *red* and *yellow*.

*Red marrow* is that variety which occupies the spaces in the cancellous tissue; it is highly vascular, and thus maintains the nutrition of the spongy bone, the interstices of which it fills. It contains a few fat-cells and a large number of marrow-cells, many of which are undistinguishable from lymphoid corpuscles, and has for a basis a small amount of areolar tissue. Among the cells are

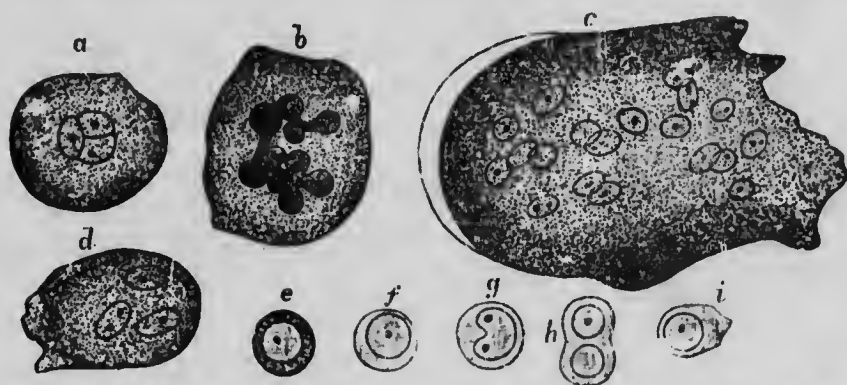

Fig. 82.—Cells of the red marrow of the guinea-pig, highly magnified. *a*, a large cell, the nucleus of which appears to be partly divided into three by constrictions; *b*, a cell, the nucleus of which shows an appearance of being constricted into a number of smaller nuclei; *c*, a so-called giant cell, or myeloplax, with many nuclei; *d*, a smaller myeloplax, with three nuclei; *e*—*i*, proper cells of the marrow. (E. A. Schäfer.)

some nucleated cells of the same tint as coloured blood-corpuscles. There are also a few large cells with many nuclei, termed *giant cells* or *myeloplaxes* (fig. 82).

*Yellow marrow* fills the medullary cavity of long bones, and consists chiefly of fat-cells with numerous blood-vessels; many of its cells also are in every respect similar to lymphoid corpuscles.

From these marrow-cells, especially those of the red marrow, are derived, as we shall presently see, large quantities of red blood-corpuscles.

**Periosteum and Nutrient Blood-vessels.**—The surfaces of bones, except the part covered with articular cartilage, are clothed by a tough, fibrous membrane, the *periosteum*; and it is from the blood-vessels which are distributed in this membrane, that the bones, especially their more compact tissue, are in great

part supplied with nourishment; minute branches from the periosteal vessels enter the little foramina on the surface of the bone, and find their way to the Haversian canals, to be immediately described. The long bones are supplied also by a proper nutrient artery which, entering at some part of the shaft so as to reach the medullary cavity, breaks up into branches for the supply of the marrow, from which again small vessels are distributed to the interior of the bone. Other small blood-

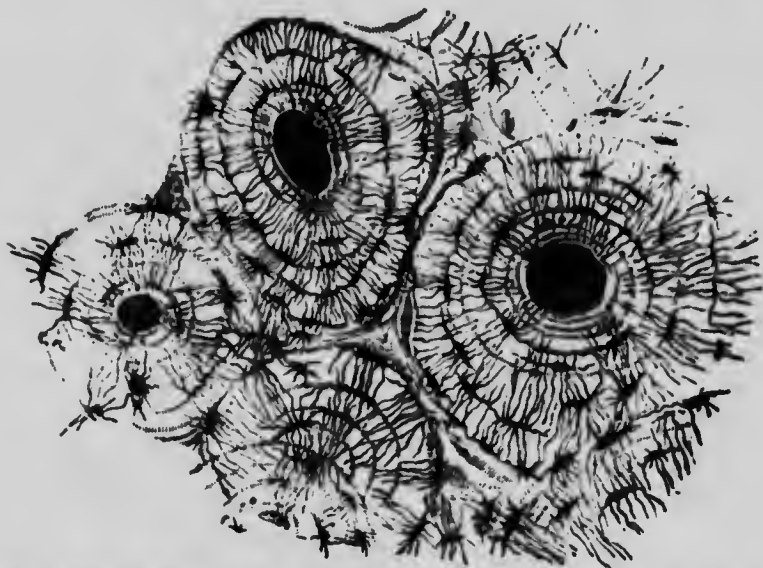

Fig. 83.—Transverse section of compact bony tissue (of humerus). Three of the Haversian canals are seen, with their concentric rings; also the lacunæ, with the canaliculi extending from them across the direction of the lamellæ. The Haversian apertures were filled with air and debris in grinding down the section, and therefore appear black in the figure, which represents the object as viewed with transmitted light. The Haversian systems are so closely packed in this section, that scarcely any interstitial lamellæ are visible.  $\times 150$ . (Sharpey.)

vessels pierce the articular extremities for the supply of the cancellous tissue.

*Microscopic Structure of Bone.*—Notwithstanding the differences of arrangement just mentioned, the structure of all bone is found under the microscope to be essentially the same.

Examined with a rather high power its substance is found to contain a multitude of small irregular spaces, approximately fusiform in shape, called *lacunæ*, with very minute canals or *canaliculi* leading from them, and anastomosing with similar little prolongations from other lacunæ (fig. 83). In very thin layers of bone, no other canals but these may be visible; but on making a transverse section of the compact tissue as of a long

bone, *e.g.*, the humerus or ulna, the arrangement shown in fig. 83 can be seen.

The bone seems mapped out into small circular districts, at or about the centre of each of which is a hole, around which is an appearance as of concentric layers; the *lacunæ* and *canaliculi* follow the same concentric plan of distribution around the small hole in the centre, with which indeed they communicate.

On making a longitudinal section, the central holes are found to be simply the cut extremities of small canals which run lengthwise through the bone, anastomosing with each other by lateral branches (fig. 84); these canals are called *Haversian canals*, after the name of the physician, Clopton Havers, who first accurately described them.

The **Haversian canals**, the average diameter of which is  $\frac{1}{500}$  of an inch, contain blood-vessels, and by means of them blood is conveyed to all, even the densest parts of the bone; the minute canaliculi and lacunæ take up the lymph exuded from the Haversian blood-vessels and convey it to the substance of the bone which they traverse.

The blood-vessels enter the Haversian canals both from without, by traversing the small holes which exist on the surface of all bones beneath the periosteum, and from within by means of small channels which extend from the medullary cavity, or from the cancellous tissue. The arteries and veins usually occupy separate canals, and the veins, which are the larger, often present, at irregular intervals, small pouch-like dilatations.

The *lacunæ* are occupied by branched cells, which are called *bone-cells*, or *bone-corpuscles* (fig. 85), which very closely resemble the ordinary branched connective-tissue corpuscles; each of these little masses of protoplasm ministers to the nutrition of the

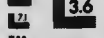

Fig. 84.—Longitudinal section from the human ulna, showing Haversian canal, lacunæ, and canaliculi. (Rollett.)



# MICROCOPY RESOLUTION TEST CHART

(ANSI and ISO TEST CHART No. 2)



**APPLIED IMAGE Inc**

1653 East Main Street  
Rochester, New York 14609 USA  
(716) 482 - 0300 - Phone  
(716) 288 - 5989 - Fax



bone immediately surrounding it, and one lacunar corpuscle communicates with another, and with its surrounding district, and with the blood-vessels of the Haversian canals, by means of the minute streams of fluent nutrient matter or lymph which occupy the canaliculi.

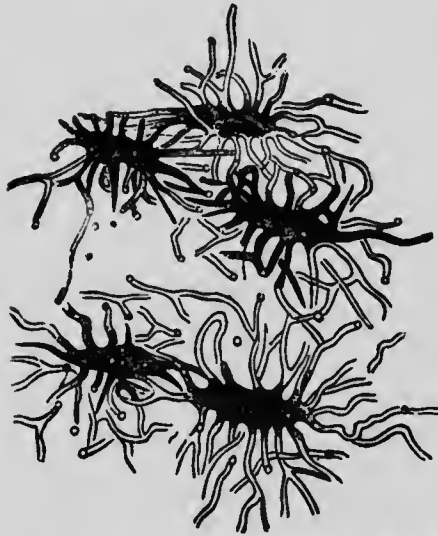

Fig. 85.—Bone-corpuscles with their processes as seen in a thin section of human bone. (Rollett.)

It will be seen from the above description that bone is essentially connective tissue, the ground-substance of which is impregnated with lime salts. The bone-corpuscles with their processes, occupying the lacunæ and canaliculi, correspond exactly to the connective-tissue corpuscles lying in branched spaces.

#### Lamellæ of Compact

**Bone.**—In the shaft of a

long bone three distinct sets of lamellæ can be clearly recognised.

1. *Circumferential lamellæ*; which are most easily traceable just beneath the periosteum, and around the medullary cavity, forming around the latter a series of concentric rings. At a little distance from the medullary and periosteal surfaces (in the deeper portions of the bone) they are more or less interrupted by

2. *Haversian lamellæ*, which are concentrically arranged around the Haversian canals to the number of six to eighteen around each.

3. *Interstitial lamellæ*, which connect the systems of Haversian lamellæ, filling the spaces between them, and consequently attaining their greatest development where the Haversian systems are few, and *vice versa*.

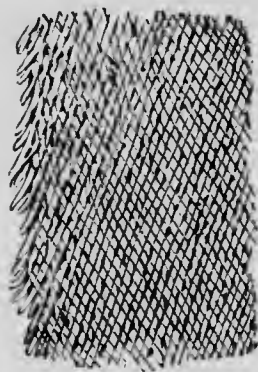

Fig. 86.—Thin layer peeled off from a softened bone. This figure, which is intended to represent the reticular structure of a lamella, gives a better idea of the object when held rather farther off than usual from the eye.  $\times 400$ . (Sharpey.)

The ultimate structure of the lamellæ is fibrous. If a thin film be peeled off the surface of a bone, from which the earthy

matter has been removed by acid, and examined with a high power of the microscope, it will be found composed of very slender fibres decussating obliquely, but coalescing at the points of intersection, as if here the fibres were fused rather than woven together (fig. 86). These are called the *intercrossing fibres of Sharpey*; they correspond to the white fibres of connective tissue and form the source of the gelatin obtained by boiling bone.

In many cases, as in the parietal bone, the lamellæ are perforated by tapering fibres called the *perforating fibres of Sharpey*, resembling in character the ordinary white or rarely the elastic fibrous tissue, which bolt the neighbouring lamellæ together, and may be drawn out when the latter are torn asunder (fig. 87). These perforating fibres originate from ingrowing processes of the periosteum, and in the adult still retain their connection with it.

**Development of Bone.**—From the point of view of their development, all bones may be subdivided into two classes:—

(a.) Those which are ossified directly or from the first in a fibrous membrane afterwards

called the periosteum—*e.g.*, the bones forming the vault of the skull, parietal, frontal, and a certain portion of the occipital bones.

(b.) Those whose form, previous to ossification, is laid down in *hyaline cartilage*—*e.g.*, humerus, femur.

The process of development, pure and simple, may be best studied in bones which are not preceded by cartilage—*i.e.*, *membrane-formed* (*e.g.*, *parietal*); and without a knowledge of this process (ossification in *membrane*), it is impossible to understand the much more complex series of changes through which such a structure as the cartilaginous femur of the fœtus passes in its



Fig. 87.—Lamellæ torn off from a decalcified human parietal bone at some depth from the surface. *a, a*, lamellæ, showing reticular fibres; *b*, darker part, where several lamellæ are superposed; *c*, perforating fibres. Apertures through which perforating fibres had passed, are seen especially in the lower part, *a, a*, of the figure. (Allen Thomson.)



transformation into the bony femur of the adult (ossification in cartilage).

**Ossification in Membrane.**—The membrane, afterwards forming the periosteum, from which such a bone as the parietal is developed, consists of two layers—an external *fibrous*, and an internal *cellular* or *osteo-genetic*.

The external layer is made up of ordinary fibrous tissue. The internal layer consists of a network of fine fibrils with a large number of nucleated cells (*osteoblasts*), some of which are oval, others drawn out into long branched processes: it is more richly supplied with capillaries than the outer layer. It is this portion of the periosteum which is immediately concerned in the formation of bone.

In such a bone as the parietal, ossification is preceded by an increase in the vascularity of this membrane, and then spicules, starting from a *centre of ossification* near the centre of the future bone, shoot out in all directions towards the periphery. These primary bone spicules consist of fibres which are termed *osteo-genetic fibres*; they are composed of a soft transparent substance called *osteogen*, around and between which calcareous granules are deposited. The fibres in their precalcified state are likened to bundles of white fibrous tissue, to which they are similar in chemical composition, but from which they differ in being stiffer and less wavy. The deposited granules after a time become so numerous as to imprison the fibres, and bony spiculæ result. By the junction of the osteo-genetic fibres and their resulting bony spicules a meshwork of bone is formed. The osteo-genetic fibres, which become indistinct as calcification proceeds, persist in the lamellæ of adult bone as the intercrossing fibres of Sharpey. The osteoblasts, being in part retained within the bony layers thus produced, form bone-corpuscles. On the bony trabeculæ first formed, layers of osteoblastic cells from the osteo-genetic layer of the periosteum repeat the process just described; and as this occurs in several thicknesses, and also at the edges of the spicules previously formed, the bone increases, both in thickness, length and breadth. The process is not completed by the time the child is born; hence the fontanelles or still soft places on the heads of infants. Fig. 88 represents a small piece of the growing edge of a parietal bone.

The bulk of the primitive spongy bone is in time converted into compact bone tissue, with Haversian systems. Those portions in the interior not converted into bone become filled with the red marrow of the cancellous tissue.

**Ossification in Cartilage.**—Under this heading, taking the

femur or any other long bone as an example, we have to consider the process by which the solid cartilaginous rod which represents the bone in the fœtus is converted into the hollow cylinder of compact bone with expanded ends formed of cancellous tissue of which the adult bone is made up. We must bear in mind the fact that this fœtal cartilaginous femur is many times smaller than even the medullary cavity of the shaft of the mature bone, and, therefore, that not a trace of the original cartilage can be present

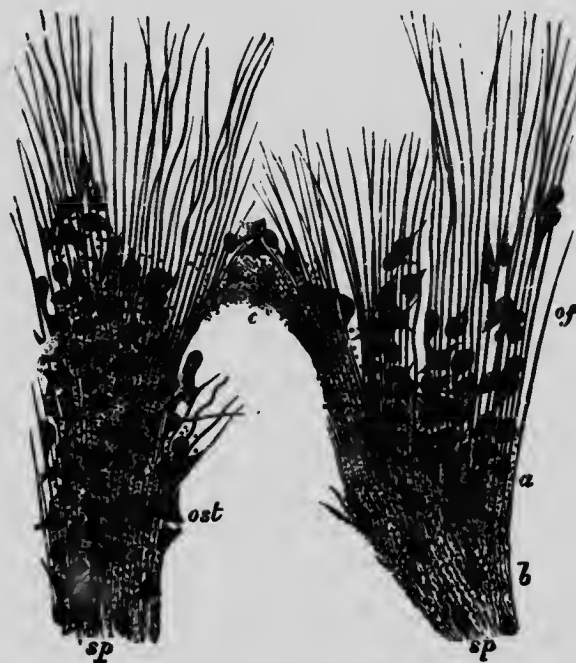

Fig. 88.—Part of the growing edge of the developing parietal bone of a fœtal cat. *sp*, bony spicules with some of the osteoblasts imbedded in them, producing the lacunæ; *of*, osteogenic fibres prolonging the spicules with osteoblasts (*ost*) between them and applied to them. (G. Lawrence.)

in the femur of the adult. Its purpose is indeed purely temporary; and, after its calcification, it is gradually and entirely absorbed.

The cartilaginous rod which forms the precursor of a fœtal long bone is sheathed in a membrane termed the *perichondrium*, which exactly resembles the periosteum described above; it consists of two layers, in the deeper one of which spheroidal and branched cells predominate and blood-vessels abound, while the outer layer consists mainly of fibres.

Between the cartilaginous prefigurement of which the fœtal

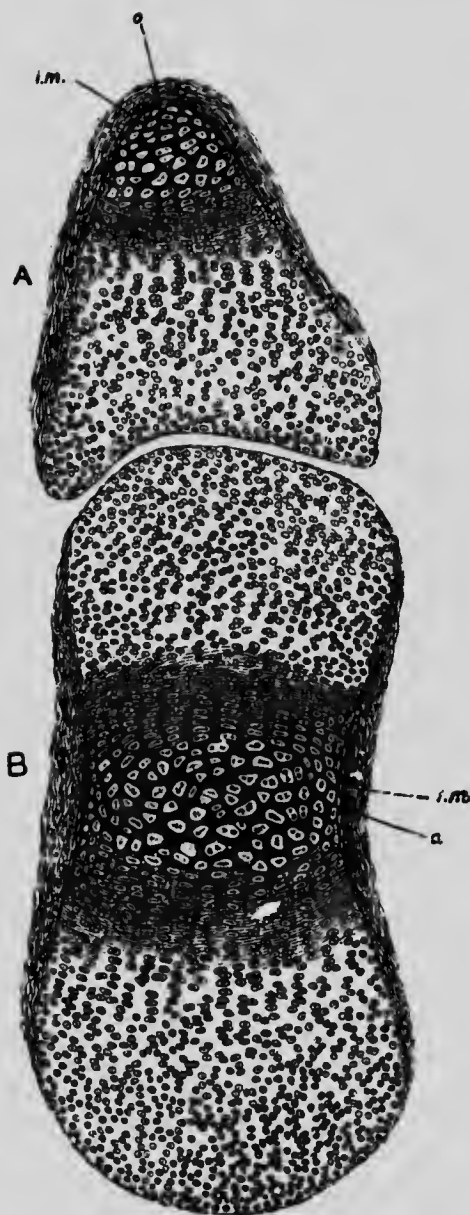

Fig. 89.—Section of two fetal phalanges; the cartilage-cells in the centre of B are enlarged and separated from one another by calcified matrix. *im*, layer of bone deposited under the periosteum. *o*, layer of osteoblasts by which this layer was formed. The rows of cartilage-cells are seen on each side of the centre of calcification. In A, the terminal phalanx, the changes begin at the tip. (After Dixey.)

long bone consists and the adult bone there are several intermediate stages.

The process may, however, be most conveniently described as occurring in three principal stages.

The first stage consists of two sets of changes, one in the cartilage, the other under the perichondrium. These take place side by side. In the cartilage the cells in the middle\* become enlarged and separated from one another. The cartilage-cells on each side get arranged in rows in the direction of the extremities of the cartilaginous rod. If at this stage one cuts the little embryonic bone with a knife, the knife encounters resistance, and there is a sensation of grittiness. This is due to the fact that calcareous particles are deposited in the matrix; and in consequence of this the matrix stains differently with histological reagents from the unaltered matrix. Simultaneously with this, the periosteal tissue is forming layer after layer of true bone; this is formed exactly in the same way as in

\* This is the case in nearly all the long bones, but in the terminal phalanges the change occurs first, not in the middle but at their distal extremities.

such a bone as the parietal; by the agency of the osteoblasts, osteogenic fibres, and then spicules of bone, are formed by deposit of calcareous matter. As the layers are formed, some of the osteoblasts get walled in between the layers, and become bone cells.

In the later part of this stage the calcareous deposit between the cartilage-cells cuts them off from nutrition, and they in con-

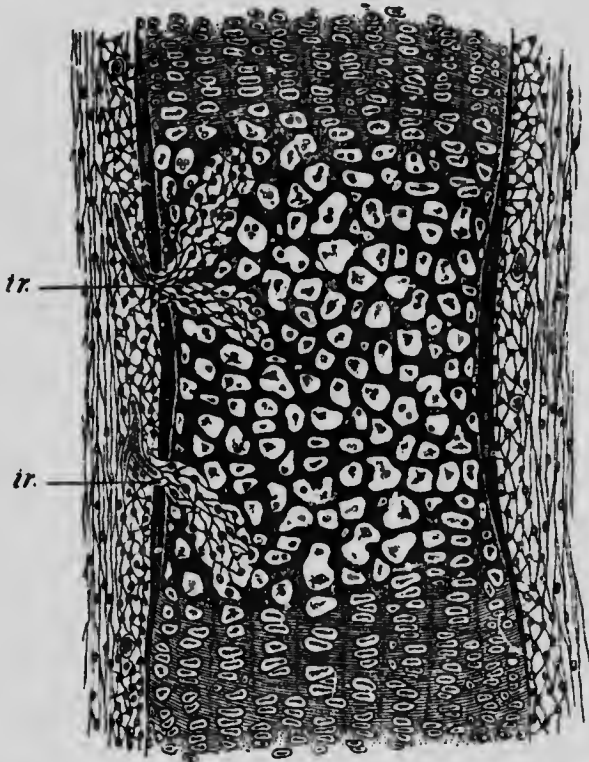

Fig. 90.—Ossification in cartilage showing stage of irruption. The shrunken cartilage-cells are seen in the primary areolæ. At *ir* an irruption of the subperiosteal tissue has penetrated the subperiosteal bony crust. (After Lawrence.)

sequence waste, leaving spaces that are called the *primary areolæ*. The calcareous deposit creeps up between the rows of cartilage-cells, enclosing them in calcified boxes containing one, two, or more cells each. The wasting of the cells leads here also to the formation of primary areolæ.

We may roughly compare the two sets of cells engaged in the process to two races of settlers in a new country. The cartilage cells constitute one race, and so successfully build for themselves calcareous homes as to be completely boxed up; so they waste

and disappear, leaving only the walls of their home enclosing the spaces called primary areolæ. The osteoblasts, the other race of cells under the perichondrium, are forming layers of true bone in that situation. Some, it is true, get walled in in the process, and become bone-corpuscles, but the system of intercommunicating lacunæ and canaliculi maintains their nutrition.

These two races are working side by side, and at first do not interfere with each other. But soon comes a declaration of war, and we enter upon the *second stage* of ossification, which is very appropriately called the *stage of irruption* (fig. 90). Breaches occur in the bony wall which the osteoblasts have built like a girdle round the calcifying cartilage, and through these the perichondrial tissue pours an invading army into the calcified cartilage. This consists of *osteoblasts*, the bone formers; *osteoclasts*, or the bone destroyers; the latter are large cells, similar to the myeloplaxes found in marrow (fig. 82). There are also a few *fibres*, and a store of nutrient supply in the shape of blood-vessels.

Having got inside, the osteoclasts set to work to demolish the homes of the cartilage-cells, the walls of the primary areolæ, and thus large spaces are formed, which are called the *secondary areolæ*, or the *medullary spaces*. On the ruins of the calcified cartilage the osteoblasts proceed to deposit true bone in layers, just as they were wont to do in their own country, under the periosteum.

The *third stage of ossification* is a repetition of these two stages towards the extremities of the cartilage. The cartilage-cells get flattened and arranged in rows; calcareous deposit occurs around these, and primary areolæ result; then follows the advance of the subperiosteal tissue, the demolition of the primary areolæ, the formation of secondary areolæ, and the deposit of true bone. At the same time, layer upon layer is still being deposited beneath the periosteum, and these, from being at first a mere girdle round the waist of the bone, now extend towards its extremities.

The next figure (fig. 91) is a magnified view of the line of advance.

The bone which is first formed is less regularly lamellar than that of the adult. The lamellæ are not deposited till after birth, and their formation is preceded by a considerable amount of absorption. To carry our simile further, the osteoblasts are not satisfied with the rough constructions that they were first able to make, but having exterminated the cartilage, they destroy (again through the agency of the regiment of giant osteoclasts) their first work, and build regular lamellæ, leaving lacunæ for the accommodation of those who desire to retire from active warfare.

About this time, too, the marrow cavity is formed by the absorption of the bony tissue that originally occupied the centre

of the shaft. Here the osteoclasts have again to do the work, and, with this final act of destruction, all remains of any calcified cartilage of the foetal bone entirely disappear.

The formation of a so-called cartilage bone is thus, after all, a formation of bone by subperiosteal tissue, just as it is in the so-called membrane bone.

After a time the cartilage at the ends of the shaft begins to ossify independently, and the epiphyses are formed. They are not joined on to the shaft till late in life, so that growth of the bone in length can continue till union takes place.

Bone grows in width by deposition of layers under the periosteum, like successive rings under the bark of a growing tree. This was shown long before the histological details which we have described were made out by Sharpey. Silver rings were placed by Duhamel around the bones of young pigeons. When killed later, the rings were completely covered in by bone; and in the animals killed last, were even found in the central cavity. Another series of experiments with pigs was made by the celebrated John Hunter. The young animals were fed alternately on ordinary food and food dyed by the red pigment madder. The new bony tissue acts like what dyers called a "mordant": it fixes the dye, and the rings of bone deposited during the madder periods were distinctly red in colour.

The importance of the periosteum in bone formation is now recognised by surgeons. When removing a piece of bone they are careful, if possible, to leave the periosteum behind: this leads to regeneration of the lost bone. If it is absolutely necessary to remove the periosteum, successful cases have occurred in which the living periosteum from an animal has effectively been transplanted.

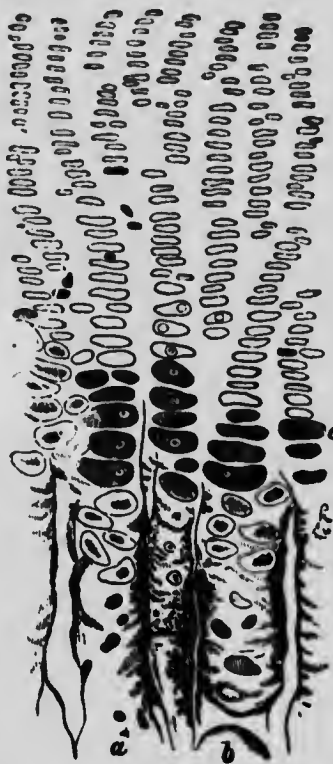

Fig. 91.—Longitudinal section of ossifying cartilage. Calcified trabeculae are seen extending between the columns of cartilage-cells. *c*, cartilage-cells; *a*, *b*, secondary areolae.  $\times 140$ . (Sharpey.)

### The Teeth.

During the course of his life, man, in common with most other mammals, is provided with two sets of teeth; the first set, called the *temporary* or *milk-teeth*, makes its appearance in infancy, and is in the course of a few years shed and replaced by the second or *permanent* set.

The **temporary** or **milk-teeth** have only a very limited term of existence.

They are ten in number in each jaw, namely, on either side from the middle line two *incisors*, one *canine*, and two deciduous *molars*, and are replaced by ten permanent teeth. The number of permanent teeth in each jaw is, however, increased to sixteen by the development of three

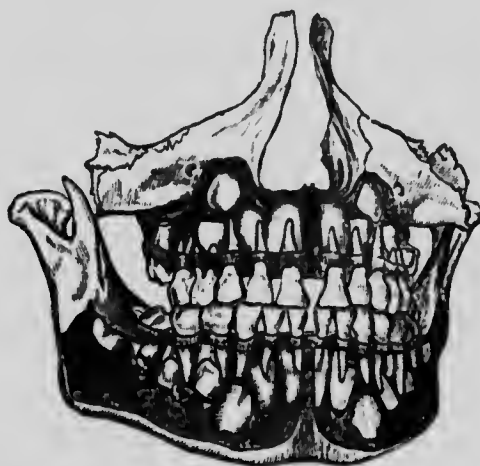

Fig. 92.—Normal well-formed jaws, from which the alveolar plate has been in great part removed, so as to expose the developing permanent teeth in their crypts in the jaws. (Tomes.)

molars on each side of the jaw, which are called the permanent or true molars.

The following formula shows, at a glance, the comparative arrangement and number of the temporary and permanent teeth :—

#### Temporary Teeth.

##### MIDDLE LINE OF JAW.

MOLARS.	CANINE.	INCISORS.	INCISORS.	CANINE.	MOLARS.
2	1	2	2	1	2 = 10
2	1	2	2	1	2 = 10

= 20

#### Permanent Teeth.

##### MIDDLE LINE OF JAW.

TRUE MOLARS.	BICUSPIDS OR PRE- MOLARS.	CANINE.	INCISORS.	INCISORS.	CANINE.	BICUSPIDS OR PRE- MOLARS.	TRUE MOLARS.
3	2	1	2	2	1	2	3
3	2	1	2	2	1	2	3

From this formula it will be seen that the two bicuspid or premolar teeth in the adult are the successors of the two deciduous molars in the child. They differ from them, however, in some respects, the *temporary* molars having a stronger likeness to the *permanent* than to their immediate descendants the so-called bicuspids, besides occupying more space in the jaws.

The temporary incisors and canines differ from their successors but little except in their smaller size and the abrupt manner in which their enamel terminates at the necks of the teeth, forming a ridge or thick edge. Their colour is more of a bluish white than of a yellowish shade.

The following tables show the average times of eruption of the Temporary and Permanent teeth. In both cases the eruption of any given tooth of the lower precedes, as a rule, that of the corresponding tooth of the upper jaw.

#### Temporary or Milk Teeth.

The figures indicate in **months** the age at which each tooth appears.

INCISORS.	DECIDUOUS FIRST MOLARS.	CANINES.	DECIDUOUS SECOND MOLARS.
6	12	18	24

#### Permanent Teeth.

The age at which each tooth is cut is indicated in this table in **years**.

FIRST MOLARS.	INCISORS.		BICUSPIDS OR PRE- MOLARS.		CANINES.	SECOND MOLARS.	THIRD MOLARS OR WISDOMS.
	CENTRALS.	LATERALS.	FIRST.	SECOND.			
6	7	8	9	10	11	12	17 to 25

The times of eruption given in the above tables are only approximate: the limits of normal variation are tolerably wide. Certain diseases affecting the bony skeleton, *e.g.*, Rickets, retard the eruptive period considerably.

It is important to notice that it is a molar which is the first tooth to be cut in the permanent dentition, not an incisor as in the case of the temporary set, and also that it appears *behind* the last deciduous molar on each side.

The third molars, often called *Wisdoms*, are sometimes unerupted through life from want of sufficient jaw space and the presence of



the other teeth; cases of whole families in which their absence is a characteristic feature are occasionally met with.

When the teeth are fully erupted it will be observed that the upper incisors and canines project obliquely over the lower front teeth and the external cusps of the upper bicuspid and molars lie outside those of the corresponding teeth in the lower jaw. This arrangement allows to some extent of a scissor-like action in dividing and biting food in the case of incisors; and a grinding motion in that of the bicuspid and molars when the side to side movements of the lower jaw bring the external cusps of the lower teeth into direct articulation with those of the upper, and then cause them to glide down the inclined surfaces of the external and up the internal cusps of these same upper teeth during the act of mastication.

The work of the canine teeth in man is similar to that of his incisors. Besides being a firmly implanted tooth and one of stronger substance than the others, the canine tooth is important in preserving the shape of the angle of the mouth, and by its shape, whether pointed or blunt, long or short, it becomes a character tooth of the dentition as a whole in both males and females.

Another feature in the fully developed and properly articulated set of teeth is that no two teeth oppose each other or, but each tooth is in opposition with two, except the upper Wisdom, usually a small tooth. This is the result of the greater width of the upper incisors, which so arranges the "bite" of the other teeth that the lower canine closes in front of the upper one.

Should a tooth be lost, therefore, it does not follow that its former opponent remaining in the mouth is rendered useless and thereby liable to be removed from the jaw by a gradual process of extrusion commonly seen in teeth that have no work to perform by reason of absence of antagonists.

### Structure of a Tooth.

A tooth is generally described as possessing a *crown*, *neck*, and *root*.

The *crown* is the portion which projects beyond the level of the gum. The *neck* is that constricted portion just below the crown which is embraced by the free edges of the gum, and the *root* includes all below this.

On making longitudinal and transverse sections through its centre (figs. 93, 94), a tooth is found to be composed of a hard

material, *dentine* or ivory, which is moulded around a central cavity which resembles in general shape the outline of the tooth; the

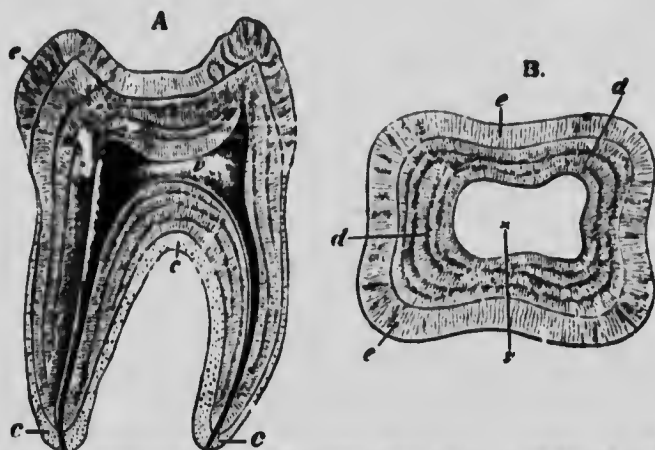

Fig. 93.—A. Longitudinal section of a human molar tooth; *c*, cement; *d*, dentine; *e*, enamel; *v*, pulp-cavity. (Owen.)  
 B. Transverse section. The letters indicate the same as in A.

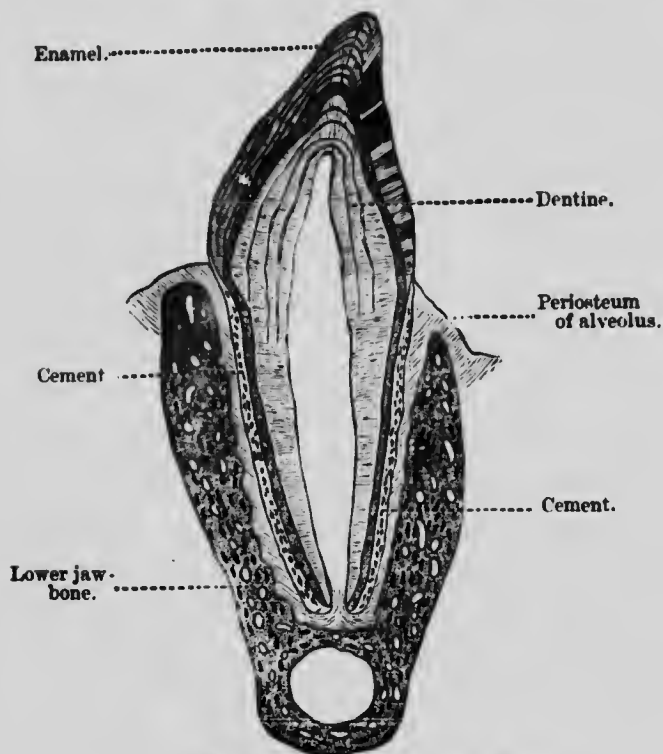

Fig. 94.—Premolar tooth of cat *in situ*.

cavity is called the *pulp* cavity from its containing the very vascular and sensitive pulp.

The *tooth-pulp* is composed of loose connective tissue, blood-vessels, nerves, and large numbers of cells of varying shapes, *e.g.*, fusiform, stellate, and on the surface in close connection with the dentine a specialised layer of cells called *odontoblasts*, which are elongated columnar-looking cells with a large nucleus at the tapering ends farthest from the *dentine*.

The blood-vessels and nerves enter the pulp through a small opening at the apical extremity of each root. The exact terminations of the nerves are not definitely known. They have never

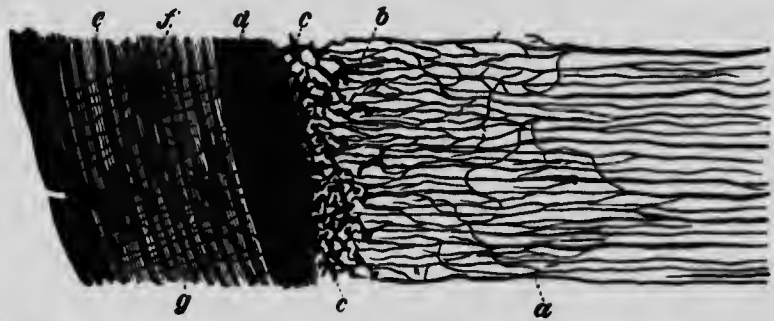

Fig. 95.—Section of a portion of the dentine and cement from the middle of the root of an incisor tooth. *a*, dentinal tubules ramifying and terminating, some of them in the interglobular spaces *b* and *c*; *d*, inner layer of the cement with numerous closely set canaliculi; *e*, outer layer of cement; *f*, lacunæ; *g*, canaliculi.  $\times 350$ . (Kölliker.)

been observed to enter the dentinal tubes. No lymphatics have been seen in the pulp.

A layer of very hard calcareous matter, the *enamel*, caps that part of the dentine which projects beyond the level of the gum; while sheathing the portion of dentine which is beneath the level of the gum, is a layer of true bone, called the *cement* or *crusta petrosa*.

At the neck of the tooth, where the enamel and cement come into contact, each is reduced to an exceedingly thin layer; here the cement overlaps the enamel and is prolonged over it. On the surface of the crown of the tooth, when it first comes through the jaw, is a thin membrane called *Nasmyth's membrane*, or the *cuticle* of the tooth. The covering of enamel becomes thicker towards the crown, and the cement towards the lower end or apex of the root.

#### *Dentine or Ivory.*

*Chemical composition.*—Dentine closely resembles bone in chemical composition. It contains, however, rather less animal

matter; the proportion in a hundred parts is about twenty-eight *animal* to seventy-two of *earthy* matter. The former, like the animal matter of bone, may be converted into *gelatin* by boiling. It also contains a trace of fat. The earthy matter is made up chiefly of *calcium phosphate*, with a small portion of the *carbonate*, and traces of *calcium fluoride* and *magnesium phosphate*.

*Structure.*—Under the microscope dentine is seen to be finely channelled by a multitude of delicate tubes, which by their inner ends communicate with the pulp-cavity, and by their outer extremities come into contact with the under part of the enamel and cement, and sometimes even penetrate them for a greater or less distance (figs. 95, 97). The matrix in which these tubes lie is

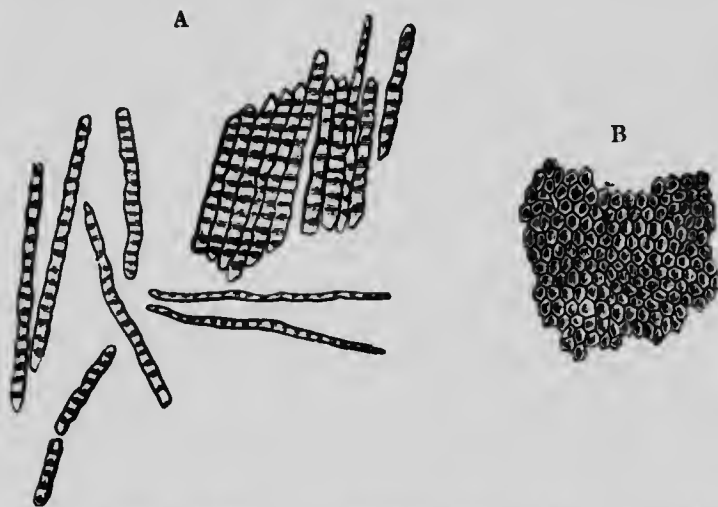

Fig. 96.—Enamel prisms. A, fragments and single prisms of the transversely-striated enamel, isolated by the action of hydrochloric acid. B, surface of a small fragment of enamel, showing the hexagonal ends of the fibres with darker centres.  $\times 350$ . (Kölliker.)

composed of “a reticulum of fine fibres of connective tissue modified by calcification, and where that process is complete, entirely hidden by the densely deposited lime salts” (Mummery).

In their course from the pulp-cavity to the surface, the minute tubes form gentle and nearly parallel curves and divide and subdivide dichotomously, but without much lessening of their calibre until they approach their peripheral termination.

From their sides proceed other exceedingly minute secondary canals, which extend into the dentine between the tubules and anastomose with each other. The tubules of the dentine, the average diameter of which at their inner and larger extremity is  $\frac{1}{4500}$  of an inch, contain fine prolongations from the tooth-pulp,

which give the dentine a certain faint sensitiveness under ordinary circumstances and, without doubt, have to do also with its nutrition. These prolongations from the tooth-pulp are processes of the dentine-cells or *odontoblasts* which are columnar cells lining the pulp-cavity; the relation of these processes to the tubules in which they lie is precisely similar to that of the processes of the bone-corpuscles to the canaliculi of bone. The outer portion of the dentine, underlying the cement, and the enamel to a much lesser degree, forms a more or less distinct layer termed the *granular* or *interglobular* layer (fig. 95). It is characterised by the presence of a number of irregular minute cell-like cavities. The explanation of these will be seen when we study the development of a tooth.



Fig. 97.—Thin section of the enamel, and a part of the dentine. *a*, cuticular pellicle of the enamel (Nasmyth's membrane); *b*, enamel columns with fissures between them and cross striae; *c*, larger cavities in the enamel, communicating with the extremities of some of the dentinal tubules (*d*).  $\times 350$ . (Kölliker.)

#### Enamel.

*Chemical composition.* — The *enamel*, which is by far the hardest tissue in the body, is composed of the same inorganic compounds that enter into the composition of dentine and bone. Its animal matter, however, amounts only to about 2 or 3 per cent., and does not yield gelatin on boiling. According to Tomes it contains no animal matter at all. Gelatin is a characteristic product of connective tissue, and enamel is not a connective tissue, but is epithelial in origin.

Examined under the microscope, enamel is found composed of six-sided prisms (figs. 96, 97)  $\frac{1}{5000}$  of an inch in diameter, which are set on end on the surface of the dentine, and fit into corresponding depressions in the same.

They radiate in such a manner from the dentine that at the top of the tooth they are more or less vertical, while towards the sides they tend to the horizontal direction. Like the dentine tubules, they are not straight, but disposed in wavy and parallel curves. The prisms are marked by transverse lines and are solid.

The enamel prisms are connected together by a very minute

quantity of hyaline cement substance. In the deeper part of the enamel, between the prisms, are often small *lacunæ*, which have the processes or fibrils lying in the dentinal tubes in connection with them (fig. 97; c).

#### *Crusta Petrosa.*

The *crusta petrosa*, or *cement* (fig. 95, e, d), is composed of true bone, and in it are *lacunæ* (f) and *canaliculi* (g), which sometimes communicate with the outer finely branched ends of the dentinal tubules, and generally with the interglobular spaces. Its laminae are bolted together by perforating fibres like those of ordinary bone (Sharpey's fibres). Cement differs from ordinary bone in possessing no Haversian canals, or, if at all, only in the thickest part. Such canals are more often met with in teeth with the cement hypertrophied than in the normal tooth.

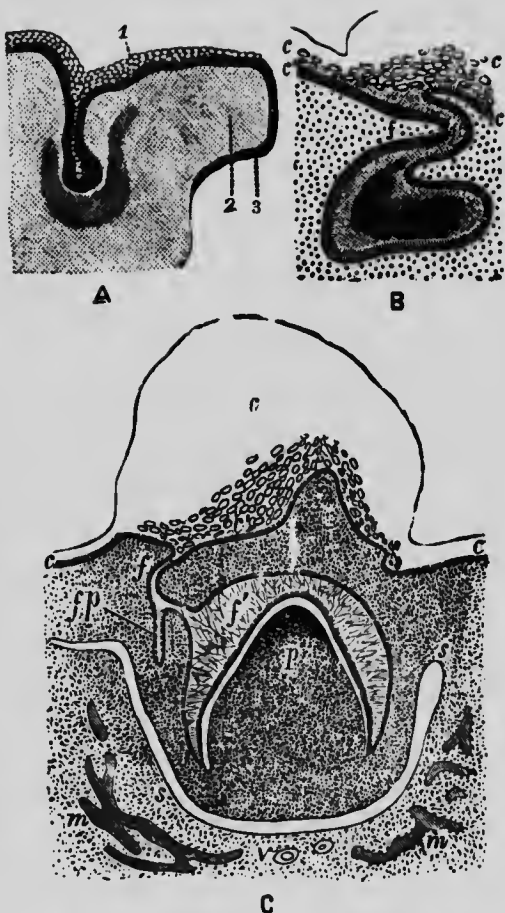

Fig. 98.—Section of the upper jaw of a foetal sheep. A.—1, common enamel germ dipping down into the mucous membrane; 2, palatine process of jaw; 3, Rete Malpighi. B.—Section similar to A, but passing through one of the special enamel germs here becoming flask-shaped; c, c', epithelium of mouth; f, neck; f', body of special enamel germ. C.—A later stage; c, outline of epithelium of gum; f, neck of enamel germ; f', enamel organ; p, papilla; s, dental sac forming; fp, the enamel germ of permanent tooth; m, bone of jaw; v, vessels cut across. (Waldeyer and Kölliker.)

#### Development of the Teeth.

The first step in the development of the teeth consists in a downward growth (fig. 98, A, 1) from the deeper layer of stratified epithelium of the mucous membrane of the mouth, which first

becomes thickened in the neighbourhood of the maxillæ or jaws now in the course of formation. This process passes downward into a recess of the imperfectly developed tissue of the embryonic jaw. The downward epithelial growth forms the *common enamel* or *dental germ*, and its position is indicated by a slight groove in the mucous membrane of the jaw. The next step in the process consists in the elongation downward of the enamel groove and of the enamel germ and the inclination outward of the deeper part (fig. 98, B, *f'*), which is now inclined at an angle with the upper portion or neck (*f*), and has become bulbous. After this there is an increased development at certain points corresponding to the situations of the future milk-teeth. The common enamel germ thus becomes extended by further growth into a number



Fig. 99.—Part of section of developing tooth of a young rat, showing the mode of deposition of the dentine. Highly magnified. *a*, outer layer of fully formed dentine; *b*, uncalcified matrix with one or two nodules of calcareous matter near the calcified parts; *c*, odontoblasts sending processes into the dentine; *d*, pulp; *e*, fusiform or wedge-shaped cells found between odontoblasts; *f*, stellate cells of pulp in fibrous connective tissue. The section is stained with carmine, which colours the uncalcified matrix but not the calcified part. (E. A. Schäfer.)

of special enamel germs corresponding to each of the above-mentioned milk-teeth, and connected to the common germ by a narrow neck. Each tooth is thus placed in its own special recess in the embryonic jaw (fig. 98, B, *ff'*).

As these changes proceed, there grows up from the underlying connective tissue into each enamel germ (fig. 98, *c*, *p*), a distinct vascular *papilla* (*dental papilla*), and upon it the enamel germ becomes moulded, and presents the appearance of a cap of

two layers of epithelium separated by an interval (fig. 98, *c*, *f'*). Whilst part of the subepithelial tissue is elevated to form the dental papilla, the part which bounds the embryonic teeth forms the dental sac (fig. 98, *c*, *s*); and the rudiment of the jaw sends up processes forming partitions between the teeth. In this way small chambers are produced in which the dental sacs are contained, and thus the sockets of the teeth are formed. The papilla is composed of nucleated cells arranged in a mesh-work, the outer or peripheral part being covered with a layer of columnar nucleated cells called *odontoblasts*. The odontoblasts form the dentine, while the remainder of the papilla forms the tooth-pulp.

The method of the formation of the dentine by the odontoblasts is given in Quain's Anatomy as follows:—

These cells either by secretion, or as some think by direct transformation of the outer part of each, form a layer of dentinal matrix on the apex of the papilla, or if the tooth has more than one cusp, then at the apex of each cusp. This layer is first uncalcified (*odontogen*), but globules of calcareous matter soon appear in it. These,

becoming more numerous, blend into the first cap of dentine. In the meanwhile the odontoblasts have formed a second layer of odontogen within this (fig. 99), and this in turn becomes calcified; thus layer after layer is formed, each extending laterally further than its predecessor; the layers blend except in some places; here portions of odontogen remain, which in a tooth macerated for histological purposes get destroyed, and appear as the *interglobular spaces* (fig. 95), so called because bounded by the deposit of calcareous salts, which occurs, as we have already seen, in the form of globules.

As the odontoblasts retire towards the centre, depositing layer after layer of dentine, they leave behind them long filaments of their protoplasm around which the calcareous deposit is moulded; thus the dentinal tubules occupied by the processes of the odontoblasts are formed.

The other cells of the dental papilla form the cells of the pulp.

*Formation of the enamel.*—The portion of the enamel or dental germ that covers the dental papilla is at this stage called the *enamel organ*. This consists of four parts (see figs. 100 and 101).

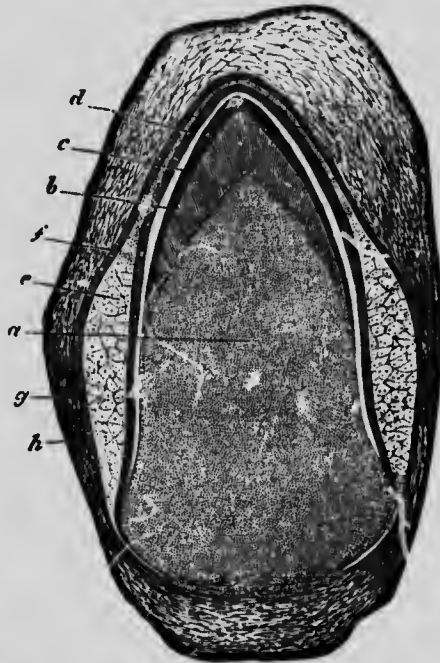

Fig. 100.—Vertical transverse section of the dental sac, pulp, &c., of a kitten. *a*, dental papilla or pulp; *b*, the cap of dentine formed upon the summit; *c*, its covering of enamel; *d*, inner layer of epithelium of the enamel organ; *e*, gelatinous tissue; *f*, outer epithelial layer of the enamel organ; *g*, inner layer, and *h*, outer layer of dental sac.  $\times 14$ . (Thiersch.)



1. A layer of columnar epithelium cells in contact with the dentine. These are called the *enamel cells*, or *adamantoblasts*.
2. Two or three layers of smaller polyhedral nucleated cells the *stratum intermedium* of Hannover.

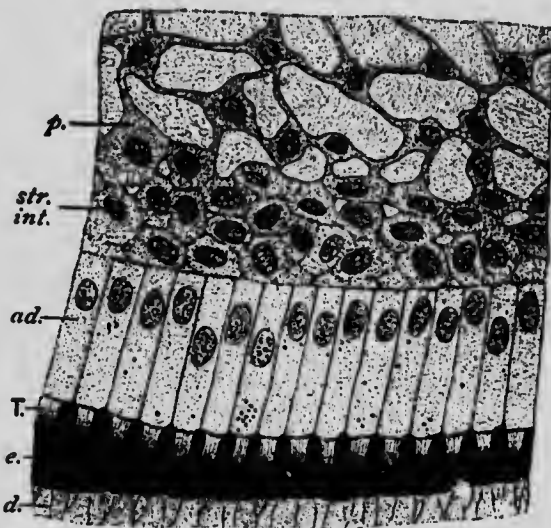

Fig. 101.—Highly magnified view of a piece of the enamel organ in a kitten's canine. *d*, superficial layer of dentine. *e*, newly formed enamel stained black by osmic acid. *T*, Tomes' processes from the adamantoblasts, *ad.*; *str. int.*, stratum intermedium of the enamel organ. *p*, branched cells of the enamel pulp. (After Röse.)

3. A matrix of non-vascular jelly-like tissue containing stellate cells.
4. An outer membrane of several layers of flattened epithelium cells.

The first three layers on an enlarged scale are seen in fig.

101.  
The enamel prisms are formed by the agency of the ends of the adamantoblasts which abut on the dental papilla. Each forms a fine deposit of globules staining with osmic acid and resembling keratin in its resistance to mineral acid. At one time it was believed that each adamantoblast was itself calcified and converted into an enamel prism, but this view has been disproved by recent research. The layer of keratin-like material is outside the bodies of the cells, although a process of each adamantoblast extends into it as a tapering fibre (process of Tomes), and it is usually produced simultaneously with the first layer of uncalcified dentine; when it undergoes calcification, the first layer of enamel is complete. The adamantoblasts then

repeat the process, first causing a deposition of keratin-like material, and this in turn is calcified, and so on. During the formation of layer after layer of enamel, the adamantoblasts retire. By the time the enamel is approaching completion the other layers of the enamel organ have almost disappeared, and they entirely disappear when the tooth emerges through the gum. But for some little time there is a somewhat more persistent membrane covering the crown; this is Nasmyth's membrane, or the *enamel cuticle*; this is the last formed keratinous layer of enamel which has remained uncalcified.

As with the dentine, the formation of enamel appears first on the apex of each cusp.

The *cement* or *crusta petrosa* is formed from the internal tissue of the tooth sac, the structure and function of which are identical with those of the osteogenetic layer of the periosteum; or, in other words, ossification in membrane occurs in it.

The outer layer or portion of the membrane of the tooth sac forms the *dental periosteum*.

This periosteum, when the tooth is fully formed, is not only a means of attachment of the tooth to its socket, but also in conjunction with the *pulp* a source of nourishment to it. Additional laminae of cement are added to the root from time to time during the life of the tooth (as is especially well seen in the abnormal condition called an *exostosis*), by the process of ossification taking place in the periosteum. On the other hand, absorption of the root (such as occurs when the milk-teeth are shed) is due to the action of the osteoclasts of the same membrane.

In this manner the first set of teeth, or the milk-teeth, are formed; and each tooth, as it grows, presses at length on the wall of the sac enclosing it, and, causing its absorption, is cut, to use a familiar phrase.

The *temporary* or *milk-teeth* are later replaced by the growth of the permanent teeth, which push their way up from beneath them.

Each temporary tooth is replaced by a tooth of the permanent set which is developed from a small sac which was originally an offshoot from the sac of the temporary tooth which precedes it, and called the *cavity of reserve* (fig. 98, c, *fp*). Thus the temporary incisors and canines are succeeded by the corresponding permanent ones, the temporary first molar by the first bicuspid; the temporary second molar develops two offshoots, one for the second bicuspid, the other for the permanent first molar. The permanent second molar is budded off from the first permanent molar, and the wisdom from the permanent second molar.

The development of the temporary teeth commences about the sixth week of intra-uterine life, after the laying down of the bony structure of the jaws. Their permanent successors begin to form about the sixteenth week of intra-uterine life. The second permanent molars originate about the third month after birth, and the wisdom teeth about the third year.

### The Blood.

A full consideration of the blood will come later, when we know more about the chemical aspects of physiology, but it will be impossible to discuss all the other phenomena we shall have to study in the meanwhile without some elementary knowledge of the principal properties of this fluid. For that reason, and also to complete our list of the connective tissues, we may here rapidly and briefly enumerate its principal characters.

The blood is a fluid which holds in suspension large numbers of solid particles which are called the *corpuscles*. The fluid itself is called the *plasma* or *liquor sanguinis*. It is a richly albuminous fluid; and one of the proteids in it is called *fibrinogen*.

After blood is shed it rapidly becomes viscous, and then sets into a jelly. The jelly contracts and squeezes out of the clot a straw-coloured fluid called *serum*, in which the shrunken clot then floats.

The formation of threads of a solid proteid called *fibrin* from the soluble proteid we have called *fibrinogen* is the essential act of coagulation; this, with the corpuscles it entangles, is called the *clot*. Serum is plasma *minus* fibrin. The following scheme shows the relationships of the constituents of the blood at a glance:—

		{ Serum	
Blood	{ Plasma	{ Fibrin	
	{ Corpuscles	} Clot.	

The corpuscles are of two chief kinds, the red and the white. The white corpuscles are typical animal cells, and we have already made their acquaintance when speaking about amœboid movements.

The red corpuscles are much more numerous than the white, averaging in man 5,000,000 per cubic millimetre, or 400 to 500 red to each white corpuscle. It is these red corpuscles that give the red colour to the blood. They vary in size and structure in

different groups of the vertebrates. In mammals they are biconcave (except in the camel tribe, where they are biconvex) non-nucleated discs, in man  $\frac{1}{3200}$  inch in diameter; during foetal life nucleated red corpuscles are, however, found. In birds, reptiles, amphibians and fishes they are biconvex oval discs with a nucleus: they are largest in the amphibia. The most important and abundant of the constituents of the red corpuscles is the pigment which is called *hæmoglobin*. This is a proteid-like substance, but is remarkable as it contains a small amount of iron (about 0.4 per cent.).

The blood during life is in constant movement. It leaves the heart by the vessels called *arteries*, and returns to the heart by the vessels called *veins*; the terminations of the arteries and the commencements of the veins are, in the tissues, connected by the thin-walled microscopic vessels called *capillaries*. In the capillaries, leakage of the blood-plasma occurs; this exuded fluid carries nutriment from the blood to the tissue-elements, and removes from them the waste products of their activity. The lymph is collected by lymphatic vessels, which converge to the main lymphatic, called the *thoracic duct*. This opens into the large veins near to their entrance into the heart; and thus the lymph is returned to the blood.

But blood is also a carrier of oxygen, and it is the pigment hæmoglobin which is the oxygen carrier; in the lungs the hæmoglobin combines with the oxygen of the air, and forms a loose compound of a bright scarlet colour called *oxyhæmoglobin*. This arterial or oxygenated blood is taken to the heart and thence propelled by the arteries all over the body, where the tissues take the respiratory oxygen from the hæmoglobin, and this removal of oxygen changes the colour of blood to the bluish-red tint it has in the veins. The veins take the blood *minus* a large quantity of oxygen and *plus* a large quantity of carbonic acid received in exchange from the tissues to the heart, which sends it to the lungs to get rid of its surplus carbonic acid, and replenish its store of oxygen; then the same round begins over again.

## CHAPTER VI.

## MUSCULAR TISSUE.

MUSCLE is popularly known as flesh. It possesses the power of contraction, and is, in the higher animals, the tissue by which their movements are executed. The muscles may be divided from a physiological standpoint into two great classes, the *voluntary* muscles, those which are under the control of the will, and the *involuntary* muscles, those which are not. The contraction of the involuntary muscles is, however, controlled by the nervous system, only by a different part of the nervous system from that which controls the activity of the voluntary muscles.

When muscular tissue is examined with the microscope, it is seen to be made up of small elongated thread-like structures, which are called *muscular fibres*; these are bound into bundles by connective tissue, and in the involuntary muscles there is in addition a certain amount of cement substance, stainable by nitrate of silver, between the fibres.

The muscular fibres are not all alike; those of the voluntary muscles are seen by the microscope to be marked by alternate dark and light stripings or striations; these are called *transversely striated muscular fibres*. The involuntary fibres have not got these markings as a rule. There is one important exception to this rule, namely, in the case of the heart, the muscular fibres of which are involuntary, but transversely striated. There are, however, histological differences between cardiac muscle and the ordinary voluntary striated muscles. The unstriated involuntary muscular fibres found in the walls of the stomach, intestine, bladder, blood-vessels, uterus, and other contractile organs are generally spoken of as *plain muscular fibres*.

From the histological standpoint there are, therefore, three varieties of muscular fibres found in the body of the higher animals: two of them are transversely striated, and one is not. The relationship of this histological classification to the physiological classification into voluntary and involuntary is shown in the following table:—

- |  |                |
|--|----------------|
| 1. Transversely striated muscular fibres : |                |
| <i>a.</i> In skeletal muscle . . . . .     | VOLUNTARY.     |
| <i>b.</i> In cardiac muscle . . . . .      |                |
| 2. Plain muscular fibres :                 |                |
| In blood-vessels, intestine, uterus,       | } INVOLUNTARY. |
| bladder, etc. . . . .                      |                |

All kinds of muscular tissue are therefore composed of fibres, but the fibres are essentially different from those we have hitherto studied in the connective tissues. There, it will be remembered, the fibres are developed between the cells; here, in muscle, the fibres are developed from the cells; that is, the cells themselves become elongated to form the muscular fibres

### Voluntary Muscle.

The voluntary muscles are those which are sometimes called *skeletal*, constituting the whole of the muscular apparatus attached to the bones.\*

Each muscle is enclosed in a sheath of areolar tissue, called the *Epimysium*; this sends in partitions, or *septa*, dividing off the



Fig. 102.—A branched muscular fibre from the frog's tongue. (Kölliker.)

fibres into *fasciculi*, or bundles; the sheath of each bundle may be called the *Perimysium*. Between the individual fibres is a small amount of loose areolar tissue, called the *Endomysium*. The blood-vessels and nerves for the muscle are distributed in this areolar tissue.

The fibres vary in thickness and length a good deal, but the average  $\frac{1}{800}$  inch in diameter, and about 1 inch in length. The fibre is cylindrical in shape, with rounded ends; many become prolonged into tendon bundles (fig. 111), by which the muscle is attached to bone. As a rule they are unbranched, but the muscle fibres of the face and tongue divide into numerous branches before being inserted to the under surface of the skin, or mucous membrane (fig. 102). The fibres in these situations are also finer than in the majority of the voluntary muscles.

Each fibre consists of a sheath, called the *sarcolemma*, enclosing

\* The muscular fibres of the pharynx, part of the oesophagus, and of the muscles of the internal ear, though not under the control of the will, have the same structure as the voluntary muscular fibres.

a soft material called the *contractile substance*. The sarcolemma is homogeneous, elastic in nature, and especially tough in fish and amphibia. It may readily be demonstrated in a microscopic preparation of fresh muscular fibres by applying gentle pressure to the cover slip; the contractile substance is thereby ruptured, leaving the sarcolemma bridging the space (fig. 103). To the sarcolemma are seen adhering some nuclei.

The contractile substance within the sheath is made up of alternate discs of dark and light substance.

Muscular fibres contain oval nuclei. In mammalian muscle these are situated just beneath the sarcolemma; but in frog's muscle they occur also in the thickness of the muscular fibre.



Fig. 103.—Muscular fibre torn across, the sarcolemma still connecting the two parts of the fibre. (Todd and Bowman.)

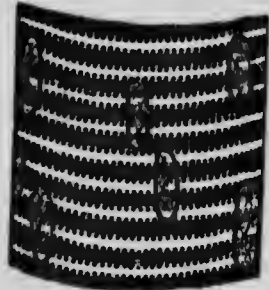

Fig. 104.—Muscular fibre of a mammal highly magnified. The surface of the fibre is accurately focussed. (Schäfer.)

The chromoplasm of the nucleus has generally a spiral arrangement, and often there is a little granular protoplasm (well seen in the muscular fibres of the diaphragm) around each pole of the nucleus.

The foregoing facts can be made out with a low power of the microscope; on examining muscular fibres with a high power other details can be seen. Treatment with different reagents brings out still further points of structure. These are differently described and differently interpreted by different histologists; and perhaps no subject in the whole of microscopic anatomy has been more keenly debated than the structure of a muscular fibre, and the meaning of the changes that occur when it contracts. A good deal of the difficulty has doubtless arisen from the fact that a muscular fibre is cylindrical, and if one focusses the surface one gets different optical effects from those obtained by focussing deep in the substance of the fibre. I shall, in the following account of the intimate structure of striated muscle, adhere very closely to the writings of Professor Schäfer.

If the surface is carefully focussed rows of apparent granules are seen lying at the boundaries of the light streaks, and fine longitudinal lines passing through the dark streaks may be detected uniting the apparent granules (fig. 104).

In specimens treated with dilute acids or gold chloride, the granules are seen to be connected side by side, or transversely also. This reticulum (fig. 105), with its longitudinal and transverse meshes, was at one time considered to be the essential contractile portion of the muscular fibre; it was thought that on contraction

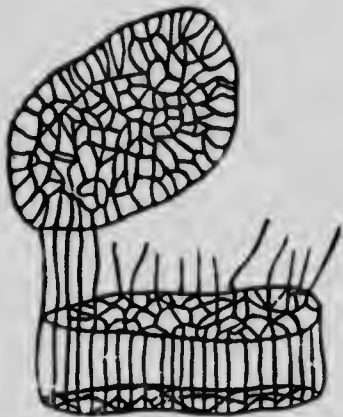

Fig. 105.—Portion of muscle-fibre of water-beetle, showing network very plainly. One of the transverse networks is split off, and some of the longitudinal bars are shown broken off. (After Melland.)

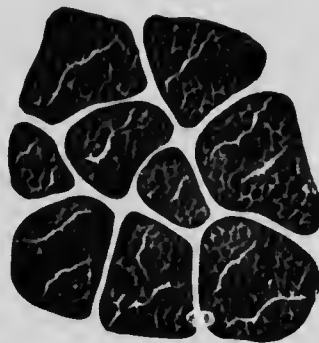

Fig. 106.—Transverse section through muscular fibres of human tongue. The nuclei are deeply stained, situated at the inside of the sarcolemma. Each muscle fibre shows "Cohnheim's areas."  $\times 450$ . (Klein and Noble Smith.)

the transverse networks, with their enlargements, the granules, became increased by the longitudinal strands diminishing in length and running into them. Most histologists have rejected this idea, and regard the network as mere interstitial substance lying between the essentially contractile portions of the muscle. A muscular fibre is thus made up of what are variously called *fibrils*, *muscle-columns* or *sarcostyles*; and the longitudinal interstitial substance with cross networks comprising the reticulum just referred to is called *sarcoplasm*. By the use of certain reagents, such as osmic acid or alcohol, the muscle-columns or sarcostyles may be completely separated from one another.

A transverse section of a muscular fibre (fig. 106) shows the sections of these sarcostyles; the interstitial sarcoplasm is represented as white in the drawing. The angular fields separated by sarcoplasm may still be called by their old name, *areas of Cohnheim*.



If, instead of focussing the surface of a fibre, it is observed in its depth, a fine dotted line is seen bisecting each light stripe; this has been variously termed *Dobie's line*, or *Krause's membrane* (fig. 107). At one time this was believed to be an actual membrane continuous with the sarcolemma. It is probably very largely an optical effect, caused by light being transmitted between discs of different refrangibility.

If cross membranes do exist they are not very resistant; this was well shown by an accidental observation first made by Kühne,

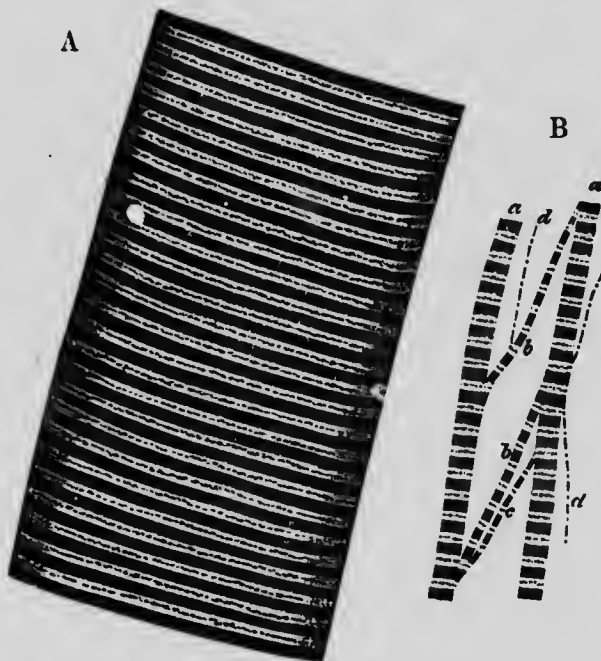

Fig. 107.—A. Portion of a medium-sized human muscular fibre.  $\times 800$ . B. Separated bundles of fibrils equally magnified *a, a*, larger, and *b, b*, smaller collections; *c*, still smaller; *d, d*, the smallest which could be detached, possibly representing a single series of sarcois elements. (Sharpey.)

and subsequently seen by others. A minute thread-worm, called the *Myorectes*, was observed crawling up the interior of the contractile substance of a muscle fibre; it crawled without any opposition from membranes, and the track it left, closed up slowly behind it without interfering with the normal cross-striations of the contractile substance. This observation strikingly illustrates the fact that the contractile substance in a muscular fibre is fluid, but only semi-fluid, for the closing of the thread-worm's track occurred slowly as a hole always closes in a viscous material.

Another appearance which is sometimes seen is a fine clear line

running across the fibre in the middle of each dark band. It is called *Hensen's line*.

A muscular fibre may not only be broken up into fibrils or muscle-columns, but under the influence of some reagents like dilute hydrochloric acid, it can be broken up into discs, the cleavage occurring in the centre of each light stripe. Bowman, the earliest to study muscular fibres with profitable results, concluded that the subdivision of a fibre into fibrils was a phenomenon of the same kind as the cross cleavage into discs. He considered that both were artificially produced by a separation in one or the other direction of particles of the fibre he called "sarcous elements." The cleavage into discs is however much rarer than the separation into fibrils; indeed, indications of the fibrils are seen in perfectly fresh muscle before any reagent has been added, and this is markedly evident in the wing muscles of many insects. It is now believed that a muscular fibre is built up of contiguous fibrils or sarcostyles, while cleavage into discs is a purely artificial phenomenon.

Haycraft, who has also investigated the question of muscular structure, has arrived at the conclusion that the cross striation is entirely due to optical phenomena. The sarcostyles are varicose, and where they are enlarged different refractive effects will be produced from those caused by the intermediate narrow portions. This view he has very ingeniously supported by taking negative casts of muscular fibres by pressing them on to the surface of collodion films. The collodion cast shows alternate dark and light bands like the muscular fibres.

Schäfer is unable to accept this view; he regards the substance of the sarcostyle in its dark stripes as being of different composition, and not merely of different diameter, from the sarcostyle in the region of the light stripes; it certainly stains very differently with many reagents, especially chloride of gold. His views regarding the intimate structure of a sarcostyle have been worked out chiefly in the wing muscles of insects, where the sarcostyles are separated by a considerable quantity of interstitial sarcoplasm, and a brief summary of his conclusions is as follows:—

Each sarcostyle is subdivided in the middle of each light stripe by transverse lines (membranes of Krause) into successive portions, which may be termed *sarcomeres*. Each sarcomere is occupied by a portion of the dark stripe of the whole fibre; this portion of the dark stripe may be called a *sarcous element*.\* The

---

\* Notice that this expression has a different meaning from what it originally had when used by Bowman.

sarcous element is really double, and in the stretched fibre (fig. 108, B) separates into two at the line of Hensen. At either end of the sarcous element is a clear interval separating it from Krause's membrane; this clear interval is more evident in the extended sarcomere (fig. 108, B), but diminishes on contraction (fig. 108, A). The cause of this is to be found in the structure of the sarcous element. It is pervaded with longitudinal canals or pores open towards Krause's membrane, but closed at Hensen's line. In the contracted muscle the clear part of the muscle substance passes into these pores, disappears from view to a great

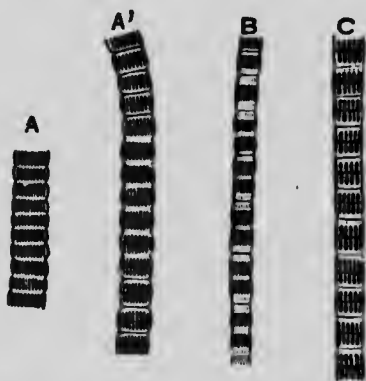

Fig. 108.—Sarcostyles from the wing-muscles of a wasp.

- A, A'. Sarcostyles showing degrees of contraction.  
 B. A sarcostyle extended with the sarcous elements separated into two parts.  
 C. Sarcostyles moderately extended (semidiagrammatic). (E. A. Schäfer.)

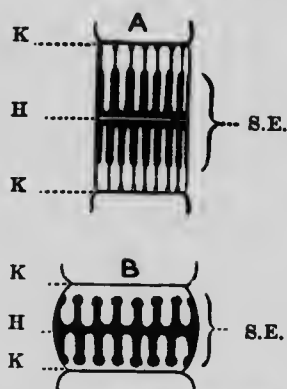

Fig. 109.—Diagram of a sarcomere in a moderately extended condition, A, and in a contracted condition, B.

K, K, Krause's membranes; H, plane of Hensen; s.e., poriferous sarcous element. (E. A. Schäfer.)

extent, swells up the sarcous element, widens it and shortens the sarcomere. In the extended muscle, on the other hand, the clear substance passes out from the pores of the sarcous element, and lies between it and the membrane of Krause; this lengthens and narrows the sarcomere.\* This is shown in the diagrams. It may be added that the sarcous element does not lie free in the middle of the sarcomere, but is attached at the sides to a fine enclosing envelope, and at either end to Krause's membrane by fine lines running through the clear substance (fig. 109, A).

This view is interesting, because it brings into harmony amoeboid, ciliary, and muscular movement. In all three instances we

\* The existence of open pores is not admitted by all observers. These regard the passage of fluid in and out of the sarcous element as due to diffusion through its membrane.

have protoplasm composed of two materials, spongioplasm and hyaloplasm. In amœboid movement the irregular arrangement of the spongioplasm allows the hyaloplasm to flow in and out of it in any direction. In ciliary movement the flow is limited by the arrangement of the spongioplasm to one direction; hence the

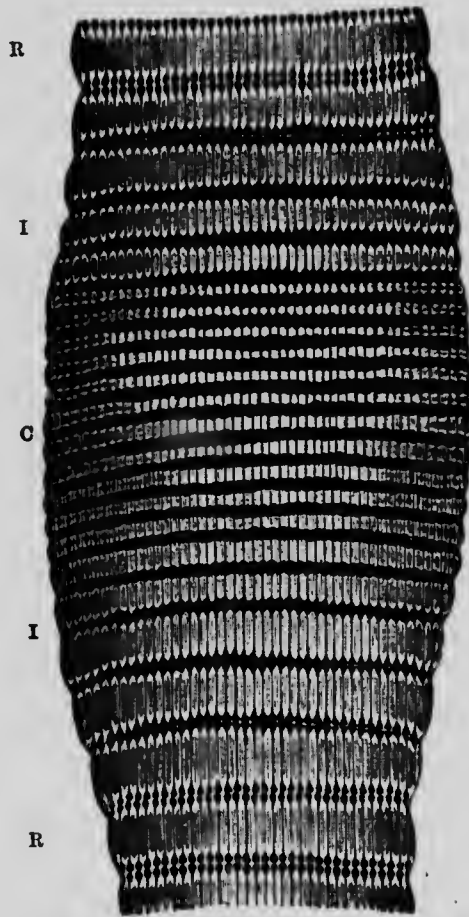

Fig. 110.—Wave of contraction passing over a muscular fibre of water-beetle. R, R, portions of the fibre at rest; c, contracted part; i, i, intermediate condition. (Schäfer.)

limitation of the movement in one direction (see p. 33). In muscle, also, the definite arrangement of the spongioplasm (represented by the sarcous element) in a longitudinal direction directs the movement of the hyaloplasm (represented by the clear substance of the light stripe), so that it must flow either in or out in that particular direction. The muscular fibre is made up of sarcostyles and the sarcostyle of sarcomeres. The contraction of

the whole muscle is only the sum total of the contraction of all the constituent sarcomeres.

In an ordinary muscular fibre it is stated that when it contracts, not only does it become thicker and shorter, but the light stripes become dark and the dark stripes light. This again is only an optical illusion, and is produced by the alterations in the shape of the sarcostyles, affecting the sarcoplasm that lies between them. When the sarcous elements swell during contraction, the sarcoplasm accumulates

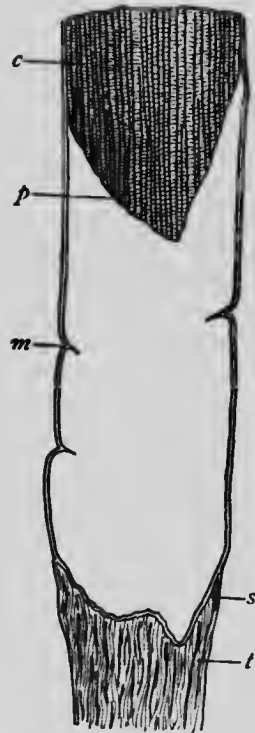

Fig. 111.—Termination of a muscular fibre in a tendon-bundle. *m*, sarcolemma; *s*, the same passing over the end of bundle; *p*, extremity of muscular substance *c*, retracted from the end of sarcolemma tube; *t*, tendon bundle fixed to sarcolemma. (Ranvier.)



Fig. 112.—Three muscular fibres running longitudinally, and two bundles of fibres in transverse section, *M*, from the tongue. The capillaries, *C*, are injected.  $\times 150$ . (Klein and Noble Smith.)

opposite the membranes of Krause, and diminishes in amount opposite the sarcous elements; the accumulation of sarcoplasm in the previously light stripes makes them appear darker by contrast than the dark stripes proper. This is very well shown in fig. 110. There is no true reversal of the stripings in the sarcostyles themselves.

That this is the case can be seen very well when a muscular fibre is examined with polarised light. A polarising microscope contains a Nicol's prism beneath the stage of the microscope which polarises the light passing through the object placed on the stage. The eye-piece contains another Nicol's prism, which detects this fact. If the two Nicols are parallel, the light passing through the first passes also through the second; but if the second is at right angles to the first, the light cannot traverse it and the field

appears dark. If an object on the microscope stage is doubly refracting it will appear bright in this dark field; if it remains dark it is singly refracting. The sarcoplasm is singly refracting or isotropous; it remains dark in the dark field of the polarising microscope. The muscle columns or sarco-styles are in great measure doubly refracting or anisotropous, and appear bright in the dark field of the polarising microscope. The sarco-styles, however, is not wholly doubly refracting; the sarcous elements are doubly refracting and the clear intervals are singly refracting. On contraction there is a reversal of these appearances, though of course the relative thickness of the singly refracting intervals varies inversely with that of the doubly refracting sarcous elements.

*Ending of Muscle in Tendon.*—A tendon-bundle passes to each muscular fibre, and becomes firmly united to the sarcolemma. The areolar tissue between the tendon-bundles becomes also continuous with that between the muscular fibres (fig. 111).

*Blood-vessels of Muscle.*—The arteries break up into capillaries, which run longitudinally in the endomysium, transverse branches connecting them (fig. 112). No blood-vessels ever penetrate the sarcolemma. The muscular fibres are thus, like other tissues, nourished by the exudation from the blood called *lymph*. The lymph is removed by lymphatic vessels found in the perimysium.

The nerves of voluntary muscle pierce the sarcolemma, and terminate in expansions called *end-plates*, to be described later on (see p. 102).

*Neuro-muscular Spindles.*—Bundles of fine muscular fibres enclosed within a thick lamellated sheath of connective tissue are found scattered through voluntary muscles; they are especially numerous near the tendon and in the proximity of intra-muscular septa. It is remarkable that they have not been found in the ocular or tongue muscles. These structures are called *neuro-muscular spindles*; they vary in length from  $\frac{1}{8}$  to  $\frac{1}{3}$  inch, and are about  $\frac{1}{125}$  inch in diameter. Each receives a nerve fibre which divides into secondary and tertiary branches. The myelin sheath is lost, and the tertiary branches enclose the muscular fibres, breaking up usually into a network. There has been considerable discussion as to the meaning of these spindles, but the belief is gaining ground that they are sensory end organs in the muscle. (See further, chapter on Touch.)

### Red Muscles.

In many animals, such as the rabbit, and some fishes, most of the muscles are pale, but some few (like the diaphragm, crureus, soleus, semi-membranosus in the rabbit) are red. These muscles contract more slowly than the pale muscles, and their red tint is due to hæmoglobin contained within their contractile substance.

In addition to these physiological distinctions, there are histological differences between them and ordinary striped muscle. These histological differences are the following:—

1. Their muscular fibres are thinner.
2. They have more sarcoplasm.
3. Longitudinal striation is more distinct.
4. Transverse striation is more irregular than usual.
5. Their nuclei are situated not only under the sarcolemma, but also in the thickness of the fibre.
6. The transverse loops of the capillary network are dilated into little reservoirs, far beyond the size of ordinary capillaries.

### Cardiac Muscle.

The muscular fibres of the heart, unlike those of most of the involuntary muscles, are striated; but although, in this respect, they resemble the skeletal muscles, they have distinguishing characteristics of their own. The fibres which lie side by side are united at frequent intervals by short branches (fig. 113). The fibres are smaller than those of the ordinary striated muscles, and their transverse striation is less marked. No sarcolemma can be discerned. One nucleus is situated in the middle of the substance of each fibre. At the junctions of the fibres there is a certain amount of cementing material, stainable by silver nitrate.



Fig. 113.—Muscular fibre cells from the heart. (E. A. Schäfer.)

### Plain Muscle.

Plain muscle forms the proper muscular coats (1.) of the digestive canal from the middle of the œsophagus to the internal sphincter ani; (2.) of the ureters and urinary bladder; (3.) of the trachea and bronchi; (4.) of the ducts of glands; (5.) of the gall-bladder; (6.) of the vesiculæ seminales; (7.) of the uterus and Fallopian tubes; (8.) of blood-vessels and lymphatics; (9.) of the iris, and ciliary muscle of the eye. This form of tissue also enters largely into the composition (10.) of the *tunica dartos*, the contraction of

which is the principal cause of the wrinkling and contraction of the scrotum on exposure to cold. It occurs also in the skin generally, being found surrounding the secreting part of the sweat glands and in small bundles attached to the hair follicles; it also occurs in the areola of the nipple. It is composed of long, fusiform cells (fig. 114), which vary in length, but are not as a rule more than  $\frac{1}{800}$  inch long. Each cell has an oval or rod-shaped



Fig. 114.—Muscular fibre-cells from the muscular coat of intestine—highly magnified. Note the longitudinal striation, and in the broken fibre the sheath is visible.

nucleus. The cell substance is longitudinally but not transversely striated. Each cell or fibre, as it may also be termed, has a delicate sheath. The fibres are collected into fasciculi, and united by cementing material, which can be stained by silver nitrate. This intercellular substance is bridged across by fine filaments passing from cell to cell.

The nerves in involuntary muscle (both cardiac and plain) do not terminate in end-plates, but by plexuses or networks, which ramify between and around the muscular fibres.

#### Development of Muscular Fibres.

All muscular fibres (except those of the sweat glands which are epiblastic) originate from the mesoblast. The *plain fibres*



are simply elongated cells in which the nucleus becomes rod-shaped. In *cardiac* muscle, the likeness to the original cells from which the fibres are formed is not altogether lost, and in certain situations (immediately beneath the lining membrane of the ventricles) there are found peculiar fibres called after their discoverer *Purkinje's fibres*; these are large clear quadrangular cells with granular protoplasm containing several nuclei in the centre, and striated at the margin. It appears that the differentiation of these cells is arrested at an early stage, though they continue to grow in size.



Fig. 115.—Developing muscular fibre from fœtus of two months. (Ranvier.)

Voluntary muscular fibres are developed from cells which become elongated, and the nuclei of which multiply. In most striated muscle fibres the nuclei ultimately take up a position beneath the cell-wall or sarcolemma which is formed on the surface. Striations appear first along one side, and extend round the fibre (fig. 115), then they extend into the centre.

During life new fibres appear to be formed in part by a longitudinal splitting of pre-existing fibres; this is preceded by a multiplication of nuclei; and in part by the lengthening and differentiation of embryonic cells (sarcoplasts) found between the fully formed fibres.

In plain muscle, growth occurs in a similar way: this is well illustrated in the enlargement of the uterus during pregnancy; this is due in part to the growth of the pre-existing fibres, and in part to the formation of new fibres from small granular cells lying between them. After parturition the fibres shrink to their original size, but many undergo fatty degeneration and are removed by absorption.

## CHAPTER VII.

### NERVE.

NERVOUS tissue is the material of which the nervous system is composed. The nervous system is composed of two parts, the *central nervous system*, and the *peripheral nervous system*. The central nervous system consists of the brain and spinal cord; the

peripheral nervous system consists of the nerves, which conduct the impulses to and from the central nervous system, and thus bring the nerve centres into relationship with other parts of the body.

Some of the nerves conduct impulses from the nerve-centres and are called *efferent*; those which conduct impulses in the opposite direction are called *afferent*. When one wishes to



Fig. 116.—Two nerve-fibres of sciatic nerve. A. Node of Ranvier. B. Axis-cylinder. C. Sheath of Schwann, with nuclei. Medullary sheath is not stained. X 300. (Klein and Noble Smith.)



Fig. 117.—Axis cylinder, highly magnified, showing its component fibrils. (M. Schultze.)

move the hand, the nervous impulse starts in the brain and passes down the efferent or motor nerve-tracts to the muscles of the hand, which contract; when one feels pain in the hand, afferent or sensory nerve-tracts convey an impulse to the brain which is there interpreted as a sensation. If all the nerves going to the hand are cut through, all communication with the nerve-centres is destroyed, and the hand loses the power of moving under the influence of the will, and the brain receives no impulses from the hand, or as we say the hand has lost sensibility.

This distinction between efferent and afferent nerves is a physiological one, which we shall work out more thoroughly later on. No histological distinction can be made out between motor and sensory nerves, and it is histological structure which we

wish to dwell upon in this chapter. Under the microscope nervous tissue is found to consist essentially of two elements, *nerve-cells* and *nerve-fibres*.

The nerve-cells are contained in the brain and spinal cord, and in smaller collections of cells on the course of the nerves called *ganglia*. The part of the nerve-centres containing cells is called *grey matter*.

The nerve-fibres are contained in the nerves, and in the *white matter* of brain and spinal cord. The nerve-fibres are long branches from the nerve-cells, which become sheathed in a manner to be immediately described.

Nerve-cells differ in size, shape, and arrangement, and we shall discuss these fully when we get to the nerve-centres. For the present it will be convenient to confine ourselves to the nerve-fibres as they are found in a nerve.

Nerve-fibres are of two histological kinds, *medullated* and *non-medullated*. Medullated nerve-fibres are found in the white matter of the nerve-centres and in the nerves originating from the brain and spinal cord. Non-medullated nerve-fibres occur in the sympathetic nerves.

The **medullated or white fibres** are characterised by a sheath of white colour, fatty in nature, and stained black by osmic acid; it is called the *medullary sheath* or *white substance of Schwann*; this sheathes the essential part of the fibre which is a process from a nerve-cell, and is called the *axis cylinder*. Outside the medullary sheath is a thin homogeneous membrane of elastic nature called the *primitive sheath* or *neurilemma*.



Fig. 118.—Nerve-fibre stained with osmic acid. A, node; B, nucleus. (Key and Retzius.)



Fig. 119.—A node of Ranvier in a medullated nerve-fibre, viewed from above. The medullary sheath is interrupted, and the primitive sheath thickened. Copied from Axel Key and Retzius.  $\times 750$ . (Klein & Noble Smith.)

The *axis cylinder* is a soft transparent thread in the middle of the fibre; it is made up of exceedingly fine fibrils (fig. 117) which stain readily with gold chloride. The *medullary sheath* gives a characteristic double contour and tubular appearance to the fibre. It is interrupted at regular intervals known as the *nodes of Ranvier*. The stretch of nerve between two nodes is called an *inter-node*, and in the middle of each inter-node is a nucleus which belongs to the primitive sheath. Besides these interruptions, a variable number of oblique clefts are also seen

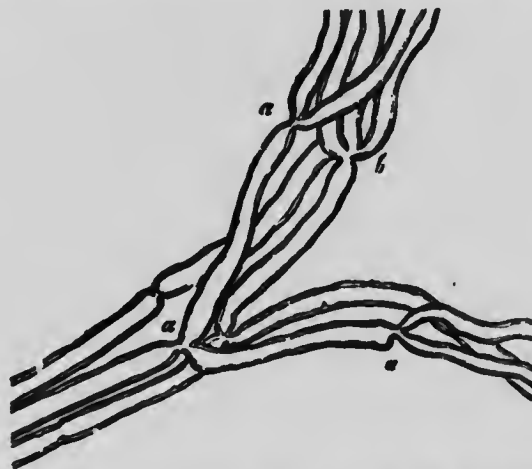

Fig. 120.—Small branch of a muscular nerve of the frog, near its termination, showing divisions of the fibres. *a*, into two; *b*, into three.  $\times 350$ . (Kölliker.)

dividing the sheath into *medullary segments* (fig. 118); but most if not all of these are produced artificially in the preparation of the specimen.

The medullary sheath also contains a horny substance called *neurokeratin*: the arrangement of this substance is in the form of a network or reticulum holding the fatty matter of the sheath in its meshes. The occurrence of horny matter in the epidermis, in the development of the enamel of teeth and in nerve is an interesting chemical reminder that all these tissues originate from the same embryonic layer, the epiblast. The fatty matter consists largely of *lecithin*, a phosphorised fat, and *cholesterin*, a monatomic alcohol. We shall make a more intimate acquaintance with these chemical materials at a later stage in our studies.

Near their terminations the nerve-fibres branch: the branching occurs at a node (fig. 120).

Staining with silver nitrate produces a peculiar appearance at the nodes, forming what is known as the *crosses of Ranvier*. One limb of the cross is produced by the dark staining of

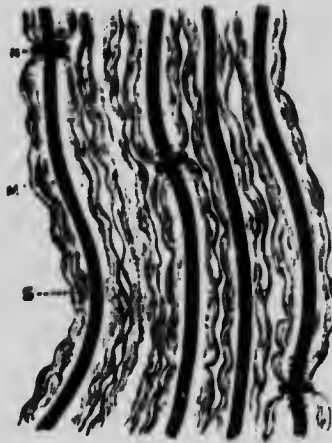

Fig. 121.—Several fibres of a bundle of medullated nerve-fibres acted upon by silver nitrate. The peculiar behaviour of nodes of Ranvier, N, towards this reagent. Silver has penetrated at the nodes, and has stained the neurilemma for a short distance. S, the white substance. (Klein's 'Anatomie', p. 114.)

the cement substance which occurs between the segments of the neurilemma; the other limb of the cross is due to the staining of

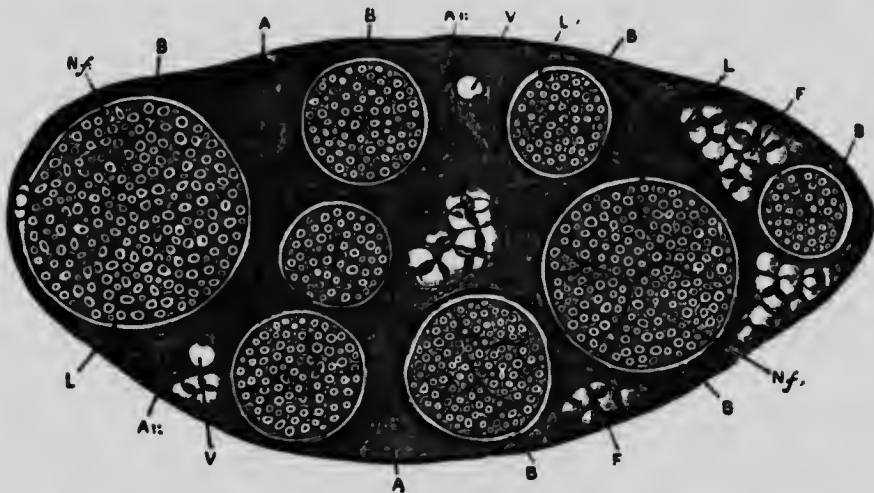

Fig. 122.—Transverse section of the sciatic nerve of a cat about  $\times 100$ .—It consists of bundles (*funiculi*) of nerve-fibres ensheathed in a fibrous supporting capsule, *epineurium*, A; each bundle has a special sheath (not sufficiently marked out from the *epineurium* in the figure) or *perineurium* B; the nerve-fibres Nf are separated from one another by *endoneurium*; L, lymph spaces; Ar, artery; V, vein; F, fat. Somewhat diagrammatic. (V. D. Harris.)

a number of minute transverse bands in the axis cylinder (*Fromann's lines*), which is here not closely invested by the medullary sheath.

The arrangement of the nerve-fibres in a nerve is best seen in a transverse section.

The nerve is composed of a number of bundles or *funiculi* of

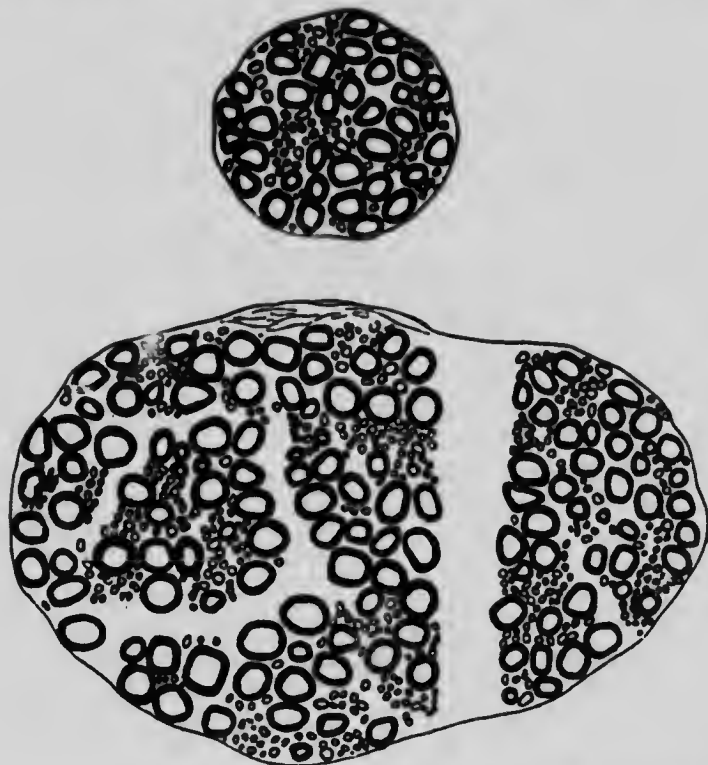

Fig. 123.— Section across the second thoracic anterior root of the dog, stained with osmic acid. (Gaskell.)

nerve fibres bound together by connective tissue. The sheath of the whole nerve is called the *epineurium*; that of the funiculi the *perineurium*; that which passes between the fibres in a funiculus, the *endoneurium* (fig. 122).

The size of the nerve-fibres varies; the largest fibres are found in the spinal nerves, where they are 14.4 to 19 $\mu$  in diameter.\* Others mixed with these measure 1.8 to 3.6 $\mu$ . These small nerve-fibres are the visceral nerves; they pass to collections of nerve-cells called

\*  $\mu$  = micro-millimetre =  $\frac{1}{1000}$  millimetre.

the sympathetic ganglia, whence they emerge as non-medullated fibres, and are distributed to involuntary muscle. They are well seen in sections stained by osmic acid, the black rings being the stained medullary sheaths (fig. 123).

The **non-medullated fibres** or *fibres of Remak* have no medullary sheath and are therefore devoid of the double contour of the medullated fibres, and are unaffected in appearance by

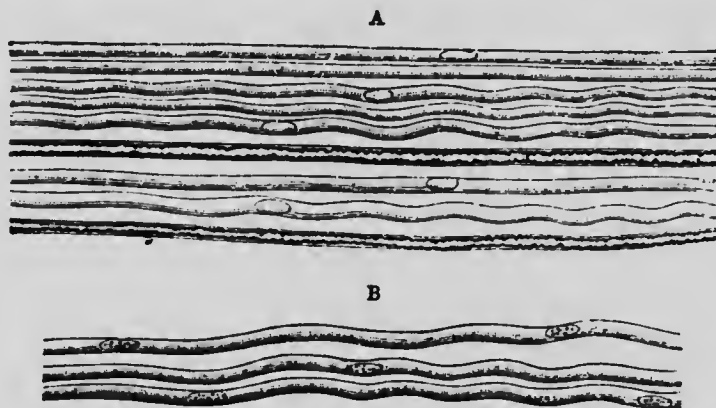

Fig. 124.—Grey, or non-medullated nerve-fibres. A. From a branch of the olfactory nerve of the sheep; two dark-bordered or white fibres from the fifth pair are associated with the pale olfactory fibres. B. From the sympathetic nerve.  $\times 450$ . (Max Schultze.)

osmic acid. They consist of an axis cylinder covered by a nucleated fibrillated sheath. They branch frequently.

Though principally found in the sympathetic nerves, a few are found in the spinal nerves mixed with the medullated fibres.

#### Termination of Nerves in Muscle.

In the *voluntary muscles* the motor nerve-fibres have special end organs called *end-plates*. The fibre branches two or three times (figs. 120, 125), and each branch goes to a muscular fibre. Here the neurilemma becomes continuous with the sarcolemma, the medullary sheath stops short, and the axis cylinder branches repeatedly. This ramification is embedded in a layer of granular protoplasm containing numerous nuclei. Considerable variation in shape of the end-plates occurs in different parts of the animal kingdom. Somewhat similar nerve-endings are seen in tendon; these however are doubtless sensory (figs. 126, 127).

In the *involuntary muscles*, the fibres which are for the most part non-medullated form complicated plexuses near their termination.

The plexus of Auerbach (fig. 128) between the muscular coats of the intestine is a typical case. Groups of nerve-cells will be noticed at the junctions of the fine nervous cords. From these plexuses fine



Fig. 125.—From a preparation of the nerve-termination in the muscular fibres of a snake. *a*, End-plate seen only broad surfaced. *b*, End-plate seen as narrow surface. (Lingard and Klein.)

branches pass off and bifurcate at frequent intervals, until at last ultimate fibrillæ are reached. These subdivisions of the axis cylinders do not anastomose with one another, but they come into



Fig. 126.—Termination of medullated nerve-fibres in tendon near the muscular insertion. (Golgi.)

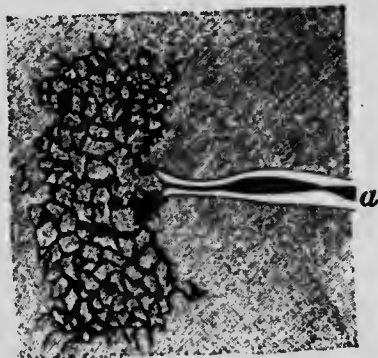

Fig. 127.—One of the reticulated end-plates of fig. 126, more highly magnified. *a*, medullated nerve-fibre; *b*, reticulated end-plates. (Golgi.)

close relationship with the involuntary muscular fibres; though some histologists have stated that they end in the nuclei of the muscular fibres, it is now believed that they do not pass into their interior.

The terminations of sensory nerves are in some cases plexuses,



in others special end organs. We shall deal with these in our study of sensation. (See Neuro-muscular Spindles, p. 93.)

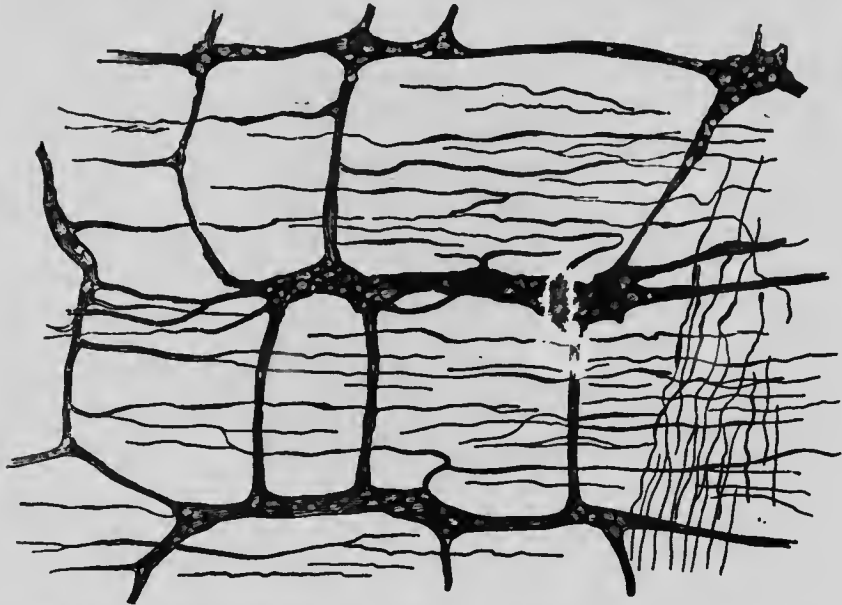

Fig. 128.—Plexus of Auerbach, between the two layers of the muscular coat of the intestine. (Cadiat.)

### Development of Nerve-fibres.

A nerve-fibre is primarily an outgrowth from a nerve-cell, as is shown in the accompanying diagram. A nerve-cell, though it



Fig. 127.—Multipolar nerve-cell from anterior horn of spinal cord; *a*, axis cylinder process. (Max Schultze.)

may have many branches, only gives off one process which becomes the axis cylinder of a nerve-fibre. This acquires a medullary sheath when it passes into the white matter of the brain or spinal cord, and a primitive sheath when it leaves the nerve-centre and gets into the nerve. But at first the axis cylinder is not sheathed at all.

The formation of the sheaths is still a matter of doubt, but the generally accepted opinion is that the primitive sheath is formed by cells which become flattened out and wrapped round the fibre end to end. These are separated at the nodes by intercellular or cement substance stainable by silver nitrate (fig. 121). These cells are probably mesoblastic. The medullary sheath is formed according to some by a fatty change occurring in the parts of these same cells which are nearest to the axis cylinder, but it is much more probable that it is formed from the peripheral layer of the axis cylinder. The presence of neurokeratin in it distinctly points to an epiblastic origin. The fact also that, in the nerve centres, the medullated nerve fibres have no primitive sheath, and the phenomena of Wallerian degeneration, to be described later, all tend to confirm the same view.

---

## CHAPTER VIII.

### IRRITABILITY AND CONTRACTILITY.

**Irritability** or **Excitability** is the power that certain tissues possess of responding by some change to the action of an external agent. This external agent is called a **stimulus**.

Undifferentiated cells like white blood corpuscles are irritable; when stimuli are applied to them they execute the movements we have learnt to call amoeboid.

Ciliated epithelium cells and muscular fibres are irritable; they also execute movements under the influence of stimuli.

Nerves are irritable; when they are stimulated, a change is produced in them; this change is propagated along the nerve and is called a nervous impulse; there is no change of form in the nerve visible to the highest powers of the microscope; much more delicate and sensitive instruments than a microscope must be employed to obtain evidence of a change in the nerve; it is of a molecular nature. But the irritability of nerve is readily manifested by the results the nervous impulse produces in the organ to which it goes; thus the stimulation of a motor nerve produces a nervous impulse in that nerve which, when it reaches

a muscle, causes the muscle to contract: stimulation of a sensory nerve produces a nervous impulse in that nerve which when it reaches the brain causes a sensation.

Secreting glands are irritable; when irritated or stimulated they secrete.

The electrical organs found in many fishes like the electric eel, and torpedo ray, are irritable; when they are stimulated they give rise to an electrical discharge.

**Contractility** is the power that certain tissues possess of responding to a stimulus by change of form. Contractility and irritability do not necessarily go together; thus both muscle and nerve are irritable, out of the two, only muscle is contractile.

Some movements visible to the microscope are not due to contractility; thus granules in protoplasm or in a vacuole may

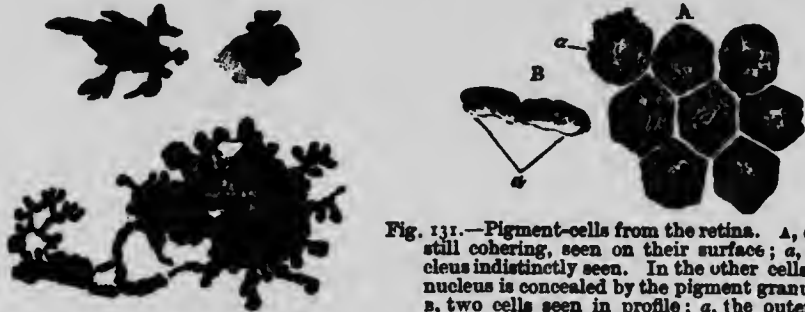

Fig. 130.—Frog's pigment cells.

Fig. 131.—Pigment-cells from the retina. A, cells still cohering, seen on their surface; a, nucleus indistinctly seen. In the other cells the nucleus is concealed by the pigment granules. B, two cells seen in profile; a, the outer or posterior part containing scarcely any pigment.  $\times 370$ . (Heale.)

often be seen to exhibit irregular, shaking movements due simply to vibrations transmitted to them from the outside. Such movement is known as *Brownian movement*.

Instances of contractility are seen in the following cases:—

1. The movements of protoplasm seen in simple animal and vegetable cells; in the former we have already considered streaming, gliding, and amœboid movement (see p. 13); in the latter case we have noted the rotatory movements of the protoplasm within the cell wall in certain plants (see p. 14).

2. The movements of pigment cells. These are well seen under the skin of such an animal as the frog; under the influence of electricity and of other stimuli, especially of light, the pigment granules are massed together in the body of the cell, leaving the processes quite transparent (fig. 130). If the stimulus is removed the granules gradually extend into the processes again. Thus the skin of the frog is sometimes uniformly dusky, and sometimes quite light coloured. The chamæleon is an animal

which has become almost proverbial, since it possesses the same power to a marked degree. This function is a protective one; the animal approximates in colour that of its surroundings, and so escapes detection.

In the retina we shall find a layer of pigment cells (fig. 131), the granules in which are capable of moving in the protoplasm in a somewhat similar way; the normal stimulus here also is light.

3. Ciliary movement; here we have a much more orderly movement which has already been described (see p. 31).

4. In *Vorticellæ*, a spiral thread of protoplasm in their stalk enables them by contracting it to lower the bell at the end of the stalk.

5. In certain of the higher plants, such as the sensitive and carnivorous plants, movements of the stalks and sensitive hairs of the leaves occur under the influence of stimuli.

6. Muscular movement. This for the student of human physiology is the most important of the series; it is by their muscles that the higher animals (man included) execute the greater number of their movements.

If we contrast together amœboid, ciliary and muscular movement, we find that they differ from each other very considerably. Amœboid movement can occur in any part of an amœboid cell, and in any direction. Ciliary and muscular movement are limited to one direction; but they are all essentially similar, consisting of the movement of hyaloplasm in and out of spongio-plasm; it is the arrangement of the spongioplasm that limits and controls the movement of the hyaloplasm (see also p. 91).

*Rhythmicality.*—In some forms of movement there is not only order in direction, but order in time also. This is seen in ciliary movement, and in many involuntary forms of muscular tissue, such as that of the heart. Here periods of contraction alternate with periods of rest, and this occurs at regular intervals. Under the influence of certain saline solutions,\* voluntary muscles may be made artificially to exhibit rhythmic contractions.

A familiar instance of rhythmic movement in the inorganic world is seen in a water-tap nearly turned off but dripping; water accumulates at the mouth of the tap till the drop is big enough to fall; it falls, and the process is repeated. If, instead of water, gum or treacle, or some other viscous substance is watched under similar circumstances, the drops fall much more

---

\* Biedermann's fluid has the following composition:—Sodium chloride 5 grammes, alkaline sodium phosphate 2 gr., sodium carbonate 0.5 gr., water 1 litre. If one end of the sartorius of a curarised frog is dipped in to this fluid, it contracts rhythmically in a manner analogous to the heart.

slowly; each drop has to get bigger before it possesses enough energy to fall. Thus we may get different degrees or rates of rhythmic movement. So in the body, during the period of rest, the cilium or the heart is accumulating potential energy, till, as it were, it becomes so charged that it discharges; potential energy is converted into kinetic energy or movement.

When contraction travels as a wave along muscular fibres, or from one muscular fibre to another, the term *peristalsis* is employed. These waves are well seen in such a muscular tube as the intestine, and are instrumental in hurrying its contents along. The heart's contraction is a similar but more complicated peristalsis occurring in a rhythmic manner.

The physiology of muscle and nerve furnish us with the best means of studying irritability and contractility. We shall have to consider these two tissues together to a large extent, but must confine our attention at the outset to the voluntary muscles.

The question may be first asked, what evidence there is of irritability in muscle? May not the irritability be a property of the nerve-fibres which are distributed throughout the muscle and terminate in its fibres? The doctrine of independent muscular irritability was enunciated by Haller more than a century ago, and was afterwards keenly debated. It was finally settled by an experiment of Claude Bernard which can be easily repeated by every student.

If a frog is taken and its brain destroyed by pithing, it loses consciousness but the circulation goes on, and the tissues of its body retain their vitality for a considerable time. If now a few drops of a solution of *curare*, the Indian arrow poison, are injected with a small syringe under the skin of its back, it loses in a few minutes all power of movement. If next the sciatic or any other nerve going to muscle is dissected out and stimulated, no movement occurs in the muscles to which it is distributed. Curare paralyzes the motor end-plates, so that for all practical purposes the muscles are nerveless; or rather nervous impulses cannot get past the end-plates and cause any effect on the muscles. But if the muscles are stimulated themselves they contract.

Another proof that muscle possesses inherent irritability was adduced by Kühne. In part of some of the frog's muscles (*e.g.* part of the sartorius) there are no nerves at all; yet they are irritable and contract when stimulated.

The evidence of the statement just made that the poisonous effect of curare is on the end-plates is the following:—The experiment described proves it is not the muscles that arc

paralysed. It must therefore be either the nerves, or the links between the nerve-fibres and the muscular fibres. By a process of exclusion we arrive at the conclusion that it is these links, for the following experiment shows it is not the nerves. The frog is pithed as before, and then one of its legs is tightly ligatured so as to include everything except the sciatic nerve of that leg. Curare is injected and soon spreads by the circulating blood all over the body except to the leg protected by the ligature. It can get to the sciatic nerve of that leg because that was not tied in with the rest. The sciatic nerve of the other leg is now dissected out; when the muscles supplied by it cease to contract when the nerve is stimulated, the frog may be considered to be fully under the influence of the drug. But on stimulating the sciatic nerve of the protected limb, the muscles respond normally; this shows that the nerve which has been exposed to the action of the poison has not been affected by it.

#### Varieties of Stimuli.

The normal stimulus that leads to muscular contraction is a nervous impulse; this is converted into a muscular impulse (visible as a contraction) at the end-plates. This nervous impulse starts at the nerve-centre, brain or spinal cord, and travels down the nerve to the muscle. In a reflex action the nervous impulse in the nerve-centre is started by a sensory impulse from the periphery; thus when one puts one's hand on something unpleasantly hot, the hand is removed; the hot substance causes a nervous impulse to travel to the brain, and the brain reflects down to the muscles of the hand another impulse by the motor-nerves which causes the muscles to contract in such a manner as to move the hand out of the way.

But the details of muscular contraction can be more readily studied in muscles removed from the body of such an animal as the frog, and made to contract by artificial stimuli. When we have considered these, we can return to the lessons they teach us about the normal contractions in our own bodies.

The first thing to do is to make from a pithed frog a *muscle-nerve preparation*; the muscle usually selected is the

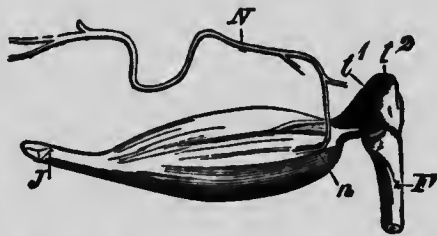

Fig. 132.—Muscle-nerve preparation. f, femur; n, nerve; T, tendo Achillis. (M'Kendrick.)

gastrocnemius, the large muscle of the calf of the leg, with the sciatic nerve attached. For some experiments the sartorius or gracilis may be used; but nearly all can be demonstrated on the gastrocnemius.

The tendon of the gastrocnemius may be tied to a lever with a flag at the end of it, and thus its contractions rendered more evident; the bone at the other end is fixed in a clamp. Stimuli may be applied either to the nerve or to the muscle. If the stimulus is applied to the nerve, it is called *indirect stimulation*; the stimulus starts a nervous impulse which travels to the muscle; the muscle is thus stimulated as it is in voluntary contraction by a nervous impulse. Stimulation of the muscle itself is called *direct stimulation*. These stimuli may be:

1. Mechanical; for instance a pinch or blow.
2. Chemical; for instance salt or acid sprinkled on the nerve or muscle.
3. Thermal; for instance touching the nerve or muscle with a hot wire.
4. Electrical; the constant or the induced current may be used.

In all cases the result of the stimulation is a muscular contraction. Of all methods of artificial stimulation, the electrical is the one most generally employed, because it is more under control and the strength and duration of the stimuli (shocks) can be regulated easily. We shall therefore have to study some electrical apparatus.

Chemical stimuli are peculiar, for some which affect muscle do not affect nerve, and *vice versa*; thus glycerine stimulates nerve, but not muscle; ammonia stimulates muscle, but not motor nerves.

We may regard stimuli as liberators of energy; muscle and nerve and other irritable structures undergo disturbances in consequence of a stimulus. The disturbance is some form of movement, visible movement in the case of muscle, molecular movement in the case of nerve. A stimulus may be regarded as added motion. Sir William Gowers compares it to the blow that causes dynamite to explode, or the match applied to a train of gunpowder. A very slight blow will explode a large quantity of dynamite; a very small spark will fire a long train of gunpowder. So in muscle or nerve the effect is often out of all proportion to the strength of the stimulus; a light touch on the surface of the body may elicit very forcible nervous and muscular disturbances; and moreover, the effect of the stimulus is propagated along the nerve or muscle without loss.

## CHAPTER IX.

## CONTRACTION OF MUSCLE.

MUSCLE undergoes many changes when it contracts; they may be enumerated under the following five heads:—

1. Changes in form.
2. Changes in extensibility and elasticity.
3. Changes in temperature.
4. Changes in electrical condition.
5. Chemical changes.

In brief, each of these changes is as follows:—

1. *Changes in form.*—The muscle becomes shorter, and at the same time thicker. The amount of shortening varies so that the length of the muscle when contracted is from 65 to 85 per cent. of what it was originally. Up to a certain point, increase of the strength of the stimulus increases the amount of contraction. Fatigue diminishes and up to about 33° C. the application of heat increases the amount of contraction. Beyond this temperature the muscular substance begins to be permanently contracted, and a condition called *heat rigor*, due to coagulation of the muscle proteids, sets in a little over 40° C.

What the muscle loses in length it gains in width; there is no appreciable change of volume.

Among the changes in form must also be mentioned those changes in the individual muscular fibres which require a microscope for their investigation; these have been already considered (see p. 90).

2. *Changes in elasticity and extensibility.*—The contracted muscle is more stretched by a weight in proportion to its length than an uncontracted muscle with the same weight applied to it; the extensibility of contracted muscle is increased; its elasticity is diminished.

3. *Changes in temperature.*—When muscle is at work or contracting, more energetic chemical changes are occurring than when it is at rest; more heat is produced and its temperature rises.

4. *Changes in electrical condition.*—A muscle when it contracts undergoes a diphasic variation in its electrical condition.

5. *Chemical changes.*—These consist in an increased consumption of oxygen, and an increased output of waste materials such as



carbonic acid, and sarco-lactic acid. After prolonged contraction the muscle consequently acquires an acid reaction.

These five sets of changes will form the subjects of the following five chapters.

## CHAPTER X.

### CHANGE IN FORM IN A MUSCLE WHEN IT CONTRACTS.

THOUGH it has been known since the time of Erasistratus (B.C. 304) that a muscle becomes thicker and shorter when it contracts, it was not until the invention of the *graphic method* by Ludwig and Helmholtz, about fifty years ago, that we possessed any accurate knowledge of this change. The main fact just stated may be seen by simply looking at a contracting muscle, such as the biceps of one's own arm; but more elaborate apparatus is necessary for studying the various phases in contraction and the different kinds of contraction that may occur.

These may be readily demonstrated on the ordinary muscle-nerve preparation (gastrocnemius and sciatic nerve) from a frog. By the graphic method, one means that the movement is recorded by a writing. We shall find that the same method is applied to the heart's movements, respiratory movements, blood pressure, and many other important problems in physiology. The special branch of the graphic method we have now to study is called *myography*; the instrument for writing is called a *myograph*; the writing itself is called a *myogram*. Put briefly, a myograph consists of a writing point at the end of a lever attached to the muscle, and a writing surface which travels at a uniform rate, on which the writing point inscribes its movement.

The first thing, however, that is wanted is something to stimulate the muscle and make it contract; the stimulus is usually applied to the nerve, and the form of stimulus most frequently employed is electrical.

The galvanic battery in most common use is the *Daniell cell*. It consists of a well-amalgamated zinc rod immersed in a cylinder of porous earthenware containing 10 per cent. sulphuric acid; this is contained within a copper vessel (represented as transparent for diagrammatic purposes in fig. 133) filled with saturated

solution of copper sulphate. Each metal has a binding screw attached to it, to which wires can be fastened. The zinc rod is called the *positive element*, the copper the *negative element*. The distal ends of the wires attached to these are called *poles* or *electrodes*, and the pair of electrodes may be conveniently held in a special form of holder. The electrode attached to the positive element (zinc) is called the *negative pole* or *kathode*; that attached to the negative element (copper) is called the *positive pole* or *anode*. If now the two electrodes are connected together, an electrical, galvanic or *constant current* flows from the copper to the zinc outside the battery, and from the zinc to the copper through the fluids of the battery; if the electrodes are not connected the circle is broken, and no current can flow at all. If now a nerve or muscle is laid across the two

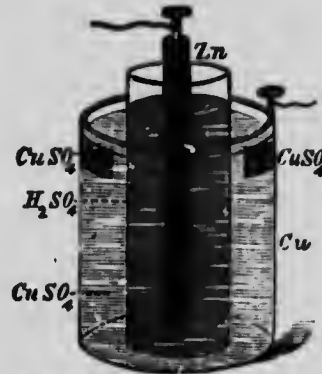
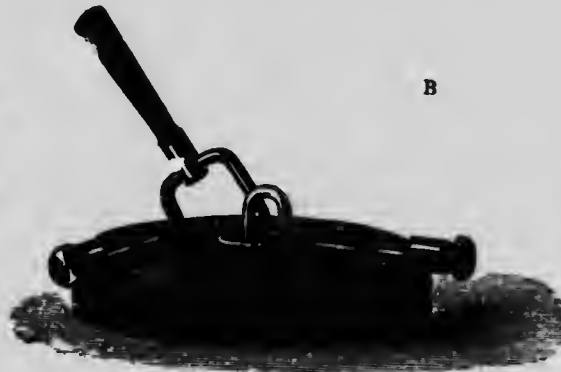

Fig. 133.—Diagram of a Daniell's battery.



Fig. 134.—A. Du Bois Reymond's Key.



B. Mercury Key.

electrodes the circuit is completed, and it will be noticed at the moment of completion of the circuit the muscle enters into contraction; if the muscle is lifted off the electrodes, another contraction occurs at the moment the circuit is broken. The same thing is done more conveniently by means of a key: fig. 134

represents two common forms of key. A key is a piece of apparatus by which the current can be allowed to pass or not through the nerve or muscle laid on the electrodes. When the key is open the current is broken, as in the next figure (fig. 135); when it is closed the current is allowed to pass. The opening of the key is called *break*; the closing of the key is called *make*. A contraction occurs only at make and break, not while the current is quietly traversing the nerve or muscle.



Fig. 135.

But it will be seen in the Du Bois Reymond key (fig. 134) that there are four binding screws. This key is used as a bridge or *short circuiting key*, and for many reasons this is the best way to use it. The next diagram (fig. 136) represents this diagrammatically. The two wires from the battery go one to each side of the key; the electrodes come off one from each side of the key. When the

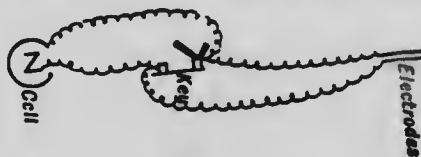

Fig. 136.

key is open no current can get across it, and therefore all the current has to go to the electrodes with the nerve resting on them; but when the key is closed, the current is cut off from the nerve, as then practically all of it goes by the metal bridge, or short cut, back to the battery. Theoretically a small amount of current goes through the nerve; but the resistance of animal tissues to electrical currents is enormous as compared to that of metal, and the amount of electricity that flows through a conductor is inversely proportional to the resistance; the resistance in the metal bridge is so small that for all practical purposes, all the current passes through it.

Another form of electrical stimulus is the *induced current*, produced in an induction coil.

In a battery of which the metals are connected by a wire, we have seen that the current in the wire travels from the

copper to the zinc ; if we have a key on the course of this wire the current can be made or broken at will. If in the neighbourhood of this wire we have a second wire forming a complete circle, nothing whatever occurs while the current is flowing through the first wire, but at the instant of making or breaking the current in the first *primary wire*, a momentary electrical current occurs in the *secondary wire*, which is called an induced current ; and if the secondary wire is not a complete circle, but its two ends are connected by a nerve, this induction shock tra-

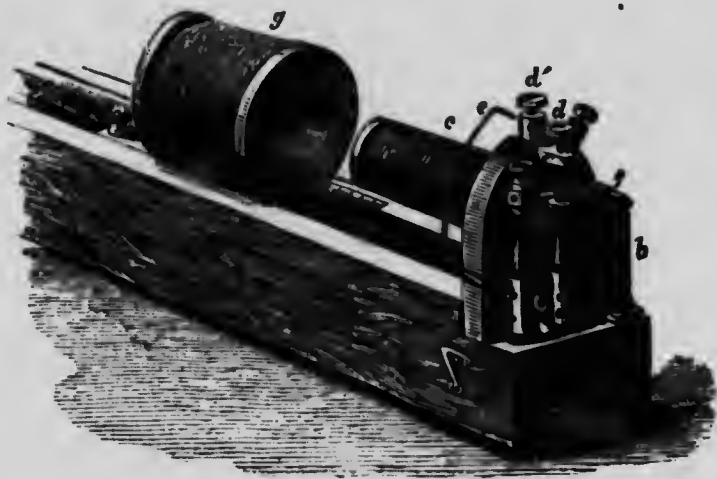

Fig. 137.—Du Bois Reymond's induction coil.

verses the nerve and stimulates it ; this causes a nervous impulse to travel to the muscle, which in consequence contracts.

If the first and second wires are coiled many times, the effect is increased, because each turn of the primary coil acts inductively on each turn of the secondary coil.

The direction of the current induced in the secondary coil is the same as that of the current in the primary coil at the break ; in the opposite direction at the make. The nearer the secondary coil is to the primary the stronger are the currents induced in the former.

Fig. 137 represents the Du Bois Reymond coil, the one generally employed in physiological experiments. *c* is the primary coil, and *d* and *d'* its two ends, which are attached to the battery, a key being interposed for making and breaking ; *g* is the secondary coil, the two terminals of which are at its far end ; to these the electrodes to the nerve are attached ; the distance between

the two coils, and so the strength of the induction currents, can be varied at will. It is only when the primary current is made or broken, or its intensity increased or diminished, that induction shocks occur in the secondary circuit which stimulate the nerve. When one wishes to produce a rapid succession of make and break shocks the automatic interrupter or Wagner's hammer seen at the right-hand end of the diagram is included in the circuit.

The next thing to be noticed is that the break effects are stronger than the make effects; this is easily felt by placing the electrodes on the tongue. This is due to what is called Faraday's extra current. This is a current produced in the primary coil by the inductive influence of contiguous turns of that wire on each other; its direction is against that of the battery current at make, and so the make shock is lessened. At the break the extra current is of such short duration (because when the circuit is broken there can be no current at all) that for all practical purposes it may be considered as non-existent.

The same difference of strength occurs alternately in the repeated shocks produced by Wagner's hammer. Helmholtz, to obviate this, introduced a modification now known after him. It consists in bridging the current by a side wire, so that the current never entirely ceases in the primary coil, but is alternately strengthened and weakened by the rise and fall of the hammer; the strengthening corresponds to the ordinary make, and is weakened by the make extra current, which occurs in the opposite direction to the battery current; the break is also incomplete, and so it is weakened by the break extra current, which being in the same direction as the battery current impedes its disappearance.

The two next diagrams show the way the interrupter acts. We are supposed to be looking at the end of the primary coil; the battery wires are attached to the binding screws A and E (fig. 138). The current now passes to the primary coil by the pillar on the left and the spring or handle of the hammer as far as the screw (C); after going round the primary coil, one turn only of which is seen, it twists round a pillar of soft iron on the right-hand side, and then to the screw E and back to the battery; the result of a current going around a bar of soft iron is to make it a magnet, so it attracts the hammer, and draws the spring away from the top screw C, and thus breaks the current; the current ceases, the soft iron is no longer a magnet, so it releases the hammer and contact is restored by the spring; then the same thing starts over again, and so a succession of break and make shocks occurs alternately and automatically.

In Helmholtz' modification (fig. 139) the battery wires are connected as before. The interrupter is bridged by a wire from B to C (also shown in fig. 137, e). C is raised out of reach, and the lower screw F is brought within reach of the spring. Owing

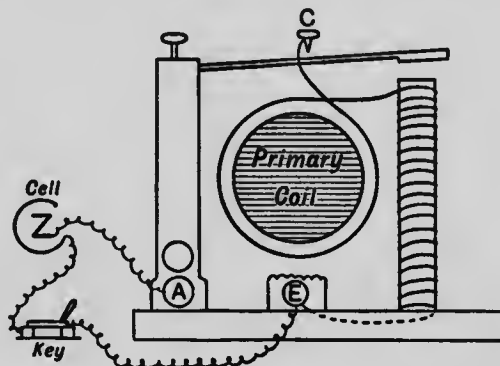

Fig. 138.

to the wire BC, the vibration of the hammer never entirely breaks the current.

Instead of Wagner's hammer a long vibrating reed constructed on the same principle is often used. This has the advantage

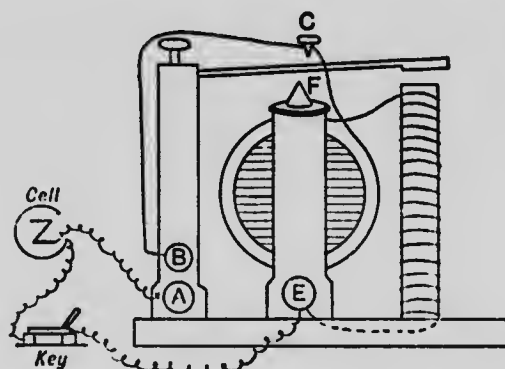

Fig. 139.

that the rate of vibration can be varied at will by means of a sliding clamp which fixes the reed so that different lengths of it can be made to vibrate. If a long piece of reed vibrates, it does so slowly, and thus successive induction shocks at long intervals can be sent into the nerve. But if one wishes to

stimulate a nerve more rapidly, the length of reed allowed to vibrate can be shortened.

In Ewald's modification of the coil there is another simple method of modifying the rate of the interrupter. But an hour spent in the laboratory with an induction coil and cell will teach the

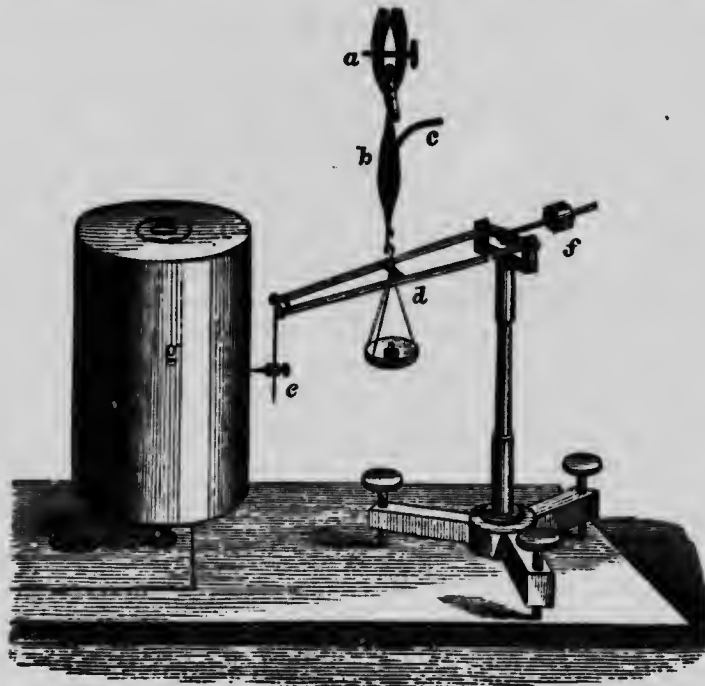

Fig. 140.—Myograph of von Helmholtz, shown in an incomplete form. *a*, forceps for holding frog's femur; *b*, gastrocnemius; *c*, sciatic nerve; *d*, scale pan; *e*, marker recording on cylinder; *f*, counterpoise. (M'Kendrick.)

student much more easily all these facts than any amount of reading and description.

We can pass now to the **myograph**. There are many different forms of this instrument. Fig. 140 shows Helmholtz' instrument.

The bony origin of the gastrocnemius is held firmly by forceps, and the tendo Achillis tied to a weighted lever; the end of the lever is provided with a writing-point such as a piece of pointed parchment; when the muscle contracts it pulls the lever up, and this movement is magnified at the end of the lever. The writing-point scratches on a piece of glazed paper covered with a layer of soot; the paper is wrapped round a cylinder. When the lever goes up the writing-point will mark an up-stroke; when it falls it

will mark a down-stroke, and if the cylinder is travelling, the down-stroke will be written on a different part of the paper than the up-stroke; thus a **muscle curve** or **myogram** is obtained. The paper may then be removed, varnished, and preserved.

Fig. 141 shows a somewhat different arrangement.

The muscle is fixed horizontally on a piece of cork B, one end being fixed by a pin thrust through the knee-joint into the

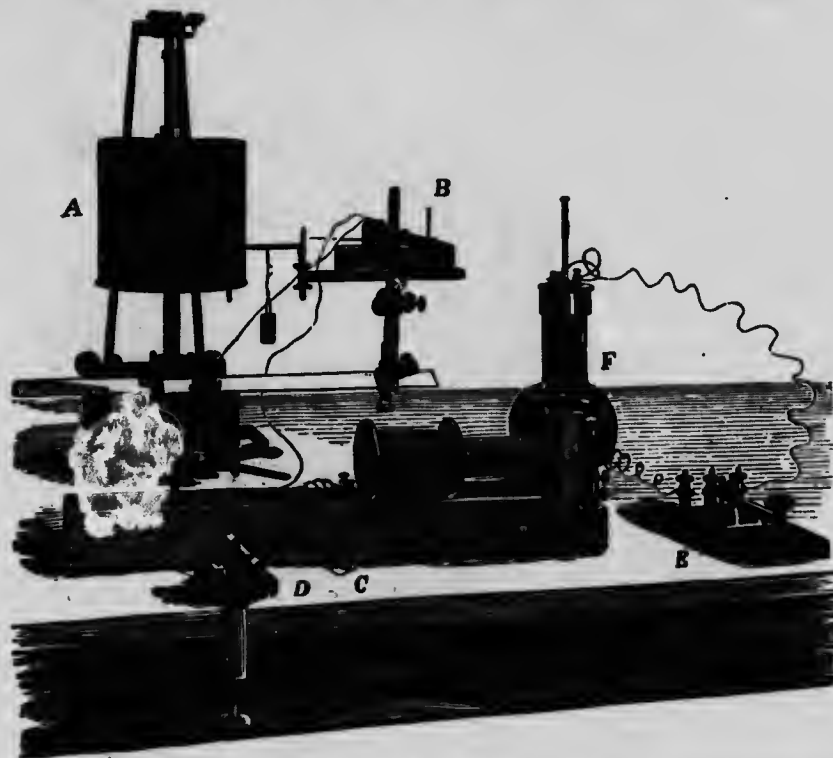

Fig. 141.—Arrangement of the apparatus necessary for recording muscle contractions with a revolving cylinder carrying smoked paper. A, revolving cylinder; B, the muscle arranged upon a cork-covered board which is capable of being raised or lowered on the upright, which also can be moved along a solid triangular bar of metal attached to the base of the recording apparatus—the tendon of the gastrocnemius is attached to the writing lever, properly weighted, by a ligature. The electrodes from the secondary coil pass to the nerve—being, for the sake of convenience, first of all brought to a short-circuiting key, D (Du Bois Reymond's); C, the induction coil; F, the battery (in this fig. a bichromate one); E, the key (Morse's) in the primary circuit.

cork; the tendo Achillis is tied to a lever which is weighted near its fulcrum: the lever is so arranged that it rests on a screw till the muscle begins to contract; the muscle therefore does not feel the weight till it begins to contract, and gives a better contraction than if it had been previously strained by the weight. This arrangement is called *after-loading*.



The writing surface is again a travelling cylinder tightly covered with smoked glazed paper. The rest of the apparatus shows how cell, coil, keys, and electrodes are applied with the object of stimulating the nerve.

The key E makes and breaks the primary circuit, but the effect is only felt by the muscle-nerve preparation when the short-circuiting key D in the secondary circuit is opened.

Instead of the key E it is better to have what is called a "kick-over" key which the cylinder by means of a bar projecting

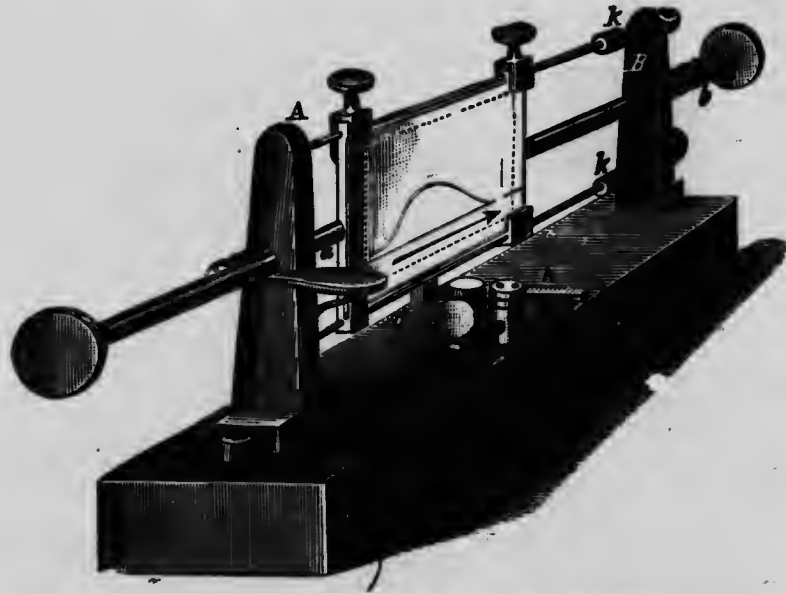

Fig. 142.—Du Bois Reymond's spring myograph. (M'Kendrick.)

from it knocks over and so breaks the primary circuit during the course of a revolution. The exact position of the writing-point at the moment of break, that is the moment of excitation, can then be marked on the blackened paper.

Besides the travelling cylinder there are other forms of writing surface. Thus fig. 142 represents the *spring myograph* of Du Bois Reymond. Here a blackened glass plate is shot along by the recoil of a spring; as it travels it kicks over a key, and the result of this, the muscular contraction, is written on the plate.

The *pendulum myograph* (fig. 143) is another form. Here the movement of the pendulum along a certain arc is substituted for the clockwork of the cylinder, or the spring of Du Bois Reymond. The pendulum carries a smoked glass plate upon which the writing-point of the muscle lever is made to mark. The break

shock is sent into the muscle-nerve preparation by the pendulum in its swing opening a key in the primary circuit. This is shown in an enlarged scale in BC (fig. 143).

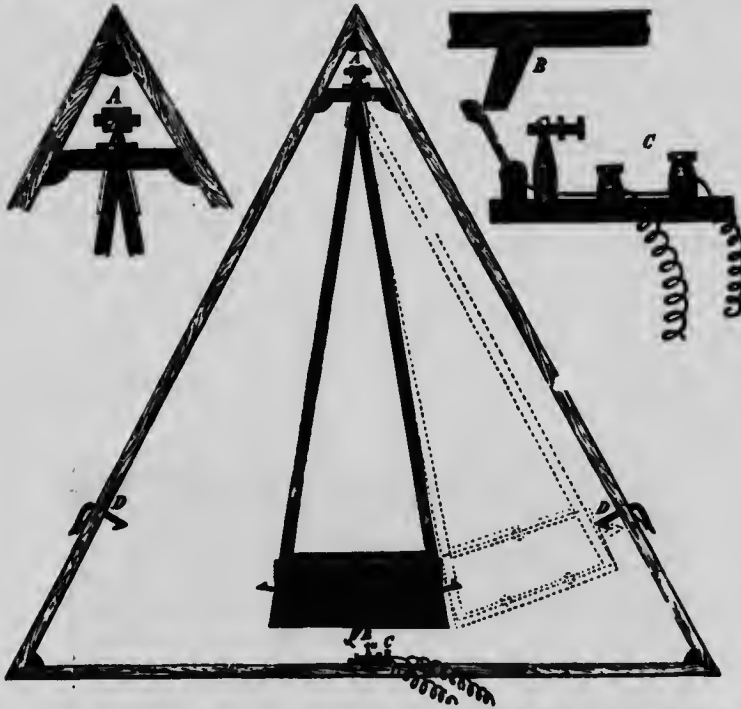

Fig. 143.—Simple form of pendulum myograph and accessory parts. *A*, pivot upon which pendulum swings; *B*, catch on lower end of myograph opening the key, *C*, in its swing; *D*, a spring-catch which retains myograph, as indicated by dotted lines, and on pressing down the handle of which the pendulum swings along the arc to *D* on the left of figure, and is caught by its spring.

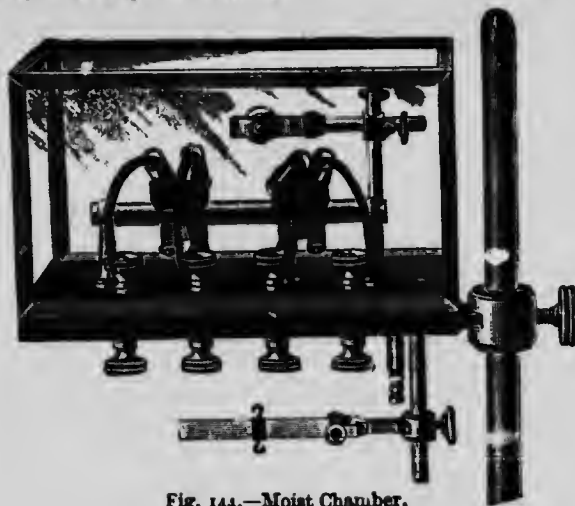

Fig. 144.—Moist Chamber.

To keep the preparation fresh during an experiment, it should be covered with a glass shade, the air of which is kept moist by means of wet blotting paper. A somewhat elaborate form of *moist chamber* is shown in fig. 144.

The last piece of apparatus necessary is a time-marker, so that the events recorded in the myogram can be timed. The simplest time-marker is a tuning-fork vibrating 100 times a second. This is struck, and by means of a writing-point fixed on to one of the prongs of the fork, these vibrations may be written beneath the myogram. More elaborate forms of electrical time-markers or *chronographs* are frequently employed.

### The Simple Muscle Curve.

We can now pass on to results, and study first the result of a single induction shock upon a muscle-nerve preparation.

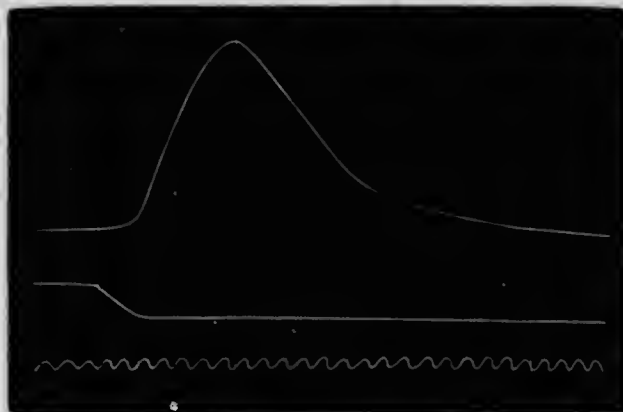

Fig. 145.—Simple muscle curve. (M. Foster.)

A single momentary stimulation causes a single or *simple muscular contraction*, or as it is often called a *twitch*. The graphic record of such a contraction is called the *simple muscle curve*. One of these is shown in the preceding figure (fig. 145).

The upper line (*m*) represents the curve traced by the end of the lever in connection with a muscle after stimulation of the muscle by a single induction-shock: the middle-line (*l*) is that described by a lever, which indicates by a sudden drop the exact instant at which the induction-shock is given. The lower wavy line (*t*) is traced by a tuning-fork vibrating 200 times a second, and serves to measure precisely the time occupied in each part of the contraction.

It will be observed that after the stimulus has been applied as indicated by the vertical line *s*, there is an interval before the contraction commences, as indicated by the line *c*. This interval, termed (*a*) the **latent period**, when measured by the number of vibrations of the tuning-fork between the lines *s* and *c*, is found to be about  $\frac{1}{100}$  sec. During the latent period there is no *apparent* change in the muscle.

The second part is the (*b*) **stage of contraction proper**. The lever is raised by the contraction of the muscle. The contraction is at first very rapid, but then progresses more slowly to its maximum, indicated by the line *mx*, drawn through its highest point. It occupies in the figure  $\frac{5}{100}$  sec. (*c*) The next stage, **stage of elongation**. After reaching its highest point, the lever begins to descend, in consequence of the elongation of the muscle. At first the fall is rapid, but then becomes more gradual until the lever reaches the *abscissa* or base line, and the muscle attains its pre-contraction length, indicated in the figure by the line *c'*. The stage occupies  $\frac{1}{200}$  second. Very often after the main contraction the lever rises once or twice to a slight degree, producing small curves (as in fig. 147). These contractions, due to the elasticity of the muscle, constitute the (*d*) **Stage of elastic after-vibration**, or contraction remainder.

The whole contraction occupies about  $\frac{1}{10}$  of a second. With regard to the latent period, it should be pointed out that if the muscle is stimulated indirectly, *i.e.*, through its nerve, some of the apparent lost time is occupied in the propagation of the nervous impulse along the nerve. To obtain the true latent period, this must be deducted. Then there is generally latency in the apparatus, friction of the lever, &c., to be taken into account. This can be got rid of by photographing the contracting muscle, on a sensitive photographic plate travelling at an accurately-timed rate. By such means it is found that the true latent period is much shorter than was formerly supposed. It is only  $\frac{1}{400}$  of a second. In red muscles it is longer.

We now come to the action of various factors in modifying the character of the simple muscle curve.

1. *Influence of strength of stimulus*.—A minimal stimulus is that which is just strong enough to give a contraction. If the strength of stimulus is increased the amount of contraction as measured by the height of the curve is increased, until a certain point is reached (maximal stimulus), beyond which increase in the stimulus produces no increase in the amount of contraction. The latent period is shorter with a strong than with a weak stimulus.

2. *Influence of load*.—Up to a certain point increase of load increases the amount of contraction, beyond which it diminishes, until at last a weight

is reached which the muscle is unable to lift. The latent period is somewhat longer with a heavy load than with a light one.

3. *Influence of fatigue.*—This can be very well illustrated by letting the muscle write a curve with every revolution of the cylinder until it ceases to contract altogether. The next diagram shows the early stages of fatigue.

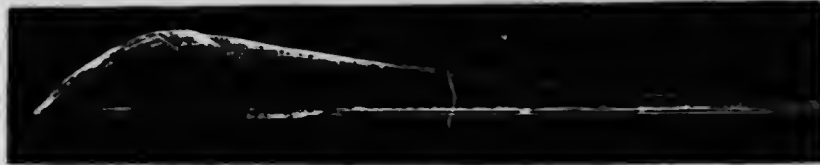

Fig. 146.—Fatigue.

At first the contractions improve, each being a little higher than the preceding; this is known as the *beneficial effect of contraction*, and the graphic record is called a *staircase*. Then the contractions get less and less. But what is most noticeable is that the contraction is much more prolonged; the latent period gets longer; the period of contraction gets longer; and the period of relaxation gets very much longer; there is a condition known as *contracture*, so that the original base line is not reached by the time the next stimulus arrives. In the last stages of fatigue, contracture passes off.



Fig. 147.—Effect of temperature on a single muscular contraction; *N*, normal; *H*, warm; *C1*, cooling; *C2*, very cold; *P*, point of stimulation. The above tracing is a considerably reduced fac-simile of a tracing taken with the pendulum myograph.

4. *Effect of temperature.*—Cold at first increases the height of contraction, then diminishes it; otherwise the effect is very like that of fatigue increasing the duration of all stages of the curve.

Moderate warmth increases the height and diminishes the duration of all stages of the curve, latent period included. This may be



Fig. 148.—Veratrine curve, taken on a very slowly-travelling cylinder; the time tracing indicates seconds.

readily shown by dropping some warm salt solution\* on to the muscle before taking its curve. Too great heat (above 40° c.) induces *heat rigor* due to the coagulation of the muscle-proteids.

5. *Effect of veratrine.*—If this is injected into the frog before the muscle-nerve preparation is made, the very remarkable result seen in the preceding diagram is produced on stimulation; there is an enormous prolongation of the period of relaxation; marked by a secondary rise, and sometimes by tremors. After repeated stimulation this effect passes off, but returns after a period of rest.

### The Muscle-Wave.

The first part of a muscle which contracts is the part where the nerve fibres enter; but nerve impulses are so rapidly carried

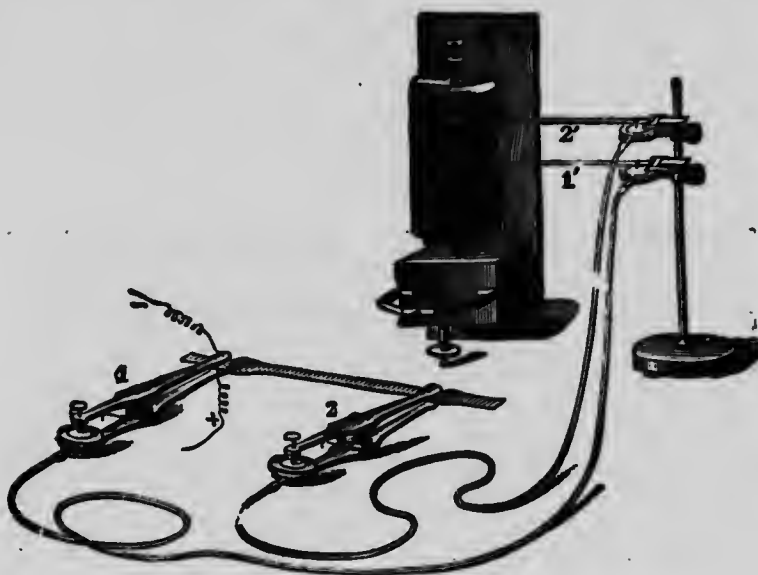

Fig. 149. - Arrangement for tracing the muscle-wave. (M'Kendrick.)

to all the fibres that for practical purposes they all contract together. But in a nerveless muscle, that is one rendered physiologically nerveless by curare, if one end of the muscle is stimulated, the contraction travels as a wave of thickening to the other end of the muscle, and the rate of propagation of this wave can be recorded graphically. The above figure (fig. 149) represents one of the numerous methods that have been devised for this purpose. A muscle with long parallel fibres, like the sartorius, is taken; it

\* Physiological saline solution used for bathing living tissue is a 0.7 to 0.9 per cent. solution of sodium chloride.

is represented diagrammatically in the figure. It is stimulated at the end, where the two wires, + and —, are placed; it is grasped in two places by pincers, which are opened by the wave of thickening; the opening of the first pair of pincers (1) presses on a drum or tambour connected to a second tambour with a recording lever (1'), and this lever goes up first; the lever (2') of the tambour connected with the second pair of pincers (2) goes up later. If the length of muscle between the pairs of pincers is measured, and by a time-tracing the delay in the raising of the second lever is ascertained, we have the arithmetical data for calculating the rate of propagation of the muscle wave. It is about 3 metres per second in frog's muscle, but is hastened by warmth and delayed by cold and fatigue.

#### The Effect of Two successive Stimuli.

If a second stimulus follows the first stimulus, so that the muscle receives the second stimulus before it has finished co-



Fig. 150.—Tracing of a double muscle-curve. To be read from left to right. While the muscle was engaged in the first contraction (whose complete course, had nothing intervened, is indicated by the dotted line), a second induction-shock was thrown in, at such a time that the second contraction began just as the first was beginning to decline. The second curve is seen to start from the first, as does the first from the base line. (M. Foster.)

tracting under the influence of the first a second curve will be added to the first, as shown in the accompanying diagram (fig. 150). The third little curve is only due to elastic after-vibration. This is called *super-position*, or *summation of effects*.

If the two stimuli are in such close succession that the second occurs during the latent period of the first, the result will differ according as the stimuli are maximal or submaximal. If they are maximal, the second stimulus is without effect; but if sub-

maximal, the two stimuli are added together, and though producing a simple muscle curve, produce one which is bigger than either would have produced separately. This is *summation of stimuli*.

#### Effect of More than Two Stimuli.

Just as a second stimulus adds its curve to that written as the result of the first, so a third stimulus superposes its effect on the



Fig. 151.—Curve of incomplete tetanus, obtained from the gastrocnemius of a frog, where the shocks were sent in from an induction coil, about sixteen times a second, by the interruption of the primary current by means of a vibrating spring, which dipped into a cup of mercury, and broke the primary current at each vibration. (Tracing to be read right to left.)

second ; a fourth on the third, and so on. Each successive increment is, however, smaller than the preceding, and at last the muscle remains at a maximum contraction, till it begins to relax from fatigue.



Fig. 152.—Curve of complete tetanus, from a series of very rapid shocks from a magnetic interrupter. (Tracing to be read right to left.)

A succession of stimuli may be sent into the nerve of a nerve-muscle preparation by means of the Wagner's hammer of a coil, or the vibrating reed previously mentioned (p. 117). This method of stimulation is called *faradisation*. Figs. 151 and 152 show



the kind of tracings one obtains. The number of contractions corresponds to the number of stimulations; the condition of prolonged contraction so produced, the muscle never relaxing completely between the individual contractions of which it is made up, is called *tetanus*: *incomplete tetanus*, or *clonus*, when the individual contractions are discernible (fig. 151); *complete tetanus*, as in fig. 152, when the contractions are completely fused to form a continuous line without waves.

The rate of faradisation necessary to cause complete tetanus varies a good deal; for frog's muscle it averages 15 to 20 per second; for the pale muscles of the rabbit, 20 per second; for the more slowly contracting red muscles of the same animal, 10 per second; and for the extremely slowly contracting muscles of the tortoise 2 per second is enough. With fatigue, the rate necessary to produce complete tetanus is diminished.

#### Voluntary Tetanus.

We have seen that voluntary muscles under the influence of artificial stimuli may be made to contract in two ways; a single excitation causes a single contraction; a rapid series of excitations causes a series of contractions which fuse to form tetanus.

We now come to the important question, in which of these two ways does voluntary muscle ordinarily contract in the body? The answer to this is, that voluntary contraction resembles, though it is not absolutely identical with, tetanus artificially produced. It is certainly never a twitch. The nerve-cells from which the motor fibres originate do not possess the power of sending isolated impulses to the muscles; they send a series of impulses which result in a muscular tetanus,\* or *voluntary tetanus*, as it may conveniently be termed.

If a stethoscope is placed over any contracting muscle of the human body, such as the biceps, a low sound is heard. The tone of this sound, which was investigated by Wollaston, and later by Helmholtz, corresponds to thirty-six vibrations per second; this was regarded as the first overtone of a note of eighteen vibrations per second, and for a long time 18 per second was believed to be the rate of voluntary tetanus.

The so-called "muscle sound" is, however, no indication of the rate of muscular vibration. Any irregular sound of low intensity will produce the same note; it is, in fact, the natural resonance-tone of the membrana tympani of the ear, and, therefore, selected

---

\* The use of the word tetanus in physiology must not be confounded with the disease known by the same name, in which the most marked symptom is an intense condition of muscular tetanus or *cramp*.

by the organ of hearing when we listen to any irregular mixture of faint, low-pitched tones and noises.

A much more certain indication of the rate of voluntary tetanus is obtained by the graphic method. The myographs hitherto described are obviously inapplicable to the investigation of such a problem in man. The instrument employed is termed a *transmission myograph*. The next figure shows the recording part of the apparatus.

It is called a Marey's Tambour. It consists of a drum, on the membrane of which is a metallic disc fastened near one end of a lever, the far extremity of which carries a writing point. The interior of the drum is connected by an india-rubber tube (seen at

Screw to regulate elevation of lever.

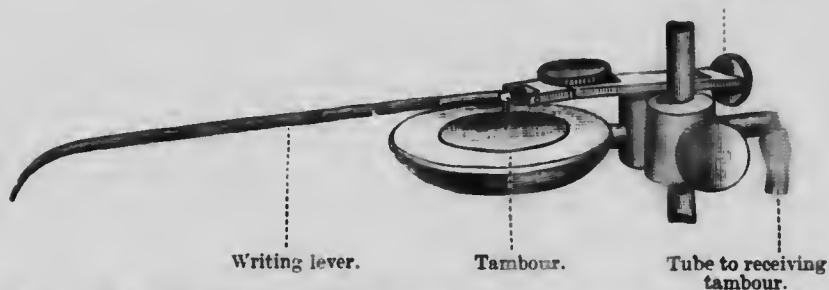

Fig. 153.—Marey's Tambour, to which the movement of the column of air in the first tambour is conducted by a tube, and from which it is communicated by the lever to a revolving cylinder, so that the tracing of the movement is obtained.

the right-hand end of the drawing) to a second tambour called the receiving tambour, in which the writing lever is absent. Now if the receiving tambour is held in the hand, and the thumb presses on the metallic disc on the surface of its membrane, the air within it is set into vibrations of the same rate as those occurring in the thumb muscles; and these are propagated to the recording tambour and are written in a magnified form by the end of the lever on a recording travelling surface.

The tracing obtained is very like that in fig. 151; it is an incomplete tetanus, which by a time marker can be seen to be made up of 10 to 12 vibrations a second.

In some diseases these tremors are much increased, as in the clonic convulsions of epilepsy, or those produced by strychnine poisoning, but the rate is the same.

Similar tracing can be obtained in animals by strapping the receiving tambour on the surface of a muscle, and causing it to contract by stimulating the brain or spinal cord. The rate of stimulation makes no difference; however slow or fast the

stimuli occur, the nerve-cells of the central nervous system give out impulses at their own normal rate.

The same is seen in a reflex action. If a tracing is taken from a frog's gastrocnemius, the muscle being left in connection with the rest of the body, its tendon only being severed and tied to a lever, and if the sciatic nerve of the other leg is cut through, and the end attached to the spinal cord is stimulated, an impulse passes up to the cells of the cord, and is then reflected down to the gastrocnemius, under observation. The impulse has thus to traverse nerve-cells; the rate of stimulation then makes no difference; the reflex contraction occurs at the same rate, 10 or 12 per second.

But now a difficulty arises; if a twitch only occupies  $\frac{1}{10}$  of a second, there would be time for ten complete twitches in a second; they would not fuse to form even an incomplete tetanus. There must be some means by which each individual contraction can be lengthened till it fuses with the next contraction; or, in other words, our results of electrical stimulation of excised muscles must not be applied without reserve to the contraction of the intact muscles in the living body in response to the will. Recent experiments made by Sir J. Burdon Sanderson on the electrical variation that accompanies voluntary movements, have shown that this is the case: each component of the so-called voluntary tetanus is a much-prolonged single contraction; a condition which closely resembles the tonic contraction of involuntary muscle.

*Lever Systems.*—The arrangement of the muscles, tendons, and bones presents examples of the three systems of levers which will be known to anyone who has studied mechanics; the student of anatomy will have no difficulty in finding examples of all three systems in the body. What is most striking is that the majority of cases are levers of the third kind, in which there is a loss of the mechanical power of a lever, though a gain in the rapidity and extent of the movement.

Most muscular acts involve the action of several muscles, often of many muscles. The acts of walking and running are examples of very complicated muscular actions in which it is necessary not only that many muscles should take part, but also must do so in their proper order and in due relation to the action of auxiliary and antagonistic muscles. This harmony in a complicated muscular action is called *co-ordination*.

By the device of taking instantaneous photographs at rapidly repeated intervals during a muscular act, the details of different modes of locomotion in man and other animals have been very thoroughly worked out. With this branch of research the name of Prof. Marey is intimately associated.

## CHAPTER XI.

## EXTENSIBILITY, ELASTICITY, AND WORK OF MUSCLE.

MUSCLE is both *extensible* and *elastic*. It is stretched by a weight, that is, it possesses *extensibility*; when the weight is taken off, it returns to its original length, that is, it possesses *elasticity*. The two properties do not necessarily go together; thus a piece of putty is very extensible, but it is not elastic;

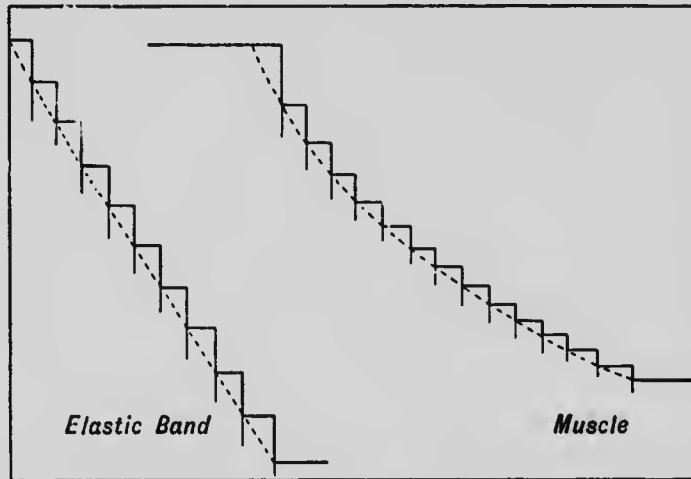

Fig. 154.—(After Waller.)

a piece of steel or a ball of ivory are only slightly extensible, but after the stretching force has been removed they return to their original size and shape very perfectly.

A substance is said to be *strongly elastic*, when it offers a great resistance to external forces: steel and ivory are strongly elastic.

A substance is said to be perfectly elastic, when its return to its original shape is absolute; again steel and ivory may be quoted as examples.

Muscle is very extensible, *i.e.*, it is easily stretched; it is feebly elastic, *i.e.*, it opposes no great resistance to external force; it is, however, perfectly elastic; that is, it returns to its original shape very exactly after stretching. This is true in the case of living muscle within the body, but after very great stretching

even in the body, and still more so after removal from the body, when it begins to undergo degenerative changes culminating in death, its elasticity is less perfect. The cohesion of muscular tissue is less than that of tendon. E. Weber stated that a frog's muscle one centimetre square in transverse section will support a weight of a kilogramme (over 2 lbs.) without rupture, but this diminishes as the muscle gradually dies.

The extensibility of any material may be studied and recorded by measuring the increase of length which occurs when that material is loaded with different weights. In Helmholtz' myograph (fig. 140), different weights may be placed in the scale-pan beneath the muscle, and the increase of length recorded on a stationary blackened cylinder by the downward movement of the writing point; the cylinder may then be moved on a short distance, more weight added, and the additional increase of length similarly recorded, and so on for a succession of weights.

If this experiment is done with some non-living substance, like a steel spring or a piece of india-rubber, instead of a living muscle, it is found that the amount of stretching is proportional to the weight; a weight = 2 produces an extension twice as great as that produced by a weight = 1; in this way one obtains a tracing like that seen on the left hand of figure 154, and the dotted line drawn through the lowest points of the extensions is a straight one.

With muscle, however, this is different; each successive addition of the same weight produces smaller and smaller increments of extension, and the dotted line obtained is a curve.

A continuous curve of extensibility may be obtained by placing a gradually and steadily increasing force beneath the muscle instead of a succession of weights added at intervals. The most convenient way of doing this is to use a steel spring, which is gradually and steadily extended; and the writing point connected to the muscle inscribes its excursion on a slowly moving cylinder. If, then, after the muscle has been stretched, the steel spring is gradually and steadily relaxed, the muscle retracts and again writes a curve now in the reverse direction, until it regains its original length.\* But in muscles removed from the body, unless they are very slightly loaded, the return to the original length is never complete; the muscle is permanently longer to a slight extent, which varies with the amount of the previous loading.

\* A mathematical examination of these curves shows that they are not rectangular hyperbola, as they were once considered. They are very variable in form and cannot be identified with any known mathematical curve.

If the muscle is slowly loaded and slowly unloaded, the curvature of its tracing is much more marked than if the experiment is done rapidly.

The following three tracings are reproduced from some obtained by Dr. Brodie. In the method used, the records are not complicated by the curve of a lever, but the movement was simply magnified by a beam of light falling on a mirror attached to the end of the muscle, and reflected on to a travelling photographic plate. Each tracing is to be read from right to left; the first one (A) shows the result of stretching a steel spring by a steadily increasing force; the end of the spring gets lower and lower, and describes a straight line; at the apex of the tracing unloading began and went on steadily till the spring once more regained its initial length. The upstroke, like the downstroke, is a straight line. In B and C muscles were used; it will be noticed that the muscle does not regain its original length after unloading, and that after unloading the upward tendency of the tracing represents after-retraction. In B, the extension was applied rapidly, the tracing is almost a straight line; in C, the extension was brought about more slowly, and the tracing is a curve; in both cases the tracing of the period of unloading shows more curvature.

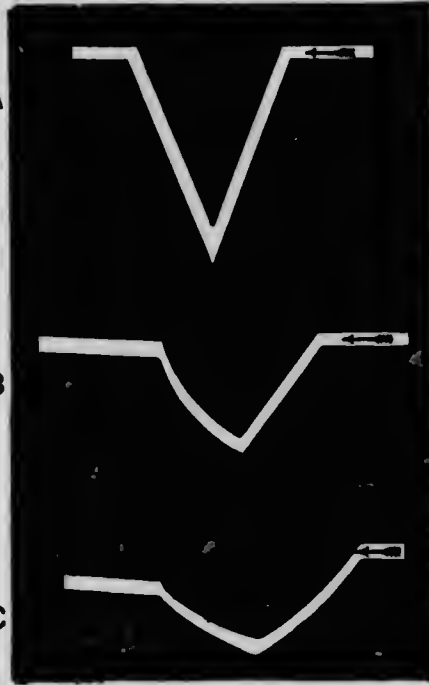

Fig. 155.—Curves of extensibility. (Brodie.)

This introduces us to what is called *after extension* and *after retraction*. That is to say, after a muscle is weighted there is an immediate elongation, followed by a gradual elongation which continues for some time; or if a muscle has been weighted and is then unloaded there is an immediate slackening, followed by a gradual after retraction.

This may be shown by looking at the graphic records shown in the next diagram. It will be noticed that the extension is

greatest when the muscle is in a contracted condition, and smallest when it is dead (in rigor). In fatigue the after extension is very marked, and the return after unloading very imperfect.

We may now give the results of an actual experiment; a muscle was loaded with successive weights of 50, 100, 150, etc., grammes, and its length carefully measured in centimetres.

Load . . . . .	50	100	150	200	250	300
Total extension . . .	3.2	6	8	9.5	10	10.3
Increment of extension	—	2.8	2	1.5	0.5	0.3

Figure 156 shows that the contracted muscle is more extensible than the uncontracted muscle. This may be still further illustrated by an example given on the opposite page in the form of a diagram.

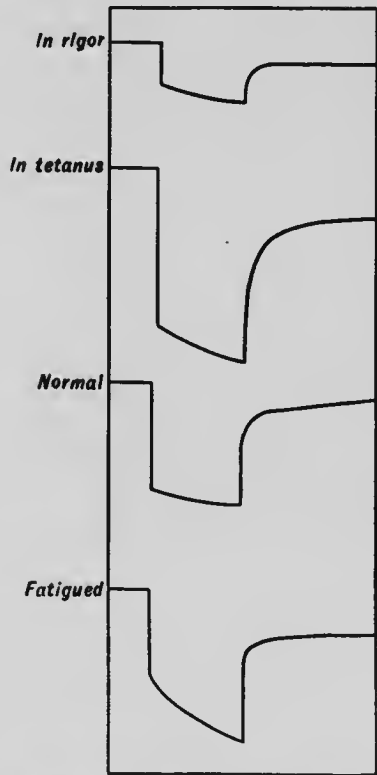

Fig. 156.—Extensibility of muscle in different states; tested by 50 grammes applied for short periods. Tracings to be read from left to right. (After Waller.)

The thick lines represent the contracted muscle, the thin ones the uncontracted. It is represented as being stretched by different weights indicated along the top line; and the lengths under the influence of these weights are separated by equal distances. Thus A C represents the length of the uncontracted muscle, A B of the contracted muscle when unloaded. A' C' and A' B' the same under the influence of a weight of 50 grammes, and so on.

The curve connecting the ends of the lengths of the contracted muscle falls faster than that obtained from the uncontracted one, until at the point P under the influence of a weight of 250 grammes, the two curves meet; that is to say, 250 grammes is the weight which the muscle is just unable to lift. Suppose a muscle has to lift the weight of

200 grammes, it begins with a length A'' C'', but when it contracts it has a length A'' B'', that is, it has contracted a distance of B'' C'', which is very small; when it has to lift a less weight

it shortens more, when a greater weight it shortens less ; till when it shortens least it lifts the greatest weight.

This experiment illustrates the general truth that when a muscle is contracted it is more extensible. At the point P the energy tending to shorten the muscle (its contractile power) is exactly equal to the energy tending to lengthen it against its elastic force. Thus we have the apparent paradox at this point that a muscle when contracted has exactly the same length as when uncontracted ; but this is a matter of everyday experience ; if one tries to lift a weight beyond one's strength, one fails to raise it, but nevertheless one's muscles have been contracting in

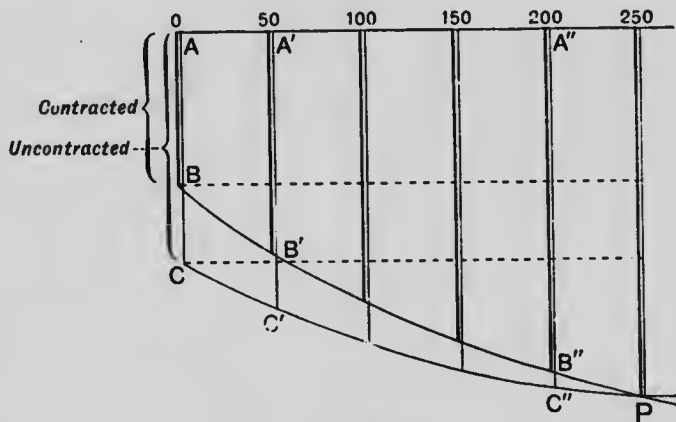

Fig. 157.

the effort ; they have not contracted in the narrow sense of becoming shorter, but that is not the only change a muscle undergoes when it contracts ; the other changes, electrical, thermal, chemical, etc., have taken place, as evidenced in one's own person by the fact that the individual has got warm in his efforts, or may even feel fatigue afterwards.

But the paradox does not end here, for if diagram 157 is again looked at, it will be seen that beyond the point P the two curves cross ; in other words, the muscle may even elongate due to increase of extensibility when it contracts. This is known after its discoverer as *Weber's paradox*.

*Influence of Temperature on Extensibility.*—If a piece of iced india-rubber is taken and stretched by a weight, its retractility when the weight is removed is very small. If, now, when the weight is on it, it is warmed at one point as by placing the hand on it, its retractility is increased and it contracts, raising the weight. Some physiologists have considered that muscular con-



traction can be explained in this way; they have supposed that the heat formed in muscular contraction acts like warmth as applied to india-rubber. This view is, however, incorrect. It is much more probable that there is no causal relationship between the temperature-change and the extensibility-change which occur when muscle contracts; both are simultaneously produced by a common cause, called a stimulus.

Moreover, the influence of heat on muscle is by no means the same as that on india-rubber. This influence is not invariable, and at certain temperatures near the freezing-point, and under the influence of certain weights, actual elongation may occur when the temperature is raised.

### Muscular Tonus.

In the living animal, muscles are more or less stretched, but never taut between their two attachments. They are in a state of *tonicity* or *tonus*, and when divided they contract and the two parts separate. Thus a muscle, even at rest, is in a favourable condition to contract without losing time or energy in taking in slack.

Muscular tonus is under the control of the nervous system (on the reflex character of this control, see later, under Tendon Reflexes, Chapter XLVII.); the muscles lengthen when their nerves are divided, or when they are rendered physiologically nerveless by curare. Besides the nervous system, the state of muscular nutrition dependent on a due supply of healthy blood must also be reckoned as important in maintaining muscular tonus.

### Work of Muscle.

The question of muscular work is intimately associated with that of elasticity. In a technical sense, work ( $W$ ) is the product of the load ( $l$ ) and the height ( $h$ ) to which it is raised.  $W = l \times h$ .

Thus in fig. 157, when the muscle is unloaded the work done is *nil*:  $W = BC \times 0 = 0$ . When the load is 250, again the work done is *nil*, because then  $h = 0$ . With the load 50,  $W = B'C' \times 50$ .

If the height is measured in feet and the load in pounds, work is expressed in terms of foot-pounds. If the height is measured in millimetres or metres, and the load in grammes, the work is expressed in gramme-millimetres or gramme-metres respectively.

This may be shown diagrammatically by marking on a horizontal base line or abscissa, distances proportionate to different weights, and vertical lines (ordinates) drawn through these represent the height to which they are lifted (see fig. 158).

In the diagram (fig. 158) the figures along the base line represent grammes, and the figures along the vertical line represent millimetres. The work done as indicated by the first line is  $10 \times 5 = 50$  gramme-millimetres, the next  $20 \times 6 = 120$  gramme-millimetres,



Fig. 158.—Diagram to show the mode of measuring muscle work. (M'Kendrick.)

and so on, while the last on the right,  $100 \times 3 = 300$  gramme-millimetres. It is thus seen that the height of a muscle curve is no measure of the work done by the muscle unless the weight lifted is taken into account as well.

The following figures are taken from an actual experiment done with the frog's gastrocnemius (Weber):—

Weight lifted.	Height.	Work done.
5 grammes	27.6 millimetres	138 gramme-millimetres
15 "	25.1 "	376 "
25 "	11.45 "	286 "
30 "	7.3 "	219 "

The work increases with the weight up to a certain maximum, after which a diminution occurs, more or less rapidly, according as the muscle is fatigued.

Similar experiments have been made in human beings, weights being lifted by the calf muscles, or elbow muscles, leverage being allowed for. In the higher animals the energy so obtained compared with the frog is about twice as great for the same volume of muscular tissue.

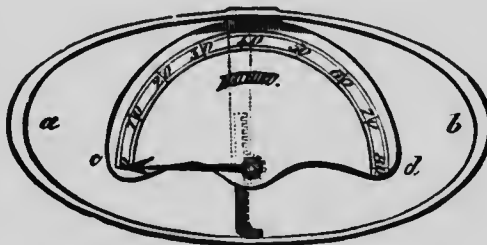

Fig. 159.—Dynamometer.

Fig. 159 represents a common form of dynamometer for clinical use, employed in testing the muscles of the arms and

hands. It is squeezed by the hand, and an index represents kilogrammes of pressure.

The muscle, regarded as a machine, is sometimes compared to artificial machines like a steam-engine. A steam-engine is supplied with fuel, the latent energy of which is transformed into work and heat. The carbon of the coal unites with oxygen to form carbonic acid, and it is in this process of combustion or oxidation that heat and work are liberated. Similar, though more complicated, combustions occur in muscle. In a steam-engine a good deal of fuel is consumed, but there is great economy in the consumption of the living muscular material. Take the work done by a gramme (about 15 grains) of muscle in raising a weight of 4 grammes to the height of 4 metres (about 13 feet); in doing this work probably less than a thousandth part of the muscle has been consumed.

Next let us consider the relationship between the work and the heat produced. An ordinary locomotive wastes about 96 per cent. of its available energy as heat, only 4 per cent. being represented as work. In the best triple-expansion steam-engine the work done rises to 12.5 per cent. of the total energy.

In muscle, various experimenters give different numbers. Thus, Fick calculated that 33 per cent. of the mechanical energy is available as work; later he found this estimate too high, and stated the number as 25; Chauveau gives 12 to 15; M'Kendrick 17. Thus muscle is a little more economical than the best steam-engines; but the muscle has this great advantage over any engine, for the heat it produces is not wasted, but is used for keeping up the body temperature, the fall of which below a certain point would lead to death not only of the muscles but of the body generally.

So far we have been speaking as though the only active phase of muscular contraction is the period of shortening. It is, however, extremely probable, though not yet proved that lengthening is also an active process. This was originally mooted by Fick, who pointed out that the fall of a muscle lever during the relaxation period is of variable speed, and is obviously not due to the passive elongation of the muscle by gravity; the way in which this part of the curve is varied by such agencies as temperature, and drugs like veratrine, also indicates that relaxation is an independent process.

*Isotonic and Isometric Curves.*—If in recording the contraction of a muscle, the load is applied vertically under the muscle, its pull upon the muscle varies during the successive stages of a single contraction, owing to the inertia of the load. In order to avoid this variation in tension, it is usual to apply the weight at a point close to the fulcrum of the recording lever, so that when the lever is raised, the weight remains practically stationary, and thus the error due to its inertia is avoided. In order to apply the necessary tension to the muscle, the weight hanging on the lever must be increased in the ratio of the distances of the muscle and weight from the fulcrum. A twitch recorded under such circumstances is called

*isotonic, i.e.*, one in which the tension remains constant throughout. If, on the other hand, the muscle is fixed at both ends, and then excited, the resulting activity expresses itself in a phase of increasing tension followed by one of decreasing tension. If the alterations of tension are recorded, we obtain what is called an *isometric* curve. This curve is obtained by making the muscle pull against a spring which is so strong that the muscle can only move it to a very slight extent. This slight movement is then highly magnified. The curve thus obtained resembles in its main features an isotonic contraction, but its maximum is reached earlier, and it returns to the zero position sooner. The flat top of the isometric curve described by the earlier observers was due to the imperfection of the instruments employed. The tracings of muscle curves given in previous illustrations (see figs. 145 to 147) were obtained by the isotonic method, but it is probable that the isometric curve is a more faithful record of the variations in the intensity of the contraction process than that yielded by the isotonic method. The momentum or swing of a light lever such as is used for obtaining isotonic curves will no doubt account for the extra upward movement it executes. The whole matter is under keen discussion at present, and the foregoing view is that expressed by Kaiser. Sehenk, on the other hand, maintains what appears to be an improbable idea that there are really two kinds of change in muscle, which account for the difference obtained by the two methods.

---

## CHAPTER XII.

### THE ELECTRICAL PHENOMENA OF MUSCLE.

WE have seen that the chemical processes occurring in muscular contraction lead to a transformation of energy into work and heat. These changes are accompanied by electrical disturbances also.

The history\* of animal electricity forms one of the most fascinating of chapters in physiological discovery. It dates from 1786, when Galvani made his first observations. Galvani was Professor of Anatomy and Physiology at the University of Bologna, and his wife was one day preparing some frogs' legs for dinner, when she noticed that the apparently dead legs became convulsed when sparks were emitted from a frictional electrical machine which stood by. Galvani then wished to try the effect of lightning and atmospheric electricity on animal tissues. So he hung up some frogs' legs to the iron trellis-work round the roof of his house by means of copper hooks, and saw that they contracted whenever the wind blew them against the iron. He

---

\* For a full and interesting account of this subject the reader is referred to Professor M'Kendrick's "Text-book of Physiology," vol. i., chap. xviii. The account in the text is mainly a brief summary of this chapter.

imagined this to be due to electricity secreted by the animal tissues, and this new principle was called *Galvanism*. But all his contemporaries did not agree with this idea, and most prominent among his opponents was Volta, Professor of Physics at another Italian university, Pavia. He considered that the muscular contractions were not due to animal electricity, but to artificial electricity produced by contact with different metals.

The controversy was a keen and lengthy one, and was terminated by the death of Galvani in 1798. Before he died, however, he gave to the world the experiment known as "contraction without metals," which we shall study presently, and which conclusively proved the existence of animal electricity. Volta, however, never believed in it. In his hand electricity took a physical turn, and the year after Galvani's death he invented the Voltaic pile, the progenitor of our modern batteries. Volta was right in maintaining that galvanism can be produced independently of animals, but wrong in denying that electrical currents could be obtained from animal tissues. Galvani was right in maintaining the existence of animal electricity, but wrong in supposing that the contact of dissimilar metals with tissues proved his point.

This conclusion has been arrived at by certain new methods of investigation. In 1820 Oersted discovered electro-magnetism:

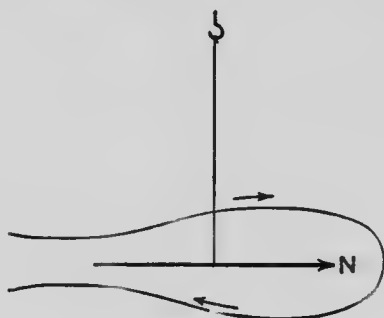

Fig. 160.

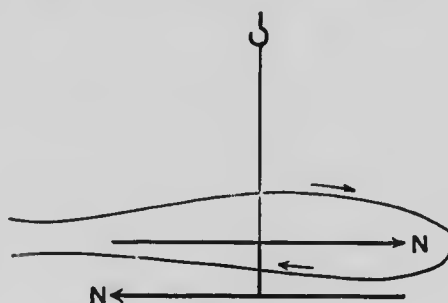

Fig. 161.

that is, when a galvanic current passes along a wire near a magnetic needle, the needle is deflected one way or the other, according to the direction of the current. This led to the invention of the astatic needle and the galvanometer, an instrument by which very weak electrical currents can be detected. For a long time the subject of animal electricity, however, fell largely into disrepute, because of the quackery that grew up around it. It is not entirely free from this evil nowadays; but the scientific investigation of the subject has led to a considerable increase of

knowledge, and among the names of modern physiologists associated with it must be particularly mentioned those of Du Bois Reymond and Hermann.

Before we can study these it is, however, necessary that we should understand the instruments employed.

**The Galvanometer.**—The essential part of a galvanometer is a magnetic needle suspended by a delicate thread; a wire coils round it; and if a current flows through the wire, the needle is deflected. Suppose a man to be swimming with the current with his

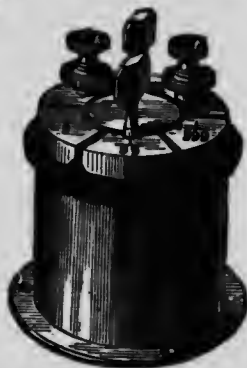
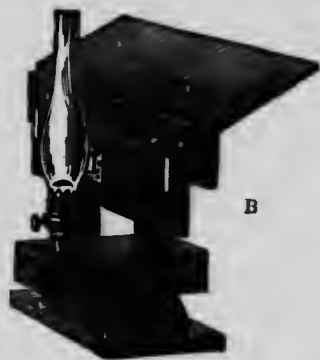

Fig. 162. — Reflecting galvanometer. (Thomson.)

A. The galvanometer consists of two systems of small astatic needles suspended by a fine hair from a support, so that each set of needles is within a coil of fine insulated copper wire, that forming the lower coil being wound in an opposite direction to the upper. Attached to the upper set of needles is a small mirror about  $\frac{1}{4}$  inch in diameter; the light from the lamp at B is thrown upon this little mirror, and is reflected upon the scale on the other side of B, not shown in figure. The coils *u* are arranged upon brass uprights, and their ends are carried to the binding screws. The whole apparatus is placed upon a vulcanite plate capable of being levelled by the screw supports, and is covered by a brass-hound glass shade, the cover of which is also of brass, and supports a brass rod *b*, on which moves a weak curved magnet *m*. C is the shunt by means of which the amount of the current sent into the galvanometer may be regulated. When in use the scale is placed about three feet from the galvanometer, which is arranged east and west, the lamp is lighted, the mirror is made to swing, and the light from the lamp is adjusted to fall upon it, and it is then regulated until the reflected spot of light from it falls upon the zero of the scale. The wires from the non-polarisable electrodes touching the muscle are attached to the outer binding screws of the galvanometer, a key intervening for short circuiting, or if a portion only of the current is to pass into the galvanometer, the shunt should intervene as well with the appropriate plug in. When a current passes into the galvanometer the needles and, with them, the mirror, are turned to the right or left according to the direction of the current. The amount of the deflection of the needle is marked on the scale by the spot of light travelling along it.

face to the needle, the north pole is turned to the left hand. But such a simple instrument as that shown in fig. 160 would not detect the feeble currents obtained from animal tissues. It is necessary to increase the delicacy of the apparatus, and this is done in several ways. In the first place, the needle must be rendered *astatic*, that is, independent of the earth's magnetism. The simplest way of doing this is to fix two needles together (as shown in fig. 161), the north pole of one pointing the same way as the south pole of the other. The current is led over one needle and then over the other; the effect is to produce a deflection in each in the same direction, and so the sensitiveness of the instrument is doubled. If now the wire is coiled not only once, but twice or more in the same position, each coil has its effect on the needles; the multiplication of the effect of a weak current in this way is accomplished in actual galvanometers by many hundreds of turns of fine wire.

Fig. 162 illustrates the best galvanometer: that of Sir William Thomson (now Lord Kelvin). It is called a reflecting galvanometer, because the observer does not actually watch the moving needle, but a spot of light reflected from a little mirror, which is attached to and moves with the needle. A very small movement of the needle is rendered evident, because the movement of the spot of light being, as it were, at the end of a long lever—namely, the beam of light, magnifies it.

**Non-polarisable Electrodes.**—If a galvanometer is connected with a muscle by wires which touch the muscle, electrical currents are obtained in the circuit which are set up by the contact of metal with muscle. The currents so obtained form no evidence of electro-motive force in the muscle itself. It is therefore necessary that the wires from the galvanometer should have interposed between them and the muscle some form of electrodes which are non-polarisable. Fig. 163 shows one of the earliest non-polarisable electrodes of Du Bois Reymond. It consists of a zinc trough on a vulcanite base. The inner surface of the trough is amalgamated and nearly filled with a saturated solution of zinc sulphate. In the trough is placed a cushion of blotting-paper, which projects over the edge of the trough; on it there is a pad of china clay or kaolin, moistened with physiological salt solution (0.8 per cent. NaCl); on this pad one end of the muscle rests. The binding screw (*k*) connects the instrument to the galvanometer; the other

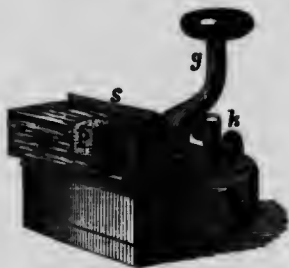

Fig. 163.—Non-polarisable electrode of Du Bois Reymond. (M'Kendrick.)

binding screw (*k*) connects the instrument to the galvanometer; the other

end, or the middle of the same muscle, is connected by another non-polarisable electrode in the same way to the other side of the



Fig. 164.—Diagram of Du Bois Reymond's non-polarisable electrodes. *a*, glass tube filled with a saturated solution of zinc sulphate, in the end, *c*, of which is china clay drawn out to a point; the clay is moistened with 0.6 NaCl solution; in the solution a well amalgamated zinc rod is immersed and connected, by means of the wire *λ*, with the galvanometer. The remainder of the apparatus is simply for convenience of application. The muscle and the end of the second electrode are to the right of the figure.

galvanometer. If there is any electrical difference of potential (that is, difference in amount of positive or negative electricity) between the two parts of the muscle thus led off, there will be a

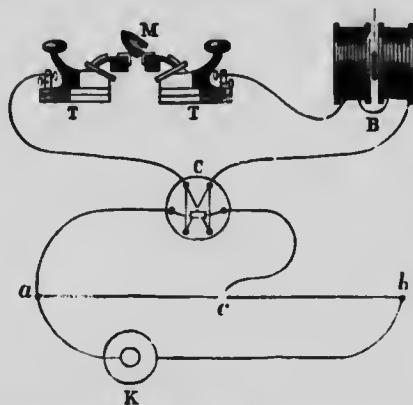

Fig. 165.—Arrangement for measuring the electromotive force of muscle. (M'Kendrick.)

swing of the galvanometer needle; the galvanometer detects the existence and direction of any current that occurs.

Fig. 164 shows a more convenient form of non-polarisable electrodes.



In order to measure the strength (electromotive force) of such currents, the mere amount of swing of the needle is only a very rough indication, and in accurate work the arrangement shown in fig. 165 must be used.

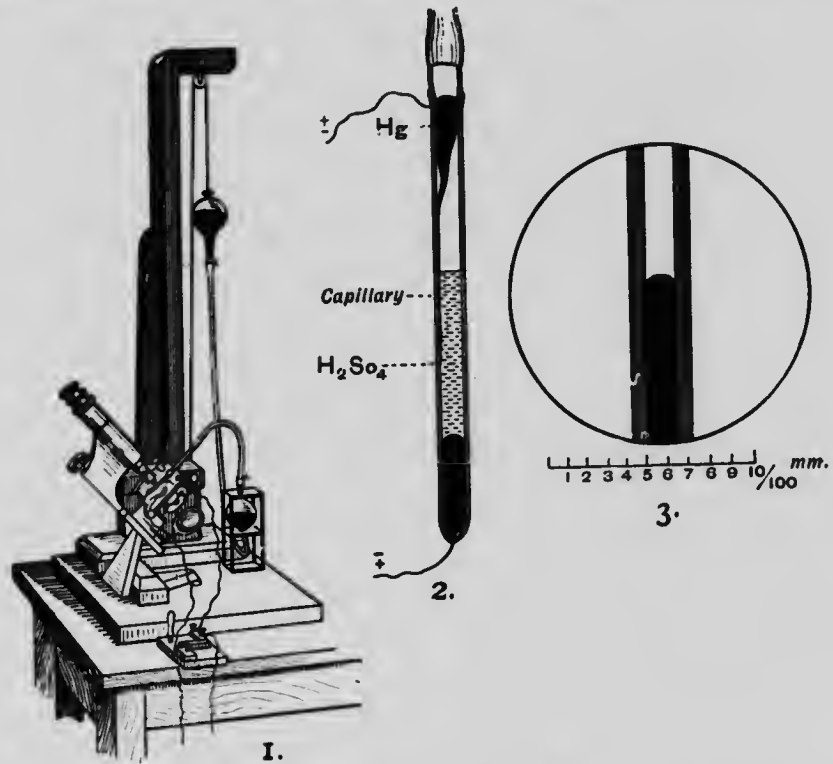

Fig. 166.—Lippmann's Capillary Electrometer. (After Waller.)  
 1. Pressure apparatus and microscope on stand of which the capillary tube is fixed.  
 2. Capillary tube, fixed in outer tube containing 10 per cent. sulphuric acid the platinum wires are also shown.  
 3. Capillary and column of mercury as seen in the field of the microscope.

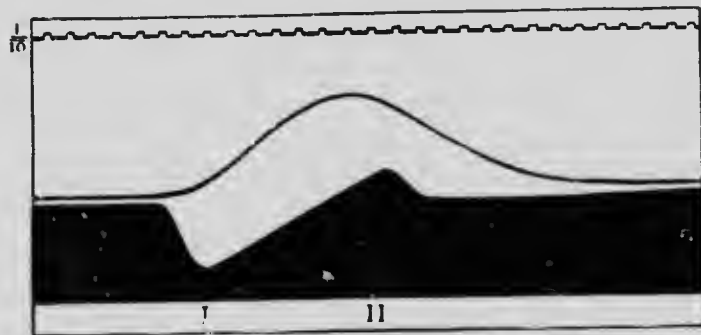

Fig. 167.—Frog's heart. Diastolic variation. Simultaneous photograph of a single beat (upper black line), and the accompanying electrical change indicated by the level of the black area, which shows the varying level of mercury in a capillary electrometer. (Waller.)

The electromotive force is usually measured in terms of a standard Daniell cell. The two surfaces of the muscle (M) are connected to a galvanometer (B); the needle swings, and then a fraction of a Daniell cell is introduced in the reverse direction so as to neutralise the muscle current, and bring

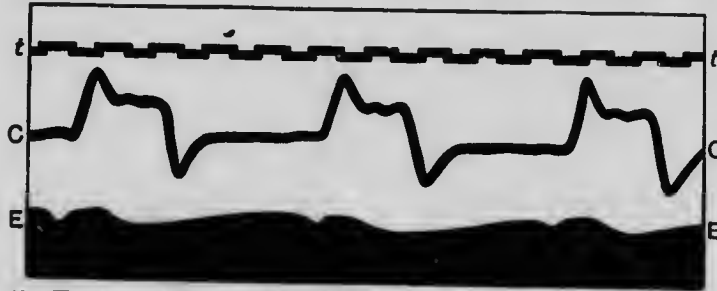

Fig. 168.—Human heart. Diphasic variation, *z*, *z*, and simultaneous cardiogram, *cc*. Time *t* is marked in  $\frac{1}{10}$ th second. The lead-offs to the capillary electrometer were from the mouth to the sulphuric acid, and from the left foot to the mercury. (Waller.)

back the needle to rest. From the Daniell cell *K*, wires pass to the ends *a*, *b* of a long platinum wire of high resistance, called the compensator; *c* is a slider on this wire: *a* and *c* are connected to the galvanometer, the commutator *C* enabling the observer to ensure that the current from the Daniell passes in the opposite direction to that produced by the muscle. If the

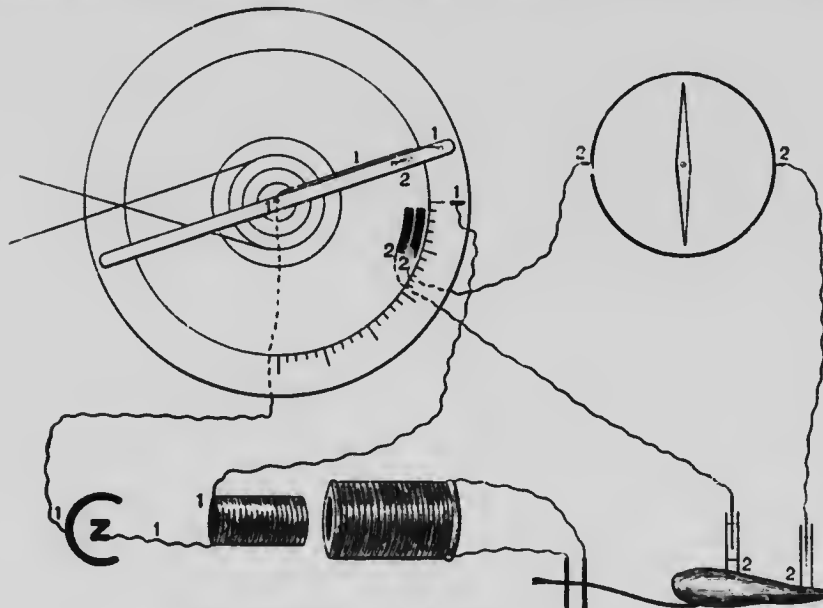

Fig. 109.—Scheme of a Rheotome. (Waller.)

slider *c* is placed at the end *b* of the compensator, the whole strength of the Daniell will be sent through the galvanometer and will more than neutralise the muscle current; if *c* is half way between *a* and *b*, half the Daniell's strength will be sent in; but this is also too much; *ac* will be found to be only quite a small fraction of *ab*; and this fraction will correspond to a proportional fraction of the electromotive force of the Daniell cell.

K.P.

L

**Lippmann's Capillary Electrometer.**—This instrument is often used instead of the galvanometer. It consists of a glass tube drawn out at one end to a fine capillary and filled with mercury. It is connected to an apparatus by which the pressure on this mercury can be lowered or increased. The open capillary tube is enclosed within another tube filled with 10 per cent. sulphuric acid. Two platinum wires fused through the glass, pass respectively into the mercury and the acid, and the other ends of these wires are connected by electrodes to two portions of the surface of a muscle. The capillary tube is observed by a microscope; the surface of the mercury is in a state of tension which is easily increased or diminished by variations of electrical potential, and the mercury moves in the direction of the negative pole.

If the shadow of the mercurial column is thrown upon a travelling sensitive photographic plate, photographs are obtained which show the electrical variations in a living tissue in a graphic manner. The instrument is exceedingly sensitive, and its indications are practically instantaneous. Figs. 167 and 168 indicate the kind of result one obtains with the heart, which will be more fully discussed when we are considering that organ.

**The Rheotome.**—This is an instrument by means of which the time of the occurrence of electrical disturbances in relation to the contraction of a muscle can be determined. This is in principle effected by a revolving bar carrying two contacts, one in the primary or exciting circuit (1, 1, 1, 1), one in the galvanometer circuit (2, 2, 2, 2). The bar revolves, and by making or breaking the primary circuit sends an induction shock into the nerve at the same instant.

The muscle is connected by non-polarisable electrodes to the galvanometer; this circuit includes the brass blocks 2, 2, on the disc over which the bar revolves, and a compensator not shown in the figure to neutralise any current set up by the muscle in a state of rest. If an electrical change occurs in the muscle, it is only noticed by the galvanometer if at the same time the bar on its revolution connects the two brass blocks on the disc, and so completes the circuit. The apparatus can be set so that the bar makes the primary contact (1, 1) simultaneously with the galvanometer contacts, or that the galvanometer contact is made 1, 2, 3, &c. hundredths of a second later than the primary contact. If the two are closed simultaneously the electrical condition of the muscle is tapped off at the moment of excitation; if the galvanometer contact is closed  $\frac{1}{100}$ ,  $\frac{2}{100}$ ,  $\frac{3}{100}$ , &c. second after excitation, the electrical condition of the muscle at that particular instant is ascertained. By a number of experiments with different intervals between the making of the two contacts, one ascertains how long after the excitation the change in the electrical condition of the muscle takes place.

We can now pass on to a consideration of results.

In muscles that are removed from the body, it is found that on leading off two parts of their surface to a galvanometer, the galvanometer needle generally swings. The most marked result is obtained with a piece of muscle in which the fibres run parallel to one another, and the longitudinal surface is connected with one of the cut ends by a wire (2 in fig. 170).

On the course of the wire a galvanometer indicates that a current flows from the centre to the cut end outside the muscle, and from the cut end to the centre inside the muscle. If, now, the muscle is thrown into tetanic contraction, the needle returns more or less completely to the position of rest.

Du Bois Reymond, who first described these facts, called the

first current the *current of rest*, and the second current, the *current of action*; the change in direction is indicated by the expression *negative variation*; this means that the current of action is in the opposite direction to the current of rest, and therefore lessens or neutralises it. The word negative is therefore used in its arithmetical, not its electrical sense. Du Bois Reymond explained this by supposing that a muscular fibre is

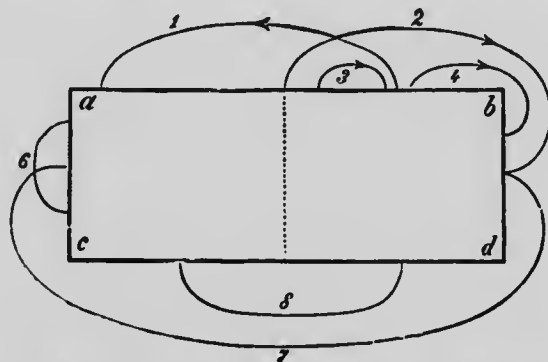

Fig. 170.—Diagram of the currents in a muscle prism. (Du Bois Reymond.)

built up of molecules, each of which is positive in the centre and negative at both ends. So when a muscle is cut across, a number of the negative ends of these molecules is exposed. On contraction the difference between the centre and ends of each molecule is lessened, and the resultant effect on the whole muscle (made up of such molecules) is similar.

There is no doubt about the facts as described by Du Bois Reymond. We now adopt, however, an entirely different view of their meaning: in causing this revolution of ideas the principal part has been played by Hermann. The new idea is that the so-called current of rest does not exist; it is really a current produced by injury, and is now generally called a *demarcation current*: the more the ends of the muscle are injured the more negative they become; and when they are connected to the uninjured centre, a current naturally is set up as described by Du Bois Reymond. If a muscle is at rest and absolutely uninjured it is iso-electric; that is, it gives no current at all when two parts of it are connected together by a wire.

Since Du Bois Reymond's researches, the electrical changes which occur during a single twitch have been studied also, and before we can understand the "negative variation" of tetanus, it is obviously necessary to consider the electrical variation which

takes place during a twitch, for tetanus is made up of a fused series of twitches.

The electrical change during a twitch is called a *diphasic variation*. The contracting part of a muscle becomes first more negative than it was before; it then rapidly returns to its previously positive condition. The increase of negativity indicates a disturbance of the stability of the tissue; the return of the galvanometer needle is the result of a return of the muscular tissue to a state of rest. If the muscle is stimulated at one end, a wave of contraction travels along it to the other end. This muscle wave (see p. 125) may be most readily studied in a curarised muscle, that is, in a muscle which is physiologically

nerveless. The electrical variation travels at the same rate as the visible contraction, but precedes it.

Suppose two points ( $p$ ) and ( $d$ ) of the muscle are connected by non-polarisable electrodes to a galvanometer, and that the muscle wave is started by a single stimulus applied at A; as soon

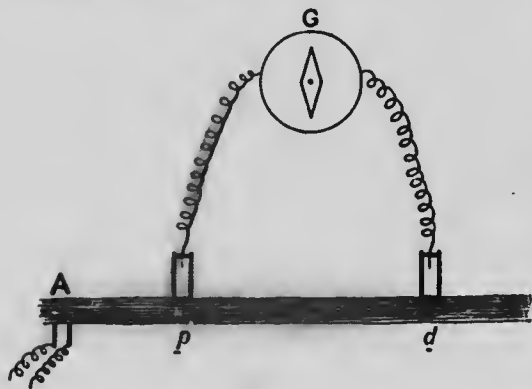

Fig. 171.

as the wave reaches ( $p$ ) this point becomes negative to ( $d$ ), and therefore a current flows from ( $d$ ) to ( $p$ ) through the galvanometer ( $G$ ). A moment later the two points are equipotential and no current flows; a minute fraction of a second\* later this balance is upset, and now when the wave reaches the point ( $d$ ), that point is negative to ( $p$ ), and the galvanometer needle moves in the opposite direction.

The electrical variations may also be investigated by the capillary electrometer; the mercury moves first in one direction, and then rapidly returns to its former position. The deep black curve in the next figure (fig. 172) shows the record obtaining by photographing the movement of the column of mercury on a rapidly travelling photographic plate.

The capillary electrometer has the advantage of giving us the means of measuring the time of onset and duration of the electrical disturbance, and experiments made with this instrument confirm the earlier experiments made with the rheotome. They show that the change only lasts a few thousandths

\* The time will vary with the distance between ( $p$ ) and ( $d$ ).

of a second, and is over long before the other changes in form, etc., are completed. Sir J. Burdon Sanderson gives the following numbers from experiments with the frog's gastrocnemius. When the muscle is excited through its nerve the electrical response begins  $\frac{1}{1000}$  and the change of form  $\frac{1}{1000}$  second after the stimulation; the second phase, that is, the return to the previous condition, begins  $\frac{11}{1000}$  second after excitation. When the muscle is directly excited, the latent period is much shorter, the change in form beginning  $\frac{1}{1000}$  and the electrical change in less than  $\frac{1}{1000}$  second after excitation.



Fig. 172.—Diphasic curve (black) of the normal sartorius. The grey curve is the monophasic curve of the same muscle when one electrometer contact was placed on the injured end. The two photographic curves are placed one over the other so that the beginnings coincide. (Burdon Sanderson.)

If, however, instead of examining the electrical change in the muscle in the manner depicted in fig 171, one electrode is placed on the uninjured surface and the other on the cut end (see fig. 173), the electrical response is a different one.

Under these circumstances, the electrical change is a *monophasic variation*, for when the

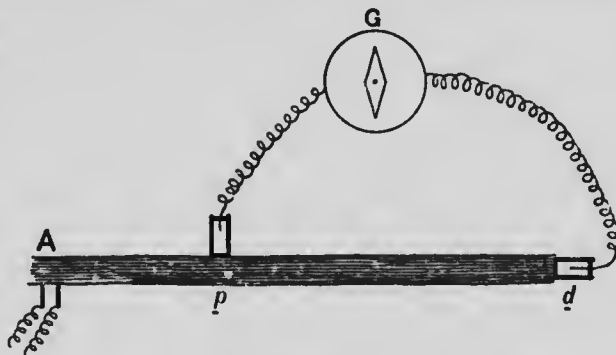

Fig. 173.

muscle wave reaches (*d*), this part of the muscle, owing to its injured state, does not respond to the excitatory condition, and the electrical response is also extinguished.

The grey curve in fig. 172 is the graphic record of the change as revealed by the capillary electrometer. It will be seen that the ascending limb of the curve is identical in the two cases, but that the second phase is absent. From the point at which the diphasic curve approaches its culmination the injury curve diverges from it, continuing to ascend; the line soon after becomes horizontal,

and then begins slowly to decline. This long tail denotes only the gradual disappearance of polarisation of the mercury meniscus.

The meaning of such photographic records becomes clear by testing the electrometer with known differences of potential, and from such data it is possible to construct what may be called an interpretation diagram (fig. 174).

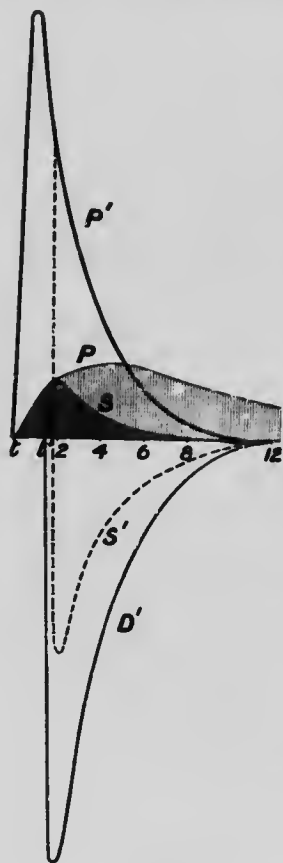

Fig. 174.—Interpretation diagram. (Burdon Sanderson.)

The horizontal line is that of equipotentiality of the two surfaces of contact ( $p$ ) and ( $d$ ). The curve  $P'$  expresses the relative negativity of the surface ( $p$ ); the curve  $D'$ , the corresponding relative negativity of the surface ( $d$ ).  $S'$  is a curve of which the ordinates are the algebraic sums of the corresponding ordinates of  $P'$  and  $D'$ .  $S$  is the photographic curve which expresses  $S'$ ;  $P$  is the photographic curve which expresses  $P'$  (monophasic variation). The numbers under the horizontal line indicate hundredths of a second; the distance  $tt'$  expresses the time taken by the wave in its progress from ( $p$ ) to ( $d$ ).

From these considerations we can now pass to study what occurs when the muscle enters into tetanus. The simplest case is that which was first observed by Du Bois Reymond. He placed his non-polarisable electrodes in the positions indicated in fig. 173, one ( $p$ ) on the comparatively uninjured surface, the other ( $d$ ) on the devitalised cut end. He sent in the tetanising series of shocks at A. The electrical response is under these circumstances a summation of the individual electrical responses evoked by instantaneous stimuli; and the monophasic character of the single response explains easily that which occurs during tetanus; the centre of the muscle becomes more negative or less positive

than it was before, and so the electrical difference of potential between the centre and the injured end is lessened. But with regard to uninjured muscle the problem is not so easy. It is at first sight difficult to see why the summed effects of a series of diphasic variations should take the direction of the first phase, as was found to be the case by Du Bois Reymond in experiments with the frog's gastrocnemius. One would have anticipated that "negative" variation in the arithmetical sense would be absent altogether, and this is the case in absolutely normal muscles;

Hermann has shown that it is so during tetanus of the human forearm. But a muscle removed from an animal's body cannot be considered absolutely normal, and if the two contacts be placed on the comparatively uninjured longitudinal surface as in fig. 171, a negative variation is observed, each excitatory phase becoming weaker as it progresses, and the second phase of each diphasic effect is weaker than the first. The following figure illustrates the record obtained by the capillary electrometer from an injured sartorius excited 14 times a second; each oscillation represents a single monophasic variation. The individual oscillations can, however, be seen when the excitations follow one another more rapidly, even up to 80 or 100 per second.

Muscle is not the only tissue which exhibits electrical phenomena.



Fig. 175.—Electrometer record of injured sartorius during tetanus. (Burdon Sanderson.)

A nerve which is uninjured is iso-electric; injury causes a demarcation current; activity is accompanied with a similar diphasic wave travelling along the nerve simultaneously with the nervous impulse. The activity of secreting glands, and also of the retina, is accompanied with electrical changes of the same kind.

But the most prominent exhibition of animal electricity is seen in the electric organs of electric fishes. In some of these fishes the electric organ is modified muscle, in which a series, as it were, of hypertrophied end-plates correspond to the plates in a voltaic pile. In other fishes the electric organ is composed of modified skin glands. But in each case the electric discharge is the principal phenomenon that accompanies activity.

In conformity with usage I have retained in the foregoing description of the electrical phenomena in living tissues, the terms positive and negative in the loose and incorrect sense in which they are employed by physiologists. The words negative and positive should really be transposed. In a Daniell cell, the zinc is the positive element, and is connected to the negative pole.



It is in this sense only that an injured or active part of a muscle is negative. To obviate the difficulty created by this mistake which has crystallised in physiological writings, Waller has suggested new terms, viz., *zincactive* and *zincable*, instead of negative and positive respectively.

### The Rheoscopic Frog.

The electrical changes in muscle can be detected not only by the galvanometer and electrometer, but also by what is known as the *physiological rheoscope*; this consists of an ordinary muscle-

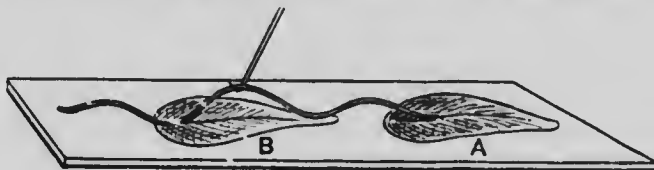

Fig. 176.—Galvani's experiment without metals.

nerve preparation from a fresh and vigorous frog. The nerve is stimulated by the electrical changes occurring in muscles, and the nervous impulse so generated causes a contraction of the muscles of the rheoscopic preparation. The following are the principal experiments that can be shown in this way:—

1. *Contraction without metals.* If the nerve of a nerve-muscle

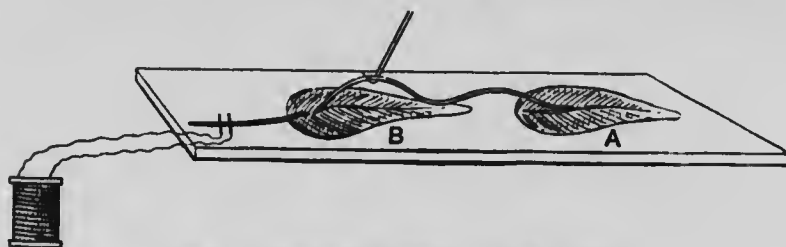

Fig. 177.—Secondary contraction. (After Waller.)

preparation A is dropped upon another muscle B (fig. 176) (or upon its own muscle) it will be stimulated by the injury current of the muscle on which it is dropped, and lead to a contraction of the muscle (A) which it supplies. The experiment succeeds best if the nerve is dropped across a longitudinal surface and a freshly made transverse section.

2. *Secondary contraction.* This is caused by the current of action. If, while the nerve of A is resting on the muscle B (fig. 177), the latter is made to contract by the stimulation of its nerve, the nerve of A is stimulated by the electrical variation which accompanies the contraction of the muscle B, and so a contraction of

muscle A is produced. This is called *secondary contraction*. It may be either a secondary twitch or secondary tetanus, according as to whether the muscle B is made to contract singly or tetanically.

3. *Secondary contraction from the heart.* If an excised but still beating frog's heart is used instead of muscle B, and the nerve of A laid across it, each heart's beat accompanied as it is by an electrical variation, will stimulate the nerve and cause a twitch in the rheoscopic muscle A.

---

## CHAPTER XIII.

### THERMAL AND CHEMICAL CHANGES IN MUSCLE.

In muscular contraction there is a transformation of the potential energy of chemical affinity into other forms of energy, especially molar motion and heat. Heat is a form of motion, in which there is movement of molecules; in molar motion there is movement of masses. The fact that when a blacksmith hammers a piece of iron it becomes hot is a familiar illustration of the transformation of one mode of movement into the other. Heat is measured in heat-units or calories. One calorie is the energy required to raise the temperature of 1 gramme of water from 0° to 1° C.; and this in terms of work is equal to 425.5 gramme-metres, that is, the energy required to raise the weight of 425.5 grammes to the height of 1 metre.

A muscle when uncontracted is nevertheless not at absolute rest. We have already seen that it possesses *tonus* or tone; it also possesses what we may call *chemical tone*; that is, chemical changes are occurring in it, and consequently heat is being produced. But when it contracts, the liberation of energy is increased; work is done, and more heat is produced; the heat produced represents more of the energy than the work done. The more resistance that is offered to a muscular contraction, the more is the work done relatively increased and the heat diminished. The amount of heat produced is increased by increasing the tension of the muscle. It diminishes as fatigue comes on. On increasing the strength of the stimulus the amount of heat increases faster, proportionately, than the work performed.

If work is done by a few large contractions, more heat is produced than if the same work is done by a larger number of smaller

contractions; that is, more chemical decomposition occurs, and fatigue ensues more rapidly in the first case. This fact is within the personal experience of everyone. If one ascends a tower, the work done is the raising of the weight of one's body to the top of the tower. If the staircase in the tower has a gentle slope, each stair being low, far less fatigue is experienced than if one ascended to the same height by a smaller number of steeper steps.

On a cold day one keeps oneself warm by muscular exercise; this common fact is confirmed by more accurate experiments on isolated muscles, the heat produced being sufficient to raise temporarily the temperature of the muscle. This can be shown in large animals by inserting a thermometer between the thigh muscles and stimulating the spinal cord. The rise of temperature may amount to several degrees.

In the case of frog's muscles, Helmholtz found that, after tetanising them for two or three minutes, the temperature rises

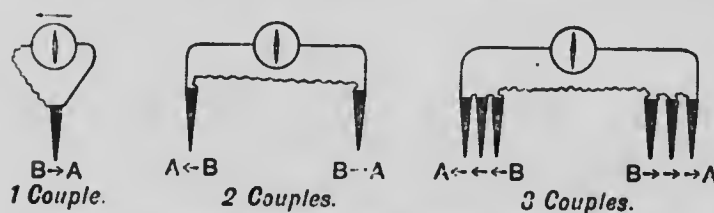

Fig. 178. - Scheme of thermo-electric couples. (After Waller.)

$0.14^{\circ}$  to  $0.18^{\circ}$  C.; and for each single twitch Heidenhain gives a rise of temperature of from  $0.001^{\circ}$  to  $0.005^{\circ}$  C.

For the detection of such small rises in temperature a thermopile, and not a thermometer, is employed.

A thermopile consists of a junction of two different metals; the metals are connected by wires to a galvanometer. If the junction is heated an electrical current passes round the circuit, and is detected by the galvanometer. The metals usually employed are iron and German silver, or antimony and bismuth. If the number of couples in the circuit is increased, each is affected in the same way, and thus the electrical current is increased through the galvanometer. The arrangement is shown in the fig. 178, which also indicates the direction of the currents produced, the metals employed being antimony and bismuth. By using 16 couples of this kind Helmholtz was able to detect a change of  $\frac{1}{1000}$  of a degree Centigrade.

Within certain limits, the strength of the current is directly proportional to the rise of temperature at the junction.

If two couples are in circuit, as shown in the second diagram, and they are heated equally, no current will pass through the galvanometer, the current through one couple being opposed by the current through the other. But if the two couples are heated unequally, the direction of swing of the galvanometer needle indicates which is the warmer. To apply this to the frog's gastrocnemius, plunge several needle-shaped couples (diagram 3) into a frog's gastrocnemius of one side and the same number of couples into the gastrocnemius of the other side, and then excite first one then the other sciatic nerve; a deflection of the galvanometer will be observed first in one, then in the other direction, indicating the production of heat first on one side, then on the other.

**Chemical Changes in Muscles.**

The chemical changes which are normally occurring in a resting muscle are much increased when it contracts. Waste products of oxidation are discharged, and the most abundant of these is carbonic acid. Sarco-lactic acid is also produced, and the alkaline reaction of a normal muscle is replaced by an acid one. The muscles of animals hunted to death are acid; the acid reaction to litmus paper of a frog's gastrocnemius can be readily shown after it has been tetanised for 10 to 15 minutes.

The quantity of oxygen consumed is increased, but the consumption of oxygen will not account for the much greater increase in the discharge of carbonic acid. This is illustrated by the following table:—

Venous Blood.	O, less than Arterial Blood.	CO <sub>2</sub> , more than Arterial Blood.
Of resting muscle...	9 per cent.	6·71 per cent.
Of active muscle ...	12·26 per cent.	10·79 per cent.

Indeed, a muscle can be made to contract and give off oxidation products like carbonic acid in an atmosphere containing no oxygen at all. The oxygen used is thus stored up in the muscle previously. The oxygen is not, however, present in the free state, for no oxygen can be detected in the gases obtained from muscles by means of an air-pump. Hermann has supposed that the oxygen enters into the formation of a complex hypothetical compound he calls *inogen*. On contraction he considers this is



# MICROCOPY RESOLUTION TEST CHART

(ANSI and ISO TEST CHART No. 2)

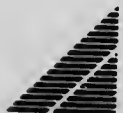
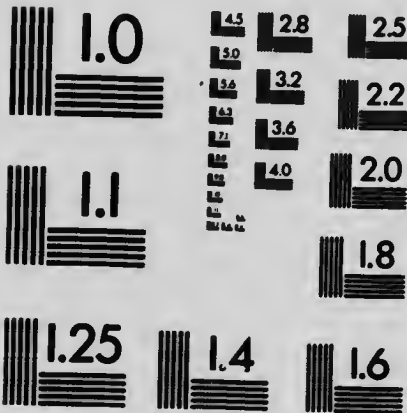

**APPLIED IMAGE Inc**

1653 East Main Street  
Rochester, New York 14609 USA  
(716) 482 - 0300 - Phone  
(716) 288 - 5989 - Fax

broken up into carbonic acid, sarco-lactic acid, and a proteid residue of myosin.

There are other chemical changes in the muscle when it contracts—namely, a change of glycogen into sugar, and an increase of nitrogenous waste. The question whether urea is increased during muscular activity is, however, a much debated one, and we shall return to it when we are studying the urine. What is certain is that the increased consumption of carbon (possibly in large measure derived from the carbohydrate stored in the muscle) is a much more marked and immediate feature than an increase in the consumption of nitrogen.

### Fatigue.

If the nerve of a nerve-muscle preparation is continually stimulated, the muscular contractions become more prolonged (see p. 124), smaller in extent, and finally cease altogether.

The muscle is said to be fatigued: this is due to the consumption of the substances available for the supply of energy in the muscle, but more particularly to the accumulation of waste products of contraction; of these, sarco-lactic acid is probably the principal one. Fatigue may be artificially induced in a muscle by feeding it on a weak solution of lactic acid, and then removed by washing out the muscle with salt solution containing a minute trace of an alkali. If the muscle is left to itself in the body, the blood stream washes away the accumulation of acid products, and fatigue passes off.

The question next presents itself, where is the seat of fatigue? Is it in the nerve, the muscle, or the end-plates? If, after fatigue has ensued and excitation of the nerve of the preparation produces no more contractions, the muscle is itself stimulated, it contracts; this shows it is still irritable, and, therefore, not to any great extent the seat of fatigue.

If an animal is poisoned with curare, and it is kept alive by artificial respiration, excitation of a motor nerve produces no contraction of the muscles it supplies. If one goes on stimulating the nerve for many hours, until the effect of the curare has disappeared, the block at the end-plates is removed and the muscles contract: the seat of exhaustion is therefore not in the nerves.

By a process of exclusion it has thus been localised in the nerve-endings.

When the muscle is fatigued in the intact body, there is, however, another factor to be considered beyond the mere local poisoning of the end-plates. This is the effect of the products of

contraction passing into the circulation and poisoning the central nervous system. It is a matter of common experience that one's mental state influences markedly the onset of fatigue and the amount of muscular work one can do. This aspect of the question has been specially studied by Mosso; he invented an instrument called the *ergograph*. The arm, hand, and all the fingers but one are fixed in a suitable holder; the free finger repeatedly lifts a weight over a pulley, and the height to which it is raised is registered by a marker on a blackened surface.

By the use of this instrument he has arrived at the conclusion that the state of the brain and central nervous system generally is a most important factor in fatigue, and that the fatigue products produced in the muscles during work cause most of their injurious effects by acting on the central nervous system and diminishing its power of sending out impulses.

One of the most striking of Mosso's experiments illustrates in a very forcible manner the fact that the central nervous system is more easily fatigued than the nerve endings in muscle. A person goes on lifting the weight until, under the influence of the will, he is unable to raise it any more. If then without waiting for fatigue to pass off, the nerves going to the finger muscles are stimulated artificially by induction shocks, they once more enter into vigorous contraction.

Mosso has also shown that the introduction of the blood of a fatigued animal into the circulation of a normal one will give rise in the latter to all the symptoms of fatigue. The blood of the fatigued animal contains the products of activity of its muscles, but still remains alkaline; the poisonous substance cannot therefore be free lactic acid; and lactates do not produce the effect. Lactic acid is doubtless one only of the products of muscular activity; we have at present no accurate knowledge of the chemical nature of the others.

### Rigor Mortis.

After death, the muscles gradually lose their irritability and pass into a contracted condition. This affects all the muscles of the body, and usually fixes it in the natural posture of equilibrium or rest. The general stiffening thus produced constitutes *rigor mortis* or *post-mortem* rigidity.

The cause of rigor is the coagulation of the muscle-plasma, which is more fully described in the next section. This coagulation results in the formation of *myosin*, and is gradual in onset.



Simultaneously the muscles (a) *become shortened and opaque*, (b) *heat is evolved*, (c) *they give off carbonic acid*, and (d) *become acid in reaction*; this is due in part to the formation of sarcolactic acid, and in part to the formation of acid phosphates.

After a varying interval, the rigor passes off, and the muscles are once more relaxed. This sometimes occurs too quickly to be caused by putrefaction, and the suggestion that in such cases at any rate such relaxation is due to a ferment-action is very plausible. It is known that pepsin (absorbed from the alimentary canal) is present in muscle, and that this ferment will act in an acid medium. The conditions for the solution of the coagulated myosin are therefore present, as the reaction of rigor muscle is acid.

*Order of Occurrence.*—The muscles are not affected simultaneously by rigor mortis. It affects the neck and lower jaw first; next, the upper extremities, extending from above downwards; and lastly, reaches the lower limbs; in some rare instances it affects the lower extremities before, or simultaneously with, the upper extremities. It usually ceases in the order in which it begins: first at the head, then in the upper extremities, and lastly in the lower extremities. It seldom commences earlier than ten minutes, or later than seven hours after death; and its duration is greater in proportion to the lateness of its accession.

Since rigidity does not ensue until muscles have lost the capacity of being excited by external stimuli, it follows that all circumstances which cause a speedy exhaustion of muscular irritability, induce an early occurrence of the rigidity, while conditions by which the disappearance of the irritability is delayed, are succeeded by a tardy onset of this rigidity. Hence its speedy occurrence, and equally speedy departure in the bodies of persons exhausted by chronic diseases; and its tardy onset and long continuance after sudden death from acute diseases.

In some cases of sudden death from lightning, violent injuries, or paroxysms of passion, rigor mortis has been said not to occur at all; but this is not always the case. It may, indeed, be doubted whether there is really a complete absence of the post-mortem rigidity in any such cases; for the experiments of Brown-Séquard make it probable that the rigidity may supervene immediately after death, and then pass away with such rapidity as to be scarcely observable.

The occurrence of rigor mortis is not prevented by the previous existence of paralysis in a part, provided the paralysis has not been attended with very imperfect nutrition of the muscular tissue.

### Chemical Composition of Muscle.

The phenomena of rigor mortis will be more intelligible if we consider the chemical composition of muscle.

The connective tissue of muscle resembles connective tissue elsewhere: the gelatin and fat obtained in analyses of muscle are derived from this tissue. The sarcolemma is composed of a substance which resembles elastin in its solubilities.

The contractile substance within the muscular fibres is, during life, of semi-liquid consistency, and contains a large percentage of proteids and smaller quantities of extractives and inorganic salts. By the use of a press this substance can be squeezed out of perfectly fresh muscles, and it is then called the *muscle-plasma*.

After death, muscle-plasma, like blood-plasma, coagulates (thus causing the stiffening known as *rigor mortis*). The solid clot corresponding to the fibrin from blood-plasma is called *myosin*, and the liquid residue is called the *muscle-serum*.

Pursuing the analogy further, it is found that the coagulation of both muscle-plasma and blood-plasma can be prevented by cold, by strong solutions of neutral salts, and by potassium oxalate, which precipitates, as the insoluble oxalate of calcium, the lime salts essential for the coagulation process. In both cases the clotting is produced by the action of a ferment developed after death. In both cases the precursor of the solid clot is a proteid of the globulin class which previously existed in solution.

Fibrin in the blood-clot is formed from the previously soluble fibrinogen of the blood-plasma. Myosin in the muscle-clot is formed from the previously soluble *myosinogen*\* of the muscle-plasma. When the blood-clot contracts it squeezes out blood-serum; when the muscle-clot contracts it squeezes out muscle-serum. The muscle-serum contains small quantities of albuminous material, together with the extractives and salts of the muscle. The origin of the sarco-lactic acid is a controversial question; some

\* The myosin precursors are really two in number, paramyosinogen, which is coagulated by heat at 47°—50°, and myosinogen, which is coagulated by heat at 56° C.

When the muscle is gradually heated at a certain temperature it contracts permanently, and loses its irritability. This phenomenon is called *heat rigor*. It is undoubtedly due to the coagulation of the proteids in the muscle. If a tracing is taken of the shortening, it is found that the first shortening occurs at the coagulation temperature of paramyosinogen (47°—50°), and if the heating is continued, a second shortening occurs at 56°, the coagulation temperature of myosinogen. If frog's muscles are used, there are three shortenings, viz., at 40°, 47° and 56° C.: frog's muscle-plasma containing an additional proteid which coagulates at 40°. (T. G. Brodie.)

believe it originates from the carbohydrate (glycogen and sugar); others think it comes from the proteid molecules in the muscle.

The general composition of muscular tissue is the following:—

Water . . . . .	75	per cent.
Solids . . . . .	25	„
Proteids . . . . .	18	„
Gelatin . . . . .	} 2 to 5	„
Fat . . . . .		
Extractives . . . . .	0.5	„
Inorganic salts . . . . .	1 to 2	„

The proteids, as already stated, chiefly pass into the clot: very little is found in the muscle-serum.

The extractives comprise a large number of organic substances, all present in small quantities, some of which are nitrogenous, like creatine, creatinine, xanthine, and hypoxanthine; the rest are non-nitrogenous—namely, fats, glycogen, sugar, inosite, and the variety of lactic acid known as sarco-lactic acid. The inorganic salts are chiefly salts of potassium, especially potassium phosphate.

The condition of dead muscle reminds one somewhat of contracted muscle. Indeed, the similarity is so striking that Hermann has propounded the idea that contracted muscle is muscle on the road to death, the differences between the two being of degree only. He considers that, on contraction, *inogen* (see p. 155) is broken up into carbonic acid, sarco-lactic acid, and myosin; on death the same change occurs, only to a much more marked extent.

This idea is a far-fetched one, but it is a useful reminder of the similarities of the two cases. In chemical condition, contracted and dead muscle are alike, so far as the formation of acid products is concerned; there is, however, no evidence of any formation of a muscle-clot (myosin) during the contraction of living muscle, as there is in dead muscle. Then heat is produced in both cases, and in both cases also the muscle is negatively electrical to uncontracted muscle.

Here, however, the analogy must end: for living contracted muscle is irritable, dead muscle is not. Living contracted muscle is more extensible than uncontracted muscle; muscle in *rigor mortis* is not so (see fig. 156, p. 134).

## CHAPTER XIV.

## COMPARISON OF VOLUNTARY AND INVOLUNTARY MUSCLE.

THE main difference between voluntary and involuntary muscle is the difference expressed in their names. Voluntary muscle is under the control of that portion of the central nervous system the activity of which is accompanied by volition. Involuntary muscle on the other hand, is, as a rule, also under the control of the central nervous system, but of a portion of the central nervous system the activity of which is independent of volition. There appear, however, to be exceptions to this rule, and the involuntary muscle executes its contractions independently of nervous control; that is to say, it is sometimes in the truest sense of the term really involuntary. This is very markedly seen in the developing heart of the embryo, which begins to beat before any nerve fibres have grown into it from the central nervous system.

Another characteristic of involuntary muscle is a tendency to regular alternate periods of rest and activity, or *rhythmicality*. This is best exemplified in the heart, but it is also seen in the lymphatic vessels, especially the lymph hearts of the frog, and the mesenteric lymphatic vessels (lacteals) of many animals. It is seen in the veins of the bat's wing, and in the muscular tissue of the spleen.

A third characteristic of involuntary muscle is *peristalsis*. If any point of a tube of smooth muscle such as the small intestine is stimulated, a ring-like constriction is produced at this point. After lasting some time at this spot it slowly passes along the tube at the rate of 20 to 30 millimetres per second. This advancing peristaltic wave normally takes place in only one direction, and so serves to drive on the contents of the tube.

Involuntary muscle nearly always contains numerous plexuses of non-medullated nerve-fibres with ganglion cells; so that much discussion has taken place on the question whether the phenomena of rhythmicality and peristalsis are properties of the muscular tissue itself or of the nerves mixed with it. The evidence available (namely, that portions of muscular tissue entirely free from nerves act in the same way as those that possess nerves) indicates that it is the muscular rather than the nervous tissues

that possess these properties; though it can hardly be doubted that under usual circumstances the contraction of involuntary muscle is influenced and controlled by nervous agency.

The artificial stimuli employed for smooth muscle are the same as those used for striated muscle; single induction shocks are often ineffectual to produce contraction, but the make, and to a less extent the break, of a constant current will act as a stimulus.

The faradic current is a good stimulus, but it never throws involuntary muscle into tetanus; in the heart, strong stimulation will sometimes effect a partial fusion of the beats, but never complete tetanus. The rate of stimulation makes no difference; in fact, very often a rapid rate of stimulation calls forth less rapidly occurring contractions than a slow rate.

A stimulus strong enough to produce a contraction at all usually elicits a maximum contraction, but the phenomenon known as the *staircase* (see p. 124) is generally better marked in the case of the heart than in that of voluntary muscle.

The contraction of smooth muscle is so sluggish that the various stages of latent period, shortening and relaxation can be followed with the eye; the latent period often exceeds half a second in duration.

The normal contraction of voluntary muscle is a kind of tetanus (voluntary tetanus, see p. 128); the normal contraction of plain muscle is a much prolonged single contraction. A very valuable piece of evidence in this direction is seen in the experiment on the heart with the physiological rheoscope (see p. 153). Each time the heart contracts the rheoscopic preparation executes a single twitch, not a tetanus. This is an indication that the electrical change is a single one, and not a succession of changes such as occurs in tetanus.

When, however, this electrical change is examined with the electrometer, it is seen that it really is a diphasic one; but in a slowly contracting tissue like the heart-muscle the two phases are separated by a prolonged period of equipotentiality, and thus they are rendered more distinct.\* The illustrations already given (figs. 167 and 168) show this fact graphically.

But though involuntary muscle cannot be thrown into tetanus, it has the property of entering into a condition of sustained

---

\* When the heart is beating sluggishly in the rheoscopic experiment above referred to, the separation of the two phases of the electrical change will sometimes cause two twitches in the muscle nerve preparation.

contraction called *tonus*. We shall have to consider this question again in connection with the plain muscular tissue of the arterioles.

Involuntary muscle when it contracts undergoes thermal and chemical changes similar to those we have dealt with in the case of the voluntary muscles.

The nerve-endings in involuntary muscle require a much larger dose of curare to affect them than the end-plates in voluntary muscle.

The phenomena of *rigor mortis* in involuntary muscle have never been fully studied. What has been found is that the chemical composition of involuntary muscle differs in no noteworthy manner from that of voluntary muscle, and on death the muscle becomes acid; such products as carbonic acid and sarcolactic acid are formed. In the heart, stomach and uterus rigidity has been noted, but in the case of the other involuntary muscles it has never been experimentally observed.

---

## CHAPTER XV.

### PHYSIOLOGY OF NERVE.

MANY points relating to the physiology of nerve have been already studied in connection with muscle. But there still remain further questions upon which we have hardly touched as yet.

#### Classification of Nerves.

The nerve fibres which form the conducting portions of the nervous system may be classified into three main groups, according to the direction in which they normally conduct nerve impulses. These three classes are:—

1. Efferent nerve fibres.
2. Afferent nerve fibres.
3. Inter-central nerve fibres.

1. **Efferent** or *centrifugal* nerves are those which conduct impulses from the central nervous system (brain and spinal cord) to other parts of the body. When for instance there is a wish to move the hand, the impulse starts in the brain, and travels a certain distance down the spinal cord; it leaves the spinal cord by

one or more of the spinal nerves, and so reaches the muscles of the hand which are thrown into contraction. Such nerves are called *motor*, but all efferent nerves are not motor; some cause secretion instead of movement, and others may cause a stoppage of movement, etc. A list of the classes of efferent nerves is as follows:—

- a. Motor.
- b. Accelerator.
- c. Inhibitory.
- d. Secretory.
- e. Electrical.
- f. Trophic.

- a. *Motor* nerves. Some of these go to voluntary muscles; others to involuntary muscles, such as the vaso-motor nerves which supply the muscular tissue in the walls of arteries.
  - b. *Accelerator* nerves are those which produce an increase in the rate of rhythmical action. An instance of these is seen in the sympathetic nerves that supply the heart.
  - c. *Inhibitory* nerves are those which cause a slowing in the rate of rhythmical action, or it may be its complete cessation. Inhibitory nerves are found supplying many kinds of involuntary muscle; a very typical instance is found in the inhibitory fibres of the heart which are contained within the trunk of the vagus nerve.\*
  - d. *Secretory* nerves are found supplying many secreting glands, such as the salivary glands, pancreas, gastric glands, and sweat glands. The impulse which travels down a secretory nerve causes a formation of the secretion in the gland it supplies.
  - e. *Electrical* nerves are found in the few fishes which possess electrical organs. The impulse which travels down these nerves causes the electrical organ to be thrown into activity.
  - f. *Trophic* nerves are those which control the nutrition of the part they supply.
2. **Afferent** or *centripetal* nerves are those which conduct impulses in the reverse direction, namely from all parts of the body to the central nervous system. When one feels pain in the finger, the nerves of the finger are stimulated, an impulse travels

\* The question has been much debated whether voluntary muscle is provided with inhibitory nerves; they do, however, appear to be present in certain nerves supplying the muscles of the claws of lobsters and similar crustaceans.

up the nerves to the spinal cord, and then to the brain. The mental process set up in the brain is called a sensation; the sensation, however, is referred to the end of the nerve where the impulse started, and the sensation of pain does not appear to occur in the brain, but in the finger. This is an instance of a sensory nerve; and the terms afferent and sensory may often be used synonymously. The nerves of sensation may be grouped as follows:—

- a. The nerves of special sense; that is, of sight, hearing, taste, smell and touch.
- b. The nerves of general sensibility; that is, of a vague kind of sensation not referable to any of the five special senses just enumerated; as instances, we may take the vague feelings of comfort or discomfort in the interior of the body.
- c. Nerves of pain. These do not appear to be anatomically distinct from the others, but any excessive stimulation of a sensory nerve whether of the special or general kind will cause pain.

The words "sensory" and "afferent," however, are not quite synonymous. Just as we may have efferent impulses leaving the brain for the heart or blood-vessels of which we have no conscious knowledge, so also afferent impulses may travel to the central nervous system which excite no conscious feelings. The afferent nerve tracts to the cerebellum form a very good instance of these.

Then, too, the excitation of any afferent nerves will excite what are called reflex actions. We are very often conscious of the sensations that form the cause of a reflex action, but we do not necessarily have such sensations. Many reflex actions, for instance, occur during sleep; many may be executed by the spinal cord even after it has been severed from the brain, and so the brain cannot be aware of what is occurring.

A reflex action is an action which is the result of an afferent impulse. Thus a speck of dust falls into the eye, and causes movements of the eyelids to get rid of the offending object. The dust excites the sensory nerve-endings in the conjunctiva, an impulse travels to the centre of this nerve in the brain, and from the brain a reflected impulse travels to the muscles of the eyelid. As an instance of a reflex action in which secretion is concerned, take the watering of the mouth which occurs when food is seen or smelt. The nerves of sight or smell convey an afferent impulse to the brain, which reflects, down the secretory nerves, an impulse which excites the salivary glands to activity.



These, however, are instances of reflex action which are accompanied with conscious sensation, but like all pure reflex actions are not under the control of the will.

An instance of a reflex action not accompanied with consciousness is seen in a man with his spinal cord cut across or crushed, so that any communication between his brain and his legs is impossible. He cannot move his legs voluntarily and is unconscious of any feelings in them. Yet when the soles of his feet are tickled he draws his legs up, the centre of reflex action being in the grey matter of the lower region of the spinal cord.

For a reflex action, three things are necessary: (1) an afferent nerve, (2) a nerve-centre consisting of nerve-cells to receive the afferent impulse and send out an efferent impulse, and (3) an efferent nerve along which the efferent impulse may travel. If the reflex action is a movement, the afferent nerve is called *excito-motor*; if it is a secretion, the afferent nerve is called *excito-secretory*, and similarly afferent nerves may also be *excito-accelerator*, *excito-inhibitory*, etc.

3. **Interoentral** nerves are those which connect nerve-centres together; they connect different parts of brain, and of the cord to one another, and we shall find in our study of the nerve-centres that they are complex in their arrangement.

### Investigation of the Functions of a Nerve.

There are always two main experiments by which the function of a nerve may be ascertained. The first is *section*, the second is *stimulation*.

*Section* consists in cutting the nerve and observing the loss of function that ensues. Thus, if a motor nerve is cut, motion of the muscles it supplies can no longer be produced by activity of the nerve-centre; the muscle is paralysed. If a sensory nerve is cut, the result is loss of sensation in the part it comes from.

*Stimulation* of the cut nerve is the opposite experiment. When a nerve is cut across, one piece of it is still connected with the brain or spinal cord; this is called the *central end*; the other piece, called the *peripheral end*, is still connected with some peripheral part of the body. Both the central and the peripheral end should be stimulated; this is usually done by means of induction shocks. In the case of a motor nerve, stimulation of the central end produces no result; stimulation of the peripheral end produces a nervous impulse which excites the muscles to contract. In the case of a sensory nerve, stimulation of the peripheral

end has no result, but stimulation of the central end causes a sensation, usually a painful one, and reflex actions, which are the result of the sensation.

When a nerve is cut across, there are other results than the loss of function just mentioned; for even though the nerve is still left within the body with a normal supply of blood, it becomes less and less irritable, till at last it ceases to respond to stimuli altogether. This diminution of excitability starts from the point of section and travels to the periphery, but is temporarily preceded by a wave of increased excitability travelling in the same direction (Ritter-Valli law).

This loss of excitability of nerve is accompanied with degenerative changes which are of so great importance as to demand a separate section.

#### Degeneration of Nerve.

Suppose a nerve is cut right across, the piece of the nerve left in connection with the brain or spinal cord remains healthy both in structure and functions; but the peripheral piece of the nerve loses its functions and undergoes what is generally called after the discoverer of the process, *Wallerian degeneration*. A nerve is made up of nerve-fibres, and each nerve-fibre is essentially a branch of a nerve-cell; when the nerve is cut, the axis cylinders in the peripheral portion are separated from the cells of which they are branches and from which they have grown. These separated portions of the axis cylinders die, and the medullary sheath of each undergoes a gradual process of disintegration into droplets of myelin, which are ultimately absorbed and removed by the lymphatics. At the same time there is a multiplication of the nuclei of the primitive sheath. This degenerative process begins one or two days after the section has been made. In the case of the non-medullated fibres, there is no medullary sheath to exhibit the disintegrative changes just alluded to; and the nuclei of the sheath do not multiply; there is simply death of the axis cylinder. The degeneration occurs simultaneously throughout the whole extent of the nerve; it does not start from the section and travel to the periphery.

A great amount of attention has been directed to this process of degeneration, because it has formed a valuable method of research in tracing nervous tracts, and ascertaining the nerve-cells from which they originate. It must not, however, be regarded as an isolated phenomenon in physiology; it is only an illustration of the universal truth that any portion of a cell (in this case

the axis cylinder process) cut off from the nucleus of the cell degenerates and dies.

If a nerve is simply cut, and allowed to heal, regeneration of function in time occurs. This is hastened by the surgeon suturing the cut ends of the nerve together. It must not, how-

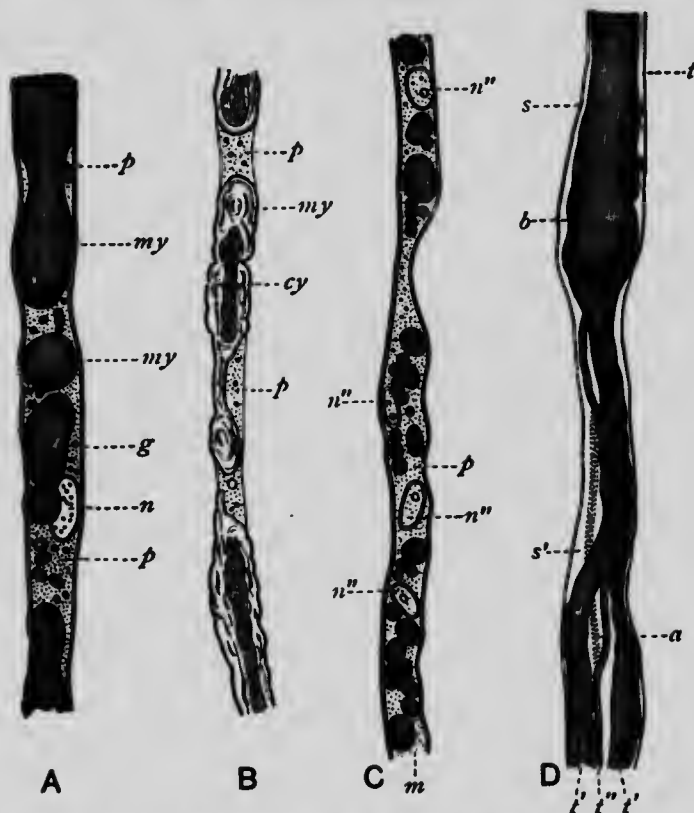

Fig. 179.—Degeneration and regeneration of nerve-fibres. A, nerve-fibre, fifty hours after operation. *my*, medullary sheath breaking up into myelin drops. *p*, granular protoplasm replacing myelin. *a*, nucleus. *g*, primitive sheath. B, nerve-fibre after four days. *cy*, axis cylinder partly broken up and enclosed in portions of myelin. C, a more advanced stage in which the medullary sheath has almost disappeared. Numerous nuclei, *n''* are seen. D, commencing regeneration; several fibres (*t*, *t'*) have sprouted from the somewhat bulbous cut end (*b*) of the nerve. *a*, an axis cylinder which has not yet acquired its medullary sheath. *s*, *s'* primitive sheath of the original fibre. (Ranvier.)

ever, be supposed that this is due to a restoration of the structure of the fibres in the peripheral portion of the cut nerve. It is due to new nerve-fibres sprouting out from the central end of the cut nerve, and growing distalwards in the old sheaths. This is illustrated in D, fig. 179. Regeneration of cut fibres never occurs in the brain or spinal cord.

When regeneration does not take place, the central ends of the

cut fibres and the cells from which they originate undergo slow atrophic changes (*disuse atrophy*).

### Functions of the Roots of the Spinal Nerves.

The general truths enunciated in the two preceding sections are well illustrated by the experiments made to determine the functions of the roots of the spinal nerves. Each spinal nerve originates from the spinal cord by two roots. One of these is called the *anterior* or *ventral* root: it consists of nerve-fibres which originate from the large multipolar cells in that portion of the grey matter in the interior of the spinal cord which we shall presently learn to call the anterior horn. These nerve-fibres are all medullated; the large ones join up with the posterior root to form the spinal nerve; the small nerve-fibres

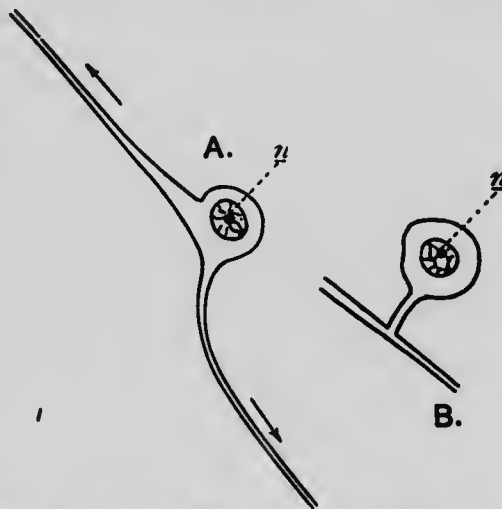

Fig. 180.—A, Bipolar cell from spinal ganglion of a  $4\frac{1}{2}$  weeks embryo. n, nucleus; the arrows indicate the direction in which the nerve processes grow, one to the spinal cord, the other to the periphery. B, a cell from the spinal ganglion of the adult; the two processes have coalesced to form a T-shaped junction. (Diagrammatic.)

leave the root and pass to the sympathetic chain, whence they are distributed as non-medullated fibres to the involuntary muscular fibres of the blood-vessels, etc.

The other root, the *posterior* or *dorsal* root, has upon it a collection of nerve-cells forming the spinal ganglion. Each nerve-cell is enclosed within a nucleated sheath of connective tissue origin, and it is from these nerve-cells that the fibres of the posterior roots grow. In the embryo, each nerve-cell has two processes (fig. 180), one of which grows to the spinal cord, where it terminates by branching around the multipolar cells of the grey matter; the other process grows outwards to the periphery. In the adult mammal (not in fishes) the two processes coalesce in the first part of their course, forming a *T-shaped junction*.

The first experiments on the functions of the spinal nerve-roots were performed in this country by Sir Charles Bell (1811), and in

France by Magendie (1822). These observers found that on section of the anterior roots there resulted paralysis of the muscles supplied by the nerves; on section of the posterior

roots there was loss of sensation. These experiments clearly pointed to the conclusion that the anterior roots contain the efferent (motor) fibres; and the posterior roots the afferent (sensory) fibres. This conclusion was confirmed by the experiment of stimulation. Stimulation of the peripheral end of the cut anterior root caused muscular movement; of the central end, no effect. Stimulation of the central end of the cut posterior root caused pain and reflex movements; of the peripheral end, no effect.

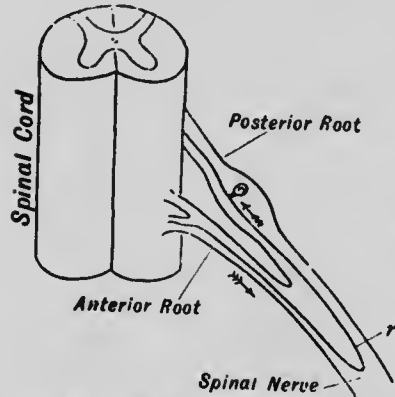

Fig. 181.—Diagram to illustrate recurrent sensibility.

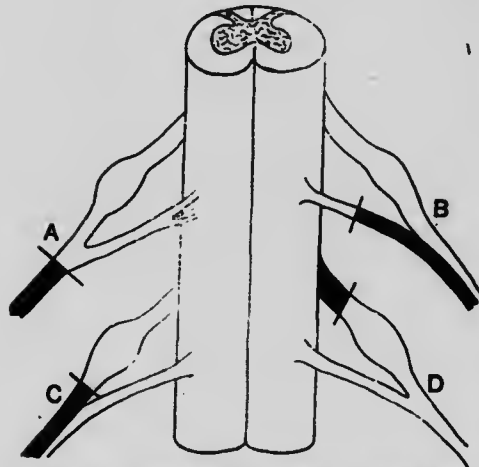

Fig. 182.—Diagram to illustrate Wallerian degeneration of nerve-roots.

They often, however, run down the mixed nerve a considerable distance before returning to the posterior roots.

The upper diagram on this page (fig. 181) illustrates the course of one of these recurrent fibres (*r*); the arrows represent the direction in which it conveys impulses.

*Degeneration of roots.*—The facts in connection with this subject were made out by Waller (1850), and may be best understood by referring to the next diagram (fig. 182).

*Recurrent sensibility.*—

One of the statements just made requires a slight modification; namely, excitation of the peripheral end of a divided anterior root will evoke pain and reflex movements, as well as direct movements; that is to say, the anterior root though composed mainly of motor fibres contains a few sensory fibres coming probably from the membranes of the spinal cord, and then running into the posterior root with the rest of the sensory fibres.

A represents a section of the mixed nerve beyond the union of the roots; the whole nerve beyond the section degenerates, and is shaded black.

B represents the result of section of the anterior root; only the anterior root-fibres degenerate; the sensory fibres of the posterior root remain intact. The small medullated nerve-fibres (not shown in the diagram) also degenerate as far as the ganglion cells of the sympathetic system with which they communicate. The recurrent sensory fibres in this root do not degenerate with the others, but are found degenerated in the part of the anterior root attached to the spinal cord.

Section of the posterior root always produces the same physiological effect (loss of sensation) \* wherever the section is made, but the degeneration effect is different according as the section is made on the proximal or distal side of the ganglion. If the section is made beyond the ganglion, the degeneration occurs as shown in C beyond the section in the peripheral portion of the posterior root-fibres; the anterior root remains intact except for the recurrent sensory fibres which it contains. If the section is made as in D, between the ganglion and the cord, the only piece that degenerates is the piece severed from the ganglion and running into the cord; these fibres may be traced up in the posterior column of the spinal cord until they terminate in grey matter, which they do at different levels. The whole of the sensory fibres including the recurrent ones which are still attached to the ganglion remain histologically healthy.

The accompanying figure (fig. 183) is one of the original illustrations made by Dr. Waller, and not published until the publication of his son's text-book quite recently. I am indebted to the present Dr. Waller for permission to reproduce it.

These facts of degeneration teach us, what we also learn



Fig. 183.—Groups of fibres from the anterior and posterior roots several days after section of both roots close to the cord; the anterior fibres are degenerated; the posterior, being still in connection with the nerve-cells from which they grew, are normal.

\* In order to obtain any appreciable loss of sensation, it is necessary to divide several posterior roots, as there is a good deal of overlapping in the peripheral distribution of the fibres.

from the study of embryology, that the nerve-fibres of the anterior root are connected to the nerve-cells within the spinal cord, while the posterior root-fibres are connected to the cells of the spinal ganglia; or, to put it another way, the trophic centres which control the nutrition of the nerve-fibres are situated within the cord for the anterior roots, and within the spinal ganglia for the posterior roots.

#### Changes in a Nerve during Activity.

When a nerve is stimulated, the change produced in it is called a nervous impulse; this change travels along the nerve, and the propagation of some change is evident from the effects which follow: sensation, movement, secretion, &c.; but in the nerve itself very little change can be detected. There is no change in form; the most delicate thermo-piles have failed to detect any production of heat, and we are also ignorant of any chemical changes. The only alteration which can be detected as evidence of this molecular change in a nerve is the electrical one. Healthy nerve is iso-electric, but during the passage of a nervous impulse along it there is a very rapid diphasic variation, which travels at the same rate as the nervous impulse. This is similar to the diphasic change in muscle, which we have already studied, and can be detected in the same way (see further, p. 188).

#### Velocity of a Nerve Impulse.

A nervous impulse is not electricity; compared to that of electricity its rate of propagation is extremely slow. It has been measured in motor-nerves as follows: a muscle-nerve preparation is made with as long a nerve as possible; the nerve is stimulated first as near to the muscle, and then as far from the muscle, as possible. The moment of stimulation and the moment of commencing contraction is measured by taking muscle tracings on a rapidly moving surface in the usual way, with a time-tracing beneath. The contraction ensues later, when the nerve is stimulated at a distance from the muscle, than in the other case, and the difference in the two cases gives the time occupied in the passage of the impulse along the piece of nerve, the length of which can be easily measured.

A similar experiment can be performed on man by means of the transmission myograph (see p. 129). If a tracing of the contraction of the thumb muscles is taken, the two stimuli may be successively applied through the moistened skin, first at the brachial plexus below the clavicle, and secondly, at the median nerve at the bend of the elbow.

Another method, largely employed by Bernstein, is to take the electrical change as the indication of the impulse. The rheotome is the instrument used. If fig. 169 (p. 145) is referred to, and a long nerve substituted for the muscle-nerve preparation, the stimulus is applied at one end, and the change in the electrical condition of the nerve is recorded by the galvanometer, which is connected to the other end of the nerve. The time measurement is effected by the adjustment of the rheotome, which must be such as to tap off the electrical change at the moment it occurs.

The rate of the transmission of nervous impulses discovered by these methods is, in a frog's motor-nerve, 28 to 30 metres a second; in human motor-nerves, 33 metres a second; in sensory nerves, 30 to 33 metres a second.

#### Direction of a Nerve Impulse.

Nerve impulses are conducted normally in only one direction: in efferent nerves from, in afferent nerves to, the nerve-centres. But there are some experiments which point to the conduction occurring under certain circumstances in both directions.

Thus, in the rheotome experiment just described, if the nerve is stimulated in the middle instead of at one end, the electrical change (the evidence of an impulse) is found to be conducted towards both ends of the nerve.

Kühne's gracilis experiment proves the same point. The gracilis muscle of the frog (fig. 184) is in two portions, with a tendinous intersection, and supplied by nerve-fibres that branch into two bundles; excitation strictly limited to one of these bundles, after division of the tendinous intersection, causes both portions of the muscle to contract.

Another striking experiment of the same kind can be performed with the nerve that supplies the electrical organ of *Malaptercorus*. This nerve consists of a single axis cylinder and its branches; stimulation of its posterior free end causes the "discharge" of the electrical organ, although the nervous impulse normally travels in the opposite direction.

Older experiments, designed to prove the same points, were performed by Paul Bert. He grafted the tip of a rat's tail either to the back of the same rat, or to the nose of another. When union had been effected, the tail was amputated near its base. After a time, irritation of the end of the trunk-

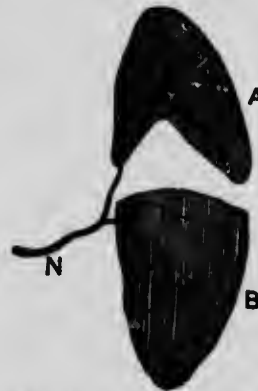

Fig. 184.—Gracilis of frog.  
(After Waller.)



like appendage on the back or nose of the rat gave rise to sensation. The impulse thus passed from base to tip, instead of from tip to base, as formerly. This experiment does not, however, prove the point at all; for all the original nerve-fibres in the tail must have degenerated, and the restoration of sensation was due to new fibres, which had grown into the tail. Exactly the same objection holds to another series of experiments, in which the motor and sensory nerves of the tongue were divided and united crosswise. Restoration of both movement and sensation does occur, but is owing to new nerve-fibres growing out from the central stumps of the cut nerves.

### Chemistry of Nervous Tissues.

The nervous tissues contain a large amount of water; it is present in larger amount (85 to 90 per cent.) in grey matter than

Portion of Nervous System.	Proteids.	Lecithin.	Cholesterol and Fat.	Cerebrin.	Neuro-keratin.	Other Organic matters.	Salts.
Grey matter of Brain ... }	55	17	19	0.5	6.7		1.5
White matter of Brain ... }	25	10	52	9.5	3.3		0.6
Spinal Cord.....	23	75.1					1.1
Human Sciatic Nerve .....	36	32	12	11	3	4	—

in white matter (about 70 per cent.); in early than in adult life; in the brain than in the spinal cord; in the spinal cord than in nerves.

The solids contain:—

- a. Proteids: these comprise about half the solid matter in grey matter, and about one-third of the solid matter in white matter and nerve. In other words, proteid is most abundant where the cells are situated, which is what one would expect. The proteids found are nucleo-proteid and globulin.
- b. Albuminoids: (1) neuro-keratin, contained within the white substance of Schwann and forming the chemical basis of neuroglia, the supporting tissue of the nerve-centres; (2) nuclein, from the nuclei of the cells.
- c. Fatty materials: the most important of these is lecithin, a complex fat containing phosphorus and nitrogen, in addition to carbon, hydrogen and oxygen. The lecithin in the nervous tissues is combined with cerebrin; the compound so formed is called protagon.
- d. Cerebrins: nitrogenous substances of unknown constitution which yield a reducing sugar (galactose) on hydration.

- e. Cholesterin : a crystalline alcohol which we shall study more fully in connection with bile, where it is also found.
- f. Extractives, similar to those found in muscle, but in very minute quantity.
- g. Gelatin and fat from the adherent connective tissue.
- h. Inorganic salts.

The table on the preceding page gives some of the quantitative analyses that have been made of the solids in percentages.

Nothing is known of the changes these undergo during the activity of nerve. It is possible that carbonic acid is produced, see p. 188. When nervous tissues die, they, like muscles and all organs of the body, become acid from the development of lactic acid.

In Wallerian degeneration, the staining reactions indicate that the lecithin, the principal constituent of the medullary sheath, is replaced by ordinary fats. This has been confirmed by chemical analysis.

---

## CHAPTER XVI.

### ELECTROTONUS.

WHEN a constant current is thrown into a nerve, there is an excitation which leads to a nervous impulse, and this produces a contraction of the muscle at the end of the nerve. Similarly, there is another contraction when the current is taken out. While the current is flowing through the nerve, the muscle is quiescent. But while the current is flowing there are changes in the nerve, both as regards its electrical condition and its excitability. These changes are summed up in the expression *electrotonus*.

In the investigation of this subject the instruments employed are the same as those already described, with the addition of two others that it will be convenient to describe before passing on to the study of electrotonus itself. These are the reverser or commutator, and the rheochord.

*Pohl's commutator* is the form of reverser generally employed. It consists of a block of carbonite provided with six pools of mercury, each of which is provided with a binding screw. The corner pools are connected by diagonal cross wires, and by a cradle consisting of an insulating handle fixed to two arcs of copper wire which can be tilted so that the two middle pools can be brought into communication with either of the two lateral

pairs of pools. Fig. 185 shows how, by altering the position of the cradle, the direction of the current from one electrode to the

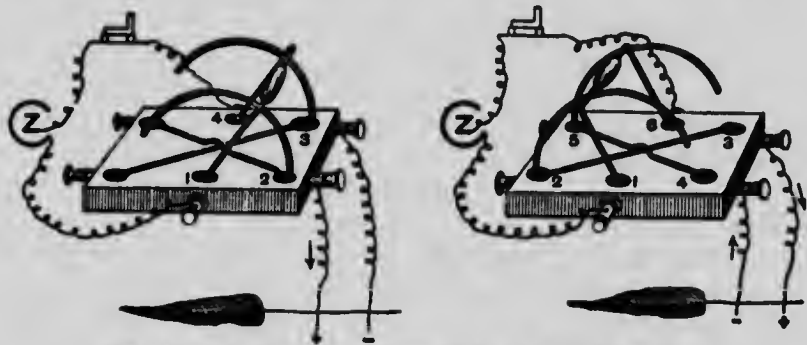

Fig. 185.—Pohl's commutator, with cross wires. (After Waller.)

other is reversed. The numbers 1, 2, 3, &c. indicate the path of the current in the two cases.

Sometimes the reverser is used without the cross wires for a different purpose. The battery wires are connected as before with the middle mercury pools. Each lateral pair of pools is connected by wires to a pair of electrodes. The two pairs of electrodes may be applied to two portions of a nerve, or to two different nerves, and by tilting the eradle to right or left the current can be sent through one or the other pair of electrodes.

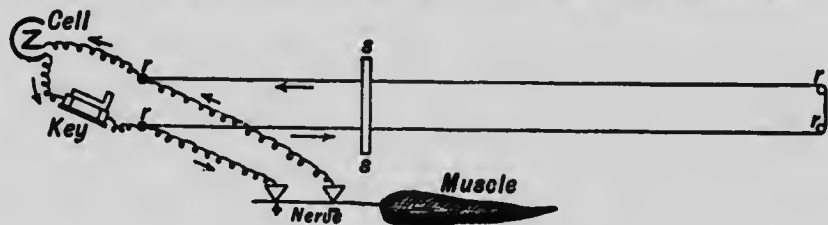

Fig. 186.—Simple rheochord.

The *rheochord* is an instrument by means of which the strength of a constant current passed through a nerve may be varied. It consists of a long wire (*r, r, r*) stretched on a board. This is placed as a bridge on the course of the battery current. (See fig. 186.) The current is thus divided into two parts: one part through the bridge, the other through the nerve which is laid across the two non-polarisable electrodes at the ends of the wires. The resistance through the bridge is varied by the position of the slider (*s s*). The farther the slider is from the battery end of the instrument the longer is the bridge, and the higher its resistance, so that less current goes that way and more to the nerve.

The next figure shows the more complicated form of rheochord:

invented by Poggendorf. The number of turns of wire is greater, so that the resistance can be varied to a much greater extent than in the simpler form of the instrument.

The term "electrotonus" includes two sets of changes in the

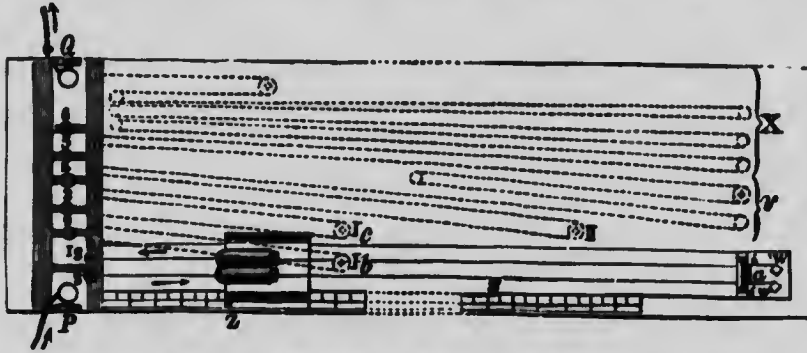

FIG. 187.—Poggendorf's rheochord. (M'Kendrick.)

nerve; first an electrical change, and secondly changes in excitability and conductivity. We will take the electrical change first.

**Electrotonic currents.**—The constant current is passed through the nerve from a battery, non-polarisable electrodes being

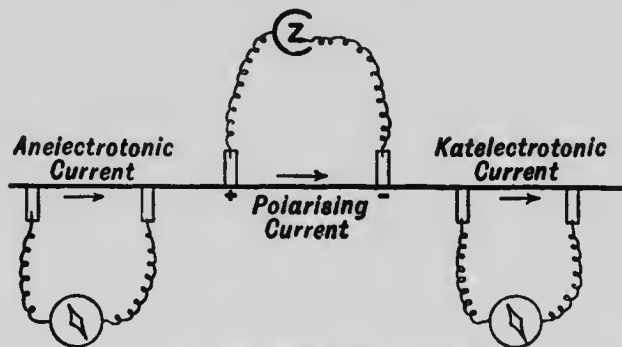

FIG. 188.—Electrotonic currents.

used; it is called the polarising current. If portions of the nerve beyond the electrodes are connected ("led off") as in the diagram (fig. 188) by non-polarisable electrodes to galvanometers, a current will in each case be indicated by the swing of the galvanometer needles. The electrotonic current in the neighbourhood of the negative pole or kathode is called the *katelectrotonic current*; and that in the neighbourhood of the anode is called the *anelectrotonic current*. In both cases the electrotonic current has the same direction as the polarising current. These currents are

dependent on the physical integrity of medullated nerve; they are not found in muscle, tendon, or non-medullated nerve; they are absent or diminished in dead or degenerated nerve. They can, however, be very successfully imitated in a model made of zinc wire encased in cotton soaked with salt solution. The electrotonic currents must be carefully distinguished from the normal current of action, which is a momentary change rapidly propagated with a nervous impulse which may be produced by any method of stimulation. The electrotonic currents are produced only by an electrical (polarising) current; they vary in intensity with the polarising current, and last as long as the polarising current passes through the nerve.

After the polarising current is removed, after-electrotonic currents occur in different directions in the three regions tested.

- (a) In the intrapolar region, the after-current is opposite in direction to the original polarising current; unless the polarising current is strong and of short duration, when it is in the same direction.
- (b) In the katelectrotonic region, the after-current has the same direction as the katelectrotonic current.
- (c) In the anelectrotonic region, the after-current has at first the same, then the opposite direction to the anelectrotonic current.

The experiment known as the *paradoxical contraction* depends upon electrotonic currents. The sciatic nerve of the frog divides in the lower part of the thigh into two parts. If one division is cut across, and its central end stimulated *electrically* (the spinal cord having been previously destroyed), the muscles supplied by the other branch contract; the nerve fibres in this branch having been stimulated by the electrotonic variation in the divided branch.\*

**Electrotonic alterations of excitability.**—When a constant current is passed through a nerve, the excitability of the nerve is increased in the region of the kathode, and diminished in the region of the anode. When the current is taken out the excitability is temporarily increased in the neighbourhood of the anode, and diminished in that of the kathode.

This may be shown in the case of a motor nerve by the following experiment. The next diagram represents the apparatus used.

An exciting circuit for single induction shocks is arranged in

\* This experiment must be carefully distinguished from Kühne's gracilis experiment described on p. 173. In the gracilis experiment the nerve fibres themselves *branch*, and any form of stimulation applied to one branch will cause contraction of both halves of the muscle. In the paradoxical contraction, the bundles of nerve fibres are merely bound *side by side* in the sciatic trunk; there is therefore no possibility of conduction of a nerve impulse in both directions; the stimulus, moreover, must be an electrical one.

the usual way, the exciting electrodes being placed on the nerve near the muscle. A polarising circuit is also arranged, and includes a battery, key, and reverser; the current is passed into the nerve by means of non-polarisable electrodes. When the polarising current is thrown into the nerve, or taken out, a contraction of the muscle occurs, but these contractions may be disregarded for the present.

The exciting circuit is arranged with the secondary coil so far from the primary that the muscle responds to break only, and the tracing may be recorded on a stationary blackened cylinder. Move the cylinder on a short distance, and repeat this. The height of the lines drawn may be taken as a measure of the excitability of the nerve. Now throw in the polarising current

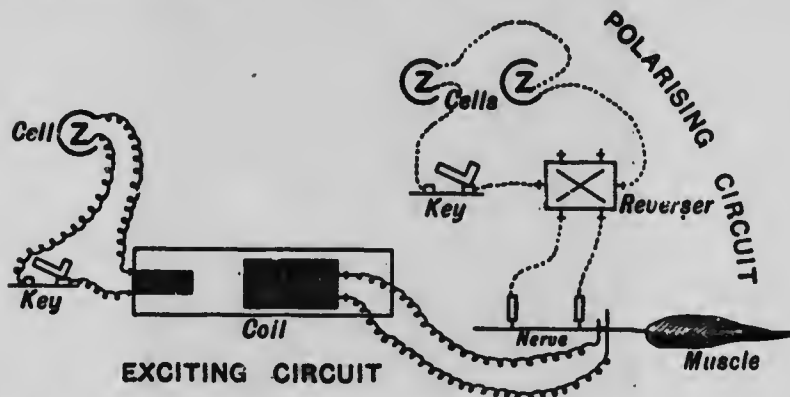

Fig. 189.—Diagram of apparatus used in testing electrotonic alterations of excitability.

in a *descending* direction (*i.e.*, towards the muscle); the kathode is then the non-polarisable electrode near to the exciting electrodes. While the polarising current is flowing, take some more tracings by breaking the exciting current. The *height* in the excitability of the nerve is shown by the much *greater* contractions of the muscle; probably a contraction will be obtained now at both make and break of the exciting current. After removing the polarising current, the contractions obtained by exciting the nerve will be for a short time smaller than the normal, but soon return to their original size.

Exactly the reverse occurs when the polarising current is *ascending*, *i.e.*, from the muscle towards the spinal cord. The non-polarisable electrode near the exciting electrodes is now the anode. While the polarising current is passing, the excitability of the nerve is diminished so that induction shocks which previously produced contractions of a certain size, now produce

smaller contractions, or none at all. On removing the polarising current, the after-effect is increase of excitability.

The following figure is a reproduction of a tracing from an actual experiment. The after-effects are not shown. N represents a series of contractions obtained when the nerve is normal, K when it is katelectrotonic, A when it is anelectrotonic.

Exactly similar results are obtained if one uses mechanical stimuli, such as hammering the nerve, instead of induction shocks. The same is true for chemical stimuli. If the exciting electrodes are removed, and salt sprinkled on the nerve near the muscle, the latter soon begins to quiver; its contractions are increased



Fig. 190.—Electrotonus. M, make. B, break.

by throwing in a descending and diminished by an ascending polarising current.

The increase in irritability is called **katelectrotonus**, and the decrease is called **anelectrotonus**. The accompanying diagram (fig. 191) shows how the effect is most intense at the points (*a*, *k*) where the electrodes are applied, and extends in gradually diminishing intensity on each side of them. Between the electrodes the increase shades off into the decrease, and it is evident that there must be a *neutral point* where there is neither increase nor decrease of irritability. The position of this neutral point is found to vary with the intensity of the polarising current—when the current is weak the point is nearer the anode, when strong nearer the kathode.

**Electrotonic alterations of conductivity.**—When a constant current is passed through a nerve, not only is its excita-

bility or power of responding to stimuli altered in the way just described, but its conductivity or power of conducting nerve impulses is altered as well. Moreover, the alteration in conductivity does not run parallel to that of excitability.

If weak currents are used, there is but little change in the conducting power of the nerve, and what little change there is, is in the direction of diminution near the kathode. But when the strength of the current is increased, the diminution of conductivity is very marked round the kathode, and gradually fades away towards the anode (fig. 192, 1). On increasing the strength of the current still more, the loss of conductivity is greater, and spreads over both the anodic and kathodic regions (fig. 192, 2).

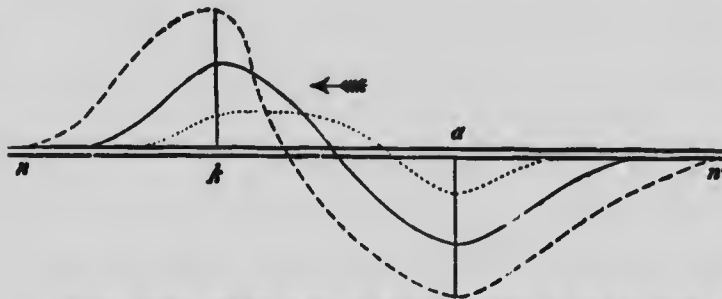

Fig. 191.—Diagram illustrating the effects of various intensities of the polarising current. *n*, *n'*, nerve; *a*, anode; *k*, kathode; the curves above indicate increase, and those below decrease of irritability, and when the current is small the increase and decrease are both small, with the neutral point near *a*, and as the current is increased in strength, the changes in irritability are greater, and the neutral point approaches *k*.

When the current is taken out, the reverse changes take place, but this after-effect only lasts a short time. In fig. 192, 3, we see the effect of breaking a current of moderate strength, viz., a fall of conductivity in the post-anodic region which gradually fades away towards the kathode.

**Pfűger's law of contraction.**—The constant current sometimes causes a contraction both at make and break, sometimes at make only, sometimes at break only. The difference depends on the strength and direction of the current; and follows from the electrotonic changes of excitability and conductivity we have been studying. Increase of excitability acts as a stimulus; so that at the make the kathode is the stimulating electrode, and at the break the anode is the stimulating electrode.

The facts may be demonstrated in the following way (fig. 193): from a battery lead the wires to the middle screws of a reverser (with cross wires) interposing a key; from one pair of end screws of the



reverser lead wires to the binding screws of the rheochord; from these same screws of the rheochord the non-polarisable electrodes lead to the nerve of a nerve-muscle preparation. The strength of the

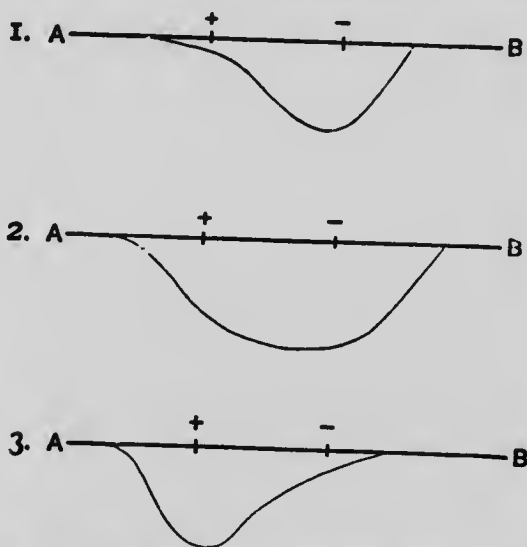

Fig. 192.—Diagram illustrating the effects of a polarising current on the conductivity of a nerve. A B represents the nerve, and the anode and kathode are indicated by + and - respectively. The curve represents the fall of conductivity which occurs; in 1, the effect of a weak current is shown, the fall of conductivity is greatest round the kathode; in 2, with a stronger current the fall is greater and has spread so as to include the anodic region. 3 shows the effect immediately after the removal of the current; the fall is then greatest in the post-anodic region. (After Stewart.)

current is varied by the slider S. The nearer S is to the binding screws the less is the resistance in the rheochord circuit, and the less the current through the nerve. With a weak current, a

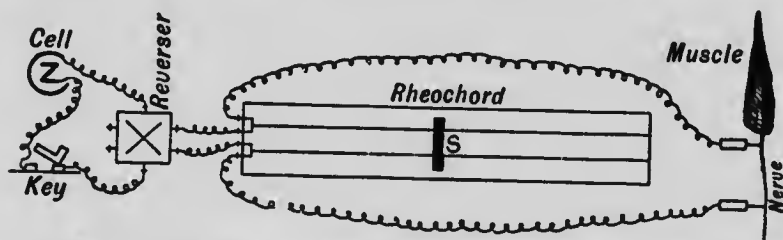

Fig. 193.—Arrangement of apparatus for demonstrating Pfüger's law.

contraction occurs at make only, but more readily, *i.e.* with a weaker current when its direction is descending, *i.e.* towards the muscle. With a stronger current (ascending or descending) contraction occurs both at make and break. With a very strong current (six Groves), the contraction occurs only at make with

a descending current; and only at break with an ascending current.

The contractions produced in the muscle of a nerve-muscle preparation by a constant current have been arranged in a table which is known as Pfüger's **Law of Contraction**. It is really only a statement as to when a contraction may be expected:

STRENGTH OF CURRENT USED.	DESCENDING CURRENT.		ASCENDING CURRENT.	
	Make.	Break.	Make.	Break.
Weak .....	Yes.	No.	Yes.	No.
Moderate.....	Yes.	Yes.	Yes.	Yes.
Strong .....	Yes.	No.	No.	Yes.

The increase of irritability at the kathode when the current is made, is greater and so more potent to produce a contraction than the rise of irritability at the anode when the current is broken; and so with weak currents the only effect is a contraction at the make. There is little or no alteration in the conductivity of the nerve to hinder the propagation of the impulse so started.

With a current of moderate strength and in an ascending direction, the excitation which occurs at the anode at break starts an impulse in a part of the nerve near the muscle, and not separated from it by any region of diminished conductivity; at make also there is no block to prevent the excitation which occurs at the kathode from reaching the muscle, since with moderate currents the fall of conductivity does not reach the anodic region (fig. 192, 1). When the current is descending, the excitation at the make is at the kathode, and as this is near the muscle there is no block in the nerve between it and the muscle; at the break, the kathodic block is removed, and so the anodic excitation is readily propagated to the muscle.

With strong currents the case is a little more complicated, because here the diminution of conductivity is so great that certain regions of the nerve become impassable by nerve-impulses. When the current has an ascending direction, the impulse at the break is started at the anode, and as this is next to the muscle there is no hindrance to the propagation of the impulse, but at the make the impulse started at the kathode is blocked by the lowering of conductivity which as we have seen with strong currents spreads and reaches the anode (fig. 192, 2). When the current is descending the kathode is near the muscle, and so the

impulse at make reaches the muscle without hindrance; but at the break, the impulse started at the anode has to traverse a region of nerve, the anodic end of which has a smaller conductivity immediately after opening than during the flow of the current (fig. 192, 3); the cathodic end of this region also does not become immediately passable after a strong current.

Thus we have seen that two circumstances influence the effect of the constant current upon a nerve, viz., the strength and direction of the current. It is also necessary that the stimulus should be applied *suddenly* and not gradually, and that the *irritability of the nerve should be normal*; not increased or diminished. Sometimes (when the preparation is specially irritable) instead of a simple contraction a tetanus occurs at the make or break of the constant current. This is liable to occur at the break of a strong ascending current which has been passing for some time into the preparation, or at the make of a strong descending current; both being conditions which increase the excitability of the piece of nerve nearest to the muscle; this is called **Ritter's tetanus**, and may be stopped in the first case by throwing in the current in the same direction, or in the second case by throwing in a current in the opposite direction.

The same general laws hold for muscle as well as for nerve, but are more difficult to demonstrate; the main fact, however, that the cathode is the stimulating electrode at the make, and the anode at the break, may be shown by the following experiment; if a curarised, that is, a physiologically nerveless muscle, is arranged as in the experiment for demonstrating the muscle wave (see fig. 149, p. 125), and a non-polarisable electrode placed at each end, the muscle wave at the make of a constant current starts at the negative electrode (cathode) and at the break at the positive electrode (anode).

An induced current in the secondary circuit of an inductorium may be regarded as a current of such short duration that the opening and closing are fused in their effects. This is true for all induction currents, whether produced by the make or break of the primary circuit. The cathode will always be the more effective in causing contraction.

#### RESPONSE OF HUMAN MUSCLES AND NERVES TO ELECTRICAL STIMULATION.

Perhaps the most important outcome of this study of the response of muscle and nerve to electrical stimulation is its application to the muscles and nerves of the human body,

because here it forms a most valuable method of diagnosis in cases of disease. The following account of this is chiefly an abstract from Sir William Gowers' Manual of Diseases of the Nervous System.

In the normal state, nerves can be stimulated either by induction shocks, or by the make and break of a constant current. In the case of the motor-nerves this is shown by the contraction of the muscles they supply; and in the case of the sensory nerves by the sensations that are produced. In the case of the sensory nerves, the sensation produced by the constant current is most intense at the instant of make and break, or when the strength of the current is changed in the direction either of diminution or increase; but there is a slight sensation due doubtless to the electrotonic alterations in excitability which we have been studying, during the whole time that the current is passing.

When the nutrition of the nerves is impaired, much stronger currents of both the induced and constant kinds are necessary to evoke muscular contractions than in the normal state. When the nerves are completely *degenerated* (as for instance when they are cut off from the spinal cord, or when the cells in the cord from which they originate are themselves degenerated, as in infantile paralysis) no muscular contraction can be obtained on stimulating the nerves even with the strongest currents.

The changes in the excitability of the muscles are less simple, because in them there are two excitable structures, the terminations of the nerves, and the muscular fibres themselves. Of these, the nerve-fibres are the more sensitive to induction currents, and the faradic stimulation of a muscle under normal circumstances is by means of these motor nerve-endings. Thus we find that its excitability corresponds in degree to that of the motor-nerve supplying it. The muscular fibres are, even in the normal state, less sensitive to faradism (that is, a succession of induction shocks) than the nerve, because they are incapable of ready response to stimuli so very short in duration as are the shocks of which a faradic current consists. The proof of this consists in the fact that under the influence of curare, which renders the muscle practically nerveless, the muscle requires a much stronger faradic current to stimulate it than in the normal state. When the nerve is degenerated, the make or break of the constant current stimulates the muscle as readily as in the normal state; but the contraction is propagated more slowly than that which occurs when the nerve-fibres are intact, and is due to the stimulation of the muscular fibres themselves. The fact that, under normal circumstances, the contraction which is caused by the constant

current is as quick as that produced by an induction shock, is ground for believing that in health the constant, like the induced current, causes the muscle to contract chiefly by exciting the motor-nerves within it.

When the motor-nerve is degenerated, and will not respond to any form of electrical stimulation, the muscle also loses all its power of response to induction shocks. The nerve-degeneration is accompanied by changes in the nutrition of the muscular fibres as is evidenced by their rapid wasting, and any power of response to faradism they possessed in the normal state is lost. But the response to the constant current remains, and is indeed more ready than in health, doubtless in consequence of nutritive changes which develop what the older pathologists called, truly enough, "irritable weakness." There is, moreover, a qualitative as well as a quantitative change. In health the first contraction to occur on gradually increasing the strength of the current is at the negative pole, when the circuit is closed (see Pflüger's law), and a stronger current is required before closure-contraction occurs at the positive pole. But in the morbid state we are discussing, closure-contraction may occur at the positive pole as readily as or even more readily than at the negative pole. This condition, the reasons for which we do not know, is called the "*Reaction of Degeneration.*"

Suppose a patient comes before one with muscular paralysis. This may be due to disease of the nerves, of the cells of the spinal cord, or of the brain. If the paralysis is due to brain disease, the muscles will be slightly wasted owing to disuse, but the electrical irritability of the muscles and nerves will be normal, as they are still in connection with the nerve-cells of the spinal cord that control their nutrition. But if the paralysis is due to disease either of the spinal cord or of the nerves, this nutritive influence can no longer be exercised over the nerves or muscles. The nerves will degenerate; the muscles waste rapidly; the irritability of the nerves to both forms of electrical stimulation will be lost; the muscles will not respond to the faradic current, but in relation to the constant current they will exhibit what we have called the "reaction of degeneration."

This illustrates the value of the electrical method as a means of diagnosis, that is, of finding out what is the matter with a patient. It is also a valuable means of treatment; by making the muscles contract artificially, their nutrition is kept up until restoration of the nerves or nerve-centres is brought about. Another illustration will indicate that the facts regarding electrotonic variation of excitability are true for sensory as well

as for motor nerves; in a case of neuralgia, relief will often be obtained by passing a constant current through the nerve; but the pole applied to the nerve must be the anode which produces diminution of excitability, not the kathode which produces the reverse.

Waller has pointed out that Pflüger's law of contraction, as formulated for frogs' muscles and nerves, is true for human muscles and nerves in the main, but there are certain discrepancies. These arise from the method necessarily employed in man being different from those used with a muscle-nerve preparation. In a muscle-nerve preparation the nerve is dissected out, the two electrodes placed on it, and the current has of necessity to traverse the piece of nerve between the two electrodes. In man, the current is applied by means of electrodes or rheophores which consist of metal discs covered with wash leather, and soaked in brine. One of these is placed on the moistened skin over the nerve, and the other on some indifferent point such as the back. The current finds its way from one electrode to the other, not necessarily through the nerves to any great extent (though it will be concentrated at the nerve as it leaves the anode or reaches the kathode),



Fig. 194.—Electrodes applied to the skin over a nerve-trunk. In A the polar area is anelectrotonic, and the peripolar katelectrotonic. The former condition, therefore, preponderates, since the current is more concentrated. In B the conditions are reversed, the polar zone corresponding here to the kathode. (After Waller.)

but diffuses widely through the body, seeking the paths of least resistance. Thus it is impossible to get pure anodic or cathodic effects. If the anode is applied over the nerve, the current enters by a series of points (polar zone), and leaves by a second series of points (peripolar zone). The second series of points is very close to the first, as the current leaves the nerve as soon as possible, seeking less resistant paths. The polar zone will be in the condition of anelectrotonous, the peripolar in that of katelectrotonous, so that although the former effect will predominate, the points being more concentrated, the latter effect may prevent a pure anelectrotonic effect being observed (fig. 194).

*Excitability and conductivity.*—We have already seen that these two properties of nerve do not necessarily go together. We learn the same lesson from the following experiments. The nerve of a frog's leg is led through a glass tube, the ends of which are sealed with clay, but the nerve must not be compressed. The tube is supplied with an inlet and outlet, so that gases may be passed through it. Two pairs of electrodes are arranged, so that the nerve can be stimulated either within or outside the tube. If carbonic acid is passed through the tube, and the nerve stimulated by an induction shock within the tube, the muscle does not respond; but on stimulating outside the tube, the muscle contracts. The nerve is, therefore, not excitable, though it will conduct impulses. If alcohol vapour is used, conductivity vanishes before excitability. Cold acts like carbonic acid; localised cold applied to nerve, however, increases its excitability to the constant current, and also to mechanical and thermal stimuli (Gotch).

Waller tests the excitability of nerve by the amount of current of action it gives rise to; not by the amount of contraction in the muscle to which it leads. He finds that the effect of carbonic acid in large doses is to depress the activity of nerve; but after the gas is removed, there is greatly increased activity. Ether acts similarly; but with chloroform there is no recovery. Small doses of carbonic acid increase the action-currents, and Waller considers that the staircase effect in muscle (p. 124), and the similar progressive increase noted in the action-currents of nerve as the result of repeated stimulation is due to the evolution of this gas during activity.

There can be no doubt that the existence of the electrical variation is as a rule the index of the excitatory alteration in a nerve. In the isolated nerve it is in fact the only change that can be detected. But in the present state of our knowledge we are not justified in assuming that it gives an absolutely faithful record. The electrical variation can be detected in a nerve for many days after its removal from the body. Although the electrical change is a concomitant of the real excitatory process, the former may be therefore perceptible when other evidence of the existence of the latter fails. Moreover, Gotch and Burch have obtained further evidence of the dissociation of the electrical response from the excitatory process. In the frog's sciatic nerve, it is possible with two stimuli in rapid succession to obtain only one electrical response near the seat of excitation which has been cooled, while two such responses occur in a more peripheral warmer region.

---

## CHAPTER XVII.

### NERVE-CENTRES.

THE nerve-centres consist of the brain and spinal cord; they are characterised by containing nerve-cells, from which the nerve-fibres of the nerves originate. Small collections of nerve-cells are found also in portions of the peripheral nervous system, where they are called *ganglia*. The spinal ganglia on the posterior roots of the spinal nerves, and the sympathetic ganglia are instances of these.

The general arrangement of the cerebro-spinal axis is given in the accompanying diagram. The nerves which take origin from the brain are called cranial nerves; there are twelve pairs of these; some of them, like the olfactory, optic, and auditory nerves, are nerves of special sense; others supply the region of the head with motor and sensory fibres. One pair (the tenth) called the pneumogastric or vagus nerves are mainly distributed to the viscera of the thorax and abdomen, and a part of another pair (the eleventh), called the spinal accessory nerves, unites with the vagus prior to such distribution. We shall in our subsequent study of the heart, lungs, stomach and other organs have frequently to allude to these nerves. The first two pairs of cranial nerves (the

olfactory and the optic) arise from the cerebrum. The remaining ten pairs arise from the district of grey matter called the floor of the fourth ventricle or its immediate neighbourhood; this tract of grey matter is situated at the lower part of the brain where it joins the spinal cord; this portion of the brain is called the *Bulb* or *Medulla oblongata*.

The spinal nerves are arranged in pairs, 31 in number. Their general structure and functions we have already studied (pp. 169—172).

The more intimate structure of the brain and spinal cord we shall consider at length in subsequent chapters. For the present we shall deal with some of the general aspects of the nerve-centres, both as regards structure and function.

Both brain and spinal cord consist of two kinds of tissue,



Fig. 195.—View of the cerebro-spinal axis of the nervous system. The right half of the cranium and trunk of the body has been removed by a vertical section; the membranes of the brain and spinal cord have also been removed, and the roots and first part of the fifth and ninth cranial, and of all the spinal nerves of the right side, have been dissected out and laid separately on the wall of the skull and on the several vertebrae opposite to the place of their natural exit from the cranio-spinal cavity. (After Bourguery.)



easily distinguishable by the naked eye. They are called respectively *white matter* and *grey matter*.

*White matter* is composed of medullated nerve-fibres, which differ in structure from the medullated fibres of nerve by having no primitive sheath.

*Grey matter* is the true central material so far as regards function; that is to say, it is the part which receives and sends out nervous impulses; it is characterised by containing nerve-cells and their branches.

In the brain the grey matter is chiefly situated on the surface, forming what is called the *cortex*; the white matter and certain subsidiary masses of grey matter are in the interior.



Fig. 106.—Branched neuroglia-cell. (After Stöhr.)

In the spinal cord, the grey matter is in the interior, the white matter outside.

In both grey and white matter the nerve-cells and nerve-fibres are supported by a peculiar tissue which is called *neuroglia*. It is composed of cells and fibres, the latter being prolonged from the cells. Some of the fibres are radially arranged. They start from the outer ends of the ciliated epithelium cells that line the central canal of the spinal cord and the ventricles of the brain, and diverge constantly branching towards the surface of the organ, where they end by slight enlargements attached to the pia mater. The other fibres of the tissue are cell processes of the neuroglia or glia cells proper, or spider cells as they are sometimes termed (see f 196).

Neuroglia is thus a connective tissue in function, but it is not

one in origin. Like the rest of the nervous system, it originates from the outermost layer of the embryo, the epiblast. All true connective tissues are mesoblastic.

Chemically it is very different from connective tissues. It consists of an insoluble material called *neuro-keratin*, or nerve-horn, similar to the horny substance keratin which is found in the surface layers of the epidermis.

### Structure of Nerve-Cells.

Nerve-cells differ a good deal both in shape and size. In the early embryonic condition, the future nerve-cell is a

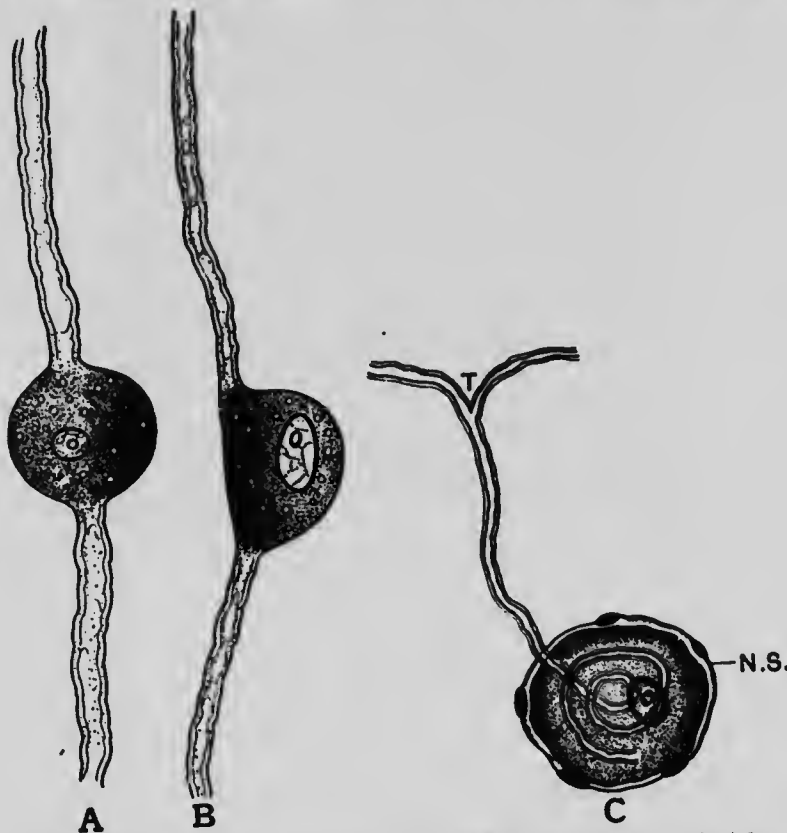

Fig. 197.—Bipolar nerve-cells. A. From the Gasserian ganglion of the pike (after Bidder). B. From a spinal ganglion of a 4½ weeks' human embryo (after His). C. Adult condition of the mammalian spinal ganglion cell: N.S. nucleated sheath; only the nuclei seen in profile are represented. T. is the T-shaped junction (after Retzius).

small nucleated mass of protoplasm without processes. As development progresses branches grow, and by this means it is brought

into contact with the branches of other nerve-cells. When the nerve-cells degenerate as they do in some cases of brain and cord disease, there is a reversal of this process; just as in a dying tree the terminal branches, those most distant from the seat of nutrition, are the first to wither, so it is in the degenerating nerve-cell. If one traces the structure of nerve-cells throughout the zoological series, there is also seen an increase in their complexity, and the

number of points of contact produced by an increase in the number and complexity of the branches multiplies.

The simplest nerve-cells known are termed *bipolar*. In the lower animals the two processes come off from the opposite ends of the cells; the cell, in other words, appears as a nucleated enlargement on the course of a nerve-fibre. Fig. 197 (A) shows one of these nerve-cells from the Gasserian ganglion of the pike. The cells of the Gasserian and spinal ganglia in the mammalian embryo are also bipolar, but as development progresses, the two branches become fused for a considerable distance, so that in the fully-formed animal the cell appears to be *unipolar*. This is shown in a more diagrammatic way in fig. 180, p. 169. The bifurcation of the nerve-fibre is spoken of as a T-shaped junction. As will be seen in fig. 197 (C), the nerve process has a convoluted course on the surface of the cell before it bifurcates. In these ganglia it should be also noted that each cell is enclosed within



Fig. 198.—Sympathetic ganglion cell of a frog, highly magnified. (Beale.)

a connective tissue sheath, and the nuclei seen are those of the connective tissue corpuscles.

In the sympathetic ganglia, the cells may have a similar structure, and here also the nucleated sheath is seen. In some cases, however, when there appear to be two fibres connected to a cell, one of them is really derived from another cell, and is passing to end in a ramification which envelops the ganglion cell; it may sometimes, as in fig. 198, be coiled spirally around the issuing nerve-fibre.

The majority of nerve-cells found in the body are *multipolar*. Here the cell becomes angular or stellate. Fig. 199 shows the usual form of cell present in sympathetic ganglia. From the angles of the cell, branches originate; the majority of these branches divide and subdivide until they end in an arborescence of fine twigs or fibrils; but one process, and one process only, of each cell becomes the axis cylinder of a nerve-fibre.

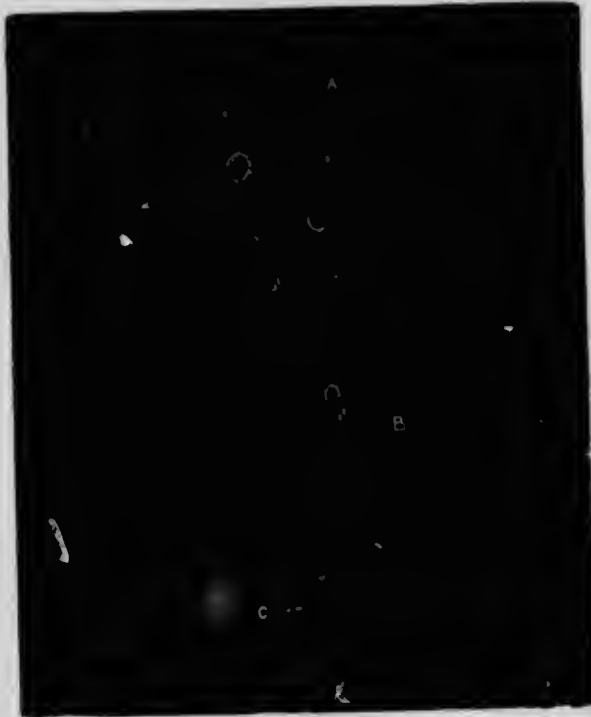

Fig. 199.—An isolated sympathetic ganglion cell of man, showing sheath with nucleated-cell lining, B. A. Ganglion cell, with nucleus and nucleolus. C. Branched process. D. Axis cylinder process. (Key and Retzius.)  $\times 750$ .

Passing next to the central nervous system, we here again find the multipolar cell is the principal kind present.

The next figure (fig. 200) shows one of the typical multipolar cells of the spinal cord. Here again, only one process (*a*) becomes the axis cylinder of a nerve-fibre, and the others break up into arborisations of fibrils. The cells have a finely fibrillar structure, and the fibrils can be traced into the axis cylinder process and the other branches of the cell. Between the fibrils the protoplasm of the cell contains a number of angular or spindle-shaped masses, which have a great affinity of basic aniline dyes like methylene blue. They are known as *Nissl's granules*. These nerve-cells also contain, especially in the adult, granules of pigment, usually yellow, the nature of which has not been determined.

In preparations made by Golgi's chromate of silver method, the cells and their processes are stained an intense black by a deposit of silver. The various structures in the cells (nucleus, granules, fibrils, etc.), are not visible in such preparations, but the great advantage of the method is that it enables one to follow the branches to their finest ramifications. It is thus found that the axis cylinder process is not unbranched as represented in fig. 200, but invariably gives off side-branches, which are called *collaterals*; these pass into the adjacent nerve tissue. The axis cylinder then acquires the sheaths, and thus is converted into a nerve-fibre. This nerve-fibre sometimes, as in the nerve-centres after a more or less extended course, breaks up into a terminal arborescence enveloping other nerve-cells; the collaterals also terminate in a



Fig. 200.—Multipolar nerve-cell from anterior horn of spinal cord; a, axis cylinder process. (Max Schultze.)

similar way. The longest type of axis cylinder is that which passes away from the nerve-centre, and gets bound up with other similarly sheathed axis cylinders to form a nerve; but all ultimately terminate in an arborescence of fibrils in various end organs (end-plates, muscle spindles, etc.).

In the grey matter of the cerebrum the nerve-cells are various in shape and size, but the most characteristic cells are large and pyramidal in shape. They are especially large and numerous in what are called the motor areas of the brain. The apex of the cell is directed to the surface; the apical process is long and tapering, and finally breaks up into fibrils that lie parallel to the surface of the brain (*tangential fibres*). From the lower angles and other parts branching processes originate; the axis cylinder comes off from the base of the pyramid. The next figure (fig. 201) shows the typical appearance of one of these cells, showing the various points just described. The following figure shows a section

of the cerebral cortex also prepared by Golgi's method (fig. 202, p. 196).

The grey matter of the cerebellum contains a large number of small nerve-cells, and one layer of large cells. These are flask-shaped, and are called the *cells of Purkinje*. The neck of the flask breaks up into branches, and the axis cylinder process comes off from the base of the flask (fig. 203, p. 197).

The study of the nervous system by the valuable method introduced by Golgi has led to some new conceptions as to its structure and to a new nomenclature. The whole nervous system consists of nerve-cells and their branches, supported by neuroglia in the central nervous system, and by connective tissue in the nerves. Some of the processes of a nerve-cell break up almost immediately into smaller branches ending in arborescences of fine twigs; these branches, which used to be called protoplasmic processes, are now termed *dendrons* and the fine twigs *dendrites*; one branch becomes the long axis cylinder of a nerve-fibre, but it also ultimately terminates in an arborisation. It is called:

the *axis cylinder process*, or, more briefly, the *axon*. The term *neuron* is applied to the complete *nerve-unit*, that is, the body of the cell, and all its branches. Some observers have supposed that the axis cylinder process is the only one that conducts nerve impulses, the dendrons being rootlets which suck up nutriment for the nerve-cell. This exclusive view has not, however, been generally

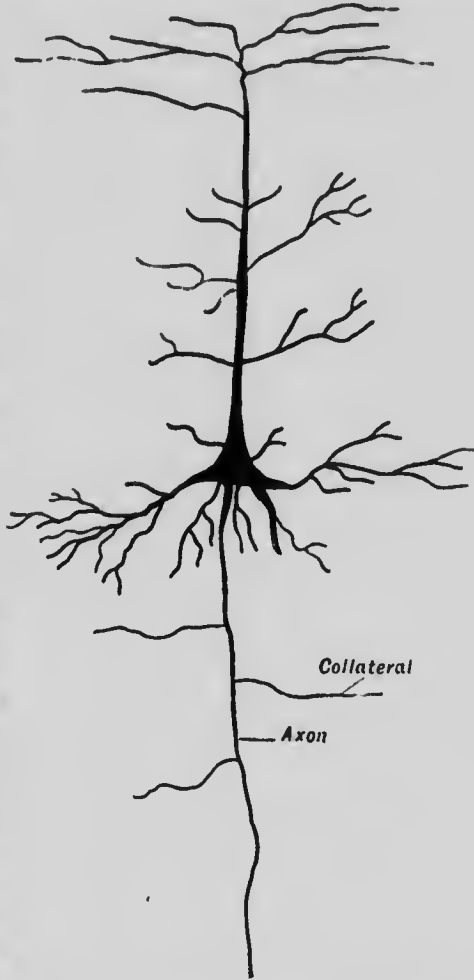

Fig. 201.—Pyramidal cell on human cerebral cortex. Golgi's method.

accepted; the dendrons may be nutritive, but it is believed that they also, like the rest of the nerve-unit, are concerned in the conduction of nerve impulses. A strong piece of evidence in this direction is the fact that the fibrils of the axis cylinder may be traced through the body of the cell into the dendrons.

The next idea which it is necessary to grasp is, that each nerve-unit (cell *plus* branches of both kinds) is anatomically independent of every other nerve-unit. There is no anastomosis of the branches from one nerve-cell with those of another; the

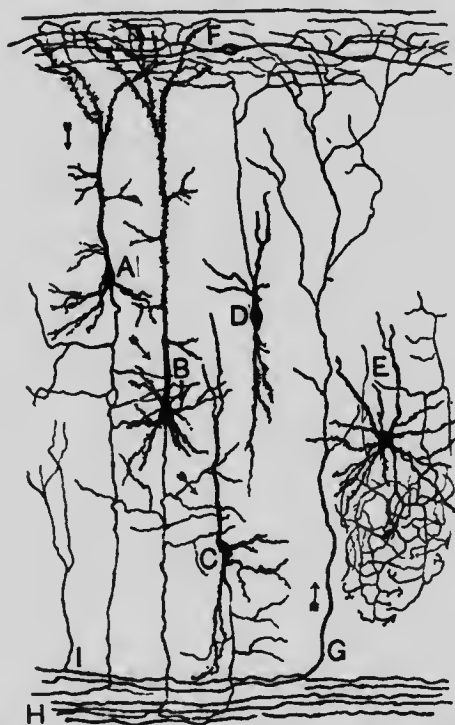

Fig. 202.—Cerebral cortex of mammal, prepared by Golgi's method. A, B, C, D, F, nerve-cells; E, neuroglia-cell. (Ramon y Cajal.)

arborisations interlace and intermingle, and nerve impulses are transmitted from one nerve-unit to another, but not by continuous structures. The impulses are transmitted through contiguous, but not through continuous structures. A convenient expression for the intermingling of arborisations is *synapse* (literally, a clasping).

The figure on page 198 is a diagram of the nervous path in a reflex action. Excitation occurs at S, the skin or other sensory surface, and the impulse is transmitted by the sensory nerve-fibre to the nerve-centre, where it ends not in a nerve-cell, but by arborising around a nerve-cell and its dendrons. The only

nerve-cell in actual continuity with the sensory nerve-fibre is the one in the spinal ganglion (G) from which it grew.

The terminal arborisation of the sensory nerve-fibre merely interlaces with the dendrons of the motor nerve-cell; yet simply by this synapse, the motor nerve-cell (M C) is affected and sends an impulse by its axis cylinder process to the muscle (M).

A very rough illustration which may help one in realising this may be taken as follows: Suppose two trees standing side by side; their stems will represent the axis cylinders; their branches the dendrons. If the trees are close together the branches of one

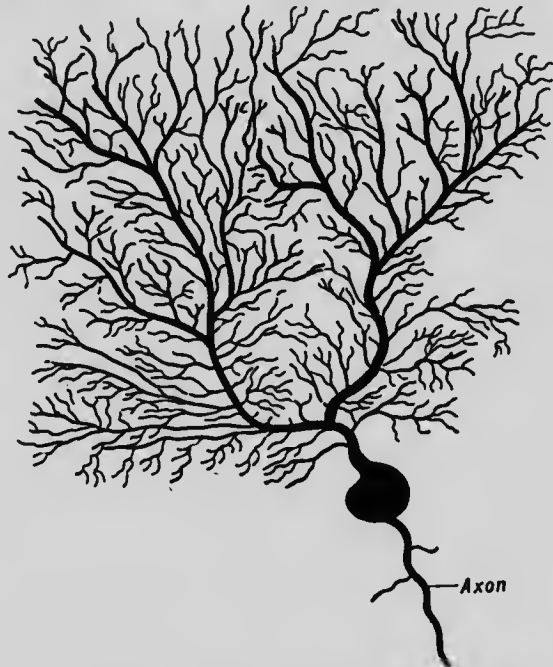

Fig. 203.—Cell of Purkinje from the human cerebellum. Golgi's method. (After Szymonowicz.)

will intermingle with those of the other: there is no actual branch from the one which becomes continuous with any branch of the other; but yet if the stem of one is vigorously shaken, the close intermixture of the branches will affect the other so that it also moves.

Another very important general idea which we must next get hold of, is that a nervous impulse does not necessarily travel along the same nerve-fibre all the way, but there is what we may term a *system of relays*. The nervous system is very often compared to a telegraphic system throughout a country. The telegraph offices represent the nerve-centres, the afferent nerve-



fibres correspond to the wires that carry the messages to the central offices, and the efferent nerve-fibres are represented by the wires that convey messages from the central offices to more or less distant parts of the country. This illustration will serve us very well for our present purpose, provided that it is always remembered that a nervous impulse is not electricity. Suppose, now, one wishes to send a message from the metropolis, which will represent the brain, to a distant house, say in the Highlands of Scotland. There is no wire straight from London to that house, but the message ultimately reaches the house; one wire takes the message to Edinburgh, another wire carries it on to

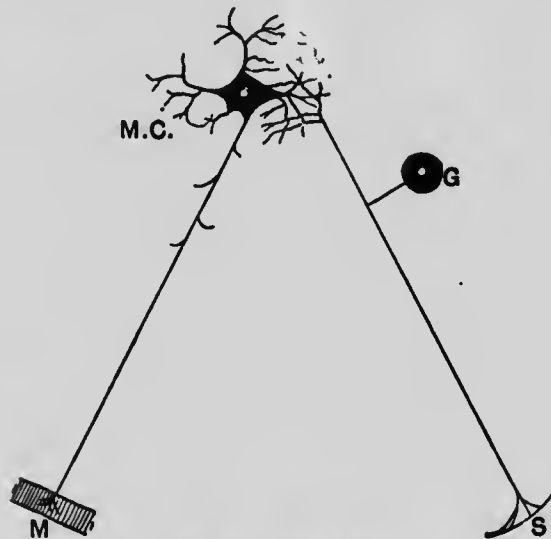

Fig. 204.—Reflex action.

the telegraph station in the town nearest to the house in question; and the last part of the journey is accomplished by a messenger on foot or horseback. There are at least two relays on the journey.

It is just the same with the nervous system. Suppose one wishes to move the arm; the impulse starts in the nerve-cells of the brain, but there are no fibres that go straight from the brain to the muscles of the arm. The impulse travels down the spinal cord, by what are called pyramidal fibres, to the nerve-cells of the spinal cord, and from these cells, fresh nerve-fibres pass to the arm-muscles, and continue the impulse. Here again the connection between the nerve-units is by contiguity, not by continuity. This is shown in the accompanying diagram (fig. 205). The cell of the cerebral grey matter is represented by C. C., the pyramidal nerve-fibre arborises around the cell of the spinal cord

(S. C.) from which the motor nerve-fibre arises, and which carries on the impulse. The spinal cord cells are thus surrounded by arborisations (synapses) derived not only from the sensory nerves (S), but by fibres from the upper part of the nervous system. We now see how it is possible that reflex actions in the cord may be controlled by impulses from the brain.

The sheaths of the nerve-fibres are not shown in the diagram.

The system of relays is still more complicated in the case of sensory impulses, as we shall see later on: the same is true for the motor path. Involuntary muscle, accessory cell-stations being situated in the sympathetic ganglia.

We may now return for a moment to the subject of degeneration. If the nerve-fibre is cut off from its connection with the spinal nerve-cell, the peripheral end degenerates as far as the muscle.

Suppose, now, the pyramidal fibre were cut across, the piece still attached to the brain-cell would remain in a comparatively normal condition, but the peripheral end would degenerate as far as the synapse round the spinal cell (S. C.), but not beyond. We can thus use the degeneration method to trace out tracts of nerve-fibres in the white matter of the central nervous system. The histological change in the fibres is here the same as that already described in the nerves, except that, as there is no primitive sheath, there can be no multiplication of its nuclei; there is instead an over-growth of neuroglia. Degenerated tracts consequently stain differently from healthy white matter, and can be by this means easily traced.

Another method of research which leads to the same results as the degeneration method is called the embryological method. The nerve-fibres which grow from different groups of nerve-cells become fully

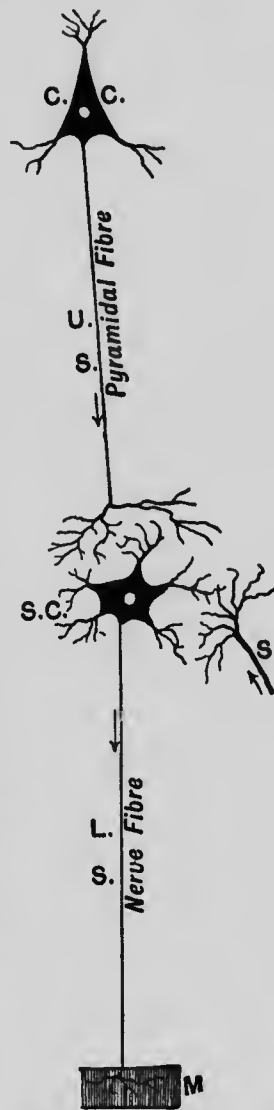

Fig. 205.—Diagram of an element of the motor path. U.S., upper segment; L.S., lower segment; C.C., cell of cerebral cortex; S.C., cell of spinal cord, in anterior cornu; M, the muscle; S, path from sensory nerve roots. (After Gowers.)

developed at different dates, and so by examining brains and cords of embryos of different ages, one is able to make out individual tracts before they have blended in the general mass of white matter.

We shall, however, return to this subject when later on we are studying the physiology of the central nervous system in detail.

### The Significance of Nissl's Granules.

If portions of the brain or spinal cord are fixed in absolute alcohol, and sections obtained from the hardened pieces are stained by means of methylene blue, the nerve-cells exhibit a characteristic appearance. The nucleus and nucleolus take up the blue stain, and throughout the cell body a number of angular-shaped masses, which are termed *Nissl's granules*, are also stained blue. These extend some distance into the dendrons, but not into the axon. The substance of which they are composed is termed *chromtoplasm*, or *chromophilic material*. The existence of granules in cells which have an affinity for basic dyes like methylene blue is not at all common; the granules in the majority of the white blood corpuscles, for instance, have an affinity for acid dyes. Micro-chemical methods have shown that the main constituent of the Nissl granules is nucleo-proteid. The name *kinetoplasm* has been given to it by Marincoseo in order to express the idea that it forms a source of energy to the cell. It can hardly be denied that the substance of which the granules are composed, forming as it does so large a proportion of the cell-contents, and made of a material in which nuclein forms an important constituent, is intimately related to the nutritional condition of the neuron. Some have even compared it to the granular material, which is present in secreting cells; in these cells before secretion occurs, the granules accumulate, and during the act of secretion they are discharged and converted into constituents of the secretion. It is stated by some observers that the Nissl granules are used up during the discharge of energy from nerve-cells, and it certainly is the case that if the cells are examined after an epileptic fit, in which there has been a very massive discharge of impulses, the Nissl granules have disappeared, or at least broken up into fine dust-like particles, so that the cell presents a more uniform blue-staining. It is, however, doubtful whether this is due to a transformation associated with intense activity, or whether it may not be caused by venosity of the blood. The cells are very sensitive to altered vascular conditions; anemia, for instance, produces a similar change accompanied with swelling of the cell, and swelling

and in extreme cases extrusion of the nucleus. High fever (hyperpyrexia) causes a very similar change, which is doubtless associated with the coagulation of the proteids of the cell-protoplasm by the high temperature.

Since attention has been directed towards the Nissl granules, a literature which has become alarmingly vast during the last few years has sprung up in relation to them. This is quite easy to understand, for neurologists have by this sensitive test been able to identify changes in the cells which could not be detected by the previous methods of staining. Thus the cells have been examined in various diseases, and after being subjected to the action of various poisons. In a new subject of this kind there is, as would be expected, considerable divergence of views, and even the fundamental question has not yet been answered satisfactorily whether the Nissl granules are present as such in the living cell, or whether they are artifacts produced by the fixative action of strong alcohol. The fact that they cannot be demonstrated when the cells are stained by the injection of methylene blue into the circulation before the animal is killed is a very strong piece of evidence in favour of the latter view. But, whichever view is correct, the method is a valuable one, and Nissl's views on this question appear to be indisputable: they are briefly as follows:—Healthy cells fixed and stained in a constant manner will appear the same under constant optical conditions, and the appearances then seen form the equivalent of such healthy cells during life. It follows that if the cells prepared by the same method and examined under the same conditions show a difference from the equivalent or symbol of healthy cells, the difference is the measure of some change that has occurred during life.

*Chromatolysis* is the term applied to designate the disappearance or disintegration of the Nissl granules. The process generally begins at the periphery of the cell and in the dendrons, but in advanced cases the whole cell may be affected. We have already alluded to the fact that chromatolysis occurs in various abnormal states, and the diminution of the chromophilic nucleo-proteid indicates a diminution of the vital interaction of the highly phosphorised nucleus with the surrounding cell protoplasm. Chromatolysis alone is not indicative of cell destruction, and a cell may recover its function afterwards. The integrity of the nucleus and of the fibrils appears to be much more important to the actual vitality of the cell.

When a nerve-fibre is cut across, the distal segment undergoes Wallerian degeneration; this is an acute change. But the nerve-cell and the piece of the nerve-fibre still attached to it do not

remain unaffected. If regeneration of the fibre, and restoration of function takes place, no change is observable. But if regeneration does not occur (and it does take place in the central nervous system), the cell and its processes undergo a slow chronic wasting; one of the earliest signs of this *disuse atrophy* is chromatolysis. Warrington has recently shown a still more interesting fact, namely, that section of the posterior roots causes chromatolysis in the anterior horn cells of the same side; this indicates that the loss of sensory stimuli produces a depression of the activity



Fig 206.—Nissl's granules. A. Normal pyramidal cell of human cerebral cortex. B. Swollen (edematous) pyramidal cell from a case of status epilepticus. Notice diffuse staining, and absence of Nissl's granules; the nucleus is enlarged and eccentric. The lymph space around the cell is dilated. C. Pyramidal cell of dog after ligature of vessels going to brain and consequent anemia. Notice great swelling of the nucleus, and advanced chromatolysis, most marked at the periphery of the cell.

and metabolic functions of the spinal motor cells. We shall see later on that this accords quite well with the physiological effects observed under these conditions.

The accompanying figures show the normal appearances presented by nerve-cells when stained with methylene blue, and the abnormal conditions observed in some of the pathological states alluded to in the preceding paragraphs. The letterpress beneath the figure should be carefully consulted. These drawings are made from photo-micrographs kindly lent me by Dr. Mott. The magnification in all cases is 700 diameters.

## CHAPTER XVIII.

## THE CIRCULATORY SYSTEM.

THE circulatory system is the collection of organs which have for their function, the circulation of the blood. It consists of the *heart*, the *arteries* or vessels that carry the blood from the heart to other parts of the body, the *veins* or vessels that carry the blood back to the heart again, and the *capillaries*, a network of minute tubes which connect the terminations of the smallest arteries to the commencements of the smallest veins. We shall also have to consider in connection with the circulatory system, (1) the *lymphatics*, which are vessels that convey back the lymph (the fluid which exudes through the thin walls of the blood-capillaries) to the large veins near to their entrance into the heart, and (2) the large lymph spaces contained in the *serous membranes*.

**The Heart.**

This is the great central pump of the circulatory system. It is contained in the chest or thorax. It lies between the right and left lungs (fig. 207), and is enclosed in a covering called the *pericardium*. The pericardium is an instance of a serous membrane. Like all serous membranes it consists of two layers; each consists of fibrous tissue containing a large amount of elastic fibres; one layer envelops the heart and forms its outer covering or *epicardium*; this is the *visceral* layer of the pericardium; the other layer of the pericardium, called its *parietal* layer, is situated at some little distance from the heart, being attached below to the diaphragm, the partition between the thorax and the abdomen. The visceral and parietal layers are continuous for a short distance along the great vessels at the base of the heart, and so form a closed sac. This sac is lined by endothelium; in health it contains just enough lymph to lubricate the two surfaces and enable them to glide over each other smoothly during the movements of the heart. The presence of elastic fibres in the epicardium enables it to follow without hindrance the changing shape of the heart itself; but the parietal layer of the pericardium appears to be inextensible, and so it limits the dilatation of the heart.

The pericardium is a comparatively simple serous membrane, because the organ it encloses is a single one of simple external form. All serous membranes are of similar structure; thus the *pleura* which encloses the lung, and the *peritoneum* which encloses the abdominal viscera differ from it only in anatomical arrangement. The great complexity of the peritoneum is due to its enclosing so many organs. Every serous membrane consists of a visceral layer applied to the organ or organs it encloses; and a parietal layer continuous with this in contiguity with the parietes or body-walls.

**The Chambers of the Heart.**—The interior of the heart is divided by a longitudinal partition in such a manner as to form two chief chambers or cavities—right and left. Each of these chambers is again subdivided transversely into an upper and a

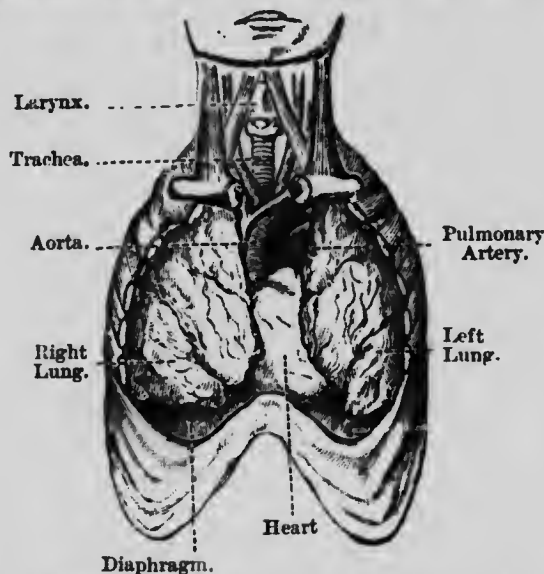

Fig. 207.—View of heart and lungs in situ. The front portion of the chest-wall and the outer or *parietal* layers of the pleuræ and pericardium have been removed. The lungs are partly collapsed.

lower portion, called respectively, auricle and ventricle, which freely communicate one with the other; the aperture of communication, however, is guarded by valves, so disposed as to allow blood to pass freely from the auricle into the ventricle, but not in the opposite direction. There are thus four cavities in the heart—the auricle and ventricle of one side being quite separate from those of the other (figs. 208, 209).

**Right Auricle.**—The right auricle is situated at the right part of the base of the heart in front. It is a thin walled cavity of more or less quadrilateral shape, prolonged at one corner into a tongue-shaped portion, the right auricular *appendix*, which slightly overlaps the exit of the great artery, the aorta, from the heart.

The interior is smooth, being lined with the general lining of the heart, the *endocardium*, and into it open the superior and inferior venæ cavæ, or great veins, which convey the blood from

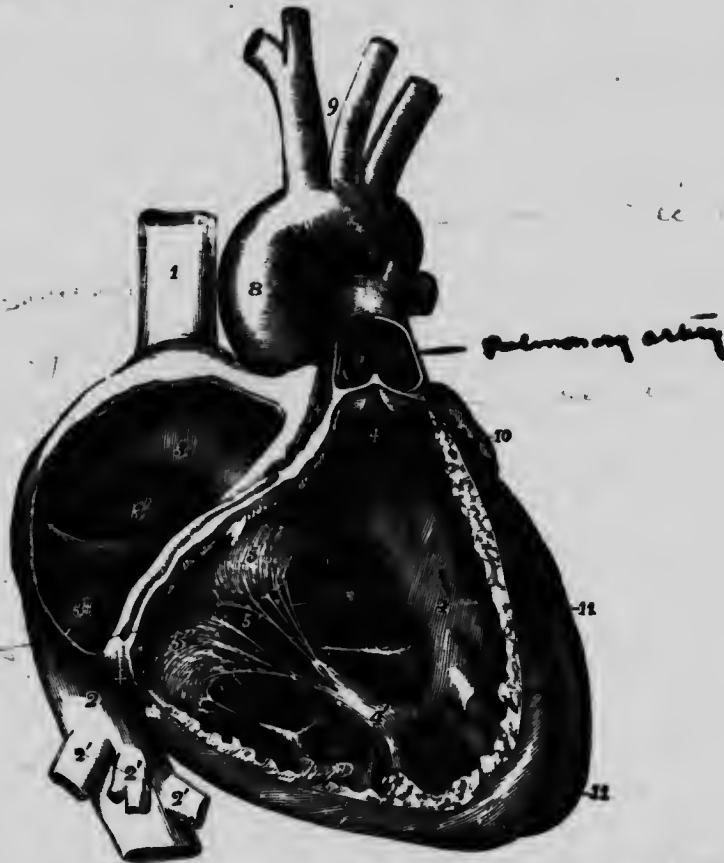

Fig. 208.—The right auricle and ventricle opened, and a part of their right and anterior walls removed, so as to show their interior. 1.—1, superior vena cava; 2, inferior vena cava; 2', hepatic veins cut short; 3, right auricle; 3', placed in the fossa ovalis, below which is the Eustachian valve; 3'', is placed close to the aperture of the coronary vein; ++, placed in the auriculo-ventricular groove, where a narrow portion of the adjacent walls of the auricle and ventricle has been preserved; 4, 4, cavity of the right ventricle, the upper figure is immediately below the semilunar valves; 4', large columna carnea or musculus papillaris; 5, 5', 5'', tricuspid valve; 6, placed in the interior of the pulmonary artery, a part of the anterior wall of that vessel having been removed, and a narrow portion of it preserved at its commencement, where the semilunar valves are attached; 7, concavity of the aortic arch close to the cord of the ductus arteriosus; 8, ascending part or sinus of the arch covered at its commencement by the auricular appendix and pulmonary artery; 9, placed between the innominate and left carotid arteries; 10, appendix of the left auricle; 11, 11, the outside of the left ventricle, the lower figure near the apex. (Allen Thomson.)

all parts of the body to the heart. The opening of the inferior cava is protected and partly covered by a membrane called the *Eustachian valve*. In the posterior wall of the auricle is a slight depression called the *fossa ovalis*, which corresponds to an opening



between the right and left auricles which exists in foetal life. The coronary *sinus*, or the dilated portion of the right coronary vein, also opens into this chamber.

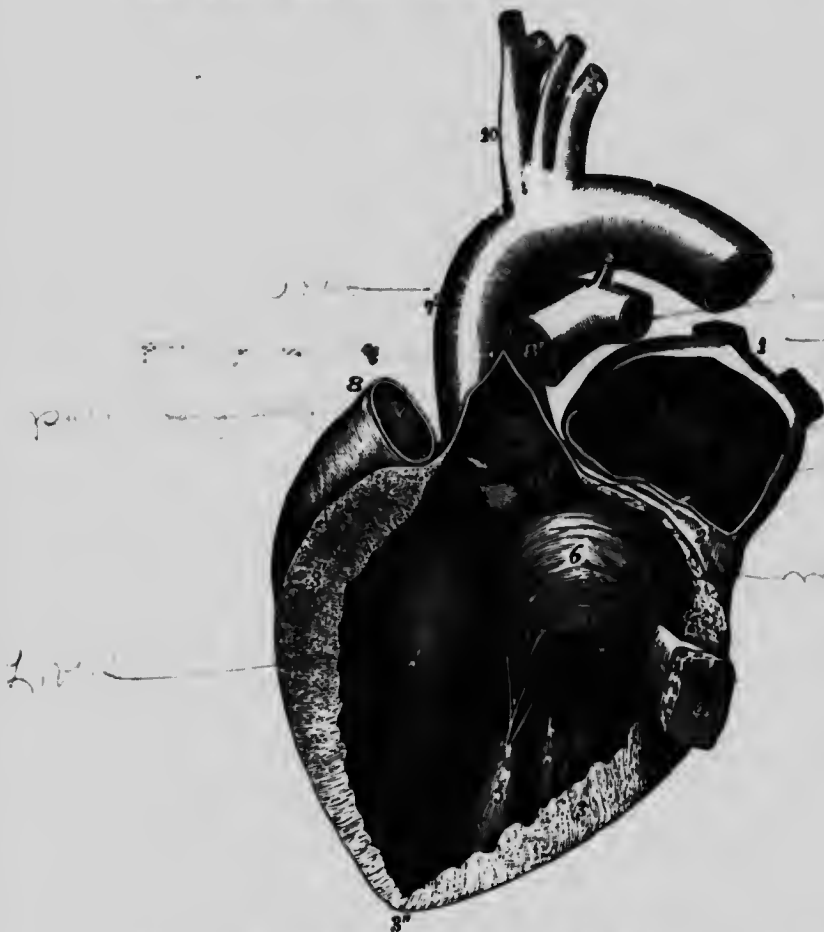
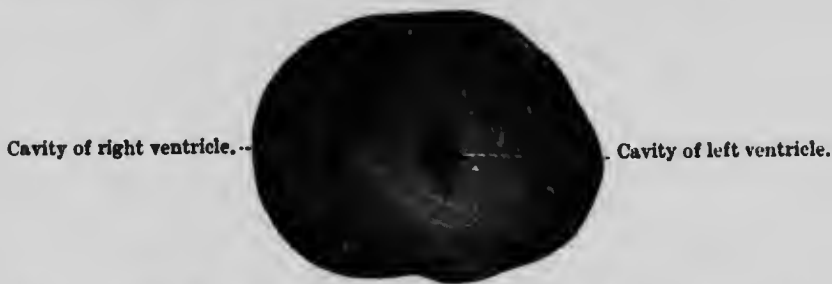

Fig. 209.—The left auricle and ventricle opened and a part of their anterior and left walls removed. 1.—The pulmonary artery has been divided at its commencement; the opening into the left ventricle is carried a short distance into the aorta between two of the segments of the semilunar valves; and the left part of the auricle with its appendix has been removed. The right auricle is out of view. 1, the two right pulmonary veins cut short; their openings are seen within the auricle; 1', placed within the cavity of the auricle on the left side of the septum and on the part which forms the remains of the valve of the foramen ovale, of which the crescentic fold is seen towards the left hand of 1'; 2, a narrow portion of the wall of the auricle and ventricle preserved round the auriculo-ventricular orifice; 3, 3', the cut surface of the walls of the ventricle, seen to become very much thinner towards 3'', at the apex; 4, a small part of the anterior wall of the left ventricle which has been preserved with the principal anterior columna carnea or musculus papillaris attached to it; 5, 5, musculi papillares; 5', the left side of the septum, between the two ventricles, within the cavity of the left ventricle; 6, 6', the mitral valve; 7, placed in the interior of the aorta, near its commencement and above the three segments of its semilunar valve which are hanging loosely together; 7', the exterior of the great aortic sinus; 8, the root of the pulmonary artery and its semilunar valves; 8', the separated portion of the pulmonary artery remaining attached to the aorta by 9, the cord of the ductus arteriosus; 10, the arteries rising from the summit of the aortic arch. (Allen Thomson.)

*Right Ventricle.*—The right ventricle occupies the chief part of the anterior surface of the heart, as well as a small part of the posterior surface; it forms the right margin of the heart. It takes no part in the formation of the apex. On section its cavity, in consequence of the encroachment upon it of the septum ventriculorum, is semilunar or crescentic (fig. 210); into it are two openings, the auriculo-ventricular at the base and the opening of the pulmonary artery also at the base, but more to the left; both orifices are guarded by valves, the former called *tricuspid* and the latter *semilunar*. In this ventricle are also the projections of the muscular tissue called *columnæ carneæ* (described at length p. 210).

*Left Auricle.*—The left auricle is situated at the left and posterior part of the base of the heart, and is best seen from behind. It is quadrilatera', and receives on either side two pulmonary veins.



Cavity of right ventricle.

Cavity of left ventricle.

Fig. 210.—Transverse section of bull's heart in a state of cadaveric rigidity. (Dalton.)

The auricular appendix is the only part of the auricle seen from the front, and corresponds with that on the right side, but is thicker, and the interior is smoother. The left auricle is only slightly thicker than the right. The left auriculo-ventricular orifice is oval, and a little smaller than that on the right side. There is a depression on the septum between the auricles, which is a vestige of the foramen between them, that exists in foetal life.

*Left Ventricle.*—Though taking part to a comparatively slight extent in the anterior surface, the left ventricle occupies the chief part of the posterior surface. In it are two openings very close together, viz. the auriculo-ventricular and the aortic, guarded by the valves corresponding to those of the right side of the heart, viz. the *bicuspid* or *mitral* and the *semilunar*. The first opening is at the left and back part of the base of the ventricle, and the aortic in front and towards the right. In this ventricle, as in the right, are the *columnæ carneæ*, which are smaller but more closely reticulated. They are chiefly found near the apex and

along the posterior wall. They will be again referred to with the description of the valves. The walls of the left ventricle, which are nearly half an inch in thickness, are, with the exception of the apex, about three times as thick as those of the right.

**Capacity of the Chambers.**—During life each ventricle is capable of containing about three ounces of blood. The capacity of the auricles after death is rather less than that of the ventricles: the thickness of their walls is considerably less. The latter condition is adapted to the small amount of force which the auricles require in order to empty themselves into their adjoining ventricles; the former to the circumstance of the ventricles being partly filled with blood before the auricles contract.

**Size and Weight of the Heart.**—The heart is about 5 inches long (about 12.6 cm.),  $3\frac{1}{2}$  inches (8 cm.) greatest width, and  $2\frac{1}{2}$  inches (6.3 cm.) in its extreme thickness. The average weight of



Fig. 211.—Network of muscular fibres from the heart of a pig. The nuclei are well shown. X 450. (Klein and Noble Smith.)

the heart in the adult is from 9 to 10 ounces (about 300 grms.); its weight gradually increases throughout life till middle age; it diminishes in old age.

**Structure.**—The walls of the heart are constructed almost entirely of layers of muscular fibres (p. 94); but a ring of connective tissue, to which some of the muscular fibres are attached, is inserted between each auricle and ventricle, and forms the boundary of the *auriculo-ventricular* opening. Fibrous tissue also exists at the origins of the pulmonary artery and aorta.

The muscular fibres of each auricle are in part continuous with those of the other, and partly separate; and the same remark holds true for the ventricles. Some muscular fibres also pass across the tendinous ring which separates each auricle from the corresponding ventricle.

**Endocardium.**—As the heart is clothed on the outside by the epicardium, so its cavities are lined by a smooth and shining

membrane, or *endocardium*, which is directly continuous with the internal lining of the arteries and veins. The endocardium is composed of connective tissue with a large admixture of elastic fibres; its inner surface is covered by endothelium. Here and there unstriped muscular fibres are sometimes found in the tissue of the endocardium.

**Valves.**—The arrangement of the heart's valves is such that the blood can pass only in one direction (fig. 212).

The *tricuspid* valve (5, fig. 208) presents *three* principal cusps or subdivisions, and the mitral or *bicuspid* valve has *two* such portions (6, fig. 209). But in both valves there is between each



Fig. 212.—Diagram of the circulation through the heart. (Dalton.)

two principal portions a smaller one: so that more properly, the tricuspid may be described as consisting of six, and the mitral of four, portions. Each portion is of triangular form. Its base is continuous with the bases of the neighbouring portions, so as to form an annular membrane around the auriculo-ventricular opening, and is fixed to a tendinous ring which encircles the orifice between the auricle and ventricle and receives the insertions of the muscular fibres of both. In each principal cusp may be distinguished a central part, extending from base to apex, and including about half its width. It is thicker and much tougher than the border pieces or edges.

While the bases of the cusps of the valves are fixed to the

tendinous rings, their ventricular surface and borders are fastened by slender tendinous fibres, the *chordæ tendineæ*, to the internal surface of the walls of the ventricles, the muscular fibres of which project into the ventricular cavity in the form of bundles or columns—the *columnæ carneæ*. These columns are not all alike, for while some are attached along their whole length on one side, and by their extremities, others are attached only by their extremities; and a third set, to which the name *musculi papillares* has been given, are attached to the wall of the ventricle by one extremity only, the other projecting, papilla-like, into the cavity of the ventricle (5, fig. 209), and having attached to it *chordæ tendineæ*. Of the tendinous cords, besides those which pass from the walls of the ventricle and the *musculi papillares* to the margins of the valves, there are some of especial strength, which pass from the same parts to the edges of the middle and thicker portions of the cusps before referred to. The ends of these cords are spread out in the substance of the valve, giving its middle piece its peculiar strength and toughness; and from the sides numerous other more slender and branching cords are given off, which are attached all over the ventricular surface of the adjacent border-pieces of the principal portions of the valves, as well as to those smaller portions which have been mentioned as lying one between each two principal ones. Moreover, the *musculi papillares* are so placed that, from the summit of each, tendinous cords proceed to the adjacent halves of two of the principal divisions, and to one intermediate or smaller division, of the valve.

The preceding description applies equally to the mitral and tricuspid valve; but it should be added that the mitral is considerably thicker and stronger than the tricuspid, in accordance with the greater force which it is called upon to resist.

The *semilunar valves* guard the orifices of the pulmonary artery and of the aorta. They are nearly alike on both sides of the heart; but the aortic valves are altogether thicker and more strongly constructed than the pulmonary valves, in accordance with the greater pressure which they have to withstand. Each valve consists of three parts which are of semilunar shape, the convex margin of each being attached to a fibrous ring at the place of junction of the artery to the ventricle, and the concave or nearly straight border being free, so as to form a little pouch like a watch-pocket (7, fig. 209). In the centre of the free edge of the pouch, which contains a fine cord of fibrous tissue, is a small fibrous nodule, the *corpus Arantii*, and from this and from the attached border fine fibres extend into every part of the mid substance of the valve, except a small lunated space just within

the free edge, on each side of the corpus Arantii. Here the valve is thinnest, and composed of little more than the endocardium. Thus constructed and attached, the three semilunar pouches are placed side by side around the arterial orifice of each ventricle; they are separated by the blood passing out of the ventricle, but immediately afterwards are pressed together so as to prevent any return (6, fig. 208, and 7, fig. 209). Opposite each of the semilunar cusps, both in the aorta and pulmonary artery, there

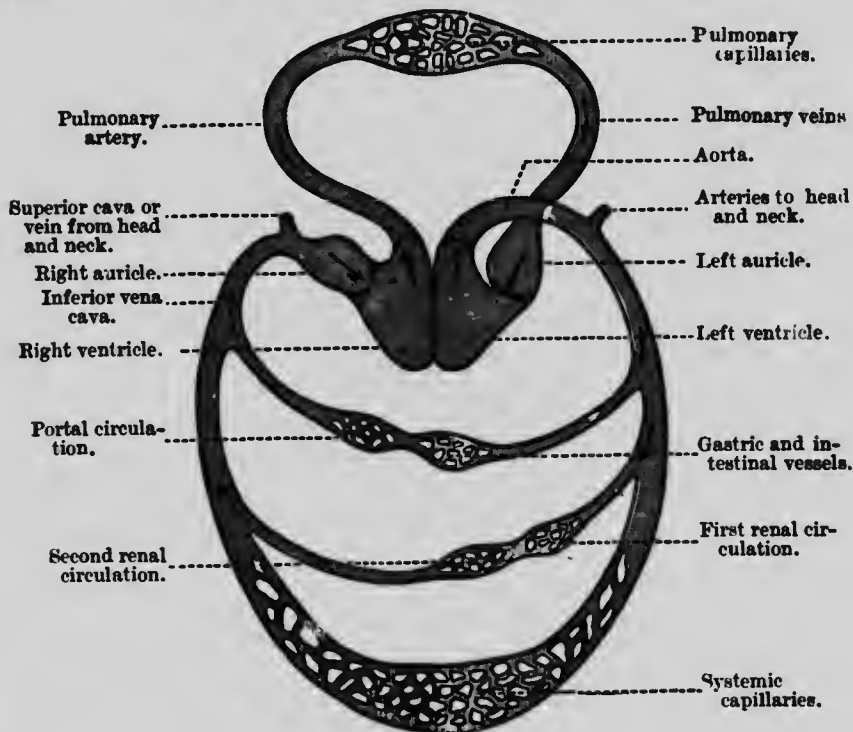

Fig. 213.—Diagram of the circulation.

is a bulging outwards of the wall of the vessel: these bulgings are called the *sinuses of Valsalva*.

*Structure.*—The valves of the heart are formed of a layer of closely woven connective and elastic tissue, over which, on every part, the endocardium is reflected.

### Course of the Circulation.

The blood is conveyed away from the left ventricle (as in the diagram, fig. 213) by the aorta to the *arteries*, and returned to the right auricle by the *veins*, the arteries and veins being

continuous with each other at the far end by means of the *capillaries*.

From the right auricle the blood passes to the right ventricle, then by the pulmonary artery, which divides into two, one for each lung, then through the pulmonary capillaries, and through the pulmonary veins (two from each lung) to the left auricle. From here it passes into the left ventricle, which brings us back to where we started from.



Fig. 214.—Minute artery viewed in longitudinal section. *e*. Nucleated endothelial membrane, with faint nuclei in lumen, looked at from above. *i*. Elastic membrane. *m*. Muscular coat or tunica media. *a*. Tunica adventitia. (Klein and Noble Smith.)  $\times 250$ .

The complete circulation is thus made up of two circuits, the one, a shorter circuit from the right side of the heart to the lungs and back again to the left side of the heart; the other and larger circuit, from the left side of the heart to all parts of the body and back again to the right side. The circulations through the lungs and through the system generally are respectively named the **Pulmonary** and **Systemic** or *lesser* and *greater* circulations. It will be noticed also in the same figure that a portion of the stream of blood having been diverted once into the capillaries of the intestinal canal, and some other organs, and gathered up again into a single stream, is a second time divided in its passage through the liver,

before it finally reaches the heart and completes a revolution. This subordinate stream through the liver is called the **Portal** circulation. A somewhat similar accessory circulation is that through the kidneys, called the **Renal** circulation. The difference of colours in fig. 213 indicates roughly the difference between *arterial* and *venous* blood. The blood is oxygenated in the lungs, and the formation of oxyhæmoglobin gives to the blood a bright red colour. This oxygenated or arterial blood (contained in the pulmonary veins, the left side of the heart, and systemic arteries) is in part reduced in the tissues, and the deoxygenated hæmoglobin is darker in tint than the oxyhæmoglobin; this venous blood passes by the systemic veins to the right side of the heart and pulmonary artery to the lungs, where it once more receives a fresh supply of oxygen.

N.B.—It should, however, be noted that the lungs, like the rest of the body, are also supplied with arterial blood, which reaches it by the *pulmonary* arteries.

### The Arteries.

**Distribution.**—The arterial system begins at the left ventricle in a single large trunk, the aorta, which almost immediately after its origin gives off in the thorax three large branches for the supply of the head, neck, and upper extremities; it then traverses the thorax and abdomen, giving off branches, some large and some small, for the supply of the various organs and tissues it passes on its way. In the abdomen it divides into two chief branches, for the supply of the lower extremities. The arterial branches wherever given off divide and subdivide, until

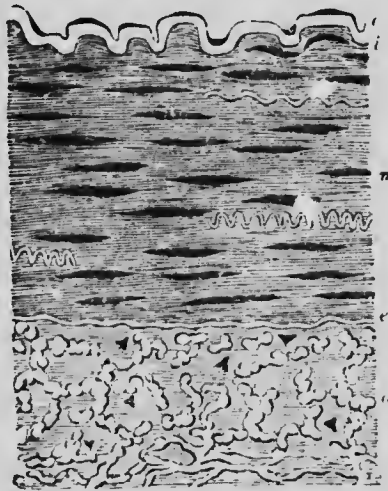

Fig. 215.—Transverse section through a large branch of the inferior mesenteric artery of a pig. *e*, endothelial membrane; *i*, tunica elastica interna, no subendothelial layer is seen; *m*, muscular tunica media, containing only a few wavy elastic fibres; *e*, *e*, tunica elastica externa, dividing the media from the connective-tissue adventitia, *a*. (Klein and Noble Smith.)  $\times 350$ .

the calibre of each subdivision becomes very minute, and these minute vessels lead into capillaries. Arteries are, as a rule, placed in situations protected from pressure and other dangers, and are, with few exceptions, straight in their course, and frequently communicate (anastomose or inosculate) with other arteries. The branches are usually given off at an acute angle, and the sum of the sectional areas of the branches of an artery generally exceeds that of the parent trunk; and as the distance from the origin is increased, the area of the combined branches is increased also. After death, arteries are usually found dilated (not collapsed as the veins are) and empty, and it was to this fact that their name (*ἀρτηρία*, the windpipe) was given them, as the ancients



believed that they conveyed air to the various parts of the body. As regards the arterial system of the lungs, the pulmonary artery is distributed much as the arteries belonging to the general systemic circulation.

*Structure.*—The walls of the arteries are composed of three coats, termed (a) the external or tunica adventitia, (b) the middle or tunica media, and (c) the internal or tunica intima.



Fig. 216.—Muscular fibre-cells from human arteries, magnified 350 diameters. (Kölliker.) a. Nucleus. b. A fibre-cell treated with acetic acid.

much greater than in the small ones; it constitutes the greater part of the arterial wall. The muscular fibres are unstriped (fig. 216), and are arranged for the most part transversely to the long axis of the artery; while the elastic element, taking also a transverse direction, is disposed in the form of closely interwoven and branching fibres, which intersect in all parts the layers of muscular fibres. In arteries of various sizes there is a difference in the proportion of the muscular and elastic element, elastic tissue preponderating in the largest arteries, and unstriped muscle in those of medium and small size.

(c) The *internal coat* is formed by a layer of elastic tissue, called the *fenestrated membrane of Henle*. Its inner surface is lined with a delicate layer of elongated endothelial cells (fig. 215, e), which make it smooth, so that the blood may flow with the smallest possible amount of resistance from friction.

Immediately external to the endothelial lining of the artery is fine connective tissue (*sub-endothelial layer*), with branched corpuscles. Thus the internal coat consists of three parts, (a) an endothelial lining, (b) the sub-endothelial layer, and (c) elastic layer.

(a) The *external coat* or *tunica adventitia* (figs. 214 and 215, a), the strongest and toughest part of the wall of the artery, is formed of areolar tissue, with which is mingled throughout a network of elastic fibres. At the inner part of this outer coat the elastic network forms, in some arteries, so distinct a layer as to be sometimes called the *external elastic coat* (fig. 215, e).

(b) The *middle coat* (fig. 215, m) is composed of both muscular and elastic fibres, with a certain proportion of areolar tissue. In the larger arteries (fig. 217) its thickness is comparatively as well as absolutely

*Vasa Vasorum.*—The walls of the arteries are, like other parts of the body, supplied with little arteries, ending in capillaries and veins, which, branching throughout the external coat, extend for some distance into the middle, but do not reach the internal coat. These nutrient vessels are called *vasa vasorum*.

*Nerves.*—Most of the arteries are surrounded by a plexus of sympathetic nerves, which twine around the vessel very much

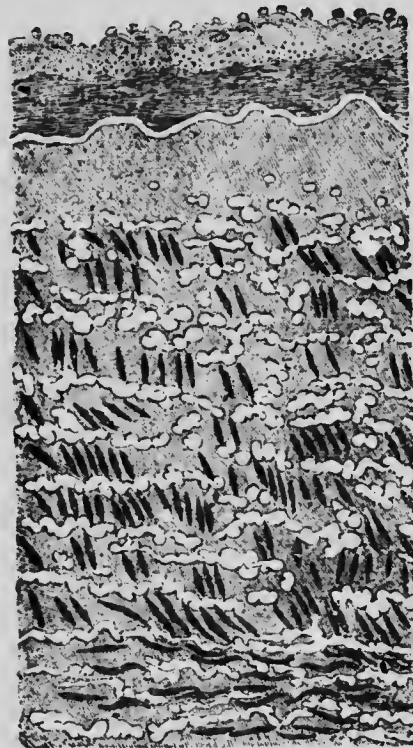

Endothelium.

Sub-endothelial layer.

Elastic intima.

Middle coat.

Fig. 217.—Transverse section of aorta through internal and about half the middle coat.

like ivy round a tree: and ganglia are found at frequent intervals. They terminate in a plexus between the muscular fibres (fig. 218).

### The Veins.

*Distribution.*—The venous system begins in small vessels which are slightly larger than the capillaries from which they spring. These vessels are gathered up into larger and larger trunks until they terminate (as regards the systemic circulation) in the two venæ cavæ and the coronary veins, which enter the right auricle, and (as regards the pulmonary circulation) in four pulmonary

veins, which enter the left auricle. The total capacity of the veins diminishes as they approach the heart; but, as a rule, their capacity is two or three times that of their corresponding arteries. The pulmonary veins, however, are an exception to this rule, as they do not exceed in capacity the pulmonary arteries. The veins are found after death more or less collapsed, owing to their want of elasticity. They are usually distributed in a superficial and a deep set which communicate frequently in their course.

*Structure.*—In structure the coats of veins bear a general resemblance to those of arteries (fig. 219). Thus, they possess outer, middle, and internal coats.

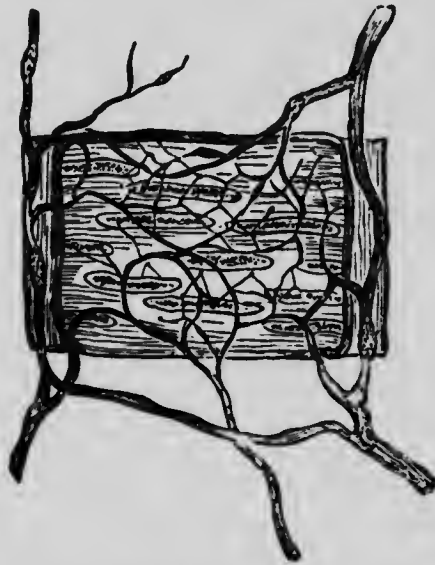

Fig. 218.—Ramification of nerves and termination in the muscular coat of a small artery of the frog. (Arnold.)

(a) The *outer* coat is constructed of areolar tissue like that of the arteries, but it is thicker. In some veins it contains muscular fibres, which are arranged longitudinally.

(b) The *middle* coat is considerably thinner than that of the arteries; it contains circular unstriped muscular fibres, mingled with a few elastic fibres and a large proportion of white fibrous tissue. In the large veins, near the heart, namely, the *venæ cavae* and

pulmonary veins, the middle coat is replaced, for some distance from the heart, by circularly arranged striped muscular fibres, continuous with those of the auricles. The veins of bones, and of the central nervous system and its membranes have no muscular tissue.

(c) The *internal* coat of veins has a very thin fenestrated membrane, which may be absent in the smaller veins. The endothelium is made up of cells elongated in the direction of the vessel, but wider than in the arteries.

*Valves.*—The chief influence which the veins have in the circulation, is effected with the help of the valves, contained in all veins subject to local pressure from the muscles between or near which they run. The general construction of these valves is

similar to that of the semilunar valves of the aorta and pulmonary artery, already described; but their free margins are turned in the opposite direction, *i.e.*, towards the heart, so as to prevent any movement of blood backward. They are commonly placed in pairs, at various distances in different veins, but almost uniformly in each (fig. 220). In the smaller veins single valves are often met with; and three or four are sometimes placed together, or near one another, in the largest veins, such as the subclavian, at their junction with the jugular veins. The valves are semilunar; the unattached edge is in some examples concave, in others straight. They are composed of an outgrowth of the subendothelial tissue covered with endothelium. Their situation in the superficial veins of the forearm is readily discovered by pressing along their surface, in the direction opposite to the venous current, *i.e.*, from the elbow towards the wrist; when little swellings (fig. 220, c) appear in the position of each pair of valves. These swellings at once disappear when the pressure is removed.

Valves are not equally numerous in all veins, and in many they are absent altogether. They are most numerous in the veins of the extremities, and more so in those of the leg than the arm. They are commonly *absent* in veins of less than a line in diameter, and, as a general rule, there are few or none in those which are not subject to muscular pressure. Among those veins which have no valves may be mentioned the superior and inferior vena cava, the pulmonary veins, the veins in the interior of the cranium and vertebral column, the veins

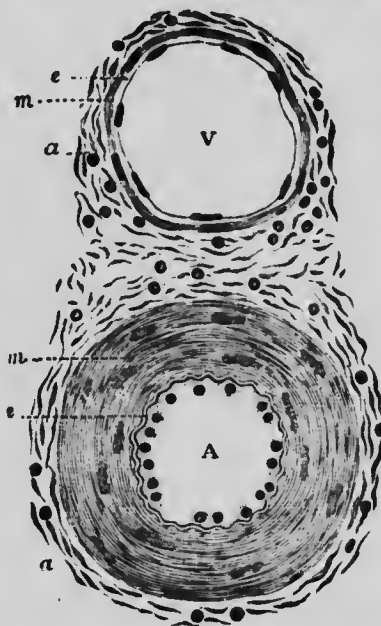

Fig. 219.—Transverse section through a small artery and vein of the mucous membrane of a child's epiglottis; the artery is thick-walled and the vein thin-walled. A. Artery, the letter is placed in the lumen of the vessel, e. Endothelial cells with nuclei clearly visible; these cells appear very thick from the contracted state of the vessel. Outside it a double wavy line marks the elastic layer of the tunica intima. m. Tunica media, consisting of unstriped muscular fibres circularly arranged; their nuclei are well seen. a. Part of the tunica adventitia showing bundles of connective-tissue fibre in section, with the circular nuclei of the connective-tissue corpuscles. This coat gradually merges into the surrounding connective-tissue. v. In the lumen of the vein. The other letters indicate the same as in the artery. The muscular coat of the vein (m) is seen to be much thinner than that of the artery.  $\times 350$ . (Klein and Noble Smith.)

of bone, and the umbilical vein. The valves of the portal tributaries are very inefficient.

*Lymphatics of Arteries and Veins.*—Lymphatic spaces are

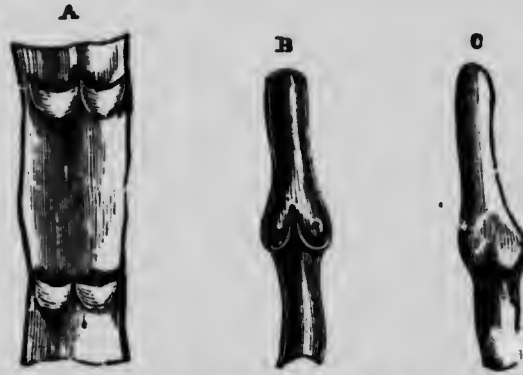

Fig. 220.—Diagram showing valves of veins. A, part of a vein laid open and spread out, with two pairs of valves. B, longitudinal section of a vein, showing the apposition of the edges of the valves in their closed state. C, portion of a distended vein, exhibiting a swelling in the situation of a pair of valves.

present in the coats of both arteries and veins. In the external coat of large vessels they form a plexus of more or less tubular vessels. In smaller vessels they appear as spaces lined by endo-

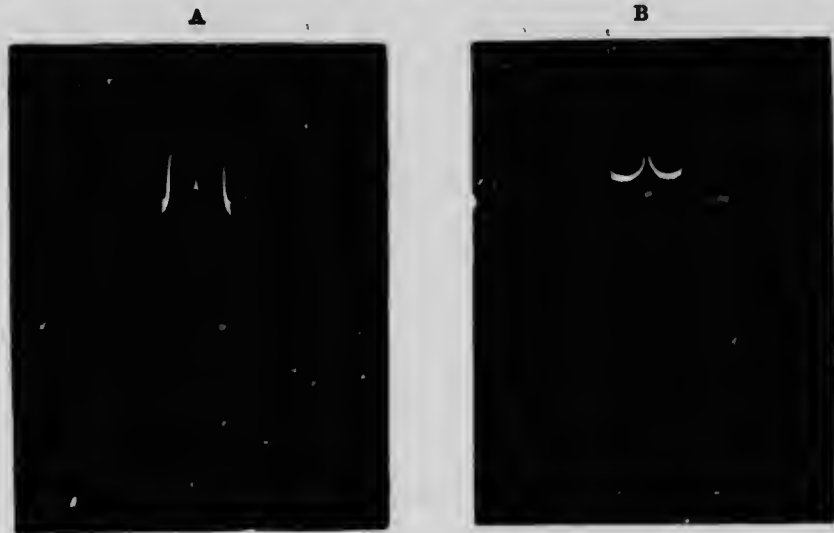

Fig. 221.—A, vein with valves open. B, with valves closed; stream of blood passing off by lateral channel. (Dalton.)

thelium. Sometimes, as in the arteries of the omentum, mesenteric, and membranes of the brain, in the pulmonary, hepatic, and splenic arteries, the spaces are continuous with vessels which distinctly ensheath them—*perivascular lymphatics* (fig. 222).

### The Capillaries.

**I**n all vascular textures except some parts of the corpora cavernosa of the penis, of the uterine placenta, and of the spleen, the transmission of the blood from the minute branches of the arteries to the minute veins is effected through a network of capillaries.

Their walls are composed of endothelium—a single layer of



Fig. 222.—Surface view of an artery from the mesentery of a frog, ensheathed in a peri-vascular lymphatic vessel. *a*, the artery, with its circular muscular coat (media) indicated by broad transverse markings, with an indication of the adventitia outside. *l*, lymphatic vessel; its wall is a simple endothelial membrane. (Klein and Noble Smith.)

elongated flattened and nucleated cells, so joined and dovetailed together as to form a continuous transparent membrane (fig. 223). Here and there the endothelial cells do not fit quite accurately; the space is filled up with cement material; these spots are called *pseudo-stomata*.

The *diameter* of the capillary vessels varies somewhat in the different tissues of the body, the most common size being about  $\frac{1}{3600}$ th of an inch ( $12\ \mu$ ). Among the smallest may be mentioned those of the brain, and of the follicles of the mucous membrane

of the intestines; among the largest, those of the skin, lungs, and especially those of the medulla of bones.

The *size* of capillaries varies necessarily in different animals in



Fig. 223.—Capillary blood-vessels from the omentum of rabbit, showing the nucleated endothelial membrane of which they are composed. (Klein and Noble Smith.)

relation to the size of their blood-corpuscles: thus, in the *Proteus*, the capillary circulation can just be discerned with the naked eye.

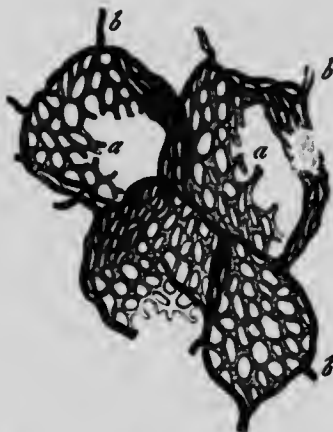

Fig. 224.—Network of capillary vessels of the air-cells of the horse's lung magnified. *a, a*, capillaries proceeding from *b, b*, terminal branches of the pulmonary artery. (Frey.)

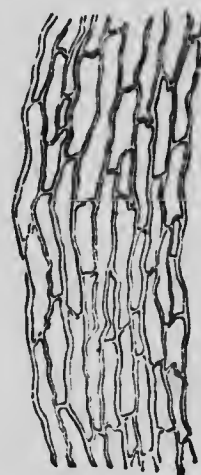

Fig. 225.—Injected capillary vessels of muscle seen with a low magnifying power. (Sharpey.)

The *form* of the capillary network presents considerable variety in the different tissues of the body: the varieties consist principally of modifications of two chief kinds of mesh, the rounded and the elongated. That kind in which the meshes or

interspaces have a roundish form is the most common, and prevails in those parts in which the capillary network is most dense, such as the lungs (fig. 224), most glands and mucous membranes, and the cutis. The meshes of this kind of network are not quite circular but more or less angular, sometimes presenting a nearly regular quadrangular or polygonal form, but

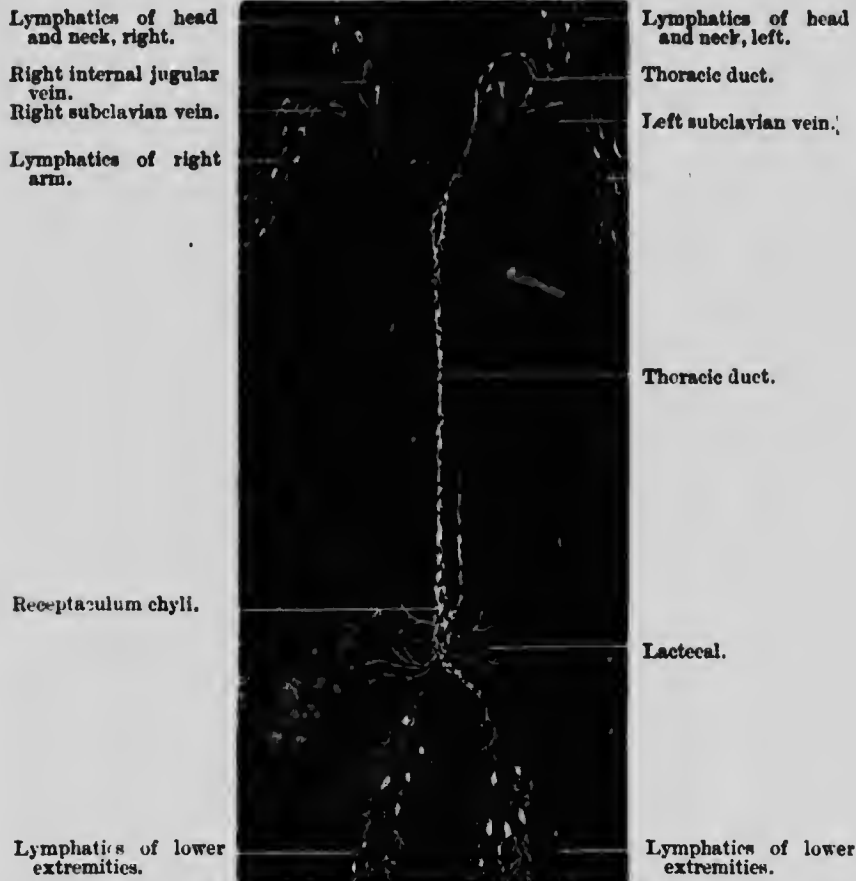

Fig. 226.—Diagram of the principal groups of Lymphatic vessels. (From Quain.)

being more frequently irregular. The capillary network with elongated meshes is observed in parts in which the vessels are arranged among bundles of fine tubes or fibres, as in muscles and nerves. In such parts, the meshes form parallelograms (fig. 225), the short sides of which may be from three to eight or ten times less than the long ones; the long sides are more or less parallel to the long axis of the fibres.



The *number* of the capillaries and the *size* of the meshes in different parts determine in general the degree of *vascularity* of those parts. The capillary network is closest in the lungs and in the choroid coat of the eye.

It may be held as a general rule, that the more active the functions of an organ are, the more vascular it is. Hence the narrowness of the interspaces in all glandular organs, in mucous membranes, and in growing parts, and their much greater width in bones, ligaments, and other tough and comparatively inactive tissues.

#### Lymphatic Vessels.

The blood leaves the heart by the arteries; it returns to the heart by the veins; but this last statement requires modification,



Fig. 227.—Superficial lymphatics of right groin and upper part of thigh. 1.—  
1. Upper inguinal glands. 2, 2'. Lower or inguinal or femoral glands. 3, 3'  
Plexus of lymphatics in the course of the long saphenous vein. (Mascagni.)

for in the capillaries some of the blood-plasma escapes into the cell spaces of the tissues and nourishes the tissue-elements. This fluid, which is called *lymph*, is gathered up and carried back again into the blood by a system of vessels called *lymphatics*.

The principal vessels of the lymphatic system are, in structure, like small thin-walled veins, provided with numerous valves. The beaded appearance of the lymphatic vessels shown in figs. 227 and 228 is due to the presence of these valves. They commence in fine microscopic *lymph-capillaries*, in the organs and



Fig. 228.—Lymphatic vessels of the head and neck and the upper part of the trunk (Mascagni). 1.—The chest and pericardium have been opened on the left side, and the left mamma detached and thrown outwards over the left arm, so as to expose a great part of its deep surface. The principal lymphatic vessels and glands are shown on the side of the head and face and in the neck, axilla, and mediastinum. Between the left internal jugular vein and the common carotid artery, the upper ascending part of the thoracic duct marked 1, and above this, and descending to 2, the arch and last part of the duct. The termination of the upper lymphatics of the diaphragm in the mediastinal glands, as well as the cardiac and the deep mammary lymphatics, is also shown.

tissues of the body, and they end in two trunks which open into the large veins near the heart (fig. 226). The fluid which they contain, unlike the blood, passes only in one direction, namely, from the fine branches to the trunk, and so to the large veins, on entering which it is mingled with the stream of blood and forms part of its constituents. In fig. 226 the

greater part of the contents of the lymphatic system of vessels will be seen to pass through a comparatively large trunk called the *thoracic duct*, which finally empties its contents into the bloodstream, at the junction of the internal jugular and subclavian veins of the left side. There is a smaller duct on the right side. The lymphatic vessels of the intestinal canal are called *lacteals*, because during digestion the fluid contained in them resembles milk in appearance; and the *lymph* in the lacteals during the period of digestion is called *chyle*.

There is no distinction of structure, however, between lacteals and lymphatics. In some parts of its course the lymph-stream passes through *lymphatic glands*, to be described later on.

*Origin of Lymph Capillaries.*—

The lymphatic capillaries commence most commonly either (a) in closely-meshed networks, or (b) in irregular lacunar spaces between the various structures of which the different organs are composed. In serous membranes such as the omentum and mesentery they occur as a connected system of very irregular branched spaces partly occupied by connective-tissue corpuscles, and in these and other varieties of connective tissue, the cell spaces communicate freely with regular lymphatic vessels. In many cases, though they are formed mostly by the chinks and crannies between the blood vessels, secreting ducts, and other parts which may happen to form the framework of the organ



Fig. 229.—Superficial lymphatics of the forearm and palm of the hand. 4.—5. Two small glands at the bend of the arm. 6. Radial lymphatic vessels. 7. Ulnar lymphatic vessels. 8, 8'. Palmar arch of lymphatics. 9, 9'. Outer and inner sets of vessels. b. Cephalic vein. d. Radial vein. e. Median vein. f. Ulnar vein. The lymphatics are represented as lying on the deep fascia. (Mascagni.)

in which they exist, they are lined by a distinct layer of endothelium.

The lacteals offer an illustration of another mode of origin,

namely (c) in blind dilated extremities in the villi of the small intestine. (See fig. 38, p. 29.)

*Structure of Lymph Capillaries.*—The structure of lymphatic capillaries is very similar to that of blood-capillaries; their walls consist of a single layer of elongated endothelial cells with sinuous outline, which cohere along their edges to form a delicate membrane. They differ from blood-capillaries mainly in their

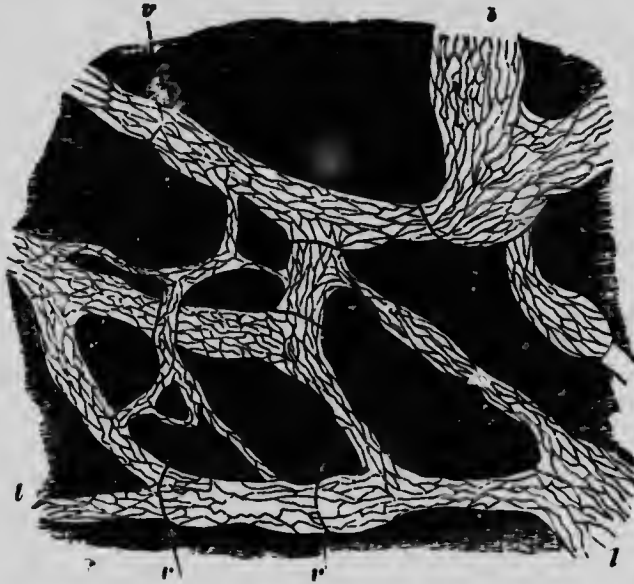

Fig. 230.—Lymphatics of central tendon of rabbit's diaphragm, stained with silver nitrate. The shaded background is composed of bundles of white fibres, between which the lymphatics lie. *l*, Lymphatics lined by long narrow endothelial cells, and showing valves at frequent intervals. (Schofield.)

larger and very variable calibre, and in their numerous communications with the spaces of the lymph-canicular system.

In certain parts of the body, *stomata* exist, by which lymphatic capillaries directly communicate with parts formerly supposed to be closed cavities. They have been found in the pleura, and in other serous membranes; a serous cavity thus forms a large lymph-sinus or widening out of the lymph-capillary system with which it directly communicates.

A very typical plexus of lymphatic capillaries is seen in the central tendon of the diaphragm. Fig. 230 represents the appearance presented after staining with silver nitrate.

## CHAPTER XIX.

## THE CIRCULATION OF THE BLOOD.

IN the preceding chapter, we have seen what the course of the circulation is, and we have devoted considerable space to a study of the structure of the heart and vessels. We have now to approach the more strictly physiological side of the subject, and study the means by which the blood is kept in movement, so that it may convey nutriment to all parts, and remove from those parts the waste products of their activity.

Previous to the time of Harvey, the vaguest notions prevailed regarding the use and movements of the blood. The arteries were supposed by some to contain air, by others to contain a more subtle essence called animal spirits; the animal spirits were supposed to start from the ventricles of the brain, and they were controlled by the soul which was situated in the pineal gland. How the animal spirits got into the arteries was an anatomical detail which was bridged across by the imagination.

There was an idea that the blood moved, but this was considered to be a haphazard, to and fro movement, and confined to the veins. The proofs that the movement is a movement in a circle were discovered by William Harvey, and to this eminent discoverer also belongs the credit of pointing out the methods by which every physiological problem must be studied. In the first place there must be correct anatomical knowledge, and in the second there must be experiment, by which deductions from structure can be tested; moreover, this second method is by far the more important of the two. Harvey's proofs of the circulation came under both these heads. The structural or anatomical facts upon which he relied were the following:

1. The existence of two distinct sets of tubes in connection with the heart, namely the arteries and the veins.
2. The existence in one of these, the veins, of valves which would only allow the passage of the blood in one direction.

His experimental facts were the following:

3. That the blood spurts with great force and in a jerky manner from an artery opened during life, each jerk corresponding with a beat of the heart.
4. That if the large veins near the heart are tied, the heart

becomes pale, flaccid, and bloodless, and on removal of the ligature the blood again flows into the heart.

5. If the aorta is tied, the heart becomes distended with blood, and cannot empty itself until the ligature is removed.

6. The preceding experiments were performed on animals, but by the following experiment he showed that the circulation is a fact in man also; if a ligature is drawn tightly round a limb, no blood can enter it, and it becomes pale and cold. If the ligature is somewhat relaxed so that blood can enter but cannot leave the limb, it becomes swollen. If the ligature is removed, the limb soon regains its normal appearance.

7. Harvey also drew attention to the fact that there is general constitutional disturbance resulting from the introduction of a poison at a single point, and that this can only be explained by a movement of the circulating fluid all over the body.

Since Harvey's time many other proofs have accumulated; for instance:—

8. If an artery is wounded, hæmorrhage may be stopped by pressure applied between the heart and the wound; but in the case of a wound in a vein, the pressure must be applied beyond the seat of injury.

9. If a substance which, like ferrocyanide of potassium, can be readily detected, is injected at a certain point into a blood vessel, it will after the lapse of a short interval have entirely traversed the circulation and be found in the blood collected from the same point.

10. Our increased knowledge of the structure of the heart and its valves has shown that its structure is such as to permit the blood to pass in one direction only.

11. Perhaps the most satisfactory proof of the circulation is one now within the reach of every student, though beyond that of Harvey. It consists in actually seeing the passage of the blood from small arteries through capillaries into veins in the transparent parts of animals, such as the tail of a tadpole or the web of a frog's foot. Harvey could not follow this part of the circulation, for he had no lenses sufficiently powerful to enable him to see it. Harvey's idea of the circulation here was that the arteries carried the blood to the tissues, which he considered to be of the nature of a sponge, and the veins collected the blood again, much in the same way as drainage pipes would collect the water of a swamp. The discovery that the ends of the arteries are connected to the commencements of veins by a definite system of small tubes we now call capillaries, was made by Malpighi, in the year 1661. He first observed them in the tail of the tadpole,

and Leeuwenhoek, seven years later, saw the circulation in the lung of the frog.

We can now proceed to study some of the principles on which the circulation depends:—

The simplest possible way in which we could represent the circulatory system is shown in fig. 231 A. Here there is a closed ring containing fluid, and upon one point of the tube is an enlargement (H) which will correspond to the heart. It is obvious that if such a ring made of an ordinary Higginson's syringe and a tube were placed upon the table, there would be no movement of the fluid in it; in order to make the fluid move there must be a difference of pressure between different parts of the fluid, and this difference of pressure is caused in the fluid by the pressure on it of the heart walls. If, for instance, one takes the syringe in one's hand and squeezes it, one imitates a con-

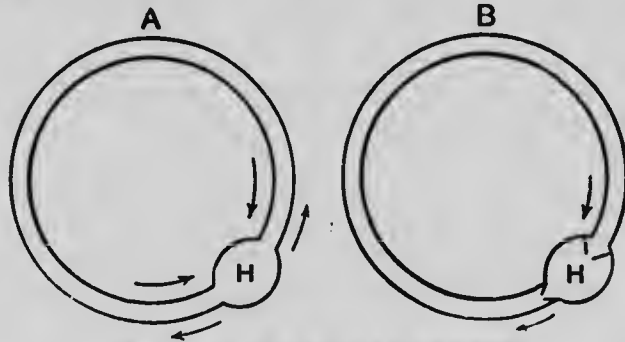

Fig. 231.—Simple schema of the circulation.

traction of the heart: if the syringe has no valves, the fluid would pass out of each end of it in the direction of the two arrows placed outside the ring. When the pressure on the syringe is relaxed (this would correspond to the interval between the heart beats), the fluid would return into the heart again in the direction of the two arrows placed inside the ring. This, however, would be merely a to and fro movement, not a circulation. Fig. 231 B shows how this to and fro movement could, by the presence of valves, be converted into a circulation; when the heart contracts the fluid could pass only in the direction of the outer arrow; when the heart relaxes it could pass only in the direction of the inner arrow; the direction of both arrows is the same, and so if the contraction and relaxation of the heart are repeated often enough the fluid will move round and round within the tubular ring.

The main factor in the circulation is difference of pressure.

Fluid always flows in the direction of pressure ; it could no more flow from a place where the pressure is low to where it is high than a river could flow uphill. This difference of pressure is produced in the first instance by the contraction of the heart, but we shall find in our study of the vessels that some of this pressure is stored up in the elastic arterial walls, and keeps up the circulation during the periods of rest of the heart.

Before passing on to consider the physiology of heart and vessels at greater length, let us take a few types of the circulatory system from different parts of the animal kingdom.

In worms, and in the lowest vertebrate *Amphioxus*, the cir-

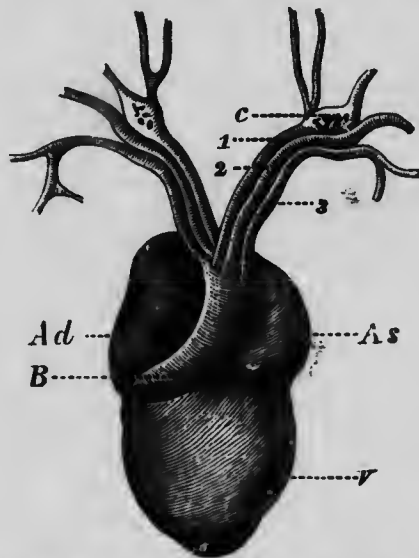

Fig. 232.—The heart of a frog (*Rana esculenta*) from the front. *V*, ventricle; *Ad*, right auricle; *As*, left auricle; *B*, bulbus arteriosus, dividing into right and left aortæ. (Ecker.)

culatory system is almost as simple as in the schema just described ; the heart is a long contractile tube provided with valves, which contracts and presses the blood forwards into the aorta at its anterior end ; this divides into arteries for the supply of the body ; the blood passes through these to capillaries, and is collected by veins which converge to one or two main trunks that enter the heart at its posterior end.

In fishes, the heart is a little more complicated ; it is divided into a number of chambers placed in single file, one in front of the other ; the most posterior which receives the veins is called the sinus venosus ; this contracts and forces the blood into the next chamber, called the auricle ; this forces the blood into the



next cavity, that of the ventricle, and last of all is the aortic bulb. From the bulb, branches pass to the gills where they break up into capillaries, and the blood is aerated: it then once more enters larger vessels which unite to form the dorsal aorta, whence the blood is distributed by arteries to all parts of the body; here it enters the systemic capillaries, then the veins which enter the sinus (whence we started) by a few large trunks.

Taking the frog as an instance of an amphibian, we find the heart more complex still, and the simple peristaltic action of the heart muscle as we have described it in the hearts of worm and fish, becomes correspondingly modified. There is only one ventricle, but there are two auricles, right and left.

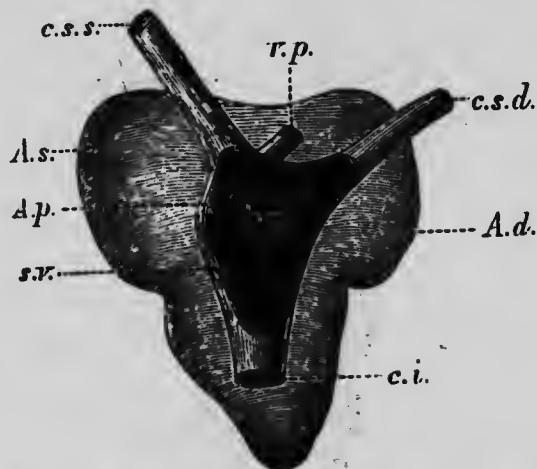

Fig. 233.—The heart of a frog (*Rana esculenta*) from the back. *s.v.*, sinus venosus opened; *c.s.s.*, left vena cava superior; *c.s.d.*, right vena cava superior; *c.i.*, vena cava inferior; *r.p.*, vena pulmonalis; *A.d.*, right auricle; *A.s.*, left auricle; *A.p.*, opening of communication between the right auricle and the sinus venosus.  $\times 2\frac{1}{2}$ —3. (Ecker.)

The ventricle contains mixed blood, since it receives arterial blood from the left auricle (which is the smaller of the two), and venous blood from the right auricle; the right auricle receives the venous blood from the sinus, which in turn receives it from the systemic veins. The left auricle, as in man, receives the blood from the pulmonary veins.

When the ventricle contracts, it forces the blood onward into the aortic bulb which divides into branches on each side for the supply of the head (fig. 232, 1), lungs and skin (fig. 232, 3), and the third branch (fig. 232, 2) unites with its fellow of the opposite side to form the dorsal aorta for the supply of the rest of the body.

Passing from the amphibians to the reptiles, we find the

division of the ventricle into two beginning, but it is not complete till we reach the birds. The heart reaches its fullest development in mammals, and we have already described the human as an example of the mammalian heart. The sinus venosus is not present as a distinct chamber in the mammalian heart, but is represented by that portion of the right auricle at which the large veins enter.

---

## CHAPTER XX.

### PHYSIOLOGY OF THE HEART.

#### The Cardiac Cycle.

THE series of changes that occur in the heart constitutes the *cardiac cycle*. This must be distinguished from the course of the circulation. The term cycle indicates that if one observes the heart at any particular moment, the heart from that moment onwards undergoes certain changes until it once more assumes the same condition that it had at the moment when the observation commenced, when the cycle is again repeated, and so on. This series of changes consists of alternate contraction and relaxation. Contraction is known as **systole**, and relaxation as **diastole**.

The contraction of the two auricles takes place simultaneously, and constitutes the *auricular systole*; this is followed by the simultaneous contraction of the two ventricles, *ventricular systole*, and that by a period during which the whole of the heart is in a state of *diastole*; then the cycle again commences with the auricular systole.

Taking 72 as the average number of heart beats per minute, each cycle will occupy  $\frac{1}{72}$  of a minute or a little more than 0.8 of a second. This may be approximately distributed in the following way:

Auricular systole about	0.1	+	Auricular diastole	0.7	=	0.8
Ventricular systole about	0.3	+	Ventricular diastole	0.5	=	0.8
Total systole about	0.4	+	Joint auricular and ventricular diastole	0.4	=	0.8

If the speed of the heart is quickened, the time occupied by each cycle is diminished, but the diminution affects chiefly the

diastole. These different parts of the cycle must next be studied in detail.

*The Auricular Diastole.*—During this time, the blood from the large veins is flowing into the auricles, the pressure in the veins though very low being greater than that in the empty auricles. The blood expands the auricles, and during the last part of the auricular diastole it passes on into the ventricles. The dilatation of the auricles is assisted by the elastic traction of the lungs. The lungs being in a closed cavity, the thorax, and being distended with air, are in virtue of their elasticity always tending to recoil and squeeze the air out of their interior; in so doing they drag upon any other organ with which their surface is in contact: this elastic traction will be greatest when the lungs are most distended, that is during inspiration, and will be more felt by the thin-walled auricles than by the thick-walled ventricles of the heart.

*The Auricular Systole* is sudden and very rapid; by contracting, the auricles empty themselves into the ventricles. The contraction commences at the entrance of the great veins and is thence propagated towards the auriculo-ventricular opening. The reason why the blood does not pass backwards into the veins, but onward into the ventricles is again a question of pressure; the pressure in the relaxed ventricles, which is so small as to exert a suction action on the auricular blood, is less than in the veins. Moreover, the auriculo-ventricular orifice is large and widely dilated, whereas the mouths of the veins are constricted by the contraction of their muscular coats. Though there is no regurgitation of the blood backwards into the veins, there is a stagnation of the flow of blood onwards to the auricles. The veins have no valves at their entrance into the auricles, except the coronary vein which does possess a valve; there are valves, however, at the junction of the subclavian and internal jugular veins.

*Ventricular Diastole*; during the last part of the auricular diastole, and the whole of the auricular systole, the ventricles have been relaxed and then filled with blood. The dilatation of the ventricles is chiefly brought about in virtue of their elasticity; this is particularly evident in the left ventricle with its thick muscular coat. It is equal to 23 mra. of mercury, and is quite independent of the elastic traction of the lungs, which, however, in the case of the thinner-walled right ventricle comes into play.

*The Ventricular Systole*; this is the contraction of the ventricles, and it occupies more time than the auricular systole; when it occurs the auriculo-ventricular valves are closed and prevent regurgitation into the auricles, and when the force of the systole

is greatest, and the pressure within the ventricles exceeds that in the large arteries which originate from them, the semilunar valves are opened, and the ventricles empty themselves, the left into the aorta, the right into the pulmonary artery. Each ventricle ejects about 3 ozs. of blood with each contraction; the left in virtue of its thicker walls acts about thrice as forcibly as the right. The greater force of the left ventricle is necessary as it has to overcome the resistance of the small vessels all over the body; whereas the right ventricle has only to overcome peripheral resistance in the pulmonary district.

The shape of both ventricles during systole is generally described as undergoing an alteration, the diameters in the plane of the base being diminished, and the length of the ventricles slightly lessened. The whole heart, moreover, moves towards the right and forwards, twisting on its long axis and exposing more of the left ventricle anteriorly than when it is at rest. These movements, which were first described by Harvey together with the hardening that occurs when the ventricles contract, have been since Harvey's time believed to be the cause of the cardiac impulse or apex beat which is to be felt in the fifth intercostal space about three inches from the middle line. It has, however, been recently shown by Hayeraft that these changes only occur when the chest walls are open. When the heart contracts in a closed thorax it undergoes no change in shape, as the contraction is concentric, that is equal in all directions. The diminution of the heart's volume which occurs in systole cannot be the cause of the apex beat; it would rather tend to draw the chest wall inwards than push it outwards.

Doubtless the apex beat is produced by the increased pressure in the aorta being transmitted backwards to the heart, and causing it to press more closely than it does in diastole against the chest walls.

### Action of the Valves of the Heart.

1. *The Auriculo-Ventricular.*—The distension of the ventricles with blood continues throughout the whole period of their diastole. The auriculo-ventricular valves are gradually brought into place by some of the blood getting behind the cusps and floating them up; and by the time that the diastole is complete, the valves are in apposition, and they are firmly closed by the reflux current caused by the systole of the ventricles. The diminution in the size of the heart during ventricular systole is well marked in the neighbourhood of the auriculo-ventricular rings, and this aids in rendering the auriculo-ventricular valves competent to close the openings, by greatly diminishing their diameter. The margins of the cusps of the valves are still more secured in apposition with one another, by the simultaneous contraction of the *musculi papillares*, whose *chordæ tendinæ* have a special mode of attachment for this object. The cusps of the auriculo-ventricular valves meet not by their edges only, but by the opposed surfaces of their thin outer borders.

The muscoli papillares prevent the auriculo-ventricular valves from being everted into the auricle. For the chordæ tendinæ might allow the valves to be pressed back into the auricle, were it not that when the wall of the ventricle is brought by its contraction nearer the auriculo-ventricular orifice, the muscoli papillares more than compensate for this by their own contraction; they hold the chords tight, and, by pulling down the valves, add slightly to the force with which the blood is expelled.

These statements apply equally to the auriculo-ventricular valves on both sides of the heart; the closure of both is generally complete every time the ventricles contract. But in some circumstances the tricuspid valve does not completely close, and a certain quantity of blood is forced back into the auricle. This has been called its *safety-valve action*. The circumstances in which it

usually happens are those in which the vessels of the lung are already completely full when the right ventricle contracts, as, e.g., in certain pulmonary diseases, and in very active muscular exertion. In these cases, the tricuspid valve does not completely close, and the regurgitation of the blood may be indicated by a pulsation in the jugular veins synchronous with that in the carotid arteries.

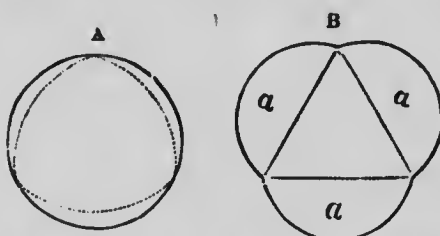

Fig. 234.—Sections of aorta, to show the action of the semilunar valves. A is intended to show the valves, represented by the dotted lines, lying near the arterial walls, represented by the continuous outer line. B (after Hunter) shows the arterial wall distended into three pouches (a), and drawn away from the valves, which are straightened into the form of an equilateral triangle, as represented by the dotted lines.

2. *The Semilunar Valves.*—It has been found that the commencement of the ventricular systole precedes the opening of the semilunar valves by a fraction of a second. This shows that the intraventricular pressure does not exceed the arterial pressure until the systole has actually begun, for the opening of the valves takes place at once when there is a distinct difference in favour of the intraventricular over the arterial pressure, and they continue open only as long as this difference continues. When the arterial exceeds the intraventricular pressure, there is a tendency of the blood to flow back to the heart, and this closes the valves. The dilatation of the arteries is, in a peculiar manner, adapted to bring this about. The lower borders of the semilunar valves are attached to the inner surface of the tendinous ring, which is inlaid at the orifice of the artery, between the muscular fibres of the ventricle and the elastic fibres of the walls of the artery. The tissue of

this ring is tough, and does not admit of extension under such pressure as it is commonly exposed to; the valves are equally inextensible, being formed of fibrous tissue. Hence, when the ventricle propels blood through the orifice into the canal of the artery, the lateral pressure which it exercises is sufficient to dilate the walls of the artery but not enough to stretch in an equal degree, if at all, the unicus valves and the ring to which their lower borders are attached. The effect, therefore, of each such propulsion of blood from the ventricle is, that the wall of the first portion of the artery is dilated into three pouches behind the valves while the free margins of the valves are drawn inward towards its centre. Their positions may be explained by the diagrams in fig. 234, in which the continuous lines represent a transverse section of the arterial walls, the dotted ones the edges of the valves, first, when the valves are nearest to the walls (A), as in the dead heart, and, secondly, when the walls are dilated, and the valves are drawn away from them (B).

This position of the valves and arterial walls is retained so long as the ventricle continues in contraction; but as soon as it relaxes, and the dilated arterial walls can recoil by their elasticity, the blood is forced backwards towards the ventricles and onwards in the course of the circulation. Part of the blood thus forced back lies in the pouches (sinuses of Valsalva) (a, fig. 234, B) between the valves and the arterial walls; and the valves are by it pressed together till their thin lunated margins meet in three lines radiating from the centre to the circumference of the artery (7 and 8, fig. 209).

### The Sounds of the Heart.

When the ear is placed over the region of the heart, two *sounds* may be heard at every beat of the heart, which follow in quick succession, and are succeeded by a *pause* or period of silence. The *first* or *systolic* sound is dull and prolonged; its commencement coincides with the impulse of the heart against the chest wall, and just precedes the pulse at the wrist. The *second* or *diastolic* sound is shorter and sharper, with a somewhat flapping character, and follows close after the arterial pulse. The periods of time occupied respectively by the two sounds taken together and by the pause, are nearly equal. Thus, according to Walshc, if the cardiac cycle be divided into tenths, the first sound occupies  $\frac{4}{10}$ ; the second sound  $\frac{2}{10}$ ; the first pause (almost imperceptible)  $\frac{1}{10}$ ; and the second pause  $\frac{3}{10}$ . The sounds are often but somewhat inaptly compared to the syllables, *lubb—dūp*.

The events which correspond, in point of time, with the *first* sound, are (1) the contraction of the ventricles, (2) the first part of the dilatation of the auricles, (3) the tension of the auriculo-ventricular valves, (4) the opening of the semilunar valves, and (5) the propulsion of blood into the arteries. The sound is succeeded, in about one-thirtieth of a second, by the pulsation of the facial arteries, and in about one-sixth of a second, by the pulsation of the arteries at the wrist. The *second* sound, in point of time, immediately follows the cessation of the ventricular contraction, and corresponds with (a) the tension of the semilunar valves, (b) the continued dilatation of the auricles, (c) the com-



Fig. 235.—Scheme of cardiac cycle. The inner circle shows the events which occur within the heart; the outer the relation of the sounds and pauses to these events. (Sharpey and Gairdner.)

mencing dilatation of the ventricles, and (d) the opening of the auriculo-ventricular valves. The *pause* immediately follows the second sound, and corresponds *in its first part* with the completed distension of the auricles, and *in its second* with their contraction, and the completed distension of the ventricles; the auriculo-ventricular valves are open, and the arterial valves closed during the whole of the pause.

**Causes.**—The exact cause of the first sound of the heart is a matter of discussion. Two factors probably enter into it, viz., first, the *vibration of the auriculo-ventricular valves and the chordæ tendineæ*. This vibration is produced by the increased intraventricular pressure set up when the ventricular systole commences, which puts the valves on the stretch. It is not unlikely

too, that the vibration of the ventricular walls themselves, and of the aorta and pulmonary artery, all of which parts are suddenly put into a state of tension at the moment of ventricular contraction, may have some part in producing the first sound. Secondly, *the muscular sound* produced by contraction of the mass of muscular fibres which form the ventricle. Looking upon the contraction of the heart as a single contraction and not as a series of contractions or tetanus, it is at first sight difficult to see why there should be any muscular sound at all when the heart contracts, as a single muscular contraction does not produce sound. It has been suggested, however, that it arises from the repeated unequal tension produced when the wave of muscular contraction passes along the very intricately arranged fibres of the ventricular walls. There can be no doubt, however, that the valvular element is the more important of the two factors, because the sound is loudest at first, when the vibration of the valves commences, and fades away as the vibrations cease. If the sound was mainly muscular, it would be loudest when the muscular contraction was most powerful, which is approximately about the middle of the ventricular systole. The facts of disease lend support to the theory that the first sound is mainly valvular; for when the valves are incompetent, the first sound is largely replaced by a murmur due to regurgitation of blood into the auricle. After the removal of the heart from the body, the muscular contribution to the first sound is audible but it is very faint. It is stated to have a somewhat lower pitch than the valvular sound.

The cause of the *second* sound is more simple than that of the first. It is entirely due to the vibration consequent on the sudden stretching of the semilunar valves when they are pressed down across the orifices of the aorta and pulmonary artery. The influence of these valves in producing the sound was first demonstrated by Hope, who experimented with the hearts of calves. In these experiments two delicate curved needles were inserted, one into the aorta, and another into the pulmonary artery, below the line of attachment of the semilunar valves, and, after being carried upwards about half an inch, were brought out again through the coats of the respective vessels, so that in each vessel one valve was included between the arterial walls and the wire. Upon applying the stethoscope to the vessels, after such an operation, the second sound ceased to be audible. Disease of these valves, when sufficient to interfere with their efficient action, also demonstrates the same fact by modifying the second sound or destroying its distinctness.



The contraction of the auricles is inaudible.

The first sound is heard most distinctly at the apex beat in the fifth interspace; the second sound is best heard over the second *right* costal cartilage—that is, the place where the aorta lies nearest to the surface. The pulmonary and aortic valves generally close simultaneously. In some cases, however, the aortic may close slightly before the pulmonary valves, giving rise to a 'reduplicated second sound.' The pulmonary contribution to this sound is best heard over the second *left* cartilage.

### The Coronary Arteries.

The coronary arteries are the first branches of the aorta; they originate from the sinuses of Valsalva, and are destined for the supply of the heart itself; the entrance of the coronary vein, into the right auricle, we have already seen (p. 206).

Ligature of the coronary arteries causes almost immediate death; the heart, deprived of its normal blood supply, beats irregularly, twitches, and then ceases to contract altogether.

In fatty degeneration of the heart in man, sudden death is by no means infrequent. This is in many cases due to a growth in thickness of the walls of the coronary arteries called atheroma, which progresses until the lumen of these arteries is obliterated, and the man dies almost as if they had been ligatured.

*Self-steering Action of the Heart.*—This expression was originated by Brücke. He supposed that the semi-lunar valves closed the orifices of the coronary arteries during the systole of the heart. Unlike all the other arteries of the body, the coronary arteries would therefore fill only during diastole, and this increased fulness of the vessels in the heart walls during diastole would assist the ventricle to dilate. This, however, is incorrect; the valves do not cover the mouths of the arteries; and at the beginning of systole the velocity and pressure in the coronary arteries increase; but later on during systole the ventricular wall is so strongly contracted that the muscular tension becomes greater than the coronary pressure, and so the coronary arteries and their tributaries are compressed and the blood driven back into the aorta; the coronary arteries are then again filled with the commencing diastole. Self-steering action of the heart therefore exists, but it is brought about in a different way from what Brücke supposed.

### Cardiographs.

A cardiograph is an instrument for obtaining a graphic record of the heart's movements. In animals the heart may be exposed, and levers placed in connection with its various parts may be employed to write on a revolving blackened surface.

A simple instrument applicable to the frog's heart is the following :—

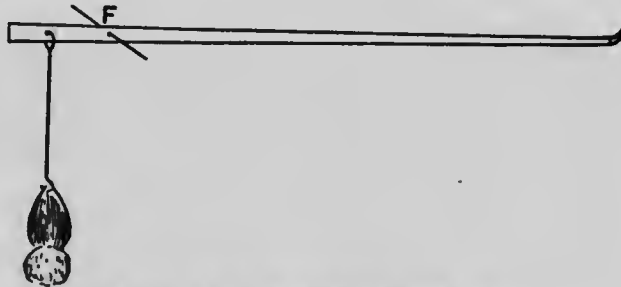

Fig. 236.—Simple cardiograph for frog's heart.

The sternum of the frog having been removed, the pericardium opened, and the fraenum (a small band from the back of the heart to the pericardium) divided, the heart is pulled through the opening, a minute hook placed in its apex, and this is fixed by a silk thread to a lever pivoted at F as in the figure. The cardiac wave of contraction starts at the sinus, this is followed by the auricular systole, and that by the ventricular systole and pause. This is recorded as in the next figure (fig. 237) by movements of the writing point at the end of the long arm of the lever. Such apparatus is, however, not applicable to the human heart, and all the various forms of cardiograph devised for this purpose are modifications of Marey's tambours. One of those most frequently used is depicted in the next two diagrams.

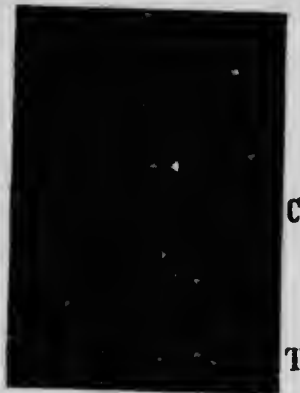

Fig. 237.—Cardiogram of frog's heart. C, showing auricular, followed by ventricular beat; T, time in half seconds.

It (fig. 238) consists of a cup-shaped metal box over the open front of which is stretched an elastic india-rubber membrane, upon which is fixed a small knob of hard wood or ivory. This knob, however, may be attached, as in the figure, to the side of the box by means of a spring, and may be made to act upon a metal disc attached to the elastic membrane.

The knob is for application to the chest-wall over the apex beat. The box or tambour communicates by means of an air-tight tube with the interior of a second tambour, in connection with which is a long and light lever. The shock of the heart's impulse being communicated to the ivory knob and through it to the first tambour, the effect is at once transmitted by the column of air in the elastic tube to the interior of the second tambour, also closed, and through the elastic and movable lid of the latter to the lever, which is placed in connection with a registering

apparatus, which consists of a cylinder covered with smoked paper, revolving with a definite velocity. The point of the lever writes upon the paper, and a tracing of the heart's impulse or **cardiogram** is thus obtained.

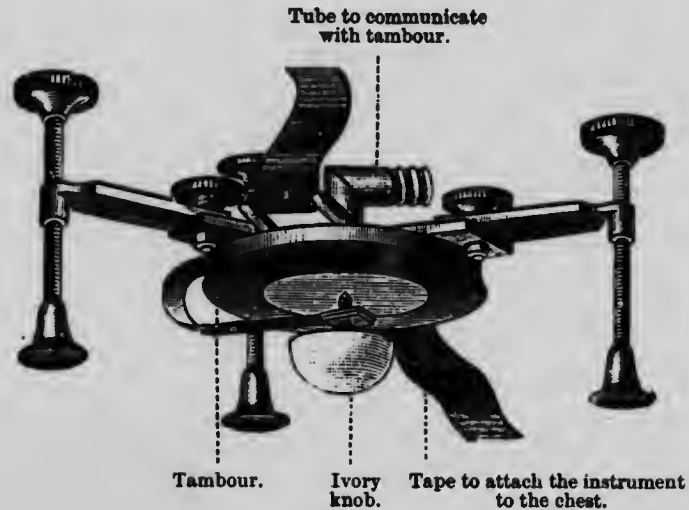

Fig. 238.—Cardiograph. (Sanderson's.)

Fig. 240 represents a typical tracing obtained in this way. The first small rise of the lever is caused by the auricular, the second larger rise by the ventricular systole; the downstroke

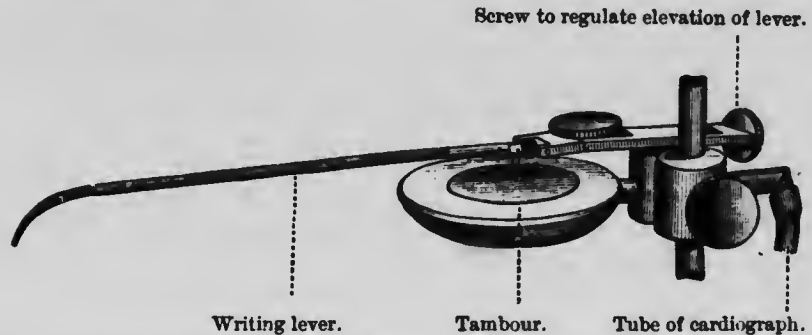

Fig. 239.—Marey's Tambour, to which the movement of the column of air in the first tambour is conducted by a tube, and from which it is communicated by the lever to a revolving cylinder, so that the tracing of the movement of the impulse beat is obtained.

represents the pause, the tremors at the commencement of which are partly instrumental and partly caused by the closure of the semilunar valves.

Another method of obtaining a tracing from one's own heart consists in dispensing with the first tambour, and placing the

tube of the recording tambour in one's mouth, and holding the breath though keeping the glottis open. The chest then acts

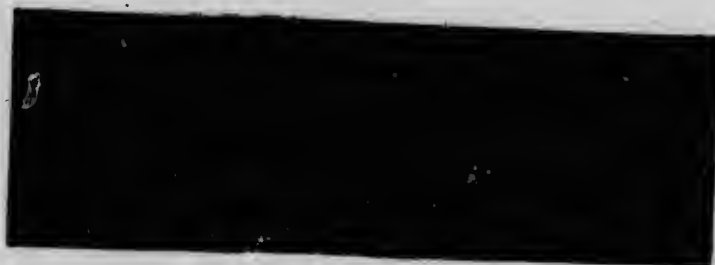

Fig. 240.—Cardiogram from human heart. The variations in the individual beats are due to the influence of the respiratory movements on the heart. To be read from left to right.

as the first tambour, and the movements of the lever (cardio-pneumatogram) may be written in the usual way.

### Endocardiac Pressure.

The tracings of the cardiograph are, however, very variable, and their interpretation is a matter of discussion. A much better method of obtaining a graphic record of the events of the cardiac cycle consists in connecting the interior of an animal's heart with recording apparatus.

There are several methods by which the endocardiac pressure may be recorded.

By placing two small india-rubber air-bags or *cardiac sounds* down the jugular vein into the interior respectively of the right auricle and the right ventricle, and a third in an intercostal space in front of the heart of a living animal (horse), and placing these bags, by means of long narrow tubes, in communication with three tambours with levers, arranged one over the others in connection with a registering apparatus (fig. 241), Chauveau and Marey were able to record and measure the variations of the endocardiac pressure and the comparative duration of the contractions of the auricles and ventricles. By means of the same apparatus, the synchronism of the impulse with the contraction of the ventricles is also shown.

In the tracing (fig. 242), the intervals between the vertical lines represent periods of a tenth of a second. The parts on which any given vertical line falls represent simultaneous events. It will be seen that the contraction of the auricle, indicated by the marked curve at A in the first tracing, causes a slight increase of

pressure in the ventricle, which is shown at A' in the second tracing, and produces also a slight impulse, which is indicated by



Fig. 241.—Apparatus of MM. Chauveau and Marey for estimating the variations of endocardial pressure, and the production of the impulse of the heart.

A'' in the third tracing. The closure of the semilunar valves causes a momentarily increased pressure in the ventricle at D', affect the pressure in the auricle D, and is also shown in the tracing of the impulse, D''.



Fig. 242.—Tracings of (1), Intra-auricular, and (2), Intra-ventricular pressure, and (3), of the impulse of the heart; to be read from left to right; obtained by Chauveau and Marey's apparatus.

The large curve of the ventricular and the impulse tracings, between A' and D', and A'' and D'', are caused by the ventricular contraction, while the smaller undulations, between B and C, B' and C', B'' and C'', are caused by the vibrations consequent on the tightening and closure of the auriculo-ventricular valves.

Much objection has, however, been taken to this method of investigation. First, because it does not admit of both positive and negative pressure being recorded.

Secondly, because the method is only applicable to large animals, such as the horse. Thirdly, because the intraventricular changes of pressure are communicated to the recording tambour by a long elastic column of air; and fourthly, because the tambour arrangement has a tendency to record inertia vibrations. Rolleston

re-investigated the subject with a more suitable but rather complicated apparatus. The principle of the method consisted in placing the cavity of a heart-chamber in communication with a recording apparatus by means of a tube containing saline solution. His recording apparatus consisted of a lever connected to a piston; the upward and downward movements of the piston-rod were due to the varying pressures exerted on the blood by the contraction and dilatation of the heart; the rise and fall of the lever were

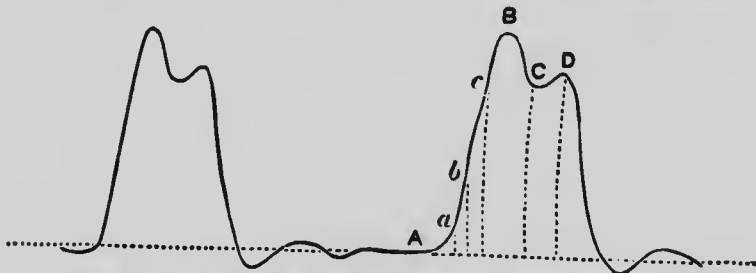

Fig. 243.—Curve from left ventricle obtained by Rolleston's apparatus; the abscissa shows atmospheric pressure.

controlled by the resistance to torsion of a steel ribbon to which it was attached. The above figure (fig. 243) shows the kind of tracing he obtained. He found:—

1. That there is no distinct and separate auricular contraction marked in the curves obtained from either right or left ventricles, the auricular and ventricular rises of pressure being merged into one continuous rise.
2. That the auriculo-ventricular valves are closed before any



Fig. 244.—Hürthle's manometer.

great rise of pressure within the ventricle above that which results from the auricular systole (*a*, fig. 243). The closure of the valve occurs probably in the lower third of the rise *AB* (fig. 243), and does not produce any notch or wave.

3. That the semilunar valves open at the point in the ventricular systole, situated (at *c*) about or a little above the junction of the middle and upper third of the ascending line (*AB*), and the closure about or a little before the shoulder (*D*).

4. That the minimum pressure in the ventricle may fall below that of the atmosphere, but that the amount varies considerably.

Another method of overcoming the imperfections of Marey's tambour is by the use of Hürthle's manometer (fig. 244). In this the tambour is very small, the membrane is made of thick rubber, and the whole, including the tube that connects it to the heart, is filled with a strong saline solution (saturated solution of sodium sulphate).

The tracing obtained by this instrument, when connected with the interior of the ventricle, is represented in the next figure.

The auricular systole causes a small rise of pressure A B; it lasts about  $\cdot 05$  second. It is immediately followed by the ventricular contraction, which lasts from B to D. From B to C the ventricle is getting up pressure, so that at C it equals the aortic pressure. This takes  $\cdot 02$  to  $\cdot 04$  second. Beyond C the aortic valves open, and blood is driven into the aorta; the outflow lasts from C to D ( $\cdot 2$  second). At D the ventricle relaxes. The flat part of the curve is spoken of as the *systolic plateau*, and according

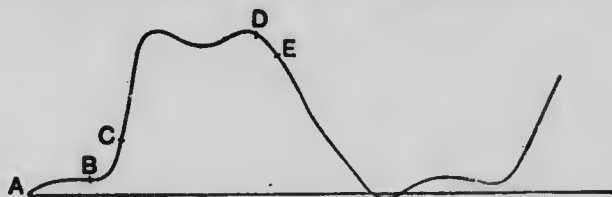

Fig. 245.—Curve of intra-ventricular pressure. (After Hürthle.)

to the state of the heart and the peripheral resistance may present a gradual ascent or descent; it occupies about  $\cdot 18$  second. Almost immediately after the relaxation begins, the intraventricular pressure falls below the aortic, so that the aortic valves close near the upper part of the descent at E.

The amount of pressure in the heart is measured by a manometer, which is connected to the heart by a tube containing a valve. This was first used by Goltz and Gaule. If the valve permits fluid to go only from the heart, the manometer will indicate the maximum pressure ever attained during the cycle. If it is turned the other way, it will indicate the minimum pressure. The following are some of the measurements taken from the dog's heart in terms of millimetres of mercury:—

	Maximum pressure.	Minimum pressure.
Left ventricle . . . .	140 mm.	- 30 to 40 mm.
Right ventricle . . . .	60 mm.	- 15 mm.
Right auricle . . . .	20 mm.	- 7 to 8 mm.

By a negative ( - ) pressure one means that the mercury is sucked up in the limb of the manometer towards the heart.

Another valuable instrument introduced by Hürthle is called the differential manometer. In this instrument, two cannulae are brought into connection with tambours (A and B) placed on opposite sides of the fulcrum (F) of a lever. The lever works against a spring, and this sets in motion a writing style (S). This instrument enables us to determine the relations of the pressure changes in any two cavities. For instance, suppose

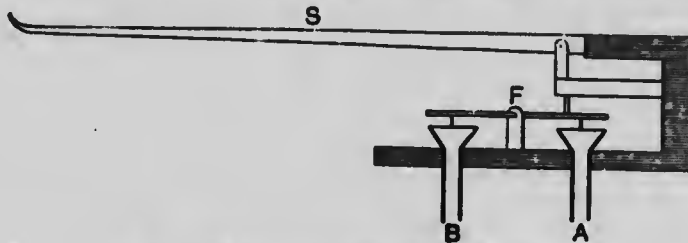

Fig. 246.—Diagram of Hürthle's differential manometer.

A is connected to the left ventricle, and B to the aorta: when the pressure in the ventricle is greater than that in the aorta, the writing style will be raised: when the pressure in the aorta is greater than that in the ventricle, the style will fall; when the two pressures are equal, it will be in the zero position.

### Frequency and Force of the Heart's Action.

The heart of a healthy adult man contracts about 72 times in a minute; but many circumstances cause this rate, which of course corresponds with that of the arterial pulse, to vary even in health. The chief are age, temperament, sex, food and drink, exercise, time of day, posture, atmospheric pressure, temperature. Some figures in reference to the influence of age are appended.

The frequency of the heart's action gradually diminishes from the commencement to near the end of life, but is said to rise again somewhat in extreme old age, thus:—

Before birth the average number of pulsations per minute is 150	About the seventh year . . . . .	from 90 to 85
Just after birth . . . from 140 to 130	About the fourteenth year . . . . .	
During the first year . . . . . 130 to 115	In adult age . . . . .	85 to 80
During the second year . . . . . 115 to 100	In old age . . . . .	80 to 70
During the third year . . . . . 100 to 90	In decrepitude . . . . .	70 to 60
		75 to 65

In health there is observed a nearly uniform relation between the frequency of the beats of the heart and of the respirations; the proportion being, on an average, 1 respiration to 3 or 4 beats. The same relation is generally maintained in the cases in which the action of the heart is naturally accelerated, as after food or exercise; but in disease this relation may cease.

In estimating the work done by any machine it is usual to express it in terms of the unit of work. In England, the unit of work is the *foot-pound*, and is defined to be the energy expended



in raising a unit of weight (1 lb.) through a unit of height (1 ft.): in France, the *gram-metre*. The work done by the heart at each contraction can be readily found by multiplying the weight of blood expelled by the ventricles by the height to which the blood rises in a tube tied into an artery. This height is about 1.5 metres (5 ft.) in man. Taking the weight of blood expelled from the left ventricle at each systole as 87 grammes (3 oz.) and the average pressure in the aorta as 110 mm. mercury (1.5 metres blood), the work done at each contraction will be 130 gram-metres. To this must be added 45 gram-metres for the work done by the right ventricle. If the heart beats 72 times a minute, it will do 18,000 kilogramme-metres of work in the 24 hours.

*The Output of the Heart.*—The first estimations of the work of the heart, made by Volkmann and Vierordt, gave numbers nearly double those stated in the preceding paragraph. Recent research has shown that their estimate of the output of the heart was excessive. Direct measurements of the heart's output have been made by Stolnikow and Tigerstedt. The former cut off by ligature the whole of the systemic circulation in the dog, and then measured the amount of blood passing through the simplified circulation which consisted only of the pulmonary and coronary vessels by means of a graduated cylinder interposed on the course of the vessels. Tigerstedt made his observations by means of a Stromuhr (see next chapter) inserted into the aorta. Severe operative measures of this kind, however, interfere with the circulation a good deal.

Gréhant and Quinquand, and Zuntz adopted an indirect method based on the comparison of the amount of oxygen absorbed in the lungs with the amount added to the blood in its passage through the pulmonary circulation.

G. N. Stewart has introduced an ingenious method, the principle of which is the following. A solution of an innocuous substance, which can be easily recognised and estimated, is allowed to flow for a definite time and at a uniform rate into the heart; the substance selected was sodium chloride. This mingles with the blood and passes into the circulation. At a convenient point of the vascular system, a sample of blood is drawn off just before the injection, and an equal amount during the passage of the salt; the quantity of the sodium chloride solution which must be added to the first sample in order that it may contain as much as the second sample is determined. This determination gives the extent to which the salt solution has been mixed with the blood in the heart, and knowing the quantity of the solution which has run into the heart, the output in a given time can be calculated.

All these experiments have been on animals. The results obtained necessarily vary with the size of the animal used, and with the rate at which the heart is beating. If the same relationship holds for man as for animals, Stewart calculates that in a man weighing 70 kilo. the output of each ventricle per second is less than 0.002 of the body weight, *i.e.*, about 105 grammes of blood per second, or 87 grammes (about 80 c.c.) per heart beat with a pulse rate of 72. Zuntz obtained rather smaller numbers by his method.

Various methods have been adopted for registering the output of the heart under varying circumstances. A simple *cardiometer* applicable to the heart of a small mammal like a cat has been devised by Barnard. It consists of an india-rubber tennis ball with a circular orifice cut in one side

of it large enough to admit the heart: a glass tube is securely fixed into a small opening on the opposite side of the ball. The animal is anaesthetised, and its thorax opened. The animal is kept alive by artificial respiration. The pericardium is then opened by a crucial incision, the heart is slipped into the ball: the pericardium overlaps the outside of the ball, and the apparatus is rendered air-tight by smearing the edges of the hole with vaseline. The four corners of the pericardium are then tightly tied by ligatures round the glass tube just mentioned. This tube is connected by a stout india-rubber tube to a Marey's tambour or a piston-recorder, the writing point of which is applied to a moving blackened cylinder. When the heart contracts, air will be withdrawn from the tambour to the cardiometer; when the heart expands, the air will move in the reverse direction. These movements are written by the end of the lever of the tambour, and variations in the excursions of this lever correspond with variations in the amount of blood expelled from or drawn into the heart with systole and diastole respectively. By calibrating the instrument the actual volume of the blood expelled can be ascertained.

This instrument has to a great extent replaced a more elaborate cardiometer invented by the late Prof. Roy. His instrument was made of metal, and oil instead of air was used as the medium in its interior.

### Innervation of the Heart.

The nerves of the heart, which under normal circumstances control its movements, are the following:—

1. Cardiac branches of the vagus.
2. The cardiac branches of the sympathetic.
3. The intrinsic nerves of the heart. These were formerly regarded as more or less independent of the other two sets of fibres; we now know, however, that they are merely the terminations of the other nerves in the heart-wall. For convenience of description, however, we will keep the old name.

**The Vagus.**—This arises from the grey matter in the floor of the fourth ventricle, at the point of the calamus scriptorius. It leaves the bulb by some 10—15 bundles behind the ninth nerve, and leaves the skull by the jugular foramen, having upon it a ganglion called the *jugular ganglion*. Shortly afterwards it passes through a second ganglion called the ganglion trunci vagi. It gives off branches to the vessels of the meninges and to the ear, and then receives certain connecting branches: (*a*) from the glosso-pharyngeal; and (*b*) it receives the whole inner division of the spinal accessory nerve. This nerve arises from a centre in the bulb close to and below the vagal nucleus; the outer half of the same nerve arises from spinal roots, and supplies the sterno-mastoid and trapezius.

The fibres of the spinal accessory that join the vagus are chiefly motor, especially to the larynx; some are cardio-inhibitory (see p. 252).

The vagus then gives off branches to the pharynx, larynx,

heart, lungs, œsophagus, and stomach, the remainder joining the cœliac plexus, and contributing to the nerve supply of various abdominal organs. We have, however, in this place only to deal with the cardiac fibres.

It has been known since the experiments of the Bros. Weber in 1845, that stimulation of one or both vagi produces slowing or stoppage of the beats of the heart. It has since been shown in all of the vertebrate animals experimented with, that this is the normal result of vagus stimulation. Moreover, section of one vagus produces slight acceleration of the heart; this result is better marked when both vagi are divided.

Weak stimulation of the peripheral end of the divided nerve produces slowing of the heart (fig. 248); a strong stimulus produces stoppage (fig. 247). It appears that any kind of



Fig. 247.—Tracing showing the actions of the vagus on the heart. *Aur.*, auricular; *Vent.*, ventricular tracing. The part between the perpendicular lines indicates the period of vagus stimulation. *C.8* indicates that the secondary coil was 8 c.m. from the primary. The part of the tracing to the left shows the regular contractions of moderate height before stimulation. During stimulation, and for some time after, the beats of auricle and ventricle are arrested. After they commence again they are small at first, but soon acquire a much greater amplitude than before the application of the stimulus. (From Brunton, after Gaskell.)

stimulus produces the same effect, either chemical, mechanical, electrical, or thermal, but that of these the most potent is a rapidly interrupted induction current. A certain amount of confusion has arisen as to the effect of vagus stimulation in consequence of the fact that within the trunk of the nerve are contained, in some animals, fibres of the sympathetic, and it depends to some extent upon the exact position of the application of the stimulus, as to the exact effect produced. Speaking generally, however, excitation of any part of the trunk of the vagus produces inhibition, the stimulus being particularly potent if applied to the termination of the vagi in the heart itself, where they enter the substance of the organ at the situation of the sinus ganglia. The stimulus may be applied to either vagus with effect, although it is frequently more potent if applied to

the nerve on the right side. The effect of the stimulus is not immediately seen; one or more beats may occur before stoppage of the heart takes place, and slight stimulation may produce only slowing and not complete stoppage of the heart. The stoppage may be due either to prolongation of the diastole, as is usually the case, or to diminution of the systole. Vagus stimulation inhibits the spontaneous beats of the heart only; it does not do away with the irritability of the heart-muscle, since mechanical stimulation may bring out a beat during the stand-still caused by vagus stimulation. The inhibition of the beats varies in duration, but if the stimulation is a prolonged one, the beats may reappear before the current is shut off. When the beats reappear on the cessation of stimulation, the first few are usually feeble, and may be auricular only; after a time the contractions become stronger, and very soon exceed both in amplitude and frequency

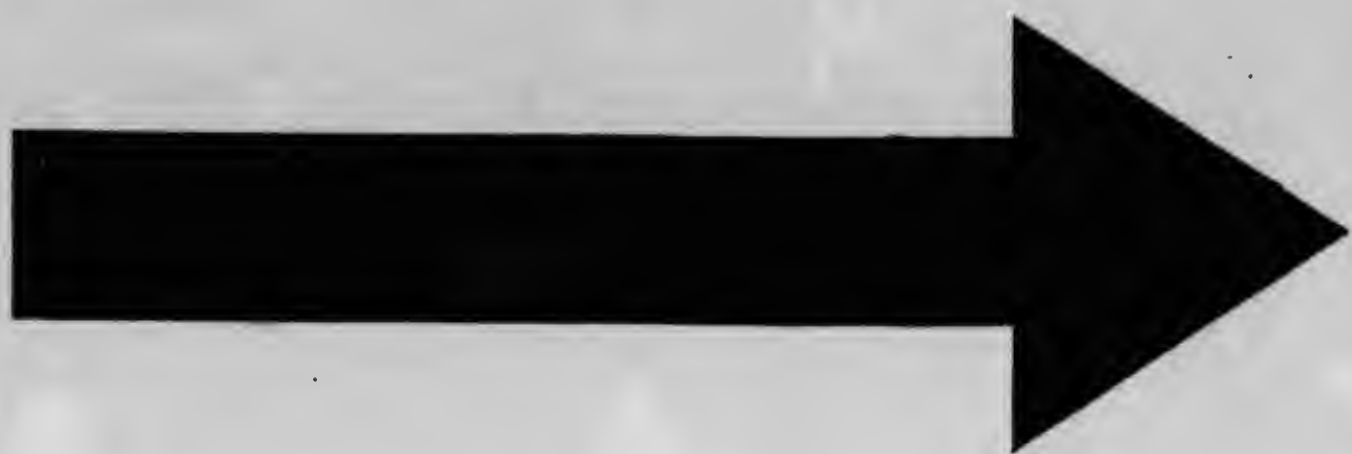

Fig. 248.—Tracing showing diminished amplitude and slowing of the pulsations of the auricle and ventricle without complete stoppage during stimulation of the vagus. (From Brunton, after Gaskell.)

those which occurred before the application of the stimulus (figs. 247, 248).

One branch of the vagus is called the *depressor*; it is a separate nerve in only a few animals. Unlike the inhibitory branches, it is afferent, not efferent; it carries impulses to the vaso-motor centre in the bulb from the heart. We shall study its use in connection with blood pressure.

**The Sympathetic.**—The influence of the sympathetic is the reverse of that of the vagus. Stimulation of the sympathetic, even of one side, produces acceleration of the heart-beats, and according to certain observers, section of the same nerve produces slowing. The acceleration produced by stimulation of the sympathetic fibres is accompanied by increased force, and so the action of the nerve is more properly termed *augmentor*. The action of the sympathetic differs from that of the vagus in several particulars besides the augmentation which is produced: first, the stimulus required to produce any effect must be more



# MICROCOPY RESOLUTION TEST CHART

(ANSI and ISO TEST CHART No. 2)

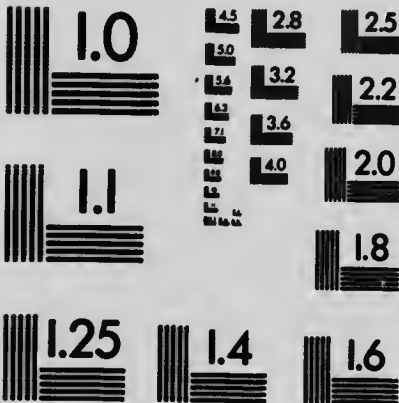

**APPLIED IMAGE Inc**

1653 East Main Street  
Rochester, New York 14609 USA  
(716) 482 - 0300 - Phone  
(716) 265 - 5989 - Fax

powerful than is the case with the vagus stimulation; secondly, a longer time elapses before the effect is manifest; and thirdly, the augmentation is followed by exhaustion, the beats being after a time feeble and less frequent.

The fibres of the sympathetic system which influence the heart-beat in the frog, leave the spinal cord by the anterior root of the third spinal nerve, and pass thence by the ramus communicans to the third sympathetic ganglion, thence to the second sympathetic

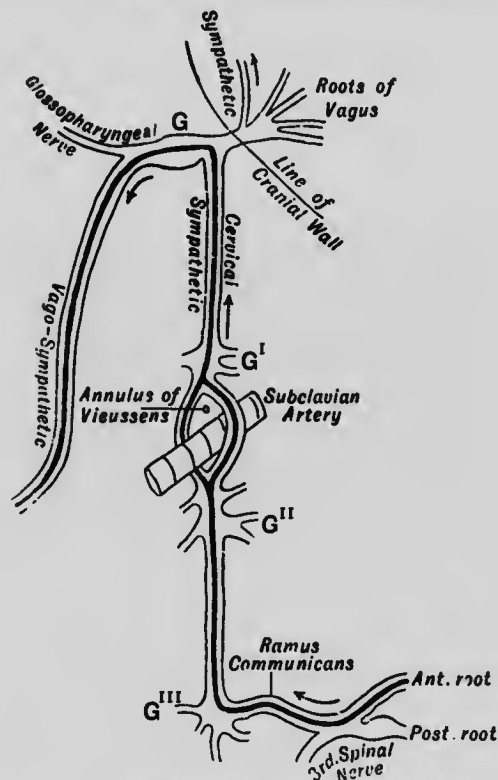

Fig. 249.—Heart nerves of frog. (Diagrammatic.)

ganglion, and thence by the annulus of Vieussens (round the subclavian artery) to the first sympathetic ganglion, and thence in the main trunk of the sympathetic, to near the exit of the vagus from the cranium, where it joins that nerve and runs down to the heart within its sheath, forming the joint vago-sympathetic trunk. These fibres are indicated by the dark line in fig. 249. The fibres of the sympathetic seen running up into the skull are for the supply of blood-vessels there. It should be noted that the frog has no spinal accessory nerve.

From the fact that the augmentor fibres are joined to the

vagus trunk, it will be understood that the effect of the stimulation of the vagus in the frog is not in all cases purely inhibitory, but may be augmentor, according to the position where the stimulus is applied, the intensity of the stimulus, and the condition of the heart; if it is beating strongly a slight vagus stimulation will produce immediate inhibition.

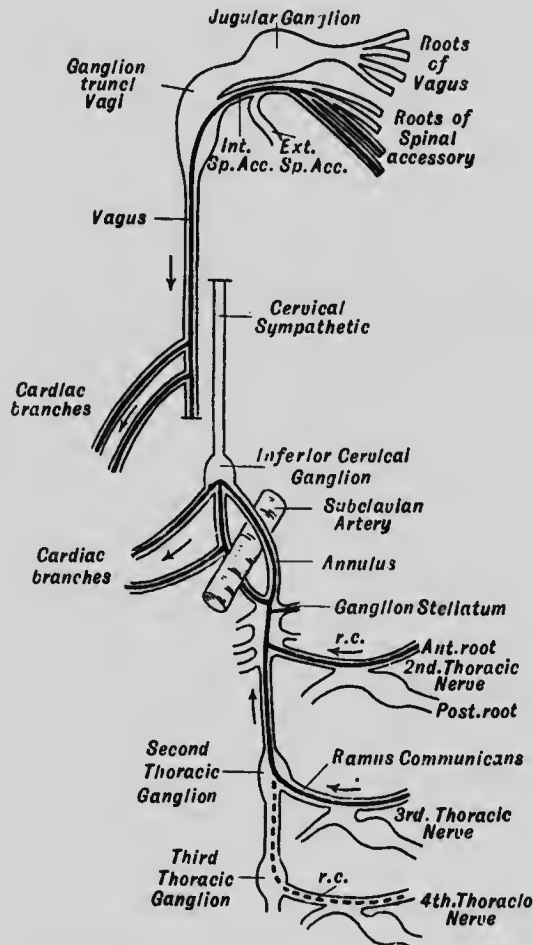

Fig. 250.—Heart nerves of mammal. (Diagrammatic.)

In the dog, the augmentor fibres leave the cord by the second and third dorsal nerves, and possibly by anterior roots of two or more lower nerves; they pass by the rami communicantes to the ganglion stellatum, or first thoracic ganglion, and thence by the annulus of Vienssens to the inferior cervical ganglion of the sympathetic; fibres from the annulus, or from the inferior cervical ganglion, proceed to the heart (see fig. 250).



In man, the cardiac branches of the sympathetic probably originate in the same way; they travel to the heart from the annulus of Vieussens and cervical sympathetic in superior, middle and lower bundles of fibres. These pass into the cardiac plexus, and surrounding the coronary vessels ultimately reach the heart. They probably contain vaso-motor fibres for these vessels, as well as the more important fibres for the heart itself.

The course of the inhibitory fibres in mammals has been recently investigated by Grossmann. He divides the rootlets that leave the medulla to form the ninth, tenth and eleventh cranial nerves into three groups, *a*, *b* and *c*; *a* corresponds fairly well with the fibres of the glossopharyngeal, *b* with those of the vagus, and *c* with those of the spinal accessory. By stimulating each rootlet he found the cardio-inhibitory fibres in the lower two or three rootlets of group *b* and the upper rootlet of group *c*. There are probably differences in different animals. In the cat and dog Cadman finds that the rootlets in the *a* group are respiratory and afferent inhibitory, and that all the efferent inhibitory fibres are in group *c*.

The inhibitory fibres are medullated, and only measure  $2\mu$  to  $3\mu$  in diameter; they pass to the heart and lose their medulla in the ganglia of that organ. The sympathetic fibres on the other hand reach the heart as non-medullated fibres; having lost their medulla in the sympathetic (inferior cervical and first thoracic) ganglia. The augmentor centre in the central nervous system has not yet been accurately localised.

*Influence of Drugs.*—The question of the action of drugs on the heart forms a large branch of pharmacology. We shall be content here with mentioning two only, as they are largely used for experimental purposes by physiologists. *Atropine* produces considerable augmentation of the heart-beats by paralysing the inhibitory mechanism. *Muscarine* (obtained from poisonous fungi) produces marked slowing, and in larger doses stoppage of the heart. It produces a similar effect to that of prolonged vagus stimulation, and, as in that case, the effect can be removed by the action of atropine. The action of atropine cannot, however, be antagonised by muscarine. That these drugs act on the nerves, and not the muscular substance of the heart, is shown by the fact that in the hearts of early embryos, so early that no nerves have yet grown to the heart, these drugs have little or no effect. (Pickering.)

*Reflex Inhibition.*—Thus there is no doubt that the vagi nerves are simply the media of an inhibitory or restraining influence over the action of the heart which is conveyed through them from the centre in the medulla oblongata which is always in operation. The restraining influence of the centre in the medulla may be reflexly *increased* by stimulation of almost any afferent nerve, particularly of the abdominal sympathetic, so as to produce slowing or stoppage of the heart, through impulses

passing down the vagi. As an example of this reflex stimulation, the well-known effect on the heart of a violent blow on the epigastrium may be referred to. The stoppage of the heart's action in this case is due to the conveyance of the nervous impulse by fibres of the sympathetic (afferent) to the medulla oblongata, and its subsequent *reflection* through the vagi (efferent) to the muscular substance of the heart. Chloroform vapour and tobacco smoke in some people and animals, by acting on the terminations of the vagi or their branches in the respiratory system, may also produce reflex inhibition of the heart. Some very remarkable facts concerning the readiness by which reflex inhibition of the fish's heart may be produced were made out by Prof. McWilliam; any slight irritation of the tail, gills, mucous membrane of mouth and pharynx, or of the parietal peritoneum, causes the heart to stop beating.

In connection with the subject of reflex inhibition, it may be mentioned in conclusion that though we have no voluntary control over the heart's movements, yet cerebral excitement will produce an effect on the rate of the heart, as in certain emotional conditions.

**Intracardiac Nerves.**—The heart beats after its removal from the body; in the case of the frog and other cold-blooded animals, this will go on for hours, and under favourable circumstances for days. In the case of the mammal, it is more a question of minutes unless the heart is artificially fed through the coronary artery with arterial blood. If this is done, especially in an atmosphere of oxygen, the dog's heart, or even strips of the dog's heart, can be kept beating for hours. (Porter.) At one time this was supposed to be due to the intrinsic nervous system of the heart; the heart was regarded almost as a complete organism, possessing not only parts capable of movement, but also a nervous system to initiate and regulate those movements.

We now, however, look upon the muscular tissue of the heart, rather than its nerves, as the tissue which possesses the power of rhythmical movement, because muscular tissue which has no nerves at all possesses this property. For instance, the ventricle apex of the frog's or tortoise's heart possesses no nerve-cells, but if it is cut off and fed with a suitable nutritive fluid at considerable pressure, it will beat rhythmically. (Gaskell.) The apparatus by which this may be accomplished we shall study at the end of this chapter. The middle third of the ureter is another instance of muscular tissue free from nerves, but which nevertheless executes peristaltic movements. Perhaps, however, the most striking instance is that of the foetal heart, which begins to beat directly it is formed, long before any nerves have grown into it.

The power of rhythmical peristalsis therefore resides in the

muscular tissue itself, though normally during life it is controlled and regulated by the nerves that supply it.

The intracardiac nerves have been chiefly studied in the frog; the two vago-sympathetic nerves terminate in various groups of ganglion cells; of these the most important are *Remak's ganglion*, situated at the junction of the sinus with the right auricle; and *Bidder's ganglion*, at the junction of the auricles and ventricle. A third collection of ganglion cells (*von Bezold's ganglion*) is situated in the inter-auricular septum. From the ganglion cells, fibres spread out over the walls of sinus, auricles, and the upper part of the ventricle. Remak's ganglion used to be called the local

inhibitory centre of the heart; it is really the termination of the inhibitory fibres, and stimulation of the heart at the sino-auricular junction is the most certain way of obtaining stoppage of the heart. Bidder's ganglion was called the local accelerator centre for a corresponding reason.

The accompanying figures show the vagal terminations in Remak's ganglion (fig. 251), some isolated nerve-cells from this ganglion (fig. 252); and fig. 253 is a rough diagram to indicate the positions of the principal ganglia.

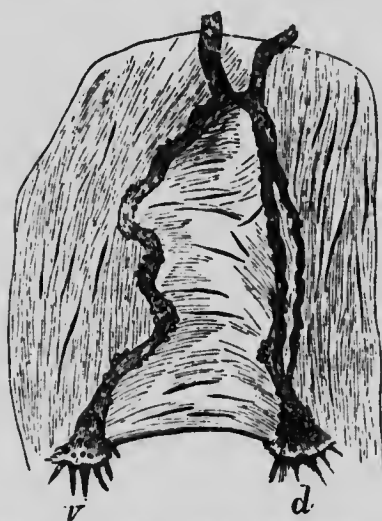

Fig. 251.—Course of the nerves in the auricular partition wall of the heart of a frog. d, dorsal branch; v, ventral branch. (Ecker.)

In connection with the rhythmic contraction of the heart, it is necessary to allude to what is known as **Stannius' experiment**. This experiment consists in applying a tight ligature to the heart between the sinus and the right auricle, the effect of which is to stop the beat of the heart beyond the ligature, whilst the sinus continues to beat. If a second ligature is applied at the junction of the auricles and ventricle, the ventricle begins to beat, whilst the auricles continue quiescent. In both cases the quiescent parts of the heart may be made to give single contractions in response to mechanical or electrical stimulation. A considerable amount of discussion has arisen as to the explanation of these phenomena. It was suggested that the action of the ligature is to stimulate the inhibitory nervous mechanism in

the sinus, whereby the auricles and ventricle can no longer continue to contract, but this suggestion must be given up if the present theory as to the functions of the nerve ganglia is correct. The effect of Stannius' ligature is simply an example of what has been called by Gaskell *blocking*. The explanation of this term is as follows:—It appears that under normal conditions

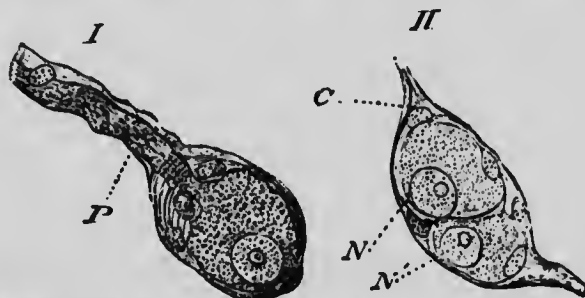

Fig. 252.—Isolated nerve-cells from the frog's heart. I. Usual form. II. Twin cell. C, capsule; N, nucleus; N', nucleolus; P, process. (From Ecker.)

the wave of contraction in the heart starts at the sinus and travels downwards over the auricles to the ventricle, the irritability of the muscle and the power of rhythmic contractility being greatest in the sinus, less in the auricles, and still less in the ventricle, whilst under ordinary conditions the apical portion of the ventricle exhibits very slight irritability and still less power of spontaneous contraction. Thus it may be supposed that the

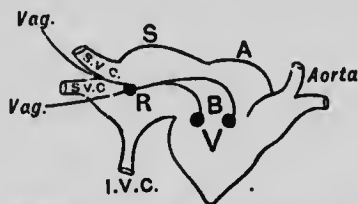

Fig. 253.—Diagram of ganglia in frog's heart. R, Remak's, B, Bidder's ganglion; S, sinus; A, auricle; V, ventricle.

wave of contraction beginning at the sinus is more or less blocked by a ring of muscle at lower irritability at its junction with the auricles; again the wave in the auricles is similarly delayed in its passage over to the ventricle by a ring of lesser irritability, and thus the wave of contraction starting at the sinus is broken as it were both at the auricles and at the ventricle. By an arrangement of ligatures, or better, of a system of clamps, one part of the heart may be isolated from the other portion, and the contraction when stimulated by an induction shock may be

made to stop in the portion of the heart-muscle in which it begins. It is not unlikely that the contraction of one portion of the heart acts as a stimulus to the next portion, and that the sinus contraction generally begins first, since the sinus is the most irritable to stimuli, and possesses the power of rhythmic contractility to the most highly developed degree. It must not be thought, however, that the wave of contraction is incapable of passing over the heart in any other direction than from the sinus onwards; it has been shown that by application of appropriate stimuli at appropriate instants, the natural sequence of beats may be reversed, and the contraction starting at the arterial part of the ventricle may pass to the auricles and then to the sinus.

The question has been discussed whether the wave from one chamber is passed on to the next by nervous or muscular connection. The slow rate of propagation of the wave and the existence of muscular fibres passing across from one chamber to the next show that the link is a muscular one.

An exceedingly interesting fact with regard to the passage of the wave in any direction has been made out by partial division of the muscular fibres at any point, whereby one part of the wall of the heart is left connected with the other parts by a small portion of undivided muscular tissue, and the wave of contraction is then able to pass to the next portion of the wall only every second or third beat. Thus division of the muscle has much the same effect as partial clamping it in the same position, or of a ligature similarly applied, but not tied tightly. The first Stannius ligature acts as a partial or complete block, and prevents the stimulus of the sinus-beat from passing further down the heart, but parts beyond the ligature may be made to contract by stimuli applied to them directly. The second Stannius ligature acts as a stimulus to the ventricle. Instead of applying the second ligature, the experiment may be varied by cutting off the heart beyond the first ligature; the stimulation caused by cutting produces waves that travel over auricles and ventricle.

The explanation of the action of the Stannius ligatures just given can hardly be regarded as wholly satisfactory though it is the best that can be offered at present. If the first ligature acts as a block it is difficult to understand why the second should act as a stimulus; and if the second acts as a stimulus, the question arises why the first should not act as a stimulus also.

The importance of the sinus as the starting-point of the peristalsis can be shown by warming it. If the heart is warmed by bathing it in salt solution at about the body temperature, it beats faster; this is due to the sinus starting a larger number of peristaltic waves; that this is the case may be demonstrated by warming localised portions of the heart by a small galvano-cautery; if

the sinus is warmed the heart beats faster, but if the auricles or ventricle are warmed there is no alteration in the heart's rate.

The sinus in the frog's heart, and that portion of the right auricle of the mammal's heart which corresponds to the sinus, is always the last portion of the heart to cease beating on death, or after removal from the body (*ultima moriens*). This is an additional proof of the superior rhythmical power which it possesses.

The fact that the Stannius heart is quiescent has enabled physiologists to study the effects of stimuli upon heart muscle. A single stimulus produces a single contraction, which has a long latent period, is slow, and propagated as a wave over the heart at the rate of  $\frac{2}{3}$  to  $\frac{3}{4}$  inch, or 10—15 mm. a second. A second stimulus causes a rather larger contraction, a third one larger still, and so on for some four or five beats, when the size of the contraction becomes constant. This *staircase* phenomenon, as it is called, is also seen in voluntary muscle (see p. 124), but it is more marked in the heart. The following tracing shows the result of an actual experiment.



Fig. 254.—Staircase from frog's heart. This was obtained from a Stannius preparation; an induction shock being sent into it with every revolution of the cylinder (rapid rate). The contractions became larger with every beat. To be read from right to left.

There are, however, more marked differences than this between voluntary and heart muscle. The first of these is, that the amount of contraction does not vary with the strength of the stimulation. A stimulus strong enough to produce a contraction at all brings out as big a beat as the strongest. The second is, that the heart muscle has a long *refractory period*; that is to say, after the application of a stimulus, a second stimulus will not cause a second contraction until after the lapse of a certain interval called the *refractory period*. The refractory period lasts as long as the heart-beat. The third difference depends on the second, and consists in the fact that the heart muscle can never be thrown into complete tetanus by a rapid series of stimulations; with a strong current there is a partial fusion of the beats, but this is entirely independent of the rate of faradisation. Indeed,

as a rule, the heart responds by fewer beats to a rapid than to a slow rate of stimulation.

In spite of these differences there are many and important resemblances between heart muscle and voluntary muscle.

The thermal and chemical changes are similar; there is a using-up of oxygen and a production of carbonic acid and sarcolactic acid. The using-up of oxygen was well illustrated by an experiment of Prof. Yeo's. He passed a weak solution of oxy-hemoglobin through an excised beating frog's heart, and found that after it had passed through the heart, the solution became less oxygenated and venous in colour.

The electrical changes are also similar, and have already been dwelt upon in Chapters XII. and XIV.

### **Instruments for Studying the Excised Frog's Heart.**

If a frog's heart is simply excised and allowed to remain without being fed, it ceases to beat after a time varying from a few minutes to an hour or so, but if it is fed with a nutritive fluid, it will continue to beat for many hours. A very good nutritive fluid is defibrinated blood diluted with twice its volume of physiological saline solution. Dr. Ringer has, however, shown that nearly as good results are obtained with physiological saline solution to which minute quantities of calcium and potassium salts have been added; in other words, the inorganic salts of the blood will maintain cardiac activity for a time without the addition of any organic material. Prof. Howell has recently shown that the sinus or venous end of the heart is especially susceptible of being thrown into rhythmical action by such an inorganic mixture. The normal stimulus for the starting of the heart-beat is therefore to be sought in the mineral constituents of the blood. The fluid is passed through the heart by means of a perfusion cannula (fig. 255). The heart is tied on to the end of the cannula; the fluid enters by one and leaves by the other tube.

Numerous instruments have been devised for obtaining graphic records of the heart's movements under these circumstances, but we shall be content with describing three of the best. They have been much used in the investigation of the effects of drugs on the heart, and the results obtained have been of much service to physicians.

(1) The heart having been securely tied on to the perfusion cannula, the circulating fluid is passed through it. One stem of the cannula is then attached by the small side branch on the left in fig. 255 by a tube containing salt solution to a small mercurial manometer, provided with a float, on

the top of which is a writing style. The apparatus is arranged so that the movements of the mercury can be recorded by the float and the writing style on a slowly revolving drum. The movements of the mercury are due to changes in the endocardiac pressure.

The other two instruments we shall describe are constructed on the opposite principle: the heart is enclosed in a chamber filled with oil, and the movements of this oil outside the heart are registered.

(2) *Roy's Tonometer* (fig. 256): A small bell-jar, open above, but provided with a firmly fitting stopper, in which is fixed a double cannula, is adjustable by a smoothly ground base upon a circular brass plate, about 2 to 3 inches in diameter. The junction is made complete by greasing the base with lard. In the plate, which is fixed to a stand adjustable on an upright, two holes, one in the centre, a large one about one-third of an inch in diameter, to which is fixed below a brass grooved collar, about half an inch deep; the other hole is the opening into a pipe provided with a stop-cock. The opening provided with the collar is closed at the lower part with a membrane, which is closely tied by means of a ligature around the groove at the lower edge of the collar. To this membrane a piece of cork is fastened by sealing-wax, from

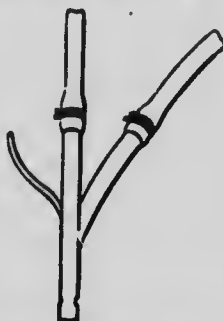

Fig. 255.—Kronecker's Perfusion Cannula, for supplying Fluids to the interior of the Frog's Heart.

It consists of a double tube, one outside the other. The inner tube branches out to the right; thus, when the ventricle is tied to the outer tube of the cannula, a current of liquid can be made to pass into the heart by one tube and out through the other.

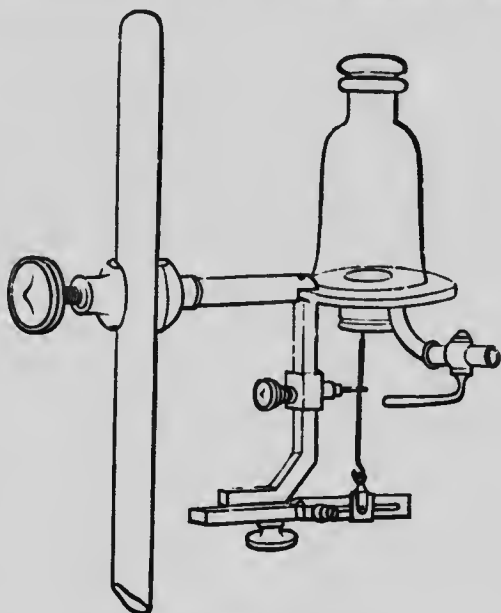

Fig. 256.—Roy's Tonometer.

which passes a wire, which is attached to a lever (cut short in the diagram) fixed on a stage below the apparatus.



When using the apparatus, the bell-jar is filled with olive oil. The heart of a large frog is prepared and the cannula fixed in the stopper is firmly tied into it; the tubes of the cannula communicate with the reservoir of circulating fluid on the one hand, and with a vessel to receive it after it has run through the heart on the other. The cannula with heart attached is passed into the oil, and the stopper firmly secured. Every time the heart enlarges, the membrane is pressed down; every time the heart contracts the membrane is pulled up; the lever follows and magnifies these movements. The lever is adjusted to a convenient elevation and allowed to write on a moving drum. After a short time the heart may stop beating; but two wires are arranged, the one in the cannula, the other projecting from the plate in such a way that the heart can be moved against them by shifting the position of the bell-jar a little. The wires act as electrodes, and can be made to communicate with an induction apparatus, so that induction shocks can be sent into the heart to produce contractions. After a time the heart ceases to beat altogether; before doing so it becomes irregular. A frequent form of irregularity seen consists of groups of contractions each showing a staircase, separated by long intervals of quiescence (Luciani's Groups).

(3) *Schäfer's Heart-plethysmograph*.—The principle of this apparatus is the same as Roy's. A diagrammatic sketch of it is given in fig. 257. The heart, tied on to a double cannula, is inserted into an air-tight vessel containing oil. On one side of the vessel is a tube, in which a lightly-moving piston is fitted; to this a writing point is attached. The piston is moved

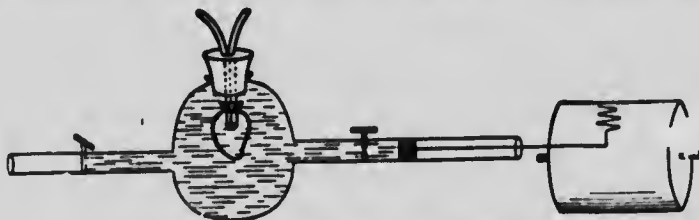

Fig. 257.—Schäfer's heart plethysmograph.

backwards and forwards by the changes of volume in the heart causing the oil to alternately recede from and pass into this side tube. The corresponding tube on the other side can be opened and the tube with the piston closed when one wishes to cease recording the movements.

## CHAPTER XXI.

## THE CIRCULATION IN THE BLOOD-VESSELS.

THE circulation through the vessels is accomplished by the heart as the primary propelling force ; the pressure in the heart is greater than that in the arteries ; the arterial pressure (which is kept high not only by the heart's force, but by the existence of resistance at the periphery) is greater than that in the capillaries, and the pressure is lowest in the veins, especially at their entrance into the heart ; and fluid always flows in the direction of lower pressure. Before, however, passing on to the all-important question of blood-pressure, we must first consider various other phenomena in connection with the flow in the vessels, such as the velocity of the stream, and the character of the flow in different parts of the vascular circuit.

**The Velocity of the Blood-Flow.**

The velocity of the blood-current at any given point in the various divisions of the circulatory system is inversely proportional to their sectional area at that point. If the sectional area of all the branches of a vessel united were always the same as that of the vessel from which they arise, and if the aggregate sectional area of the capillary vessels were equal to that of the aorta, the mean rapidity of the blood's motion in the capillaries would be the same as in the aorta ; and if a similar correspondence of capacity existed in the veins and arteries, there would be an equal correspondence in the rapidity of the circulation in them. But when an artery divides, the sectional area of its branches is greater than that of the artery from which they originate. The only exception to this rule is seen in the division of the aorta into the two common iliac arteries. It is the same with the veins ; the sectional area of a vein formed by the union of smaller veins is less than the total sectional area of its tributaries. From the aorta onwards to the capillaries there is a gradual increase of the area of the stream with a corresponding diminution of its velocity ; from the capillaries onwards to the heart there is a gradual decrease of the bed of the stream and a corresponding increase in its velocity.

In other words the arterial and venous systems may be represented by two truncated cones with their apices directed towards the heart ; the area of their united base (the sectional area

of the capillaries) is about 700 times as great as that of the truncated apex representing the aorta. Thus the velocity of blood in the capillaries is not more than  $\frac{1}{700}$  of that in the aorta. The veins are larger than the corresponding arteries, and so the rate there is proportionally slower.

*In the Arteries.*—The velocity of the stream of blood is greater in the arteries than in any other part of the circulatory system, and in them it is greatest in the neighbourhood of the heart, and during the ventricular systole. The rate of movement diminishes during the diastole of the ventricles, and in the parts of the arterial system most distant from the heart.

A few of the results obtained by different observers may be here given.

In the carotid of the dog, the velocity is 205—350 mm. per second.

"	"	"	horse	"	306	"
"	metatarsal	"	"	"	56	"

In very round numbers we may state the average speed in the large arteries as a foot per second.



Fig. 258.—Ludwig's Stromuhr.

**Estimation of the Velocity.**—Various instruments have been devised for measuring the velocity of the blood-stream in the arteries. Ludwig's *Stromuhr* (fig. 258), which is the best instrument to use, consists of a U-shaped glass tube dilated at *a* and *a'*, the ends of which, *h* and *i*, are of known calibre. The bulbs can be filled by a common opening at *k*. The instrument is so contrived that at *b* and *b'*, the glass part is firmly fixed into metal cylinders, attached to a circular horizontal table *c c'*, capable of horizontal movement on a similar table *d d'* about the vertical axis marked in figure by a dotted line. The openings in *c c'*, when the instrument is in position, as in fig. 258, corresponds exactly with those in *d d'*; but if *c c'* be turned at right angles to its present position, there is no communication between *h* and *a* and *i* and *a'*, but *h* communicates directly with *i*; and if turned through two right angles *c c'* communicates with *d*, and *c* with *d'*, and there is no direct communication between *h* and *i*. The experiment is performed in the following way:—The artery to be experimented upon is divided and connected with two cannulae and tubes which fit it accurately with *h* and *i*; *h* is the central end, and *i* the peripheral; the bulb *a* is filled with olive oil up to a point rather lower than *k*, and *a'* and the remainder of *a* is filled with defibrinated blood; the tube on *k* is then carefully clamped: the tubes *d* and *d'* are also filled with defibrinated blood. When everything is

ready, the blood is allowed to flow into *a* through *h*, and it pushes before it the oil, and that the defibrinated blood into the artery through *i*; *a'* is then full of oil; when the blood reaches the former level of the oil in *a*,

the disc  $c c'$  is turned rapidly through two right angles, and the blood flowing through  $d$  into  $a'$  again displaces the oil which is driven into  $a$ . This is repeated several times, and the duration of the experiment noted. The capacity of  $a$  and  $a'$  is known; the diameter of the artery is also known by its corresponding with the cannulæ of known diameter, and as the number of times  $a$  has been filled in a given time is known, the velocity of the current can be calculated.

We may take an example to illustrate this :—

$$\text{Velocity} = \frac{\text{volume per second}}{\text{sectional area}} = \frac{V}{S}.$$

If the capacity of the bulb is 5 c.c., and it required 100 seconds to fill it 10 times, then the amount of blood passing through the instrument would be 50 c.c. in 100 seconds, or 0.5 c.c. in 1 second. Next, suppose the diameter is 4 mm. The sectional area is  $\pi r^2$ ;  $r$  is the radius (2 mm.), and  $\pi = 3.1416$ . From these data we get

$$\text{Velocity} = \frac{V}{S} = \frac{0.5 \text{ c.c.}}{3.1416 \times 2^2} = \frac{500 \text{ cubic millimetres}}{3.1416 \times 4} = 39.8 \text{ mm. per sec.}$$

Chauveau's *Dromograph* (fig. 259) consists of a thin brass tube,  $a$ , in one side of which is a small perforation closed by thin vulcanised india-rubber.

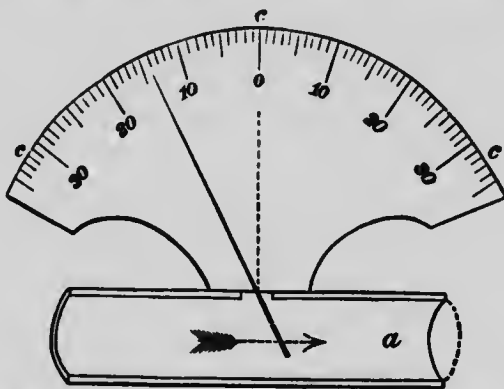

Fig. 259.—Diagram of Chauveau's Dromograph.  $a$ , Brass tube for introduction into the lumen of the artery, and containing an index-needle, which passes through the elastic membrane in its side, and moves by the impulse of the blood current.  $c$ , Graduated scale, for measuring the extent of the oscillations of the needle.

Passing through the rubber is a fine lever, one end of which, slightly flattened, extends into the *lumen* of the tube, while the other moves over the face of a dial. The tube is inserted into the interior of an artery, and ligatures applied to fix it, so that the "velocity pulse," *i.e.*, the change of velocity with each heart-beat, may be indicated by the movement of the outer extremity of the lever on the face of the dial.

The *Hæmatometer* of Vierordt resembles in principle that of Chauveau.

The *Hæmadromometer* of Volkmann, one of the earliest instruments devised for this purpose, is simply a long glass U-tube of the same calibre as the artery under investigation. It is provided with a stop-cock, so that at a given moment the blood can be admitted, and the time that the blood takes to reach its other end is observed.

*In the Capillaries.*—The microscopic observations of E. H. Weber and Valentin agree very closely as to the rate of the blood-current in the capillaries of the frog; and the mean of their

estimates gives the velocity of the *systemic* capillary circulation at about one inch (25 mm.) per minute. The velocity in the capillaries of warm-blooded animals is somewhat greater; in the dog it is  $\frac{1}{50}$  to  $\frac{3}{100}$  inch (.5 to .75 mm.) a second. This may seem inconsistent with the facts, which show that the whole circulation may be accomplished in less than half a minute. But the whole length of capillary vessels through which any given portion of blood has to pass, probably does not exceed from  $\frac{1}{30}$ th to  $\frac{1}{10}$ th of an inch (.5 mm.); and therefore the time required for each quantity of blood to traverse its own appointed portion of the general capillary system will scarcely amount to a second.

*In the Veins.*—The velocity of the blood is greater in the veins than in the capillaries, but less than in the arteries: this fact depends upon the relative capacities of the arterial and venous systems. If an accurate estimate of the proportionate areas of arteries and the veins corresponding to them could be made, we might, from the velocity of the arterial current, calculate that of the venous. A usual estimate is, that the capacity of the veins is about twice or three times as great as that of the arteries, and that the velocity of the blood's motion is, therefore, about twice or three times as great in the arteries as in the veins, 8 inches (200 mm.) a second. The rate at which the blood moves in the veins gradually increases the nearer it approaches the heart, for the sectional area of the venous trunks, compared with that of the branches opening into them, becomes gradually less as the trunks advance towards the heart.

*Of the Circulation as a whole.*—Among the earliest investigators of the question how long an entire circulation takes was Hering. He injected a solution of potassium ferrocyanide into the central end of a divided jugular vein and collected the blood either from the other end of the same vein, or from the corresponding vein of the other side. The substance injected is one that can be readily detected by a chemical test (the prussian blue reaction). Vierordt improved this method by collecting the blood as it flowed out, in a rotating disc divided into a number of compartments. The blood was tested in each compartment, and the ferrocyanide discovered in one which in the case of the horse received the blood about half a minute after the injection had been made. The experiment was performed in a large number of animals, and the following were a few of the results obtained:

In the horse . . . . .	31 seconds.
„ dog . . . . .	16 „
„ cat . . . . .	6.5 „
„ fowl . . . . .	5 „

At first sight these numbers show no agreement, but in each case it was found that the time occupied was 27 heart beats. The dog's heart, for instance, beats twice as fast as the horse's, and so the time of the entire circulation only occupies half as much time.

The question has recently been re-investigated by Prof. Stewart by improved methods, which have shown that the circulation time is about 15 seconds, that is considerably less than was found by the researches of Hering and Vierordt. The great objection to the older method is the fact that hæmorrhage is occurring throughout the experiment, and this would materially weaken the heart and slow down the circulation. Stewart has employed two methods. In the first, the carotid artery is exposed, and non-polarisable electrodes applied to it. These are placed in circuit with a galvanometer and one arm of a Wheatstone's bridge. After the resistances in the bridge have been balanced, and the galvanometer needle brought to rest, a small quantity of sodium chloride solution is injected into the opposite jugular vein. As soon as the salt reaches the carotid artery, the resistance of the blood is altered, the balance of the Wheatstone's bridge is upset, and the galvanometer needle moves. The period between the injection and the swing of the needle is accurately noted.

The second method used is even simpler, and gives practically the same results; a solution of methylene blue is injected into the jugular vein. The carotid artery on the opposite side is exposed, placed upon a sheet of white paper, and strongly illuminated. The time is noted between the injection and the moment when the blue colour is seen to appear in the artery. Stewart has applied these methods also for determining the time occupied by the passage of blood through various districts of the circulation; the longest circulation times were found in the kidney, the portal system and the lower limbs.

None of these methods, however, give the true time of the entire circulation; they give merely the shortest possible time in which any particle of blood can travel through the shortest pathway. The blood that travels in the axial current, or which takes a broad pathway through wide capillaries, will arrive far more speedily at its destination than that which creeps through tortuous or constricted vessels. The direct observations of Tigerstedt on the output of the left ventricle show that the circulation time of the whole blood is at least five times as long as the period arrived at by the Hering method. It is therefore fallacious to use the circulation times arrived at by Hering's or Stewart's methods as a basis for calculating the total amount of the blood in the body.

### The Use of the Elasticity of the Vessels.

If a pump is connected with a rigid tube, such as a glass tube, every time that a certain amount is forced into one end of the tube an exactly equal quantity will be forced out at the other end. During the intervals between the pumpings, the flow will cease. If the far end of the tube is partially closed, the flow will still be intermittent, only the quantity injected and the quantity ejected, though still of equal volume, will be diminished. If we employ an elastic tube instead of a rigid tube, and the end is left freely open, the flow will still be intermittent as in the case of the rigid tube; but if the end of the elastic tube is narrowed by a clamp the intermittent flow will be converted into a more or less perfectly constant flow. Each stroke of the pump forces a certain amount of fluid into the tube, but owing to the peripheral resistance, it cannot all escape at once, and part of the force of the pump is spent in distending the walls of the tube. This distended elastic tube, however, tends to empty itself, and forces out the fluid which distends it before the next stroke of the pump takes place. One part of the fluid is therefore forced out by the immediate effect of the pump, and another part by the elastic recoil of the tube between the strokes. If the rate of the pump and the distension of the tube which it produces is sufficiently great, the fluid forced out between the strokes will be equal to that entering at each stroke and thus the outflow becomes continuous.

Let us now apply this to the body.

At each beat the left ventricle forces about three ounces of blood into the already full arterial system. The arteries are elastic tubes, and the amount of elastic tissue is greatest in the large arterics. The first effect of the extra three ounces is to distend the aorta still further; the elastic recoil of the walls drives on another portion of blood which distends the next section of the arterial wall, and this wave of distension is transmitted along the arteries with gradually diminishing force as the total arterial stream becomes larger. This wave constitutes the pulse. Between the strokes of the pump, or, in other words, during the periods of diastole, the arteries tend to return to their original size, and so drive the blood on. The flow, therefore, does not cease during the heart's inactivity, so that although the force of the heart is an intermittent one, the flow through the capillaries and the veins beyond is a constant one, all trace of the pulse having disappeared. The peripheral resistance which keeps up the blood-pressure in the arteries, and like the clamp on our india-rubber

tube, assists in the conversion of the intermittent into a continuous stream, is to be found in the arterioles or small arteries, just before the blood passes into what we may term the vast capillary lake. These small arteries with their relative excess of muscular tissue, which in health is always in a tonic state of moderate contraction, play the part of a multitudinous system of stop-cocks.

The large arteries contain a considerable amount of muscular as well as elastic tissue. This co-operates with the elastic tissue in adapting the calibre of the vessels to the quantity of blood they contain. For the amount of blood in the vessels is never quite constant, and were elastic tissue only present, the pressure exercised by the walls of the containing vessels on the contained blood would be sometimes very small, sometimes too great. The presence of a contractile element, however, provides for a certain uniformity in the amount of pressure exercised. There is no reason to suppose that the muscular coat assists in propelling the onward current of blood, except in virtue of the fact that muscular tissue is elastic, and therefore co-operates in the large arteries with the elastic tissue in keeping up the constant flow in the way already described.

The contractility of the arterial walls fulfils a useful purpose in checking hæmorrhage should a small vessel be cut as it assists in the closure of the cut end, and this in conjunction with the coagulation of the blood arrests the escape of blood.

### The Pulse.

This is the most characteristic feature of the arterial flow. It is a wave of expansion which travels along the arteries due to the propulsion of the contents of the left ventricle into the already full arterial system. The more distant the artery from the heart, the longer is the interval that elapses between the ventricular beat and the arrival of the pulse. Thus it is felt in the carotid earlier than in the radial artery, and it is still later in the dorsal artery of the foot. The difference of time is, however, very slight; it is only a minute fraction of a second; for a distinction must be drawn between the propagation of the pulse and the rate of blood flow in the arteries; the wave travels at the rate of from 5 to 10 metres a second, that is twenty or thirty times the rate of the blood current. The pulse may be compared to a wave produced by the wind travelling rapidly down a sluggishly-flowing river.

A physician usually feels the pulse in the radial artery, since



this is near the surface, and supported by bone. It is a most valuable indication of the condition of the patient's heart and

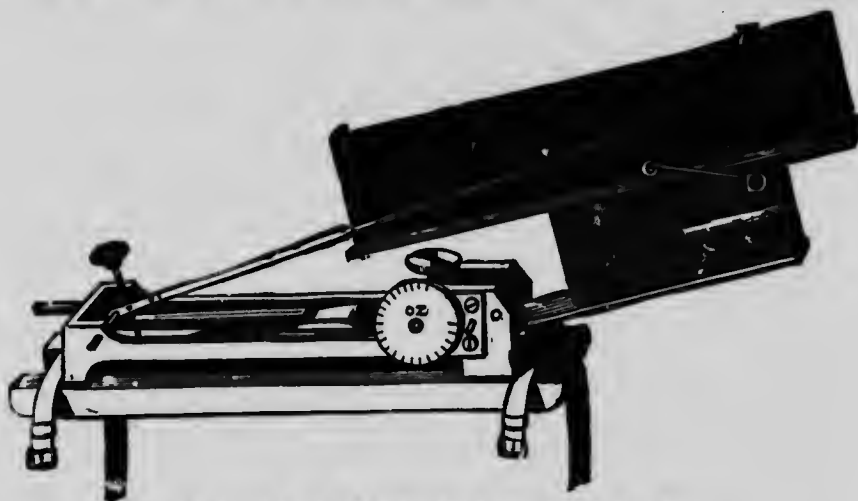

Fig. 260.—Marey's Sphygmograph, modified by Mahomed.

vessels. It is necessary in feeling a pulse to note the following points :—

1. *Its frequency* ; that is the number of pulse beats per minute. This gives the rate of the heart beats.
2. *Its length* ; that is how long a time each pulse-beat occupies.
3. *Its strength* ; whether it is a strong, bounding pulse, or a

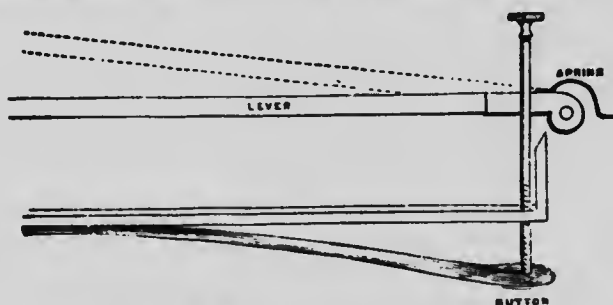

Fig. 261.—Diagram of the lever of the Sphygmograph.

feeble beat ; this indicates the force with which the heart is beating.

4. *Its regularity or irregularity* ; irregularity may occur owing to irregular cardiac action either in force or in rhythm.
5. *Its tension* ; that is the force necessary to obliterate it. This gives an indication of the state of the arterial walls and the peripheral resistance.

In disease there are certain variations in the pulse, of which we shall mention only two; namely, the *intermittent pulse*, due to the heart missing a beat every now and then; and the *water hammer*

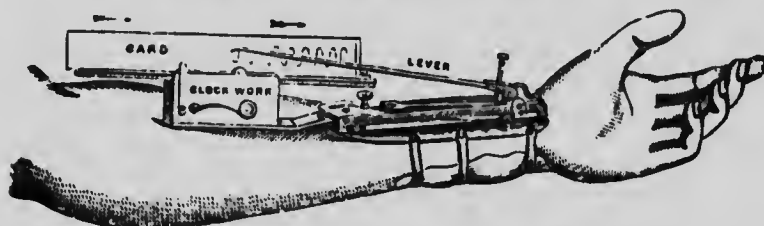

Fig. 262.—The Sphygmograph applied to the arm.

pulse, due either to aortic regurgitation or to a loss of elasticity of the arterial walls; either of these circumstances diminishes the onward flow of blood during the heart's diastole, and thus the suddenness of the impact of the blood on the arterial wall

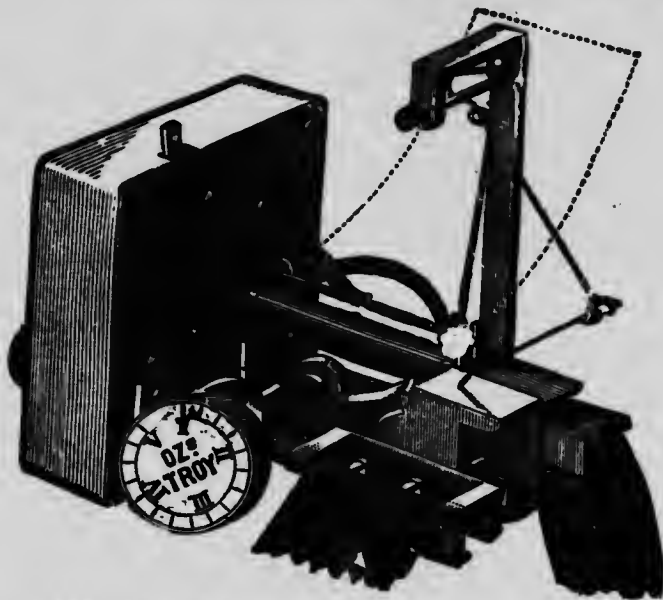

Fig. 263.—Dudgeon's Sphygmograph. The dotted outline represents the piece of blackened paper on which the sphygmogram is written.

during systole is increased. When this condition is due to arterial disease, such as atheroma or calcification, this sudden pulse combined with the increased brittleness of the arteries may lead to rupture of the walls, and this is especially serious if it occurs in the arteries of the brain (one cause of apoplexy).

In order to study the pulse more fully, it is necessary to obtain a graphic record of the pulse-beat, and this is accomplished by the use of an instrument called the **sphygmograph**. This instrument consists of a series of levers, at one end of which is a button placed over the artery; the other end is provided with a writing point to inscribe the magnified record of the arterial movement on a travelling surface.

The instruments most frequently used are those of Marey, one of the numerous modifications of which is represented in figures 260, 261, and 262, and of Dudgeon (fig. 263).

Each instrument is provided with an arrangement by which the pressure can be adjusted so as to obtain the best record. The measurement of the pressure is, however, rough, and both instruments have the disadvantage of giving oscillations of their own to the sphygmogram; this is specially noticeable

in Dudgeon's sphygmograph. But these defects may be overcome by the use of some form of sphygmometer. (See later, p. 295.) It is also important to remember that the pad or button placed upon the artery rests partly on the venæ comites, so that not only arterial tension, but any turgidity arising from venous congestion, will affect the height and form of the sphygmographic record.



Fig. 264.—Diagram of pulse-tracing. A, up-stroke; B, down-stroke; C, pre-dicrotic wave; D, dicrotic; E, post-dicrotic wave.

Fig. 264 represents a typical sphygmographic tracing obtained from the radial artery. It consists of an upstroke due to the expansion of the artery, and a downstroke due to its retraction. The descent is more gradual than the upstroke, because the elastic recoil acts more constantly and steadily than the heart-beat. On the descent are several secondary (katacrotic) elevations.

A is the *primary*, or percussion wave; C is the *pre-dicrotic*, or *tidal* wave; D is the *dicrotic* wave, and E the *post-dicrotic* wave, and of these there may be several. In some cases there is a secondary wave on the upstroke, which is called an *anacrotic* wave (fig. 265).

These various secondary waves have received different interpretations, but the best way of explaining them is derived from information obtained by taking simultaneous tracings of

the pulse, aortic pressure, apex beat, and intraventricular pressure, as in the researches of Hürthle. By this means it is found that the primary and pre-dicrotic waves occur during the systole of the heart, and the other waves during the diastole. The closure of the aortic valves occurs just before the dicrotic wave. The secondary waves, other than the dicrotic wave, are due to the elastic tension of the arteries, and are increased in number when the tension of the arteries is greatest; the tauter an elastic substance is, the more does it tend to vibrate under the influence of any fresh force suddenly applied to it. Some of the post-dicrotic waves are also doubtless instrumental in origin. The dicrotic wave is of different origin. It was at one time thought that this wave was reflected from the periphery, but this view is at once excluded by the fact that wherever we take the pulse-tracing, whether from the aorta, carotid, radial, dorsalis pedis, or elsewhere, this secondary elevation is always situated at the same distance from the



Fig. 265.—Anacrotic pulse.

beginning of the primary elevation, showing that it is centrifugal, travelling in the same direction as the primary wave, and having its origin in the commencement of the arterial system. Moreover, a single reflected wave from the periphery would be impossible, as the waves reflected from one part would be interfered with by those from other parts; and a reflected wave would be increased by high peripheral resistance, and not diminished as the dicrotic wave is.

The primary cause of the dicrotic wave is the closure of the semilunar valves; the inflow of the blood into the aorta suddenly ceases, and the blood is driven up against the closed aortic doors by the elastic recoil of the aorta; the wave rebounds from there and is propagated through the arterial system as the dicrotic elevation.

The systolic secondary waves, namely, the pre-dicrotic and the anacrotic when it is present, are due to elastic vibrations of the aortic wall and perhaps of the heart wall itself; they are increased by an increase in the peripheral resistance.

In our study of endo-cardiac pressure, we saw that the systolic plateau sometimes has an ascending, sometimes a descending, slope (see p. 244); we now come to the explanation of this fact. If



Fig. 266.—Dicrotic pulse.

after the first sudden rise of pressure in the aorta the peripheral resistance is low and the blood can escape more rapidly than it is thrown in, the plateau will sink. If, on the other hand, the peripheral resistance is high, the aortic pressure will rise as long as the blood is flowing in, and we get an ascending systolic plateau and an anacrotic pulse. Thus an anacrotic pulse is seen in Bright's disease, where the peripheral resistance is very high.

The production of the dicrotic wave is favoured by relaxation of the arterioles when the heart is beating forcibly as in fever, and to a certain extent after taking alcohol. Such a pulse is called a dicrotic pulse (fig. 266), and the second beat can be easily felt by the finger on the radial artery.



Fig. 267.—Haem-autograph, to be read from right to left.

The main waves of a pulse tracing can be demonstrated without the use of any instruments at all by allowing the blood to spurt from a cut artery on to the surface of a piece of white paper travelling past it. We thus obtain what is very appropriately called a *haem-autograph* (fig. 267).

If a long pulse-tracing is taken, the effect of the respiration can be seen causing an increase of pressure, and a slight acceleration of the heart's beats during inspiration. This we shall study at greater length in connection with blood-pressure.

*The Rate of Propagation of the Pulse-Wave.*—The method of ascertaining this may be illustrated by the use of a long elastic tube into which fluid is forced by the sudden stroke of a pump. If a series of levers are placed along the tube at measured distances those nearest the pump will rise first, those farthest from it last. If these are arranged to write on a revolving cylinder under one another, this will be shown graphically, and the time interval between their movements can be measured by a time tracing. The same principle is applied to the arteries of the body; a series of Marey's tambours are applied to the heart and to various arteries at known distances from the heart; then levers are arranged to write immediately under one another, as in fig. 241. The difference in the time of their up-strokes is measured by a time tracing in the usual way.

### The Capillary Flow.

When the capillary circulation is examined in any transparent part of a living animal by means of the microscope (fig. 268), the blood is seen to flow with a constant equable motion; the red blood-corpuscles move along, mostly in single file, and bend in various ways to accommodate themselves to the tortuous course of the capillary, but instantly recover their normal outline on reaching a wider vessel.

At the circumference of the stream in the larger capillaries, but especially well marked in the small arteries and veins, there is a layer of liquor sanguinis in contact with the walls of the vessel, and adhering to them, which moves more slowly than the blood in the centre. The existence of this **still layer**, as it is termed, is inferred both from the general fact that such a one exists in all tubes traversed by fluid, and from what can be seen in watching the movements of the blood-corpuscles. Anyone who has rowed on a river will know that the swiftest current is in the middle of the stream. The red corpuscles occupy the middle of the stream and move with comparative rapidity; the colourless corpuscles run much more slowly by the walls of the vessel; while next to the wall there is a transparent space in which the fluid is at comparative rest; for if any of the corpuscles happen to be forced within it, they move more slowly than before, rolling lazily along the side of the vessel, and often adhering to its wall. Part of this slow movement of the colourless corpuscles and their occasional stoppage may be due to their having a natural tendency to adhere to the walls of the vessels. Sometimes, indeed, when the motion of the blood is not strong, many of the white corpuscles collect in a capillary vessel and for a time entirely prevent the passage of the red corpuscles.

When the peripheral resistance is greatly diminished by the dilatation of the small arteries, so much blood passes on from the arteries into the capillaries at each stroke of the heart, that there is not sufficient remaining in the arteries to distend them. Thus, the intermittent current of the ventricular



Fig. 268.—Capillaries (C) in the web of the frog's foot connecting a small artery (A) with a small vein (V). (After Allen Thomson.)

systole is not converted into a continuous stream by the elasticity of the arteries before the capillaries are reached; and so intermittency of the flow occurs both in capillaries and veins and a pulse is produced. The same phenomenon may occur when the arteries become rigid from disease, and when the beat of the heart is so slow or so feeble that the blood at each cardiac systole has time to pass on to the capillaries before the next stroke occurs; the amount of blood sent out at each stroke being insufficient to properly distend the elastic arteries.

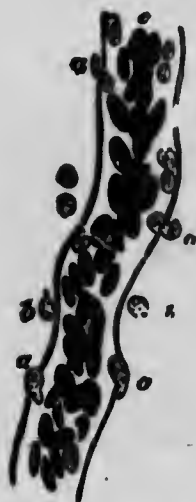

Fig. 269.—A large capillary from the frog's mesentery eight hours after irritation had been set up, showing emigration of leucocytes. *a*, Cells in the act of traversing the capillary wall; *b*, some already escaped.  
(Frey.)

It was formerly supposed that the occurrence of any transudation from the interior of the capillaries into the midst of the surrounding tissues was confined, in the absence of injury, strictly to the fluid part of the blood; in other words, that the corpuscles could not escape from the circulating stream, unless the wall of the containing blood-vessel was ruptured. Augustus Waller affirmed, in 1846, that he had seen blood-corpuscles, both red and white, pass bodily through the wall of the capillary vessel in which they were contained (thus confirming what had been stated a short time previously by Addison); and that, as no opening could be seen before their escape, so none could be observed afterwards—so rapidly was the part healed. But these observations did not attract much notice until the phenomena of escape of the blood-corpuscles from the capillaries and minute veins, apart from mechanical injury, were rediscovered by Cohnheim in 1867.

Cohnheim's experiment, demonstrating the passage of the corpuscles through the wall of the blood-vessel, is performed in the following manner: A frog is curarized, and the abdomen having been opened a portion of small intestine is drawn out, and its transparent mesentery spread out under a microscope. After a variable time, occupied by dilatation, following contraction of the minute vessels and accompanying quickening of the blood-stream, there ensues a retardation of the current, and blood-corpuscles, both red and white, begin to make their way through the capillaries and small veins.

The process of *diapedesis* of the red corpuscles, which occurs under circumstances of impeded venous circulation, and con-

sequently increased blood-pressure, resembles closely the migration of the white ones, with the exception that they are squeezed through the wall of the vessel, and do not, like them, work their way through by amoeboid movement.

Various explanations of these phenomena have been suggested.

Some believe that pseudo-stomata between contiguous endothelial cells provide the means of escape for the blood-corpuscles. But the chief share in the process is to be found in the vital endowments with respect to mobility and contraction of the parts concerned—both of the corpuscles and of the capillary wall itself.

Diapedesis or emigration of the white corpuscles occurs to a small extent in health. But it is much increased in inflammation, and may go on so as to form a large collection of leucocytes (*i.e.* white corpuscles) outside the vessels. Such a collection is called an *abscess*, and the corpuscles are called *pus* corpuscles; they are, however, mostly dead leucocytes, and show a considerable amount of fatty degeneration in their protoplasm.

The emigration of red corpuscles is only seen in inflammation and is a passive process; it occurs when the holes made by the emigrating leucocytes do not close up immediately and so the red corpuscles escape too.

The real meaning of the process of inflammation is a subject which is being much discussed now, but it may be interesting to state briefly the views of Metschnikoff, who has in recent years been one of the most prominent investigators of the subject. Even if these views do not represent the whole truth, it can hardly be doubted that the phenomena described play a very important part in the process. Metschnikoff teaches that the vascular phenomena of inflammation have for their object an increase in the emigration of leucocytes, which have the power of devouring the irritant substance, and removing the tissues killed by the lesion. They are therefore called *phagocytes* (devouring or scavenging corpuscles). It may be that the microbic influence, or the influence of the chemical poisons they produce, is too powerful for the leucocytes; then they are destroyed and the dead leucocytes become *pus* corpuscles; but if the leucocytes are successful in destroying the foreign body, micro-organisms, and disintegrated tissues, they disappear, wandering back to the blood-vessels, and the lost tissue is replaced by a regeneration of the surrounding tissues.

The circulation through the capillaries must, of necessity, be largely influenced by that which occurs in the vessels on either



side of them in the arteries or the veins; their intermediate position causes them to feel at once any alteration in the size, rate, or pressure of the arterial or venous blood-stream. Thus, the apparent contraction of the capillaries, on the application of certain irritating substances, and during fear, and their dilatation in blushing, may be referred primarily to the action of the small arteries.

### The Venous Flow.

The blood-current in the veins is maintained (a) primarily by the *vis a tergo*, that is, the force behind, which is the blood pressure transmitted from the heart and arteries; but very effectual assistance to the flow is afforded (b) by the action of the muscles capable of pressing on the veins with valves, as well as (c) by the suction action of the heart, and the aspiratory action of the thorax (*vis a fronte*).

The effect of muscular pressure upon the circulation may be thus explained. When pressure is applied to any part of a vein and the current of blood in it is obstructed, the portion behind the seat of pressure becomes swollen and distended as far back as the next pair of valves, which are in consequence closed (fig. 221, B, p. 218). Thus, whatever force is exercised by the pressure of the muscles on the veins, is distributed partly in pressing the blood onwards in the proper course of the circulation, and partly in pressing it backwards and closing the valves behind.

The circulation might lose as much as it gains by such an action, if it were not for the numerous communications which the veins make with one another; through these, the closing up of the venous channel by the backward pressure is prevented from being any serious hindrance to the circulation, since the blood, of which the onward course is arrested by the closed valves, can at once pass through some anastomosing channel, and proceed on its way by another vein. Thus, the effect of muscular pressure upon veins which have valves, is turned almost entirely to the advantage of the circulation; the pressure of the blood onwards is all advantageous, and the pressure of the blood backwards is prevented from being a hindrance by the closure of the valves and the anastomoses of the veins.

In the web of the bat's wing, the veins are furnished with valves, and possess the remarkable property of *rhythmical contraction and dilatation*, whereby the current of blood within them is distinctly accelerated (Wharton Jones). The contraction occurs, on an average, about ten times in a minute; the existence

of valves prevents regurgitation, so the entire effect of the contractions is auxiliary to the onward current of blood. Analogous phenomena have been observed in other animals.

A venous pulse is observed under the conditions previously described (p. 274) when the arterioles are dilated so that the arterial pulse passes through the capillaries to the veins.

A venous pulse is also seen in the superior and inferior vena cava near to their entrance into the heart; this corresponds to variations of the pressure in the right auricle. When the ventricle is contracting there is a slow rise due to the fact that the blood cannot get into the ventricle and so distends the auricle; a second short sharp elevation of pressure is produced by the auricular systole. Alterations of venous pressure are also produced in the great veins by the respiratory movements, the pressure sinking during inspiration, and rising during expiration.

#### Local Peculiarities of the Circulation.

The most remarkable peculiarities attending the circulation of blood through different organs are observed in the cases of the *brain, erectile organs, lungs, liver, spleen, and kidneys.*

*In the Brain.*—The brain must always be supplied with blood, for otherwise immediate loss of consciousness would follow. Hence, to render accidental obliteration almost impossible, four large arteries are supplied to the brain, and these anastomose together in the circle of Willis. The two vertebral arteries are, moreover, protected in bony canals. Two of the brain arteries can be tied in monkeys, and three or even all four in dogs without the production of serious symptoms. In the last case enough blood reaches the brain by branches from the superior intercostal arteries to the anterior spinal artery. The sudden obliteration of one carotid artery in man may in some cases produce epileptiform spasms; the sudden occlusion of both occasions loss of consciousness. Uniformity of supply is further ensured by the arrangement of the vessels in the pia mater, in which, previous to their distribution to the substance of the brain, the large arteries break up and divide into innumerable minute branches ending in capillaries, which, after frequent communication with one another, enter the brain and carry into nearly every part of it uniform and equable streams of blood. The arteries are enveloped in a special lymphatic sheath. The arrangement of the veins within the cranium is also peculiar. The large venous trunks or sinuses are formed so as to be scarcely

capable of change of size; and composed, as they are, of the tough tissue of the dura mater, and, in some instances, bounded on one side by the bony cranium, they are not compressible by any force which the fulness of the arteries might exercise through the substance of the brain; nor do they admit of distension when the flow of venous blood from the brain is obstructed. No valves are placed between the vertebral veins and the vena cava; the vertebral veins anastomose with the cerebral sinuses. Hence on squeezing the thorax and abdomen, venous blood can be pressed from those parts out of any opening made into the longitudinal sinus. Expiration acts in the same way; it raises the cerebral venous pressure; if the skull wall is defective the brain expands owing to the distension of its capillaries during the expiratory act. The exposed brain also expands with each systole of the heart. Owing to the fact that the brain lies enclosed in the cranium, the arterial pulse is transmitted through the brain substance to the cerebral veins and so the blood issues from these in pulses.

Since the brain is enclosed in the rigid cranium the volume of blood in the cerebral vessels cannot alter unless the volume of the other cranial contents alter in the opposite sense.

These conditions of the brain and skull led *Monro* and *Kellie* many years ago to advance the opinion that the quantity of blood in the brain must be the same at all times. This doctrine has been frequently disputed, and many have advanced the theory that increase or diminution of the blood is accompanied with simultaneous diminution or increase of the cerebro-spinal fluid, so that the contents of the cranium are kept uniform in volume. But the recent work of *Leonard Hill*\* has shown that the *Monro-Kellie* doctrine is true. Histological evidence has recently been obtained of the existence of nerve plexuses round the pial arteries. The arteries are muscular, and the nerves therefore are most probably vaso-motor in function. Experimental evidence so far, however, has not established the action of these nerves; the cerebral circulation passively follows the slightest changes in aortic and, more especially, vena cava pressure, and no active vaso-motor change has been conclusively proved. The velocity of blood-flow through the brain is thus influenced markedly by the condition of the vessels of the splanchnic area. If the tone of the skeletal muscles and that of the vessels be suddenly inhibited by fear, or temporarily destroyed by shock, the blood will drop owing to its weight into the dilated and supported

---

\* I am much indebted to Mr. Hill for assistance in the preparation of these paragraphs on the cerebral circulation.

vessels in the most dependent parts of the body. The flow of blood through the brain will, under these conditions, cease, that is to say, so long as the body is in the erect posture. Thus, to restore a fainting person the head must be lowered between the knees. Muscular exercise, by returning blood to the heart from the veins of the lower parts of the body, conduces to the maintenance of an efficient cerebral circulation.

It is not the volume of the blood but the velocity of flow which is altered in the brain by changes in the general circulation. The brain with its circulating blood almost entirely fills the cranial cavity in the living animal; that is, there is no more cerebro-spinal fluid there than is sufficient to moisten the membranes. Cerebro-spinal fluid escapes into the veins at any pressure above the cerebral venous pressure; the tension of this fluid and the pressure in the veins are therefore always the same. The fluid probably transudes from the vascular fringes of the choroid plexuses in the ventricles of the brain, and is absorbed by the pial veins. There is not enough of this absorbable fluid present to allow of more than a slight increase of the volume of blood in the brain. If the aortic pressure rises and the vena cava pressure remains constant the conditions in the brain are as follows:—

More blood in the arteries, less in the veins, increased velocity of flow.

While if the aortic pressure remains constant and the vena cava pressure rises, the conditions are:—

Less blood in the arteries, more in the veins, diminished velocity of flow.

The brain presses against the cranial wall with a pressure equal to that in the cerebral capillaries. A foreign body introduced within the cranium, such as a blood-clot or depressed bone, produces local anæmia of the brain, by occupying the room of the blood. So soon as the capillaries are thus obliterated the pressure is raised to arterial pressure. This local increase of cerebral tension cannot be transmitted by the cerebro-spinal fluid, because this fluid can never be retained in the meningeal spaces at a tension higher than that of the cerebral veins, but is immediately re-absorbed. The anatomical arrangements of the tentorium cerebelli and the falxiform ligaments are such as to largely prevent the transmission through the brain-substance of a local increase of pressure. There is complete pressure discontinuity between the cranial and vertebral cavities. The serious results that follow cerebral compression are primarily due to obliteration of the blood-vessels, and consequent anæmia of the brain. A very

small foreign body will, if situated in the region of the spinal bulb, produce the gravest symptoms. For the centres which control the vascular and respiratory systems are rendered anæmic thereby. The cerebral hemispheres may, on the other hand, be compressed to a large extent without causing a fatal result. The major symptoms of compression arise so soon as any local increase of pressure is transmitted to the spinal bulb and causes anæmia there.

*In Erectile Structures.*—The instances of greatest variation in the quantity of blood contained, at different times, in the same organs, are found in certain structures which, under ordinary circumstances, are soft and flaccid, but, at certain times, receive an unusually large quantity of blood, become distended and swollen by it, and pass into the state which has been termed *erection*. Such structures are the *corpora cavernosa* and *corpus spongiosum* of the penis in the male, and the *clitoris* in the female; and, to a less degree, the *nipple* of the mammary gland in both sexes. The corpus cavernosum penis, which is the best example of an erectile structure, has an external fibrous membrane or sheath; and from the inner surface of the latter are prolonged numerous fine lamellæ which divide its cavity into small compartments. Within these is situated the plexus of veins upon which the peculiar erectile property of the organ mainly depends. It consists of short veins which very closely interlace and anastomose with each other in all directions, and admit of great variations of size, collapsing in the passive state of the organ, but capable of an amount of dilatation which exceeds beyond comparison that of the arteries and veins which convey the blood to and from them. The strong fibrous tissue lying in the intervals of the venous plexuses, and the external fibrous membrane or sheath with which it is connected, limit the distension of the vessels, and during the state of erection, give to the penis its condition of tension and firmness. The same general condition of vessels exists in the corpus spongiosum urethræ, but around the urethra the fibrous tissue is much weaker than around the body of the penis, and around the glans there is none. The venous blood is returned from the plexuses by comparatively small veins. For all these veins one condition is the same; namely, that they are liable to the pressure of muscles when they leave the penis. The muscles chiefly concerned in this action are the erector penis and accelerator urinæ. Erection results from the distension of the venous plexuses with blood. The principal exciting cause in the erection of the penis is nervous irritation, originating in the part itself, and derived reflexly from the brain and spinal cord. The nervous influence

is communicated to the penis by the pudic nerves, which ramify in its vascular tissue; and after their division the penis is no longer capable of erection.

Erection is not complete, nor maintained for any time except when, together with the influx of blood, the muscles mentioned contract, and by compressing the veins, stop the efflux of blood or prevent it from being as great as the influx.

*The circulation in the Lungs, Liver, Spleen and Kidneys will be described in our study of those organs.*

### Blood-pressure.

The circulation of the blood depends on the existence of different degrees of pressure in different parts of the circulatory system; there is a diminution of pressure from the heart onwards through arteries, capillaries, and veins, back to the heart again.

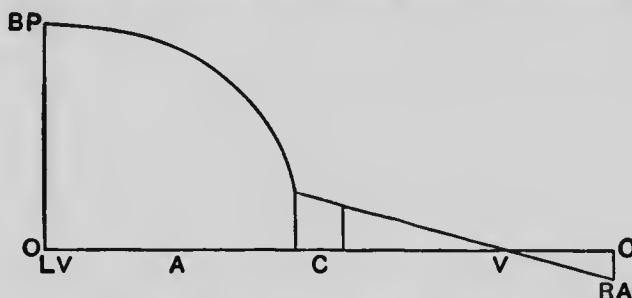

Fig. 270.—Height of blood-pressure (BP) in LV, left ventricle. A, arteries; C, capillaries; V, veins; RA, right auricle; O, line of no pressure. (After Starling.)

Fig. 270 represents roughly the fall of pressure along the systemic vascular system.

It falls slowly in the great arteries; at the end of the arterial system it falls suddenly and especially just beyond the resistance of the arterioles; it again falls gradually through the capillaries and veins till in the large veins near the heart it is negative. Such a diagram of blood-pressure is thus very different from one of velocity; the velocity like the pressure falls from the arteries to the capillaries, but unlike it, rises again in the veins.

We must now study the methods by which blood-pressure is measured and recorded, and the main causes that produce variations in its amount.

In order to do this in the simplest way, it will be first necessary to inquire how we may measure pressure in an artificial schema of the circulation.

Take the simplest possible case of a fluid flowing from a

reservoir, R (fig. 271), along a tube, which we will imagine is open at the other end.

In the course of the tube we will suppose three upright glass tubes (A, B, and D) are inserted at equal distances. Between B and D there is a bladder, which may be divided into a number of channels by packing it with tow to represent the capillaries, and between B and C, a clip E, which can be tightened or loosened at will, and which will roughly represent the peripheral resistance produced by the constricted arterioles. The far end of the tube is provided with a stop-cock. If this stop-cock is closed there will naturally be no flow of fluid, and the fluid will rise to equal heights indicated by the dotted line in all the upright tubes. This shows

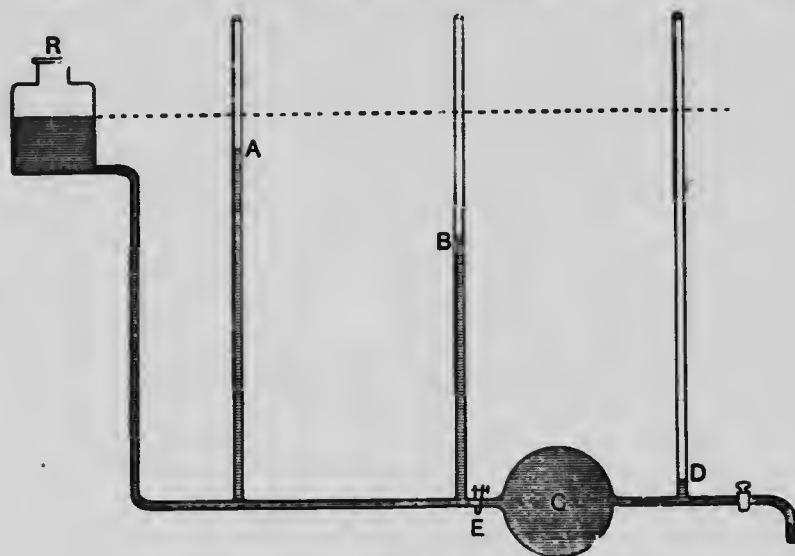

Fig. 271.—Schema to illustrate blood-pressure.

that the pressure in all parts of the tube is the same. The upright tubes which measure the lateral pressure exerted by the fluid on the wall of the main tube are called *manometers* or *pressure measurers*. The lateral pressure of a fluid is equal to the forward pressure.

If now the stop-cock is opened, the fluid flows on account of the difference of pressure brought about by gravitation; the height of the fluid in the manometers indicates that the pressure is greatest in R, less in A, less still in B, and least of all in D.

On account of the peripheral resistance of the arterioles and capillaries, the pressure is very small in the veins as indicated by the height of the fluid in the manometer D. The difference between D and B is much more marked than the difference between B and A. If the fluid which flows out of the end of the

tube is collected in a jug and poured back into R we complete the circulation. But the schema is an extremely rough one, and is especially faulty in that the pressure which starts at R is nearly constant and not intermittent. This may be remedied by taking R in the hand, and raising and lowering it alternately. The fluid in the manometers bobs up and down with every rise and fall of R: this is least marked in D. The greater and the faster the movement of R, the greater is the rise of arterial pressure. This is a rough illustration of the fact that increase in the force and frequency of the heart's beat causes a rise of arterial pressure.

Again, if more fluid is poured into R, there is a corresponding

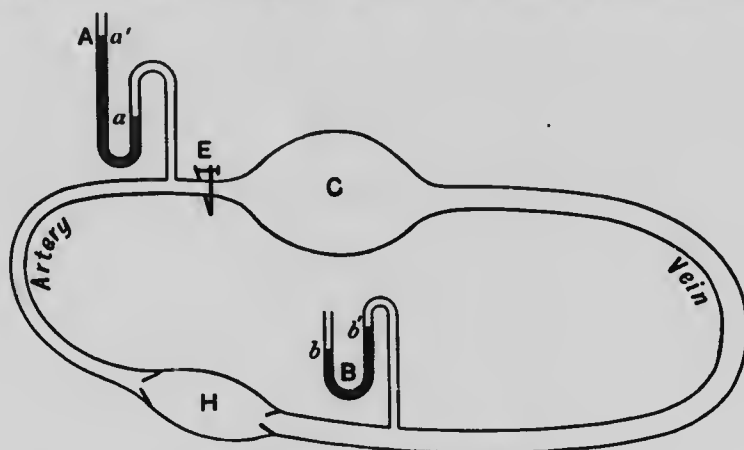

Fig. 272.—Schema of the circulation.

rise in fluid in the manometers. This illustrates the rise of pressure produced by an increase in the contents of the vascular system.

And this schema, rough though it is, also serves to illustrate the third important factor in the maintenance of the blood-pressure, namely, the peripheral resistance. This is done by means of the clip E; if the clip is tightened, one imitates increased constriction of the arterioles; if it is loosened, one imitates dilatation of the arterioles. If it is closed entirely, the fluid in A and B rises to the same level as that in R; the pressure of R is not felt at all by C and D, which empty themselves, and the flow ceases. If the clip E is only tightened so as not to be quite closed, the arterial pressure (in A and B) rises, and the venous pressure (in D) falls; if the clip is freely opened, the arterial pressure falls, and the venous pressure rises.

These same facts can be demonstrated by a more perfect circulation schema such as is represented in fig. 272.

The heart (H) is represented by a Higginson's syringe, which is



worked with the hand; the tube from it represents the arterial system, the clip E the resistance of the arterioles; C is the capillary lake, from which the vein (larger than the artery) leads back to the heart H. A and B are two manometers which respectively indicate arterial and venous pressures. Only in place of straight tubes, mercurial manometers are used. Each of these is a U-tube about half filled with mercury, and united to the artery or vein by a tube containing fluid. If the mercury in the two limbs of the U is at the same level, the pressure of the fluid in connection with one limb is exactly equal to that exerted by

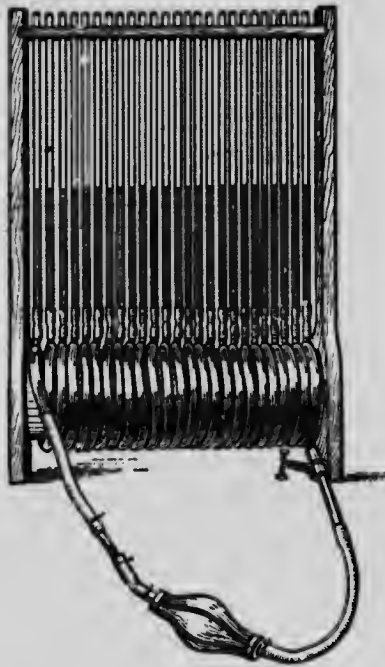

Fig. 273.—Anderson Stuart's sphygmoscope.

the atmospheric pressure on the other. The mercury, however, is pushed up in the far limb of the manometer connected to the artery, the pressure there being greater than that of the atmosphere; this is therefore called *positive pressure*, and the total amount of pressure, usually measured in millimetres, is the difference between the levels *a* and *b'*. The manometer B attached to the vein, however, indicates a *negative pressure* (*b b'*), that is, a pressure less than that of the atmosphere, so that the mercury in the limb nearest the vein is sucked up.

Anderson Stuart's *sphygmoscope* (fig. 273) is a much more complete schema. It consists of a long leaden tube filled with

fluid, the two ends of which are connected by an india-rubber tube on which is a valved syringe to represent the heart. On the course of the tube are a large number of open-mouthed upright manometers which indicate the pressure when the syringe is worked, and confer on the tube the elasticity necessary to cause the disappearance of the pulse in the middle region which represents the capillaries. The long leaden tube is twisted round a cylinder so that the manometers are placed closely side by side.

We can now pass on to the methods adopted in the investigations of blood-pressure in animals.

The fact that the blood exerts considerable pressure on the arterial walls may be readily shown by puncturing any artery; the blood is propelled with great force through the opening, and the jet rises to a considerable height; in the case of a small artery, where the pressure is lower, the jet is not so high as in a large artery: the jerky character of the outflow due to the intermittent action of the heart is also seen. If a vein is similarly injured, the blood is expelled with much less force and the flow is continuous, not intermittent.

The first to make an advance on this very rough method of demonstrating blood-pressure was the Rev. Stephen Hales, Vicar of Teddington (1727). He inserted, using a goose-quill as a cannula, a glass tube at right angles to the femoral artery of a horse, and noted the height to which the blood rose in it. This is a method like that which we used in the first schema described (fig. 271). The blood rose to the height of about 8 feet, and having reached its highest point, it oscillated with the heart-beats, and also with the respiration; each inspiration causing a rise, each expiration a fall of pressure; each cardiac systole causing a smaller rise, each diastole a smaller fall. The method taught Hales these primary truths in connection with arterial pressure, but it possesses many disadvantages; in the first place the blood in the glass tube very soon clots, and in the second place, a column of liquid eight feet high is an inconvenient one to work with.

The first of these disadvantages was overcome to a great extent by Vierordt, who attached a tube filled with saturated solution of sodium carbonate to the artery, and the blood-pressure was measured by the height of the column of this saline solution which the blood would support.

The second disadvantage was overcome by Poiseuille, who introduced the heavy liquid, mercury, as the substance on which the blood exerted its pressure; and the U-shaped mercurial manometer was connected to the artery by a tube filled with sodium carbonate solution to delay clotting

The study of blood-pressure cannot, however, be considered to have been in a satisfactory condition until the introduction by Carl Ludwig of the *Kymograph*; that is to say, Poiseuille's *hæmodynamometer* was combined with apparatus for obtaining a graphic record of the oscillations of the mercury. The name *kymograph* or *wave-writer* we shall see immediately is a very suitable one.

A skeleton sketch of the apparatus is given in fig. 274.

The artery is exposed and clamped, so that no hæmorrhage occurs; it is then opened and a glass cannula is inserted and firmly tied in. The form of cannula usually employed (François Franck's) is shown on a larger scale at A; the narrow part with the neck in

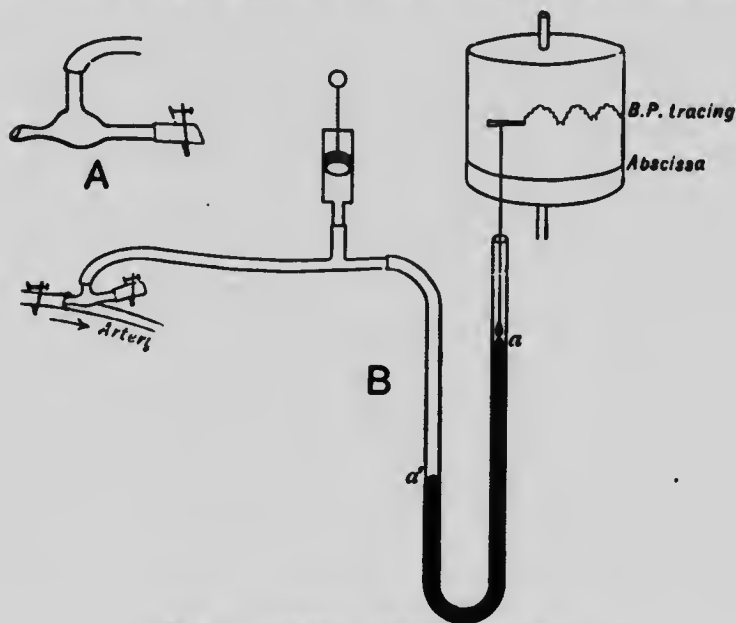

Fig. 274.—Diagram of mercurial kymograph.

it is tied into the artery towards the heart; the cross piece of the T is united to the manometer; the third limb is provided with a short piece of india-rubber tubing which is kept closed by a clip and only opened on emergencies, such as to clear out a clot with a feather should one form in the cannula during the progress of an experiment.

The tube by means of which the cannula is united to the manometer is not an elastic one, but is made of flexible metal, so that none of the arterial force may be wasted in expanding it. The tube, cannula and proximal limb of the manometer are all filled with a saturated solution of sodium carbonate, sodium sulphate, or other salt which will mix with blood and delay its

clotting. Before the clip is removed from the artery, the pressure is first got up by a syringe (or pressure bottle containing the same saline solution suspended at a good height above the apparatus and connected to it by a tube), so that the mercury rises in the distal limb to a height greater than that of the anticipated blood-pressure; this prevents blood passing into the cannula when the arterial clip is removed.

In the distal limb of the U-tube, floating on the surface of the mercury, is an ivory float, from which a long steel wire extends



Fig. 273.—The Manometer of Ludwig's Kymograph. It is also shown in fig. 276, D, C, E. The mercury which partially fills the tube supports a float in the form of a piston, nearly filling the tube; a wire is fixed to the float, and the writing style or pen fixed to the wire is guided by passing through the brass cap of the tube; the pressure is communicated to the mercury by means of a flexible metal tube filled with fluid.

upwards, and terminates in a writing point. The writing point may be a stiff piece of parchment or a bristle which writes on a moving surface covered with smoked paper, or a small brush kept full of ink which writes on a long strip of white paper made to travel by clockwork in front of it. When the two limbs of the mercury are at rest, the writing point inscribes a base line or abscissa on the travelling surface; when the pressure is got up by the syringe it writes a line at a higher level. When the arterial clip is removed it writes waves as shown in the diagram (fig. 274), the large waves corresponding to respiration (the rise of pressure in most animals accompanying inspiration),\* the smaller ones to the

\* The explanation of the respiratory curves on the tracing is postponed till after we have studied Respiration.

individual heart-beats. The blood-pressure is really twice as great as that indicated by the height of the tracing above the abscissa, because if the manometer is of equal bore throughout, the mercury falls in one limb the same distance that it rises in the other; the true pressure is the difference of level between  $a$  and  $a'$  (fig. 274).

Fig. 275 shows a more complete view of the manometer, and



Fig. 276.—Diagram of mercurial kymograph.  $A$ , revolving cylinder, worked by a clock-work arrangement contained in the box ( $B$ ), the speed being regulated by a fan above the box; the cylinder is supported by an upright ( $b$ ), and is capable of being raised or lowered by a screw ( $a$ ), by a handle attached to it;  $D$ ,  $C$ ,  $Z$ , represent the mercurial manometer, which is shown on a larger scale in fig. 275.

fig. 276 is a diagram of the arrangement by means of which it is made into a kymograph.

Fig. 277 shows a typical normal arterial blood-pressure tracing on a larger scale.

In taking a tracing of *venous blood-pressure*, the pressure is so low and corresponds to so few millimetres of mercury, that a saline solution is usually employed instead of mercury. If the vein which is investigated is near the heart, a venous pulse

is exhibited on the tracing, with small waves as before corresponding to heart-beats, and larger waves to respiration, only



Fig. 277.—Normal tracing, somewhat magnified, of arterial pressure in the rabbit obtained with the mercurial kymograph. The smaller undulations correspond with the heart-beats, the larger curves with the respiratory movements. (Burdon-Sanderson.)

the respiratory rise in pressure now accompanies expiration (see p. 277).

The *capillary pressure* is estimated by the amount of pressure

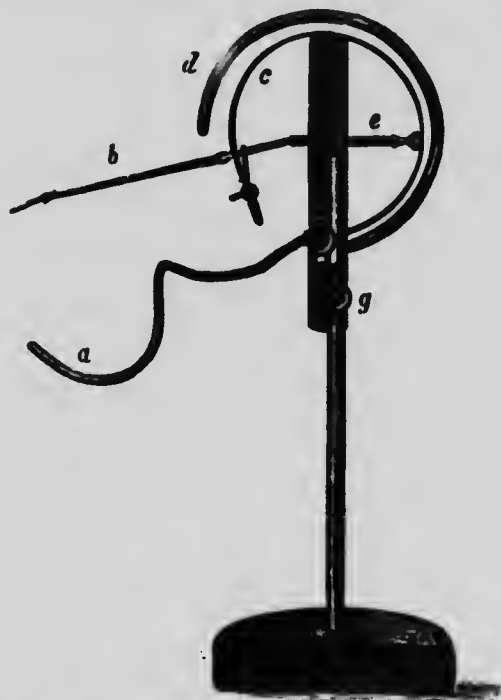

Fig. 278.—A form of Fick's Spring Kymograph. *a*, tube to be connected with artery; *c*, hollow spring, the movement of which moves *b*, the writing lever; *e*, screw to regulate height of *b*; *d*, outside protective spring; *g*, screw to fix on the upright of the support.

necessary to blanch the skin; this has been done in animals and men (v. Kries, Roy and Brown).

Other manometers are often employed instead of the mercurial one. Fick's is one of these. The blood-vessel is connected as before

with the manometer, and the pressure got up by the use of a syringe (which is seen in fig. 279 *g*), before the clip is removed from the artery. The manometer itself is a hollow C-shaped spring filled with liquid; this opens with increase, and closes with decrease of pressure, and the movements of the spring are communicated to a lever provided with a writing point.

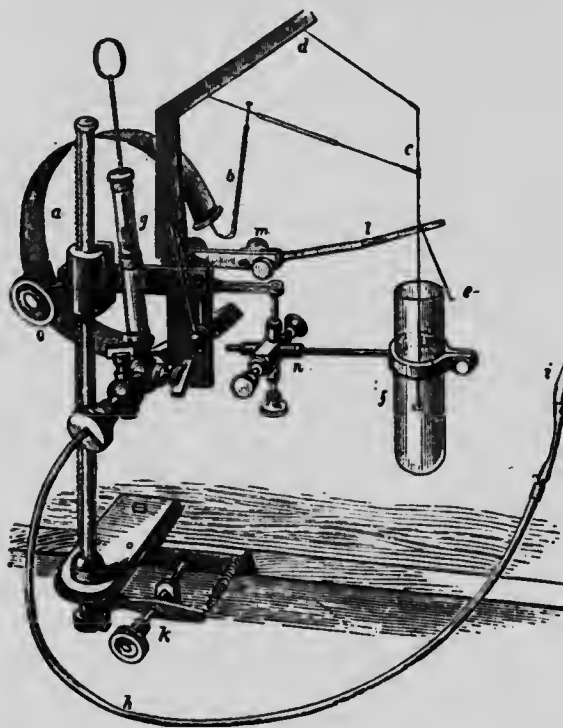

Fig. 279.—Fick's Kymograph, improved by Hering (after McKendrick). *a*, hollow spring filled with alcohol, bearing lever arrangement *b, d, c*, to which is attached the marker *e*; the rod *c* passes downwards into the tube *f*, containing castor oil, which offers resistance to the oscillations of *c*; *g*, syringe for filling the leaden tube *h* with saturated sulphate of sodium solution, and to apply sufficient pressure as to prevent the blood from passing into the tube *h* at *i*, the cannula inserted into the vessel; *l*, abscissa-marker, which can be applied to the moving surface by turning the screw *m*; *k*, screw for adjusting the whole apparatus to the moving surface; *o*, screw for elevating or depressing the Kymograph by a rack-and-pinion movement; *n*, screw for adjusting the position of the tube *f*.

Hürthle's manometer (see p. 243) is also very much used. The advantage of these forms of manometer is that the character of each individual movement is much better seen; in the case of a heavy liquid like mercury the inertia is so great that it cannot catch the finer movements which we have seen as secondary vibrations on the pulse wave. If Fick's or Hürthle's manometer

is employed, and the surface travels sufficiently fast, these can be recorded (see fig. 280).

We may now proceed to give some results. The following table gives the probable average height of blood-pressure in



Fig. 280.—Normal arterial tracing obtained with Fick's Kymograph in the dog.  
(Burdon-Sanderson.)

various parts of the vascular system in man. They have been very largely inferred from experiments on animals :—

Large arteries ( <i>e.g.</i> carotid)	.	{	+ 140 mm. (about 6 inches)	
			mereury.	
Medium arteries ( <i>e.g.</i> radial)	.		+ 110 mm. mereury.	
Capillaries	.	.	+ 15 to + 20 "	"
Small veins of arm	.	.	+ 9 "	"
Portal vein	.	.	+ 10 "	"
Inferior vena cava	.	.	+ 3 "	"
Large veins of neck	.	from 0 to -	8 "	"

(Starling.)

These pressures are, however, subject to considerable variations; the principal factors that cause variation are the following :—

*Increase of arterial blood-pressure is produced by*

1. Increase in the rate and power of the heart-beat.
2. Increase in the quantity of blood (plethora, after a meal, after transfusion).
3. Increase in the contraction of the arterioles.

*Decrease in the arterial blood-pressure is produced by*

1. Decrease in the rate and force of the heart-beat.
2. Decrease in the quantity of blood (*e.g.* after hæmorrhage).
3. Decrease in the contraction of the arterioles.

The above is true for general arterial pressure; but if we are investigating local arterial pressure in any organ, the increase or decrease in the size of the arterioles of other areas may make its effect felt in the special area under investigation.

*Venous pressure* varies in the opposite way to arterial pressure, in so far as the first and third factors are concerned. Like



arterial pressure it is increased by plethora, diminished by anæmia. It is increased by a decrease in the rate and force of the heart, and by a dilatation of the arterioles. It is diminished by the opposites.

It is quite easy to understand how this is; when the heart beats with increased force, it naturally raises the pressure in the arteries; but an increase during systole in the force of propulsion into the arteries means an increase also during diastole in the force of suction upon the venous blood, that is, a reduction of the pressure there; it becomes more negative than it usually is.

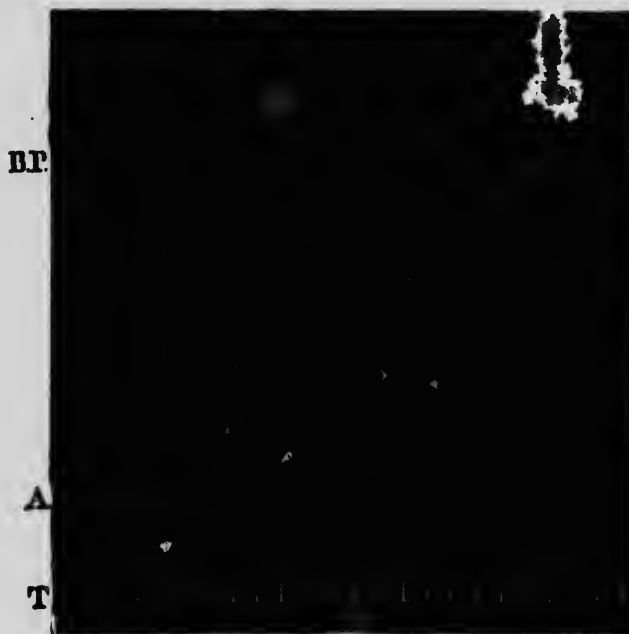

Fig. 281.—Effect of weak stimulation of the peripheral end of vagus on arterial blood-pressure (carotid of rabbit). BP, blood-pressure; A, abscissa or base line; T, time in seconds. Note fall of blood-pressure and slow heart-beats.

With regard to the arterioles, contraction in the arterioles means a rise in pressure in the arteries, just as narrowing the doors of a theatre during the exit of the audience will increase the pressure behind the doors; but a contraction of the arterioles causes a fall in pressure in the capillaries and veins beyond them, just as the narrowing of the theatre doors will lessen the congestion in the street outside of them.

*Capillary pressure* is increased by

1. Dilatation of the arterioles; the blood-pressure of the large arteries is then more readily propagated into them.
2. The size of the arterioles remaining the same, increase of

arterial pressure from any other cause will produce a rise of capillary pressure.

3. By narrowing the veins leading from the capillary area; complete closure of the veins may quadruple the capillary pressure. This leads secondarily to an increased formation of lymph (dropsy); as when a tumour presses on the veins coming from the legs.

4. Any circumstance that leads to increased pressure in the veins will act similarly; this is illustrated by the effects produced by gravity on the circulation, as in alterations of posture.

*Capillary pressure* is decreased by the opposite conditions.

*Effect of gravity on the circulation.*—The main effect of gravity is that the veins are filled with blood in the part which is placed down. Thus, if an animal is placed suddenly with its legs hanging down, less blood will go to the heart, and the blood-pressure in the arteries will fall temporarily in consequence. This hydrostatic effect of gravity is soon overcome by an increased constriction of the vessels of the splanchnic area, when the vaso-motor mechanism is working normally. The efficient action of the "respiratory pump" is also of importance in counteracting gravity.

A very striking illustration of the effect of gravity on the circulation can be demonstrated on the eel. The animal is anæsthetised, and a small window is made in the body wall to expose the heart. If the animal is then suspended tail downwards, the beating heart is seen to be empty of blood; all the blood accumulates in the tail and lower part of the body; the animal has no "respiratory pump," such as a mammal possesses, to overcome the effects of gravity. If, however, the animal, still with its tail downwards, be suspended in a tall vessel of water, the pressure of the water outside its body enables it to overcome the hydrostatic effect of gravitation, and the heart-cavities once more fill with blood during every diastole. Another experiment, originally performed by Salathe, can be demonstrated on a "hutch" rabbit. If the animal is held by the ears with its legs hanging down, it soon becomes unconscious, and if left in that position for about half an hour it will die. This due to anæmia of the brain; the blood accumulates in the very pendulous abdomen which such domesticated animals acquire, and the vaso-motor mechanism of the splanchnic area is deficient in tone, and cannot be set into such vigorous action as is necessary to overcome the bad effects of gravity. Consciousness is, however, soon restored if the animal is placed in a horizontal position, or if while it is still hanging vertically the abdomen is squeezed or bandaged. A wild rabbit, on the other hand, suffers no inconvenience from a vertical position; it is a more healthy animal in every respect;

its abdomen is not pendulous, and its vaso-motor power is intact. (Leonard Hill.)

*The pressure in the Pulmonary Circulation* is roughly about one-third of what it is in the systemic vessels.

*The influence of the Cardiac Vagus* on blood-pressure. The importance of the heart's action in the maintenance of blood-pressure is well shown by the effect that stimulation of the vagus nerve has on the blood-pressure curve. If the vagus of an

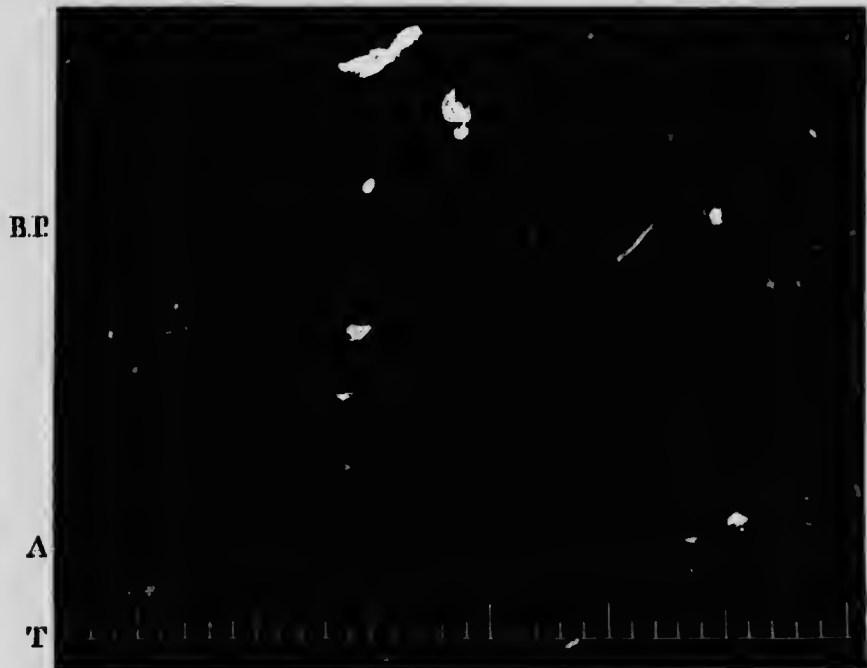

Fig. 282.—Effect of strong stimulation of the peripheral end of vagus on arterial blood-pressure (carotid of rabbit). Note stoppage of heart and fall of blood-pressure nearly to zero; after the recommencement of the heart, the blood-pressure rises, as in fig. 274, above the normal for a short time.

animal is exposed and cut through, and the peripheral end stimulated, the result is that the heart is slowed or stopped; the arterial blood-pressure falls simultaneously; the fall being especially sudden and great if the heart is completely stopped. There is a rise in venous pressure. The effect on arterial pressure is shown in the two accompanying tracings; fig. 281 representing the effect of partial, and fig. 282 of complete stoppage of the heart; in both cases the animal used was a rabbit, and the artery the carotid.

The effects of stimulating the central end of the vagus and

other nerves cannot be understood until we have studied the vaso-motor nervous system, to the consideration of which we shall immediately pass.

### Measurement of Blood-pressure in Man.

The measurement of the blood-pressure in the human subject cannot obviously be effected by the apparatus employed on animals, and numerous instruments have been invented for the purpose which may be applied to the vessels without any dissection. One of the simplest of these *sphygmometers*, as they are termed, has been introduced by Hill and Barnard, and I am indebted to Mr. L. Hill for the following description of their methods and results.

The instrument consists of a vertical glass tube about five inches in length, which expands above into a small bulb, and is closed at the top by a glass tap (see fig. 283).

A small india-rubber bag is fixed to the tube below; this is surrounded by a metal cup, attached in such a way that only the base of the bag is exposed. The bag is filled with coloured fluid. On pressing the instrument down over the radial or other artery, the fluid rises in the tube and compresses the air in the bulb; the air acts as an elastic spring. The more one presses the more the fluid rises; at a certain height the meniscus of the fluid exhibits more pulsation than it does at any other height (*maximal pulsation*). The tube is empirically graduated in divisions that correspond to millimetres of mercury pressure. The point of maximal pulsation gives the arterial pressure. Before each observation the tap is opened, and by gentle pressure on the bag the fluid is set at the zero mark on the scale. Thus errors due to changes in barometric pressure or temperature are avoided.

We now come to the explanation why the maximal pulsation gives us a reading of arterial pressure. If the mean pressure inside and outside an artery be made equal, then the wall of the vessel is able to vibrate at each pulse with the greatest freedom. The mean pressure is less than the systolic, but greater than the diastolic pressure; thus during the heart's systole the artery is opened out to its fullest extent, while during the heart's diastole its lumen is obliterated; hence the vessel wall swings with the greatest amplitude. If the pressure exerted by the sphygmometer



Fig. 283. — Hill and Barnard's Sphygmometer.

is less than the mean arterial pressure, the artery will not be compressed to its utmost during diastole; if, on the other hand, the pressure exerted is greater than the mean, the artery will not fully expand during systole. In either case, the pulsation will not be so great as when the pressure exerted on the outside of the artery equals the mean pressure within.

By recording the arterial pressure in the dog with a mercury manometer, and at the same time taking readings with the sphygmometer, the instrument has been proved to give accurate results.

The normal pressure in the radial artery of healthy young adults is 110 to 120 mm. Hg. It appears to be as constant as the body temperature. In the recumbent posture the pressure is slightly lower than in the erect position. This relation is reversed in conditions of exhaustion. During muscular exertion the pressure is raised, while in the subsequent period of rest it is sub-normal. Mental work raises the pressure; during rest and sleep it is lowered. The taking of food produces no noteworthy effect. In disease there are naturally variations in different directions, and the study of these has already yielded valuable results.

With this instrument the venous pressure can also be obtained in the manner suggested by Dr. George Oliver. On the back of the hand or arm a vein is chosen free from anastomoses, and the sphygmometer is pressed upon the peripheral end of this. The vein is then emptied centrally—*i.e.*, towards the heart—by the pressure of the finger. Next the pressure in the sphygmometer is gradually relaxed, and the exact height noted at which the vein refills with blood.

Since the flow of blood through the capillaries is maintained by the difference in pressure between the artery and vein, we can, by obtaining readings both of the arterial and of the venous pressures, estimate the comparative efficiency of the capillary circulation in man under varying conditions.

### The Vaso-motor Nervous System.

The vaso-motor nervous system consists of the *vaso-motor centre* situated in the bulb, of certain subsidiary vaso-motor centres in the spinal cord, and of vaso-motor nerves, which are of two kinds—(a) those the stimulation of which causes constriction of the vessels; these are called *vaso-constrictor* nerves; (b) those the stimulation of which causes dilatation of the vessels; these are called *vaso-dilatator* nerves.

The following names are associated with the history of the

subject. The muscular structure of arteries was first described by Henle in 1841; in 1852 Brown Séquard made a study of the vaso-constrictor, or, as he termed them, tonic nerves. The vaso-motor centre was discovered by Schiff (1855), and more accurately localised by Ludwig (1871). The dilatator nerves were also discovered by Schiff; at first they were termed paretic nerves. Other names which must be mentioned in connection with the subject are those of Claude Bernard, Heidenhain, and in more recent years, Gaskell, Langley, and Ramon y Cajal.

The nerves supply the muscular tissue in the walls of the blood-vessels and regulate their calibre, but exert their most important action in the vessels which contain relatively the greatest amount of muscular tissue, namely, the small arteries or arterioles.

Under ordinary circumstances, the arterioles are maintained in a state of moderate or tonic contraction, and this constitutes the peripheral resistance, the use of which is to keep up the arterial pressure, which must be high in order to force the blood in a continuous stream through the capillaries and veins back to the heart.

Another function which is served by this muscular tissue is to regulate the amount of blood which flows through the capillaries of any organ in proportion to its needs. During digestion, for instance, it is necessary that the digestive organs should be supplied with a large quantity of blood: for this purpose the arterioles of the splanchnic area are relaxed, and there is a vast amount of blood in this area, and therefore a correspondingly small amount in other areas, such as the skin; this accounts for the sensation of chilliness experienced after a full meal. The skin vessels form another good example; one of the most important uses of the skin is to get rid of the heat of the body in such a way that the body temperature shall remain constant; when excess of heat is produced there is also an increase in the loss of heat; the skin vessels are then dilated and so more blood is exposed on the surface, and thus increase in the radiation of heat from the surface is brought about. On the other hand, when it is necessary that the heat produced should be kept in the body, the loss of heat is diminished by a constriction of the skin vessels, as in cold weather. The alteration of the calibre of the vessels is brought about by the action of the vaso-motor nervous system on the muscular tissue of the arterioles.

There are certain organs of the body in which the necessity for alterations in their blood supply does not exist. Such organs are the lungs and the brain. It is in the vessels of these organs that the influence of vaso-motor nerves is at a minimum. The pulmonary vessels are supplied by nerves which have been

discovered by stimulating certain nerve-roots in the upper thoracic region ; but the action of vaso-motor nerves in the brain has not yet been established by experimental evidence (see p. 278).

The *vaso-motor centre* lies in the grey matter of the floor of the fourth ventricle ; it is a few millimetres in length reaching from the upper part of the floor to within about 4 mm. of the *calamus scriptorius*. The position of this centre has been discovered by the following means : when it is destroyed the tone of the small vessels is no longer kept up, and in consequence there is a great and universal fall in arterial blood-pressure ; when it is stimulated there is an increase in the constriction of the arterioles all over the body, and therefore a rise of arterial blood-pressure. Its upper and lower limits have been accurately determined in the following way ; a series of animals is taken and the central nervous system divided in a different place in each ; the cerebrum and cerebellum may be cut off without affecting blood-pressure, the vaso-motor centre must therefore be below these ; if the section is made just above the medulla, the blood-pressure still remains high, and it is not till the upper limit of the centre is passed that the blood-pressure falls. Similarly in another series of animals, if the cervical cord is cut through, and the animal kept alive by artificial respiration, there is an enormous fall of pressure due to the influence of the centre being removed from the vessels ; in other experiments the section is made higher and higher, and the same result noted, until at last the lower limit of the centre is passed, and the fall of pressure is less and less marked the higher one goes there, until in the animal in which the section is made at the upper boundary of the centre the blood-pressure is not affected at all, and the centre can be influenced reflexly by the stimulation of afferent nerves, the pressor and depressor nerves, which we shall be considering immediately.

After the destruction of the vaso-motor centre in the bulb, there is a fall of pressure. If the animal is kept alive, the vessels after a time recover their tone, and the arterial pressure rises ; it rises still more on stimulating the central end of a sensory nerve ; this is due to the existence of subsidiary vaso-motor centres in the spinal cord ; for on the subsequent destruction of the spinal cord the vessels again lose their tone and the blood-pressure sinks.

The *vaso-motor nerves* travel down the lateral column of the spinal cord, and terminate by arborising around the cells in the grey matter of the subsidiary vaso-motor centres, the exact anatomical position of which is uncertain. From these cells fresh axis-cylinder processes originate which pass out as the small medullated nerve-fibres in the anterior roots of the spinal nerves,

The *vaso-constrictor* nerves for the whole body leave the spinal cord by the anterior roots of the spinal nerves from the second thoracic to the second lumbar both inclusive. They leave the roots by the white rami communicantés and pass into the ganglia of the sympathetic chain which lies on each side along the front of the vertebral column. The ganglia on this chain (the lateral

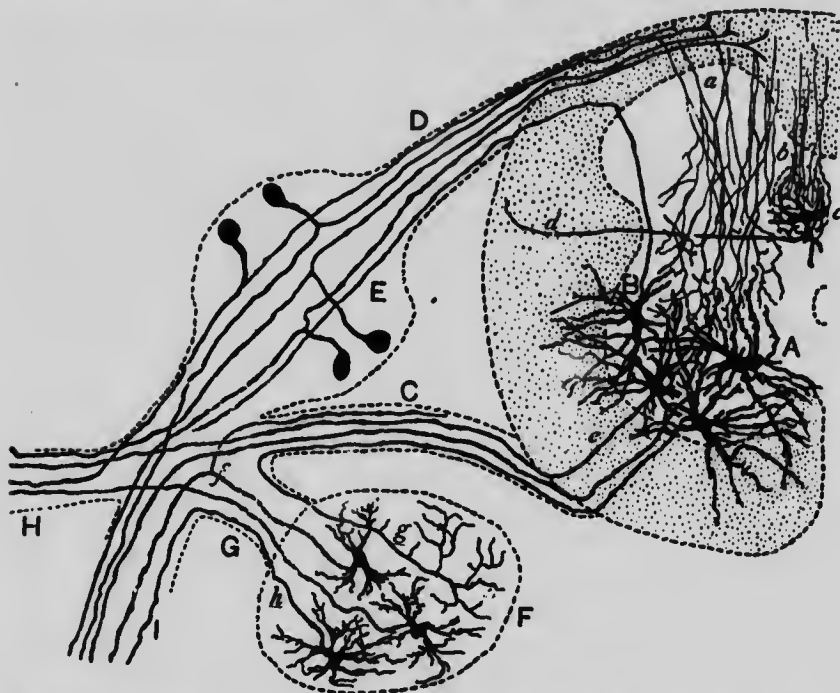

Fig. 284.—Transverse section through half the spinal cord, showing the ganglia. A, anterior cornual cells; B, axis-cylinder process of one of these going to posterior root; C, anterior (motor) root; D, posterior (sensory) root; E, spinal ganglion on posterior root; F, sympathetic ganglion; G, ramus communicans; H, posterior branch of spinal nerve; I, anterior branch of spinal nerve; a, long collaterals from posterior root fibres reaching to anterior horn; b, short collaterals passing to Clarke's column; c, cell in Clarke's column sending an axis-cylinder (d) process to the direct cerebellar tract; e, fibre of the anterior root; f, axis-cylinder from sympathetic ganglion cell, dividing into two branches, one to the periphery, the other towards the cord; g, fibre of the anterior root terminating by an arborisation in the sympathetic ganglion; h, sympathetic fibre passing to periphery. (Ramon y Cajal.)

ganglia of Gaskell) may also be called the chain of vaso-motor ganglia, because here are situated cell stations on the course of the vaso-constrictor nerves for the head, trunk and limbs. That is to say, the small medullated nerve-fibres terminate by arborising around the cells of these ganglia, and a fresh relay of axis-cylinder processes from these cells carry on the impulses.

The preceding figure represents diagrammatically how this occurs. The sheaths of the fibres are not represented.



The cell station of any particular fibre is not necessarily situated in the first ganglion to which it passes; the fibres of the white ramus communicans of the second thoracic do not for instance all have their cell stations in the second thoracic ganglion, but may pass upwards or downwards in the chain to a more or less distant ganglion before they terminate by arborising around a cell or cells.

The vaso-constrictor nerves, however, have all cell stations somewhere in the sympathetic system, and the new axis-cylinders that arise from the cells of the ganglia differ from those which terminate there in the circumstance that they do not possess a medullary sheath, but they are pale, grey or non-medullated fibres. Those which are destined for the supply of the vessels of the head and neck pass into the ganglion stellatum or first thoracic ganglion, thence through the annulus of Vieussens to the inferior cervical ganglion, and thence along the sympathetic trunk to their destination. Their cell station is in the superior cervical ganglion.

Those for the body wall and limbs pass back from the sympathetic ganglia to the spinal nerves by the grey rami communicantes, and are distributed with the other spinal nerve-fibres. The cell stations for the upper limb fibres are in the ganglion stellatum, and for the lower limb fibres in the lower lumbar, and upper sacral ganglia.

Those for the interior of the body pass into the various plexuses of sympathetic nerves in the thorax and abdomen and are distributed to the vessels of the thoracic and abdominal viscera. This set includes the most important vaso-motor nerves of the body, the splanchnics. Their cell stations are situated in the various ganglia of the abdominal plexuses.

The *vaso-dilatator* nerves in part accompany those just described, but they are not limited to the outflow from the second thoracic to the second lumbar. Thus, the *nervi erigentes* originate as white rami communicantes from the second and third sacral nerves, and the *chorda tympani*, another good example of a vaso-dilatator nerve, is a branch of the seventh cranial nerve.

The vaso-dilatator nerves also differ from the vaso-constrictors in not communicating with cell stations in the sympathetic chain: they pass through these ganglia, retaining their medullary sheath, and have their cell stations in the collateral ganglia (such as the semilunar) or in the terminal ganglia on the walls of the blood-vessels themselves.

All vaso-motor nerves, whether they are constrictor or dilatator, differ very markedly from the spinal nerve-fibres which are distributed to voluntary muscles in being ganglionated; that is,

in having cell stations or positions of relay on their course from the central nervous system to the muscular fibres they supply.

The existence of cell stations between the central nervous system and the muscular fibres is not confined to the nerves of blood-vessels, but is found also in the nerves which supply the heart and other viscera.

Moreover, the nerves which supply the voluntary muscles are motor in function; inhibitory fibres to the voluntary muscles of vertebrates do not exist. But in the case of the involuntary muscles there are usually the two sets of nerve-fibres with opposite functions.

In the case of the heart, we have an accelerator set which course through the sympathetic, and an inhibitory set which course through the vagus.

In the case of the vessels, we have an accelerator set, which we have hitherto called vaso-constrictors, and an inhibitory set we have been calling vaso-dilatators.

In the case of the other contractile viscera, we have also visceromotor and visceroinhibitory which respectively hasten and lessen their peristaltic movements.

Adopting Gaskell's nomenclature, we may further term the accelerator groups of nerves, *katabolic*, as they increase the activity of the muscles they supply, bringing about an increase of wear and tear, and an increase in the discharge of waste material. The inhibitory nerves, on the other hand, are *anabolic*, as they produce a condition of rest in the tissues they supply, and so give an opportunity for repair or constructive metabolism.

The distribution of the vaso-motor nerves and the visceromotor nerves has been within recent years very thoroughly worked out by Langley. The nerves of the various viscera we shall take with the individual organs. In all these cases, there is a cell station somewhere in the sympathetic system, and only one for each nerve-fibre. The *preganglionic fibres* (i.e., the fibres from the spinal cord to the sympathetic cell station) are usually medullated; the *postganglionic fibres* (i.e., those that leave the ganglion) are usually non-medullated. But this histological distinction, so much emphasised by Gaskell, is not without exceptions, and the localisation of cell stations is made with far greater certainty by Langley's nicotine method. Nicotine in small doses paralyzes nerve-cells,\* but not nerve-fibres; if the drug is injected into an

\* It is still a matter of uncertainty whether this drug acts upon the nerve-cells themselves, or the terminal arborisations (synapses) of the nerve-fibres that surround them. Before the paralytic effect of nicotine comes on, it excites the nerve-cells, and thus causes a general constriction of the arterioles and a rise of arterial pressure.

animal, stimulation of the anterior nerve-roots produces no movements of the involuntary muscles, because the paralysed cell stations on the course of the nerve-fibres act as blocks to the propagation of the impulse. If the nicotine is applied locally by painting it over one or more ganglia, there will be a block in those fibres only which have their cell stations in those particular ganglia. Thus, in the lateral chain of ganglia we find the cells on the course of the pilo-motor nerves (*i.e.*, to the muscles of the hairs), of the vaso-constrictors of the head, limbs, and body walls, and possibly of the splenic nerves. In the collateral ganglia are found, amongst others, the cells on the course of the splanchnic nerves, of the nerves to sweat glands, of the cardiac accelerators, and of the inhibitory fibres of the alimentary canal; while in the terminal ganglia are placed, among others, the cells on the cardiac inhibitory nerves, on the motor fibres to the lower part of the intestine and bladder, and on the inhibitory fibres to the external genital organs.

The cell stations on the vaso-constrictors are situated for the trunk in the corresponding lateral ganglia: for the head, neck and salivary glands in the superior cervical ganglion; for the upper limb in the ganglion stellatum; for the lower limb in the sixth and seventh lumbar, and first and second sacral ganglia; for the tail in the coccygeal ganglia; for the stomach in the coeliac ganglion; for the small intestine in the superior mesenteric; for the large intestine and rectum in the inferior mesenteric; and for the external genitals in the sacral ganglia. The cells on the vaso-dilatators are placed in the superior cervical ganglion for the gums and lips; in the hilus of the gland for the submaxillary; and near the viscus for the rectum, external genitals, &c. The cells for the motor-fibres of the upper part of the alimentary canal are in the ganglion trunci vagi; for the lower part on the course of the fibres near the viscus. The cells on the inhibitory fibres of the upper part of the alimentary canal are in the coeliac or superior mesenteric ganglia, and for the lower part in the inferior mesenteric ganglia, or along the course of the hypogastric nerves.

We may now ask what is the object that is served by the existence of ganglia on the course of these nerves. It appears to be a means of distributing nerve-fibres to a vast area of muscular tissue by means of a comparatively small number of nerve-fibres that leave the central nervous system; for each fibre that leaves the central nervous system arborises around a number of cells, and thus the impulse it carries is transferred to a number of new axis-cylinder processes.

In some cases, it is true, a single nerve-fibre will divide into multitudinous branches to accomplish the same object (as in the supply of the electric organ of *Malapterurus*, the fibres to the millions of its subdivisions all originating from a single axis-cylinder), but the usual way appears to be a combination of this method with that of subsidiary cell-stations.

At one time a ganglion was supposed to be the seat of reflex action. The submaxillary ganglion was the battle-field in which this question was fought out. In all the researches of Langley and Anderson, who have investigated every ganglion in the body, they have never found that a ganglion is the seat of a reflex action. The only instances where such a thing seemed possible were the following:—When all the nervous connections of the inferior mesenteric ganglion are divided except the hypogastric nerves, stimulation of the central end of one hypogastric causes contraction

of the bladder, the efferent path to which is the other hypogastric nerve. In addition they observed an apparent reflex excitation of the nerve supplying the erector muscles of the hairs (pilo-motor nerves) through other sympathetic ganglia. In neither case is the action truly reflex, but is caused by the stimulation of the central ends of motor nerves which issue from the spinal cord, and which after passing through a ganglion send branches down each hypogastric nerve. The experiment is in fact similar to Kühne's gracilis experiment (p. 173).

A series of most interesting and important experiments have more recently been carried out by Langley, in which he shows that nerve-fibres will under certain experimental conditions

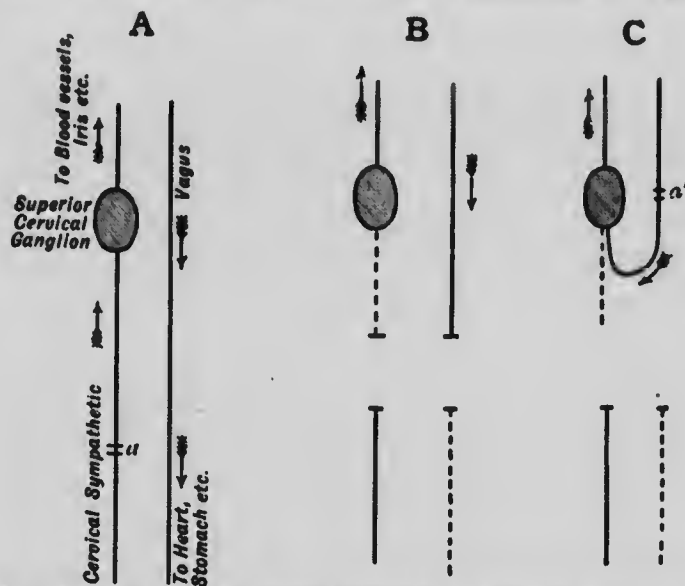

Fig. 285.—Diagram to illustrate Langley's experiment on vagus and cervical sympathetic nerves. In A, the two nerves are shown intact; the direction of the impulses they normally carry is shown by arrows, and the names of some of the parts they supply are mentioned. In B, both nerves are cut through. The degenerated portions are represented by discontinuous lines. In C, the union described in the text has been accomplished, and stimulation at the point *a*' now produces the same results as were in the intact nerves (A) produced by stimulation at *a*.

terminate by arborising around other nerve cells than those which they normally form connections (synapses) with. It will be sufficient to give one typical experiment. If the vagus nerve is cut across in the neck, its peripheral end degenerates downwards; if the cervical sympathetic is cut across below the superior cervical ganglion, its peripheral end degenerates upwards, as far as the ganglion. If subsequently the central end of the cut vagus is united to the peripheral end of the cut sympathetic, in the course of some weeks the vagus fibres grow into the sympathetic and form synapses around the cells of the superior cervical ganglion, and stimulation of the united nerve

now produces such effects as are usually obtained when the cervical sympathetic is irritated; for instance, dilatation of the pupil, raising of the upper eyelid, and constriction of blood-vessels of the head and neck. (See accompanying diagram, fig. 285.)

Such experiments as these are important because they teach us that though the action of nerves may be so different in different cases (some being motor, some inhibitory, some secretory, some sensory, &c.), after all what occurs in the nerve trunk itself is always the same; the difference of action is due to difference either in the origin or distribution of the nerve-fibres. If we go back to our old illustration in which we compared the nerve

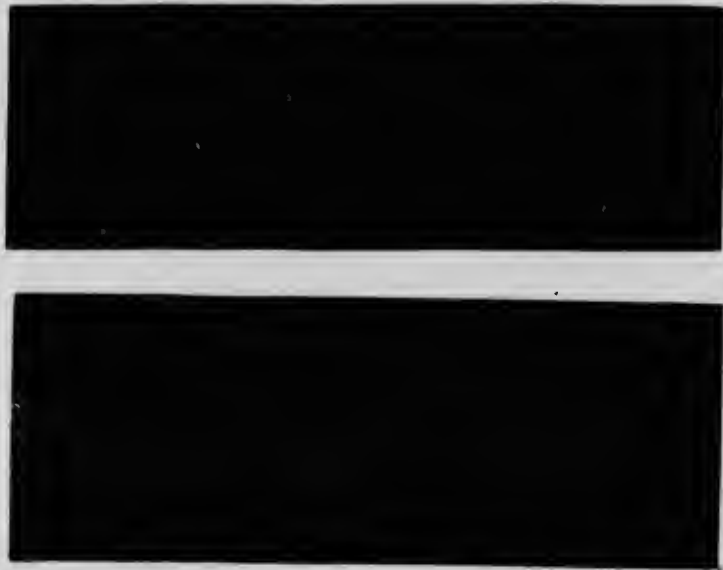

Fig. 286.—Arterial blood-pressure tracings showing Traube-Hering waves. (Starling.)

trunks to telegraph wires, we may be helped in realising this. The destination of a certain group of telegraph wires may be altered, and the alteration may produce different consequences at different places; the electric change, however, in the wires would be the same in all cases. So the nerve impulse going along a nerve is always the same sort of molecular disturbance; if it is made as in the experiment just described, to go by a wrong channel, it produces just the same results as though the impulse had reached its destination by the usual channel.

**The Vaso-motor centre can be excited directly, as by induction currents; the result is an increase of blood-pressure owing to an increase of the contraction of the peripheral arterioles.**

It can also be excited by the action of *poisons* in the blood which circulates through it; thus *strophanthus* or *digitalis* causes a marked rise of general arterial pressure due to the constriction of the peripheral vessels brought about by impulses from the centre.

It is also excited by venous blood, as in *asphyxia*; the rise of blood-pressure which occurs during the first part of *asphyxia* is due to constriction of peripheral vessels; the fall during the last stage of *asphyxia* is largely due to heart failure. We shall study *asphyxia* more at length in connection with

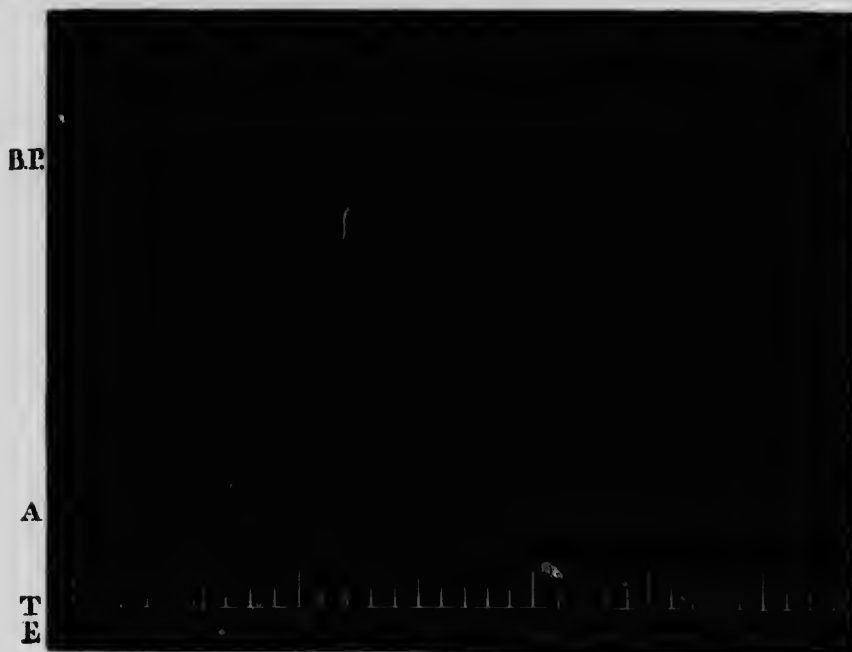

Fig. 287.—Result on arterial blood-pressure curve of stimulating the central end of cut sciatic nerve in rabbit. BP, blood-pressure; A, abscissa or base line; T, time in seconds; z, signal of period of excitation of the nerve.

respiration. During the period of decreased pressure, waves are often observed on the blood-pressure curve which arise from a slow rhythmic action of the vaso-motor centre. The centre alternately sends out stronger and weaker constrictor impulses. They are known as the *Traube-Hering* waves, and are much slower in their rhythm than the waves on the tracing which are due to respiration. They are not peculiar to *asphyxia*, but are frequently seen in tracings from normal animals. Fig. 286 represents tracings obtained from a dog under the influence of *morphia* and *curare*. The upper curve taken while artificial

respiration was being carried on shows the three sets of waves, first the oscillations due to the heart beats, next in size those due to the respiratory movements, which in their turn are superposed on the prolonged Traube-Hering waves. The lower tracing was taken immediately after the cessation of the artificial respiration and shows only the heart beats and the Traube-Hering waves.

**The Vaso-motor centre may be excited reflexly.**—The afferent impulses to the vaso-motor centre may be divided into **pressor** and **depressor**.

Most sensory nerves are *pressor* nerves. The sciatic or the vagus nerves may be taken as instances; when they are divided and their central ends stimulated, the result is a rise of blood-pressure due to the stimulation of the vaso-motor centre, and a consequent constriction of the arterioles all over the body, but especially in the splanchnic area. Fig. 287 shows the result of such an experiment. It is convenient in performing such an experiment to administer curare as well as an anæsthetic to the animal, in order to obviate reflex muscular struggles.

**Depressor nerve.**—In most animals the depressor fibres are bound up in the trunk of the vagus, but in some, like the rabbit, cat and horse, the nerve runs up as a separate branch from the heart and joins the vagus or its superior laryngeal branch and ultimately reaches the vaso-motor centre. When this nerve is stimulated (the vagi having been previously divided to prevent reflex inhibition of the heart), a marked fall of arterial blood-pressure is produced (see fig. 288). Stimulation of this nerve affects the vaso-motor centre in such a way that the normal constrictor impulses that pass down the vaso-constrictor nerves are inhibited. The fall of pressure is very slight after section of the splanchnic nerves, showing that the splanchnic area is the part of the body most affected. The normal function of this nerve is to adapt the heart's action to the peripheral resistance: if the constriction of the arterioles is too high for the heart to overcome, an impulse by this nerve to the vaso-motor centre produces reflexly a lessening of the peripheral resistance.

N.B.—The term depressor should be carefully distinguished from inhibitory; stimulation of the peripheral end of the vagus produces a fall of blood-pressure due to inhibition (slowing or stoppage) of the heart (see figs. 281 and 282); stimulation of the central end of the depressor nerve produces a lowering of blood-pressure for a different reason, namely a reflex relaxation of the splanchnic arterioles.

**Experiments on Vaso-motor nerves.**—The experiments on the vaso-motor nerves are similar to those performed on other

nerves when one wishes to ascertain their functions. They consist of section and excitation.

Section of a vaso-constrictor nerve, such as the splanchnic, causes a loss of normal arterial tone, and consequently the part supplied by the nerve becomes flushed with blood. Stimulation of the peripheral end causes the vessels to contract and the part to become comparatively pale and bloodless. This can be very readily demonstrated on the ear of the rabbit. This is a classical experiment associated with the name of Claude Bernard. Division of the cervical sympathetic produces an increased redness of the side of the head, and looking at the ear, the transparency of which

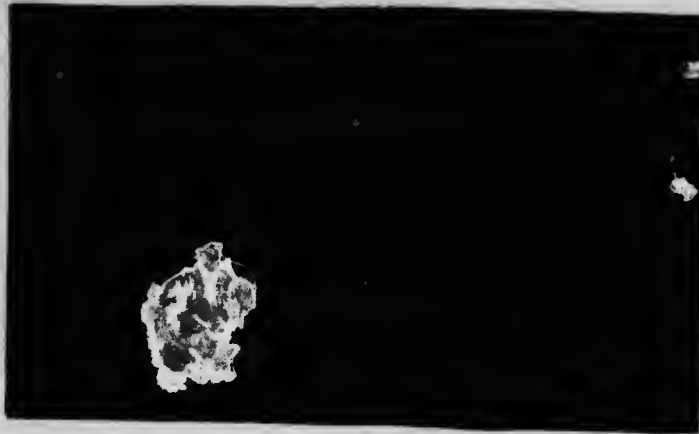

Fig. 288.—Tracing showing the effect on blood-pressure of stimulating the central end of the Depressor nerve in the rabbit. To be read from right to left. T, indicates the rate at which the recording-surface was travelling, the intervals correspond to seconds; C, the moment of entrance of current; O, moment at which it was shut off. The effect is some time in developing, and lasts after the current has been taken off. The larger undulations are the respiratory curves; the pulse oscillations are very small. (Foster.)

enables one to follow the phenomena easily, the central artery with its branches is seen to become larger, and many small branches not previously visible come into view. The ear feels hotter, though this effect soon passes off as the exposure of a large quantity of blood to the air causes a rapid loss of heat. On stimulating the peripheral end of the cut nerve, the ear resumes its normal condition and then becomes paler than usual owing to excessive constriction of the vessels.

The first part of the experiment, the dilatation following section, can be demonstrated in a very simple way, by pressing the thumb-nail forcibly on the nerve where it lies by the side of the central artery of the ear.

Section of a vaso-dilatator nerve, such as the chorda tympani,



produces no effect on the vessels, but stimulation of its peripheral end causes great enlargement of all the arterioles, so that the submaxillary gland and the neighbouring parts supplied by the nerve become red, and gorged with blood, and the pulse is propagated through to the veins; the circulation through the capillaries is so rapid that the blood loses very little of its oxygen, and is therefore arterial in colour in the veins. Another effect, free secretion of saliva, we shall study in connection with that subject.

Other examples of vaso-dilatator nerves are the *nervi erigentes* to the erectile tissue of the penis, &c., and of the lingual nerve to the vessels of the tongue.



Fig. 289.—Flethysmograph. By means of this apparatus, the alteration in volume of the arm, *x*, which is enclosed in a glass tube, *A*, filled with fluid, the opening through which it passes being firmly closed by a thick gutta-percha band, *r*, is communicated to the lever, *D*, and registered by a recording apparatus. The fluid in *A* communicates with that in *B*, the upper limit of which is above that in *A*. The chief alterations in volume are due to alteration in the blood contained in the arm. When the volume is increased, fluid passes out of the glass cylinder, and the lever, *D*, also is raised, and when a decrease takes place the fluid returns again from *B* to *A*. It will therefore be evident that the apparatus is capable of recording alterations of the volume of blood in the arm.

It is, however, probable that all the vessels of the body receive both constrictor and dilatator nerves. But the presence of the latter is difficult to determine unless they are present in excess; if they are not, stimulation affects the constrictors most. The effect of section is also inconclusive; for if a mixed nerve is cut the only effect observed is a dilatation due to removal of the tonic constrictor influence.

To solve this difficult problem, three methods are in use.

1. *The method of degeneration.*—If the sciatic nerve is cut, the vessels of the limb dilate. This passes off in a day or two. If the peripheral end of the nerve is then stimulated, the vessels are dilated, as the constrictor fibres degenerate earliest, and so one gets a result due to the stimulation of the still intact dilatator fibres.

2. *The method of slowly interrupted shocks.*—If a mixed nerve is stimulated with the usual rapidly interrupted faradic current, the effect is constriction; but if the induction shocks are sent in at long intervals (*e.g.* at intervals of a second), vaso-dilatator effects are obtained. This can be readily demonstrated on the kidney vessels by stimulation of the anterior root of the eleventh thoracic nerve in the two ways just indicated.

3. *The influence of temperature.*—Exposure to a low temperature depresses the constrictors, more than the dilatators. If the leg is placed in ice-cold water, stimulation of the sciatic, even if it has only been recently divided, produces a flushing of the skin with blood.

The action of vaso-motor nerves can be studied in another way than by the use of the mercurial or other forms of manometer, which is the only method we have considered so far. The second method, which is often used together with the manometer, consists in the use of an instrument which records variations in the volume of any limb, or organ of an animal. Such an instrument is called a **plethysmograph**. One of these instruments applied to the human arm is shown in the accompanying figure (fig. 289).

Every time the arm expands with every heart's systole, a little of the fluid in the plethysmograph is expelled and raises the lever. Variations in volume due to respiration are also seen in the tracing. An air plethysmograph connected to a Marey's tambour gives equally good results.

The same instrument in a modified form applied to such organs as the spleen and kidney is generally called an **oncometer**, and the recording part of the apparatus, the **oncograph**. These instruments we owe to Prof. Roy, and the next two figures represent respectively sections of the kidney oncometer and oncograph.

Each consists of a metal capsule, of shape suitable to enclose the organ: its two halves are jointed together, and fit accurately except at one opening which is left for the vessels of the organ. A delicate membrane is attached to the rim of each half, the space between which and the metal is filled with warm oil. The tube from the oncometer is connected to the oil-containing cavity of the oncograph by a tube also containing oil. An increase in the volume of the organ squeezes the oil out of the oncometer into the oncograph and so produces a rise of the oncograph piston and lever; a contraction of the organ produces a fall of the lever.

Very good results are obtained by using saline solution instead of oil; and Prof. Schafer has recently shown in connection with the spleen that a spleen box of simple shape covered with a glass

plate, made air-tight with vaseline, except where it communicates by a tube with a Marey's tambour, gives a far more delicate record of the splenic alterations of volume than the oil oncometer.

If now we are investigating the action of the anterior root of eleventh thoracic nerve on the vessels of the kidney, a tracing is taken simultaneously of the arterial blood-pressure in the carotid, and of the volume of the kidney by the oncometer. On stimulating the nerve rapidly, there is a slight rise of arterial pressure, but a large fall of the oncograph lever showing that the kidney



Fig. 290.—Diagram of Roy's Oncometer. *a*, represents the kidney enclosed in a metal box, which opens by hinge *f*; *b*, the renal vessels and duct. Surrounding the kidney are two chambers formed by membranes, the edges of which are firmly fixed by being clamped between the outside metal capsule, and one (not represented in the figure) inside, the two being firmly screwed together by screws at *h*, and below. The membranous chamber below is filled with a varying amount of warm oil, according to the size of the kidney experimented with, through the opening, then closed with the plug *i*. After the kidney has been enclosed in the capsule, the membranous chamber above is filled with warm oil through the tube *e*, which is then closed by a tap (not represented in the diagram); the tube *d* communicates with a recording apparatus, and any alteration in the volume of the kidney is communicated by the oil in the tube to the chamber *d* of the Oncograph, fig. 291.

has diminished in volume. It is evident that there must be an active contraction of the arterioles of the kidney, causing it to diminish in size, for the blood-pressure tracing shows that there is no failure of the heart's activity to account for it.

We shall return to the subject of the oncometer in connection with the spleen and kidney.

The vaso-motor nervous system is influenced to some extent by conditions of the cerebrum, some emotions, such as fear, causing pallor (vaso-constriction), and others causing blushing (vaso-dilatation).

It is almost impossible to over-estimate the importance of the study of vaso-motor phenomena, as a means of explaining certain pathological conditions; our knowledge of the processes concerned in *inflammation* is a case in point.

Disorders of the vessels due to vaso-motor disturbances are generally called *angio-neuroses*. Of these we may mention the following:—

*Tache cérébrale* is due to abnormal sensitiveness of the vascular nerves; drawing the finger-nail across the skin causes an immediate *wheal*, or at least a red mark that lasts a considerable time. At one time this was considered characteristic of affections of the cerebral meninges like tubercular meningitis, and was



Fig. 291.—Roy's Oncograph, or apparatus for recording alterations in the volume of the kidney, &c., as shown by the oncometer—*a*, upright, supporting recording lever *l*, which is raised or lowered by needle *b*, which works through *f*, and which is attached to the piston *c*, working in the chamber *d*, with which the tube from the oncometer communicates. The oil is prevented from being squeezed out as the piston descends by a membrane, which is clamped between the ring-shaped surfaces of cylinder by the screw *i* working upwards; the tube *h* is for filling the instrument.

consequently called the “meningeal streak.” It, however, occurs in a variety of pathological conditions of the nervous system both cerebral and spinal.

In certain conditions which lead to *angina pectoris* the pain in the heart is due to its being unable to overcome an immense peripheral resistance, and the condition is relieved by the administration of drugs like amyl-nitrite or nitro-glycerine, which relax the vessels and cause universal blushing.

*Raynaud's disease* is one in which there is a localised constriction of the vessels which is so effectual as to entirely cut off the blood supply to the capillary areas beyond, and if this lasts any considerable time may lead to gangrene of the parts in question.

## CHAPTER XXII.

## LYMPH AND LYMPHATIC GLANDS.

As the blood circulates through the capillary blood-vessels some of its liquid constituents exude through the thin walls of these vessels, carrying nutriment to the tissue elements. This exudation is called *lymph*; it receives from the tissues the products of their activity, and is collected by the lymph channels, which converge to the thoracic duct—the main lymphatic vessel—and thus the lymph once more re-enters the blood-stream near to the entrance of the large systemic veins into the right auricle.

Lymph is a fluid, which comes into much more intimate relationship with metabolic processes in the tissues than the blood; in fact, there is only one situation—the spleen—where the blood comes into actual contact with the elements—that is, cells, fibres, &c.—of a tissue.

**Composition of Lymph.**

Lymph is alkaline; its specific gravity is about 1.015, and after it leaves the vessels it clots, forming a colourless coagulum of fibrin. It is like blood-plasma in composition, only diluted so far as its proteid constituents are concerned. This is due to the fact that proteids do not pass readily through membranes. The proteids present are called *fibrinogen*, *serum globulin*, and *serum albumin*; these we shall study with the blood-plasma. The salts are similar to those of blood-plasma, and are present in the same proportions. The waste products, like carbonic acid and urea, are more abundant in lymph than in blood. The total amount of solids dissolved in lymph is about 6 per cent., more than half of which is proteid in nature.

When examined with the microscope the transparent lymph is found to contain colourless corpuscles, which are called *lymphocytes*; these are cells with large nuclei and comparatively little protoplasm. They pass with the lymph into the blood, where they undergo growth, and are called *leucocytes*.

All the lymphatics pass at some point of their course through lymphatic glands, which are the factories of these corpuscles. Lymphocytes also pass into the lymph stream wherever lymphoid tissue is found, as in the tonsils, thymus, Malpighian bodies of the spleen Peyer's patches, and the solitary glands of the intestine.

The lymph that leaves these tissues is richer in lymph-cells than that which enters them.

When lymph is collected from the thoracic duct after a meal containing fat, it is found to be milky. This is due to the presence in the lymph of minutely subdivided fat particles absorbed from the interior of the alimentary canal. The lymph is then called *chyle*. The fat particles constitute what used to be called the *molecular basis* of chyle. If the abdomen is opened during the process of fat absorption, the lymphatics are seen as white lines, due to their containing this milky fluid. They are consequently called *lacteals*.

The structure and arrangement of the lymphatic vessels are given in Chapter XVIII., and we have now to proceed to the study of the structure of

### The Lymphatic Glands.

Lymphatic glands are round or oval bodies varying in size from a hemp-seed to a bean, interposed in the course of the

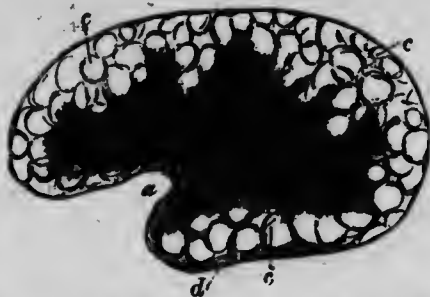

Fig. 292.—Section of a mesenteric gland from the ox, slightly magnified. *a*, Hilus; *b* (in the central part of the figure), medullary substance; *c*, cortical substance with indistinct alveoli; *d*, capsule. (Kölliker.)

lymphatic vessels, and through which the lymph passes in its course to be discharged into the blood-vessels. They are found in great numbers in the mesentery, and along the great vessels of the abdomen, thorax, and neck; in the axilla and groin; a few in the popliteal space, but not further down the leg, and in the arm as far as the elbow.

A lymphatic gland is covered externally by a capsule of connective-tissue, generally containing some unstriped muscle. At the inner side of the gland, which is somewhat concave (*hilus*), (fig. 292), the capsule sends inwards processes called *trabeculae* in which the blood-vessels are contained, and these join with other processes prolonged from the inner surface of the

part of the capsule covering the convex or outer part of the gland; they have a structure similar to that of the capsule, and entering the gland from all sides, and freely communicating, form a fibrous scaffolding. The interior of the gland is seen on section, even when examined with the naked eye, to be made up of two parts, an outer or *cortical*, which is light coloured, and an inner or *medullary* portion of redder appearance (figs. 292, 293). In the outer part, or *cortex*, of the gland (fig. 293) the intervals between the trabeculæ are large and regular; they are termed

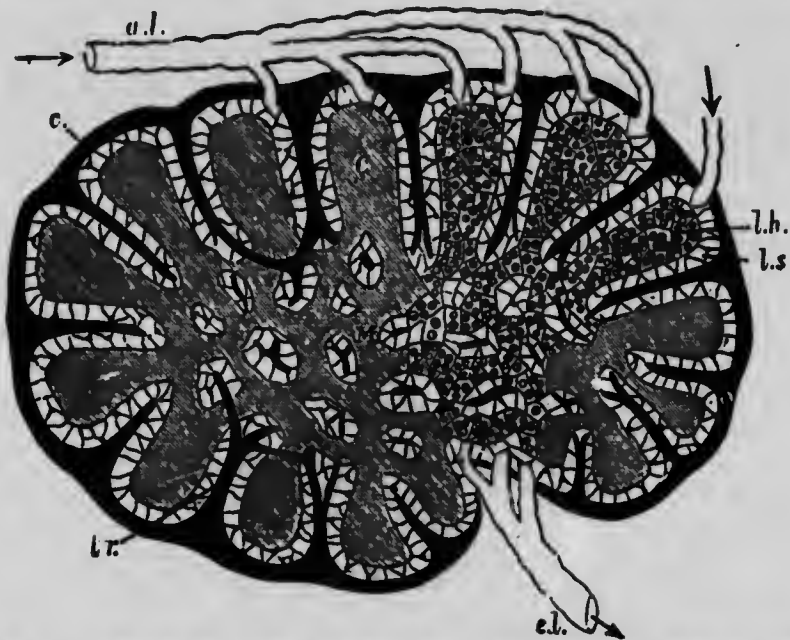

Fig. 293.—Diagrammatic section of lymphatic gland. *a.l.*, afferent; *e.l.*, efferent lymphatics; *C*, cortical substance; *l.h.*, lymphoid tissue; *l.s.*, lymph-path; *c.*, fibrous capsule sending in trabeculæ *tr.* into the substance of the gland. (Sharpey.)

*alveoli*; whilst in the more central or medullary part is a finer meshwork formed by an irregular anastomosis of the trabecular processes. Within the alveoli of the cortex and in the meshwork formed by the trabeculæ in the medulla, is contained lymphoid tissue; this occupies the central part of each alveolus; but at the periphery, surrounding the central portion and immediately next the capsule and trabeculæ, is a more open meshwork of retiform tissue constituting the *lymph-path*, and containing but few lymph-corpuscles. At the inner part of the alveolus, the central mass divides into two or more smaller rounded or cord-like masses which, joining with those from the other alveoli, form a much

closer arrangement than in the cortex; spaces (fig. 294, *b*) are left within those anastomosing cords, in which are found portions of the trabecular meshwork and the continuation of the lymph-path.

The lymph enters the gland by several afferent vessels, which pierce the capsule and open into the lymph-path; at the same time they lay aside all their coats except the endothelial lining, which is continuous with the lining of the lymph-path. The



Fig. 294. —A small portion of medullary substance from a mesenteric gland of the ox. *d, d*, trabeculae; *a*, part of a cord of lymphoid tissue from which all but a few of the lymph-corpuscles have been washed out to show its supporting meshwork of retiform tissue and its capillary blood-vessels (which have been injected, and are dark in the figure); *b, b*, lymph-path, of which the retiform tissue is represented only at *c, c*.  $\times 300$ . (Kölliker.)

*efferent* vessels begin in the medullary part of the gland, and are continuous with the lymph-path here as the afferent vessels were with the cortical portion; the endothelium of one is continuous with that of the other.

The efferent vessels leave the gland at the *hilus*, and generally either at once, or very soon after, join together to form a single vessel.

Blood-vessels which enter and leave the gland at the hilus are freely distributed to the trabecular tissue and to the lymphoid tissue.



### The Lymph Flow.

The flow of the lymph towards the point of its discharge into the veins is brought about by several agencies. With the help of the valvular mechanism all occasional pressure on the exterior of the lymphatic and lacteal vessels propels the lymph onward; thus muscular and other external pressure accelerates the flow of the lymph as it does that of the blood in the veins. The action of the muscular fibres of the small intestine, and the layer of unstripped muscle present in each intestinal villus, assist in propelling the chyle; for, in the small intestine of a mouse, the chyle has been seen moving with intermittent propulsions that correspond with the peristaltic movements of the intestine. But, for the general propulsion of the lymph and chyle, it is probable that, together with the *vis a tergo* resulting from external pressure, some of the force may be derived from the contractility of the vessel's own walls. The respiratory movements, also, favour the current of lymph through the thoracic duct as they do the current of blood in the thoracic veins.

**Lymph-Hearts.**—In reptiles and some birds, an important auxiliary to the movement of the lymph and chyle is supplied in certain muscular sacs, named *lymph-hearts*, and it has been shown that the caudal heart of the eel is a lymph-heart also. The number and position of these organs vary. In frogs and toads, there are usually four, two anterior and two posterior. Into each of these cavities several lymphatics open, the orifices of the vessels being guarded by valves, which prevent the retrograde passage of the lymph. From each heart a single vessel proceeds, and conveys the lymph directly into the venous system. Blood is prevented from passing into the lymphatic heart by a valve at its orifice.

The muscular coat of these hearts is of variable thickness; in some cases it can only be discovered by means of the microscope; but in every case it is composed of striped fibres. The contractions of the hearts are rhythmical, occurring about sixty times in a minute. The pulsations of the cervical pair are not always synchronous with those of the pair in the ischiatic region, and even the corresponding sacs of opposite sides are not always synchronous in their action.

Unlike the contractions of the blood-heart, those of the lymph-heart appear to be directly dependent upon a certain limited portion of the spinal cord. For Volkmann found that so long as the portion of spinal cord corresponding to the third vertebra of the frog was uninjured, the cervical pair of lymphatic hearts continued pulsating after all the rest of the spinal cord and the brain were destroyed; while destruction of this portion, even though all other parts of the nervous centres were uninjured, instantly arrested the hearts' movements. The posterior, or ischiatic, pair of lymph-hearts were found to be governed, in like manner, by the portion of spinal cord corresponding to the eighth vertebra. Division of the posterior spinal roots did not arrest the movements; but division of the anterior roots caused them to cease at once.

**Innervation of the Thoracic Duct.**—By determining the rate of outflow of a fluid at constant pressure passing through the thoracic duct Camus and

Gley have obtained evidence of the presence of nerves, causing both dilatation and constriction of the duct. These are contained in the sympathetic chain below the first thoracic ganglion. The effect of stimulation is principally dilatation.

### Relation of Lymph and Blood.

The volume of blood in the body remains remarkably constant. If the amount is increased by injection of fluids, at first its specific gravity is lessened, but in a short time, often in a few minutes, it returns to the normal. The excess of fluid is got rid of in two ways: (1) by the kidneys, which secrete profusely; and (2) by the tissues, which become more watery in consequence. After the renal arteries are ligatured, and the kidney is consequently thrown out of action, the excess of water passes only into the tissues.

On the other hand, a deficiency of blood (for instance, after hæmorrhage) is soon remedied by a transfer of water from the tissues to the blood through the intermediation of the lymph.

In severe hæmorrhage life has often been saved by injection of saline solution into the vessels, or by transfusion from another person. The transfer of the blood of another animal to the human vascular system is usually dangerous, especially if the blood has been defibrinated, for the serum of one animal is usually poisonous to another, producing various changes, of which a breakdown of the corpuscles (hæmolysis) is the most constant sign.

### Formation of Lymph.

Carl Ludwig taught that the lymph flow is conditioned by two factors: first, differences in the pressure of the blood in the capillaries and of the fluid in the tissue spaces, giving rise to a *filtration* of fluid through the capillary walls; and secondly, chemical differences between these two fluids, setting up *osmotic* interchanges through the wall of the blood-vessel.

*Osmosis.* The phenomenon of the passage of fluids through animal membrane, which occurs quite independently of vital conditions, was first demonstrated by Dutrochet. The instrument which he employed in his experiments was named an *endosmometer*. One form of this, represented in the figure (fig. 295), consists of a graduated tube expanded into an open-mouthed bell at one end, over which a portion of membrane is tied. If the bell is filled with a solution of a salt—say sodium chloride—and is immersed in water, the water will pass into the solution, and part of the salt will pass out into the water; the water, however, will pass into the solution much more rapidly than the salt will pass out into the water, and the diluted solution will rise in the tube. It is to this passage of fluids through membrane that the terms *dialysis* and *osmosis* are applied.

The nature of the membrane used as a septum, and its affinity for the

fluids subjected to experiment, have an important influence, as might be anticipated, on the rapidity and duration of the osmotic current. Thus, if a piece of ordinary bladder be used as a septum between water and alcohol, the current is almost solely from the water to the alcohol, on account of the much greater affinity of water for this kind of membrane; while, on the other hand, in the case of a membrane of caoutchouc, the alcohol, from its greater affinity for this substance, would pass freely into the water.

The general question of osmosis will be more fully discussed in relation to the work of the kidney.

If the lymph is produced by a simple act of filtration, then the amount of lymph must rise and sink with the value of  $D-d$ ;  $D$  representing the capillary blood-pressure, and  $d$  the pressure in the tissue spaces.

In support of this mechanical theory, various workers in Ludwig's laboratory showed that increased capillary pressure due to obstruction of the venous outflow increases the amount of lymph formed; and that diminution of the pressure in the lymph spaces, by squeezing out the lymph previously contained in them, leads to an increase in the transudation.

On the other hand, there were some facts which could not be well explained by the filtration theory, among which may be mentioned the action of curare in causing an increase of lymph flow.

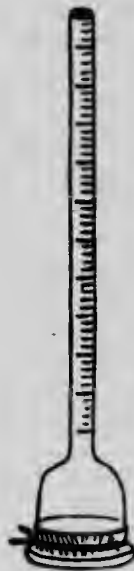

Fig. 295. — Endosmometer.

Heidenhain was the first to fully recognise that the laws of filtration and osmosis as applied to dead membranes may be considerably modified when the membranes are composed of living cells; and he considered that the formation of lymph is due to the selective or secretory activity of the endothelial walls of the capillaries. This so-called

vital action of the endothelial cells is seen in the fact that after the injection of sugar into the blood, in a short time the percentage of sugar in the lymph becomes higher than that in the blood. There must, therefore, be some activity of the endothelial cells in picking out the sugar from the blood and passing it on to the lymph.

Heidenhain is also the inventor of the term *lymphagogues* (literally lymph drivers). These are substances like curare, which have a specific action in causing an increased lymph flow. Heidenhain considers the majority of these act by stimulating the endothelial cells to activity. This conclusion, however, has been subjected to much criticism. In this country the question has been taken up by Dr. Starling, who has shown that the influence

of vital action is not so marked as Heidenhain supposes it to be, but that most of the phenomena in connection with lymph formation can be explained by the simpler mechanical theory. Starling's views may be briefly stated as follows:—

The amount of lymph produced in any part depends on two factors:—

1. The pressure at which the blood is flowing through the capillaries. Heidenhain took the arterial pressure in his experiments as the measure of the capillary pressure; Starling points out, very justly, that this is incorrect, as there is between the arteries and the capillaries the peripheral resistance in the arterioles.

2. The permeability of the capillary wall. This varies enormously in different regions; it is greatest in the liver, so that an intracapillary pressure which would cause lymph to flow here is without effect on the production of lymph in the limbs.

The flow of lymph may therefore be increased in two ways:—

1. By increasing the intracapillary pressure. This may be done locally by ligaturing the veins of an organ; or generally by injecting a large amount of fluid into the circulation, or by the injection of such substances as sugar and salt (Heidenhain's first class of lymphagogues) into the blood. These attract water from the tissues into the blood, and thus increase the volume of the circulating fluid and raise the intracapillary pressure.

2. By increasing the permeability of the capillary wall by injuring its vitality. This may be done locally by scalding a part; or generally, by injecting certain poisonous substances, such as peptone, leech extract, decoction of mussels, &c. (Heidenhain's second class of lymphagogues). These act chiefly on the liver capillaries; curare acts chiefly on the limb capillaries.

In the light of our present knowledge on this question, it is impossible to pronounce any absolutely positive opinion. But facts appear to me to be accumulating which tell in favour of the secretion theory. If the endothelial wall were a non-living membrane, physical processes would obviously explain all the phenomena of lymph formation. But we must recognise that the endothelial cells are alive, and that like other cells they are capable of a selective action which may mask or counteract or assist the purely physical processes. If the action of poisons was simply to injure the vessel wall and increase its permeability, the amount of lymph should be proportional to the intensity of the injury, but this is not found to be the case. Heidenhain no doubt went too far when he attributed lymph formation almost

exclusively to endothelial activity; and Starling has gone too far in the other direction. My own opinion is that lymph formation is mainly influenced by the physical conditions present, for the action of such thin cells as those of the capillary wall cannot be sufficiently great to entirely counteract these conditions; at the same time it is impossible to deny that there is some such action as may be described by the terms "selective" or "vital." The question is closely related to that of absorption from the alimentary canal, and we shall find in studying that subject that there is a similar difference of opinion, and that recently published researches confirm the theory of selective activity of the absorptive epithelium.

---

## CHAPTER XXIII.

### THE DUCTLESS GLANDS.

THE ductless glands form a heterogeneous group of organs, most of which are related in function or development with the circulatory system. They include the lymphatic glands, the spleen, the thymus, the thyroid, the suprarenal capsules, the pineal body, the pituitary body, and the carotid and coccygeal glands. The function of a gland that has a duct is a comparatively simple physiological problem, but the use of ductless glands has long been a puzzle to investigators. Recent research has, however, shown that most of, if not all, the ductless glands do form a secretion, and this *internal secretion*, as it is termed, leaves the gland by the venous blood or lymph, and thus is distributed and ministers to the needs of parts of the body elsewhere. Many of the glands which possess ducts and form an external secretion, form an internal secretion as well. Among these the liver, pancreas, and kidney may be mentioned.

In many cases the internal secretion is essential for life, and removal of the gland that forms it, leads to a condition of disease culminating in death. In other cases the internal secretion is not essential, or its place is taken by that formed in similar glands in other parts of the body.

The body is a complex machine; each part of the machine has its own work to do, but must work harmoniously with other parts. Just as a watch will stop if any of its numerous wheels get broken, so the metabolic cycle will become disarranged or

cease altogether if any of the links in the chain break down.

In unravelling the part which the ductless glands play in this cycle, it is at present impossible in many cases to state precisely what the particular function of each is; all one can say is, when the gland is removed or its function interfered with, that the metabolic round is broken somehow, and that this upsets the whole of the machinery of the body. The difficulty of investigating this subject is increased by the fact that it is impossible to get the internal secretion in a state of purity and examine it; it is always mixed with, and masked by, the lymph or blood into which it is poured.

In spite of this, however, our knowledge in this branch of physiology is increasing, particularly in connection with some of these ductless glands. The methods of investigation which have been employed are the following:—

1. *Extirpation.*—The gland in question is removed, and the effect of the absence of the internal secretion noted.

2. *Disease.*—In cases where the function of the gland is in abeyance, owing to its being diseased, the symptoms are closely observed.

3. *Injection of Extracts.*—The gland is taken in a fresh condition; an extract is made of it, and this is injected into the circulation of healthy animals, and into that of those animals from which the gland has been previously removed, and the effects watched.

4. *Transplantation.*—After the gland is removed and the usual effect produced, the same gland from another animal is transplanted into the first animal and restoration of function looked for.

The case of the lymphatic glands we have already studied; they form an internal secretion which consists of lymph-cells, and these furnish the blood with its most important supply of colourless corpuscles. Removal of lymphatic glands is not fatal, as the other lymphatic glands and other collections of lymphoid tissue that remain behind carry on the work of those that are removed.

The internal secretion theory of the ductless glands is that which is most in vogue at present. It should be mentioned, however, that there is another theory, which may be called the *auto-intoxication* theory. According to this view the gland is excretory (*i.e.*, gets rid of waste and harmful materials) rather than secretory (*i.e.*, production of something useful to the organism). When the gland is removed, the waste products therefore accumulate and produce harmful results. It is possible that as our knowledge increases it may be found in certain cases that both these theories may be in part true.

### The Spleen.

**The Spleen** is the largest of the ductless glands; it is situated to the left of the stomach, between it and the diaphragm. It is of a deep red colour and of variable shape. Vessels enter and leave the gland at a depression on the inner side called the *hilus*.

*Structure.*—The spleen is covered externally almost completely



Fig. 296.—Section of injected dog's spleen. *c*, capsule; *tr*, trabeculae; *m*, two Malpighian bodies with numerous small arteries and capillaries; *a*, artery; *l*, lymphoid tissue, consisting of closely-packed lymphoid cells supported by very delicate retiform tissue; a light space unoccupied by cells is seen all round the trabeculae, which corresponds to the "lymph-path" in lymphatic glands. (Schöfield.)

by a serous coat derived from the peritoneum, while within this is the proper fibrous coat or capsule of the organ. The latter is composed of connective-tissue, with a large preponderance of elastic fibres and a certain proportion of unstriated muscular tissue. Prolonged from its inner surface are fibrous processes or *trabeculae*, containing much unstriated muscle, which enter the

interior of the organ and, dividing and anastomosing in all parts, form a supporting framework in the interstices of which the proper substance of the spleen (*spleen-pulp*) is contained.

At the hilus of the spleen, the blood-vessels, nerves, and lymphatics enter or leave, and the fibrous coat is prolonged into the spleen substance in the form of investing sheaths for the arteries and veins, which sheaths again are continuous with the trabeculæ before referred to.

The *spleen-pulp*, which is of a dark red or reddish-brown colour, is composed chiefly of cells, imbedded in a network formed of fibres, and the branchings of large nucleated cells. The network so formed is thus very like a coarse kind of retiform tissue. The spaces of this network are only partially occupied by cells and form a freely communicating system. Of the cells some are granular corpuscles resembling the lymph-corpuscles, both in general appearance and in being able to perform amœboid movements; others are red blood-corpuscles of normal appearance or variously changed; while there are also large cells containing either a pigment allied to the colouring matter of the blood, or rounded corpuscles like red corpuscles.

The splenic artery, after entering the spleen by its concave surface, divides and subdivides, with but little anastomosis between its branches; at the same time its branches are sheathed by the prolongations of the fibrous coat, which they, so to speak, carry into the spleen with them. The arteries soon leave the trabeculæ, and their outer coat is then replaced by one of lymphoid tissue; they end in an open brushwork of capillaries, the endothelial cells of which become continuous with those of the *rete* of the spleen-pulp. The veins begin by a similar open set of capillaries from the large blood spaces of the pulp. The veins soon pass into the trabeculæ, and ultimately unite to form the splenic vein. This arrangement readily allows lymphoid and other corpuscles to be swept into the blood-current.

On the face of a section of the spleen can be usually seen readily with the naked eye, minute, scattered rounded or oval whitish spots, mostly from  $\frac{1}{30}$  to  $\frac{1}{60}$  inch ( $\frac{5}{6}$  to  $\frac{2}{3}$  mm.) in diameter. These are the *Malpighian corpuscles* of the spleen, and are situated on the sheaths of the minute splenic arteries. They are in fact outgrowths of the outer coat of lymphoid tissue

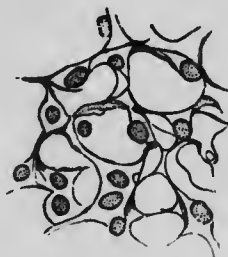

Fig. 297.—Reticulum of the spleen of a cat, shown by injection with gelatine. (Cadiat.)



just referred to (see fig. 298). Blood capillaries traverse the Malpighian corpuscles and form a plexus in their interior. The structure of a Malpighian corpuscle of the spleen is practically identical with that of a lymphoid nodule.

*Functions.*—These are the following:—

(1.) The spleen, like the lymphatic glands, is engaged in the formation of colourless blood-corpuscles. For it is quite certain, that

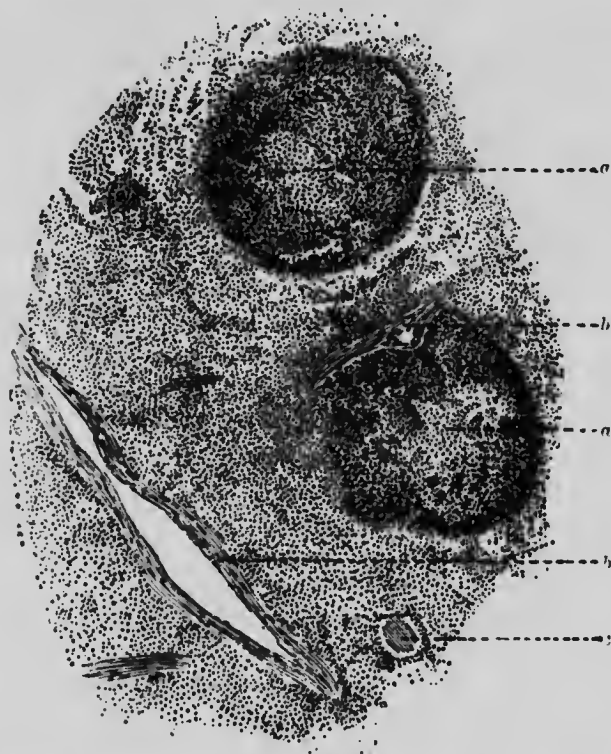

Fig. 298.—Section of spleen of cat. *a, a'*, Malpighian corpuscle ; in the case of *a'*, the connection with a small artery, *b*, is seen ; *b, b'*, small arteries ; *c*, section of trabecule.

the blood of the splenic vein contains an unusually large proportion of white corpuscles ; and in the disease termed *leucocythæmia*, in which the white corpuscles of the blood are remarkably increased in number, there is found a hypertrophied condition of the spleen, especially of the Malpighian corpuscles. The white corpuscles formed in the spleen also doubtless partly leave that organ by lymphatic vessels.

By stimulating the spleen to contract in a case of splenic leucocythæmia by means of an electric current applied over it

through the skin, the number of leucocytes in the blood is almost immediately increased.

Removal of the spleen is not fatal; but after its removal there is an overgrowth of the lymphatic glands to make up for its absence.

(2.) It forms *coloured corpuscles*, at any rate, in some animals; in these animals, cells are found in the spleen similar to those we have described in red marrow, and called *hæmatoblasts*. In these animals, if the spleen is removed, the red marrow hypertrophies.

(3.) There is reason to believe that in the spleen many of the *red corpuscles* of the blood, those probably which have discharged their office and are worn out, *undergo disintegration*; for in the coloured portions of the spleen-pulp an abundance of such corpuscles, in various stages of degeneration, are found, and in those cases of disease in which the destruction of blood-corpuscles is increased (*perilicious anæmia*) iron accumulates in the spleen as in the liver. It was formerly supposed that the spleen broke down the corpuscles and liberated hæmoglobin, which, passing in the blood of the splenic vein to the liver, was discharged by that organ as bile-pigment. But this is not the case; the disintegration does not proceed so far as to actually liberate hæmoglobin; there is no free hæmoglobin in the blood-plasma of the splenic vein.

(4.) From the almost constant presence of uric acid, in larger quantities than in other organs, as well as of the nitrogenous bodies, xanthine and hypoxanthine, in the spleen, some share in *nitrogenous metabolism* may be fairly inferred to occur in it.

(5.) Besides these direct offices, the spleen fulfils some purpose in regard to the portal circulation with which it is in close connection. From the readiness with which it admits of being distended, and from the fact that it is generally small while gastric digestion is going on, and enlarges when that act is concluded, it is supposed to act as a kind of vascular reservoir, or diverticulum to the portal system; or more particularly to the vessels of the stomach. That it may serve such purpose is also made probable by the enlargement which it undergoes in certain affections of the heart and liver, attended with obstruction to the passage of blood through the latter organ, and by its diminution when the congestion of the portal system is relieved by discharges from the bowels, or by the effusion of blood into the stomach. This mechanical influence on the circulation, however, can hardly be supposed to be more than a very subordinate function.

*Influence of the Nervous System upon the Spleen.*—When the spleen is enlarged after digestion, its enlargement is due to two

causes : (1) a relaxation of the muscular tissue which forms so large a part of its framework ; (2) a dilatation of the vessels. Both these phenomena are under control of the nervous system.



Fig. 299.—Roy's Oncometer for spleen ; A, open ; B, closed.

It has been found by experiment that when the splenic nerves are cut the spleen enlarges, and that contraction can be brought about by stimulation of the peripheral ends of the divided nerves. If the splenic nerves are not cut, contraction is produced by

(1) stimulation of the spinal cord ; (2) reflexly by stimulation of the central stumps of certain divided nerves, *e.g.*, vagus and sciatic ; (3) by local stimulation by an electric current ; (4) by the administration of quinine and some other drugs.

It has been shown by the oncometer of Roy that the spleen undergoes rhythmical contractions and dilatations, due to the contraction and relaxation of the muscular tissue in its capsule and trabeculæ. A tracing also shows waves due to the rhythmical alterations of the general blood-pressure.

The form of oncometer adapted for the shape of the spleen

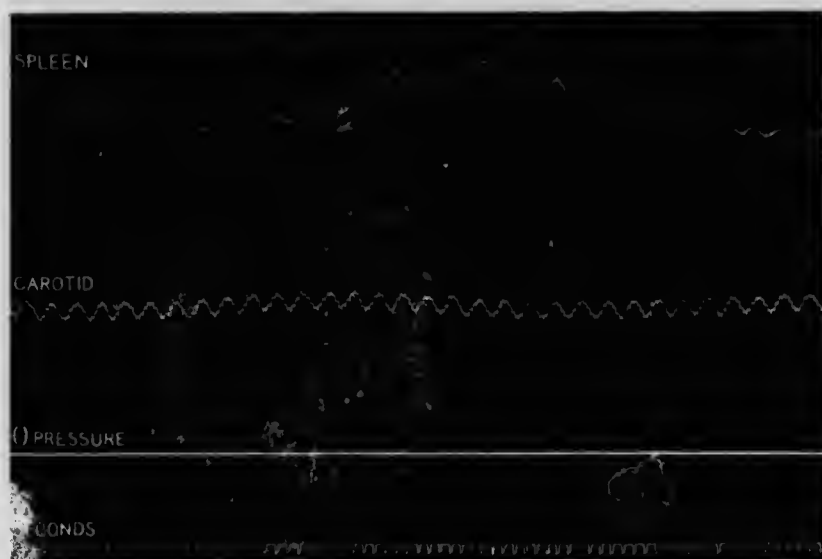

Fig. 300.--The upper tracing is the spleen record ; the next is carotid blood pressure taken with a mercurial kymograph. The straight line beneath this is the abscissa of the arterial pressure ; and the lowest tracing is the time in seconds.

of most animals is shown on p. 326. In most mammals the spleen is not kidney-shaped as in man, but narrow and ribbon shaped. The general principles of the oncometer have been explained on p. 309, where it is mentioned that by an air oncometer Schäfer has obtained good tracings ; these show first, the large waves occurring about once a minute, due to the splenic systole and diastole ; secondly, smaller waves on this, due to the effect of respiration on the blood-pressure ; and on these, smaller waves still, corresponding with the individual heart-beats. The large waves due to the splenic contractility still go on after the division of all the splenic nerves. These nerve-fibres leave the spinal cord in numerous thoracic anterior roots ; they have

cell stations in the sympathetic chain (Schäfer) or semi-lunar ganglia (Langley).

The preceding figure (fig. 300) shows a typical tracing obtained by Schäfer's instrument, from a dog's spleen.

### The Thymus.

This gland is a temporary organ; it attains its greatest size early after birth, and after the second year gradually diminishes, until in adult life hardly a vestige remains. At its greatest development it is a long narrow body, situated in the front of the chest



Fig. 301.—Transverse section of a lobule of an injected infantile thymus gland. *a*, capsule of connective-tissue surrounding the lobule; *b*, membrane of the glandular vesicles; *c*, cavity of the lobule, from which the larger blood-vessels are seen to extend towards and ramify in the spheroidal masses of the lobule.  $\times 30$ . (Kölliker.)

behind the sternum and partly in the lower part of the neck. It is of a reddish or greyish colour, and is distinctly lobulated.

*Structure.*—The gland is surrounded by a fibrous capsule, which sends in processes, forming trabeculæ, that divide the gland into lobes, and carry the blood- and lymph-vessels. The large trabeculæ branch into small ones, which divide the lobes into lobules. The lobules are further subdivided into follicles by fine connective-tissue. A follicle (fig. 303), is seen on section to be more or less polyhedral in shape, and consists of cortical and medullary portions, both of which are composed of adenoid or lymphoid tissue, but in the medullary portion the matrix is coarser, and is not so filled up with lymphoid corpuscles as in the cortex.

Scattered in the lymphoid tissue of the medulla are the *concentric corpuscles of Hassall* (fig. 304), which consist of a nucleated granular centre, surrounded by flattened nucleated epithelial

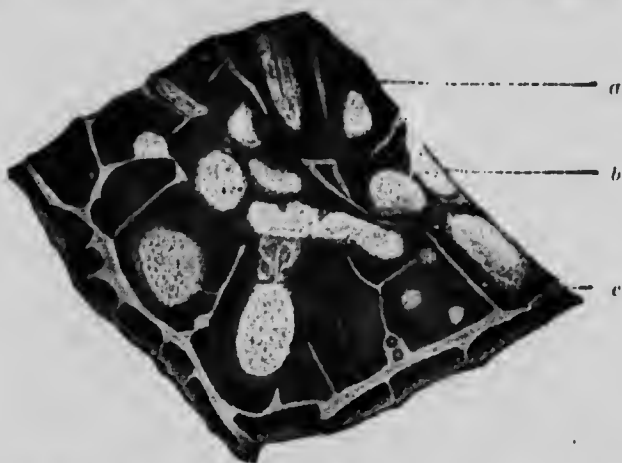

Fig. 302.—Thymus of a calf. *a*, cortex of follicle; *b*, medulla; *c*, interfollicular tissue. Magnified about twelve times. (Watney.)

cells. These are islands of epithelial cells cut off from the epithelium of the pharynx in process of development. They are not occluded blood-vessels, as was at one time supposed. They

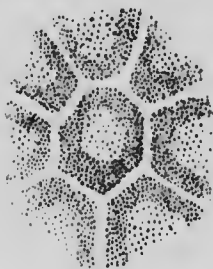

Fig. 303.—From a horizontal section through superficial part of the thymus of a calf, slightly magnified. Showing in the centre a follicle of polygonal shape with similarly shaped follicles round it. (Klein and Noble Smith.)



Fig. 304.—The reticulum of the thymus. *a*, lymph cells; *b*, corpuscles of Hassall. (Cadiat.)

remind one somewhat of the epithelial nests seen in some varieties of cancer.

The arteries radiate from the centre of the gland. Lymph sinuses may be seen occasionally surrounding the periphery of the follicles (Klein). The nerves are very minute.

From the thymus various substances may be extracted, many of them similar to those obtained from the spleen, *e.g.*, xanthine, hypoxanthine, adenuine, and leucine.

The main constituent of the cells is proteid, and especially nucleo-proteid. Indeed the thymus is usually employed as the source of nucleo-proteid when one wishes to inject that substance into the blood-vessels of an animal to produce experimentally intravascular clotting. It is, however, not characteristic of the thymus, but is found in all protoplasm. The method of preparation will be given later (see Coagulation of Blood).

*Function.*—The thymus takes part in producing the colourless corpuscles like other varieties of lymphoid tissue. In hibernating animals it exists throughout life, and as each successive period of hibernation approaches it greatly enlarges and becomes laden with fat. Hence it appears to serve for the storing up of materials which, being reabsorbed during the inactivity of the hibernating period, may maintain the respiration and the temperature of the body in the reduced state to which they fall during that time. Some observers state that it is also a source of the red blood-corpuscles, at any rate in early life.

Removal of the thymus in the frog (in which animal it persists throughout life) produces muscular weakness, paralysis, and finally death. Intravenous injection of extracts of thymus lowers blood pressure, though the heart may be somewhat accelerated.

### The Thyroid.

The thyroid gland is situated in the neck. It consists of two lobes, one on each side of the trachea, extending upwards to the thyroid cartilage, covering its inferior cornu and part of its body; these lobes are connected across the middle line by a middle lobe or isthmus. It is highly vascular, and varies in size in different individuals.

*Structure.*—The gland is encased in a capsule of dense areolar tissue. This sends in strong fibrous trabeculæ, which enclose the thyroid *vesicles*—which are rounded or oblong irregular sacs, consisting of a wall of thin hyaline membrane lined by a single layer of short cylindrical or cubical cells. These vesicles are filled with transparent colloid nucleo-albuminous material. The colloid substance increases with age, and the cavities appear to coalesce. In the interstitial connective-tissue is a round meshed capillary plexus, and a large number of lymphatics. The nerves adhere closely to the vessels.

In the vesicles there are, in addition to the yellowish glassy

colloid material, epithelium cells, colourless blood-corpuscles, and also coloured corpuscles undergoing disintegration.

*Function.*—It is difficult to state definitely the function of the thyroid body; it is one of those organs of great importance in the metabolic round; and its removal or disease is followed by general disturbances. It no doubt forms an internal secretion; to this the colloid material mentioned contributes, as it is found in the lymphatic vessels of the organ.

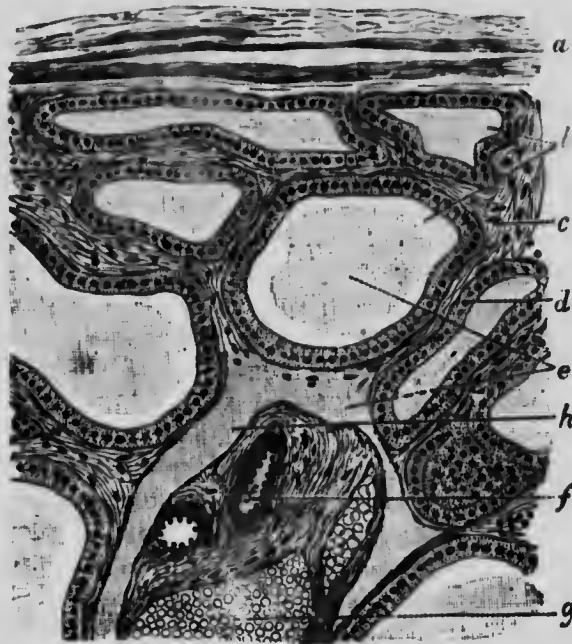

Fig. 305.—Part of a section of the human thyroid. *a*, fibrous capsule; *b*, thyroid vesicles filled with, *c*, colloid substance; *c*, supporting fibrous tissue; *d*, short columnar cells lining vesicles; *f*, arteries; *g*, veins filled with blood; *h*, lymphatic vessel filled with colloid substance. (S. K. Alcock.)

When the gland is diseased in children and its function obliterated a species of idiocy is produced called *cretinism*.

The same condition in adults is called *myxœdema*; the most marked symptoms of this condition are slowness, both of body and mind, usually associated with tremors and twitchings. There is also a peculiar condition of the skin leading to the overgrowth of the subcutaneous tissues, which in time is replaced by fat; the hair falls off, the hands become spade-like; the whole body is unwieldy and clumsy like the mind.

A similar condition occurs after the thyroid is completely removed surgically; this is called *cachexia strumipriva*; this operation,



which was performed previous to our knowledge of the importance of the thyroid, is not regarded as justifiable nowadays.

Lastly, in many animals removal of the thyroid produces analogous symptoms, in the overgrowth of the connective-tissues especially under the skin, and in the nervous symptoms (twitchings, convulsions, etc.).

The term *Myxœdema* was originally given under the erroneous idea that the swelling of the body is due to mucin. In the early stages of the disease there is a slight increase of mucin, because all new connective-tissues contain a relatively large amount of ground substance, the most abundant constituent of which, next to water, is mucin. But there is nothing characteristic about that.

The discovery of the relationships between the thyroid and these morbid conditions is especially interesting, because important practical results in their treatment have followed close on the heels of experimental investigation. The missing internal secretion of the thyroid may be replaced in these animals and patients by grafting the thyroid of another animal into the abdomen; or more simply by injecting thyroid extract subcutaneously; or even by feeding on the thyroid of other animals. This treatment, which has to be kept up for the rest of the patient's life, is entirely successful. Chemical physiologists have been searching recently to try and discover what the active material in thyroid extract is which produces such marvellous results; the view at present held is that the efficacy of thyroid extract is due to a substance which Baumann separated from the gland and which stands almost unique among physiological compounds by containing a large percentage of iodine in its molecule. *Thyro-iodin* or *Iodo-thyrin*, as this substance has been called, is present in combination with proteid matter in the colloid substance.

Intravenous injection of thyroid extract in a normal animal lowers blood pressure; in an animal from which the thyroid has been removed injection stimulates the heart and raises blood pressure.

*Parathyroids.*—These are small bodies situated in the neighbourhood of, or embedded in the substance of, the thyroid. They are made up of elongated groups of polyhedral cells bound together by connective-tissue and well supplied with blood-vessels. Some observers look upon these as being even more essential to healthy life than the thyroid, but this point is by no means decided.

The general idea, however, that prevails is that the thyroid

supplies something which is a stimulator of metabolic processes, and that the action on the nervous system is more especially the work of the parathyroids.

### The Supra-renal Capsules.

These are two triangular or cocked-hat-shaped bodies, each resting by its lower border upon the upper border of the kidney.

*Structure.*—The gland is surrounded by an outer sheath of con-

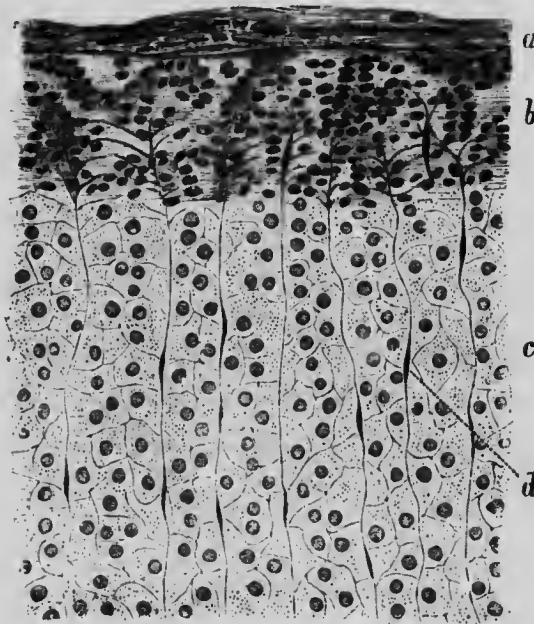

Fig. 306.—Vertical section through part of the cortical portion of supra-renal of guinea-pig. *a*, capsule; *b*, zona glomerulosa; *c*, zona fasciculata; *d*, connective-tissue supporting the columns of the cells of the latter, and also indicating the position of the blood-vessels. (S. K. Alcock.)

nective-tissue, which sends in fine prolongations forming the framework of the gland. The gland tissue proper consists of an outside firmer cortical portion and an inside soft, dark medullary portion.

(1.) The *cortical portion* is divided into (fig. 306) columnar groups of cells (*zona fasciculata*). Immediately under the capsule, however, the groups are more rounded (*zona glomerulosa*), while next to the medulla they have a reticular arrangement (*zona reticularis*). The cells themselves are polyhedral, each with a clear round nucleus, and often with oil globules in their protoplasm. The blood-vessels run in the fibrous septa between the columns, but do not penetrate between the cells.

(2.) The *medullary substance* consists of a coarse rounded or irregular meshwork of fibrous tissue, in the alveoli of which are masses of multinucleated protoplasm (fig. 307); numerous blood-vessels; and an abundance of nerve-fibres and cells. The cells are very irregular in shape and size, poor in fat, and often branched; the nerves run through the cortical substance, and anastomose over the medullary portion.

The cells of the medulla are characterised by the presence of certain reducing substances. One of these takes a brown stain with chromic acid, and gives other colour reactions; it is, therefore, called a *chromogen*. Another is similar in many of its

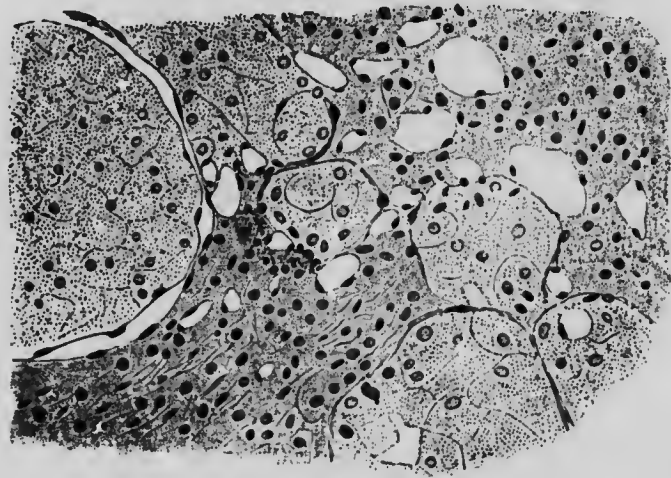

Fig. 307.—Section through a portion of the medullary part of the supra-renal of guinea-pig. The vessels are very numerous, and the fibrous stroma more distinct than in the cortex, and is, moreover, reticulated. The cells are irregular and larger, clear, and free from oil globules. (S. K. Alcock.)

characters to jecorin, a lecithin-like substance also found in the liver, spleen, and other organs.

*Function.*—The immense importance of the supra-renal bodies was first indicated by Addison, who, in 1855, pointed out that the disease now known by his name is associated with pathological alterations of these glands. This was tested experimentally by Brown-Séquard, who found a few years later that removal of the supra-renals in animals is invariably and rapidly fatal. The symptoms are practically the same (although more acute) as those of Addison's disease, namely, great muscular weakness, loss of vascular tone, and nervous prostration. The pigmentation (bronzing) of the skin, however, which is a marked symptom in Addison's disease, is not seen in animals. The experiments of

Brown-Séguard attracted much attention at the time they were performed, but were almost forgotten until quite recently, when they were confirmed by Abelous, Langlois, Schäfer, and others. The effects on the muscular system are the most marked results both after removal of the capsules and after injection of an extract of the glands. The effect of injecting such an extract on the voluntary muscles is to increase their tone, so that a tracing obtained from them resembles that produced by a small dose of veratrine, namely, a prolongation of the period of relaxation. The effect on involuntary muscle is equally marked; there is an enormous rise of arterial blood-pressure due chiefly to a contraction of the arterioles. This is produced by the direct action of the extract on the muscular tissue of the arterioles, not an indirect one through the vaso-motor centre. The active chemical substance in the extract that produces the effect is either the reducing substance or chromogen alluded to above, or some other substance united to it; it is confined to the medulla of the capsules, and is absent in cases of Addison's disease.

The capsules, therefore, form something which is distributed to the muscles and is essential for their normal tone; when they are removed or diseased the poisonous effects seen are the result of the absence of this internal secretion.

Some physiologists have considered that the substance which produces these effects is allied to pyrocatechin; this, however, is incorrect; it is more probable that the active material is alkaloidal in nature, possibly allied to piperidine or nicotine, both of which substances produce a large rise of blood-pressure. Abel states he has succeeded in isolating the alkaloid; he has named it *epinephrine*. v. Fürth has separated another body which he calls *suprarenine*. It is extremely doubtful if either of these materials is the active substance; for Moore has shown that a millionth part of a gramme of dried supra-renal will produce an effect on blood-pressure, so a very small contamination of any so-called pure material would vitiate the results.

Whether this discovery will lead to the same important practical results as in the case of the thyroid and myxœdema must be left to the future to decide. There is already some evidence to show that injection of supra-renal extract is beneficial in cases of Addison's disease.

There are some points of interest in the development and comparative physiology of the supra-renals. In mammals the medullary portion is developed in connection with the sympathetic, and is at first distinct and outside the cortical portion which is developed in connection with the upper part of the Wollfian body; it gradually insinuates itself within the cortex (Mitsukiri). In elasmobranch fishes the supra-renals consist throughout life of separate portions; one the inter-renal body is

medium in position and single ; this corresponds to the cortex of the mammalian supra-renal ; extracts of this are inactive, and in the Teleostean fishes, where it is the sole representative of the supra-renal, it may be removed without any harm to the animal. The other portion of the Elasmobranch supra-renal is paired, and derived from the sympathetic ganglia. This corresponds to the medulla ; it contains the same chromogen as the medulla of the mammalian supra-renal, and extracts of it have the same physiological action (S. Vincent).

#### The Pituitary Body.

This body is a small reddish-grey mass, occupying the sella turcica of the sphenoid bone. It consists of two lobes—a small posterior one, consisting of nervous tissue ; and an anterior larger one, resembling the thyroid in structure. A canal lined with flattened or with ciliated epithelium passes through the anterior lobe ; it is connected with the infundibulum. The alveoli are approximately spherical ; they are filled with nucleated cells of various sizes and shapes not unlike ganglion cells, collected together into rounded masses, filling the vesicles, and contained in a semi-fluid granular substance. The vesicles are enclosed by connective-tissue, rich in capillaries. Disease of the pituitary body produces the condition called *acromegaly*, in which the bones of limbs : d face hypertrophy.

When the gland is removed in animals, tremors and spasms occur like those which take place after removal of the thyroid. Death usually occurs within fourteen days. Some observers have stated that overgrowth of the pituitary occurs after excision of the thyroid. But there is no ground for the assumption that the two glands have a similar function. *Acromegaly* is a very different disease from myxœdema. The injection of extracts of the organs are also different. Thyroid extract produces a fall of arterial pressure. Extracts of the anterior lobe (hypophysis) of the pituitary body are inactive ; but extracts of the posterior lobe or infundibular body contain two active substances, one of which produces a rise, and the other a fall of blood-pressure. A second dose of the former of these injected soon after the first dose is inactive ; and so it is not the same thing as in supra-renal extract. The chemical nature of the two substances is not known.

#### The Pineal Gland.

This gland, which is a small reddish body, is placed beneath the back part of the corpus callosum, and rests upon the corpora

quadrigemina. It contains a central cavity lined with ciliated epithelium. The gland substance proper is divisible into—(1) An outer cortical layer, analogous in structure to the anterior lobe of the pituitary body; and (2) An inner central layer, wholly nervous. The cortical layer consists of a number of closed follicles, containing (*a*) cells of variable shape, rounded, elongated, or stellate; (*b*) fusiform cells. There is also present brain-sand, gritty matter consisting of round particles aggregated into small masses. The central substance consists of white and grey matter. The blood-vessels are small and form a very delicate capillary plexus.

The pineal gland is the atrophied remains of a third eye situated centrally. This eye is found in a more perfect condition, though covered by skin, in certain lizards, such as *Hatteria*.

#### The Coccygeal and Carotid Glands.

These so-called glands are situated, the one in front of the tip of the coccyx and the other at the point of bifurcation of the common carotid artery on each side. They are made up of a plexus of small arteries, are enclosed and supported by a capsule of fibrous tissue, which contains connective-tissue corpuscles. The blood-vessels are surrounded by one or more layers of cells resembling secreting-cells, which are said to be modified plasma cells of the connective-tissue. The function of these bodies is unknown.

---

## CHAPTER XXIV.

### RESPIRATION.

THE respiratory apparatus consists of the lungs and of the air-passages which lead to them. In marine animals the gills fulfil the same functions as the lungs of air-breathing animals. The muscles which move the thorax and the nerves that supply them must also be included under the general heading Respiratory System; and, using this expression in the widest sense, it includes practically all the tissues of the body, since they are all concerned in the using up of oxygen and the production of waste materials, like carbonic acid.

Essentially a lung or gill is constructed of a thin membrane, one surface of which is exposed to the air or water, as the case may be, while, on the other, is a network of blood-vessels—

the only separation between the blood and aerating medium being the thin wall of the blood-vessels, and the fine membrane on one side of which vessels are distributed. The difference between the simplest and the most complicated respiratory membrane is one of degree only.

The lungs or gills are only the medium for the *exchange*, on the part of the blood, of carbonic acid for oxygen. They are not the seat, in any special manner, of those combustion-processes of which the production of carbonic acid is the final result. These processes occur in all parts of the body in the substance of the tissues.

### The Respiratory Apparatus.

The object of respiration being the interchange of gases in the lungs, it is necessary that the atmospheric air should pass into them, and that the changed air should be expelled from them. The lungs are contained in the chest or thorax, which is a closed cavity having no communication with the outside except by means of the respiratory passages. The air enters these passages through the nostrils or through the mouth, whence it passes through the larynx into the trachea or windpipe, which about the middle of the chest divides into two tubes, bronchi, one to each (right and left) lung.

The *Larynx* is the upper part of the passage, and will be described in connection with the voice.

*The Trachea and Bronchi.*—The trachea extends from the cricoid cartilage, which is on a level with the fifth cervical vertebra, to a point opposite the third dorsal vertebra, where it divides into the two bronchi, one for each lung (fig. 308). It measures, on an average, four or four and a half inches in length and from three-quarters of an inch to an inch in diameter, and is essentially a tube of fibro-elastic membrane, within the layers of which are imbedded a series of cartilaginous rings, from sixteen to twenty in number. These rings extend only around the front and sides of the trachea (about two-thirds of its circumference), and are deficient behind; the interval between their posterior extremities is bridged over by a continuation of the fibrous membrane in which they are enclosed (fig. 309). The cartilages of the trachea and bronchial tubes are of the hyaline variety.

Immediately within this tube, at the back, is a layer of unstriped muscular fibres, which extends, *transversely*, between the ends of the cartilaginous rings to which they are attached, and opposite the intervals between them also; their function

is to diminish, when required, the calibre of the trachea by approximating the ends of the cartilages. Outside these are a few

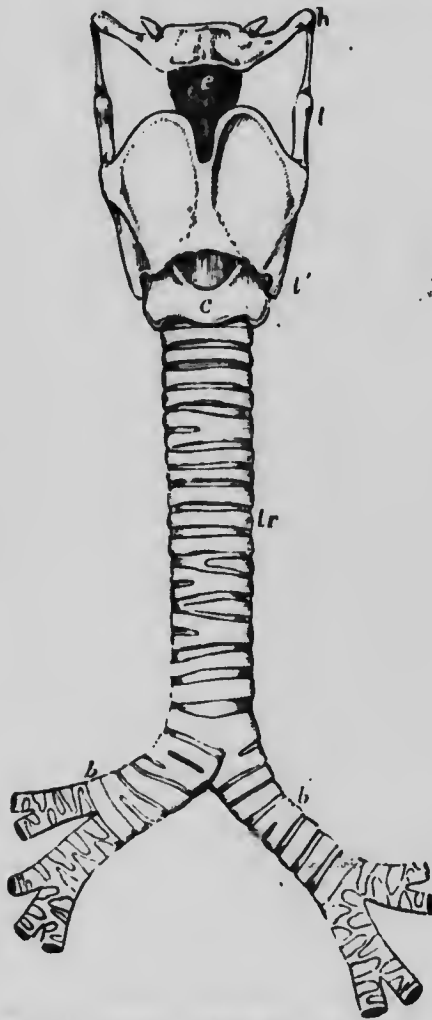

Fig. 308.—Outline showing the general form of the larynx, trachea, and bronchi, as seen from the front. *h*, the great cornu of the hyoid bone; *e*, epiglottis; *t*, superior, and *t'*, inferior cornu of the thyroid cartilage; *c*, middle of the cricoid cartilage; *tr*, the trachea, showing sixteen cartilaginous rings; *b*, the right, and *b'*, the left bronchus. (Allen Thomson.)

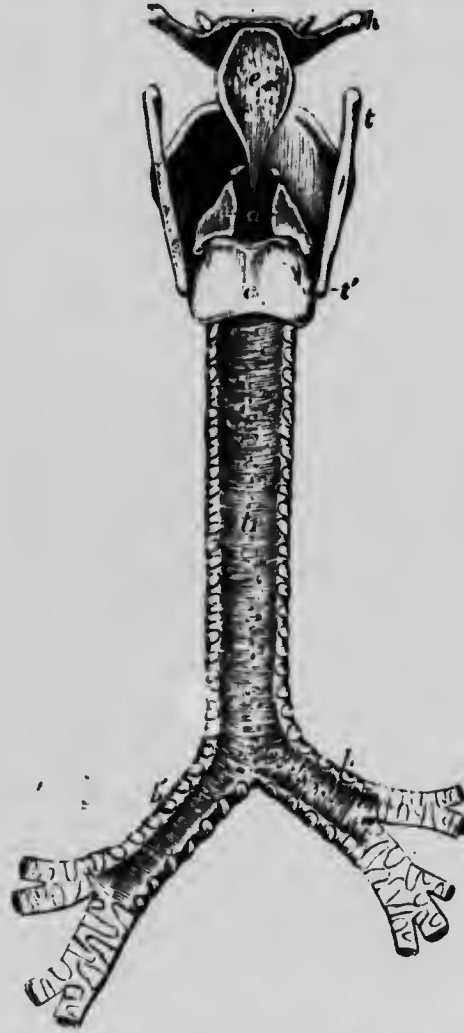

Fig. 309.—Outline showing the general form of the larynx, trachea, and bronchi, as seen from behind. *h*, great cornu of the hyoid bone; *t*, superior, and *t'*, the inferior cornu of the thyroid cartilage; *e*, epiglottis; *a*, points to the back of both the arytenoid cartilages, which are surmounted by the cornicula; *c*, the middle ridge on the back of the cricoid cartilage; *tr*, the posterior membranous part of the trachea; *b*, *b'*, right and left bronchi. (Allen Thomson.)

*longitudinal* bundles of muscular tissue, which, like the preceding, are attached both to the fibrous and cartilaginous framework.

The mucous membrane consists to a great extent of loose



lymphoid tissue, separated from the ciliated epithelium which lines it by a homogeneous basement membrane. The epithelium is formed of several layers of cells, of which the most superficial layer is ciliated; while between these cells are smaller elongated cells prolonged up towards the surface and down to the basement

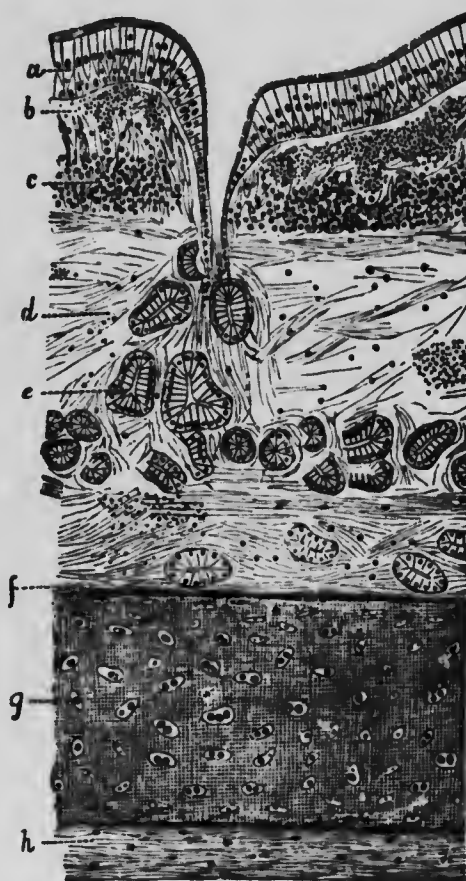

Fig. 310.—Section of the trachea. *a*, columnar ciliated epithelium; *b* and *c*, corium of the mucous membrane, containing elastic fibres cut across transversely; *d*, submucous tissue containing mucous glands, *e*, separated from the hyaline cartilage, *g*, by fine fibrous tissue, *f*; *h*, external investment of fine fibrous tissue. (S. K. Alcock.)

membrane. Beneath these are one or more layers of more irregularly shaped cells (fig. 313). Many of the superficial cells are of the goblet variety. In the deeper part of the corium of the mucous membrane are many elastic fibres between which lie connective-tissue corpuscles and capillary blood-vessels.

Numerous mucous glands are situated in the substance of the mucous membrane of the trachea; their ducts perforate the

various structures which form the wall of the trachea, and open through the mucous membrane into the interior (fig. 310).

The two bronchi into which the trachea divides, of which the right is shorter, broader, and more horizontal than the left (fig. 308), resemble the trachea in structure, with the difference that in them there is a distinct layer of unstriped muscle arranged circularly beneath the mucous membrane, forming the *muscularis mucosa*. On entering the substance of the lungs the cartilaginous rings, although they still form only larger or smaller segments of a circle, are no longer confined to the front and sides of the tubes, but are distributed impartially to all parts of their circumference.

The bronchi divide and subdivide, in the substance of the lungs,



Fig. 311.—Transverse section of a bronchial tube, about  $\frac{1}{4}$  inch in diameter. *e*, epithelium (ciliated); immediately beneath it is the corium of the mucous membrane, of varying thickness; *m*, muscular layer; *s.m.*, submucous tissue; *f*, fibrous tissue; *c*, cartilage enclosed within the layers of fibrous tissue; *g*, mucous gland. (F. E. Schulze.)

into a number of smaller and smaller branches (bronchial tubes), which penetrate into every part of the organ, until at length they end in the smaller subdivisions of the lungs called *lobules*.

All the larger branches have walls formed of fibrous tissue, containing portions of cartilaginous rings, by which they are held open, and unstriped muscular fibres, as well as longitudinal bundles of elastic tissue. They are lined by mucous membrane the surface of which, like that of the larynx and trachea, is covered with ciliated epithelium, but the several layers become less and less distinct until the lining consists of a single layer of short columnar cells covered with cilia (fig. 311). The mucous membrane is abundantly provided with mucous glands.

As the subdivisions become smaller and smaller, and their walls thinner, the cartilaginous rings become scarcer and more irregular, until, in the smaller bronchial tubes, they are represented

only by minute and scattered cartilaginous flakes. When the bronchial tubes, by successive branchings, are reduced to about  $\frac{1}{8}$  of an inch (.6 mm.) in diameter they lose their cartilaginous element altogether, and their walls are formed only of a fibrous elastic membrane with circular muscular fibres; they are still lined, however, by a thin mucous membrane with ciliated epithelium, the length of the cells bearing the cilia having become so far diminished that the cells are now cubical. In the smaller bronchial tubes the muscular fibres are relatively more abundant than in the larger ones, and form a distinct circular coat.

*The Lungs and Pleuræ.*—The lungs occupy the greater portion of the thorax. They are of a spongy elastic texture, and are composed of numerous minute air-sacs, and on section every here

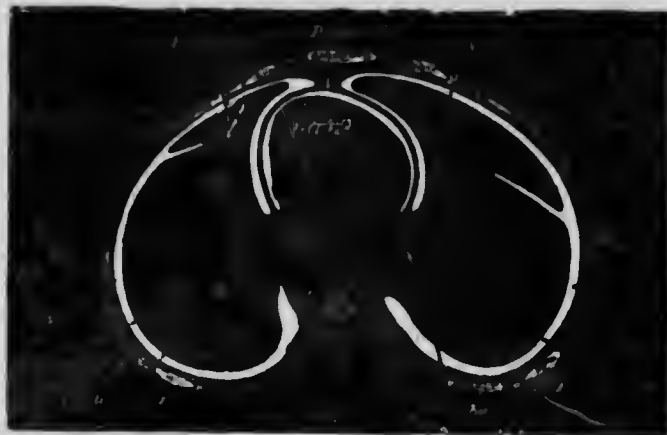

Fig. 312.—Transverse section of the chest.

and there the air-tubes may be seen cut across. Any fragment of lung (unless from a child that has never breathed, or in cases of disease in which the lung is consolidated) floats in water; no other tissue does this.

Each lung is enveloped by a serous membrane—the *pleura*, one layer of which adheres closely to its surface, and provides it with its smooth and slippery covering, while the other adheres to the inner surface of the chest-wall. The continuity of the two layers, which form a closed sac, as in the case of other serous membranes, will be best understood by reference to fig. 312. The appearance of a space, however, between the pleura which covers the lung (*visceral layer*) and that which lines the inner surface of the chest (*parietal layer*) is inserted in the drawing only for the sake of distinctness. It does not really exist. The

layers are, in health, everywhere in contact one with the other ; and between them is only just so much fluid as will ensure the

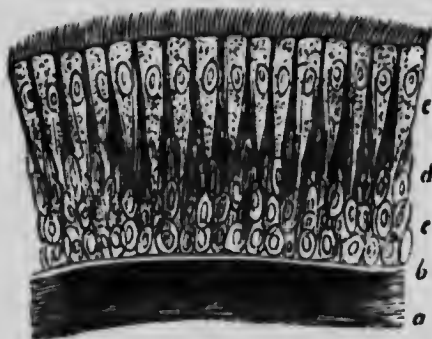

Fig. 313.—Ciliated epithelium of the human trachea. *a*, layer of longitudinally arranged elastic fibres; *b*, basement membrane; *c*, deepest cells, circular in form; *d*, intermediate elongated cells; *e*, outermost layer of cells fully developed and bearing cilia.  $\times 350$ . (Kölliker.)

lungs gliding easily, in their expansion and contraction, on the inner surface of the parietal layer, which lines the chest-wall.

If, however, an opening is made so as to permit air or fluid to enter the pleural sac, the lung, in virtue of its elasticity, recoils, and a considerable space

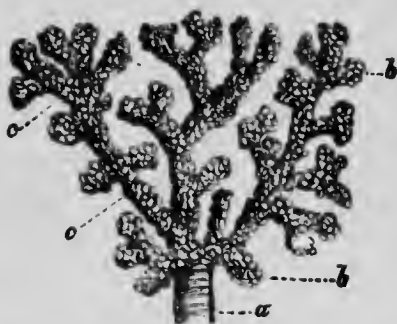

Fig. 314.—Terminal branch of a bronchial tube, with its infundibula and air-sacs, from the margin of the lung of a monkey, injected with quicksilver. *a*, terminal bronchial twig; *b b*, infundibula and air-sacs.  $\times 10$ . (F. E. Schulze.)



Fig. 315.—Two small infundibula or groups of air-sacs, *a a*, with air-sacs, *b b*, and the ultimate bronchial tubes, *c c*, with which the air-sacs communicate. From a new-born child. (Kölliker.)

is left between it and the chest-wall. In other words, the natural elasticity of the lungs would cause them at all times to contract away from the ribs were it not that the contraction is resisted by atmospheric pressure which bears only on the *inner* surface of



# MICROCOPY RESOLUTION TEST CHART

(ANSI and ISO TEST CHART No. 2)

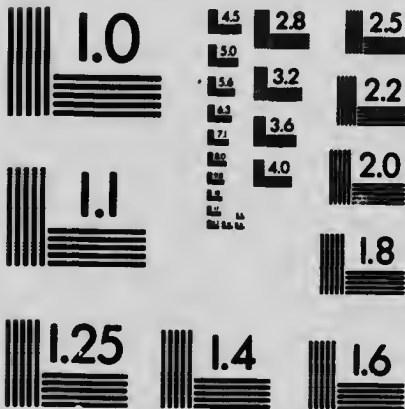

**APPLIED IMAGE Inc**

1653 East Main Street  
Rochester, New York 14609 USA  
(716) 482 - 0300 - Phone  
(716) 288 - 5989 - Fax

the air-tubes and air-sacs. On the admission of air into the pleural sac atmospheric pressure bears alike on the inner and outer surfaces of the lung, and their elastic recoil is no longer prevented.

Each lung is partially subdivided into separate portions called *lobes*; the right lung into three lobes, and the left into two. Each of these lobes, again, is composed of a large number of minute parts, called *lobules*. Each pulmonary lobule may be considered to be a lung in miniature, consisting as it does of a branch of the bronchial tube, of air-sacs, blood-vessels, nerves, and lymphatics, with a sparing amount of areolar tissue.

On entering a lobule, the small bronchial tube, the structure of which has just been described (*a*, fig. 314), divides and subdivides; its walls at the same time become thinner and thinner, until at length they are formed only of a thin membrane of areolar, muscular, and elastic tissue, lined by a layer of pavement epithelium not provided with cilia. At the same time they are altered in shape; each of the minute terminal branches widens out funnel-wise, and its walls are pouched out irregularly into small saccular dilatations, called *air-sacs* (fig. 314, *b*). Such a funnel-shaped terminal branch of the bronchial tube, with its group of pouches or air-sacs, has been called an *infundibulum* (figs. 314, 315), and the irregular oblong space in its centre, with which the air-sacs communicate, an *intercellular passage*.

The air-sacs, or air-vesicles, may be placed singly, like recesses from the intercellular passage, but more often they are arranged in groups, or even in rows, like minute sacculated tubes; so that a short series of vesicles, all communicating with one another, open by a common orifice into the tube. The vesicles are of various forms, according to the mutual pressure to which they are subject; their walls are nearly in contact, and they vary from  $\frac{1}{50}$ th to  $\frac{1}{70}$ th of an inch (.5 to .3 mm.) in diameter. Their walls are formed of fine membrane, like those of the intercellular passage; this membrane is folded on itself so as to form a sharp-edged border at each circular orifice of communication between contiguous air-vesicles, or between the vesicles and the bronchial passages. Numerous fibres of elastic tissue are spread out between contiguous air-sacs, and many of these are attached to the outer surface of the fine membrane of which each sac is composed, imparting to it additional strength and the power of recoil after distension. The vesicles are lined by a layer of pavement epithelium (fig. 316) not provided with cilia. Outside the air-vesicles a network of pulmonary capillaries is spread out so densely (fig. 317) that the interspaces or meshes are even narrower than the vessels, which are, on an average,  $\frac{1}{3000}$ th of an inch ( $8\mu$ ) in

diameter. Between the air in the sacs and the blood in these vessels nothing intervenes but the thin walls of the air-sacs and of the capillaries; and the exposure of the blood to the air is the more complete, because the folds of membrane between contiguous air-sacs, and often the spaces between the walls of the same, contain only a single layer of capillaries, both sides of which are thus at once exposed to the air. The arrangement of the capillaries is shown on a larger scale in fig. 224 (p. 220).

The vesicles of adjacent lobules do not communicate; so that, when any bronchial tube is closed or obstructed, the supply of air is lost for all the sacs opening into it or its branches.

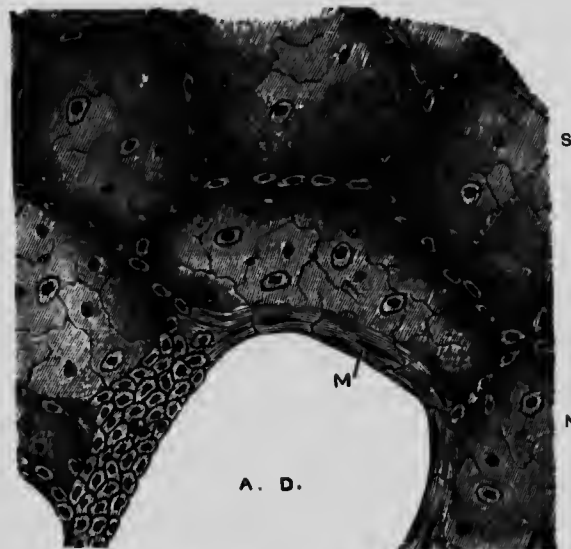

Fig. 316.—Section of lung stained with silver nitrate. A. D., alveolar duct or intercellular passage; S, alveolar septa; N, alveoli or air-sacs, lined with large flat cells, with some smaller polyhedral cells; M, plain muscular fibres surrounding the alveolar duct. (Klein and Noble Smith.)

*Blood-supply.*—The lungs receive blood from two sources, (a) the pulmonary artery, (b) the bronchial arteries. The former conveys *venous* blood to the lungs to be *arterialized*, and this blood takes no share in the nutrition of the pulmonary tissues through which it passes. The branches of the bronchial arteries convey arterial blood from the aorta for the nutrition of the walls of the bronchi, of the larger pulmonary vessels, of the interlobular connective-tissue, &c.; the blood of the bronchial vessels is returned chiefly through the bronchial and partly through the pulmonary veins.

*Lymphatics.*—The lymphatics are arranged in three sets:—  
1. Irregular lacunæ in the walls of the alveoli or air-sacs. The



lymphatic vessels which lead from these accompany the pulmonary vessels towards the root of the lung. 2. Irregular anastomosing spaces in the walls of the bronchi. 3. Lymph-spaces in the pulmonary pleura. The lymphatic vessels from all these

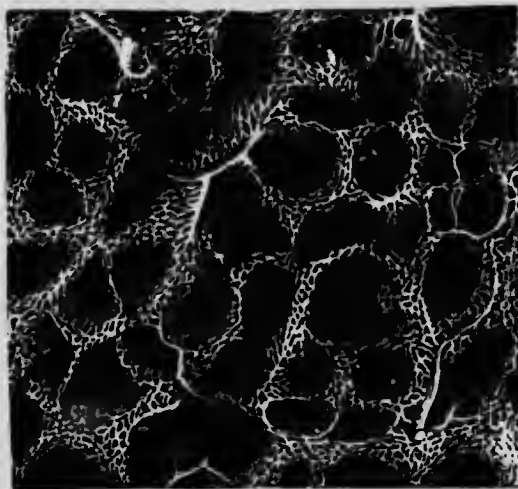

Fig. 317.—Capillary network of the pulmonary blood-vessels in the human lung.  $\times 60$ .  
(Kölliker.)

irregular sinuses pass in towards the root of the lung to reach the bronchial glands.

*Nerves.*—The nerves of the lung are to be traced from the anterior and posterior pulmonary plexuses, which are formed by branches of the vagus and sympathetic. The nerves follow the course of the vessels and bronchi, and in the walls of the latter many small ganglia are situated.

### The Respiratory Mechanism.

Respiration consists of the alternate expansion and contraction of the thorax, by means of which air is drawn into or expelled from the lungs. These acts are called *Inspiration* and *Expiration* respectively.

For the inspiration of air into the lungs it is evident that all that is necessary is such a movement of the side-walls or floor of the chest, or of both, that the capacity of the interior shall be enlarged. By such increase of capacity there will be a diminution of the pressure of the air in the lungs, and a fresh quantity will enter through the larynx and trachea to equalise the pressure on the inside and outside of the chest.

For the expiration of air, on the other hand, it is also evident

that, by an opposite movement which shall diminish the capacity of the chest, the pressure in the interior will be increased, and air will be expelled, until the pressure within and without the chest are again equal. In both cases the air passes through the trachea and larynx, whether in entering or leaving the lungs, there being no other communication with the exterior of the body; and the lung, for the same reason, remains, under all the circumstances described, closely in contact with the walls and floor of the chest. To speak of expansion of the chest, is to speak also of expansion of the lung. The movements of the lung are therefore passive, not active, and depend on the changes of shape of the closed cavity in which they are contained. A perforation of the chest-wall would mean that the lung in that side would no longer be of use; a similar injury on the other side (double pneumothorax) would cause death. If the two layers of the pleura were adherent, those portions of the lung would be expanded most where the movements of the chest are greatest. The existence of the two layers prevents this, and thus the lung is equally expanded throughout.

**Inspiration.**—The enlargement of the chest in inspiration is a muscular act; the effect of the action of the inspiratory muscles is an increase in the size of the chest cavity (*a*) in the vertical, and (*b*) in the lateral and antero-posterior diameters. The muscles engaged in *ordinary* inspiration are the diaphragm; the external intercostals; parts of the internal intercostals; the levatores costarum; and serratus posticus superior.

(*a*.) The *vertical diameter* of the chest is increased by the contraction and consequent descent of the diaphragm; at rest, the diaphragm is dome-shaped with the convexity upwards; the central tendon forms a slight depression in the middle of this dome. On contraction the muscular fibres shorten and so the convexity of the double dome is lessened. The central tendon, which was formerly regarded as remaining fixed, is drawn down a certain distance, but the chief movement is at the sides. For the effective action of this muscle, its attachment to the lower ribs is kept fixed by the contraction of the quadratus lumborum. The diaphragm is supplied by the *phrenic* nerves.

(*b*.) The increase in the *lateral* and *antero-posterior diameters* of the chest is effected by the raising of the ribs, the upper ones being fixed by the scaleni. The greater number of the ribs are attached very obliquely to the spine and sternum.

The elevation of the ribs takes place both in front and at the sides—the hinder ends being prevented from performing any upward movement by their attachment to the spine. The

movement of the front extremities of the ribs is of necessity accompanied by an upward and forward movement of the sternum

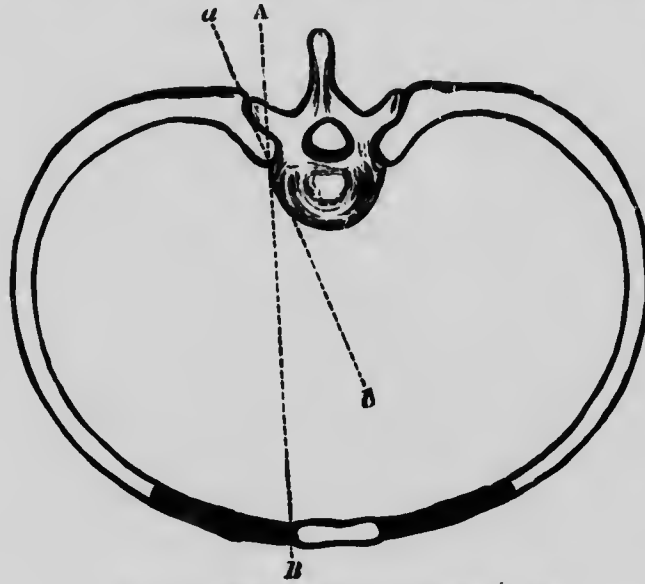

Fig. 318.—Diagram of axes of movement of ribs.

to which they are attached, the movement being greater at the lower end than at the upper end of the latter bone.



Fig. 319.—Diagram of movement of a rib in inspiration.

The axes of rotation in these movements are two; one corresponding with a line drawn through the two articulations which the rib forms with the spine (*a, b*, fig. 318); and the other with

a line drawn from one of these (head of rib) to the sternum (A B, fig. 318); the motion of the rib around the latter axis being somewhat after the fashion of raising the handle of a bucket.

The elevation of the ribs is accompanied by a slight opening out of the angle which the bony part forms with its cartilage (fig. 319, A); and thus an additional means is provided for increasing the antero-posterior diameter of the chest.

The muscles by which the ribs are raised, in *ordinary* quiet inspiration, are the *external intercostals*, and that portion of the *internal intercostals* which is situated between the costal cartilages; and these are assisted by the *levatores costarum*, and the *serratus posticus superior*. The action of the *levatores* and the *serratus* is very simple. Their fibres, arising from the spine as a fixed point, pass obliquely downwards and forwards to the ribs, and necessarily raise the latter when they contract. The action of the intercostal muscles is not quite so simple, inasmuch as, passing merely from rib to rib, they seem at first sight to have no fixed point towards which they can pull the bones to which they are attached.

In tranquil breathing, the expansive movements of the lower part of the chest are greater than those of the upper. In forced inspiration, on the other hand, the greatest extent of movement appears to be in the upper antero-posterior diameter.

In *extraordinary* or forced inspiration, as in great exercise, or in cases in which there is some interference with the due entrance of air into the chest, and in which, therefore, strong efforts are necessary, other muscles than those just enumerated, are pressed into service. It is impossible to separate by a hard-and-fast line the muscles of *ordinary* from those of *extraordinary* inspiration; but there is no doubt that the following are but little used as *respiratory* agents, except in cases in which unusual efforts are required—the *sternomastoid*, the *serratus magnus*, the *pectorales*, and the *trapezius*. Laryngeal and face muscles also come into play.

The expansion of the chest in inspiration presents some peculiarities in different persons. In young children, it is effected chiefly by the diaphragm, which being highly arched in expiration, becomes flatter as it contracts, and, descending, presses on the abdominal viscera, and pushes forward the front walls of the abdomen. The movement of the abdominal walls being here more manifest than that of any other part, it is usual to call this the *abdominal* type of respiration. In men, together with the descent of the diaphragm, and the pushing forward of the front wall of the abdomen, the chest and the sternum are subject to a wide movement in inspiration (*inferior costal* type). In women,

the movement appears less extensive in the lower, and more so in the upper, part of the chest (*superior costal* type).

There are also differences in different animals. In the frog, for example, the air is forced into the lungs by the raising of the floor of the mouth, the mouth and nostrils being closed.

**Expiration.**—From the enlargement produced in inspiration, the chest and lungs return, in ordinary tranquil expiration, by their elasticity; the force employed by the inspiratory muscles in distending the chest and overcoming the elastic resistance of the lungs and chest-walls, is returned as an expiratory effort when the muscles are relaxed. This elastic recoil of the chest and lungs is sufficient, in ordinary quiet breathing, to expel air from the lungs in the intervals of inspiration, and no muscular power is required. In all voluntary expiratory efforts, however, as in speaking, singing, blowing, and the like, and in many involuntary actions also, as sneezing, coughing, &c., something more than merely passive elastic power is necessary, and the proper expiratory muscles are brought into action. By far the chief of these are the abdominal muscles, which, by pressing on the viscera of the abdomen, push up the floor of the chest formed by the diaphragm, and by thus making pressure on the lungs, expel air from them through the trachea and larynx. All muscles, however, which depress the ribs, must act also as muscles of expiration, and therefore we must conclude that the abdominal muscles are assisted in their action by the interosseous part of the *internal intercostals*, the *triangularis sterni*, the *serratus posticus inferior*, and *quadratus lumborum*. When by the efforts of the expiratory muscles, the chest has been squeezed to less than its average diameter, it again, on relaxation of the muscles, returns to the normal dimensions by virtue of its elasticity. The construction of the chest-walls, therefore, admirably adapts them for recoiling against and resisting as well undue contraction as undue dilatation.

In the natural condition of the parts, the lungs can never contract to the utmost, but are always more or less "on the stretch," being kept closely in contact with the inner surface of the walls of the chest by cohesion as well as by atmospheric pressure, and can contract away from these only when, by some means or other, as by making an opening into the pleural cavity, or by the effusion of fluid there, the pressure on the exterior and interior of the lungs becomes equal.

#### **Methods of recording Respiratory Movements.**

The movements of respiration may be recorded graphically in several ways. One method is to introduce a tube into the trachea of an animal,

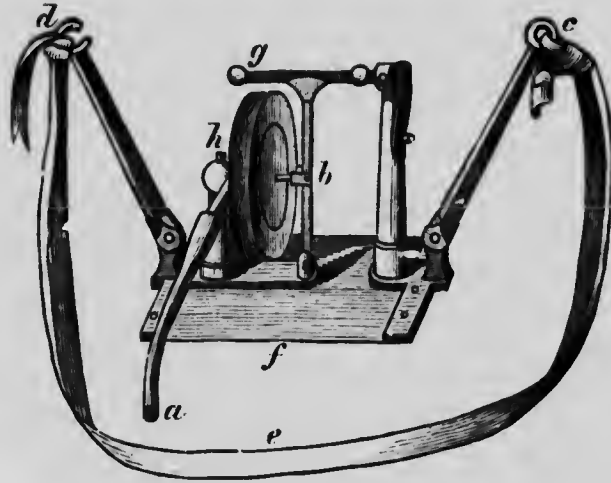

Stethograph. *h*, tambour fixed at right angles to plate of steel *f*; *d*, arms by which instrument is attached to chest by belt *e*. When the chest expands, the arms are pulled asunder, which bends the steel plate, and the tambour is affected by the pressure of *b*, which is attached to it on the one hand, and to the upright in connection with horizontal screw *g*. (Modified from Marey's instrument.)

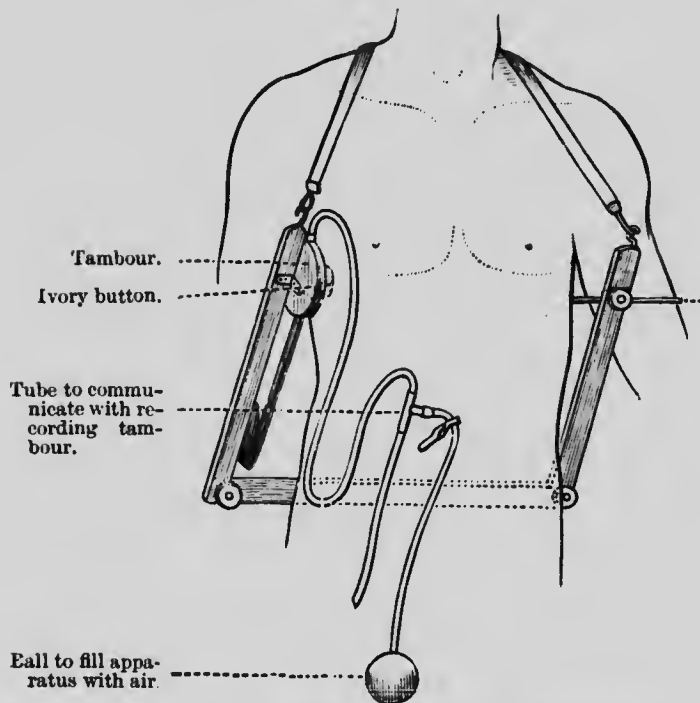

Fig. 321.—Stethograph. (Burdon-Sanderson.)

and to connect this tube by some gutta-percha tubing with a T-piece introduced into the cork of a large bottle, the other end of the T having attached to it a second piece of tubing, which can remain open or can be partially or completely closed by means of a screw clamp. Into the cork is inserted a second piece of glass tubing connected with a Marey's tambour by suitable tubing. This second tube communicates any alteration of the pressure in the bottle to the tambour, and this may be made to write on a recording surface.

There are various instruments for recording the movements of the chest by application of apparatus to the exterior. Such is the **stethograph** of Burdon-Sanderson (fig. 321). This consists of a frame formed of two parallel steel bars joined by a third at one end. At the free end of the bars is attached a leather strap, by means of which the apparatus may be suspended from the neck. Attached to the inner end of one bar is a tambour and ivory button, to the

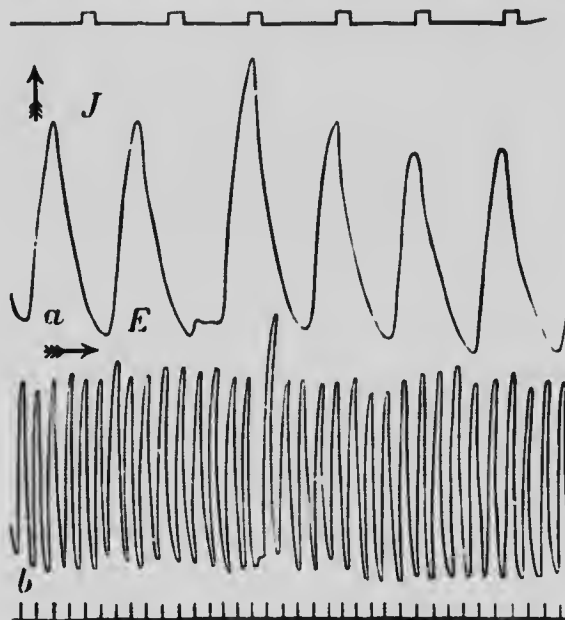

Fig. 322.—Tracing of the normal diaphragm respirations of rabbit. *a*, with quick movement of drum. *b*, with slow movement. The upstrokes represent inspiration; the downstrokes, expiration. To be read from left to right. (Marckwald.)

end of the other an ivory button. When in use, the apparatus is suspended with the transverse bar posteriorly, the button of the tambour is placed on the part of the chest the movement of which it is desired to record, and the other button is made to press upon the corresponding point on the other side of the chest, so that the chest is, as it were, held between a pair of callipers. The tambour is connected by tubing and a T-piece with a recording tambour and with a ball, by means of which air can be squeezed into the cavity of the tympanum. When in work the tube connected with the air ball is shut off by means of a screw clamp. The movement of the chest is thus communicated to the recording tambour.

A simpler form of this apparatus consists of a thick india-rubber bag of elliptical shape about three inches long, to one end of which a rigid gutta-percha tube is attached. This bag may be fixed at any required place on the chest by means of a strap and buckle. By means of the gutta-percha

tube the variations of the pressure of air in the bag produced by the movements of the chest are communicated to a recording tambour. This apparatus is a simplified form of Marey's stethograph (fig. 320).

The variations of intrapleural pressure may be recorded by the introduction of a cannula into the pleural cavity, which is connected with a mercurial manometer.

Finally, it has been found possible in various ways to record the diaphragmatic movements by the insertion of an elastic bag connected with a tambour into the abdomen below it (**phrenograph**), by the insertion of needles into different parts of its structure, or by recording the contraction of isolated strips of the diaphragm. Such a strip attached in the rabbit to the xiphisternal cartilage may be detached, and attached by a thread to a recording lever. This method was largely used by Head; this strip serves as a sample of the diaphragm.

Fig. 322 shows a tracing obtained in this way; but in tracings taken with a stethograph, or any of the numerous arrangements of tambours which are applied to the chest-walls of men and animals, the large up-and-down strokes due to the respiratory movements have upon them smaller waves due to heart-beats.

The acts of expansion and contraction of the chest take up under ordinary circumstances a nearly equal time. The act of inspiring air, however, especially in women and children, is a little shorter than that of expelling it, and there is commonly a very slight pause between the end of expiration and the beginning of the next inspiration. The respiratory **rhythm** may be thus expressed:—

<i>Inspiration</i>	. . . . .	6
<i>Expiration</i>	. . . . .	7 or 8
A very slight <i>pause</i> .		

If the ear be placed in contact with the wall of the chest, or be separated from it only by a good conductor of sound or stethoscope, a faint *respiratory* or *vesicular murmur* is heard during inspiration. This sound varies somewhat in different parts—being loudest or coarsest in the neighbourhood of the trachea and large bronchi (tracheal and bronchial breathing), and fading off into a faint sighing as the ear is placed at a distance from these (vesicular breathing). It is best heard in children, and in them a faint murmur is heard in expiration also. The cause of the vesicular murmur has received various explanations; but most observers hold that the sound is produced by the air passing through the glottis and larger tubes, and that this sound is modified in its conduction through the substance of the lung. The alterations in the normal breath-sounds, and the various additions to them that occur in different diseased conditions, can only be properly studied at the bedside.

*Respiratory movements of the Nostrils and of the Glottis.*—During the action of the muscles which directly draw air into the



chest, those which guard the opening through which it enters are not passive. In hurried breathing the instinctive dilatation of the nostrils is well seen, although under ordinary conditions it may not be noticeable. The opening at the upper part of the larynx or rima glottidis is slightly dilated at each inspiration for the more ready passage of air, and becomes smaller at each expiration; its condition, therefore, corresponds during respiration with that of the walls of the chest. There is a further likeness between the two acts in that, under ordinary circumstances, the dilatation of the rima glottidis is a muscular act and its narrowing chiefly an elastic recoil.

**Terms used to express Quantity of Air breathed.—**

a. *Breathing* or *tidal air* is the quantity of air which is habitually and almost uniformly changed in each act of breathing. In a healthy adult man it is about 20 cubic inches, or about 300 ccm. It will be seen that this amount of air is not nearly sufficient to fill the lungs; it fills the upper respiratory passages; the air principally finds its way into the alveoli by the much slower process of diffusion, the oxygen diffusing downwards, and the carbonic acid diffusing upwards. Some of the tidal air, however, probably reaches the alveoli directly, for the "respiratory dead space" (the capacity of the upper air passages and the bronchial tubes) is only 140 cc. (Zuntz)

b. *Complemental air* is the quantity over and above this which can be drawn into the lungs in the deepest inspiration; its amount varies, but it may be reckoned as 100 cubic inches, or about 1,600 ccm.

c. *Reserve* or *supplemental air*.—After ordinary expiration, such as that which expels the breathing or tidal air, a certain quantity of air, about 100 cubic inches (1,600 ccm.) remains in the lungs, which may be expelled by a forcible and deeper expiration. This is termed *reserve* or *supplemental air*.

d. *Residual air* is the quantity which still remains in the lungs after the most violent expiratory effort. Its amount depends in great measure on the absolute size of the chest, but may be estimated at about 100 cubic inches, or about 1,600 ccm.

The total quantity of air which passes into and out of the lungs of an adult, at rest, in 24 hours, varies from 400,000 (Marect) to 680,000 (Hutchinson) cubic inches. This quantity, however, is increased and may be more than doubled by exertion.

e. *Respiratory or Vital Capacity*.—The vital capacity of the chest is indicated by the quantity of air which a person can expel from his lungs by a forcible expiration after the deepest inspiration possible. The average capacity of an adult, at 15.4° C. (60° F.),

is about 225 to 250 cubic inches, or 3,500 to 4,000 ccm. It is the sum of the complemental, tidal, and supplemental air.

The *respiratory capacity*, as John Hutchinson called it, *vital capacity*, is usually measured by a modified gasometer or *spirometer*, into which the experimenter breathes,—making the most prolonged expiration possible after the deepest possible inspiration. The quantity of air which is thus expelled from the lungs is indicated by the height to which the air-chamber of the spirometer rises; and by means of a scale placed in connection with this, the number of cubic inches is read off.

In healthy men, the respiratory capacity varies chiefly with the stature, weight, and age.

It was found by Hutchinson, from whom most of our information on this subject is derived, that at a temperature of 15.4° C. (60° F.), 225 cubic inches is the average *vital capacity* of a healthy person, five feet seven inches in height.

*Circumstances affecting the amount of respiratory capacity.*—For every inch of height above this standard the capacity is increased, on an average, by eight cubic inches; and for every inch below, it is diminished by the same amount.

The influence of *weight* on the capacity of respiration is less manifest and considerable than that of height; and it is difficult to arrive at any definite conclusions on this point, because the natural average weight of a healthy man in relation to stature has not yet been determined. As a general statement, however, it may be said that the capacity of respiration is not affected by weights under 161 pounds, or 11½ stones; but that, above this point, it is diminished at the rate of one cubic inch for every additional pound up to 196 pounds or 14 stones.

By *age*, the capacity is increased from about the fifteenth to the thirty-fifth year, at the rate of five cubic inches per year; from thirty-five to sixty-five it diminishes at the rate of about one and a half cubic inch per year; so that the capacity of respiration of a man of sixty years old would be about 30 cubic inches less than that of a man forty years old, of the same height and weight.

*Sex.*—The vital capacity of an adult man to that of a woman of the same height is 10 to 7.

The *number* of respirations in a healthy adult person usually ranges from 14 to 18 per minute. It is greater in infancy and childhood. It varies also much according to different circumstances, such as exercise or rest, health or disease, &c. Variations in the number of respirations correspond ordinarily with similar variations in the pulsations of the heart. In health the proportion is about 1 to 4, or 1 to 5, and when the rapidity of the heart's action is increased, that of the chest movement is commonly increased also; but not in every case in equal proportion. It happens occasionally in disease, especially of the lungs or air-passages, that the number of *respiratory* acts increases in quicker proportion than the beats of the *pulse*; and, in other

affections, much more commonly, that the number of the pulse-beats is greater in proportion than that of the respirations.

*The Force of Inspiratory and Expiratory Muscles.*—The force with which the inspiratory muscles are capable of acting is greatest in individuals of the height of from five feet seven inches to five feet eight inches, and will elevate a column of nearly three inches (about 60 mm.) of mercury. Above this height the force decreases as the stature increases; so that the average of men of six feet can elevate only about two and a half inches of mercury. The force manifested in the strongest expiratory acts is, on the average, one-third greater than that exercised in inspiration. But this difference is in great measure due to the power exerted by the elastic reaction of the walls of the chest; and it is also much influenced by the disproportionate strength which the expiratory muscles attain, from their being called into use for other purposes than that of simple expiration. The force of the inspiratory act is, therefore, better adapted than that of the expiratory for testing the muscular strength of the body. (John Hutchinson.)

In ordinary quiet breathing, there is a negative pressure of only 1 mm. during inspiration, and a positive pressure of from 2 to 3 mm. mercury during expiration.

The instrument used by Hutchinson to gauge the inspiratory and expiratory power was a mercurial manometer, to which was attached a tube fitting the nostrils, and through which the inspiratory or expiratory effort was made.

The greater part of the force exerted in deep inspiration is employed in overcoming the resistance offered by the elasticity of the lungs.

In man the pressure exerted by the elasticity of the lungs alone is about 6 mm. of mercury. This is estimated by tying a manometer into the trachea of a dead subject, and observing the rise of mercury that occurs on puncture of the chest-walls. If the chest is distended beforehand so as to imitate a forcible inspiration, a much larger rise (30 mm.) of the mercury is obtained. In the body this elastic force is assisted by the contraction of the plain muscular fibres of the alveoli and bronchial tubes, the pressure of which probably does not exceed 1 or 2 mm. Hutchinson calculated that the total force to be overcome by the muscles in the act of inspiring 200 cubic inches of air is more than 450 lbs.

It is possible that the contractile power which the bronchial tubes and air-vesicles possess, by means of their *muscular fibres*, may assist in expiration; but it is more likely that its chief purpose is to regulate and adapt, in some measure, the quantity

of air admitted to the lungs, and to each part of them, according to the supply of blood: the muscular tissue also contracts upon and gradually expels collections of mucus, which may have accumulated within the tubes, and which cannot be ejected by forced expiratory efforts, owing to collapse or other morbid conditions of the portion of lung connected with the obstructed tubes (Gairdner).

#### The Nervous Mechanism of Respiration.

In the central nervous system there is a specialised small district called the *Respiratory centre*. This gives out impulses which travel down the spinal cord to the branches of the spinal nerves that innervate the muscles of respiration. It also receives various afferent fibres, the most important of which are contained in the trunk of the vagus. The vagus is chiefly an afferent nerve in relation to respiration. It, however, also is in a minor degree efferent, for it supplies the muscular tissue of the lungs and bronchial tubes, and exercises a trophic influence on the lung.

The respiratory centre was discovered by Flourens; it is situated at the tip of the calamus scriptorius, and almost exactly coincides in position with the centre of the vagus. The existence of subsidiary respiratory centres in the spinal cord has been mooted, but the balance of experimental evidence is against their existence. Flourens found that when the respiratory centre is destroyed, respiration at once ceases, and the animal dies. He therefore called it the "vital knot" (*nœud vitale*).

The centre is affected not only by the afferent impulses which reach it from the vagus, but also by those from the cerebrum; so that we have a limited amount of voluntary control over the respiratory movement.

The sensory nerves of the skin have also an effect. The action of the cold air on the body of a new-born child is no doubt the principal afferent cause of the first respirations. During foetal life, the need of the embryo for oxygen is very small, and is amply met by the transference of oxygen from the maternal blood through the thin walls of the foetal capillaries in the placenta. The application of cold water to the skin always causes a deep inspiration; this is another instance of the reflex effect which follows stimulation of the cutaneous nerves. Stimulation of the central end of the splanchnics causes expiration. Stimulation of the central end of the glosso-pharyngeal causes an inhibition of the respiratory movements for a short period; this accounts for the very necessary cessation of breathing during swallowing. Stimulation of the central end of the cut superior laryngeal nerve, or

of its terminations in the mucous membrane of the larynx, as when a crumb is "swallowed the wrong way," produces inhibition of inspiratory and increase of expiratory efforts, culminating in coughing.

These nerves, however, are none of them in constant action as the vagi are, and the influence of the vagus is somewhat complicated. Still, respiration continues after the vagi are cut. The character of the respiration becomes altered, especially if both nerves are severed; it is slower and deeper. This is due to the cessation of the impulses that normally run up the vagi to the respiratory centre. The animal, however, lives a considerable time; a warm-blooded animal usually dies after about a week or ten days from *vagus pneumonia*, due to the removal of trophic influences from the lungs. Cold-blooded animals live longer; they exhibit fatty degeneration of the heart-muscle also.

The question has been much debated whether the activity of the respiratory centre is *automatic* or *reflex*; that is to say, whether the rhythmic discharges proceeding from it depend on local changes induced by the condition of its blood supply, or on the repeated stimulations it receives by afferent nerves.

There appears every reason to believe that the centre has the power of automatism, but this is never excited under normal circumstances. Normally the respiratory process is a series of reflex actions.

The evidence in favour of the automatic activity of the centre is the following:—

(1.) If the spinal cord is cut just below the bulb, respiration ceases, except in the case of the facial and laryngeal muscles, which are supplied by nerves that originate above the point of injury. The *alæ nasi* work vigorously. Such respiration is not effective in drawing any air into the chest, and so the animal soon dies; but the forcible efforts of these muscles show that the respiratory centre is in a state of activity sending out impulses to them. If the two vagus nerves are cut, these movements continue; this shows that afferent impulses from the vagus are not essential. As the blood gets more and more venous, the movements become more pronounced. The question has been much debated whether this increased activity of the respiratory centre is due to increase of carbonic acid, or decrease of oxygen in the blood which it receives. The balance of evidence shows that the diminution in the oxygen is the more important of the two.

(2.) In asphyxia, one always gets great increase of respiratory activity, called *dyspnœa*; this is produced by the stimulating of

the centre by venous blood. It is not due (or not wholly due) to the action of the venous blood on the terminations of the vagi in the lungs, as the same phenomenon occurs when these nerves are cut; and, moreover, dyspnoea takes place if the venous blood is allowed to circulate through the brain alone, and not through the lungs at all. For instance, it ensues when localised venosity of the blood is produced in the brain by ligature of the carotid and vertebral arteries.

But, as before stated, the normal activity of the respiratory centre is not automatic, it is reflex, and the principal afferent channel is the vagus. The way in which it works has been made out of recent years by Marckwald, Hering and Head. The following is a brief *résumé* of Head's results.

His method of recording the movements was by means of that convenient slip of the diaphragm which is found in rabbits (see p. 353).

His method of dividing the vagus was by freezing it; he laid it across a copper wire, the end of which was placed in a freezing mixture. This method is free from the disadvantage which a cut with a knife or scissors possesses, namely, a stimulation at the moment of section. On dividing one vagus, respiration became slightly slower and deeper; on dividing the second nerve, this effect was much more marked.

On exciting the central end of the divided nerve, inspiratory efforts increased until at last the diaphragm came to a standstill in the inspiratory position. But if a weak stimulus was employed, the reverse was the case; the expiratory efforts increased, inspiration becoming weaker and weaker, until at last the diaphragm stopped in the position of expiration. This result always follows stimulation of the superior laryngeal nerve.

Most of these facts were known previously, but the interpretation of them, in the light of further experiments immediately to be described, is the following:

That there are in the vagus two sets of fibres, one of which produces an increased activity of the inspiratory part of the respiratory centre, and the other an increased activity of the expiratory part of that centre. Stimulation of the first stops expiration and produces inspiration; stimulation of the second does the reverse.

The question now is, What is it that normally produces this alternate stimulation of the two sets of fibres? If we discover this we shall discover the prime moving cause in the alternation of the inspiratory and expiratory acts. It was sought and found in the alternate distension and contraction of the air-vesicles of the lungs where the vagus terminations are situated.

In one series of experiments *positive ventilation* was performed; that is, air was pumped repeatedly into the lungs, and so increased their normal distension; this was found to decrease the inspiratory contractions of the diaphragm, until at last they ceased altogether, and the diaphragm stood still in the expiratory position (fig. 323, A).

In a second series of experiments, *negative ventilation* was performed; that is, the air was pumped repeatedly out of the lungs, and a condition of collapse of the air-vesicles produced. This was found to increase the inspiratory contractions of the diaphragm, expiration became less and less, and at last the diaphragm assumed the position of inspiratory standstill (fig. 323, B).



Fig. 323.—Tracings of diaphragm. The upward movements of the tracings represent inspiration; the downward movements, expiration. A, result of positive, B, of negative ventilation. (After Head.)

Distension of the air-vesicles therefore stimulates the fibres of the vagus which excite the expiratory phase of respiration; collapse stimulates those which excite the inspiratory phase.

Ordinary respiration is an alternate positive and negative ventilation, though not so excessive as in the experiments just described. Inspiration is positive ventilation, and so provides the nervous mechanism of respiration with a stimulus that leads to expiration. Expiration is a negative ventilation, and so provides the stimulus that leads to inspiration.

It is probable that of the two sets of impulses, those which are started by the inspiratory movement play a more active part in the regulation of respiration than those started by the expiratory movement. Gad explains the latter by supposing they are simply due to a cessation of the former, or, in other words,

that there only exists one class of afferent fibres in the vagus concerned in respiration. This view has not, however, met with general acceptance, and is against the mass of experimental evidence.

**Apnœa.**—If positive and negative ventilation are used together rapidly and alternately at a rate quicker than the respiratory rhythm, both inspiratory and expiratory processes are inhibited, and the respiration ceases for a short time. This follows naturally from the experiments previously described. This can be done on an animal with a pair of bellows fixed to a tube in the trachea; or voluntarily by oneself, taking a number of deep breaths rapidly. This condition, called *apnœa*, is not due, as at one time supposed, to over-oxygenation of the blood, but is produced reflexly. Under normal circumstances arterial blood is always fully oxygenated. It is observed if inert gases, like nitrogen or hydrogen, are used instead of air. The pause, however, is then shorter, as the blood becomes venous, and in a short time stimulates the respiratory centre to activity.

Under abnormal circumstances, namely, after division of the vagi, apnœa cannot obviously be due to such reflex action. In such depressed conditions of the respiratory centre, the blood becomes more venous than normal, and then the rapid inflation of the lungs with air will produce an apnœic condition. Fredericq still holds that ordinary apnœa has a chemical rather than a nervous origin. He attributes it, however, not to over-oxygenation, but to a lessening of the carbonic acid in the blood.

#### Special Respiratory Acts.

**Coughing.**—In the act of coughing there is first of all a deep inspiration, followed by an expiration; but the latter, instead of being easy and uninterrupted, as in normal breathing, is obstructed, the glottis being momentarily closed by the approximation of the vocal cords. The abdominal muscles, then strongly acting, push up the viscera against the diaphragm, and thus make pressure on the air in the lungs until its tension is sufficient to noisily open the vocal cords which oppose its outward passage. In this way considerable force is exercised, and mucus or any other matter that may need expulsion from the air-passages is quickly and sharply expelled by the outstreaming current of air. The act is a reflex one, the sensory surface which is excited being the mucous membrane of the larynx, and the superior laryngeal nerve is the afferent nerve; stimulation of other parts of the respiratory mucous membrane will also produce cough, and the point of bifurcation of the trachea is specially sensitive. Other



sensory surfaces may also act as the "*signal surface*" for a cough. Thus, a cold draught on the skin, or tickling the external auditory meatus, in some people will set up a cough.

The question has been discussed whether such a thing as a stomach cough exists; it has not been produced experimentally, but there is no reason why irritation of the gastric mucous membrane, supplied as it is by the vagus, should not cause the reflex act of coughing.

*Sneezing*.—The same remarks that apply to coughing, are almost exactly applicable to the act of sneezing; but, in this instance, the blast of air, on escaping from the lungs, is directed, by an instinctive contraction of the pillars of the fauces and descent of the soft palate, chiefly through the nose, and any offending matter is thence expelled.

The "*signal surface*" is usually the nasal mucous membrane, but here, as in coughing, other causes (such as a bright light) will sometimes set the reflex going.

*Hiccough* is an involuntary sudden contraction of the diaphragm

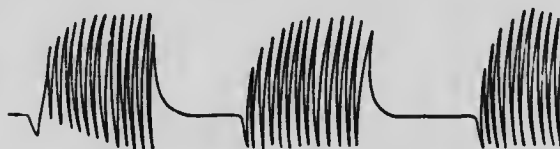

Fig. 324.—Cheyne-Stokes respiration. (After Waller.)

causing an inspiration which is suddenly arrested by the closure of the glottis, causing a characteristic sound. It arises from gastric irritation.

*Snoring* is due to vibration of the soft palate.

*Sobbing* consists of a series of convulsive inspirations at the moment of which the glottis is partially closed.

*Sighing and Yawning* are emotional forms of inspiration, the latter associated with stretching movements of jaws and limbs. They appear to be efforts of nature to correct by an extra deep inspiration, the venosity of the blood due to inactivity produced by ennui or grief. Their contagious character is due to sympathy.

Among abnormal disturbances of the nervous mechanism of respiration, the following diseases must be mentioned: laryngismus stridulus, asthma, and whooping cough.

*Cheyne-Stokes respiration* is due to rhythmical activity of the respiratory centre. It reminds one somewhat of the Traube-Hering waves due to a similar rhythmical activity of the vaso-motor centre. It is seen in many nervous diseases and

in fatty degeneration of the heart. A typical tracing of the condition is given above (fig. 324). It is seen to a slight extent during ordinary sleep, and is very marked in hibernating animals.

Pembrey and Pitts have recently taken graphic records of this



Fig. 325.—Cheyne-Stokes respiration in hibernating dormouse. The line marked T gives time in seconds. Line 1 gives the tracing of a respiratory group which occurred once every 80 seconds, the temperature of the animal being 11° C. On warming the animal to 13° C. the respiratory groups became more frequent (line 2). On warming the animal still further it awakened, and breathing at first accompanied by shivering became continuous. (Pembrey and Pitts.)

condition in the hibernating dormouse, hedgehog, marmot, and bat. In some cases the respiration has the typical Cheyne-Stokes character, with a gradual waxing and waning (fig. 325). In other cases periods of respiratory activity alternate with periods of apnoea, but all the respiratory efforts are about equal in force. (Biot's respiration.)

#### The effect of Respiration on the Circulation.

As the heart, the aorta, and pulmonary vessels are situated in the air-tight thorax, they are exposed to a certain alteration of pressure when the capacity of the latter is increased in inspiration; for although the expansion of the lungs tends to counterbalance this increase of area, it never does so entirely, since part of the pressure of the air which is drawn into the lungs through the trachea is expended in overcoming their elasticity. The amount thus used up increases as the lungs become more and more expanded, so that the pressure inside the thorax during inspiration, as far as the heart and great vessels are concerned, never quite equals that outside, and at the conclusion of inspiration is considerably less than the atmospheric pressure. It has been ascertained that the amount of the pressure used up in the

way above described, varies from 5 or 7 mm. of mercury during the pause, to 30 mm. of mercury when the lungs are expanded at the end of a deep inspiration, so that it will be understood that the pressure to which the heart and great vessels are subjected diminishes as inspiration progresses, and at its minimum is less by 30 mm. than the normal pressure, 760 mm. of mercury. It will be understood from the accompanying diagram that if there were no lungs in the chest, and its capacity were increased, the effect of the increase would be expended in pumping

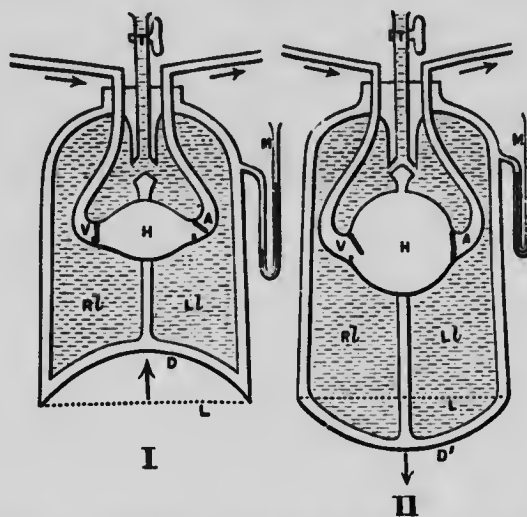

Fig. 326.—Diagram of an apparatus illustrating the effect of inspiration upon the heart and great vessels within the thorax. I, the thorax at rest; II, during inspiration; D, represents the diaphragm when relaxed; D', when contracted (it must be remembered that this position is a mere diagram), i.e., when the capacity of the thorax is enlarged; H, the heart; V, the veins entering it, and A, the aorta; RL, LL, the right and left lung; T, the trachea; M, mercurial manometer in connection with pleura. The increase in the capacity of the box representing the thorax is seen to dilate the heart as well as the lungs, and so to pump in blood through V, whereas the valve prevents reflex through A. The position of the mercury in M shows also the suction which is taking place. (Landois.)

blood into the heart from the veins. With the lungs placed as they are, during inspiration the pressure outside the heart and great vessels is diminished, and they have therefore a tendency to expand and to diminish the intra-vascular pressure. The diminution of pressure within the veins passing to the right auricle and within the right auricle itself, will draw the blood into the thorax, and so assist the circulation. This suction action is independent of the suction power of the diastole of the auricle about which we have previously spoken. The effect of sucking more blood into the right auricle will, *cæteris paribus*, increase

the amount passing through the right ventricle, which also exerts a similar suction action, and through the lungs into the left auricle and ventricle, and thus into the aorta. This all tends to increase the blood-pressure. The effect of the diminished pressure upon the pulmonary vessels will also help towards the same end, *i.e.*, an increased flow through the lungs, so that, as far as the heart and its veins are concerned, inspiration increases the blood-pressure in the arteries. The effect of inspiration upon the aorta, and its branches within the thorax, would be, however, the contrary; for as the pressure outside is diminished, the vessels would tend to expand, and thus to diminish the tension of the



Fig. 327.—Comparison of blood-pressure curve with curve of intra-thoracic pressure. (To be read from left to right.) *a* is the curve of blood-pressure with its respiratory undulations, the slower beats on the descent being very marked; *b* is the curve of intra-thoracic pressure obtained by connecting one limb of a manometer with the pleural cavity. Inspiration begins at *i* and expiration at *e*. The intra-thoracic pressure rises very rapidly after the cessation of the inspiratory effort, and then slowly falls as the air issues from the chest; at the beginning of the inspiratory effort the fall becomes more rapid. (M. Foster.)

blood within them, but inasmuch as the large arteries are capable of little expansion beyond their natural calibre, the diminution of the arterial tension caused by this means would be insufficient to counteract the increase of blood-pressure produced by the effect of inspiration upon the veins of the chest, and the balance of the whole action would be in favour of an increase of blood-pressure during the inspiratory period. But if a blood-pressure tracing be taken at the same time that the respiratory movements are being recorded, it will be found that, although speaking generally the arterial tension is increased during inspiration, the maximum of arterial tension does not correspond with the acme of inspiration (fig. 327). In fact, at the beginning of inspiration the

pressure continues to fall, then gradually rises until the end of inspiration, and continues to do so for some little time after expiration has commenced.

As regards the effect of *expiration*, the capacity of the chest is diminished, and the intra-thoracic pressure returns to the normal, which is not exactly equal to the atmospheric pressure. The effect of this on the veins is to increase their extra-vascular and so their intra-vascular pressure, and to diminish the flow of blood into the left side of the heart, and with it the general blood-pressure, but this is almost exactly balanced by the necessary increase of arterial tension caused by the increase of the extra-vascular pressure of the aorta and large arteries, so that the arterial tension is not much affected during expiration either way. Thus, ordinary expiration does not produce a distinct obstruction to the circulation, as even when the expiration is at an end the intra-thoracic pressure is less than the extra-thoracic.

The effect of violent expiratory efforts, however, has a distinct action in obstructing the current of blood through the lungs, as seen in the blueness of the face from congestion in straining; this condition being produced by pressure on the small pulmonary vessels.

We may summarise this mechanical effect of respiration on the blood-pressure therefore, and say that inspiration aids the circulation and so increases the arterial tension, and that although expiration does not materially aid the circulation, yet under ordinary conditions neither does it obstruct it. Under extraordinary conditions, however, as in violent expiration, the circulation is decidedly obstructed.

We have seen, however, that there is no exact correspondence between the point of highest blood-pressure and the end of inspiration, and we must suppose that there are other mechanical factors, such, for example, as the effect of the abdominal movements, both in inspiration and expiration, upon the arteries and veins within the abdomen and of the lower extremities, and the influence of the varying intra-thoracic pressure upon the pulmonary vessels, both of which ought to be taken into consideration. As regards the first of these, the effect during inspiration—as the cavity of the abdomen is diminished by the descent of the diaphragm—should be two-fold: on the one hand, blood would be sent upwards into the chest by compression of the vena cava inferior; on the other hand, the passage of blood downwards from the chest in the abdominal aorta, and upwards in the veins of the lower extremity, would be to a certain extent obstructed. In ordinary expiration all this would be reversed, but if the abdominal

muscles are violently contracted, as in extraordinary expiration, the same effect will be produced as by inspiration. The effect of the varying intra-thoracic pressure which occurs during inspiration upon the pulmonary vessels is to produce an initial dilatation of

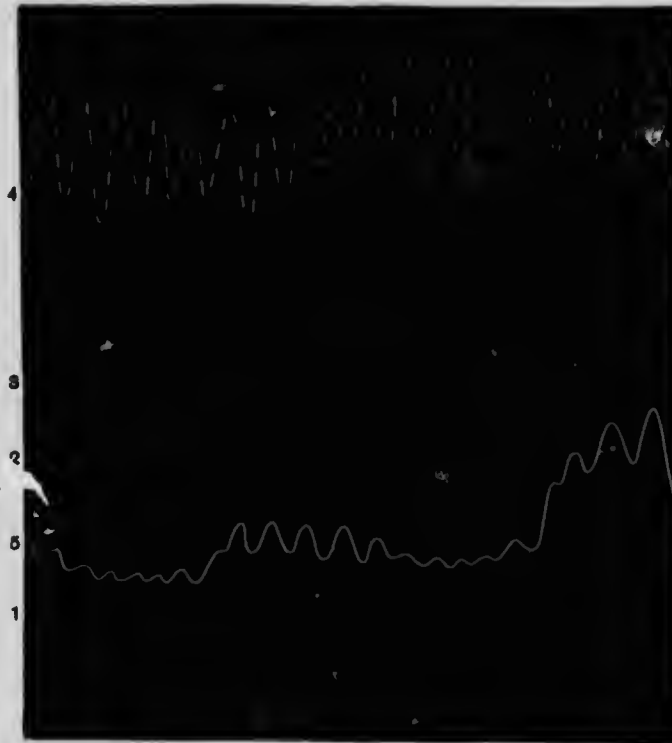

Fig. 328.—Traube-Hering's curves. (To be read from left to right.) The curves 1, 2, 3, 4 and 5 are portions selected from one continuous tracing forming the record of a prolonged observation, so that the several curves represent successive stages of the same experiment. Each curve is placed in its proper position relative to the base line, which is omitted; the blood-pressure rises in stages 2, 3, and 4, but falls again in stage 5. Curve 1 is taken from a period when artificial respiration was being kept up, but the vagi having been divided, the pulsation of the heart. The ascent and descent of the undulations do not differ; when artificial respiration ceased these undulations for a while disappeared, and the blood-pressure rose steadily while the heart-beats became slower. Soon, as at 2, new undulations appeared: a little later, the blood-pressure was still rising, the heart-beats still slower, but the undulations still more obvious (3); still later (4), the pressure was still higher, but the heart-beats were quicker, and the undulations flatter, the pressure then began to fall rapidly (5), and continued to fall until some time after artificial respiration was resumed. (M. Foster.)

both artery and veins, and this delays for a short time the passage of blood towards the left side of the heart, and the arterial pressure falls, but the fall of blood-pressure is soon followed by a steady rise, since the flow is increased by the initial dilatation of the vessels: the converse is the case with expiration. As, however, the pulmonary veins and capillaries are more easily dilatable than

the pulmonary artery, the greater distensibility increases the flow of blood as inspiration proceeds, whilst during expiration, except at its beginning, this property of theirs acts in the opposite direction, and diminishes the flow. Thus, at the beginning of inspiration the diminution of blood-pressure, which commenced during expiration, is continued, but after a time the diminution is succeeded by a steady rise; the reverse is the case with expiration—at first a rise and then a fall.

The **nervous system** also plays a part in producing rhythmical alterations quite independent of the mechanically caused undulations of the blood-pressure. It will be noticed that the heart beats more rapidly during the rise of blood-pressure than during the fall which accompanies expiration. This will be seen in the tracing (fig. 327, p. 365; see also fig. 277, p. 289). This effect disappears after section of the vagi (fig. 328, 1). It has been found that it is reflexly caused. Stimulation of the pulmonary branches of the vagus by electrical stimuli, or of their terminations in the alveoli by certain irritating vapours like chloroform or bromine, causes a reflex inhibition of the heart; great distension of the alveoli has a similar effect, but moderate distension, such as occurs during ordinary inspiration, has the opposite reflex effect, causing the heart to beat more rapidly. The afferent fibres from the pulmonary alveoli enter the bulb by the upper set of the rootlets of the combined glossopharyngeal-vagus-spinal accessory nucleus (the *a* group, see p. 252). Sometimes the rootlets of this group are three in number, sometimes two; when there are two the lower rootlet, when there are three the lower two rootlets, contain the fibres in question. (Cadman.)

### Asphyxia.

**Asphyxia** may be produced in various ways: for example, by the prevention of the due entry of oxygen into the blood, either by direct obstruction of the trachea or other part of the respiratory passages, or by introducing instead of ordinary air a gas devoid of oxygen, or by interference with the due interchange of gases between the air and the blood.

The symptoms of asphyxia may be divided into three groups, which correspond with the stages of the condition which are usually recognised; (1) the stage of exaggerated breathing; (2) the stage of convulsions; (3) the stage of exhaustion.

In the *first stage* the breathing becomes more rapid and at the same time deeper than usual, the inspiration at first being especially exaggerated and prolonged. The muscles of

extraordinary inspiration are called into action, and the effort to respire is laboured and painful. This is soon followed by a similar increase in the expiratory efforts, which become excessively prolonged, being aided by all the muscles of extraordinary expiration. During this stage, which lasts a varying time, from a minute upwards, according as the deprivation of oxygen is sudden or gradual, the lips become blue, the eyes are prominent, and the expression intensely anxious. The prolonged respirations are accompanied by a distinctly audible sound; the muscles attached to the chest stand out as distinct cords. This stage includes the two conditions *hyperpnœa* (excessive breathing) and *dyspnœa* (difficult breathing) which follows later. It is due to the increasingly powerful stimulation of the respiratory centre by the increasingly venous blood.

In the *second stage*, which is not marked by any distinct line of demarcation from the first, the violent expiratory efforts become convulsive, and then give way, in men and other warm-blooded animals, to general convulsions, which arise from the further stimulation of the centres. Spasms of the muscles of the body in general occur, and not of the respiratory muscles only. The convulsive stage is a short one, and lasts less than a minute.

The *third stage*, or stage of *exhaustion*. In it the respirations all but cease, the spasms give way to flaccidity of the muscles, there is insensibility, the conjunctivæ are insensitive and the pupils are widely dilated. Every now and then a prolonged sighing inspiration takes place, at longer and longer intervals, until breathing ceases altogether, and death ensues. During this stage the pulse is scarcely to be felt, but the heart may beat for some seconds after the respiration has stopped. The condition is due to the gradual paralysis of the respiratory centre by the prolonged action of the increasingly venous blood. This stage may last three minutes and upwards.

The *conditions of the vascular system* in asphyxia are:—  
(1) More or less interference with the passage of the blood through the systemic and pulmonary blood-vessels; (2) Accumulation of blood in the right side of the heart and in the systemic veins; (3) Circulation of impure (non-aerated) blood in all parts of the body.

After death from asphyxia it is found in the great majority of cases that the right side of the heart, the pulmonary arteries, and the systemic veins are gorged with dark, almost black, blood, and the left side of the heart, the pulmonary veins, and the arteries are empty. The explanation of these appearances may be thus summarised: when oxygenation ceases, venous blood at first



passes freely through the lungs to the left heart, and so to the great arteries. When it reaches the arterioles either by its direct action upon their muscular tissue, or more probably

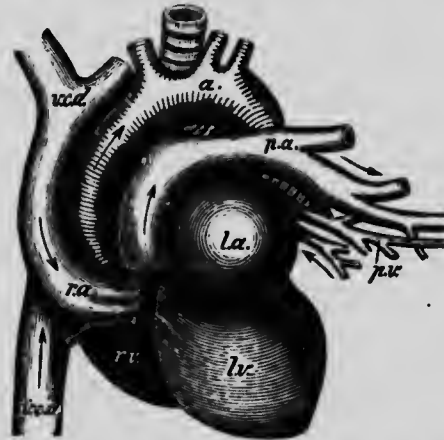

Fig. 329.—The heart in the first stage of asphyxia. The left cavities are seen to be distended; the left ventricle partly overlaps the right. *l.a.*, left auricle; *l.v.*, left ventricle; *a.*, aorta; *p.a.*, pulmonary artery; *p.v.*, pulmonary vein; *r.a.*, right auricle; *r.v.*, right ventricle; *v.c.d.*, descending vena cava; *v.c.a.*, ascending vena cava. (Sir George Johnson.)

through the medium of the vaso-motor centres, the arterioles contract, particularly those of the splanchnic area, the blood-

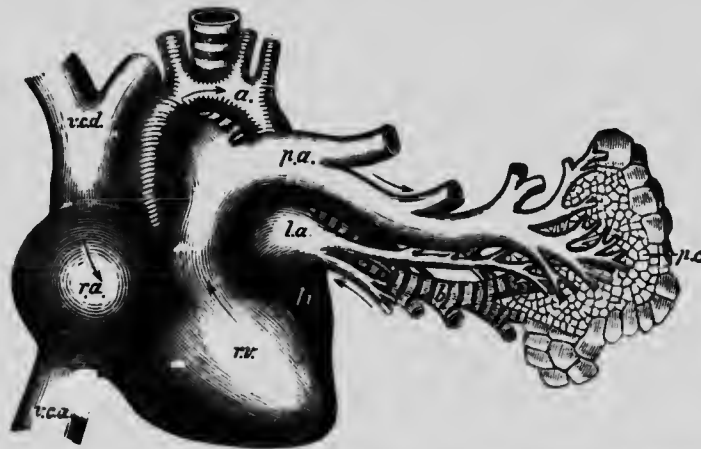

Fig. 330.—The heart in the final stage of asphyxia. The letters have the same meaning as in fig. 329; in addition, *p.c.* represents the pulmonary capillaries. The right auricle and ventricle, and the pulmonary artery, are fully distended, while the left cavities of the heart and the aorta are nearly empty. (Sir George Johnson.)

pressure rises, and the left side of the heart becomes distended. Although the arterioles are contracted, the highly venous blood is allowed to pass through them, and, favoured by the laboured

respiratory movements, arrives at the right side of the heart. When it reaches the pulmonary arterioles it gives rise to a certain amount of constriction of them as of the systemic vessels. The obstruction to the circulation through the lungs thus produced assists in bringing about a distended condition of the right heart and pulmonary artery, and, on the other hand, produces a diminished blood-flow through the pulmonary veins into the left side of the heart. The main cause, however, of the distended state of these parts, is due to the fact that the suction action of the left ventricle diminishes as asphyxia progresses, and so the blood accumulates in the right heart and veins. In the third stage of asphyxia the left side of the heart therefore gets into the empty condition in which it is found after death. (See figs. 329 and 330.)

In the first and second stages of asphyxia the arterial blood-pressure continuously rises until it reaches a point far above the

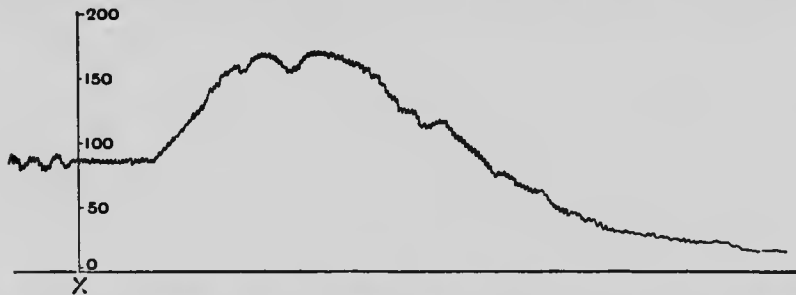

Fig. 331.—Blood-pressure tracing during asphyxia, much reduced in size. The tracing was taken by a manometer connected with the femoral artery of a dog under curare. Artificial respiration was discontinued at X. Both vagi had been previously divided. If the vagi are not divided, the rise of pressure is much less, and the heart beats very slowly. This enables the heart to last longer, and is due to excitation of the cardio-inhibitory centre by venous blood. (Starling.)

normal, and in the third stage blood-pressure falls rapidly. A tracing of the arterial pressure is shown in fig. 331.

#### Effects of Breathing Gases other than the Atmosphere.

The diminution of oxygen has a more direct influence in the production of asphyxia than the increased amount of carbonic acid. Indeed the fatal effect of **carbonic acid** in the blood when a due supply of oxygen is maintained, resembles rather the action of a narcotic poison than it does asphyxia.

Then again we must carefully distinguish the asphyxiating effect of an insufficient supply of oxygen from the directly poisonous action of such a gas as **carbonic oxide**, which is contained to a considerable amount in common coal-gas. The fatal effects often produced by this gas (as in accidents from

burning charcoal stoves in small, close rooms), are due to its entering into combination with the hæmoglobin of the blood-corpuscles and thus expelling the oxygen. **Hydrogen** may take the place of nitrogen if the oxygen is in the usual proportion, with no marked ill effect. **Sulphuretted hydrogen** interferes with the oxygenation of blood. **Nitrous oxide** acts directly on the nervous system as a narcotic. Certain gases, such as **carbon dioxide** in more than a certain proportion; **sulphurous and other acid gases, ammonia,** and **chlorine** produce spasmodic closure of the glottis, and are irrespirable.

#### Alterations in the Atmospheric Pressure.

The normal condition of breathing is that the oxygen of the air breathed should be at the pressure of  $\frac{1}{5}$  of the atmosphere, viz.,  $\frac{1}{5}$  of 760 mm. of mercury, or 152 mm., but considerable variations may occur without producing ill effects. This is due to the fact that the blood gases are mostly in a state of chemical combination, not of simple solution. Variations beyond certain limits are, however, fatal. When the tension of oxygen exceeds  $3\frac{1}{2}$  atmospheres (*i.e.*, in air at a pressure of 17 atmospheres), slow but powerful poisonous (narcotic) effects are produced on all living matter. (Bert.) The excised sartorius is paralysed by about half an hour's exposure to 80 atmospheres of oxygen; and the excised frog's heart ceases to beat in about two hours under the same conditions. It is dangerous for men to work in caissons where the atmospheric pressure is greater than 4 atmospheres. Even lower pressures may be followed on "decompression" (*i.e.*, on coming out of the increased pressure), by what are called "bends," that is, pains in the joints and muscles, by paralysis, and auditory symptoms such as deafness and vertigo. The cause of such symptoms is probably the setting free of bubbles of nitrogen in the lymph spaces and capillaries; any oxygen set free is rapidly re-absorbed by the blood. Capillary embolism from gas bubbles in the central nervous system is the most probable cause of the paralysis. (Bert.) Oxygen poisoning may be a secondary cause of the symptoms. Short shifts are essential for caisson workers, for then the body has not time to become saturated with gas at the caisson pressure.

A toad was but slightly affected by 5 minutes exposure to 20 atmospheres of oxygen, but after 40 minutes on "decompression" it went into tetanic convulsions and died; the heart was distended with frothed blood; bubbles of gas were in all the lymph spaces, in the anterior chamber of the eye, and other parts.

A mouse in a similar high pressure is narcotised, and on "decompression" convulsions and death ensue. (L. Hill.) Prolonged exposure to 2 atmospheres of oxygen is followed by pneumonia. (Lorrain Smith.) Mechanical pressure by itself has little or no influence; thus frog's muscle is not injured by exposure to fluid pressure in salt solution equal to 400 atmospheres. Crustacea are found alive on marine telegraph cables at a depth where the pressure is as great.

Turning now to diminution of pressure, we find that "mountain sickness" occurs at the height of 4,800 metres, the summit of Mt. Blanc. Here the atmospheric pressure is 418 mm. of mercury, and the pressure of oxygen is only 11.53 per cent. of an atmosphere. The malady is increased by muscular effort, and is due to want of oxygen. In those who habitually live in high altitudes, the number of red blood corpuscles is said to be increased. Crocé-Spinelli, the balloonist, perished at an altitude of 8,600 metres, where the tension of oxygen would be 7 per cent. of an atmosphere. His companion Tissandier recovered. In such cases muscular paralysis occurs before loss of consciousness. Higher ascents could be made by aeronauts if they breathed oxygen from a gas cylinder. (Bert.) That death is due to want of oxygen and not to the setting free of gas bubbles in the blood is shown by the following fact: a sparrow lived in pure oxygen at 95 mm. of mercury pressure. Haldane has shown that animals can live in two atmospheres of oxygen after all the hæmoglobin is taken up by carbonic oxide, for then sufficient oxygen is dissolved in the blood-plasma.

The foregoing paragraph is written largely from notes kindly provided me by Dr. Leonard Hill, F.R.S., who has recently been working at the subject in connection with "caisson disease." I have to thank him for allowing me to quote some of his unpublished experiments.

#### CHEMISTRY OF RESPIRATION.

The atmospheric air does not to any great extent penetrate beyond the bronchial tubes; the gases which get into the smaller tubes and air-vesicles do so principally by diffusion. The most vigorous expiratory effort is unable to expel the alveolar air. This air and the blood in the capillaries are separated only by the thin capillary and alveolar walls. The blood parts with its excess of carbonic acid and watery vapour to the alveolar air; the blood at the same time receives from the alveolar air a supply of oxygen which renders it arterial.

The intake of oxygen is the commencement, and the output of carbonic acid is the end of the series of changes known as

respiration. The intermediate steps take place all over the body and constitute what is known as *tissue-respiration*. The oxygen which goes into the blood is held there in loose combination as oxyhæmoglobin. In the tissues this substance parts with its respiratory oxygen. The oxygen does not necessarily undergo immediate union with carbon to form carbonic acid, and with hydrogen to form water, but in most cases, as in muscle, is held in reserve by the tissue itself. Owing to this reserve oxygen, a muscle will contract in an atmosphere of pure nitrogen and yet give off carbonic acid; and a frog will live under the same conditions and give off carbonic acid for several hours. Besides carbonic acid and water, certain other products of combustion are generated; those like urea and uric acid, which are the result of nitrogenous metabolism, ultimately leave the body in the urine. The carbonic acid and a portion of the water find an outlet by the lungs.

**Inspired and Expired Air.**—The composition of the inspired or atmospheric air and the expired air may be compared in the following table:—

—	Inspired air.	Expired air.
Oxygen . . . .	20·96 vols. per cent.	16·03 vols. per cent.
Nitrogen . . . .	79 " "	79 " "
Carbonic acid . . . .	0·04 " "	4·4 " "
Watery vapour . . . .	variable	saturated
Temperature . . . .	"	that of body (36° C.)

The nitrogen remains unchanged. The recently discovered gases argon, krypton, &c., are in the above table reckoned in with the nitrogen. They are, however, only present in minute quantities. The chief change is in the proportion of oxygen and carbonic acid. The loss of oxygen is about 5, the gain in carbonic acid about 4·5. If the inspired and expired airs are carefully measured at the same temperature and barometric pressure, the volume of expired air is thus found to be rather less than that of the inspired.\* The conversion of oxygen into carbonic acid would not cause any change in the volume of the gas; for a molecule of oxygen ( $O_2$ ) would give rise to a molecule of carbonic acid ( $CO_2$ ) which would occupy the same volume (Avogadro's law). It must, however, be remembered that carbon is not the only element which is oxidised. Fat and proteid contain a number of atoms

\* This diminution of volume will cause a slight rise in the proportionate volume of nitrogen per cent.

of hydrogen, which, during metabolism, are oxidised to form water; a small amount of oxygen is also used in the formation of urea. Carbohydrates contain sufficient oxygen in their own molecules to oxidise their hydrogen; hence the apparent loss of oxygen is least when a vegetable diet (that is, one consisting largely of starch and other carbohydrates) is taken, and greatest when much fat and proteid are eaten. The quotient  $\frac{\text{CO}_2 \text{ given off}}{\text{O}_2 \text{ absorbed}}$  is called the respiratory quotient. Normally it is  $\frac{4.5}{5} = 0.9$ , but it varies considerably with diet as just stated. It varies also with muscular exercise as the output of carbonic acid is then increased both absolutely and relatively to the amount of oxygen used up.

The amount of respiratory interchange of gases is estimated by enclosing an animal in an air-tight chamber, except that there is a tube entering and another leaving it; by one tube oxygen or

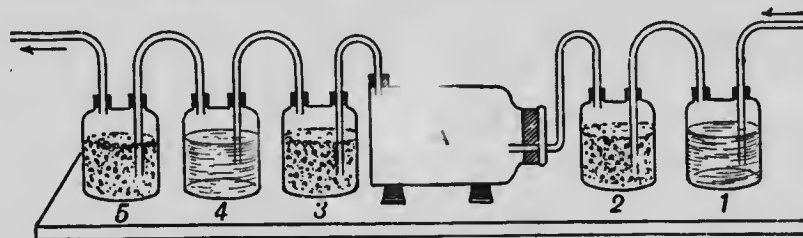

Fig. 332.—Haldane's apparatus for estimating the carbonic acid and aqueous vapour given off by an animal.

air can enter and is measured by a gas-meter as it passes in. The air is drawn through the chamber, and leaves it by the other tube; this air has been altered by the respiration of the animal, and in it the carbonic acid and water are estimated; the carbonic acid is estimated by drawing the air through tubes containing a known amount of an alkali; this combines with the carbonic acid and the increase in weight: the increase in weight gives the amount of carbonic acid; the alkali used in Regnault and Reiset's apparatus was potash; Pettenkofer used baryta water; Haldane recommends soda-lime. The water is estimated in tubes containing pumice moistened with sulphuric acid.

The accompanying drawing (fig. 332) shows the essential part of the simple but effective apparatus used by Haldane. The animal is placed in the vessel A; air is sucked through the apparatus (which must be perfectly air-tight) by a water pump at a suitable rate. The arrows indicate the direction in which the air passes. It goes first through two Woulf's bottles, 1 and 2. No. 1 contains soda-lime, which frees the air from

carbonic acid; No. 2 contains pumice stone moistened with sulphuric acid, which frees the air from aqueous vapour. The air next reaches the animal chamber, and the animal gives off to it carbonic acid and aqueous vapour. It passes then through the three bottles, 3, 4, and 5. No. 3 contains pumice and sulphuric acid, which removes the water; No. 4 contains soda-lime, which absorbs the carbonic acid; and No. 5 contains pumice and sulphuric acid, which absorbs any water carried over from bottle 4. The increase of weight in bottle 3 at the end of a given time (*e.g.*, an hour) is the weight of water given off by the animal in that time; the increase of weight in bottles 4 and 5 weighed together gives the amount of carbonic acid produced by the animal in the same time.

Ranke gives the following numbers from experiments made on a man, who was taking a mixed diet consisting of 100 grammes of proteid, 100 of fat, and 250 of carbohydrate in the twenty-four hours. The amount of oxygen absorbed in the same time was 666 grammes; of which 560 passed off as carbonic acid, 9 in urea, 19 as water formed from the hydrogen of the proteid, and 78 from that of the fat.

Vierordt from a number of experiments on human beings gives the following numbers: the amount of oxygen absorbed in the twenty-four hours, 744 grammes; this leads to the formation of 900 grammes of carbonic acid (this contains about half a pound of carbon) and 360 grammes of water.

The respiratory interchange is lessened during sleep. It is especially small in the winter sleep of hibernating animals.

*Circumstances affecting the amount of carbonic acid excreted.* (a) *Age and sex.* In males the quantity increases with growth till the age of 30; at 50 it begins to diminish again. In females the decrease begins when menstruation ceases. In females the quantity exhaled is always less than in males of the same age.

(b) *Respiratory movements.*—The quicker the respiration the smaller is the proportionate quantity of carbonic acid in each volume of expired air. The total quantity is, however, increased, not because more is formed in the tissues, but more is got rid of. The last portion of the expired air which comes from the more remote parts of the lungs is the richest in carbonic acid.

(c) *External temperature.*—In cold-blooded animals, a rise in the external temperature causes a rise in their body temperature, accompanied with increased chemical changes, including the formation of a larger amount of carbonic acid. In warm-blooded animals, it is just the reverse; in cold weather the body temperature has to be kept at the normal level, and so increased combustion is necessary.

(d) *Food.*—This produces an increase which usually comes on about an hour after a meal.

(e) *Exercise.*—Moderate exercise causes an increase of about 30 to 40 per cent. in the amount excreted. With excessive work, the increase is still greater.

**Diffusion of Gases within the Lungs.**—If two chambers containing a mixture of gases in unequal amount are connected together, a slow movement called diffusion takes place until the percentage amount of each gas in each chamber is the same. Let us suppose that one chamber contains a large quantity of oxygen and a small quantity of carbonic acid; and the other a small quantity of oxygen and a large quantity of carbonic acid; the oxygen moves from the first to the second, and the carbonic acid from the second to the first chamber. The pressure of a gas is proportional to the percentage amount in which it is present in a mixture. This is true for each gas in a mixture, the presence of the others making no difference.

In the atmosphere, for instance, the total barometric pressure is 760 mm. of mercury; the amount of oxygen in the air is roughly one-fifth, and the pressure it exercises is also one-fifth of 760; the nitrogen accounts for the other four-fifths. The carbonic acid is present in such small quantities that the pressure it exercises is only a fraction of a millimetre.

In the alveolar air, however, the carbonic acid is present in larger and the oxygen in smaller amount; and in the intermediate air passages there is an intermediate condition: hence as in the two chambers we first considered, oxygen diffuses down to the air vesicles, and carbonic acid from them. These slow movements of diffusion are assisted by the large draughts which are created in the upper respiratory tract by the respiratory movements of the chest.

**Gases of the Blood.**—From 100 volumes of blood, about 60 volumes of gas can be removed by the mercurial air-pump. The average composition of this gas in dog's blood is:—

	Arterial blood.	Venous blood.
Oxygen . . . . .	20 . . . . .	8 to 12
Nitrogen . . . . .	1 to 2 . . . . .	1 to 2
Carbonic acid . . . . .	40 . . . . .	46

The nitrogen in the blood is simply dissolved from the air just as water would dissolve it; it has no physiological importance. The other two gases are present in much greater amount than can be explained by simple solution; they are, in fact, chiefly present in loose chemical combinations. Less than one volume of the oxygen and about two of carbonic acid are present in simple solution in the plasma.

**Oxygen in the Blood.**—The amount of gas dissolved in a liquid varies with the pressure of the gas; double the pressure and the amount of gas dissolved is doubled. Now this does not occur in the case of oxygen and blood; very nearly the same



amount of oxygen is dissolved whatever be the pressure. We have thus a proof that oxygen is not merely dissolved in the blood, but is in chemical union; and the fact that the oxygen of oxyhæmoglobin can be replaced by equivalent quantities of other gases, like carbonic oxide, is a further proof of the same statement. The tension or partial pressure of oxygen in the air of the alveoli is less than that in the atmosphere, but greater than that in venous blood; hence oxygen passes from the alveolar air into the blood-plasma; the oxygen immediately combines with the hæmoglobin, and thus leaves the plasma free to absorb more oxygen; and this goes on until the hæmoglobin is entirely, or almost entirely, saturated with oxygen. The reverse change occurs in the tissues when the partial pressure of oxygen is lower than in the plasma, or in the lymph that bathes the tissue elements; the plasma parts with its oxygen to the lymph, the lymph to the tissues; the oxyhæmoglobin then undergoes dissociation to supply more oxygen to the plasma and lymph, and thus in turn to the tissues once more. This goes on until the oxyhæmoglobin loses a great portion of its store of oxygen, but even in asphyxia it does not lose all.

The following values are given by Fredericq for the tension of oxygen in percentages of an atmosphere. His experiments were made on dogs.

External air	.	.	.	.	.	.	20.96	
Alveolar air	.	.	.	.	.	.	18	
Arterial blood	.	.	.	.	.	.	14	
Tissues	.	.	.	.	.	.	0	

The arrow shows the direction in which the gas passes.

When the gases are being pumped off from the blood, very little oxygen comes off till the pressure has been greatly reduced, and then, at a certain point, it is disengaged at a burst. This shows that it is not in simple solution but is united chemically to some constituent of the blood, which is suddenly dissociated at the reduced pressure. This constituent of the blood is hæmoglobin.

The avidity of the tissues for oxygen is shown by Ehrlich's experiments with methylene blue and similar pigments. Methylene blue is more stable than oxyhæmoglobin; but if it is injected into the circulation of a living animal, and the animal killed a few minutes later, the blood is found dark blue, but the organs (especially those which like glandular organs are in a state of activity) colourless. On exposure to oxygen the organs become blue. In other words, the tissues have removed the oxygen from methylene blue to form a colourless reduction product; on exposure to the air this once more unites with oxygen to form methylene blue.

**Carbonic Acid in the Blood.**—What has been said for oxygen holds good in the reverse direction for carbonic acid. Compounds are formed in the tissues where the tension of the gas is high: these pass into the lymph, then into the blood, and in the lungs they undergo dissociation, carbonic acid passing into the alveolar air, where the tension of the gas is comparatively low, though it is greater here than in the expired air.

The relations of this gas and the compounds it forms are more complex than in the case of oxygen. If blood is divided into plasma and corpuscles, it will be found that both yield carbonic acid, but the yield from the plasma is the greater. If we place blood in a vacuum it bubbles, and gives out all its gases; addition of a weak acid causes no further liberation of carbonic acid. When plasma or serum is similarly treated the gas also comes off, but about 5 per cent. of the carbonic acid is fixed—that is, it requires the addition of some stronger acid, like phosphoric acid, to displace it. Fresh red corpuscles will, however, take the place of the phosphoric acid, and thus it has been surmised that oxyhæmoglobin has the properties of an acid.

One hundred volumes of venous blood contain forty-six volumes of carbonic acid. Whether this is in solution or in chemical combination is determined by ascertaining the tension of the gas in the blood. One hundred volumes of blood-plasma would dissolve more than an equal volume of the gas at atmospheric pressure, if its solubility in plasma were equal to that in water.\* If, then, the carbonic acid were in a state of solution, its tension would be very high, but it proves to be only equal to 5 per cent. of an atmosphere. This means that when venous blood is brought into an atmosphere containing 5 per cent. of carbonic acid, the blood neither gives off any carbonic acid nor takes up any from that atmosphere. Hence the remainder of the gas, 95 per cent., is in a condition of chemical combination. The chief compound appears to be sodium bicarbonate.

The carbonic acid and phosphoric acid of the blood are in a state of constant struggle for the possession of the sodium. The salts formed by these two acids depend on their relative masses. If carbonic acid is in excess, we get sodium carbonate ( $\text{Na}_2\text{CO}_3$ ), and mono-sodium phosphate ( $\text{NaH}_2\text{PO}_4$ ); but if the carbonic acid is diminished, the phosphoric acid obtains the greater share of sodium to form disodium phosphate ( $\text{Na}_2\text{HPO}_4$ ). In this way, as soon as the amount of free carbonic acid diminishes, as in the

---

\* To be exact, the solubility of carbon dioxide in plasma is a little less than in pure water.

lungs, the amount of carbonic acid in combination also decreases; whereas in the tissues, where the tension of the gas is highest, a large amount is taken up into the blood, where it forms sodium bicarbonate.

The tension of the carbonic acid in the tissues is high, but one cannot give exact figures; we can measure the tension of the gas in certain secretions: in the urine it is 9, in the bile 7 per cent. The tension in the cells themselves must be higher still.

The following figures (from Fredericq) give the tension of carbonic dioxide in percentages of an atmosphere:—

Tissues . . . . .	5 to 9	} in dog. ↓
Venous blood . . . . .	3·8 to 5·4	
Alveolar air . . . . .	2·8	
External air . . . . .	0·03	

The arrow indicates the direction in which the gas passes, namely, in the direction of pressure from the tissues to the atmosphere.

In some other experiments, also on dogs, the following are the figures given:—

Arterial blood . . . . .	2·8	↓
Venous blood . . . . .	5·4	
Alveolar air . . . . .	3·56	
Expired air . . . . .	2·8	

It will be seen from these figures that the tension of carbonic acid in the venous blood (5·4) is higher than in the alveolar air (3·56); its passage into the alveolar air is therefore intelligible by the laws of osmosis. Osmosis, however, should cease when the tension of the gas in the blood and alveolar air are equal. But the transference goes beyond the establishment of such an equilibrium, for the tension of the gas in the blood continues to sink until it is ultimately less (2·8) than in the alveolar air.

The whole question is beset with great difficulties and contradictions. Analyses by different observers have given very different results, but if such figures as those just quoted are ultimately found to be correct, we can only explain this apparent reversal of a law of nature by supposing with Bohr that the alveolar epithelium possesses the power of excreting carbonic acid, just as the cells of secreting glands are able to select certain materials from the blood and reject others. Recent work by Bohr and Haldane has also shown that in all probability the same explanation—epithelial activity—must be called in to account for the absorption of oxygen. In the swim-bladder of fishes (which is analogous to the lungs of mammals) the

oxygen is certainly far in excess of anything that can be explained by mere diffusion. The storage of oxygen, moreover, ceases when the vagus nerves which supply the swim-bladder are divided.

**Tissue-Respiration.**—Before the processes of respiration were fully understood the lungs were looked upon as the seat of combustion; they were regarded as the stove for the rest of the body to which effete material was brought by the venous blood to be burnt up. When it was shown that the venous blood going to the lungs already contained carbonic acid, and that the temperature of the lungs is not higher than that of the rest of the body, this explanation had of necessity to be dropped.

Physiologists next transferred the seat of the combustion to the blood; but since then numerous facts and experiments have demonstrated that it is in the tissues themselves, and not in the blood, that combustion occurs. The methylene-blue experiments already described (p. 378) show this; and the following experiment is also quite conclusive. A frog can be kept alive for some time after salt solution is substituted for its blood. The metabolism goes on actively if the animal is kept in pure oxygen. The taking up of oxygen and giving out of carbonic acid must therefore occur in the tissues, as the animal has no blood.

**Ventilation.**—It is necessary to allude in conclusion to this very important practical outcome of our consideration of respiration.

Some Continental observers have stated that certain noxious substances are ordinarily contained in expired air which are much more poisonous than carbonic acid, but researches in this country have failed to substantiate this. If precautions be taken by absolute cleanliness to prevent admixture of the air with exhalations from skin, teeth, and clothes, the expired air only contains one noxious substance, and that is carbonic acid.

Absolute cleanliness is however not the rule; and the air of rooms becomes stuffy when the amount of expired air in them is just so much as to raise the percentage of carbonic acid to 0.1 per cent. An adult gives off about 0.6 cubic feet of carbonic acid per hour, and if he is supplied with 1,000 cubic feet of fresh air per hour he will add 0.6 to the 0.4 cubic feet of carbonic acid it already contains; in other words the percentage of that gas will be raised to 0.1. An hourly supply of 2,000 cubic feet of fresh air will lower the percentage of carbonic acid to 0.07, and of 3,000 cubic feet to 0.06, and this is the supply which is usually recommended. In order that the air may be renewed without giving rise to draughts, each adult should be allotted sufficient space in a room, at least 1,000 cubic feet.

### The Mercurial Air-Pump.

The extraction of the gases from the blood is accomplished by means of a mercurial air-pump, of which there are many varieties, those of Ludwig, Alvergriat, Geissler, and Sprengel being the chief. The principle of action in all is the same. Ludwig's pump, which may be taken as a type, is represented in fig. 333. It consists of two fixed glass globes, *C* and *F*, the

upper one communicating by means of the stopcock, *D*, and a stout india-rubber tube with another glass globe, *L*, which can be raised or lowered by means of a pulley; it also communicates by means of a stopcock, *B*, and a bent glass tube, *A*, with a gas receiver (not represented in the figure); *A* dips into a bowl of mercury, so that the gas may be received over mercury. The lower globe, *F*, communicates with *C* by means of the stopcock, *E*, with *I* in which the blood is contained by the stopcock, *G*, and with

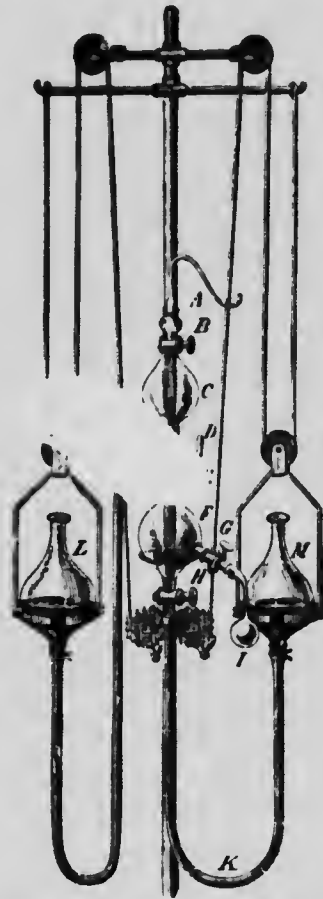

Fig. 333.—Ludwig's mercurial pump.

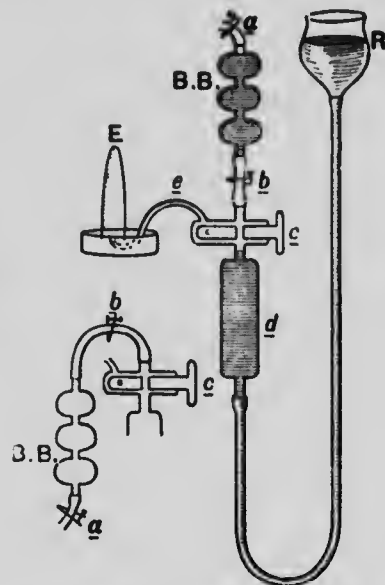

Fig. 334.—L. Hill's air-pump.

a movable glass globe, *M*, similar to *L*, by means of the stopcock, *H*, and the stout india-rubber tube, *K*.

In order to work the pump, *L* and *M* are filled with mercury, the blood from which the gases are to be extracted is placed in the bulb *I*, the stopcocks, *H*, *E*, *D*, and *B*, being open, and *G* closed. *M* is raised by means of the pulley until *F* is full of mercury, and the air is driven out. *E* is then closed, and *L* is raised so that *C* becomes full of mercury, and the air is driven off. *B* is then closed. On lowering *L* the mercury runs into it from *C*, and a vacuum is established in *C*. On opening *E* and lowering *M*, a vacuum is similarly established in *F*; if *G* is now opened, the blood in *I* will

enter into ebullition, and the gases will pass off into *F* and *C*, and on raising *M* and then *L*, the stopcock *B* being opened and *G* closed, the gas is driven through *A*, and is received in the receiver over mercury. By repeating the experiment several times the whole of the gases of the specimen of blood is obtained, and may be estimated.

The very simple air-pump (fig. 334) devised by Leonard Hill will be, however, amply sufficient for most purposes. It consists of three glass bulbs; (B.B.), which we will call the *blood bulb*; this is closed above by a piece of tubing and a clip, *a*; this is connected by good india-rubber tubing to another bulb, *d*. Above *d*, however, there is a stopcock with two ways cut through it: one by means of which B.B. and *d* may be connected, as in the figure; and another seen in section, which unites *d* to the tube *e*, when the stopcock is turned through a right angle. In intermediate positions, the stopcock cuts off all communication from *d* to all parts of the apparatus above it; *d* is connected by tubing to a receiver, R, which can be raised or lowered at will. At first the whole apparatus is filled with mercury, R being raised. Then, *a* being closed, R is lowered, and when it is more than the height of the barometer (30 inches) below the top of B.B., the mercury falls and leaves the blood bulb empty; by lowering R still further, *d* can also be rendered a vacuum. A few drops of mercury should be left behind in B.B. B.B. is then detached from the rest of the apparatus and weighed, the clips, *a* and *b*, being tightly closed. Blood is then introduced into it by connecting the tube with the clip *a* on it to a cannula filled with blood inserted in an artery or vein of a living animal. Enough blood is withdrawn to fill about half of one of the bulbs. This is defibrinated by shaking it with the few drops of mercury left in the bulbs. It is then weighed again: the increase of weight gives the amount of blood which is being investigated. B.B. is then once more attached to the rest of the apparatus, hanging downwards, as in the side drawing in fig. 334, and the blood gases boiled off; these pass into *d*, which has been made a vacuum; and then, by raising R again, the mercury rises in *d*, pushing the gases in front of it, through the tube, *e* (the stopcock being turned in the proper direction), into the endiometer, E, which has been filled with and placed over mercury. The gas can then be measured and analysed.

**Gas analysis.**—There are many pieces of apparatus devised for this purpose. In physiology, however, we have generally to deal with only three gases, oxygen, nitrogen, and carbonic acid.

Waller's modification of Zuntz's more complete apparatus will be found very useful in performing gas analysis, say, of the expired air, or of the blood

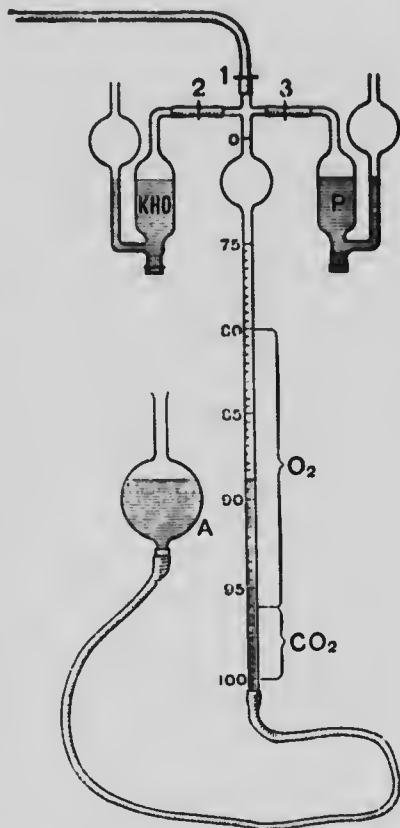

Fig. 335.—Waller's apparatus for gas analysis.

gases. A 100 c.c. measuring-tube graduated in tenths of a cubic centimetre between 75 and 100; a filling bulb (A) and two gas pipettes are connected up as in the diagram (fig. 335).

It is first charged with acidulated water up to the zero mark by raising the filling bulb, tap 1 being open. It is then filled with 100 c.c. of expired air, the filling bulb being lowered till the fluid in the tube has fallen to the 100 mark. Tap 1 is now closed. The amount of carbonic acid in the expired air is next ascertained; tap 2 is opened, and the air is expelled into the gas pipette containing strong caustic potash solution by raising the filling bulb until the fluid has risen to the zero mark of the measuring tube. Tap 2 is closed, and the air left in the gas pipette for a few minutes, during which the carbonic acid is absorbed by the potash. Tap 2 is then opened and the air drawn back into the measuring tube by lowering the filling bulb. The volume of air (*minus* the carbonic acid) is read, the filling bulb being adjusted so that its contents are at the same level as the fluid in the measuring tube. The amount of oxygen is next ascertained in a precisely similar manner by sending the air into the other gas pipette, which contains sticks of phosphorus in water, and measuring the loss of volume (due to absorption of oxygen) in the air when drawn back into the tube.

## CHAPTER XXV.

### THE CHEMICAL COMPOSITION OF THE BODY.

THE body is built up of a large number of chemical elements, which are in most instances united together into compounds.

The **elements** found in the body are carbon, nitrogen, hydrogen, oxygen, sulphur, phosphorus, fluorine, chlorine, iodine, silicon, sodium, potassium, calcium, magnesium, lithium, iron, and occasionally traces of manganese, copper, and lead.

Of these very few occur in the free state. Oxygen (to a small extent) and nitrogen are found dissolved in the blood; hydrogen is formed by putrefaction in the alimentary canal. With some few exceptions such as these, the elements enumerated above are found combined with one another to form what are called *compounds*.

The **compounds**, or, as they are generally termed in physiology, the *proximate principles*, found in the body are divided into—

- (1) Mineral or inorganic compounds.
- (2) Organic compounds, or compounds of carbon.

The **inorganic compounds** present are water, various acids (such as hydrochloric acid in the gastric juice), ammonia (as in the urine), and numerous salts, such as calcium phosphate in bone, sodium chloride in blood and urine, and many others.

The **organic compounds** are more numerous; they may be subdivided into—

1. Various groups of alcohols and organic acids, and their compounds, such as the fats and carbohydrates.
2. Various derivatives of ammonia, amides, amines, urea, &c.
3. Aromatic bodies, or derivatives of benzene.
4. Proteids, the most important of all, and substances allied to proteids, like the albuminoids, pigments, and ferments.

Many of these substances we shall study with the blood, food, urine, &c.

A more convenient practical method of grouping physiological proximate principles is the following:—

<b>Inorganic</b>	.	.	.	{ <i>Water.</i> <i>Salts—e.g.</i> chlorides and phosphates of sodium and calcium.
<b>Organic</b>	{	Nitrogenous	.	{ <i>Proteids—e.g.</i> albumin, myosin, casein. <i>Albuminoids—e.g.</i> gelatin, chondrin, nuclein. <i>Simpler nitrogenous bodies—e.g.</i> lecithin, creatine.
		Non-nitrogenous	{	{ <i>Fats—e.g.</i> butter, fats of adipose tissue. <i>Carbohydrates—e.g.</i> sugar, starch. <i>Simple organic bodies—e.g.</i> cholesterin, lactic acids.

Many of the substances enumerated above only occur in small quantities. The most important are the inorganic substances, *water* and *salts*; and the organic substances, *proteids*, *carbohydrates*, and *fats*. It is necessary in our subsequent study of the principles of chemical physiology that we should always keep in mind this simple classification; the subdivision of proximate principles into proteids, fats, and carbohydrates forms the starting-point of chemical physiology.

### Carbohydrates.

The **carbohydrates** are found chiefly in vegetable tissues, and many of them form important foods. Some carbohydrates are, however, found in or formed by the animal organism. The most important of these are *glycogen*, or animal starch; *dextrose*; and *lactose*, or milk sugar.

The carbohydrates may be conveniently defined as compounds of carbon, hydrogen, and oxygen, the two last-named elements being in the proportion in which they occur in water.\*

They may be for the greater part arranged into three groups according to their empirical formulæ. The names and formulæ

---

\* This definition is only a rough one, and if pushed too far would include several substances like acetic acid, lactic acid, and inosite, which are not carbohydrates.



of these groups, and the most important members of each, are as follows :—

1. Monosaccharides or Glucoses, $C_6H_{12}O_6$ .	2. Disaccharides, Sucroses, or Saccharoses, $C_{12}H_{22}O_{11}$ .	3. Polysaccharides or Amyloses, $(C_6H_{10}O_5)_n$ .
+ Dextrose. - Levulose. + Galactose.	+ Cane sugar. + Lactose. + Maltose.	+ Starch. + Glycogen. + Dextrin. Cellulose. Gums.

The + and - signs in the above list indicate that the substances to which they are prefixed are dextro- and levo-rotatory respectively as regards polarised light. (See Polarimeter, p. 402.)

The formulæ given above are merely empirical; and there is no doubt that the quantity  $n$  in the starch group is variable and often large; hence the name *polysaccharides* that is given to the group. Research has, moreover, shown that the glucoses are either aldehydes or ketones of hexatomic alcohols  $C_6H_8(OH)_6$ . Thus dextrose is the aldehyde of sorbite, levulose the ketone of mannite, and galactose the aldehyde of dulcitol. The amyloses may be regarded as the anhydrides of the glucoses [ $nC_6H_{12}O_6 - nH_2O = (C_6H_{10}O_5)_n$ ]. The sucroses are condensed glucoses—*i.e.* they are formed by the combination of two molecules of glucose with the loss of one molecule of water ( $C_6H_{12}O_6 + C_6H_{12}O_6 - H_2O = C_{12}H_{22}O_{11}$ ); hence the term *disaccharide*. The following are the chief facts in relation to each of the principal carbohydrates :—

**Dextrose or Grape Sugar.**—This carbohydrate is found in fruits, honey, and in minute quantities in the blood and numerous tissues, organs, and fluids of the body. It is the form of sugar found in large quantities in the blood and urine in the disease known as *diabetes*.

Dextrose is soluble in hot and cold water and in alcohol. It is crystalline, but not so sweet as cane sugar. When heated with strong potash certain complex acids are formed which have a yellow or brown colour. This constitutes *Moore's test* for sugar. In alkaline solutions dextrose reduces salts of silver, bismuth, mercury, and copper. The reduction of cupric to cuprous salts constitutes *Trommer's test*, which is performed as follows: put a few drops of copper sulphate into a test-tube, then solution of dextrose, and then strong caustic potash. On adding the potash a precipitate is first formed which dissolves forming a blue solution. On boiling this a yellow or red precipitate (cuprous hydrate or oxide) forms.

On boiling a solution of dextrose with an alkaline solution of picric acid, a dark red opaque solution due to reduction to picramic acid is produced.

Another important property of grape sugar is that under the influence of yeast it is converted into alcohol and carbonic acid ( $C_6H_{12}O_6 = 2C_2H_6O + 2CO_2$ ).

Dextrose may be estimated by the fermentation test, by the polarimeter, and by the use of Fehling's solution. The last method is the most important: it rests on the same principles as Trommer's test, and we shall study it in connection with diabetic urine.

**Levulose.**—When cane sugar is treated with dilute mineral acids it undergoes a process known as *inversion*—*i.e.*, it takes up water and is converted into equal parts of dextrose and levulose. The previously dextro-rotatory solution of cane sugar then becomes levorotatory, the levo-rotatory power of the levulose being greater than the dextro-rotatory power of the dextrose formed. Hence the term *inversion*. Similar hydrolytic changes are produced by certain ferments, such as the invert ferment of the intestinal juice.

Pure levulose can be crystallised, but so great is the difficulty of obtaining crystals of it that one of its names was *uncrystallisable sugar*. Small quantities of levulose have been found in blood, urine, and muscle. It has been recommended as an article of diet in diabetes in place of ordinary sugar; in this disease it does not appear to have the harmful effect that other sugars produce. Levulose gives the same general reactions as dextrose.

**Galactose** is formed by the action of dilute mineral acids or inverting ferments on lactose. It resembles dextrose in its action on polarised light, in reducing cupric salts in Trommer's test, and in being directly fermentable with yeast. When oxidised by means of nitric acid it yields an acid called *mucic acid* ( $C_6H_{10}O_8$ ), which is only slightly soluble in water. Dextrose when treated in this way yields an isomeric acid—*i.e.*, an acid with the same empirical formula, called *saccharic acid*, which is very soluble in water.

**Cane Sugar** is generally distributed in the vegetable kingdom, but especially in the juices of the sugar cane, beetroot, mallow, and sugar maple. It is a substance of great importance as a food. It undergoes inversion in the alimentary canal. It is crystalline, and dextro-rotatory. With Trommer's test it gives a blue solution, but no reduction occurs in boiling. After inversion it is, of course, strongly reducing.

Inversion may be accomplished by boiling with dilute mineral

acids, or by means of inverting ferments such as that occurring in the intestinal juice. It then takes up water, and is split into equal parts of dextrose and levulose.

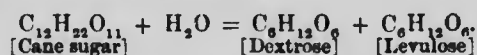

With yeast, cane sugar is first inverted by means of a special soluble ferment secreted by the yeast cells, and then there is an alcoholic fermentation of the glucoses so formed.

**Lactose, or Milk Sugar**, occurs in milk. It is occasionally found in the urine of women in the early days of lactation, or after weaning. It is crystallisable, dextro-rotatory, much less soluble in water than other sugars, and has only a slightly sweet taste. It gives Trommer's test, but when the reducing power is tested quantitatively by Fehling's solution it is found to be a less powerful reducing agent than dextrose, in the proportion of 7 to 10.

When hydrolysed by similar agencies as those mentioned in connection with cane sugar it takes up water and splits into dextrose and galactose.

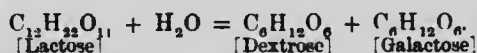

With yeast it is first inverted, and then alcohol is formed. This, however, occurs slowly.

The lactic acid fermentation which occurs when milk turns sour is brought about by lactic acid micro-organisms, which are somewhat similar to yeast cells. Putrefactive bacteria in the intestine bring about the same result. The two stages of the lactic acid fermentation are represented in the following equations:—

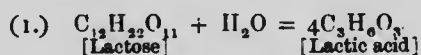

**Maltose** is the chief end product of the action of malt diastase on starch, and is also formed as an intermediate product in the action of dilute sulphuric acid on the same substance. It is the chief sugar formed from starch by the diastatic ferments contained in the saliva and pancreatic juice. An isomeric sugar called *iso-maltose* is also formed under the same circumstances. It can be obtained in the form of acicular crystals, and is strongly dextro-rotatory. It gives Trommer's test; but its reducing power, as measured by Fehling's solution, is one-third less than that of dextrose.

By prolonged boiling with water, or, more readily, by boiling

with a dilute mineral acid, or by means of an inverting ferment, such as occurs in the intestinal juice, it is converted into dextrose.

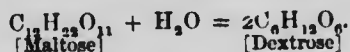

It undergoes readily the alcoholic fermentation.

**Phenyl hydrazine test.**—The three important reducing sugars with which we have to deal in physiology are dextrose, lactose, and maltose. They may be distinguished by their relative reducing powers on Fehling's solution, or by the characters of their osazones. The osazone is formed in each case by adding phenyl hydrazine hydrochloride, and sodium acetate, and boiling the mixture for half an hour. In each case the osazone is deposited in the form of bright canary-coloured, needle-like crystals, usually in bunches, which differ in their crystalline form, melting-point, and solubilities.

**Starch** is widely diffused through the vegetable kingdom. It occurs in nature in the form of microscopic grains, varying in size and appearance, according to their source. Each consists of a central spot, round which more or less concentric envelopes of starch proper or granuloase alternate with layers of cellulose. Cellulose has very little digestive value, but starch is a most important food.



Fig. 336.—Grains of potato starch.

Starch is insoluble in cold water: it forms an opalescent solution in boiling water, which if concentrated gelatinises on cooling. Its most characteristic reaction is the blue colour it gives with iodine.

On heating starch with mineral acids, dextrose is formed. By the action of diastatic ferments, maltose is the chief end product. In both cases dextrin is an intermediate stage in the process.

Before the formation of dextrin the starch solution loses its opalescence, a substance called *soluble starch* being formed. This, like native starch, gives a blue colour with iodine. Although the molecular weight of starch is unknown, the formula for soluble starch is probably  $5(\text{C}_{12}\text{H}_{20}\text{O}_{10})_{20}$ . Equations that represent the formation of sugars and dextrans from this are very complex, and are at present only hypothetical.

**Dextrin** is the name given to the intermediate products in the hydration of starch or glycogen, and two chief varieties are distinguished:—*erythro-dextrin*, which gives a reddish-brown colour with iodine; and *achroo-dextrin*, which does not.

It is readily soluble in water, but insoluble in alcohol and ether. It is gummy and amorphous. It does not give Trommer's test, nor does it ferment with yeast. It is dextro-rotatory. By hydrating agencies it is converted into glucose.

**Glycogen**, or animal starch, is found in liver, muscle, and white blood-corpuscles. It is also abundant in all embryonic tissues.

Glycogen is a white tasteless powder, soluble in water, but it forms, like starch, an opalescent solution. It is insoluble in alcohol and ether. It is dextro-rotatory. With Trommer's test it gives a blue solution, but no reduction occurs on boiling.

With iodine it gives a reddish or port-wine colour, very similar to that given by erythro-dextrin. Dextrin may be distinguished from glycogen by (1) the fact that it gives a clear, not an opalescent, solution with water; and (2) it is not precipitated by basic lead acetate as glycogen is. It is, however, precipitated by basic lead acetate and ammonia. (3) Glycogen is precipitated by 55 per cent. of alcohol; the dextrans require 85 per cent. or more.

**Cellulose**.—This is the colourless material of which the cell-walls and woody fibres of plants are composed. By treatment with strong mineral acids it is, like starch, converted into glucose, but with much greater difficulty. The various digestive ferments have little or no action on cellulose; hence the necessity of boiling starch before it is taken as food. Boiling bursts the cellulose envelopes of the starch grains, and so allows the digestive juices to get at the starch proper.

Cellulose is found in a few animals, as in the test or outer investment of the Tunicates.

[**Inosite**, or muscle sugar, is found in muscle, kidney, liver, and other parts of the body in small quantities. It is also largely found in the vegetable kingdom. It is crystallisable, and has the same formula as the glucoses. It is, however, not a sugar, and careful analysis has shown that it really belongs to the aromatic series.]

#### The Fats.

**Fat** is found in small quantities in many animal tissues. It is, however, found in large quantities in three situations, viz., marrow, adipose tissue, and milk.

The contents of the fat cells of adipose tissue are fluid during life, the normal temperature of the body ( $36^{\circ}$  C., or  $99^{\circ}$  F.) being considerably above the melting-point ( $25^{\circ}$  C.) of the mixture of the fats found there. These fats are three in number, and are called *palmitin*, *stearin*, and *olein*. They differ from one another

in chemical composition and in certain physical characters, such as melting-point and solubilities. Olein melts at  $-5^{\circ}$  C., palmitin at  $45^{\circ}$  C., and stearin at  $53-66^{\circ}$  C. It is thus olein which holds the other two dissolved at the body temperature. Fats are all soluble in hot alcohol, ether, and chloroform, but insoluble in water.

**Chemical Constitution of the Fats.**—The fats are compounds of fatty acids with glycerin, and may be termed *glycerides* or *glyceric ethers*. The term *hydrocarbon*, applied to them by some authors, is wholly incorrect.

The fatty acids form a series of acids derived from the monatomic alcohols by oxidation. Thus, to take ordinary ethyl alcohol,  $C_2H_6O$ , the first stage in oxidation is the removal of two atoms of hydrogen to form aldehyde,  $C_2H_4O$ ; on further oxidation an atom of oxygen is added to form acetic acid,  $C_2H_4O_2$ .

A similar acid can be obtained from all the other alcohols, thus:—

From methyl alcohol	$CH_3.HO$ , formic acid	$H.COOH$ is obtained.
" ethyl "	$C_2H_5.HC$ , acetic "	$CH_3.COOH$ "
" propyl "	$C_3H_7.HO$ , propionic "	$C_2H_5.COOH$ "
" butyl "	$C_4H_9.HO$ , butyric "	$C_3H_7.COOH$ "
" amyl "	$C_5H_{11}.HO$ , valeric "	$C_4H_9.COOH$ "
" hexyl "	$C_6H_{13}.HO$ , caproic "	$C_5H_{11}.COOH$ "

and so on.

Or in general terms:—

From the alcohol with formula  $C_nH_{2n+1}.HO$ , the acid with formula  $C_{n-1}H_{2n-1}.COOH$  is obtained. The sixteenth term of this series has the formula  $C_{15}H_{31}.COOH$ , and is called **palmitic acid**; the eighteenth has the formula  $C_{17}H_{35}.COOH$ , and is called **stearic acid**. Each acid, as will be seen, consists of a radicle,  $C_{n-1}H_{2n-1}CO$ , united to hydroxyl (OH). **Oleic acid**, however, is not a member of this series, but belongs to a somewhat similar series known as the *acrylic series*, of which the general formula is  $C_{n-1}H_{2n-3}.COOH$ . It is the eighteenth term of the series, and its formula is  $C_{17}H_{33}.COOH$ .

**Glycerin** or **Glycerol** is a triatomic alcohol,  $C_3H_5(HO)_3$ —i.e., three atoms of hydroxyl united to a radicle glyceryl ( $C_3H_5$ ). The hydrogen in the hydroxyl atoms is replaceable by other organic radicles. As an example, take the radicle of acetic acid called *acetyl* ( $CH_3.CO$ ). The following formulæ represent the derivatives that can be obtained by replacing one, two, or all three hydroxyl hydrogen atoms in this way:—

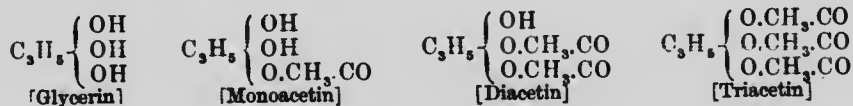

Triacetin is a type of a neutral fat; stearin, palmitin, and olein ought more properly to be called *tristearin*, *tripalmitin*, and *triolein* respectively. Each consists of glycerin in which the three atoms of hydrogen in the hydroxyls are replaced by radicles of the fatty acid. This is represented in the following formulæ:—

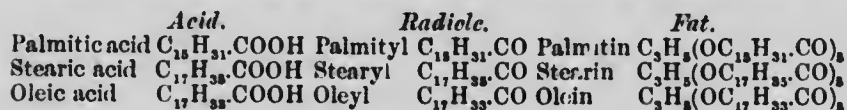

**Decomposition Products of the Fats.**—The fats split up into the substances out of which they are built up.

Under the influence of superheated steam, mineral acids, and in the body by means of certain ferments (for instance, the fat-splitting ferment, *steapsin*, of the pancreatic juice), a fat combines with water and splits into glycerin and the fatty acid. The following equation represents what occurs in a fat, taking tripalmitin as an example:—

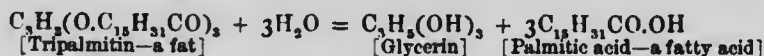

In the process of **saponification** much the same sort of reaction occurs, the final products being glycerin and a compound of the base with the fatty acid which is called a *soap*. Suppose, for instance, that potassium hydrate is used; we get—

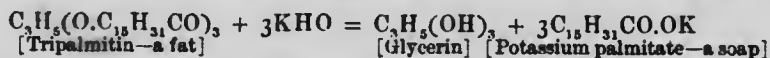

**Emulsification.**—Another change that fats undergo in the body is very different from saponification. It is a physical rather than a chemical change; the fat is broken up into very small globules, such as are seen in the natural *emulsion*—milk.

**Lecithin** ( $C_{42}H_{84}NPO_9$ ).—This is a very complex fat, which yields on decomposition not only glycerin and a fatty (*stearic*) acid, but phosphoric acid, and an alkaloid [ $N.(CH_3)_3C_2H_6O_2$ ] called *choline* in addition. This substance is found to a great extent in the nervous system (see p. 174), and to a small extent in bile. Together with **cholesterin**, a crystallisable, monatomic alcohol ( $C_{27}H_{45}.HO$ ), which we shall consider more at length in connection with the bile, it is found in small quantities in the protoplasm of all cells.

### The Proteids.

The **proteids** are the most important substances that occur in animal and vegetable organisms; none of the phenomena of life

occur without their presence ; and though it is impossible to state positively that they occur as such in living protoplasm, they are invariably obtained by subjecting living structures to analysis.

Proteids are highly complex compounds of carbon, hydrogen, oxygen, nitrogen, and sulphur occurring in a solid viscous condition or in solution in nearly all the liquids and solids of the body. The different members of the group present differences in chemical and physical properties. They all possess, however, certain common chemical reactions, and are united by a close genetic relationship.

The various proteids differ a good deal in elementary composition. Hoppe-Seyler gives the following percentages :—

	C	H	N	S	O
From	51·5	6·9	15·2	0·3	20·9
To	54·5	7·3	17·0	2·0	23·5

We are, however, not acquainted with the constitutional formula of proteid substances. There have been many theories on the subject, but practically all that is known with certainty is that many different substances may be obtained by the decomposition of proteids. How they are built up into the proteid molecule is unknown. The decompositions that occur in the body are, moreover, different from those which can be made to occur in the laboratory ; hence the conclusion that living protoplasm differs from the non-living proteid material obtainable from it.

(1) In the body. Carbonic acid, water, and urea are the chief final products. Glycocine, leucine, creatine, uric acid, ammonia, &c., are probably intermediate products. Carbohydrates (glycogen) and fats may also originate from proteids.

(2) Outside the body. Various strong reagents break up proteids into ammonia, carbonic acid, amines, fatty acids, amido-acids like leucine and arginine, and aromatic compounds like tyrosine.

**Solubilities.**—All proteids are insoluble in alcohol and ether. Some are soluble in water, others insoluble. Many of the latter are soluble in weak saline solutions. Some are insoluble, others soluble in concentrated saline solutions. It is on these varying solubilities that proteids are classified.

All proteids are soluble with the aid of heat in concentrated mineral acids and alkalies. Such treatment, however, decomposes as well as dissolves the proteid. Proteids are also soluble in gastric and pancreatic juices ; but here, again, they undergo a change, being converted into a hydrated variety of proteid, of smaller molecular weight, called *peptone*. The intermediate substances formed in this process are called *proteoses* or *albumoses*. Commercial peptone contains a mixture of proteoses and true peptone.



**Heat Coagulation.**—Most native proteids, like white of egg, are rendered insoluble when their solutions are heated. The temperature of heat coagulation differs in different proteids; thus myosinogen and fibrinogen coagulate at  $56^{\circ}\text{C}$ ., serum albumin and serum globulin at about  $75^{\circ}\text{C}$ .

The proteids which are coagulated by heat come under two classes: the *albumins* and the *globulins*. These differ in solubility; the albumins are soluble in distilled water, the globulins require salts to hold them in solution.

**Indiffusibility.**—The proteids (peptones excepted) belong to the class of substances called *colloids* by Thomas Graham; that is, they pass with difficulty, or not at all, through animal membranes. In the construction of dialysers, vegetable parchment is largely used.

Proteids may thus be separated from diffusible (*crystalloid*) substances like salts, but the process is a tedious one. If some serum or white of egg is placed in a dialyser (fig. 337) and distilled water outside, the greater amount of the salts passes into the water through the membrane and is replaced by water; the two proteids albumin and globulin remain inside; the globulin is, however, precipitated, as the salts which previously kept it in solution are removed.

The terms diffusion and dialysis should be distinguished from each other.

If water is carefully poured on the surface of a solution of any substance, this substance

gradually spreads through the water, and the composition of the mixture becomes uniform in time. The time occupied is short for substances like sodium chloride, and long for substances like albumin. The phenomenon is called *diffusion*. If the solutions are separated by a membrane the term *dialysis* is employed. The term *osmosis* is employed when semi-permeable membranes are used (see further, under Work of the Kidney).

**Crystallisation.**—Hæmoglobin, the red pigment of the blood, is a proteid substance and is crystallisable (for further details, see The Blood, Chapter XXVI.). Like other proteids it has an enormously large molecule; though crystalline, it is not, however, crystalloid in Graham's sense of that term. Blood pigment is not the only crystallisable proteid. Long ago crystals of proteid (globulin or vitellin) were observed in the aleurone grains of many

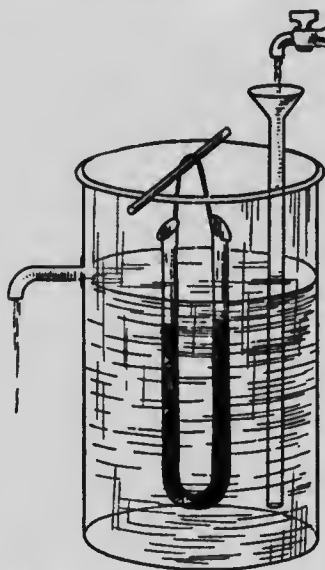

Fig. 337.—Dialyser made of a tube of parchment paper, suspended in a vessel through which water is kept flowing.

seeds, and in the somewhat similar granules occurring in the egg-yolk of some fishes and amphibians. By appropriate methods these have been separated and re-crystallised. Further, egg-albumin itself has been crystallised. If a solution of white of egg is diluted with an equal volume of saturated solution of ammonium sulphate, the globulin present is precipitated and is removed by filtration. The filtrate is now allowed to remain some days at the temperature of the air, and as it becomes more concentrated from evaporation, minute spheroidal globules and finally minute needles, either aggregated or separate, make their appearance (Hofmeister). Crystallisation is more rapid if a little acetic or sulphuric acid is added (Hopkins). Serum albumin (from horse and rabbit) has also been similarly crystallised (Gürber).

**Action on Polarised Light.**—All proteids are levo-rotatory, the amount of rotation varying with individual proteids.

**Colour Reactions.**—The principal colour reactions by which proteids are recognised are the following:—

(1) The *xantho-proteid reaction*; if a few drops of nitric acid are added to a solution of a proteid like white of egg, the result is a white precipitate; this and the surrounding liquid become yellow on boiling and are turned orange by ammonia. The preliminary white precipitate is not given by some proteids like peptones; but the colours are the same.

(2) *Millon's reaction*. Millon's reagent is a mixture of mercuric and mercurous nitrate with excess of nitric acid. This gives a white precipitate with proteids which is turned brick-red on boiling. This reaction and the preceding (xanthoproteic) depend on the presence in proteids of aromatic radicles.

(3) *Copper sulphate, or Piotrowski's test*. A trace of copper sulphate and excess of strong caustic potash give with most proteids a violet solution. Proteoses and peptones, however, give a rose-red colour instead; this same colour is given by the substance called *biuret*; hence the test is generally called the *biuret reaction*. This name does not imply that biuret is present in proteid; but both proteid and biuret give the reaction because they possess a common radicle, probably CONH.

Biuret is formed by heating solid urea; ammonia passes off and leaves biuret, thus:—



4. *Adamkiewicz reaction* (Hopkins' modification). When a solution of proteid is added to a dilute solution of glyoxylic acid, and then excess of sulphuric acid is added, an intense violet colour is obtained.

**Precipitants of Proteids.**—Solutions of most proteids are precipitated by :—

1. Strong acids like nitric acid.
2. Picric acid.
3. Acetic acid and potassium ferrocyanide.
4. Acetic acid and excess of a neutral salt like sodium sulphate ; when these are boiled with the proteid solution.
5. Salts of the heavy metals like copper sulphate, mercuric chloride, lead acetate, silver nitrate, &c.
6. Tannin.
7. Alcohol.
8. Saturation with certain neutral salts such as ammonium sulphate.

It is necessary that the words *coagulation* and *precipitation* should in connection with proteids be carefully distinguished. The term *coagulation* is used when an insoluble proteid (coagulated proteid) is formed from a soluble one. This may occur :

1. When a proteid is heated—*heat coagulation* ;
2. Under the influence of a ferment ; for instance, when a curd is formed in milk by rennet or a clot in shed blood by the fibrin ferment—*ferment coagulation* ;
3. When an insoluble precipitate is produced by the addition of certain reagents (nitric acid, picric acid, tannin, &c.).

There are, however, other precipitants of proteids in which the precipitate formed is readily soluble in suitable reagents like saline solutions, and the proteid continues to show its typical reactions. Such precipitation is not coagulation. Such a precipitate is produced by saturation with ammonium sulphate. Certain proteids, called *globulins*, are more readily precipitated by such means than others. Thus, serum globulin is precipitated by half-saturation with ammonium sulphate. Full saturation with ammonium sulphate precipitates all proteids but peptone. The globulins are precipitated by certain salts, like sodium chloride and magnesium sulphate, which do not precipitate the albumins.

The precipitation produced by alcohol is peculiar in that after a time it becomes a coagulation. Proteid freshly precipitated by alcohol is readily soluble in water or saline media ; but after it has been allowed to stand some weeks under alcohol it becomes more and more insoluble. Albumins and globulins are most readily rendered insoluble by this method ; proteoses and peptones are never rendered insoluble by the action of alcohol. This fact is of value in the separation of these proteids from others.

### Classification of Proteids.

Both animal and vegetable proteids can be divided into the following classes. We shall, however, be chiefly concerned with the animal proteids:—

If we use the term proteid in the widest sense, the first main subdivision of these substances is into—

- A. The Simple Proteids.
- B. The Conjugated or Compound Proteids.
- C. The Albuminoids.
- D. The Protamines.

We will take these classes one by one.

#### A. THE SIMPLE PROTEIDS.

**Class I. Albumins.**—These are soluble in water, in dilute saline solutions, and in saturated solutions of sodium chloride and magnesium sulphate. They are, however, precipitated by saturating their solutions with ammonium sulphate. Their solutions are coagulated by heat, usually at 70–73° C. Serum albumin, egg albumin, and lact-albumin are instances.

**Class II. Globulins.**—These are insoluble in water, soluble in dilute saline solutions, and insoluble in concentrated solutions of neutral salts like sodium chloride, magnesium sulphate, and ammonium sulphate. A globulin dissolved in a dilute saline solution may therefore be precipitated—

1. By removing the salt—by dialysis (see p. 394).
2. By increasing the amount of salt. The best salts to employ are ammonium sulphate (half-saturation) or magnesium sulphate (complete saturation). This method is often called “salting out.”

The globulins are coagulated by heat; the temperature of heat coagulation varies considerably. The following are instances:—

- |   |   |                  |
|---|---|------------------|
| (a) Fibrinogen                          | } | in blood-plasma. |
| (b) Serum globulin (paraglobulin)       |   |                  |
| (c) Myosinogen in muscle.               |   |                  |
| (d) Crystallin in the crystalline lens. |   |                  |

If we compare together these two classes of proteids, the most important of the native proteids, we find that they all give the same general tests, that all are coagulated by heat, but that they

differ in their solubilities. This difference in solubility may be stated in tabular form as follows:—

Reagent.	Albumin.	Globulin.
Water . . . . .	soluble	insoluble
Dilute saline solution . . . . .	soluble	soluble
Saturated solution of magnesium sulphate or sodium chloride . . . . .	soluble	insoluble
Half-saturated solution of ammonium sulphate . . . . .	soluble	insoluble
Saturated solution of ammonium sulphate . . . . .	insoluble	insoluble

Class III. **Proteoses** } These products of digestion will be  
 Class IV. **Peptones** } studied in connection with that  
 subject.

Class V. **Coagulated Proteids.** — There are two subdivisions of these:—

(a) Proteids in which coagulation has been produced by heat; they are insoluble in water, saline solutions, weak acids, and weak alkalis; they are soluble after prolonged boiling in concentrated mineral acids; dissolved by gastric and pancreatic juices, they give rise to peptones.

(b) Proteids in which coagulation has been produced by ferments:—i. Fibrin (see BLOOD). ii. Myosin (see MUSCLE). iii. Casein (see MILK).

**Appendix to the class of simple proteids.** **Albuminates** are compounds of proteid with mineral substances. Thus, if a solution of copper sulphate is added to a solution of albumin a precipitate of copper albuminate is obtained. Similarly, by the addition of other salts of the heavy metals other metallic albuminates are obtainable.

The albuminates which are obtained by the action of dilute acids and alkalis on either albumins or globulins are, however, of greater physiological interest, and it is to these we shall confine our attention. The general properties of the *acid-albumin* or *syntonin*, and the *alkali-albumin*, which are thereby respectively formed, are as follows: they are insoluble in pure water, but are soluble in either acid or alkali, and are precipitated by neutralisation unless certain salts like sodium phosphate are present. Like globulins, they are precipitated by saturation with such neutral salts as sodium chloride and magnesium sulphate. They are not coagulated by heat.

A variety of alkali-albumin (probably a compound containing a

large quantity of alkali) may be formed by adding strong potash to undiluted white of egg. The resulting jelly is called *Lieberkühn's jelly*. A similar jelly is formed by adding strong acetic acid to undiluted egg-white.

The halogens (chlorine, bromine, and iodine) also form albuminates, and may be used for the precipitation of proteids.

### B. THE CONJUGATED PROTEIDS.

These complex substances are compounds of albuminous substances with other organic materials, which are, as a rule, also of complex nature. They may be divided into the following groups:—

1. HÆMOGLOBIN and its allies. These are compounds of proteid with an iron-containing pigment. All will be fully discussed under Blood.

2. GLUCO-PROTEIDS. These are compounds of proteid with members of the carbohydrate group. This class includes the mucins and substances allied to mucins called mucoids.

**Mucin.**—This is a widely distributed substance, occurring in epithelial cells or shed out by them (mucus, mucous glands, goblet cells), and in connective-tissue, where it forms the chief constituent of the ground substance or intercellular material.

There are several varieties of mucin, but all agree in the following points:—

(a) Physical character. Viscid and tenacious.

(b) Precipitability from solutions by acetic acid. They are soluble in dilute alkalis, like lime water.

(c) They are all compounds of a proteid with a carbohydrate called animal gum, which by treatment with dilute mineral acid can be hydrated into a reducing but non-fermentable sugar.

The name animal gum is only a provisional name for the carbohydrate radicle of the mucins. It is probable that the carbohydrate radicle may differ in different mucins; in some cases it is certainly the case that the so-called sugar derived from it is not sugar, but a nitrogenous derivative of sugar called glucosamine—*i.e.*, glucose in which HO is replaced by  $\text{NH}_2$  ( $\text{C}_6\text{H}_{11}\text{O}_5\text{.NH}_2$ ).

The **Mucoids** differ from the mucins either in not being precipitable from alkaline solutions by acetic acid, or in being readily soluble in excess of that acid. One of these (ovo-mucoid) is found in white of egg, and others (pseudo-mucin and paramucin) are occasionally found in dropsical effusions.

Dr. Pavy has shown that a *small* quantity of a similar carbohydrate can be split off from various other proteids, which we have already classified as simple proteids.

3. **NUCLEINS AND NUCLEO-PROTEIDS.** These are compounds of proteid with a complex organic acid called nucleic acid, which contains phosphorus.

**Nucleo-proteids.**—Compounds of proteids with nuclein. They are found in the nuclei and protoplasm of cells. Caseinogen of milk and vitellin of egg-yolk are similar substances. In physical characters they often closely simulate mucin; in fact, the substance called mucin in the bile is in some animals a nucleo-proteid. They may be distinguished from mucin by the fact that they yield on gastric digestion not only peptone but also an insoluble residue of nuclein which is soluble in alkalis, is precipitable by acetic acid from such a solution, and contains a high percentage (10-11) of phosphorus.

Some of the nucleo-proteids also contain iron, and it is probable that the normal supply of iron to the body is contained in the nucleo-proteids, or hæmatogens (Bunge), of plant and animal cells.

The relationship of nucleo-proteids to the coagulation of the blood is described in the next chapter.

Nucleo-proteids may be prepared from cellular structures like testis, thymus, kidney, &c., by two methods:—

1. *Wooldridge's method.*—The organ is minced and soaked in water for twenty-four hours. Acetic acid added to the aqueous extract precipitates the nucleo-proteid, or, as Wooldridge called it, *tissue fibrinogen*.

2. *Sodium chloride method.*—The minced organ is ground up in a mortar with solid sodium chloride; the resulting viscous mass is poured into excess of distilled water, and the nucleo-proteid rises in strings to the top of the water.

The solvent usually employed for a nucleo-proteid, whichever method it is prepared by, is a 1 per cent. solution of sodium carbonate.

**Nuclein** is the chief constituent of cell-nuclei. Its physical characters are somewhat like those of mucin, but it differs chemically in its high percentage of phosphorus. It is identical with the chromatin of histologists (see p. 11). On decomposition, it yields an organic acid called *nucleic acid*, together with a variable amount of proteid. In the nucleus which composes the head of a spermatozoon proteid is practically absent. Nucleic acid on decomposition yields phosphoric acid and various bases of the xanthine group. Some forms of nuclein, called *pseudo-nuclein*, such as are obtained from casein and vitellin, differ from the true nucleins in not yielding these xanthine compounds, or, as they are sometimes termed, *alloxuric* or *purine* bases. The purine bases are closely allied chemically to uric

acid, and we shall have to consider them again in relation to that substance.

The following diagrammatic way of representing the decomposition of nucleo-proteid will assist the student in remembering the inter-relationships of these substances.

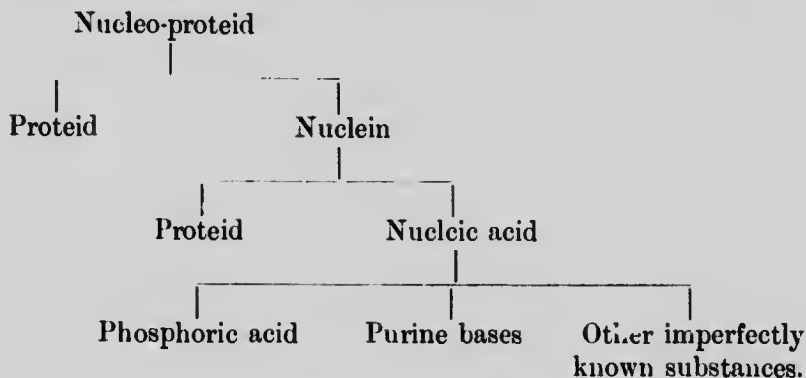

### C. ALBUMINOIDS.

The **albuminoids** are a group of substances which, though similar to the proteids in many particulars, differ from them in certain other points. The principal members of the group are the following:—

**Collagen**, the substance of which the white fibres of connective-tissue are composed. Some observers regard it as the anhydride of gelatin. In bone it is often called *ossein*.

**Gelatin**.—This substance is produced by boiling collagen with water. It possesses the peculiar property of setting into a jelly when a solution made with hot water cools. It gives most of the proteid colour tests. Many observers state, however, that it contains no sulphur. On digestion it is like proteid converted into peptone-like substances, and is readily absorbed. Though it will replace in diet a certain quantity of proteid, acting as what is called a 'proteid-sparing' food, it cannot altogether take the place of proteid as a food. Animals fed on gelatin instead of proteid waste rapidly.

**Chondrin**, the very similar substance obtained from hyaline cartilage, is a mixture of gelatin with mucinoid materials.

**Elastin**.—This is the substance of which the yellow or elastic fibres of connective-tissue are composed. It is a very insoluble material. The sarcolemma of muscular fibres and certain basement membranes are very similar.

**Keratin**, or horny material, is the substance found in the surface layers of the epidermis, in hairs, nails, hoofs, and horns.



It is very insoluble, and chiefly differs from proteids in its high percentage of sulphur. A similar substance, called *neurokeratin*, is found in neuroglia and nerve fibres. In this connection it is interesting to note that the epidermis and the nervous system are both formed from the same layer of the embryo—the epiblast.

**Chitin** and similar substances found in the exoskeleton of many invertebrates.

#### D. THE PROTAMINES.

**Protamines.**—These are basic substances which are combined with nuclein in the heads of the spermatozoa of certain fishes (salmon, sturgeon, &c.). They resemble proteids in many of their characters; *e.g.*, they give Piotrowski's reaction and some of the other tests for proteids. They are regarded by Kossel as the simplest proteids. By decomposition in various ways they yield bases containing six atoms of carbon, and called in consequence the *hexone* bases; the bases are named lysine, arginine, and histidine. The following equation represents the decomposition of the protamine prepared from salmon roe:—

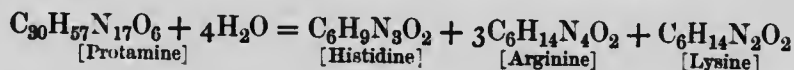

The more complex proteids and albuminoids yield these bases also; therefore Kossel considers that all these substances contain a protamine nucleus. The more complex proteids, however, yield many other products of decomposition in addition to these bases, such as leucine and tyrosine.

#### The Polarimeter.

This instrument is one by means of which the action of various substances on the plane of polarised light can be observed and measured.

Most of the carbohydrates are dextro-rotatory.

All the proteids are levo-rotatory.

There are many varieties of the instrument; these can only be properly studied in a practical class, and all one can do here is to state briefly the principles on which they are constructed.

Suppose one is shooting arrows at a fence made up of narrow vertical palings: suppose also that the arrows are flat like the laths of a venetian blind. If the arrows are shot vertically they will pass easily through the gaps between the palings, but if they are shot horizontally they will be unable to pass through at all. This rough illustration will help us in understanding what is meant by polarised light. Ordinary light is produced by the undulations of æther occurring in all directions at right angles to the path of propagation of the wave. Polarised light is produced by undulations in one plane only; we may compare it to our flat arrows.

In a polarimeter, there is at one end of the instrument a Nicol's prism, which is made of Iceland spar. This polarises the light which passes through it; it is called the polariser. At the other end of the instrument

is another called the analyser. Between the two is a tube which can be filled with fluid. If the analyser is parallel to the polariser the light will pass through to the eye of the observer. But if the analyser is at right angles to the polariser it is like the flat arrows hitting horizontally the vertical palings of the fence, and there is darkness. At intermediate angles there will be intermediate degrees of illumination.

If the analyser and polariser are parallel and the intermediate tube filled with water, the light will pass as usual, because water has no action on the plane of polarised light. But if the water contains sugar or some 'optically active' substance in solution the plane is twisted in one direction or the other according as the substance is dextro- or levo-rotatory. The amount of rotation is measured by the number of angles through which the analyser has to be turned in order to obtain the full illumination. This will vary with the length of the tube and the strength of the solution.

### Ferments.

The word **fermentation** was first applied to the change of sugar into alcohol and carbonic acid by means of yeast. The evolution of carbonic acid causes frothing and bubbling; hence the term 'fermentation.' The agent, yeast, which produces this, is called the ferment. Microscopic investigation shows that yeast is composed of minute rapidly-growing unicellular organisms (torulæ) belonging to the fungus group of plants.

The souring of milk, the transformation of urea into ammonium carbonate in decomposing urine, and the formation of vinegar (acetic acid) from alcohol are brought about by very similar organisms. The complex series of changes known as putrefaction, which are accompanied by the formation of malodorous gases, and which are produced by the various forms of bacteria, also come into the same category.

That the change or fermentation is produced by these organisms is shown by the fact that it occurs only when the organisms are present, and stops when they are removed or killed by a high temperature or by certain substances (carbolic acid, mercuric chloride, &c.) called antiseptics.

The 'germ theory' of disease explains the infectious diseases by considering that the change in the system is of the nature of fermentation, and, like the others we have mentioned, produced by microbes; the transference of the bacteria or their spores from one person to another constitutes infection. The poisons produced by the growing bacteria appear to be either alkaloidal (ptomaines) or proteid in nature. The existence of poisonous proteids is a very remarkable thing, as no chemical differences can be shown to exist between them and those which are not



Fig. 338.—Cells of the yeast plant in process of budding.

poisonous, but which are useful as foods. The most virulent poison in existence, namely snake poison, is a proteid of the proteose class.

There is another class of chemical transformations which differ very considerably from all of these. They, however, resemble these fermentations in the fact that they occur independently of any apparent change in the agents that produce them. The agents that produce them are not living organisms, but chemical substances, the result of the activity of living cells. The change of starch into sugar by the ptyalin of the saliva is an instance.

Ferments may therefore be divided into two classes:—

1. The organised ferments—torulæ, bacteria, &c.
2. The unorganised ferments, or enzymes—like ptyalin.

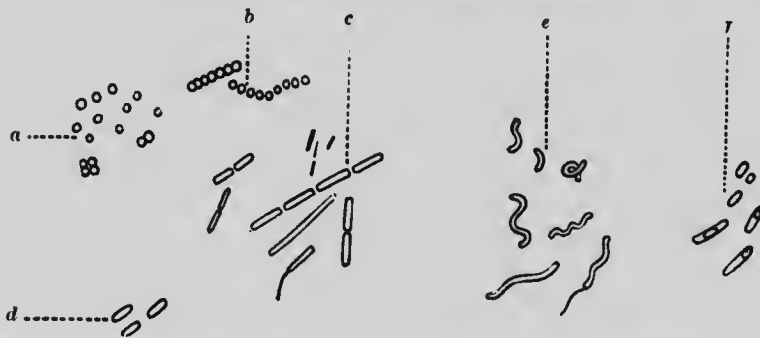

Fig. 339.—Types of micro-organisms. *a*, micrococci arranged singly; in twos, diplococci—if all the micrococci at *a* were grouped together they would be called staphylococci—and in fours, sarcinæ; *b*, micrococci in chains, streptococci; *c* and *d*, bacilli of various kinds (one is represented with flagellum); *e*, various forms of spirilla; *f*, spores, either free or in bacilli.

Each may be again subdivided according to the nature of the chemical change produced.

In digestion, the study of which we shall soon be commencing, it is the unorganised ferments with the action of which we have chiefly to deal.

The unorganised ferments may be classified as follows:—

(*a*) Amylolytic—those which change amyloses (starch, glycogen) into sugars. Examples: ptyalin, diastase, amylopsin.

(*b*) Proteolytic—those which change proteids into proteoses and peptones. Examples: pepsin, trypsin.

(*c*) Steatolytic—those which split fats into fatty acids and glycerin. An example, steapsin, is found in pancreatic juice.

(*d*) Inversive—those which convert saccharoses (cane sugar, maltose, lactose) into glucose. Examples: invertin of intestinal juice and of yeast cells.

(e) Coagulative—those which convert soluble into insoluble proteids. Examples: rennet, fibrin ferment, myosin ferment.

Most ferment actions are hydrolytic—*i.e.*, water is added to the material acted on, which then splits into new materials. This is seen by the following examples:—

1. Conversion of cellulose into carbonic acid and marsh gas (methane) by putrefactive organisms—

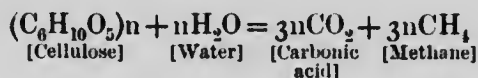

2. Inversion of cane sugar by the unorganised ferment invertin—

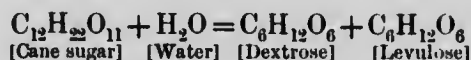

A remarkable fact concerning the ferments is that the substances they produce in time put a stop to their activity; thus, in the case of the organised ferments, the alcohol produced by yeast, the phenol, cresol, &c., produced by putrefactive organisms from proteids, first stop the growth of and ultimately kill the organisms which produce them. In the case of the enzymes also the products of their activity hinder and finally stop their action, but on the removal of these products the ferments resume work.

This fact suggested to Croft Hill the question whether ferments will act in the reverse manner to their usual action; and in the case of one ferment, at any rate, he finds this to be the case. Inverting ferments, as we have just seen, usually convert a disaccharide into monosaccharides. One of these inverting ferments, called *maltase*, converts maltose into dextrose. If, however, the ferment is allowed to act on strong solutions of dextrose, it converts a small proportion of that sugar back into maltose again.

Ferments act best at a temperature of about 40° C. Their activity is stopped, but the ferments are not destroyed, by cold; it is stopped and the ferments killed by too great heat. A certain amount of moisture and oxygen is also necessary; there are, however, certain micro-organisms that act without free oxygen, and are called anaërobic in contradistinction to those which require oxygen, and are called aërobic.

The chemical nature of the enzymes, or unorganised ferments, is very difficult to investigate; they are substances that elude the grasp of the chemist to a great extent. So far, however,

research has taught us that they are either proteid in nature or are substances closely allied to the proteids.

The distinction between organised ferments and enzymes is more apparent than real; for the micro-organisms exert their action by enzymes that they secrete. By crushing yeast cells Buchner has succeeded in obtaining from them an enzyme that produces alcoholic fermentation.

---

## CHAPTER XXVI.

### THE BLOOD.

THE blood is the fluid medium by means of which all the tissues of the body are directly or indirectly nourished; by means of it also such of the materials resulting from the metabolism of the tissues which are of no further use in the economy are carried to the excretory organs to be removed from the body. It is a somewhat viscid fluid, and in man and in all other vertebrate animals, with the exception of two,\* is red in colour. The exact shade of red is variable; that taken from the arteries, from the left side of the heart, and from the pulmonary veins is of a bright scarlet hue; that obtained from the systemic veins, from the right side of the heart, and from the pulmonary artery is of a much darker colour. At first sight the red colour appears to belong to the whole mass of blood, but on further examination this is found not to be the case. In reality blood consists of an almost colourless fluid, called **plasma** or **liquor sanguinis**, in which are suspended numerous **blood corpuscles**, which are, for the most part, coloured, and it is to their presence in the fluid that the red colour of the blood is due.

Even when examined in very thin layers, blood is *opaque*, on account of the different refractive powers possessed by its two constituents, viz., the plasma and the corpuscles. On treatment with ether, water, and other reagents, however, it becomes transparent and assumes a lake colour, in consequence of the colouring matter of the corpuscles having been discharged into the plasma. The average *specific gravity* of blood at 15° C. (60° F.) varies from 1055 to 1062. A rapid and useful method of estimating the specific gravity of blood was invented by Roy. Drops of blood

---

\* The *amphioxus* and the *leptocephalus*.

are taken and allowed to fall into fluids of known specific gravity. When the drop neither rises nor sinks in the fluid it is taken to be of the same specific gravity as that of the standard fluid. The *reaction* of blood is faintly alkaline and the *taste* saltish. Its *temperature* varies slightly, the average being  $37.8^{\circ}$  C. ( $100^{\circ}$  F.). The blood stream is warmed by passing through the muscles, nerve centres, and glands, but is somewhat cooled on traversing the capillaries of the skin. Recently drawn blood has a distinct *odour*, which in many cases is characteristic of the animal from which it has been taken. It may be further developed by adding to blood a mixture of equal parts of sulphuric acid and water.

**Quantity of the Blood.**—The quantity of blood in any animal under normal conditions bears a fairly constant relation to the body-weight. The methods employed for estimating it are not so simple as might at first sight have been thought. For example, it would not be possible to get any accurate information on the point from the amount obtained by rapidly bleeding an animal to death, for then an indefinite quantity would remain in the vessels; nor, on the other hand, would it be possible to obtain a correct estimate by less rapid bleeding, as, since life would be more prolonged, time would be allowed for the passage into the blood of lymph from the lymphatic vessels and from the tissues. In the former case, therefore, we should underestimate, and in the latter over-estimate, the total amount of the blood.

Of the several *methods* which have been employed the most accurate is the following. A small quantity of blood is taken from an animal by venesection; it is defibrinated and measured, and used to make standard solutions of blood. The animal is then rapidly bled to death, and the blood which escapes is collected. The blood-vessels are next washed out with saline solution until the washings are no longer coloured, and these are added to the previously withdrawn blood; lastly the whole animal is finely minced with saline solution. The fluid obtained from the mincings is carefully filtered and added to the diluted blood previously obtained, and the whole is measured. The next step in the process is the comparison of the colour of the diluted blood with that of standard solutions of blood and water of a known strength, until it is discovered to what standard solution the diluted blood corresponds. As the amount of blood in the corresponding standard solution is known, as well as the total quantity of diluted blood obtained from the animal, it is easy to calculate the absolute amount of blood which the latter contained, and to this is added the small amount which was withdrawn to

make the standard solutions. This gives the total amount of blood which the animal contained. It is contrasted with the weight of the animal, previously known.

The result of many experiments shows that the quantity of blood in various animals averages  $\frac{1}{12}$  to  $\frac{1}{14}$  of the total body-weight.

An estimate of the quantity in man which corresponded nearly with this proportion has been more than once made from the following data. A criminal was weighed before and after decapitation; the difference in the weight represented the quantity of blood which escaped. The blood-vessels of the head and trunk were then washed out by the injection of water until the fluid which escaped had only a pale red or straw colour. This fluid was then also weighed; and the amount of blood which it represented was calculated by comparing the proportion of solid matter contained in it with that of the first blood which escaped on decapitation. Two experiments of this kind gave the same results. (Weber and Lehmann.)

Haldane and Lorrain Smith have recently investigated the question by another method. A man breathes a certain measured volume of carbonic oxide; the percentage saturation of the hæmoglobin is then determined in a drop of blood colorimetrically; from this, the total capacity of the subject's blood for absorbing carbonic oxide can easily be calculated; this is the same as the 'oxygen capacity.' The total volume of the blood is then calculated from the total and percentage oxygen capacities, and the total weight obtained by multiplying the volume by the specific gravit (about 1.055). These experiments show that the commonly accepted estimate of the mass of the blood is too high; the average in fourteen healthy adults was  $\frac{1}{20}$  of the body weight.

#### Coagulation of the Blood.

One of the most characteristic properties which the blood possesses is that of *clotting* or *coagulating*. This phenomenon may be observed under the most favourable conditions in blood which has been drawn into an open vessel. In about two or three minutes, at the ordinary temperature of the air, the surface of the fluid is seen to become semi-solid or *jelly-like*, and this change takes place in a minute or two afterwards at the sides of the vessel in which it is contained, and then extends throughout the entire mass. The time which is occupied in these changes is about eight or nine minutes. The solid mass is of exactly the same volume as the previously liquid blood, and adheres so closely to the sides of the containing vessel that if the latter is inverted

none of its contents escape. The solid mass is the *crassamentum*, or *clot*. If the clot is watched for a few minutes, drops of a light straw-coloured fluid, the *serum*, may be seen to make their appearance on the surface, and, as they become more and more numerous, to run together, forming a complete superficial stratum above the solid clot. At the same time the fluid begins to transude at the sides and at the under-surface of the clot, which in the course of an hour or two floats in the liquid. The first drops of serum appear on the surface about eleven or twelve minutes after the blood has been drawn; and the fluid continues to transude for from thirty-six to forty-eight hours.

The clotting of blood is due to the development in it of a substance called *fibrin*, which appears as a meshwork (fig. 340) of

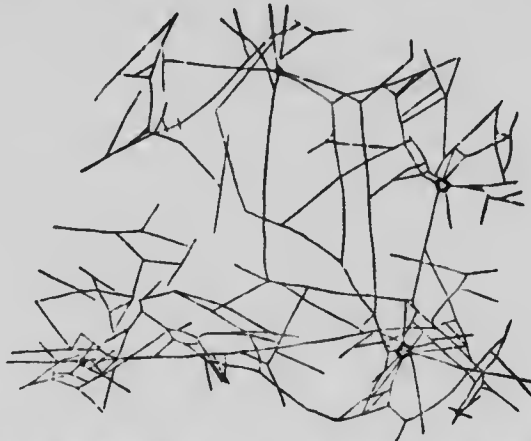

Fig. 340.—Reticulum of fibrin, from a drop of human blood, after treatment with rosanilin. The entangled corpuscles are not seen. (Ranvier.)

fine fibrils. This meshwork entangles and encloses within itself the blood corpuscles. The first clot formed, therefore, includes the whole of the constituents of the blood in an apparently solid mass, but soon the fibrinous meshwork begins to contract, and the serum which does not belong to the clot is squeezed out. When the whole of the serum has transuded the clot is found to be smaller, but firmer and harder, as it is now made up chiefly of fibrin and blood corpuscles. Thus coagulation re-arranges the constituents of the blood; liquid blood is made up of plasma and blood corpuscles, and clotted blood of serum and clot.

Fibrin is formed from the plasma, and may be obtained free from corpuscles when blood-plasma is allowed to clot, the corpuscles having previously been removed. It may be also obtained from blood by whipping it with a bunch of twigs; the fibrin adheres



to the twigs and entangles the few corpuscles. These may be removed by washing with water. Serum is plasma *minus* fibrin. The relation of plasma, serum, and clot can be seen at a glance in the following scheme of the constituents of the blood:—

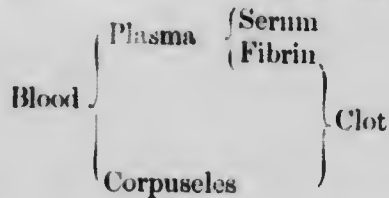

It may be roughly stated that in 100 parts by weight of blood 60-65 parts consist of plasma and 35-40 of corpuscles.

The *buffy coat* is seen when blood coagulates slowly, as in horse's blood. The red corpuscles sink more rapidly than the white, and the upper stratum of the clot (*buffy coat*) consists mainly of fibrin and white corpuscles.

Coagulation is hastened by—

1. A temperature a little over that of the body.
2. Contact with foreign matter.
3. Injury to the vessel walls.
4. Agitation.
5. Addition of calcium salts.

Coagulation is hindered or prevented by—

1. A low temperature. In a vessel cooled by ice, coagulation may be prevented for an hour or more.
2. The addition of a large quantity of neutral salts like sodium sulphate or magnesium sulphate.
3. Contact with the living vascular walls.
4. Contact with oil.
5. Addition of oxalates. These precipitate the calcium necessary for coagulation as insoluble calcium oxalate.
6. Injection of commercial peptone (which consists chiefly of proteoses) into the circulation of the living animal.
7. Addition of leech extract. This acts in virtue of a protease it contains.

The theory generally received which accounts best for the coagulation of the blood is that of Hammarsten, and it may be briefly stated as follows:—

*When blood is in the vessels one of the constituents of the plasma, a proteid of the globulin class called fibrinogen, exists in soluble form.*

*When the blood is shed the fibrinogen molecule is split into two parts: one part is a globulin, which remains in solution: the other is the insoluble material fibrin.*

*This change is brought about by the activity of a special unorganised ferment called the fibrin-ferment or thrombin.*

*This ferment does not exist in healthy blood contained in healthy blood-vessels, but is one of the products of the disintegration of the white corpuscles and blood tablets that occurs when the blood leaves the vessels or comes into contact with foreign matter.*

To this it may be added, as the result of recent research, that a soluble calcium salt is essential for the formation of the ferment; that the fibrin-ferment belongs to the class of nucleo-proteids; that other nucleo-proteids (Woodridge's tissue fibrinogens) obtained from most of the cellular organs of the body produce intravascular clotting when injected into the circulation of a living animal.

The substance which is converted into fibrin-ferment or thrombin by the action of a calcium salt may be conveniently termed *prothrombin*.

The process of fibrin formation may therefore be represented in the following tabular way:—

In the plasma a proteid substance exists, called—  
FIBRINOGEN.

From the colourless corpuscles a nucleo-proteid is shed out, called—  
PROTHROMBIN.

By the action of calcium salts prothrombin is converted into fibrin-ferment, or  
THROMBIN.

Thrombin acts on fibrinogen in such a way that two new substances are formed.

One of these is unimportant, viz. a globulin which remains in solution. Its amount is very small.

The other is important, viz. FIBRIN, which entangles the corpuscles and so forms the CLOT.

### The Plasma and Serum.

The liquid in which the corpuscles float may be obtained by employing one or other of the methods already described for preventing the blood from coagulating. The corpuscles, being heavy, sink, and the supernatant plasma can then be removed by a pipette or siphon, or more thoroughly by the use of a centrifugal machine (see fig. 341).

On counteracting the influence which has prevented the blood from coagulating the plasma then itself coagulates. Thus plasma

obtained by the use of cold clots on warming gently; plasma which has been decalcified by the action of a soluble oxalate clots on the addition of a calcium salt; plasma obtained by the use of a strong solution of salt coagulates when this is diluted by the addition of water, the addition of fibrin-ferment being necessary

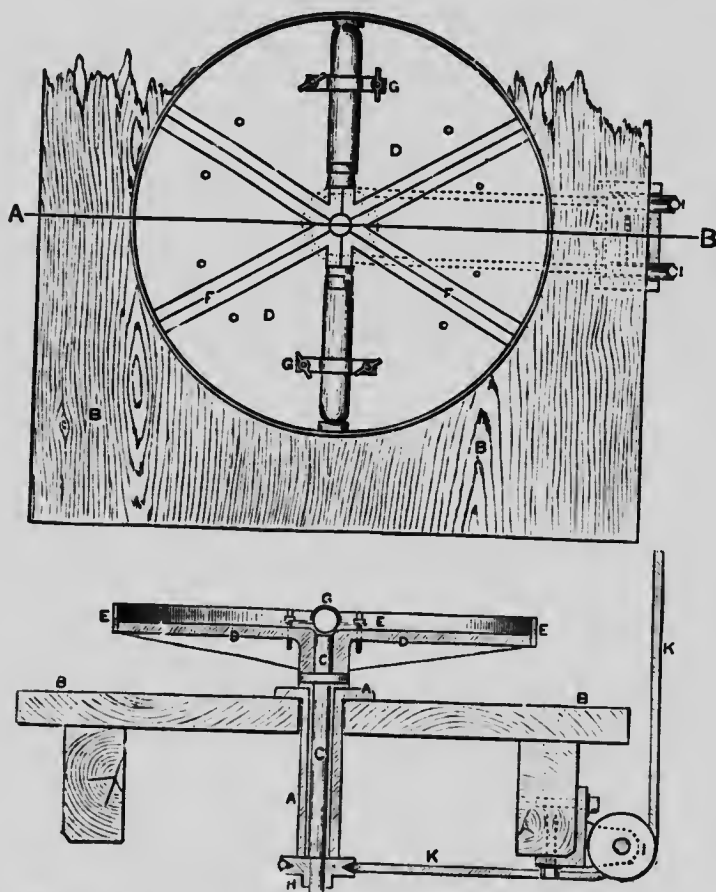

Fig. 341.—Plan and section of centrifugal machine. A, an iron socket secured to top of table B; C, a steel spindle carrying the turntable D and turning freely in A; E, a flange round turntable D; F F, shallow grooves on face of D in which the test tubes are fixed by clamps G G; H, a pulley fixed to end of spindle C and turned by the cord K; I I are two guide pulleys for cord K. The upper part of the figure is a surface view of the rotating turntable. (Gamble.)

in most cases; where coagulation occurs without the addition of fibrin-ferment no doubt some is present from the partial disintegration of the corpuscles which has already occurred. Pericardial and hydrocele fluids resemble pure plasma very closely in composition. As a rule, however, they contain few or no white corpuscles, and do not clot spontaneously, but after the addition

of fibrin-ferment, or liquids like serum that contain fibrin-ferment, they always yield fibrin.

Pure plasma may be obtained from horse's veins by what is known as the 'living test-tube' experiment. If the jugular vein is ligatured in two places so as to include a quantity of blood within it, then removed from the animal and hung in a cool place, the blood will not clot for many hours. The corpuscles settle, and the supernatant plasma can be removed with a pipette.

The plasma is alkaline, yellowish in tint, and its specific gravity is about 1026 to 1029. 1000 parts of plasma contain :—

Water . . . . .	902.90
Solids . . . . .	97.10
Proteids : 1, yield of fibrin . . . . .	4.05
2, other proteids . . . . .	78.84
Extractives (including fat) . . . . .	5.66
Inorganic salts . . . . .	8.55

In round numbers, plasma contains 10 per cent. of solids, of which 8 are proteid in nature. Note, however, the comparatively small yield of fibrin.

Serum contains the same three classes of constituents—proteids, extractives, and salts. The extractives and salts are the same in both liquids. The proteids are different, as is shown in the following table :—

<i>Proteids of Plasma.</i>	<i>Proteids of Serum.</i>
Fibrinogen.	Serum globulin.
Serum globulin.	Serum albumin.
Serum albumin.	Fibrin-ferment.

The gases of plasma and serum are small quantities of oxygen, nitrogen, and carbonic acid. The greater part of the oxygen of the blood is combined in the red corpuscles with hæmoglobin; the carbonic acid is chiefly combined as carbonates. The gases of the blood have already been considered under Respiration (see p. 377).

We may now study one by one the various constituents of the plasma and serum.

A. **Proteids.**—*Fibrinogen.* This is the substance acted on by fibrin-ferment. It yields, under this action, an insoluble product called *fibrin* and a soluble proteid of the globulin class.

Fibrinogen is a globulin. It differs from serum globulin, and may be separated from it, by making use of the fact that half-saturation with sodium chloride precipitates it. It coagulates by heat at the low temperature of 56° C.

*Serum globulin and serum albumin.*—These substances exhibit the usual differences already described between albumins and globulins (p. 397). Both are coagulated by heat at a little over 70° C.

They may be separated by dialysis or the use of neutral salts.\* The readiest way to separate them is to add to the serum an equal volume of saturated solution of ammonium sulphate. This is equivalent to semi-saturation, and it precipitates the globulin. If magnesium sulphate is used as a precipitant of the globulin it must be added in the form of crystals, and the mixture well shaken to ensure complete saturation.

Serum globulin was formerly called *fibrinoplastin*, because it was believed to take some share in fibrin formation. It is also called *paraglobulin*. It may be imperfectly precipitated by diluting serum with twenty times its volume of water and then adding a trace of acetic acid, or passing a stream of carbonic acid gas through the diluted serum.

*Fibrin-ferment*.—Schmidt's method of preparing it is to take serum and add excess of alcohol. This precipitates all the proteids, fibrin-ferment included. After some weeks the alcohol is poured off; the serum globulin and serum albumin have been by this means rendered insoluble in water; an aqueous extract is, however, found to contain fibrin-ferment, which is not so easily coagulated by alcohol as the other proteids are.

B. **Extractives**.—These are non-nitrogenous and nitrogenous. The non-nitrogenous are fats, soaps, cholesterol, and sugar, the nitrogenous are urea (0.02 to 0.04 per cent.) and still smaller quantities of uric acid, creatine, creatinine, xanthine, and hypoxanthine.

C. **Salts**.—The most abundant salt is sodium chloride; it constitutes between 60 and 90 per cent. of the total mineral matter. Potassium chloride is present in much smaller amount. It constitutes about 4 per cent. of the total ash. The other salts are phosphates and sulphates.

Schmidt gives the following table:—

1000 parts of plasma yield—	
Mineral matter . . . . .	8.550
Chlorine . . . . .	3.640
SO <sub>3</sub> . . . . .	0.115
P <sub>2</sub> O <sub>5</sub> . . . . .	0.191
Potassium . . . . .	0.323
Sodium . . . . .	3.341
Calcium phosphate . . . . .	0.311
Magnesium phosphate . . . . .	0.222

### The Blood-Corpuscles.

There are two principal forms of corpuscles, the *red* and the *white*, or, as they are now frequently named, the *coloured* and the *colourless*. In the moist state the red corpuscles form about 40 per

\* The globulin of the serum precipitated by 'salting out' really consists of two proteids, one of which is precipitated by dialysis, and the other is not.

cent. by weight of the whole mass of the blood. The proportion of colourless corpuscles is only as 1 to 500 or 600 of the coloured.

**Red or Coloured Corpuscles.**—Human red blood corpuscles are circular biconcave discs with rounded edges,  $\frac{1}{3200}$  inch in diameter ( $7\mu$  to  $8\mu$ ) and  $\frac{1}{12000}$  inch, or about  $2\mu$ , in thickness. When viewed singly they appear of a pale yellowish tinge; the deep red colour which they give to the blood is observable in them only when they are seen *en masse*. They are composed of a colourless, structureless, and transparent filmy framework, or *stroma*, infiltrated in all parts by a red colouring matter

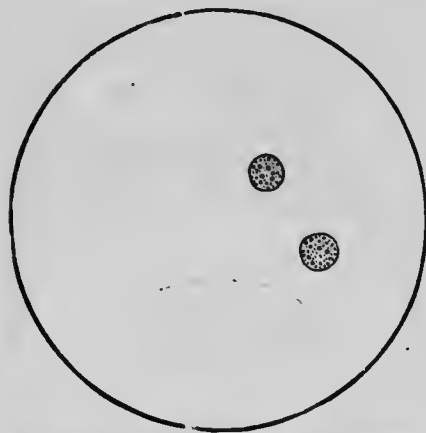

Fig. 342.—Red corpuscles in rouleaux. The white corpuscles are uncoloured.

Fig. 343.—Corpuscles of the frog. The central mass consists of nucleated coloured corpuscles. The other corpuscles are two varieties of the colourless form.

termed *hæmoglobin*. The *stroma* is elastic, so that as the corpuscles circulate they admit of changes of form, in adaptation to the vessels, and recover their natural shape as soon as they escape from compression. The colouring matter uniformly pervades the *stroma*. The consistency of the peripheral part of the *stroma* is greater than that of the more central portions; this plays the part of a membrane in the processes of osmosis that occur when water or salt solution are added to the corpuscles.

The red corpuscles have no nuclei; the unequal refraction of transmitted light gives the appearance of a central spot, darker or brighter than the border, according as it is viewed in or out of focus. Their specific gravity is about 1088.

The corpuscles of all mammals, with the exception of the camel tribe, are circular and biconcave. They are generally very nearly the size of human red corpuscles. They are smallest in

the deer tribe and largest in the elephant. In the camelidæ they are biconvex. In all mammals the corpuscles are non-nucleated, and in all other vertebrates (birds, reptiles, amphibia, and fishes) the corpuscles are oval, biconvex, and nucleated

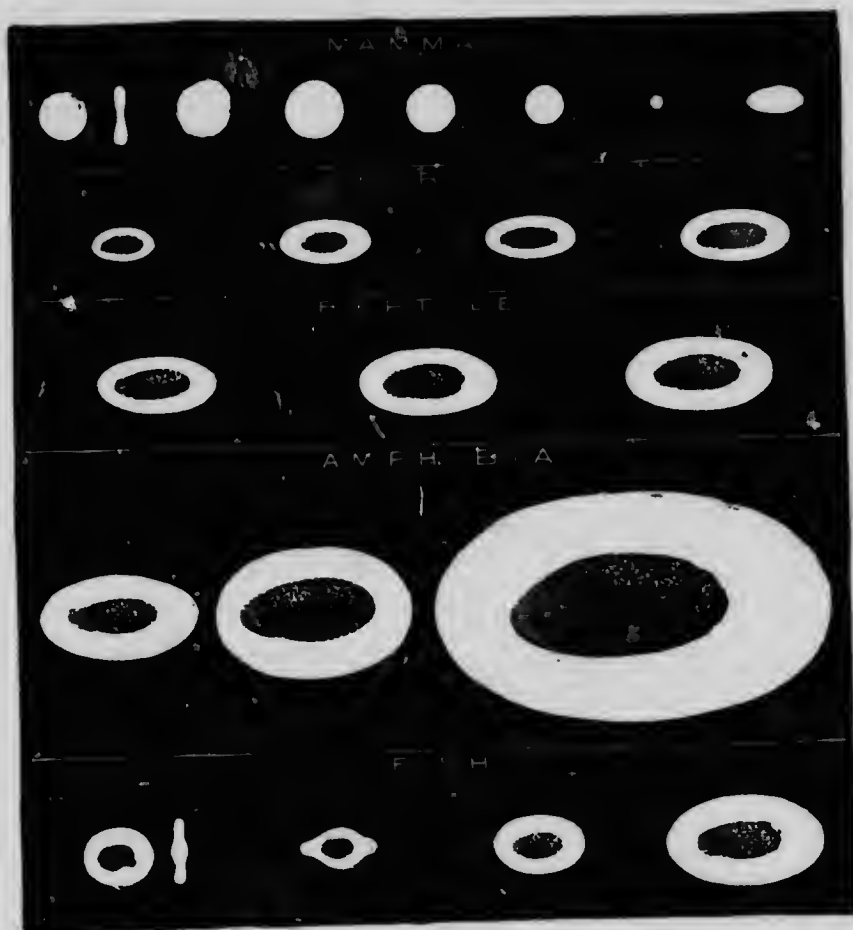

Fig. 344.—The above illustration is somewhat altered from a drawing by Gulliver, in the *Proceed. Zool. Society*, and exhibits the typical characters of the red blood-cells in the main divisions of the Vertebrata. The fractions are those of an inch, and represent the average diameter. In the case of the oval cells, only the long diameter is here given. It is remarkable, that although the size of the red blood-cells varies so much in the different classes of the vertebrate kingdom, that of the white corpuscles remains comparatively uniform, and thus they are, in some animals, larger, in others smaller, than the red corpuscles.

(fig. 344) and larger than in mammals. They are largest of all in certain amphibians (*amphiuma, proteus*).

The red corpuscles are not all alike, for in almost every specimen of blood may be also observed a certain number of corpuscles smaller than the rest. They are termed *microcytes*, or *hæmatoblasts*, and are probably immature corpuscles.

A property of the red corpuscles, which is exaggerated in inflammatory blood, is a tendency to adhere together in rolls or columns (*rouleaux*), like piles of coins. These rolls quickly fasten together by their ends, and cluster; so that, when the blood is spread out thinly on a glass, they form an irregular network (fig. 342).

**Action of Reagents.**—Considerable light has been thrown on the physical and chemical constitution of red blood-cells by studying the effects produced by mechanical means and by various reagents; the following is a brief summary of these reactions:—

**Water.**—When water is added gradually to frog's blood, the oval disc-shaped corpuscles become spherical, and gradually discharge their hæmoglobin, a pale, transparent stroma being left behind: human red blood-cells swell, change from a discoidal to a spheroidal form, and discharge their pigment, becoming quite transparent and all but invisible.

**Physiological saline solution** causes no effect on the red corpuscles beyond preventing them running into *rouleaux*. If a stronger salt solution is used, the corpuscles shrink and become crenated (fig. 345).

**Dilute acetic acid** causes the nucleus of the red blood-cells in the frog to become more clearly defined; if the action is prolonged, the nucleus becomes strongly granulated, and all the colouring matter seems to be concentrated in it, the surrounding cell-substance and outline of the cell becoming almost invisible; after a time the cells lose their colour altogether. The cells in the figure (fig. 346) represent the successive stages of the change. A similar loss of colour occurs in the red corpuscles of human blood, which, however, from the absence of nuclei, seem to disappear entirely.

**Dilute alkalis** cause the red blood-cells to dissolve slowly, and finally to disappear.

**Chloroform** added to the red blood-cells of the frog causes them to part with their hæmoglobin; the stroma of the cells becomes gradually broken up. A similar effect is produced on the human red blood-corpuscles.

**Tannic acid.**—When a 2 per cent. fresh solution of tannic acid is applied to frog's blood it causes the appearance of a sharply-defined little knob, projecting from the free surface (*Roberts' macula*): the colouring matter becomes at the same time concentrated in the nucleus, which grows more distinct (fig. 347). A somewhat similar effect is produced on the human red blood-corpuscle, the colouring matter being discharged and coagulated as a little knob of hæmatin on the surface of the stroma.

**Boric acid.**—A 2 per cent. solution applied to nucleated red blood-cells (frog) will cause the concentration of all the colouring matter in the nucleus; the coloured body thus formed gradually quits its central position, and comes to be partly, sometimes entirely, protruded from the surface of the now colourless cell (fig. 348). The result of this experiment led Brücke to distinguish the coloured contents of the cell (*zooid*) from its colourless stroma (*æcoïd*). When applied to the non-nucleated mammalian corpuscle its effect merely resembles that



Fig. 345.—Effect of saline solution (crenation).



Fig. 346.—Effect of acetic acid.

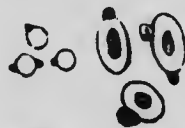

Fig. 347.—Effect of tannin.



Fig. 348.—Effect of boric acid.



**Heat.**—The effect of heat up to 50°–60° C. (120°–140° F.) is to cause the formation of a number of bud-like processes (fig. 349).

**Electricity** causes the red blood-corpuscles to become crenated, and at length mulberry-like. Finally they recover their round form and become quite pale.



Fig. 349.—Effect of heat.

**The Colourless Corpuscles.**—In human blood the white or colourless corpuscles or *leucocytes* (when at rest) are nearly spherical masses of granular protoplasm. In all cases one or more nuclei exist in each corpuscle. The size of the corpuscles varies considerably, but averages  $\frac{1}{1500}$  of an inch ( $10\mu$ ) in diameter.

In health, the proportion of white to red corpuscles, which, taking an average, is about 1 to 500 or 600, varies considerably even in the course of the same day. The variations appear to depend chiefly on the amount and probably also on the kind of food taken; the number of leucocytes is generally increased by a meal, and diminished by fasting. Also in young persons, during pregnancy, and after great loss of blood, there is a larger proportion of colourless blood-corpuscles. In old age, on the other hand, their proportion is diminished.

**Varieties.**—The colourless corpuscles present greater diversities of form than the red ones. Two chief varieties are to be seen in human blood; one of which contains a considerable number of coarse granules, and the other, which is paler and less granular, contains several nuclei united by fine threads of chromatin.



Fig. 350.—A. Three coloured blood-corpuscles. B. Three colourless blood-corpuscles acted on by acetic acid; the nuclei are very clearly visible. Human blood.  $\times 900$ .

The granules of these cells have an affinity for acid, aniline dyes like eosin. They are therefore spoken of as *oxyphile* or *eosinophile*. The large granules of the coarsely granular cells are much more deeply stained by eosin than the granules of the finely granular cells. The latter cells are by far the most numerous; the coarsely granular cells only comprise about 5 per cent. of the total number of leucocytes. In size the variations are great, for in most specimens of blood it is possible to make out, in addition to the full-sized varieties, a number of smaller corpuscles, consisting of a large spherical nucleus surrounded by a variable amount of more or less granular protoplasm. These small corpuscles are the undeveloped forms of the others, and are derived from the cells of the lymphatic glands; they are called *lympho-*

cles are the undeveloped forms of the others, and are derived from the cells of the lymphatic glands; they are called *lympho-*

*cytes*. A fourth variety of leucocyte is the *hyaline* corpuscle, in the protoplasm of which there are no granules. They have a single nucleus. Very rarely *basophile* cells (*i.e.*, cells whose granules have an affinity for basic aniline dyes like methylene blue) are found. The nucleus of all these varieties of cells is basophile.

**Amœboid Movement.**—The remarkable property of the colourless corpuscles of spontaneously changing their shape was first demonstrated by Wharton Jones in the blood of the skate. If a drop of blood is examined with a high power of the micro-

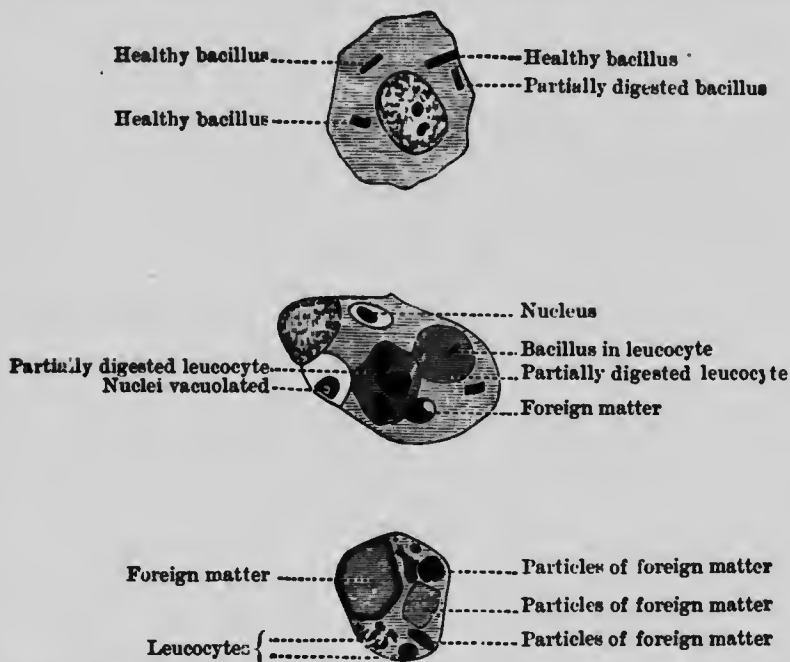

Fig. 351.—Macrophages containing bacilli and other structures supposed to be undergoing digestion. (Ruffer.)

scope, under conditions by which loss of moisture is prevented, and at the same time the temperature is maintained by a warm stage at about that of the body,  $37^{\circ}$  C. ( $98.5^{\circ}$  F.), the colourless corpuscles will be observed slowly to alter their shapes, and to send out processes at various parts of their circumference. The amœboid movement, which can be demonstrated in human colourless blood-corpuscles, can be more readily seen in newt's blood.

The full consideration of amœboid movement is given on p. 13. An interesting variety of amœboid movement is that which leads to the ingestion of foreign particles. This gives to the leucocytes their power of taking in and digesting bacilli (*phagocytosis*). The

multi-nucleated, finely granular corpuscles are the most vigorous phagocytes. The accompanying figure illustrates this; the cells represented, however, are not leucocytes, but the large amœboid cells found in connective tissues, especially in inflamed parts. (See also p. 275.)

The process of *emigration* of the leucocytes is described on p. 274.

*Action of Reagents on the colourless corpuscles.*—Water causes the corpuscles to swell and their nuclei to become apparent. *Acetic acid* (1 per cent.) has a similar action; it also causes the granules to aggregate round the nucleus (fig. 350). *Dilute alkalis* produce swelling and bursting of the corpuscles.

### The Blood-Platelets.

Besides the two principal varieties of blood-corpuscles, a third kind has been described under the name blood-platelets (*Blutplättchen*). These are colourless disc-shaped or irregular bodies, much smaller than red corpuscles. Different views are held as to their origin. At first they were regarded as immature red corpuscles; but this view is discarded. They may be disintegrative products of white corpuscles; some state that they are merely a precipitate of nucleo-proteid which occurs when the plasma dies or is cooled. There is, however, no doubt that they do occur in living blood.

### Enumeration of the Blood-Corpuscles.

Several methods are employed for counting the blood-corpuscles; most of them depend upon the same principle, *i.e.*, the dilution of a minute volume of blood with a given volume of a colourless saline solution similar in specific gravity to blood plasma, so that the size and shape of the corpuscles is altered as little as possible. A minute quantity of the well-mixed solution is then taken, examined under the microscope, either in a flattened capillary tube (Malassez) or in a cell (Hayem & Nacet, Gowers) of known capacity, and the number of corpuscles in a measured length of the tube, or in a given area of the cell, is counted. The length of the tube and the area of the cell are ascertained by means of a micrometer scale in the microscope ocular; or in the case of Gowers' modification, by the division of the cell area into squares of known size. Having ascertained the number of corpuscles in the diluted blood, it is easy to find out the number in a given volume of normal blood.

Gowers' *Hæmacytometer* consists of a small pipette (A), which, when filled up to a mark on its stem, holds 995 cubic millimetres. It is furnished with an india-rubber tube and glass mouth-piece to facilitate filling and emptying; a capillary tube (B) marked to hold 5 cubic millimetres, and also furnished with an india-rubber tube and mouth-piece; a small glass jar (D) in which the dilution of the blood is performed; a glass stirrer (E) for mixing the blood and salt solution thoroughly; (F) a needle, the length of which can be regulated by a screw; a brass stage plate (C) carrying a glass slide, on which is a cell one-fifth of a millimetre

deep, and the bottom of which is divided into one-tenth millimetre squares. On the top of the cell the cover-glass rests. A standard saline solution of sodium sulphate, or similar salt, of specific gravity 1.025, is made, and 995 cubic millimetres are measured by means of the pipette into the glass jar, and with this five cubic millimetres of blood, obtained by pricking the finger with the needle, and measured in the capillary pipette (B), are thoroughly mixed by the glass stirring-rod. A drop of this diluted blood is then placed in the cell and covered with a cover-glass, which is fixed in position by means of the two lateral springs. The layer of diluted blood between the slide and cover-glass is  $\frac{1}{2}$  millimetre thick. The preparation is then examined under a microscope with a power of about 400 diameters, and focused until the lines dividing the cell into squares are visible.

After a short delay, the red corpuscles which have sunk to the bottom of



Fig. 352.—Haemacytometer. (Gowers.)

the cell, and are resting on the squares, are counted in ten squares, and the number of white corpuscles noted. By adding together the numbers counted in ten (one-tenth millimetre) squares, and, as the blood has been diluted, multiplying by ten thousand, the number of corpuscles in one cubic millimetre of blood is obtained. The average number of corpuscles per cubic millimetre of healthy blood, according to Vierordt and Welcker, is 5,000,000 in adult men, and 4,500,000 in women; this corresponds to an average of 50 and 45 corpuscles respectively per square of Gowers' instrument.

A haemacytometer of another form, and one that is much used at the present time, is known as the Thoma-Zeiss haemacytometer. It consists of a carefully graduated pipette, in which the dilution of the blood is done; this is so formed that the capillary stem has a capacity equalling one-hundredth of the bulb above it. If the blood is drawn up in the capillary tube to the line marked 1 (fig. 354) the saline solution may afterwards be drawn up the stem to the line 101; in this way we have 101 parts, of which the blood forms 1. As the contents of the stem can be displaced unmixed we shall

have in the mixture the proper dilution. The blood and the saline solution are well mixed by shaking the pipette, in the bulb of which is contained a small glass bead for the purpose of aiding the mixing. The other part of the instrument consists of a glass slide (fig. 353) upon which is mounted

Fig. 353.



a covered disc, *m*, accurately ruled so as to present one square millimetre divided into 400 squares of one-twentieth of a millimetre each. The micrometer thus made is surrounded by another annular cell, *c*, which has such a height as to make the cell project exactly one-tenth millimetre beyond *m*. If a drop of the diluted blood is placed upon *m*, and *c* is covered with a perfectly flat cover-glass, the volume of the diluted blood above each of the squares of the micrometer, *i.e.*, above each  $\frac{1}{20}$ , will be  $\frac{1}{400}$  of a cubic millimetre. An average of ten or more squares are then taken, and this number multiplied by  $4000 \times 100$  gives the number of corpuscles in a cubic millimetre of undiluted blood.

Fig. 354.



Dr. George Oliver's Hæmacytometer is a much easier instrument to use, and the results obtained are accurate; it does not enable one, however, to ascertain the proportion of red and white corpuscles. A small measured quantity of blood is taken up into a pipette and washed out into a graduated flattened test-tube with Hayem's fluid (sodium chloride 0.5 gramme, sodium sulphate 0.25 gr., corrosive sublimate 0.25 gr., distilled water 100 c.c.). The graduations of the tube are so adjusted that with normal blood (*i.e.*, blood containing 5,000,000 red corpuscles per cubic millimetre) the light of a small wax candle placed three yards from the eye in a dark room, is just visible as a thin bright line when looked at through the tube held edgewise between the fingers, and filled up to the 100 mark with Hayem's fluid. If the number of corpuscles is less than normal, less of the diluting solution is required before the light is transmitted; if more than normal, more of the solution is necessary. The graduations of the tube correspond to percentages of the normal standard which is taken as 100.

#### Development of the Blood-Corpuscles.

Figs. 353 and 354.—  
Thoma-Zeiss  
Hæmacytometer.

The first formed blood-corpuscles of the human embryo differ much in their general characters from those which belong to the later periods of intra-uterine, and to all periods of extra-uterine life. Their manner of origin is at first very simple.

Surrounding the early embryo is a circular area, called the vascular area, in which the first rudiments of the blood-vessels and blood-corpuscles are developed. Here the nucleated embryonic cells of the mesoblast, from which the blood-vessels and corpuscles are to be formed, send out processes in various directions, and

these, joining together, form an irregular meshwork. The nuclei increase in number, and collect chiefly in the larger masses of protoplasm, but partly also in the processes. These nuclei gather around them a certain amount of the protoplasm, and, becoming coloured, form the red blood corpuscles. The protoplasm of the cells and their branched network in which these corpuscles lie then become hollowed out into a system of canals enclosing fluid, in which the red nucleated corpuscles float. The corpuscles at first are from about  $\frac{1}{3300}$  to  $\frac{1}{1300}$  of an inch ( $10\mu$  to  $16\mu$ ) in diameter, mostly spherical, and with granular contents, and a well-marked nucleus. Their nuclei,

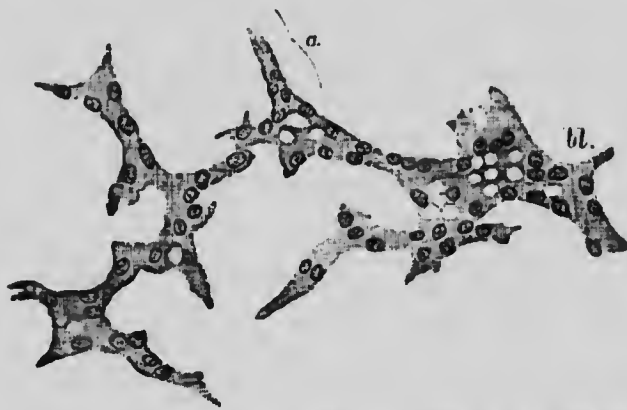

Fig. 355.—Part of the network of developing blood-vessels in the vascular area of a guinea-pig. *bl.*, blood-corpuscles becoming free in an enlarged and hollowed-out part of the network; *a.*, process of protoplasm. (E. A. Schäfer.)

which are about  $\frac{1}{3000}$  of an inch ( $5\mu$ ) in diameter, are central and circular.

The corpuscles then strongly resemble the colourless corpuscles of the fully developed blood, but are coloured. They are capable of amœboid movement and multiply by division.

When, in the progress of embryonic development, the liver begins to be formed, the multiplication of blood-cells in the whole mass of blood ceases, and new blood-cells are produced by this organ, and also by the lymphatic glands, thymus and spleen. These are at first colourless and nucleated, but afterwards acquire the ordinary blood-tinge, and resemble very much those of the first set. They also multiply by division. In whichever way produced, however, whether from the original formative cells of the embryo, or by the liver and the other organs mentioned above, these coloured nucleated cells begin very early in foetal life to be mingled with coloured *non-nucleated* corpuscles resembling

those of the adult, and at about the fourth or fifth month of embryonic existence are completely replaced by them.

**Origin of the Matured Coloured Corpuscles.**—The non-nucleated red corpuscles may possibly be derived from the nucleated, but in all probability are an entirely new formation. Their chief origin is:—

*From the medulla of bone.*—It has been shown that coloured corpuscles are to a very large extent derived during adult life from the large pale cells in the red marrow of bones, especially of the ribs. These cells become coloured from the formation of hæmoglobin chiefly in one part of their protoplasm. This coloured part becomes separated from the rest of the cell and forms a red corpuscle, being at first cup shaped, but soon taking on the normal appearance of the mature corpuscle. Mingled with the amœboid colourless marrow cells (p. 59) are a number of other smaller

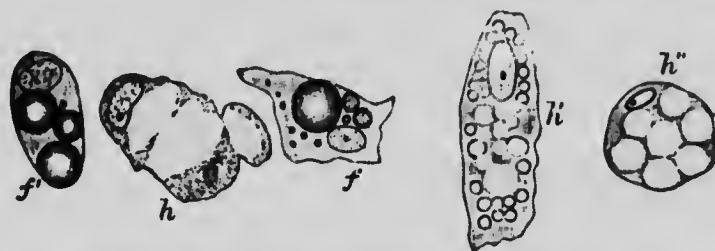

Fig. 356.—Development of red corpuscles in connective tissue cells. From the subcutaneous tissue of a new-born rat. *h*, a cell containing hæmoglobin in a diffused form in the protoplasm; *h'*, one containing coloured globules of varying size and vacuoles; *h''*, a cell filled with coloured globules of nearly uniform size; *f, f'*, developing fat cells. (E. A. Schäfer.)

amœboid cells called *erythroblasts* (fig. 358); these are tinted with hæmoglobin; they divide and multiply, lose their nucleus, and are thus transformed into discoid blood-corpuscles.

*From the tissue of the spleen.*—It is probable that coloured as well as colourless corpuscles may be produced in the spleen from cells similar to the erythroblasts of red marrow.

The belief which formerly prevailed that the red corpuscles are derived from the white or from the platelets has now been discarded.

During fetal life and possibly in some animals, e.g. the rat, which are born in an immature condition, for some little time after birth, the blood discs have been stated by Schäfer to arise in the connective tissue cells in the following way. Small globules, of varying size, of colouring matter arise in the protoplasm of the cells (fig. 356), and the cells themselves become branched, their branches joining the branches of similar cells. The cells next become vacuolated, and the red corpuscles are free in a cavity

filled with fluid (fig. 357); by the extension of the cavity of the cells into their processes anastomosing vessels are produced, which ultimately join with the previously existing vessels, and the globules, now having the size and appearance of the ordinary red corpuscles, are passed into the general circulation. This method of formation is called *intracellular*. Without doubt, the red corpuscles have, like all other parts of the organism, a tolerably definite term of existence, and in a like manner die and waste away when the portion of work allotted to them has been performed. Neither the length of their life, however, nor the fashion of their decay has been yet clearly made out. It is generally believed that a certain number of the coloured corpuscles undergo disintegration in the spleen; and indeed corpuscles in various degrees of degeneration have been observed in that organ.

**Origin of the White Corpuscles.**—The hyaline corpuscles are derived from the lymphocytes which are formed in the lymphatic glands, and enter the blood-stream by the thoracic duct.

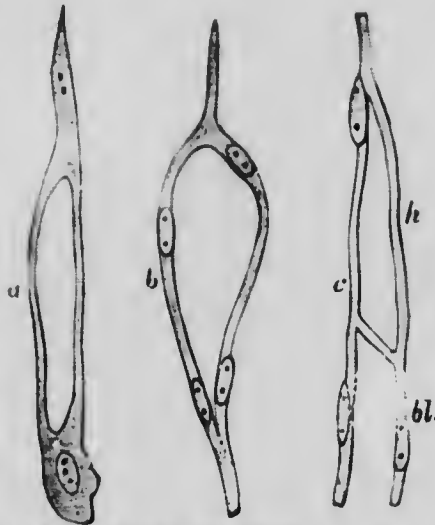

Fig. 357.—Further development of blood-corpuscles in connective tissue cells and transformation of the latter into capillary blood-vessels. *a*, an elongated cell with a cavity in the protoplasm occupied by fluid and by blood-corpuscles which are still globular; *b*, a hollow cell, the nucleus of which has multiplied. The new nuclei are arranged around the wall of the cavity, the corpuscles in which have now become discoid; *c*, shows the mode of union of a "haemopoietic" cell, which, in this instance, contains only one corpuscle, with the prolongation (*bl*) of a previously existing vessel; *a* and *c*, from the new-born rat; *b*, from the foetal sheep. (E. A. Schäfer.)

Fig. 358.—Coloured nucleated corpuscles, from the red marrow of the guinea-pig. (E. A. Schäfer.)

The finely granular leucocytes which are the most numerous white corpuscles in the blood originate either in the same way, or by cell division in the blood-stream itself.

The coarsely granular eosinophile corpuscles, which form about 5 per cent. of the total leucocytes in normal blood, are found in larger numbers in the connective tissue in various parts of the



body; they are found in special abundance in red marrow, in which at one time they were supposed to originate. But they do not seem to be exclusively formed here. Some look upon each eosinophile corpuscle as a little unicellular gland, and the mass of corpuscles as a migratory glandular tissue.

### Chemistry of the Blood-Corpuscles.

**The white blood corpuscles.**—Our chemical knowledge of the white corpuscles is small. Their nucleus consists of nuclein, their cell-protoplasm yields proteids belonging to the globulin and nucleo-proteid groups. The nucleo-proteid obtained from them is not quite the same thing as fibrin-ferment (*thrombin*); it is probably the zymogen or precursor of the ferment (*prothrombin*); the action of the calcium salts of the plasma in shed blood is to convert prothrombin into thrombin (see p. 411). The protoplasm of these cells often contains small quantities of fat and glycogen.

**The red blood corpuscles.**—1000 parts of red corpuscles contain:—

Water . . . . .	688	parts.
Solids { Organic . . . . .	303.88	..
{ Inorganic . . . . .	8.12	..

One hundred parts of the dry organic matter contain—

Proteid . . . . .	5 to 12	parts.
Hæmoglobin . . . . .	86 to 94	..
Lecithin . . . . .	1.8	..
Cholesterin . . . . .	0.1	..

The proteid present is identical with the nucleo-proteid of white corpuscles. The mineral matter consists chiefly of chlorides of potassium and sodium, and phosphates of calcium and magnesium. In man potassium chloride is more abundant than sodium chloride; this, however, does not hold good for all animals.

Oxygen is contained in combination with the hæmoglobin to form oxyhæmoglobin. The corpuscles also contain a certain amount of carbonic acid.

**Hæmoglobin and Oxyhæmoglobin.**—The pigment is by far the most abundant and important of the constituents of the red corpuscles. It is a substance which gives the reactions of a proteid, but differs from other proteids in containing the element iron, and in being readily crystallisable.

It exists in the blood in two conditions: in arterial blood it is combined loosely with oxygen, is of a bright red colour, and is called oxyhæmoglobin; the other condition is the deoxygenated or reduced hæmoglobin (better called simply hæmoglobin). This

is found in the blood after asphyxia. It also occurs in all venous blood—that is, blood which is returning to the heart after it has supplied the tissues with oxygen. Venous blood, however, always contains a considerable quantity of oxyhæmoglobin also. Hæmoglobin is the oxygen-carrier of the body, and it may be called a respiratory pigment.\*

Crystals of oxyhæmoglobin† may be obtained with readiness from the blood of such animals as the rat, guinea-pig, or dog; with difficulty from other animals such as man, ape, and most of the common mammals. The following methods are the best:—

1. Mix a drop of defibrinated blood of the rat on a slide with a drop of water; put on a cover-glass; in a few minutes the corpuscles are rendered colourless, and then the oxyhæmoglobin crystallises out from the solution so formed.

2. Microscopical specimens may also be made by Stein's method, which consists in using Canada balsam instead of water in the foregoing experiment.

Fig. 359.—Crystals of oxyhæmoglobin—prismatic, from human blood.

3. On a larger scale, crystals may be obtained by mixing the blood with one-sixteenth of its volume of ether; the corpuscles dissolve and the blood assumes a *laky* appearance. After a period varying from a few minutes to days, abundant crystals are deposited.

In nearly all animals the crystals are rhombic prisms (fig. 359); but in the guinea-pig they are rhombic tetrahedra, or four-sided pyramids (fig. 360); in the squirrel and hamster, hexagonal plates (fig. 361).

The crystals contain a varying amount of water of crystalli-

\* In the blood of invertebrate animals hæmoglobin is sometimes found, but usually in the plasma, not in special corpuscles. Sometimes it is replaced by other respiratory pigments, such as the green one, chlorocruorin, found in certain worms, and the blue one, hæmocyanin, found in many molluscs and crustacea. Chlorocruorin contains iron; hæmocyanin contains copper.

† Crystals of hæmoglobin can also be obtained by carrying out the crystallisation in an atmosphere free from oxygen.

sation; this probably explains their different crystalline form and solubilities. Different observers have analysed hæmoglobin. They find carbon, hydrogen, nitrogen, oxygen, sulphur and iron. The percentage of iron is 0.4. The amounts of the other elements are variously given, but roughly they are the same as in the proteids. On adding an acid or alkali to hæmoglobin, it is broken up into two parts—a brown pigment called *hæmatin*, which contains all the iron of the original substance, and a proteid called *globin*.

Fig. 36c.—Oxyhæmoglobin crystals—tetrahedral, from blood of the guinea-pig.

**Hæmatin** is not crystallisable; it has the formula  $C_{34}H_{35}N_4FeO_5$  (Hoppe-Seyler), or  $C_{32}H_{30}N_4FeO_3$  (Nencki and Sieber); its constitutional formula is, however, not known. Hæmatin presents different spectroscopic appearances in acid and alkaline solutions (see accompanying plate).

Fig. 36f.—Hexagonal oxyhæmoglobin crystals, from blood of squirrel. (After Funke.)

**Globin** is a somewhat curious proteid; it is coagulable by heat, soluble in dilute acids, and precipitable from such solutions by ammonia. It closely resembles a substance previously

separated from red corpuscles by Kossel, and termed by him *histone*. (Schulz.)

**Hæmochromogen** is sometimes called reduced hæmatin; it may be formed by adding a reducing agent like ammonium sulphide to an alkaline solution of hæmatin. Its absorption spectrum shown on the accompanying plate (No. 8), forms the

**BLOOD-SPECTRA COMPARED WITH SOLAR SPECTRUM.**

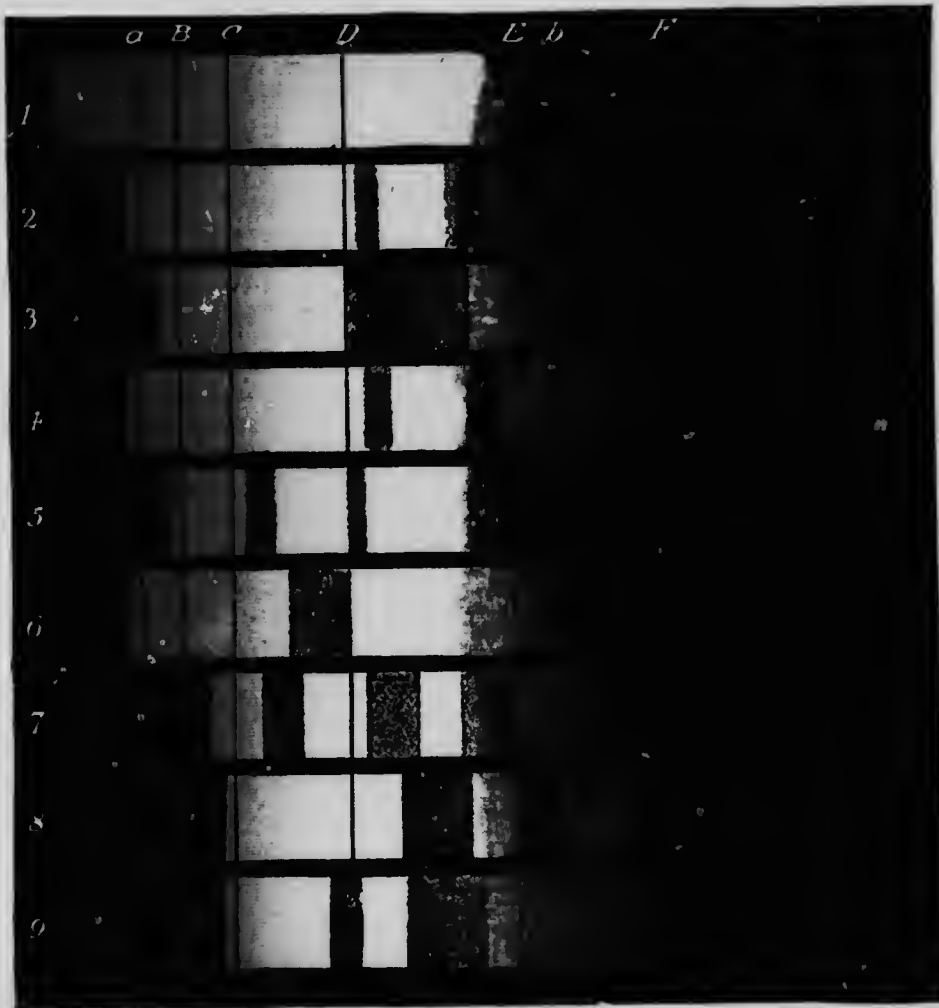

1. Solar Spectrum.
2. Spectrum of dilute solution of oxyhæmoglobin.
3. " " hæmoglobin.
4. " " carbonic oxide hæmoglobin.
5. " " acid hæmatin in ethereal solution.
6. " " alkaline hæmatin.
7. " " methæmoglobin.
8. " " hæmochromogen.
9. " " acid hæmatoporphyrin.

1868

...

...

...

...

...

...

...

...

...

...

...

...

...

...

...

...

...

...

...

...

...

...

...

...

...

...

...

...

...

...

...

...

...

...

...

...

...

...

...

...

...

...

best spectroscopic test for blood pigment; the suspected pigment is dissolved in potash and ammonium sulphide added. Very dilute specimens show the absorption bands, especially the one midway between D and E.

**Hæmin** is of great importance, as the obtaining of this substance forms the best chemical test for blood. Hæmin crystals, sometimes called after their discoverer Teichmann's crystals, are composed of hydrochloride of hæmatin. They may be prepared for microscopical examination by boiling a fragment of dried blood with a drop of glacial acetic acid on a slide; on cooling triclinic plates and prisms of a dark brown colour, often in star-shaped clusters and with rounded angles (fig. 362), separate out.

In the case of an old blood stain it is necessary to add a

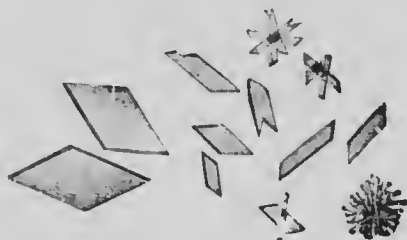

Fig. 362.—Hæmin crystals. (Frey.)

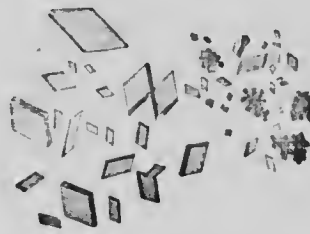

Fig. 363.—Hæmatoidin crystals. (Frey.)

crystal of sodium chloride. Fresh blood contains sufficient sodium chloride in itself.

The action of the acetic acid is, (1) to split the hæmoglobin into hæmatin and globin; and (2) to evolve hydrochloric acid from the sodium chloride. The hæmatin unites with the hydrochloric acid and thus hæmin is formed. The formula for hæmin, like that of hæmatin, is variously given. Mörner gives  $C_{35}H_{35}N_4FeClO_4$ .

**Hæmatoporphyrin** is iron-free hæmatin; it may be prepared by mixing blood with strong sulphuric acid; the iron is taken out as ferrous sulphate. This substance is also found sometimes in nature; it occurs in certain invertebrate pigments, and may also be found in certain forms of pathological urine. Even normal urine contains traces of it. It presents different spectroscopic appearances according as it is dissolved in acid, neutral or alkaline media. The absorption spectrum figured (No. 9) is that of acid hæmatoporphyrin.

**Hæmatoidin.**—This substance is found in the form of yellowish red crystals (fig. 363) in old blood extravasations, and is derived from the hæmoglobin. Its crystalline form and the

reaction it gives with fuming nitric acid shows it to be closely allied to *Bilirubin*, the chief colouring matter of the Bile, and on analysis it is found to be identical with it.

Like hæmatoporphyrin, hæmatoidin is free from iron. These two substances are not identical (*e.g.*, hæmatoidin shows no spectroscopic bands); they are probably isomeric.

### Compounds of Hæmoglobin.

Hæmoglobin forms at least four compounds with gases:—

With oxygen . . . . .	} 1. Oxyhæmoglobin. 2. Methæmoglobin. 3. Carbonic oxide hæmoglobin. 4. Nitric oxide hæmoglobin.
With carbonic oxide . . . . .	
With nitric oxide . . . . .	

These compounds have similar crystalline forms; they each probably consist of a molecule of hæmoglobin combined with one of the gas in question. They part with the combined gas somewhat readily; they are arranged in order of stability in the above list, the least stable first.

**Oxyhæmoglobin** is the compound that exists in arterial blood. Many of its properties have been already mentioned. The oxygen linked to the hæmoglobin, which is removed by the tissues through which the blood circulates, may be called the *respiratory oxygen* of hæmoglobin. The processes that occur in the lungs and tissues, resulting in the oxygenation and de-oxygenation respectively of the hæmoglobin, may be imitated outside the body using either blood or pure solutions of hæmoglobin. The respiratory oxygen can be removed, for example, in the Torricellian vacuum of a mercurial air-pump, or by passing a neutral gas like hydrogen through the blood, or by the use of reducing agents like ammonium sulphide or Stokes' reagent.\* 1 gramme of hæmoglobin will combine with 1.34 c.c. of oxygen.

If any of these methods for reducing oxyhæmoglobin is used, the bright red (arterial) colour of oxyhæmoglobin changes to the purplish (venous) tint of hæmoglobin. On once more allowing oxygen to come into contact with the hæmoglobin, as by shaking the solution with the air, the bright arterial colour returns.

These colour-changes may be more accurately studied with the spectroscope, and the constant position of the absorption bands

\* Stokes' reagent must always be freshly prepared; it is a solution of ferrous sulphate to which a little tartaric acid has been added, and then ammonia till the reaction is alkaline.

seen constitutes an important test for blood pigment. It will be first necessary to describe briefly the instrument used.

**The Spectroscope.**—When a ray of white light is passed through a prism, it is refracted or bent at each surface of the prism; the whole ray is, however, not equally bent, but it is split into its constituent colours, which may be allowed to fall on a screen. The band of colours beginning with the red, passing through orange, yellow, green, blue, and ending with violet, is called a *spectrum*: this is seen in nature in the rainbow. It may be obtained artificially by the glass prism or prisms of a spectro-scope.

The spectrum of sunlight is interrupted by numerous dark lines crossing it vertically, called Fraunhofer's lines. These are perfectly constant in position and serve as landmarks in the spectrum. The more prominent are A, B, and C, in the red; D, in the yellow; E, *b*, and F, in the green; G and H, in the violet. These lines are due to certain volatile substances in the solar atmosphere. If the light from burning sodium or its compounds is examined spectroscopically, it will be found to give a bright yellow line, or, rather, two bright yellow lines very close together. Potassium gives two bright red lines and one violet line; and the other elements, when incandescent, give characteristic lines, but none so simple as sodium. If now the flame of a lamp is examined, it will be found to give a continuous spectrum like that of sunlight in the arrangement of its colours, but unlike it in the absence of dark lines; but if the light from the lamp is made to pass through sodium vapour before it reaches the spectro-scope, the bright yellow light will be found absent, and in its place a dark line, or, rather, two dark lines very close together, occupying the same position as the two bright lines of the sodium spectrum. The sodium vapour thus absorbs the same rays as those which it itself produces at a higher temperature. Thus the D line, as we term it in the solar spectrum, is due to the presence of sodium vapour in the solar atmosphere. The other dark lines are similarly accounted for by other elements.

The large form of spectro-scope (fig. 364) consists of a tube A, called the collimator, with a slit at the end S, and a convex lens at the end L. The latter makes the rays of light passing through the slit from the source of light, parallel: they fall on the prism P, and then the spectrum so formed is focussed by the telescope T.

A third tube, not shown in the figure, carries a small transparent scale of wave-lengths, as in accurate observations the position of any point in the spectrum is given in the terms of the corresponding wave-lengths.



If we now interpose between the source of light and the slit S a piece of coloured glass (H in fig. 364), or a solution of a coloured substance contained in a vessel with parallel sides (the hæmato-scope of Herrmann), the spectrum is found to be no longer continuous, but is interrupted by a number of dark shadows, or *absorption bands* corresponding to the light absorbed by the coloured medium. Thus a solution of oxyhæmoglobin of a certain strength gives two bands between the D and E lines; hæmoglobin gives only one; and other red solutions, though to the naked eye similar to oxyhæmoglobin, will give characteristic bands in other positions.

A convenient form of small spectroscope is the *direct vision*

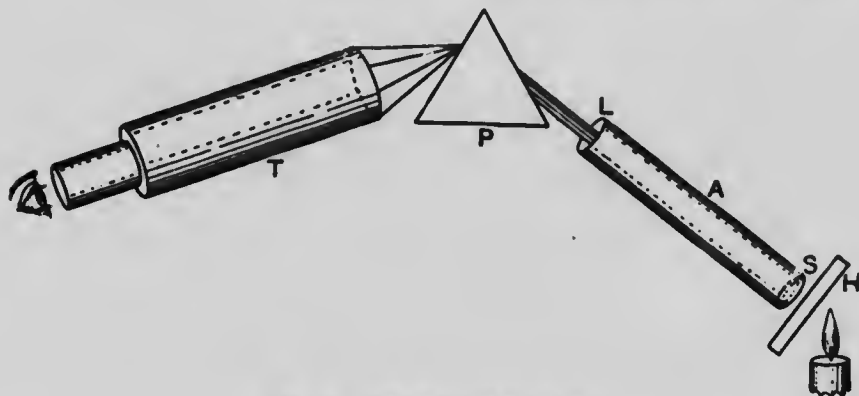

Fig. 364.—Diagram of spectroscope.

*spectroscope*, in which, by an arrangement of alternating prisms of crown and flint glass, the spectrum is observed by the eye in the same line as the tube furnished with the slit—indeed slit and prisms are both contained in the same tube.

In the examination of the spectrum of small coloured objects a combination of the microscope and direct vision spectroscope, called the *micro-spectroscope*, is used.

The next figure illustrates a method of representing absorption spectra diagrammatically. The solution was examined in a layer 1 centimetre thick. The base line has on it at the proper distances the chief Fraunhofer lines, and along the right-hand edges are percentages of the amount of oxyhæmoglobin present in I, of hæmoglobin in II. The width of the shadings at each level represents the position and amount of absorption corresponding to the percentages.

The characteristic spectrum of oxyhæmoglobin, as it actually appears through the spectroscope, is seen in the accompanying

coloured plate (spectrum 2). There are two distinct absorption bands between the D and E lines; the one nearest to D (the  $\alpha$  band) is narrower, darker, and has better-defined edges than the other (the  $\beta$  band). As will be seen on looking at fig. 365, a solution of oxyhæmoglobin of concentration greater than 0.65 per cent. and less than 0.85 per cent. (examined in a cell of the usual thickness of 1 centimetre) gives one thick band overlapping both D and E, and a stronger solution only lets the red light through between C and D. A solution which gives the two characteristic bands must therefore be a dilute one. The one band ( $\gamma$  band) of hæmoglobin (spectrum 3) is not so well

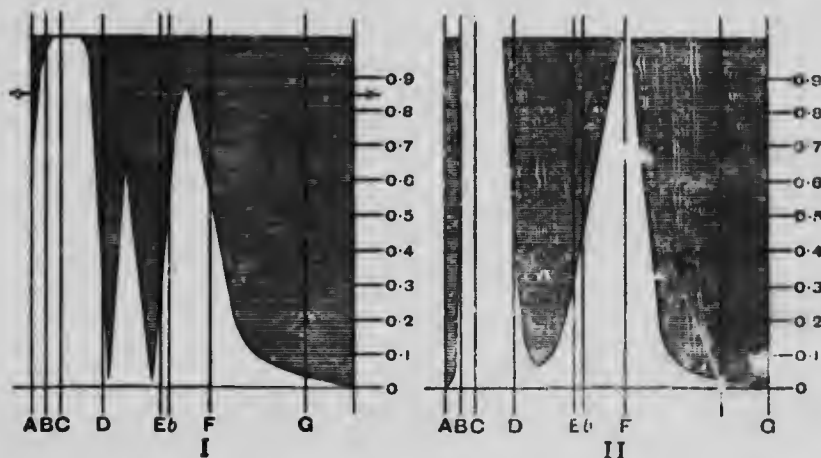

Fig. 365.—Graphic representations of the amount of absorption of light by solution of (I) oxyhæmoglobin, (II) of hæmoglobin, of different strengths. The shading indicates the amount of absorption of the spectrum; the figures on the right border express percentages. (Rollett.)

defined as the  $\alpha$  or  $\beta$  bands. On dilution it fades rapidly, so that in a solution of such strength that both bands of oxyhæmoglobin would be quite distinct the single band of hæmoglobin has disappeared from view. The oxyhæmoglobin bands can be distinguished in a solution which contains only one part of the pigment to 10,000 of water, and even in more dilute solutions which seem to be colourless the  $\alpha$  band is still visible.

Hæmoglobin and its compounds also show absorption bands in the ultra-violet portion of the spectrum. This portion of the spectrum is not visible to the eye, but can be rendered visible by allowing the spectrum to fall on a fluorescent screen, or on a sensitive photographic plate. In order to show absorption bands in this part of the spectrum very dilute solutions of the pigment must be used.

Oxyhæmoglobin shows a band (Soret's band) between the lines G and H. In hæmoglobin, carbonic oxide hæmoglobin, and

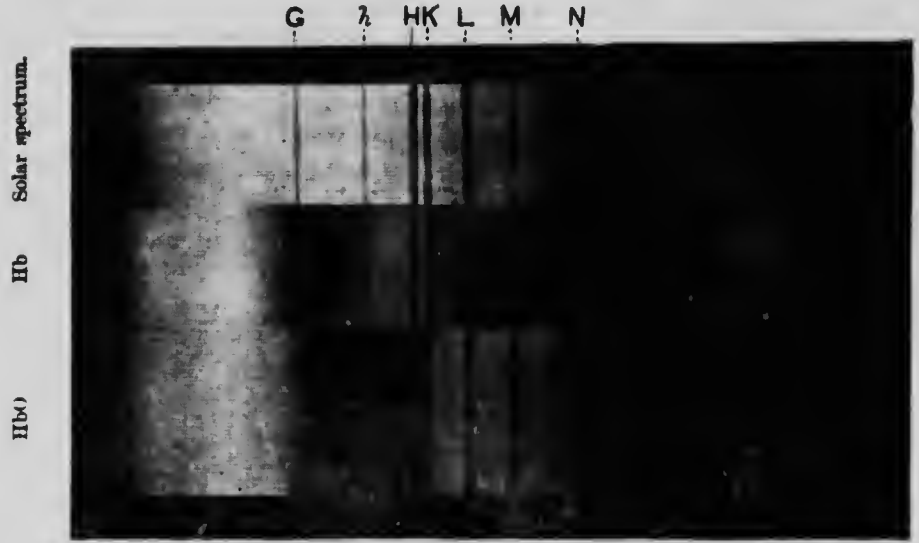

Fig. 366.—The photographic spectrum of hæmoglobin and oxyhæmoglobin. (Gamgee.)

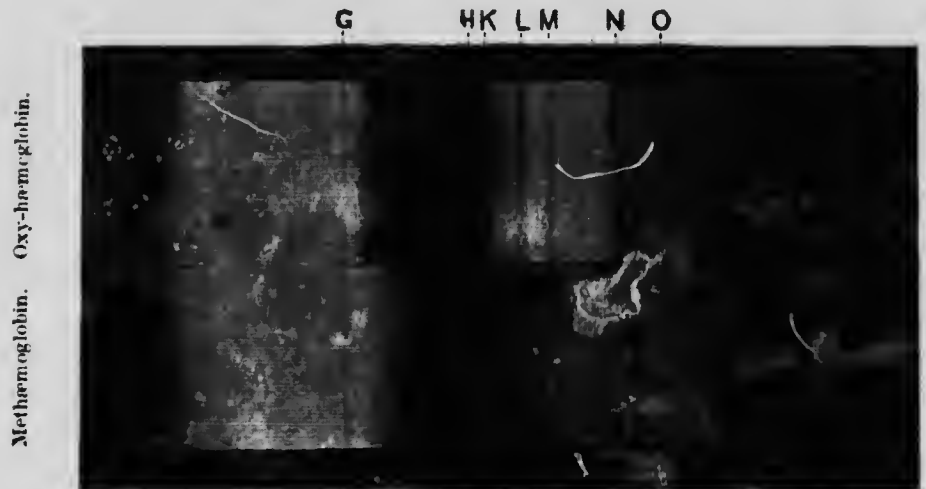

Fig. 367.—The photographic spectrum of oxyhæmoglobin and methæmoglobin. (Gamgee.)

nitric oxide hæmoglobin this band is rather nearer G. Methæmoglobin and hæmatoporphyrin show similar bands.

We owe most of our knowledge of the "photographic spec-

trum" to Prof. Gamgee, through whose kindness I am enabled to present reproductions of two of his numerous photographs (figs. 366 and 367).

**Methæmoglobin.**—This may be produced artificially in various ways, as by adding potassium ferricyanide or amyl nitrite to blood, and as it also may occur in certain diseased conditions in the urine, it is of considerable practical importance. It can be crystallised, and is found to contain the same amount of oxygen as oxyhæmoglobin, only combined in a different way. The oxygen is not removable by the air-pump, nor by a stream of neutral gas like hydrogen. It can, however, by reducing agents like ammonium sulphide, be made to yield hæmoglobin. Methæmoglobin is of a brownish-red colour, and gives a characteristic absorption band in the red between the C and D lines (spectrum 7 in coloured plate). In dilute solutions other bands can be seen.

Potassium ferricyanide is the most convenient re-agent for making methæmoglobin. It is, however, necessary to mention that it produces another effect as well, namely, it causes an evolution of gas, if the blood has been previously laked by the addition of an equal quantity of water. This gas is oxygen; in fact, all the oxygen combined as oxyhæmoglobin is discharged, and this may be collected and measured; the addition of a small amount of sodium carbonate or ammonia to the blood is necessary to prevent the evolution of any carbonic acid. This discharge of oxygen from oxyhæmoglobin is at first sight puzzling, because, as just stated, methæmoglobin contains the same amount of oxygen that is present in oxyhæmoglobin. What occurs is that after the oxygen is discharged from oxyhæmoglobin, an equal quantity of oxygen, due to the oxidising action of the re-agents added, takes its place; this new oxygen, however, is combined in some way different from that which was previously united to the hæmoglobin. (Haldane.)

**Carbonic oxide hæmoglobin** may be readily prepared by passing a stream of carbonic oxide or coal gas through blood or through a solution of oxyhæmoglobin. It has a peculiar cherry-red colour. Its absorption spectrum is very like that of oxyhæmoglobin, but the two bands are slightly nearer the violet end of the spectrum (spectrum 4 in coloured plate). Reducing agents, like ammonium sulphide, do not change it; the gas is more firmly combined than the oxygen in oxyhæmoglobin. CO-hæmoglobin forms crystals like those of oxyhæmoglobin. It resists putrefaction for a very long time.

Carbonic oxide is given off during the imperfect combustion of carbon such as occurs in charcoal stoves or during the explosions that occur in coal mines: it acts as a powerful poison by combining with the hæmoglobin of the blood, and thus interferes with normal respiratory processes. The bright colour of the



# MICROCOPY RESOLUTION TEST CHART

(ANSI and ISO TEST CHART No. 2)

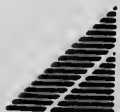
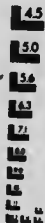

**APPLIED IMAGE Inc**

1653 East Main Street  
Rochester, New York 14609 USA  
(716) 482 - 0300 - Phone  
(716) 288 - 5989 - Fax

blood in both arteries and veins and its resistance to reducing-agents are in such cases characteristic.

**Nitric Oxide Hæmoglobin.**—When ammonia is added to blood, and then a stream of nitric oxide passed through it, this compound is formed. It may be obtained in crystals isomorphous with oxy- and CO-hæmoglobin. It also has a similar spectrum.

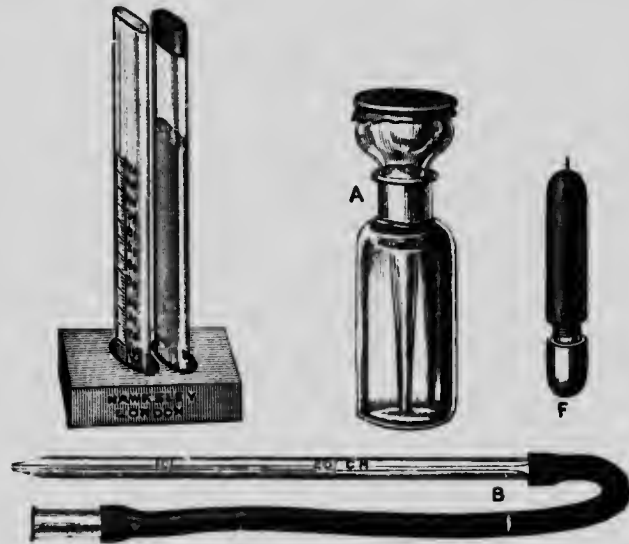

Fig. 368.—Hæmoglobinometer of Dr. Gowers

It is even more stable than CO-hæmoglobin; it has no practical interest, but is of theoretical importance as completing the series.

Bohr has advanced a theory that hæmoglobin forms a compound with carbonic acid, and that there are numerous oxyhæmoglobins containing different amounts of oxygen, but his views have not been accepted.

**Estimation of Hæmoglobin.**—The most exact method is by the estimation of the amount of iron (dry hæmoglobin containing 42 per cent. of iron) in the ash of a given specimen of blood, but as this is a somewhat complicated process, various colorimetric methods have been proposed which, though not so exact, have the advantage of simplicity.

**Gowers's Hæmoglobinometer.**—The apparatus (fig. 368) consists of two glass tubes of the same size. One contains glycerine jelly tinted with carmine to a standard colour—viz. that of normal blood diluted 100 times with distilled water. The finger is pricked and 20 cubic millimetres of blood are measured out by the capillary pipette, B. This is blown out into the other tube and diluted with distilled water, added drop by drop from the pipette stopper of the bottle, A, until the tint of the diluted blood reaches the standard colour. This tube is graduated into 100 parts. If the tint of the diluted blood is the same as the standard when the tube is filled up to the graduation 100, the quantity of oxyhæmoglobin in the blood is normal. If it has to be diluted more largely, the oxyhæmoglobin is in excess; if to a smaller extent, it is less than normal. If the blood has, for instance, to be

diluted up to the graduation 50, the amount of hæmoglobin is only half what it ought to be—50 per cent. of the normal—and so for other percentages.

**Von Fleisch's Hæmometer.**—The apparatus (fig. 369) consists of a stand bearing a white reflecting surface (S) and a platform. Under the platform is a slot carrying a glass wedge stained red (K) and moved by a wheel (R). On the platform is a small cylindrical vessel divided vertically into two compartments, *a* and *a'*.

Fill with a pipette the compartment *a'* over the wedge with distilled water. Fill about a quarter of the other compartment (*a*) with distilled water.



Fig. 369.—Fleisch's Hæmoglobinometer.

Prick the finger and fill the short capillary pipette provided with the instrument with blood. Dissolve this in the water in compartment *a*, and fill it up with distilled water.

Having arranged the reflector (S) to throw *artificial* light vertically through both compartments, look down through them, and move the wedge of glass by the milled head (T) until the colour of the two is identical. Read off the scale, which is so constructed as to give the percentage of hæmoglobin.

**Dr. George Oliver's Method** consists in comparing a specimen of blood suitably diluted in a shallow white palette with a number of standard tests very carefully prepared by the use of Lovibond's coloured glasses. These standards are much better matches for blood in various degrees of dilution than in the other colorimetric methods. The yellow tint of diluted hæmoglobin is very successfully imitated.

**Tests for Blood.**—These may be gathered from preceding descriptions. Briefly, they are microscopic, spectroscopic, and chemical. The best chemical test is the formation of hæmin crystals. The old test with tincture of guaiacum and hydrogen peroxide, the blood causing the red tincture to become green,



is very untrustworthy, as it is also given by many other organic substances.

In medico-legal cases it is often necessary to ascertain whether or not a red fluid or stain upon clothing is or is not blood. In any such case it is advisable not to rely upon one test only, but to try every means of detection at one's disposal. To discover whether it is blood or not is by no means a difficult problem, but to distinguish human blood from that of the common mammals is practically impossible.

---

## CHAPTER XXVII.

### THE ALIMENTARY CANAL.

THE alimentary canal consists of a long muscular tube lined by mucous membrane beginning at the mouth, and terminating at the anus. It comprises the mouth, pharynx, œsophagus, stomach, small intestine and large intestine. Opening into it are numerous glands which pour juices into it; these bring about the digestion of the food as it passes along. Some of the glands, like the gastric and intestinal glands, are situated in the lining mucous membrane of the canal; others like the salivary glands, liver, and pancreas, are situated at a distance from the main canal, and pour their secretion into it by means of side tubes or ducts.

The events that take place in the alimentary canal are, (1) *digestion*, that is the conversion of the food into soluble substances; and (2) *absorption*, that is the passage of these soluble materials into the blood or lymph in the vessels of the wall of the canal.

Digestion is a series of chemical actions produced by the digestive juices on the food. We shall therefore have to study the composition of the food as a preliminary to the consideration of their digestion. In addition to chemical processes, there are a number of mechanical actions such as mastication, deglutition, peristalsis, which we shall reserve for a separate chapter.

In the present chapter we shall take the structure of the alimentary canal, reserving, however, a detailed study of the glands until we consider the action of their secretions.

## THE MOUTH.

This cavity is lined by a mucous membrane consisting of a *corium* of fibrous tissue with numerous patches of lymphoid tissue in it, especially in the posterior regions; and an epithelium of the stratified variety closely resembling the epidermis. The surface layers, like those of the epidermis, are made of horny scales. Opening into the mouth are a large number of little mucous glands, and the salivary glands pour their secretion into the mouth also. The teeth (p. 70) have been previously studied. The tongue will be considered later in connection with taste.

## THE PHARYNX.

That portion of the alimentary canal which intervenes between the mouth and the œsophagus is termed the *Pharynx*. It is constructed of a series of three muscles with striated fibres (*constrictors*), which are covered by a thin fascia externally, and are lined internally by a strong fascia (pharyngeal aponeurosis), on the inner aspect of which is areolar (submucous) tissue and mucous membrane, continuous with that of the mouth, and, as regards the part concerned in swallowing, is identical with it in general structure. The epithelium of this part of the pharynx, like that of the mouth, is stratified. The upper portion of the pharynx into which the nares open is lined with ciliated epithelium.

The pharynx is well supplied with mucous glands.

Between the anterior and posterior arches of the soft palate are situated the *Tonsils*, one on each side. A tonsil consists of an elevation of the mucous membrane presenting 12 to 15 orifices, which lead into crypts or recesses, in the walls of which are placed nodules of lymphoid tissue (fig. 371). These nodules are enveloped in a less dense adenoid tissue which reaches the mucous surface. The surface is covered with stratified epithelium, and the corium may present rudimentary papillæ formed of adenoid tissue. The tonsil is bounded beneath by a fibrous capsule (fig. 371, 4). Into the crypts open the ducts of numerous mucous glands.



Fig. 370.—Lingual follicle or crypt. *a*, involution of mucous membrane with its papillæ; *b*, lymphoid tissue, with several lymphoid nodules. (Frey.)

## THE ŒSOPHAGUS OR GULLET.

The Œsophagus or Gullet, the narrowest portion of the alimentary canal, is a muscular tube, nine or ten inches in length, which extends from the lower end of the pharynx to the cardiac orifice of the stomach.

*Structure.*—The œsophagus is made up of three coats—viz., the outer, *muscular*; the middle, *submucous*; and the inner,

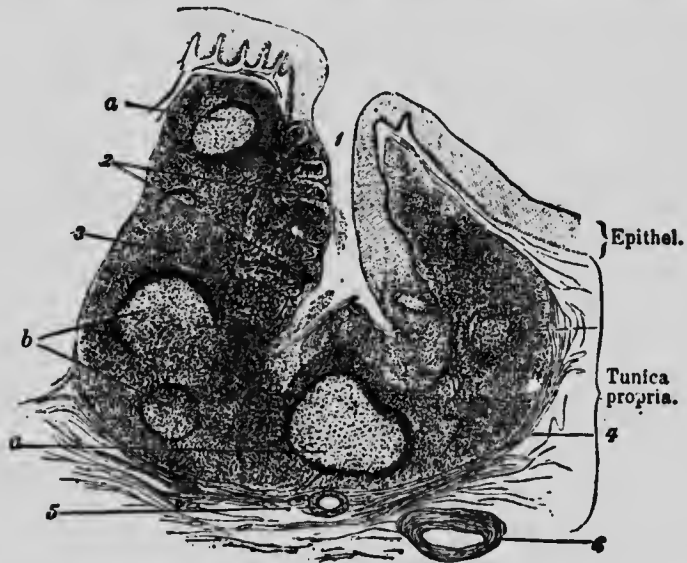

Fig. 371.—Vertical section through a crypt of the human tonsil. 1, entrance to the crypt; 2 and 3, the framework of adenoid tissue; 4, the enclosing fibrous tissue; 5 and 6, lymphoid nodules; 5 and 6, blood-vessels. (Stühr.)

*mucous.* The *muscular* coat is covered externally by a varying amount of loose fibrous tissue. It is composed of two layers of fibres, the outer being arranged longitudinally, and the inner circularly. At the upper part of the œsophagus this coat is made up principally of striated muscle fibres; they are continuous with the constrictor muscles of the pharynx; but lower down the unstriated fibres become more and more numerous, and towards the end of the tube form the entire coat. The muscular coat is connected with the mucous coat by a more or less developed layer of areolar tissue, which forms the *submucous* coat, in which are contained in the lower half or third of the tube many mucous glands, the ducts of which, passing through the mucous membrane, open on its surface (fig. 372). Separating this coat from the mucous membrane proper is a well-developed layer of

longitudinally arranged nustriated muscle, called the *muscularis mucosæ*. The corium of the mucous membrane is composed of fine connective tissue, which, towards the surface, is elevated into papillæ. It is covered with a stratified epithelium, of which the

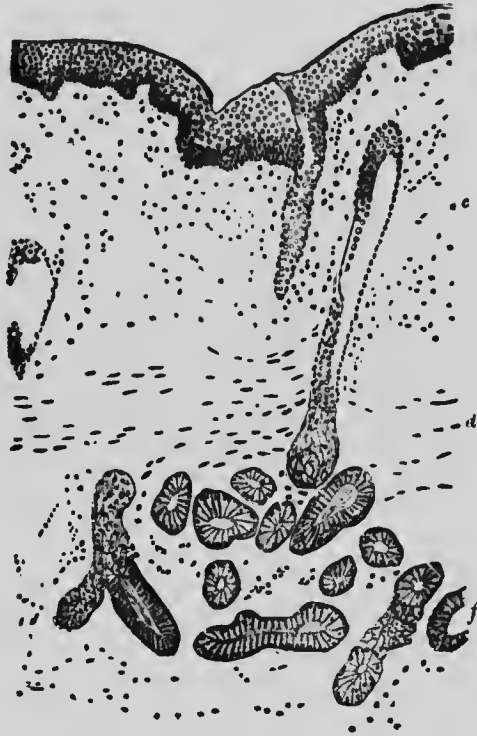

Fig. 372.—Section of the mucous membrane and submucous coat of the œsophagus.

most superficial layers are squamous. The epithelium is arranged upon a basement membrane.

In newly-born children the corium exhibits, in many parts, the structure of lymphoid tissue (Klein).

#### THE STOMACH.

In man and those Mammalia which are provided with a single **stomach**, it consists of a dilatation of the alimentary canal placed between and continuous with the œsophagus, which enters its larger or cardiac end on the one hand, and the small intestine, which commences at its narrowed end or pylorus, on the other. It varies in shape and size according to its state of distension.

*Structure.*—The stomach is composed of four coats, called respectively—(1) an external or peritoneal, (2) muscular, (3) sub-mucous, and (4) mucous coat; with blood-vessels, lymphatics, and nerves distributed in and between them.

(1) The *peritoneal* coat has the structure of serous membranes in general.

(2) The *muscular* coat consists of three separate layers or sets of fibres, which, according to their several directions, are named the longitudinal, circular, and oblique. The *longitudinal* set are the most superficial: they are continuous with the longitudinal fibres of the œsophagus and spread out in a diverging manner over the cardiac end and sides of the stomach. They extend as far as the pylorus, being especially distinct at the lesser or upper curvature of the stomach, along which they pass in several strong bands. The next set, the *circular* or *transverse* fibres, are most abundant at the middle and in the pyloric portion of the organ, and form the chief part of the thick projecting ring of the pylorus. They are continuous with the circular

Fig. 373.—From a vertical section through the mucous membrane of the cardiac end of stomach. Two glands are shown with a duct common to both. *a*, duct with columnar epithelium becoming shorter as the cells are traced downward; *n*, neck of gland tubes, with central and parietal cells; *b*, fundus with curved caecal extremity—the parietal cells are not so numerous here. (Klein and Noble Smith.)

layer of the intestine. The deepest set of fibres are the *oblique*, continuous with the circular muscular fibres of the œsophagus: they are comparatively few in number, and are found only at the

cardiac portion of the stomach; they form a sphincter around the cardiac orifice. The muscular fibres of the stomach and of the intestinal canal are *unstriated*, being composed of elongated, spindle-shaped fibre-cells.

(3) The *submucous coat* consists of loose areolar tissue, which connects the muscular coat to the mucous membrane. It contains blood-vessels and nerves; in the contracted state of the stomach it is thrown into numerous, chiefly longitudinal, folds or rugæ, which disappear when the organ is distended.

(4) The *mucous membrane* is composed of a corium of fine connective tissue, which approaches closely in structure to adenoid tissue; this tissue supports the tubular glands of which the superficial and chief part of the mucous membrane is composed, and passing up between them assists in binding them together. The glands are separated from the rest of the mucous membrane by a very fine, reticulated basement membrane. The corium is covered with a layer of columnar epithelium, which passes down into the mouths of the glands.

At the deepest part of the mucous membrane are two thin layers (circular and longitudinal) of unstriated muscular fibres, called the *muscularis mucosæ*, which separate the mucous membrane from the scanty submucous tissue.

When examined with a lens, the internal or free surface of the stomach presents a peculiar honeycomb appearance, produced by shallow polygonal depressions, the diameter of which varies generally from  $\frac{1}{200}$ th to  $\frac{1}{150}$ th of an inch (about  $125\mu$ ); but near the pylorus is as much as  $\frac{1}{100}$ th of an inch ( $250\mu$ ). In the bottom of these little pits, and to some extent between them, minute openings are visible, which are the orifices of the ducts of perpendicularly arranged tubular glands (fig. 373), imbedded side by side in sets or bundles, on the surface of the mucous membrane, and composing nearly the whole structure.

The glands of the mucous membrane are of two varieties, (a) Cardiac, (b) Pyloric.

(a) *Cardiac* glands are found throughout the whole of the cardiac half and fundus of the stomach. They are arranged in groups of four or five, which are separated by a fine connective

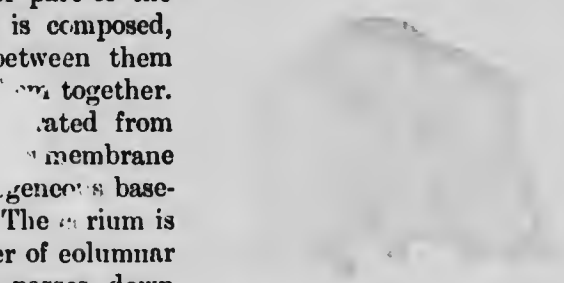

Fig. 374.—Transverse section through lower part of cardiac glands of a cat. a, parietal cells; b, central cells; c, transverse section of capillaries. (Frey.)

tissue. Two or three tubes open into one duet, which forms about a third of the whole length of the tube and opens on the surface. The duets are lined with columnar epithelium. Of the gland-tube proper, *i.e.* the part of the gland below the duet, the upper third is the *neck* and the rest the *body*. The neck is narrower than the body, and is lined with coarsely granular polyhedral

cells which are continuous with the columnar cells of the duet. Between these cells and the basement membrane of the tubes, are large oval or spherical cells, opaque or granular in appearance, with clear oval nuclei, bulging out the basement membrane; these cells are called *parietal cells*. They do not form a continuous layer. The body, which is broader than the neck and terminates in a blind extremity or *fundus* near the muscularis mucosæ, is lined by cells continuous with the *central* cells of the neck, but longer, more columnar and more transparent. In this part are a few parietal cells of the same kind as in the neck (fig. 373).

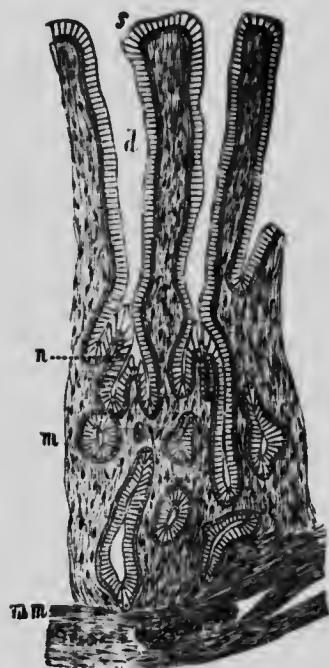

Fig. 375.—Section showing the pyloric glands. *s*, free surface; *d*, ducts of pyloric glands; *n*, neck of same; *m*, the gland alveoli; *mm*, muscularis mucosæ. (Klein and Noble Smith.)

(*b*) *Pyloric Glands*.—These glands (fig. 375) have much longer ducts than the cardiac glands. Into each duct two or three tubes open by very short and narrow necks, and the body of each tube is branched, wavy, and convoluted. The lumen is large. The ducts are lined with

columnar epithelium, and the neck and body with shorter and finely granular eubical cells, which correspond with the central cells of the cardiac glands. As they approach the duodenum the pyloric glands become larger, more convoluted and more deeply situated. They are directly continuous with Brunner's glands in the duodenum.

*Lymphatics*.—Lymphatic vessels surround the gland tubes to a greater or less extent. Towards the fundus of the cardiac glands are found masses of lymphoid tissue, which may appear as distinct follicles, somewhat like the solitary glands of the small intestine.

*Blood-vessels.*—The blood-vessels of the stomach, which first break up in the sub-mucous tissue, send branches upward between the closely packed glandular tubes, anastomosing around them by means of a fine capillary network, with oblong meshes. Continuous with this deeper plexus, or prolonged upwards from it, is a more superficial network of larger capillaries, which branch densely around the orifices of the tubes, and form the framework on which are moulded the small elevated ridges of mucous membrane bounding the minute, polygonal pits before referred to. From this *superficial* network the veins chiefly take their origin. Thence passing down between the tubes, with no very frequent anastomosis with the deeper *inter-tubular* capillary plexus, they open finally into the venous network in the sub-mucous tissue (fig. 376).

*Nerves.*—The nerves of the stomach are derived from the pneumogastric and sympathetic, and form two plexuses, one in the sub-mucous and the other between the muscular layers.

These plexuses are continuous with those which occur in the same situations in the intestine, and which we shall again refer to there.

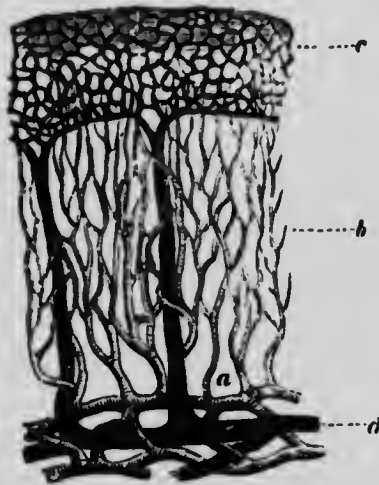

Fig. 376.—Plan of the blood-vessels of the stomach, as they would be seen in a vertical section. *a*, arteries, passing up from the vessels of submucous coat; *b*, capillaries branching between and around the tubes; *c*, superficial plexus of capillaries occupying the ridges of the mucous membrane; *d*, vein formed by the union of veins which, having collected the blood of the superficial capillary plexus, are seen passing down between the tubes. (Brinton.)

## THE INTESTINES.

The Intestinal Canal is divided into two chief portions, named, from their differences in diameter, the *small* and *large* intestine. These are continuous with each other, and communicate by means of an opening guarded by a valve, the *ileo-cæcal* valve, which allows the passage of the products of digestion from the small into the large bowel, but not, under ordinary circumstances, in the opposite direction.

**The Small Intestine.**—The Small Intestine, the average



length of which in an adult is about twenty feet, has been divided, for convenience of description, into three portions, viz., the *duodenum*, which extends for eight or ten inches beyond the pylorus; the *jejunum*, which forms two-fifths, and the *ileum*, which forms three-fifths of the rest of the canal.

*Structure.*—The small intestine, like the stomach, is constructed



Fig. 377.

of four coats, viz, the serous, muscular, sub-mucous, and mucous.

(1.) The *serous* coat is formed by the visceral layer of the peritoneum, and has the structure of serous membranes in general.

(2.) The *muscular* coat consists of an internal circular and an external longitudinal layer: the former is usually considerably the thicker. Both alike consist of bundles of unstriped muscle

supported by connective tissue. They are well provided with lymphatic vessels, which form a set distinct from those of the mucous membrane.

Between the two muscular coats is a nerve-plexus (Auerbach's

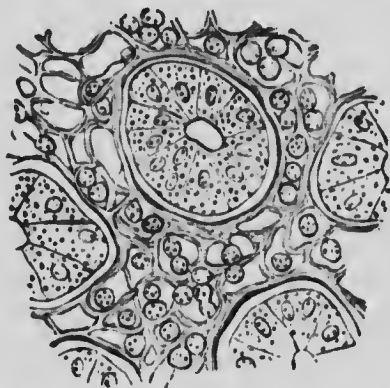

Fig. 378.—Horizontal section of a small fragment of the mucous membrane, showing one entire crypt of Lieberkühn and parts of several others. The glands are separated by loose adenoid tissue.

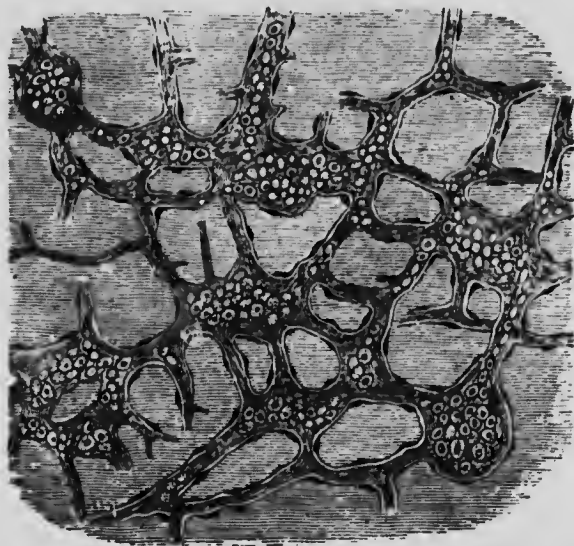

Fig. 379.—Auerbach's nerve-plexus in small intestine. Ganglion-cells are imbedded in the plexus, the whole of which is enclosed in a nucleated sheath. (Klein.)

plexus) (fig. 379), similar in structure to Meissner's (in the sub-mucous coat), but coarser and with more numerous ganglia.

(3.) Between the mucous and muscular coats is the *submucous* coat, which consists of connective tissue in which numerous blood-

vessels and lymphatics ramify. A fine plexus, consisting mainly of non-medullated nerve-fibres, *Meissner's plexus*, with ganglion cells at its nodes, occurs in the submucous tissue from the stomach to the anus.

(4.) The *mucous membrane* is the most important coat in relation to the function of digestion. The following structures, which enter into its composition, may now be successively described:—the *valvulæ conniventes*; the *villi*; and the *glands*. The general structure of the mucous membrane of the intestines



Fig. 380.—Piece of small intestine (previously distended and hardened by alcohol), laid open to show the normal position of the valvulæ conniventes. Natural size.

resembles that of the stomach, and, like it, is lined on its inner surface by columnar epithelium. Adenoid tissue (fig. 378) enters largely into its construction; and on its deep surface is the *muscularis mucosæ* (*m*, fig. 381), the fibres of which are arranged in two layers: the outer longitudinal and the inner circular.

*Valvulæ Conniventes.*—The valvulæ conniventes (fig. 380) commence in the duodenum, about one or two inches beyond the pylorus, and becoming larger and more numerous immediately beyond the entrance of the bile duct, continue thickly arranged and well developed throughout the jejunum; then, gradually diminishing in size and number, they cease near the middle of the ileum. They are formed by a doubling inwards of the mucous membrane; the crescentic, nearly circular, folds thus formed

are arranged transversely to the axis of the intestine, but each individual fold seldom extends around more than  $\frac{1}{2}$  or  $\frac{2}{3}$  of the bowel's circumference. Unlike the rugæ in the œsophagus and stomach, they do not disappear on distension of the canal. Their function is to afford a largely increased surface for secretion and absorption. They are covered with villi.

*Villi.*—The Villi (figs. 381, 382, and 383) are confined exclusively to the mucous membrane of the small intestine. They are minute vascular processes, from  $\frac{1}{8}$  to  $\frac{1}{3}$  of an inch (.5 to 3 mm.) in length, covering the surface of the mucous membrane, and giving it a peculiar velvety, fleecy appearance. Krause estimates them at fifty to ninety in number in a square line at the upper part of the small intestine, and at forty to seventy in the same area at the lower part. They vary in form even in the

same animal, and differ according as the lymphatic vessels or *lacteals* which they contain are empty or full; being usually, in the former case, flat and pointed at their summits, in the latter cylindrical.

Each villus consists of a small projection of mucous membrane; its interior consists of fine adenoid tissue, which forms the framework in which the other constituents are contained.

The surface of the villus is clothed by columnar epithelium, which rests on a fine basement membrane; while within this are found, reckoning from without inwards, blood-vessels, fibres of

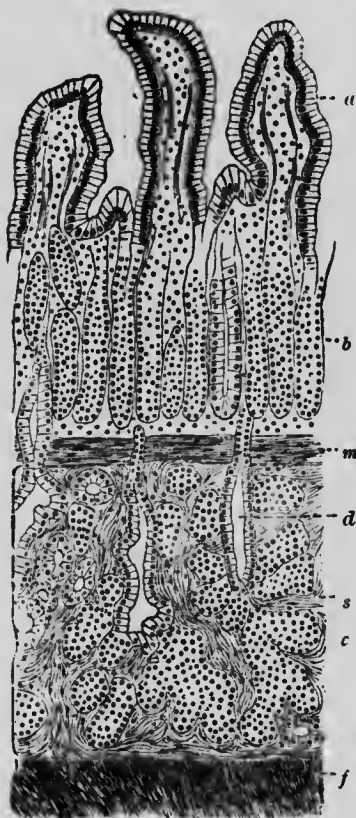

Fig. 381.—Vertical section of duodenum, showing *a*, villi; *b*, crypts of Lieberkühn, and *c*, Brunner's glands in the submucosa *s*, with ducts, *d*; muscularis mucosae, *m*; and circular muscular coat *f*. (Schofield.)



Fig. 382.—Vertical section of a villus of the small intestine of a cat. *a*, striated border of the epithelium; *b*, columnar epithelium; *c*, goblet cells; *d*, central lymph-vessel; *e*, smooth muscular fibres; *f*, adenoid stroma of the villus in which lymph corpuscles lie. (Klein.)

the *muscularis mucosae*, and a single lymphatic or lacteal vessel sometimes looped or branched (fig. 383).

The epithelium is continuous with that lining the other parts of the mucous membrane. The cells are arranged with their long axis radiating from the surface of the villus (fig. 382), and their smaller ends resting on the basement membrane. The free surface of the epithelial cells of the villi, like that of the cells

which cover the general surface of the mucous membrane, is surmounted by a bright border which exhibits very delicate striations, whence it derives its name, *striated border* (see pp. 27—29).

Immediately beneath the basement membrane there is a rich supply of *blood-vessels*. Two or more minute arteries are distributed within each villus; and from their capillaries, which form



Fig. 383.—A. Villus of sheep. B. Villi of man. (Slightly altered from Teichmann.)

a dense network, proceed one or two small veins, which pass out at the base of the villus.

The layer of the *muscularis mucosæ* in the villus forms a kind of thin hollow cone immediately around the central lacteal, and is, therefore, situated beneath the blood-vessels. It is instrumental in the propulsion of chyle along the lacteal.

The *lacteal vessel* in each villus is the form of commencement of the lymphatic system of vessels in the intestines. It begins almost at the tip of the villus commonly by a dilated extremity. In the larger villi there may be two small lacteal vessels which join, or the lacteals may form a network in the villus (fig. 383).

*Glands.*—The glands are of two kinds:—viz., those of Lieberkühn and of Brunner. Peyer's patches and the solitary follicles are composed of lymphoid nodules. Though sometimes called glands, they form no external secretion.

The *glands* or *crypts* of *Lieberkühn* are tubular depressions of the intestinal mucous membrane, thickly distributed over the whole surface both of the large and small intestines. In the small intestine they are visible only with the aid of a lens; and their orifices appear as minute dots scattered between the villi. They are larger in the large intestine, and increase in size

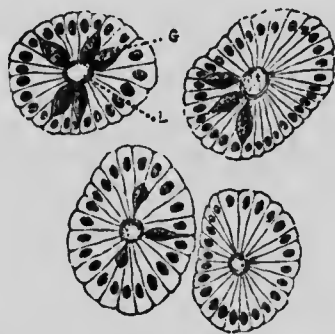

Fig. 384.—Transverse section through four crypts of Lieberkühn from the large intestine of the pig. They are lined by columnar epithelial cells, the nuclei being placed in the outer part of the cells. The divisions between the cells are seen as lines radiating from L, the lumen of the crypt; G, epithelial cells, which have become transformed into goblet cells.  $\times 350$ . (Klein and Noble Smith.)



Fig. 385.—A gland of Lieberkühn in longitudinal section. (Brinton.)

the nearer they approach the anal end of the intestinal tube; and in the rectum their orifices may be visible to the naked eye. In length they vary from  $\frac{1}{180}$  to  $\frac{1}{80}$  of an inch. Each tubule (fig. 385) is constructed of a fine *basement membrane*, lined by a layer of columnar epithelium, many of the cells of which are goblet cells.

*Brunner's glands* (fig. 381) are confined to the duodenum; they are most abundant and thickly set at its commencement, and diminish gradually as the duodenum advances. They are situated beneath the *mucosæ*, imbedded in the submucous tissue; each gland is a branched and convoluted tube, lined with columnar epithelium. In structure they are very similar to the pyloric glands of the stomach, but they are more branched and convoluted and their ducts are longer. The duct of each gland

passes through the muscularis mucosæ, and opens on the surface of the mucous membrane.

*Peyer's patches* are found in greatest abundance in the lower part of the ileum near to the ileo-cæcal valve. They consist of aggregated groups of lymphoid nodules; they vary from one to three inches in length, and are about half-an-inch in width, chiefly of an oval form, their long axes being parallel with that of the intestine. They are almost always placed opposite the attachment of the mesentery.

When the lymphoid nodules occur singly, as they often do



Fig. 386.—Agminate follicles, or Peyer's patch, in a state of distension.  $\times 5$ . (Boehm.)

both in small and large intestines, they are called *solitary glands*, or *follicles*.

**The Large Intestine.**—The Large Intestine, which in an adult is from about 4 to 6 feet long, is subdivided for descriptive purposes into three portions, viz.:—the *cæcum*, a short wide pouch, communicating with the lower end of the small intestine through an opening, guarded by the *ileo-cæcal* valve; the *colon*, continuous with the cæcum, which forms the principal part of the large intestine, and is divided into ascending, transverse, and descending portions; and the *rectum*, which, after dilating at its lower part, again contracts, and immediately afterwards opens externally through the *anus*. Attached to the cæcum is the small *appendix vermiformis*.

**Structure.**—Like the small intestine, the large intestine is constructed of four coats, viz., the serous, muscular, sub-mucous, and mucous. The *serous* coat has connected with it the small processes of peritoneum containing fat, called *appendices epiploicæ*. The fibres of the *muscular* coat, like those of the small intestine, are arranged in two layers—the outer longitudinal,

the inner circular. In the cæcum and colon, the longitudinal fibres, instead of being, as in the small intestine, thinly disposed in all parts of the wall of the bowel, are collected, for the most part, into three strong bands, which, being shorter, from end to end, than the other coats of the intestine, hold the canal in folds, bounding intermediate sacculi. On the division of these bands, the intestine can be drawn out to its full length, and it then assumes an uniformly cylindrical form. In the rectum, the fasciuli

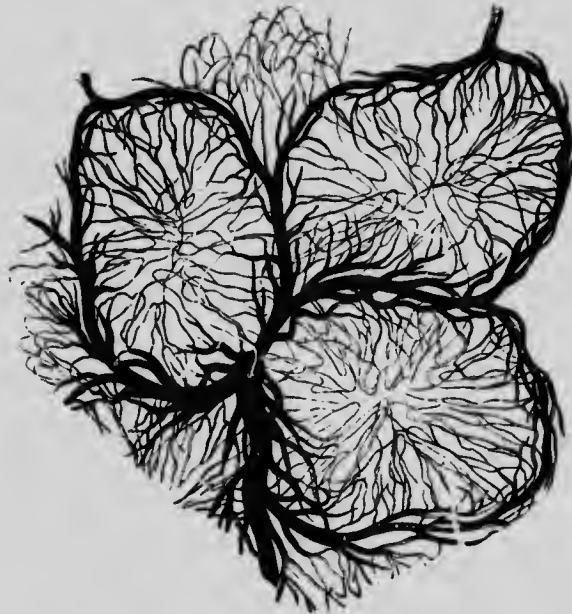

Fig. 387.—Transverse section of injected Peyer's patch (from Kölliker). The drawing was taken from a preparation made by Frey from the intestine of the rabbit: it represents the fine capillary-looped network spreading from the surrounding blood-vessels into the interior of three of the lymphoid nodules.

of these longitudinal bands spread out and mingle with the other longitudinal fibres, forming with them a thicker layer of fibres than exists in any other part of the intestinal canal. The circular muscular fibres are spread over the whole surface of the bowel, but are somewhat more marked in the intervals between the sacculi. Towards the lower end of the rectum they become more numerous, and at the anus they form a strong ring called the *internal sphincter* muscle.

The *mucous membrane* of the large, like that of the small intestine, is lined throughout by columnar epithelium, but, unlike it, is quite destitute of villi, and is not projected in the form of *valvulæ conniventes*. Its general microscopic structure otherwise



resembles that of the small intestine: and it is bounded below by the *muscularis mucosæ*.

The arrangement of ganglia and nerve-fibres in the large resembles that in the small intestine.

*Glands.*—The glands with which the large intestine is provided are simple *tubular* glands, or glands of Lieberkühn; they resemble those of the small intestine, but are somewhat larger and more numerous, and contain a very great number of goblet cells; nodules of *adenoid* or *lymphoid* tissue are most numerous in the cæcum and vermiform appendix. They resemble in shape and structure the solitary glands of the small intestine. Peyer's patches are not found in the large intestine.

*Ileo-cæcal Valve.*—The ileo-cæcal valve is situated at the place of junction of the small with the large intestine, and guards against any reflux of the contents of the latter into the ileum. It is composed of two semilunar folds of mucous membrane. Each fold is formed by a doubling inwards of the mucous membrane, and is strengthened on the outside by some of the circular muscular fibres of the intestine, which are contained between the outer surfaces of the two layers of which each fold is composed. While the circular muscular fibres, however, at the junction of the ileum with the cæcum are contained between the outer opposed surfaces of the folds of mucous membrane which form the valve, the longitudinal muscular fibres and the peritoneum of the small and large intestine respectively are continuous with each other, without dipping in to follow the circular fibres and the mucous membrane. In this manner, therefore, the folding inwards of these two last-named structures is preserved, while on the other hand, by dividing the longitudinal muscular fibres and the peritoneum, the valve can be made to disappear, just as the constrictions between the sacculi of the large intestine can be made to disappear by performing a similar operation. The mucous membrane of the ileum is continuous with that of the cæcum. That surface of each fold of the ileo-cæcal valve, which looks towards the small intestine is covered with villi, while that which looks to the cæcum has none. When the cæcum is distended, the margins of the folds are stretched, and thus are brought into firm apposition one with the other.

## CHAPTER XXVIII.

## FOOD.

THE chief chemical compounds or *proximate principles* in food are:—

1. Proteids . . . . .	} organic.
2. Carbohydrates . . . . .	
3. Fats . . . . .	} inorganic.
4. Water . . . . .	
5. Salts . . . . .	

In milk and in eggs, which form the exclusive foods of young animals, all varieties of these proximate principles are present in suitable proportions. Hence they are spoken of as perfect foods. Eggs, though a perfect food for the developing bird, contain too little carbohydrate for a mammal. In most vegetable foods carbohydrates are in excess, while in animal food, like meat, the proteids are predominant. In a suitable diet these should be mixed in proper proportions, which must vary for herbivorous and carnivorous animals.

A healthy and suitable diet must possess the following characters:—

1. It must contain the proper amount and proportion of the various proximate principles.
2. It must be adapted to the climate; to the age of the individual and to the amount of work done by him.
3. The food must contain not only the necessary amount of proximate principles, but these must be present in a digestible form. As an instance of this, many vegetables (peas, beans, lentils) contain even more proteid than beef or mutton, but are not so nutritious, as they are less digestible, much passing off in the fæces unused.

The nutritive value of a diet depends chiefly on the amount of carbon and nitrogen it contains. A man doing a moderate amount of work will eliminate, chiefly from the lungs, in the form of carbonic acid, from 250 to 280 grammes of carbon *per diem*. During the same time he will eliminate, chiefly in the form of urea in the urine, about 15 to 18 grammes of nitrogen. These substances are derived from the metabolism of the tissues, and various forms of energy, mechanical motion and heat being

the chief, are simultaneously liberated. During muscular exercise the output of carbon greatly increases; the increased excretion of nitrogen is not nearly so marked. Taking, then, the state of moderate exercise, it is necessary that the waste of the tissues should be replaced by fresh material in the form of food; and the proportion of carbon to nitrogen should be the same as in the excretions: 250 to 15, or 16.6 to 1. The proportion of carbon to nitrogen in proteid is, however, 53 to 15, or 3.5 to 1. The extra supply of carbon must come from non-nitrogenous food—viz. fat and carbohydrate.

Moleschott gives the following daily diet:—

Proteid	. . . . .	120	grms.
Fat	. . . . .	90	"
Carbohydrate	. . . . .	333	"

Ranke's diet closely resembles Moleschott's; it is—

Proteid	. . . . .	100	grms.
Fat	. . . . .	100	"
Carbohydrate	. . . . .	250	"

Such typical diets as these must not be considered as more than rough averages of what is necessary for a man in the course of the day. Actual experience shows that in the diets of different nations there are considerable variations from this standard without the production of ill effects. Age, and the amount of work done also influence the amount of food necessary; growing children, for instance, require a relatively rich diet; thus, milk, the diet of the infant, is proportionally twice as rich in proteids, and half as rich again in fats, as the normal diet given above. During work more food is necessary than during inactivity.

Ranke's and Moleschott's diets just given are by no means generous ones; most English people take more proteid. From the composition of the more commonly-used foods, G. N. Stewart calculates that 500 grammes of bread and 250 grammes of lean meat constitute a fair quantity for a man fit for hard work. Adding 500 grammes of milk, 75 grammes of oatmeal porridge, 30 grammes of butter, and 450 grammes of potatoes, we get, approximately, 20 grammes of nitrogen and 300 grammes of carbon contained in 135 grammes of proteid, 97 grammes of fat, and about 400 grammes of carbohydrate. This diet is thus a more liberal one than the "adequate" diets just given.

In tabular form the facts just given may be more succinctly stated:—

Food-stuff.	Quantity.		Grammes of					
			Nitro- gen.	Car- bon.	Pro- teids.	Fats.	Carb- hydrates	Salts.
Lean meat	Metric system. 250 grammes	English weights. 9 oz.	8	33	55	8.5	0	4
Bread . .	500 "	18 "	6	112	40	7.5	245	6.5
Milk . .	500 "	$\frac{1}{2}$ pint	3	35	20	20	25	3.5
Butter . .	30 "	1 oz.	0	20	0	27	0	0.5
Fat with meat . .	30 "	1 "	0	22	0	30	0	0
Potatoes .	450 "	16 "	1.5	47	10	0	95	4.5
Oatmeal .	75 "	3 "	1.7	30	10	4	48	2
			20.2	299	135	97	413	21

We shall have to return to the composition of diets again in our study of metabolism; and now we will proceed to consider the principal foods.

### Milk.

**Milk**, which we have already spoken of as a perfect food, is only so for young children. For those who are older, it is so voluminous that unpleasantly large quantities of it would have to be taken in the course of the day to ensure the proper supply of nitrogen and carbon. Moreover, it is relatively too rich in proteid and fat. It also contains too little iron (Bunge): hence children weaned late become anæmic.

The microscope reveals that it consists of two parts: a clear fluid and a

number of minute particles that float in it. These consist of minute oil globules, varying in diameter from 0.0015 to 0.005 millimetre (fig. 388).

The milk secreted during the first few days of lactation is called *colostrum*. It contains very little caseinogen, but large

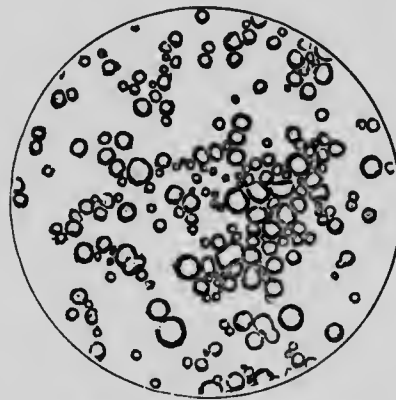

Fig. 388.—Globules of cow's milk.  $\times 400$ .

quantities of globulin instead. Microscopically, cells from the acini of the mammary gland are seen, which contain fat globules in their interior; they are called *colostrum corpuscles*.

**Reaction and Specific Gravity.**—The reaction of fresh cow's milk and of human milk is generally neutral or slightly alkaline. In carnivora the milk is acid. All milk readily turns acid or sour as the result of fermentative change, part of its lactose being transformed into lactic acid. The specific gravity of milk is usually ascertained with the hydrometer. That of normal cow's milk varies from 1028 to 1034. When the milk is skimmed the specific gravity rises, owing to the removal of the light constituent, the fat, to 1033 to 1037. In all cases the specific gravity of water, with which other substances are compared, is taken as 1000.

**Composition.**—Frankland gives the following table, contrasting the milk of woman, ass, and cow:—

	Woman.	Ass.	Cow.
	Per cent.	Per cent	Per cent.
Proteids (chiefly caseinogen).	2·7	1·7	4·2
Butter (fat) . . . . .	3·5	1·3	3·8
Lactose . . . . .	5·0	4·5	3·8
Salts . . . . .	0·2	0·5	0·7

Hence, in feeding infants on cow's milk, it is necessary to dilute it, and add sugar to make it approximately equal to natural human milk.

**The Proteids of Milk.**—The principal proteid in milk is called *caseinogen*; it is *precipitable* by acids such as acetic acid, and also by saturation with magnesium sulphate, or half saturation with ammonium sulphate, so resembling globulins; it is *coagulated* by rennet to form *casein*. Cheese consists of casein with the entangled fat. The other proteid in milk is an albumin. It is present in small quantities only; it differs in some of its properties (specific rotation, coagulation temperature, and solubilities) from serum-albumin; it is called *lact-albumin*.

**The Coagulation of Milk.**—Rennet is the agent usually employed for this purpose: it is a ferment secreted by the stomach, especially in sucking animals, and is generally obtained from the calf.

The *curd* consists of the casein and entangled fat: the liquid residue called *whey* contains the sugar, salts, and albumin of the milk. There is also a small quantity of a new proteid called *whey-proteid*, which differs from caseinogen by not being con-

vertible into casein; this is produced by the decomposition of the caseinogen molecule during the process of curdling.

The curd formed in human milk is more finely divided than that in cow's milk; and it is more digestible. In feeding children and invalids on cow's milk, the lumpy condition of the curd may be obviated by the addition of lime water or barley water to the milk.

The addition of rennet produces coagulation in milk, provided that a sufficient amount of calcium salts is present. If the calcium salts are precipitated by the addition of potassium oxalate, rennet causes no formation of casein. The process of curdling in milk is a double one; the first action due to rennet is to produce a change in caseinogen; the second action is that of the calcium salt which precipitates the altered caseinogen as casein. In blood also, calcium salts are necessary for coagulation, but there they act in a different way, namely, in the production of fibrin ferment (see p. 411).

Caseinogen is often compared to alkali-albumin. The latter, however, does not clot with rennet, and is, unlike caseinogen, readily soluble in acids. Caseinogen is not a globulin, though it is, like globulins, readily precipitated by neutral salts. It differs from a globulin in not being coagulated by heat. It is a nucleoproteid; that is, a compound of a proteid, with the proteid-like but phosphorous rich material called *nuclein* (see p. 400).

**The Fats of Milk.**—The chemical composition of the fat of milk (butter) is very like that of adipose tissue. It consists chiefly of palmitin, stearin, and olein. There are, however, smaller quantities of fats derived from fatty acids lower in the series, especially butyric and caproic. The relation between these varies somewhat, but the proportion is roughly as follows:—Olein,  $\frac{2}{3}$ ; palmitin,  $\frac{1}{3}$ ; stearin,  $\frac{1}{8}$ ; butyric, caproic, and caprylic,  $\frac{1}{14}$ . The old statement that each fat globule is surrounded by a film of caseinogen is not now regarded as true by most authorities. Milk also contains small quantities of lecithin, a phosphorised fat; of cholesterin, an alcohol which resembles fat in its solubilities, and a yellow fatty pigment or lipochrome.

**Milk Sugar, or Lactose.**—This is a saccharose ( $C_{12}H_{22}O_{11}$ ). Its properties have already been described in Chap. XXV., p. 388.

**Souring of Milk.**—When milk is allowed to stand, the chief change which it is apt to undergo is a conversion of a part of its lactose into lactic acid. This is due to the action of microorganisms, and would not occur if the milk were contained in closed sterilised vessels. Equations showing the change produced are given on p. 388. When souring occurs, the acid formed precipitates a portion of the caseinogen. This must not

be confounded with the formation of casein from caseinogen which is produced by rennet. There are, however, some bacterial growths which, like rennet, produce true coagulation.

**Alcoholic Fermentation in Milk.**—When yeast is added to milk, the sugar does not readily undergo the alcoholic fermentation. Other somewhat similar fungoid growths are, however, able to produce the changes, as in the preparation of koumiss; the milk sugar is first inverted, that is dextrose and galactose are formed from it (see p. 388), and it is these sugars from which alcohol and carbonic acid originate.

**The Salts of Milk.**—The chief salt present is calcium phosphate; a small quantity of magnesium phosphate is also present. The other salts are chiefly chlorides of sodium and potassium.

#### The Mammary Glands.

The mammary glands are composed of large divisions or lobes, and these are again divisible into lobules; the lobules are composed of the convoluted and dilated subdivisions of the main ducts held together by connective-tissue. Covering the general surface of the gland, with the exception of the nipple, is a considerable quantity of fat, itself lobulated by sheaths and processes of areolar tissue (fig. 389) connected both with the skin in front and the gland behind; the same bond of connection extends also from the under surface of the gland to the sheathing connective-tissue of the great pectoral muscle on which it lies. The main ducts of the gland, fifteen to twenty in number, called the *lactiferous* ducts, are formed by the union of the smaller (lobular) ducts, and open by small separate orifices through the nipple. At the points of junction of lobular ducts to form lactiferous ducts, and just before these enter the base of the nipple, the ducts are dilated; and during the period of active secretion by the gland, the dilatations form reservoirs for the milk, which collects in and distends them. The walls of the gland-ducts are formed of areolar with some unstriped muscular tissue, and are lined internally by short columnar and near the nipple by flattened epithelium. The alveoli consist of a basement membrane of flattened cells lined by low columnar epithelium.

The nipple is composed of areolar tissue, and contains unstriped muscular fibres. Blood-vessels are also freely supplied to it, so as to give it an erectile structure. On its surface are very sensitive papillæ; and around it is a small area or *areola* of pink or dark-tinted skin, on which are to be seen small projections formed by minute secreting glands.

Blood-vessels, nerves, and lymphatics are plentifully supplied to the mammary glands; the calibre of the blood-vessels, as well as the size of the glands, varies very greatly under certain conditions, especially those of pregnancy and lactation. The secretory nerves of the mammary glands have not yet been discovered.

The alveoli of the glands during the secreting periods are found to be lined with very short columnar cells, with nuclei situated towards the centre. The edges of the cells towards the lumen may be irregular and jagged, and the remainder of the alveolus is filled up with the materials of the milk. During the intervals between the acts of discharge, the cells of the alveoli elongate towards the lumen, their nuclei divide, and in the part of the cells towards the lumen a collection of oil globules and of other materials takes place.

The next stage is that the cells divide and the part of each towards the

lumen containing a nucleus and the materials of the secretion, disintegrates and goes to form the solid part of the milk. The cells also secrete water,

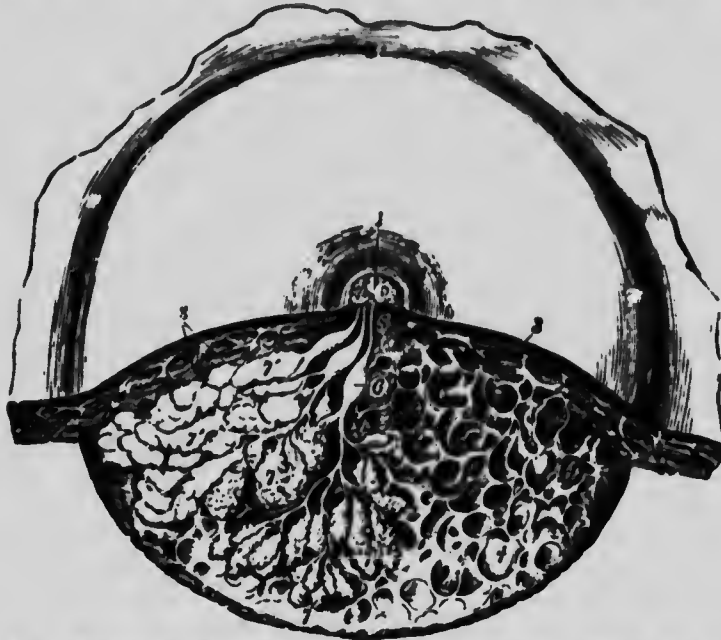

Fig. 389.—Dissection of the lower half of the female mamma, during the period of lactation. 1.—In the left-hand side of the dissected part the glandular lobes are exposed and partially unravelled; and on the right-hand side, the glandular substance has been removed to show the reticular loculi of the connective-tissue in which the glandular lobules are placed: 1, upper part of the mamilla or nipple; 2, areola; 3, subcutaneous masses of fat; 4, reticular loculi of the connective-tissue which support the glandular substance and contain the fatty masses; 5, one of three lactiferous ducts shown passing towards the mamilla where they open; 6, one of the sinus lactei or reservoirs; 7, some of the glandular lobules which have been unravelled; 7, others massed together. (Luschka.)

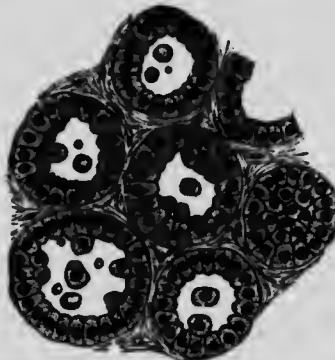

Fig. 390.—Section of mammary gland of bitch, showing acini, lined with epithelial cells of a short columnar form.  $\times 200$ . (V. D. Harris.)

salts, and milk sugar. The fat, &c., of milk are not simply picked out from the blood by the secreting cells, but these materials are formed by metabolic processes within the protoplasm of the cells.



In the earlier days of lactation, epithelial cells only partially transformed are discharged in the secretion: these are termed *colostrum corpuscles*. It is stated that colostrum possesses a purgative action.

During pregnancy the mammary glands undergo changes (*evolution*) which are readily observable. They enlarge, become harder, and more distinctly lobulated: the veins on the surface become more prominent. The areola becomes enlarged and dusky, with projecting papillæ; the nipple too becomes more prominent, and milk can be squeezed from the orifices of the ducts. This is a very gradual process, which commences about the time of conception, and progresses steadily during the whole period of gestation. In the gland itself solid columns of cells bud off from the old alveoli to form new alveoli. But these solid columns after a while are converted into tubes by the central cells becoming fatty and being discharged as the colostrum corpuscles above mentioned.

After the end of lactation, the mamma gradually returns to its original size (*involution*). The acini, in the early stages of involution, are lined with cells in all degrees of vacuolation. As involution proceeds the acini diminish considerably in size, and at length, instead of a mosaic of lining epithelial cells (twenty to thirty in each acinus), we have five or six nuclei (some with no surrounding protoplasm) lying in an irregular heap within the acinus. During the later stages of involution, large yellow granular cells are to be seen. As the acini diminish in size, the connective-tissue and fatty matter between them increase, and in some animals, when the gland is completely inactive it is found to consist of a thin film of glandular tissue overlying a thick cushion of fat. Many of the products of waste are carried off by the lymphatics.

### Eggs.

In this country the eggs of hens and ducks are those particularly selected as foods. The chief constituent of the *shell* is calcium carbonate. The *white* is composed of a richly albuminous fluid enclosed in a network of firmer and more fibrous material. The amount of solids is 13.3 per cent.; of this 12.2 is proteid in nature (egg-albumin, with smaller quantities of egg-globulin, and of a mucinoid substance called ovo-mucoid), and the remainder is made up of sugar (0.5 per cent.), traces of fats, lecithin and cholesterin, and 0.6 per cent. of inorganic salts. The *yolk* is rich in food materials for the development of the future embryo. In it there are two varieties of yolk-spherules, one kind yellow and opaque (due to admixture with fat and a yellow lipochrome), and the other smaller, transparent and almost colourless: these are proteid in nature, consisting of the nucleo-proteid called *vitellin*. Small quantities of sugar, lecithin, cholesterin and inorganic salts are also present.

The nutritive value of eggs is high, as they are so readily digestible; but the more an egg is cooked the more insoluble do its proteid constituents become.

### Meat.

This is composed of the muscular and connective (including adipose) tissues of certain animals. The flesh of some animals is

not eaten; in some cases this is a matter of fashion, in others, owing to an unpleasant taste, such as the flesh of carnivora is said to have; and in other cases (*e.g.* the horse) because it is more lucrative to use the animal as a beast of burden.

Meat is the most concentrated and most easily assimilable of nitrogenous foods. It is our chief source of nitrogen. Its chief solid constituent is proteid, and the principal proteid is myosin. In addition to the extractives and salts contained in muscle, there is always a certain percentage of fat, even though all visible adipose tissue is dissected off. The fat-cells are placed between the muscular fibres, and the amount of fat so situated varies in different animals; it is particularly abundant in pork; hence the indigestibility of this form of flesh: the fat prevents the gastric juice from obtaining ready access to the muscular fibres.

The following table gives the chief substances in some of the principal meats used as food:—

Constituents.	Ox.	Calf.	Fig.	Horse.	Fowl.	Pike.
Water . . . . .	76·7	75·6	72·6	74·3	70·8	79·3
Solids . . . . .	23·3	24·4	27·4	25·7	29·2	20·7
Proteids and gelatin*	20·0	19·4	19·9	21·6	22·7	18·3
Fat . . . . .	1·5	2·9	6·2	2·5	4·1	0·7
Carbohydrate . . . .	0·6	0·8	0·6	0·6	1·3	0·9
Salts . . . . .	1·2	1·3	1·1	1·0	1·1	0·8

The large percentage of water in meat should be particularly noted; if a man wished to take his daily minimum of 100 grammes of proteid entirely in the form of meat, it would be necessary for him to consume about 500 grammes (*i.e.*, a little more than 1lb.) of meat *per diem*.

### Flour.

The best wheat flour is made from the interior of wheat grains, and contains the greater proportion of the starch of the grain and most of the proteid. Whole flour is made from the whole grain *minus* the husk, and thus contains not only the white interior but also the harder and browner outer portion of the grain. This outer region contains a somewhat larger proportion of the proteids of the grain. Whole flour contains 1 to 2 per cent. more proteid

\* The flesh of young animals is richer in gelatin than that of old: thus, 1000 parts of beef yield 6, of veal 50, parts of gelatin.

than the best white flour, but it has the disadvantage of being less readily digested. Brown flour contains a certain amount of bran in addition: it is still less digestible, but is useful as a mild laxative, the insoluble cellulose mechanically irritating the intestinal canal as it passes along.

The best flour contains very little sugar. The presence of sugar indicates that germination has commenced in the grains. In the manufacture of malt from barley this is purposely allowed to go on.

When mixed with water, wheat flour forms a sticky, adhesive mass called dough. This is due to the formation of gluten, and the forms of grain poor in gluten cannot be made into dough (oats, rice, &c.). Gluten does not exist in the flour as such, but is formed on the addition of water from the pre-existing globulins in the flour.

The following table contrasts the composition of some of the more important vegetable foods:—

Constituents.	Wheat.	Barley.	Oats.	Rice.	Lentils.	Peas.	Potatoes.
Water . . . . .	13·6	13·8	12·4	13·1	12·5	14·8	76·0
Proteid . . . . .	12·4	11·1	10·4	7·9	24·8	23·7	2·0
Fat . . . . .	1·4	2·2	5·2	0·9	1·9	1·6	0·2
Starch . . . . .	67·9	64·9	57·8	76·5	54·8	49·3	20·6
Cellulose . . . . .	2·5	5·3	11·2	0·6	3·6	7·5	0·7
Mineral salts . . . . .	1·8	2·7	3·0	1·0	2·4	3·1	1·0

We see from this table—

1. The great quantity of starch always present.
2. The small quantity of fat; that bread is generally eaten with butter is a popular recognition of this fact.
3. Proteid, except in potatoes, is pretty abundant, and especially so in the pulses (lentils, peas, &c.). The proteid in the pulses is not gluten, but consists of vitellin and globulin-like substances.

In the mineral matters in vegetables, salts of potassium and magnesium are, as a rule, more abundant than those of sodium and calcium.

### Bread.

Bread is made by cooking the dough of wheat flour mixed with yeast, salt, and flavouring materials. A ferment in the flour acts at the commencement of the process, when the temperature is kept a little over that of the body, and forms dextrin and

sugar from the starch, and then the alcoholic fermentation, due to the action of the yeast, begins. The bubbles of carbonic acid, burrowing passages through the bread, make it light and spongy. This enables the digestive juices subsequently to soak into it readily and affect all parts of it. In the later stages, viz., baking, the temperature is raised, the gas and alcohol are expelled from the bread, the yeast is killed, and a crust forms from the drying of the outer portions of the dough.

White bread contains, in 100 parts, 7 to 10 of proteid, 55 of carbohydrates, 1 of fat, 2 of salts, and the rest water.

### Cooking of Food.

The cooking of foods is a development of civilisation and serves many useful ends :—

1. It destroys all parasites and danger of infection. This relates not only to bacterial growths, but also to larger parasites, such as tapeworms and trichinæ.

2. In the case of vegetable foods it breaks up the starch grains, bursting the cellulose and allowing the digestive juices to come into contact with the granulose.

3. In the case of animal foods it converts the insoluble collagen of the universally distributed connective tissues into the soluble gelatin. The loosening of the fibres is assisted by the formation of steam between them. By thus loosening the binding material, the more important elements of the food, such as muscular fibres, are rendered accessible to the gastric and other juices. Meat before it is cooked is generally kept a certain length of time to allow *rigor mortis* to pass off.

Of the two chief methods of cooking, roasting and boiling, the former is the more economical, as by its means the meat is first surrounded with a coat of coagulated proteid on its exterior, which keeps in the juices to a great extent, letting little else escape but the dripping (fat). Whereas in boiling, unless both bouillon and bouilli are used, there is considerable waste. Cooking, especially boiling, renders the proteids more insoluble than they are in the raw state; but this is counterbalanced by the other advantages that cooking possesses.

In making *beef tea* and similar extracts of meat it is necessary that the meat should be placed in cold water, and this is gradually and carefully warmed. In boiling a joint it is usual to put the meat into boiling water at once, so that the outer part is coagulated, and the loss of material minimised.

An extremely important point in this connection is that

beef tea and similar meat extracts should not be regarded as foods. They are valuable as pleasant stimulating drinks for invalids, but they contain very little of the nutritive material of the meat, their chief constituents, next to water, being the salts and extractives (creatine, creatinine, lactic acid, &c.) of flesh.

*Soup* contains the extractives of meat, a small proportion of the proteids, and the principal part of the gelatin. The gelatin is usually increased by adding bones and fibrous tissue to the stock. It is the presence of this substance which causes the soup when cold to gelatinise.

#### Accessories to Food.

Among these must be placed *alcohol*, the value of which within moderate limits is not as a food but as a stimulant; *condiments* (mustard, pepper, ginger, curry powder, &c.) which are stomachic stimulants, the abuse of which is followed by dyspeptic troubles; and *tea*, *coffee*, *cocoa*, and similar drinks. These are stimulants chiefly to the nervous system; tea, coffee, maté (Paraguay), guarana (Brazil), cola nut (Central Africa), bush tea (South Africa) and a few other plants used in various countries all owe their chief property to an alkaloid called *theine* or *caffeine* ( $C_8 H_{10} N_4 O_2$ ); cocoa to the closely related alkaloid, *theobromine* ( $C_7 H_8 N_4 O_2$ ); coca to *cocaine*. These alkaloids are all poisonous, and used in excess, even in the form of infusions of tea and coffee, produce over-excitement, loss of digestive power, and other disorders well known to physicians. Coffee differs from tea in being rich in aromatic matters; tea contains a bitter principle, tannin; to avoid the injurious solution of too much tannin, tea should only be allowed to infuse (draw) for a few minutes. Cocoa is not only a stimulant, but a food in addition; it contains about 50 per cent. of fat, and 12 per cent. of proteid. Still, as ordinarily prepared as an infusion, the quantity taken does not contain much of these food materials.

*Green vegetables* are taken as a palatable adjunct to other foods, rather than for their nutritive properties. Their potassium salts are, however, abundant. Cabbage, turnips, and asparagus contain 80 to 92 water, 1 to 2 proteid, 2 to 4 carbohydrates, and 1 to 1.5 cellulose per cent. The small amount of nutriment in most green foods accounts for the large meals made by, and the vast capacity of the alimentary canal of, herbivorous animals.

## CHAPTER XXIX.

## SECRETING GLANDS.

BEFORE passing on to the action of the digestive secretions on foods, it will be well to discuss some of the general aspects of the question, and the varieties of glands by means of which these substances are formed.

It is the function of gland cells to produce by the metabolism of their protoplasm certain substances called secretions. These materials are of two kinds; viz., those which are employed for the purpose of serving some ulterior office in the economy, and those which are discharged from the body as useless or injurious. In the former case the separated materials are termed *secretions*; in the latter they are termed *excretions*.

The secretions, as a rule, consist of substances which do not pre-exist in the same form in the blood, but require special cells and a process of elaboration for their formation, *e.g.*, the liver cells for the formation of bile, the mammary gland-cells for the formation of milk. The excretions, on the other hand, commonly consist of substances which exist ready-formed in the blood, and are merely abstracted therefrom. If from any cause, such as extensive disease or extirpation of an excretory organ, the separation of an excretion is prevented, and an accumulation of it in the blood ensues, it frequently escapes through other organs, and may be detected in various fluids of the body. An instance of this is seen after the kidneys have been removed. Urea then accumulates in the blood. But this is never the case with secretions; for after the removal of the special organ by which each of them is manufactured, the secretion is no longer formed.

The circumstances of their formation, and their final destination, are, however, the only particulars in which secretions and excretions can be distinguished; for, in general, the structure of the parts engaged in eliminating excretions is as complex as that of the parts concerned in the formation of secretions. And since the differences of the two processes of separation, corresponding with those in the several purposes and destinations of the fluids, are not yet ascertained, it will be sufficient to speak in general terms of the process.

Every secreting apparatus consists essentially of a layer of secreting cells arranged round a central cavity; they take from

the lymph which bathes them the necessary material and transform it into the secretion which they pour into the cavity.

The principal secreting organs are the following :—(1) the serous and synovial membranes ; (2) the mucous membranes with their special glands, *e.g.*, the buccal, gastric and intestinal glands ; (3) the salivary glands and pancreas ; (4) the mammary glands ; (5) the liver ; (6) the lacrimal gland ; (7) the kidney and skin ; and (8) the testes.

**Serous membranes.**—We have already discussed the struc-

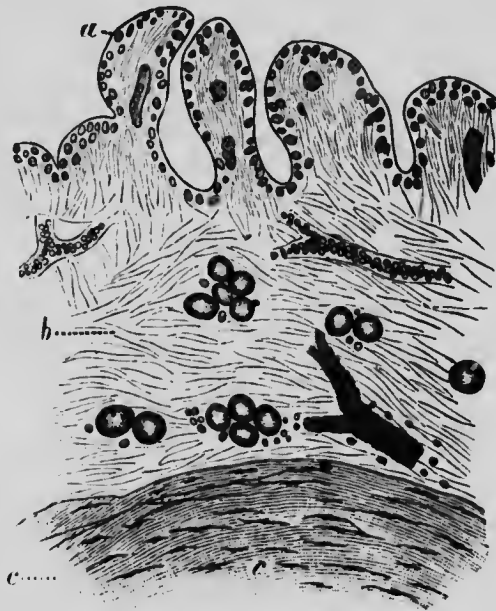

Fig. 391.—Section of synovial membrane. *a*, epithelial covering of the elevations of the membrane ; *b*, underlying tissue containing fat and blood-vessels ; *c*, ligament covered by the synovial membrane. (Cadiat.)

ture of *serous* membranes (p. 204), and also the question whether the lymph is a true secretion (pp. 317—320).

The **synovial membranes** line the joints and the sheaths of tendons and ligaments with which we may include the *synovial bursae*. The contents of these sacs is called *synovia* ; it lubricates the surfaces of the joint and so ensures an easy movement. *Synovia* is a rich lymph *plus* a mucinoid material ; and it is this latter constituent which gives the secretion its viscidly. It is thus a true secretion ; and is formed by the epithelial cells which form an imperfect lining to the sac, and which are especially accumulated on the processes of the synovial fringes (fig. 391).

A **mucous membrane** consists of two parts; the *epithelium* on its surface, and the *corium* of connective tissue beneath. The epithelium generally rests on a basement membrane which is usually composed of clear flattened cells placed edge to edge.

The name *mucous* is derived from the fact that these membranes all secrete *mucin*, the chief constituent of *mucus*; this may be formed from the surface epithelium cells breaking down into goblet cells (see p. 29), or an analogous process may occur in the cells of little glands called mucous glands, situated more or less deeply under the epithelium, and opening on the surface by ducts. Many mucous membranes (*e.g.*, that of the stomach) form other secretions as well.

*Mucous membranes* line all those passages by which internal parts communicate with the exterior, and by which either matters are eliminated from the body or foreign substances taken into it. The principal tracts are *Gastro-pulmonary* and *Genito-urinary*; the former is sub-divided into the *Digestive* and *Respiratory* tracts.

**Secreting glands** may be classified according to certain types, which are the following:—1. The *simple tubular* gland (A, fig. 392), examples of which are furnished by the crypts of Lieberkühn, in the intestinal wall. They are simple tubular depressions of the mucous membrane, the wall of which is formed of a basement membrane and is lined with secreting cells arranged as an epithelium. To the same class may be referred the elongated and tortuous *sudoriferous glands*.

2. The *compound tubular* glands (B, fig. 392) form another division. These consist of main gland-tubes, which divide and sub-divide. Each gland may be made up of the subdivisions of one or more main tubes. The ultimate subdivisions of the tubes are generally highly convoluted. They are formed of a basement-membrane, lined by epithelium of various forms. The larger tubes may have an outside coating of fibrous, areolar, or muscular tissue. The *kidneys* and *testes* are examples of this type.

3. The *racemose* glands are those in which a number of vesicles or *acini* are arranged in groups or lobules (C, fig. 392). The *Meibomian follicles* are examples of this kind of gland. Some glands like the pancreas are of a mixed character, combining some of the characters of the tubular with others of the racemose type; these are called *tubulo-racemose* or *tubulo-acinous* glands. These glands differ from each other only in secondary points of structure, but all have the same essential character in consisting of rounded groups of vesicles containing gland-cells, and opening by a common central



cavity into minute ducts, which ducts in the large glands converge and unite to form larger and larger tubes, and at length

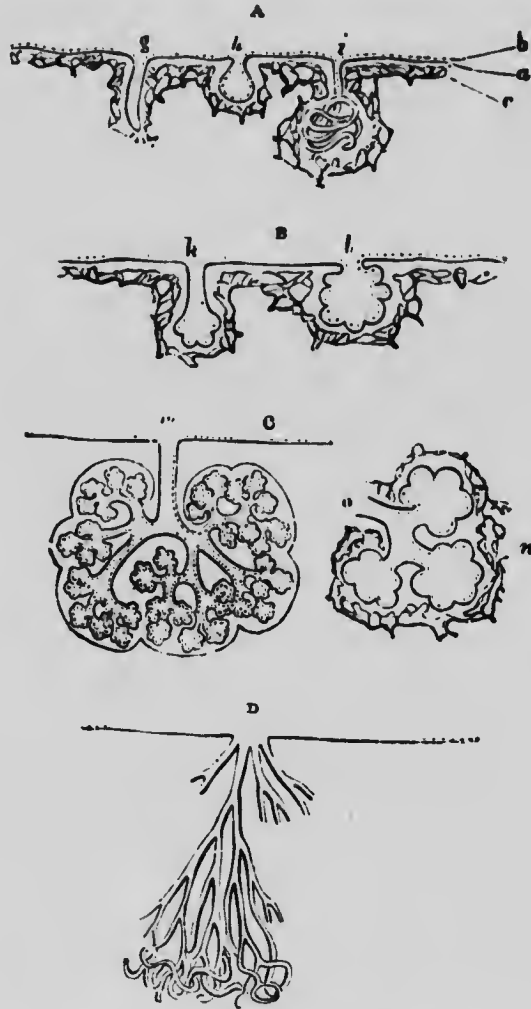

Fig. 392.—Diagram of types of secreting glands. A, simple glands, viz., *g*, straight tube; *h*, sac; *i*, coiled tube. B, multilocular crypts; *k*, of tubular form; *l*, saccular. C, racemose, or saccular compound gland; *m*, entire gland, showing branched duct and lobular structure; *n*, a lobule, detached with *o*, branch of duct proceeding from it. D, compound tubular gland. (Sharpey.)

open by one common trunk on a free surface. The larger racemose glands like the salivary glands are called *compound racemose glands*. On internal secretions, see p. 321.

## CHAPTER XXX.

## SALIVA.

THE saliva is formed by three pairs of salivary glands, called the parotid, submaxillary, and sublingual glands.

## The Salivary Glands.

These are typical secreting glands. They are made up of *lobules* united by connective tissue. Each lobule is made of a group of tubulo-saccular *alveoli* or *acini*, from which a duct passes; this unites with other ducts to form larger and larger tubes, the main duct opening into the mouth.

Each alveolus is surrounded by a plexus of capillaries; the

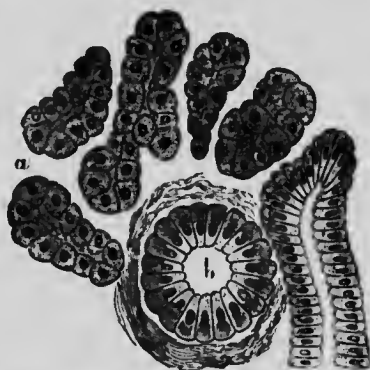

Fig. 393.—From a section through a salivary gland. *a*, serous or albuminous alveoli; *b*, intralobular duct cut transversely. (Klein and Noble Smith.)

lymph which exudes from these is in direct contact with the basement membrane that encloses the alveolus. The basement membrane is lined by secreting cells which surround the central cavity or lumen. The basement membrane is thin in many places to allow the lymph more ready access to the secreting cells; it is continued along the ducts.

The secreting epithelium is composed of a layer of polyhedral cells.

The epithelium of the ducts is columnar, except where it passes into an alveolus; at this point it is flattened. The columnar epithelium cells of the ducts exhibit striations in their outer part (see fig. 393); the inner zone of each cell is made of granular proto-

plasm. The largest ducts have a wall of connective tissue outside the basement-membrane, and a few unstriated muscular fibres.

The secreting cells differ according to the substance they secrete. In alveoli that secrete mucin (such as those in the dog's

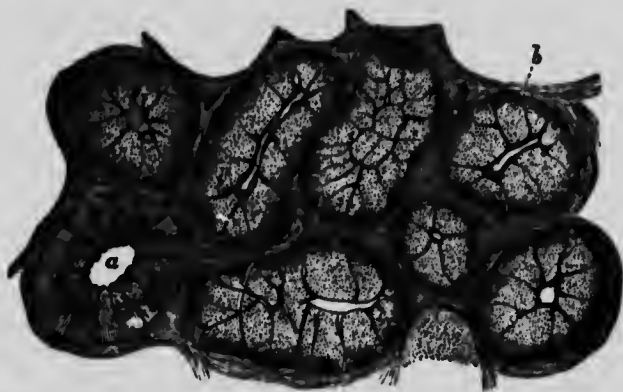

Fig. 394.—Section of sub-maxillary gland of dog. Showing gland-cells, *b*, and a duct, *a*, *b*, in section. (Kölliker.)

submaxillary, and some of the alveoli in the human submaxillary), the cells after treatment with water or alcohol are clear and swollen (fig. 395); this is the appearance they usually present in

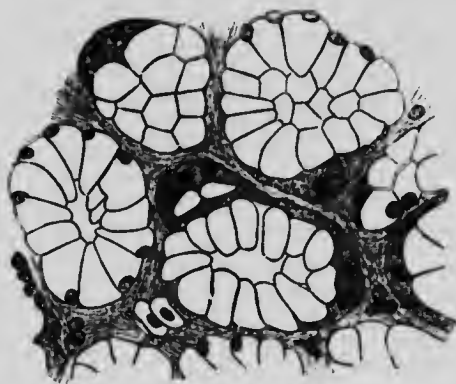

Fig. 395.—Section through a mucous gland hardened in alcohol. The alveoli are lined with transparent mucous cells, and outside these are the demilunes. (Heidenhain.)

sections of the organ. But if examined in their natural state by teasing a portion of the fresh gland in serum, they are seen to be occupied by large granules composed of a substance known as *mucigen* or *mucinogen*. When the gland is active, mucigen is transformed into mucin and discharged as a clear droplet of that substance into the lumen of the alveolus. Outside these are

smaller, highly granular cells containing no mucigen; these marginal cells stain darkly, and generally form crescentic groups (*crenata* or *demiluna* of Giannuzzi) next to the basement membrane. They do not secrete mucin, but are albuminous cells. After secretion their granules are lessened.

In those alveoli which do not secrete mucin, but a watery



Fig. 396.—A part of a section through a mucous gland after prolonged electrical stimulation. The alveoli are lined with small granular cells. (Lavjovski.)

non-viscid saliva (parotid, and some of the alveoli of the human submaxillary), the cells are filled with small granules of albuminous nature. Such alveoli are called *serous* or *albuminous*,



Fig. 397.—Alveoli of parotid gland. A, before secretion; B, in the first stage of secretion; C, after prolonged secretion. (Langley.)

to distinguish them from the *mucous* alveoli we have just described.

These yield to the secretion its ferment, *ptyalin*. The granular substance within the cell is the mother substance of the ferment (*zymogen*), not the ferment itself. It is converted into the ferment in the act of secretion. We shall study the question of zymogens more fully in connection with the gastric glands and the pancreas where they have been separated from the ferments by chemical methods. In the case of saliva we may

term the zymogen, *ptyalinogen* provisionally, but it has never been satisfactorily separated chemically from ptyalin.

After secretion, due to the administration of food or of such a drug as pilocarpine, the cells shrink, they stain more readily, their nuclei become more conspicuous, and the outer part of each cell becomes clear and free from granules (fig. 397).

### The Secretory Nerves of Salivary Glands.

The nerve-fibres which are derived from cranial and sympathetic nerves ramify between the gland cells, but have never actually been traced into them.

These nerves control and regulate the secretion of saliva.

The general truth concerning the existence of secretory nerves, we have already become acquainted with (p. 164). The subject has been worked out most thoroughly in connection with the salivary glands, particularly the submaxillary gland in dog, rabbit, &c., which we will take first.

**The Submaxillary and Sublingual Glands.**—These glands receive two sets of nerve-fibres; namely, from the chorda tympani and the sympathetic:

The *chorda tympani* off from the seventh cranial nerve in the region of the tympanic plexus. After quitting the temporal bone it passes downwards and forwards, and joins the lingual nerve, with which it is bound up for a short distance. On leaving the lingual nerve it traverses the *submaxillary ganglion*; it then runs parallel to the duct of the gland, gives off a branch to the sublingual gland, and others to the tongue. The main nerve enters the hilus of the submaxillary gland, where it traverses a second ganglion concealed within the substance of the gland, and which may be called after its discoverer, *Langley's ganglion*.

The *sympathetic* branches to these two glands are derived from the plexus around the facial artery, and accompany the arteries which supply the glands.

Section of the nerves produces no immediate result; but after a few days an abundant secretion of thin watery saliva takes place; this is called *paralytic secretion*, and is produced either by the activity of the local nervous mechanism, which is then uncontrolled by impulses from the central nervous system; or else, it is a degenerative effect analogous to the fibrillar contractions

\* Though the chorda tympani is usually spoken of as a branch of the seventh or facial nerve, it is probable that its fibres are derived from the glosso-pharyngeal, which communicates with the facial in the tympanum.

which occur in degenerating muscles after severance of their nerves. If the operation is performed on one side, the glands of the opposite side also show a similar condition, and the thin saliva secreted there is called the *antilytic* secretion.

*Stimulation* of the peripheral end of the divided chorda tympani produces an abundant secretion of saliva, which is accompanied by vaso-dilatation (see p. 308).

Stimulation of the peripheral end of the divided sympathetic causes a scanty secretion of thick viscid saliva, accompanied by vaso-constriction.

The abundant secretion of saliva, which follows stimulation of the chorda tympani, is not merely the result of a filtration of fluid from the blood-vessels, in consequence of the largely increased circulation through them. This is proved by the fact that, when the main duct is obstructed, the pressure within it may considerably exceed the blood pressure in the arteries,\* and also that when into the veins of the animal experimented upon, some *atropine* has been previously injected, stimulation of the peripheral end of the divided chorda produces all the vascular effects as before, without any secretion of saliva accompanying them. Again, if an animal's head is cut off, and the chorda be rapidly exposed and stimulated with an interrupted current, a secretion of saliva ensues for a short time, although the blood flow is necessarily absent. These experiments serve to prove that the chorda contains two sets of nerve fibres, one set (*vaso-dilatator*) which, when stimulated, cause the vessels to dilate; while another set, which are paralysed by atropine, directly stimulate the cells themselves to activity, whereby they secrete and discharge the constituents of the saliva which they produce. On the other hand, the sympathetic fibres are also of two kinds, vaso-constrictor and secretory, the latter being paralysed by atropine. The chorda tympani nerve is, however, the principal nerve through which efferent impulses proceed from the central nervous system to excite the secretion of these glands.

The function of the ganglia has been made out by Langley by the nicotine method (see p. 301). At one time the submaxillary ganglion was supposed to be the seat of reflex action for the secretion. This, however, is not the case. The ganglia are cell-stations on the course of the fibres to the submaxillary and

---

\* The student should not fall into the error of supposing that the saliva is normally secreted at such high pressure. If it were so the saliva would spurt from the salivary duct with greater force than the blood would spurt from the arteries when they are cut. The high pressure alluded to in the text only occurs when the duct is obstructed.

sublingual glands. Nicotine applied locally has the power of paralysing nerve-cells, but not nerve-fibres. If the submaxillary ganglion is painted with nicotine, and the nerve stimulated on the central side of the ganglion, secretion from the submaxillary gland continues, but that from the sublingual gland ceases. The paralysed nerve-cells in the ganglion act as blocks to the propagation of the impulse, not to the submaxillary, but to the sublingual gland. The cell station for the submaxillary fibres is in Langley's ganglion.

**Parotid Gland.**—This gland also receives two sets of nerve-

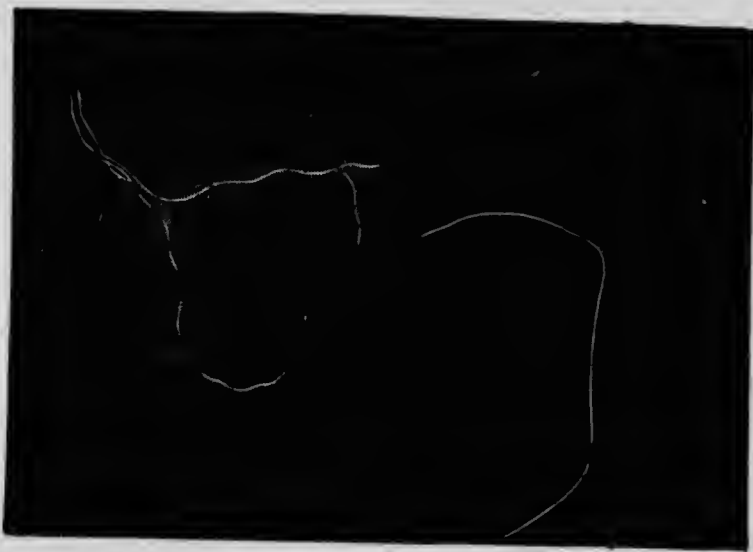

Fig. 398.—Diagrammatic representation of the submaxillary gland of the dog with its nerves and blood-vessels. (This is not intended to illustrate the exact anatomical relations of the several structures.) *sm. gland.*, the submaxillary gland into the duct (*sm. d.*) of which a cannula has been tied. The sublingual gland and duct and Langley's ganglion are not shown. *n. l.*, *n. l.*', the lingual or gustatory nerve; *ch. t.*, *ch. t.*', the chorda tympani proceeding from the facial nerve, becoming conjoined with the lingual at *n. l.*', and afterwards diverging and passing to the gland along the duct; *sm. gl.*, submaxillary ganglion with its roots; *n. l.*, the lingual nerve proceeding to the tongue; *a. car.*, the carotid artery, two branches of which, *a. sm. a.* and *r. sm. p.* pass to the anterior and posterior parts of the gland; *v. sm.*, the anterior and posterior veins from the gland ending in *v. j.*, the jugular vein; *v. sym.*, the conjoined vagus and sympathetic trunks; *gl. cer. s.*, the superior-cervical ganglion, two branches of which forming a plexus, *a. f.*, over the facial artery are distributed (*n. sym. sm.*) along the two glandular arteries to the anterior and posterior portion of the gland. The arrows indicate the direction taken by the nervous impulses; during reflex stimulations of the gland they ascend to the brain by the lingual and descend by the chorda tympani. (M. Foster.)

fibres analogous to those we have studied in connection with the submaxillary gland. The principal secretory nerve-fibres are glossopharyngeal in origin; the sympathetic is mainly vaso-constrictor, but in some animals does contain a few secretory fibres also.

When secretory nerves are stimulated, the main result is secretion leading to a diminution of the granules in the cells. The accompanying vascular condition determines the quantity of saliva secreted. Electrical changes also accompany secretory activity. A rise of temperature is stated by some to occur, but if this is the case it is very slight, so that some observers have not been able to detect it.

**Reflex Secretion.**—Under ordinary circumstances the secretion of saliva is a reflex action. The principal afferent nerves are those of taste; but the smell or sight of food will also cause “the mouth to water;” and under certain circumstances, as before vomiting, irritation of the stomach has a similar effect. These sensory nerves stimulate a centre in the medulla from which efferent secretory impulses are reflected along the secretory nerves (chorda tympani, &c.) to the glands.

**Extirpation of the Salivary Glands.**—These may be removed without any harmful effects in the lower animals.

### The Saliva.

The **saliva** is the first digestive juice to come in contact with the food. The secretions from the different salivary glands differ somewhat in composition, but they are mixed in the mouth; the secretion of the minute mucous glands of the mouth and a certain number of epithelial cells and *débris* are added to it. The so-called ‘salivary corpuscles’ are derived from the glands themselves or from the tonsils.

On microscopic examination of mixed saliva a few epithelial scales from the mouth and salivary corpuscles from the salivary glands are seen. The liquid is transparent, slightly opalescent, of slimy consistency, and may contain lumps of nearly pure mucin. On standing it becomes cloudy owing to the precipitation of calcium carbonate, the carbonic acid, which held it in solution as bicarbonate, escaping.

Of the three forms of saliva which contribute to the mixture found in the mouth the sublingual is richest in solids (2.75 per cent.). The submaxillary saliva comes next (2.1 to 2.5 per cent.). When artificially obtained by stimulation of nerves in the dog the saliva obtained by stimulation of the sympathetic is richer in solids than that obtained by stimulation of the chorda tympani. The parotid saliva is poorest in total solids (0.3 to 0.5 per cent.), and contains no mucin. Mixed saliva contains in man an average of about 0.5 per cent. of solids: it is alkaline in reaction, due to the salts in it; and has a specific gravity of 1.002 to 1.006.



The solid constituents dissolved in saliva may be classified thus:

- |                  |   |   |  |
|------------------|---|---|--|
| <b>Organic</b>   | . | { | <ul style="list-style-type: none"> <li>a. Mucin : this may be precipitated by acetic acid.</li> <li>b. Ptyalin : an amylolytic ferment.</li> <li>c. Protein : of the nature of a globulin.</li> <li>d. Potassium sulphocyanide.</li> </ul> |
| <b>Inorganic</b> | . | { | <ul style="list-style-type: none"> <li>e. Sodium chloride : the most abundant salt.</li> <li>f. Other salts : sodium carbonate, calcium phosphate and carbonate ; magnesium phosphate ; potassium chloride.</li> </ul>                     |

The action of saliva is twofold, physical and chemical.

The physical use of saliva consists in moistening the mucous membrane of the mouth, assisting the solution of soluble substances in the food, and in virtue of its mucin, lubricating the bolus of food to facilitate swallowing.

The chemical action of saliva is due to its active principle, ptyalin. This substance belongs to the class of unorganised ferments, and to that special class of unorganised ferments which are called amylolytic (starch splitting) or diastatic (resembling diastase, the similar ferment in germinating barley and other grains).

The starch is first split into dextrin and maltose ; the dextrin is subsequently converted into maltose also : this occurs more quickly with erythro-dextrin, which gives a red colour with iodine, than with the other variety of dextrin called achroo-dextrin, which gives no colour with iodine. Brown and Morris give the following equation :—

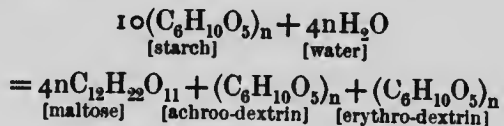

Ptyalin acts in a similar way, but more slowly on glycogen : it has no action on cellulose ; hence it is inoperative on uncooked starch grains, for in them the cellulose layers are intact.

Ptyalin acts best at about the temperature of the body (35–40° C.). It acts best in a neutral medium ; a small amount of alkali makes but little difference ; a very small amount of acid stops its activity. The conversion of starch into sugar by saliva in the stomach continues for a short time (15 to 30 minutes). It then ceases owing to the hydrochloric acid secreted by the glands of the stomach. The acid which is first poured out neutralises the saliva, and combines with the proteids of the food, but when free acid appears ptyalin is destroyed, and so it cannot resume work when the acid is neutralised in the duodenum. Another amylolytic ferment contained in pancreatic juice (to be considered later), however, digests starch in the intestine.

## CHAPTER XXXI.

## THE GASTRIC JUICE.

THE juice secreted by the glands in the mucous membrane of the stomach varies in composition in the different regions, but the mixed gastric juice, as it may be termed, is a solution of a proteolytic ferment called *pepsin* in a saline solution, which also contains a little free hydrochloric acid.

The gastric juice can be obtained during the life of an animal by means of a gastric fistula.\* Gastric fistulæ have also been made in human beings, either by accidental injury or by surgical operations. The most celebrated case is that of Alexis St. Martin, a young Canadian, who received a musket wound in the abdomen in 1822. Observations made on him by Dr. Beaumont formed the starting-point for our correct knowledge of the physiology of the stomach and its secretion.

We now make artificial gastric juice by mixing weak hydrochloric acid (0.2 per cent.) with the glycerine extract of the stomach of a recently-killed animal. This artificial juice acts like the normal juice.

Two kinds of glands are distinguished in the stomach, which differ from each other in their position, in the character of their epithelium, and in their secretion. Their structure will be found described on pp. 443, 444. We may, however, repeat that the *cardiac glands* are those situated in the cardiac part of the stomach: their ducts are short, their tubules long in proportion. The latter are filled with polyhedral cells, only a small lumen being left; they are more coarsely granular than the corresponding cells in the pyloric glands. They are called *principal* or *central* cells. Between them and the basement membrane of the tubule are other cells which stain readily with aniline dyes. They are called *parietal* or *oxyntic* cells. The *pyloric glands*, in the pyloric part of the stomach, have long ducts and short tubules lined with cubical granular cells. There are no parietal cells.

The **central** cells of the cardiac glands and the cells of the

---

\* A gastric fistula is made by cutting through the abdominal wall so as to expose the stomach. The stomach is then attached to the edges of the abdominal wound, and a small orifice is finally made through the wall of the stomach. When the wound heals there is then a free communication between the stomach and the exterior.

pyloric glands are loaded with granules. During secretion they discharge their granules, those that remain being chiefly situated near the lumen, leaving in each cell a clear outer zone. These are the cells that secrete the pepsin. Like secreting cells generally, they select certain materials from the lymph that bathes them; these materials are worked up by the protoplasmic activity of the cells into the secretion, which is then discharged into the lumen of the gland. The most important substance in a digestive secretion is the ferment. In the case of the gastric juice this is pepsin. We can trace an intermediate step in this process by the presence of the granules. The granules are not, however, composed of pepsin, but of a mother-substance which is readily converted into pepsin. We shall find a similar ferment precursor in the cells of the pancreas, and the term *zymogen* is applied to these ferment precursors. The zymogen in the gastric cells is called *pepsinogen*. The rennet-ferment or rennin that causes the curdling of milk is distinct from pepsin, but is formed by the same cells.

The **parietal cells** undergo merely a change of size during secretion, being at first somewhat enlarged and after secretion they are somewhat shrunken. They are also called *oxyntic* (acid-forming) cells, because they secrete the hydrochloric acid of the juice. Heidenhain succeeded in making in one dog a *cul-de-sac* of the fundus, in another of the pyloric region of the stomach; the former secreted a juice containing both acid and pepsin; the latter, parietal cells being absent, secreted a viscid alkaline juice containing pepsin. The formation of a free acid from the alkaline blood and lymph is an important problem. There is no doubt that it is formed from the chlorides of the blood and lymph, and of the many theories advanced as to how this is done, Maly's is, on the whole, the most satisfactory. He considers that it originates by the interaction of the calcium chloride with the di-sodium hydrogen phosphate of the blood, thus:—

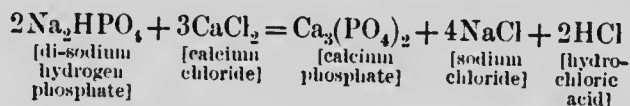

or more simply by the interaction of sodium chloride and sodium di-hydrogen phosphate, as is shown in the following equation:—

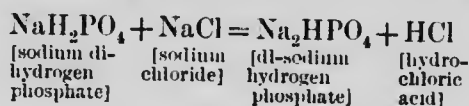

The sodium di-hydrogen phosphate in the above equation is

derived from the interaction of the di-sodium hydrogen phosphate and the carbonic acid of the blood, thus :—

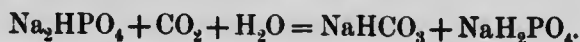

But, as Professor Gamgee has pointed out, these reactions can hardly be considered to occur in the blood generally, but rather in the oxyntic cells, which possess the necessary selective powers in reference to the saline constituents of the blood, and the hydrochloric acid, as soon as it is formed, passes into the secretion of the gland in consequence of its high power of diffusion.

### Composition of Gastric Juice.

The following table gives the percentage composition of the gastric juice of man and the dog :—

Constituents.	Human.	Dog.
Water . . . . .	99'44	97'30
Organic substances (chiefly pepsin) . . . . .	0'32	1'71
HCl . . . . .	0'20	0'30
CaCl <sub>2</sub> . . . . .	0'006	0'06
NaCl . . . . .	0'14	0'25
KCl . . . . .	0'05	0'11
NH <sub>4</sub> Cl . . . . .	—	0'05
Ca <sub>3</sub> (PO <sub>4</sub> ) <sub>2</sub> . . . . .	}	0'17
Mg <sub>3</sub> (PO <sub>4</sub> ) <sub>2</sub> . . . . .		0'02
FePO <sub>4</sub> . . . . .		0'008

One sees from this how much richer in all constituents the gastric juice of the dog is than that of man. Carnivorous animals have always a more powerful gastric juice than other animals ; they have more work for it to do ; but the great contrast seen in the table is, no doubt, partly due to the fact that the persons from whom it has been possible to collect gastric juice have been invalids. In the foregoing table one also sees the great preponderance of chlorides over other salts : apportioning the total chlorine to the various metals present, that which remains over must be combined with hydrogen to form the free hydrochloric acid of the juice.

Pepsin stands apart from nearly all other ferments by requiring an acid medium in order that it may act. Probably a compound of the two substances, called *pepsin-hydrochloric acid*, is the really active agent. Other acids may take the place of hydrochloric acid, but none act so well. Lactic acid is often found in

gastric juice : this is derived by fermentative processes from the food.

Hydrochloric acid is absent in some diseases of the stomach ; the best colour tests for it are the following :—

(a) Gunsberg's reagent consists of 2 parts of phloroglucinol, 1 part of vanillin, and 30 parts of rectified spirit. A drop of filtered gastric juice is evaporated with an equal quantity of the reagent. Red crystals form, or if much peptone is present, there will be a red paste. The reaction takes place with 1 part of hydrochloric acid in 10,000. The organic acids do not give the reaction.

(b) Tropæolin test. Drops of a saturated solution of tropæolin-oo in 94 per cent. methylated spirit are allowed to dry on a porcelain slab at 40° C. A drop of the fluid to be tested is placed on the tropæolin drop, still at 40° C. ; and if hydrochloric acid is present, a violet spot is left when the fluid has evaporated. A drop of 0.006 per cent. hydrochloric acid leaves a distinct mark.

Lactic acid is soluble in ether, and is generally detected by making an ethereal extract of the stomach contents, and evaporating the ether. If lactic acid is present in the residue it may be identified by the following way :—

A solution of dilute ferric chloride and carbolic acid is made as follows :—  
10 c.c. of a 4-per-cent. solution of carbolic acid.  
20 c.c. of distilled water.

1 drop of the liquor ferri perchloridi of the British Pharmacopœia.

On mixing a solution containing a mere trace (up to 1 part in 10,000) of lactic acid with this violet solution, it is instantly turned yellow. Larger percentages of other acids (for instance, more than 0.2 per cent. of hydrochloric acid) are necessary to decolorise the test solution.

### The Innervation of the Gastric Glands.

As long ago as 1852 Bidder and Schmidt showed in a dog with a gastric fistula that the sight of food caused a secretion of gastric juice ; and in 1878 Richet observed that in a man with complete occlusion of the gullet, the act of mastication caused a copious flow of gastric juice. There can therefore have been no doubt that the glands are under the control of the nervous system, but until quite recently all attempts to discover the secretory nerves of the stomach proved unsuccessful. Pawlow solved the problem by experiments on dogs : he first made a gastric fistula ; and a few days later exposed the œsophagus, divided it, and sewed the two cut ends to the two corners of the wound in the neck. The animal was fed by means of the lower piece of the œsophagus ; but any food taken by the mouth or any saliva secreted into the mouth was never allowed to enter the stomach, but fell out of the opening of the œsophagus in the neck. These animals were kept alive for months and soon accommodated themselves to their new conditions of life.

If one of them was kept without food for a few hours, and then given a meal of meat, it devoured it with avidity though none ever reached the stomach. The effect of this sham feeding

was a reflex and abundant flow of gastric juice, which commenced five minutes after the beginning of the meal. If water, milk, or soup was given instead of meat no such secretion occurred.

The same phenomena occurred when both splanchnics were divided. It is therefore evident that the splanchnics are not the secretory nerves. But after division of both vagi (below the point of origin of the recurrent laryngeal nerves to avoid paralysis of the larynx), the reflex secretion ceased, though the dog went through the process of sham feeding with the same avidity as before.

The vagi therefore contain the secretory fibres; this conclusion was confirmed by the experiment of stimulation. If the peripheral end of a divided vagus is stimulated, however, the usual result is stoppage of the heart; this difficulty was overcome by letting a few days elapse between the division of the nerves and the experiment of stimulating them. During this time the cardio-inhibitory fibres degenerated, and then stimulation of the nerve by induction shocks at intervals of one second called forth a flow of gastric juice, after a latent period of about five minutes.

Pawlow's method enabled him to obtain a gastric juice free from any admixture with saliva or food. The main facts in relation to this pure juice are as follows:—It is clear and colourless; it has a specific gravity of 1003 to 1006. It is feebly dextro-rotatory, gives no biuret reaction, but gives the ordinary proteid reactions. It contains from 0.4 to 0.6 per cent. of hydrochloric acid. It is strongly proteolytic and inverts cane sugar. When cooled to 0°C. it deposits a fine precipitate of pepsin; this settles in layers, and the layers first deposited contain most of the acid, which is loosely combined with and carried down by the pepsin. Pepsin is also precipitable by ammonium sulphate (Kühne). Elementary analysis gave the following results:—

Pepsin precipitated by cold—	Precipitated by $\text{Am}_2\text{SO}_4$ —
Carbon . . . . . 50.73 per cent.	50.37
Hydrogen . . . . . 7.23 "	6.88
Chlorine . . . . . 1.01 to 1.17 "	0.89
Sulphur . . . . . 0.98 "	1.34
Nitrogen . . . . . not estimated	14.55 to 15.0
Oxygen . . . . . the remainder.	the remainder.

Since these experiments were performed, Pawlow has continued his work on gastric secretion. He has by a very ingenious surgical operation succeeded in the dog in separating off from the stomach a diverticulum which pours its secretion through an opening in the abdominal wall. The following are his main results:—

1. Increase in the quantity of food given causes an increase in the amount of gastric juice secreted.
2. The juice is most abundant in the early periods of digestion, but it continues to be secreted in declining quantity as long as any food remains to be dealt with. When there is no food given there is no juice. But sham feeding or chewing will cause it to flow.
3. The amount of pepsin secreted is similarly proportional to the needs of the animal.
4. The larger the proportion of proteid in the diet, the more abundant and active is the juice secreted.

### Action of Gastric Juice.

The principal action of the gastric juice consists in converting the proteids of the food into the diffusible peptones. In the case of milk this is preceded by the curdling due to rennet (see p. 458).

There is a still further action—that is, the gastric juice is antiseptic; putrefactive processes do not normally occur in the stomach, and the organisms that produce such processes, many of which are swallowed with the food, are in great measure destroyed, and thus the body is protected from them. The acid is the agent in the juice that possesses this power.

The formation of peptones is a process of hydration; peptones may be formed by other hydrating agencies like super-heated steam and heating with dilute mineral acids. There are certain intermediate steps in this process: the intermediate substances are called pro-peptones or proteoses. The word 'proteose' is the best: it includes the albumoses (from albumin), globuloses (from globulin), vitelloses (from vitellin), &c. Similar substances are also formed from gelatin (gelatinoses) and elastin (elastoses).

Another intermediate step in gastric digestion is called para-peptone: this is acid albumin or syntonin. The products of digestion may be classified, according to the order in which they are formed, as follows:—

1. Parapeptone or acid albumin.
2. Propeptone 

{	(a) Proto-albumose	}	The primary albumoses, <i>i.e.</i> , those which are formed first.
	(b) Hetero-albumose		
	(c) Deutero-albumose		
3. Peptone.

It is doubtful whether all the proteid present passes through the acid-albumin stage.

The primary albumoses are precipitated by saturation with magnesium sulphate or sodium chloride. Deutero-albumose is not; it is, however, precipitated by saturation with ammonium sulphate. Proto- and deutero-albumose are soluble in water; hetero-albumose is not; it requires salt to hold it in solution.

**Peptones.**—These are the final products of the action of gastric juice on native proteids.

They are soluble in water, are not coagulated by heat, and are not precipitated by nitric acid, copper sulphate, ammonium sulphate, and a number of other precipitants of proteids. They are precipitated but not coagulated by alcohol. They are also precipitated by tannin, picric acid, potassio-mercuric iodide, phospho-molybdic acid, and phospho-tungstic acid.

They give the biuret reaction (rose-red solution with a trace of copper sulphate and caustic potash or soda).

Peptone is readily diffusible through animal membranes. The utility of the formation of diffusible substances during digestion is obvious.

**Proteoses.**—These are the intermediate products in the hydration of native proteids into peptones.

They are not coagulated by heat; they are precipitated but not coagulated by alcohol: like peptone they give the biuret

Variety of proteid	Action of heat	Action of alcohol	Action of nitric acid	Action of ammonium sulphate	Action of copper sulphate and caustic potash	Diffusibility.
Albumin	Coagulated	Precipitated, then coagulated	Precipitated in the cold; not readily soluble on heating	Precipitated by complete saturation	Violet colour	Nil
Globulin	Ditto.	Ditto.	Ditto.	Precipitated by half saturation; also precipitated by MgSO <sub>4</sub> .	Ditto.	Ditto.
Proteoses (albumoses)	Not coagulated	Precipitated, but not coagulated	Precipitated in the cold; readily soluble on heating; the precipitate reappears on cooling*	Precipitated by saturation	Rose-red colour (biuret reaction)	Slight
Peptones	Not coagulated	Precipitated, but not coagulated	Not precipitated	Not precipitated	Rose-red colour (biuret reaction)	Great

reaction. They are precipitated by nitric acid, the precipitate being soluble on heating, and reappearing when the liquid cools. This last is a distinctive property of proteoses. They are slightly diffusible.

The above table will give us at a glance the chief characters of peptones and proteoses in contrast with those of the native proteids, albumins, and globulins.

We see that the main action of the gastric juice is upon the proteids of the food, converting them into more soluble and

\* In the case of deuterio-albumose this reaction only occurs in the presence of excess of salt.



diffusible products. The fats are not chemically altered in the stomach; their proteid envelopes are, however, dissolved, and the solid fats are melted. Starch is unaffected; but cane sugar is inverted. The inversion of cane sugar is largely due to the hydrochloric acid of the juice, and is frequently assisted by inverting ferments contained in the vegetable food swallowed.

## CHAPTER XXXII.

### DIGESTION IN THE INTESTINES.

HERE we have to consider the action of pancreatic juice, of bile, and of the succus entericus.

#### The Pancreas.

This is a tubulo-racemose gland closely resembling the salivary glands in structure. The principal differences are that the alveoli or acini are more tubular in character; the connective tissue between them is looser, and in it are small groups of epithelium-like cells, which are supplied by a close network of capillaries (fig. 400).

The secreting cells of the pancreas are polyhedral. When examined in the fresh condition, or in preparations preserved by osmic acid, their protoplasm is seen to



Fig. 399.—Section of the pancreas of a dog during digestion. *a*, alveoli lined with cells, the clear outer zone of which is well stained with hæmatoxylin; *d*, duct lined with short cubical cells.  $\times 350$ . (Klein and Noble Smith.)

be filled in the inner two-thirds with small granules; but the outer third is left clear, and stains readily with reagents (fig. 399).

During secretion the granules are discharged; the clear zone consequently becomes wider, and the granular zone narrower.

These granules indicate the presence of a zymogen which is

called *trypsinogen*; that is, the precursor of trypsin, the most important ferment of the pancreatic juice.

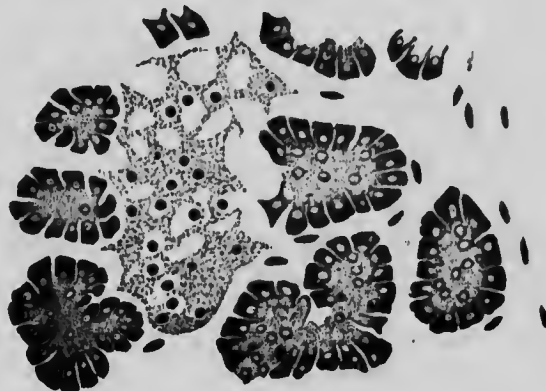

Fig. 400.—Section of the pancreas of armadillo, showing alveoli and an islet of epithelium in the connective tissue. (V. D. Harris.)

In the centre of the acini, spindle-shaped cells (*centro-acinar* cells) are often seen; their function and origin are unknown.

#### Composition and Action of Pancreatic Juice.

The pancreatic juice may be obtained by a fistula in animals, a cannula being inserted into the main pancreatic duct; but as in the case of gastric juice, experiments on the pancreatic secretion are usually performed with an artificial juice made by mixing a weak alkaline solution (1 per cent sodium carbonate) with a glycerin extract of pancreas. The pancreas should be treated with dilute acid for a few hours before the glycerin is added. This ensures a conversion of the trypsinogen into trypsin.

Quantitative analysis of human pancreatic juice gives the following results:—

Water	. . .	97.6 per cent.
Organic solids	. . .	1.8 „
Inorganic salts	. . .	0.6 „

In the dog the amount of solids is much greater.

The organic substances in pancreatic juice are—

(a) Ferments. These are the most important both quantitatively and functionally. They are four in number:—

- i. Trypsin, a proteolytic ferment.
- ii. Amylopsin or pancreatic diastase, an amylolytic ferment.
- iii. Steapsin, a fat-splitting or lipolytic ferment.
- iv. A milk-curdling ferment.

(b) A small amount of proteid matter, coagulable by heat.

(c) Traces of leucine, tyrosine, xanthine, and soaps.

The inorganic substances in pancreatic juice are—

Sodium chloride, which is the most abundant, and smaller quantities of potassium chloride, and phosphates of sodium, calcium, and magnesium. The alkalinity of the juice is due to phosphates and carbonates, especially of sodium.

The action of pancreatic juice, which is the most powerful and important of all the digestive juices, may be described under the headings of its four ferments.

1. **Action of Trypsin.**—Trypsin acts like pepsin, but with certain differences, which are as follows:—

(a) It acts in an alkaline, pepsin in an acid medium.

(b) It acts more rapidly than pepsin; deutero-proteoses can be detected as intermediate products in the formation of peptone; the primary proteoses have not been detected.

(c) An albuminate of the nature of alkali-albumin is formed in place of the acid-albumin of gastric digestion.

(d) It acts more powerfully on certain albuminoids (such as elastin) which are difficult of digestion in gastric juice. It does not, however, digest collagen.

(e) Acting on solid proteids like fibrin, it eats them away from the surface to the interior; there is no preliminary swelling as in gastric digestion.

(f) Trypsin acts further than pepsin, on prolonged action partly decomposing some of the peptone which has left the stomach into simpler products, of which the most important are leucine, tyrosine, arginine (see p. 402), aspartic acid, and ammonia.

The peptones are diffusible because their molecules are smaller than those of proteid. Peptone by the prolonged activity of pancreatic juice is split into substances of still smaller molecular weight. Antipeptone was so called because it resists this action. It is, however, not a true peptone at all, but a substance of extremely low molecular weight. Siegfried states it is a single substance which he calls *carnic acid* ( $C_{10}H_{15}N_3O_5$ ), because he first separated it from muscle. Kutscher finds, however, that it is a mixture of several comparatively simple materials, histidine, arginine, aspartic acid, etc.

2. **Action of Amylopsin.**—The conversion of starch into maltose is the most powerful and rapid of all the actions of the pancreatic juice. It is much more powerful than saliva, and will act even on unboiled starch. The absence of this ferment in the pancreatic juice of infants is an indication that milk, and not starch, is their natural diet.

3. **Action on Fats.**—The action of pancreatic juice on fats is a double one: it forms an *emulsion*, and it decomposes the fats into fatty acids and glycerin by means of its fat-splitting ferment steapsin. The fatty acids unite with the alkaline bases to form soaps (*saponification*). The chemistry of this is described on p. 392. The fat-splitting power of pancreatic juice cannot be studied with a glycerin extract, for steapsin is not soluble in glycerin: either the fresh juice or a watery extract of pancreas must be used.

The formation of an emulsion may be studied in this way. Shake up olive oil and water together, and allow the mixture to stand; the finely divided oil globules soon separate from and float on the surface of the water; but if a colloid matter like albumin or gum is first mixed with the water, the oil separates more slowly. A more permanent emulsion is formed by an alkaline fluid, and especially when a small amount of free fatty acid is being continually liberated; the acid combines with the alkali to form a soap. Pancreatic fluid possesses all the necessary qualifications for forming an emulsion:—

- i. It is alkaline.
- ii. It is viscous from the presence of proteid.
- iii. It has the power of liberating free acids.

4. **Milk-curdling Ferment.**—The addition of pancreatic extracts or pancreatic juice to milk causes clotting; but this action (which differs in some particulars from the clotting caused by rennet) can hardly ever be called into play, as the milk upon which the juice has to act has been already curdled by the rennin of the stomach.

### Intestinal Digestion.

The pancreatic juice does not act alone on the food in the intestines. There are, in addition, the bile, the succus entericus (secreted by the crypts of Lieberkühn), and bacterial action to be considered.

The **bile**, as we shall find, has little or no digestive action by itself, but combined with pancreatic juice it assists the latter in all its actions. This is true for the digestion of starch and of proteid, but most markedly so for the digestion of fat. Occlusion of the bile-duct by a gall-stone or by inflammation prevents bile entering the duodenum. Under these circumstances the fæces contain a large amount of undigested fat.

The **succus entericus** appears to have to some extent the power of converting starch into sugar; whether it acts on proteids

or fats is very doubtful; its most important action is due to a ferment it contains called *invertin*, which inverts saccharoses—that is, it converts cane sugar and maltose into glucose.

The original use of the term “inversion” has been explained on p 387. It may be extended to include the similar hydrolysis of other saccharoses, although there may be no formation of levo-rotatory substances. There are probably numerous inverting ferments, each of which acts on a different saccharose.

Suecus entericus has been obtained free from other secretions by means of a fistula. Thiry's method is to cut the intestine across in two places; the loop so cut out is still supplied with blood and nerves, as its mesentery is

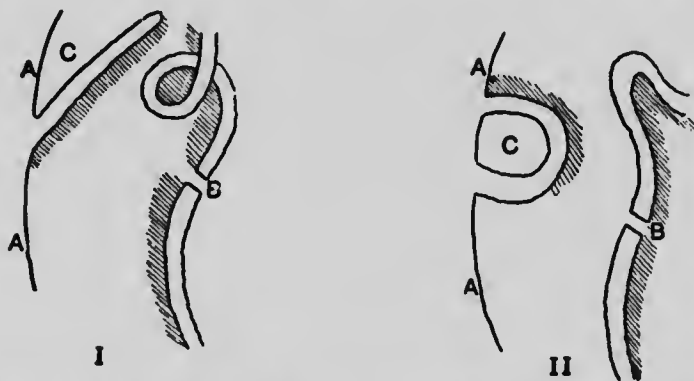

Fig. 401.—Diagram of intestinal fistula. I., Thiry's method; II., Vella's method. A, abdominal wall; B, intestine with mesentery; C, separated loop of intestine, with attached mesentery.

intact; this loop is emptied, one end is sewn up, and the other stitched to the abdominal wound, and so a *cul-de-sac* from which the secretion can be collected is made. The continuity of the remainder of the intestine is restored by fastening together the upper and lower portions of the bowel from which the loop has been removed. Vella's method resembles Thiry's except that both ends of the loop are sutured to the wound in the abdomen. Fig. 401 illustrates the two methods.

**Bacterial action.**—The gastric juice is an antiseptic; the pancreatic juice is not. A feebly-alkaline fluid like pancreatic juice is just the most suitable medium for bacteria to flourish in. Even in an artificial digestion the fluid is very soon putrid, unless special precautions to exclude or kill bacteria are taken. It is often difficult to say where pancreatic action ends and bacterial action begins, as many of the bacteria that grow in the intestinal contents, having reached that situation in spite of the gastric juice, act in the same way as the pancreatic juice. Some form sugar from starch, others peptone, leucine, and tyrosine from proteids,

while others, again, break up fats. There are, however, certain actions that are entirely due to these putrefactive organisms.

i. On carbohydrates. The most frequent fermentation they set up is the lactic acid fermentation: this may go further and result in the formation of carbonic acid, hydrogen, and butyric acid (see p. 388). Cellulose is broken up into carbonic acid and methane. This is the chief cause of the gases in the intestine, the amount of which is increased by vegetable food.

ii. On fats. In addition to acting like steapsin, they produce lower acids (valeric, butyric, &c.). The formation of acid products from fats and carbohydrates gives to the intestinal contents an acid reaction. Recent researches show that the contents of the intestine become acid much higher up than was formerly supposed. Organic acids do not, however, hinder pancreatic digestion.

iii. On proteids. Fatty acids and amido-acids, especially leucine and tyrosine, are produced; but these putrefactive organisms have a special action in addition, producing substances having an evil odour, like indole ( $C_8H_7N$ ), skatole ( $C_9H_9N$ ), and phenol ( $C_6H_6O$ ). There are also gaseous products in some cases.

If excessive, putrefactive processes are harmful; if within normal limits, they are useful, helping the pancreatic juice and, further, preventing the entrance into the body of poisonous products. It is possible that, in digestion, poisonous alkaloids are formed. Certainly this is so in one well-known case. Lecithin, a material contained in small quantities in many foods, and in large quantities in egg-yolk and brain, is broken up by the pancreatic juice into glycerine, phosphoric acid, stearic acid, and an alkaloid called choline. We are, however, protected from the poisonous action of choline by the bacteria, which break it up into carbonic acid, methane, and ammonia.

### Leucine and Tyrosine.

These two substances have been frequently mentioned in the preceding pages. As types of the decomposition products of proteids they are important, though probably only small quantities are normally formed during digestion.

They belong to the group of amido-acids. On p. 391 we have given a list of the fatty acids; if we replace one of the hydrogen atoms in a fatty acid by amidogen ( $NH_2$ ), we obtain what is called an amido-acid. Take acetic acid: its formula is  $CH_3.COOH$ ; replace one H by  $NH_2$ , and we get  $CH_2.NH_2.COOH$ , which is *amido-acetic acid* or *glycocine*. If we take caproic acid—a term

a little higher in the series—its formula is  $C_5H_{11}.COOH$ ; amido-caproic acid is  $C_5H_{10}.NH_2.COOH$ , which is also called **leucine**.

According to the way in which the amidogen is linked, a large number of isomeric amido-caproic acids, all with the same empirical formula, are theoretically possible. Some of these have been actually prepared in the laboratory; and chemical research has shown that the amido-caproic acid called leucine formed during digestion should be more accurately named *α*-amido-isobutylic acid  $(CH_3)_2CH.CH_2.CH(NH_2)COOH$ .

**Tyrosine** is a little more complicated, as it is not only an amido-acid, but also contains an aromatic radicle. Propionic acid has the formula  $C_2H_5.COOH$ ; amido-propionic acid is

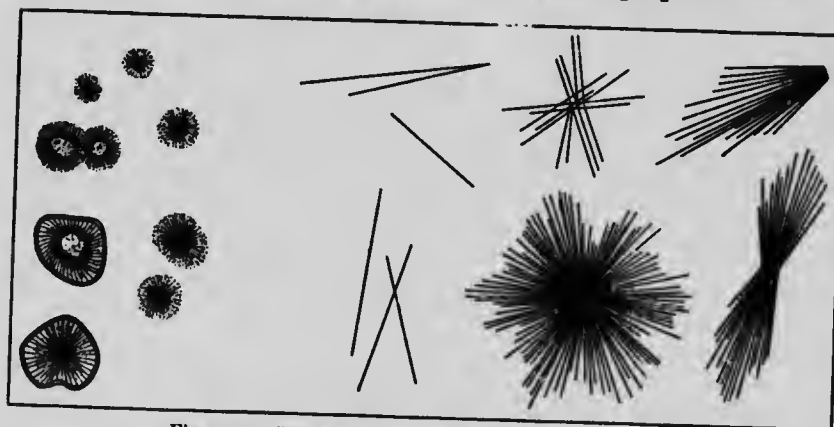

Fig. 402.—Crystals of leucine and tyrosine.  $\times 216$ .

$C_2H_4.NH_2.COOH$ , and is called *alanine*. If another H in this is replaced by oxyphenyl ( $C_6H_4.OH$ ), we get  $C_2H_3.NH_2.C_6H_4.OH.COOH$ , which is oxyphenyl-amido-propionic acid, or tyrosine. Leucine and tyrosine are both crystalline; the former crystallises in the form of spheroidal clumps of crystals, the latter in collections of fine silken needles (fig. 402).

#### Secretory Nerves of the Pancreas.

It has been known since the work of Claude Bernard in 1856 that the introduction of ether into the stomach produces a reflex flow of pancreatic juice, but all attempts to discover the path of the nerve impulses failed until the recent work of Pawlow. The reason of the failure of previous workers is that the pancreas is remarkably sensitive to external conditions. If the pancreas is cooled or wounded during the process of making the fistula, or if sensory nerves are excited, or if anæsthesia is deep, the gland refuses to secrete.

Pawlow discovered that the vagus contains the secretory nerves of the pancreas; he took care to avoid the sources of error just referred to. In the first place he stimulated the vagi below the origin of their cardiac branches; in the second, the spinal cord was divided high up to prevent reflexes occurring from sensory nerves, and lastly, the operation of stimulating the nerve was done without an anæsthetic.

In another series of experiments, he cut through one vagus in the neck, and stimulated the peripheral end two or three days later, when the cardio-inhibitory fibres had degenerated: in this way he got rid of the heart stoppage which would have interfered with the normal condition of the animal.

In all cases, the stimulation of the vagus produced an abundant flow of pancreatic juice, after a latent period of from fifteen seconds to two minutes. The stimulation applied to the nerve consisted of a slow series of shocks (either induction currents or mechanical blows) about once a second. By this means stimulation of vaso-constrictor nerves to the pancreas contained in the vagus is avoided. If the blood supply is diminished by stimulation of vaso-constrictor nerves, the secretion is stopped.

#### **Extirpation of the Pancreas.**

Complete removal of the pancreas in animals and diseases of the pancreas in man produce a condition of diabetes, in addition to the loss of pancreatic action in the intestines. Grafting the pancreas from another animal into the abdomen of the animal from which the pancreas has been removed relieves the diabetic condition.

How the pancreas acts other than in producing the pancreatic juice is not known. It must, however, have other functions related to the general metabolic phenomena of the body, which are disturbed by removal or disease of the gland. This is an illustration of a universal truth—viz., that each part of the body does not merely do its own special work, but is concerned in the great cycle of changes which is called general metabolism. Interference with any organ upsets not only its specific function, but causes disturbances through the body generally. The interdependence of the circulatory and respiratory systems is a well-known instance. Removal of the thyroid gland upsets the whole body, producing widespread changes known as myxœdema. Removal of the testis produces not only a loss of the spermatic secretion, but changes the whole growth and appearance of the animal. Removal of the greater part of the kidneys produces



rapid wasting and the breaking down of the tissues to form an increased quantity of urea. The precise way in which these glands are related to the general body processes is, however, a subject of which we know as yet very little. The theory at present most in favour is that certain glands produce an *internal secretion*, which leaves them *via* the lymph, and is then distributed to minister to parts elsewhere. The question of the internal secretions of the thyroid and suprarenal capsules is discussed in Chap. XXIII. In the case of the pancreas, Professor Schäfer has propounded the theory that its internal secretion, stoppage of which in some way leads to diabetes, is produced in the islets of epithelium-like cells scattered through the connective tissue of the organ (see fig. 400, p. 487).

## CHAPTER XXXIII.

### THE LIVER.

THE Liver, the largest gland in the body, situated in the abdomen on the right side chiefly, is an extremely vascular

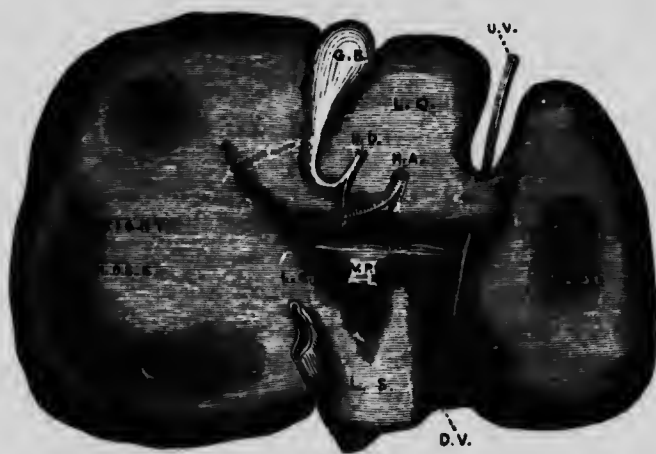

Fig. 403.—The under surface of the liver. G. B., gall-bladder; H. D., common bile-duct; H. A., hepatic artery; V. P., portal vein; L. Q., lobulus quadratus; L. S., lobulus spigelii; L. C., lobulus caudatus; D. V., ductus venosus; U. V., umbilical vein. (Noble Smith.)

organ, and receives its supply of blood from two distinct sources, viz., from the *portal vein* and from the *hepatic artery*, while the blood is returned from it into the vena cava inferior by the

*hepatic veins.* Its secretion, the *bile*, is conveyed from it by the *hepatic duct*, either directly into the intestine, or, when digestion is not going on, into the *cystic duct*, and thence into the gall-bladder, where it accumulates until required. The portal vein,

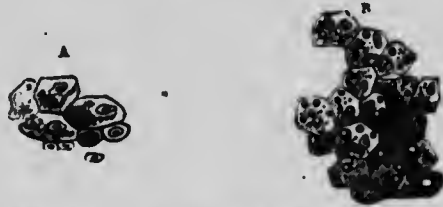

Fig. 404.—A. Liver-cells. B. Ditto, containing various-sized particles of fat.

hepatic artery, and hepatic duct branch together throughout the liver, while the hepatic veins and their tributaries run by themselves.



Fig. 405.—Longitudinal section of a portal canal, containing a portal vein, hepatic artery and hepatic duct, from the pig. *p*, branch of vena portæ, situated in a portal canal amongst the lobules of the liver; *l, l*, and giving off vaginal branches; there are also seen within the large portal vein numerous orifices of the smallest interlobular veins arising directly from it; *a*, hepatic artery; *d*, bile duct.  $\times 5$ . (Kiernan.)

On the outside, the liver has an incomplete covering of peritoneum, and beneath this is a very fine coat of areolar tissue, continuous over the whole surface of the organ. It is thickest where the peritoneum is absent, and is continuous on the general surface of the liver with the fine and, in the human subject, almost imperceptible areolar tissue investing the lobules. At the



Fig. 46.—Capillary network of the lobules of the rabbit's liver. The figure is taken from a very successful injection of the hepatic veins, made by Harting: it shows nearly the whole of two lobules, and parts of three others; *p*, interlobular (portal) branches running in the interlobular spaces; *h*, intralobular (hepatic) veins occupying the centre of the lobules. The interlobular and intralobular vessels are connected by radiating capillaries.  $\times 45$ . (Kölliker.)

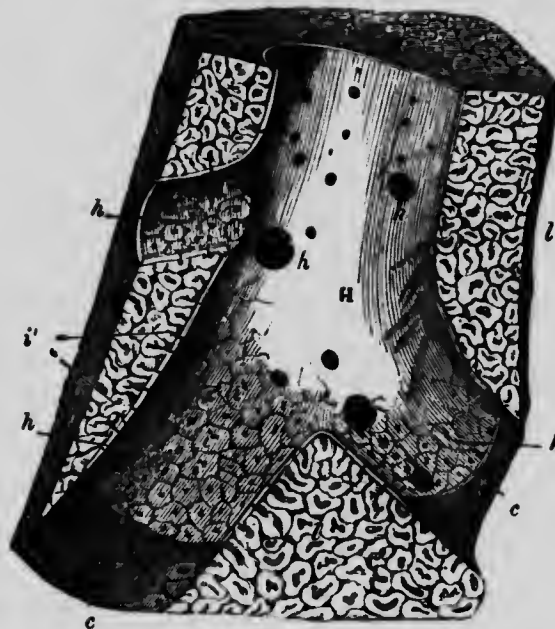

Fig. 407.—Section of a portion of liver passing longitudinally through a considerable hepatic vein, from the pig. *H*, hepatic venous trunk, against which the sides of the lobules (*l*) are applied; *h*, *h*, *h*, sublobular hepatic veins, on which the bases of the lobules rest, and through the coats of which they are seen as polygonal figures; *i*, mouth of the intralobular veins, opening into the sublobular veins; *i*, intralobular veins shown passing up the centre of some divided lobules; *l*, *l*, cut surface of the liver; *c*, *c*, walls of the hepatic venous canal, formed by the polygonal bases of the lobules.  $\times 5$ . (Kiernan.)

transverse fissure it is merged in the areolar investment called Glisson's capsule, which, surrounding the portal vein, hepatic artery and hepatic duct, accompanies them in their branchings through the substance of the liver.

*Structure.*—The liver is in origin a tubular gland, but as development progresses it soon loses all resemblance to the tubular glands found elsewhere. It is made up of small roundish or oval portions called *lobules*, each of which is about  $\frac{1}{30}$  of an inch (about 1 mm.) in diameter, and composed of the liver cells, between which the blood-vessels and bile-vessels ramify. The *hepatic cells* (fig. 404), which form the glandular or secreting

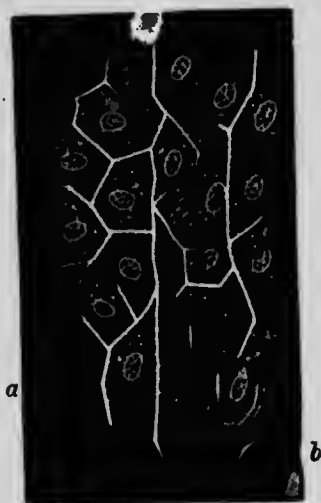

Fig. 408.—Portion of a lobule of liver. *a*, bile capillaries between liver-cells, the network in which is well seen; *b*, blood capillaries.  $\times 350$ . (Klein and Noble Smith.)

part of the liver, are of a spheroidal form, somewhat polygonal from mutual pressure, about  $\frac{1}{300}$  to  $\frac{1}{1000}$  inch (about  $\frac{1}{32}$  to  $\frac{1}{40}$  mm.) in diameter, possessing a nucleus, sometimes two. The cell-substance, composed of protoplasm, contains numerous fatty particles, as well as a variable amount of glycogen. The cells sometimes exhibit slow amoeboid movements. They are held together by a very delicate sustentacular tissue, continuous with the interlobular connective tissue.

To understand the distribution of the blood-vessels in the liver, it will be well to trace, first, the two blood-vessels and the duct which enter the organ on the under surface at the transverse fissure, viz., the portal vein, hepatic artery, and hepatic duct. As before remarked, all three run in company, and their appearance on longitudinal section is shown in fig. 405. Running together

through the substance of the liver, they are contained in small channels called *portal canals*, their immediate investment being a sheath of areolar tissue continuous with Glisson's capsule.

To take the distribution of the portal vein first:—In its course through the liver this vessel gives off small branches which divide and subdivide *between* the lobules surrounding them and limiting them, and from this circumstance called *inter-lobular veins*. From these vessels a dense capillary network is prolonged into the substance of the lobule, and this network converges to a single small vein, occupying the centre of the lobule, and hence

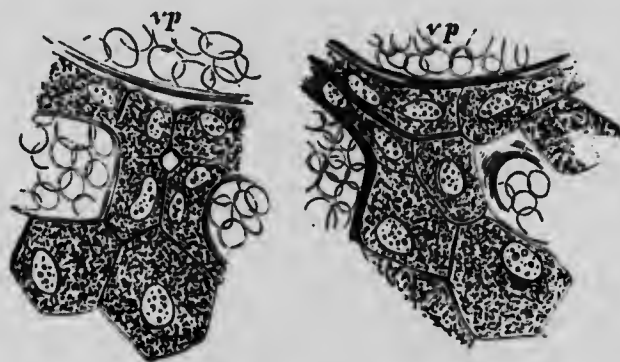

Fig. 409.—Hepatic cells and bile capillaries, from the liver of a child three months old. Both figures represent fragments of a section carried through the periphery of a lobule. The red corpuscles of the blood are recognised by their circular contour; *vp*, corresponds to an interlobular vein in immediate proximity with which are the epithelial cells of the biliary ducts, to which, at the lower part of the figures, the much larger hepatic cells suddenly succeed. (E. Hering.)

called *intra-lobular*. This arrangement is well seen in fig. 406, which represents a section of a small piece of an injected liver.

The small *intra-lobular* veins discharge their contents into veins called *sub-lobular* (*h h h*, fig. 407); while these again, by their union, form the main branches of the *hepatic veins*, which leave the posterior border of the liver to end by two or three principal trunks in the inferior vena cava, just before its passage through the diaphragm. The *sub-lobular* and *hepatic veins*, unlike the *portal* vein and its companions, have little or no areolar tissue around them, and their coats are very thin; they form little more than mere channels in the liver substance which closely surrounds them.

The hepatic artery, the chief function of which is to distribute blood for nutrition to Glisson's capsule, the walls of the ducts and blood-vessels, and other parts of the liver, is distributed in a very

similar manner to the portal vein, its blood being returned by small branches which pass into the capillary plexus of the lobules which connects the *inter-* and *intra-*lobular veins.

The hepatic duct divides and subdivides in a manner very like that of the portal vein and hepatic artery, the larger branches being lined by *columnar*, and the smaller by small *polygonal* epithelium.

The bile-capillaries commence between the hepatic cells, and are bounded by a delicate membranous wall of their own. They are always bounded by hepatic cells on all sides, and are thus

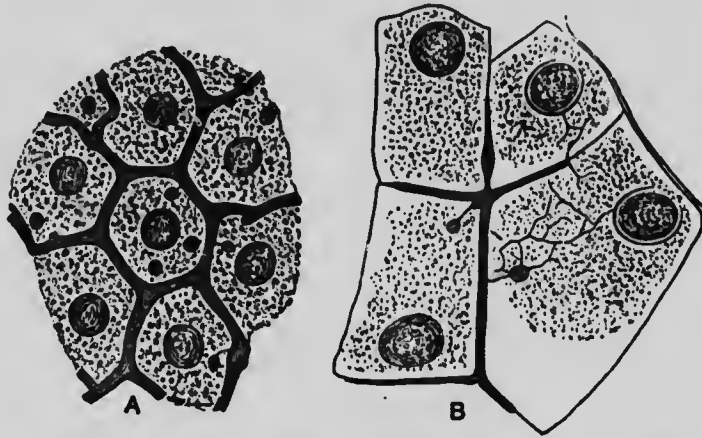

Fig. 410.—Sketches illustrating the mode of commencement of the bile-canaliculi within the liver-cells (Heidenhain, after Kupffer). A, rabbit's liver, injected from hepatic duct with Berlin blue. The intercellular canaliculi give off minute twigs which penetrate into the liver-cells, and there terminate in vacuole-like enlargements. B, frog's liver naturally injected with sulph-indigotate of soda. A similar appearance is obtained, but the communicating twigs are ramified.

separated from the nearest blood-capillary by at least the breadth of one cell (figs. 408 and 409).

To demonstrate the intercellular network of bile-capillaries, Chrzonszewsky employed a method of natural injection. A saturated aqueous solution of sulph-indigotate of soda is introduced into the circulation of dogs and pigs by the jugular vein. The animals are killed an hour and a half afterwards, and the blood-vessels washed free from blood, or injected with gelatin stained with carmine. The bile-ducts are then seen filled with blue, and the blood-vessels with red material. If the animals are killed sooner than this, the pigment is found within the hepatic cells, thus demonstrating it was through their agency that the canals were filled.

Pfűger and Kupffer have since this shown that the relation

between the hepatic cells and the bile-canaliculi is even more intimate, for they have demonstrated the existence of vacuoles in the cells communicating by minute intracellular channels with the adjoining bile-canaliculi (fig. 410). It is important to notice that the bile-canaliculi are always separated by at least a portion of a cell from the nearest blood-capillaries, and that the formation of bile is no mere transudation from the blood or lymph. The liver-cells take certain materials from the lymph and elaborate the constituents of the bile, the bile-salts and the bile pigments. There can be no doubt that these substances are formed by the hepatic cells, for they are not found in the blood nor in any other organ or tissue; and after extirpation of the liver they do not accumulate in the blood.

Intracellular canaliculi in the liver-cells are not unique. Recent research by Golgi's method has shown that in the salivary and gastric glands, and in the pancreas, there is a similar condition of affairs.

The **Gall-bladder** (G., B., fig. 403) is a pyriform bag, attached to the under surface of the liver, and supported also by the peritoneum, which passes below it. The larger end, or *fundus*, projects beyond the front margin of the liver; while the smaller end contracts into the cystic duct.

*Structure.*—The walls of the gall-bladder are constructed of three principal coats. (1) Externally (excepting that part which is in contact with the liver) is the *serous* coat, which has the same structure as the peritoneum with which it is continuous. Within this is (2) the *fibrous* or areolar coat, with which is mingled a considerable number of plain muscular fibres, both longitudinal and circular. (3) Internally the gall-bladder is lined by mucous membrane, and a layer of columnar epithelium. The surface of the mucous membrane presents to the naked eye a minutely honeycombed appearance from a number of tiny polygonal depressions with intervening ridges, by which its surface is mapped out. In the cystic duct the mucous membrane is raised up in the form of crescentic folds, which together appear like a spiral valve, and which assist the gall-bladder in retaining the bile during the intervals of digestion.

The gall-bladder and all the main biliary ducts are provided with mucous glands, which open on the internal surface.

#### Functions of the Liver.

The functions of the liver are connected with the general metabolism of the body; these are especially in connection with

the metabolism of carbohydrates (glycogenic function); and in connection with the metabolism of nitrogenous material (formation of urea and uric acid). This second function we shall discuss with the urine. The third function is the formation of bile, which must very largely be regarded as a subsidiary one, bile containing the waste products of the liver, the results of its other activities. This, however, it will be convenient to take first.

### Bile.

**Bile** is the secretion of the liver which is poured into the duodenum; it has been collected in living animals by means of a biliary fistula; the same operation has occasionally been performed in human beings. After death the gall-bladder yields a good supply of bile which is more concentrated than that obtained from a fistula.

Bile is being continuously poured into the intestine, but there is an increased discharge immediately on the arrival of food in the duodenum; there is a second increase in secretion a few hours later.

Though the chief blood supply of the liver is by a vein (the portal vein), the amount of blood in the liver varies with its needs, being increased during the periods of digestion. This is due to the fact that in the area from which the portal vein collects blood—stomach, intestine, spleen, and pancreas—the arterioles are all dilated, and the capillaries are thus gorged with blood. Further, the active peristalsis of the intestine and the pumping action of the spleen are additional factors in driving more blood onwards to the liver.

The bile being secreted from the portal blood is secreted at much lower pressure than one finds in glands such as the salivary glands, the blood supply of which is arterial. Heidenhain found that the pressure in the bile duct of the dog averaged 15 mm. of mercury, which is nearly double that in the portal vein. This fact is of considerable importance, as it illustrates the general truth that secretion is not mere process of passive filtration, but that the cells exercise secretory force.

The second increase in the flow of bile—that which occurs some hours after the arrival of the semi-digested food (chyme) in the intestine—appears to be due to the effect of the digestive products carried by the blood to the liver, stimulating the hepatic cells to activity: this is supported by the fact that proteid food increases the quantity of bile secreted, whereas fatty food which



is absorbed, not by the portal vein, but by the lacteals, has no such effect.

The chemical process by which the constituents of the bile are formed is obscure. We, however, know that the biliary pigment is produced by the decomposition of hæmoglobin. Bilirubin is, in fact, identical with the iron-free derivative of hæmoglobin called hæmatoidin, which is found in the form of crystals in old blood-clots such as occur in the brain after cerebral hæmorrhage (see p. 429).

An injection of hæmoglobin into the portal vein or of substances like water which liberate hæmoglobin from the red blood corpuscles produces an increase of bile pigment. If the spleen takes any part in the elaboration of bile pigment, it does not proceed so far as to liberate hæmoglobin from the corpuscles. No free hæmoglobin is discoverable in the blood plasma in the splenic vein.

The amount of bile secreted is differently estimated by different observers; the amount secreted daily in man varies from 500 c.c. to a litre (1,000 c.c.).

The constituents of the bile are the bile salts proper (taurocholate and glycocholate of soda), the bile pigments (bilirubin, biliverdin), a mucinoid substance, small quantities of fats, soaps, cholesterin, lecithin, urea, and mineral salts, of which sodium chloride and the phosphates of iron, calcium, and magnesium are the most important.

Bile is a yellowish, reddish-brown, or green fluid, according to the relative preponderance of its two chief pigments. It has a musk-like odour, a bitter-sweet taste, and a neutral or faintly alkaline reaction.

The specific gravity of human bile from the gall-bladder is 1026 to 1032; that from a fistula, 1010 to 1011. The greater concentration of gall-bladder bile is partly but not wholly explained by the addition to it from the walls of that cavity of the mucinoid material it secretes.

The amount of solids in bladder bile is from 9 to 14 per cent., in fistula bile from 1.5 to 3 per cent. The following table shows that this low percentage of solids is almost entirely due to want of bile salts. This can be accounted for in the way first suggested by Schiff—that there is normally a bile circulation going on in the body, a large quantity of the bile salts that pass into the intestine being first split up, then reabsorbed and again secreted. Such a circulation would obviously be impossible in cases where all the bile is discharged to the exterior.



The taurocholate of soda has the formula  $C_{26}H_{44}NaNO_7S$ .

The colour reaction called **Pettenkofer's reaction**, is due to the presence of cholalic acid. Small quantities of cane sugar and strong sulphuric acid are added to the bile. The sulphuric acid acting on sugar forms a small quantity of a substance called *furfuraldehyde*, in addition to other products. The furfuraldehyde gives a brilliant purple colour with cholalic acid.

**The Bile Pigments.**—The two chief bile pigments are bilirubin and biliverdin. Bile which contains chiefly the former (such as dog's bile) is of a golden or orange-yellow colour, while the bile of many herbivora, which contains chiefly biliverdin, is either green or bluish-green. Human bile is generally described as containing chiefly bilirubin, but there have been some cases described in which biliverdin was in excess. The bile pigments show no absorption bands with the spectroscop; their origin from the blood pigment has already been stated.

**Bilirubin** has the formula  $C_{16}H_{18}N_2O_3$ : it is thus an iron-free derivative of hæmoglobin. The iron is apparently stored up in the liver cells, perhaps for future use in the manufacture of new hæmoglobin. The bile contains only a trace of iron.

**Biliverdin** has the formula  $C_{16}H_{18}N_2O_4$  (*i.e.* one atom of oxygen more than in bilirubin): it may occur as such in bile; it may be formed by simply exposing red bile to the oxidising action of the atmosphere; or it may be formed as in Gmelin's test by the more vigorous oxidation produced by fuming nitric acid.

**Gmelin's test** consists in a play of colours—green, blue, red, and finally yellow, produced by the oxidising action of fuming nitric acid (that is, nitric acid containing nitrous acid in solution). The end or yellow product is called *choletelin*,  $C_{16}H_{18}N_2O_6$ .

**Hydrobilirubin.**—If a solution of bilirubin or biliverdin in dilute alkali is treated with sodium amalgam or allowed to putrefy, a brownish pigment, which is a reduction product, is formed called hydrobilirubin,  $C_{32}H_{40}N_4O_7$ . With the spectroscop it shows a dark absorption band between *b* and F, and a fainter band in the region of the D line.

This substance is interesting because a similar substance is formed from the bile pigment by reduction processes in the intestine, and constitutes *stercobilin*, the pigment of the fæces. Some of this is absorbed and ultimately leaves the body in the urine as one of its pigments called *urobilin*. A small quantity of urobilin is sometimes found preformed in the bile. The identity of urobilin and stercobilin has been frequently disputed, but the recent work of Garrod and Hopkins has confirmed the old

statement that they are the same substance with different names. Hydrobilin differs from urobilin in containing much more nitrogen in its molecule (9.2 instead of 4.1 per cent.).

**Cholesterin.**—This substance is contained not only in bile, but very largely in nervous tissues. Like lecithin, it is an abundant constituent of the white substance of Schwann. It is found also in blood corpuscles. In bile it is normally present in small quantities only, but it may occur in excess, and form the concretions known as gall-stones, which are usually more or less tinged with bilirubin.

Though its solubilities remind one of a fat, cholesterin is not a fat. It is, in fact, chemically speaking, a monatomic alcohol. Its formula is  $C_{27}H_{45}.HO$ .

From alcohol or ether containing water it crystallises in the form of rhombic tables, which contain one molecule of water of crystallisation: these are easily recognised under the microscope (see fig. 411).

It gives the following colour tests:—

1. With iodine and concentrated sulphuric acid the crystals give a play of red, blue, and green.

2. Heated with sulphuric acid and water (5 : 1) the edges of the crystals turn red.

3. A solution of cholesterin in chloroform, shaken with an equal amount of concentrated sulphuric acid, turns red, and ultimately purple, the subjacent acid acquiring a green fluorescence. (Salkowski's reaction.)

“The mode of origin of cholesterin in the body has not been clearly made out. Whether it is formed in the tissues generally, in the blood, or in the liver, is not known; nor has it been determined conclusively that it is derived from albuminous or nervous matter. It is also doubtful if we are to regard it as a waste substance of no use to the body, as its presence in the blood-corpuscles, in nervous matter, in the egg, and in vegetable grains, points to a possible function of a histogenetic or tissue-forming character.” (McKendrick.)

A substance called *iso-cholesterin*, isomeric with ordinary cholesterin, is found in the fatty secretion of the skin (sebum); it is largely contained in the preparation called *lanoline* made from



Fig. 411.—Crystalline scales of cholesterin.

sheep's-wool fat. It does not give Salkowski's reaction with chloroform and sulphuric acid just described.

**The Uses of Bile.**—One of the most remarkable facts concerning the bile is its apparently small use in the digestion of food. It is doubtless, to a large extent, excretory. Some state that it has a slight action on fats and carbohydrates, but it appears to be rather a coadjutor to the pancreatic juice (especially in the digestion of fat) than to have any independent digestive activity. In some animals it has a feeble diastatic power.

Bile is said to be a natural antiseptic, lessening the putrefactive processes in the intestine. This is also very doubtful. Though the bile salts are weak antiseptics, the bile itself is readily putrescible, and the power it has of diminishing putrescence in the intestine is due chiefly to the fact that by increasing absorption it lessens the amount of putrescible matter in the bowel.

When the bile meets the chyme the turbidity of the latter is increased owing to the precipitation of unpeptonised proteid. This is an action due to the bile salts, and it has been surmised that this conversion of the chyme into a more viscid mass is to hinder somewhat its progress through the intestines; it clings to the intestinal wall, thus allowing absorption to take place.

Bile is alkaline; it therefore assists the pancreatic juice in neutralising the acid mixture that leaves the stomach.

Bile assists the absorption of fats, as we shall see in studying that subject. It is also a solvent of fatty acids.

We have seen that fistula bile is poor in solids as compared with normal bile, and that this is explained on the supposition that the normal bile circulation is not occurring—the liver cannot excrete what it does not receive back from the intestine. Schiff was the first to show that if the bile is led back into the duodenum, or even if the animal is fed on bile, the percentage of solids in the bile excreted is at once raised. It is on these experiments that the theory of a bile circulation is mainly founded. The bile circulation relates, however, chiefly, if not entirely, to the bile salts: they are found but sparingly in the fæces; they are only represented to a slight extent in the urine: hence it is calculated that seven-eighths of them are re-absorbed from the intestine. Small quantities of cholalic acid, taurine, and glycocine are found in the fæces; the greater part of these products of the decomposition of the bile salts is taken by the portal vein to the liver, where they are once more synthesised into the bile salts. Some of the taurine is absorbed and excreted as tauro-carbamic acid in the urine. Some of the absorbed glycocine may be excreted as urea or uric acid. The cholesterin and mucus are found

in the fæces ; the pigment is changed into stercobilin, a substance like hydrobilirubin. Some of the stercobilin is absorbed, and leaves the body as the urinary pigment, urobilin (see p. 504).

**The bile-expelling mechanism** must be carefully distinguished from the bile-secreting action of the liver-cells. The bile is forced into the ducts, and ultimately into the duodenum, by the pressure of newly-formed bile pressing on that previously in the ducts, and this is assisted by the contraction of the plain muscular fibres of the larger ducts and gall-bladder, which occurs reflexly when the food enters the duodenum. In cases of obstruction, as by a gall-stone, in the ducts, this action becomes excessive, and gives rise to the intense pain known as *hepatic colic*.

Many so-called *cholagogues* (bile-drivers), like calomel, act on the bile-expelling mechanism and increase the peristalsis of the muscular tissue ; they do not really cause an increased formation of bile.

**Jaundice.**—The commonest form of jaundice is produced by obstruction in the bile ducts preventing the bile entering the intestine. A very small amount of obstruction, for instance, a plug of mucus produced in excess owing to inflammatory processes, will often be sufficient, as the bile is secreted at such low pressure. Under these circumstances, the fæces are whitish or clay coloured, and the bile passing backwards into the lymph,\* enters the blood and is thus distributed over the body, causing a yellow tint in the skin and mucous membranes, and colouring the urine deeply.

In some cases of jaundice, however (*e.g.* produced by various poisons), there is no obvious obstruction ; the causes of non-obstructive, or blood-jaundice, form a pathological problem of some interest. A few years ago it was believed that the bile pigment was actually produced in the blood. But all recent work shows that the liver is the only place where production of bile occurs, and that in all cases of so-called non-obstructive jaundice, the bile is absorbed from the liver. There may be obstruction present in the smaller ducts, or the functions of the liver may be so upset that the bile passes into the lymph even when there is no obstruction.

### The Glycogenic Function of the Liver.

The important fact that the liver normally forms sugar, or a substance readily convertible into it, was discovered by Claude Bernard in the following way : he fed a dog for seven days with

\* The absorption is by the lymph, because if jaundice is produced in an animal by ligation of the bile duct, it will cease when the thoracic duct is tied.

food containing a large quantity of sugar and starch; and, as might be expected, found sugar in both the portal and hepatic blood. But when this dog was fed with meat only, to his surprise, sugar was still found in the blood of the hepatic veins. Repeated experiments gave invariably the same result; no sugar was found, under a meat diet, in the portal vein, if care were taken, by applying a ligature on it at the transverse fissure, to prevent reflux of blood from the hepatic venous system. Bernard found sugar also in the substance of the liver. It thus seemed certain that the liver formed sugar, even when, from the absence of saccharine and amyloid matters in the food, none could have been brought directly to it from the stomach or intestines.

Bernard found, subsequently to the before-mentioned experiments, that a liver, removed from the body, and from which all sugar had been completely washed away by injecting a stream of water through its blood-vessels, contained sugar in abundance after the lapse of a few hours. This post-mortem production of sugar was a fact which could only be explained on the supposition that the liver contained a substance readily convertible into sugar; and this theory was proved correct by the discovery of a substance in the liver allied to starch, and now termed *glycogen*.

We are thus led to the conclusion that glycogen is formed first and stored in the liver cells, and that the sugar, when present, is the result of its transformation.

*Source of Glycogen.*—Although the greatest amount of glycogen is produced by the liver upon a diet of starch or sugar, a certain quantity is produced upon a proteid diet. It must, then, be produced by protoplasmic activity within the cells. The glycogen when stored in the liver cells may readily be demonstrated in sections of liver containing it by its reaction (red or port-wine colour) with iodine, and moreover, when the hardened sections are soaked in water in order to dissolve out the glycogen, the protoplasm of the cell is so vacuolated as to appear little more than a framework. In the liver of a hibernating frog the amount of glycogen stored up in the outer parts of the liver cells is very considerable.

*Average Amount of Glycogen in the liver of Dogs under various Diets (Pavy).*

Diet.	Amount of Glycogen in Liver.
Animal food . . . . .	7·19 per cent.
Animal food with sugar (about $\frac{1}{4}$ lb. of sugar daily)	14·5     ,,
Vegetable diet (potatoes, with bread or barley-meal)	17·23     ,,

The dependence of the formation of glycogen on the kind of

food taken is also well shown by the following results, obtained by the same experimenter:—

*Average Quantity of Glycogen found in the Liver of Rabbits after Fasting, and after a Diet of Starch and Sugar respectively.*

	Average amount of Glycogen in Liver.
After fasting for three days . . .	Practically absent.
„ diet of starch and grape-sugar . . .	15.4 per cent.
„ „ cane-sugar . . . . .	16.9 „

The diet most favourable to the production of a large amount of glycogen is a mixed diet containing a large amount of carbohydrate, but with some proteid. Fats taken in as food do not increase the amount of glycogen in the cells. Glycerin injected into the alimentary canal may increase the glycogen of the liver, probably because it hinders the conversion of glycogen into sugar and other substances; the glycogen therefore is allowed to accumulate in the liver.

*Destination of Glycogen.*—There are two chief theories as to the destination of hepatic glycogen. (1.) That the glycogen is converted into sugar during life by the agency of a ferment (*liver diastase*) also formed in the liver; and that the sugar is conveyed away by the blood of the hepatic veins, to undergo combustion in the tissues. (2.) That the conversion into sugar only occurs after death, and that during life no sugar exists in healthy livers, glycogen not undergoing this transformation.

The first view is that of Claude Bernard, and has been adopted by the majority of physiologists. The second view is that of Dr. Pavy: he denies that the liver is a sugar-forming organ, he regards it as a sugar-destroying organ; the sugar is stored as animal starch, but never again leaves the liver as sugar during life. He has been unable to find more sugar in the hepatic blood than in the portal blood. Other observers have found an increase in the sugar of the blood leaving the liver, but the estimation of sugar in a fluid rich in proteids, as is the blood, is a matter of great difficulty. Even if the increase is so small as hardly to be detected, it must be remembered that the whole blood of the body passes through the liver about twice a minute, so that a very small increase each time would mount up to a large total.

Pavy further denies that the *post-mortem* formation of sugar from glycogen that occurs in an excised liver is a true picture of what occurs during life, but is due to a ferment which is only formed after death. During life, he regards the glycogen as a source of other substances, like fat and proteid. It is certainly



a fact that increase of carbohydrate food leads to the formation of fat in the body and in the liver-cells. In support of the theory that glycogen may also lead to the formation of proteids, he has shown that many proteids contain a carbohydrate radicle.

The whole question is in a very unsettled state, and is under keen discussion at present. We may state, however, that the prevalent opinion is that the liver-cells may be able to convert part of the store of glycogen into fat, but that most of the glycogen leaves the liver as sugar, so justifying the name (literally, mother substance of sugar) given to it by Bernard.

Carbohydrate metabolism is thus a series of hydrations and dehydrations before combustion finally occurs. Starch is first hydrated in the alimentary canal to form sugar. This passes to the liver, where it is dehydrated to form glycogen, or animal starch; and finally hydrated once more to pass to the tissues as sugar, where it undergoes combustion.

**Diabetes.**—In certain disorders of hepatic metabolism, the glycogenic function is upset, and excess of sugar passes into the blood, leaving the body in the urine (*glycosuria*). This may be due to an increased formation of sugar from glycogen, or to a diminished formation of glycogen from the sugar of the portal blood, according as either Bernard's or Pavy's view of the liver function is adopted. In many cases the diabetic condition may be removed by a close attention to diet; starchy and saccharine food must be rigidly abstained from.

In other cases, which are much more serious, diet makes little or no difference. Under these circumstances the sugar must come from the metabolism of the proteid constituents of protoplasm.

The disease *diabetes* is not a single one; the term includes many pathological conditions, which all possess in common the symptom of excess of sugar in the blood and urine.

A diabetic condition may be produced in animals artificially in several ways:—

(1) *By diabetic puncture.*—Claude Bernard was the first to show that injury to the floor of the fourth ventricle in the region of the vaso-motor centre leads to glycosuria. The injury produces a disturbance of the vaso-motor mechanism, but diabetes cannot be regarded as purely vaso-motor in origin.

This condition is of interest, because brain disease in man, especially in the region of the bulb, is frequently associated with glycosuria.

(2) *By extirpation of the pancreas.*—This is alluded to on p. 493.

(3) *By administration of phloridzin.*—Many poisons produce

temporary glycosuria, but the most interesting and powerful of these is phloridzin. The diabetes produced is very intense. Phloridzin is a glucoside, but the sugar passed in the urine is too great to be accounted for by the small amount of sugar derivable from the drug. Besides that, phloretin, a derivative of phloridzin, free from sugar, produces the same results.

Phloridzin produces diabetes in starved animals, or in those in which any carbohydrate store must have been got rid of by the previous administration of the same drug. Phloridzin-diabetes is therefore analogous to those intense forms of diabetes in man in which the sugar must be derived from protoplasmic metabolism.

**Acetonæmia.**—Death in diabetic patients is usually preceded by deep coma, or unconsciousness. Some poison must be produced that acts soporifically upon the brain. The breath and urine of these patients smell strongly of acetone; hence the term *acetonæmia*. This apple-like smell should always suggest the possible onset of coma and death, but it is exceedingly doubtful whether acetone (which can certainly be detected in the urine) is the true poison; ethyl-diacetic acid, which accompanies, and is the source of the acetone, was regarded by some as the actual poison, but these substances, when introduced into the circulation artificially, do not cause serious symptoms. The actual poison is a matter of doubt; the idea most in vogue at present is that it is amido-hydroxybutyric acid, which is discoverable in the blood and urine of the patients who die from so-called acetonæmia.

### The Nerves of the Liver.

Claude Bernard observed that an increase of sugar in the blood is brought about by stimulation of the central and peripheral ends of the divided vagus, and that on the section of both vagi sugar disappears from the blood, and glycogen from the liver and tissues generally. These results have been confirmed in recent experiments, and it has been in addition found that stimulation of the celiac plexus also leads to a loss of glycogen in the liver, with a corresponding production of glucose that passes into the blood. The disappearance of glycogen from the liver cells after the stimulation of these nerves can also be seen histologically (Cavazzani). These results are due to a direct influence of the nerves on the liver cells, for they are obtained while the circulation is intact, or when it is stopped by a ligature of the aorta and portal vein (Morat and Dufourt).

*Vaso-motor nerves.*—The vaso-constrictor fibres for the portal

vein leave the spinal cord in the third to the eleventh thoracic nerves inclusive (Bayliss and Starling). The nerves of the hepatic artery are constrictors contained in the splanchnic, and dilators in both splanchnic and vagus.

---

## CHAPTER XXXIV.

### THE ABSORPTION OF FOOD.

Food is digested in order that it may be absorbed. It is absorbed in order that it may be assimilated, that is, become an integral part of the living material of the body.

The digested food thus diminishes in quantity as it passes along the alimentary canal, and the fæces contain the undigested or indigestible residue.

In the mouth and œsophagus the thickness of the epithelium and the quick passage of the food through these parts reduce absorption to a minimum. Absorption takes place more rapidly in the stomach: the small intestine with its folds and villi to increase its surface is, however, the great place for absorption; and although the villi are absent from the large intestine, absorption occurs there also, but to a less extent.

Foods such as water and soluble salts like sodium chloride are absorbed unchanged. The organic foods are, however, considerably changed, colloid materials like starch and proteid being converted respectively into the diffusible materials sugar and peptone.

There are two channels of absorption, the blood-vessels (portal capillaries) and the lymphatic vessels or lacteals.

Absorption, however, is no mere physical process of osmosis and filtration. We must also take into account the fact that the cells through which the absorbed substances pass are living, and in virtue of their vital activity not only select materials for absorption, but also change those substances while in contact with them. These cells are of two kinds—(1) the columnar epithelium that covers the surface; and (2) the lymph cells in the lymphoid tissue beneath. It is now generally accepted that of the two the former, the columnar epithelium, is the more important.

**Absorption of Carbohydrates.**—Though the sugar formed

from starch by ptyalin and amylopsin is maltose, that found in the blood is glucose. Under normal circumstances little if any is absorbed by the lacteals. The glucose is formed from the maltose by the succus entericus, aided by the action of the epithelial cells through which it passes. Cane sugar and milk sugar are also converted into glucose before absorption.

The carbohydrate food which enters the blood as glucose is taken to the liver, and there stored up in the form of glycogen—a reserve store of carbohydrate material for the future needs of the body. Glycogen, however, is found in animals who take no carbohydrate food. It must, then, be formed by the protoplasmic activity of the liver cells from their proteid constituents. The glycogenic function of the liver is discussed in the chapter preceding this. Glucose is the only sugar from which the liver is capable of forming glycogen. If other carbohydrates like cane sugar or lactose are injected into the blood-stream direct, they are unaltered by the liver, and finally leave the body by the urine.

**Absorption of Proteids.**—A certain amount of soluble proteid is absorbed unchanged. Thus, after taking a large number of eggs, egg albumin is found in the urine. Patients fed *per rectum* derive nourishment from proteid food, though proteolytic ferments are not present in this part of the intestine.

Most proteid, however, is normally absorbed as peptone and proteose (albumose). Peptones and proteoses are absent from the blood under all circumstances, even from the portal blood during the most active digestion. In other words during absorption the epithelial cells change the products of proteolysis (peptones and proteoses) back once more into native proteids (albumin and globulin).

The greater part of the proteid absorbed passes into the blood; a little into the lymph vessels also; but this undergoes the same change.

When peptone (using the word to include the proteoses also) is injected into the blood-stream, poisonous effects are produced, the coagulability of the blood is lessened, the blood pressure falls, secretion ceases, and in the dog 0.3 gramme of "peptone" per kilogramme of body weight is sufficient to kill the animal.

The epithelial cells of the alimentary canal thus protect us from those poisonous effects by converting the harmful peptone into the useful albumin.

**Absorption of Fats.**—The fats undergo in the intestine two changes: one a physical change (emulsification), the other a chemical change (saponification). The lymphatic vessels are the great channels for fat absorption, and their name *lacteals*, is

derived from the milk-like appearance of their contents (*chyle*) during the absorption of fat.

The way in which the minute fat globules pass from the intestine into the lacteals has been the subject of much controversy. The course they take may be studied by killing animals at varying periods after a meal of fat and making osmic acid microscopic preparations of the villi. Figs. 412 and 413 illustrate the appearances observed by Professor Schäfer.

The columnar epithelium cells become first filled with fatty



Fig. 412.—Section of the villus of a rat killed during fat absorption. *ep*, epithelium; *str*, striated border; *c*, lymph-cells; *c'*, lymph-cells in the epithelium; *l*, central lacteal containing disintegrating lymph-corpuses. (E. A. Schäfer.)

globules of varying size, which are generally larger near the free border. The globules pass down the cells, the larger ones breaking up into smaller ones during the journey; they are then transferred to the amœboid cells of the lymphoid tissue beneath: these ultimately penetrate into the central lacteal, where they either disintegrate or discharge their cargo into the lymph stream. The globules are by this time divided into immeasurably small ones, the molecular basis of chyle. The chyle enters the blood-stream by the thoracic duct, and after an abundant fatty meal the blood-plasma is quite milky; the fat droplets are so

small that they circulate without hindrance through the capillaries. The fat in the blood after a meal is eventually stored up in the connective-tissue cells of adipose tissue. It must, however, be borne in mind that the fat of the body is not exclusively derived from the fat of the food, but it may originate also both from proteid and from carbohydrate.

The great difficulty in fat absorption was to explain how the fat first gets into the columnar epithelium: these cells will not take up other particles, and it appears certain that the epithelial cells do not in the higher animals protrude pseudopodia from their borders (this, however, does occur in the endoderm of some of the lower invertebrates); moreover fat particles have never been seen in the striated border of the cells.

Recent research has shown that particles may be present in the epithelium and lymphoid cells while no fat is being absorbed. These particles are apparently protoplasmic in nature, as they stain with reagents that stain protoplasmic granules; they however also stain darkly with osmic acid, and so are apt to

be mistaken for fat. There is, however, no doubt that the particles found during fat absorption are composed of fat. There is no doubt that the epithelial cells have the power of forming fat out of the fatty acids and glycerin into which fats have been broken up in the intestine. Munk, who has performed a large number of experiments on the subject, showed that the splitting of fats into glycerine and fatty acids occurs to a much greater extent than was formerly supposed; these substances being soluble pass readily into the epithelium cells; and these cells perform the synthetic act of building them into fat once more, the fat so formed appearing in the form of small globules, surrounding or becoming mixed with the protoplasmic granules that are ordinarily present. Another remarkable fact which he made out is that after feeding an animal on fatty acids the chyle contains fat. The necessary glycerin must have been formed by protoplasmic activity during absorption. The more recent work of Moore and Roekwood has shown that fat is absorbed entirely as fatty acid or soap; and that preliminary emulsification,

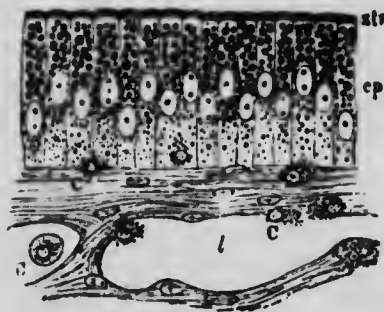

Fig. 413.—Mucous membrane of frog's intestine during fat absorption. ep, epithelium; str, striated border; C, lymph corpuscles; l, lacteal. (E. A. Schäfer.)

though advantageous for the formation of these substances, is not essential.

We thus see how with increase of knowledge due to improved methods of research, a complete change has come in the ideas physiologists hold regarding this subject. It is not so many years ago, that the physical change—emulsification—which fats undergo in the intestine was considered to be more important than the chemical changes—fat-splitting and saponification. In fact, the small amount of chemical change which was supposed to occur was regarded as quite subordinate, and of value merely in assisting the process of emulsification. We now know that the exact converse is the truth; the chemical change is the important process, and emulsification the subordinate one.

Bile aids the digestion of fat, in virtue of its being a solvent of fatty acids, and it probably assists fat absorption by reducing the surface tension of the intestinal contents; membranes moistened with bile allow fatty materials to pass through them more readily than would otherwise be the case. In cases of disease in which bile is absent from the intestines, a large proportion of the fat in the food passes into the fæces.

Since the days of Lieberkühn it has been the desire of physiologists to prove that the absorption of solutions from the intestines can be explained upon some simple physical basis. Thus the processes of filtration, osmosis, and imbibition, either alone or in combination, have been in turns called upon as affording the requisite explanation. Such theories have alternated with others in which the physical cause has been either wholly or in part rejected as inadequate, and the deficiencies of the physical cause supplemented by the physiological action of the epithelial lining of the alimentary tract. The terms "vital selection" or "physiological action of living cells" are admittedly unsatisfactory. They afford no real explanation of the intimate nature of the process; they are provisional names for what cannot yet be brought into line with precise physical and chemical data, but that such processes do exist is undeniable, and so we must be content for the present with the way in which they are labelled.

The difficulty of the problem does not, however, entirely depend on the impossibility of defining the word vital, but also on the complicated nature of the physical processes to which we have alluded. Since the days when Fischer and Dutrochet inaugurated our elementary knowledge of osmotic phenomena, a great amount of research has been expended in making that knowledge more accurate, and at the present day it requires almost a specialist in this branch of physics to thoroughly understand it. Even so eminent a man as the late Professor Heidenhain did not fully comprehend the nature of osmotic processes, and his epoch-marking work on absorption consequently suffers. The subject has more recently been taken up by Waymouth Reid, who has made a life-study of such phenomena, and whose work must be regarded as authoritative.

The animals he experimented on were dogs, and the material selected for absorption was the serum or plasma of the blood from the same animals. The substances to be absorbed were thus of the same kind as those in the blood and lymph on the other side of the absorptive epithelium. The serum or plasma was analysed, introduced into an isolated loop of the gut, and

at the end of a given time the contents of the loop were again analysed. The pressure in the loop and in the mesenteric veins was estimated manometrically during the progress of the experiment; allowance was made for the secretion of intestinal juice, and other precautions taken to make each experiment as complete as possible.

It was found that the absorption by an animal of its own serum or plasma takes place under conditions in which filtration or osmosis into blood capillaries or lacteals and also adsorption (or imbibition) are excluded. The active force must therefore by a process of exclusion reside in the physiological activity of the lining epithelium. The same conclusion was reached by another method, namely, that when the epithelium is removed, injured or poisoned, the absorption either ceases or is markedly lessened, and this in spite of the fact that removal of the epithelium must increase the facilities for osmosis and filtration.

The activity of the cells is characterised by a slower uptake of the organic solids of the serum than of water, and a quicker uptake of the salts than of the water; but the absolute numerical relations varies in different regions of the intestine. The state of nutrition of the cells is the main factor in their activity; specific absorptive nerve-fibres were sought for but not found. The absorption of water from the gut depends partly on the physical relation of the osmotic pressure of the solution in the intestine to that of the blood plasma; but even the absorption of water is influenced by the physiological regulation of this difference by the directing or, as it may be termed, orienting mechanism of the cells. Such orienting action was first noted in connection with salts by Otto Cohnheim: he showed that, in an intestinal loop with injured cells, sodium chloride enters its lumen from the blood though the same salt is being actively absorbed from a normal loop in the same animal at the same time. In all probability the cell activity which causes the organic constituents of serum to pass into the blood is of the same nature as that involved in the orienting action of the cells upon salts in solution.

Professor Reid's conclusions with regard to the absorption of peptone and sugar are as follows:—The chief factor in the absorption of peptone is an assimilation (or adsorption) by the cells, while in the absorption of glucose diffusion variable by the permeability of the cells (and so probably related to their physiological condition) is the main factor. By removal of the epithelium the normal ratio of peptone to glucose absorption is upset, and the value tends to approach that of diffusion of these substances through parchment paper into serum. Differences are also noted in different parts of the intestinal canal.

The still more wonderful synthetic power which the cells exercise in relation to proteids and fats has been already mentioned in the main text.

**The fæces** are alkaline in reaction, and contain the following substances:—

1. Water: in health from 68 to 82 per cent.; in diarrhœa it is more abundant still.
2. Undigested food: that is, if food is taken in excess, some escapes the action of the digestive juices. On a moderate diet unaltered proteid is never found.
3. Indigestible constituents of the food: cellulose, keratin, mucin, chlorophyll, gums, resins, cholesterin.
4. Constituents digestible with difficulty: uncooked starch, tendons, elastin, various phosphates, and other salts of the alkaline earths.



5. Products of decomposition of the food: indole, skatole, phenol, acids such as fatty acids, lactic acid, &c.; hæmatin from hæmoglobin; insoluble soaps like those of calcium and magnesium.

6. Bacteria of all sorts and *débris* from the intestinal wall; cells, nuclei, mucus, &c.

7. Bile residues: mucus, cholesterin, traces of bile acids and their products of decomposition, stercobilin from the bile pigment.

The average quantity of solid fæcal matter passed by the human adult per diem is 6 to 8 ounces.

**Meconium** is the name given to the greenish-black contents of the intestine of new-born children. It is chiefly concentrated bile, with *débris* from the intestinal wall. The pigment is a mixture of bilirubin and biliverdin, not stercobilin.

---

## CHAPTER XXXV.

### THE MECHANICAL PROCESSES OF DIGESTION.

UNDER this head we shall study the muscular movements of the alimentary canal, which have for their object the onward movements of the food, and its thorough admixture with the digestive juices. We shall therefore have to consider mastication, deglutition, the movements of the stomach and intestines, and the acts of defæcation, and vomiting.

#### MASTICATION.

The act of chewing, or mastication, is performed by the biting and grinding movement of the lower range of teeth against the upper. The simultaneous movements of the tongue and cheeks assist partly by crushing the softer portions of the food against the hard palate and gums, and thus supplement the action of the teeth, and partly by returning the morsels of food to the action of the teeth, again and again, as they are squeezed out from between them, until they have been sufficiently chewed.

The act of mastication is much assisted by the saliva, and the intimate incorporation of this secretion with the food is called *insalivation*.

Mastication is much more thoroughly performed by some animals than by others. Thus, dogs hardly chew their food at all, but the œsophagus is protected from abrasion by a thick coating of very viscid saliva which lubricates the pieces of rough food.

In vegetable feeders, on the other hand, insalivation is a much more important process. This is especially so in the ruminants; in these animals, the grass, &c. taken, is hurriedly swallowed, and passes into the first compartment of their four-chambered stomach. Later on, it is returned to the mouth in small instalments for thorough mastication and insalivation; it is then once more swallowed and passes on to the digestive regions of the stomach. This is the act of *ruminatio*n or "chewing the cud."

In man, mastication is also an important process, and in people who have lost their teeth severe dyspepsia is often produced, which can be cured by a new set of teeth.

#### DEGLUTITION.

When properly masticated, the food is transmitted in successive portions to the stomach by the act of deglutition or swallowing. This, for the purpose of description, may be divided into *three* acts. In the first, particles of food collected as a bolus are made to glide between the surface of the tongue and the palatine arch, till they have passed the anterior arch of the fauces; in the second, the morsel is carried through the pharynx; and in the third, it reaches the stomach through the œsophagus. These three acts follow each other rapidly. (1.) The first act is voluntary, although it is usually performed unconsciously; the morsel of food when sufficiently masticated, is pressed between the tongue and palate, by the agency of the muscles of the former, in such a manner as to force it back to the entrance of the pharynx. (2.) The second act is the most complicated, because the food must go past the posterior orifice of the nose and the upper opening of the larynx without entering them. When it has been brought, by the first act, between the anterior arches of the palate, it is moved onwards by the movement of the tongue backwards, and by the muscles of the anterior arches contracting on it and then behind it. The root of the tongue being retracted, and the larynx being raised with the pharynx and carried forwards under the base of the tongue, the epiglottis is pressed over the upper opening of the larynx, and the morsel glides past it; the closure of the glottis is additionally secured by the simultaneous contraction of its own muscles: so that, even when the epiglottis is destroyed, there is little danger of food passing into the larynx so long as its muscles can act freely. In man, and some other animals, the epiglottis is not drawn as a lid over the larynx during swallowing. At the same time, the raising of the soft palate, so that its posterior edge touches the back part of the pharynx, and the approximation of the sides of

the posterior palatine arch, which move quickly inwards like side curtains, close the passage into the upper part of the pharynx and the posterior nares, and form an inclined plane, along the under surface of which the morsel descends; then the pharynx, raised up to receive it, in its turn contracts, and forces it onwards into the œsophagus. The passage of the bolus of food through the three constrictors of the pharynx is the last step in this stage. (3.) In the third act, in which the food passes through the œsophagus, every part of that tube, as it receives the morsel and is dilated by it, is stimulated to contract: hence an undulatory or peristaltic contraction of the œsophagus occurs, which is easily observable through the skin in long-necked animals like the swan. If we suppose the bolus to be at one particular place in the tube, it acts stimulatingly on the circular muscular fibres behind it, and inhibitingly on those in front; the contraction therefore squeezes it into the dilated portion of the tube in front, where the same process is repeated, and this travels along the whole length of the tube. The second and third parts of the act of deglutition are involuntary. The action of these parts is more rapid than peristalsis usually is. This seems to be due to the large amount of striated muscular tissue present. It serves the useful purpose of getting the bolus as quickly as possible past the opening of the respiratory tract.

*Nervous Mechanism.*—The nerves engaged in the reflex act of deglutition are:—*sensory*, branches of the fifth cranial nerve supplying the soft palate and tongue; glosso-pharyngeal, supplying the tongue and pharynx; the superior laryngeal branch of the vagus, supplying the epiglottis and the glottis; while the *motor* fibres concerned are:—branches of the fifth, supplying part of the digastric and mylo-hyoid muscles, and the muscles of mastication; the bulbar part of the spinal accessory through the pharyngeal plexus, supplying the levator palati, probably by rootlets which are glosso-pharyngeal in origin; the glosso-pharyngeal and vagus, and possibly the bulbar part of the spinal accessory, supplying the muscles of the pharynx through the pharyngeal plexus; the vagus, in virtue of its spinal accessory roots, supplying the muscles of the larynx through the inferior laryngeal branch; and the hypoglossal, the muscles of the tongue. The nerve-centre by which the muscles are harmonised in their action, is situated in the medulla oblongata. Stimulation of the vagi gives rise to peristalsis of the œsophagus. The cell stations of these fibres are in the ganglion trunci vagi. Division of both pneumo-gastric nerves gives rise to paralysis of the œsophagus and stomach, and firm contraction of the cardiac orifice. These nerves therefore normally supply the

œsophagus with motor, and the cardiac sphincter with inhibitory fibres. If food is swallowed after these nerves are divided, it accumulates in the gullet and never reaches the stomach.

In discussing peristalsis on a previous occasion (p. 161), we arrived at the conclusion that it is an inherent property of muscle rather than of nerve; though normally it is controlled and influenced by nervous agency. This nervous control is especially marked in the œsophagus; for if that tube is divided across, leaving the nerve branches intact, a wave of contraction will travel from one end to the other across the cut.

**Swallowing of Fluids.**—We must next note that the swallowing both of food and drink is a muscular act, and can, therefore, take place in opposition to the force of gravity. Thus, horses and many other animals habitually drink up-hill, and the same feat can be performed by jugglers.

Under ordinary circumstances, however, the swallowing of fluids is differently produced from what we have already described: the division of the act of deglutition into three stages is true for the swallowing of solids only. This has been shown by Kronecker.

In swallowing liquids the two mylo-hyoid muscles form a diaphragm which pulls the root of the tongue upwards and backwards; the two hyo-glossi act with these, pulling the tongue backwards and downwards. The action of these four muscles resembles that of a force-pump projecting the mass of fluid down into the œsophagus; it reaches the cardiac orifice with great speed, and the pharyngeal and œsophageal muscles do not contract on it at all, but are inhibited during the passage of the fluid through them.

This is proved in a striking way in cases of poisoning by corrosive substances like oil of vitriol; the mouth and tongue are scorched and burnt, but the pharynx and œsophagus escape serious injury, so rapidly does the fluid pass along them; the cardiac orifice of the stomach is the next place to show the effects of the corrosive.

There is, however, no hard-and-fast line between the swallowing of solids and fluids: the more liquid the food is, the more does the force-pump action just described manifest itself.

#### MOVEMENTS OF THE STOMACH.

The gastric fluid is assisted in accomplishing its share in digestion by the movements of the stomach. In granivorous birds, for example, the contraction of the strong muscular gizzard affords a necessary aid to digestion, by grinding and triturating

the hard seeds which constitute their food. But in the stomachs of man and other Mammalia the movements of the muscular coat are too feeble to exercise any such mechanical force on the food; neither are they needed, for mastication has already done the mechanical work of a gizzard; and experiments have demonstrated that substances are digested even enclosed in perforated tubes, and consequently protected from mechanical influence.

The normal actions of the muscular fibres of the human stomach appear to have a three-fold purpose: (1) to adapt the stomach to the quantity of food in it, so that its walls may be in contact with the food on all sides, and, at the same time, may exercise a certain amount of compression upon it; (2) to keep the orifices of the stomach closed until the food is digested; and (3) to perform certain peristaltic movements, whereby the food, as it becomes chymified, is gradually propelled towards, and ultimately through, the pylorus. In accomplishing this latter end, the movements without doubt materially contribute towards effecting a thorough intermingling of the food and the gastric juice.

When digestion is not going on, the stomach is uniformly contracted, its orifices not more firmly than the rest of its walls; but, if examined shortly after the introduction of food, it is found closely encircling its contents, and its orifices are firmly closed like sphincters. The cardiac orifice, every time food is swallowed, opens to admit its passage to the stomach, and immediately again closes. The pyloric orifice, during the first part of gastric digestion, is usually so completely closed, that even when the stomach is separated from the intestines, none of its contents escape. But towards the termination of the digestive process, the pylorus offers less resistance to the passage of substances from the stomach; first it yields to allow the successively digested portions to go through it; and then it allows the transit even of undigested substances. It appears that food, so soon as it enters the stomach, is subjected to a kind of peristaltic action of the muscular coat, whereby the digested portions are gradually moved towards the pylorus. The movements are observed to increase in rapidity as the process of chymification advances, and are continued until it is completed.

The contraction of the fibres situated towards the pyloric end of the stomach seems to be more energetic and more decidedly peristaltic than those of the cardiac portion. Thus, it was found in the case of St. Martin, that when the bulb of a thermometer was placed about three inches from the pylorus, through the gastric fistula, it was tightly embraced from time to time, and drawn towards the pyloric orifice for a distance of three or four

inches. The object of this movement appears to be, as just said, to carry the food towards the pylorus as fast as it is formed into chyme, and to propel the chyme into the duodenum; the undigested portions of food are kept back until they are also reduced into chyme, or until all that is digestible has passed out. The action of these fibres is often seen in the contracted state of

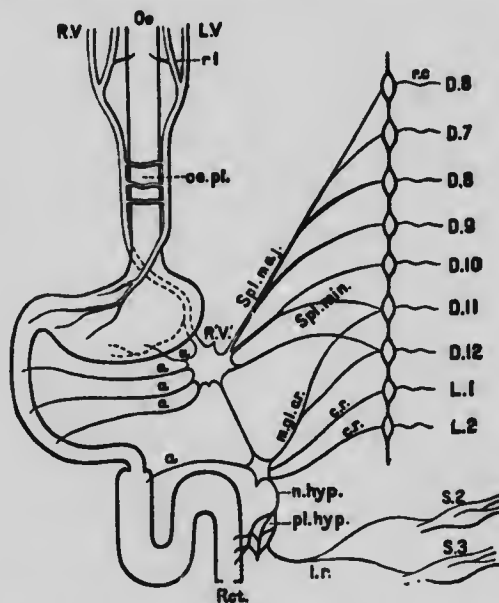

Fig. 414.—Very diagrammatic representation of the nerves of the alimentary canal. Oe to Ret., the various parts of the alimentary canal from oesophagus to rectum: L. V., left vagus, ending on front of stomach; r.l., recurrent laryngeal nerve, supplying upper part of oesophagus; R. V., right vagus, joining left vagus in oesophageal plexus, oe. pl., supplying the posterior part of stomach, and continues as R.V.' to join the solar plexus, here represented by a single ganglion, and connected with the inferior mesenteric ganglion m.gl.; a., branches from the solar plexus to stomach and small intestine, and from the mesenteric ganglia to the large intestine; Spl.maj., large splanchnic nerve, arising from the thoracic ganglia and rami communicantes, r.e. belonging to dorsal nerves from the 6th to the 9th (or 10th); Spl.min., small splanchnic nerve similarly from the 10th and 11th dorsal nerves. These both join the solar plexus, and thence make their way to the alimentary canal; c.r., nerves from the ganglia, &c., belonging to 11th and 12th dorsal and 1st and 2nd lumbar nerves, proceeding to the inferior mesenteric ganglia (or plexus), m.gl., and thence by the hypogastric nerve, n.hyp., and the hypogastric plexus, pl.hyp., to the circular muscles of the rectum; l.r., nerves from the 2nd and 3rd sacral nerves, S. 2, S. 3 (nervi erigentes) proceeding by the hypogastric plexus to the longitudinal muscles of the rectum. (M. Foster.)

the pyloric portion of the stomach after death, when it alone is contracted and firm, while the cardiac portion forms a dilated sac. Sometimes, by a predominant action of strong circular fibres placed between the cardia and pylorus, the two portions, or ends as they are called, of the stomach, are partially separated from each other by a kind of hour-glass contraction. By means of the peristaltic action of the muscular coats of the stomach, not merely is chymified food gradually propelled through the pylorus,

but a kind of double current is continually kept up among the contents of the stomach, the circumferential parts of the mass being gradually moved onward toward the pylorus by the contraction of the muscular fibres, while the central portions are propelled in the opposite direction, namely towards the cardiac orifice; in this way is kept up a constant circulation of the contents of the viscus, highly conducive to their thorough admixture with the gastric fluid and to their ready digestion.

Under ordinary circumstances, three or four hours may be taken as the average time occupied by the digestion of a meal in the stomach. But the digestibility and quantity of the meal, and the state of body and mind of the individual, are important causes of variation. The pylorus usually opens for the first time about twenty minutes after digestion begins; it, however, quickly closes again. The intervals between its openings diminish, and the periods during which it remains open increase, until towards the end of the time it is permanently open, and the chyme can pass freely into the duodenum.

The results which have just been stated were made out previous to the discovery of the Röntgen rays. The subject has recently been taken up again by Cannon. He gave an animal food mixed with bismuth subnitrate, and obtained shadow photographs of the stomach, because the bismuth salt renders its contents opaque. His results mainly confirm those of the earlier investigators: the principal peristalsis occurs in the pyloric portion of the stomach. The cardiac portion presses steadily on its contents, and as they become chymified urge them onwards towards the pyloric portion: the latter empties itself gradually through the pylorus into the duodenum, and in the later stages of digestion the cardiac part also is constricted into a tube.

**Influence of the Nervous System.**—The normal movements of the stomach during gastric digestion do not appear to be so closely connected with the plexuses of nerves and ganglia contained in its walls as was formerly supposed. The action, however, appears to be set up by the presence of food within it. The stomach is, however, directly connected with the higher nerve-centres by means of branches of the vagi and of the splanchnic nerves through the solar plexus.

The vagi (especially the left) contain the accelerator nerves of the stomach; when they are stimulated the result is peristaltic movement. The sympathetic fibres are inhibitory; when they are stimulated peristalsis ceases. The cell stations on the course of the vagus fibres are in the ganglion trunci vagi; the post-ganglionic fibres that issue from this ganglion are non-medullated.

The sympathetic fibres leave the spinal cord by the anterior roots of the spinal nerves from the fifth to the eighth thoracic. They pass into the sympathetic system, have cell stations in the

coeliac ganglion, and ultimately pass to the stomach by the splanchnic nerves.

It seems probable that automatic peristaltic contraction is inherent in the muscular coat of the stomach, and that the central nervous system is only employed to regulate it by impulses passing down by the vagi or splanchnic nerves.

The secretory nerves of the gastric glands are treated on p. 482.

#### VOMITING.

The expulsion of the contents of the stomach in vomiting, like that of mucus or other matter from the lungs in *coughing*, is preceded by an inspiration; the glottis is then closed, and immediately afterwards the abdominal muscles strongly act; but here occurs the difference in the two actions. Instead of the vocal cords yielding to the action of the abdominal muscles, they remain tightly closed. Thus the diaphragm being unable to go up, forms an unyielding surface against which the stomach can be pressed. At the same time the *cardiac* sphincter-muscle being relaxed, and the orifice which it naturally guards being dilated, while the *pylorus* is closed, and the stomach itself also contracting, the action of the abdominal muscles expels the contents of the organ through the œsophagus, pharynx, and mouth. The reversed peristaltic action of the œsophagus possibly increases the effect.

It has been frequently stated that the stomach itself is quite passive during vomiting, and that the expulsion of its contents is effected solely by the pressure exerted upon it when the capacity of the abdomen is diminished by the contraction of the diaphragm, and subsequently of the abdominal muscles. The experiments and observations, however, which are supposed to confirm this statement, only show that the contraction of the abdominal muscles alone is sufficient to expel matters from an unresisting bag through the œsophagus; and that, under very abnormal circumstances, the stomach, by itself, cannot expel its contents. They by no means show that in ordinary vomiting the stomach is passive, for there are good reasons for believing the contrary. In some cases of violent vomiting the contents of the duodenum are passed by anti-peristalsis into the stomach, and are then vomited. Where there is obstruction to the intestine, as in strangulated hernia, the contents of all the small intestine may be vomited.

**Nervous mechanism.**—Some few persons possess the power of vomiting at will, or the power may be acquired by effort and practice. But normally the action is a reflex one.

The *afferent* nerves are principally the fifth, and glossopharyngea



(as in vomiting produced by tickling the fauces), and the vagus (as in vomiting produced by gastric irritants); but vomiting may occur from stimulation of other sensory nerves, *e.g.* those from the kidney, uterus, testicle, &c. The centre may also be stimulated by impressions from the cerebrum and cerebellum, producing so-called *central* vomiting occurring in diseases of those parts.

The *centre* for vomiting is in the medulla oblongata, and coincides with the centres of the nerves concerned.

The *efferent* (motor) impulses are carried by the vagi to the stomach, by the phrenics to the diaphragm, and by various other spinal nerves to the abdominal muscles.

*Emetics.*—Some emetics produce vomiting by irritating the stomach; others, like tartar emetic, apomorphine, &c., by stimulating the vomiting centre.

#### MOVEMENTS OF THE INTESTINES.

The movement of the intestines is *peristaltic* or *vermicular*, and is effected by the alternate contractions and dilatations of successive portions of the muscular coats. The contractions, which may commence at any point of the intestine, extend in a wave-like manner along the tube. They are similar to what we have described in the œsophagus. In any given portion, the longitudinal muscular fibres contract first, or more than the circular; they draw a portion of the intestine upwards, over the substance to be propelled, and then the circular fibres of the same portion contracting in succession from above downwards, press the substance into the portion next below, in which at once the same succession of actions next ensues. These movements take place slowly, and, in health, commonly give rise to no sensation; but they are perceptible when they are accelerated under the influence of any irritant.

The movements of the intestines are sometimes retrograde: and there is no hindrance to the backward movement of the contents of the small intestine, as in cases of violent vomiting just referred to. But almost complete security is afforded against the passage of the contents of the large into the small intestine by the ileo-cæcal valve. Besides,—the orifice of communication between the ileum and cæcum (at the borders of which orifice are the folds of mucous membrane which form the valve) is encircled with muscular fibres, the contraction of which prevents the undue dilatation of the orifice.

Proceeding from above downwards, the muscular fibres of the large intestine become, on the whole, stronger in direct proportion

to the greater strength required for the onward moving of the feces, which are gradually, owing to the absorption of water, becoming firmer. The greatest strength is in the rectum, at the termination of which the circular unstriped muscular fibres form a strong band called the *internal* sphincter; while an *external* sphincter muscle with striped fibres is placed rather lower down, and more externally, and holds the orifice close by a constant slight tonic contraction.

**Nervous mechanism.**—Experimental irritation of the brain or cord produces no evident or constant effect on the movements of the intestines during life: yet in consequence of certain mental conditions the movements are accelerated or retarded; and in paraplegia the intestines appear after a time much weakened in their power, and costiveness, with a tympanitic condition, ensues.

As in the case of the œsophagus and stomach, the peristaltic movements of the intestines may be directly set up in the muscular fibres by the presence of food or chyme acting as the stimulus. Few or no movements occur when the intestines are empty.

The small intestines are connected with the central nervous system by the vagi and by the splanchnic nerves. The fibres which leave the medulla in the vagal rootlets are fine medullated ones: they are connected with cells in the ganglion trunci, and then continue as non-medullated fibres to the intestinal walls: they pass through the solar plexus, but are not connected with nerve-cells in that plexus. In animals stimulation of the pneumogastric nerves induces peristaltic movements of the intestines. If the intestines are contracting peristaltically before the stimulus is applied, the movements are inhibited for a brief period, after which they are greatly augmented. The sympathetic fibres leave the cord as fine medullated fibres by the anterior roots from the sixth thoracic to the first lumbar, pass through the lateral chain, but do not reach their cell stations until they arrive at the superior mesenteric ganglia: thence they pass as non-medullated fibres to the muscular coats. Stimulation of these fibres causes inhibition of any peristaltic movements that may be present. These nerves also contain vaso-motor fibres, and section of these leads to vasodilatation and a great increase of very watery succus entericus.

Peristalsis in the small intestine can be excited artificially even when all nerves running to it from the central nervous system have been cut through. After pinching any particular spot a wave of inhibition travels downwards, and a wave of contraction upwards. (Starling.)

In the case of the large intestine there is no supply from the

vagus. The inferior mesenteric nerves are inhibitory in function, and the pelvic nerves take the place of the vagal fibres as excitatory: this refers to both coats of the muscular wall. If one pinches any particular spot, the upward wave of contraction is not so marked as in the small intestine, but the downward travelling wave of inhibition is well seen.

*Duration of Intestinal Digestion.*—The time occupied by the journey of a given portion of food from the stomach to the anus, varies considerably even in health, and on this account probably it is that such different opinions have been expressed in regard to the subject. About twelve hours are occupied by the journey of an ordinary meal through the *small* intestine, and twenty-four to thirty-six hours by the passage through the *large* bowel.

*Drugs* given for relief of diarrhœa or constipation act in various ways; some influence the amount of secretion and thus increase or diminish the fluidity of the intestinal contents; others acting on the muscular tissue or its nerves increase or diminish peristalsis.

**Defœcation.**—The act of the expulsion of fœces is in part due to an increased reflex peristaltic action of the lower part of the large intestine, namely of the sigmoid flexure and rectum, and in part to the action of the abdominal muscles. In the case of active voluntary efforts, there is usually, first an inspiration, as in the case of coughing, sneezing, and vomiting; the glottis is then closed, and the diaphragm fixed. The abdominal muscles are contracted as in expiration; but as the glottis is closed, the whole of their pressure is exercised on the abdominal contents. The sphincter of the rectum being relaxed, the evacuation of its contents takes place accordingly, the effect being increased by the peristaltic action of the intestine.

*Nervous Mechanism.*—The anal sphincter muscle is normally in a state of tonic contraction. The nervous centre which governs this contraction is situated in the lumbar region of the spinal cord, inasmuch as in cases of division of the cord above this region the sphincter regains, after a time, to some extent the tonicity which is lost immediately after the operation. By an effort of the will, acting on the centre, the contraction may be relaxed or increased. Such voluntary control over the act is obviously impossible when the cord is divided. In ordinary cases the apparatus is set in action by the gradual accumulation of fœces in the sigmoid flexure and rectum, pressing by the peristaltic action of these parts of the large intestine against the sphincter, and causing by reflex action its relaxation; this sensory impulse acts upon the brain and reflexly through the spinal centre. At the same time that the sphincter is

inhibited or relaxed, impulses pass to the muscles of the lower intestine increasing their peristalsis, and to the abdominal muscles as well.

Both inhibitory and motor fibres for the lower part of the intestine leave the cord by anterior roots lower than those which contain the fibres for the small intestine. The cell-stations are situated in the inferior mesenteric ganglia, or along the course of the colonic or hypogastric nerves. The lower portion of the large intestine resembles the œsophagus in being more under external nervous control than the small intestine.

## CHAPTER XXXVI.

### THE URINARY APPARATUS.

This consists of the kidneys; from each a tube called the *ureter* leads to the bladder in which the urine is temporarily stored; from the bladder a duct called the *urethra* leads to the exterior.

**The Kidneys** are two in number, and are situated deeply in the lumbar region of the abdomen on either side of the spinal column behind the peritonæum. They correspond in position to the last dorsal and three upper lumbar vertebræ; the right is slightly below the left in consequence of the position of the liver on the right side of the abdomen. They are about 4 inches long,  $2\frac{1}{2}$  inches broad, and  $1\frac{1}{2}$  inch thick. The weight of each kidney is about  $4\frac{1}{2}$  oz.

*Structure.*—The kidney is covered by a fibrous capsule, which is slightly attached at its inner surface to the proper substance of the organ by means of very fine bundles of areolar tissue and minute blood-vessels. From the healthy kidney, therefore, it may be easily torn off without much injury to the subjacent cortical portion of the organ. At the *hilus* of the kidney, it becomes continuous with the external coat of the upper and dilated part of the ureter (fig. 415).

On dividing the kidney into two equal parts by a section carried through its long convex border it is seen to be composed of two portions called respectively *cortical* and *medullary*; the latter is composed of about a dozen conical bundles of urinary tubules, each bundle forming what is called a *pyramid*. The upper part of the *ureter* or duct of the organ, is dilated into the *pelvis*; and this, again, after separating into two or three principal divisions, is finally subdivided into still smaller portions, varying



# MICROCOPY RESOLUTION TEST CHART

(ANSI and ISO TEST CHART No. 2)

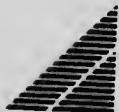
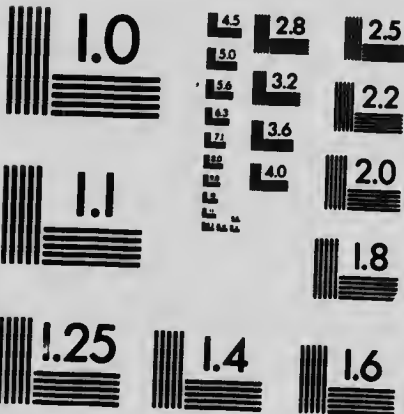

**APPLIED IMAGE Inc**

1653 East Main Street  
Rochester, New York 14609 USA  
(716) 482 - 0300 - Phone  
(716) 288 - 5989 - Fax

in number from about 8 to 12, called *calyces*. Each of these little calyces or cups receives the pointed extremity or *papilla* of a pyramid. The number of pyramids varies in different animals; in some there is only one.

The kidney is a compound tubular gland, and both its cortical and medullary portions are composed of tubes, the *tubuli uriniferi*, which, by one extremity, in the *cortical* portion, commence around tufts of capillary blood-vessels, called *Malpighian bodies*, and, by the other, open through the papillæ into the pelvis of the kidney, and thus discharge the urine which flows

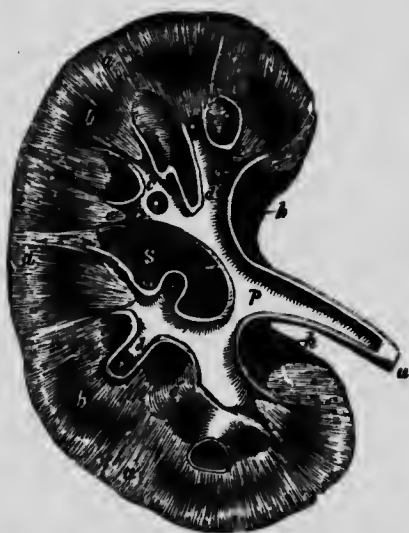

Fig. 415.—Plan of a longitudinal section through the pelvis and substance of the right kidney, *a*, the cortical substance; *b, b*, broad part of the pyramids of Malpighi; *c, c*, the divisions of the pelvis named calyces, laid open; *c'*, one of those unopened; *d*, summit of the pyramids of papillæ projecting into calyces; *e, e*, section of the narrow part of two pyramids near the calyces; *p*, pelvis or enlarged portion of the ureter within the kidney; *u*, the ureter; *s*, the sinus; *h*, the hilus.



Fig. 416.—A. Portion of a secreting tubule from the cortical substance of the kidney. B. The epithelial or gland-cells.  $\times 700$  times.

through them. They are bound together by connective-tissue.

In the pyramids the tubes are straight—uniting to form larger tubes as they descend through these from the cortical portion; while in the latter region they spread out more irregularly, and become much convoluted. But in the *boundary zone* between cortex and medulla, small collections of straight tubes called *medullary rays* project into the cortical region.

*Tubuli Uriniferi*.—The tubuli uriniferi (fig. 420) are composed of a basement membrane, lined internally by epithelium. They vary considerably in size in different parts of their course, but are, on an average, about  $\frac{1}{800}$  of an inch ( $\frac{1}{24}$  mm.) in diameter,

and are found to be made up of several distinct portions which differ from one another very markedly, both in situation and structure.

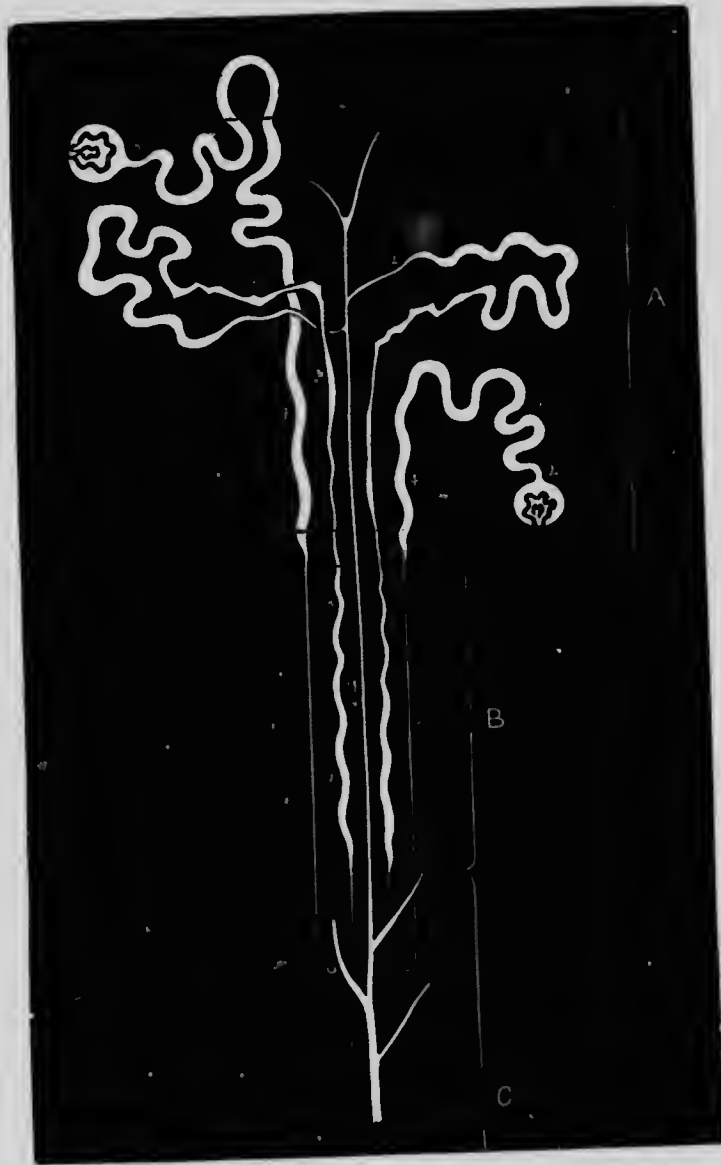

Fig. 417.—A diagram of the sections of uriniferous tubes. A, cortex limited externally by the capsule; *a*, subcapsular layer not containing Malpighian corpuscles; *a'*, inner stratum of cortex, also without Malpighian corpuscles; B, boundary layer; C, medullary part next the boundary layer; 1, Bowman's capsule of Malpighian corpuscle; 2, neck of capsule; 3, first convoluted tubule; 4, spiral tubule; 5, descending limb of Henle's loop; 6, the loop proper; 7, thick part of the ascending limb; 8, spiral part of ascending limb; 9, narrow ascending limb in the medullary ray; 10, the zigzag tubule; 11, the second convoluted tubule; 12, the junctional tubule; 13, the collecting tubule of the medullary ray; 14, the collecting tube of the boundary layer; 15, duet of Bellini. (Klein.)



Each begins in the cortex as a dilatation called the *Capsule of Bowman*; this encloses a tuft or glomerulus of capillaries called a *Malpighian corpuscle*. The tubule leaves the capsule by a *neck*, and then becomes convoluted (*first convoluted tubule*), but soon after becomes nearly straight or slightly spiral (*spiral tubule*); then rapidly narrowing it passes down into the medulla as the *descending tubule of Henle*; this

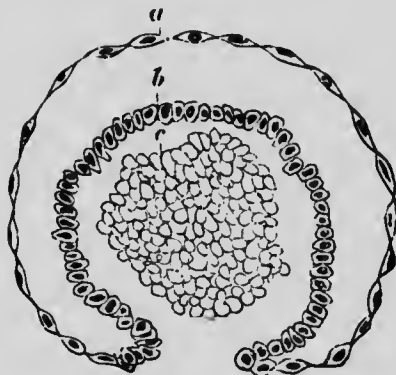

Fig. 418.—Transverse section of a developing Malpighian capsule and tuft (human).  $\times 300$ . From a foetus at about the fourth month; a, flattened cells growing to form the capsule; b, more rounded cells; continuous with the above, reflected round c, and finally enveloping it; c, mass of embryonic cells which will later become developed into blood-vessels. (W. Pye.)

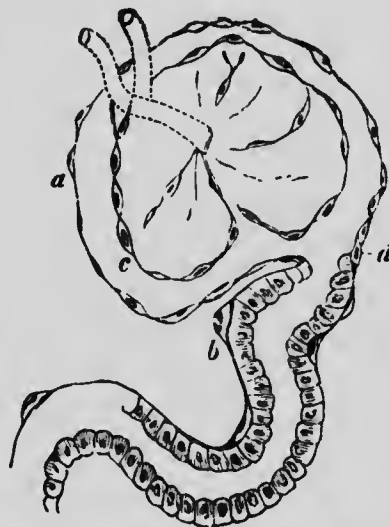

Fig. 419.—Epithelial elements of a Malpighian capsule and tuft, with the commencement of a urinary tubule showing the afferent and efferent vessel; a, layer of flat epithelium forming the capsule; b, similar, but rather larger epithelial cells, placed in the walls of the tube; c, cells, covering the vessels of the capillary tuft; d, commencement of the tubule, somewhat narrower than the rest of it. (W. Pye.)

turns round, forming a loop (*loop of Henle*), and passes up to the cortex again as the *ascending tubule of Henle*. It then becomes larger and irregularly zigzag (*zigzag tubule*) and again convoluted (*second convoluted tubule*). Eventually it narrows into a *junctional tubule*, which joins a straight or *collecting tubule*. This passes straight through the medulla, where it joins with others to form one of the *ducts of Bellini* that open at the apex of the pyramid. These parts are all shown in fig. 417.

The character of the epithelium that lines these several parts of the tubules is as follows:—

In the *capsule*, the epithelium is flattened and reflected over the glomerulus.

The way in which this takes place in process of development is shown in figs. 418 and 419.

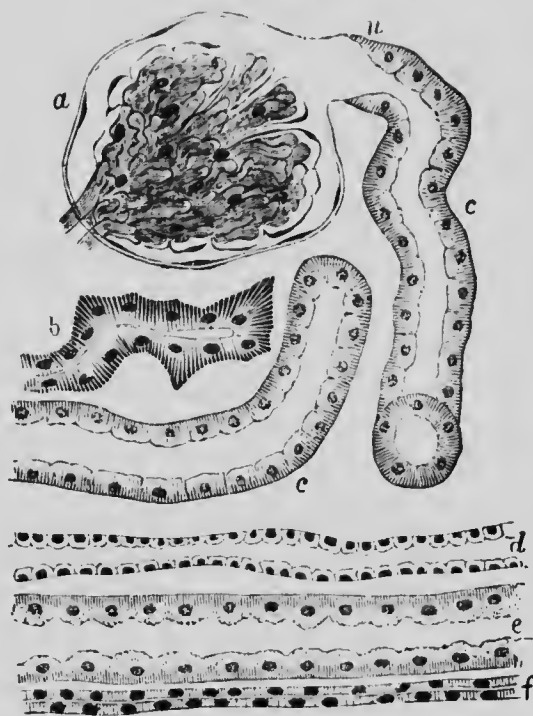

Fig. 420.—From a vertical section through the kidney of a dog—the capsule of which is supposed to be on the right. *a*, the capillaries of the Malpighian corpuscle, which are arranged in lobules; *n*, neck of capsule; *c*, convoluted tubes cut in various directions; *b*, zigzag tubule; *d*, *e*, and *f*, are straight tubes in a medullary ray; *d*, collecting tube; *e*, spiral tube; *f*, narrow section of ascending limb.  $\times 380$ . (Klein and Noble Smith.)

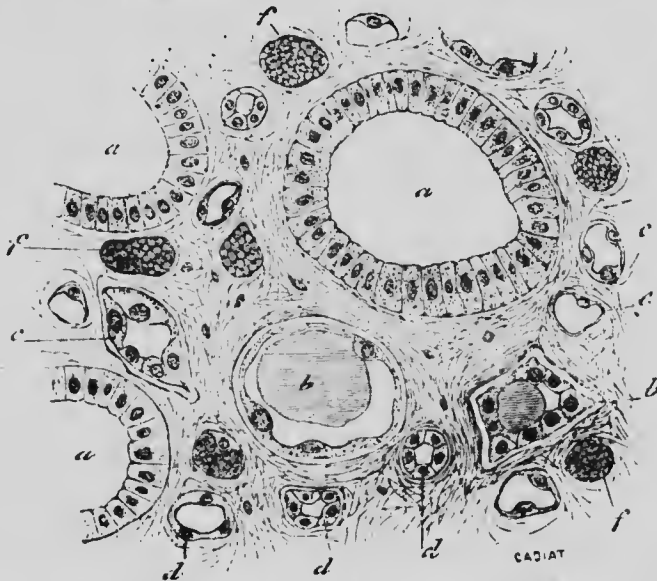

Fig. 421.—Transverse section of a renal papillar; *a*, large tubes or ducts of Bellini; *b*, *c*, and *d*, smaller tubes of Henle; *e*, *f*, blood capillaries, distinguished by their flatter epithelium. (Cadlat.)

In the *neck* the epithelium is still flattened, but in some animals, like frogs, where the neck is longer, the epithelium is ciliated.

In the *first convoluted and spiral tubules*, it is thick and the cells show a fibrillated structure, except around the nucleus, where the protoplasm is granular. The cells interlock laterally and are difficult to isolate. In some animals they are described as ciliated. In the *narrow descending tubule of Henle* and in *the loop itself*, the cells are clear and flattened and leave a considerable lumen; in the *ascending limb* they again become striated and nearly fill the tubule. In the *zigzag and second convoluted tubules* the fibrillations become even more marked. The *junctional tubule* has a large lumen, and is lined by clear flattened cells; the *collecting tubules and ducts of Bellini* are lined by clear cubical or columnar cells.

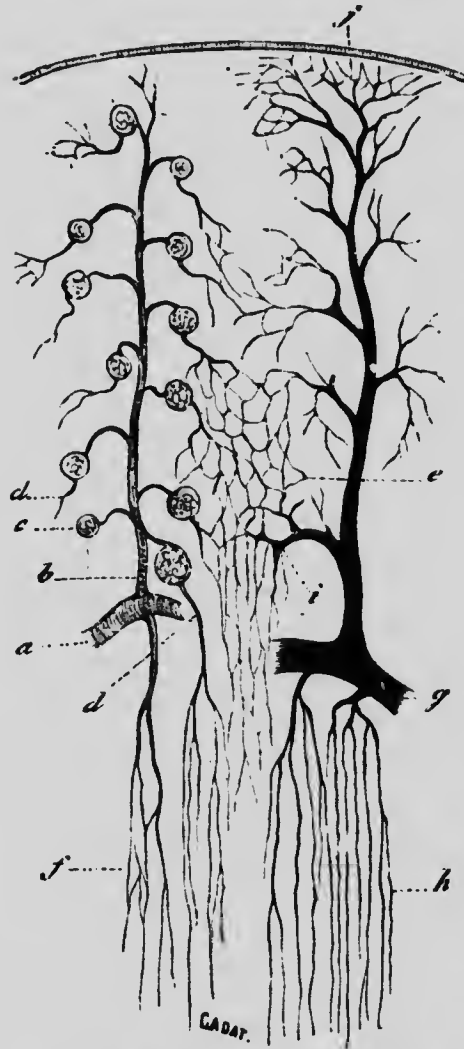

Fig. 422.—Vascular supply of kidney. *a*, part of arterial arch; *b*, interlobular artery; *c*, glomerulus; *d*, efferent vessel passing to the medulla as false arteria recta; *e*, capillaries of cortex; *f*, capillaries of medulla; *g*, venous arch; *h*, straight veins of medulla; *i*, interlobular vein; *j*, ven. stellula. (Cadat.)

**Blood - vessels of Kidney.**—The renal artery enters the kidney at the hilus, and divides into branches that pass towards the cortex, then turn over and form incomplete arches in the region between cortex and medulla. From these arches

vessels pass to the surface which are called the *interlobular arteries*; they give off vessels at right angles, which are the *afferent vessels of the glomeruli*; a glomerulus is made up of capillaries as

previously stated. From each, a smaller vessel (*the efferent vessel of the glomerulus*) passes out, and like a portal vessel on a small scale,



Fig. 423.—Diagram showing the relation of the Malpighian body to the uriniferous ducts and blood-vessels. *a*, one of the interlobular arteries; *a'*, afferent artery passing into the glomerulus; *c*, capsule of the Malpighian body, forming the termination of and continuous with *t*, the uriniferous tube; *e', e''*, efferent vessels which subdivide and form a plexus, *p*, surrounding the tube, and finally terminate in the branch of the renal vein *e*. (After Bowman.)



Fig. 424.—Malpighian corpuscle, injected through the renal artery with coloured gelatin; *a*, glomerular vessels; *b*, capsule; *c*, anterior capsule; *d*, afferent vessel of glomerulus; *e*, efferent vessels; *f*, epithelium of tubes. (Cadiat.)

breaks up once more into capillaries which ramify between the convoluted tubules. These unite to form veins (*interlobular veins*) which accompany the interlobular arteries; they pass to venous

arches, parallel to, but more complete than the corresponding arterial arches; they ultimately unite to form the renal vein that leaves the hilus. These veins receive also others which have a stellate arrangement near the capsule (*venæ stellatæ*).

The medulla is supplied by pencils of fine straight arterioles which arise from the arterial arches. They are called *arteriæ rectæ*. The efferent vessels of the glomeruli nearest the medulla may also break up into similar vessels which are called *false arteriæ rectæ*. The veins (*venæ rectæ*) take a similar course and empty themselves into the venous arches. In the boundary zone groups of *vasa recta* alternate with groups of tubules, and give a striated appearance to this portion of the medulla.

**The Ureters.**—The duct of each kidney, or *ureter*, is a tube about the size of a goose-quill, and from twelve to sixteen inches in length, which, continuous above with the pelvis, ends below by perforating obliquely the walls of the bladder, and opening on its internal surface.

It is constructed of three coats: (a) an outer *fibrous* coat; (b) a middle *muscular* coat, of which the fibres are unstriated, and arranged in three layers—the fibres of the central layer being circular, and those of the other two longitudinal in direction; the outermost longitudinal layer is, however, present only in the lower part of the ureter; and (c) a *mucous membrane* continuous with that of the pelvis above, and of the urinary bladder below. It is composed of areolar tissue lined by transitional epithelium.

**The Urinary Bladder**, which forms a receptacle for the temporary lodgment of the urine in the intervals of its expulsion from the body, is pyriform, its widest part, which is situated above and behind is termed the *fundus*; and the narrow constricted portion in front and below, by which it becomes continuous with the urethra, is called its *cervix* or *neck*.

It is constructed of four coats,—*serous*, *muscular*, *areolar* or *submucous*, and *mucous*. (a.) The *serous* coat, which covers only the posterior and upper part of the bladder, has the same structure as the peritoneum, with which it is continuous. (b.) The fibres of the *muscular* coat, which are unstriated, are arranged in three layers, of which the external and internal have a general longitudinal, and the middle layer a circular direction. The latter are especially developed around the *cervix* of the organ and form the *sphincter vesicæ*. (c.) The *areolar* or *submucous* coat is constructed of connective-tissue with a large portion of elastic fibres. (d.) The *mucous* membrane is like that of the ureters. It is provided with mucous glands, which are most numerous near the neck of the bladder.

The bladder is well provided with *blood- and lymph-vessels*, and with *nerves*. The latter are both medullated and non-medullated fibres, and consist of branches from the sacral plexus and hypogastric plexus. Ganglion cells are found, here and there, on the course of the nerve-fibres.

**The Urethra.**—This occupies the centre of the corpus spongiosum in the male. As it passes through the prostate it is lined by transitional, but elsewhere by columnar epithelium, except near the orifice, where it is stratified like the epidermis with which it becomes continuous. The female urethra has stratified epithelium throughout. The epithelium rests on a

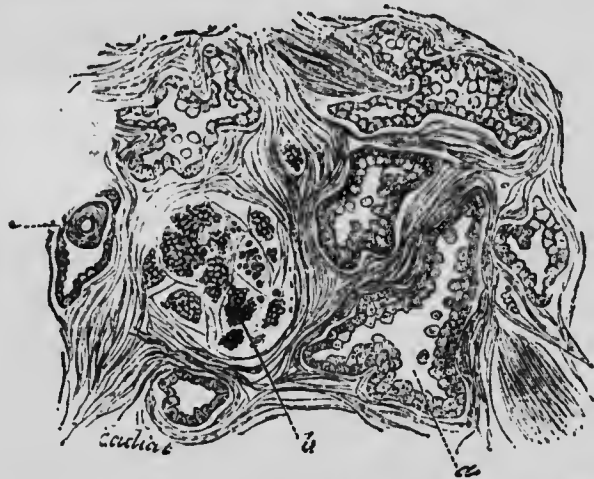

Fig. 425.—Section of a small portion of the prostate. *a*, gland duct cut across obliquely; *b*, gland structure; *c*, prostatic calculus. (Cadiat.)

vascular corium, and this is covered by submucous tissue containing an inner longitudinal and an outer circular muscular layer. Outside this a plexus of veins passes insensibly into the surrounding erectile tissue.

Into the urethra open a number of oblique recesses or *lacunæ*, a number of small mucous glands (glands of Littre), two compound racemose glands (Cowper's glands), the glands of the prostate, and the vas deferens. *The prostate*, which surrounds the commencement of the male urethra, is a muscular and glandular mass. Its glands are tubular and lined by columnar epithelium.

#### THE FUNCTIONS OF THE KIDNEYS.

The main function of the kidneys is to separate the urine from the blood. The true secreting part of the kidney is the glandular epithelium that lines the convoluted portions of the tubules;

there is in addition to this what is usually termed the filtering apparatus: we have already seen that the tufts of capillary blood-vessels called the Malpighian glomeruli are supplied with afferent vessels from the renal artery; the efferent vessels that leave these have a smaller calibre, and thus there is high pressure in the Malpighian capillaries. Certain constituents of the blood, especially water and salts, pass through the thin walls of these vessels into the surrounding Bowman's capsule which forms the commencement of each renal tubule. Though the process which occurs here is generally spoken of as a filtration, yet it is no purely mechanical process, but the cells exercise a selective influence, and prevent the albuminous constituents of the blood from escaping. During the passage of the water which leaves the blood at the glomerulus through the rest of the renal tubule, it gains the constituents urea, urates, &c., which are poured into it by the secreting cells of the convoluted tubules.

The term *excretion* is better than *secretion* as applied to the kidney, for the constituents of the urine are not actually formed in the kidney itself (as, for instance, the bile is formed in the liver), but they are formed elsewhere; the kidney is simply the place where they are picked out from the blood and eliminated from the body.

#### The Nerves of the Kidney.

*Nerves.*—The nerves of the kidney are derived from the renal plexus of each side. This consists of both medullated and non-medullated nerve-fibres, the former of varying size, and of nerve-cells. Fibres from the anterior roots of the eleventh, twelfth, and thirteenth dorsal nerves (in the dog) pass into this plexus. They are both vaso-constrictor and vaso-dilatator in function. The nerve-cells on the course of the constrictor fibres are situated in the cœliac, mesenteric, and renal ganglia; the cells on the course of the dilatator fibres are placed in the solar plexus and renal ganglia.

These nerves are thus vaso-motor in function; we have at present no knowledge of true secretory nerves to the kidney; the amount of urine varies directly with the blood-pressure in its capillaries.

Increase in the quantity of urine is caused by a rise of intra-capillary pressure. This may be produced by increasing the general blood-pressure; and this in turn may be produced in the following ways:—

- (1.) By increase in the force or frequency of the heart beat.
- (2.) By constriction of the arterioles of areas other than that

of the kidney, as in cold weather, when the cutaneous capillaries are constricted.\*

(3.) By increase in the total contents of the vascular system, as after drinking large quantities of fluid.

The blood-pressure in the renal capillaries may also be increased locally by anything which leads to relaxation of the renal arterioles.

Decrease in the quantity of urine is produced by the opposites in each case.

If the renal nerves are divided, the renal arterioles are relaxed, and pressure in the renal capillaries is raised, so there is an increased flow of urine. This is accompanied by an increase in the volume of the kidney, as can be seen by the oncometer.

Stimulation of the divided nerves produces a diminution in the amount of urine, and a shrinkage of the kidney due to a constriction of the blood-vessels.†

If the splanchnic nerves are experimented with instead of the renal, the effects are not so marked, as these nerves have a wide distribution, and section leads to vascular dilatation in the whole splanchnic area; hence the increase in pressure in the renal capillaries is not so noticeable.

Puncture of the floor of the fourth ventricle in the neighbourhood of the vaso-motor centre (close to the spot, puncture of which produces glycosuria) leads to a relaxation of the renal arterioles and a consequent large increase of urine (polyuria).

Section of the spinal cord just below the medulla causes a cessation of secretion of urine, because of the great fall of general blood-pressure which occurs. If the animal is kept alive, however, blood-pressure goes up after a time, owing to the action of subsidiary vaso-motor centres in the cord. When this has occurred stimulation of the peripheral end of the cut spinal cord again causes urinary secretion to stop, because the renal artery (like the other arteries of the body) is so constricted that the pressure in the renal capillaries becomes too low for secretion to occur.

We thus see that the amount of urine varies with blood-pressure. But such a statement does not give the whole truth. Increase of blood-pressure and an increased amount of blood flowing through the kidney go together when the blood is circulating normally, and it is really the increase in the amount of

\* The reciprocal action between skin and kidneys will be discussed more fully in the chapter on the skin.

† The nerves also contain vaso-dilatator fibres, which are excited when a low rate of stimulation is used (see p. 309).



blood which causes the rise in the amount of urine secreted. If the blood-pressure is increased without allowing the blood to flow the amount of urine formed is not raised. This can be done by ligaturing the renal vein; the blood-pressure within the kidney then rises enormously, but the flow of urine stops.



Fig. 426.—Oncometers for kidneys of different sizes.

Another effect of ligaturing the blood-vessels of the kidney must be here mentioned. If the vessels are temporarily ligatured, and then the ligature is released, the urine which is then formed is for a time albuminous. This is because the temporary anemia of the kidney produced by the ligature has lessened the vitality



Fig. 427.—Curve taken by renal oncometer compared with that of ordinary blood-pressure. *a*, Kidney curve; *b*, blood-pressure curve. (Roy.)

of the renal epithelium in such a way that it is no longer able to prevent the escape of albumin from the blood.

The **Oncometer** is an instrument constructed on plethysmographic principles, by means of which the volume of the kidney is registered. The general characters of this instrument are described in the diagrams on pp. 310, 311. The special form adapted for the kidney is shown in fig. 426. An air oncometer

connected with Marey's tambour gives equally good or even better results.

It is found that the effect on the volume of the organ of dividing or stimulating nerves corresponds to blood-pressure. A rise of blood-pressure in the renal artery is produced by constriction of the renal arterioles; this is accompanied by a fall of pressure in the renal capillaries, and a shrinkage of the kidney. Increase in the volume of the kidney is produced by the opposite circumstances.

The accompanying tracing (fig. 427) shows that in a kidney curve one gets a rise of volume due to each heart beat, and larger waves which accompany respiration. In many cases larger sweeping waves (Tranbe-Hering curves) are often shown as well. If a kidney curve is compared with a tracing of arterial pressure, it will be seen that the rise of arterial pressure coincides with all of the oncograph lever due to constriction of the renal vessel.

**Diuretics** are drugs which produce an increased flow of urine; they act in various ways, some by increasing the general blood-pressure, others by acting locally upon the kidney (increasing its volume as measured by the oncometer); under this latter head are doubtless to be included some also which act on the renal epithelium rather than on the blood-vessels.

#### Activity of the Renal Epithelium.

The epithelium of the convoluted tubules has a structure which suggests from its resemblance to other forms of secreting epitheliums, that its function here also is secreting. This is confirmed by the manner in which the blood-vessels break up into capillaries around these tubules; and is further confirmed by experiments.

Heidenhain has shown that if a substance (sodium sulph-indigotate), which ordinarily produces blue urine, is injected into the blood (after section of the medulla oblongata, which causes lowering of the blood-pressure in the renal glomeruli), when the kidney is examined, the cells of the convoluted tubules (and of these alone) are stained with the substance, which is also found in the lumen of the tubules. This shows that the pigment at any rate is eliminated by the cells of the convoluted tubules, and that when by diminishing the blood-pressure, the filtration of urine is stopped, the pigment remains in the convoluted tubes, and is not, as would be under ordinary circumstances, swept away from them by the flushing of them by the watery part of urine derived from the glomeruli. It therefore is probable

that the cells, if they excrete the pigment, excrete urea and other substances also.

But the proof is not absolute, for the pigment is a foreign substance. Urea is a very difficult substance to trace in this way because it does not leave any coloured trail behind it. In birds the place of urea is taken by uric acid, and the urates can be actually traced, because they are deposited as crystals, and can be seen in the cells and convoluted tubes much in the same way as Heidenhain's blue pigment.

Other experiments, however, have been undertaken to prove the point for the case of urea.

If the part of the cortex of the kidney which contains the glomeruli is removed, urea still continues to be formed. This is an additional proof that the excretion is performed by the portions of the convoluted tubules that remain.

By using the kidney of the frog or newt, which has two distinct vascular supplies, one from the renal artery to the glomeruli, and the other from the renal-portal vein to the convoluted tubes, Nussbaum has shown that certain foreign substances, *e.g.* peptones and sugar, when injected into the blood, are eliminated by the glomeruli, and so are not got rid of when the renal arteries are tied; whereas certain other substances, *e.g.* urea, when injected into the blood, are eliminated by the convoluted tubes, even when the renal arteries have been tied. These experiments have, however, been subjected to considerable criticism, and some observers have failed to obtain the same result. It is a subject of so great importance that it demands complete re-investigation.

### The Work done by the Kidney.

Recent work by Starling, Hamburger, Dreser, and others has shown the great importance a proper study of osmosis in the body has in the understanding of many physiological facts.

The subject is by no means a simple one, but the following account of its bearing on urinary secretion (abstracted from Starling) will not lead us into anything very abstruse.

We have already seen that the urine is separated from the blood by a process which is not the simple one called filtration. This is further supported by the fact that it is possible to measure the work of the kidney, and it is found to be vastly greater than could be carried out by the intracapillary blood-pressure. The following facts will also teach us that reabsorption of water cannot, as Ludwig held, take place in the tubules.

The measurement of the work done by the kidney depends upon a determination of the respective *osmotic pressures* of the urine and blood plasma.

If a bladder containing strong salt solution is placed in a vessel of distilled water, water passes into the bladder by osmosis, so that the bladder is swollen, and a manometer connected with its interior will show a rise of pressure (osmotic pressure). But the total rise of pressure cannot be measured in this way for two reasons: (1) because the salt diffuses out as the water diffuses in; and (2) because the membrane of the bladder leaks; that is, permits of filtration when the pressure within it has attained a certain height.

It is therefore necessary to use a membrane which will not allow salt to pass out either by dialysis or filtration, though it will let the water pass in. Such membranes are called *semi-permeable* membranes, and one of the best of these is ferrocyanide of copper. This may be made by taking a cell of porous earthenware and washing it out first with copper sulphate and then with potassium ferrocyanide. An insoluble precipitate of copper ferrocyanide is thus deposited in the pores of the earthenware.

If such a cell is arranged as in fig. 428, and filled with a 1 per cent. solution of sodium chloride, water diffuses in, till the pressure registered by the manometer reaches the enormous height of 5000 millim. of mercury. If the pressure in the cell is increased beyond this artificially, water will be pressed through the semi-permeable walls of the cell and the solution will become more concentrated.

In other words, in order to make a solution of sodium chloride of greater concentration than 1 per cent., a pressure greater than 5000 mm. of mercury must be employed. The osmotic pressure exerted by a 2 per cent. solution would be twice as great.

It is, moreover, found that the osmotic pressures of various

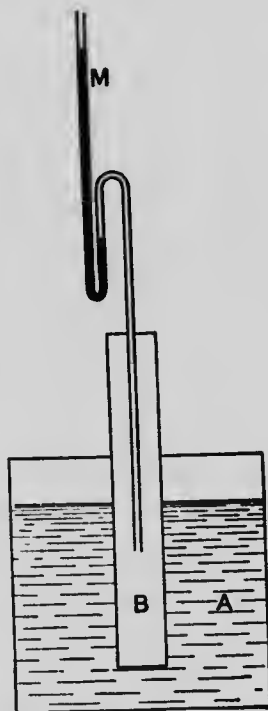

Fig. 428.—A, outer vessel, containing distilled water; B, inner semi-permeable vessel containing 1 per cent. salt solution; M, mercurial manometer. (After Starling.)

solutions depend merely on the number of molecules of any substance present; the nature of the substance makes no difference. The osmotic pressure is, in fact, equal to that which the dissolved substance would exert if it occupied the same space in the form of a gas. The osmotic pressure, however, of substances like sodium chloride which are electrolytes, is double what one would expect; this is because each molecule in solution is split into its constituent ions, sodium and chlorine.

Hence, if the osmotic pressures of blood plasma and urine are determined, the work done by the kidney cells in order to separate from the blood plasma a fluid with the osmotic pressure of the urine, can be estimated.

We may take some examples from Dreser's work. He took the case in which 200 c.c. of urine were excreted during a night; the blood plasma in this case had an osmotic pressure = 0.92 per cent. solution; while that of the urine was = 4.0 per cent. solution of sodium chloride. In this case the kidney had performed 37 kilogramme-metres of work. In another case of more concentrated urine obtained from a cat previously deprived of water for three days, the numbers were respectively 1.1 and 8.0. The difference was equal to a pressure of 498 metres of water; so that the kidney had separated urine from the blood against a pressure of 49,800 grammes per square centimetre, a force about six times greater than the maximum force of muscle.

The actual method of estimating osmotic pressure is not by means of a manometer as in the diagram, but by certain indirect methods. The one usually employed depends on the fact that the freezing point of a solution of any substance in water is lower than that of water; the lowering of the freezing point is proportional to the molecular concentration of the dissolved substance, and that as we have seen is proportional to the osmotic pressure. The gramme-molecule is the number of grammes corresponding to the molecular weight. Thus the gramme-molecular weight of sodium chloride is 58.37 grammes (Na = 23; Cl = 35.37), and of grape sugar ( $C_6H_{12}O_6$ ) 179.58 grammes. When a gramme-molecule of any substance is dissolved in a litre of water, the freezing point is lowered by 1.87° C., and the osmotic pressure is 16,963 mm. of mercury. From this we can calculate the osmotic pressure of any solution if we know the lowering of its freezing point.

$$\text{Osmotic pressure} = \frac{\text{lowering of freezing point}}{1.87} \times 16,963.$$

For example, a 1 per cent. solution of sugar would freeze at  $-0.052^\circ$  C. Its osmotic pressure is therefore  $\frac{0.052 \times 16,963}{1.87} = 472$  mm. of mercury.

The osmotic pressure of solutions may also be compared by observing their effect on red blood corpuscles, or on vegetable cells such as those in *Tradescantia*. If the solution is *hypertonic*, i.e. has a greater osmotic pressure than the cell contents, the protoplasm shrinks, and loses water, or if red corpuscles are used, they become crenated; if the solution is *hypotonic*, i.e. has a less osmotic pressure than the material within the cell-wall, no shrinking of the

protoplasm in the vegetable cell takes place, and if red corpuscles are used they swell and liberate their pigment. *Isotonic* solutions produce neither of these effects, because they have the same molecular concentration and osmotic pressure as the material within the cell-wall.

### Extirpation of the Kidneys.

*Extirpation of one kidney* for various diseases (stone, &c.), is a by no means uncommon operation. It is not followed by any untoward result. The remaining kidney enlarges and does the work previously shared between the two.

*Extirpation of both kidneys* is fatal; the urea, &c., accumulate in the blood, and the animal dies in a condition of deep coma preceded by convulsions (uræmia). See p. 552.

*Ligature of both renal arteries* practically amounts to the same thing as extirpation of the kidneys, and leads to the same result. If the ligature is released the kidney once more sets to work, but the urine secreted is then albuminous, owing to the epithelium having been impaired by being deprived for a time of its normal blood supply.

*Removal of one kidney, followed at a later period by removal of a half or two-thirds of the other*, leads in dogs, in which the operation has been performed by Bradford, to a surprising result. After the second operation the urine is increased in amount, and the quantity of urea is much greater than normal. This comes from a disintegration of the nitrogenous tissues; the animal wastes rapidly and dies in a few weeks. It is thus evident that the kidneys play an important part in nitrogenous metabolism apart from merely excreting waste substances. The exact explanation has still to be found, but it is possible that the kidney, like the pancreas and liver, and many ductless glands, forms an internal secretion (see p. 493).

### The Passage of Urine into the Bladder.

As each portion of urine is secreted it propels that which is already in the uriniferous tubes onwards into the pelvis of the kidney. Thence through the ureter the urine passes into the bladder, into which its rate and mode of entrance has been watched in cases of *ectopia vesicæ*, i.e. of such fissures in the anterior and lower part of the walls of the abdomen, and of the front wall of the bladder, as expose to view its hinder wall together with the orifices of the ureters. The urine does not enter the bladder at any regular rate, nor is there a synchronism in its movement through the two ureters. During fasting, two or three drops enter the bladder every minute; each drop as it

enters first raises up the little papilla through which the ureter opens, and then passes slowly through its orifice, which at once again closes like a sphincter. In the recumbent posture, the urine collects for a little time in the ureters, then flows gently, and, if the body is raised, runs from them in a stream till they are empty. Its flow is aided by the peristaltic contractions of the ureters, and is increased in deep inspiration, or by straining, and in active exercise, and in fifteen or twenty minutes after a meal. The urine is prevented from regurgitation into the ureters by the mode in which these pass through the walls of the bladder, namely, by their lying for between half and three-quarters of an inch between the muscular and mucous coats before they turn rather abruptly forwards, and open through the latter into the interior of the bladder.

### Micturition.

The contraction of the muscular walls of the bladder may by itself expel the urine with little or no help from other muscles. In so far, however, as it is a *voluntary* act, it is performed by means of the abdominal and other expiratory muscles, which in their contraction press on the abdominal viscera, the diaphragm being fixed, and cause the expulsion of the contents of those whose sphincter muscles are at the same time relaxed. The muscular coat of the bladder co-operates, in micturition, by reflex *involuntary* action, with the abdominal muscles; and the act is completed by the *accelerator urinæ*, which, as its name implies, quickens the stream, and expels the last drop of urine from the urethra. The act, so far as it is not directed by volition, is under the control of a nervous *centre* in the lumbar spinal cord, through which, as in the case of the similar centre for defæcation, the various muscles concerned are harmonised in their action. It is well known that the act may be reflexly induced, *e.g.* in children who suffer from intestinal worms, or other such irritation. Generally the afferent impulse which calls into action the desire to micturate is excited by over distension of the bladder, or even by a few drops of urine passing into the urethra. The impulse passes up to the lumbar centre and produces on the one hand inhibition of the sphincter and on the other hand contraction of the necessary muscles for the expulsion of the contents of the bladder. The tonic action of the lumbar centre can also be inhibited by the will.

The bladder receives nerves from two sources:—(1) from the lower dorsal and upper lumbar nerves; these fibres pass to the

sympathetic chain, from here to the inferior mesenteric ganglion, and ultimately reach the bladder by the hypogastric nerves. Stimulation of these nerves causes contraction of the circular fibres of the bladder, including the sphincter; (from the second and third sacral nerves; these run to the bladder by the nervi erigentes. Stimulation of these nerves causes relaxation of the sphincter and contraction of the detrusor urinæ. (Zeissl.) Langley and Anderson find however that stimulation of both sets of nerves causes contraction of both longitudinally and circularly arranged muscle bundles.

---

## CHAPTER XXXVII.

### THE URINE.

**Quantity.**—A man of average weight and height passes from 1,400 to 1,600 c.c., or about 50 oz. daily. This contains about 50 grammes ( $1\frac{1}{2}$  oz.) of solids. For analytical purposes it should be collected in a tall glass vessel capable of holding 3,000 c.c., which should have a smooth-edged neck accurately covered by a ground-glass plate to exclude dust and prevent evaporation. The vessel, moreover, should be graduated so that the amount may be easily read off. From the total quantity thus collected in the twenty-four hours, samples should be drawn off for examination.

**Colour.**—This is some shade of yellow which varies considerably in health with the concentration of the urine. It is due to a mixture of pigments; of these urobilin is the one of which we have the most accurate knowledge. Urobilin has a reddish tint and is undoubtedly derived from the blood pigment, and, like bile pigment, is an iron-free derivative of hæmoglobin. The theory usually accepted concerning its mode of origin is that bile pigment is in the intestines converted into stercobilin; the most of the stercobilin leaves the body with the fæces; that some is reabsorbed and is excreted with the urine as urobilin. Both stercobilin and urobilin are very like the artificial reduction product of bilirubin called hydrobilirubin (see p. 504). Normal urine, however, contains very little urobilin. The actual body present is a chromogen or mother substance called urobilinogen, which by oxidation, for instance standing exposed to the air, is converted into the pigment proper. In certain diseased conditions the amount of urobilin is considerably increased.

The most abundant urinary pigment is a yellow one, named



*urochrome*. It shows no absorption bands. It is probably an oxidation product of urobilin. (Riva, A. E. Garrod.)

**Reaction.**—The reaction of normal urine is acid. This is not due to free acid, as the uric and hippuric acids in the urine are combined as urates and hippurates respectively. The acidity is due to acid salts of which acid sodium phosphate is the most important. Under certain circumstances the urine becomes less acid and even alkaline; the most important of these are as follows:—

1. During digestion. Here there is a formation of free acid in the stomach, and a corresponding liberation of bases in the blood, which, passing into the urine, diminish its acidity, or even render it alkaline. This is called *the alkaline tide*; the opposite condition, *the acid tide*, occurs after a fast—for instance, before breakfast.

2. In herbivorous animals and vegetarians. The food here contains excess of alkaline salts of acids like tartaric, citric, malic, &c. These acids are oxidised into carbonates, which passing into the urine give it an alkaline reaction.

**Specific Gravity.**—This should be taken in a sample of the twenty-four hours' urine with a urinometer.

The specific gravity varies inversely as the quantity of urine passed under normal conditions from 1015 to 1025. A specific gravity below 1010 should excite suspicion of hydruria; one over 1030, of a febrile condition, or of diabetes, a disease in which it may rise to 1050. The specific gravity has, however, been known to sink as low as 1002 (after large potations, *urina potus*), or to rise as high as 1035 (after great sweating) in perfectly healthy persons.

**Composition.**—The following table gives the average amounts of the urinary constituents passed by a man in the twenty-four hours:—

Total quantity of urine . . . . .	1500·00 grammes.
Water . . . . .	1440·00 "
Solids . . . . .	60·00 "
Urea . . . . .	35·00 "
Uric acid . . . . .	0·75 "
Sodium chloride . . . . .	16·5 "
Phosphoric acid . . . . .	3·5 "
Sulphuric acid . . . . .	2·0 "
Ammonia . . . . .	0·65 "
Creatinine . . . . .	0·9 "
Chlorine . . . . .	11·0 "
Potassium . . . . .	2·5 "
Sodium . . . . .	5·5 "
Calcium . . . . .	0·26 "
Magnesium . . . . .	0·21 "

The most abundant constituents of the urine are water, urea, and sodium chloride. In the foregoing table one must not be

misled by seeing the names of the acids and metals separated. The acids and the bases are combined to form salts, such as urates, chlorides, sulphates, phosphates, &c.

### Urea.

**Urea**, or **Carbamide**,  $\text{CO}(\text{NH}_2)_2$ , is isomeric (that is, has the same empirical, but not the same structural formula) with ammonium cyanate  $(\text{NH}_4)\text{CNO}$ , from which it was first prepared synthetically by Wöhler in 1828. Since then it has been prepared synthetically in other ways. Wöhler's observation derives interest from the fact that this was the first organic substance which was prepared synthetically by chemists.

When crystallised out from the urine it is found to be readily soluble both in water and alcohol: it has a saltish taste, and is neutral to litmus paper. The form of its crystals is shown in fig. 429.

When treated with nitric acid, nitrate of urea  $(\text{CON}_2\text{H}_4.\text{HNO}_3)$  is formed; this crystallises in octahedra, lozenge-shaped tablets



Fig. 429.—Crystals of Urea.

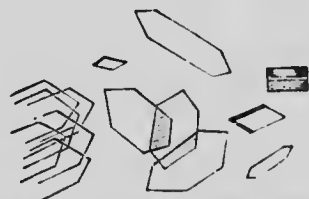

Fig. 430.—Crystals of Urea nitrate.

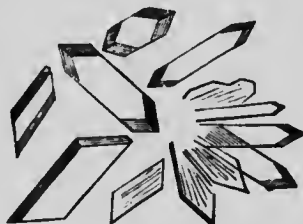

Fig. 431.—Crystals of Urea oxalate.

or hexagons (fig. 430). When treated with oxalic acid, flat or prismatic crystals of urea oxalate  $(\text{CON}_2\text{H}_4.\text{H}_2\text{C}_2\text{O}_4 + \text{H}_2\text{O})$  are formed (fig. 431).

These crystals may be readily obtained by adding excess of the respective acids to urine which has been concentrated to a third or a quarter of its bulk.

Under the influence of an organised ferment, the torula or micrococcus urææ, which grows readily in stale urine, urea takes up water, and is converted into ammonium carbonate

$[\text{CON}_2\text{H}_4 + 2\text{H}_2\text{O} = (\text{NH}_4)_2\text{CO}_3]$ . Hence the ammoniacal odour of putrid urine.

By means of nitrous acid, urea is broken up into carbonic acid, water and nitrogen,  $\text{CON}_2\text{H}_4 + 2\text{HNO}_2 = \text{CO}_2 + 3\text{H}_2\text{O} + 2\text{N}_2$ . The evolution of gas bubbles which takes place on the addition of fuming nitric acid may be used as a test for urea.

Hypobromite of soda decomposes urea in the following way :—

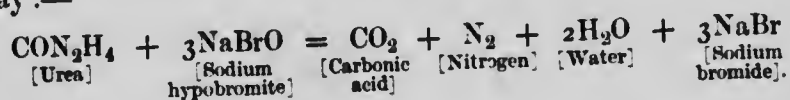

This reaction is important, for on it one of the readiest methods for estimating urea depends. There have been various pieces of apparatus invented for rendering the analysis easy; but the one described below is the best. If the experiment is performed as directed, nitrogen is the only gas that comes off, the carbonic acid being absorbed by excess of soda. The amount of nitrogen is a measure of the amount of urea.

Dupré's apparatus (fig. 432) consists of a bottle (A) united to a measuring tube by indiarubber tubing. The measuring tube (C) is placed within a cylinder of water (D), and can be raised and lowered at will. Measure 25 c.c. of alkaline solution of sodium hypobromite (made by mixing 2 c.c. of bromine with 23 c.c. of a 40 per cent. solution of caustic soda) into the bottle A. Measure 5 c.c. of urine into a small tube (B), and lower it carefully, so that no urine spills, into the bottle. Close the bottle securely with a stopper perforated by a glass tube; this glass tube (the bulb blown on this tube prevents froth from passing into the rest of the apparatus) is connected to the measuring tube by indiarubber tubing and a T-piece. The third limb of the T-piece is closed by a piece of indiarubber tubing and a pinch-cock, seen at the top of the figure. Open the pinch-cock and lower the measuring tube until the surface of the water with which the outer cylinder is filled is at the zero point of the graduation. Close the pinch-cock, and raise the measuring tube to ascertain if the apparatus is air-tight. Then lower it again. Tilt the bottle A so as to upset the urine, and shake well for a minute or so. During this time there is an evolution of gas. Then immerse the bottle in a large beaker containing water of the same temperature as that in the cylinder. After two or three minutes raise the measuring tube until the surfaces of the water inside and outside it are at the same level. Read off the amount of gas (nitrogen) evolved. 35.4 c.c. of nitrogen are yielded by 0.1 gramme of urea. From this the quantity of urea in the 5 c.c. of urine and the percentage of urea can be calculated. If the total urea passed in the twenty-four hours is to be ascertained, the twenty-four hours' urine must be carefully measured and thoroughly mixed. A sample is then taken from the total for analysis; and then, by a simple sum in proportion, the total amount of urea is ascertained. Sometimes the measuring tubes supplied with this apparatus are graduated in divisions corresponding to percentages of urea.

Another method (Liebig's) of estimating urea in urine is the following :— Take 40 c.c. of urine; add to this 20 c.c. of baryta mixture (two volumes of barium hydrate and one of barium nitrate, both saturated in the cold). Filter off the precipitate of barium phosphate and sulphate which is formed. Take 15 c.c. of the filtrate (this corresponds to 10 c.c. of urine) in a beaker. Run

into it from a burette standard mercuric nitrate solution of such a strength that 1 c.c. exactly precipitates 0.01 gramme of urea as a compound with the formula  $(\text{CON}_2\text{H}_4)_2\text{Hg}(\text{NO}_3)_2(\text{HgO})_2$ . The solution is run in until the precipitate ceases to form, and free mercuric nitrate is present in the mixture; this can be detected by the yellow colour a drop of the mixture gives with a drop of saturated solution of sodium carbonate on a white slab. The amount used from the burette can be read off, and the percentage of urea calculated. In another specimen of the same urine, the chlorides are then estimated, and 1 gramme of urea subtracted for every 1.3 gramme of sodium chloride formed.

The hypobromite and Liebig's method give practically identical results; the former is the easier to perform and the results are sufficiently accurate for ordinary purposes.

A more accurate determination can be best made by the method introduced by Mörner and Sjöquist. The following reagents, &c., are wanted:—(i.) A saturated solution of barium chloride containing 5 per cent. of barium hydrate; (ii.) A mixture of alcohol and ether in the proportion 2:1; (iii.) The apparatus, &c., necessary for carrying out Kjeldahl's method of estimating nitrogen. 5 c.c. of urine are mixed with 5 c.c. of the barium mixture, and 100 c.c. of the ether-alcohol mixture. By this means all nitrogenous substances except urea are precipitated. Twenty-four hours later this is filtered off, and the precipitate is washed with 50 c.c. of the ether-alcohol mixture. The washings are added to the filtrate, and a little magnesia is added to drive off ammonia. The fluid is then evaporated down at  $55^\circ\text{C}$ . until its volume is about 10 c.c., and the nitrogen in this estimated by Kjeldahl's method. The nitrogen found is multiplied by 2.143, and the result is the amount of the urea.

Kjeldahl's method of estimating nitrogen consists in boiling the material under investigation with strong sulphuric acid. The nitrogen present is by this means converted into ammonia. Excess of soda is then added, and the ammonia distilled over into a known volume of standard acid. The amount of diminution of acidity in the standard enables one to calculate the amount of ammonia, and thence the amount of nitrogen.

The quantity of urea is somewhat variable, the chief cause of variation being the amount of proteid food ingested. In a man in a state of equilibrium the quantity of urea secreted daily is about 33 to 35 grammes (500 grains). The normal percentage in human urine is 2 per cent.; but this also varies, because the concentration of the urine varies considerably in health. In dogs it may be 10 per cent. The excretion of urea is usually at a

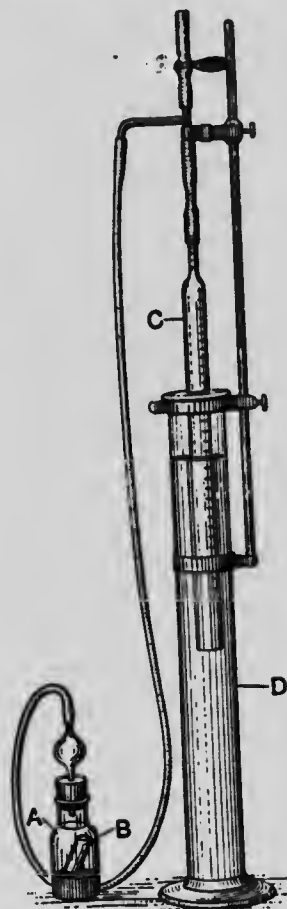

Fig. 432.—Dupré's urea apparatus.

maximum three hours after a meal, especially after a meal rich in proteids. The urea does not come, however, direct from the food; the food must be first assimilated, and become part of the body, before it can break down to form urea. An exception to this rule is to be found in the case of the amido-acids, especially leucine and arginine (see p. 488), which are formed in the intestinal canal from proteids during digestion. These substances are carried to the liver, and there converted into urea; but only a very small fraction of the urea in the urine is formed in this way. Food increases the elimination of urea because it stimulates the tissues to increased activity; their waste nitrogenous products are converted into urea, which, passing into the blood, is directly excreted by the kidneys. The greater the amount of proteid food given, the more waste products do the tissues discharge from their protoplasm, in order to make room for the new proteid which is built into its substance.

Muscular exercise has little immediate effect on the amount of urea discharged. In very intense muscular work there is a slight immediate increase of urea, but this is quite insignificant when compared to the increase of work. This is strikingly different from what occurs in the case of carbonic acid; the more the muscles work, the more carbonic acid do they send into the venous blood, which is rapidly discharged by the expired air. Recent careful research has, however, shown that an increase of nitrogenous waste does occur on muscular exertion, but appears as urea in the urine to only a slight extent on the day of the work; the major part is excreted during the next day.

**Where is Urea formed?**—The older authors considered that it was formed in the kidneys, just as they also erroneously thought that carbonic acid was formed in the lungs. Prévost and Dumas were the first to show that after complete extirpation of the kidneys the formation of urea goes on, and that it accumulates in the blood and tissues. Similarly, in those cases of disease in which the kidneys cease work, urea is still formed and accumulates. This condition is called *uræmia* (or urea in the blood), and unless the urea be discharged from the body the patient dies. There is no doubt, however, that it is not urea but some antecedent of urea that acts most poisonously, and is the cause of death.

Where, then, is the seat of urea formation? Nitrogenous waste occurs in all the living tissues, and the principal final result of this proteid metabolism is urea. It may not be that the formation of urea is perfected in each tissue, for if we look to the most abundant tissue, the muscular tissue, urea is absent, or

nearly so. Yet there can be no doubt that the chief place from which urea ultimately comes is the muscular tissue. Some intermediate step occurs in the muscles; the final steps occur elsewhere.

In muscles we find a substance called *creatine* in fairly large quantities. If creatine is injected into the blood it is discharged as creatinine. But there is very little creatinine in normal urine; what little there is can be nearly all accounted for by the creatine in the food; the muscular creatine is discharged as urea; moreover, urea can be artificially obtained from creatine in the laboratory.

Similarly, other cellular organs, spleen, lymphatic glands, secreting glands, participate in the formation of urea; but the most important appears to be the liver: this is the organ where the final changes take place. The urea is then carried by the blood to the kidney, and is there excreted.

The facts of experiment and of pathology point very strongly in support of the theory that urea is formed in the liver. The principal are the following:—

1. After removal of the liver in such animals as frogs, urea formation almost ceases, and ammonia is found in the urine instead.

2. In mammals, the extirpation of the liver is such a severe operation that the animals do not live. But the liver of mammals can be very largely thrown out of gear by connecting the portal vein directly to the inferior vena cava (Eck's fistula). This experiment has been done successfully in dogs; the amount of urea in the urine is lessened, and its place is taken by ammonia.

3. When degenerative changes occur in the liver, as in *cirrhosis* of that organ, the urea formed is much lessened, and its place is taken by ammonia. In *acute yellow atrophy* urea is almost absent in the urine, and, again, a considerable increase in the ammonia. In this disease leucine and tyrosine are also found in the urine; undue stress should not be laid upon this latter fact, for the leucine and tyrosine doubtless originate in the intestine, and, escaping further decomposition in the degenerated liver, pass as such into the urine.

We have to consider next the intermediate stages between proteid and urea. A few years ago Drechsel succeeded in artificially producing urea from casein. More recent work has shown that this is true for other proteids also. If a proteid is decomposed by hydrochloric acid, a little stannous chloride being added to prevent oxidation, a number of products are obtained, such as ammonium salts, leucine, tyrosine, aspartic, and glutaminic acids.

This was known before, so the chief interest centres round two new substances, precipitable by phosphotungstic acid. One of these is called *lysine* ( $C_6H_{14}N_2O_2$ , probably di-amido-caproic acid); the other was first called *lysatinine*. Hedin then showed that lysatinine is a mixture of lysine with another base called *arginine* ( $C_6H_{14}N_4O_2$ ); it is from the arginine that the urea comes in the experiment to be next described. Arguing from some resemblances between this substance and creatinine, Drechsel expected to be able to obtain urea from it, and his expectation was confirmed by experiment. He took a silver compound of the base, boiled it with barium carbonate, and after twenty-five minutes' boiling, obtained urea.

It is, however, extremely doubtful whether the chemical decompositions produced in laboratory experiments on proteids are comparable to those occurring in the body. Many physiologists consider that the amido-acids are intermediate stages in the metabolic processes that lead to the formation of urea from proteids. We have already alluded to this question in relation to the creatine of muscle, and we are confronted with the difficulty that injection of creatine into the blood leads to an increase not of urea, but of creatinine in the urine. If creatine is an intermediate step, it must undergo some further change before it leaves the muscle. Other amido-acids, such as glycocine (amido-acetic acid), leucine (amido-caproic acid) and arginine are probably to be included in the same category; there is, however, no evidence that tyrosine acts in this way. The facts upon which such a theory depends are (1) that the introduction of glycocine or leucine into the bowel, or into the circulation, leads to an increase of urea in the urine; and (2) that amido-acids appear in the urine of patients suffering from acute yellow atrophy of the liver. Then, again, it is perfectly true that, in the laboratory, urea can be obtained from creatine, and also from uric acid, but such experiments do not prove that creatine or uric acid are normally intermediate products of urea formation in the body. Still, if we admit for the sake of argument that amido-acids are normally intermediate stages in proteid metabolism, and glance at their formulæ—

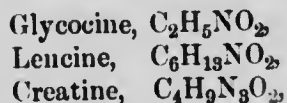

—we see that the carbon atoms are more numerous than the nitrogen atoms. In urea,  $CON_2H_4$ , the reverse is the case. The amido-acids must therefore be split into simpler compounds, which unite with one another to form urea. Urea formation

is thus, in part, synthetic. There have been various theories advanced as to what these simpler compounds are. Some have considered that cyanate, others that carbamate, and others still that carbonate of ammonium is formed. Schröder's work, which has been confirmed by subsequent investigators, proves that ammonium carbonate is one of the urea precursors, if not the principal one. The equation which represents the reaction is as follows:—

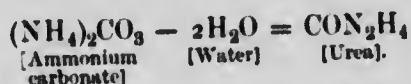

Schröder's principal experiment was this: a mixture of blood and ammonium carbonate was injected into the liver by the portal vein; the blood leaving the liver by the hepatic vein was found to contain urea in great abundance. This does not occur when the same experiment is performed with any other organ of the body, so that Schröder's experiments also prove the great importance of the liver in urea formation.

There is, however, no necessity to suppose that the formation of amido-acids is a necessary preliminary to urea formation. The conversion of the leucine and arginine formed in the intestine into ammonium salts and then into urea does certainly occur, but this only accounts for quite an insignificant fraction of the urea in the urine. If this also occurs in tissue metabolism, we ought to find considerable quantities of leucine, glycocine, creatine, arginine, and such substances in the blood, leaving the various tissues and entering the liver; but we do not. We do, however, constantly find ammonia which, after passing into the blood or lymph, has united with carbonic acid to form either carbonate or carbamate of ammonium. It is quite probable that the nitrogenous waste that leaves the muscles and other tissues is split off from them as ammonia, and not in the shape of large molecules of amido-acid, which are subsequently converted into ammonia. The experiments outside the body which most closely imitate those occurring within the body are those of Drechsel, in which he passed strong alternating currents through solutions of proteid-like materials. Such alternating currents are certainly absent in the body, but their effect, which is a rapidly changing series of small oxidations and reductions, are analogous to metabolic processes; under such circumstances the carbon atoms are burnt off as carbon dioxide, and the nitrogen is split off in the form of ammonia; by the union of these two substances ammonium carbonate is formed.

The following structural formulæ exhibit the relationship



between ammonium carbonate, ammonium carbamate and urea. The loss of one molecule of water from ammonium carbonate produces ammonium carbamate; the loss of a second molecule of water produces urea—

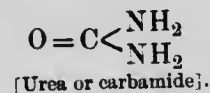
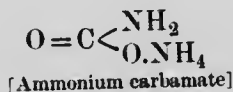
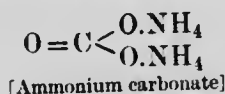

### Uric Acid.

**Uric Acid** ( $\text{C}_5\text{N}_4\text{H}_4\text{O}_3$ ) is in mammals, the medium by which a very small quantity of nitrogen is excreted from the body. It is, however, in birds and reptiles the principal nitrogenous constituent of their urine. It is not present in the free state, but is combined with bases to form urates.

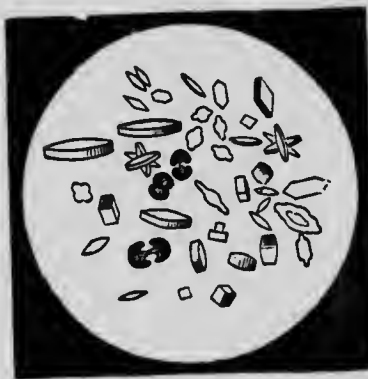

Fig. 433.—Various forms of uric acid crystals.

It may be obtained from human urine by adding 5 c.c. of hydrochloric acid to 100 c.c. of the urine, and allowing the mixture to stand for twelve to twenty-four hours. The crystals which form are deeply tinged with urinary pigment, and though by repeated solution in caustic soda or potash, and precipitation by hydrochloric acid, they may be obtained fairly

free from pigment, pure uric acid is more readily obtained from the solid urine of a serpent or bird, which consists principally of the acid ammonium urate. This is dissolved in soda, and then the addition of hydrochloric acid produces as before the crystallisation of uric acid from the solution.

The pure acid crystallises in colourless rectangular plates or prisms. In striking contrast to urea it is a most insoluble substance, requiring for its solution 1,900 parts of hot and 15,000 parts of cold water. The forms which uric acid assumes when precipitated from human urine, either by the addition of hydrochloric acid or in certain pathological processes, are very various, the most frequent being the whetstone shape; there are also bundles of crystals resembling sheaves, barrels, and dumb-bells (see fig. 433).

The *murexide* test is the principal test for uric acid. The test has received the name on account of the resemblance of the colour

to the purple of the ancients, which was obtained from certain snails of the genus *Murex*. It is performed as follows : place a little uric acid or a urate in a capsule ; add a little dilute nitric acid and evaporate to dryness. A yellowish-red residue is left. Add a little ammonia carefully, and the residue turns violet ; this is due to the formation of purpurate of ammonia. On the addition of potash the colour becomes bluer.

Another reaction that uric acid undergoes (though it is not applicable as a test) is, that on treatment with certain oxidising reagents urea and oxalic acid can be obtained from it. Alloxan ( $C_4H_2N_2O_4$ ) or allantoin ( $C_4H_6N_4O_3$ ) are intermediate products. It is, however, doubtful whether a similar oxidation occurs in the normal metabolic processes of the body.

Uric acid is dibasic, and thus there are two classes of urates—the normal urates and the acid urates. A normal urate is one in which two atoms of the hydrogen are replaced by two of a monad metal like sodium ; an acid urate is one in which only one atom of hydrogen is thus replaced. The formulæ would be—

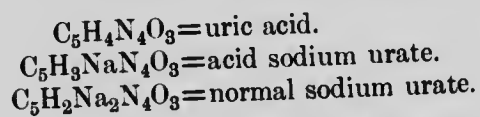

The acid sodium urate is the chief constituent of the pinkish deposit of urates, which often occurs in urine, and is called the *lateritious deposit*.

The quantity of uric acid excreted by an adult varies from 7 to 10 grains (0.5 to 0.75 gramme) daily.

The best method for determining the quantity of uric acid in the urine is that of Hopkins. Ammonium chloride in crystals is added to the urine until no more will dissolve. This saturation completely precipitates all the uric acid in the form of ammonium urate. After standing for two hours the precipitate is collected on a filter, washed with saturated solution of ammonium chloride, and then dissolved in weak alkali. From this solution the uric acid is precipitated by neutralising with hydrochloric acid. The precipitate of uric acid is collected on a weighed filter, dried, and weighed ; or the crystals may be dissolved in sodium carbonate solution, and titrated with standard solution of potassium permanganate, until a diffused pink flush appears throughout the solution.

**Origin of Uric Acid.**—Uric acid is not made by the kidneys. When the kidneys are removed uric acid continues to be formed and accumulates in the organs, especially in the liver and spleen. The liver has been removed from birds, and uric acid is then

hardly formed at all, its place being taken by ammonia and lactic acid. It is therefore probable that ammonia and lactic acid are normally synthesised in the liver to form uric acid.

The chief conditions which lead to an increase of uric acid are :—

1. Increase of meat diet and diminution of oxidation processes, such as occur in people with sedentary habits.
2. Pathological conditions allied to gout.
3. Increase of white corpuscles in the blood, especially in the disease known as *leucocythæmia*. This latter fact is of great interest, as leucocytes contain large quantities of nuclein. Nuclein yields nitrogenous (purine) bases (adenine, hypoxanthine, &c.), which are closely related to uric acid.

The close relationship of the purine bases to uric acid has been clearly demonstrated by the work of Emil Fischer, for they are all derivatives of the substance called *purine*. The names and formulæ of these substances are as follows :—

	Purine	. . . . .	$C_5H_4N_4$
Purine bases	{	Hypoxanthine (monoxy-purine)	. . . . . $C_5H_4N_4O$
		Xanthine (dioxy-purine)	. . . . . $C_5H_4N_4O_2$
		Adenine (amino-purine)	. . . . . $C_5H_4N_4.NH$
		Guanine (amino-oxy purine)	. . . . . $C_5H_4N_4O.NH$
		Uric acid (trioxy-purine)	. . . . . $C_5H_4N_4O_3$

Leaving aside other possible ways in which uric acid is undoubtedly formed in the organism, we have here a way in which uric acid may arise by oxidation from the nuclein bases and thus ultimately from the nuclei of cells. Certain forms of diet increase uric acid formation by leading to an increase of leucocytes and consequently increase in the metabolism of their nuclei; some investigators think, however, that the increase is chiefly due to nuclein in the food. The question is not yet settled.

### Hippuric Acid.

**Hippuric Acid** ( $C_9H_9NO_3$ ), combined with bases to form hippurates, is present in small quantities in human urine, but in large quantities in the urine of herbivora. This is due to the food of herbivora containing substances belonging to the aromatic group—the benzoic acid series. If benzoic acid is given to a man, it unites with glycocine with the elimination of a molecule of water, and is excreted as hippuric acid—

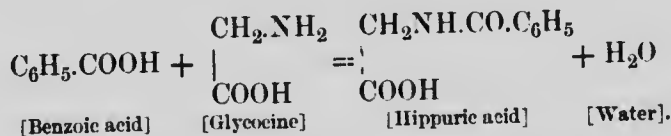

This is a well-marked instance of synthesis carried out in the

animal body, and experimental investigation shows that it is accomplished by the living cells of the kidney itself; for if a mixture of glycocine, benzoic acid, and blood is injected through the kidney (or mixed with a minced kidney just removed from the body of an animal), their place is found to have been taken by hippuric acid.

### Creatinine.

The **creatinine** in the urine is nearly all derived from the creatine contained in the meat of the food. There is, however, a small amount in the urine even during starvation: this possibly represents a small percentage of creatine from the muscles.

The formation of creatinine from creatine is represented in the following equation:—

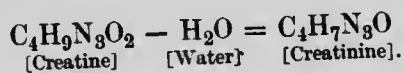

Creatine and creatinine are of considerable chemical interest, because urea can be obtained from them as one of their decomposition products in the laboratory; the equation which represents the formation of urea from creatine is as follows:—

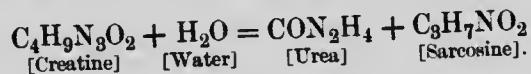

The second substance formed is sarcosine. Sarcosine is methylglycocine—that is, amido-acetic acid in which one H is replaced by methyl (CH<sub>3</sub>)



It is, however, doubtful whether decompositions of this kind occur in the body.

Creatinine with zinc chloride gives a characteristic crystalline precipitate (groups of fine needles) with composition

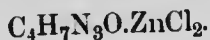

According to the recent researches of G. S. Johnson, urinary creatinine, though isomeric with the creatinine obtained artificially from the creatine of flesh, differs from it in some of



Fig. 434.—Crystals of hippuric acid.

its properties, such as reducing power, solubility, and character of its gold salts. The reducing action of urinary creatinine has led to some confusion, for some physiologists have supposed that the reducing action on Fehling's solution and picric acid of normal urine is due to sugar, whereas it is really chiefly due to creatinine. The readiest way of separating creatinine from urine is the following:—To the urine a twentieth of its volume of a saturated solution of sodium acetate is added, and then one-fourth of its volume of a saturated solution of mercuric chloride: this produces an immediate abundant precipitate of urates, sulphates, and phosphates, which is removed by filtration; the filtrate is then allowed to stand for twenty-four hours, when the precipitation of a mercury salt of creatinine  $(C_4H_5HgN_3OHCl)_4(HgCl_2)_3 + 2H_2O$  occurs in the form of minute spheres, quite typical on microscopic examination. This compound lends itself very well to quantitative analysis. It may be collected, dried, and weighed, and one-fifth of the weight found is creatinine. Creatinine may be obtained from it by suspending it in water, decomposing it with sulphuretted hydrogen, and filtering. The filtrate deposits creatinine hydrochloride, from which lead hydrate liberates creatinine. An important point in Johnson's process is that all the operations are carried out in the cold; if heat is applied one obtains the creatinine of former writers, which has no reducing power.

#### The Inorganic Constituents of Urine.

The inorganic or mineral constituents of urine are chiefly chlorides, phosphates, sulphates, and carbonates; the metals with which these are in combination are sodium, potassium, ammonium, calcium, and magnesium. The total amount of these salts varies from 19 to 25 grammes daily. The most abundant is sodium chloride, which averages in amount 10 to 16 grammes per diem. These substances are derived from two sources—first from the food, and secondly as the result of metabolic processes. The chlorides and most of the phosphates come from the food; the sulphates and some of the phosphates, as a result of metabolism. The salts of the blood and of the urine are much the same, with the important exception that, whereas the blood contains only traces of sulphates, the urine contains abundance of these salts. The sulphates are derived from the changes that occur in the proteids of the body; the nitrogen of proteids leaves the body as urica and uric acid; the sulphur of the proteids is oxidised to form sulphuric acid, which passes into the urine in the form of sulphates. The excretion of sulphates, moreover, runs parallel to that of urica.

**Chlorides.**—The chief chloride is that of sodium. The ingestion of sodium chloride is followed by its appearance in the urine, some on the same day, some on the next day. Some is decomposed to form the hydrochloric acid of the gastric juice. The salt, in passing through the body, fulfils the useful office of stimulating metabolism and secretion.

**Sulphates.**—The sulphates in the urine are principally those of potassium and sodium. They are derived from the metabolism of proteids in the body. Only the smallest trace enters the body with the food. Sulphates have an unpleasant bitter taste (for instance, Epsom salts): hence we do not take food that contains them. The sulphates vary in amount from 1.5 to 3 grammes daily.

In addition to these sulphates there is a small quantity, about one-tenth of the total sulphates, that are combined with organic radicles: these are known as ethereal sulphates, and they originate from putrefactive processes occurring in the intestine. The chief of these ethereal sulphates are phenyl sulphate of potassium and indoxyl sulphate of potassium. The latter originates from the indole formed in the intestine, and as it yields indigo when treated with certain reagents it is sometimes called *indican*. It is very important to remember that the indican of urine is not the same thing as the indican of plants, which is a glucoside. Both yield indigo, but there the resemblance ceases.

The formation of these sulphates is somewhat important; the aromatic substances liberated by putrefactive processes in the intestine are poisonous, but their conversion into ethereal sulphates renders them harmless.

The equation representing the formation of potassium phenyl-sulphate is as follows:—

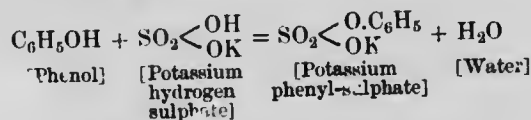

Indole ( $\text{C}_8\text{H}_7\text{N}$ ) on absorption is converted into indoxyl—

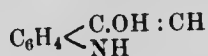

The equation representing the formation of potassium indoxyl-sulphate is as follows:—

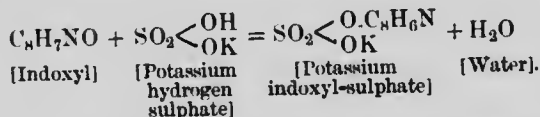

**Carbonates.**—Carbonates and bicarbonates of sodium, calcium, magnesium, and ammonium are only present in alkaline urine. They arise from the carbonates of the food, or from vegetable

acids (malic, tartaric, &c.) in the food. They are, therefore, found in the urine of herbivora and vegetarians, whose urine is thus rendered alkaline. Urine containing carbonates becomes, like saliva, cloudy on standing, the precipitate consisting of calcium carbonate, and also phosphates.

**Phosphates.**—Two classes of phosphates occur in normal urine:—

- (1) Alkaline phosphates — that is, phosphates of sodium (abundant) and potassium (scanty).
- (2) Earthy phosphates—that is, phosphates of calcium (abundant) and magnesium (scanty).



Fig. 435.—Urinary sediment of triple phosphates (large prismatic crystals) and urate of ammonium, from urine which had undergone alkaline fermentation.



Fig. 436.—Mucus deposited from urine.

The composition of the phosphates in urine is liable to variation. In acid urine the acidity is due to the acid salts. These are chiefly—

Sodium dihydrogen phosphate,  $\text{NaH}_2\text{PO}_4$ , and calcium dihydrogen phosphate,  $\text{Ca}(\text{H}_2\text{PO}_4)_2$ .

In neutral urine, in addition, disodium hydrogen phosphate ( $\text{Na}_2\text{HPO}_4$ ), calcium hydrogen phosphate,  $\text{CaHPO}_4$ , and magnesium hydrogen phosphate,  $\text{MgHPO}_4$ , are found. In alkaline urine there may be instead of, or in addition to the above, the normal phosphates of sodium, calcium, and magnesium [ $\text{Na}_3\text{PO}_4$ ,  $\text{Ca}_3(\text{PO}_4)_2$ ,  $\text{Mg}_3(\text{PO}_4)_2$ ].

The earthy phosphates are precipitated by rendering the urine alkaline by ammonia. In decomposing urine, ammonia is formed from the urea: this also precipitates the earthy phosphates. The phosphates most frequently found in the white creamy precipitate which occurs in decomposing urine are—

(1) Triple phosphate or ammonio-magnesium phosphate ( $\text{NH}_4\text{MgPO}_4 + 6\text{H}_2\text{O}$ ). This crystallises in "coffin-lid" crystals (see fig. 435) or feathery stars.

(2) Stellar phosphate, or calcium phosphate; this crystallises in star-like clusters of prisms.

As a rule normal urine gives no precipitate when it is boiled; but sometimes neutral, alkaline, and occasionally faintly acid urines give a precipitate of calcium phosphate when boiled: this precipitate is amorphous, and is liable to be mistaken for albumin. It may be distinguished readily from albumin, as it is soluble in a few drops of acetic acid, whereas coagulated proteid does not dissolve.

The phosphoric acid in the urine chiefly originates from the phosphates of the food, but is partly a decomposition product of the phosphorised organic materials in the body, such as lecithin and nuclein. The amount of  $\text{P}_2\text{O}_5$  in the twenty-four hours' urine varies from 2.5 to 3.5 grammes, of which the earthy phosphates contain about half (1 to 1.5 gr.).

#### Tests for the Inorganic Salts of Urine.

*Chlorides.*—Acidulate with nitric acid and add silver nitrate: a white precipitate of silver chloride, soluble in ammonia, is produced. The object of acidulating with nitric acid is to prevent phosphates being precipitated by the silver nitrate.

*Sulphates.*—Acidulate with hydrochloric acid, and add barium chloride. A white precipitate of barium sulphate is produced. Hydrochloric acid is again added first, to prevent precipitation of phosphates.

*Phosphates.*—i. Add ammonia: a white crystalline precipitate of earthy (that is, calcium and magnesium) phosphates is produced. This becomes more apparent on standing. The alkaline (that is, sodium and potassium) phosphates remain in solution. ii. Mix another portion of urine with half its volume of nitric acid; add ammonium molybdate, and boil. A yellow crystalline precipitate falls. This test is given by both classes of phosphates.

*Quantitative estimation* of the salts is accomplished by the use of solutions of standard strength, which are run into the urine till the formation of a precipitate ceases. The standards are made of silver nitrate, barium chloride, and uranium nitrate or acetate for chlorides, sulphates and phosphates respectively.

#### Urinary Deposits.

The different substances that may occur in urinary deposits are formed elements and chemical substances.

The **formed** or **anatomical elements** may consist of blood corpuscles, pus, mucus, epithelium cells, spermatozoa, casts of the urinary tubules, fungi, and entozoa. All of these, with the exception of a small quantity of mucus, which forms a flocculent cloud in the urine, are pathological, and the microscope is chiefly employed in their detection.



The chemical substances are uric acid, urates, calcium oxalate, calcium carbonate, and phosphates. Rarer forms are leucine, tyrosine, xanthine, and cystin. We shall, however, here only consider the commoner deposits, and for their identification the microscope and chemical tests must both be employed.

**Deposit of Uric Acid.**—This is a sandy reddish deposit resembling cayenne pepper. It may be recognised by its crystalline form (fig. 433, p. 556) and the murexide reaction. The presence of these crystals generally indicates an increased formation of uric acid, and, if excessive, may lead to the formation of stones or calculi in the bladder.

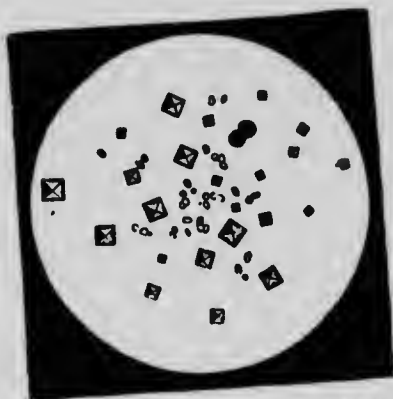

Fig. 437.—Crystals of Calcium Oxalate.

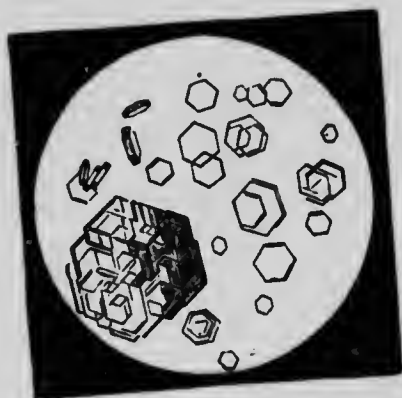
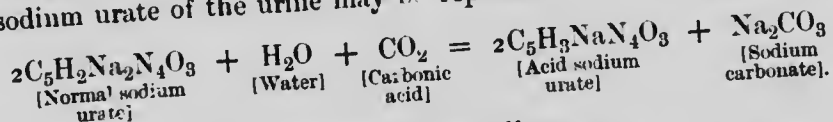

Fig. 438.—Crystals of Cystin.

**Deposit of Urates.**—This is much commoner, and may, if the urine is concentrated, occur in normal urine when it cools. It is generally found in the concentrated urine of fevers; and there appears to be a kind of fermentation, called the acid fermentation, which occurs in the urine after it has been passed, and which leads to the same result. The chief constituent of the deposit is the acid sodium urate, the formation of which from the normal sodium urate of the urine may be represented by the equation—



This deposit may be recognised as follows:—

- (1) It has a pinkish colour; the pigment called *uro-erythrin* is one of the pigments of the urine, but its relationship to the other urinary pigments is not known.
- (2) It dissolves upon warming the urine.
- (3) Microscopically it is usually amorphous, but crystalline forms similar to those depicted in fig. 435 may occur.

Crystals of calcium oxalate may be mixed with this deposit (see fig. 437).

**Deposit of Calcium Oxalate.**—This occurs in envelope crystals (octahedra) or dumb-bells.

It is insoluble in ammonia, and in acetic acid. It is soluble with difficulty in hydrochloric acid.

**Deposit of Cystin.**—Cystin ( $C_6H_{12}N_2S_2O_4$ ) is recognised by its colourless six-sided crystals (fig. 438). These are rare: they occur only in acid urine, and they may form concretions or calculi. Cystinuria (cystin in the urine) is hereditary.

**Deposit of Phosphates.**—These occur in alkaline urine. The urine may be alkaline when passed, due to fermentative changes occurring in the bladder. All urine, however, if exposed to the air (unless the air is perfectly pure, as on the top of a snow mountain), will in time become alkaline, owing to the growth of the *micrococcus ureæ*. This forms ammonium carbonate from the urea.

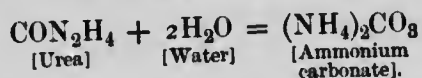

The ammonia renders the urine alkaline and precipitates the earthy phosphates. The chief forms of phosphates that occur in urinary deposits are—

- (1) Calcium phosphate,  $\text{Ca}_3(\text{PO}_4)_2$ ; amorphous.
- (2) Triple or ammonio-magnesium phosphate,  $\text{MgNH}_4\text{PO}_4$ ; coffin-lids and feathery stars (fig. 435).
- (3) Crystalline phosphate of calcium,  $\text{CaHPO}_4$ , in rosettes of prisms, in spherules, or in dumb-bells.
- (4) Magnesium phosphate,  $\text{Mg}_3(\text{PO}_4)_2 + 22\text{H}_2\text{O}$ , occurs occasionally, and crystallises in long plates.

All these phosphates are dissolved by acids, such as acetic acid, without effervescence.

They do not dissolve on heating the urine; in fact, the amount of precipitate may be increased by heating. Very often neutral or alkaline urine will become cloudy when boiled; this may be due to albumin or to phosphates. It is very important to distinguish between these two, as albuminuria is a serious condition. They may be distinguished by the use of acetic acid, which dissolves phosphates but not albumin.

A solution of ammonium carbonate (1-in-5) eats magnesium phosphate away at the edges; it has no effect on the triple phosphate. A phosphate of calcium ( $\text{CaHPO}_4 + 2\text{H}_2\text{O}$ ) may occasionally be deposited in acid urine. Pus in urine is apt to be mistaken for phosphates, but can be distinguished by the microscope.

**Deposit of calcium carbonate,  $\text{CaCO}_3$ ,** appears but rarely as whitish balls or biscuit-shaped bodies. It is commoner in the urine of herbivora. It dissolves in acetic or hydrochloric acid, with effervescence.

The following is a summary of the chemical sediments that may occur in urine:—

#### CHEMICAL SEDIMENTS IN URINE.

##### IN ACID URINE.

*Uric Acid.*—Whetstone, dumb-bell, or sheaf-like aggregations of crystals deeply tinged by pigment.

*Urates.*—Generally amorphous. The acid urate of sodium and of ammonium may sometimes occur in star-shaped clusters of needles or spheroidal clumps with projecting spines. Tinged brick-red. Soluble on warming.

*Calcium Oxalate.*—Octahedra, so-called envelope crystals. Insoluble in acetic acid.

*Cystin.*—Hexagonal plates. Rare.

*Leucine and Tyrosine.*—Rare.

*Calcium Phosphate,*  
 $\text{CaHPO}_4 + 2\text{H}_2\text{O}$ .—Rare.

##### IN ALKALINE URINE.

*Phosphates.*—Calcium phosphate,  $\text{Ca}_3(\text{PO}_4)_2$ . Amorphous.

Triple phosphate,

$\text{MgNH}_4\text{P}_3\text{O}_{10} + 6\text{H}_2\text{O}$ . Coffin-lids or feathery stars.

Calcium hydrogen phosphate,  $\text{CaHPO}_4$ . Rosettes, spherules, or dumb-bells.

Magnesium phosphate,  $\text{Mg}_3(\text{PO}_4)_2 + 22\text{H}_2\text{O}$ . Long plates.

All soluble in acetic acid without effervescence.

*Calcium Carbonate,*  $\text{CaCO}_3$ .—Biscuit-shaped crystals. Soluble in acetic acid with effervescence.

*Ammonium Urate,*  
 $\text{C}_8\text{H}_2(\text{NH}_4)_2\text{N}_4\text{O}_8$ .—“Thorn-apple” spherules.

*Leucine and Tyrosine.*—Very rare.

#### PATHOLOGICAL URINE.

Under this head we shall briefly consider only those abnormal constituents which are most frequently met with.

**Proteids.**—There is no proteid matter in normal urine,\* and the most common cause of the appearance of albumin in the urine is disease of the kidney (Bright's disease). The term “albumin” is the one used by clinical observers. Properly speaking, it is a mixture of serum albumin and serum globulin. The best methods of testing for and estimating the albumin are the following:—

(a) Boil the top of a long column of urine in a test-tube. If the urine is acid, the albumin is coagulated. If the quantity of albumin is small, the cloudiness produced is readily seen, as the unboiled urine below it is clear. This is insoluble in a few drops of acetic acid, and so may be distinguished from phosphates. If the urine is alkaline, it should be first rendered acid with a little dilute acetic acid.

\* This absolute statement is true for all practical purposes. Mörner, however, has recently stated that a trace of proteid matter (serum albumin plus the proteid constituent of mucin) does occur in normal urine; but the trace is negligible, many hundreds of litres of urine having to be used to obtain an appreciable quantity.

(b) *Heller's Nitric-acid Test.*—Pour some of the urine gently on to the surface of some nitric acid in a test-tube. A ring of white precipitate occurs at the junction of the two liquids. This test is used for small quantities of albumin.

(c) *Estimation of Albumin by Esbach's Albuminometer.*—Esbach's reagent for precipitating the albumin is made by dissolving 10 grammes of picric acid and 20 grammes of citric acid in 800 or 900 c.c. of boiling water and then adding sufficient water to make up to a litre (1000 c.c.).

The albuminometer is a test-tube graduated as shown in fig. 439.

Pour the urine into the tube up to the mark U; then the reagent up to the mark R. Close the tube with a cork, and to ensure complete mixture, tilt it to and fro a dozen times without shaking. Allow the corked tube to stand upright twenty-four hours; then read off on the scale the height of the coagulum. The figures indicate grammes of dried albumin in a litre of urine. The percentage is obtained by dividing by 10. Thus, if the coagulum stands at 3, the amount of albumin is 3 grammes per litre, or 0.3 gr. in 100 c.c. If the sediment falls between any two figures, the distance  $\frac{1}{2}$ ,  $\frac{1}{3}$ , or  $\frac{1}{4}$  from the upper or lower figure can be read off with sufficient accuracy. Thus, the surface of the sediment being midway between 3 and 4 would be read as 3.5. When the albumin is so abundant that the sediment is above 4, a more accurate result is obtained by first diluting the urine with one or two volumes of water, and then multiplying the resulting figure by 2 or 3, as the case may be. If the amount of albumin is less than 0.5 per cent., it cannot be accurately estimated by this method.

A condition called "peptonuria," or peptone in the urine, is observed in certain pathological states, especially in diseases where there is a formation of pus, and particularly if the pus is decomposed owing to the action of a bacterial growth called *staphylococcus*; one of the products of disintegration of pus cells appears to be peptone; and this leaves the body by the urine. The term "peptone," however, is in the strict sense of the word incorrect; the proteid present is deutero-proteose. In the disease called "osteomalacia" a proteose is also usually found in the urine. This more nearly resembles hetero-proteose in its properties.

**Sugar.**—Normal urine contains no sugar, or so little that for clinical purposes it may be considered absent. It occurs in the disease called diabetes mellitus, which can be artificially produced by puncture of the medulla oblongata, or by extirpation of the pancreas. The disease as it occurs in man may be due to disordered metabolism of the liver, to disease of the pancreas, and to other not fully understood causes (see p. 510).

The sugar present is dextrose. Lactose may occur in the urine of nursing mothers. Diabetic urine also contains hydroxybutyric



Fig. 439.—Esbach's albuminometer.

acid, and may contain or yield on distillation acetone, and ethyl-diacetic acid. The methods usually adopted for detecting and estimating the sugar are as follows :—

(a) The urine has generally a high specific gravity.

(b) The presence of sugar is shown by the reduction (yellow precipitate of cuprous oxide) that occurs on boiling with Fehling's solution. Fehling's solution is an alkaline solution of copper sulphate to which Rochelle salt has been added. The Rochelle salt (double tartrate of potash and soda) holds the cupric hydrate in solution. Fehling's solution should always be freshly prepared, as, on standing, racemic acid is formed from the tartaric acid, and this substance itself reduces the cupric to cuprous oxide. Fehling's solution should, therefore, always be tested by boiling before it is used. If it remains clear on boiling, it is in good condition.

(c) *Picric Acid Test.*—The work of Sir George Johnson and G. S. Johnson has shown the value of this reagent in detecting both albumin and sugar in the urine. The same reagent may be employed for the detection of both substances. The method of testing for albumin has been already studied with Esbach's tube. To test for sugar do the following experiment. Take a drachm (about 4 c.c.) of diabetic urine; add to it an equal volume of saturated aqueous solution of picric acid, and half the volume (*i.e.*, 2 c.c.) of the liquor potassæ of the British Pharmacopœia. Boil the mixture for about a minute, and it becomes so intensely dark red as to be opaque. Now do the same experiment with normal urine. An orange-red colour appears even in the case of normal urine, but it never becomes opaque, and so the urine, for all practical purposes, may be considered free from sugar. This reduction of cupric to cuprous oxide by normal urine is due to creatinine (see p. 559).

(d) *Quantitative Determination of Sugar in Urine.*—Fehling's solution is prepared as follows :—34.639 grammes of copper sulphate are dissolved in about 200 c.c. of distilled water; 173 grammes of Rochelle salt are dissolved in 600 c.c. of a 14 per cent. solution of caustic soda. The two solutions are mixed and diluted to a litre. Ten c.c. of this solution are equivalent to 0.05 grammes of dextrose. Dilute 10 c.c. of this solution with about 40 c.c. of water, and boil it in a porcelain basin. Run into this from a burette the urine (which should be previously diluted with nine times its volume of distilled water) until the blue colour of the copper solution disappears—that is, till all the cupric hydrate is reduced. The mixture in the basin should be boiled after every addition. The quantity of diluted urine used from the burette contains 0.05 gramme of sugar. Calculate the percentage from this, remembering that the urine has been diluted to ten times its original volume.

Pavy's modification of Fehling's solution is sometimes used. Here ammonia holds the copper in solution, and no precipitate forms on boiling with sugar, as ammonia holds the cuprous oxide in solution. The reduction is complete when the blue colour disappears; 10 c.c. of Pavy's solution = 1 c.c. of Fehling's solution = 0.005 grammes of dextrose.

In some cases of diabetic urine where there is excess of ammonio-magnesian phosphate, the full reduction is not obtained with Fehling's solution, and when the quantity of sugar is small it may be missed. In such a case excess of soda or potash should be first added, the precipitated phosphates filtered off, and the filtrate after it has been well boiled may then be titrated with Fehling's solution.

Fehling's test is not absolutely trustworthy. Often a normal urine will decolorise Fehling's solution, though seldom a red precipitate is formed. This is due to excess of urates and creatinine. Another substance called glycuronic acid ( $C_6H_{10}O_7$ ) is, however, very likely to be confused with sugar by Fehling's test; the cause of its appearance is sometimes the administration of drugs (chloral, camphor, &c.); but sometimes it appears independently

of drug treatment. The cause of this is not known, but the condition has not the serious meaning one attaches to diabetes: hence, for life assurance purposes, it is most necessary to confirm the presence of sugar by other tests.

Then, too, in the rare condition called *alcaptonuria*, confusion may similarly arise. *Alcapton* is a substance which probably originates from tyrosine by an unusual form of metabolism. It gives the urine a brown tint, which darkens on exposure to the air. It is an aromatic substance, and the recent researches of Baumann and Wolkow have identified it with homogentisinic acid ( $C_8H_8(OH)_2CH_2COOH$ ).

(e) The best confirmatory test for sugar is the *fermentation test*, which is performed as follows:—

Half fill a test tube with the urine and add a little German yeast. Fill up the tube with mercury; invert it in a basin of mercury, and leave it in a warm place for twenty-four hours. The sugar will undergo fermentation: carbonic acid gas accumulates in the tube, and the liquid no longer gives the tests for sugar, or only faintly, but gives those for alcohol instead. A control experiment should be made with yeast and water in another test-tube, as a small yield of carbonic acid is sometimes obtained from impurities in the yeast.

(f) The *phenylhydrazine test* (p. 389) may also be applied.

**Bile.**—This occurs in jaundice. The urine is dark-brown, greenish, or in extreme cases almost black in colour. The most readily applied test is Gmelin's test for the bile pigments. Pettenkofer's test for the bile acids seldom succeeds in urine if the test is done in the ordinary way. The best method is to warm a thin film of urine and cane sugar solution in a flat porcelain dish. Then dip a glass rod in strong sulphuric acid, and draw it across the film. Its track is marked by a purplish line. Excess of urobilin should not be mistaken for bile pigment.

**Blood.**—When hæmorrhage occurs in any part of the urinary tract, blood appears in the urine. It is found in the acute stage of Bright's disease. If a large quantity is present, the urine is deep red. Microscopic examination then reveals the presence of blood corpuscles, and on spectroscopic examination the bands of oxyhæmoglobin are seen.

If only a small quantity of blood is present, the secretion—especially if acid—has a characteristic reddish-brown colour, which physicians term “smoky.”

The blood pigment may, under certain circumstances, appear in the urine without the presence of any blood corpuscles at all. This is produced by a disintegration of the corpuscles occurring in the circulation, and the most frequent cause of this is a disease allied to ague, which is called *paroxysmal hæmoglobinuria*. The pigment is in the condition of methæmoglobin mixed with more or less oxyhæmoglobin, and the spectroscope is the means used for identifying these substances.

**Pus** occurs in the urine as the result of suppuration in any part of the urinary tract. It forms a white sediment resembling that of phosphates, and, indeed, is always mixed with phosphates. The pus corpuscles may, however, be seen with the microscope; their nuclei are rendered evident by treatment with 1 per cent. acetic acid, and the pus corpuscles are seen to resemble white blood corpuscles, which, in fact, they are in origin.

Some of the proteid constituents of the pus cells—and the same is true for blood—pass into solution in the urine, so that the urine pipetted off from the surface of the deposit gives the tests for albumin.

On the addition of liquor potassæ to the deposit of pus cells, aropy gelatinous mass is obtained. This is distinctive. Mucus treated in the same way is dissolved.

## CHAPTER XXXVIII.

### THE SKIN.

THE skin is composed of two parts, *epidermis*, or *cuticle*, and *dermis*, or *cutis vera*. In connection with the skin we shall also have to consider the nails, the hairs with their sebaceous glands, and the sweat glands.

**The Epidermis** is composed of a large number of layers of cells; it is a very thick stratified epithelium. The deeper layers are protoplasmic, and form the *rete mucosum*, or *Malpighian layer*; the surface layers are hard and horny; this horny layer is the thickest part of the epidermis, and is specially thick on the palms and soles, where it is subjected to most friction. The cells of the deepest layers of the Malpighian layer are columnar in shape; the layers next to these are composed of polyhedral cells, which become flatter as they approach the horny layers. Between these cells are fine intercellular passages, bridged across by fine protoplasmic processes, which pass from cell to cell; the channels between the cells serve for the passage of lymph. It is in the cells of the Malpighian layer that pigment granules are deposited in the coloured races.

Between the horny layer and the Malpighian layer are two intermediate strata, in which the transformation of protoplasm

into horny material (*keratin*) is taking place. In the first of these—that is, the one next to the Malpighian layer, the cells are flattened, and filled with large granules of *eleidin*, an intermediate substance in the formation of horn. This layer is called the *stratum granulosum*.

Above this are several layers of clear, more rounded cells, which constitute the *stratum lucidum*; and above this the horny

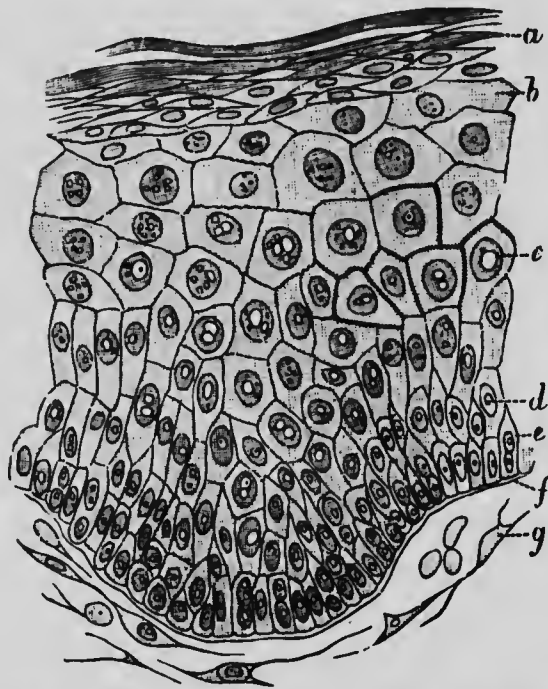

Fig. 440.—Vertical section of the epidermis of the prepuce. *a*, stratum corneum, of very few layers, the stratum lucidum and stratum granulosum not being distinctly represented; *b*, *c*, *d*, and *e*, the layers of the stratum Malpighii, a certain number of the cells in layers *d* and *e* showing signs of segmentation; it consists chiefly of prickle cells; *g*, cells in cutis vera. (Cadiat.)

layer proper, many strata deep, begins. The cells become more and more scaly as they approach the surface, where they lose their nuclei and eventually become detached.

The epidermis grows by a multiplication of the deepest layer of cells (fig. 440, *e*); the newly-formed cells push towards the surface those previously formed, in their progress undergoing the transformation into keratin.

The epidermis has no blood-vessels; nerve-fibrils pass into its deepest layers, and ramify between the cells.

**The Dermis** is composed of dense fibrous tissue, which becomes



looser and more reticular in its deeper part, where it passes by insensible degrees into the arcolar and adipose tissue of the subcutaneous region. The denser superficial layer is very vascular, and is covered with minute *papillæ*; the epidermis is moulded

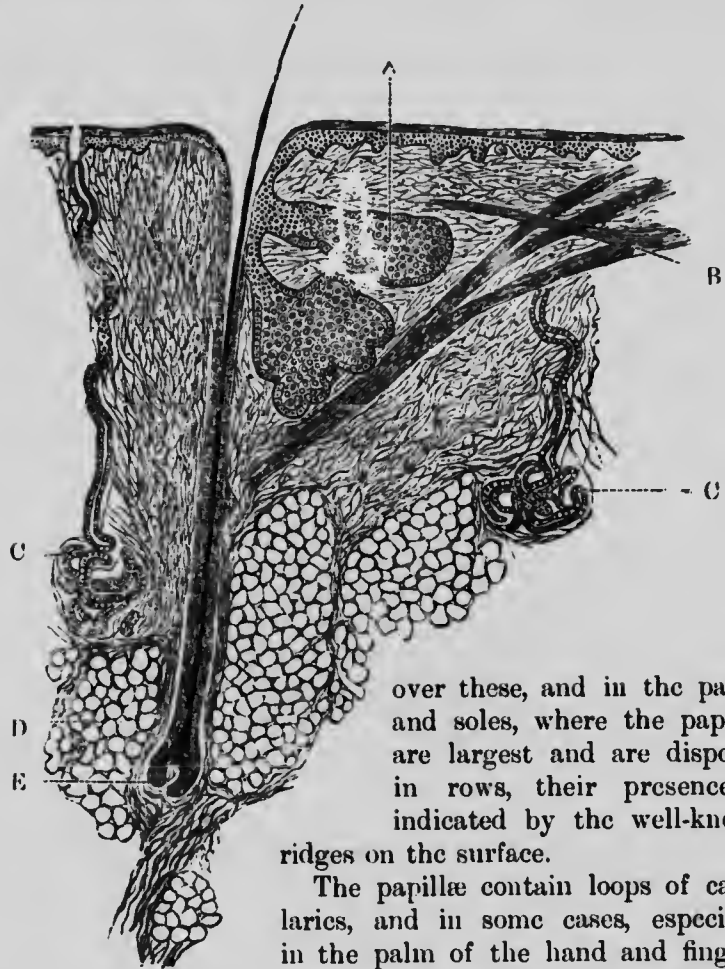

Fig. 441.—Vertical section of skin. A. Sebaceous gland opening into hair follicle. B. Muscular fibres. C. Sudoriferous or sweat-gland. D. Subcutaneous fat. E. Fundus of hair-follicle, with hair-papilla. (Klein.)

over these, and in the palms and soles, where the papillæ are largest and are disposed in rows, their presence is indicated by the well-known ridges on the surface.

The papillæ contain loops of capillaries, and in some cases, especially in the palm of the hand and fingers, they contain tactile corpuscles (which will be more fully described in connection with the sense of touch). Special capillary networks are distributed to the sweat-glands, sebaceous glands, and hair follicles.

The deeper portions of the dermis in the scrotum, penis and nipple, contain involuntary muscular tissue; there is also a bundle of muscular tissue attached to each hair follicle.

**The Nails** are thickenings of the stratum lucidum. Each

lies in a depression called the *bed* of the nail, the posterior part of which is overlapped by epidermis, and called the *nail-groove*. The dermis beneath is beset with longitudinal ridges instead of papillæ; these are very vascular; but in the *lunula*, the crescent at the base of the nail, there are papillæ, and this part is not so vascular.



Fig. 442.—Surface of a wall, magnified 160 diameters. The wavy lines mark the upper or free edges of the cortical scales. B, separated scales, magnified 350 diameters. (Kölliker.)

**The Hairs** are epidermal growths, contained in pits called *hair follicles*. The part within the follicle is called the *root* of the hair. The main substance of the hair is composed of pigmented



Fig. 443.—Longitudinal section of a hair follicle. a and b, external root-sheath; c, internal root-sheath; d, fibrous layer of the hair; e, medulla; f, hair papilla; g, blood-vessels of the hair-papilla; h, dermic coat. (Cadiat.)

horny fibrous material, in reality long fibrillated cells. It is covered by a layer of scales imbricated upwards (*hair cuticle*). In many hairs the centre is occupied by a *medulla*, formed of rounded cells containing eleidin granules. Minute air-bubbles

may be present in both medulla and fibrous layer, and cause the hair to look white by reflected light. The grey hair of old age, however, is produced by a loss of pigment.

The root is enlarged at its extremity into a *knob*, into which projects a vascular *papilla* from the true skin.

The hair follicle consists of two parts, one continuous with the epidermis, called the *root-sheath*, the other continuous with the

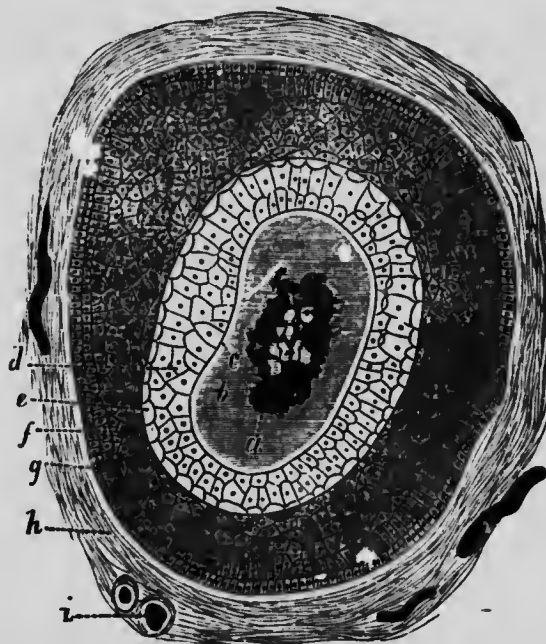

Fig. 444.—Transverse section of a hair and hair-follicle made below the opening of the sebaceous gland. *a*, medulla or pith of the hair; *b*, fibrous layer; *c*, cuticle; *d*, Huxley's layer; *e*, Henle's layer of internal root-sheath; *f* and *g*, layers of external root-sheath, outside of *g* is the basement membrane or hyaline layer; *h*, dermic (fibrous) coat of hair follicle; *i*, vessels. (Cadiat.)

dermis, called the *dermic coat*. The two are separated by a basement membrane called the *hyaline layer* of the follicle. The root-sheath consists of an outer layer of cells like the Malpighian layer of the epidermis, with which it is directly continuous (*outer root-sheath*), and of an inner horny layer (*inner root-sheath*), continuous with the horny layer of the epidermis. The inner root-sheath consists of three layers, the outermost being composed of long, non-nucleated cells (*Henle's layer*), the next of squarish nucleated cells (*Huxley's layer*), and the third is a *cuticle* of scales, imbricated downwards, which fit over the scales of the cuticle of the hair itself.

A small bundle of plain muscular fibres is attached to each

follicle (fig. 441). When it contracts, as under the influence of cold, or of certain emotions such as fear, the hair is erected and the whole skin is roughened ("goose skin"). The nerves supplying these muscles are called *pilo-motor* nerves. The distribution of these nerves closely follows those of the vaso-constrictor nerves of the skin; their cell stations are in the lateral sympathetic chain.

The **sebaceous glands** (figs. 441 and 445) are small saccular



Fig. 445.—Sebaceous gland from human skin. (Klein and Noble Smith.)

glands, with ducts opening into the upper portion of the hair follicles. The secreting cells become charged with fatty matter, which is discharged into the lumen of the saccules owing to the disintegration of the cells. The secretion, *sebum*, contains isocholesterin (see p. 505) in addition to fatty matter. It acts as a lubricant to the hairs.

The **sweat-glands** are abundant over the whole human skin, but are most numerous where hairs are absent, on the palms and soles. Each consists of a coiled tube in the deepest part of the dermis; the duct from which passes up through the dermis, and by a corkscrew-like canal through the epidermis to the surface.

The secreting tube is lined by one or two layers of cubical or columnar cells; outside this is a layer of longitudinally arranged muscular fibres, and then a basement-membrane.

The duct is of similar structure, except that there is usually but one layer of cubical cells, and muscular fibres are absent;

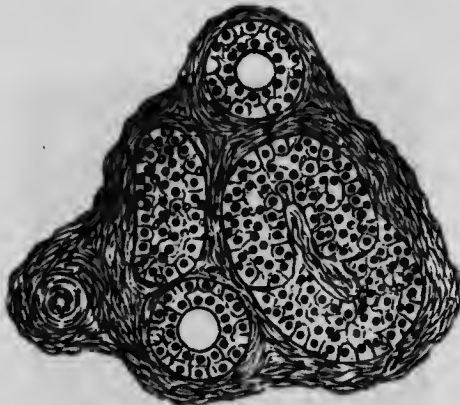

Fig. 416.—Terminal tubules of sudoriferous or sweat-glands, cut in various directions from the skin of the pig's ear. (V. D. Harris.)

the passage through the epidermis has no proper wall; it is merely a channel excavated between the epidermal cells.

The ceruminous glands of the ear are modified sweat-glands.

#### THE FUNCTIONS OF THE SKIN.

**Protection.**—The skin acts as a protective organ, not only by mechanically covering and so defending internal structures from external violence, but more particularly in virtue of its being an organ of **sensation** (see later in the chapter on Touch).

**Heat Regulation.**—See Chapter XL.

**Respiration.**—A small amount of respiratory interchange of gases occurs through the skin, but in thick-skinned animals this is very small. In man, the carbonic acid exhaled by the skin is about  $\frac{1}{150}$  to  $\frac{1}{200}$  of that which passes from the lungs. But in thin-skinned animals, like frogs, cutaneous respiration is very important; after the removal of the lungs of a frog, the respiratory interchange through the skin is sufficient to keep the animal alive, the amount of carbonic acid formed being about half as much as when the lungs are present (Bischoff).

**Absorption.**—This also is an unimportant function; but the skin will in a small measure absorb oily materials placed in contact

with it; thus in some cases infants who will not take cod-liver oil by the mouth, can yet be dosed with it by rubbing it into the skin. Many ointments also are absorbed, and thus general effects produced by local inunction.

**Secretion.**—The secretions of the skin are two in number. The *sebum* is the natural lubricant of the hairs. The *sweat* is an excretion. The secretion of sweat is an important function of the skin, and we will therefore discuss it at greater length.

#### THE SWEAT.

**Physiology of the Secretion of Sweat.**—We have seen that the sweat-glands are most abundant in man on the palms and soles, and here the greatest amount of perspiration occurs. Different animals vary a good deal in the amount of sweat they secrete, and in the place where the secretion is most abundant. Thus the ox perspires less than the horse and sheep; perspiration is absent from rats, rabbits, and goats; pigs perspire mostly on the snout; dogs and cats on the pads of the feet.

As long as the secretion is small in amount, it is evaporated from the surface at once; this is called *insensible perspiration*. As soon as the secretion is increased or evaporation prevented, drops appear on the surface of the skin. This is known as *sensible perspiration*. The relation of these two varies with the temperature of the air, the drier and hotter the air, the greater being the proportion of insensible to sensible perspiration. In round numbers the total amount of sweat secreted by a man is two pounds in the twenty-four hours.

The amount of secretion is influenced by the vaso-motor nerves; an increase in the size of the skin-vessels leads to increased, a constriction of the vessels to diminished, perspiration. There are also special secretory fibres, stimulation of which causes a secretion even when the circulation is suspended, as in a recently amputated limb. These fibres are paralysed by atropine. They are contained in the same nerve-trunks as the vaso-motor nerves, as are also the nerve-fibres which supply the plain muscular fibres of the sweat-glands which act during the expulsion of the secretion. The secretory nerves for the lower limbs issue from the spinal cord by the last two or three dorsal and first two or four lumbar nerves (in the cat); they have cell stations in the lower ganglia of the lateral chain, and pass to the abdominal sympathetic and thence to the sciatic nerve. They are controlled by a centre in the upper lumbar region of the cord;

those for the upper limbs leave the cord by the sixth, seventh, and eighth anterior thoracic roots, have cell stations in the ganglion stellatum and ultimately pass to the ulnar and median nerves; they are controlled by a centre in the cervical enlargement of the cord. The secretory fibres for the head pass in the cervical sympathetic, and in some branches of the fifth cranial nerves. These subsidiary centres are dominated by one in the medulla oblongata (Adamkiewicz). These facts have been obtained by experiments on animals (cat, horse).

The sweat-centres may be excited directly by venous blood, as in asphyxia; or by over-heated blood (over  $45^{\circ}$  C.); or by certain drugs (see further); or reflexly by stimulation of afferent nerves such as the crural and peroneal.

Nervous diseases are often accompanied with disordered sweating; thus unilateral perspiration is seen in some cases of hemiplegia; degeneration of the anterior nerve-cells of the cord may cause stoppage of the secretion. It is sometimes increased in paralysed limbs.

The changes that occur in the secreting cells have been investigated by Renault in the horse. When charged they are clear and swollen, the nucleus being situated near their attached ends; when discharged they are smaller, granular, and their nucleus is more central.

The sweat, like the urine, must be regarded as an excretion, the secreting cells eliminating substances formed elsewhere.

**Composition of the Sweat.**—Sweat may be obtained in abundant quantities by placing the animal or man in a closed hot-air bath, or from a limb by enclosing it in a vessel made airtight with an elastic bandage. Thus obtained it is mixed with epidermal scales and a small quantity of fatty matter from the sebaceous glands. The continual shedding of epidermal scales is in reality an excretion. Keratin, of which they are chiefly composed, is rich in sulphur, and, consequently, this is one means by which sulphur is removed from the body.

The reaction of sweat is acid, and the acidity, as in the urine, is due to acid sodium phosphate. In profuse sweating, however, the secretion usually becomes alkaline or neutral. It has a peculiar and characteristic odour, which varies in different parts of the body, and is due to volatile fatty acids; its taste is saltish, its specific gravity about 1.005.

In round numbers the percentage of solids is 1.2, of which 0.8 is inorganic matter. The following table is a compilation from several analyses:—

Water	. 98·88	per cent.	
Solids	. 1·12	"	
Salts	. 0·57	"	
NaCl	. 0·22 to 0·33	"	
Other salts	. 0·18	"	(alkaline sulphates, phosphates, lactates, and potassium chloride)
Fats	. 0·41	"	(including fatty acids and isocholesterin)
Epithelium	. 0·17	"	
Urea	. 0·08	"	

The salts are in kind and relative quantity very like those of the urine. Funke was unable to find any urea, but most other observers agree on the presence of a minute quantity. It appears to become quickly transformed into ammonium carbonate. The proteid which is present, is probably derived from the epithelial cells of the epidermis, sweat-glands, and sebaceous glands, which are suspended in the excretion; but in the horse there is albumin actually in solution in the sweat.

**Abnormal, Unusual, or Pathological Conditions of the Sweat.**—*Drugs.*—Certain drugs (sudorifics) favour sweating, *e.g.* pilocarpine, Calabar bean, strychnine, picrotoxine, muscarine, nicotine, camphor, ammonia. Others diminish the secretion, *e.g.* atropine and morphine in large doses.

Large quantities of water, by raising the blood-pressure, increase the perspiration.

Some substances introduced into the body reappear in the sweat, *e.g.* benzoic, tartaric, and succinic acids readily, quinine and iodine with more difficulty. Compounds of arsenic and mercury behave similarly.

*Diseases.*—Cystin has been found in some cases of cystinuria; dextrose in diabetic patients; bile-pigment in those with jaundice (as evidenced by the staining of the clothes); indigo in a peculiar condition known as chromidrosis; blood or hæmatin derivatives in red sweat; albumin in the sweat of acute rheumatism, which is often very acid; urates and calcium oxalate in gout; lactic acid in puerperal fever, and occasionally in rickets and scrofula.

*Kidney Diseases.*—The relation of the secretion of the skin to that of the kidneys is a very close one. Thus copious secretions of urine, or watery evacuations from the alimentary canal, coincide with dryness of the skin; abundant perspiration and scanty urine generally go together. In the condition known as *uræmia* (see p. 552), when the kidneys secrete little or no urine, the percentage of urea rises in the sweat; the sputum and the saliva also contain urea under those circumstances. The clear indication for the physician in



such cases is to stimulate the skin to action by hot-air baths and pilocarpine, and the alimentary canal by means of purgatives. In some of these cases the skin secretes urea so abundantly that when the sweat dries on the body, the patient is covered with a coating of urea crystals.

*Varnishing the Skin.*—By covering the skin of such an animal as a rabbit with an impermeable varnish, the temperature is reduced, a peculiar train of symptoms set up, and ultimately the animal dies. If, however, cooling be prevented by keeping such an animal in warm cotton wool, it lives longer. Varnishing the human skin does not seem to be dangerous. Many explanations have been offered to explain the peculiar condition observed in animals; retention of the sweat would hardly do it; the blood is not found *post mortem* to contain any abnormal substance, nor is it poisonous when transfused into another animal. Cutaneous respiration is so slight in mammals that stoppage of this function cannot be supposed to cause death. The animal, in fact, dies of cold; the normal function of the skin in regulating temperature is interfered with, and it is animals with delicate skins which are most readily affected.

---

## CHAPTER XXXIX.

### GENERAL METABOLISM.

THE word *metabolism* has been often employed in the preceding chapters, and, as there explained, it is used to express the sum total of the chemical exchanges that occur in living tissues. The chemical changes have been considered separately under the headings Alimentation, Excretion, Respiration, &c. We have now to put our knowledge together, and consider these subjects in their relation to one another.

The living body is always giving off by the lungs, kidneys, and skin the products of its combustion, and is thus always tending to lose weight. This loss is compensated for by the intake of food and of oxygen. For the material it loses, it receives in exchange fresh substance. If, as in a normal adult, the income is exactly equal to the expenditure, the body-weight remains constant. If, as in a growing child, the income exceeds the

expenditure, the body gains weight; and if, as in febrile conditions, or during starvation, the expenditure exceeds the income, the body wastes.

The first act in the many steps which constitute nutrition is the taking of food, the next digestion of that food, the third absorption, and the fourth assimilation. In connection with these subjects, it is important to note the necessity for a mixed diet, and the relative and absolute quantities of the various proximate principles which are most advantageous. Assimilation is a subject which is exceedingly difficult to describe; it is the act of the living tissues in selecting, appropriating, and making part of themselves the substances brought to them by the nutrient blood-stream from the lungs on the one hand, and the alimentary canal on the other. The chemical processes involved in some of these transactions have been already dwelt on in connection with the functions of the liver and other secreting organs, but even there our information on the subject is limited; much more is this the case in connection with other tissues. Assimilation, or the building up of the living tissues, may, to use Gaskell's expression, be spoken of as *anabolic*.

Supposing the body to remain in the condition produced by these anabolic processes, what is its composition? A glance through the chapters on the cell, the blood, the tissues, and the organs will convince the inquirer that different parts of the body have very different compositions; still, speaking of the body as a whole, Volckmann and Bischoff state that it contains 64 per cent. of water, 16 of proteids (including gelatin), 14 of fat, 5 of salt, and 1 of carbohydrates. The carbohydrates are thus the smallest constituent of the body; they are the glycogen of the liver and muscles, and small quantities of dextrose in various parts.

The most important, because the most abundant of the tissues of the body, is the muscular tissue. Muscle forms about 42 per cent. of the body-weight,\* and contains, in round numbers, 75 per cent. of water and 21 per cent. of proteids; thus about half the proteid material and of the water of the body exist in its muscles.

The body, however, does not remain in this stable condition; even while nutrition is occurring, destructive changes are taking place simultaneously; each cell may be considered to be in a

---

\* The following is in round numbers the percentage proportion of the different structural elements of the body: skeleton, 16; muscles, 42; fat, 18; viscera, 9; skin, 8; brain, 2; blood, 5.

state of unstable equilibrium, undergoing *anabolic*, or constructive processes, on the one hand, and destructive, or *katabolic*, processes on the other. The katabolic series of phenomena commences with combustion; the union of oxygen with carbon to form carbonic acid, with hydrogen to form water, with nitrogen, carbon, and hydrogen to form urea, uric acid, creatinine, and other less important substances of the same nature. The formation of these last-mentioned substances, the nitrogenous metabolites, is, however, as previously pointed out, partly synthetical. The discharge of these products of destructive metabolism by the expired air, the urine, the sweat, and fæces is what constitutes excretion; excretion is the final act in the metabolic round, and the composition of the various excretions has already been considered.

An examination of the intake (food and oxygen) and of the output (excretion) of the body can be readily made; much more readily, it need hardly be said, than an examination of the intermediate steps in the process. A contrast between the two can be made by means of a balance-sheet. A familiar comparison may be drawn between the affairs of the animal body and those of a commercial company. At the end of the year the company presents a report in which its income and its expenditure are contrasted on two sides of a balance-sheet. This sheet is a summary of the monetary affairs of the undertaking; it gives few details, it gives none of the intermediate steps of the manner in which the property has been employed. This is given in the preliminary parts of the report, or may be entered into by still further examining the books of the company.

In the parts of this book that precede this chapter I have endeavoured to give an account of various transactions that occur in the body. I now propose to present a balance-sheet. Those who wish still further to investigate the affairs of the body may do so by the careful study of works on physiology; still, text-books and monographs, however good, will teach one only a small amount; the rest is to be learnt by practical study and research; and we may compare physiologists to the accountants of a commercial enterprise, who examine into the details of its working. Sometimes, in business undertakings, a deficit or some other error is discovered, and it may be that the source of the mistake is only found after careful search. Under these conditions, the accountants should be compared to physicians, who discover that something is wrong in the working of the animal body; and their object should be to discover where, in the metabolic cycle, the mistake has occurred, and subsequently endeavour to rectify it.

The construction of balance-sheets for the human and animal body may be summed up in the German word *Stoffwechsel*, or "exchange of material." A large number of investigators have applied themselves to this subject, and from the large mass of material published, it is now possible to select a few typical examples. The subject has been worked out specially by the Munich school, under the lead of Pettenkofer and Voit.

The necessary data for the construction of such tables are:—

- (1) The weight of the animal before, during, and after the experiment.
- (2) The quantity and composition of its food.
- (3) The amount of oxygen absorbed during respiration.
- (4) The quantity and composition of urine, fæces, sweat, and expired air.
- (5) The amount of work done, and the amount of heat developed. (The subject of animal heat will be considered in the next chapter.)

*Water* is determined by subtracting the amount of water ingested as food from the quantity lost by bowels, urine, lungs, and skin. The difference is a measure of the katabolism of hydrogen.

*Nitrogen*.—The nitrogen is derived from proteids and albuminoids, and appears chiefly in the urine as urea and uric acid. Minute quantities are eliminated as similar compounds in sweat and fæces. From the amount of nitrogen so found, the amount of proteids which have undergone katabolism is calculated. Proteids contain, roughly, 16 per cent. of nitrogen; so 1 part of nitrogen is equivalent to 6.3 parts of proteid; or 1 gramme of nitrogen to 30 grammes of flesh.

*Fat and carbohydrate*.—Subtract the carbon in the metabolised proteid (proteid contains 54 per cent. of carbon) from the total carbon eliminated by lungs, skin, bowels, and kidneys, and the difference represents fat and carbohydrate that have undergone metabolism.

### The Discharge of Carbon.

The influence of food on the rate of discharge of carbonic acid is immediate. The increase after each meal, which may amount to 20 per cent., reaches its maximum in about one or two hours. This effect is most marked when the diet consists largely of carbohydrates.

About 95 per cent. of the carbon discharged leaves the organism

as carbonic acid. The total insensible loss (= carbonic acid + water given off - oxygen absorbed) amounts in man to about 25 grammes per hour. Of the total hourly discharge of carbonic acid, less than 0.5 per cent. is cutaneous. The hourly discharge of carbonic acid in a man at rest is about 32 grammes, the weight of oxygen absorbed being 25 to 28 grammes in the same time. The hourly discharge of watery vapour is about 20 grammes.

As a volume of carbonic acid ( $\text{CO}_2$ ) contains the same weight of oxygen as an equal volume of oxygen ( $\text{O}_2$ ), it is obvious that, if all the absorbed oxygen were discharged as carbonic acid, the

"respiratory quotient" (by volume) =  $\frac{\text{CO}_2 \text{ expired}}{\text{O}_2 \text{ absorbed}}$  would be equal

to 1. This, however, is not the case, the volume of oxygen absorbed being in excess of the carbonic acid discharged. In animals fed exclusively on carbohydrates (this would only be possible for a short time) equality is approached. The excess of oxygen is greatest when the diet consists largely of fats.

On a mixed diet, comprising 100 grammes of proteid, 100 of fat, and 250 of carbohydrates, with a carbonic acid discharge of 770 grammes daily, and a daily assumption of 666 grammes of oxygen, 560 grammes of the oxygen are discharged in the carbonic acid, about 9 in urea, and 97 grammes in the form of water (of which 78 grammes are formed from the hydrogen of the fat); the respiratory quotient is then 0.84. In hibernation the respiratory quotient sinks lower than in any other known condition (often less than 0.5), for the animal then lives almost entirely on its own fat. The discharge of carbonic acid is increased by muscular work, and the respiratory quotient also rises. Diminution of the surrounding temperature causes increased discharge of carbonic acid. (These points are all discussed more fully in Chapter XXIV.)

#### The Discharge of Nitrogen.

In man the minimum daily allowance of nitrogen is 15 grammes, or 0.02 per cent. of the body-weight; in the carnivora about 0.1 per cent.; in the ox, as an instance of a herbivorous animal, 0.005 per cent. In certain races of mankind (*e.g.* coolies) the nitrogen requirement is less than in Europeans. The reason why this is so is not understood.

Some recent experiments by Hirschfeld have shown that for a short time nitrogenous equilibrium can be maintained on a smaller daily supply of nitrogen than 15 grammes. But

experiments extended over a longer time have shown that sooner or later the body begins to waste if the 15 grammes daily are not supplied in the food.

In an animal fed exclusively on flesh, the discharge of nitrogen at first increases *pari passu* with the absorption of proteid, the absorption of oxygen being proportionately increased at the same time. The animal, however, gains weight from increase of fat, the proteid being split into what is called a nitrogenous moiety, which is burnt off, and a non-nitrogenous moiety which is converted into fat.

The discharge of nitrogen is not immediately or markedly influenced by muscular work (see p. 552); the increased combustion that occurs in working as compared with resting muscles falls chiefly on their non-nitrogenous constituents.

#### Balance of Income and Discharge in Health.

In Chapter XXVIII. tables are given of adequate diets; these will in our balance-sheets represent the source of income; the other side of the balance-sheet, the expenditure, consists of the excretions.

EXCHANGE OF MATERIAL ON AN ADEQUATE DIET  
(Ranke's table).\*

Income.			Expenditure.		
Foods.	Nitrogen.	Carbon.	Excretions.	Nitrogen.	Carbon.
Proteid . 100 gr.	15.5 gr.	53.0 gr.	Urea . 31.5 gr.	} 14.4	6.16
Fat . 100 "	0.0 "	79.0 "	Uric acid 0.5 "		
Carbohy- drates. 250 "	0.0 "	93.0 "	Fæces . . . . .		
			Respiration(CO <sub>2</sub> )	0.0	208.00
	15.5 "	225.0 "		15.5	225.00

In man the discharge of nitrogen per kilo. of body-weight is 0.21 gramme, and of carbon 3.03 grammes, the quotient  $\frac{C}{N} = 14.5$ . In carnivorous animals, which, according to Bidder

\* The above table was constructed from data derived from the observations of Prof. Ranke on himself. Though made many years ago, Ranke's tables still serve as typical and standard examples of metabolic balance-sheets.

and Schmidt, use 1.4 N and 6.2 C per kilo. per diem,  $\frac{C}{N} = 4.4$ .

In the human being on a flesh diet  $\frac{C}{N} = 5.2$ ; the exchange thus approaches the condition of the carnivora. This is illustrated by the following balance-sheet (Ranke):—

Income.			Expenditure.		
—	Nitrogen.	Carbon.	—	Nitrogen.	Carbon.
Food . . . . .	62.3 gr.	279.6	Discharged by excretion . . . . .	44.0	263.0
Disintegration of tissues . . . . .	—	45.9	Retained in store . . . . .	18.3	62.5
	<u>62.3</u>	<u>325.5</u>		<u>62.3</u>	<u>325.0</u>

The details of the above experiment may be given as illustrating the method of working out a problem in exchange of material: 1832 grammes of meat used as food yielded 3.4 per cent. of nitrogen, *i.e.* 62.3 gr., and 12.5 per cent. of carbon, *i.e.* 229.3 gr.; 70 gr. of fat added to the food yielded 72 per cent. of carbon, *i.e.* 50.3 gr.:  $229.3 + 50.3 = 279.6 =$  total carbon in food. During the same period 86.3 gr. of urea were discharged, containing 46.6 per cent., *i.e.* 40.4 gr. of nitrogen, and 20 per cent., *i.e.* 17.3 gr. of carbon, to which must be added 2 gr. of uric acid, containing 33 per cent., *i.e.* 0.66 gr. of nitrogen, and 35 per cent., *i.e.* 0.7 gr. of carbon. Further, 2.9 gr. of nitrogen and 14 gr. of carbon were discharged in the fæces, and 231 gr. of carbon as carbonic acid in the expired air. Hence the total discharge of nitrogen =  $40.4 + 0.66 + 2.9 = 44$  gr., and the total discharge of carbon =  $17.3 + 0.7 + 14 + 231 = 263$  gr. Deducting the quantity of nitrogen discharged from that taken in, 18.3 gr. must have been retained in the body, as 108 gr. of proteid, and consequently 53 per cent. of that weight = 62.5 gr. of carbon, were also retained. Comparing the quantity of carbon disposed of in the twenty-four hours with the quantity introduced as food, we find the latter is in excess by 45.9 gr., which must have been derived from the disintegration of the fat of the body.

Another table of exchange of material on adequate diet may be quoted from the work of Pettenkofer and Voit. This takes into account the elimination of water as well as of carbon and nitrogen. In the first experiment the man did no work.

Income.			Expenditure.			
Food.	Nitrogen.	Carbon.	Excre- tions.	Nitrogen.	Carbon.	Water.
Proteid . 137 gr.	} 19.5	315.5	Urine .	17.4	12.7	1279
Fat . 117 "			Fæces .	2.1	14.5	83
Carbohy- drate . 352 "			Expired air .	—	248.6	828
Water . 2016 "	—	—		19.5	275.2	2190

Here the body was in nitrogenous equilibrium, and it eliminated more water than it took in by 174 grammes, this being derived from oxidation of hydrogen. It stored 39.7 grammes of carbon, which is equivalent to 52 grammes of fat.

The next table gives the results of an experiment on the same man on the same diet, but who did active muscular work during the day:—

Expenditure.	Nitrogen.	Carbon.	Water.
Urine . . . . .	17.4	12.6	1194
Fæces . . . . .	2.1	14.5	94
Expired air . . . . .	—	309.2	1412
	19.5	336.3	2700

It is important to notice that the discharge of nitrogen was unaltered while that of both carbon and hydrogen was increased.

#### Inanition or Starvation.

The income from without is, under these circumstances, *nil*; expenditure still goes on, as a result of the disintegration of the tissues; the amount of disintegration is measured by the discharges in the manner already described. The following table from Ranke's experiment on himself represents the exchange for a period of twenty-four hours, twenty-four hours having elapsed since the last meal.

Disintegration of tissue.			Expenditure.		
—	Nitrogen.	Carbon.	—	Nitrogen.	Carbon.
Proteid. 50 gr.	7.8	26.5	Urea . 17 gr.	} 7.8	3.4
Fat . 199.6 "	0.0	157.5	Uric acid 0.2 "		
	7.8	184.0	Respiration (CO <sub>2</sub> )		
				7.8	184.0



The discharge of nitrogen per kilo. of body-weight was reduced to 0.1,  $\frac{C}{N}$  being 23.5. In carnivorous animals, in prolonged inanition, the discharge of nitrogen per kilo. is 0.9 and  $\frac{C}{N} = 6.6$ .

During starvation the man or animal gradually loses weight; the temperature, after a preliminary rise, sinks; the functions get weaker by degrees, and ultimately death ensues, the total weight lost being from 0.3 to 0.5 of the original body-weight.

The age of the animal influences the time at which death occurs, old animals withstanding the effects of hunger better than young ones. This statement was originally made by Hippocrates, and was borne out by the experiments of Martigny and Chossat. Young animals lose weight more quickly, and die after a smaller loss of weight, than old ones.

The excretion of nitrogen falls quickly at the commencement of an experiment; it reaches a minimum which remains constant for several days; it then rises when the fat of the animal has been used up, and then quickly falls with the onset of symptoms of approaching death.

The sulphates and phosphates in the urine show approximately the same series of changes.

The discharge of carbonic acid and the intake of oxygen fall, but not so quickly as the body loses weight; it is not until quite the last stages that these are small in proportion to one another.

The fæces become smaller and smaller in quantity until no discharge from the rectum occurs at all.

The amount of bile secreted also falls; but bile is found in the gall-bladder and intestine after death.

Taking the total loss of weight as 100, the loss due to that of individual organs may be stated as follows (Voit):—

Bone . . . . .	5.4	Pancreas . . . . .	0.1	Brain and cord . . . . .	0.1
Muscle . . . . .	42.2	Lungs . . . . .	0.3	Skin and hair . . . . .	8.8
Liver . . . . .	4.8	Heart . . . . .	0.0	Fat . . . . .	26.2
Kidneys . . . . .	0.6	Testes . . . . .	0.1	Blood . . . . .	3.7
Spleen . . . . .	0.6	Intestine . . . . .	2.0	Other parts . . . . .	5.0

Some organs, such as heart and brain, thus lose but little weight; the loss of weight is greatest in the muscles, fat, skin, liver, and blood. Of the muscles, the great pectoral muscles waste most. Death may be delayed somewhat by artificial warmth, but ultimately occurs from asthenia, sometimes accompanied by convulsions.

### Exchange of Material with various Diets.

The reasons why a mixed diet is necessary have been already explained (Chap. XXVIII). Numerous experiments have, however, been made in the study of metabolism on abnormal diets.

*Feeding with meat.*—As the chief solid in meat is proteid, one must take either too much nitrogen or too little carbon. The principle that underlies Banting's method of treating obesity is to give meat almost exclusively: the individual then derives the additional supply of carbon necessary for combustion from his own adipose tissue. We have already seen that this may be and often is counteracted by the laying on of fat which comes from the non-nitrogenous moiety of the proteid.

*Feeding with fat.*—If an animal receives fat only, the nitrogenous excreta are derived from the disintegration of tissue without any corresponding supply of nitrogen being supplied in exchange in the food. When fat only is given, or a large excess of fat exists in the food, the respiratory quotient falls. F. Hofmann fed a dog on a mixture of a large amount of fat and a small amount of proteid. After death the quantity of fat found in the body was such that only a small part could have been derived from the proteid, the greater amount being directly derived from the fat of the food. The animal, moreover, lays on fat in which palmitin, stearin, and olein are mixed in a definite proportion: this proportion is often different in the fat of the food. In addition to this an animal will fatten (laying on fat with its usual composition) on fatty food, such as spermaceti, which contains no glycerides.

*Feeding with carbohydrates.*—The respiratory quotient approaches unity when carbohydrates alone are taken. So far as regards nitrogen the animal is in a state of inanition, as when fat alone is taken. If given in combination with other foods, both carbohydrates and fat act as proteid-sparing foods.

The following table is from Pettenkofer and Voit, and illustrates what happens in a dog on a mixed diet of flesh and carbohydrates.

Food.				Changes in the body.			Fat.		
Flesh.	Starch.	Sugar.	Fat.	Amount of proteid decomposed calculated from urea excreted.	Proteid gained or lost by the body.	Amount of carbohydrates decomposed.	From fat of food.	Lost from the body.	Derived from food other than fat.
0	379	—	17	211	-211	379	+17	—	24
0	608	—	22	193	-193	608	+22	—	22
400	210	—	10	436	-36	210	+10	— 8	—
400	—	227	—	393	+ 7	227	—	-25	—
400	344	—	6	413	- 13	344	+ 6	—	39
500	167	—	6	530	- 30	167	+ 6	—	8
500	—	182	—	537	- 37	182	—	—	16
800	379	—	14	608	+192	379	+14	—	55
1500	172	—	4	1475	+ 25	172	+ 4	—	43
1800	379	—	10	1469	+331	379	+10	—	112
2500	—	—	—	2512	+ 12	0	—	—	57

Even when the diet consists wholly of carbohydrates, fat is laid on; the fat laid on when meat and starch are both present in the food comes partly from the proteid and partly from the carbohydrate of the food. When no carbohydrate is given at all, as in the last experiment, the nitrogenous

metabolism is raised. Carbohydrate food is thus when given with other foods both fat-sparing and proteid-sparing. The formation of fat from carbohydrates was first observed in pigs by Lawes and Gilbert, and has since been confirmed by numerous investigators.

One of the most important instances of the carbohydrate origin of fat is the formation of bees'-wax.

Instances of the formation of fat from proteids are (1) the laying on of fat in carnivorous animals; (2) the formation of adipocere, a wax-like material which forms in the muscles of corpses buried in damp soil, or allowed to remain in water; (3) the gradually increasing quantity of fat in old cheeses.

The most striking examples of the formation of fat by intracellular metabolic processes is seen in fatty degeneration, and in that special form of this degeneration that occurs in the formation of milk. The blood contains a mere trace of fat, so milk formation is no mere filtration process. The food may, as in the case of cows, contain little or no fat.

*Feeding with gelatin.*—A diet containing gelatin alone will not support life. This fact is somewhat remarkable when one considers the closely allied chemical nature of gelatin and proteids. When gelatin alone is given the body wastes, and the urea excreted is diminished as in inanition. If an enormous amount of gelatin is given the urea increases. Gelatin, however, like carbohydrates and fats, appears to be a "proteid-sparing" food, and if given mixed with proteids seems to protect the proteids from oxidation. Gelatin can thus be substituted for a part of the proteid in the food.

*Feeding with "peptones."*—In the present day, when artificially digested foods are so much employed, it is of great importance that their nutritive value should be known. Here experimental and clinical evidence coincide in a most favourable way in relation to their nutritive value. Albumoses and the preparations called peptone in commerce, which are in reality mainly albumoses, have the same nutritive value as meat.

Artificially digested foods of this kind (Witte's peptone, plasmon, somatose, &c.) must naturally be distinguished from beef-tea and extracts of meat of which there are so many in the market, but which are mere stimulants and are valueless for nutrition (see p. 466).

#### **Effect of Varying External Conditions on Exchange of Material.**

*Effect of atmospheric temperature.*—In warm-blooded animals the effect of a low surrounding temperature is to increase katabolism, or combustion in the body; the body loses more heat, and therefore more must be produced to keep the animal's temperature within normal limits. The effect of a rise of atmospheric temperature is the reverse. In cold-blooded animals, *i.e.*, animals whose temperature varies with that of the surrounding atmosphere, a rise or fall of the latter is accompanied respectively with a rise or fall of combustion in the body. Pembrey has shown that warm-blooded animals in an embryonic condition are practically cold-blooded; that is, their metabolism, body temperature, and the external temperature vary directly the one with the others.

*Alterations of body-temperature.*—If the changes of the external temperature are so great as to cause a rise (as in steam-baths) or a fall (as in hibernation) of body-temperature, the metabolic changes are increased and decreased respectively as in cold-blooded animals.

*Effect of removal of blood from the body.*—The chief effect of a removal of blood from the body is the speedy formation of new blood-corpuscles. The intake of oxygen and discharge of carbonic acid are lessened, and the output of urea is increased. The menstrual flow and epistaxis in strong, healthy people cause no alteration in exchange of material.

### Exchange of Material in Diseases.

*Fever.*—Fever is a condition in which the temperature of the body is raised above the normal, and the degree to which it is raised is a measure of the intensity of the febrile condition. A rise of temperature may be produced either by increased production of heat, due to the increase of katabolic processes in the body, or to a diminished loss of heat from the body. A mere increase in the production of heat does not necessarily produce fever. By administering an excess of food, combustion is increased in the body; but in the healthy individual this does not produce a rise of temperature, because *pari passu* with the increased production, there is increased loss of heat. Similarly, diminution in the loss of heat, such as occurs on a hot as compared with a cold day, does not produce fever,\* because the production of heat within the body is correspondingly diminished. In fever there is increased production of heat, as is seen by the study of exchange of material; the intake of food is, as a rule, very small; the discharge of nitrogen and carbon results from the disintegration of tissues, which, as compared with that in simple inanition, is large; the tissues are said to be in a labile condition, that is, they are easily broken down. In most febrile states, the skin is dry, the sweat-glands, like most of the secreting organs of the body, being comparatively inactive, and so the discharge of heat is lessened. The skin may, however, sometimes be bathed in perspiration, and yet high fever be present. The essential cause of the high temperature is neither increased formation nor diminished discharge of heat, but an interference with the reflex mechanism, which in health operates so as to equalise the two.

Increased nitrogenous metabolism in fever has been observed in pneumonia, in pyæmia and in other febrile conditions. Ringer showed the correspondence in temperature and output of nitrogen very clearly in intermittent fever (ague).

What is known as the epicritical increase of urea is the greatly increased secretion of urea that occurs at the commencement of the defervescence of a fever. It is probably not due to an increased formation of urea, but to the removal of urea which has accumulated, owing to the fact that the kidneys have been acting sluggishly during the height of the fever.

\* A febrile condition does occur on undue exposure to a tropical sun, for instance in soldiers in India; this is mainly due to their tight fitting and otherwise unsuitable clothing, which interferes with the proper action of the skin.

Increased output of carbonic acid also occurs in fever.

Other changes noted in fever are a rapid loss of the liver glycogen, a lessening of chlorides in the urine, and often an increase of the urobilin in the urine.

The following table illustrates exchange of material in fever, no food being taken :—

Income.			Expenditure.		
Disintegration of tissue.	Nitrogen.	Carbon.	Excretions.	Nitrogen.	Carbon.
Proteid, 120 gr.	18·6	63·6	Urea and uric acid, 40 gr.	18·6	8·3
Fat, 205·7 gr.	0·0	157·4			
	18·6	221·0	Respiration (CO <sub>2</sub> ), 780 gr.	0·0	212·7
				18·6	221·0

Compare this table with that at the bottom of p. 587.

*Diabetes mellitus.*—In addition to the presence of sugar in the urine in this disease, the most marked symptoms are intense thirst and ravenous hunger. As a rule diabetic patients digest their food well. The thirst is an indication of the necessity of replacing the large quantities of water lost by the kidneys; the hunger, that of replacing the great waste of tissues that occurs. For not only does the urine contain sugar, but, in addition, a great excess of urea and uric acid. The carbonic acid output is somewhat smaller than in health. In health the carbohydrates, after assimilation, give rise, by oxidation, to carbonic acid; in diabetes, all the carbohydrates do not undergo this change, but pass as sugar into the urine. Not that all the sugar of the urine is derived from carbohydrates, for many diabetics continue to pass large quantities when all carbohydrate food is withheld; under these circumstances, it must be derived from the destruction of proteid matter (see also pp. 510, 567).

### Luxus Consumption.

In former portions of this book we have insisted on the fact that the food does not undergo combustion, or katabolic changes, until after it is assimilated, that is, until after it has become an integral part of the tissues. Formerly the blood was supposed to be the seat of oxidation; but the reasons why this view is not held now have been already given. When a student is first confronted with balance-sheets, representing metabolic exchanges, it

is at first a little difficult for him to grasp the fact, that although the amount of nitrogen and carbon ingested is equal to the amount of the same elements which are eliminated, yet the eliminated carbon and hydrogen are not derived from the food direct, but from the tissues already formed; the food becomes assimilated and takes the place of the tissues thus disintegrated. Let us suppose we have a tube open at both ends and filled with a row of marbles; if an extra marble is pushed in at one end, a marble falls out at the other; if two marbles are introduced instead of one, there is an output of two at the other end; if a dozen, or any larger number be substituted, there is always a corresponding exit of the same number at the other end of the tube. This very rough illustration may perhaps assist in the comprehension of the metabolic exchanges.

The difficulty just alluded to, which a student feels, was also felt by the physiologists who first studied metabolism; and Voit formulated a theory, of which the following is the gist: All proteid taken into the alimentary canal appears to affect proteid metabolism in two ways; on the one hand, it excites rapid disintegration of proteids, giving rise to an immediate increase of urea; on the other hand, it serves to maintain the more regular proteid metabolism continually taking place in the body, and so contributes to the normal regular discharge of urea. It has been, therefore, supposed that the proteid which plays the first of these two parts is not really built up into the tissues, does not become living tissue, but undergoes the changes that give rise to urea, somewhere outside the actual living substance. The proteids are therefore divided into "tissue-proteids," which are actually built up into living substance, and "floating or circulating proteids," which are not thus built up, but by their metabolism outside the living substance set free energy in the form of heat only. It was at this time erroneously supposed that the exclusive use of proteid food was to supply proteid tissue elements, and that vital manifestations other than heat had their origin in proteid metabolism, the metabolism of fats and carbohydrates giving rise to heat only. Hence, when it was first surmised that a certain proportion of proteids underwent metabolism, which gave rise to heat only, this appeared to be a wasteful expenditure of precious material, and the metabolism of this portion of food was spoken of as a "luxus consumption," a wasteful consumption. There were many deductions from this general theory to explain particular points; of these two may be mentioned: (1) In inanition, the urea discharged for the first few days is much greater than it is subsequently: this was supposed to be due to the fact that in the first

few days all the floating capital was consumed ; (2) the effect of feeding with a mixture of gelatin and proteid was supposed to be due to the fact that gelatin was able to replace "floating proteid," but not "tissue proteid."

This theory of Voit's, ingenious and plausible at first sight, has met with but little general acceptance, because so many observed facts are incompatible with it.

Sir Michael Foster writes as follows : "The evidence we have tends to show that in muscle (taking it as an instance of a tissue) there exists a framework of what we may call more distinctly living substance, whose metabolism, though high in quality, does not give rise to massive discharges of energy, and that the interstices, so to speak, of this framework are occupied by various kinds of material related in different degrees to this framework, and therefore deserving to be spoken of as more or less living, the chief part of the energy set free coming directly from the metabolism of some or other of this material. Both framework and intercalated material undergo metabolism, and have in different degrees their anabolic and katabolic changes ; both are concerned in the life of the organism, but one more directly than the other. We can, moreover, recognise no sharp break between the intercalated material and the lymph which bathes it ; hence such phrases as 'tissue proteid' and 'floating proteid' are undesirable if they are understood to imply a sharp line of demarcation between the 'tissue' and the blood or lymph, though useful as indicating two different lines or degrees of metabolism."

Sir John Burdon-Sanderson writes as follows : "The production of urea and other nitrogenous metabolites is exclusively a function of 'living material' ; and this process is carried on in the organism with an activity which is dependent on the activity of the living substance itself, and on the quantity of material supplied to it. No evidence at present exists in favour of a 'luxus consumption' of proteid."

Professor Hoppe-Seyler, after stating that he can make out no clear distinction between the two varieties of proteid from Voit's own writings, proceeds as follows : "Voit states that the circulating proteid is no other than that which is dissolved in the tissue juice, which is derived from the lymph-stream, and ultimately from the circulating blood. He (Voit) further says : 'As soon as the proteid of the blood-plasma leaves the blood-vessels, and circulates among the tissue elements themselves, it is then the proteid of the nutrient fluid or circulating proteid. It is no longer proteid of the blood-plasma, nor yet is it the proteid of the lymph-stream.'

The place where Voit situates his circulating proteid is beyond the ken of the anatomist; it is in a mysterious space between tissue-elements, blood-vessels, and lymph-vessels; the chemist meets with equal difficulties, as there is apparently no chemical difference between tissue proteid and circulating proteid. I can, therefore, arrive at no other conclusion than that these terms are not only useless, but unscientific, and are the outcome of speculations in a region where there is as yet no positive knowledge. These criticisms on Voit's theories do not, however, by any means, lessen the importance and high value of the immense amount of practical research carried on by Voit and his pupils."

I have placed Sir Michael Foster's view first because it takes into account certain facts which tend to show that there are degrees in metabolism. The most important of these is the formation of amido-acids in the intestine. It is an undoubted fact that by feeding an animal on leucine and other amido-acids, the urea is increased. This transformation of leucine into urea occurs in the liver. It can hardly be supposed that leucine becomes to any great extent an integral part of the living framework of the liver cells, but like other extractives, and like aromatic compounds absorbed from the alimentary canal, it becomes a part of what Foster terms the intercalated material. Here it undergoes the final change, and is ultimately and apparently very rapidly discharged in the urine. Dr. Sheridan Lea discussing the probable rôle of the amido-acids in the animal economy, compares it to the part played by the salts of the food. Neither salts nor extractives simply pass into the urine without fulfilling a useful purpose on their way; but the exact and specific use of each, whether on the synthetic or analytic side of metabolic phenomena, must be the subject of renewed research.

---

## CHAPTER XL.

### ANIMAL HEAT.

AMONG the most important results of the chemical processes we sum up under the term metabolism, is the production of heat. Heat, like mechanical motion, is the result of the katabolic side of metabolic processes; the result, or accompaniment, that is to say, of the formation of carbonic acid, water, urea, and other excreted products.



As regards temperature, animals may be divided into two great classes :—

(1) Warm-blooded or *homiothermal* animals or those which have an almost constant temperature. This class includes mammals and birds.

(2) Cold-blooded or *poikilothermal* animals, or those whose temperature varies with that of the surrounding medium, being, always, however, a degree, or a fraction of a degree, above that of the medium. This class includes reptiles, amphibians, fish, embryonic birds and mammals, and probably most invertebrates.

The temperature of a man in health varies but slightly, being between  $36.5^{\circ}$  and  $37.5^{\circ}$  C. ( $98^{\circ}$  to  $99^{\circ}$  F.). Most mammals have approximately the same temperature: horse, donkey, ox,  $37.5^{\circ}$  to  $38^{\circ}$ ; dog, cat,  $38.5^{\circ}$  to  $39^{\circ}$ ; sheep, rabbit,  $38^{\circ}$  to  $39.5^{\circ}$ ; mouse,  $37.5^{\circ}$ ; rat,  $37.9^{\circ}$ . Birds have a higher temperature, about  $42^{\circ}$  C. The temperature varies a little in different parts of the body, that of the interior being greater than that of the surface; the blood coming from the liver where chemical changes are very active is warmer than that of the general circulation; the blood becomes rather cooler in its passage through the lungs.

The temperature also shows slight diurnal variations, reaching a maximum about 4 or 5 P.M. ( $37.5^{\circ}$  C.) and a minimum about 3 A.M. ( $36.8^{\circ}$  C.); that is, at a time when the functions of the body are least active. If, however, the habits of a man are altered, and he sleeps in the day, working during the night, the times of the maximum and minimum temperatures are also inverted. Inanition causes the temperature to fall, and just at the onset of death it may be below  $30^{\circ}$  C. Active muscular exercise raises the temperature temporarily by about  $0.5^{\circ}$  to  $1^{\circ}$  C. Diseases may cause the temperature to vary considerably, especially those which we term febrile (see p. 591).

Although certain mechanical actions, such as friction, due to movements of various kinds, may contribute a minute share in the production of heat in the body, yet we have no knowledge as to the actual amount thus generated. The great source of heat is, as already stated, chemical action, especially oxidation. Any given oxidation will always produce the same amount of heat. Thus, if we oxidise a gramme of carbon, a known amount of heat is produced, whether the element be free or in a chemical compound. The following figures show the approximate number of heat-units produced by the combustion of one gramme of the following substances. A heat-unit, or calorie, is the amount of heat necessary to raise the temperature of one gramme of water  $1^{\circ}$  C. :—

Hydrogen . . . . .	3450	Fat . . . . .	9069
Carbon . . . . .	8100	Cane sugar . . . . .	3348
Urea . . . . .	2205	Starch . . . . .	3898
Albumin . . . . .	4998		

It is, however, most important to remember that the "physiological heat-value" of a food may be different from the "physical heat-value," i.e., the amount of heat produced by combustion in the body may be different from that produced when the same amount of the same food is burnt in a calorimeter. This is the case with the proteids, because they do not undergo complete combustion in the body, for each gramme of proteid yields a third of a gramme of urea, which has a considerable heat-value of its own. Thus albumin, which, by complete combustion, yields 4998 heat-units, has a physiological heat-value = 4998 minus one-third of the heat-value of urea (2205) = 4998 - 735 = 4263. Rubner has recently shown that this figure must be reduced to 4000, as some of the imperfectly burnt products of decomposition of proteids escape as uric acid, creatinine, &c., in the urine, and there is a small quantity of similar substances in the fæces.

Of the heat produced in the body, it is estimated by Helmholtz that about 7 per cent. is represented by external mechanical work, and that of the remainder about four-fifths are discharged by radiation, conduction, and evaporation from the skin, and the remaining fifth by the lungs and excreta.

The following table exhibits the relation between the production and discharge of heat in twenty-four hours in the human organism at rest, estimated in calories.\* The table conveniently takes the form of a balance-sheet in which production and discharge of heat are compared; to keep the body-temperature normal these must be equal. The basis of the table in the left-hand (income) side is the same as Ranke's diet (see p. 585):—

<i>Production of heat.</i>		<i>Discharge of heat.</i>	
Consumption of	Calories.		Calories.
Proteid (100 gr.)	$100 \times 4000 = 400,000$	Warming water in food,	
Fat (100 gr.)	$100 \times 9069 = 906,900$	2.6 kilos. $\times 25^\circ \text{C.} =$	65,000
Carbohydrates		Warming air in respiration,	
(250 gr.)	$250 \times 3898 = 974,500$	16 kilos. $\times 25^\circ \times 0.24 =$	96,000
		Evaporation in lungs,	
		630 gr. $\times 582 =$	366,660
		Radiation, evaporation,	
		etc., at surface . . . =	1,753,740
	<hr/> <b>2,814,000</b> <hr/>		<hr/> <b>2,281,400</b> <hr/>

\* The calorie we are taking is sometimes called the small calorie; by some the word *calorie* is used to denote the amount of heat necessary to raise one kilogramme of water  $1^\circ \text{C.}$

The figures under the heading Production are obtained by multiplying the weight of food by its physiological heat-value. The figures on the other side of the balance-sheet are obtained as follows: The water in the food is reckoned as weighing 2.6 kilos. This is supposed to be at the temperature of the air taken as  $12^{\circ}\text{C}$ .; it has to be raised to the temperature of the body,  $37^{\circ}\text{C}$ ., that is, through  $25^{\circ}\text{C}$ . Hence the weight of water multiplied by 25 gives the number of calories expended in heating it. The weight of air is taken as weighing 16 kilos.; this also has to be raised  $25^{\circ}\text{C}$ ., and so to be multiplied by 25; it has further to be multiplied by the relative heat of air (0.24). The 630 grammes of water evaporated in the lungs must be multiplied by the potential or latent heat of steam at  $37^{\circ}\text{C}$ . (582); the portion of heat lost by radiation, conduction, and evaporation from the skin constitutes about four-fifths of the whole, and is obtained by deducting the three previous amounts from the total. This table does not take into account the small quantities of heat lost with urine and feces.

It need hardly be remarked that the above is a mere illustrative experiment. Changes in the diet, in the atmospheric temperature, in the temperature of the food taken, in the activity of the sweat-glands, in the amount of moisture in the atmosphere, and in the amount of work done would considerably alter the above figures.

*Calorimetry.*—Calorimeters employed in chemical operations are not suitable for experiments on living animals. An animal surrounded by ice or mercury, the melting and expansion of which respectively are measures of the amount of heat evolved, would be under such abnormal conditions that the results would be valueless. Lavoisier, however, used an ice calorimeter in his experiments on animals.

The apparatus often employed is the water calorimeter. This was first used by Crawford (1788). Dulong's instrument is shown in fig. 447. The animal is placed in a metal chamber, surrounded by a water-jacket. There are also tubes for the entrance and exit of the inspired and expired gases respectively. The heat given out by the animal warms the water in the jacket, and is measured by the rise of temperature observed in the water, of which the volume is also known. The air which passes out from the chamber goes through a long spiral tube, passing through the water-jacket, and thus the heat is abstracted from it and not lost.

Air-calorimeters are now, however, generally used. Fig. 448 is an outline sketch of the one which has been most used in this country.

It consists of two precisely similar chambers made of thin sheet copper. Each chamber has two walls between which is an air space; and the outer is covered by a thick casing of felt (F) to prevent fluctuations in the temperature of the surroundings

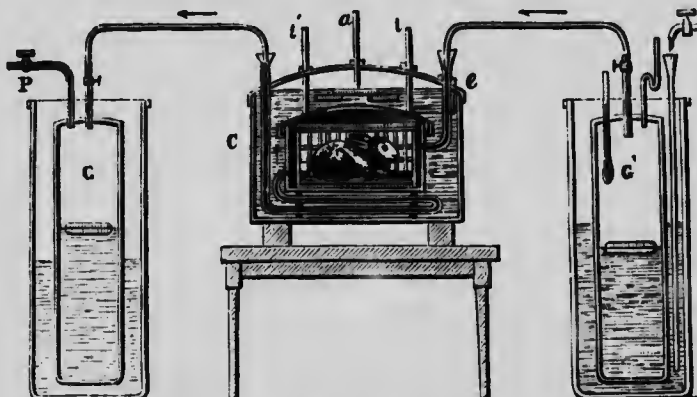

Fig. 447.—Dulong's calorimeter: C, calorimeter, consisting of a vessel of cold water in which the chamber holding the animal is placed; G', gasometer from which air is expelled by a stream of water. The air enters the respiratory chamber. G, gasometer receiving the gases of expiration and the excess of air. t, t', thermometers; a, a wheel for agitating the water. Observe the delivery-tube on the left is much twisted in the water-chamber, so as to give off its heat to the surrounding water. (From McKendrick's "Physiology.")

from affecting the air in the air-space. The chambers are made perfectly air-tight, except for the ventilating tubes AA, A'A'. By means of these, the chambers are filled with perfectly dry air

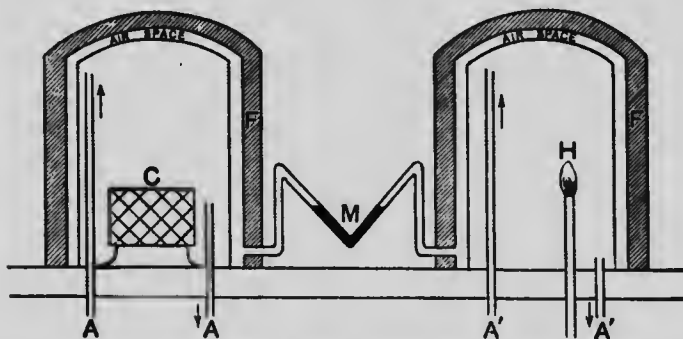

Fig. 448.—Air calorimeter of Haldane, Hale White and Washbourn. C, cage for animal. In order to make the conditions in both chambers as much alike as possible, an empty cage should be placed in the other chamber.

before the experiment is commenced. Leading from each air-space is a tube; the two tubes are connected to the two limbs of a manometer (M) shaped as in the figure, and containing oil of erigeron.

The action of the calorimeter is as follows:—In one chamber,

the animal, the heat production of which is to be ascertained, is placed within the cage C. In the other, hydrogen is burnt (H). Both chambers are shut, the tubes AA, A'A' being clamped. The heat given off from the animal warms its chamber, and thus increases the pressure of the air in the air-space between the two copper walls of the chamber. This would lead to movement of the fluid in the manometer but that the heat given off by the burning of the hydrogen increases at the same time the pressure in the air-space between the walls of its chamber. This latter increase of pressure tends to make the fluid in the manometer move in the other direction. If the fluid in the manometer remains stationary, the amount of heat given off by the animal is equal to that produced by the burning hydrogen; and during an experiment the fluid in the manometer is kept stationary by turning the hydrogen flame up and down. The amount of hydrogen burnt is estimated by the amount of water formed, and the heat of combustion of hydrogen being known, it is perfectly easy to calculate the calories produced, which equal those given off by the animal.

#### **Regulation of the Temperature of Warm-blooded Animals.**

We have seen that heat is produced by combustion processes, and lost in various ways. In order to maintain a normal temperature, both sides of the balance-sheet must be equal. This equalisation may be produced by the production of heat adapting itself to variations in discharge, or by the discharge of heat adapting itself to variations in production, or lastly, and more probably, both sets of processes may adapt themselves mutually to one another. We have, therefore, to consider (1) regulation by variations in loss and (2) by variations in production.

*Regulation by Variations in Loss.*—The two means of loss susceptible of any amount of variation are the lungs and the skin. The more air that passes in and out of the lungs, the greater will be the loss in warming the expired air and in evaporating the water of respiration. In such animals as the dog, which perspire but little, respiration is a most important means of regulating the temperature; and in these animals a close connection is observed between the production of heat and the respiratory activity. The panting of a dog when overheated is a familiar instance of this. A dog also, under the same circumstances, puts out its tongue, and loses heat from the evaporation that occurs from its surface. The great regulator, however, is undoubtedly the skin, and this

has a double action. In the first place, it regulates the loss of heat by its vaso-motor mechanism; the more blood passing through the skin, the greater will be the loss of heat by conduction, radiation, and evaporation. Conversely, the loss of heat is diminished by anything that lessens the amount of blood in the skin, such as constriction of the cutaneous vessels, or dilatation of the splanchnic vascular area. In the second place, the special nerves of the sweat-glands are called into action. Familiar instances of the action of these two sets of nerves are the reddening of the skin and sweating that occurs after exercise, on a hot day, or in a hot-air or vapour bath, and the pallor of the skin and absence of sensible perspiration on the application of cold to the body.

*Regulation by Variations in Production.*—The rate of production of heat in a living body, as determined by calorimetry, depends on a variety of circumstances. It varies in different kinds of animals. The general rate of katabolism of a man is greater than that of a dog, and of a dog greater than that of a rabbit. Probably every species has a specific coefficient, and every individual a personal coefficient of heat production, which is the expression of the inborn qualities proper to the living substance of the species and individual. Another factor is the proportion of the bulk of the animal to its surface area, the struggle for existence raising the specific coefficient of the animals in which the ratio is high. Other important considerations are the relation of the intake of food to metabolic processes, and the amount of muscular work which is performed. These various influences are themselves regulated by the nervous system, and physiologists have long suspected that afferent impulses arising in the skin or elsewhere may, through the central nervous system, originate efferent impulses, the effect of which would be to increase or diminish the metabolism of the muscles and other organs, and by that means increase or diminish respectively the amount of heat there generated. That such a metabolic or thermogenic nervous mechanism does exist in warm-blooded animals is supported by the following experimental evidence:—

(1) Though in cold-blooded animals a rise or fall of the surrounding temperature causes respectively a rise and fall of their metabolic activity, in a warm-blooded animal the effect is just the reverse. Warmth from the exterior demands a diminished production of heat in the interior, and *vice versa*. For exceptions, see p. 590.

(2) That this is due to a reflex nervous impulse is supported by the fact that a warm-blooded animal, when poisoned by curare, no longer manifests its normal behaviour to external heat and cold,

but is affected in the same way as a cold-blooded animal. Section of the medulla produces the same effects, as the nerve-channels, by which the impulses travel, are severed. When curare is given, the reflex chain is broken at its muscular end, the poison exerting its influence on the end-plates, and causing a diminution of the chemical tonus of the muscles. The centre of this thermotaxic reflex mechanism must be situated somewhere above the spinal cord; according to some observers, in the optic thalamus.

(3) The reflex mechanism is well exemplified in *shivering*, here the muscles are thrown into involuntary contraction, and so produce more heat, as the result of the stimulation of the skin by cold.

(4) Various injuries caused by accident, or purposely produced by puncture, or cautery, or electrical stimulation of limited portions of the more central portions of the brain, may give rise to great increase of temperature, not accompanied by other marked symptoms.

We thus see that the nervous system is intimately associated with the regulation of the temperature of the body. There is at least one—there may be several centres associated in this action. The centres receive afferent impulses from without; they send out efferent impulses by at least three sets of nerves: (1) the vaso-motor nerves, (2) the secretory nerves of the sweat-glands, (3) trophic or nutritional nerves. The first two sets of nerves, the vaso-motor and the secretory, affect the regulation of temperature on the side of discharge; the third set on the side of production.

The foregoing account of heat regulation does not take into account what after all is, at any rate in man, a very important factor, namely, the voluntary and artificial means which he employs, such as various kinds of clothing suitable to the climate, heating of rooms, and voluntary muscular exercise.

---

## CHAPTER XLI.

### THE CENTRAL NERVOUS SYSTEM.

WE already know sufficient from our preliminary study of nerve-centres to be aware that the central nervous system is divided into the two main parts called the brain and spinal cord. We now return to the subject, and must enter into the somewhat complicated details of the construction and mode of action of these parts.

Fig. 449 shows the general arrangement of the cerebro-spinal axis, and some anatomical details concerning the membranes that envelope the brain and cord may here conveniently be added.

**Membranes of the Brain and Spinal Cord.**—The Brain and Spinal Cord are enveloped in three membranes—(1) the Dura Mater, (2) the Arachnoid, (3) the Pia Mater.

(1) The *Dura Mater*, or external covering, is a tough membrane composed of bundles of connective tissue which cross at various angles, and in whose interstices branched connective-tissue corpuscles lie: it is lined by a thin elastic membrane, on the inner surface of which is a layer of endothelial cells.

(2) The *Arachnoid* is a much more delicate membrane, very similar in structure to the dura mater, and lined on its outer or free surface by an endothelial membrane.

(3) The *Pia Mater* of the cord consists of two layers between which numerous blood-vessels ramify. In that of the brain only the inner of the two layers is represented. Between the arachnoid and pia mater is a network of fibrous tissue trabeculæ sheathed with endothelial cells: these sub-arachnoid trabeculæ divide up the sub-arachnoid space into a number of irregular sinuses. There are some similar trabeculæ, but much fewer in number, traversing the sub-dural space, *i.e.*, the space between the dura mater and arachnoid.



Fig. 449.—View of the cerebro-spinal axis of the nervous system. The right half of the cranium and trunk of the body has been removed by a vertical section; the membranes of the brain and spinal cord have also been removed, and the roots and first part of the fifth and ninth cranial, and of all the spinal nerves of the right side, have been dissected out and laid separately on the wall of the skull and on the several vertebrae opposite to the place of their natural exit from the cranio-spinal cavity. (After Bourguery.)



*Pacchionian* bodies are growths from the sub-arachnoid network of connective-tissue trabeculae which project through small holes in the inner layers of the dura mater into the venous sinuses of that membrane. The venous sinuses of the dura mater have been injected from the sub-arachnoidal space through the intermediation of these villous outgrowths.

In the chapters preceding this one we have seen how all pervading nervous action is ; in connection with circulation, respiration, secretion, peristalsis, etc., the way in which such functions are regulated by nervous activity has taken up a considerable amount of space. Some of the facts there described will be better understood, or be seen in a clearer light if the student turns back to them and studies them once more after he has grasped what we are going to consider in the chapters that follow this on the physiology of the central nervous system.

It would also be advisable before he begins this subject, that he should once more read Chap. XVII. on nerve-centres, in order to refresh his memory concerning the elementary and fundamental problems in relation to nervous activity in these regions.

---

## CHAPTER XLII.

### STRUCTURE OF THE SPINAL CORD.

THE spinal cord is a column of nerve-substance connected above with the brain through the median of the bulb, and situated in the spinal canal. In transverse section it is approximately circular, but the cord is not of the same size throughout its course. It exhibits two enlargements, one in the cervical, the other in the lumbar region. These are the situations whence the large nerves for the supply of the limbs issue. The cord terminates below, about the lower border of the first lumbar vertebra, in a slender filament of grey substance, the *filum terminale*, which lies in the midst of the roots of many nerves forming the *cauda equina*.

It is composed of grey and white matter ; the white matter is situated externally, and constitutes its chief portion ; the grey matter is in the interior, and is so arranged that in a transverse section of the cord it appears like two crescentic masses (the

horns of each of which are called respectively the anterior and posterior cornua) connected together by a narrower portion or isthmus, called the posterior commissure (fig. 450). Passing through the centre of this isthmus in a longitudinal direction is a minute canal; in a transverse section it appears as a hole; this *central canal* of the spinal cord is continued throughout its entire length, and opens above into the space at the back of the medulla oblongata and pons Varolii, called the fourth ventricle.

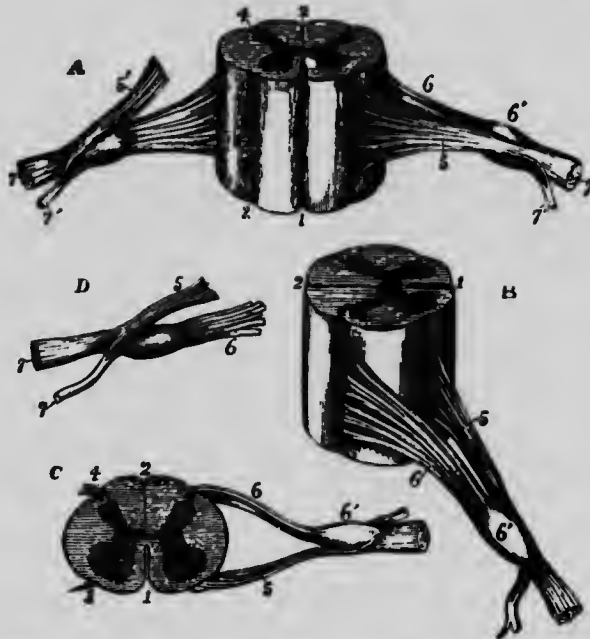

Fig. 450.—Different views of a portion of the spinal cord from the cervical region, with the roots of the nerves (slightly enlarged). In A, the anterior surface of the specimen is shown; the anterior nerve-root of its right side is divided; in B, a view of the right side is given; in C, the upper surface is shown; in D, the nerve roots and ganglion are shown from below. 1, the anterior median fissure; 2, posterior median fissure; 3, anterior lateral depression, over which the anterior nerve-roots are seen to spread; 4, posterior lateral groove, into which the posterior roots are seen to sink; 5, anterior roots passing the ganglion; 5', in A, the anterior root divided; 6, the posterior roots, the fibres of which pass into the ganglion 6'; 7, the united or compound nerve; 7', the posterior primary branch, seen in A and D to be derived in part from the anterior and in part from the posterior root. (Allen Thomson.)

It is lined by a layer of columnar ciliated epithelium, and contains a fluid called *cerebro-spinal fluid*.

The spinal cord consists of two symmetrical halves, separated anteriorly and posteriorly by vertical *fissures* (the posterior fissure being deeper, but less wide and distinct than the anterior), and united in the middle by nervous matter which is usually described as forming two commissures—an *anterior* commissure in front of the central canal, consisting of medullated

nerve-fibres, and a *posterior* commissure behind the central canal consisting also of medullated nerve-fibres, but with more neuroglia, which gives the grey aspect to this commissure (fig. 450, B). Each half of the spinal cord is marked on the sides (obscurely at the lower part, but distinctly above) by two longitudinal furrows, which divide it into three portions, columns, or tracts, an *anterior*, *lateral*, and *posterior*. From the groove between the anterior and lateral columns spring the *anterior roots* of the spinal nerves (fig. 450, B and C, 5); and just in front of the groove between the lateral and posterior column arise the *posterior roots* of the same (B, 6): a pair of roots on each side corresponds to each vertebra.

**White matter.**—The white matter of the cord is made up of medullated nerve-fibres, of different sizes, arranged longitudinally, and of a supporting material of two kinds, viz.:—(a) ordinary fibrous connective-tissue with elastic fibres, which is connected with septa from the pia mater which pass into the cord to carry the blood-vessels. (b) Neuroglia; the processes of the neuroglia-cells are arranged so as to support the nerve-fibres which are without the usual external nerve sheaths.

The general rule respecting the size of different parts of the cord is, that each part is in direct proportion to the size and number of nerve-roots given off from it. Thus the cord is very large in the middle and lower part of its cervical portion, whence arise the large nerve-roots for the formation of the brachial plexuses and the supply of the upper extremities; it again enlarges at the lowest part of its dorsal portion and the upper part of its lumbar, at the origins of the large nerves which, after forming the lumbar and sacral plexuses, are distributed to the lower extremities. The chief cause of the greater size at these parts of the spinal cord is increase in the quantity of grey matter; the white part of the cord (especially the lateral columns) becomes gradually and progressively smaller from above downwards, because a certain number of fibres coming down from the brain pass into the spinal grey matter at different levels.

**Grey matter.**—The grey matter of the cord consists of nerve-fibres, most of which are very fine and delicate, of nerve-cells with branching processes, and of an extremely delicate network of the primitive fibrillæ of axis-cylinders and of dendrites. This fine plexus is called *Gerlach's network*, and is mingled with the meshes of neuroglia. The neuroglia of the grey matter resembles that of the white, but instead of everywhere forming a close network to support the nerve-fibres, here and there it is in the form of a more open sponge-work to support the nerve-cells. It is especially developed around the central canal, which is lined with

columnar ciliated epithelium, the cells of which at their outer end terminate in fine processes, which join the neuroglia network surrounding the canal, and form the *substantia gelatinosa centralis*. It is also developed at the tip of the posterior cornu of grey matter, forming what is known as the *substantia gelatinosa lateralis* of Rolando, which is much enlarged in the upper cervical region.

*Groups of cells in grey matter.*—The multipolar cells are either scattered singly or arranged in groups, of which the following are to be distinguished on either side—certain of the groups being

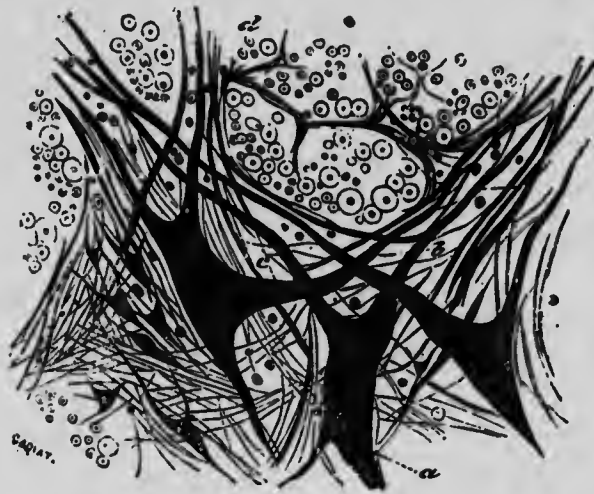

Fig. 451.—Section of grey matter of anterior cornu of a calf's spinal cord; *d*, nerve-fibres of white matter in transverse section, showing axis-cylinder in centre of each; *a*, large stellate nerve-cells with their nuclei and prolongations. (Cadiat.)

more or less marked in all of the regions of the cord, viz., those (*a*) in the anterior cornu and (*b*) those in the posterior cornu.

(*a*) The cells in the anterior cornu are large and branching, and each gives rise to an axis-cylinder process which passes out in the anterior nerve-root. These cells are everywhere conspicuous, but are particularly numerous in the cervical and lumbar enlargements. In these districts they may be divided into several groups—(i.) a group of large cells close to the tip of the inner part of the anterior cornu—most of the cells of the anterior cornu in the dorsal or thoracic region are said to belong to this group; (ii.) several lateral groups (*2a*, *2b*, and *2c*, fig. 452) on the outer side of the grey matter, and (iii.) a certain number of cells at the base of the inner part of the anterior cornu particularly well marked in the thoracic region.

(b) Cells of the posterior cornu—these are not numerous; they are small and branched, and each has an axis-cylinder process passing off; but these processes do not pass into the posterior nerve-roots. The groups are two at least in number, viz., (i.) in connection with the edge of the grey matter externally, where it is considerably broken up by the passage of bundles of fibres through it, and called the *lateral reticular formation*; and (ii.) in connection with a similar reticular formation, more at the tip of

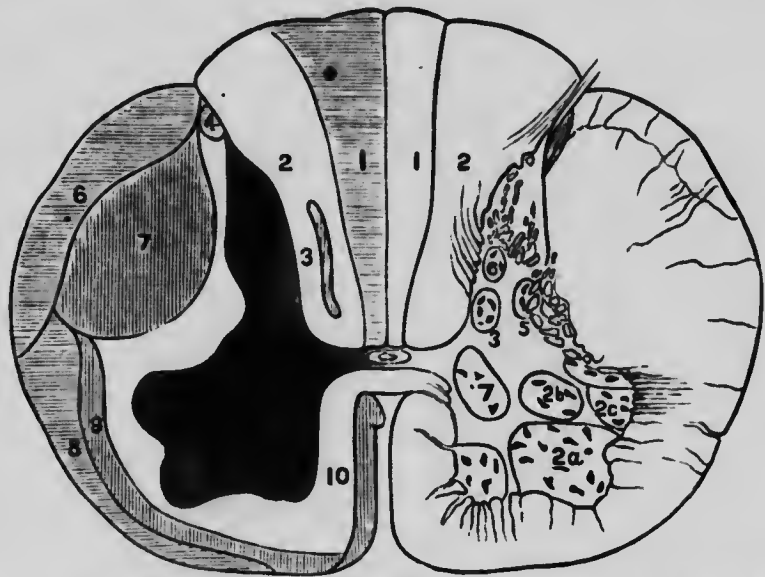

Fig. 452.—Section of spinal cord (cervical region), one half of which (left) shows the tracts of the white matter, and the other half (right) shows the position of the nerve-cells in the grey matter. 7, 10, 9, and 3 are tracts of descending degeneration; 1, 2, 4, 6, and 8, of ascending degeneration. Semidiagrammatic. (After Sherrington.)

the grey matter of the posterior cornu; this is known as the *posterior reticular formation*.

The other groups of cells (not represented in fig. 452) are confined to the thoracic region of the cord, and are two in number, viz.: one situated at the base of the posterior cornu, formed of large fusiform cells, constitutes the *posterior vesicular column of Lockhart Clarke* (fig. 456, c c), and the other situated on the outer portion of the grey matter, about midway between the anterior and posterior cornua, constitutes the cells of the *inter-medio-lateral tract* (fig. 456, 1 T). These cells are small and spindle-shaped, and are found in the upper lumbar as well as in the thoracic region.

*Columns and tracts in the white matter of the spinal cord.*—In

addition to the columns of the white matter which are marked out by the points from which the nerve-roots issue, and which are the *anterior*, the *lateral* and the *posterior*, the posterior is further divided by a septum of the pia mater into two almost equal parts, constituting the *postero-external* column, or *column of Burdach* (fig. 452, 2), and the *postero-median*, or *column of Goll* (fig. 452, 1). In addition to these columns, however, it has been shown that the white matter can be still further subdivided. This subdivision has been accomplished by evidence of several kinds, that the parts, or as they are called, tracts in the white matter, perform different functions in the conduction of impulses.

The methods of observation are the following :—

(a) The *embryological* method. It has been found by examining the spinal cord at different stages of its development that certain groups of the nerve-fibres put on their myelin sheath at earlier periods than others, and that the different groups of fibres can therefore be traced in various directions. This is also known as the method of Flechsig.

(b) *Wallerian or degeneration method*.—This method depends upon the fact that if a nerve-fibre is separated from its nerve-cell, it wastes or degenerates. It consists in tracing the course of tracts of degenerated fibres, which result from an injury to any part of the central nervous system. When fibres degenerate below a lesion the tract is said to be of *descending degeneration*, and when the fibres degenerate in the opposite direction, the tract is one of *ascending degeneration*. By the modern methods employed in staining the central nervous system, it has proved comparatively easy to distinguish degenerated parts in sections of the cord and of other portions of the central nervous system. Degenerated fibres have a different staining reaction when the sections are stained by what are called Weigert's and Pal's methods, which consist in subjecting them to a special solution of hæmatoxylin, and then to special differentiating solutions. The degenerated fibres appear light yellow, whereas the healthy fibres are a deep blue. Marchi's method is even better. After hardening in Müller's fluid Marchi's solution (a mixture of Müller's fluid and osmic acid) stains degenerated fibres black, and leaves the rest of the tissue unstained. Accidents to the central nervous system in man have given us much information upon this subject, but this has of late years been supplemented and largely extended by experiments on animals, particularly upon monkeys; and considerable light has been shed upon the conduction of impulses to and from the nervous system by the study of the

results of section of different parts of the central nervous system, and of the spinal nerve-roots.

By these methods the tracts in the white matter have now been mapped out, and the principal ones are shown in the left half of fig. 452. But as they are there all put together, it will be a better way of studying the subject to enumerate the ascending and descending tracts with separate diagrams.

It will be convenient to begin by considering the result of cutting through the roots of the spinal nerves.

Cutting the anterior roots produces no degeneration in the cord; the fibres of the anterior roots come off from the large cells of the anterior horn, and degeneration is found only on the distal side of the point of section, in the motor nerve-fibres of the nerves.

Cutting the posterior roots between the spinal ganglia and the cord leaves the peripheral part of the nerve healthy, and degeneration occurs in the portion of the root which runs into the cord, because the fibres are cut off from the cells of the spinal ganglion from which they grew. These degenerated nerve-fibres may be traced up the cord for a considerable distance. Each posterior root-fibre when it enters the cord bifurcates, the main branch passing upwards, and the shorter branch downwards, so that the degeneration is seen in a small tract called the comma tract (fig. 452, 3) immediately below the point of entrance of the cut posterior root. The upgoing fibre is contained in the posterior column of white matter, and it terminates in one or other collection of grey matter either in the cord itself, or in the medulla oblongata.

Fig. 453 represents in a schematic way the manner in which the fibres of the two roots of a spinal nerve are connected to the grey matter in the cord.

1, 2, 3, 4 represent four cells of the anterior horn. Each gives rise to an axis-cylinder, process A, one of which is shown terminating in its final ramification in the end plate of a muscular fibre M. Each of these four cells is further surrounded by an arborisation (synapse) derived from the fibres of the pyramidal tract P, which comes down from the brain.

According to Schäfer's recent work, the pyramidal fibres really terminate around the cells at the base of the posterior horn; these cells therefore act as intermediate cell-stations on the way to those in the anterior horn. This is not shown in the diagram.

A fibre of the posterior root is also shown; this originates from the cell G of the spinal ganglion; the process of this cell bifurcates, one branch (B) passing to the periphery where it ends in an

arborescence in the skin (S); the arrow by the side of this branch represents the direction of conduction of the sensory impulses from the skin. An arrow in the opposite direction would indicate the direction of its growth. The other branch C passes into the spinal cord, where it again bifurcates; the branch E, a short one, passes downwards and ends in an arborisation around one of the small cells  $P_1$  of the posterior cornu; from which a new axis-

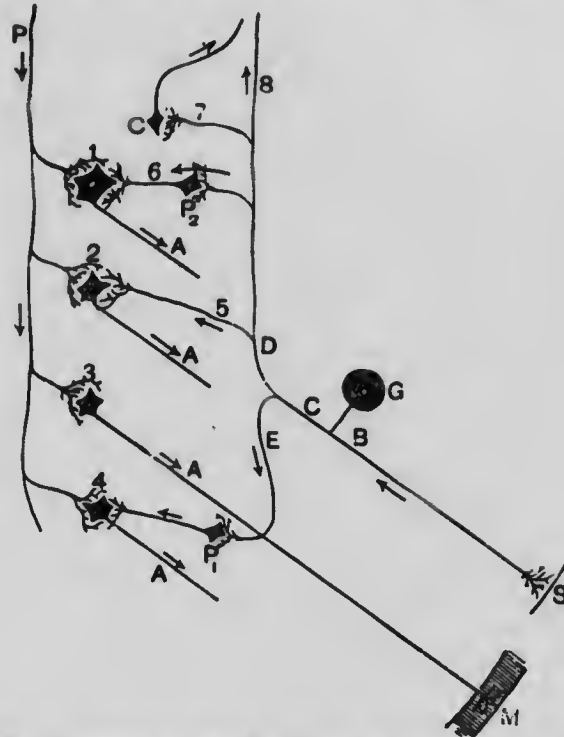

Fig. 453.—Course of nerve-fibres in spinal cord. (After Schäfer.)

cylinder arises, and terminates around one of the multipolar cells (4) of the anterior horn.

The main division D travels up in the posterior column of the cord, and ends in grey matter at various levels. Some collaterals (5) terminate by arborising directly around the anterior cornual cells, principally of the same side; others (6) do so with an intermediate cell station in a posterior cornual cell  $P_2$ ; others (7) arborise around the cells of Clarke's column (C) in the thoracic region of the cord, and from these cells fresh axis-cylinders carry up the impulse to the cerebellum in what is called the direct cerebellar tract, while the main fibre (8) may terminate in any of these ways at a higher level in the cord, or above the cord in



the medulla oblongata. When we become acquainted with the structure of the medulla oblongata, we shall be able to trace these fibres further (see fig. 484).

In general terms the anterior root-fibres pass out of the grey matter of the anterior horns, and after a short course leave the spinal cord in the anterior spinal nerve-roots. The posterior roots on the other hand do not pass to any great extent into the grey matter immediately, but into the white matter on the inner side of the posterior horn; in other words they go into the column of Burdach (fig. 452, 2); they pass up in this column but gradually approach the middle line, and are continued upwards to the medulla in the column of Goll; but as they go up they become less numerous, as some terminate in the grey matter of the cord

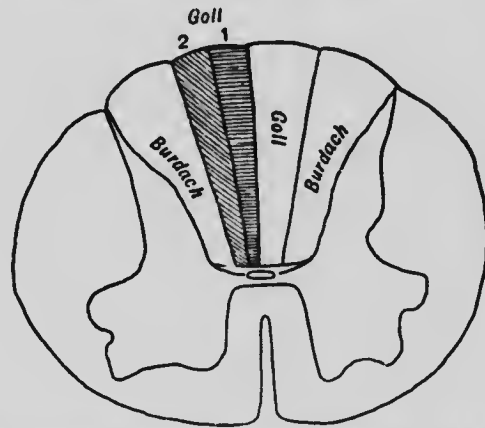

Fig. 454.—Degeneration in column of Goll after section of posterior nerve-roots.

on the way in the manner described. A few fibres of the posterior root, however, travel for a short distance in a small tract on the outer side of the posterior horn; this is called the tract of Lissauer (4 in fig. 452); the comma tract (3 in fig. 452) has been already explained.

Suppose now one cuts through several posterior roots between the spinal ganglia and the cord, so that the course of degeneration may be more readily traced. Immediately below the points of entrance of these nerve-roots, the comma tract will be found degenerated; immediately above, the degenerated fibres will be found in the column of Burdach; higher up in the cord they will be less numerous, and have approached the middle line; the fibres which enter the cord lowest get ultimately nearest the middle line, so that the greater part of the column of Goll is made up of sensory fibres from the legs; the fibres which enter the cord last,

for instance those from the upper limbs and neck, pursue their course in the inner part of the column of Burdach.

The preceding figure (fig. 454) shows the degeneration in a section of the spinal cord, after the division of a number of nerve-roots on one side. The microscopic section is taken high up, so that all the degenerated fibres have passed into the column of Goll on the same side; the inner set (1) are shaded differently from the outer set (2), indicating that those nearest the middle line come from the lowest nerve-roots.

We may pass from this to consider the tracts of degeneration that occur when the spinal cord is cut right across in the thoracic region. Some tracts will be found degenerated in the piece of cord below the lesion; these consist of nerve-fibres that are

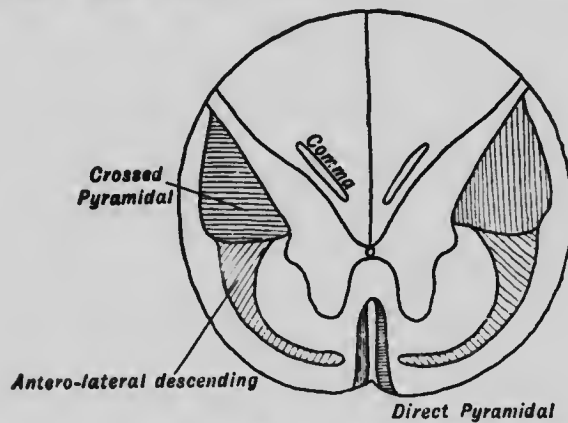

Fig. 455.—Descending tracts of degeneration.

connected with the nerve-cells in the brain; they are called the pyramidal tracts. Other tracts are found degenerated in the piece of cord above the lesion; these consist of nerve-fibres that are connected with the nerve-cells of the spinal ganglia, or with the cells of the spinal cord itself below the lesion and are passing upwards.

The tracts which degenerate downwards are the motor tracts; the tracts that degenerate upwards are the sensory tracts.

If the animal is killed a few weeks after the operation, its cord removed, and microscopic sections of it made and stained in an appropriate manner, the ascending tracts will be found degenerated in the piece of cord above the lesion; the descending tracts degenerated in the piece of cord below the lesion. These are shown in figs. 455 and 456.

**Tracts of descending degeneration (fig. 455).**

(i.) *The crossed pyramidal tract.*—This tract is situated in the

lateral column on the outer side of the posterior cornu of grey matter. At the lower part of the spinal cord it extends to the margin, but higher up it becomes displaced from this position by the interpolation of another tract of fibres, to be presently described, viz., the direct cerebellar tract. The crossed pyramidal tract is large, and may touch the grey matter at the tip of the posterior cornu but is separated from it elsewhere. Its shape on cross section is somewhat like a lens, but varies in different regions of the cord, and diminishes in size from the cervical region downwards, its fibres passing off as they descend, to arborise around the nerve-cells and their branchings in the grey matter of the cord. The fibres of which this tract is composed are moderately large, but are mixed with some that are smaller.

(ii.) *The direct or uncrossed pyramidal tract.*—This tract is situated in the anterior column by the side of the anterior fissure. It is smaller than (i.), and is not present in all animals, though conspicuous in the human cord. It can be traced upwards to the brain, and downwards as far as the mid or lower thoracic region, where it ends.

The two pyramidal tracts come down from the brain; in the medulla oblongata, the greater number of the pyramidal fibres cross over to the other side of the cord which they descend; hence the term crossed pyramidal tract; a smaller collection of the pyramidal fibres goes straight on, on the same side of the cord, and these cross at different levels in the anterior commissure of the cord lower down; hence the disappearance of the direct pyramidal tract in the lower part of the cord. The fact that the crossed pyramidal tract of one side is the fellow of the direct pyramidal tract of the other side, is indicated in the diagram by the direction of shading

(iii.) *Antero-lateral descending tract.*—An extensive tract, elongated but narrow, and reaching from the crossed to the direct pyramidal tract. It is a mixed tract, since not all of its fibres degenerate below the lesion.

(iv.) *Comma tract* is a small tract of fibres which degenerate below section or injury of the cord. It is only found for a few millimetres below the actual lesion; though it degenerates downwards it is in reality a sensory tract, being composed, as we have already seen, of the branches of the entering posterior root-fibres which pass downwards on entering the cord.

#### **Tracts of ascending degeneration (fig. 456).**

(i.) *Postero-median column.*—This tract degenerates upwards on injury or on section of the cord, as well as on section of the posterior nerve-roots. It exists throughout the whole of the cord

from below up, and can be traced into the bulb. It consists of fine fibres. The figure represents a microscopic section prepared from a piece of cord some distance above the injury, so that the degenerated fibres which begin in the column of Burdach have passed into the column of Goll.

(ii.) *Dorsal or direct cerebellar tract.*—This tract is situated on the outer part of the cord between the crossed pyramidal tract and the margin. It is found in the cervical, thoracic, and upper lumbar regions of the cord, and increases in size from below upwards. It degenerates on injury or section of the cord itself, but not on section of the posterior nerve-roots. As its name implies, it passes up into the cerebellum. Its fibres are large,

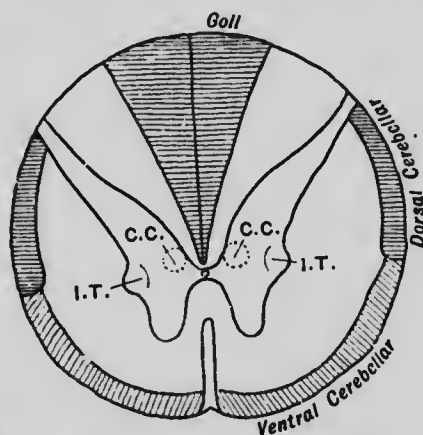

Fig. 456.—Ascending tracts of degeneration. The diagram also indicates the position of Clarke's column (C.C.) and the intermedio-lateral tract (I.T.) in the lateral horn.

and originate from the cells of Clarke's column of the same side of the cord.

(iii.) *Ventral cerebellar tract*, called also the *antero-lateral ascending tract*, or *tract of Gowers*.—This tract is situated at the margin of the cord outside the corresponding descending tract. Its fibres are of various sizes, and they also originate from the cells of Clarke's column (Schäfer). They terminate above principally in the cerebellum, but partly in the corpora quadrigemina.

(iv.) *Tract of Lissauer, or posterior marginal zone.*—A small tract of ascending fibres (4 in fig. 452) situated at the outer side of the tip of the posterior cornu. It is made up of fibres of the posterior nerve-roots; they subsequently pass into the posterior column.

**Complete transverse section** of the spinal cord leads to:—

1. Loss of motion of the parts supplied by the nerves below the section on both sides of the body. The paralysis is not

confined to the voluntary muscles, but includes the muscular fibres of the blood-vessels and viscera. Hence there is fall of blood pressure, paralysis of sphincters, etc.

2. Loss of sensation in the same regions.

3. Degeneration, ascending and descending, on both sides of the cord.

**Hemisection.**—If the operation performed is not a complete cutting of the spinal cord across transversely, but a cutting of half the cord across, it is termed hemisection.

This operation leads to:—

1. Loss of motion of the parts supplied by the nerves below the section on the same side of the body as the injury.

2. Loss of sensation in the same region. The loss of sensation is not a very prominent symptom, and is limited to the sense of localisation and the muscular sense. The animal can still feel sensations of pain and of heat and cold.

3. Degeneration, ascending and descending, nearly entirely confined to the same side of the cord as the injury. These are shown in the photo-micrographs (fig. 457) on the opposite page, the small text beneath which should be carefully studied.

*Differences in different regions of the spinal cord.*—The outline of the grey matter and the relative proportion of the white matter varies in different regions of the spinal cord, and it is, therefore, possible to tell approximately from what region any given transverse section of the spinal cord has been taken. The white matter increases in amount from below upwards. The amount of grey matter varies; it is greatest in the cervical and lumbar enlargements, viz., at and about the 5th lumbar and 6th cervical nerve, and least in the thoracic region. The greatest development of grey matter corresponds with greatest number of nerve-fibres passing from the cord.

*In the cervical enlargement* the grey matter occupies a large proportion of the section, the grey commissure is short and thick, the anterior horn is blunt, whilst the posterior is somewhat tapering. The anterior and posterior roots run some distance through the white matter before they reach the periphery. At the extreme upper part of the cervical region, the end of the posterior horn is swollen out by excess of neuroglia into a rounded mass called the *substantia gelatinosa of Rolando*. The cervical cord is wider from side to side than from before back; this is owing to the great width of the lateral columns.

*In the dorsal region* the grey matter bears only a small proportion to the white, and the posterior roots in particular run a long course through the white matter after they enter the cord; the grey commissure is thinner and narrower than in the cervical region. The intermedio-lateral tract is here most marked, and forms a prominence often called the lateral horn. This is shown in fig. 455 (1 T). Clarke's column is also confined to this region of the cord; the position of the cells which make up this column is shown in the same figure (C C). The cord in this region is circular in transverse section (see also fig. 457 C.).

*In the lumbar enlargement* the grey matter again bears a very large proportion to the whole size of the transverse section, but its posterior cornua are shorter and blunter than they are in the cervical region. The grey

commissure is short and extremely narrow. The cord is circular on transverse section.

*At the upper part of the conus medullaris*, which is the portion of the cord immediately below the lumbar enlargement, the grey substance occupies nearly the whole of the transverse section, as it is only invested by a thin

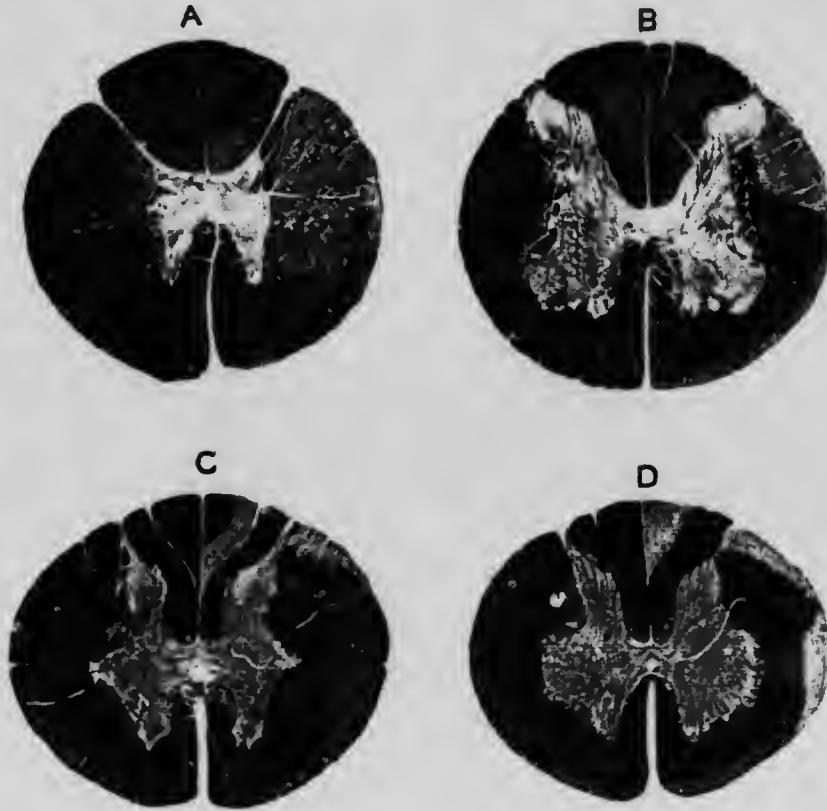

Fig. 457.—The above diagrams are reproductions of photo-micrographs from the spinal cord of a monkey in which the operation of left hemisection had been performed some weeks previously (Mott). The sections were stained by Weigert's method, by which the grey matter is bleached, while the healthy white matter remains dark blue. The degenerated tracts are also bleached. A is a section of the cord in the thoracic region below the lesion; the crossed pyramidal tract is degenerated. B is a section lower down in the lumbar enlargement; the degenerated pyramidal tract is now smaller. C is a section in the thoracic region some little distance above the lesion. The degenerated tracts seen are in the outer part of Goll's column and in the direct cerebellar tract. D is a section higher up in the cervical region; the degeneration in Goll's column now occupies a median position; the degenerations in the direct cerebellar tract, and in the tract of Gowers are also well shown. Notice that in all cases, the degenerated tracts are on the same side as the injury.

layer of white substance. This thin layer is wanting in the neighbourhood of the posterior nerve-roots. The grey commissure is extremely thick.

*At the level of the fifth sacral nerve* the grey matter is also in excess, and the central canal is enlarged, appearing T-shaped in section; whilst in the upper portion of the *filum terminale* the grey matter is uniform in shape without any central canal.

## CHAPTER XLIII.

## THE BRAIN.

A STUDENT'S first glance at a brain, or at such a drawing of it as is given in fig. 458, will be sufficient to convince him of its complicated structure. It certainly is extremely complex, but by studying it systematically we shall find that a knowledge of the



Fig. 458.—Base of the brain. 1, superior longitudinal fissure; 2, 2', 2, anterior cerebral lobe; 3, fissure of Sylvius, between anterior and 4, 4', 4', middle cerebral lobe; 5, 5', posterior lobe; 6, medulla oblongata; the figure is in the right anterior pyramid; 7, 8, 9, 10, the cerebellum; +, the inferior vermiciform process. The figures from I. to IX. are placed against the corresponding cerebral nerves; III. is placed on the right crus cerebri. VI. and VII. on the pons Varolii; X. the first cervical or suboccipital nerve. (Allen Thomson.) 4.

essential facts in its anatomy will be attainable with comparative ease. An acquaintance with the structure of the brain is, moreover, essential for understanding its functions. So we shall devote this and a few succeeding chapters to anatomical considerations, before passing on to the study of its physiology.

An outline diagram of its parts, such as is presented in the next figure, will indicate the various parts of the brain which we shall have to take into consideration.

At the lowest part of the brain, continuing the spinal cord upwards, is the *medulla oblongata* or *bulb* (D). Next comes the *pons Varolii* (C), very appropriately called the bridge, because in it are the connections between the bulb and the upper regions of the brain, and between the *cerebellum* or small brain (B) and the rest of the nervous system.

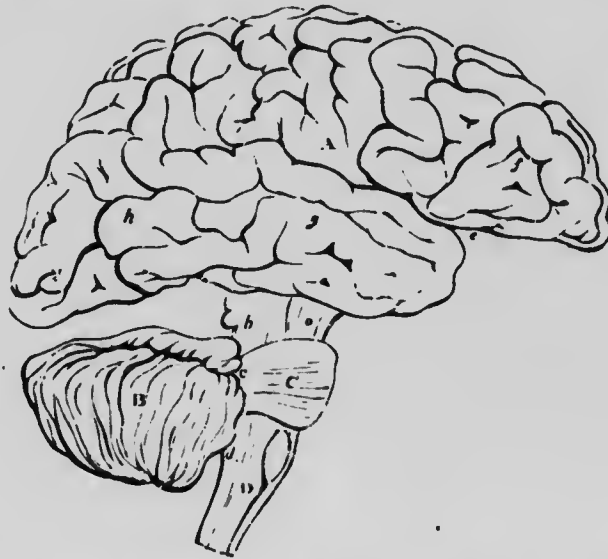

Fig. 459.—Plan in outline of the brain, as seen from the right side.  $\frac{3}{4}$ . The parts are represented as separated from one another somewhat more than natural, so as to show their connections. A, cerebrum; *f, g, h*, its anterior, middle, and posterior lobes; *e*, fissure of Sylvius; B, cerebellum; C, pons Varolii; D, medulla oblongata; *a*, peduncles of the cerebrum; *b, c, d*, superior, middle, and inferior peduncles of the cerebellum. (From Quain.)

The *mid-brain* comes next (*a, b*), and this leads into the peduncles or *crura* of the *cerebrum* (A), the largest section of the brain.

Through the brain runs a cavity filled with cerebro-spinal fluid, and lined by ciliated epithelium; this is continuous with the central canal of the spinal cord. In the brain, however, it does not remain a simple canal, but is enlarged at intervals into what are called the **ventricles**. There is one ventricle in each half or hemisphere of the cerebrum; these are called the *lateral ventricles*, they open into the *third ventricle*, which is in the middle line; and then a narrow canal (*aqueduct of Sylvius*) leads from this to the *fourth ventricle*, which is placed on the back of the bulb and pons, which form its floor; its roof is formed partly by the over-



hanging cerebellum (fig. 459), partly by pia mater. This piece of pia mater is pierced by a hole (*Foramen of Magendie*), and so the cerebro-spinal fluid in the interior of the cerebro-spinal cavity is continuous with that which bathes the external surface of brain and cord in the sub-arachnoid space. The fourth ventricle leads into the central canal of the spinal cord. The fifth ventricle in the central structures of the brain does not communicate with the others. The cerebro-spinal fluid is a thin watery fluid, containing a small quantity of salts and proteids in solution, and a substance which gives Trommer's test for sugar; it is, however, not sugar, but a substance of the aromatic group, allied to pyrocatechin.

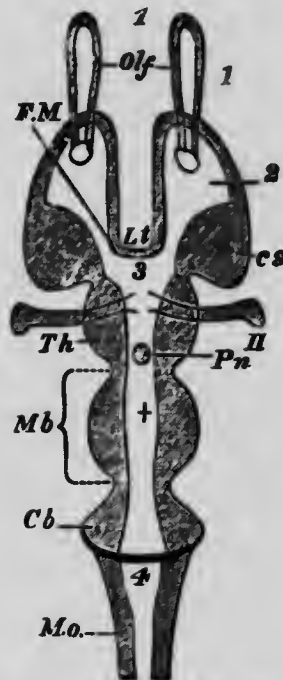

Fig. 460.—Diagrammatic horizontal section of a vertebrate brain. The figures serve both for this and the next diagram. *Mb*, mid-brain: what lies in front of this is the fore-, and what lies behind, the hind-brain; *L.t.*, lamina terminalis; *olf*, olfactory lobes; *Hmp*, hemispheres; *Th*, *E.*, thalamencephalon; *Pn*, pineal gland; *Py*, pituitary body; *F.M.*, foramen of Munro; *cs*, corpus striatum; *Th*, optic thalamus; *cc*, crura cerebri: the mass lying above the canal represents the corpora quadrigemina; *Cb*, cerebellum; *M.o.*, medulla oblongata; *I-IX*, the nine pairs of cranial nerves; 1, olfactory ventricle; 2, lateral ventricle; 3, third ventricle; 4, fourth ventricle; +, iter a tertio ad quartum ventriculum, or aqueduct of Sylvius. (Huxley.)

Before passing on to describe these portions of the brain one by one, it will be convenient to state first a few general facts.

(i.) *In the bulb*; at the lower part, the distribution of grey matter follows that which prevails in the cord. Higher up the chief part is found towards the posterior or dorsal aspect, surrounding the central canal. When the central canal opens out into the fourth ventricle, the grey matter comes to that surface chiefly, and is found to consist more particularly, on either side, of the nuclei of origin of the cranial nerves, viz., the 12th, 11th, 10th, 9th, and 8th, and more externally of the nucleus gracilis and nucleus euneatus. In addition to these masses of grey matter there are the *olivary bodies* towards the ventral surface with the *accessory olives* and the *external arcuate nuclei*,

placed at the tip of the anterior fissure on either side on the ventral surface of the anterior pyramids.

(ii.) *In the pons Varolii*.—In addition to the origins of nerves in the floor of the fourth ventricle on the dorsal aspect of the

pons, viz., of the 7th, 6th, and 5th nerves, there are several masses of grey matter, viz., in the front part, the *superior olive* and in the back part the *locus caeruleus*, as well as small amounts of the same material mixed with fibres in the more ventral surface.

(iii.) In the mid-brain, the grey matter preponderates in the *corpora quadrigemina*, and *corpora geniculata*. It is also found surrounding the aqueduct of Sylvius (where it gives origin to the third and fourth nerves) and in other parts of the crura, notably such masses as the *red nucleus* and *substantia nigra*.

(iv.) In the cerebral hemispheres, the cerebral cortex is made up of grey matter which encloses white matter; the *corpora striata* and *optic thalami* at the base of the brain are made up chiefly of grey matter.

(v.) In the cerebellum, the grey matter forms the encasing

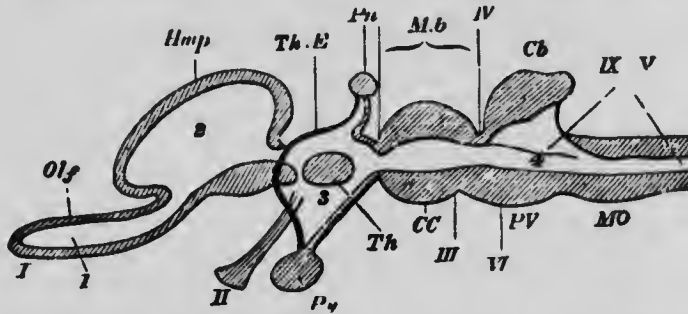

Fig. 461.—Longitudinal and vertical diagrammatic section of a vertebrate brain. Letters as before. PV, PONS VAROLII. Lamina terminalis is represented by the strong black line joining Pu and Py. (Huxley.)

material of the white matter. In the interior too there are masses of grey matter forming the *corpora dentata*.

Speaking generally, there are two main collections of grey matter—that on the surface, and that in the interior bordering on the cerebro-spinal cavity, and subdivided into various masses (*corpora striata*, *optic thalami*, &c.), whose names have been mentioned, but whose closer acquaintance we shall make presently.

The cerebral or cranial nerves, some of which have also been mentioned, are those which originate from the brain; there are twelve pairs of these altogether, and all of them, with the exception of the first and second, originate from nerve-cells in the grey matter of the floor of the fourth ventricle or its immediate neighbourhood.

In the fœtus the central nervous system is formed by an infolding of a portion of the surface epiblast. This becomes a tube of nervous matter, which loses all connection with the surface of

the body, though later in life this is in a sense re-established by the nerves that grow from the brain and cord to the surface. The anterior end of this tube becomes greatly thickened, to form the brain, its cavity becoming the cerebral ventricles; the rest of the tube becomes the spinal cord. The primitive brain is at first subdivided into three parts, the *primary cerebral vesicles*; the first and third of these again subdivide, so that there are ultimately five divisions, which have received the following names:—

1. **Pros-encephalon**, or *fore brain*. This is developed into the cerebrum with the corpora striata. It encloses the lateral ventricles.

2. **Thalam-encephalon**, or *twixt brain*. This is developed into the parts including the optic thalami, which enclose the third ventricle.

3. **Mes-encephalon**, or *mid brain*, consists of the parts which enclose the aqueduct of Sylvius—namely, the corpora quadrigemina, which form its dorsal, and the crura cerebri, which form its ventral aspect.

4. **Ep-encephalon**, or *hind brain*, which forms the cerebellum and pons.

5. **Met-encephalon**, or *after brain*, which forms the bulb or medulla oblongata.

Figs. 460 and 461 represent a diagrammatic view of a vertebrate brain; the attachment of the pineal gland, pituitary body, and olfactory (I) and optic (II) nerves is also shown.

---

## CHAPTER XLIV.

### STRUCTURE OF THE BULB, PONS, AND MID-BRAIN.

WE may study the bulb and pons by examining first the anterior or ventral, then the posterior or dorsal aspect, and last of all the interior.

#### Anterior Aspect.

The bulb is seen to be roughly shaped, like an inverted truncated cone, larger than the spinal cord, and enlarging as it goes up until it terminates in the still larger pons (fig. 462, *p*). In the

middle line is a groove, which is a continuation upwards of the anterior median fissure of the spinal cord; the columns of the bulb are, speaking roughly, continuations upwards of those of the cord, but there is a considerable rearrangement of the fibres in each. Thus the prominent columns in the middle line, called the *pyramids* (*a a*), are composed of the pyramidal fibres, which



Fig. 462.—Ventral or anterior surface of the pons Varolii, and medulla oblongata. *a, a*, pyramids; *b, b*, their decussation; *c, c*, olivary bodies; *d, d*, restiform bodies; *e, e*, arcuate fibres; *f, f*, fibres passing from the anterior column of the cord to the cerebellum; *g, g*, anterior column of the spinal cord; *h, h*, lateral column; *p, p*, pons Varolii; *i, i*, its upper fibres; *s, s*, roots of the fifth pair of nerves.



Fig. 463.—Dorsal or posterior surface of the pons Varolii, corpora quadrigemina, and medulla oblongata. The peduncles of the cerebellum are cut short at the sides. *a, a*, the upper pair of corpora quadrigemina; *b, b*, the lower; *f, f*, superior peduncles of the cerebellum; *c, c*, eminence connected with the nucleus of the hypoglossal nerve; *e, e*, that of the glossopharyngeal nerve; *i, i*, that of the vagus nerve; *d, d*, restiform bodies; *p, p*, posterior columns; *v, v*, groove in the middle of the fourth ventricle, ending below in the calamus scriptorius; *7, 7*, roots of the auditory nerves.

in the spinal cord are situated principally in the lateral columns of the opposite side (crossed pyramidal tracts). The decussation or crossing of the pyramids (*b*) occurs at their lower part; a small collection of the pyramidal fibres is, however, continued down the cord in the anterior column of the same side of the cord (direct pyramidal tract): these cross at different levels in the cord.

On the outer side of each pyramid is an oval prominence (*c c*), which is not represented in the spinal cord at all. These are



# MICROCOPY RESOLUTION TEST CHART

(ANSI and ISO TEST CHART No. 2)

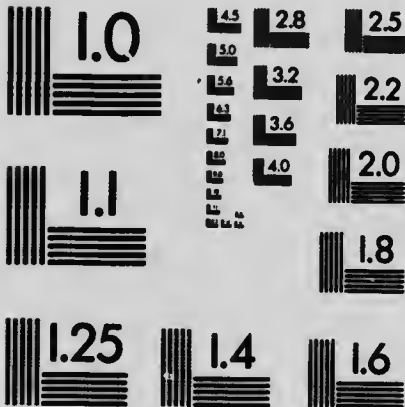

**APPLIED IMAGE Inc**

1653 East Main Street  
Rochester, New York 14609 USA  
(716) 482 - 0300 - Phone  
(716) 288 - 5989 - Fax

called the *olivary bodies* or *olives*; they consist of white matter outside, with grey and white matter in their interior.

The *restiform bodies* at the sides (*d d*) are the continuation upwards of those fibres from cord and bulb which enter the cerebellum, and the upper part of each restiform body is called the *inferior peduncle of the cerebellum*.\*

### Posterior Aspect.

Fig. 463 shows a surface view of the back of the bulb, pons, and mid-brain. Again we recognise some of the parts of the spinal cord continued upwards, though generally with new names, and again we see certain new structures.

The posterior median fissure is continued upwards, and on each side of it is the prolongation upwards of the posterior columns of the cord. The column of Goll is now called the *Funiculus gracilis*, and the column of Burdach the *Funiculus cuneatus*.

The two funiculi graciles lie at first side by side, but soon diverge and form the two lower boundaries of a diamond-shaped space called the *floor of the fourth ventricle*; this is made of grey matter; the central canal of the cord gets nearer and nearer to the dorsal surface of the bulb, till at last it opens out on the back of the bulb, and its surrounding grey matter is spread out to form the floor of the fourth ventricle. The two upper boundaries of the diamond-shaped space are made by the superior peduncles of the cerebellum, which contain fibres coming down through the mid-brain from the cerebrum. The middle peduncles of the cerebellum are principally made up of fibres running from one cerebellar hemisphere towards the other through the pons.

Running down the centre of the floor of the fourth ventricle is a shallow groove; on each side of this is a rounded longitudinal eminence called the *funiculus teres*; running across the middle of the floor are a number of fibres (the *strixæ acusticæ*), which join the auditory nerve.

In the upper part of the diagram the mid-brain, with the *corpora quadrigemina* (*a a, b b*), is shown. Here there is once more a canal which penetrates the substance of the mid-brain, and is called the *aqueduct of Sylvius*, or the *iter a tertio ad quartum ventriculum*; it leads, as its second name indicates, from the third to the fourth ventricle.

---

\* Each half of the cerebellum has three peduncles: inferior, middle, and superior.

### Origin of the Cranial Nerves.

Each cranial nerve arises from a collection or collections of nerve-cells situated in the grey matter; these collections are called *nuclei* of origin. The nerve-fibres run a certain distance through the brain substance and then pass away to their destinations. The region of the brain's surface where the nerve leaves it, is often spoken of as the *superficial origin* of the nerve.

There are twelve pairs of cranial nerves altogether, and of these ten originate from the floor of the fourth ventricle or the neighbouring grey matter. Fig. 464 is a diagram to show the nuclei of origin of these ten nerves (3rd to the 12th). The first two pairs of nerves will be described more fully later. In the following brief account of the cranial nerves, it will be noticed that many of them are either wholly motor, or wholly sensory in function.

1. *Olfactory nerve*.—This is the nerve of smell.
2. *Optic nerve*.—This is the nerve of sight.
3. *Motor oculi*.—This is wholly motor. It supplies the following extrinsic eye-muscles: superior rectus, inferior rectus, internal rectus, inferior oblique and levator palpebræ; and the following intrinsic eye-muscles (*i.e.*, within the eyeball itself):—the ciliary muscle, and the sphincter fibres of the iris. Its deep origin is in the grey matter on the side of the Sylvian aqueduct underneath the corpora quadrigemina close to the middle line. The anterior part of the nucleus is composed of small cells from which nerve-fibres originate for the ciliary muscle and sphincter of the iris; the other muscles mentioned are supplied by fibres from the larger cells of the posterior part of the nucleus.
4. *Trochlear*.—This is wholly motor too. It supplies the superior oblique muscle of the eyeball. It takes origin from the grey matter immediately below the centre of the third, but slightly more lateral in position; its centre is connected with that of the third and sixth nerves.
6. *Abducens*.—It is convenient to take this next. It also is wholly motor, supplying the external rectus of the eyeball. Its centre is beneath the eminentia teres in the upper part of the floor of the fourth ventricle, near the middle line. By the posterior longitudinal bundle it is connected to the nucleus of the third nerve of the opposite side, and thus it partially supplies the internal rectus of the opposite side.
5. *Trigeminal*.—This is a mixed nerve. Its smaller motor division supplies the muscles of mastication, the tensors of the



palate and tympanum, the mylo-hyoid, and the anterior belly of the digastric; its larger sensory division, the Gasserian

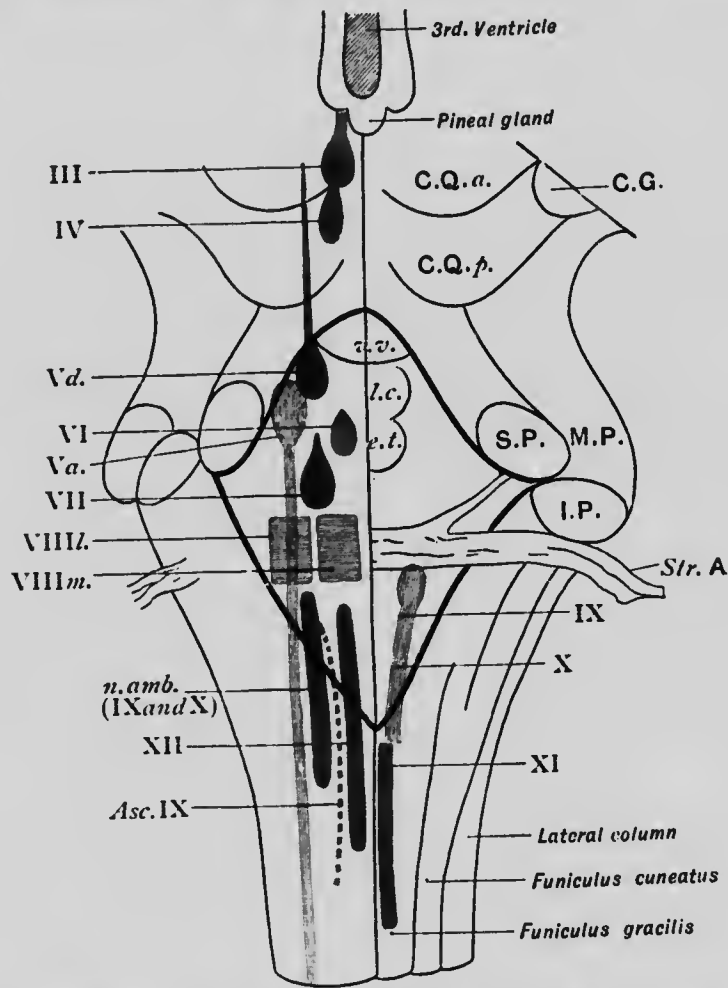

Fig. 464.—Diagram to show the position of the nuclei of the cranial nerves (after Sherrington). The medulla and pons are viewed from the dorsal aspect, the cerebrum and cerebellum having been cut away. The nuclei (sensory coloured red, and motor blue) are represented as being seen through transparent material. C.Q. a., anterior corpus quadrigeminum; C.Q. p., posterior corpus quadrigeminum; C.G., corpus geniculatum; v.v., valve of Vieussens; l.c., locus caeruleus; e.t., eminentia teres; str. A., stria acustica. S.P., M.P., and I.P., superior middle and inferior cerebellar peduncles respectively cut through. The numerals III. to XII. indicate the nuclei of the respective cranial nerves, all shown on the left side except the accessory-vago-glossopharyngeal IX., X., XI., which to avoid confusion is placed on the right side. Vd. is the motor nucleus of the fifth nerve with the descending root; Va., the sensory nucleus of the same nerve with its long ascending root; VIII m., the median nucleus; and VIII l., the lateral nucleus of the auditory nerve; n. amb., nucleus ambiguus. The position of the ascending root of the ninth (fasciculus solitarius) is also indicated (Asc. IX.).

ganglion on which corresponds to the spinal ganglion on a spinal nerve, is the great sensory nerve of the face and head. Its

deep origin is also double. The *motor centre* is internal to the sensory, and from it reach a number of fibres stretching upwards as far as the anterior corpus quadrigeminum; this is termed its descending root; it is also connected with the *locus cæruleus*. The *sensory centre* or *nucleus* outside the motor has connected with it a tract of fibres from the cord as low as the second cervical nerve (ascending root).

7. *Facial*.—This is the great motor nerve of the face muscles. It also supplies the platysma, the stapedius, stylo-hyoid, and posterior belly of the digastric. When it is paralysed, the muscles of the face being all powerless, the countenance acquires on the paralysed side a characteristic, vacant look, from the absence of all expression: the angle of the mouth is lower, and the paralysed half of the mouth looks longer than that on the other side; the eye has an unmeaning stare, owing to the paralysis of the orbicularis palpebrarum. All these peculiarities are exaggerated when at any time the muscles of the opposite side of the face are made active in any expression, or in any of their ordinary functions. In an attempt to blow or whistle, one side of the mouth and cheeks acts properly, but the other side is motionless, or flaps loosely at the impulse of the expired air; so in trying to suck, one side only of the mouth acts; in feeding, the lips and cheek are powerless, and on account of paralysis of the buccinator muscle, food lodges between the cheek and gums.

The deep origin of this nerve is shown in the diagram below that of the fifth, and to the outer side of that of the sixth nerve.

The chorda tympani, which is generally described as a branch of this nerve, is probably a continuation of the pars intermedia, which is connected with the upper part of the glosso-pharyngeal nucleus.

8. *Auditory*.—This nerve leaves the hinder margin of the pons by two roots. One winds round the restiform body dorsal to it, and the other passes ventro-mesially on the other side of the restiform body. The former is called the *dorsal root*. The latter is called the *ventral root*. The dorsal root contains a large number of nerve-cells, which give origin to many of its fibres. Ventral to the restiform body and between the two roots is another mass of ganglion cells, the *accessory auditory nucleus*. Higher up these two collections of cells blend to form a *ventral nucleus*, for this division of the auditory nerve. Some of the fibres of this root are superficial in position, and form the *stria acusticæ* across the ventricular floor. This root becomes the cochlear branch of the auditory nerve; it is the auditory nerve proper, and it is distributed to the cochlea of the internal

car. The ventral root originates from a collection of nerve-cells external to the glosso-pharyngeal nucleus, called the *inner* or *dorsal auditory nucleus*. This root becomes the vestibular division of the auditory nerve and is distributed to the vestibule and ampullæ of the semicircular canals of the internal ear. The vestibular (Scarpa's) ganglion on the vestibular portion and the spiral ganglion on the cochlear division have bipolar cells and represent a spinal ganglion (see Ear).

Ventral to the inner auditory nucleus is a collection of large nerve-cells, formerly called the outer auditory nucleus, but now known as the *nucleus of Deiters*. Its cells are connected with those of the cerebellum.

9, 10, 11.—These three nerves are called respectively the *glosso-pharyngeal*, *vagus* or *pneumogastric*, and *spinal accessory*. They arise from an area of grey matter, reaching from about the middle of the floor of the fourth ventricle down into the spinal cord, as low as the origin of the sixth or seventh cervical nerves. The nuclei of the three nerves are closely connected with each other.

In addition to this *combined nucleus*, which is composed of small cells, there are certain lateral contributions, namely:—  
i. the *nucleus ambiguus*, a large celled nucleus, which lies on the lateral side of the reticular formation and is an accessory origin of the vagus and glosso-pharyngeal; ii. the *fasciculus solitarius*, which is situated in the bulb, ventral and a little lateral to the combined nucleus, and which is also called the ascending root of the glosso-pharyngeal nerve or the respiratory bundle; and iii. the *spinal portion* which takes origin from a group of cells lying in the extreme lateral margin of the anterior cornu. This is the origin of the spinal accessory; it corresponds to the antero-lateral nucleus of the bulb, and the lateral part of the grey matter of the spinal cord. The fibres of the spinal origin of the nerve pass from these cells through the lateral column to the surface of the cord.

The fibres from the *combined nucleus*, chiefly from the *median part*, pass in a ventral and lateral direction through the reticular formation, then ventral to or through the gelatinous substance and the strand of fibres connected with the fifth nerve, to the surface of the bulb.

The bundles of fibres of the *fasciculus solitarius* start in the lateral grey matter of the cervical cord and higher in the reticular formation of the bulb; they run longitudinally forwards to pass into the roots of the ninth nerve.

The glosso-pharyngeal and vagus portions of the combined

nucleus are sensory ; the spinal accessory portion of the combined nucleus, the nucleus ambiguus and fasciculus solitarius are motor.

The *glosso-pharyngeal nerve* gives filaments through its tympanic branch (Jacobsen's nerve), to the fenestra ovalis and fenestra rotunda, and the Eustachian tube, parts of the middle ear ; also, to the carotid plexus, and through the great superficial petrosal nerve, to the sphenopalatine (Meckel's) ganglion. The small superficial petrosal (Jacobsen's nerve) passes to the otic ganglion and thus controls the parotid secretion. The carotid plexus may also connect the nerve with the sphenopalatine ganglion. Connections are also made with the sympathetic plexus on the great meningeal artery by the external superficial petrosal. This is important, as another possible connecting link between the glosso-pharyngeal and the otic ganglion is thus provided. After communicating, either within or without the cranium, with the vagus, it leaves the cranium, divides into the two principal divisions indicated by its name, and supplies the mucous membrane of the posterior and lateral walls of the upper part of the pharynx, the Eustachian tube, the arches of the palate, the tonsils and their mucous membrane, and the tongue as far forwards as the foramen cæcum in the middle line, and to near the tip at the sides and inferior part.

*Functions.*—The glosso-pharyngeal roots contain motor fibres to the stylo-pharyngeus, middle constrictor of pharynx, and cricothyroid muscles, and probably to the levator palati and other muscles of the palate, except the tensor which is supplied by the fifth nerve, and the other constrictors of the pharynx which are supplied from the nucleus ambiguus by cranial rootlets of both ninth and tenth nerves. The nerve also contains fibres concerned in common sensation, and the sense of taste, and secretory fibres for the salivary glands.

The *vagus* or *pneumogastric nerve* has most varied functions, giving branches to the pharynx, larynx, œsophagus, stomach, lungs, heart, intestines, liver, and spleen. Some fibres are afferent and some efferent. Most of these functions we have already studied in connection with the organs just named. It should be particularly noted that the principal origin of this nerve is at the lower end of the ventricular floor below the level of the ninth, and, like it, beneath the inferior fovea.

The *spinal accessory nerve* arises by two distinct origins—one from a centre in the floor of the fourth ventricle, and connected with the glosso-pharyngeal-vagus-nucleus ; the other, from the outer side of the anterior cornu of the spinal cord as low down as the fifth or sixth cervical nerve. The fibres from the two origins



nucleus of the ninth, tenth, and eleventh nerves. Fibres from this nucleus run from the ventral surface through the reticular formation in a series of bundles, and it emerges from a groove between the anterior pyramid and olivary body. It is connected with the vagus, with the superior cervical ganglion of the sympathetic and with the upper cervical nerves.

*Distribution.*—This nerve is the motor nerve to the muscles of the tongue (stylo-glossus, hyo-glossus, genio-hyo-glossus, and linguales). The branches of this nerve to the genio-hyoid, thyro-hyoid, sterno-thyroid, sterno-hyoid, and omo-hyoid are branches of the first, second, and third cervical nerves carried down in its sheath and slipped off at various points as descendens (hypoglossi) cervicis, &c.

The reader should now turn once more to fig. 44 (p. 626) and try to obtain a more general idea of the nuclei of origin of all these nerves. It will be noticed that the centres of afferent nerves (coloured red) are in the minority; these comprise the sensory nucleus of the fifth, the nuclei of the eighth nerve, and the glosso-pharyngeal and vagal portions of the combined nucleus of the ninth, tenth and eleventh nerves. The remaining nuclei (coloured blue) are efferent, and may be principally arranged into two groups:—(1) the nuclei of the third, fourth, sixth and twelfth nerves which are close to the middle line, and (2) the motor nucleus of the fifth, seventh, and nucleus ambiguus (motor nucleus of ninth and tenth nerves) which form a line more lateral in position.

A mere enumeration of the destination of the nerves arising in the bulb shows how supremely important this small area of the brain is for carrying on the organic functions of life. It contains centres which regulate deglutition, vomiting, the secretion of saliva, sweat, &c., respiration, the heart's movements, and the vaso-motor nerves.

#### The Internal structure of the Bulb, Pons, and Mid-brain.

The structure of the interior of these parts is best studied in a series of transverse sections. We will limit ourselves to seven, the level of which is indicated in fig 465. The cerebellum has been bisected into two halves and turned outwards, its upper peduncles cut through to render the parts more evident. The position of our seven sections is indicated by the transverse lines numbered 1 to 7.

**First section.**—This is taken at the lowest level of the bulb, through the region of the decussation of the pyramids. The similarity to the cervical cord will be at once recognised; the passage of the pyramidal fibres (P) from the anterior part of the bulb to the crossed pyramidal tract of the opposite side of the cord cuts off the tip of the anterior horn (A), which in sections higher up appears as an isolated mass of grey matter, called the *lateral nucleus* (fig. 467, *nl*). The V formed by the two posterior horns is opened out, and thus the grey matter with the central canal is brought nearer to the dorsal aspect of the bulb; the tip of the cornu swells out to form the *substantia gelatinosa of Rolando* (R), which causes a prominence on the surface called the

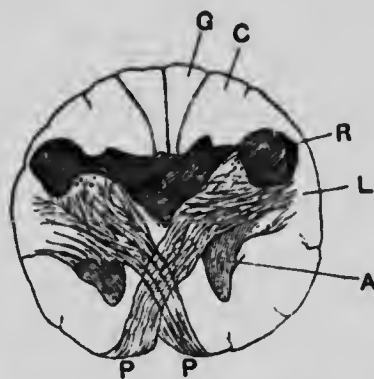

Fig. 466.—Section through the bulb at the level of the decussation of the pyramids. *g*, funiculus gracilis, continuation of column of Goll; *c*, funiculus cuneatus, continuation of column of Burdach; *r*, substantia gelatinosa of Rolando, continuation of posterior horn of spinal cord; *l*, continuation of lateral column of cord; *a*, remains of part of the anterior horn, separated from the rest of the grey matter by the pyramidal fibres *p*, which are crossing from the pyramid of the medulla to the posterior part of the lateral column of the opposite side of the cord. (After L. Clarke.)

*tubercle of Rolando*; *G* and *C* are the *funiculi gracilis* and *cuneatus* respectively, the continuations upwards of the columns of Goll and Burdach.

**Second section.**—This is taken through the upper part of the decussation. Beginning in the middle line at the top of the diagram, we see first the posterior median fissure (*p.m.f.*), below which is the grey matter enclosing the central canal (*c.c.*), and containing the nuclei of the eleventh and twelfth nerves; the funiculus gracilis (*f.g.*) comes next, and then the funiculus cuneatus (*f.c.*); these two funiculi have now grey matter in their interior: these masses of grey matter are called respectively *nucleus gracilis* (*n.g.*) and *nucleus cuneatus* (*n.c.*); the fibres which have ascended the posterior columns of the cord terminate by arborising around the cells of this grey matter; the fibres from the lower part of the

body end in the nucleus gracilis, and those from the upper part of the body in the nucleus cuneatus. These nuclei form a most important position of relay in the course of the afferent fibres from cord to brain. The new fibres arising from the cells of these nuclei pass in a number of different directions, and break up the rest of the grey matter into what is called the *formatio reticularis*. The fibres may be divided into three main groups; they are termed arcuate fibres.

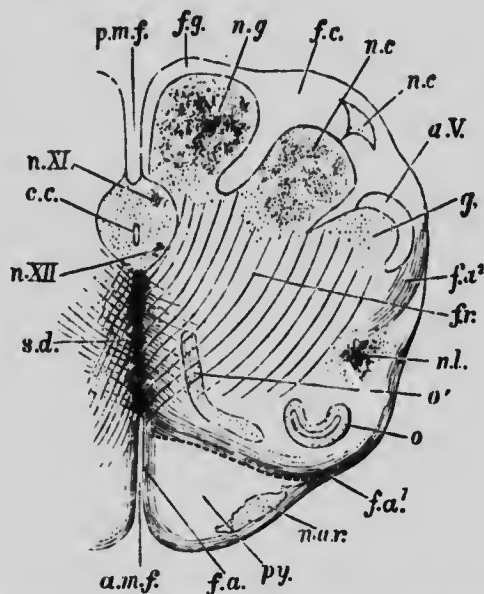

Fig. 457.—Transverse section of the medulla oblongata in the region of the superior decussation. *a.m.f.*, anterior median fissure; *f.a.*, superficial arcuate fibres emerging from the fissure; *py.*, pyramid; *n.a.r.*, nuclei of arcuate fibres; *f.a.¹*, deep arcuate fibres becoming superficial; *o, o'*, lower end of olivary nucleus; *n.l.*, nucleus lateralis; *f.r.*, formatio reticularis; *f.a.²*, arcuate fibres proceeding from the formatio reticularis; *g.*, substantia gelatinosa of Rolando; *a.V.*, ascending root of fifth nerve; *f.c.*, funiculus cuneatus; *n.c.*, nucleus cuneatus; *n.c.*, external cuneate nucleus; *n.g.*, nucleus gracilis; *f.g.*, funiculus gracilis; *p.m.f.*, posterior median fissure; *c.c.*, central canal surrounded by grey matter, in which are *n.XI.*, nucleus of the spinal accessory, and *n.XII.*, nucleus of the hypoglossal; *s.d.*, superior decussation (decussation of fillet). (Modified from Schwalbe.)

1. The *external arcuate fibres* (*f a, f a¹*) course round the ventral surface of the bulb.
2. Some of these turn round sharply (*f a²*) to the restiform body of the same side.
3. The *internal arcuate fibres* are those which pass into the formatio reticularis and cross with their fellows at the median raphé, forming what is sometimes called the *superior pyramidal decussation* (*s.d.*), but which should be more properly called the *decussation of the fillet*. The fillet fibres, after having crossed to



the other side, become a longitudinal bundle, which lies just dorsal to the pyramid (*py*), and passes upwards to various parts of the cerebrum, passing, however, through one or more cell stations (positions of relay) before ultimately arriving at the cortex.

We now see that the brain has a crossed relationship to the body, the left half of the brain governing the right half of the body,

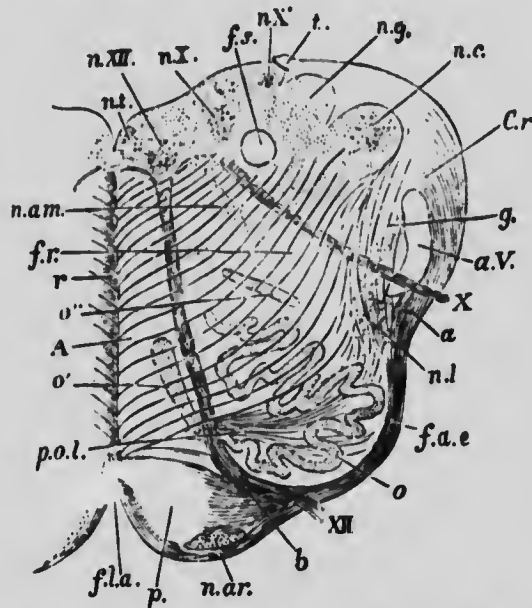

Fig. 468.—Section of the medulla oblongata at about the middle of the olivary body. *f.l.a.*, anterior median fissure; *n.ar.*, nucleus arcuatus; *p.*, pyramid; *XII.*, bundle of hypoglossal nerve emerging from the surface; at *b*, it is seen coursing between the pyramid and the olivary nucleus, *o*; *f.a.e.*, external arcuate fibres; *n.l.*, nucleus lateralis; *a.*, arcuate fibres passing towards restiform body, partly through the substantia gelatinosa, *g.*, partly superficial to the ascending root of the fifth nerve, *a.V.*; *X.*, bundle of vagus root emerging; *f.r.*, formatio reticularis; *Cr.*, corpus restiforme, beginning to be formed, chiefly by arcuate fibres; superficial and deep; *n.c.*, nucleus cuneatus; *n.g.*, nucleus gracilis; *t.*, attachment of the ligula; *f.s.*, funiculus solitarius; *n.X.*, *n.X'*, two parts of the vagus nucleus; *n.XII.*, hypoglossal nucleus; *n.t.*, nucleus of the funiculus teres; *n.am.*, nucleus ambiguus; *r.*, raphé; *A.*, continuation of the anterior column of cord; *o'*, *o''*, accessory olivary nucleus; *p.o.l.*, pedunculus olivae. (Modified from Schwalbe.)

and *vice versa*, both as regards motion and sensation; the motor fibres mostly cross at the decussation of the pyramids, some few (those in the direct pyramidal tract) crossing at lower levels in the cord; the sensory fibres mostly cross at the decussation of the *Cr.*, though some few cross at lower levels in the cord, soon after their entrance into the cord by the posterior nerve-roots.

Other points to be noticed in the section are the substantia gelatinosa of Rolando (*g*) (remains of posterior cornu of the cord), now separated from the surface by the ascending root of the fifth

nerve (*a V*); the lateral nucleus (*n l*) (remains of the anterior cornu of the cord); the lower part of the grey matter of the olivary body (*o, o'*), and most anteriorly the *pyramid* (*py*).

**Third section.**—This (fig. 468) is taken at about the middle of the olivary body, and passes also through the lower part of the floor of the fourth ventricle. The central canal has now opened out into the fourth ventricle, and the grey matter on its floor contains the nuclei of the twelfth and tenth nerves; bundles of the fibres of these nerves course through the substance of the bulb, leaving it at the places indicated in the diagram.

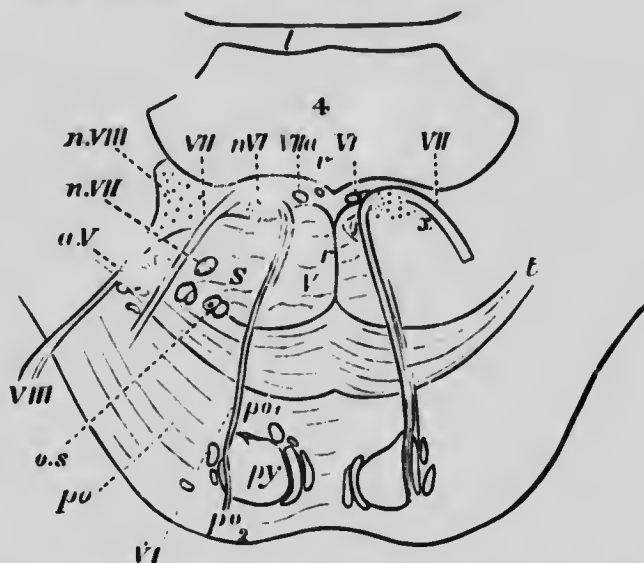

Fig. 469.—Section across the pons, about the middle of the fourth ventricle. *py.*, pyramidal bundles; *po.*, transverse fibres (using *po1*, behind, and *po2*, in front of *py*); *r.*, raphe; *o.s.*, superior olive; *a.V.*, bundles of ascending root of V. nerve enclosed in a prolongation of the substance of Rolando; *t*, trapezium; *VI.*, the sixth nerve, *n.VI.*, its nucleus; *VII.*, facial nerve; *VII.a.*, intermediate portion, *n.VII.*, its nucleus; *VIII.*, auditory nerve, *n.VIII.*, lateral nucleus of the auditory. (After Quain.)

The nucleus gracilis, nucleus cuneatus, and tubercle of Rolando are pushed into a more lateral position; the *restiform body* (*C.r.*) now forms a well-marked prominence, and the olivary body is well seen with its *dentate nucleus*; from the open mouth of this corrugated layer of grey matter a large number of fibres issue, and passing through the raphe, course as internal arcuate fibres to the opposite restiform body, and thus to the cerebellum; some pass to the restiform body of the same side; the continuation of the direct cerebellar tract of the cord also passes into the restiform body. Its fibres terminate by arborisations round Purkinje's cells in the *vermis* of the cerebellum. The *funiculus solitarius* and *nucleus*

*ambiguus*, also seen in this section, have been already alluded to in our account of the origin of the cranial nerves (p. 628).

**Fourth section.**—This is taken through the middle of the pons, and shows much the same kind of arrangement as in the upper part of the bulb. The general appearance of the section is, however, modified by a number of transversely coursing bundles of fibres, most of which are passing from the cerebellar hemispheres to the raphé, and form the middle cerebellar peduncles. Intermingled with these is a considerable amount of grey matter (*nuclei pontis*). The continuation upwards of the pyramids (fig. 469, *py*) is embedded between these transverse bundles, and separated by them from the reticular formation; the deeper transverse fibres, which form the *trapezium* (*t*), connect the superior olivary nucleus of one side to the accessory auditory nucleus of the other side. The large olivary nucleus is no longer seen, but one or two small collections of grey matter (*o.s.*) represent it, and constitute the *superior olivary nucleus*. The nerves taking origin in this region of the floor of the fourth ventricle are the sixth, seventh, and eighth. The fifth nerve originates higher up, where the floor of the fourth ventricle is narrowing, till at last, in the region of the mid-brain, we once more get a canal (Sylvian aqueduct) corresponding to the central canal of the spinal cord.

The reticular formation between the grey floor of the ventricle and the trapezium is a continuation upwards of the reticular formation seen in previous sections. It consists of white fibres passing transversely in different directions, between which there are fibres running longitudinally, and a considerable amount of grey matter. In such a complex system of intercrossing fibres, it is extremely difficult to separate any definite tracts, but there are at least two longitudinal tracts of fibres in it which a little higher up in the mid-brain are separated off from the rest; one of these is the *fillet*, the origin of which in the nuclei gracilis and cuneatus of the opposite side we have already seen; the other is the *posterior longitudinal bundle*, which is stated by some to be a continuation upwards of some of the fibres of the anterior column of the cord; it certainly contains fibres connecting the nuclei of the third and sixth nerves of opposite sides. These are shown in the

**Fifth and Sixth sections**, which are taken through the mid-brain, and are drawn on a smaller scale than the others we have been examining; they represent the actual size of the sections obtained from the human subject.

Near the middle is the *Sylvian aqueduct*, with its lining of

ciliated epithelium. In the grey matter which surrounds it are large nerve-cells, from which the fourth nerve, and higher up the third nerve, originate; the fibres of the third nerve are seen issuing from these in fig. 470, B III. The reticular formation of the pons is continued up into the mid-brain, and is called the *tegmentum*. Its transverse fibres include the decussating fibres of the *superior peduncles of the cerebellum*. The fibres of the *fillet* partly pass in an oblique manner to the side of the mid-brain, and terminate in the grey matter of the corpora quadrigemina (C Q); this is called the *lateral fillet*; the rest of the fillet (*mesial fillet*) goes on through the crus, and has been traced

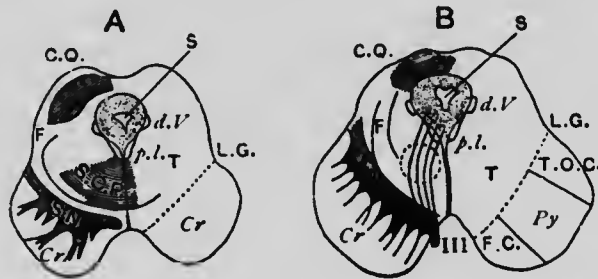

Fig. 470.—Outline of two sections across the mid-brain: A, through the middle of the inferior; B, through the middle of the superior corpora quadrigemina C.Q. Cr., crusta; S.N., substantia nigra—shown only on one side; T, tegmentum; S, Sylvian aqueduct, with its surrounding grey matter; L. G., lateral groove; p.l., posterior longitudinal bundle; d.V., descending root of the fifth nerve; S.C.P., superior cerebellar peduncle; F, fillet; III., third nerve. The dotted circle in B represents the situation of the tegmental nucleus. In B the three divisions of the crusta are indicated on one side. The pyramidal fibres (Py) are in the middle, and the fronto-cerebellar (F.C.) and temporo-occipital cerebellar (T.O.C.) at the sides. (After Schäfer.)

into the *optic thalamus*; from here fresh nerve-fibres, forming a new relay, continue the afferent impulses to the cortex of the cerebrum.

The pyramidal bundles of the pons are continued upwards, and form the middle third of the *crusta* (*cr*) or *pes*. The crusta and tegmentum are separated by a layer of grey matter called the *substantia nigra* (S N). There is also grey matter in the tegmentum itself, which is called the *tegmental* or *red nucleus*.

The *corpora quadrigemina* are formed mainly of grey matter; from each superior corpus a bundle of white fibres passes upwards and forwards to the geniculate bodies, eventually joining the optic tract of the same side. The white layer on the surface of the grey matter of the C. quadrigemina is derived from the optic tract; these fibres come from the retina, and terminate by arborescing around the cells of the grey matter of the C. quadrigemina.

The further relationships of these parts of the brain we shall study in connection with vision.

**Seventh section.**—This is through the crus. It is made up of *crusta* (which contains the motor fibres), *tegmentum* (which contains the sensory fibres, especially the bundle called the mesial fillet), and the *substantia nigra*, the grey matter which separates them.

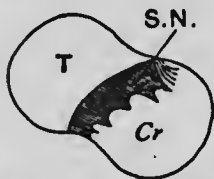

Fig. 471.—Section through crus of cerebrum. *Cr*, crusta; *S.N.*, substantia nigra; *T*, tegmentum.

The destination of one of the spinal cord tracts we have not yet mentioned; this is the tract of Gowers. This is continued up through the ventral part of the pons lateral to the pyramidal bundles; when it reaches

the superior cerebellar peduncles the main part of the tract takes a sharp backward turn and enters the middle lobe or *vermis* of the cerebellum by the superior peduncle and superior medullary velum. Some of the fibres of the tract are continued, however, into the corpora quadrigemina.

## CHAPTER XLV.

### STRUCTURE OF THE CEREBELLUM.

THE Cerebellum is composed of an elongated central portion or lobe, called the *vermis* or vermiform process, and two hemispheres. Each hemisphere is connected with its fellow, not only by means of the vermiform process, but also by a bundle of fibres called the *middle peduncle* (the latter forming the greater part of the transverse fibres of the pons Varolii), while the *superior peduncles*, which decussate in the mid-brain, connect it with the cerebrum (5, fig. 472), and the *inferior peduncles* (restiform bodies) connect it with the medulla oblongata (3, fig. 472).

The cerebellum is composed of white and grey matter, the latter being external, like that of the cerebrum, and like it, infolded, so that a larger area may be contained in a given space. The convolutions of the grey matter, however, are arranged after a different pattern, as shown in fig. 472. The tree-like arrangement of the white matter has given rise to the name *arbor vitæ*. Besides the grey substance on the surface, there are, in the centre of the white substance of each hemisphere, small

masses of grey matter, the largest of which, called the *corpus*



Fig. 472.—Cerebellum in section and fourth ventricle, with the neighbouring parts. 1, median groove of fourth ventricle, ending below in the *calamus scriptorius*, with the longitudinal eminences formed by the *fasciculi teretes*, one on each side; 2, the same groove, at the place where the white streaks of the auditory nerve emerge from it to cross the floor of the ventricle; 3, inferior peduncle of the cerebellum, formed by the restiform body; 4, funiculus gracilis; above this is the *calamus scriptorius*; 5, superior peduncle of cerebellum; 6, 6, fillet to the side of the *crura cerebri*; 7, 7, lateral grooves of the *crura cerebri*; 8, *corpora quadrigemina*. (From Sappey after Hirschfeld and Leveillé.)

*dentatum* (fig. 473, *cd*), resembles very closely the *corpus dentatum* of the olivary body of the medulla oblongata in appearance.

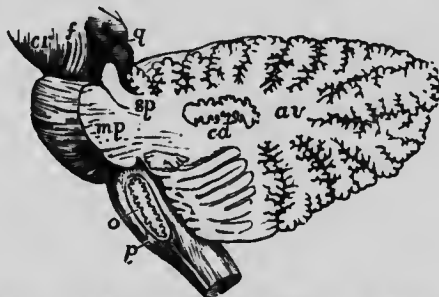

Fig. 473.—Outline sketch of a section of the cerebellum, showing the *corpus dentatum*. The section has been carried through the left lateral part of the pons, so as to divide the superior peduncle and pass nearly through the middle of the left cerebellar hemisphere. The olivary body has also been divided longitudinally so as to expose in section its *corpus dentatum*. *cr*, *crus cerebri*; *f*, *fillet*; *q*, *corpora quadrigemina*; *sp*, *superior peduncle of the cerebellum divided*; *mp*, *middle peduncle or lateral part of the pons Varolii*, with fibres passing from it into the white stem; *av*, *continuation of the white stem radiating towards the arbor vitae of the folia*; *cd*, *corpus dentatum*; *o*, *olivary body with its corpus dentatum*; *p*, *pyramid*. (Allen Thomson.) †.

If a section is taken through the cortical portion of the cerebellum, the following distinct layers can be seen (fig. 474) by microscopic examination.

Underneath the pia mater is the *external layer* of grey matter; it is formed chiefly of fine nerve-fibres with small nerve-cells

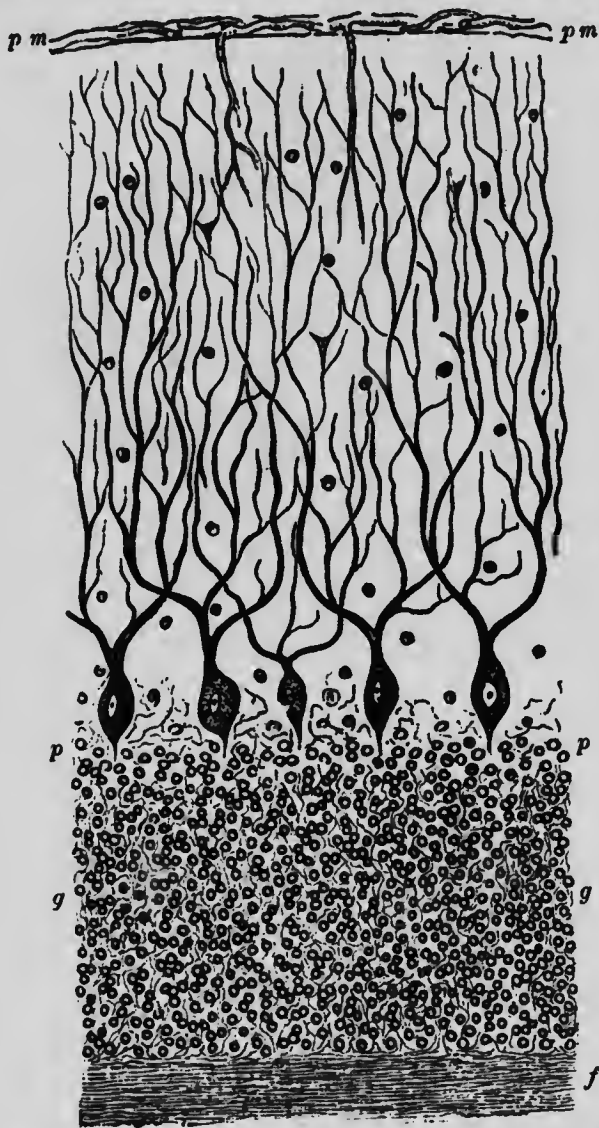

Fig. 474.—Vertical section of dog's cerebellum; *p m*, pia mater; *p*, cells of Purkinje, which are branched nerve-cells lying in a single layer and sending single processes downwards and more numerous ones upwards, which branch continuously and extend through the external "molecular layer" towards the free surface; *g*, dense (granular) layer of small nerve-cells; *f*, layer of nerve-fibres, with a few scattered nerve-cells. This last layer (*f f*) constitutes part of the *white* matter of the cerebellum, while the layers between it and the free surface are *grey* matter. (*F* in and Noble Smith.)

scattered through it. Into its outer part, processes of pia mater pass vertically; these convey blood-vessels. There are also here numerous long tapering neuroglia-cells. The *internal* or *granular*

layer of grey matter is made up of a large number of small nerve-cells mixed with a few larger ones, and some neuroglia-cells. Between the two layers is an incomplete stratum of large flask-shaped cells, called the *cel. of Purkinje*. Each of these gives off from its base a fine process which becomes the axis-cylinder of one of the medullated fibres of the white matter; the neck of the flask passing in the opposite direction breaks up into dendrites which pass into the external layer of grey matter. By Golgi's method (fig. 475) these dendrons have been shown to spread out in planes transverse to the direction of the lamellæ of the organ.

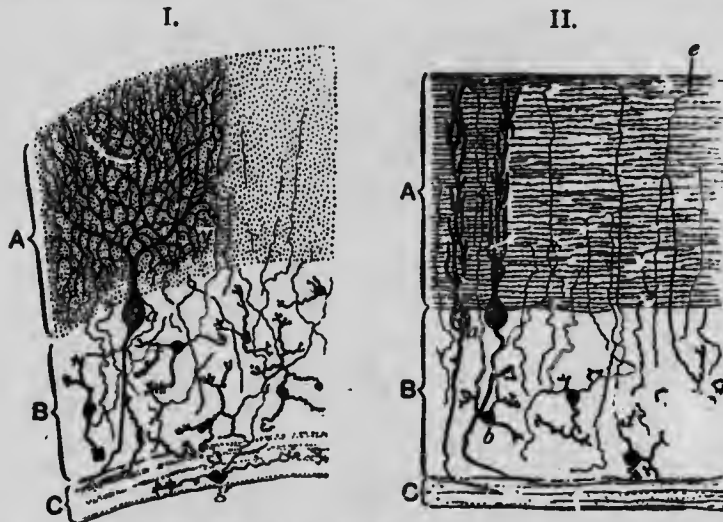

Fig. 475.—Section of cerebellar cortex, stained by Golgi's method; *i.* taken across the lamina; *ii.* in the direction of the lamina; *A*, outer or molecula. layer; *B*, inner or granular layer; *C*, white matter. *a*, Cell of Purkinje; *b*, small cells of inner layer; *c*, dendrons of these cells; *d*, axis-cylinder process of one of these cells becoming longitudinal in the outer layer; *e*, bifurcation of one of these; *g*, a similar cell lying in the white matter. (Ramon y Cajal.)

Each cell of Purkinje is further invested by arborisations of two sets of nerve-fibres. One of these (originating from the fibres of the white matter which are not continuous as axis-cylinders from the cells of Purkinje) forms a basket-work round the dendrons; the other (originating as axis-cylinder processes from the nerve-cells of the external layer) forms a felt-work of fibrils round the body of the cell.

The cells of the internal layer of grey matter are small; their dendrites intermingle with those of neighbouring cells; their axons penetrate into the external layer, but their final destination is uncertain. Ramifying among these cells are fibres characterised by possessing bunches of short branches at intervals (moss-fibres of Cajal).



## CHAPTER XLVI.

## STRUCTURE OF THE CEREBRUM.

THE large size and complexity of the cerebrum distinguishes the brain of man from that of the lower animals; the amount of

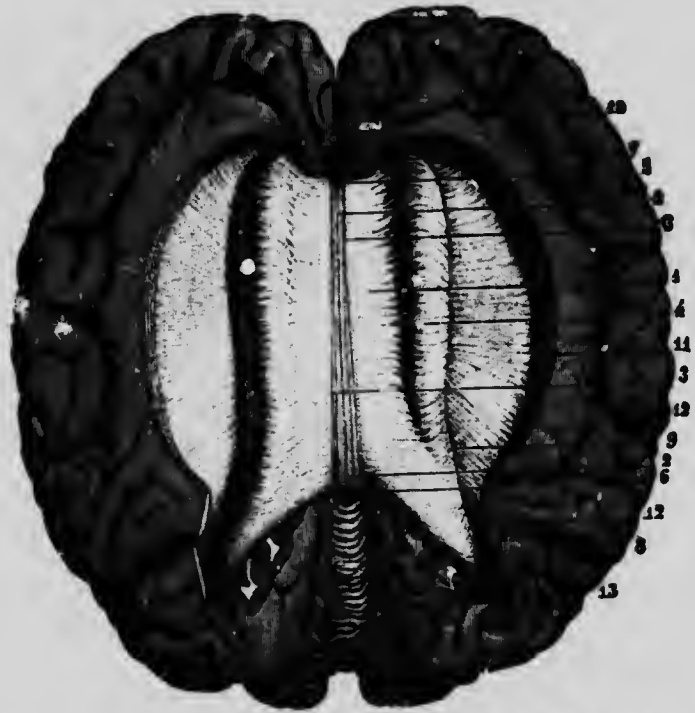

Fig. 476.—View of the Corpus Callosum from above. 1.—The upper surface of the corpus callosum has been fully exposed by separating the cerebral hemispheres and throwing them to the side; the gyrus fornicatus has been detached, and the transverse fibres of the corpus callosum traced for some distance into the cerebral medullary substance. 1, the upper surface of the corpus callosum; 2, median furrow or raphe; 3, longitudinal striae bounding the furrow; 4, swelling formed by the transverse bands as they pass into the cerebrum; 5, anterior extremity or knee of the corpus callosum; 6, posterior extremity; 7, anterior, and 8, posterior part of the mass of fibres proceeding from the corpus callosum; 9, margin of the swelling; 10, anterior part of the convolution of the corpus callosum; 11, hem or band of union of this convolution; 12, internal convolutions of the parietal lobe; 13, upper surface of the cerebellum. (Sappey, after Foville.)

convolution of its surface corresponds roughly with the degree of intelligence.

The cerebrum consists of two halves called *cerebral hemispheres*, separated by a deep longitudinal fissure and connected by a large

band of transverse commissural fibres known as the *corpus callosum*. The interior of each hemisphere contains a cavity of complicated shape called the *lateral ventricle*; the lateral ventricles open into the third ventricle. The corpus callosum is shown in fig. 476.



Fig. 477.—Dissection of brain, from above, exposing the lateral, fourth, and fifth ventricles with the surrounding parts. *a*, anterior part, or *genu* of corpus callosum; *b*, corpus striatum; *b'*, the corpus striatum of left side, dissected so as to expose its grey substance; *c*, points by a line to the *tenia semicircularis*; *d*, optic thalamus; *e*, anterior pillars of fornix divided; below they are seen descending in front of the third ventricle, and between them is seen part of the anterior commissure; in front of the letter *e* is seen the slit-like fifth ventricle, between the two laminae of the septum lucidum; *f*, soft or middle commissure; *g* is placed in the posterior part of the third ventricle; immediately behind the latter are the posterior commissure (just visible) and the pineal gland, the two crura of which extend forwards along the inner and upper margins of the optic thalami; *h* and *i*, the corpora quadrigemina; *k*, superior crus of cerebellum; close to *k* is the valve of Vieussens, which has been divided so as to expose the fourth ventricle; *l*, hippocampus maior and corpus fimbriatum, or *tenia hippocampi*; *m*, hippocampus minor; *n*, eminentia collateralis; *o*, fourth ventricle; *p*, posterior surface of medulla oblongata; *r*, section of cerebellum; *s*, upper part of left hemisphere of cerebellum exposed by the removal of part of the posterior cerebral lobe. (Hirschfeld and Leveillé.)

The next figure (fig. 477) represents a dissected brain in which the corpus callosum has been removed; the ventricles are thus exposed.

Each hemisphere is covered with grey matter, which passes down into the fissures that abound on its exterior. This surface

grey matter is called the *cerebral cortex*. The amount of this grey matter varies directly with the amount of convolution of the surface. Under it white matter is situated; and at the base there are masses of grey matter; part of these *basal ganglia* are seen forming part of the wall of the ventricles. The anterior basal ganglion is called the *corpus striatum*; it is divided into two parts called the *lenticular* or *extraventricular nucleus*, and the *caudate* or *intra-ventricular nucleus*. It has received the latter name because it is seen in the interior of the ventricle. The posterior basal ganglion is called the *optic thalamus*.

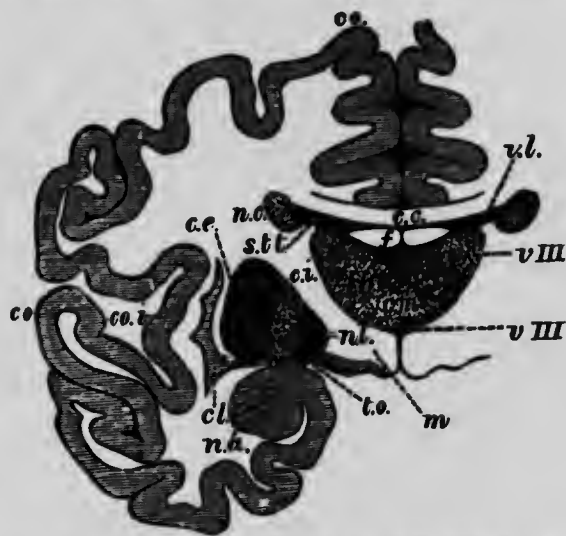

Fig. 478.—Vertical section through the cerebrum and basal ganglia to show the relations of the latter. *co.*, cerebral convolutions; *c.c.*, corpus callosum; *v.l.*, lateral ventricle; *f.*, fornix; *v.III.*, third ventricle; *n.c.*, caudate nucleus; *th.*, optic thalamus; *n.l.*, lenticular nucleus; *c.i.*, internal capsule; *cl.*, claustrum; *c.e.*, external capsule; *m.*, corpus mammillare; *t.o.*, optic tract; *s.t.*, stria terminalis; *n.a.*, nucleus amygdalæ; *cm.*, soft commissure; *co.i.*, island of Reil. (Schwalbe.)

Passing up between the basal ganglia are the white fibres which enter the cerebral hemisphere from the crus; these constitute the *internal capsule*. This passes in front between the two subdivisions of the corpus striatum, and behind between the optic thalamus and the lenticular nucleus of the corpus striatum.

The relationship of these parts is best seen in a vertical section; such as is represented in the next diagram (fig. 478).

One hemisphere is seen, with portions of the other. The surface darkly shaded indicates the grey matter of the cortex, which passes down into the fissures; one very extensive set of convolutions (*co.i.*) passes deeply into the substance of the hemisphere; this is called the Island of Reil; the lowest stratum of grey

matter is separated from this to form a narrow isolated strip of grey matter called the *claustrum* (*cl.*). In the middle line from above down are seen the great longitudinal fissure extending as far as (*c.c.*) the corpus callosum, the band of white matter that forms the great commissure between the two hemispheres; beneath this are the lateral ventricles which communicate by the *foramen of Monro* with the third ventricle: *the fornix* is indicated by the letter *f.* Contributing to the floor of the lateral ventricle, one next sees the optic thalamus (*th.*), and the tail end of the nucleus caudatus (*n.c.*); the section being taken somewhat posteriorly. The nucleus lenticularis is marked *nl.*; and the band of white fibres passing up between it and the thalamus is called the *internal capsule* (*c.i.*); the narrow piece of white matter between the claustrum and the lenticular nucleus is called the *external capsule*.

For the student of medicine the internal capsule is one of the most important parts of the brain. Into it are continued up the fibres which we have previously traced as far as the crus cerebri; the motor-fibres of the crura are continued into the anterior two-thirds of its posterior limb (*i.e.* behind the genu \* in fig. 479); the sensory fibres of the tegmentum into the posterior third of this limb. When these fibres get beyond the narrow pass between the basal ganglia, they spread out in a fan-like manner and are distributed to the grey cortex; the motor-fibres going to the motor convolutions around the fissure of Rolando; the sensory fibres to the same convolutions and also to others behind these which are associated with special sensations. The name *corona radiata* is applied to the fan-like spreading of the fibres; the fibres as they pass through the handle of the fan, or internal capsule, communicate with the nerve-cells of the grey matter of the basal ganglia; the pyramidal fibres on their way down to the medulla and cord from the motor areas of the brain send off collaterals or side branches which arborise around the cells of the corpus striatum, and to a lesser degree around those of the optic thalamus; the axis-cylinder processes of these cells pass out to join the pyramidal tract on its downward course. The sensory fibres on their way up may pass straight on to the cortex, but the majority, especially those in the fillet, terminate by arborising round the cells of the optic thalamus, and in the *subthalamie area*. This, in fact, is another cell-station or position of relay: the fibres passing out from the cells of the thalamus continue the impulse on to the cortex.

The importance of the internal capsule is rendered evident when one considers the blood supply of these parts; at the *anterior and posterior perforated spots*, numerous small blood-vessels

enter for the supply of the basal ganglia, and these are liable to become diseased, and if they rupture, a condition called *apoplexy* is the result; if the hæmorrhage is excessive, death may occur almost immediately; but if the patient recovers, a condition of more or less permanent paralysis remains behind; and a very large amount of paralysis results from a comparatively limited lesion, because so many fibres are congregated together in this narrow isthmus of white matter. If the hæmorrhage is in the

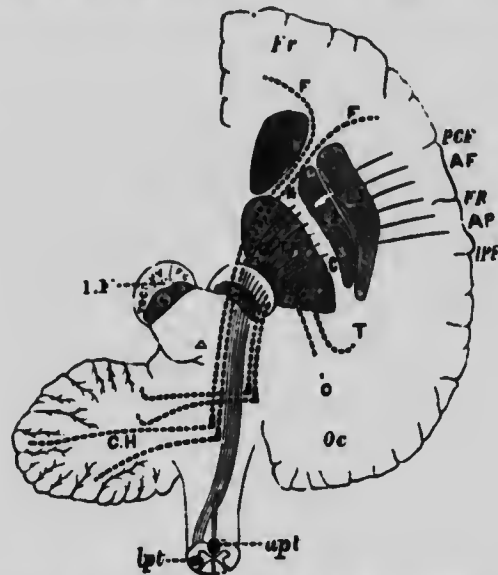

Fig. 479.—Diagram to show the connection of the Frontal Occipital Lobes with the Cerebellum, &c. The dotted lines passing in the crura (r.oc), outside the motor fibres, indicate the connection between the temporo-occipital lobe and the cerebellum. F.C., the fronto-cerebellar fibres, which pass internally to the motor tract in the crura; I.F., fibres from the caudate nucleus to the pons. Fr., frontal lobe; Oc., occipital lobe; A.F., ascending frontal; A.P., ascending parietal convolutions; P.C.F., precentral fissure in front of the ascending frontal convolution; F.R., fissure of Rolando; I.P.F., interparietal fissure. A section of crus is lettered on the left side. s.n., substantia nigra; P.V., pyramidal motor fibres, which on the right are shown as continuous lines converging to pass through the posterior limb of I.C., internal capsule (the knee or elbow of which is shown thus \*) upwards into the hemisphere and downwards through the pons to cross at the medulla in the pyramidal decussation. *lpt*, crossed pyramidal tract; *apt*, direct pyramidal tract. (Gowers.)

anterior part of one internal capsule, motor paralysis of the opposite side of the body (hemiplegia) will be the most marked symptom. If the hæmorrhage occurs in the posterior part, sensory paralysis of the opposite side of the body will be the most marked symptom. If the motor-fibres are affected, degeneration will occur in the pyramidal tract and can be traced through the pes of the crus and mid-brain to the pyramid of the pons and bulb, and then in the crossed pyramidal tract of the opposite side and in the direct pyramidal tract of the same side of the cord.

Figure 479 represents a horizontal view through the hemisphere. The internal capsule (*c*) at the point \* makes a bend called the *genu* or knee, behind which the motor-fibres, and more posteriorly still the sensory-fibres, pass. The connection between cerebrum and cerebellum is also indicated; one cerebral hemisphere is connected with the opposite cerebellar hemisphere by the superior cerebellar peduncle which decussates with its fellow in the mid-brain.

The remainder of the white matter consists of association fibres which run from convolution to convolution.

#### Histological Structure of the Cerebral Cortex.

The cortex consists of the following five layers (Meynert):—

1. Superficial layer with abundance of neuroglia and a few small multipolar nerve-cells.
2. A thin layer of a large number of closely packed small nerve-cells of pyramidal shape.
3. The most important layer, and the thickest of all: it contains many large pyramidal nerve-cells, each with an axis-cylinder running off from the base vertically towards the free surface, and lateral processes at the base which are always branched. There is also a median process from the base of each cell which becomes continuous with the axis-cylinder of a nerve-fibre. The bundles of fibres spread out in this layer.
4. Numerous nerve-cells, some large and others small, forming the *granular formation* of Meynert.
5. Spindle-shaped and branched nerve-cells of moderate size arranged chiefly parallel to the free surface (fig. 480). This layer

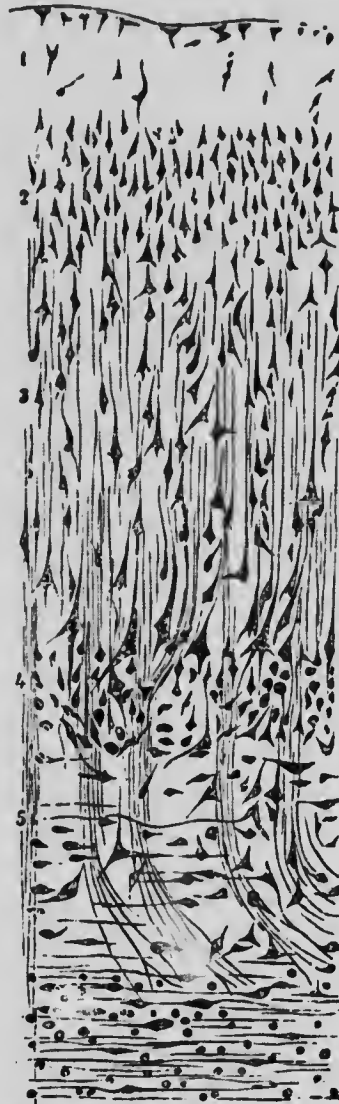

Fig. 480.—The layers of the cortical grey matter of the cerebrum (Meynert.)

is remarkable in being broken up by fibres arranged in groups passing to the outer layers.

It is a noticeable fact that the different layers do not bear the same relation to one another in thickness in different regions. In the area about the fissure of Rolando, which we shall presently see is called the *sensori-motor area*, the large pyramidal cells of the



Fig. 481.—Principal types of cells in the cerebral cortex.

- A, medium-sized pyramidal cell of the second layer.
- B, large pyramidal cell of third layer.
- C, polymorphous cell of fourth layer.
- D, cell of which the axis-cylinder process is ascending.
- E, neuroglia cell.
- F, cell of the first, or molecular, layer, forming an intermediate cell-station between sensory fibres and motor cells. Notice the *tangential* direction of the nerve-fibres.
- G, sensory fibre from the white matter.
- H, white matter.
- I, collateral of the white matter. (Ramon y Cajal.)

third layer are conspicuous in size and number, and numerous large cells are found in the fourth layer. These latter attain their greatest development in the pre-central and post-central convolutions. The granular layer is very marked in the occipital region, forming a distinct and broad division of the fourth layer. The large cells are scarce. In the frontal region, the pyramidal and fourth layers are well marked but the cells are less

numerous; the nuclear layer is very distinct. The pyramidal



Fig. 482.—Human cerebral cortex: Golgi's method. (Mott.)



Fig. 483.—Human cerebral cortex: Golgi's method. (Mott.)

cells are those from which the motor or efferent fibres originate. The separation of the fifth layer from the rest to form the



claustrum in the region of the Island of Reil has been already alluded to (p. 645).

By Golgi's method the arrangement of these cells has been recently made out much better. The diagram on p. 648 (fig. 481) is taken from Ramon y Cajal's Croonian Lecture, and the following two (figs. 482 and 483) are from photo-micrographs kindly lent me by Dr. Mott. Fig. 482 represents a section through the motor cortex of the human brain, and shows very beautifully the large pyramidal cells with dendrons passing off from their corners, and the axis-cylinder process passing from the base of each towards the white matter, giving off collaterals on the way. Neuroglia-cells are also seen.

Fig. 483 is a high-power view of the same; in the lower part of the diagram some of the neuroglia-cells are seen in the sheath of a small blood-vessel.

The cells of the cortex thus give rise to the motor or efferent fibres; these pass into the white matter of the interior of the brain. Some go either directly or by collaterals, (1) to the cortex of more or less distant convolutions. These are called *Association fibres*. (2) Others pass to the corpus callosum, and so reach the cortex of the opposite hemisphere. These are called *Commissural fibres*. In each case they terminate by arborisations (synapses) around the cells of the grey matter of the cortex; while others again, especially those of the largest pyramidal cells, extend downward through the corona radiata and internal capsule and become, (3) fibres of the pyramidal tract. These are called *Projection fibres*. As they pass down they give off collaterals to the adjacent grey matter, to the opposite hemisphere *via* the corpus callosum, to the corpus striatum and the optic thalamus, which terminate there by arborisations: the main fibres terminate in synapses round the multipolar cells of the anterior horn of the opposite side of the spinal cord.

The cells of the cortex are, in addition to all this, surrounded by the arborising terminations of the sensory nerve-fibres, which, after relays at various cell-stations, ultimately reach the cortex.

We are now in a position to complete diagram 453 (p. 611), and obtain an idea of the relations of the principal cells and fibres of the cerebro-spinal nervous system to one another.

Pyr. (fig. 484) is a cell of the Rolandic area of the cerebral cortex; AX is its axis-cylinder process which passes down in the pyramidal tract, and crosses the middle line AB at the pyramidal decussation. It gives off collaterals, one of which (*coll*) is shown passing in the corpus callosum to terminate in an arborisation in the cortex of the opposite hemisphere; another (*str*) passes into the corpus striatum. In the cord collaterals pass off and end in arbori-

sations round cells of the anterior horn of the spinal cord (see also fig. 453); the main fibre has a similar termination.\* The motor nerve-fibre passes from the anterior cornual cell to muscular fibres where it ends in the terminal arborisations called end-plates.

Coming now to the sensory fibres, a cell of one of the spinal ganglia is

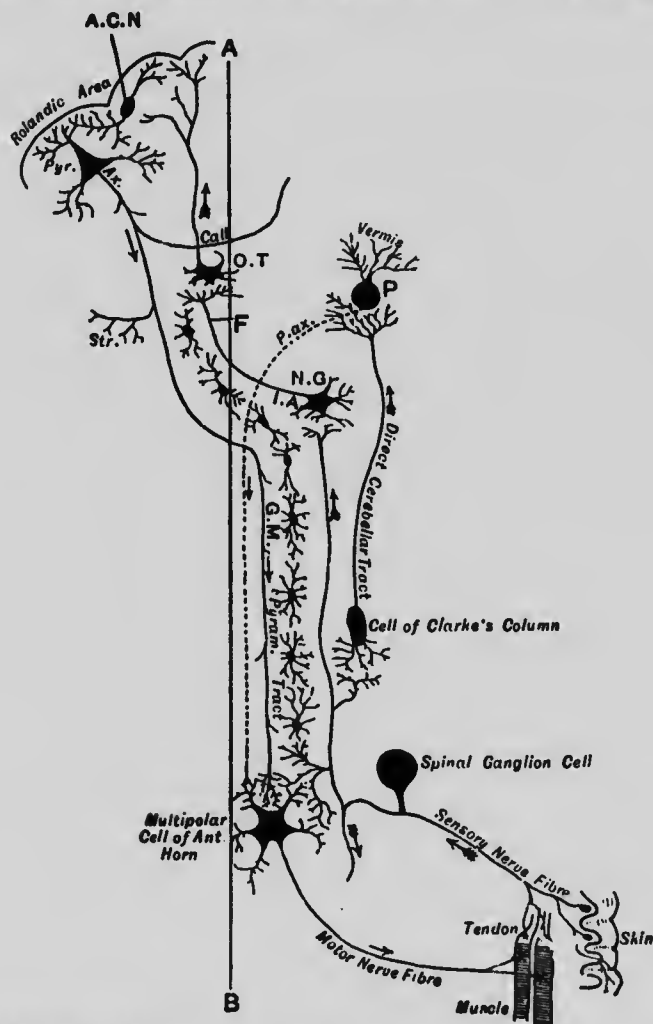

Fig. 484.—Scheme of relationship of cells and fibres of brain and cord. (In the preparation of this diagram I have received considerable assistance from Dr. Mott.)

shown. Its axis-cylinder process bifurcates, and one branch passes to the periphery ending in arborisations in skin and tendon. The other (central) branch bifurcates on entering the cord, and its divisions pass upwards and downwards, the latter for a short distance only; the terminations of this descending branch and of collaterals of the ascending branch round the cells

\* The intermediate cell station in the posterior horn between the pyramidal fibre and the anterior cornual cell (Schäfer) is not shown in the diagram (see also p. 610).

of the spinal cord are more fully shown in figure 453. The main ascending branch arborises around a cell of the nucleus gracilis (N.G.) or nucleus cuneatus in the posterior columns of the bulb; the axis-cylinder process of this cell passes over to the other side as an internal arcuate fibre (I.A.), and becomes longitudinal as one of the fibres of the mesial fillet (F), which terminates round a cell of the optic thalamus (O.T.), from which a new axis-cylinder process passes to form an arborisation around the dendrons of one of the cerebral cells (Cajal's nerve-unit of association A.C.N.) in the surface layer of the cortical grey matter (shown on a larger scale in fig. 481 F); the axis-cylinder process of A.C.N. arborises round the dendrons of the pyramidal cell from which we started.

In this way one gets a complete physiological circle of nerve-units; the segments of the circle are, however, anatomically distinct, and the impulses travel through contiguous, not through continuous, structures. The simple arrows indicate the direction of the impulses in the efferent projection system; the feathered arrows in the afferent projection system.

Next we come to the connections of the cerebellum. One of the collaterals of the sensory nerve-fibre arborises round a cell of Clarke's column, from which a fibre of the direct cerebellar tract passes to end in an arborisation around a cell in the vermis of the cerebellum. P is one of the cells of Purkinje, the axis-cylinder process of which P.ax passes to the cerebro-spinal axis; it is depicted as passing down to envelop one of the cells of the anterior horn; but this has never been satisfactorily demonstrated; so a dotted line has been used to indicate this uncertainty. No doubt also some of its collaterals pass up to the cerebrum.

The origin and destination of the tract of Gowers are not shown in the diagram; the fibres of communication from the cerebral to the opposite cerebellar hemisphere, which pass through the superior cerebellar peduncle, are also omitted. The sympathetic system, with its numerous cell stations in the sympathetic ganglia, we have studied in connection with the blood-vessels and viscera to which the sympathetic fibres are distributed (see especially pp. 299-303).

G.M. is the grey matter which is continuous from spinal cord to the optic thalamus, and through this certain afferent impulses, such as those of pain, travel upwards.

Particular attention should be paid to the following point: when an afferent fibre enters the spinal cord, it divides into three main sets of branches. The first set, the shortest, forms synapses with the motor cells of the anterior horn; here we have the anatomical basis of spinal reflex action. The second set passes through an intermediate cell-station in Clarke's column to the cerebellum, the emerging fibres from which also influence the motor discharge of the anterior horn cells. The third set, the longest, passes through three intermediate cell-stations (the first in the nucleus gracilis or cuneatus, the second in the optic thalamus, the third in the association units in the cerebral cortex), and ultimately reaches the pyramidal nerve cells of the cerebral cortex, the efferent fibres (pyramidal fibres) of which pass to the motor cells of the anterior horn and influence their discharge. The motor nerve cells of the anterior horn may thus be influenced by the afferent impulses *via* three paths or *nervous circles*. In health, all these nervous circles are in action to produce co-ordinated muscular impulses. In locomotor ataxy, which is a degeneration of the cells of the ganglia on the posterior roots and their branches, all these nervous circles are deranged, and the result is loss of reflex action, and incoordination of muscular movements.

### The Convolution of the Cerebrum.

The surface of the brain is marked by a great number of depressions which are called *fissures* or *sulci*, and it is this folding

of the surface that enables a very large amount of the precious material called the grey matter of the cortex to be packed within the narrow compass of the cranium. In the lowest vertebrates the surface of the brain is smooth, but going higher in the animal scale the fissures make their appearance, reaching their greatest degree of complexity in the higher apes and in man.

In an early embryonic stage of the human foetus the brain is also smooth, but as development progresses the sulci appear, until the climax is reached in the brain of the adult.

The sulci, which make their appearance first, both in the animal scale and in the development of the human foetus, are the same. They remain in the adult as the deepest and best marked sulci; they are called the *primary fissures or sulci*, and they divide the brain into *lobes*; the remaining sulci, called the *secondary fissures or sulci*, further subdivide each lobe into *convolutions or gyri*.



Fig. 485.

A. Brain of adult Macaque monkey.

B. Brain of child shortly before birth.

The two brains are very much alike, but the growth forwards of the frontal lobes even at this early stage of development of the human brain is quite well seen. S, fissure of Sylvius; R, fissure of Rolando.

A first glance at an adult human brain reveals what appears to be a hopeless puzzle; this, however, is reduced to order when one studies the brain in different stages of development, or compares the brain of man with that of the lower animals. The monkey's brain in particular has given the key to the puzzle, because there the primary fissures are not obscured by the complexity and contorted arrangement of secondary fissures.

The preceding figure, comparing the brain of one of the lower monkeys with that of the child shortly before birth, shows the close family likeness in the two cases.

Fig. 486 gives a representation of the brain of one of the higher monkeys, the orang-outang, where there is an intermediate condition of complexity by which we are led lastly to the human brain.

Let us take first the outer surface of the human hemisphere; the primary fissures are—

1. *The fissure of Sylvius*; this divides into two limbs, the posterior of which is the larger, and runs backwards and upwards,

and the anterior limb, which passing into the substance of the hemisphere, forms the *Island of Reil*.

2. *The fissure of Rolando*, running from about the middle of the top of the diagram (fig. 487) downwards and forwards.

3. *The external parieto-occipital fissure* (PAR. OC. F) parallel to the fissure of Rolando but more posterior and much shorter; in some monkeys it is longer (see fig. 486).

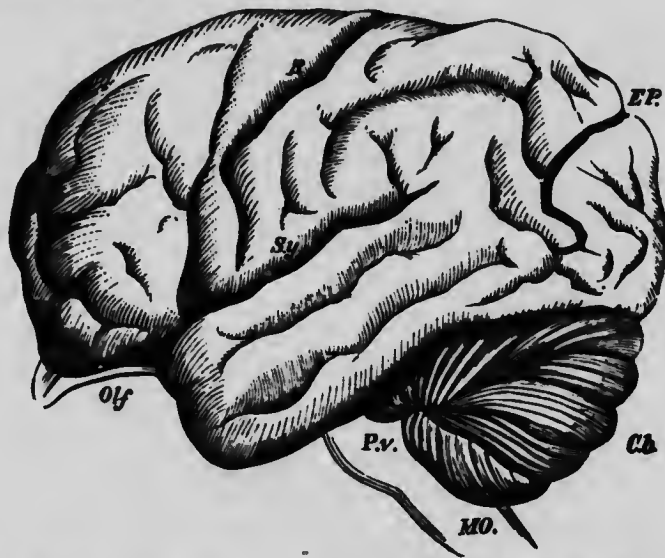

Fig. 486.—Brain of the Orang,  $\frac{2}{3}$  natural size, showing the arrangement of the convolutions. *Sy*, fissure of Sylvius; *R*, fissure of Rolando; *EP*, external parieto-occipital fissure; *Olf*, olfactory lobe; *Cb*, cerebellum; *P.v.*, pons Varolii; *MO*, medulla oblongata. As contrasted with the human brain, the frontal lobe is short and small relatively, the fissure of Sylvius is oblique, the temporo-sphenoidal lobe very prominent, and the external parieto-occipital fissure very well marked. (Gratiolet.)

These three fissures divide the brain into five lobes:—

1. *The frontal lobe*; in front of the fissure of Rolando.
2. *The parietal lobe*; between the fissure of Rolando and the external parieto-occipital fissure.
3. *The occipital lobe*; behind the external parieto-occipital fissure.
4. *The temporal or temporo-sphenoidal lobe*; below the fissure of Sylvius.
5. *The Island of Reil*.

It will be noticed that the names of the lobes correspond to those of the bones of the cranial vault which cover them. There is no exact correspondence between the bones and the lobes, but the precise position of the various convolutions in relation to the surface of the skull is a matter of anatomy, which, in these days of brain-surgery, is of overwhelming importance to the surgeon. The position of a localised disease in the brain can be determined

very accurately, as we shall see later, by the symptoms exhibited by the patient, and it would be obviously inconvenient to the patient if the surgeon was unable to trephine over the exact spot under which the diseased convolution lies, but had to make a number of exploratory holes to find out where he was.

Each lobe is divided into convolutions by secondary fissures.

1. **The frontal lobe** is divided by the *central frontal* or *pre-frontal sulcus* which runs upwards parallel to the fissure of Rolando, and two *transverse frontal sulci*, upper and lower, into four convolutions; namely, the *ascending frontal convolution* in front of the fissure of Rolando, and three *transverse frontal convolutions*, *upper*, *middle*, and *lower*, which run outwards and forwards from it.

2. **The parietal lobe** has one important secondary sulcus, at first running parallel to the fissure of Rolando and then turning back parallel to the margin of the brain. It is called the

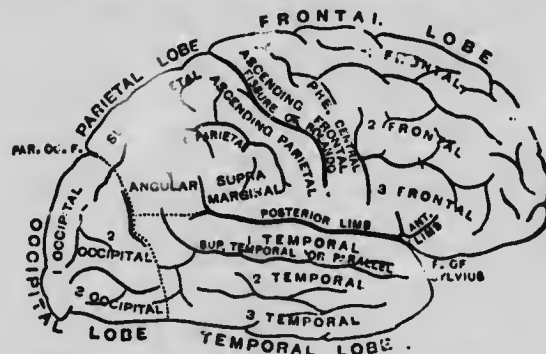

Fig. 487.—Right cerebral hemisphere, outer surface.

*intra-parietal sulcus*. The lobe is thus divided into the *ascending parietal convolution* behind the fissure of Rolando, the *supra-marginal convolution* between the intra-parietal sulcus, and the fissure of Sylvius; the *angular convolution* which turns round the end of the Sylvian fissure, and the *superior parietal convolution*, or *parietal lobule*, in front of the external parieto-occipital fissure.

3. **The occipital lobe** is divided into *upper*, *middle*, and *lower occipital convolutions* by two secondary fissures running across it.

4. **The temporal lobe** is similarly divided into *upper*, *middle*, and *lower temporal convolutions* by two fissures running parallel to the fissure of Sylvius; the upper of these fissures is called the *parallel fissure*.

5. **The Island of Reil** is divided into convolutions by the breaking up of the anterior limb of the Sylvian fissure.

Coming now to the mesial surface of the hemisphere (fig. 488), its subdivisions are made evident by cutting through the corpus

callosum which unites the hemisphere to its fellow. The subdivision into lobes is not so apparent here as on the external surface of the hemisphere, so we may pass at once to the convolutions into which it is broken up by fissures.

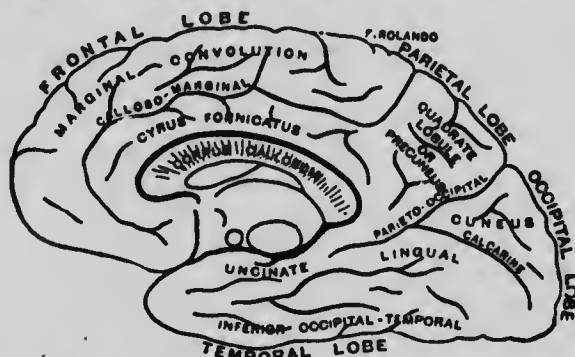

Fig. 488.—Right cerebral hemisphere, mesial surface.

In the middle the corpus callosum is seen cut across; above it and parallel to its upper border is a fissure called the *calloso-marginal fissure* which turns up and ends on the surface near the upper end of the fissure of Rolando. The convolution above this is called the *marginal convolution*, and the one below it the *callosal convolution* or *gyrus fornicatus*. The deep fissure below the corpus callosum running from its posterior end forwards and

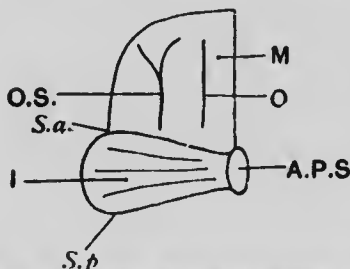

Fig. 489.—Orbital surface of frontal lobe.

- M, marginal convolution.
- O, olfactory sulcus.
- O.S., orbital sulcus.
- I, island of Reil.
- S.a, anterior limb of Sylvian fissure.
- S.p, posterior limb of Sylvian fissure.
- A.P.S., anterior perforated spot.

downwards is called the *dentate fissure*; this forms a projection seen in the interior of the lateral ventricle and called there the *hippocampus major*; it is sometimes called the *hippocampal convolution* which, together with the gyrus fornicatus above the corpus callosum, constitutes the *limbic lobe*. Below the dentate fissure is another called the *collateral fissure*, above which is the *uncinate convolution*, and below which is the inferior temporal convolution which we have previously seen on

the external surface of the hemisphere (see fig. 487). In the occipital region the internal *parieto-occipital fissure*, which is a continuation of the external parieto-occipital fissure, passes downwards and forwards till it meets the *calcarine fissure*; these two enclose between them a wedge-shaped piece of brain called the *cuneus* or

*cuneate lobule*; the square piece above it is called the *precuneus* or *quadrilateral lobule*.

The only convolutions now left are those which are placed on the surface of the frontal lobe that rests on the orbital plate of the frontal bone; they are shown in fig. 458, 2 2' 2" (p. 618), and may be seen diagrammatically in fig. 489, the end of the temporal lobe being cut off to expose the convolutions of the central lobe or Island of Reil.

Along the edge is the continuation of the marginal convolution (M); next comes the olfactory sulcus (o) in which the olfactory tract and bulb lie; then the triradiate *orbital sulcus* (o.s.) which divides the rest of this surface into three convolutions.

---

## CHAPTER XLVII.

### FUNCTIONS OF THE SPINAL CORD.

THE functions of the spinal cord fall into two categories: functions of the grey matter, which consist in the reflection of afferent impulses, and their conversion into efferent impulses (*reflex action*); and functions of the white matter, which are those of *conduction*.

#### The Cord as an Organ of Conduction.

We have studied at some length the various paths in the white matter, and so we have the materials at hand for recapitulating the main facts in connection with the physiological aspect of the problem.

Complete section of the spinal cord in animals, and diseases or injuries of the cord or spinal canal in man, which practically cut the cord in two, lead to certain *histological* changes of a degenerative nature, which we have already studied, and to *physiological* results, which are briefly—(1) paralysis, both motor and sensory, of the parts of the body supplied by spinal nerves which originate below the point of injury; and (2) increased reflex irritability of the same parts, the reason for which we shall study immediately.

Hemisection of the cord leads to degenerative changes on the



same side of the cord, and loss of motion and sensation on the same side of the body below the lesion (see p. 616).

The motor path in the cord from the brain is the pyramidal tract; the anatomy of this tract is described in Chapters XLII. to XLVI., and we need do no more here than remind the reader that it originates from the pyramidal cells of the cortex of the opposite cerebral hemisphere, and that the principal decussation occurs at the lower part of the bulb.

The sensory tracts are more complex, on account of the numerous cell-stations on their course. The path for tactile and muscular sense impressions is up the posterior columns to the nucleus gracilis and nucleus cuneatus; thence by the internal arcuate fibres and fillet to the optic thalamus of the opposite side, and thence by the posterior part of the internal capsule to the Rolandic area of the hemisphere; the decussation of the fillet occurs in the bulb.

Schiff, one of the earliest to work at the subject of conducting paths in the cord, arrived at the conclusion that painful impressions travelled to the brain by the grey matter of the cord. This conclusion was regarded as paradoxical, for white matter is conducting, grey matter is central or reflecting. But the conclusion is not so paradoxical as it appears at first sight, for we now know the grey matter is made up of nerve-units, communicating physiologically by their interlacement of dendrons; and it is quite easy to understand that impulses may travel up grey matter through a vast series of cell stations or positions of relay. The more exact methods of modern research have gone far to justify Schiff's conclusions, and it is now generally held that the impulses due to painful impressions, and also those produced by heat and cold, travel up to the optic thalamus by the loopings of fibres from cell to cell through the tract of grey matter, which is continuous from cord to optic thalamus (fig. 484, G.M.); from the optic thalamus the fibres of the corona radiata carry on the impulse to the cortex. These conclusions are confirmed by recent experiments on hemisection (see p. 616), and by the phenomena seen in certain diseases. One of the most instructive of these from the physiological standpoint is known as *locomotor ataxy*. This disease is an affection of the afferent channels, and the most marked and constant change in the spinal cord is a degenerative one in the posterior columns. In such a case muscular and tactile sense are abolished, particularly in the lower limbs, but painful and thermal sensations are felt. On the other hand, in the disease of the grey matter of the cord called *syringomyelia*, sensations of heat, cold and pain are lost, and tactile sensations remain.

Some afferent impulses reach the cerebellum *via* the cells of Clarke's column and the direct or dorsal cerebellar tract to the restiform body and inferior peduncle of the cerebellum. It terminates in the vermis or middle lobe of the cerebellum; the fibres of the tract of Gowers originate in the same cells, and those of its fibres which enter the cerebellum do so by its superior peduncle, and these also end in the vermis.

This leaves us still one more set of fibres to consider; these are the fibres that leave the cerebellum and travel up to the brain and down the cord. They, like most of the other tracts, have been investigated by the degeneration method. Their exact course is, however, uncertain, though probably they ultimately terminate by arborising round the multipolar cells of the cerebrum and of the anterior horn of the cord (see fig. 484, p. 651; see also under Cerebellum, Chapter XLIX).

### Reflex Action of the Spinal Cord.

There are two theories of a speculative nature regarding the relationship of reflex and voluntary actions: one is, that all actions are in essence reflex, and that the so-called voluntary actions are modified reflexes, in which the afferent impulse to act, though often obscure, is nevertheless by seeking always to be found. Put in popular language, this theory implies that we have really no such thing as a will of our own, but our actions are simply the result of external circumstances.

The other theory is the exact opposite—namely, that all actions are in the beginning voluntary, and become reflex by practice in the lifetime of the individual, or the lifetime of his ancestors, who transmit this character to their descendants.

This is not the place to discuss a philosophical question of this kind, and still less the debated question whether acquired characters are transmissible by inheritance. The distinction between voluntary and reflex actions is a useful practical one, and certainly it cannot be doubted that many practised actions become reflex in the lifetime of every one of us. Take walking as an example: at first the act of locomotion is one in which the brain is concerned; it is an action demanding the concentration of the attention; but later on the action is largely carried out by the spinal cord, the afferent impulses to the cord from the feet directing the efferent impulses to the muscles concerned.

The reflex actions of the spinal cord may first be studied in a brainless frog, as in this animal the spinal cord possesses a great power of controlling very complex reflex actions.

### Reflexes in a Brainless Frog.

After destruction of the brain the shock of the operation renders the animal for a short time motionless and irresponsive to stimuli, but in a few minutes it gradually assumes a position which differs but little from that of a living conscis frog. If thrown into water it will swim; if placed on a slanting board it will crawl up it (Goltz); if stroked on the flanks it will croak (Goltz); if it is laid on its back, and a small piece of blotting-paper moistened with acid be placed on the skin, it will generally succeed in kicking it off; if a foot is pinched it will draw the foot away; if left perfectly quiet it remains motionless.

The muscular response that follows an excitation of the surface is purposive and constant, the path along which the impulse is propagated being definite.

Under certain abnormal conditions, however, the propagation of the impulse in the cord is widespread, the normal paths being, as it were, broken down. This is seen in the convulsions that occur on slight excitation in animals or men who have suffered from profuse hæmorrhage, or in the disease called lockjaw or tetanus. Such a condition is easily demonstrable in a brainless frog under the influence of strychnine: after the injection of a few drops of a 1 per cent. solution under the skin, cutaneous excitation no longer produces co-ordinated muscular responses, but paroxysms of convulsions, in which the frog assumes a characteristic attitude, with arms flexed and legs extended.

*Spreading of reflexes.*—If one lower limb is excited, it is that limb which responds: if the excitation is a strong one it will spread to the limb of the opposite side, and if stronger still to the upper limbs also.

*Cumulation of reflexes.*—This is well illustrated by Turck's method. If a number of beakers of water are prepared, acidulated with 1, 2, 3, &c. parts of sulphuric acid per 1,000, and the tips of the frog's toes are immersed in the weakest, the frog at first takes no notice of the fact, but in time the cumulation or summation of the sensory impulses causes the animal to withdraw its feet. If this is repeated with the stronger liquids in succession, the time that intervenes before the muscles respond becomes less and less. This method also serves to test reflex irritability when the frog is under the influence of various drugs.

*Inhibition of reflexes.*—If, instead of the whole brain, the cerebrum only is destroyed, and the optic lobes are left intact, response to excitation is much slower, the influence of the remaining part of the brain inhibiting the reflex action of the cord. Or if in

doing the experiment with acid just described the toes of the other foot are being simultaneously pinched, the response to the acid is delayed. Inhibition, or delay of reflex time is thus produced by other sensations, which, as it were, take up the attention of the cord.

This influence of the brain on the cord is also illustrated in man, by the fact that a strong effort of the will can control many reflex actions. It is, for instance, possible to subdue the tendency to sneeze; if one accidentally puts one's hand in a flame, the natural reflex is to withdraw it: yet it is well known that Cranmer, when being burnt at the stake, held his hand in the flames till it was consumed.

After the spinal cord has been divided by injury or disease in the thoracic region, the brain can no longer exert this controlling action; hence the part of the cord below the injury having it, as it were, all its own way, has its reflex irritability increased.\* The increase of reflex irritability is also seen in the disease called *lateral sclerosis*; here the lateral columns, including the pyramidal tract, become degenerated, and so the path from the brain to the cells of the cord is in great measure destroyed. In these patients the increase of reflex irritability may become a very distressing symptom, slight excitations, like a movement of the bed-clothes, arousing powerful convulsive spasms of the legs.

*Reflex time.*—In the frog, deducting the time taken in the transmission of impulses along nerves, the time consumed in the cord (reflex time) varies from 0.008 to 0.015 second; if the reflex crosses to the other side it is one-third longer. It is lessened by heat, and under the influence of a strong stimulus.

### Reflex Action in Man.

The reflexes obtainable in man form a most important factor in diagnosis of diseases of the nervous system; each action is effected through an afferent sensory nerve, a system of nerve-cells in the cord termed the reflex centre, and an efferent motor nerve; the whole constitutes what is called the *reflex arc*. The absence of certain reflexes may determine the position in the spinal cord, which is the seat of disease.

Two forms of reflex action must be distinguished:—

1. Superficial reflexes. These are true reflex actions, and are excited by stimulation of the skin.

\* In some injuries to the cord produced by crushing, there is a loss of reflexes below the injury. These, however, are not simple transverse lesions; the loss of reflex action is due to extensive injury to grey matter by hæmorrhage.

2. Deep reflexes or tendon reflexes. This is a most undesirable name, as they are not true reflex actions.

**Superficial Reflexes.**—These are obtained by a gentle stimulation, such as a touch on the skin; the muscles beneath are usually affected, but muscles at a distance may be affected also. Thus a prick near the knee will cause a reflex flexion of the hip.

The most important of these reflexes are :—

a. *Plantar reflex* : withdrawal of the feet when the soles are tickled.

b. *Gluteal reflex* : a contraction in the gluteus when the skin over it is stimulated.

c. *Cremasteric reflex* : a retraction of the testicle when the skin on the inner side of the thigh is stimulated.

d. *Abdominal reflex* in the muscles of the abdominal wall when the skin over the side of the abdomen is stroked; the upper part of this reflex is a very definite contraction at the epigastrium, and has been termed the *epigastric reflex*.

e. A series of similar reflex actions may be obtained in the muscles of the back, the highest being in the muscles of the scapula.

f. In the region of the cranial nerves the most important reflexes are those of the eye—(i) the *conjunctival reflex*, the movement of the eyelids when the front of the eyeball is touched; and (ii) the contraction of the iris on exposure of the eye to light, and its dilatation on stimulation of the skin of the neck.

**Tendon Reflexes.**—When the muscles are in a state of slight tension, a tap on their tendons will cause them to contract. The two so-called tendon reflexes which are generally examined are the patella tendon reflex or *knee-jerk*, and the foot phenomenon or *ankle-clonus*.

*The knee-jerk.*—The quadriceps muscle is slightly stretched by putting one knee over the other; a slight blow on the patella tendon causes a movement of the foot forwards, as indicated in the dotted line of fig. 490. This phenomenon is present in health.

*Ankle-clonus.*—This is elicited as depicted in the next figure : the hand is pressed against the sole of the foot, the calf muscles are thus put on the stretch and they contract, and if the pressure is kept up a quick succession or clonic series of contractions is obtained. This, however, is not readily obtained in health.

These phenomena are not true reflexes; the time that intervenes between the tap and the response is so short that they must be due to direct stimulation of the muscles or of their tendons.

Nevertheless, the idea that they are reflex is supported by the following facts :—

1. There are nerves in tendon.

2. The phenomena depend for their occurrence on the integrity of the reflex arc. Disease or injury to the afferent nerve, efferent nerve, or spinal grey matter, abolishes them. Thus they cannot



Fig. 490.—The Knee-jerk. (Gowers.)

be obtained in locomotor ataxy (damage to the posterior nerve-roots), or in infantile paralysis (damage to the anterior horns of grey matter).

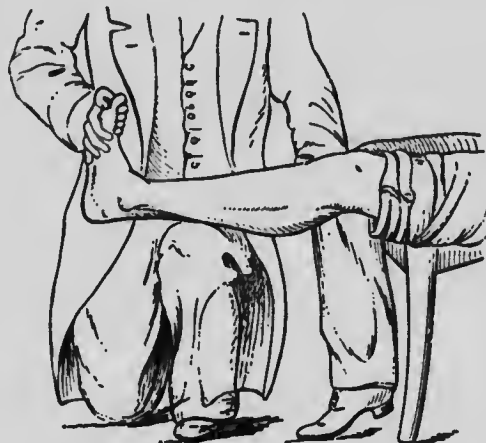

Fig. 491.—Ankle-clonus. (Gowers.)

3. They are excessive in those conditions that increase the true reflex irritability, such as severance of brain from cord, and in lateral sclerosis.

How, then, is it possible to reconcile these two sets of facts?

The explanation advanced by Sir William Gowers does so best it is briefly as follows :—

(i) The tendon reflexes are not reflexes, but are due to direct stimulation of the muscle itself.

(ii) In order that the muscle may respond it is necessary that it be in an irritable condition ; this is accomplished by putting it slightly on the stretch, and so calling forth the condition called *tonus* (see p. 136), a readiness to contract on slight provocation.

(iii) Muscular tonus depends on the integrity of the reflex arc. The sensory stimulus for this reflex muscular tone arises either in the muscle itself, or more probably in the condition of the antagonistic muscles. (See more fully, next paragraph but one.)

(iv) Hence injury to any part of the reflex arc, by abolishing the healthy tone of a muscle, deprives it of that irritable condition necessary for the production of these so-called reflex actions.

**Reciprocal Action of Antagonistic Muscles.**—This is an interesting branch of muscle physiology related to the question of tendon reflexes, which we owe to the researches of Sherrington. In brief, he shows that the inhibition of the tonus of a voluntary muscle may be brought about by excitation of its antagonist.

Movement at a joint in any direction involves the shortening of one set of muscles and the elongation of another (antagonistic) set. The stretching of a muscle produced by the contraction of its antagonist may excite (mechanically) the sensorial organs (probably the muscle-spindles, see p. 93) in the muscle that is under extension ; in this way a reflex of pure muscular initiation may be started. Experiments show that electrical excitation of the central end of an exclusively muscular nerve produces inhibition of the tonus of its antagonist. For instance, the central end of the severed hamstring nerve is faradised. This nerve contains in the cat 4510 nerve-fibres, and of these about 1810 are sensory in function\* ; these come from the flexor muscles of the knee, not from the skin. The effect of the stimulation of the nerve on the tonus of the extensor muscles of the knee is seen (*a*) in elongation of those muscles, (*b*) in temporary diminution of the knee-jerk. The experiment may be varied as follows : the exposed flexor muscles detached from the knee, and therefore incapable of mechanically affecting the position of the joint, are stretched or kneaded. This produces a reflex elongation of the extensor muscles of the knee and a temporary diminution of the knee-jerk.

---

\* The number of sensory nerve-fibres is determined by counting the degenerated fibres in the nerves after section of the posterior nerve-roots.

The effects are in fact the same as those produced by faradisation of the central end of the nerve supplying them. It may therefore be that reciprocal innervation, which is a common form of co-ordination of antagonistic muscles, is secured by a simple reflex mechanism, an important factor in its execution being the tendency by the action of a muscle to produce its own inhibition reflexly by mechanical stimulation of the sensory apparatus in its antagonist.

On p. 652 we have drawn attention to the three "*nervous circles*" by which an afferent impulse may affect the motor discharge from the anterior horn-cells of the cord; there is the short path by the collaterals of the entering fibre which pass directly to these cells, and there are the two longer paths, *via* the cerebellum and cerebrum respectively. In the execution of a voluntary action all three circles are in activity to produce the co-ordination and due contraction and elongation of antagonistic muscles which characterise an effective muscular act. Section of the posterior roots produces not only an inability to carry out reflex actions, but also leads to an inability to carry out effectively those more complicated reflex actions which are called voluntary and in which the brain participates. Locomotor ataxy, or tabes dorsalis, is a slowly progressive disease, the anatomical basis of which is a degeneration of the nerve-units of the spinal ganglia. It is, therefore, analogous to a physiological experiment in which the posterior roots are divided, and although fibres may remain which still allow of the passage of nervous impulses, the action of the three circles is greatly interfered with; the spinal reflex arc is at fault; this is shown by the loss of reflex action, the disappearance of the tendon reflexes, and the want of tonus in antagonistic muscles; the main symptom of the disease is want of muscular co-ordination, and this is produced not only by the lesion in the spinal cord, but is accentuated by the want of continuity in the other two circles, so that the brain is unable to effectively control the motor discharge from the anterior cornual cells.

**Reaction Time in Man.**—The term reaction time is applied to the time occupied in the centre in that complex response to a pre-arranged stimulus in which the brain as well as the cord comes into play. It is sometimes called the *personal equation*. It may be most readily measured by the electrical method, and the accompanying diagram (fig. 492) will illustrate one of the numerous arrangements which have been proposed for the purpose.

In the primary circuit two keys *A* and *B* are included, and a chronograph (1), arranged to write on a revolving cylinder (fast rate). Another chronograph (2), marking 1-100ths of a second, is placed below this. The experiment is performed by two persons *C* and *D*. The key *A* under the control of *C* is opened. The key *B*, under the control of *D* is closed. The electrodes *E* are applied to some part of *D*'s body. *C* closes *A*. The



primary circuit is made, and the chronograph moves. As soon as *D* feels the shock he opens *B*, the current is thus broken, and the chronograph lever returns to rest. Measure the time between the two movements of the chronograph (1), by means of the time tracing written by chronograph (2). From this, the time occupied by transmission along the nerves has to be deducted, and the remainder is the *reaction time*. It usually varies from 0.15 to 0.2 second, but is increased in:—

*The Dilemma.*—The primary circuit is arranged as before. Lead the

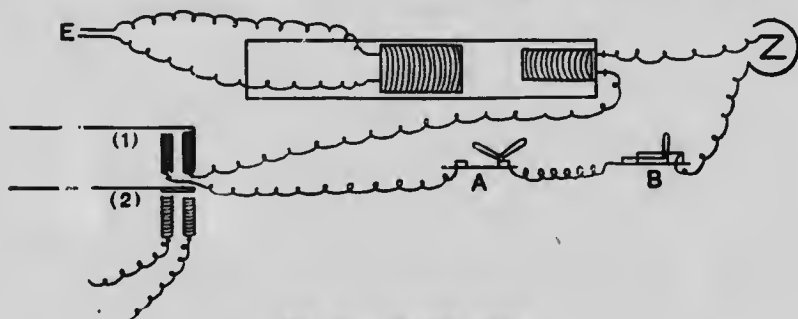

Fig. 492.—Reaction time.

wires from the secondary coil to the middle screws of a reverser without cross wires. To each pair of end screws, attach a pair of electrodes *E* and *E'*, applied to different parts of *D*'s body (Fig. 492).

Arrange previously that *D* is to open *B*, when one part is stimulated, but not the other, *C* adjusting the reverser unknown to *D*. Under these circumstances the reaction time is longer.

The reaction time in response to various kinds of stimuli, sound, light,

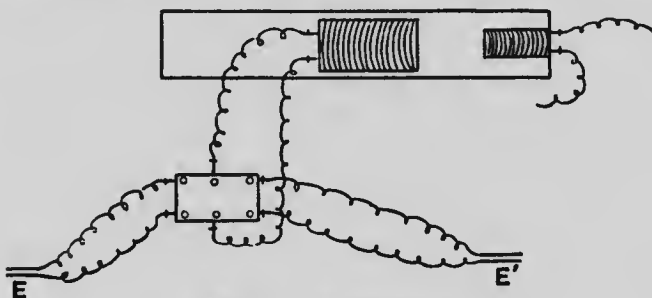

Fig. 493.—The Dilemma.

pain, etc., varies a good deal; the condition of the subject of the experiment is also an important factor. This, however, is really a practical branch of psychology, and has recently been much worked at by students of that science.

**Special Centres in the Cord.**—In addition to the general function of reflex action, the grey matter also exercises control over certain special actions.

*Cilio-spinal centre*; this centre controlling the dilatation of the pupil is situated in the lower cervical region, reaching as far down as the origin of the first to the third thoracic nerve.

Centres for *defaecation*, *micturition*, *erection*, and *parturition*, are situated in the lumbar enlargement of the cord.

Subsidiary *vaso-motor centres* are scattered through the grey matter, the principal *vaso-motor centre* being situated in the bulb.

## CHAPTER XLVIII.

## FUNCTIONS OF THE CEREBRUM.

THE brain is the seat of those psychical or mental processes which are called volition and feeling; volition is the starting point in motor activity; feeling is the final phase of sensory impressions.

In the days of the ancients very curious ideas prevailed as to the use of the brain. It is true that Alkmæon as early as 580 B.C. placed the seat of consciousness in the brain, but this view was of the nature of a guess, and did not meet with general acceptance; and two hundred years later Aristotle considered that the principal use of the brain was to cool the hot vapours rising from the heart. At this time the seat of mental processes, especially those of an emotional kind, was supposed to be in the heart, an idea now confined to poets, or in the bowels, as those acquainted with such ancient writings as the Bible will know.

As time went on truer notions regarding the brain came to the fore; thus Herophilus (300 B.C.) was aware of the danger attending injury to the medulla; Arctæus and Cassius (97 A.D.) knew that injury to one side of the brain produced paralysis of the opposite side of the body; and Galen (131—203 A.D.) was acquainted with the main motor and sensory tracts in brain and cord. Between that time and this, most of the celebrated anatomists have contributed something to our knowledge, and one may particularly mention Vesalius, Sylvius, Rolando, Gall, Carus, Willis, and Burdach; many of these names are familiar because certain structures in the brain to which they called attention have been christened after them. The erroneous notion that the brain was not excitable by stimuli lasted even to the days of Flourens and Magendie. In modern times, new methods of research in the microscopic and experimental direction have produced results which perhaps in no other branch of physiology have been of such immediate benefit to the human race.

**Effects of Removal of the Cerebrum.**

When the cerebral hemispheres are removed in a frog, it is deprived of volition and of feeling; it remains perfectly quiescent unless stimulated; it is entirely devoid of initiatory power, but as we have already seen, it will execute reflex actions many of which are of a complex nature (see p. 660).

A pigeon treated in the same way remains perfectly motionless and unconscious unless it is disturbed (see fig. 494). When disturbed in any way it will move, for instance, when thrown into the air it will fly; but these movements are, as in the frog, purely reflex in character.

In mammals the operation of extirpation of the brain is attended with such severe hæmorrhage that the animal dies very rapidly, but in some few cases where the animals have been kept alive, the phenomena they exhibit are precisely similar to those shown by a frog or pigeon. In the case of the dog portions of the cortex have been removed piecemeal by Goltz of Strasburg, until at last the whole of the cortex has been extirpated. Such animals carry out co-ordinated movements of a complicated character very well,



Fig. 494.—Pigeon after removal of the hemispheres. (Dalton.)

but they manifest no intelligence, and have complete lack of memory. They are in a condition analogous to that of the frogs and pigeons just mentioned.

#### Localisation of Cerebral Functions.

When the main function of the cerebrum was understood, physiologists were divided into two schools; those who thought that the brain acted as a whole, and those who thought that different parts of the brain had different functions to perform. One of the most prominent of the first school was Flourens, and Goltz, whose work has been done chiefly on dogs, is about the only prominent living survivor of this set of physiologists. Gradually, as better methods have come in, and especially since monkeys have been used for experiment, those who believe in the localisation of function have multiplied; and now, localisation of

cerebral function is more than a theory, it is an accepted fact. Perhaps the best practical evidence of this is the fact that experiments on monkeys have been taken as the basis for surgical operations on the human brain, and with perfect success.

The earliest to work in the direction of localisation were Hitzig and Fritsch. The subject was then taken up by Ferrier and Yeo, and later by Schäfer, Horsley, etc., in this country, and by Munk and many others in Germany. In addition to those who have studied the matter from the experimental standpoint, must also be reckoned the pathologists, who in the *post-mortem* room have examined the brains of patients dying from cerebral disease, and carefully compared the position of the disease with the symptoms exhibited by the patients during life. In this way two series of independent investigations have led to the same results; both methods are essential, as many minor details discovered by the one method correct the erroneous conclusions which are apt to be drawn by those who devote their entire attention to the other.

The main point which these researches have brought out is the overwhelming importance of the cortex; it contains the highest cerebral centres. Before Hitzig began his work, the corpus striatum was regarded as the great motor centre, and the optic thalamus as the chief centre of sensation; very little note was taken of the cortex; it appears to have been almost regarded as a kind of ornamental finish to the brain. The idea that the basal ganglia were so important, arose from the examination of the brains of people who had died from, or at least suffered from, cerebral hæmorrhage.

The most common situation for cerebral hæmorrhage, is either in the region of the corpus striatum or optic thalamus; it was noticed that motor paralysis was the most marked symptom if the corpus striatum was injured, and sensory paralysis if the optic thalamus was injured. The paralysis, however, is due, not to injury of the basal ganglia, but of the neighbouring internal capsule. The internal capsule consists in front of the motor-fibres passing down from the cortex to the cord, and behind of the sensory fibres passing up from cord to the cortex (see p. 645). Hence, if these fibres are ploughed up by the escaping blood, paralysis naturally is the result. If a hæmorrhage or injury is so limited as to affect the basal ganglia only, and not the fibres that pass between them, the resulting paralysis is slight or absent.

The question will next be asked: What, then, is the function of the basal ganglia? They are what we may term subsidiary centres; the corpus striatum, principally in connection with

movement, and the optic thalamus, in connection with sensation, and especially with the sense of vision as its name indicates.

A subsidiary centre may be compared to a subordinate official in an army. The principal centre may be compared to the commander-in-chief. This highest officer gives a general order for the movement of a body of troops in a certain direction; we may compare this to the principal motor-centre of the cortex sending out an impulse for a certain movement in a limb. But the general does not give the order himself to each individual soldier, any more than the cerebral cortex does to each individual muscle; but the order is first given to subordinate officers, who arrange exactly how the movement shall be executed, and their orders are in the end distributed to the individual men, who must move in harmony with their fellows with regard to both time and space. So the subsidiary nerve-centres or positions of relay enable the impulse to be widely distributed by collaterals to numerous muscles which contract in a similar orderly, harmonious, and co-ordinate manner. The subject of muscular co-ordination we shall consider at greater length in the next chapter, on the functions of the cerebellum.

There is just the same sort of thing in the reverse direction in the matter of sensory impulses. Just as a private in the army, when he wishes to communicate with the general, does so through one or several subordinate officers, so the sensory impulse passes through many cell-stations or subsidiary centres on the way to the highest centre where the mental process called sensation, that is, the appreciation of the impulse, takes place.

There are two great experimental methods used for determining the function of any part of the cerebrum. The first is *stimulation*; the second is *extirpation*. These words almost explain themselves; in *stimulation* a weak interrupted induction current is applied by means of electrodes to the convolution under investigation, and the resulting movement of the muscles of the body, if any occurs, is noticed. In *extirpation* the piece of brain is removed, and the resulting paralysis, if any, is observed.

It is essential when the experiment of stimulating the cortex of the brain is being performed that the animal should be anæsthetised, otherwise voluntary or reflex actions will occur which mask those produced by stimulation. If, however, the animal is too deeply under the influence of a narcotic the brain is inexcitable.

On p. 378 Ehrlich's experiments with methylene blue are described. In an anæsthetised animal the brain is inactive, and if the pigment is injected into the blood, the brain is seen to be of a blue colour. If, however, a spot of the cerebral surface is stimulated, that part of the brain is thrown into action, oxygen is used up, and the methylene blue is reduced, and in

consequence that area of the brain loses its blue tint. If the animal is so deeply narcotised that the brain does not discharge an impulse, the part stimulated remains blue.

By such means the cortex has been mapped out into what we may provisionally term motor areas, and sensory areas.

**Motor areas.**—These areas are also termed *sensori-motor* or *kinæsthetic*, for reasons which will be explained more fully later. The name *Rolandic area* which they have also received is derived from their anatomical position.

*Stimulation* of them produces movement of some part of the

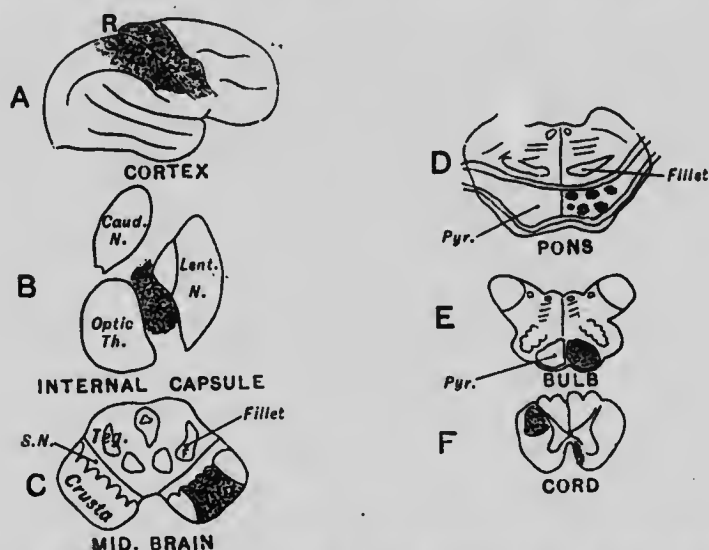

Fig. 495.—Degeneration after destruction of the Rolandic area of the right hemisphere. (After Gowers.)

opposite side of the body; excitation of the same spot is always followed by the same movement in the same animal. In different animals excitation of anatomically corresponding spots produces similar or corresponding results. It is this which has enabled one to apply the results of stimulating areas of the monkey's brain to the elucidation of the function of the similar brain of man.

*Extirpation*, or removal, of these areas produces paralysis of the same muscles which are thrown into action by stimulation.

The degeneration tracts after destruction of the Rolandic area are shown in fig. 495.

The shaded area in each case represents the injured or degenerated material; A in the cortex, B in the anterior part of the posterior limb of the internal capsule, C in the middle of the crusta of crus and mid-brain, D in the pyramidal bundles of

the pons, **E** in the pyramid of the bulb, and **F** in the crossed and direct pyramidal tracts of the cord.

**Sensory areas.**—*Stimulation* of these produces no direct movements, but doubtless sets up a sensation called a *subjective* sensation; that is, one produced in the animal's own brain, and this indirectly leads to movements which are reflex; thus on stimulating the auditory area there is a pricking up of the ears; on stimulating the *visual area* there is a turning of the head and eyes in the direction of the supposed visual impulse. That such movements are reflex and not direct is shown by the long period of delay intervening between the stimulation and the movement.

*Extirpation* of a sensory area leads to loss of the sense in question.

The rougher experiments performed by nature in the shape of diseases of the brain produce corresponding results.

Some diseases are of the nature of extirpation.

An instance of this is cerebral hæmorrhage. If the hæmorrhage is in the region of the internal capsule, it cuts through fibres to the muscles of the whole of the opposite side of the body, as they are all collected together in a narrow compass, and the condition obtained is called *hemiplegia*. The varieties of hemiplegia are numerous, according as motor or sensory fibres are most affected, and in one variety of hemiplegia, called *crossed hemiplegia*, the face is paralysed on one side of the body, the limbs on the other; this is due to injury of the nerve-tracts in the bulb subsequent to the crossing of the fibres to the nucleus of the seventh nerve, but above the crossing of the pyramids (just below the asterisk in fig. 505).

If now the hæmorrhage occurs on the surface of the brain, a much more limited paralysis, called *monoplegia*, is the result; if the arm area is affected, there will be paralysis of the opposite arm; if the leg area, of the opposite leg; if a sensory area, there will be loss of the corresponding sense.

Some diseases, on the other hand, act as the induction currents do in artificial stimulation; they irritate the surface of the brain; such a disease is a tumour growing in the membranes of the brain; if the tumour irritates a piece of the motor area, there will be involuntary movements in the corresponding region of the body; these movements may culminate in the production of epileptiform convulsions commencing in the arm, leg, or other part of the body which corresponds to the brain area irritated. It is these cases of "*Jacksonian Epilepsy*" which have given the best results in surgery; the movement produced is an indication of the area of the brain which is being irritated, and the surgeon after trephining is able to remove the source of the mischief. If the area of the brain which is irritated is a sensory area, the

result produced is a subjective sensation, similar to what we imagine is produced in animals with an electric current.

We may now proceed from these general considerations to

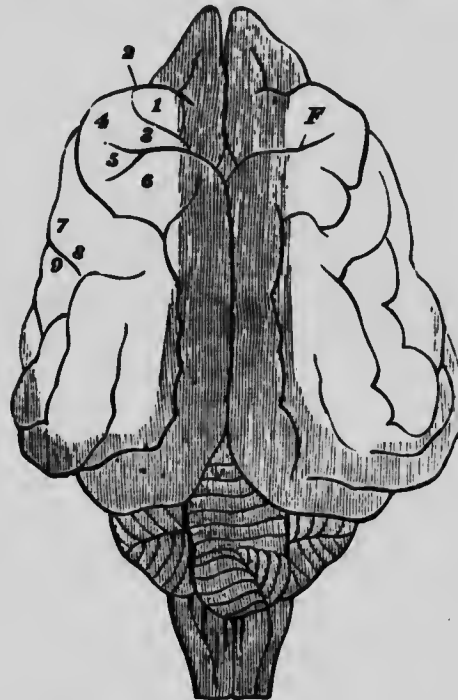

Fig. 496

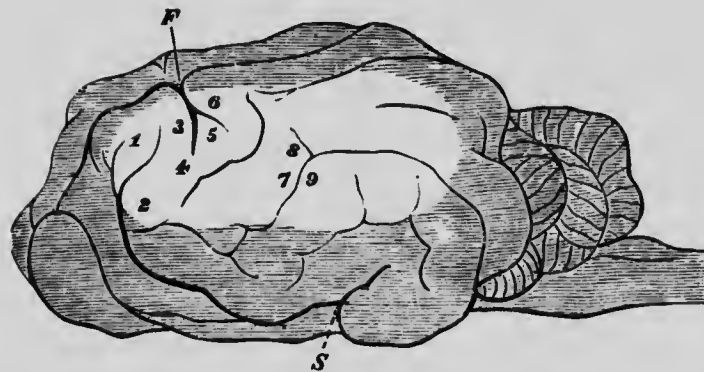

Fig. 497.

Figs. 496 and 497.—Brain of dog, viewed from above and in profile. *F*, frontal fissure sometimes termed crucial sulcus, corresponding to the fissure of Rolando in man. *S*, fissure of Sylvius, around which the four longitudinal convolutions are concentrically arranged; 1, flexion of head on the neck, in the median line; 2, flexion of head on the neck, with rotation towards the side of the stimulus; 3, 4, flexion and extension of anterior limb; 5, 6, flexion and extension of posterior limb; 7, 8, 9, contraction of orbicularis oculi, and the facial muscles in general. The unshaded part is that exposed by opening the skull. (Dalton.)



particular points, and give maps of the brain to show the areas we have been speaking of.

Figs. 496 and 497 are views of the dog's brain. It is convenient

to take this first because it was the starting-point of the experimental work on the subject in the hands of Hitzig and Fritsch. If the text beneath the figure is consulted, it will be seen that the motor areas, mapped out by the method of stimulation, are situated in the neighbourhood of

the *crucial sulcus*, which corresponds to the fissure of Rolando in man.

Coming next to the brain of the monkey, figures 498 and 499 are reproductions from Ferrier. He marked out the surface into a number of circles, stimulation of each of which produced movements of various sets of muscles, face, arm, and leg from below upwards; extirpation of these same areas produced the corresponding paralysis. It will be further noticed that these areas are all grouped around the fissure of Rolando, particularly in the ascending frontal and ascending parietal convolu-



Fig. 498.



Fig. 499.

Figs. 498 and 499.—Diagrams of monkey's brain to show the effects of electric stimulation of certain spots. (According to Ferrier.)

tions; hence the term *Rolandic area* which is often applied to this region of the brain.

These facts, however, are of principal interest because of their

application to the human brain, to which we now pass. The following maps of the human brain were prepared from data partly derived from the examination of the monkey's brain, and partly from the *post-mortem* examination of human brains in cases of brain disease. Fig. 50c shows the outer surface of the right

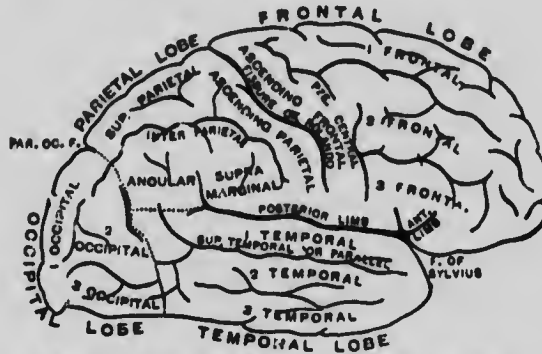

Fig. 500.—Right cerebral hemisphere, outer surface.

cerebral hemisphere with the names of the principal convolutions and fissures inserted. Fig. 501 gives the corresponding surface of the left hemisphere with the principal motor and

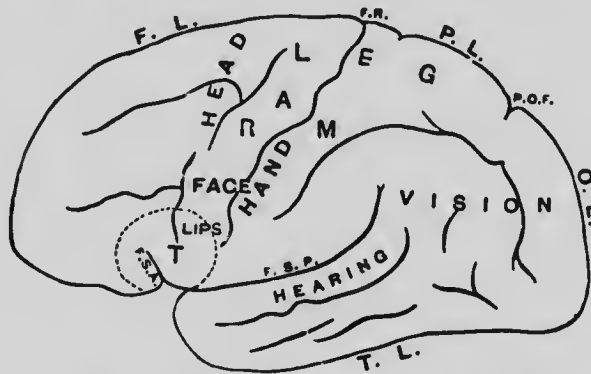

Fig. 501.—Left cerebral hemisphere, outer surface.

sensory areas marked. Fig. 502 shows the mesial surface of the right hemisphere with the names of the convolutions and fissures. Fig. 503 gives the corresponding surface of the left hemisphere with the functional areas marked.

**Motor areas of the Human Brain.**—Roughly, these occupy the convolutions around the fissure of Rolando, and turn over the edge of the hemisphere into the marginal convolution of the mesial surface; from below, up and backwards, we have the areas for

the head, arm, and leg in the order named. More accurately the areas are as follows:—

*Head, neck, and face* : lower two-thirds of the ascending frontal, bases of the lower and middle transverse frontal, a small piece

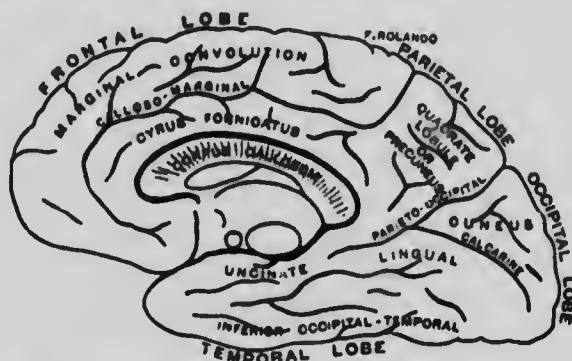

Fig. 502.—Right cerebral hemisphere, mesial surface.

reaching the front of the motor region in the marginal convolution of the mesial surface.

*Upper limb* : upper third of the ascending frontal, the base of the upper transverse frontal, the ascending parietal (where the

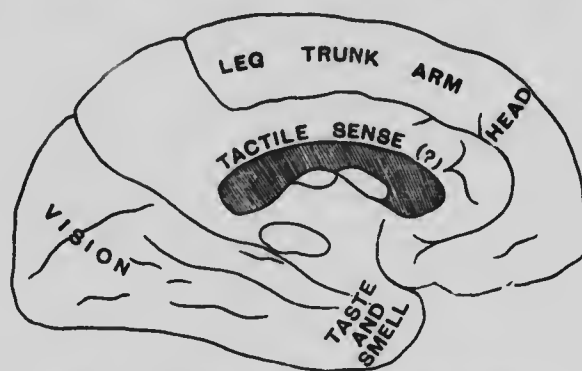

Fig. 503.—Left cerebral hemisphere, mesial surface.

centres of hand and wrist are situated), and the piece of the marginal behind the head-centre.

*Lower limb* : the parietal lobule, and the posterior part of the marginal.

*Trunk* : the marginal between the leg and arm areas.

The next diagram (fig. 504) shows the relative position of the several motor-tracts in their course from cortex to crus, according to Sir William Gowers.

The following diagram (fig. 505) shows a vertical section through the brain, and enables one to trace the motor-tracts to the nucleus

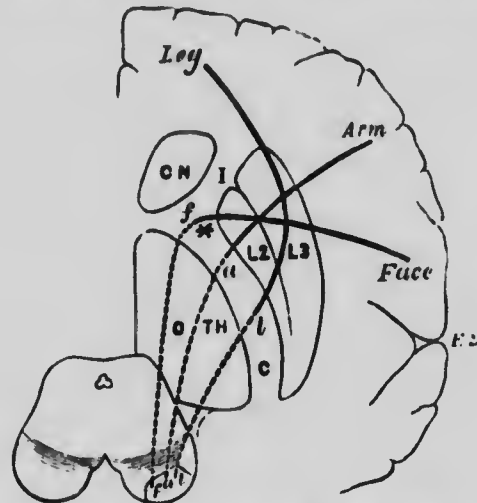

Fig. 504.—Diagram to show the relative positions of the several motor tracts in their course from the cortex to the crus. The section through the convolutions is vertical; that through the internal capsule, I, C, horizontal; that through the crus also horizontal. C. N., caudate nucleus; O. TH., optic thalamus; L2 and L3, middle and outer part of lenticular nucleus; *f, a, l*, face, arm, and leg fibres. The words in italics indicate corresponding cortical centres; F.S., fissure of Sylvius. (Gowers.)

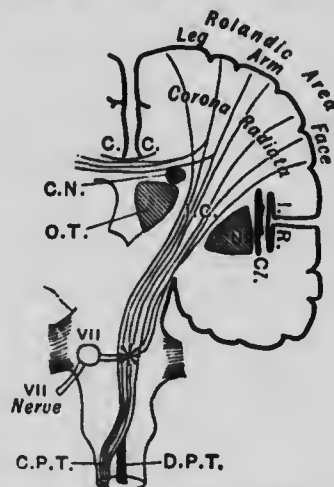

Fig. 505.—Fibres are seen passing from the cortex of the Rolandic area through the corona radiata to the internal capsule (I.C.); a few collaterals to the corpus callosum (C.C.) are also put in. I.R., island of Reil; Cl., claustrum; O.T., optic thalamus; C.N., caudate nucleus; L.N., lenticular nucleus. The asterisk indicates the place of decussation of the face fibres to VII., the nucleus of the seventh nerve. C.P.T., crossed pyramidal tract; D.P.T., direct pyramidal tract.

of the seventh or facial nerve of the opposite side, and to the pyramidal tracts of the spinal cord. In this and in the

preceding figure the letterpress underneath them should be carefully consulted.

The marginal convolution was first investigated by Schäfer and Horsley, and to them belongs the credit of discovering the centre for the trunk muscles. If one marginal convolution is removed in an animal, there is much more marked paralysis of the opposite limbs than of the trunk; if the two marginal convolutions are removed, there is very complete paralysis of the trunk as well as of the limbs. In cases of hemiplegia in man, there is usually very little paralysis of the trunk muscles. It is the muscles which act normally unilaterally that are most paralysed. The muscles of the trunk always normally move bilaterally; thus we use both sides of our chest in breathing; both sets of back muscles in maintaining an erect position, and so on. The spinal centres of the muscles of the two sides are, no doubt, connected by commissural fibres, and therefore can be affected from both sides of the brain.

*The Speech centre.*—This is surrounded by a dotted circle in fig. 501. There are other centres concerned in speech besides this, but this is the centre for the muscular actions concerned in speech. The discovery of this centre was the earliest feat in the direction of cerebral localisation. It was discovered by a French physician named *Broca*; he noticed that patients who died after hæmorrhage in the brain, but who previous to death exhibited a curious disorder of speech called *aphasia*, were found, after death, to have the seat of the hæmorrhage in this convolution. The convolution is generally called *Broca's convolution*. Experiments on animals are obviously useless in discovering the centre for speech.

The most curious fact about the speech-centre is that it is unilateral; it is situated only on the left side of the brain, except in left-handed people, where it is on the right. We are thus left-brained so far as the finer movements of the hand-muscles are concerned, and we are also left-brained in regard to speech, an action which is apparently bilateral. (See also p. 738.)

**The Sensory areas of the Human Brain.**—These are much less accurately mapped out than the motor areas. They are in part coincident with the so-called motor areas, and in part situated behind these.

*The visual area* is situated in the occipital lobe, and the angular gyrus. Extirpation of one occipital lobe in an animal, or disease of that lobe in man, produces blindness of the same side of each retina; this condition is called *hemianopsia*.

If, for instance, the right occipital lobe is removed, the result is blindness of the temporal half of the right retina, and the nasal half of the left retina, leading to an inability to see things in the

left half of the field of vision; the animal turns its head and eyes to the same side as the lesion, or in technical language there is *conjugate deviation of head and eyes to the right*.

Stimulation of the visual area (and this is true for both the occipital lobe and the angular gyrus) leads, no doubt, to a subjective visual sensation of the corresponding halves of the two retinae. Suppose the right visual area is stimulated, the subjective sensation will appear to come from the right halves of the retinae; the animal therefore imagines light is falling on its eyes from the left, and so there is *conjugate deviation of the head and eyes to the left*; that is, the opposite side to that stimulated.

*The auditory area* was localised by Ferrier in the superior temporo-sphenoidal convolution. But there is considerable doubt whether this is correct; it is so much more difficult to tell when an animal is deaf than when it is blind. Similar uncertainty exists as to the situations for *taste* and *smell*. No doubt they are closely connected, and they have been placed provisionally in the uncinate convolution, and tip of the temporo-sphenoidal lobe. The large size of these parts in animals with a keen sense of smell lends support to this idea.

*Tactile sensibility* was localised by Schäfer in the limbic lobe, but there is so much doubt about this, that a query is placed after the words "tactile sense," in the gyrus fornicatus in fig. 503.

Munk's view, supported in this country by Bastian, Mott, and numerous others, is that the sensory fibres from the skin and muscles terminate in the Rolandic area; and the histological researches of Golgi and Ramon y Cajal (see figs. 481 and 484) point to the same conclusion. This is, in fact, what one would expect; volition and feeling are associated together so closely physiologically, that anatomically we should expect to find the commencement of the volitional fibres contiguous to the terminations of the sensory fibres. That this is really the case has been shown by a careful examination of the sensation in animals in which the Rolandic area has been removed, and in cases of hemiplegia in man. A delicate test is to place a clip on the fingers or toes, taking care the animal does not see the clip put on. If there is loss of tactile sensibility the monkey either takes no notice at all of the clip or removes it after a long delay. Whereas if sensation is perfect the monkey at once seizes the clip and flings it away. It is found that the intensity of both the motor and sensory paralysis are directly proportional to each other. Hence the term motor area, which we have been provisionally employing for the Rolandic area, should be replaced by the more correct term *sensori-motor* or *kinæsthetic area*. These new terms indicate that what really

occurs in the Rolandic area is a sense of movement, and this acts as a stimulus *via* the pyramidal tracts to the true motor centres which are in the opposite anterior horn of the spinal cord. If the posterior roots of the spinal nerves are divided there is a loss of sensation, and so the sense of movement cannot reach the brain from the muscles, and consequently the muscles are not called into action; when all the posterior roots coming from a limb in a monkey are cut, the muscles, so far as voluntary movements are concerned, are in fact as effectually paralysed as if the anterior roots of the spinal nerves had been cut. The muscles, however, do not degenerate as they would if the anterior roots had been cut. They merely undergo a small amount of wasting due to want of use ("disuse atrophy").

The question will then be asked, what is the function of the gyrus fornicatus? On removal of this convolution there is some loss of sensation; this has been explained by the fact that on removing this area of grey matter it is almost impossible to avoid injury to the white matter beneath it, and thus there will be loss of function due to division of the fibres on the way to the marginal convolution, which is like the Rolandic area, sensori-motor in function.

Prof. Schäfer is one prominent worker who has not accepted Munk's views on this subject. He still regards the Rolandic area as essentially motor in function. Naturally, he does not deny that it has connections with sensory fibres, but he considers it incorrect to speak of the area as a sensory one. He has produced injuries of the area without obtaining any loss of sensation, and in testing the sensations of his monkeys employs the method of stroking the skin, which he regards as more trustworthy than Schiff's clip test. The sensory disturbances observed by other investigators he regards as due to general disturbance of the whole brain produced by the severity of the operation. The exact localisation of the tactile areas must be left to the future, as in his most recent experiments Schäfer has failed to confirm his earlier ones on the gyrus fornicatus.

On referring once more to the maps of the brain, it will be seen that there is a large blank in the anterior part of the frontal region. This is left blank because its function is absolutely unknown. Extirpation or stimulation of this part of the brain in animals produces no appreciable result. It has also been removed accidentally in man, as in the celebrated American crowbar accident; owing to the premature explosion of a charge of dynamite in one of the American mines, a crowbar was sent through the frontal region of the foreman's head, removing the anterior part of his brain. He, however, recovered, and no noteworthy

symptoms were observed in him during the rest of his life. He, indeed, returned to his work as overseer of the mine.

The large size of this portion of the brain is very distinctive of the human brain, and it has therefore been supposed that here is the seat of the intellectual faculties. This may be so, but experimental physiology lends no support to this view, as the sensory centres (and sensations are the materials for intellect) are situated behind or within, and not in front of, the Rolandic area.

A very large amount of the white matter of the brain is composed of association fibres which link convolution to convolution. In the development of the brain these are the last fibres to become myelinated; white fibres do not become functional until they receive their medullary sheath. This coincides with the well-known fact that association of ideas is the last phase in the psychical development of the child.

---

## CHAPTER XLIX.

### FUNCTIONS OF THE CEREBELLUM.

In past times there have been several views held as to the functions of the cerebellum. One of the oldest of these was the idea that the cerebellum was associated with the function of generation; another view, first promulgated by Willis, was that the cerebellum contained the centres which regulate the functions of organic life; this arose from the circumstance that diseases of the cerebellum are often associated with nausea and vomiting; it is a familiar fact that in displacements of equilibrium such as occur on board ship in a rough sea, or in the disease called Ménière's disease, sickness is a frequent result; it appears from this that the cerebellum does receive from or send to the viscera certain impulses. The third and last of these older theories was that the cerebellum was the centre for sensation. This arose from the fact that certain of the afferent channels of the spinal cord were traced into the cerebellum. The impulses that travel along these, however, though afferent, are not truly sensory, and their reception in the cerebellum is not associated with consciousness.

The true function of the cerebellum was first pointed out by Flourens, and our knowledge about it has not advanced much from the condition in which Flourens left it. He showed that the cerebellum is the great centre for the co-ordination of muscular movement, and especially for that variety of co-ordination which is called equilibration—that is, the harmonious adjustment



of the working of the muscles which maintain the body in a position of equilibrium.

It must not be supposed from this that the cerebellum is the sole centre for co-ordination. We have already seen that all the machinery necessary for carrying out very complicated locomotive movements is present in the spinal cord. The higher centres set this machinery going, and the work of arranging what muscles are to act, and in what order, is carried out by the whole of the grey matter from the corpora striata to the end of the spinal cord, including such outgrowths as the corpora quadrigemina and cerebellum. An instance of a complex co-ordinated movement is seen in what we learnt to call in the last chapter *conjugate deviation of head and eyes*. The higher cortical centre gives the general word of command to turn the head and eyes to the right: the subsidiary centres or subordinate officials arrange that this is to be accomplished by the external rectus of the right eye supplied by the right sixth nerve, the internal rectus of the left eye supplied by the left third nerve, and numerous muscles of neck and back of both sides supplied by numerous nerves. We thus see how the complicated intercrossing of fibres and connections of the centres of the various nerves are brought into play.

The functions of the cerebellum are investigated by the same two methods of experiment (*stimulation* and *extirpation*) that are employed in similar researches on the cerebrum. The anatomical connections of the cerebellum with other parts of the cerebro-spinal axis have been chiefly elucidated by the degeneration method. Each side of the cerebellum has three peduncles; the *superior* peduncle connecting it to the opposite hemisphere of the cerebrum, the *inferior* peduncle connecting it to the same side of the spinal cord, and the *middle* peduncle contains fibres which link the two halves of the cerebellum together in a physiological though not in an anatomical sense. The inferior peduncle terminates in the vermis; in some of the lower animals the vermis is practically the only part of the cerebellum which is present, and it is this part of the cerebellum which is principally concerned in the co-ordination of the bodily movements. The cerebellar hemispheres are especially connected with the opposite cerebral hemispheres; and possibly just as the different regions of the body have corresponding areas in the cerebrum, so also they are similarly represented in the cerebellum; but localisation of function in the cerebellum has not gone sufficiently far yet to make this a certainty.

After *hemi-extirpation*, degeneration occurs in the peduncles of the same side; there are, therefore, no commissural fibres that actually pass from

one hemisphere to the other. In the *superior* peduncle, the degenerated fibres pass chiefly to the tegmental nucleus of the opposite side, but partly to that of the same side; in other words, the decussation of these peduncles in the mid-brain is not complete. Some fibres are traceable to the optic thalamus. The *middle* peduncle is completely degenerated as far as the raphe, where its fibres intermingle with those from the opposite side. The *inferior* peduncle was stated by Luciani and Marchi to be also degenerated, and these observers traced the fibres down into the cord. But their statements have not been confirmed by the most recent and careful work of Ferrier and Risien Russell. If such fibres do exist, their exact course has yet to be discovered (hence the use of a dotted line in fig. 484, p. 651). Some degenerated fibres in the inferior peduncle have been traced to the opposite lower olivary body which completely atrophies, and also to the nucleus of Deiters (see p. 628), the cells of which are probably cell stations on the course of the fibres that emerge from the cerebellum.

If the cerebellum is removed in an animal, or if it is the seat of disease in man, the result is a condition of slight muscular



Fig. 506.—Pigeon after removal of the cerebellum. (Dalton.)

weakness; but the principal symptom observed is *inco-ordination*, chiefly evidenced by a staggering gait similar to that seen in a drunken man. It is called *cerebellar ataxy*.

This condition is well illustrated in the above figure (fig. 506); the disturbed condition of the animal contrasts very forcibly with the sleepy state produced by removal of the cerebrum (see fig. 494).

In order that the cerebellum may duly execute its function of equilibration it is necessary that it should send out impulses; this it does by fibres that leave its cells and pass out through its peduncles; they pass out to the opposite cerebral hemisphere, and so influence the discharge of the impulses from the cortex of the cerebrum. It is also probable that impulses pass out to the cord (see dotted line in fig. 484), but the exact course of these fibres, if they do exist, has still to be worked out. The only way of

which we have any certain knowledge by means of which the cerebellum influences the motor discharge is as an elaborate cell station on the course of sensory impulses to the cerebrum.

The cerebellum thus acts upon the muscles of the same side of the body in conjunction with the cerebral hemisphere of the opposite side. The close inter-relation of one cerebral with the opposite cerebellar hemisphere is shown in cases of brain disease, in which atrophy of one cerebellar hemisphere follows that of the opposite cerebral hemisphere (see fig. 507).

In order that the cerebellum may send out impulses in this way, it is necessary that it receive impulses which guide it by keeping it informed of the position of the body in space. These afferent impulses are of four kinds, namely :—

- |              |                  |
|--------------|------------------|
| 1. Tactile.  | 3. Visual.       |
| 2. Muscular. | 4. Labyrinthine. |

We will take these one by one :—

1. *Tactile impressions.*—The importance of impulses from the skin is shown in those diseases of the sensory tracts (especially locomotor ataxy) where there is diminution in the tactile sense in the soles of the feet. In such cases the patient cannot stand with his eyes shut. The same effect may be produced experimentally by freezing the soles of the feet.

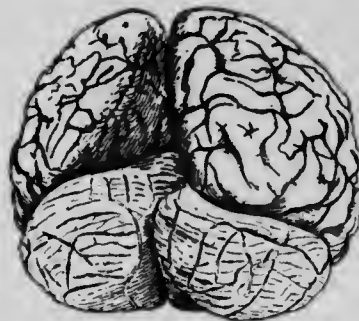

Fig. 507.—This is a reproduction of a photograph of a lunatic's brain lent me by Dr. Fricke. One cerebral and the opposite cerebellar hemisphere are atrophied.

Again, if the skin is stripped from the hind limbs of a brainless frog, it is unable to execute such reflex actions as climbing an inclined plane, which it can do quite well when the skin is uninjured.

2. *Muscular impressions.*—Quite as important as the tactile sense from the skin is the muscular sense, the sense which enables us to know what we are doing with our muscles. We have hitherto chiefly spoken of the muscular nerves as being motor; they also contain sensory fibres; these pass from the muscles, and their tendons to the posterior roots of the spinal nerves, and the impulses ascend the sensory tracts through cord and brain to reach the cerebellum and the Rolandic area. In some cases of locomotor ataxy there is but little loss of tactile

sensibility, and the condition of inco-ordination is then chiefly due to the loss of the muscular sense.

3. *Visual impressions.*—The use of visual impressions in guiding the nervous centres for the maintenance of equilibrium is seen in those cases of locomotor ataxy where there is loss of equilibrium when the patient closes his eyes. Destruction of the eyes in animals often causes them to spin round and lose their balance. The giddiness experienced by many people on looking at moving water, or after the onset of a squint, or when objects are viewed under unusual circumstances, as in the ascent of a mountain railway, is due to the same thing. The importance of keeping one's eyes open is brought home to one very forcibly when one is walking in a perilous position, as along the edge of a precipice, where an upset of the equilibrium would be attended with serious consequences.

4. *Labyrinthine impressions.*—

These are the most important of all; they are the impressions that reach the central nervous system from that part of the internal ear called the labyrinth.

Here, however, we must pause to consider first some anatomical facts in connection with the semicircular canals that make up the labyrinth. Fig. 508 is an external view of the internal ear; it is enclosed within the petrous portion of the temporal bone;

and consists of three parts—the vestibule (1), the three semicircular canals (3, 4, 5) which open into the vestibule, and the tube, coiled like a snail's shell, called the cochlea (6, 7, 8). The cochlea is the part of the apparatus which is concerned in the reception of auditory impressions; it is supplied by the cochlear division of the eighth or auditory nerve. The remainder of the internal ear is concerned not in hearing, but in the reception of the impressions we are now studying. Within the vestibule are two chambers made of membrane, called the utricle and the saccule; these communicate with one another and with the canal



Fig. 508.—Right bony labyrinth, viewed from the outer side. The specimen here represented was prepared by separating piecemeal the looser substance of the petrous bone from the dense walls which immediately enclose the labyrinth. 1, the vestibule; 2, fenestra ovalis; 3, superior semicircular canal; 4, horizontal or external canal; 5, posterior canal; \*, ampullæ of the semicircular canals; 6, first turn of the cochlea; 7, second turn; 8, apex; 9, fenestra rotunda. The smaller figure in outline below shows the natural size.  $\frac{2\frac{1}{2}}{1}$  (Sömmering.)

of the cochlea. Within each bony semicircular canal is a membranous semicircular canal of similar shape. Each canal is filled with a watery fluid called *endolymph*, and separated from the

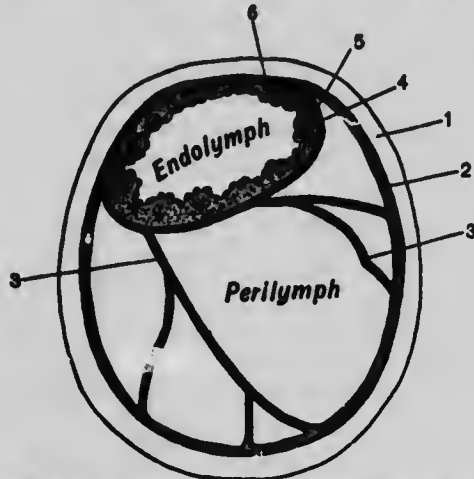

Fig. 509.—Section of human semicircular canal. (After Rüdinger.)  
1, bone; 2, periosteum; 3, 3, fibrous bands connecting the periosteum to 4, the outer fibrous coat of the membranous canal; 5, tunica propria; 6, epithelium.

bony canal by another fluid called *perilymph*. Each canal has a swelling at one end called the *ampulla*. The membranous canals open into the utricle; the *horizontal* canal by each of its ends;

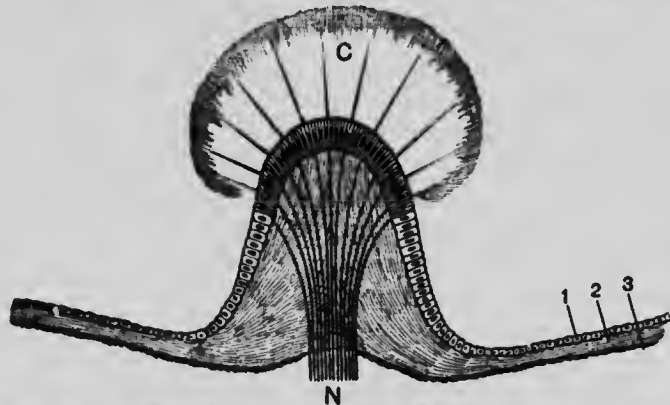

Fig. 510.—Section through the wall of the ampulla of a semicircular canal, passing through the crista acoustica. 1, epithelium; 2, tunica propria; 3, fibrous layer of canal; N, bundles of nerve-fibres; C, cupula, into which the hairs of the hair-cells project. (After Schäfer.)

the *superior* and *posterior* vertical canals by three openings, these two canals being connected at their non-ampullary ends.

Fig. 509 shows in transverse section the way in which the membranous is contained within the bony canal; the membranous

canal consists of three layers, the outer of which is fibrous and continuous with the periosteum that lines the bony canal; then comes the *tunica propria*, composed of homogeneous material, and thrown into papillæ except just where the attachment of the membranous to the bony canal is closest; and the innermost layer is a somewhat flattened epithelium.

At the ampulla there is a different appearance; the *tunica propria* is raised into a hillock called the *crista acoustica* (see fig. 510); the cells of the epithelium become columnar in shape, and to some of them fibres of the auditory nerve pass, arborising round them; these cells are provided with stiff hairs, which project into what is called the *cupula*, a mass of mucus-like material containing otoliths or crystals of calcium carbonate. Between the hair-cells are fibre-cells which act as supports (fig. 511). When the endolymph in the interior of the canals is thrown into vibration, the hairs of the hair-cells are affected, and a nervous impulse is set up in the contiguous nerve-fibres, which carry it to the central nervous system.

The walls of the saccule and utricle are similar in composition, and each has a similar hillock, called a *macula*, to the hair-cells on which nerve-fibres are distributed.

The macula of the utricle and the cristæ of the superior and horizontal canals are supplied by the vestibular division of the eighth or auditory nerve. The macula of the saccule and the crista of the posterior canal are supplied by a branch of the cochlear division of the same nerve (see p. 719).

When these canals are diseased in man, as in Menière's disease, there are disturbances of equilibrium: a feeling of giddiness, which may lead to the patient's falling down, is associated with nausea and vomiting. In animals similar results are produced by injury, and the subject has been chiefly worked out on birds by Flourens, where the canals are large and readily exposed, and more recently in fishes, by Lee.

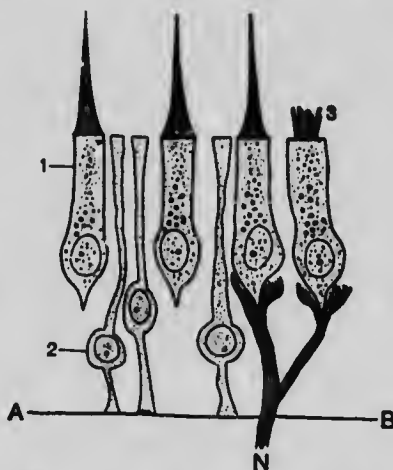

Fig. 511.—1, hair-cell; 3, hair-cell, showing the hair broken, and the base of the hair, split into its constituent fibrils; 2, fibre-cell; N, bundle of nerve-fibres which have lost their medullary sheath, and terminate by arborising round the base of the hair-cells; A.B., surface of tunica propria. (After Retzius.)

Thus if the horizontal canal is divided in a pigeon, the head is thrown into a series of oscillations in a horizontal plane, which are increased by section of the corresponding canal of the opposite side. After section of the vertical canals, the forced movements are in a vertical plane, and the animal tends to turn somersaults.

"When the whole of the canals are destroyed on both sides the disturbances of equilibrium are of the most pronounced character. Goltz describes a pigeon so treated which always kept its head with the occiput touching the breast, the vertex directed downwards, with the right eye looking to the left and the left looking to the right, the head being incessantly swung in a pendulum-like manner. Cyon says it is almost impossible to give an idea of the perpetual movements to which the animal is subject. It can neither stand, nor lie still, nor fly, nor maintain



Fig. 512.—Diagram of semicircular canals, to show their positions in three planes at right angles to each other. It will be seen that the two horizontal canals (H) lie in the same plane: and that the superior vertical of one side (S) lies in a plane parallel to that of the posterior vertical (P) of the other. (After Ewald.)

any fixed attitude. It executes violent somersaults, now forwards, now backwards, rolls round and round, or springs in the air and falls back to recommence anew. It is necessary to envelope the animals in some soft covering to prevent them dashing themselves to pieces by the violence of their movements, and even then not always with success. The extreme agitation is manifest only during the first few days following the operation, and the animal may then be set free without danger; but it is still unable to stand or walk, and tumultuous movements come on from the slightest disturbance. But after the lapse of a fortnight it is able to maintain its upright position with some support. At this stage it resembles an animal painfully learning to stand and walk. In this it relies mainly on its vision, and it is only necessary to cover the eyes with a hood to dispel all the fruits of this new education, and cause the reappearance of all the motor disorders.' (Ferrier.)

It is these canals which enable all of us to know in which direction we are being moved, even though our eyes are bandaged, and the feet are not allowed to touch the ground. On being whirled round, such a person knows in which direction he is being moved, and when the whirling stops he seems, especially if he opens his eyes, to be whirling in the opposite direction, owing to the rebound of the fluid in the canals. The forced movements just described in animals are due either to the absence of the normal sensations from the canals, or to delusive sensations arising from their irritation, and the animal makes efforts to correct the movement which it imagines it is being subjected to.

It will be noticed that the canals of each side are in three planes at right angles to each other, and we learn the movements of our body with regard to the three dimensions of space by means of impressions from the ampullary endings of the auditory nerve; these impressions are set up by the varying pressure of the endolymph in the ampullæ.

Thus a sudden turning of the head from right to left will cause movement of the endolymph towards, and therefore increased pressure on, the ampullary nerve-endings of the right horizontal canal, and diminished pressure on the corresponding nerve-endings of the left side.

"One canal can be affected by, and transmit the sensation of rotation about one axis in one direction only; and for complete perception of rotation in any direction about any axis, six canals are required in three pairs, each pair being in the same or parallel planes, and their ampullæ turned opposite ways. Each pair would thus be sensitive to any rotation about a line at right angles to its plane or planes, the one canal being influenced by rotation in one direction, the other by rotation in the opposite direction." (Crum-Brown.)

The two horizontal canals are in the same plane; the posterior vertical of one side is in a plane parallel to that of the superior vertical of the other side (see fig. 512).

These four sets of impressions (tactile, muscular, visual, and labyrinthine) reach the cerebellum by its peduncles; from the eyes through the superior peduncle, from the semicircular canals through the middle and inferior peduncles, and from the body generally through the restiform body or inferior peduncle. Section and stimulation of the peduncles cause inco-ordination, chiefly evidenced by rotatory and circus movements similar to those that occur when the nerve-endings in the semicircular canals are destroyed or stimulated. Stimulation of the cerebellum itself—and this has been done through the skull in man—causes



giddiness, and consequent muscular efforts to correct it. The results of stimulation, indeed, are precisely analogous to those of extirpation, only in the reverse direction.

---

## CHAPTER L.

### SENSATION.

BEFORE passing to the study of the various special senses, there are a number of general considerations in connection with the subject of sensation that demand our attention.

The psychologist divides the mental phenomena, which the physiologist localises in the brain, into three main categories:—

1. *Intellectual* : perceiving, remembering, reasoning, &c.
2. *Emotional* : joy, love, hate, anger, &c.
3. *Volitional* : purposing, deliberating, doing.

These are all closely connected together, and are all present in each healthy brain; but according as one or other may predominate, we speak of intellectual, emotional, or strong-willed individuals. The connection is especially close between intellect and will, which represent as it were the two sides of what we may call a conscious reflex action; the intellect gives the reason or stimulus for the exercise of the volitional power. The emotions are more complex, and we shall not discuss them; they are elaborate mental processes, in which sensations predominate.

The intellectual faculties are derived from the senses; sensations form the materials for intellect; in other words, we know and learn from what we see, feel, hear, taste, and smell. People born blind or deaf thus labour under the great disadvantage of having one or the other channel of knowledge closed; they can, however, make up for this in some measure by an education, and consequent increased sensibility of the channels that remain open.

The simplest mental operation is a **sensation**—that is, the conscious reception on the mind of an impression from the external world. For this the following things are necessary:—

1. A stimulus.
2. A nerve-ending to receive it.
3. A path to the brain.
4. A part of the brain to receive the impulse.

The brain refers the sensation to the nerve-ending which received the stimulus; thus pain in the finger is referred to the

finger, the sight of an object to the eyes, &c. If the ulnar nerve is stimulated by a knock on the elbow, the sensation is referred to the fingers where the nerve is distributed; if the stump of a recently amputated leg be stimulated, the brain not having got used to the new condition of things, refers the sensation to the toes, which still seem to be present.

**Perception** is a more complicated mental process; it consists in the grouping of sensations, and the imagining of the object from which they arise, and which is called the *percept*. The smell, the taste, the colour, &c., of an orange are all sensations; the grouping of these together constitutes the perception of an orange. Each mental process leaves an impress on the mind; these impressions build up memory, or *representative imagination*; this may be reproductive, as in recalling a friend's face; or constructive, as in picturing the face of an historical person.

During the whole operation, moreover, there must be *attention*; it is quite possible, for instance, in a dreamy person, that he may look at a thing without seeing it, or be present at a lecture without hearing it.

The more complex intellectual operations consist in the formation of *concepts*, and reasoning the grouping and discrimination of conceptions. Just as perception is built up of sensations, so **conception** is built up of perceptions. Thus the orange of our previous example is learned to be one of similar substances called fruits; fruits to be products of the vegetable, as distinguished from the animal world, and so on.

This is seen in the education of a child; at first scattered sensations only are perceived, and education consists in learning what these sensations correspond to in the external world, and how they may be classified. The other mental faculties are in the same way built of simpler material; the volitional operations are at first simple responses to external conditions; later on they become more complex and representative, culminating in speech, the most complicated movement of all. The emotions, too, are at first simple, and merely exaggerated sensations; the higher ones are complex and representative.

The nerve-endings that receive the impression from the external world are of various kinds. They may be simply ramifying and interlacing plexuses of nerve-fibrils, as in the cornea, parts of the skin, and in the interior of the body; this kind of nerve-ending is chiefly associated with *general sensibility*, that vague kind of sensation which cannot be put under any of the special headings—taste, sight, hearing, touch, and smell. The nerve-endings of the nerves of special sense are usually end-organs of a

specialised kind. The most frequent kind of sensory end-organ is made of what is called *nerve-epithelium*; certain epithelial cells of the surface of the body become peculiarly modified, and grouped in special ways to receive the impressions from the outer world; these send an impulse into the arborisations at the termination of the axis-cylinders of the nerves which envelop the cells. One of these varieties of nerve-epithelium we have already made the acquaintance of, in the hair-cells of the semicircular canals; we shall find other kinds in the hair-cells of the cochlea, in the rods and cones of the retina, &c.

*Pain* is due to an excessive stimulation of the other sensory nerves, but there is some evidence that it may be a distinct sensation. Thus in some cases of diseases of sensory channels, tactile sensation may be intact, but sensitiveness to pain absent, and *vice versa*; see also p. 658.

The other essential anatomical necessities for a sensation, the channels to the brain with their numerous cell-stations on the road, and the parts of the brain to which these tracts pass, we have already dwelt upon. Some of these points we shall, however, be obliged to return to, especially in connection with vision. But here it is sufficient to insist on the necessity of the presence not only of the end-organ, but also of the nervous tracts and centres. Blindness, for instance, may not only be due to disease of the eye, but also to disease of the optic nerve, or of the parts of the brain to which the optic nerve passes.

A small stimulus, or a small increase or decrease in a big stimulus, will have no effect; a light touch, a feeble light, a gentle sound, may be so slight as to produce no effect on the brain. The smallest stimulus that produces an effect is called the *lower limit of excitation* or the *liminal* (from *limen*, a threshold) *intensity of the sensation*. The *height of sensibility* or *maximum of excitation* is a stimulus, so strong that the brain is incapable of recognising any increase in it; a bright light, for instance, may be so intense that any increase in its brightness is not perceptible. Between these two extremes we have what is called the *range of sensibility*. Most of our ordinary sensations fall somewhere about the middle of the range, and *Weber's* or *Fechner's law* is a law that regulates the proportion between the stimulus and the sensation, and which is operative for this region of the range of sensibility. In general terms it may be stated that sensations increase as the logarithm of the stimuli; or, in order that the intensity of a sensation may increase in arithmetical progression, the stimulus must increase in a geometrical progression.

A definite example will help us to understand these mathematical terms a little better. We will select our example from the sense of vision, because the intensity of the cause of visual sensations, light, is easily measurable. Suppose a room lighted by 100 candles, and one candle more is brought in, the increase of light produced by the extra candle is quite perceptible to the eye; or if a candle were removed, the decrease in light would be perfectly appreciable. Next suppose the room lighted by 1,000 candles, and one extra was brought in, no difference would be seen in the amount of illumination; in order to notice increase or decrease in the light it would be necessary to bring in ten extra candles, or take away ten of the candles, as the case might be. In each case an increment or decrease of one-hundredth of the original light is necessary to cause a corresponding increase or diminution in the sensation.

This is after all a perfectly familiar fact; a farthing rushlight will increase the illumination in a dimly-lighted cellar, but it makes no apparent difference in the bright sunshine.

The magnitude of the fraction representing the increment of stimulus necessary to produce an increase of sensation determines what is called the *discriminative sensibility*. This fraction differs considerably for different sense-organs; thus:—

For light it is  $\frac{1}{100}$ .

For sound it is  $\frac{1}{5}$ .

For weight it is  $\frac{1}{17}$ .

For temperature it is  $\frac{1}{5}$ .

For tactile pressure  $\frac{1}{5}$  to  $\frac{1}{6}$  in different parts of the body.

Another general consideration in connection with sensation is that the sensation lasts longer than the stimulus; a familiar instance of this is the sting after a blow. The *after-sensations*, as they are called, have been specially studied in connection with the eye (see After-images).

*Subjective sensations* are those which are not produced by stimuli in the external world, but arise in one's own inner consciousness; they are illustrated by the sensations experienced during sleep (dreams), and in the illusions to which mad and delirious people are subject.

*Homologous stimuli*.—Each kind of peripheral end-organ is specially suited to respond to a certain kind of stimulus. The homologous stimuli of the organs of special sense may be divided into:—

1. Vibrations set up at a distance without actual contact with the object; for instance, light and radiant heat.
2. Changes produced by actual contact with the object; for

instance, in the production of sensations of taste, touch, weight, and alteration of temperature by conduction; in the case of the olfactory end-organs, the sensation is also excited by material particles given off by the odoriferous body, and borne by the air to the nostrils. In sound also, though there is no actual contact of the ear with the vibrating body which emits the sound, the organ of hearing is excited by waves of material substance, first of air, then of bones, then of endolymph, and these excite the nerve-endings of the internal ear.

When the eye is excited by any other kind of stimulus than by light, which is its adequate or homologous stimulus, the sensation experienced is light all the same; for instance, one sees sparks when the eyeball is struck; singing in the ears, the result of an accumulation of wax against the *membrana tympani*, is a similar example.

This brings us to the conclusion of this chapter by leading to the question, Is there such a thing as *specific nerve-energy*? It is an old question, but the answer has still to be found. Sight is a different thing from hearing, and both are different from taste and smell. What is the difference really due to? Can it be explained by supposing that the nervous impulse along the optic nerve is a different kind of molecular change from that which accompanies gustatory or auditory impulses? Or can it be explained by supposing that the main difference is in the end-organ, or in the psychological process which interprets the impulse from the end-organ? Until we know more about the nature of the molecular change which constitutes a nervous impulse, it is merely a matter of speculation whether specific nerve-energy exists. (See Langley's experiments, p. 303.)

---

## CHAPTER LI.

### TOUCH.

UNDER the general heading Touch we shall include the various kinds of sensory impressions that start from the skin and muscles.

#### Tactile End-organs.

First, however, it is necessary to study the varieties of end-organs concerned in the reception of the impressions. They are of numerous kinds, but the following are the principal ones:—

**Pacinian Corpuscles.**—These are named after their discoverer,

Pacini. They are little oval bodies, situated on some of the cerebro-spinal and sympathetic nerves, especially the cutaneous nerves of the hands and feet, where they lie deeply placed in the true skin. They also occur on the nerves of the mesentery of some animals like the cat. They have been observed also in the pancreas, lymphatic glands and thyroid glands, as well as in the penis. They are about  $\frac{1}{3}$  inch long. Each corpuscle is attached by a narrow pedicle to the nerve on which it is situated, and is formed of several concentric layers of membrane, consisting of a hyaline ground-membrane with connective-tissue fibres, each layer being lined by endothelium (figs. 514, 515); through its pedicle passes a single nerve-fibre, which, after traversing the several concentric layers and their intermediate spaces, loses its medullary sheath and enters a central core, at or near the distal end of which it terminates in an arborisation. Some of these layers are continuous with those of the perineurium, but some are super-added. In some cases two nerve-fibres have been seen entering one Pacinian body, and in others a nerve-fibre after passing unaltered through one has been observed to terminate in a second Pacinian corpuscle.

The **corpuscles of Herbst** (fig. 516) are closely allied to Pacinian corpuscles, except that they are smaller and longer with a row of nuclei around the central termination of the nerve in the core. They have been found chiefly in the tongues and bills of ducks. The capsules are nearer together, and towards the centre the endothelial sheath appears to be absent.

**End-bulbs** are found in the conjunctiva (where in man they are spheroidal, but in most animals oblong), in the glans penis and clitoris, in the skin, in the lips, in the epineurium of nerve-trunks, and in tendon; each is about  $\frac{1}{100}$  inch in diameter, oval or spheroidal, and is composed of a medullated nerve-fibre, which terminates among cells of various shapes. Its capsule contains a transparent or striated core, in the centre of which terminates the axis-cylinder of the nerve-fibre, the ending of which is somewhat clubbed (fig. 517).



Fig. 513.—Extremities of a nerve of the finger with Pacinian corpuscles attached, about the natural size. (Adapted from Henle and Kölliker.)

**Touch-corpuses** (figs. 518, 520) are found in the papillæ of the skin of the fingers and toes. They are small oblong masses, about  $\frac{1}{100}$  inch long, and  $\frac{1}{100}$  inch broad, composed of connective-tissue, surrounded by elastic fibres and a capsule of more or less numerous nucleated cells. They do not occur in all



Fig. 514.—Pacinian corpuscle of the cat's mesentery. The stalk consists of a nerve-fibre (N) with its thick outer sheath. The peripheral capsules of the Pacinian corpuscle are continuous with the outer sheath of the stalk. The intermediary part becomes much narrower near the entrance of the axis-cylinder into the clear central core. A hook-shaped termination (T) is seen in the upper part. A blood-vessel (V) enters the Pacinian corpuscle, and approaches the end; it possesses a sheath which is the continuation of the peripheral capsules of the Pacinian corpuscle.  $\times 100$ . (Klein and Noble Smith.)

the papillæ of the parts where they are found, and, as a rule, in the papillæ in which they are present there are no blood-vessels. The peculiar way in which the medullated nerve winds round and round the corpuscle before it enters it is shown in fig. 520. It loses its sheath before it enters into the interior, and then

its axis-cylinder branches, and the branches after either a straight or convoluted course terminate within the corpuscle.



Fig. 515.—Summit of a Pacinian corpuscle of the human finger, showing the endothelial membranes lining the capsules.  $\times 220$ . (Klein and Nobl-Smith.)

The corpuscles of Grandry (fig. 519) form another variety, and have been noticed in the beaks and tongues of birds. They

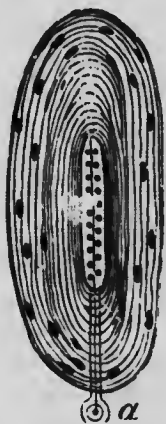

Fig. 516.—A corpuscle of Herbst, from the tongue of a duck.  $\alpha$ , medullated nerve cut away. (Klein.)

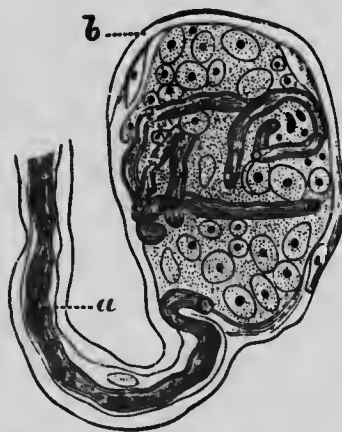

Fig. 517.—End-bulb of Krause.  $a$ , medullated nerve-fibre;  $b$ , capsule of corpuscle.

consist of oval or spherical cells, two or more of which compressed vertically are contained within a delicate nucleated sheath. The



cells are granular and transparent, with a nucleus. The nerve enters on one side and, laying aside its medullary sheath, terminates between the cells in flattened expansions.

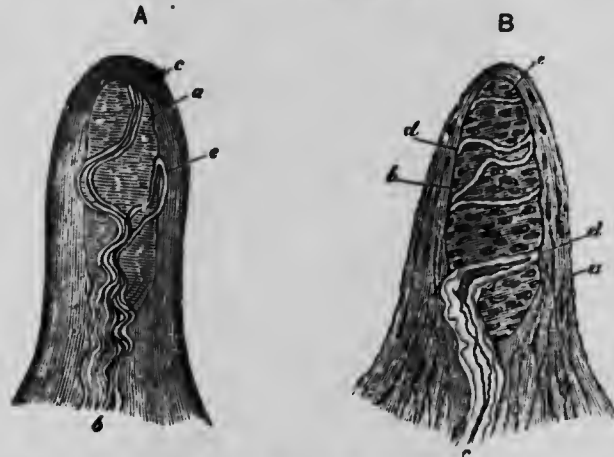

Fig. 518.—Papillæ from the skin of the hand, freed from the cuticle and exhibiting tactile corpuscles. A. Simple papilla with four nerve-fibres; a, tactile corpuscle; b, nerves with winding fibres c and e. B. Papilla treated with acetic acid; a, cortical layer with cells and fine elastic filaments; b, tactile corpuscle with transverse nuclei; c, entering nerve; d and e, nerve-fibres winding round the corpuscle.  $\times 350$ . (Kölliker.)

**Sensory nerve-endings in muscle.**—Nerve terminations, sensory in function, are found in tendon. These appear very much like end-plates, and are represented in figs. 521 and 522.



Fig. 519.—A corpuscle of Grandry, from the tongue of a duck.



Fig. 520.—A touch-corpuscle from the skin of the human hand, stained with gold chloride.

The *neuro-muscular spindles*, which are described on p. 93, and which are principally found in muscles in the neighbourhood of tendons and aponeuroses, are believed by the majority of observers to be sensory end-organs. One of these spindles is shown in the accompanying drawing (fig. 523).

The principal grounds for believing the neuro-muscular spindles to be sensory, are first, that the nerve-fibres that supply them do not degenerate when the anterior roots of the spinal nerves are cut, and secondly, that they do degenerate when the posterior



Fig. 521.—Termination of medullated nerve-fibres in tendon near the muscular insertion. (Golgi.)

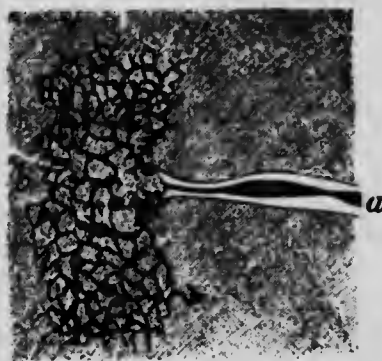

Fig. 522.—One of the reticulated end-plates of Fig. 521, more highly magnified. *a*, medullated nerve-fibre; *b*, reticulated end-plate. (Golgi.)

roots are divided (Sherrington). They also undergo degenerative changes in locomotor ataxy, which is a disease of the sensory nerve-units, and remain healthy in infantile paralysis, which is a

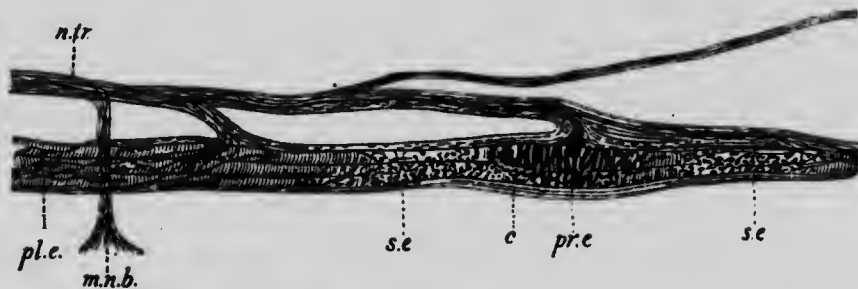

Fig. 523.—Neuro-muscular spindle. *c*, capsule; *n.tr.*, nerve trunk; *m.n.b.*, motor nerve bundle; *pl.e.*, plate-ending; *pr.e.*, primary nerve-ending; *s.e.*, secondary ending. (After Ruffini.)

disease of the motor cells of the anterior horn of the cord (Batten).

In addition to the special end-organs, sensory fibres may terminate in **plexuses**, as in the sub-epithelial and the intra-epithelial plexus of the cornea (fig. 524).

We may now proceed to the consideration of the sense of touch itself; it may be taken under three heads:—

1. Localisation of sensations.

2. The sense of pressure.
3. The sense of temperature.



Fig. 524.—Vertical section of rabbit's cornea, stained with gold chloride. The nerves *a*, terminate in a plexus under and within the epithelial layer, *e*.

When any object rests on the skin, it is possible by tactile sense to ascertain its shape and the part of the skin which it touches (localisation); to estimate its weight even if it is not lifted (sense of pressure); if it is lifted the muscular sense is called into play; and, thirdly, by the temperature sense we determine whether it is hot or cold. The end-organs in the skin are numerous, and it is quite possible that these sensations are received by different kinds of end-organs, though we are not acquainted with which corresponds to which. It is also not possible to draw a hard-and-fast line between touch proper on the one hand and general sensibility and pain on the other. The facts of disease, especially in that disease of the sensory tracts called locomotor ataxy, point to the conclusion that these varieties of sensation are transmitted to the central nervous system by different tracts (see p. 658), and it may be that they are received and interpreted there by different areas.

#### Localisation of Tactile Sensations.

The ability to localise tactile sensations on different parts of the surface is proportioned to the power which such parts possess of distinguishing and isolating the sensations produced by two points placed close together. This power depends in part on the number of nerve-fibres distributed to the part; for the fewer the fibres which any part receives, the more likely is it that several impressions on different contiguous points will act on only one nerve-fibre, and hence produce but one sensation. Experiments have been made to determine the tactile properties of different parts of the skin, as measured by this power of distinguishing distances. These consist in touching the skin, while the eyes are

closed, with the points of a pair of compasses, and in ascertaining how close the points of the compasses may be brought to each other, and still be felt as two points.

**Table of variations in the tactile sensibility of different parts.—**  
*The measurement indicates the least distance at which the two points of a pair of compasses could be separately distinguished.*  
 (E. H. Weber.)

	$\frac{1}{32}$ inch	1 mm.
Tip of tongue . . . . .	$\frac{1}{32}$ "	2 "
Palmar surface of third phalanx of forefinger . . . . .	$\frac{1}{16}$ "	4 "
Palmar surface of second phalanges of fingers . . . . .	$\frac{1}{8}$ "	4 "
Red surface of under-lip . . . . .	$\frac{1}{8}$ "	6 "
Tip of the nose . . . . .	$\frac{1}{4}$ "	8 "
Middle of dorsum of tongue . . . . .	$\frac{1}{2}$ "	10 "
Palm of hand . . . . .	$\frac{3}{8}$ "	12 "
Centre of hard palate . . . . .	$\frac{1}{2}$ "	14 "
Dorsal surface of first phalanges of fingers . . . . .	$\frac{7}{16}$ "	25 "
Back of hand . . . . .	$1\frac{1}{8}$ "	37 "
Dorsum of foot near toes . . . . .	$1\frac{1}{2}$ "	37 "
Gluteal region . . . . .	$1\frac{1}{2}$ "	37 "
Sacral region . . . . .	$1\frac{1}{2}$ "	37 "
Upper and lower parts of forearm . . . . .	$1\frac{1}{2}$ "	50 "
Back of neck near occiput . . . . .	2 "	50 "
Upper dorsal and mid-lumbar regions . . . . .	2 "	62 "
Middle part of forearm . . . . .	$2\frac{1}{2}$ "	62 "
Middle of thigh . . . . .	$2\frac{1}{2}$ "	62 "
Mid-cervical region . . . . .	$2\frac{1}{2}$ "	62 "
Mid-dorsal region . . . . .	$2\frac{1}{2}$ "	62 "

Moreover, in the case of the limbs, it was found that before they were recognised as two, the points of the compasses had to be *further* separated when the line joining them was in the long axis of the limb, than when in the transverse direction.

According to Weber the mind estimates the distance between two points by the number of unexcited nerve-endings which intervene between the two points touched. It would appear that a certain number of intervening unexcited nerve-endings are necessary before the points touched can be recognised as separate, and the greater this number the more clearly are the points of contact distinguished as separate. But the number of nerve-endings is not the only factor in the case, for by practice the delicacy of a sense of touch may be very much increased. A familiar illustration occurs in the case of the blind, who, by constant practice, can acquire the power of reading raised letters the forms of which are almost if not quite undistinguishable by the sense of touch to an ordinary person.

The power of correctly localising sensations of touch is gradually derived from experience. Thus, infants when in pain simply cry but make no effort to remove the cause of irritation, as an older child or adult would, doubtless on account of their imperfect

knowledge of its exact situation. As education proceeds the brain gets to know more and more accurately the surface of the body, and the map of the surface in the brain is most accurately known where there is most practice of the use of touch. The great delicacy of the tongue as a touch organ in judging the form and size of objects can be explained by the fact that this organ has to rely upon the sense of touch alone. Usually, in ascertaining the shape of an object on the part of the skin it touches, we use our eyes as well. In the case of the interior of the mouth this is impossible.

The different degrees of sensitiveness possessed by different parts may give rise to errors of judgment in estimating the distance between two points where the skin is touched. Thus, if the blunted points of a pair of compasses (maintained at a constant distance apart) are slowly drawn over the skin of the cheek towards the lips, it is almost impossible to resist the conclusion that the distance between the points is gradually increasing. When they reach the lips they seem to be considerably further apart than on the cheek. Thus, too, our estimate of the size of a cavity in a tooth is usually exaggerated when based upon sensation derived from the tongue alone. Another curious illusion may here be mentioned. If we close the eyes, and place a marble between the crossed fore and middle fingers, we seem to be touching two marbles. This illusion is due to an error of judgment. The marble is touched by two surfaces which, under ordinary circumstances, could only be touched by two separate marbles, hence, the mind, taking no cognizance of the fact that the fingers are crossed, forms the conclusion that the two sensations are due to two marbles.

#### The Sense of Pressure.

The sense of pressure may be estimated by the ability of the skin to distinguish different weights placed upon it. There must be no lifting of the weight, or the muscular sense is brought into play also. The acuteness of the pressure sense is differently distributed from that of ability to localise sensations; the forearm, for instance, is as sensitive in this direction as the skin of the palm. The tip of the tongue is the most discriminative portion of the body for locality, but it is not so for pressure; one cannot, for instance, feel one's radial pulse with the tongue. The fraction which by Weber's law represents the discriminative sensibility varies from  $\frac{1}{8}$  at the finger tip to  $\frac{1}{3}$  at the shoulder blade (see p. 693).

### The Sense of Temperature.

Here again the distribution of acuteness is different; the tip of the finger is not nearly so sensitive as the forearm or the cheek, to which a washerwoman generally holds her iron when forming a judgment of its temperature. The fraction which represents the discriminative sensibility is approximately  $\frac{1}{3}$ .

It has been further shown that there are two kinds of nerve-endings for temperature in the skin which are respectively excited by heat and cold. Thus, if a small metallic pencil kept warm by a stream of water inside it, is moved over the surface, there are some points where the sensation is merely tactile, and at others the pencil will feel

uncomfortably hot; these spots are called *heat spots*. *Cold spots* may be similarly mapped out by the use of a cold pencil. The accompanying figure (fig. 525) indicates a small piece of the skin of the thigh with the heat spots horizontally, and the cold spots vertically shaded.

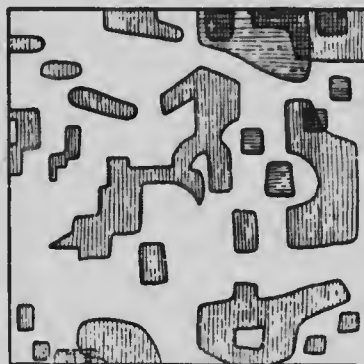

Fig. 525.—Heat and cold spots. (Waller, after Goldscheider).

### The Muscular Sense.

The muscular sense has been much discussed; some have even denied its existence, and supposed that it is merely a variety of the tactile sense; when the muscles contract they press upon the skin over them and the joints. No doubt the tactile sense of pressure helps us to know what we are doing with our muscles, but there are two sets of facts which show that the muscular sense proper is different from the tactile sense. One of these is that the muscular sense estimated by the lifting of weights, or by the amount of convergence of the axes of the eyes in looking at objects at different distances, is much more sensitive than the tactile sense of pressure; the fraction representing the discriminative sensibility being only  $\frac{1}{17}$  instead of  $\frac{1}{3}$  or  $\frac{1}{6}$ , which is the fraction for the pressure sense. The other set of facts are obtained from the study of disease; locomotor ataxy is a selective disease; it may pick out certain sensory tracts and leave others for a time

intact; in this way the muscular sense may be destroyed without the tactile sense being much affected.

Those who believe in the muscular sense are again divided into two sets; some believe that the muscular sense is an accompaniment of the efferent impulse and it is variously spoken of as an estimation of will force, or a sense of expended energy; others, and among these the majority of physiologists must be included, look upon the sense as due to efferent impulses from the muscles to the brain. The "estimation of will force" doctrine is put out of court by the fact that people know when their muscles are contracting, and whether they are contracting much or little, when there is no expenditure of will force at all, as when the muscles are made to contract artificially under the influence of electrical stimulation. There are now many anatomical facts which point to the correctness of the view that the muscular sense is a true sense. Many years ago it was shown that out of the nerve-fibres which go to the frog's sartorius some few degenerate after section of the posterior nerve-roots. This has been more recently demonstrated to be also the case in the muscles of mammals by Sherrington. The discovery of sensory nerve-endings in muscle and tendon points in the same direction.

---

## CHAPTER LII.

### TASTE AND SMELL.

THESE two senses are very closely allied to one another, and it will therefore be convenient to consider them in one chapter.

#### Taste.

Certain anatomical facts must be studied first in connection with the tongue, the upper surface of which is concerned in the reception of taste stimuli.

The tongue is a muscular organ covered by mucous membrane. The muscles, which form the greater part of the substance of the tongue (*intrinsic* muscles) are termed *linguales*; and by these, which are attached to the mucous membrane, its smaller and more delicate movements are performed.

By other muscles (*extrinsic* muscles), like the genio-hyoglossus, the styloglossus, &c., the tongue is fixed to surrounding parts; and by these its larger movements are performed.



Fig. 526.—Papillar surface of the tongue, with the fauces and tonsils. 1, 1, circumvallate papillæ, in front of 2, the foramen cæcum; 3, fungiform papillæ; 4, filiform and conical papillæ; 5, transverse and oblique rugæ; 6, mucous glands at the base of the tongue and in the fauces; 7, tonsils; 8, part of the epiglottis; 9, median glosso-epiglottidean fold (frenum epiglottidis). (From Sappey.)

The mucous membrane of the tongue resembles other mucous membranes in essential points of structure, but contains *papillæ*, peculiar to itself. The tongue is also beset with numerous mucous glands (fig. 527) and lymphoid nodules.



The larger *papillæ* of the tongue are thickly set over the anterior two-thirds of its upper surface, or *dorsum* (fig. 526), and give to it its characteristic roughness. In carnivorous animals, especially those of the cat tribe, the *papillæ* attain a large size,

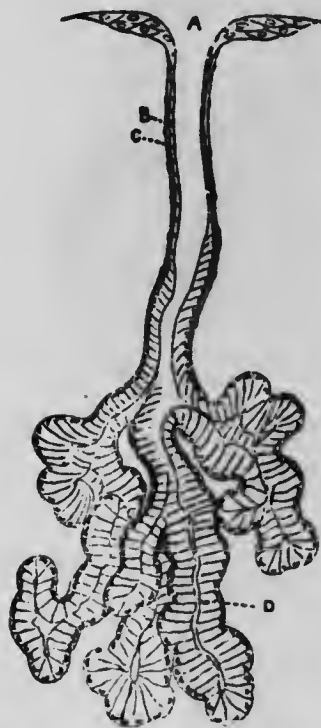

Fig. 527.—Section of a mucous gland from the tongue. A, opening of the duct on the free surface; C, basement membrane with nuclei; B, flattened epithelial cells lining duct. The duct divides into several branches, which are convoluted and end blindly, being lined throughout by columnar epithelium. D, lumen of one of the tubuli of the gland.  $\times 50$ . (Klein and Noble Smith.)

and are developed into sharp recurved horny spines. Such *papillæ* cannot be regarded as sensitive, but they enable the tongue to play the part of a rasp, as in scraping bones, or of a comb in cleaning fur. The *papillæ* of the tongue present several diversities of form; three principal varieties may be distinguished, namely, the (1) *circumvallate*, the (2) *fungiform*, and the (3) *conical and filiform* *papillæ*. They are all formed by a projection of the corium of the mucous membrane, covered by stratified epithelium; they contain special branches of blood-vessels and nerves.

The corium in each kind is studded by minute conical processes or microscopic *papillæ*.

(1.) *Circumvallate*.—These *papillæ* (fig. 528), eight or ten in number, are situate in a V-shaped line at the base of the tongue (1, 1, fig. 526). They are circular elevations, from  $\frac{1}{8}$ th to  $\frac{1}{2}$ th of an inch wide (1 to 2 mm.), each with a slight central depression, and surrounded by a circular moat, at the outside of which again is a slightly elevated ring or rampart; their walls contain taste-bnds. Into the

moat that surrounds the central tower, a few little glands open. They form a thin watery secretion.

(2.) *Fungiform*.—The fungiform *papillæ* (3, fig. 526) are scattered chiefly over the sides and tip, and sparingly over the middle of the dorsum, of the tongue; their name is derived from their being shaped like a puff-ball fungus. (See fig. 529B.)

(3.) *Conical and Filiform*.—These, which are the most abundant *papillæ*, are scattered over the whole upper surface of the

tongue, but especially over the middle of the dorsum. They vary in shape, some being conical (simple or compound) and others filiform; they are covered by a thick layer of epithelium, which is either arranged over them, in an imbricated manner, or is prolonged from their surface in the form of fine stiff projections

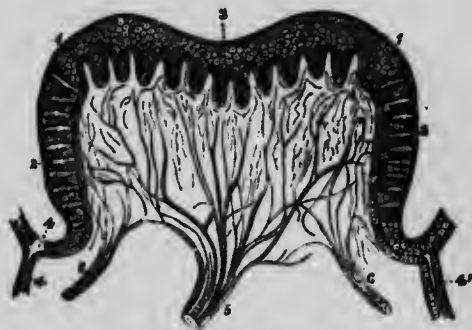

Fig. 528.—Vertical section of a circumvallate papilla of the calf. 1 and 3, epithelial layers covering it; 2, taste-buds; 4 and 4', duct of serous gland opening out into the pit in which papilla is situated; 5 and 6, nerves ramifying within the papilla. (Engelmann.)

(fig. 530.) From their structure, it is likely that these papillæ have a mechanical and tactile function, rather than that of taste; the latter sense is seated especially in the other two varieties of papillæ, the *circumvallate* and the *fungiform*.



Fig. 529.—Surface and section of the fungiform papillæ. A, the surface of a fungiform papilla, partially denuded of its epithelium; *p*, secondary papillæ; *e*, epithelium. B, section of a fungiform papilla with the blood-vessels injected; *a*, artery; *v*, vein; *c*, capillary loops of similar papillæ in the neighbouring structure of the tongue; *d*, capillary loops of the secondary papillæ; *e*, epithelium. (From Kölliker, after Todd and Bowman.)

In the circumvallate papillæ of the tongue of man peculiar structures known as *taste-buds* have been discovered. They are of an oval shape, and consist of a number of closely packed, very narrow and fusiform, cells (*gustatory cells*). This central

core of gustatory cells is enclosed in a single layer of broader fusiform cells (*encasing cells*). The gustatory cells terminate in fine stiff spikes which project on the free surface (fig. 531, *a*).

These bodies also occur side by side in considerable numbers in the epithelium of the papilla foliata, which is situated near the root of the tongue in the rabbit, and is composed of a number of closely packed papillæ very similar in structure to the circumvallate papillæ of man. Taste-buds have also been observed scattered over the posterior third of the tongue and the pharynx, as low as the posterior (laryngeal) surface of the epiglottis.

The gustatory cells in the interior of the taste-buds are surrounded by arborisations of the terminations of the glosso-pharyngeal nerve.

The middle of the dorsum of the tongue is not endowed to any great degree with the sense of taste; the tip and margins, and especially the posterior third of the dorsum (*i.e.*, in the region of the taste-buds), possess this faculty. The anterior part of the



Fig. 530.—Filiform papillæ, one with epithelium, the other without. *p*, the substance of the papillæ dividing at their upper extremities into secondary papillæ; *a*, artery, and *v*, vein, dividing into capillary loops; *e*, epithelial covering, laminated between the papillæ, but extended into hair-like processes, *f*, from the extremities of the secondary papillæ. (From Külliker, after Todd and Bowman.)

tongue is supplied by the lingual branch of the fifth nerve and the chorda tympani, and the posterior third by the glosso-pharyngeal nerve. Considerable discussion has arisen whether there is more than one nerve of taste. The view generally held by physiologists is that the glosso-pharyngeal nerve is the nerve of taste, and the lingual the nerve of tactile sensation. Nevertheless, the lingual and the chorda tympani do contain taste-fibres, which may be,

however, ultimately derived from the glosso-pharyngeal by its communication with the chorda tympani in the tympanic plexus. Sir William Gowers, on the other hand, holds that the true

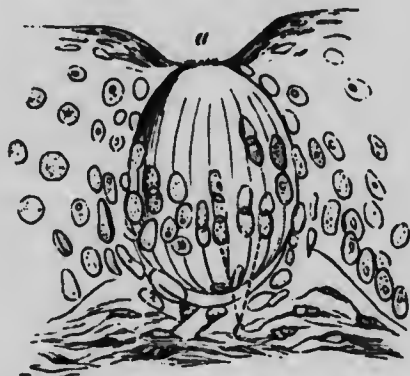

Fig. 531.—Taste-goblet from dog's epiglottis (laryngeal surface near the base), precisely similar in structure to those found in the tongue. *a*, depression in epithelium over goblet; below the letter are seen the fine hair-like processes in which the cells terminate; *c*, two nuclei of the axial (gustatory) cells. The more superficial nuclei belong to the superficial (encasing) cells; the converging lines indicate the fusiform shape of the encasing cells.  $\times 400$ . (Schofield.)

nerve of taste is the fifth, and that the taste-fibres in the glosso-pharyngeal come ultimately from the fifth.

*Tastes* may be classified into—

- |           |            |
|-----------|------------|
| 1. Sweet. | 2. Bitter. |
| 3. Acid.  | 4. Saline. |

Sweet is antagonised by acid as well as by bitter tastes. Acids and salines apparently affect nerves of tactile sense as well as those of taste proper. Sweet tastes are best appreciated by the tip, acid by the side, and bitter tastes by the back of the tongue. Flavours are really odours.

The substance to be tasted must be dissolved; here there is a striking contrast to the sense of smell. In testing the sense of taste in a patient, the tongue should be protruded, and drops of the substance to be tasted applied with a camel's hair brush to the different parts; the subject of the experiment must signify his sensations by signs, for if he withdraws the tongue to speak, the material gets widely spread. The more concentrated the solution, and the larger the surface acted on, the more intense is the taste; some tastes are perceived more rapidly than others, saline tastes the most rapidly of all. The best temperature of the substance to be tasted is from  $10^{\circ}$  to  $35^{\circ}$  C. Very high or very low temperatures deaden the sense.

It is possible by chewing the leaves of an Indian plant

(*Gymnema sylvestre*) to do away with the power of tasting bitters and sweets, while the taste for acids and salts remains.

The delicacy of the sense of taste is sufficient to discern 1 part of sulphuric acid in 1,000 of water. The sense may be improved by practice, as in professional tea-tasters.

### Smell.

Here again we shall take anatomical considerations before studying the physiology of the sense of smell.

The nasal cavities are divided into three districts:—

(a) *Regio vestibularis*; this is the entrance to the cavity; it is lined with a mucous membrane closely resembling the skin, and contains hairs (*vibrissæ*) with sebaceous glands.

(b) *Regio respiratoria* includes the lower meatus of the nose, and all the rest of the nasal passages except (c); its mucous membrane is covered by ciliated epithelium. The corium is thick and consists of fibrous connective-tissue; it contains a certain number of tubular mucous and serous glands.

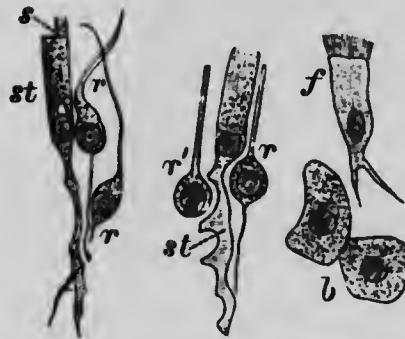

Fig. 532.—Cells from the olfactory region of the rabbit. *st*, supporting cells; *r*, *r'*, olfactory cells; *f*, ciliated cell; *s*, cilia-like processes; *b*, cells from Bowman's gland. (Stöhr.)

(c) *Regio olfactoria*, includes the anterior two-thirds of the superior meatus, the middle meatus, and the upper half of the septum nasi. It is considerably larger in animals like the dog, with a keener sense of smell than we possess. It consists of a thicker mucous membrane than in (b), made up of loose areolar connective-tissue covered by epithelium of a special variety, resting upon a basement membrane. The cells of the epithelium are of several kinds:—first, columnar cells not ciliated (fig. 532, *st*), with the broad end at the surface, and below tapering into an irregular branched process or processes, the terminations of which pass into the next layer: the second kind of cell (fig. 532, *r*) consists of a small cell body with large spherical nucleus, situated between the ends of the first kind of cell, and sending upwards a process to the surface between the cells of the first kind, and from the other pole of the nucleus a process towards the corium. The latter process is very delicate and may be varicose. The upper process is prolonged beyond the surface, where it becomes stiff, and in

some animals, like the frog, is provided with hairs. These cells, which are called *olfactorial cells*, are numerous, and the nuclei of



Fig. 533.—Nerves of the septum nasi, seen from the right side. 1.—I, the olfactory bulb; 1, the olfactory nerves passing through the foramina of the cribriform plate, and descending to be distributed on the septum; 2, the internal or septal twig of the nasal branch of the ophthalmic nerve; 3, naso-palatine nerves. (From Sappey, after Hirschfeld and Leveillé.)

the cells not being on the same level, a comparatively thick nuclear layer is the result (fig. 534, *b*). In the corium are a number of serous glands called Bowman's glands. They open upon the surface by fine ducts passing up between the epithelium cells.

The distribution of the olfactory nerves which penetrate the cribriform plate of the ethmoid bone and pass to this region of the nasal mucous membrane is shown in fig. 533. The nerve-fibres are continuous with the inner processes of the cells we have termed olfactorial; the columnar cells between these act as supports to them.

The olfactory tract is an outgrowth of the brain which was originally hollow, and remains so in many animals, in man the cavity is obliterated, and the centre is occupied by neuroglia: outside this the white fibres lie, and a thin superficial layer of neuroglia covers these. The three "roots" of the olfactory tract have been traced to the insulate gyrus mainly

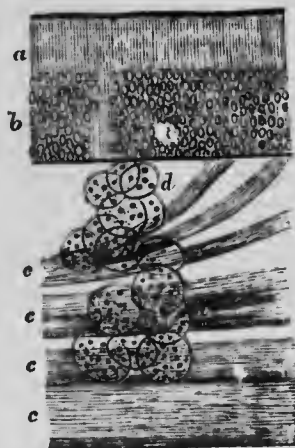

Fig. 534.—Semi-diagrammatic section through the olfactory mucous membrane of the new-born child. *a*, non-nuclear; and *b*, nucleated portions of the epithelium; *c*, nerves; *d*, Bowman's glands. (M. Schultze.)

of the same side of the brain. This is the region of the brain experimentally found to be associated with the sense of smell (see p. 679).

The olfactory bulb has a more complicated structure; above there is first a continuation of the olfactory tract (white fibres enclosing neuroglia); below this four layers are distinguishable; they are shown in the accompanying diagram from Ramon y Cajal's work, the histological method used being Golgi's.

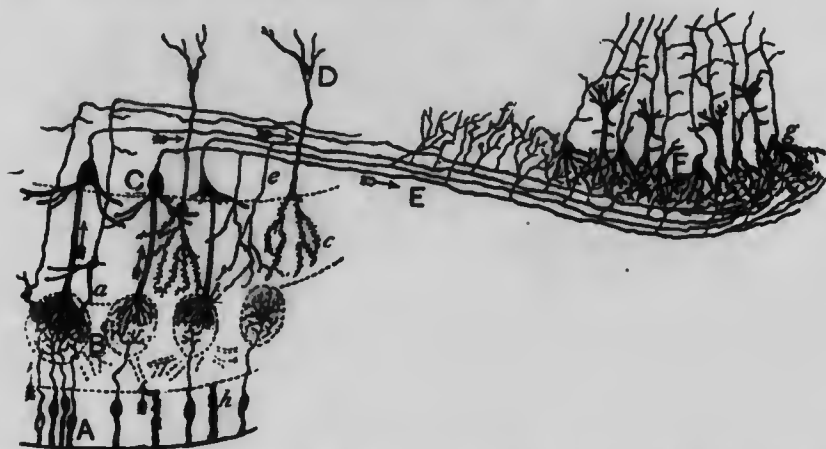

Fig 535.—Nervous mechanism of the olfactory apparatus. A, bipolar cells of the olfactory apparatus (Max Schultze's olfactorial cells); B, olfactory glomeruli; C, mitral cells; D, granule of white layer; E, external root of the olfactory tract; F, grey matter of the sphenoidal region of the cortex; a, small cell of the mitral layer; b, basket of a glomerulus; c, spiny basket of a granule; e, collateral of the axis-cylinder process of a mitral cell; f, collaterals terminating in the molecular layer of the frontal and sphenoidal convolutions; g, superficial triangular cells of the cortex; h, supporting epithelium cells of the olfactory mucous membrane. (Ramon y Cajal.)

(1) A layer of white fibres containing numerous small cells, or "granules" (D).

(2) A layer of large nerve-cells called "mitral cells" (C), with smaller cells (a) mixed with them. The axis-cylinder processes of these cells pass up into the layer above and eventually become fibres of the olfactory tract E, which passes to the grey matter of the base of the brain F. They give off numerous collaterals on the way (e, f).

(3) The layer of olfactory glomeruli (B). Each glomerulus is a basket-work of fibrils derived on the one hand from the terminal arborisations of the mitral cells, and on the other from similar arborisations of the non-medullated fibres which form the next layer.

(4) The layer of olfactory nerve-fibres.—These are non-medullated; they continue upwards the bipolar olfactory cells, or as we have already termed them, the olfactorial cells of the mucous membrane.

In testing a patient's sense of smell, substances like musk or assafœtida should be employed; pungent substances like ammonia

affect the nerves of tactile sense (fifth nerve) more than the olfactory nerves.

The sense of smell is excited either by gaseous or very finely-divided solid particles; these affect the terminations of the olfactorial or bipolar cells and the path to the brain of the nervous impulse so set up we have already indicated. Liquids, unless they are volatile (that is, give off vapours), do not, as a rule, excite the sense; thus Weber could not smell the slightest odour when his nostrils were completely filled with water containing eau-de-Cologne. It is matter of common experience that odours and flavours (which are really odours) cannot be perceived readily when the amount of moisture in the nose is increased, as when one has a bad cold.

On the other hand, the mucous membrane must not be too dry; this also impairs the delicacy of the sense. The delicacy of the sense is most remarkable; thus, Valentin calculates that  $\frac{3}{100,000,000}$  of a grain of musk can be distinctly smelt; and even this can be improved by practice, as in certain tribes of Indians.

We cannot at present give a scientific classification of odours; the only possible classification into pleasant and unpleasant is a matter of individual education and taste to a great extent.

---

## CHAPTER LIII.

### HEARING.

#### Anatomy of the Ear.

THE Organ of Hearing is divided into three parts, (1) the external, (2) the middle, and (3) the internal ear. The two first are only accessory to the third or internal ear, which contains the essential parts of the organ of hearing. The accompanying figure shows the relation of these divisions, one to the others (fig. 536).

**External Ear.**—The external ear consists of the *pinna* and the *external auditory meatus*.

The principal parts of the *pinna* are two prominent rims enclosed one within the other (*helix* and *antihelix*), and enclosing a central hollow named the *concha*; in front of the *concha* is a prominence directed backwards, the *tragus*, and opposite to this one directed forwards, the *antitragus*. From the *concha*, the auditory canal, with a slight arch directed upwards, passes inwards and a little forwards to the *membrana tympani*, to which it thus serves to convey the vibrating air. Its outer



part consists of fibro-cartilage continued from the concha, its inner part of bone. Both are lined by skin continuous with that of the pinna; the skin also extends over the outer part of the *membrana tympani*. Towards the outer part of the canal are fine hairs and sebaceous glands, while deeper in the canal are small

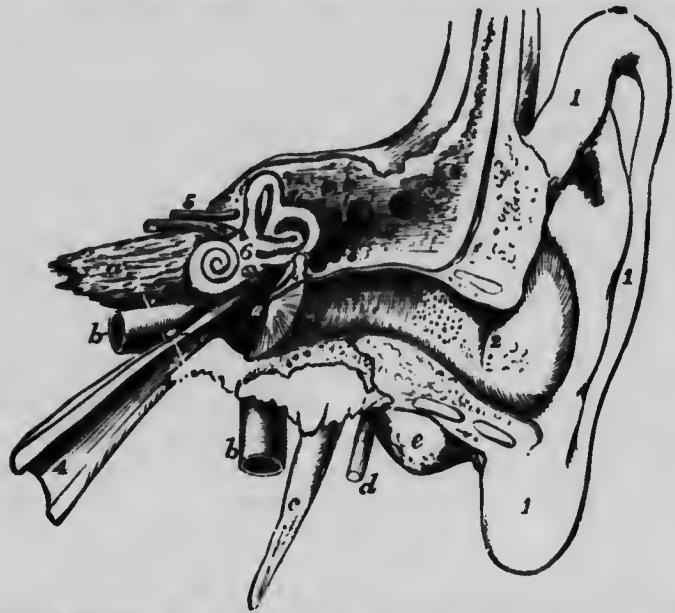

Fig. 536.—Diagrammatic view from before of the parts composing the organ of hearing of the left side. The temporal bone of the left side, with the accompanying soft parts, has been detached from the head, and a section has been carried through it transversely, so as to remove the front of the meatus externus, half the tympanic membrane, the upper and anterior wall of the tympanum and Eustachian tube. The meatus internus has also been opened, and the bony labyrinth exposed by the removal of the surrounding parts of the petrous bone. 1, the pinna and lobe; 2, meatus externus; 2', membrana tympani; 3, cavity of the tympanum; 3', its opening backwards into the mastoid cells; between 3 and 3', the chain of small bones; 4, Eustachian tube; 5, meatus internus, containing the facial (uppermost) and the auditory nerves; 6, placed on the vestibule of the labyrinth above the fenestra ovalis; a, apex of the petrous bone; b, internal carotid artery; c, styloid process; d, facial nerve issuing from the stylo-mastoid foramen; e, mastoid process; f, squamous part of the bone covered by integument, &c. (Arnold.)

glands, resembling the sweat-glands in structure, which secrete the *cerumen* or wax of the ear.

**Middle Ear or Tympanum.**—The middle ear, or tympanum or drum (3, fig. 536), is separated by the *membrana tympani* from the external auditory meatus. It is a cavity in the temporal bone, opening through its anterior and inner wall into the Eustachian tube, a cylindrical flattened canal, dilated at both ends, composed partly of bone and partly of elastic cartilage, and lined with mucous membrane, which forms a communication between the tympanum and the pharynx. It opens into the cavity of the pharynx just behind the posterior aperture of the nostrils.

The cavity of the tympanum communicates posteriorly with air-cavities, the *mastoid cells* in the mastoid process of the temporal bone; but its only opening to the external air is through the Eustachian tube (4, fig. 536). The walls of the tympanum are osseous, except where apertures in them are closed with membrane, as at the *fenestra rotunda*, and *fenestra ovalis*, and at the outer part where the bone is replaced by the *membrana tympani*. The cavity of the tympanum is lined with mucous membrane, the epithelium of which is ciliated and continuous through the Eustachian tube with that of the pharynx. It contains a chain of small bones which extends from the *membrana tympani* to the *fenestra ovalis*.



Fig. 537.—The hammer-bone or malleus, seen from the front. 1, the head; 2, neck; 3, short process; 4, handle. (Schwalbe.)

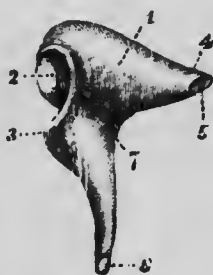

Fig. 538.—The incus, or anvil-bone. 1, body; 2, ridged articulation for the malleus; 3, processus brevis, with 5, rough articular surface for ligament of incus; 4, processus magnus, with articulating surface for stapes; 7, nutrient foramen. (Schwalbe.)



Fig. 539.—The stapes, or stirrup-bone. 1, base; 2 and 3, arch; 4, head of bone, which articulates with orbicular process of the incus; 5, constricted part of neck; 6, one of the crura. (Schwalbe.)

The *membrana tympani* is placed in a slanting direction at the bottom of the external auditory canal, its plane being at an angle of about  $45^\circ$  with the lower wall of the canal. It is formed of tough and tense fibres, some running radially, some circularly; its margin is set in a bony groove; its outer surface is covered with a continuation of the cutaneous lining of the auditory canal, its inner surface with the mucous membrane of the tympanum.

The *ossicles* are three in number; named malleus, incus, and stapes. The malleus, or hammer-bone, has a long slightly-curved process, called its handle, which is inserted between the layers of the *membrana tympani*; the line of attachment is vertical, including the whole length of the handle, and extending from the upper border to the centre of the membrane. The head of the malleus is irregularly rounded; its neck, or the line of boundary between the head and the handle, supports two

processes: a *short* conical one, which receives the insertion of the *tensor tympani*, and a *slender* one, *processus gracilis*, which extends

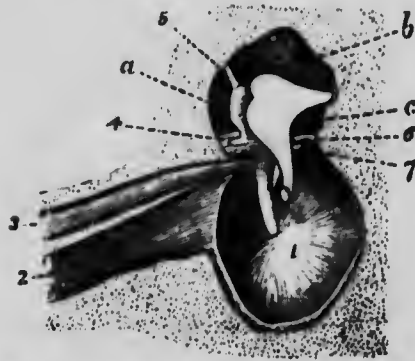

Fig. 540.—Interior view of the tympanum, with membrana tympani and bones in natural position. 1, Membrana tympani; 2, Eustachian tube; 3, tensor tympani muscle; 4, lig. mallei exter.; 5, lig. mallei super.; 6, chorda tympani nerve; a, b, and c, sinuses about ossicles. (Schwalbe.)

forwards, and is attached to the wall of the cavity at the Glasorian fissure. The *incus*, or anvil-bone, shaped like a bicuspid molar tooth, is articulated by its broader part, corresponding with the surface of the crown of the tooth, to the malleus. Of its two fang-like processes, one, directed backwards, has a free end lodged in a depression in the mastoid bone; the other, curved downwards, longer and more pointed, articulates by means of a roundish

tubercle, formerly called *os orbiculare*, with the *stapes*, a little bone shaped exactly like a stirrup, of which the base or bar fits into the membrane of the fenestra ovalis. To the neck of the stapes, a short process, corresponding with the loop of the stirrup, is attached the *stapedius* muscle.

The bones of the ear are covered with mucous membrane reflected over them from the wall of the tympanum; and are movable both altogether and slightly one upon the other. The malleus moves and vibrates with every movement and vibration of the membrana tympani, and its movements are communicated through the incus to the stapes, and through it to the membrane closing the fenestra ovalis.

The *muscles of the tympanum* are two in number. The *tensor tympani* arises from the cartilaginous end of the Eustachian tube and the adjoining surface of the sphenoid and from the sides of the canal in which the muscle lies; the tendon of the muscle bends at nearly a right angle over the end of the *processus cochleariformis* and is inserted into the inner part of the handle of the malleus. The *Stapedius* is concealed within a canal in the bone in front of the aqueductus Fallopii. The tendon issues from the aperture of this canal and is inserted into the neck of the stapes posteriorly.

**The Internal Ear.**—The proper organ of hearing is formed by the distribution of the auditory nerve within the internal

ear, or *labyrinth*, a set of cavities within the petrous portion of the temporal bone. The bone which forms the walls of these cavities is denser than that around it, and forms the *osseous labyrinth*; the membrane within the cavities forms the *membranous labyrinth*. The membranous labyrinth contains a fluid called *endolymph*; while outside it, between it and the osseous



Fig. 541.—Right bony labyrinth, viewed from the outer side. The specimen here represented is prepared by separating piecemeal the looser substance of the petrous bone from the dense walls which immediately enclose the labyrinth. 1, the vestibule; 2, fenestra ovalis; 3, superior semicircular canal; 4, horizontal or external canal; 5, posterior canal; 6, first turn of the cochlea; 7, second turn; 8, apex; 9, fenestra rotunda. The smaller figure in outline below shows the natural size.  $\frac{2\frac{1}{2}}{1}$ . (Sümmering.)



Fig. 542.—View of the interior of the left labyrinth. The bony wall of the labyrinth is removed superiorly and externally. 1, fovea hemispherica; 2, fovea hemispherica; 3, common opening of the superior and posterior semicircular canals; 4, opening of the aqueduct of the vestibule; 5, the superior; 6, the posterior, and 7, the external semicircular canals; 8, spiral tube of the cochlea (scala tympani); 9, opening of the aqueduct of the cochlea; 10, placed on the lamina spiralis in the scala vestibuli.  $\frac{2\frac{1}{2}}{1}$ . (Sümmering.)

labyrinth, is a fluid called *perilymph*. This fluid is not pure lymph, as it contains mucin.

The **osseous labyrinth** consists of three principal parts, namely the *vestibule*, the *cochlea*, and the *semicircular canals*.

The *vestibule* is the middle cavity of the labyrinth, and the central organ of the whole auditory apparatus. It presents, in its inner wall, several openings for the entrance of the divisions of the auditory nerve; in its outer wall, the *fenestra ovalis* (2, fig. 541), an opening filled by membrane in which is inserted the base of the stapes; in its posterior and superior walls, five openings by which the *semicircular canals* communicate with it: in its anterior wall, an opening leading into the *cochlea*. The structure of the *semicircular canals* is described in Chapter XLIX.

The *cochlea* (6, 7, 8, fig. 541, and 8, fig. 542), a small organ,

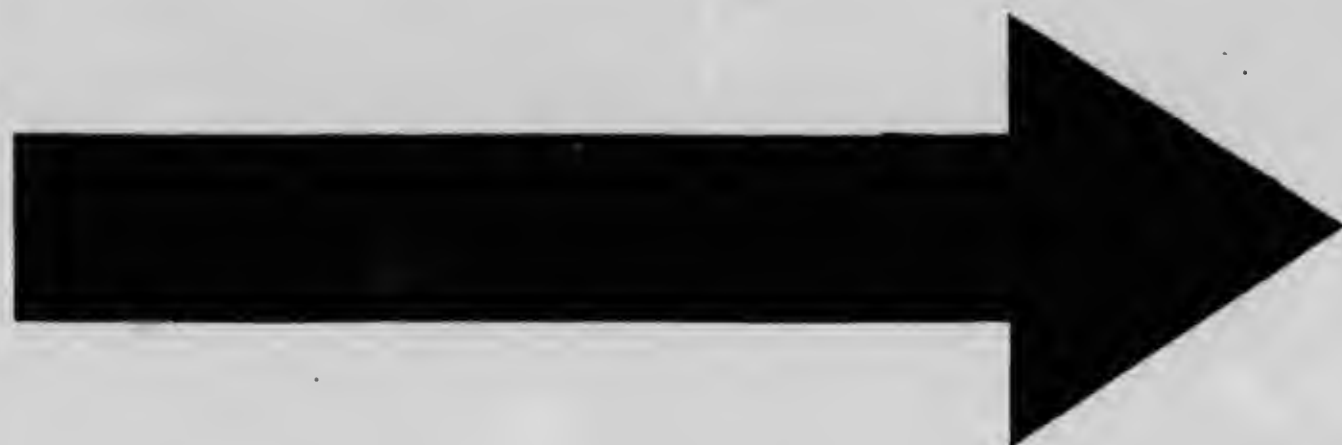

!!

# MICROCOPY RESOLUTION TEST CHART

(ANSI and ISO TEST CHART No. 2)

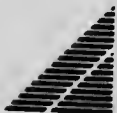
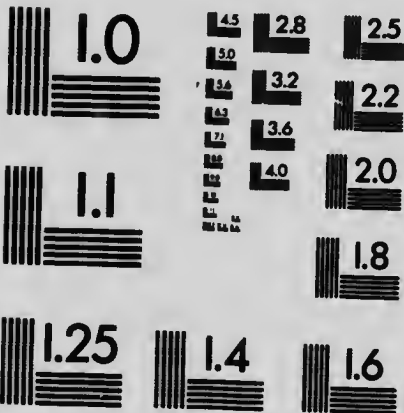

**APPLIED IMAGE Inc**

1653 East Main Street  
Rochester, New York 14609 USA  
(716) 482 - 0300 - Phone  
(716) 288 - 5989 - Fax

shaped like a snail-shell, is situated in front of the vestibule, its base resting on the bottom of the internal meatus, where some apertures transmit to it the cochlear filaments of the auditory nerve. In its axis, the cochlea is traversed by a conical column, the *modiolus*, around which a *spiral canal* winds with two turns and a half from the base to the apex. At the apex of the cochlea the canal is closed; at the base it presents three openings, of which one, already mentioned, communicates with the vestibule; another, called *fenestra rotunda*, is separated by a membrane from the cavity of the tympanum; the third is the orifice of the *aquæductus cochleæ*, a canal leading to the jugular fossa of the petrous bone. The spiral canal is divided into two passages, or *scalæ* (staircases), by a partition formed partly of bone, the *lamina spiralis*, connected with the modiolus, and partly of a membrane called the *basilar membrane*.

The **Membranous Labyrinth**.—The membranous labyrinth

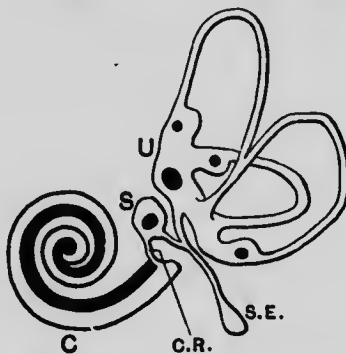

Fig. 543.—Diagram of the right membranous labyrinth. U, utricle, into which the three semicircular canals open; S, saccule, communicating with the cochlea (C) by C.R., the canalis reuniens, and with the utricle by a canal having on it an enlargement, the saccus endolymphaticus (S.E.). The black shading represents the places of termination of the auditory nerve, namely, in the maculae of the utricle and saccule; the cristae in the ampullary ends of the three semicircular canals; and in the whole length of the canal of the cochlea. (After Schäfer.)

corresponds generally with the form of the osseous labyrinth, so far as regards the vestibule and semicircular canals, but is separated from the walls of these parts by perilymph, except where the nerves enter into connection within it. The labyrinth is a closed membrane containing endolymph, which is of much the same composition as perilymph, but contains less solid matter. It is somewhat viscid, as is the perilymph, and it is secreted by the epithelium lining its cavity; all the sonorous vibrations impressing the auditory nerves in these parts of the internal ear, are conducted through fluid to a membrane suspended in and containing fluid. In the cochlea, the membranous labyrinth completes the septum between the

two *scalæ*, and encloses a spiral canal, previously mentioned, called the *canalis cochleæ* (fig. 543). The fluid in the *scalæ* of the cochlea is continuous with the perilymph in the vestibule and semicircular canals. The vestibular portion of the membranous labyrinth comprises two communicating cavities, of which the larger and upper is named the *utricle*; the lower, the *sacculæ*. They are lodged in depressions in the bony labyrinth, termed respectively *fovea hemielliptica* and *fovea hemispherica*. The membranous semicircular canals open into the utricle; the canal of the cochlea opens by the *canalis reuniens* into the sacculæ. The accompanying diagram (fig. 543) gives the relationship of all these parts to one another.

**Auditory Nerve.**—All the organs now described are provided for the appropriate exposure of the filaments of the auditory nerve to vibrations. It enters the bony canal (the *meatus auditorius internus*), with the facial nerve and the *nervus intermedius*, and, traversing the bone, enters the labyrinth at the angle between the base of the cochlea and the vestibule, in two divisions; one for the vestibule and semicircular canals, and the other for the cochlea.

There are two branches for the vestibule, one, superior, distributed to the utricle and to the superior and horizontal semicircular canals, and the other, inferior, which arises from the cochlear nerve, ends in the sacculæ and posterior semicircular canal. There can, however, be little doubt that the inferior nerve, although it is contained for some distance in the sheath of the cochlear nerve, is really composed of vestibular fibres. Where the nerve comes in connection with the utricle and sacculæ, the structure of the membrane is modified and the places are called *maculæ acoustice*. At the ampullæ of the semicircular canals, too, the structure is altered, becoming elevated into a ridge, which projects into the interior of the cavity, forming the *crista acoustica*. The distribution of the true cochlear nerve occurs along the whole length of the canal of the cochlea.

The structure of the membranous canals has been given in Chapter XLIX., so we can pass at once to the cochlea.

This is best seen in vertical section; the cavity is divided into two *scalæ*, partly by bone (the *spiral lamina*), partly by membrane (the *basilar membrane*); the other end of the basilar membrane is attached to the bone by a ligament (the *spiral ligament*), formerly supposed to be a muscle (Bowman's muscle); the two spiral staircases or *scalæ* are named *scala vestibuli* and *scala tympani* (fig. 544). At the apex of the cochlea, the spiral lamina ends in a small *hamulus*, the inner and concave part of



which being detached from the summit of the modiolus, leaves a small aperture named the *helicotrema*, by which the two scalæ, separated in all the rest of their length, communicate.

Besides the scala vestibuli and scala tympani, there is a third space between them, called *scala media* or *canal of the cochlea* (CC, fig. 545). In section it is triangular, its external wall being formed by the wall of the cochlea, its upper wall (separating it from the scala vestibuli) by the membrane of Reissner, and its lower wall (separating it from the scala tympani) by the basilar membrane, these two meeting at the outer edge of the bony lamina spiralis. Following the turns of the cochlea to its apex,

the scala media there terminates blindly; while towards the base of the cochlea it is also closed with the exception of a very narrow passage (*canalis reuniens*) uniting it with the sacculæ.

The scala media (like the rest of the membranous labyrinth) contains *endolymph*.

*Organ of Corti.*—

Upon the basilar membrane arc arranged cells of various shapes. About midway between the outer edge of the lamina spiralis and the outer wall of the cochlea are situated the *rods of Corti*.

Viewed sideways, they are seen to consist of an external and internal pillar, each rising from an expanded foot or *base* attached



Fig. 544.—View of the osseous cochlea divided through the middle. 1, central canal of the modiolus; 2, lamina spiralis ossea; 3, scala tympani; 4, scala vestibuli; 5, porous substance of the modiolus near one of the sections of the canalis spiralis modiolii. †. (Arnold.)

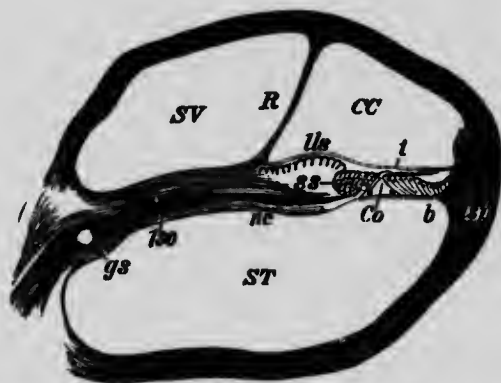

Fig. 545.—Section through one of the coils of the cochlea (diagrammatic). ST, scala tympani; SV, scala vestibuli; CC, canalis cochleæ or canalis membranaceus; R, membrane of Reissner; lso, lamina spiralis ossea; lls, limbus laminae spiralis; ss, sulcus spiralis; nc, cochlear nerve; gs, ganglion spirale; t, membrana tectoria (below the membrana tectoria is the lamina reticularis); b, membrana basilaris; Co, rods of Corti; lso, ligamentum spirale. (Quain.)

to the basilar membrane (o, n, fig. 546). They slant inwards towards each other, and each ends in a swelling termed the *head*; the head of the inner pillar overlies that of the outer (fig. 546).

Each pair of pillars forms a pointed roof arching over a space, and by a succession of them a tunnel is formed.

There are about 3,000 of these pairs of pillars, in proceeding from the base of the cochlea towards its apex. They are found progressively to increase in length, and become more oblique; in other words the tunnel becomes wider, but diminishes in height as we approach the apex of the cochlea. Leaning against these external and internal pillars are certain other cells, called *hair-cells*, which terminate in small hair-like processes. There are several rows of these on the outer and one row on the inner side. Between them are certain supporting cells called *cells of Deiters*.

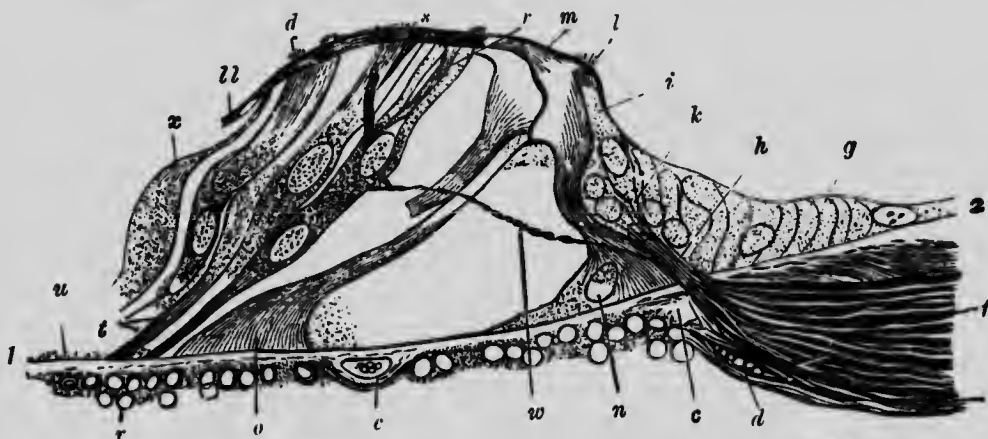

Fig. 546.—Vertical section of the organ of Corti from the dog. 1 to 2, homogeneous layer of the membrana basilaris; *u*, vestibular layer; *v*, tympanal layer, with nuclei and protoplasm; *a*, prolongation of tympanal periosteum of lamina spiralis ossea; *c*, thickened commencement of the membrana basilaris near the point of perforation of the nerves *h*; *d*, blood-vessel (vas spirale); *e*, blood-vessel; *f*, nerves; *g*, the epithelium of the sulcus spiralis internus; *i*, internal hair-cell, with basal process *k*, surrounded with nuclei and protoplasm (of the granular layer), into which the nerve-fibres radiate; *l*, hairs of the internal hair-cell; *n*, base or foot of inner pillar of organ of Corti; *m*, head of the same uniting with the corresponding part of an external pillar, whose under half is missing, while the next pillar beyond, *o*, presents both middle portion and base; *r s d*, three external hair-cells; *t*, bases of two neighbouring hair or tufted cells; *x*, supporting cell of Deiters; *w*, nerve-fibre arborising round the first of the external hair-cells; *ll* to *l*, lamina reticularis.  $\times 800$ . (Waldeyer.)

Most of the above details are shown in the accompanying figure (fig. 546). This structure rests upon the basilar membrane; it is roofed in by a fenestrated membrane or lamina reticularis into the fenestræ of which the tops of the various rods and cells are received. When viewed from above, the organ of Corti shows a remarkable resemblance to the key-board of a piano. The top of the organ is roofed by the *membrana tectoria* (fig. 545, *t*) that extends from the end of the limbus (*lls*, fig. 545), a connective-tissue structure on the spiral lamina. In close relation with the hair-cells which form the auditory nerve epithelium, are filaments

of the auditory nerve. These are derived from the cochlear division already mentioned. This passes up the axis of the cochlea, and in its course gives off fibres to the lamina spiralis. These fibres are thick at their origin, but thin out peripherally, and containing bipolar ganglion cells form the *ganglion spirale*. Beyond the ganglion at the edge of the lamina the fibres pass up and become connected with the organ of Corti, arborising around the hair-cells.

### Physiology of Hearing.

Sounds are caused by vibrations ; when a bell or a piano-string is struck, it is thrown into a series of rapid regular vibrations ; the more rapidly the vibrations occur the higher is the *pitch* of the musical note, that is, it is shriller. The vibrations are transmitted as waves through the air, and ultimately affect the hair-cells at the extremities of the auditory nerve in the cochlea. The semicircular canals are not concerned in the sense of hearing ; their function in connection with equilibration is described in Chapter XLIX. The external and middle ears are conducting ; the internal ear is conducting and receptive. In the external ear the vibrations travel through air ; in the middle ear through solid structures—membranes and bones ; and in the internal ear through fluid, first through the perilymph on the far side of the fenestra ovalis ; and then the vibrations pass through the basilar membrane, and membrane of Reissner, and set the endolymph of the canal of the cochlea in motion.

This is the normal way in which the vibrations pass, but the endolymph may be affected in other ways, for instance through the other bones of the head ; one can, for example, hear the ticking of one's watch when it is placed between the teeth, even when the ears are stopped. From this fact is derived a valuable practical method of distinguishing in a deaf person what part of the organ of hearing is at fault. The patient may not be able to hear a watch or a tuning-fork when it is held close to the ear ; but if he can hear it when it is placed between his teeth or on his forehead, the malady is localised in either the external or middle ear ; if he can hear it in neither situation it is a much more serious case, for then the internal ear or the nervous mechanism of hearing is at fault.

In connection with the external ear there is not much more to be said ; the pinna in many animals is large and acts as a kind of natural ear-trumpet to collect the vibrations of the air ; in man this function is to a very great extent lost, and though there are muscles present to move it into appropriate postures, they are not

under the control of the will in the majority of people, and are functionless, ancestral vestiges.

In the middle ear, however, there are several points to be considered, namely, the action of the *membrana tympani*, of the ossicles, of the tympanic muscles, and of the Eustachian tube.

*The Membrana Tympani.*—This membrane, unlike that of ordinary drums, can take up and vibrate in response to, not only its own fundamental tone, but to an immense range of tones differing from each other by as much as seven octaves. This would clearly be impossible if it were an evenly stretched membrane. It is not evenly nor very tightly stretched, but owing to its attachment to the chain of ossicles it is slightly funnel-shaped: the ossicles also damp the continuance of the vibrations.

When the membrane gets too tightly stretched, by increase or decrease of the pressure of the air in the tympanum, then the sense of hearing is dulled. The pressure in the tympanic cavity is kept the same as that of the atmosphere by the *Eustachian tube*, which leads from the cavity to the pharynx and so to the external air. The Eustachian tube is not, however, always open; it is opened by the action of the *tensor palati* during swallowing. Suppose it were closed owing to swelling of its mucous membrane—this often happens in inflammation of the throat—the result would be what is called *Eustachian* or *throat deafness*, and this is relieved by passing a catheter so as to open the tube. When the tube is closed, the blood in the vessels of the tympanic wall takes up oxygen from the imprisoned air, and gives off carbonic acid in exchange; but the amount of carbonic acid given out is less than the amount of oxygen removed, so that the total quantity of gases within the tympanum is reduced, and its pressure consequently becomes less than that of the atmosphere, so the membrane is cupped inwards; it is this increased tightening of the membrane that produces deafness. There is also an accumulation of mucus. When one makes a violent expiration, as in sneezing, some air is often forced through the Eustachian tube into the tympanum. The ears feel as though they were bulged out, as indeed the *membrana tympani* is, and there is again partial deafness, which sensations are at once relieved by swallowing so as to open the Eustachian tube and so re-establish equality of pressure once more.

*The ossicles* communicate the vibrations of the *membrana tympani* (to which the handle of the malleus is fixed) to the membrane which closes the fenestra ovalis (to which the foot of the stapes is attached). Thus the vibrations are communicated to the fluid of the internal ear which is situated on the other side of the oval window.

The following diagram will assist us in understanding how this is brought about. The bones all vibrate as if they were one, the slight movements between the individual bones being inappreciable. The utility of there being several bones is seen when the vibrations are excessive; the small amount of "give" at the articulations is really protective and tends to prevent fractures.

The handle of the malleus is inserted between the layers of the tympanic membrane; the processus gracilis (*p. g.*) has its end A attached to the tympanic wall on the inner aspect of the Glaserian

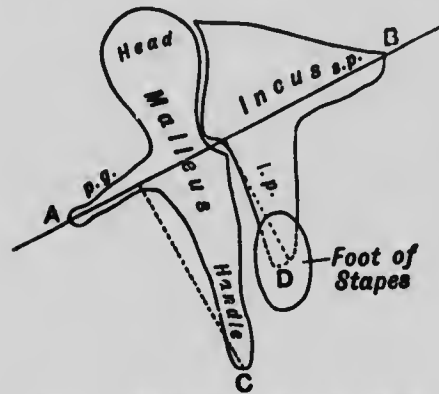

Fig. 547.—Diagrammatic view of ear ossicles.

fissure; the end B of the short process (*s. p.*) of the incus is fastened by a ligament to the opposite wall of the tympanic cavity; the end D of the long process of the incus articulates with the stirrup, the base of which is turned towards the reader. The handle vibrates with the membrana tympani; and the vibrations of the whole chain take place round the axis of rotation AB. Every

time C comes forwards D comes forwards, but by drawing perpendiculars from C and D to the axis of rotation, it is found that D is about  $\frac{2}{3}$  of the distance from the axis that C is. So in the transmission of the vibrations from membrane to membrane across the bony chain, the amplitude of the vibration is decreased by about  $\frac{1}{3}$ , and the force is correspondingly increased. The final movement of the stapes is, however, always very small; it varies from  $\frac{1}{15}$  to less than  $\frac{1}{10000}$  of a millimetre.

The action of the *tensor tympani* by pulling in the handle of the malleus increases the tension of the membrana tympani. It is supplied by the fifth nerve. It is opposed by the strong external ligament of the malleus. The *stapedius* attached to the neck of the stapes tilts it backwards. It is supplied by the seventh nerve.

We have still to consider the use of the *fenestra rotunda*; this is closed by a membrane, and its action is to act as a vent for the vibrations of the perilymph. The next very simple diagram (fig. 548) will explain how this happens.

The cochlea is supposed to be uncoiled; the scala vestibuli leads from the fenestra ovalis, to the other side of which the

stapes is attached; the scala tympani leads to the fenestra rotunda; the two scalæ communicate at the helicotrema, and are separated from the canal of the cochlea by the basilar membrane, and the membrane of Reissner. C.R. is the canalis reuniens leading to the sacculæ. The two scalæ contain perilymph; the canal of the cochlea contains endolymph which is set in vibration by the perilymph through the membranes. Every time the membrane of the oval window is bulged in by the stirrup, the membrane of the round window is bulged out, and *vice versa*. If there were no vent in this way the propagation of vibrations through the fluid would be impossible.

The theories in connection with the *cochlea* are two in number:

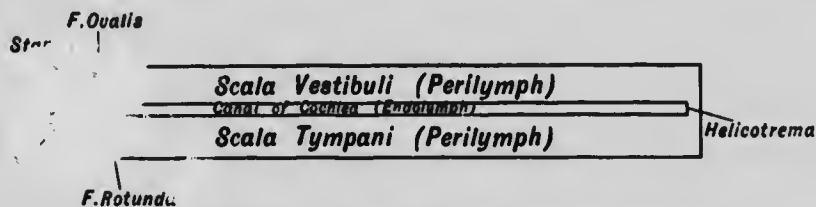

Fig. 548.—Diagram to illustrate the use of the fenestra rotunda.

one is Helmholtz' piano theory; the other is the telephone theory of Rutherford and Waller.

*The Piano Theory.*—If one sings a note in front of a piano, the string of the piano that emits that note will take up the vibration and answer; another note will elicit an answer from another string. It was supposed by Helmholtz that there is an analogous arrangement in the cochlea. Different parts of the organ of Corti will respond to different notes as do the strings of a piano. At first he thought it was the rods of Corti which acted in this way, but when it was shown that in birds there are no rods, he referred it to the different fibres of the basilar membrane. This is supported by the fact that this membrane increases in breadth from below upwards; low notes will set in sympathetic vibration the long fibres of the upper part, and high notes the short fibres of the lower part of the organ.

These responsive vibrations extend to the hair-cells resting on these particular portions of the membrane, and give rise to excitations which, conducted along the nerve-fibres to the brain, produce different auditory sensations. This theory therefore localises the analysis of sounds in the cochlea. The *membrana tectoria* acts as a damping mechanism.

*The Telephone Theory.*—Just as in a telephone one membrane

vibrates in response to a sound but at different rates for different sounds, so in this theory it is supposed that the basilar membrane vibrates as a whole, the hair-cells on it are affected, the nerve impulse travels to the brain, and the analysis of the sound occurs there. In other words, the basilar membrane acts very much like the membrana tympani. "It is the internal drum-head, repeating the complex vibrations of the membrana tympani, and vibrating in its entire area to all sounds—although more in some parts than in others—giving what we may designate as acoustic pressure patterns between the membrana tectoria and the subjacent field of hair-cells. In place of an analysis by sympathetic vibration of particular radial fibres, it may be imagined that varying combinations of sound give varying pressure patterns, comparable to the varying retinal images of external objects." (Waller.)

*The Range of hearing* is more extensive than that of voice. Sounds can be heard that are produced by 30 vibrations per second, up to those caused by 30,000 to 40,000 vibrations per second; and in this range as many as 6,000 variations of pitch can be perceived, or about twice as many as the pairs of arches of Corti. Two sounds can be recognised as distinct if the interval between them is less than 0.1 second, a fact that shows us the perfection of the damping as well as of the vibrating mechanism.

The distinction between musical notes is not equally obvious to all observers. People differ a good deal in the musical element in their nature. But in all there is a limit to the perception of high-pitched notes. In Galton's whistle, one has an instrument by which the rate of vibration of the air which produces the sound can be increased; it gets shriller and shriller, and at last when the vibration frequency exceeds 30,000 or 40,000, the sound becomes inaudible. Probably many animals, however, are able to hear much higher notes than we can detect.

A judgment, by the sense of hearing alone, of the direction in which a sound comes, is always most imperfect.

## CHAPTER LIV.

## VOICE AND SPEECH.

THE fundamental tones of the voice are produced by the current of expired air causing the vibration of the vocal cords, two elastic bands contained in a cartilaginous box placed at the top of the wind-pipe or trachea. This box is called the *larynx*. The sounds produced here are modified by other parts like the tongue, teeth, and lips, as will be explained later on.

**Anatomy of the Larynx.**

The **cartilages** of the larynx are the thyroid, the cricoid, the two arytenoids. These are the most important for voice production; they are made of hyaline cartilage. Then there are the epiglottis, two cornicular, and two cuneiform cartilages. These are made of yellow fibro-cartilage.

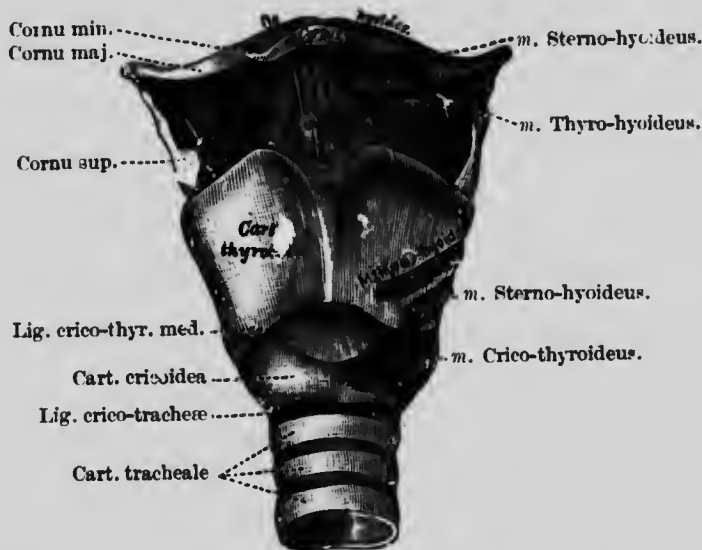

Fig. 549.—The larynx, as seen from the front, showing the cartilages and ligaments. The muscles, with the exception of one crico-thyroid, are cut off short. (Stoerk.)

The *thyroid* cartilage (fig. 550, 1 to 4) does not form a complete ring around the larynx, but only covers the front portion. It forms the prominence in front of the throat known as Adam's apple. (a) The *cricoid* cartilage (fig. 550, 5, 6), on the other hand, is a complete ring; the back part of the ring is much broader than the front. On the top of this



broad portion of the cricoid are (*b*) the *arytenoid* cartilages (fig. 550, 7), the connection between the cricoid below and arytenoid cartilages above is a joint with synovial membrane and ligaments, the latter permitting



Fig. 550.—Cartilages of the larynx seen from the front. 1 to 4, thyroid cartilage; 1, vertical ridge or pomum Adami; 2, right ala; 3, superior, and 4, inferior cornu of the right side; 5, 6, cricoid cartilage; 5, inside of the posterior part; 6, anterior narrow part of the ring; 7, arytenoid cartilages.  $\times 3$ .

tolerably free motion between them. But although the arytenoid cartilages can move on the cricoid, they accompany the latter in all its movements. The base by means of which each arytenoid cartilage sits on the cricoid

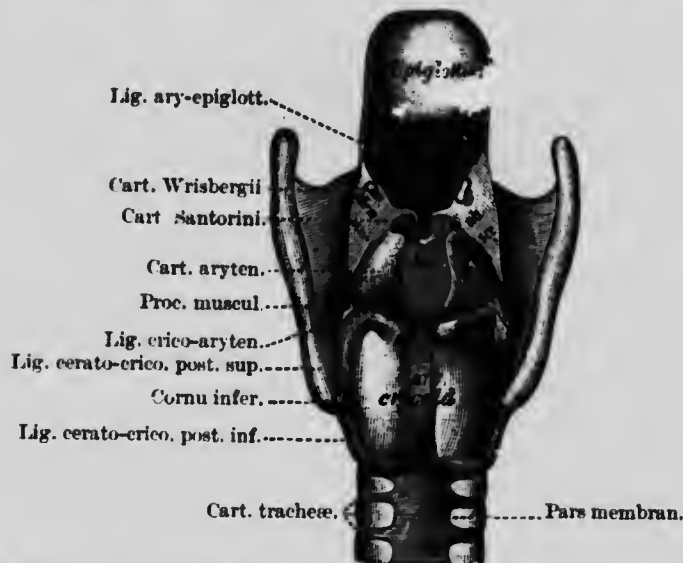

Fig. 551.—The larynx as seen from behind after removal of the muscles. The cartilages and ligaments only remain. (Stoerk.)

is triangular; the anterior angle is often called the vocal process; to it the posterior ends of the true vocal cords are attached. The outer angle is thick and called the muscular process.

The cornicular cartilages, or cartilages of Santorini, are perched on the top of the arytenoids; the cuneiform cartilages, or cartilages of Wrisberg,

are in a fold of mucous membrane; the epiglottis looks like a lid to the whole (fig. 551).

The thyroid cartilage is connected with the cricoid, by the crico-thyroid membrane, and also by joints with synovial membranes; the lower *cornua* of the thyroid clasp the cricoid between them, yet not so tightly but that the thyroid can revolve, within a certain range, around an axis passing transversely through the two joints at which the cricoid is clasped. The vocal cords are attached behind to the front portion of the base (vocal process) of the arytenoid cartilages, and in front to the re-entering angle at the back of the thyroid; it is evident, therefore, that all move-

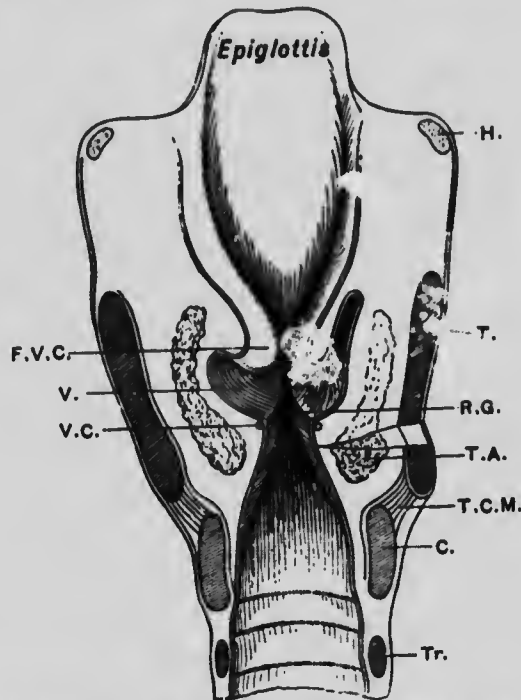

Fig. 552.—Vertical section through the larynx, passing from side to side. H, hyoid bone; T, thyroid cartilage; T.C.M., thyro-cricoid membrane; C, cricoid cartilage; Tr, first ring of trachea; T.A., thyro-arytenoid muscle; R.G., rima glottidis; V.C., vocal cord; V, ventricle; F.V.C., false vocal cord. (After Allen Thomson.)

ments of either of these cartilages must produce an effect on them of some kind or other. Inasmuch, too, as the arytenoid cartilages rest on the top of the back portion of the cricoid cartilage, and are connected with it by capsular and other ligaments, all movements of the cricoid cartilage must move the arytenoid cartilages, and also produce an effect on the vocal cords.

**Mucous membrane.**—The larynx is lined with a mucous membrane continuous with that of the trachea; this is covered with ciliated epithelium except over the vocal cords and epiglottis, where it is stratified. The vocal cords are thickened bands of elastic tissue in this mucous membrane which run from before back. They are attached behind to the vocal processes of the arytenoid cartilages, and in front to the angle where the two wings of the thyroid meet. The cleft between them is called the *rima glottidis* (see fig. 552). Two ridges of mucous membrane above and

parallel to these are called the *false vocal cords*; between the true and false vocal cord on each side is a recess called the *ventricle*.

**Muscles.**—The muscles of the larynx are divided into intrinsic and extrinsic. The intrinsic are named from their attachments to the various cartilages; the extrinsic are those which connect the larynx to other parts like the hyoid bone.

The intrinsic muscles of the larynx are as follows:—

1. Crico-thyroid.
2. Posterior crico-arytenoid.
3. Lateral crico-arytenoid.
4. Thyro-arytenoid.
5. Arytenoid.

All these muscles except the arytenoid are in pairs.

Their attachments and actions are as follows:—

1. *Crico-thyroid*.—This is a short, thick triangular muscle, attached below to the cricoid cartilage: this attachment extends from the middle line backwards. The fibres pass upwards and outwards, diverging slightly to be attached above to the inferior border of the thyroid cartilage, and to the anterior border of its lower cornu. In the latter portion of the muscle, the fibres are nearly horizontal. Some of the superficial fibres are continuous with those of the inferior constrictor of the pharynx.

The thyroid cartilage being fixed by extrinsic muscles, the contraction of this muscle draws upwards the anterior part of the cricoid cartilage, and depresses the posterior part, and with it the arytenoid cartilages, so that the vocal cords are stretched. Paralysis of these muscles therefore causes an inability to produce high-pitched tones.

2. *Posterior crico-arytenoid*.—This arises from the broad depression on the corresponding half of the posterior surface of the cricoid cartilage: its fibres converge upwards and outwards and are inserted into the outer angle of the base of the arytenoid cartilage behind the attachment of the lateral crico-arytenoid muscle. Near their insertion the upper fibres are blended with the lower fibres of the arytenoid muscle.

These muscles draw the outer angles of the arytenoid cartilages backwards and inwards, and thus rotate the anterior or vocal processes outwards, and widen the rima glottidis. They come into action during deep inspiration. If they are paralysed, the lips of the glottis approach the middle line and come in contact during each inspiration, so that dyspnoea is produced.

3. *Lateral crico-arytenoid*.—This arises from the sloping upper border of the cricoid cartilage, and is inserted into the muscular process of the arytenoid cartilage and the adjacent part of its anterior surface. Its upper part is more or less blended with the thyro-arytenoid, and a few of its fibres are continuous round the outer side of the arytenoid cartilage with the arytenoid muscle.

These muscles draw the muscular processes of the arytenoid cartilages forwards and downwards, and thus approximate the vocal cords. They are antagonistic to the posterior crico-arytenoids.

4. *Thyro-arytenoid*.—This consists of two portions, inner and outer. The *inner* portion arises in the lower half of the angle formed by the *alæ* of the thyroid cartilage, and passing backwards are attached behind to the vocal process and to the adjacent parts of the outer surface of the arytenoid cartilage. They are joined internally by short fibres which are attached in front to the vocal cord, and behind to the vocal process. Some oblique fibres pass from the sloping portion of the crico-thyroid membrane below the vocal cord, upwards, outwards, and somewhat backwards, to end in the tissue of the false vocal cord. The fibres of the *outer* portion arise in front from the thyroid cartilage close to the origin of the inner portion and from the crico-thyroid membrane. They pass backwards to be inserted in part into the lateral border and muscular process of the arytenoid cartilage, and in part they pass obliquely upwards towards the aryteno-epiglottidean fold, ending

in the false vocal cord. The portion of this muscle which extends towards the epiglottis is often described as a separate muscle (*thyro-epiglottidean*); it resembles the crico-arytenoid in that some of its fibres are continuous with those of the arytenoid muscle.

The antero-posterior fibres will tend to draw forward the arytenoid cartilage, and with it the posterior part of the cricoid cartilage, rotating the latter upwards and antagonizing the action of the crico-thyroid muscle, the effect being to relax the vocal cords. But if the latter are kept stretched those fibres of the inner portion of the muscle which are inserted into the vocal cord may serve to modify its elasticity, tightening the parts of the cord in front of, and relaxing those behind, its attachment. The vertical fibres of the muscle which extend from the crico-thyroid membrane across the base of the vocal fold and over the ventricle into the false vocal cord, render the free edge of the former more prominent. Then the fibres which are inserted into the muscular process and outer surface of the arytenoid cartilage will tend to draw the arytenoid cartilage forwards and rotate it inwards; finally, the fibres which pass into the aryteno-epiglottidean fold may assist in depressing the epiglottis.

If these muscles are paralysed, the lips of the glottis are no longer parallel, but are curved with the concavity inwards, and a much stronger blast of air is required for the production of the voice.

5. *Arytenoid*. — When the mucous membrane is removed from the back of the arytenoid cartilages, a band of transverse fibres is exposed, on the dorsal surface of which are two slender decussating oblique bundles. These are often described as separate muscles (arytenoid and aryteno-epiglottidean), but they are intimately blended together. The ventral fibres (arytenoid proper) pass straight across from the outer half of the concave surface on the back of one arytenoid cartilage to the corresponding surface of the other. The dorsal fibres can be followed to the lateral walls of the larynx, the uppermost ones to the cartilage of Santorini, the intermediate ones run with the uppermost fibres of the thyro-arytenoid muscle forming the so-called aryteno-epiglottidean muscle, and the lowest fibres blend at the level of the true vocal cords with the thyro-arytenoid and lateral crico-arytenoid muscles.

The arytenoid muscle draws the arytenoid cartilages together. If it is paralysed, the intercartilaginous part of the glottis remains open, although the membranous lips can still be approximated during vocalisation.

It has been generally supposed that the epiglottis is depressed as a lid over the glottis during swallowing. This may be so in some animals, but in man it is not the case; the epiglottis projects upwards in close contact with



Fig. 553.—The larynx as seen from behind. To show the intrinsic muscles posteriorly. (Stoerk.)

the base of the tongue. The necessary closure of the glottis during swallowing is brought about by the contraction of the arytenoid and thyro-arytenoid muscles; by this means the arytenoid cartilages are drawn towards each other, and also forwards into contact with the posterior surface of the epiglottis (Anderson Stuart). Henle remarks that "the muscles which lie in the space enclosed by the laminae of the thyroid cartilage and above the cricoid may be regarded in their totality as a kind of sphincter such as is found in its simplest form embracing the entrance of the larynx in reptiles" (Quain's Anatomy).

**Nerves.**—The larynx is supplied by two branches of the vagus; the

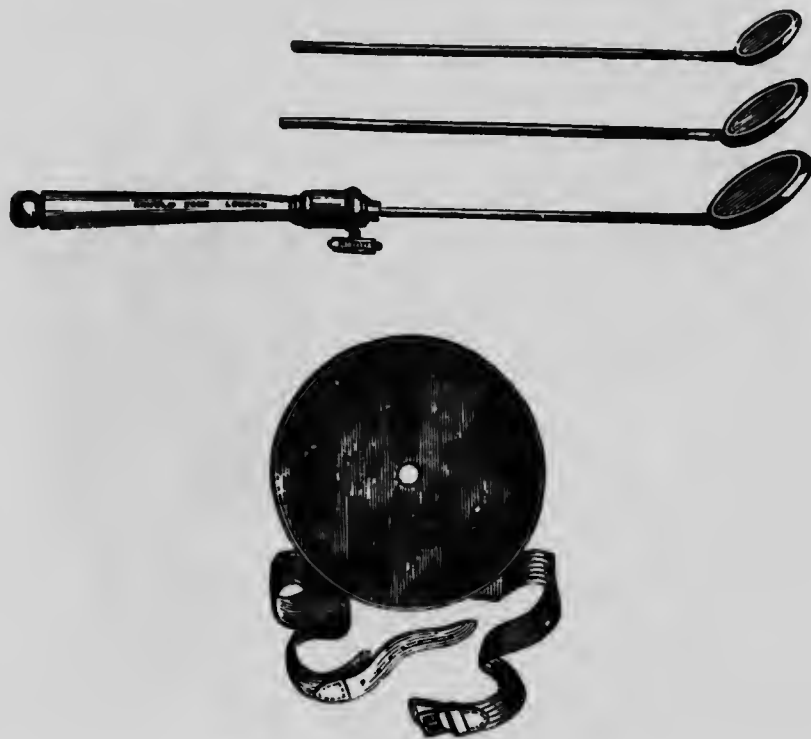

Fig. 554.—The parts of the Laryngoscope.

*superior laryngeal* is the sensory nerve; by its *external* branch, it supplies one muscle, namely, the crico-thyroid. These fibres, however, probably arise from glosso-pharyngeal rootlets (see p. 629). The rest of the muscles are supplied by the *inferior laryngeal nerve*, the fibres of which come from the spinal accessory, not the vagus proper.

The **laryngoscope** is an instrument employed in investigating during life the condition of the pharynx, larynx, and trachea. It consists of a large concave mirror with perforated centre, and of a smaller mirror fixed in a long handle. It is thus used: the patient is placed in a chair, a good light (argand burner, or electric lamp) is arranged on one side of, and a little above his head. The operator fixes the large mirror round his head in such a manner, that he looks through the central aperture with one eye. He then seats himself opposite the patient, and so alters the position of the mirror, which

is for this purpose provided with a ball-and-socket joint, that a beam of light is reflected on the lips of the patient.

The patient is now directed to throw his head slightly backwards, and to open his mouth; the reflection from the mirror lights up the cavity of the mouth, and by a little alteration of the distance between the operator and the patient the point at which the greatest amount of light is reflected by the mirror—in other words, its focal length—is readily discovered. The small mirror fixed in the handle is then warmed, either by holding it over the lamp, or by putting it into a vessel of warm water; this is necessary to prevent the condensation of breath upon its surface. The degree of heat is regulated by applying the back of the mirror to the hand or cheek, when it should feel warm without being painful.

After these preliminaries the patient is directed to put out his tongue, which is held by the left hand gently but firmly against the lower teeth by means of a handkerchief. The warm mirror is passed to the back of the mouth, until it rests upon and slightly raises the base of the uvula, and at the same time the light is directed upon it: an inverted image of the larynx and trachea will be seen in the mirror. If the dorsum of the tongue is alone seen, the handle of the mirror must be slightly lowered until the



Fig. 555.—To show the position of the operator and patient when using the Laryngoscope.

larynx comes into view; care should be taken, however, not to move the mirror upon the uvula, as it excites retching. The observation should not be prolonged, but should rather be repeated at short intervals.

The structures seen will vary somewhat according to the condition of the parts as to inspiration, expiration, phonation, &c.; they are (fig. 556) first, and apparently at the posterior part, the *base of the tongue*, immediately below which is the arcuate outline of the *epiglottis*, with its cushion or tubercle. Then are seen in the central line the *true vocal cords*, white and shining in their normal condition. The cords approximate (in the inverted image) posteriorly; between them is left a chink, narrow whilst a high note is being sung, wide during a deep inspiration. On each side of the true vocal cords, and on a higher level, are the pink *false vocal cords*. Still more externally than the false vocal cords is the *aryteno-epiglottidean fold*, in which are situated upon each side three small elevations; of these the most external is the *cartilage of Wrisberg*, the intermediate is the *cartilage of Santorini*, whilst the summit of the *arytenoid cartilage* is in front, and somewhat below the preceding, being only seen during deep inspiration.

The *rings of the trachea*, and even the bifurcation of the trachea itself, if the patient be directed to draw a deep breath, may be seen in the interval between the true vocal cords.

### Movements of the Vocal Cords.

*In Respiration.*—The position of the vocal cords in ordinary tranquil breathing is so adapted by the muscles, that the opening of the glottis is wide and triangular (fig. 556, B). For all practical purposes, the glottis remains unaltered during ordinary quiet breathing, though in a small proportion of people it becomes a little wider at each inspiration, and a little narrower at each expiration. In the cadaveric position the glottis has about half the width it has during ordinary breathing; during life, therefore, except during vocalisation, the abductors of the vocal cords (posterior crico-arytenoids) are in constant action. (F. Semon.) On making a rapid and deep inspiration the opening of the glottis is widely dilated (fig. 556, C), and somewhat lozenge-shaped.

*In Vocalisation.*—At the moment of the emission of a note, the chink is narrowed, the margins of the arytenoid cartilages being brought into contact and the edges of the vocal cords approximated and made parallel; at the same time their tension is much increased. The higher the note produced, the tenser do the cords become (fig. 556, A); and the range of a voice depends, in the main, on the extent to which the degree of tension of the vocal cords can be thus altered. In the production of a high note the vocal cords are brought well within sight, so as to be plainly visible with the help of the laryngoscope. In the utterance of low-pitched tones, on the other hand, the epiglottis is depressed and brought over them, and the arytenoid cartilages look as if they were trying to hide themselves under it (fig. 557). The epiglottis, by being somewhat pressed down so as to cover the superior cavity of the larynx, serves to render the notes deeper in tone and at the same time somewhat duller.

The degree of approximation of the vocal cords also usually corresponds with the height of the note produced; but the width of the aperture has no essential influence on the pitch of the note, as long as the vocal cords have the same tension: only with a wide aperture the tone is more difficult to produce and is less perfect, the rushing of the air through the aperture being heard at the same time.

No true vocal sound is produced at the posterior part of the aperture of the glottis, that, viz., which is formed by the space between the arytenoid cartilages.

## The Voice.

The human musical instrument is often compared to a reed organ-pipe: certainly the notes produced by such pipes in the *vox humana* stop of organs is very like the human voice. Here

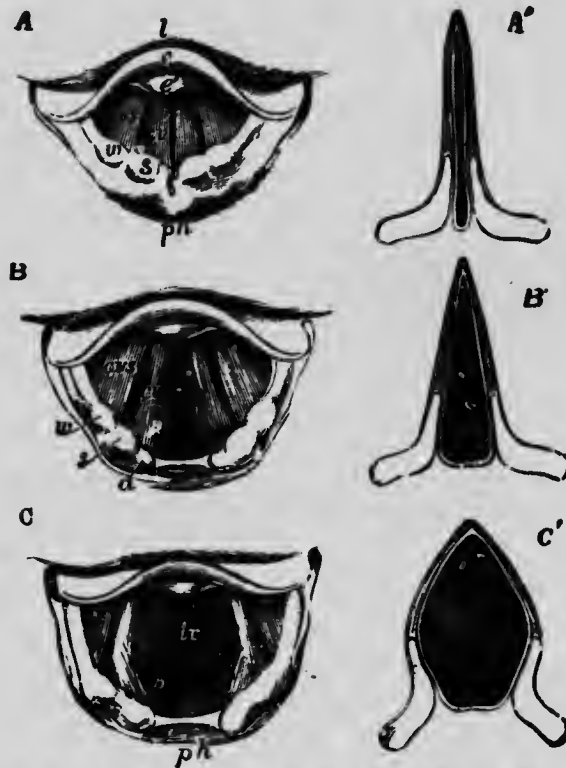

Fig. 56.—Three laryngoscopic views of the superior aperture of the larynx and surrounding parts. A, the glottis during the emission of a high note in singing; B, in easy and quiet inhalation of air; C, in the state of widest possible dilatation, as in inhaling a very deep breath. The diagrams A', B', and C', show in horizontal sections of the glottis the position of the vocal cords and arytenoid cartilages in the three several states represented in the other figures. In all the figures so far as marked, the letters indicate the parts as follows, viz.: *l*, the base of the tongue; *e*, the upper free part of the epiglottis; *e'*, the tubercle or cushion of the epiglottis; *ph*, part of the anterior wall of the pharynx behind the larynx; in the margin of the aryteno-epiglottidean fold, *w*, the swelling of the membrane caused by the cartilages of Wrisberg; *s*, that of the cartilages of Santorini; *a*, the tip or summit of the arytenoid cartilages; *cvs*, the true vocal cords or lips of the rima glottidis; *cvs'*, the superior or false vocal cords; between them the ventricle of the larynx; in C, *tr* is placed on the anterior wall of the receding trachea, and *b* indicates the commencement of the two bronchi beyond the bifurcation which may be brought into view in this state of extreme dilatation. (Quain, after Czermak.)

there is not only the vibration of a column of air, but also of a reed, which corresponds to the vocal cords in the air-chamber composed of the trachea and the bronchial system beneath it. The pharynx, mouth, and nasal cavities above the glottis are



resonating cavities, which by alterations in their shape and size, are able to pick out and emphasize certain component parts of the fundamental tones produced in the larynx. The natural voice is often called the *chest voice*. The *false voice* is differently explained by different observers; on laryngoscopic examination, the glottis is found to be widely open, so that there is an absence of chest resonance; some have supposed that the attachment of the thyro-arytenoid muscle to the vocal cord renders it capable of acting like the finger on a violin string, part of the cord being allowed to vibrate while the rest is held still. Such a shortening of a vibrating string would produce a higher pitched note than is natural.

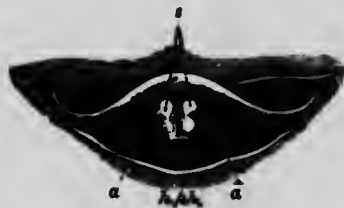

Fig. 557.—View of the upper part of the larynx as seen by means of the laryngoscope during the utterance of a bass note. *e*, epiglottis; *s*, tubercles of the cartilages of Santorini; *a*, arytenoid cartilages; *z*, base of the tongue; *ph*, the posterior wall of the pharynx. (Czermak.)

Musical sounds differ from one another in three ways:—

1. *In pitch*. This depends on the rate of vibration; and in the case of a string, the pitch increases with the tension, and diminishes with the length of the string. The vocal cords of a woman are shorter than those of a man, hence the higher

pitched voice of women. The average length of the female cord is 11.5 millimetres; this can be stretched to 14; the male cord averages 15.5 and can be stretched to 19.5 millimetres.

2. *In loudness*.—This depends on the amplitude of the vibrations, and is increased by the force of the expiratory blast which sets the cords in motion.

3. *In "timbre"*.—This is the difference of character which distinguishes one voice, or one musical instrument, from another. It is due to admixture of the primary vibrations with secondary vibrations or overtones. If one takes a tracing of a tuning-fork on a revolving cylinder, it writes a simple series of up and down waves corresponding in rate to the note of the fork. Other musical instruments do not lend themselves to this form of graphic record, but their vibrations can be rendered visible by allowing them to act on a small sensitive gas-flame; this bobs up and down, and if the reflection of this flame is allowed to fall on a series of mirrors, the top of the continuous image formed is seen to present waves. The mirrors are usually arranged on the four lateral sides of a cube which is rapidly rotated. If one sings a note on to the membrane in the side of the gas-chamber

with which the flame is in connection, the waves seen are not simple up and down ones, but the primary large waves are complicated by smaller ones on their surface, at twice, thrice, &c., the rate of the primary vibration. The richer a voice, the richer the sound of a musical instrument, the more numerous are these overtones or harmonics.

The range of the voice is seldom, except in celebrated singers, more than two-and-a-half octaves, and for different voices this is in different parts of the musical scale.

Although the voice is usually produced by the expiratory blast, by practice one can employ the inspiratory blast: this con-

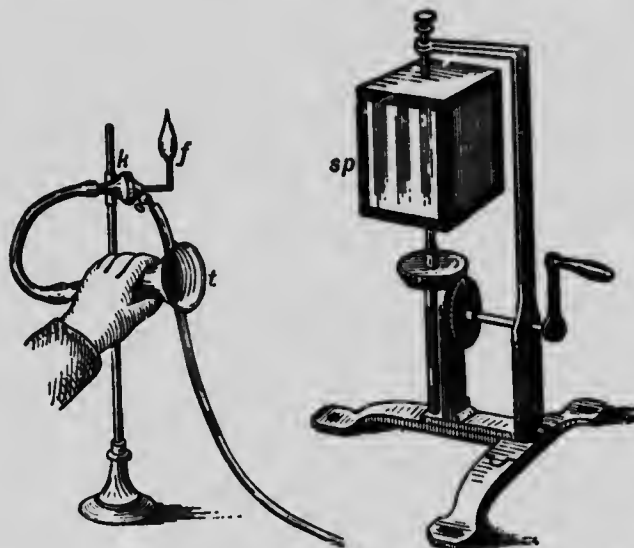

Fig. 558. — König's apparatus for obtaining flame pictures of musical notes.

stitutes the form of speech known as *ventriloquism*. The voice does not appear to come out of the speaker's mouth; and as we never readily distinguish the direction in which the sounds reach our ear, the ventriloquist, by directing the attention of the audience to various parts of the room, is able to make them imagine the voice is proceeding from those parts.

### Speech.

This is due to the modification produced in the fundamental laryngeal notes, by the resonating cavities above the vocal cords. By modifying the size and shape of the pharynx, mouth, and nose, certain overtones or harmonics are picked out and exaggerated;

this gives us the vowel sounds ; the consonants are produced by interruptions, more or less complete, of the outflowing air in different situations. The soft palate is raised at each word. When the larynx is passive, and the resonating cavities alone come into play, then we get whispering.

The pitch of the **Vowels** has been estimated musically ; *u* has the lowest pitch, then *o*, *a* (as in father), *ā* (as in cane), *i*, and *e*. We may give a few examples of the shape of the resonating cavities in pronouncing vowel sounds, and producing their characteristic timbre: when sounding *a* (in father) the mouth has the shape of a funnel wide in front ; the tongue lies on the floor of the mouth ; the lips are wide open ; the soft palate is moderately and the larynx slightly raised.

In pronouncing *u* (*oo*), the cavity of the mouth is shaped like a capacious flask with a short narrow neck. The whole resonating cavity is then longest, the lips being protruded as far as possible ; the larynx is depressed and the root of the tongue approaches the fauces.

In pronouncing *o*, the neck of the flask is shorter and wider, the lips being nearer the teeth ; the larynx is slightly higher than in sounding *oo*.

In pronouncing *e*, the flask is a small one with a long narrow neck. The resonating chamber is then shortest as the larynx is raised as much as possible, and the mouth is bounded by the teeth, the lips being retracted ; the approach of the tongue near the hard palate makes the long neck of the flask.

The **Consonants** are produced by a more or less complete closure of certain doors on the course of the outgoing blast. If the closure is complete, and the blast suddenly opens the door, the result is an *explosive* ; if the door is partly closed, and the air rushes with a hiss through it, the result is an *aspirate* ; if the door is nearly closed and its margins are thrown into vibration, the result is a *vibrative* ; if the mouth is closed, and the sound has to find its way out through the nose, the result is a *resonant*.

These doors are four in number ; Brücke called them the *articulation positions*. They are—

1. Between the lips.
2. Between the tongue and hard palate.
3. Between the tongue and soft palate.
4. Between the vocal cords.

The following table classifies the principal consonants according to this plan :—

Articulation position.	Explosives.	Aspirates.	Vibratives.	Resonants.
1	... B, P.	... F, V, W.	—	... M.
2	... T, D.	... S, Z, L, Sch, Th....	R.	... N.
3	... K, G.	... J, Ch.	Palatal R.	... Ng.
4	... —	... H.	... R of lower Saxon...	—

#### Defects of Speech.

Speech is an action confined to man ; experiments on animals are therefore here inapplicable ; hence our knowledge of the nervous mechanism of speech defects depends on deductions drawn from the clinical and pathological study of disease.

Speech may be absent in certain forms of lunacy, and temporarily in that defect of will called *hysteria*.

It may be absent owing to congenital defects. Children born deaf are dumb also. This is because we think with remembered sounds, and in a person born deaf the auditory centres are never set into activity. By educating the child by the visual inlet, it can be taught to think with the remembered shapes of the mouth and expressions of the face produced in the act of speaking, and so can itself speak in time.

If a child becomes deaf before it is six or seven years old, there is a liability it will forget the speech it has learnt, and so become dumb.

In congenital hemiplegia there may be speechlessness, especially if the injury is due to meningeal hæmorrhage affecting the grey cortex of the left hemisphere. These children generally talk late, the right side of the brain taking on the function of the left.

Disorders of speech and voice occur from affections of the larynx, and of the nerves which supply the larynx. Stammering is a want of co-ordination between the various muscles employed in the act of speaking.

Perhaps the most interesting of the disorders of speech, however, are those due to brain disease in adults. These fall into three principal categories:—

1. *Aphemia*.—A difficulty or inability to utter or articulate words. It is often associated with difficulty of swallowing, and occurs in lesions of the base of the brain, especially of pons and bulb. The blurring of speech noticed in most cases of apoplexy may also be included under this head.

2. *Aphasia*.—This is a complex condition in which the will to speak exists, and also the ability to speak, but the connection between the two is broken down. When the patient speaks, the words which he utters are well pronounced, but are not those he wishes to utter. This is often associated with *Agraphia*, a similar condition in respect to writing. It is the form of disordered speech associated with disorganisation of Broca's convolution.

3. *Amnesia*.—This term includes a large class of cases in which the main symptom is loss of memory for words, or a defect of the association of ideas of things with ideas of words, not as in aphasia with ideas of verbal action. Amnesia is associated with lesions of the intellectual, *i.e.*, the sensory centres of the cortex behind the Rolandic area. We have seen that in this region of the brain there are two important centres, the visual and the auditory, and the parts of these which are associated with words may be called the *visual word-centre* and the *auditory word-centre*. They have not, however, been anatomically localised. In amnesia, either these centres themselves, or the tracts that connect them, are diseased or broken down.

With regard to the auditory word-centre, impressions for the sounds of words are revived in one of three ways:—

*a.* Spontaneous or volitional; owing to accumulated traces which constitute memory, a man when he wants to express his thoughts in words remembers the sounds it is necessary to use; impulses pass to the motor-centre (Broca's convolution), thence to the nerve-centres, nerves, and muscles of the larynx, mouth, chest, &c., and the man speaks.

*b.* In slight disease of the auditory word-centre, he is unable to do this, but if his mind is set into a certain groove he will speak: thus if the alphabet or a well-known piece of poetry be started for him he will finish it by himself.

*c.* Mimetic. In more severe cases, a more powerful stimulus still is needed; he will repeat any words after another person, but forget them immediately afterwards.

With regard to the visual word-centre as tested by writing, there are also three ways of reviving impressions for written words or letters.

(a.) Spontaneous or normal.

(b.) A train of thought must first be set going; as, for instance, converting printed words into written characters.

(c.) Mimetic; he can only write from a copy.

Two operations require the combined activity of both centres; the first of these is reading aloud, the second is writing from dictation.

In reading aloud, the impression of the words enters by the eyes, reaches the visual word-centre, travels across to the auditory word-centre, where the sounds of the words are revived and the person pronounces them.

Writing from dictation is just the opposite; there the impressions of the words enter by the ears, reach the auditory word-centre, travel across to the visual word-centre, where the shapes of the words are revived and the person writes them.

In the investigation of any case of defective speech there are always the following six things to be inquired into:—

1. Can the patient understand spoken words? (The patient, of course, not being deaf.) If he cannot, the auditory word-centre is deranged.

2. Can he repeat words when requested? This tests the efferent fibres from the auditory word-centre which pass through the motor-centres for speech in Broca's convolution. If he cannot do this, the patient has aphasia.

3. Can he write from dictation? If he cannot, either the auditory or visual word-centre, or the fibres passing from the one to the other, are injured.

4. Does he understand printed matter, and can he point out printed letters and words? Can he read to himself? (The patient, of course, not being blind.) This tests the visual word-centre.

5. Can he copy written words? This tests the channels from the visual word-centre to the motor-centres for movements of the hand in writing.

6. Can he read aloud, or, what is the same thing, name objects he sees? This is the opposite to writing from dictation, and tests the healthiness of the word-centres or the fibres which connect the visual to the auditory word-centre.

---

## CHAPTER LV.

### THE EYE AND VISION.

THE eyeball is contained in the cavity of the skull called the orbit; here also are vessels and nerves for the supply of the eyeball, muscles to move it, and a quantity of adipose tissue. In the front of the eyeball are the lids and lacrimal apparatus.

The *eyelids* consist of two movable folds of skin, each of which is kept in shape by a thin plate of fibrous tissue called the *tarsus*. Along their free edges are inserted a number of curved

hairs (*eyelashes*), which, when the lids are half closed, serve to protect the eye from dust and other foreign bodies: the tactile sensibility of the lids is very delicate. On the inner surface of the tarsus are disposed a number of small racemose glands (*Meibomian*), the ducts of which open near the free edge of the lid.

The orbital surface of each lid is lined by a delicate, highly sensitive mucous membrane (*conjunctiva*), which is continuous with the skin at the free edge of each lid, and after lining the inner surface of the eyelid is reflected on to the eyeball, being somewhat loosely adherent to the sclerotic coat. Its epithelium, which is columnar, is continued over the cornea as its anterior epithelium, where it becomes stratified. At the inner edge of the eye the *conjunctiva* becomes continuous with the mucous lining of the lacrimal sac and duct, which again is continuous with the mucous membrane of the inferior meatus of the nose.

The *lacrimal gland*, composed of several lobules made up of acini resembling the serous salivary glands, is lodged in the upper and outer angle of the orbit. Its secretion, which issues from several ducts on the inner surface of the upper lid, under ordinary circumstances just suffices to keep the conjunctiva moist. It passes out through two small openings (*puncta lacrymalia*) near the inner angle of the eye, one in each lid, into the lacrimal sac, and thence along the nasal duct into the inferior meatus of the nose. The excessive secretion poured out under the influence of an irritating vapour or painful emotion overflows the lower lid in the form of tears. The secretory nerves are stated to be contained in the lacrimal and subcutaneous molar branches of the fifth nerve, and in the cervical sympathetic.

The eyelids are closed by the contraction of a sphincter muscle (*orbicularis*), supplied by the facial nerve; the upper lid is raised by the *levator palpebræ superioris*, supplied by the third nerve.

### The Eyeball.

The eyeball or the organ of vision (fig. 559) consists of a variety of structures which may be thus enumerated:—

The *sclerotic*, or outermost coat, envelops about five-sixths of the eyeball: continuous with it, in front, and occupying the remaining sixth, is the *cornea*. Immediately within the sclerotic is the *choroid* coat, and within the choroid is the *retina*. The interior of the eyeball is filled by the *aqueous* and *vitreous humours* and the *crystalline lens*; but, also, there is suspended in the

interior a contractile and perforated curtain,—the *iris*, for regulating the admission of light, and behind at the junction of the sclerotic and cornea is the ciliary muscle, the function

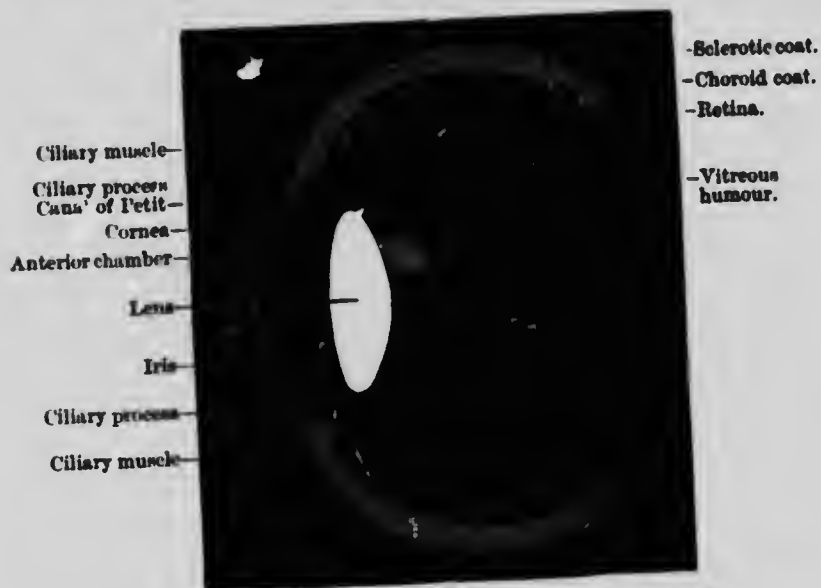

Fig. 559.—Section of the anterior four-fifths of the eyeball.

of which is to adapt the eye for seeing objects at various distances.

*Structure of the Sclerotic Coat.*—The sclerotic coat is composed

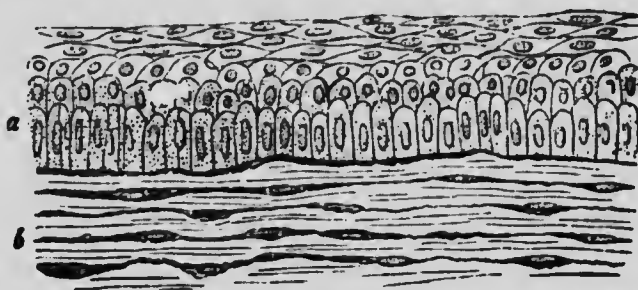

Fig. 560.—Vertical section of rabbit's cornea. *a*, Anterior epithelium, showing the different shapes of the cells at various depths from the free surface; *b*, portion of the substance of cornea. (Klein.)

of white fibrous tissue, with some elastic fibres near the inner surface, arranged in variously disposed and interlacing layers. Many of the bundles of fibres cross the others almost at right angles. It is strong, tough, and opaque, and not very elastic.

It is separated from the choroid by a lymphatic space (*perichoroidal*), and this is in connection with smaller spaces lined with endothelium in the sclerotic coat itself. There is a

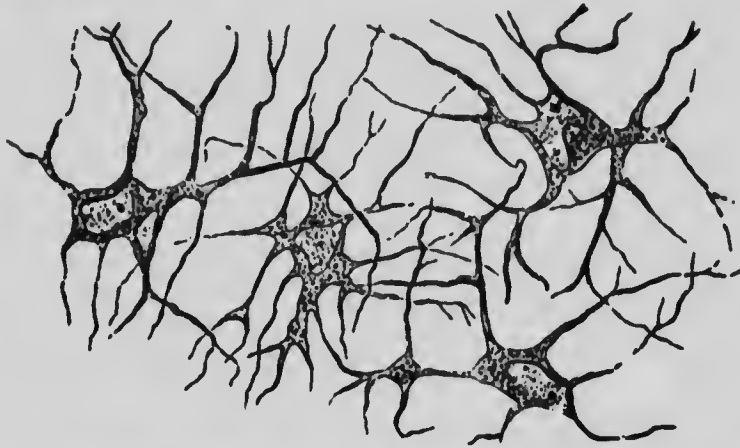

Fig. 561.—Horizontal preparation of cornea of frog; showing the network of branched cornea-corpuses. The ground substance is completely colourless.  $\times 400$ . (Klein.)

lymphatic space also outside the sclerotic separating it from a loose investment of connective tissue, containing some smooth muscular fibres, called the *capsule of Tenon*. The innermost layer

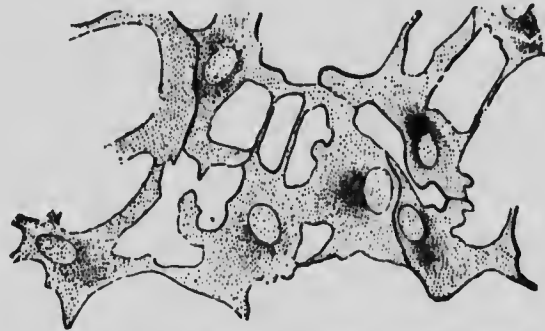

Fig. 562.—Surface view of part of lamella of kitten's cornea, prepared first with caustic potash and then with nitrate of silver. (By this method the branched cornea-corpuses with their granular protoplasm and large oval nuclei are brought out.)  $\times 450$ . (Klein and Noble Smith.)

of the sclerotic is made up of loose connective tissue and pigment-cells, and is called the *lamina fusca*.

*Structure of the Cornea.*—The cornea is a transparent membrane which forms a segment of a smaller sphere than the rest of the eyeball, and is let in, as it were, into the sclerotic, with which it is



continuous all round. It is covered by stratified epithelium (*a*, fig. 560), consisting of seven or eight layers of cells, of which the superficial ones are flattened and scaly, and the deeper ones more or less columnar. Immediately beneath this is the *anterior homogeneous lamina of Bowman*, which differs, only in being more condensed tissue, from the general structure of the cornea.

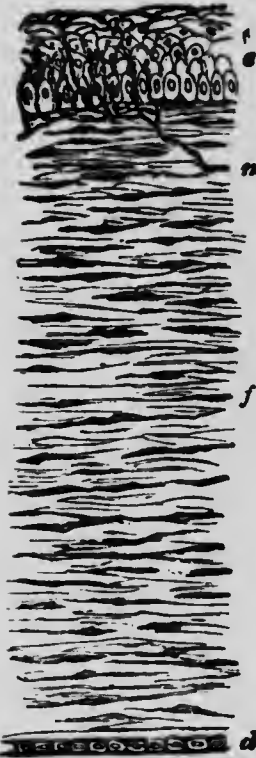

Fig. 563.—Vertical section of rabbit's cornea, stained with gold chloride. *e*, Stratified anterior epithelium. Immediately beneath this is the anterior homogeneous lamina of Bowman. *n*, Nerves forming a delicate sub-epithelial plexus, and sending up fine twigs between the epithelial cells to end in a second plexus on the free surface; *d*, Descemet's membrane, consisting of a fine elastic layer, and a single layer of epithelial cells; the substance of the cornea, *f*, is seen to be fibrillated, and contains many layers of branched corpuscles, arranged parallel to the free surface, and here seen edgewise. (Schofield.)

The corneal tissue, as well as its epithelium, is, in the adult, completely destitute of blood-vessels; it consists of an intercellular ground-substance of rather obscurely fibrillated flattened bundles of connective tissue, arranged parallel to the free surface, and forming the boundaries of branched anastomosing spaces in which the corneal corpuscles lie. These corneal corpuscles have been seen to execute amoeboid movements. At its posterior surface the cornea is limited by the *posterior homogeneous lamina*, or *membrane of Descemet*, which is elastic in nature, and lastly a single stratum of cubical epithelial cells (fig. 563, *d*).

*Nerves*.—The nerves of the cornea are both large and numerous: they are derived from the ciliary nerves. They traverse the substance of the cornea, in which some of them near the anterior surface break up into axis cylinders, and their primitive fibrillæ. The latter form a plexus immediately beneath the epithelium, from which delicate fibrils pass up between the cells anastomosing with horizontal branches, and forming an intra-epithelial plexus. Most of the primitive fibrillæ have a beaded or varicose appearance. The cornea has no blood-vessels penetrating its

structure, nor yet lymphatic vessels proper. It is nourished by the circulation of lymph in the spaces in which the corneal corpuscles lie. These communicate freely and form a lymph-canalicular system.

*Structure of the Choroid Coat (tunica vasculosa).*—This coat is attached to the inner layer of the sclerotic in front at the corneo-scleral junction and behind at the entrance of the optic nerve; elsewhere it is connected to it only by loose connective tissue. Its external coat is formed chiefly of elastic fibres and large pigment corpuscles loosely arranged; it contains lymphatic spaces lined with endothelium. This is the *lamina supra-choroidea*. More internally is a layer of arteries and veins arranged in a system of venous whorls, together with elastic fibres and pigment cells. The lymphatics, too, are well developed around the blood-vessels, and there are besides distinct lymph spaces lined with endothelium. Internally to this is a layer of fine capillaries, very dense and derived from the arteries of the outer coat and ending in veins in that coat. It contains

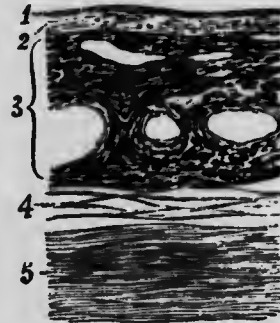

Fig. 564.—Section through the choroid coat of the human eye. 1, membrane of Bruch; 2, chorio-capillaris or tunica Rnyschiana; 3, proper substance of the choroid with large vessels cut through; 4, suprachoroidea; 5, sclerotic. (Schwalbe.)

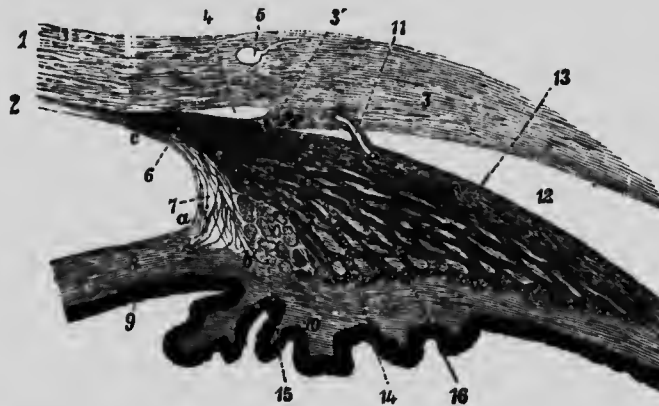

Fig. 565.—Section through the eye carried through the ciliary processes. 1, cornea; 2, membrane of Descemet; 3, sclerotic; 3', corneo-scleral junction; 4, canal of Schlemm; 5, vein; 6, nucleated network on inner wall of canal of Schlemm; 7, lig. pectinatum iridis, abc; 8, iris; 9, pigment of iris (uvea); 10, ciliary processes; 11, ciliary muscle; 12, choroid tissue; 13, meridional and 14, radiating fibres of ciliary muscle; 15, ring-muscle of Müller; 16, circular or angular bundles of ciliary muscle. (Schwalbe.)

corpuscles without pigment, and lymph spaces which surround the blood-vessels (*membrana chorio-capillaris*). It is separated from the retina by a fine elastic membrane (*membrane of Bruch*), which is either structureless or finely fibrillated. (Fig. 564, 1.)

The choroid coat ends in front in what are called the *ciliary processes* (figs. 565, 566). These consist of from 70 to 80 meridionally arranged radiating plaits, which consist of blood-vessels, fibrous connective tissue, and pigment corpuscles. They are lined by a continuation of the membrane of Bruch. The ciliary processes

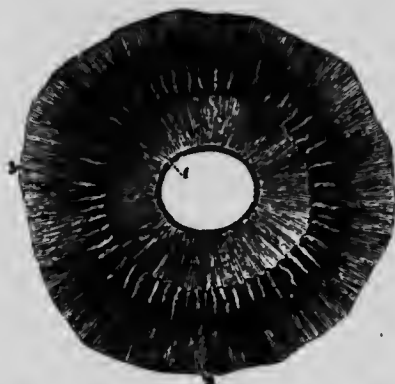

Fig. 566.—Ciliary processes, as seen from behind. 1, posterior surface of the iris, with the sphincter muscle of the pupil; 2, anterior part of the choroid coat; 3, one of the ciliary processes, of which about seventy are represented. 4.

terminate abruptly at the margin of the lens. The *ciliary muscle* (13, 14 and 15, fig. 565), takes origin at the corneo-scleral junction. It is a ring of muscle, 3 mm. broad and 8 mm. thick, made up of fibres running in three directions. (a) Meridional fibres near the sclerotic and passing to the choroid; (b) radial fibres passing to be inserted into the choroid behind the ciliary processes; and (c) circular fibres (muscle of Müller), more internal; they constitute a sphincter.

*The Iris.*—The iris is a continuation of the choroid inwards beyond the ciliary processes. It

is a fibro-muscular membrane perforated by a central aperture, the pupil. It is made up chiefly of blood-vessels and connective tissue, with pigment-cells and unstriated muscle.

Posteriorly is a layer of pigment cells (*uvea*), which is a continuation forwards of the pigment layer of the retina. The structure of the iris proper is made of connective tissue in front with corpuscles which may or may not be pigmented, and behind of similar tissue supporting blood-vessels enclosed in connective tissue. The pigment cells are usually well developed here, as are also many nerve-fibres radiating towards the pupil. Surrounding the pupil is a layer of circular unstriated muscle, the *sphincter pupillæ*. In some animals there are also muscle-fibres which radiate from the sphincter in the substance of the iris forming the *dilatator pupillæ*. The iris is covered anteriorly by a layer of epithelium continued upon it from the posterior surface of the cornea.

*The Lens.*—The lens is situated behind the iris, being enclosed in a distinct capsule, the posterior layer of which is not so thick as the anterior. It is supported in place by the suspensory ligament, fused to the anterior surface of the capsule. The suspensory ligament is derived from the hyaloid membrane, which encloses the vitreous humour.

The lens is made up of a series of concentric laminæ (fig. 567), which, when it has been hardened, can be peeled off like the coats of an onion. The laminæ consist of long ribbon-shaped fibres, which in the course of development have originated from cells.

The fibres near the margin have nuclei and are smooth, those near the centre are without nuclei and have serrated edges. They are hexagonal in transverse section. The fibres are united together by a scanty amount of cement substance. The central portion (*nucleus*) of the lens is the hardest.

The epithelium of the lens consists of a layer of cubical cells anteriorly, which merges at the equator into the lens fibres. The development of the lens explains this transition. The lens at first consists of a closed sac composed of a single layer of epithelium. The cells of the posterior part soon elongate forwards and obliterate the cavity; the anterior cells do not grow, but at the edge they become continuous with the posterior cells, which are gradually developed into fibres (fig. 568). The principal chemical constituent of the lens is a proteid of the globulin class called *crystallin*.

*Corneo-scleral junction.*—At this junction the relation of parts (fig. 565) is so important as to need a short description. In this

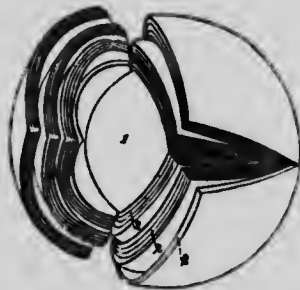

Fig. 567.—Laminated structure of the crystalline lens. The laminæ are split up after hardening in alcohol. 1, the denser central part or nucleus; 2, the successive external layers. 4. (Arnold.)

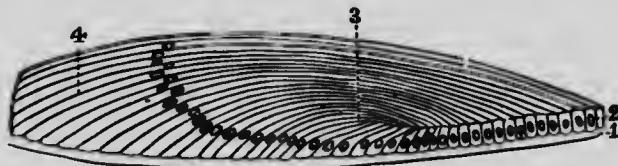

Fig. 568.—Meridional section through the lens of a rabbit. 1, Lens capsule; 2, epithelium of lens; 3, transition of the epithelium into the fibres; 4, lens fibres. (Bubuchin.)

neighbourhood, the iris and ciliary processes join with the cornea. The proper substance of the cornea and the posterior elastic lamina become continuous with the iris, at the *angle of the iris*, and the iris sends forwards processes towards the posterior elastic lamina, forming the *ligamentum pectinatum iridis*, and these join with fibres of the elastic lamina. The epithelial covering of the posterior surface of the cornea is, as we have seen, continuous over the front of the iris. At the iridic angle, the compact inner substance of the cornea is looser, and between the bundles are

lymph spaces filled with fluid, called the *spaces of Fontana*. They are little developed in the human cornea.

The spaces which are present in the broken up bundles of corneal tissue at the angle of the iris, are continuous with the larger lymphatic space of the anterior chamber. Above the angle at the corneo-scleral junction is a canal, which is called the *canal of Schlemm*. It is a lymphatic channel.

*Structure of the Retina.*—The retina (fig. 569) is a delicate

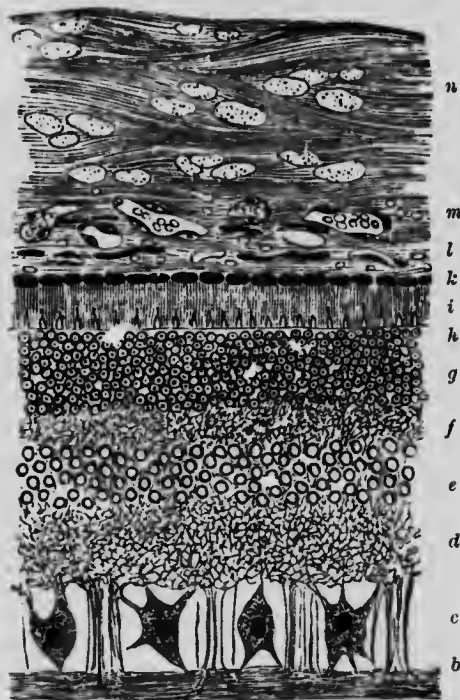

Fig. 569. A section of the retina, choroid, and part of the sclerotic, moderately magnified; *a*, membrana limitans interna; *b*, nerve-fibre layer traversed by Müller's sustentacular fibres; *c*, ganglion-cell layer; *d*, internal molecular layer; *e*, internal nuclear layer; *f*, external molecular layer; *g*, external nuclear layer; *h*, membrana limitans externa, running along the lower part of *i*, the layer of rods and cones; *k*, pigment cell layer; *l*, *m*, internal and external vascular portions of the choroid, the first containing capillaries, the second larger blood-vessels, cut in transverse section; *n*, sclerotic. (W. Pye.)

membrane, concave with the concavity directed forwards and apparently ending in front, near the outer part of the ciliary processes, in a finely-notched edge, — the *ora serrata*, but really represented by the uvea to the very margin of the pupil. It results from the expansion of the optic nerve, of whose terminal fibres, deprived of their external white substance, together with nerve-cells, it is essentially composed. The presence of nerve-cells in the retina which come into contact with the rods and cones (visual nerve-epithelium) reminds us that the optic, like the olfactory nerve, is not a mere nerve, but an outgrowth of the brain.

In the centre of the retina is a round yellowish elevated spot, about  $\frac{1}{4}$  of an inch (1 mm.) in diameter, having a depression in the centre, called after its discoverer the

*macula lutea*, or *yellow spot of Saemmering*. The depression in its centre is called the *fovea centralis*. About  $\frac{1}{10}$  of an inch (2.5 mm.) to the inner side of the yellow spot, is the point

(*optic disc* or *white spot*) at which the optic nerve enters the eyeball, and begins to spread out its fibres into the retina.

The optic nerve passes forwards from the ventral surface of the cerebrum towards the orbit enclosed in prolongations of the membranes, which cover the brain. This external sheath at the entrance of the nerve into the eyeball becomes continuous with the sclerotic, which at this part is perforated by holes to allow of the passage of the optic nerve fibres, the perforated part being the *lamina cribrosa*. The pia mater here becomes incomplete,

and the subarachnoid and the superarachnoid spaces become continuous. The pia mater sends in processes into the nerve to support the fibres. The fibres of the nerve themselves are exceedingly fine, and are surrounded by the myelin sheath, but do not possess the ordinary external nerve sheath. As they pass into the retina they lose their myelin sheaths and proceed as axis cylinders. Neuroglia supports the nerve fibres in the optic nerve trunk. In the centre of the nerve is a small artery, the *arteria centralis retinae*. The number of fibres in the optic nerve is said to be upwards of 500,000. The axis cylinders pass on to the retina, turning over the edges of the *porus optici* to be distributed on the inner surface of the retina, as far as the *ora serrata*, as the layer of optic nerve-fibres.

The retina consists of certain elements arranged in ten layers from within outwards (figs. 569, 570, 571).

1. *Membrana limitans interna*: This so-called membrane in contact with the vitreous humour is formed by the junction laterally of the bases of the *sustentacular* or *supporting fibres* of *Müller*, which bear the same relation to the retina as the neuroglia does to the brain. The character of these fibres may be seen in fig. 570.

2. *Optic nerve fibres*.—This layer is of very varying thickness

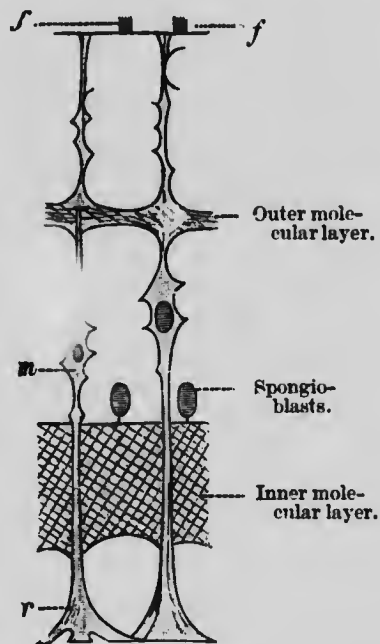

Fig. 570.—Diagram showing the sustentacular fibres of the retina; *f*, fibre-basket above the external limiting membrane; *m*, nucleus of the fibre; *r*, base of the fibre. (From McKendrick, after Stöhr.)

in different parts of the retina: it consists of non-medullated fibres which interlace, and some of which are continuous with processes of the large nerve-cells forming the next layer. The fibres are supported by the sustentacular fibres. They become less and less numerous anteriorly and end at the ora serrata.

3. *Layer of ganglion cells.* This consists of large multipolar nerve-cells with large and round nuclei, forming either a single layer, or in some parts of the retina, especially near the *macula lutea*, where this layer is very thick, it consists of several strata of nerve-cells. They are arranged with their single axis-cylinder processes inwards. These pass into and are continuous with the layer of optic nerve-fibres. Externally the cells send off several branched processes which pass into the next layer.

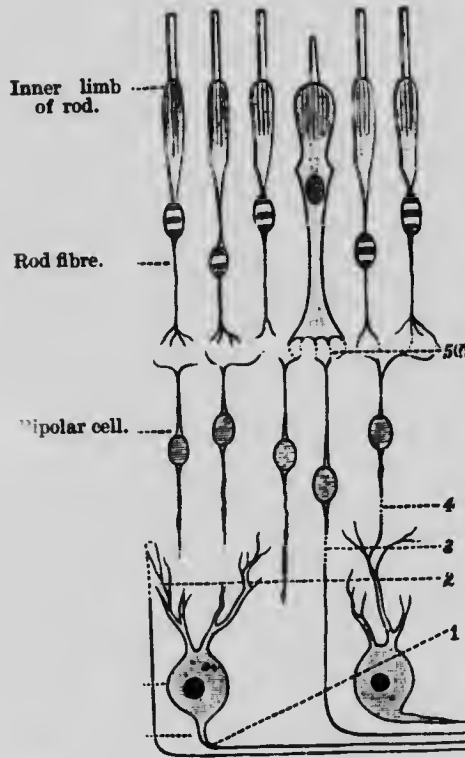

Fig. 571. — Diagram showing the nervous elements of retina. 1, nerve fibre of ganglion cell; 2, processes of ganglion cell going outwards; 3, nerve fibre passing direct to bipolar cell in inner nuclear layer; 4, process of ganglion cell towards bipolar cell; 5, fibre from cone-granule breaking up into fibrils which arborise round the branches of bipolar cells. (From McKendrick, after Stöhr.)

4. *Inner molecular layer.* —This presents a finely granulated appearance. It consists of neuroglia traversed by numerous very fine fibrillar processes of the nerve-cells just described, and the minute branchings of the processes of the bipolar cells of the next layer.

5. *Inner nuclear layer.* —This consists chiefly of numerous small round cells, with a very small quantity of protoplasm surrounding

a large ovoid nucleus; they are generally bipolar, giving off one process outwards and another inwards. One process passes inwards to form a synapse with the arborisation of a ganglion cell, the other outwards to similarly arborise with the branchings of the rod and cone fibres. Some cells, called *spongioblasts*, or *amacrine cells*, however, only send off one process, which passes

inwards (fig. 570). The large oval nuclei (fig. 570) belonging to the Müllerian fibres occur in this layer.

6. *Outer molecular layer.*—This layer closely resembles the inner molecular layer, but is much thinner. It contains the branchings of the rod and cone fibres on the one hand and of the bipolar cells on the other.

7. *External nuclear layer.*—This layer consists of small cells resembling at first sight those of the internal nuclear layer; they are classed as rod and cone granules, according as they are connected with the rods and cones respectively, and will be described with them. They are lodged in the meshes of a framework, which is formed by the breaking up of the Müllerian fibres.

8. *Membrana limitans externa.*—A delicate well-defined membrane, clearly marking the internal limit of the rod and cone layer, and made up of the junction of the bases of the sustentacular fibres externally.



Fig. 572.—The posterior half of the retina of the left eye, viewed from before; *s*, the cut edge of the sclerotic coat; *ch*, the choroid; *r*, the retina; in the interior at the middle the macula lutea with the depression of the fovea centralis is represented by a slight oval shade; towards the left side the light spot indicates the colliculus or eminence at the entrance of the optic nerve, from the centre of which the arteria centralis is seen spreading its branches into the retina, leaving the part occupied by the macula comparatively free. (After Henle.)

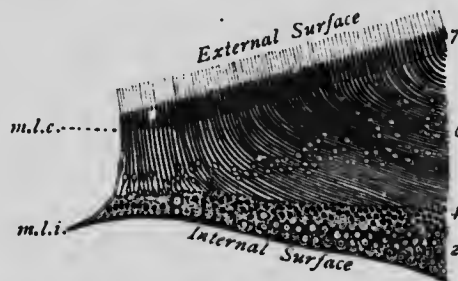

Fig. 573.—Diagram of a section through half the fovea centralis. 2, ganglionic layer; 4, inner nuclear; 6, outer nuclear layer, the cone fibres forming the so-called external fibrous layer; 7, cones; *m.l.e.*, membrana limitans externa; *m.l.i.*, membrana limitans interna. (Schäfer and Golding Bird.)

Small hairlike processes project outwards between the rods and cones to support them.



9. *Layer of rods and cones.*—This layer is the nerve-epithelium of the retina. It consists of two kinds of cells, rods and cones, which are arranged at right angles to the external limiting membrane, and supported by hairlike processes (*basket*) proceeding from the latter for a short distance (fig. 570).

*The rods.*—Each rod (fig. 571) is made up of two parts, very different in structure, called the outer and inner limbs. The outer limb of the rods is about  $30\mu$  long and  $2\mu$  broad, is transparent, and doubly refracting. It is said to be made up of fine superimposed discs. It stains brown with osmic acid but not with hæmatoxylin, and resembles in some ways the myelin sheath of a medullated nerve. It is the part of the rod in which the pigment called *visual purple* is found. In some animals, a few rods have a greenish pigment instead. The inner limb is about as long but slightly broader than the outer, is longitudinally striated at its outer and

granular at its inner part. It stains with hæmatoxylin but not with osmic acid. Each rod so constructed is connected internally with a rod fibre, very fine, but here and there varicose; in the middle of the fibre is a *rod granule*, really the nucleus of the rod, striped broadly transversely, and situated about the middle of the external nuclear layer; the internal end of the rod fibre termi-

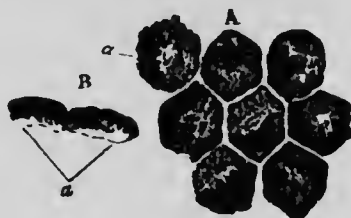

Fig. 574.—Pigment-cells from the retina. A, cells still cohering, seen on their surface; a, nucleus indistinctly seen. In the other cells the nucleus is concealed by the pigment granules. B, two cells seen in profile; a, the outer or posterior part containing scarcely any pigment.  $\times 370$ . (Henle.)

nates in branchings in the outer molecular layer.

*The cones.*—Each cone (fig. 571), like the rods, is made up of two limbs, outer and inner. The outer limb is tapering and not cylindrical like the corresponding part of the rod, and about one-third only of its length. There is, moreover, no visual purple found in the cone. The inner limb of the cone is broader in the centre. It is protoplasmic, and under the influence of light has been seen to execute movements. In birds there is often a coloured oil globule present here. Each cone is in connection by its internal end with a cone fibre, which has much the same structure as the rod fibre, but is much stouter and has its nucleus quite near to the external limiting membrane. Its inner end terminates by branchings in the external molecular layer.

In the rod and cone layer of birds, the cones usually predominate largely in number, whereas in man the rods are by

far the more numerous, except in the fovea centralis, where cones only are present. The number of cones has been estimated at 3,000,000.

10. *Pigment-cell layer* consists of a single layer of polygonal cells, mostly six-sided, which send down a beard-like fringe to surround the outer ends of the rods. It is this layer which is continuous with the uvea, where, however, the cells become rounded, and arranged two or three deep.

The next figure (fig. 575) represents the structure of the retina as made out by Golgi's method.

*Differences in Structure of different parts.*—Towards the centre of the *macula lutea* all the layers of the retina become greatly

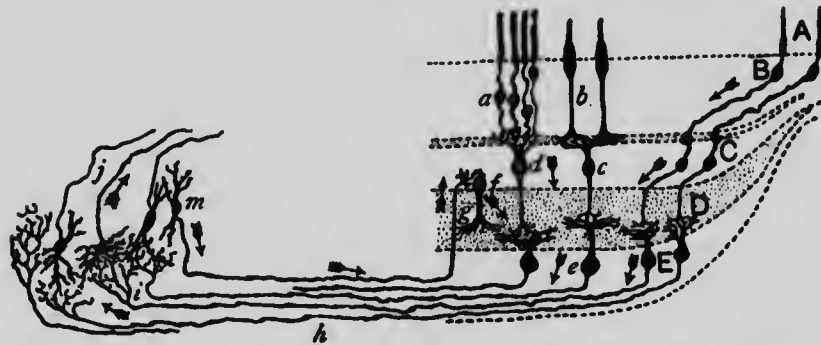

Fig. 575.—Scheme of the retinal elements. A, cones of the fovea centralis; B, granules (nuclei) of these cones; C, synapse between the cones and bipolar cells in external molecular layer; D, synapse between the bipolar and ganglion cells in the internal molecular layer; a and b, rods and cones in other regions of the retina; c, bipolar cell destined for the cones; d, bipolar cell destined for the rods; E, e, ganglion cells; f, spongioblast; g, efferent fibre (? trophic), originating from the cell m, in geniculate body; h, optic nerve; i, terminal arborisations of optic nerve fibres in geniculate body; j, fibres from the cells of geniculate body on the way to cerebral cortex. (R. y Cajal.)

thinned out and almost disappear, except the rod and cone layer, and at the *fovea centralis* the rods disappear, and the cones, especially their inner segments, are long and narrow. At the margin of the fovea the layers increase in thickness, and in the rest of the *macula lutea* are thicker than elsewhere. The ganglionic layer is especially thickened, the cells being six to eight deep (2, fig. 573). The bipolar inner granules (cone nuclei) are obliquely disposed (figs. 573 and 575) on the course of the cone fibres, and are situated at some distance from the *membrana limitans externa*, which is cupped towards the fovea (fig. 573). The yellow tint of the macula is due to a diffuse colouring matter in the interstices of the four or five inner layers; it is absent at the centre of the fovea.

At the *ora serrata* the layers are not perfect and disappear in this order: nerve-fibres and ganglion cells, then the rods, leaving only the inner limbs of the cones, next these cease, then the outer molecular layer, the inner and outer nuclear layers coalescing, and finally the inner molecular layer also is unrepresented.

At the *pars-ciliaris retinae*, the retina is represented by a layer of columnar cells, derived from the fusion of the nuclear layers. The cells externally are in contact with the pigment layer of the retina, which is continued over the ciliary processes and back of the iris.

At the entrance of the optic nerve the only structures present are nerve-fibres.

*The chambers of the eye.*—The *anterior* chamber is the space behind the cornea and in front of the iris. It is filled with aqueous humour, which is diluted lymph.

The *posterior* chamber, or that behind the iris, contains the *vitreous humour*, which is a jelly-like connective tissue (see p. 52). It is enclosed in a membrane called *membrana hyaloidea*, which in front is continuous with the capsule of the lens; round the edge of the lens the canal left is called the *Canal of Petit* (fig. 559, p. 742), the membrane itself being the *Zonule of Zinn*. The hyaloid membrane separates the vitreous from the retina.

*Blood-vessels of the Eyeball.*—The eye is very richly supplied with blood-vessels. In addition to the conjunctival vessels which are derived from the palpebral and lacrimal arteries, there are at least two other distinct sets of vessels supplying the tunics of the eyeball. (1) The vessels of the sclerotic, choroid, and iris, and (2) the vessels of the retina.

(1.) These are the short and long *posterior* ciliary arteries which pierce the sclerotic in the posterior half of the eyeball, and the *anterior* ciliary which enter near the insertions of the recti. These vessels anastomose and form a very rich choroidal plexus; they also supply the iris and ciliary processes, forming a very highly vascular circle round the outer margin of the iris and adjoining portion of the sclerotic.

The distinctness of these vessels from those of the conjunctiva is well seen in the difference between the bright red of blood-shot eyes (conjunctival congestion), and the pink zone surrounding the cornea which indicates deep-seated ciliary congestion.

(2.) The *retinal vessels* (fig. 572) are derived from the *arteria centralis retinae*, which enters the eyeball along the centre of the optic nerve. They ramify all over the retina, in its inner layers. They can be seen by ophthalmoscopic examination.

### The Eye as an Optical Instrument.

The eye may be compared to a photographic *camera*, and the transparent media correspond to the photographic lens. In such a camera images of external objects are thrown upon a ground-glass screen at the back of a box, the interior of which is painted black. In the eye, the camera is represented by the eyeball with its black pigment, the screen by the layer of rods and cones of the retina, and the lens by the refracting media. In the case of the camera, the screen is enabled to receive clear images of objects at different distances, by an apparatus for focussing. The corresponding contrivance in the eye is called accommodation.

The iris, which is capable of allowing more or less light to pass into the eye, corresponds with the diaphragms used in the photographic apparatus.

The refractive media are the cornea, aqueous humour, crystalline lens, and vitreous humour. The most refraction or bending of the rays of light occurs where they pass from the air into the cornea; they are again bent slightly in passing through the crystalline lens. Alterations in the anterior curvature of the crystalline lens lead to what we have already termed accommodation—that is, the power the eye has for adjusting itself to objects at different distances.

We may first consider the refraction through a simple transparent spherical surface, separating two media of different density.

The rays of light which fall upon the surface exactly perpendicularly do not suffer refraction, but pass through, cutting the optic axis ( $O A$ , fig. 576), a line which passes exactly through the centre of the surface, at a certain point, the *nodal point* (fig. 576,  $N$ ), or centre of curvature. Any rays which do not so strike the curved surface are refracted towards the optic axis. Rays which impinge upon the spherical surface parallel to the optic axis, will meet at a point behind, upon the said axis which is called the *chief posterior focus* (fig. 576,  $F_1$ ); and again there is a point in the optic axis in front of the surface, rays of light from which so strike the surface that they are refracted in a line parallel with the axis  $d f''$ ; this point (fig. 576,  $F_2$ ) is called the *chief anterior focus*. The optic axis cuts the surface at what is called the *principal point*.

It is quite obvious that the eye is a much more complicated optical apparatus than the one described in the figure. It is,

however, possible to reduce the refractive surfaces and media to a simpler form when the refractive indices of the different media

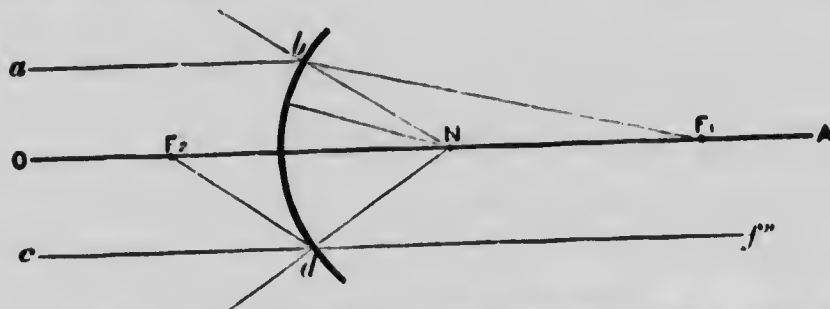

FIG. 576.—Diagram of a simple optical system (after M. Foster). The curved surface, *b, d*, is supposed to separate a less refractive medium towards the left from a more refractive medium towards the right.

and the curvature of each surface are known. These data are as follows:—

refraction of cornea	=	1.37
" aqueous and vitreous	=	1.34 to 1.36
" lens	=	{ 1.4 in outer to 1.45
		{ in inner part.
Radius of curvature of cornea	=	7.8 mm.
" " anterior surface of lens	=	10 "
" " posterior " "	=	6 "
Distance from anterior surface of cornea to anterior surface of lens	=	3.6 "
Distance from posterior surface of cornea to posterior surface of lens	=	7.2 "
Distance from posterior surface of lens to retina	=	15.0 "

With these data, it has been found comparatively easy to reduce by calculation the different surfaces of different curvature, into one mean curved surface of known curvature, and the differently refracting media, into one mean medium the refractive power of which is known.

The simplest so-called schematic eye formed upon this principle, suggested by Listing as *the reduced eye*, has the following dimensions:—

From anterior surface of cornea to the principal point . . . . .	=	2.3448 mm.
From the nodal point to the posterior surface of lens . . . . .	=	4.764 mm.
Posterior chief focus lies behind cornea . . . . .	=	22.8237 mm.
Anterior chief focus in front of cornea . . . . .	=	12.8326 mm.
Radius of curvature of ideal surface . . . . .	=	5.1248 mm.

The term index of refraction means the ratio of the sine of the angle of incidence to the sine of the angle of refraction; this is shown in the next figure.

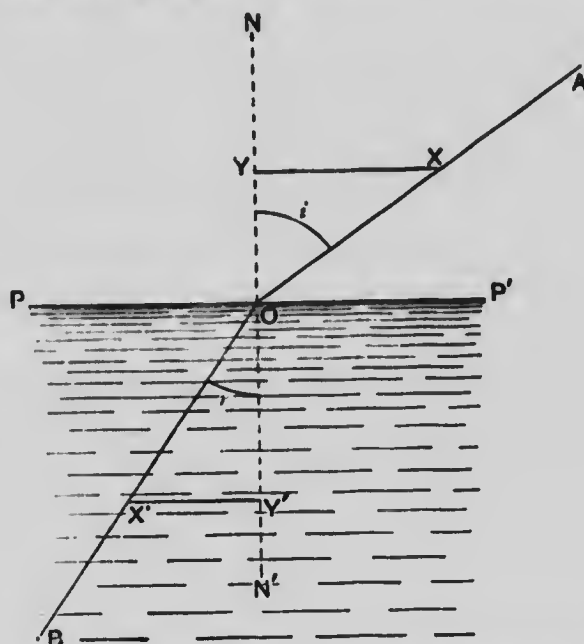

Fig. 577.—If  $PP'$  is a line which separates two media, the lower one being the denser, and  $AO$  is a ray of light falling on it, it is bent at  $O$  towards the normal or perpendicular line  $NN'$ .  $AO$  is called the incident ray, and  $OB$  the refracted ray;  $AO N$  is called the angle of incidence ( $i$ ), and  $N'O B$  the angle of refraction ( $r$ ). If any distance  $OX$  is measured off along  $OA$ , and an equal distance  $OX'$  along  $OB$  and perpendiculars drawn to  $NN'$ ; then  $\frac{XY}{X'Y'} = \text{index of refraction}$ .

In this reduced or simplified eye, the principal posterior focus, about 23 mm. behind the spherical surface, would correspond to

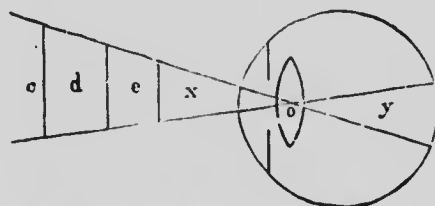

Fig. 578.—Diagram of the optical angle.

the position of the retina behind the anterior surface of cornea. The refracting surface would be situated about midway between the posterior surface of the cornea and the anterior surface of the lens.

The *optical axis* of the eye is a line drawn through the centres of curvature of the cornea and lens, prolonged backwards to touch the retina between the porus opticus and fovea centralis, and this differs from the *visual axis* which passes through the nodal point of the reduced eye to the fovea centralis; this forms an angle of  $5^\circ$  with the optical axis. But for practical purposes the optical axis and the visual axis may be considered to be identical. The visual or optical angle (fig. 578) is included between the lines drawn from the borders of any object to the nodal point; if the lines be prolonged backwards they include an equal angle. It has been shown by Helmholtz that the smallest angular distance between two points which can be appreciated = 50 seconds, the size of the retinal image being  $3.65\mu$ ;

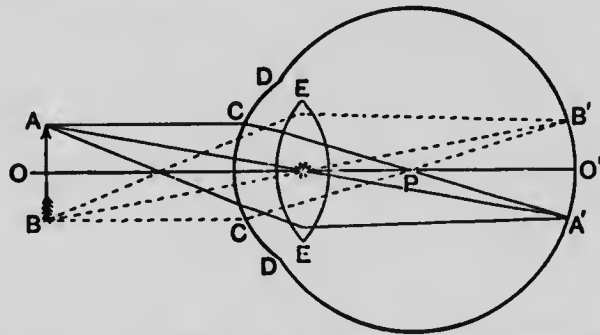

Fig. 579.—Diagram of the course of the rays of light, to show how an image is formed upon retina. The surface C C should be supposed to represent the ideal curvature.

this practically corresponds to the diameter of the cones at the fovea centralis which =  $3\mu$ , the distance between the centres of two adjacent cones being =  $4\mu$ .

Any object, for example, the arrow A B (fig. 579), may be considered as a series of points from each of which a pencil of light diverges to the eye. Take, for instance, the rays diverging from the tip of the arrow A; C C represents the curvature of the schematic or reduced eye; the ray which passes through the centre of the circle of which C C is part is not refracted; this point is represented as an asterisk in fig. 579; it is near the posterior surface of the crystalline lens; the ray A C, which is parallel to the optic axis O O', is refracted through the principal posterior focus P, and cuts the first ray at the point A' on the retina. All the other rays from A meet at the same point. Similarly the other end of the arrow B is focussed at B', and rays from all other points have corresponding foci.

It will thus be seen that an inverted image of external objects

is formed on the retina. The retina is a curved screen, but the images fall only on a small area of the retina under normal circumstances; hence for practical purposes this small area may be regarded as flat.

The question then arises, Why is it that objects do not appear to us to be upside down? This is easily understood when we remember that the *sensation* of sight occurs not in the eye, but in the brain. By education the brain learns that the tops of objects excite certain portions of the retina, and the lower parts of objects other portions of the retina. That these portions of the retina are reversed in position to the parts of the object does not matter at all, any more than it matters when one's photograph arrives home from the photographer's that it was wrong way up in the photographer's camera—one puts it right way up in the photograph album.



#### ACCOMMODATION.

The power of accommodation, or the *adaptation of the eye to vision at different distances*, is primarily due to an ability to vary the shape of the lens; its front surface becomes more or less convex, according as the distance of the object looked at is near or far. The nearer the object, the more convex, up to a certain limit, the front surface of the lens becomes, and *vice versa*; the back surface takes no share in the production of the effect required. The posterior surface, which during rest is more convex than the anterior, is thus rendered the less convex of the two during accommodation. The following simple experiment illustrates this point: If a lighted candle be held a little to one side of a person's eye an observer looking at the eye from the other side sees three images of the flame (fig. 580). The first and brightest is (1) a small erect image formed by the anterior convex surface of the cornea; the second (2) is also erect, but larger and less distinct than the preceding, and is formed at the anterior convex surface of the lens; the third (3) is smaller, inverted, and indistinct; it is formed at the posterior surface of the lens, which is concave forwards, and therefore, like all concave mirrors, gives an inverted image. If now the eye under observation is made to look at a near object, the second image becomes smaller,

Fig. 580.—Diagram showing three reflections of a candle. 1, From the anterior surface of cornea; 2, from the anterior surface of lens; 3, from the posterior surface of lens. For further explanation, see text. The experiment is best performed by employing an instrument invented by Helmholtz, termed a *Phakoscope* (see fig. 582).



clearer, and approaches the first. If the eye is now adjusted for a far point, the second image enlarges again, becomes less distinct, and recedes from the first. In both cases the first and third images remain unaltered in size, distinctness, and position. This proves that during accommodation for near objects the curvature of the cornea, and of the *posterior surface* of the lens, remain unaltered, while the *anterior surface* of the lens becomes more convex and approaches the cornea.

The experiment is more striking when two candles (represented by arrows in fig. 581) are used, and the images of the two candles from the front surface of the lens during accommodation not only

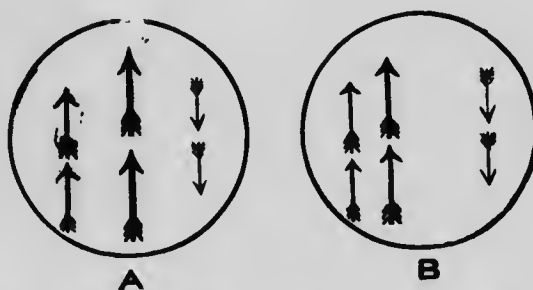

Fig. 581.—Diagram of Sanzon's images. A, when the eyes are not, and B, when they are focussed for near objects. The fig. to the right in A and B is the inverted image from the posterior surface of the lens.

approach those from the cornea, but also approach one another, and become somewhat smaller. (*Sanzon's Images*.) Helmholtz's Phakoscope (fig. 582) is a triangular box with arrangements for demonstrating this experiment.

*Mechanism of accommodation.*—The lens having no inherent power of contraction, its changes of outline must be produced by some power from without; this power is supplied by the ciliary muscle. Its action is to draw forwards the choroid, and by so doing to slacken the tension of the suspensory ligament of the lens which arises from it. The anterior surface of the lens is kept flattened by the action of this ligament. The ciliary muscle during accommodation, by diminishing its tension, diminishes to a proportional degree the flattening of which it is the cause. On diminution or cessation of the action of the ciliary muscle, the lens returns to its former shape, by virtue of the elasticity of the suspensory ligament (fig. 583). From this it will appear that the eye is usually focussed for distant objects. In viewing near objects the ciliary muscle contracts; the ciliary muscle relaxes on withdrawal of the attention from near objects, and fixing it on those distant.

*Range of Distinct Vision. Near-point.*—In every eye there is a limit to the power of accommodation. If a book be brought

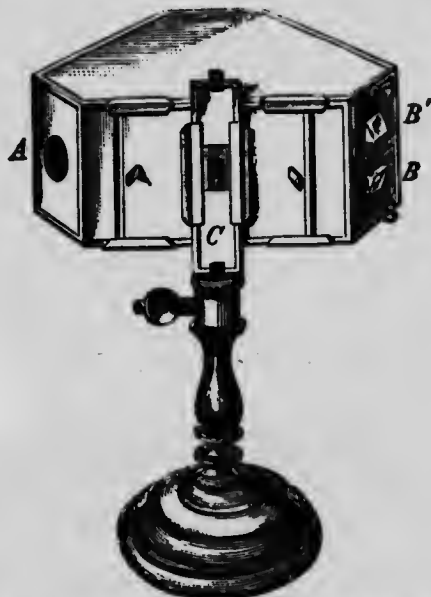

Fig. 582.—Phakoscope of Helmholtz. At  $B B'$  are two prisms, by which the light of a candle is concentrated on the eye of the person experimented with, which is looking through a hole in the third angle of the box opposite to the window  $C$ .  $A$  is the aperture for the eye of the observer. The observer notices three double images, represented by arrows, in fig. 581, reflected from the eye under examination when the eye is fixed upon a distant object, the position of the images having been noticed, the eye is then made to focus a near object, such as a reed pushed up at  $C$ ; the images from the anterior surface of the lens will be observed to move towards each other, in consequence of this surface of the lens becoming more convex.

nearer and nearer to the eye, the type at last becomes indistinct, and cannot be brought into focus by any effort of accommodation,



Fig. 583.—Diagram representing by dotted lines the alteration in the shape of the lens on accommodation for near objects. (E. Landolt.)

however strong. This, which is termed the *near-point*, can be determined by the following experiment (*Scheiner*). Two small holes are pricked in a card with a pin not more than a twelfth of an inch (2 mm.) apart; at any rate their distance from each other must not exceed the diameter of the pupil. The card is held close in front of the eye, and a small needle viewed through the pin-holes. At a moderate distance it can be clearly focussed, but when brought nearer, beyond a certain point, the image appears double or at any rate blurred. This point where the needle ceases to appear single is the near-point. Its distance from the eye can of course be readily measured. It is usually about 5 or 6 inches (13 c.n.). In the accompanying figure (fig. 584) the lens *b* represents the eye; *ef* the two pin-holes in the card, *nn* the retina; *a* represents the position of the needle. When the needle is at a



Fig. 584.—Diagram of experiment to ascertain the minimum distance of distinct vision.

moderate distance, the two pencils of light coming from *e* and *f* are focussed at a single point on the retina *nn*. If the needle is brought nearer than the near-point, the strongest effort of accommodation is not sufficient to focus the two pencils, they meet at a point behind the retina. The effect is the same as if the retina were shifted forward to *nn*. Two images *h.g.* are formed, one from each hole. It is interesting to note that when two images are produced, the lower one *g* really appears in the position *q*, while the upper one appears in the position *p*. This may be readily verified by covering the holes in succession.

During accommodation two other changes take place in the eyes:

(1) *The eyes converge* owing to the action of the internal rectus muscle of each eyeball.

(2) *The pupils contract.*

The contraction of all of the muscles which have to do with accommodation, viz. of the ciliary muscle, of the internal recti muscles, and of the sphincter pupillæ is under the control of the third nerve.

The account of accommodation as given in the preceding pages is true for man and other mammals, birds and certain reptiles.

Beer has, however, shown that in many animals lower in the scale, the mechanism of accommodation varies a good deal, and is often very different from that just described, consisting, in fact, in a power of altering the distance between the lens and the retina.

In bony fishes, the eye at rest is accommodated for near objects; in focussing for distant objects the lens is drawn nearer to the retina by a special muscle called the *retractor lentis*. In cephalopods the same occurs, but the retractor lentis is absent; here the approach of the lens to the retina is brought about by an alteration of intra-ocular tension. In Amphibia and most snakes, the eye at rest is focussed for distant objects; in accommodating for near objects the lens, by alteration of intra-ocular tension, is brought forward, that is, the distance between it and the retina is increased. There appear to be not a few animals in all classes which do not possess the power of accommodation at all. Indeed, Barrett states this is so for most mammals.

#### DEFECTS IN THE OPTICAL APPARATUS.

Under this head we may consider the defects known as (1) Myopia, (2) Hypermetropia, (3) Astigmatism, (4) Spherical Aberration, (5) Chromatic Aberration.

The normal (*emmetropic*) eye is so adjusted that parallel rays are brought exactly to a focus on the retina without any effort of accommodation (1, fig. 585). Hence all objects except near ones (practically all objects more than twenty feet off) are seen without any effort of accommodation; in other words, the far-point of the normal eye is at an infinite distance. In viewing near objects we are conscious of the effort (the contraction of the ciliary muscle) by which the anterior surface of the lens is rendered more convex, and rays which would otherwise be focussed *behind* the retina are converged upon the retina (see dotted lines 2, fig. 585).

1. *Myopia* (short-sight) (4, fig. 585).—This defect is due to an abnormal elongation of the eyeball. The retina is too far from the lens and consequently parallel rays are focussed in front of the retina, and, crossing, form little circles on the retina; thus the images of distant objects are blurred and indistinct. The eye is, as it were, permanently adjusted for a near-point. Rays from a point near the eye are exactly focussed on the retina. But those which issue from any object beyond a certain distance (*far-point*) cannot be distinctly focussed. This defect is corrected by *concave* glasses which cause the rays entering the eye to diverge: hence they do not come to a focus so soon. Such glasses of course are only needed to give a clear vision of distant objects. For near objects, except in extreme cases, they are not required.

2. *Hypermetropia* (3, fig. 585).—This is the reverse defect. The eyeball is too short. Parallel rays are focussed *behind* the retina: an effort of accommodation is required to focus even parallel rays on the retina; and when they are divergent, as in viewing

a near object, the accommodation is insufficient to focus them. Thus in well-marked cases distant objects require an effort of accommodation, and near ones a very powerful effort, and the ciliary muscle is, therefore, constantly acting. This defect is obviated by

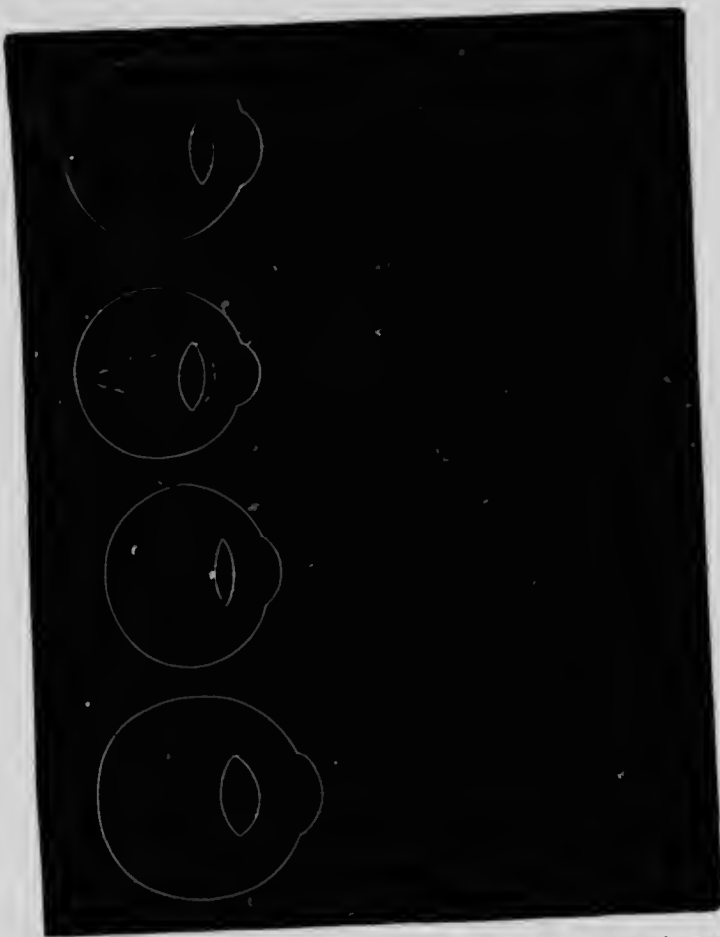

Fig. 385.—Diagrams showing—1, normal (*emmetropic*) eye bringing parallel rays exactly to a focus on the retina; 2, normal eye adapted to a near-point; without accommodation the rays would be focussed behind the retina, but by increasing the curvature of the anterior surface of the lens (shown by a dotted line) the rays are focussed on the retina (as indicated by the meeting of the two dotted lines); 3, *hypermetropic* eye; in this case the axis of the eye is shorter than normal; parallel rays are focussed behind the retina; 4, *myopic* eye; in this case the axis of the eye is abnormally long; parallel rays are focussed in front of the retina. The figure incorrectly represents the refraction as occurring only in the crystalline lens; the principal refraction really occurs at the anterior surface of the cornea.

the use of *convex* glasses, which render the pencils of light more convergent. Such glasses are of course especially needed for near objects, as in reading, &c. They rest the eye by relieving the ciliary muscle from excessive work.

3. *Astigmatism*.—This defect, which was first discovered by Airy, is due to a greater curvature of the eye in one meridian than in others. The eye may be even myopic in one plane and hypermetropic in others. Thus vertical and horizontal lines crossing each other cannot both be focussed at once; one set stand out clearly and the others are blurred and indistinct. This defect, which is present in a slight degree in all eyes, is generally seated in the cornea, but occasionally in the lens as well; it may be corrected by the use of cylindrical glasses (*i.e.*, curved only in one direction).

4. *Spherical Aberration*.—The rays of a cone of light from an object situated at the side of the field of vision do not meet all in the same point, owing to their unequal refraction; for the refraction of the rays which pass through the circumference of a lens is greater than that of those traversing its central portion. This defect is known as *spherical aberration*, and in the camera, telescope, microscope, and other optical instruments, it is remedied by the interposition of a screen with a circular aperture in the path of the rays of light, cutting off all the marginal rays and only allowing the passage of those near the centre. Such correction is effected in the eye by the iris, which prevents the rays from passing through any part of the refractive apparatus but its centre. The posterior surface of the iris is coated with pigment, to prevent the passage of rays of light through its substance. The image of an object will be most defined and distinct when the pupil is narrow, the object at the proper distance for vision, and the light abundant; so that, while a sufficient number of rays are admitted, the narrowness of the pupil may prevent the production of indistinctness of the image by *spherical aberration*.

Distinctness of vision is further secured by the pigment of the outer surface of the retina, the posterior surface of the iris and the ciliary processes, which absorb the greater part of light that may be reflected within the eye, and prevents its being thrown again upon the retina so as to interfere with the images there formed.

5. *Chromatic Aberration*.—In the passage of light through an ordinary convex lens, decomposition of each ray into its elementary colours commonly ensues, and a coloured margin appears around the image, owing to the unequal refraction which the elementary colours undergo. In optical instruments this, which is termed *chromatic aberration*, is corrected by the use of two or more lenses, differing in shape and density, the second of which continues or increases the refraction of the rays produced by the first, but by recombining the individual parts of each ray

into its original white light, corrects any chromatic aberration which may have resulted from the first. It is probable that the unequal refractive power of the transparent media in front of the retina may be the means by which the eye is enabled to guard against the effect of chromatic aberration. The human eye is achromatic, however, only so long as the image is received at its focal distance upon the retina, or so long as the eye adapts itself to the different distances of sight. If either of these conditions be interfered with, a more or less distinct appearance of colours is produced.

From the insufficient adjustment of the image of a small white object, it appears surrounded by a sort of halo or fringe. This phenomenon is termed *Irradiation*. It is for this reason that a white square on a black ground appears larger than a black square of the same size on a white ground.

*Defective Accommodation—Presbyopia.*—This condition is due to the gradual loss of the power of accommodation which is an early sign of advancing years. In consequence the person is obliged in reading to hold the book further and further away in order to focus the letters, till at last the letters are held too far for distinct vision. The defect is remedied by weak convex glasses. It is due chiefly to the gradual increase in density of the lens, which is unable to swell out and become convex when near objects are looked at, and also to a weakening of the ciliary muscle, and a general loss of elasticity in the parts concerned in the mechanism.

#### FUNCTIONS OF THE IRIS.

The iris has three uses :—

1. To act as a diaphragm in order to lessen spherical aberration in the manner just described.
2. To regulate the amount of light entering the eye. In a bright light the pupil contracts; in a dim light it enlarges. This may be perfectly well seen in one's own iris by looking at it in a mirror while one alternately turns a gas-light up and down.
3. By its contraction during accommodation it supports the action of the ciliary muscle.

The muscular fibres (unstriped in mammals, striped in birds) of the iris are arranged circularly around the margin of the pupil, and radiatingly from its margin. The radiating fibres are best seen in the eyes of birds and otters; some look upon them as elastic in nature, but there is little doubt that they are contractile. Those who believe they are not contractile explain

dilatation of the pupil as due to inhibition of the circular fibres. But if the iris is stimulated near its outer margin at three different points simultaneously the pupil assumes a triangular shape, the angles of the triangle corresponding to the points stimulated; this must be due to contraction of three strands of the radiating muscle; inhibition of the circular fibres would occur equally all round.

The iris is supplied by three sets of nerve-fibres contained in the ciliary nerves.

(a) The third nerve supplies the circular fibres.

(b) The cervical sympathetic supplies the radiating fibres. The cilio-spinal centre which governs them is in the cervical region of the cord (see p. 666).

(c) Fibres of the fifth nerve which are probably sensory.

The experiments on these nerves are those of section and stimulation of the peripheral ends; the usual experiments by which the functions of a motor-nerve are discovered.

Nerve.	Experiment.	Effect on pupil.
Third . . . . .	Section . . . . .	Dilatation.
Third . . . . .	Stimulation . . . . .	Contraction.
Sympathetic . . . . .	Section . . . . .	Contraction.
Sympathetic . . . . .	Stimulation . . . . .	Dilatation.
Both nerves together .	Stimulation . . . . .	Contraction overcomes the dilatation.

Certain drugs dilate the pupil. These are called *mydriatics*; atropine is a well-known example. Others cause the pupil to contract. These are called *myotics*; physostigmine and opium (taken internally) are instances. Different myotics and mydriatics act in different ways, some exerting their activity on the muscular, and others on the nervous structures of the iris.

*Reflex actions of the iris.*—When the iris contracts under the influence of light, the sensory nerve is the optic, and the motor the third nerve. The central connection of the two nerves in the region of the mid-brain we shall see later on (fig. 598, p. 786). The iris also contracts on accommodation; and the reflex path concerned in this action is a different one from that concerned in the light reflex, as this reflex often remains in cases of locomotor ataxy, after there is an entire loss of the reflex to light (Argyll-Robertson pupil).

On painful stimulation of any part of the body, there is reflex



dilatation of the pupil. This is accompanied by starting of the eyeballs, due to contraction of the plain muscle in the capsule of Tenon, which, like the dilatator fibres of the iris, is supplied by the cervical sympathetic nerve.

We may sum up the principal conditions under which the pupil contracts and dilates in the following table :—

Causes of—

**Contraction of the Pupil.**

1. Stimulation of third nerve.
2. Paralysis of cervical sympathetic.
3. When the eye is exposed to light.
4. When accommodation occurs.
5. Under the local influence of physostigmine.
6. Under the influence of opium.
7. During sleep.

**Dilatation of the Pupil.**

1. Paralysis of the third nerve.
2. Stimulation of the cervical sympathetic.
3. In the dark.
4. When the accommodation is relaxed.
5. Under the local influence of atropine. This drug also paralyzes the ciliary muscle.
6. In the last stage of asphyxia.
7. In deep chloroform narcosis.
8. Under the influence of certain emotions, such as fear.
9. During pain.

There is a close connection of the centres that govern the activity of the two irides. If one eye is shaded by the hand, its pupil will of course dilate, but the pupil of the other eye will also dilate. The two pupils always contract or dilate together unless the cause is the local injury to the nerves of one side or the local action of drugs.

FUNCTIONS OF THE RETINA.

The Retina is the nervous coat of the eye ; it contains the layer of nerve-epithelium (rods and cones) which is capable of receiving the stimulus of light, and transforming it into a nervous impulse which passes to the brain by the optic nerve.

The bacillary layer, or layer of rods and cones, is at the back of all the other retinal layers, which the light has to penetrate before it can affect this layer. The proofs of the statement that it is the layer of the retina which is capable of stimulation by light are the following :—

(1) The point of entrance of the optic nerve into the retina where the rods and cones are absent, is insensitive to light, and is called the *blind spot*. The phenomenon itself is very readily demonstrated. If we direct one eye, the other being closed, upon a point at such a distance to the side of any object,

that the image of the latter must fall upon the retina at the point of entrance of the optic nerve, this image is lost. If, for example, we close the left eye, and direct the axis of the right



eye steadily towards the circular spot here represented, while the page is held at a distance of about six inches from the eye, both dot and cross are visible. On gradually increasing the distance between the eye and the object, by removing the book farther and farther from the face, and still keeping the right eye steadily on the dot, it will be found that suddenly the cross disappears from view, while on removing the book still farther, it suddenly comes in sight again. The cause of this phenomenon is simply that the portion of the retina which is occupied by the entrance of the optic nerve is quite blind; and therefore when the images of objects fall on it they cease to be visible. By a psychical process the blind spot is not normally perceived.

(2) In the fovea centralis and macula lutea which contain rods and cones but no optic nerve-fibres, and in which the other layers of the retina are thinned down to a minimum, light produces the greatest effect. In the latter situation, cones occur in large numbers, and in the former cones without rods are found, whereas in the rest of the retina which is not so sensitive to light, there are fewer cones than rods. We may conclude, therefore, that cones are even more important to vision than rods.

(3) If a small lighted candle is moved to and fro at the side of and close to one eye in a darkened room while the eyes look steadily forward on to a dull background, a remarkable branching figure (*Purkinje's figures*) is seen floating before the eye, consisting of dark lines on a reddish ground. As the candle moves, the figure moves in the opposite direction, and from its whole appearance there can be no doubt that it is a reversed picture of the retinal vessels projected before the eye.\* This remarkable appearance is due to shadows of the retinal vessels cast by the candle; and it is only when they are thrown upon the retina in an unusual slanting direction that they are perceived. The branches of these vessels are distributed in the nerve-fibre and ganglionic layers; and since the light of the candle falls on the retinal vessels from in front, the shadow is cast behind them, and hence those elements of the retina which perceive the shadows must also lie behind the vessels. Here, then, we have a clear

\* Purkinje's figures can be much more readily seen by simply looking steadily down a microscope, and moving the whole instrument backwards and forwards, or from side to side, while so doing.

proof that the light-perceiving elements are not the inner, but one of the external layers of the retina; further than this, calculation has shown it is the layer of rods and cones. The data for such a calculation are—the dimensions of the eyeball, the distance of the screen from the eye, the angle through which the candle is moved, and the displacement of the figure seen.

*Duration of Visual Sensations.*—The duration of the sensation produced by a luminous impression on the retina is always greater than that of the impression which produces it. However brief the luminous impression, the effect on the retina always lasts for about one-eighth of a second. Thus, supposing an object in motion, say a horse, to be revealed on a dark night by a flash of lightning. The object would be seen apparently for an eighth of a second, but it would not appear in motion; because, although the image remained on the retina for this time, it was really revealed for such an extremely short period (a flash of lightning being almost instantaneous) that no appreciable movement on the part of the object could have taken place in the period during which it was revealed to the retina of the observer. The same fact is proved in a reverse way. The spokes of a rapidly revolving wheel are not seen as distinct objects, because at every point of the field of vision over which the revolving spokes pass, a given impression has not faded before another replaces it. Thus every part of the interior of the wheel appears occupied.

The after-sensations are called *after-images*. They are of two kinds, *positive* and *negative*. Positive after-images are those which resemble the original image in distribution of light and shade, and colour. Negative after-images which occur after strong, and especially after prolonged, excitation of the retina, are those in which the light parts appear dark, the dark parts light, and the coloured parts of the opposite or contrast colour. Hence the image of a bright object, as of the panes of a window through which the light is shining, may be perceived in the retina for a considerable period, if we have previously kept our eyes fixed for some time on it. But the image in this case is *negative*. If, however, after shutting the eyes for some time, we open them and look at an object for an instant, and again close them, the after-image is *positive*.

### The Ophthalmoscope.

Every one is perfectly familiar with the fact, that it is quite impossible to see the *fundus* or back of another person's eye by simply looking into it. The interior of the eye forms a perfectly

black background.\* The same remark applies to an ordinary photographic camera, and may be illustrated by the difficulty we experience in seeing into a room from the street through the window until the room is lighted within. In the case of the eye this is partly due to the feebleness of the light reflected from the retina, most of it being absorbed by the retinal pigment; but more to the fact that every such ray is reflected straight to the source of light (*e.g.*, candle), and cannot, therefore, be seen by the unaided eye without intercepting the incident light from the candle, as well as the reflected rays from the retina. This difficulty is surmounted by the use of the *ophthalmoscope*.

The ophthalmoscope was invented by Helmholtz; as a mirror for reflecting the light into the eye, he employed a bundle of thin glass plates; this mirror was transparent, and so he was able to look through it in the same direction as that of the rays of the light it reflected. It is almost impossible to over-estimate the boon this instrument has been to mankind; previous to this in the examination of cases of eye disease, the principal evidence on which the surgeon had to rely was that derived from the patient's sensations; now he can look for himself.

The instrument, however, has been greatly modified since Helmholtz's time; the principal modification being the substitution of a concave mirror of silvered glass for the bundle of glass plates; this is mounted on a handle, and is perforated in the centre by a small hole through which the observer can look.

The methods of examining the eye with this instrument are—the *direct* and the *indirect*: both methods of investigation should be employed. A drop of a solution of atropine (two grains to the ounce) or of homatropine hydrobromate, should be instilled about twenty minutes before the examination is commenced; the ciliary muscle is thereby paralysed, the power of accommodation is abolished, and the pupil is dilated. This will materially facilitate the examination; but it is quite possible to observe all the details to be presently described without the use of such drugs. The room being now darkened, the observer seats himself in front of the person whose eye he is about to examine, placing himself upon a somewhat higher level. Let us suppose that the right eye of the patient is being examined. A brilliant and steady light is placed close to the left ear of the patient. Taking the mirror in his right hand, and looking through the central hole, the operator directs a beam of light into the eye

\* In some animals (*e.g.*, the cat), the pigment is absent from a portion of the retinal epithelium; this forms the *Tapetum lucidum*. The use of this is supposed to be to increase the sensitiveness of the retina, the light being reflected back through the layer of rods and cones. It is certainly the case that these animals are able to see clearly with less light than we can, hence the popular idea that a cat can see in the dark. In fishes a tapetum lucidum is often present; here the brightness is increased by crystals of guanine.

of the patient. A red glare, known as *the reflex*, is seen ; it is due to the illumination of the retina. The patient is then told to look at the little finger of the observer's right hand as he holds the mirror ; to effect this the eye is rotated somewhat inwards, and at the same time the reflex changes from red to a lighter colour, owing to the reflection from the optic disc. The observer now approximates the mirror, and with his eye to the eye of the patient, taking care to keep the light fixed upon the pupil, so as not to lose the reflex. At a certain point, which varies with different eyes, but is usually reached when there is an interval of about two or three inches between the observed and the observing eye, *the vessels of the retina* will become visible. Examine carefully the fundus of the eye, *i.e.*, the red surface—until *the optic*



Fig. 586.—The ophthalmoscope. The small upper mirror is for direct, the larger for indirect illumination.

retinal vessels becomes visible, when very slight movements on the part of the operator will suffice to bring into view the details of the fundus above described, but the image will be much smaller and inverted. The appearances seen are depicted in fig. 572. The lens should be kept fixed at a distance of two or three inches, the mirror alone being moved until the disc becomes visible : should the image of the mirror, however, obscure the disc, the lens may be slightly tilted.

The two next figures show diagrammatically the course of the rays of light.

Fig. 587 represents what occurs when employing the direct method. S is the source of light, and M M the concave mirror with its central aperture, which reflects the rays ; these are focussed by the eye E, which is being

*disc* is seen ; trace its circular outline, and observe the small central white spot, the porus opticus, or *physiological pit* : near the centre is the central artery of the retina breaking up upon the disc into branches ; veins also are present, and correspond roughly to the course of the arteries. Trace the vessels over the disc on to the retina. Somewhat to the outer side, and only visible after some practice, is the *yellow spot*, with the smaller lighter-coloured *fovea centralis* in its centre. This constitutes the direct method of examination ; by it the various details of the fundus are seen as they really exist, and it is this method which should be adopted for ordinary use.

If the observer is myopic or hypermetropic, he will be unable to employ the direct method of examination until he has remedied his defective vision by the use of proper glasses.

In the indirect method the patient is placed as before, and the operator holds the mirror in his right hand at a distance of twelve to eighteen inches from the patient's right eye. At the same time he rests his left little finger lightly upon the right temple, and holding a convex lens between his thumb and forefinger, two or three inches in front of the patient's eye, directs the light through the lens into the eye. The red reflex, and subsequently the white one, having been gained, the operator slowly moves his mirror, and with it his eye, towards or away from the face of the patient, until the outline of one of the

examined, to a point in the vitreous humour, and this produces a diffuse lighting of the interior of the eyeball. Rays of light issuing from the point  $p$  emerge from the eye parallel to one another, and enter the observer's eye  $E^1$ ; they are brought to a focus  $p^1$  on the retina as the eye is accommodated for distant vision. Similarly the point  $m$  and  $n$  will give rise to images at  $m^1$  and  $n^1$  respectively.

Fig. 588 represents what occurs in examining the eye by the indirect method.

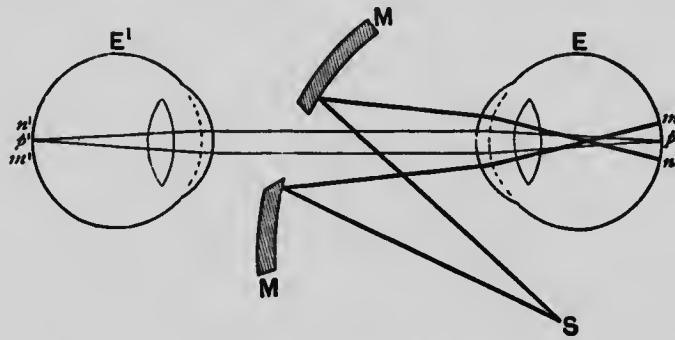

Fig. 587.—The course of the light in examining the eye by the direct method.  
(T. G. Brodie.)

$S$  is the source of light,  $M M$  the mirror,  $E$  the observed, and  $E^1$  the observing eye as before. The rays of light are reflected from the mirror and form an image at  $o^1$ ; they then diverge and are again made convergent by the lens  $L$  held in front of the eye by the observer; by this means a

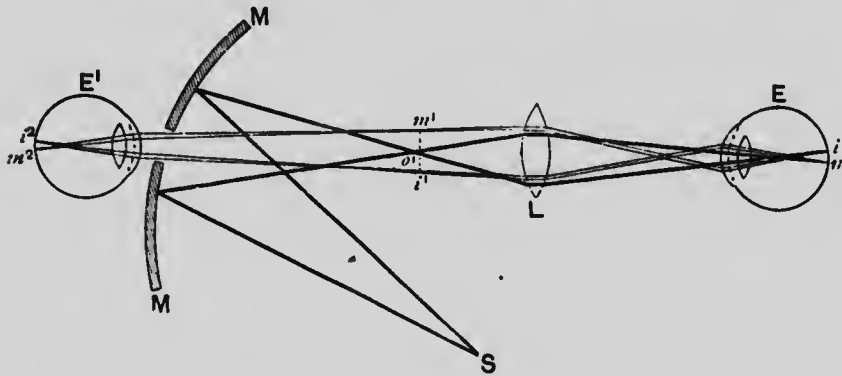

Fig. 588.—The course of the light in examining the eye by the indirect method.  
(T. G. Brodie.)

second image is focussed just behind the crystalline lens of the eye  $E$ . They then again diverge and diffusely light up the interior of the eyeball. The rays of light reflected from two points  $i$  and  $m$  on the retina diverging from the eye are refracted to the glass lens  $L$ , and give an inverted real image  $i^1 m^1$  larger than the object  $i m$ . These latter rays then diverge, and are collected and focussed by the observing eye  $E^1$  to give an image  $i^2 m^2$  on the retina. (T. G. Brodie.)

### The Perimeter.

This is an instrument for mapping out the field of vision. It consists of a graduated arc, which can be moved into any position, and which when rotated traces out a hollow hemisphere. In the centre of this the eye under examination is placed, the other eye being closed. The examiner then determines on the surface of the hemisphere those points at which the patient just ceases or just begins to see a small object moved along the arc of the circle. These points are plotted out on a chart graduated in degrees, and by connecting them the outline of the field of vision is obtained.

Fig. 589 shows one of the forms of perimeter very generally employed, and fig. 590 represents one of the charts provided with the instrument. The blind spot is shown, and the dotted line represents the normal average field of vision for the right eye.

It will be seen that the field of vision is most extensive on the outer side; it is less on the inner side because of the presence of the nose.

By the use of the same instrument, it is found that the colour of a coloured object is not distinguishable at the margin, but only towards the centre of the field of vision, but there are differences for different colours; thus a blue object is seen over a wider field than a red, and a red over a wider field than a green object.

In disease of the optic nerve, contraction of the field of vision for white and coloured objects is found. This is often seen before any change in the optic nerve is discoverable by the ophthalmoscope.

### The Fovea Centralis.

This is the region of most acute vision; when we want to see an object distinctly we look straight at it. It is also the region where the colours of objects are best distinguishable. It is, however, stated to be less sensitive from one point of view than the zone immediately surrounding it; that is to say, the minimum intensity of white light which will cause an impression is somewhat greater. But with this exception, the sensibility of the retina diminishes steadily from centre to circumference.

The yellow spot of one's own eye can be rendered evident by what is called Clerk-Maxwell's experiment:—on looking through a solution of chrome-alum in a bottle with parallel sides, an oval purplish spot is seen in the green colour of the alum. This is due to the pigment of the yellow spot.



Fig. 589.—Priestley Smith's Perimeter.

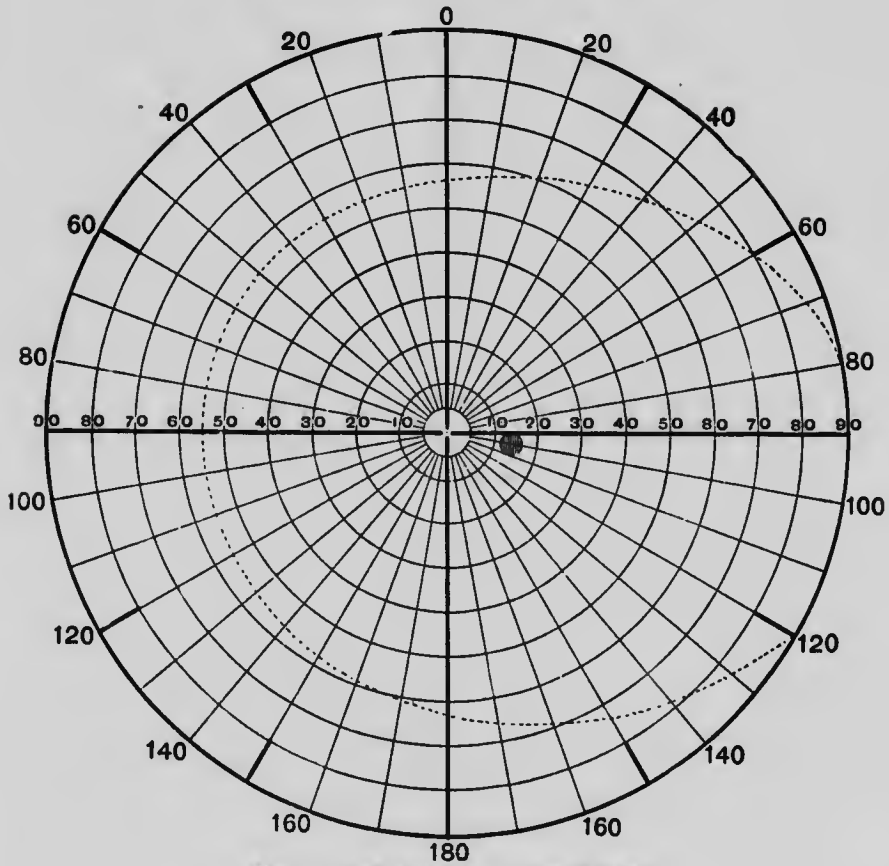

Fig. 590.—Perimeter chart for the right eye.



## Colour Sensations.

If a ray of sunlight is allowed to pass through a prism, it is decomposed by its passage into rays of different colours, which are called the colours of the spectrum; they are red, orange, yellow, green, blue, indigo, and violet. The red rays are the least turned out of their course by the prism, and the violet the most, whilst the other colours occupy in order places between these two extremes. The differences in the colour of the rays depend upon the rapidity of vibrations producing each, the red rays being the least rapid and the violet the most. In

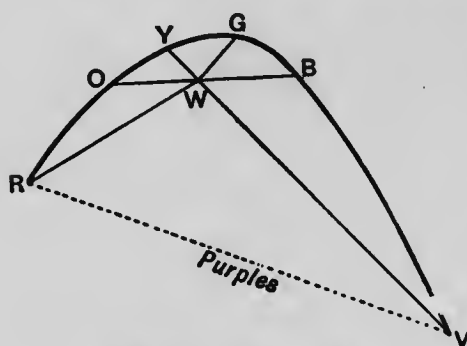

Fig. 591.—Colour triangle.

addition to the coloured rays of the spectrum, there are others which are invisible but which have definite properties; those to the left of the red are less refrangible, being the calorific rays which act upon the thermometer, and those to the right of the violet, which are called the actinic or chemical rays, have a powerful chemical action.

White light may be built from its constituents either *physically*, as by a second prism reversing the dispersion produced by the first, or *physiologically* by causing the colours of the spectrum to fall on the retina in rapid succession. The best way to study the effects of mixing colour sensations is by means of a rapidly revolving disc to which two or more coloured sectors are fixed. Each colour is viewed in rapid succession, and owing to the persistence of retinal impressions, the two or more constituent colour impressions blend and give a single compound colour. (Maxwell.)

White light can be produced by the mixture of the three primary colours, or even of two colours in certain proportions. These pairs of colours, which are roughly red and greenish blue, orange and blue, and violet and yellow, are called *complementary*.

The colours are not of equal stimulation energy, otherwise they might be arranged around a circle; they are more properly arranged in a triangle, with red, green, and violet at the angles (fig. 591). The red, green, and violet are selected on the theory of Helmholtz that they constitute the three primary colour sensations; other colour sensations are mixtures of these.

Thus, the orange and yellow between the red and green are mixtures of the red and green sensations ; the blue a mixture of green and violet ; and the purples (which are not represented in the spectrum) of red and violet.

Join the three angles red, green, and violet, and one gets white light ; or join the blue and orange, which comes to the same thing, and one also gets white.

Blue and orange on Maxwell's disc give white ; but it is well known that a mixture of blue and orange paint gives green ; how can one explain this ? Suppose the paint is laid on white paper ; the white light from the paper on its way to the eye passes through transparent particles of blue and orange pigment ; the blue particles only let the green and violet sensations reach the eye, and cut off the red ; the yellow particles only let the red and green through, and cut off the violet. The red and violet being thus cut off, the green sensation is the only one which reaches the eye.

The experiments which led Helmholtz and others to the selection of green, red, and violet as the three fundamental colour sensations were performed in this way : the eye undergoes exhaustion to a colour when exposed to it for some time ; suppose, for instance, the eye is fatigued for red,

and is then exposed to a pure yellow light, such as that given off by the sodium flame, the yellow then appears greenish ; or fatigue the eye for green and then expose it to blue, the blue will have a violet tint. By the repetition of

numerous experiments of this kind, it was found that the fatigue experienced manifested itself in three colours, red, green, and violet, which were therefore selected as the three fundamental colour sensations. It was also found that these three colour sensations could not be produced by any combination of other colour sensations.

The theory of colour vision constructed on these data was originated by Thomas Young, and independently discovered and elaborated by Helmholtz. It is consequently known as the Young-Helmholtz theory. This theory teaches that there are in the retina rods or cones which answer to each of these primary colours, whereas the innumerable intermediate shades of colour are produced by stimulation of the three primary colour terminals in

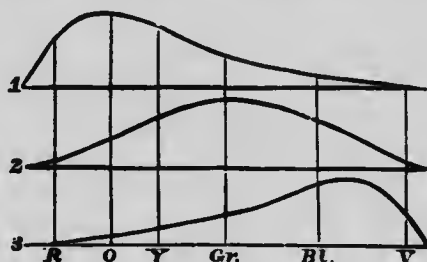

Fig. 592.—Diagram of the three primary colour sensations. (Young-Helmholtz theory.) 1, is the red ; 2, green, and 3, violet, primary colour sensation. The lettering indicates the colours of the spectrum. The diagram indicates by the height of the curve to what extent the several primary sensations of colour are excited by vibrations of different wave lengths.

different degrees, the sensation of white being produced when the three elements are equally excited. Thus if the retina is stimulated by rays of certain wave length, at the red end of the spectrum, the terminals of the other colours, green and violet, are hardly stimulated at all, but the red terminals are strongly stimulated, the resulting sensation being red. The orange rays excite the red terminals considerably, the green rather more, and the violet slightly, the resulting sensation being that of orange, and so on (fig. 592).

Another theory of colour vision (Hering's) supposes that there are six primary colour sensations, viz.:—three pairs of antagonistic or complementary colours, black and white, red and green, and yellow and blue; and that these are produced by the changes either of disintegration or of assimilation taking place in certain substances, somewhat it may be supposed of the nature of the visual purple, which (the theory supposes) exist in the retina. Each of the substances corresponding to a pair of colours, is capable of undergoing two changes, one of construction and the other of disintegration, with the result of producing one or other colour. For instance, in the white-black substance, when disintegration is in excess of construction or assimilation, the sensation is white, and when assimilation is in excess of disintegration the reverse is the case; and similarly with the red-green substance, and with the yellow-blue substance. When the repair and disintegration are equal with the first substance, the visual sensation is grey; but in the other pairs when this is the case, no sensation occurs. The rays of the spectrum to the left produce changes in the red-green substance only, with a resulting sensation of red, whilst the (orange) rays further to the right affect both the red-green and the yellow-blue substances; blue rays cause constructive changes in the yellow-blue substances, but none in the red-green and so on. These changes produced in the visual substances in the retina are perceived by the brain as sensations of colour.

Neither theory satisfactorily accounts for all the numerous complicated problems presented in the physiology of colour vision. One of these problems is *colour blindness or Daltonism*, a by no means uncommon visual defect. One of the commonest forms is the inability to distinguish between red and green. Helmholtz's explanation of such a condition is, that the elements of the retina which receive the impression of red, etc., are absent, or very imperfectly developed, and Hering's would be that the red-green substance is absent from the retina. Other varieties of colour-blindness in which the other colour-perceiving elements are absent have been shown to exist occasionally.

Hering's theory appears to meet the difficulty best, for if the red element of Helmholtz were absent, the patient ought not to be able to perceive white sensations, of which red is a constituent part: whereas, according to Hering's theory, the white-black visual substance remains intact.

The two theories that have just been described may be called the classical theories of colour vision, at any rate they are those which have been for the longest time before the scientific world. As facts have accumulated it has been for some years recognised that many such facts could not be reconciled with either theory; and modifications of one or the other theory have been from time to time introduced.

The observations recently made by C. J. Burch are of considerable importance; the following is a brief account of his methods and results.

He finds that by exposing the eye to bright sunlight in the focus of a burning glass behind transparent coloured screens it is possible to produce temporary colour blindness. After red light, the observer is for some minutes red-blind, scarlet geraniums look black, yellow flowers green, and purple flowers violet. After violet light, violet looks black, purple flowers crimson, and green foliage richer than usual. After light of other colours, corresponding effects are produced. If one eye is made purple-blind, and the other green-blind, all objects are seen in their natural colours, but in exaggerated perspective, due to the difficulty the brain experiences in combining the images from the two eyes.

By using a brightly-illuminated spectrum, and directing the eye to certain of its colours, the eye in time becomes fatigued and blind for that colour, so that it is no longer seen in the spectrum. Thus, after green blindness is induced the red appears to meet the blue, and no green is seen. If, however, the eye is exposed to yellow light, it does not similarly become blind for yellow only, but for red and green too. This supports the Young-Helmholtz theory that the sensation yellow is one compounded of the red and green sensations. By an exhaustive examination of the different parts of the spectrum in this way it thus becomes possible to differentiate between the primary colour sensations and those which are compound. By a study of this kind, Burch concludes that the phenomena of colour vision are in accordance with the Young-Helmholtz theory, with the important addition that there is a fourth primary colour sensation, namely, blue. He could not discover that colour sensations are related to each other in the sense indicated by Hering. Each may be exhausted without either weakening or strengthening the others.

These observations were confirmed by examining in a similar way the colour sensations of seventy other people, but there are individual differences in the extent to which the colour sensations overlap.

#### Changes in the Retina during activity.

The method by which a ray of light is able to stimulate the endings of the optic nerve in the retina in such a manner that a visual sensation is perceived by the cerebrum is not yet understood. It is supposed that the change effected by the agency of the light which falls upon the retina is in fact a chemical alteration in the protoplasm, and that this change stimulates the optic nerve-endings. The discovery of a certain temporary reddish-purple pigmentation of the outer ends of the retinal rods in certain animals (*e.g.*, frogs) which had been killed in the dark, forming the so-called *rhodopsin* or *visual purple*, appeared likely to offer some explanation of the matter, especially as it was also found that the pigmentation disappeared when the retina was exposed to light, and reappeared when the light was removed, and also that it underwent distinct changes of colour when other than white light was used. It was also found that if the operation were performed quickly enough, the bleached image of a bright object (*optogram*) might be fixed on the retina by soaking the retina of an animal which has been killed in the dark, in alum solution.

The visual purple cannot however be absolutely essential to the due production of visual sensations, as it is absent from the retinal cones, and from the macula lutea and fovea centralis of the human retina, and does not appear to exist at all in the retinae of many animals, *e.g.*, bat, dove, and hen, which are, nevertheless, possessed of good vision.

However the fact remains that light falling upon the retina bleaches the *visual purple*, and this must be considered as one of its effects. If it produces chemical changes in other substances, these must be colourless and so extremely difficult to discover. The rhodopsin is derived in some way from the black pigment (melanin or fuscine) of the polygonal epithelium of the retina, since the colour is not renewed after bleaching if the retina is detached from its pigment layer. Certain pigments, not sensitive to light, are contained in the inner segments of the cones. These coloured bodies are oil globules of various colours, red, green, and yellow, called *chromophanes*, and are found in the retinas of marsupials (but not other mammals), birds, reptiles, and fishes. Practically nothing is known about the yellow pigment of the yellow spot. Another change produced by the action of the light

upon the retina is the *movement of the pigment cells*. On being stimulated by light the granules of pigment in the cells which overlie the outer part of the rod and cone layer of the retina pass down into the processes of the cells, which hang down between the rods: these *melanin* or *fuscine* granules are generally rod-shaped, and look almost like crystals. In addition to this a *movement of the cones* and possibly of the rods occurs, as has been already incidentally mentioned; in the light the cones shorten and in the dark they lengthen (Engelmann).

According to the careful researches of Dewar and McKendrick, and of Holmgren, it appears that the stimulus of light is able to produce a *variation of the natural electrical currents of the retina*. The current is at first increased and then diminished; this is the electrical expression of those chemical changes in the retina of which we have already spoken.

The electrical variations in the retina under the influence of light have been recently reinvestigated by Waller. The excised eyeball of a frog is led off by non-polarisable electrodes to a galvanometer. One electrode is placed on the front, the other on the back of the eye. A current of rest (demarcation current) is observed passing through the eyeball from front to back. When light falls on the eye this current is increased; on shutting off the light there is a momentary further increase, and then the current slowly returns back to its previous condition. Waller explains this by supposing that anabolic changes in the eye predominate during stimulation by light. With the onset of darkness, the katabolic changes cease at once, and the anabolic more slowly; hence a further positive variation. If the eyeball has been excised the day before the observations are made, or has been fatigued or injured, light produces principally katabolic changes, as evidenced by a negative variation. A slight positive effect follows when the light is shut off.

#### MOVEMENTS OF THE EYEBALL.

*Protrusion* of the eyeballs occurs (1) when the blood-vessels of the orbit are congested; (2) when contraction of the plain muscular fibres of the capsule of Tenon takes place; these are innervated by the cervical sympathetic nerve; and (3) in the disease called exophthalmic goitre.

*Retraction* occurs (1) when the lids are closed forcibly; (2) when the blood-vessels of the orbit are comparatively empty; (3) when the fat in the orbit is reduced in quantity, as during starvation; and (4) on section or paralysis of the cervical sympathetic nerves.

The most important movements, however, are those produced by the six ocular muscles.

The eyeball possesses the power of movement around three axes indicated in fig. 593, viz. an antero-posterior, a vertical, and a transverse, passing through a centre of rotation a little behind the centre of the optic axis. The movements are accomplished by pairs of muscles.

Direction of movement.	By what muscles accomplished
Inwards . . . . .	Internal rectus.
Outwards . . . . .	External rectus.
Upwards . . . . .	{ Superior rectus.
	{ Inferior oblique.
Downwards . . . . .	{ Inferior rectus.
	{ Superior oblique.
Inwards and upwards . . . . .	{ Internal and superior rectus.
	{ Inferior oblique.
Inwards and downwards . . . . .	{ Internal and inferior rectus.
	{ Superior oblique.
Outwards and upwards . . . . .	{ External and superior rectus.
	{ Inferior oblique.
Outwards and downwards . . . . .	{ External and inferior rectus.
	{ Superior oblique.

These muscles are all supplied by the third nerve except the superior oblique which is supplied by the fourth and the external rectus by the sixth nerve. The internal rectus is in



Fig. 593. - Diagram of the axes of rotation to the eye. The thin lines indicate axes of rotation, the thick the position of muscular attachment.

part supplied by the sixth nerve of the opposite side, *via* the posterior longitudinal bundle.

The muscles of the two eyes act simultaneously, so that images of the objects looked at may fall on corresponding points of the two retinae. The inner side of one retina corresponds to the outer side of the other, so that any movement of one eye inwards

must be accompanied by a movement of the other eye outwards. If one eyeball is forcibly fixed by pressing the finger against it so that it cannot follow the movement of the other, the result is double vision (*diplopia*), because the image of the objects looked at will fall on points of the two retinæ which do not correspond. The same is experienced in a squint, until the brain learns to disregard the image from one eye.

If the external rectus is paralysed, the eye will squint inwards; if this occurs in the right eye the false image will lie on the left side of the yellow spot, and appear in the field of vision to the right of the true image. If the third nerve is paralysed, the case is a more complicated one: owing to the paralysis of the levator palpebræ superioris, the patient will be unable to raise his upper lid (*ptosis*), and so in order to see will walk with his chin in the air. If the paralysis is on the right side, the eyeball will squint downwards and to the right; the false image will be formed below and to the right of the yellow spot, and the apparent image in the field of vision will consequently appear above and to the left of the true image, and owing to the squint being an oblique one, the false image will slant in a corresponding direction.

#### Various Positions of the Eyeballs.

All the movements of the eyeball take place around the *point of rotation*, which is situated 1.77 mm. behind the centre of the visual axis, or 10.9 mm. behind the front of the cornea.

The three axes around which the movements occur are:—

1. The *visual* or antero-posterior axis.
2. The *transverse* axis, which connects the points of rotation of the two eyes.
3. The *vertical* axis, which passes at right angles to the other two axes through their point of intersection.

The line which connects the fixed point in the outer world at which the eye is looking to the point of rotation is called the *visual line*. The plane which passes through the two visual lines is called the *visual plane*.

The various positions of the eyeballs are designated primary, secondary, and tertiary.

The *primary* position occurs when both eyes are parallel, the visual lines being horizontal (as in looking at the horizon).

*Secondary positions* are of two kinds:—

- (1) The visual lines are parallel but directed either upwards or downwards from the horizontal (as in looking at the sky).
- (2) The visual lines are horizontal, but converge towards one



another (as in looking at a small object near to and immediately on the same level as the eyes).

*Tertiary* positions are those in which the visual lines are not horizontal, and converge towards one another (as in looking at the tip of the nose).

It is possible to conceive positions of the eyeballs in which the

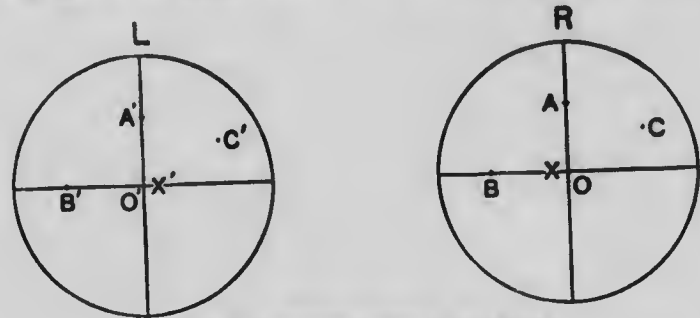

Fig. 594.—Identical points of the retinae.

visual lines diverge from one another; but such positions do not occur in normal vision in man.

Both eyes are moved simultaneously, even if one of them happens to be blind. They are moved so that the object in the outer world is focussed on the two yellow spots, or other corresponding points of the two retinae. The images which do not fall on corresponding points are seen double, but these are disregarded by the brain, which

only pays attention to those images which fall on corresponding points.

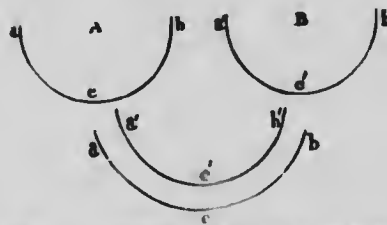

Fig. 595.—Diagram to show the corresponding parts of both retinae.

The following diagrams will assist us in understanding more fully what is meant by *corresponding* or *identical* points of the two retinae.

If R and L (fig. 594) represent the right and left retinae respectively, O and O' the two yellow spots are identical; so are A and A', both being the same distance above O and O'. But the corresponding point to B on the inner side of O in the right retina, is B', a point to the same distance on the outer side of O' in the left retina, similarly C and C' are identical. The two blind spots X and X' are not identical.

Fig. 595 shows the same thing in rather a different way; A and B represent a horizontal section through the two retinae; the points a', b', and c', being identical. In the lower part

of the diagram is shown the way in which the brain combines the images in the two retinae, one as it were overlapping so as to coincide with the other.

The *Horopter* is the name given to the surface in the outer world which contains all the points which fall on the identical points of the retinae. The shape of the horopter will vary with the position of the eyeballs. In the primary position, and in the first variety of the secondary position, the visual lines are parallel; hence the horopter will be a plane at infinity, or at a great distance.

In the other variety of the secondary position, and in tertiary positions in which the visual lines converge as when looking at a

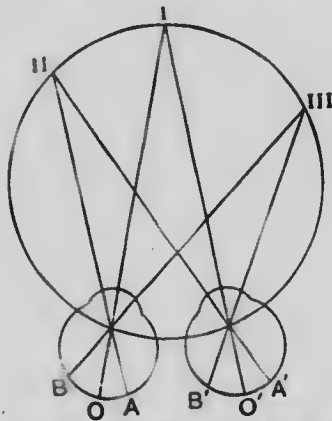

Fig. 596.—The Horopter, when the eyes are convergent.

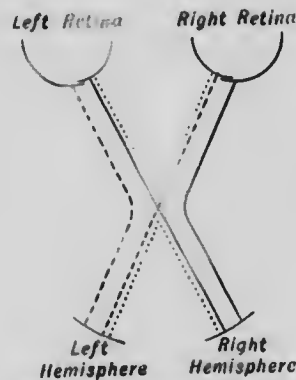

Fig. 597.—Course of fibres at optic chiasma.

near object, the horopter is a circle (fig. 596) which passes through the nodal points of the two eyes, and through the fixed point (I) in the outer world at which the eyes are looking, and which will consequently fall on the two yellow spots (O, and O'). All other points in this circle (II, III) will fall on identical points of the two retinae. The image of II will fall on A and A'; of III on B, and B'; it is a very simple mathematical problem to prove that  $OA = O'A'$ , and  $OB = O'B'$ .

This, however, applies to man only, or to animals with both eyes in front of the head; in those animals in which the eyes are lateral in position, and the visual lines diverge, the problem of bilateral vision is a very different one.

### Nervous Paths in the Optic Nerves.

The correspondence of the two retinae and of the movements of the eyeballs is produced by a close connection of the nervous

centres controlling these phenomena, and by the arrangement of the nerve-fibres in the optic nerves. The crossing of the nerve fibres at the optic chiasma is incomplete, and the preceding diagram (fig. 597) gives a simple idea of the way the fibres go.

It will be seen that it is only the fibres from the inner portions of the retinae that cross; and that those represented by continuous lines from the right side of the two retinae ultimately reach the right hemisphere, and those represented by interrupted

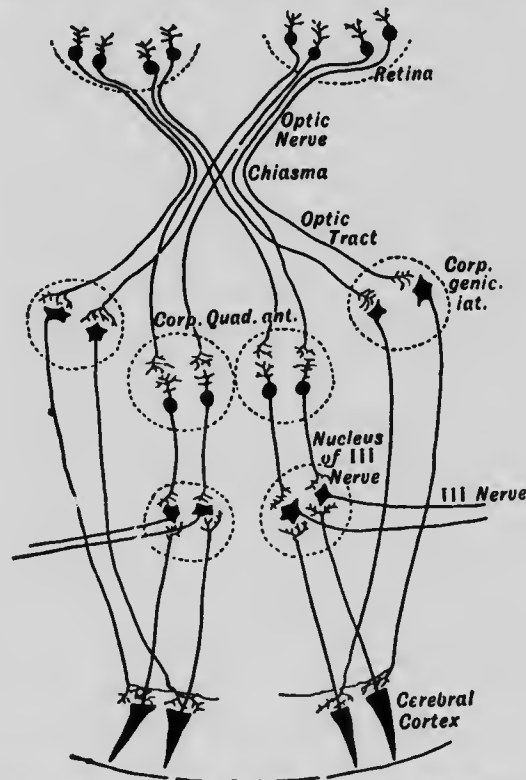

Fig. 598.—Relations of nerve cells and fibres of visual apparatus. (After Schäfer.)

lines from the left side of the two retinae ultimately reach the left hemisphere. The two halves of the retinae are not, however, separated by a hard-and-fast line from one another; this is represented by the two halves being depicted as slightly overlapping, and this comes to the same thing as saying that the central region of each retina is represented in each hemisphere. The fibres (represented by finely dotted lines in the diagram) connecting the two retinae and the two hemispheres are problematical.

The part of the hemisphere concerned in vision is the occipital lobe, and the reader should turn back to our previous considera-

tion of this subject in connection with cerebral localisation, the phenomena of hemianopsia (p. 678), and the conjugate deviation of head and eyes (pp. 679, 682).

Fig. 598, though diagrammatic, will assist the reader in more fully comprehending the paths of visual impulses, and the central connections of the nerves and nerve-centres concerned in the process. The fibres to the lateral geniculate body end there by arborising around its cells, and a fresh relay of fibres from these cells passes to the cortex of the occipital lobe. Those to the anterior corpus quadrigeminum are continued on by a fresh relay to the nucleus of the third nerve, the cells of which are also surrounded by arborisations of the axis cylinder processes of the cortical cells.

### Visual Judgments.

The psychical or mental processes which constitute the visual sensation proper have been studied to a far greater degree than is possible in connection with other forms of sensation.

We have already seen that in spite of the reversion of the image in the retina, the mind sees objects in their proper position, the sense of sight being here educated in great measure by that of touch.

We are also not conscious of the blind spot. This is partly due to the fact that those images which fall on the blind spot of one eye are not focussed there in the other eye. But even when one looks at objects with one eye, there is no blank, the area corresponding to the blind spot being closed up by a mental process.

*Our estimate of the size* of various objects is based partly on the visual angle under which they are seen, but much more on the estimate we form of their distance. Thus a lofty mountain many miles off may be seen under the same visual angle as a small hill near at hand, but we infer that the former is much the larger object because we know it is much further off than the hill. Our estimate of distance is often erroneous, and consequently the estimate of size also. Thus persons seen walking on the top of a small hill against a clear twilight sky appear unusually large, because we over-estimate their distance, and for similar reasons most objects in a fog appear immensely magnified. The same mental process gives rise to the idea of depth in the field of vision; this idea is fixed in our mind principally by the circumstance that, as we ourselves move forwards, different images in succession become depicted on our retina, so that we seem to pass between these images, which to the mind is the same thing as passing between the objects themselves.

The action of the sense of vision in relation to external objects is, therefore, quite different from that of the sense of touch. The objects of the latter sense are immediately present to it; and our own body, with which they come in contact, is the measure of their size. The part of a table touched by the hand appears as large as the part of the hand receiving an impression from it, for the part of our body in which a sensation is excited, is here the measure by which we judge of the magnitude of the object. In the sense of vision, on the contrary, the images of objects are mere fractions of the objects themselves, realised upon the retina, the extent of which remains constantly the same. But the imagination, which analyses the sensations of vision, invests the images of objects, together with the whole field of vision in the retina, with very varying dimensions; the relative size of the image in proportion to the whole field of vision, or of the affected parts of the retina to the whole retina, alone remains unaltered.

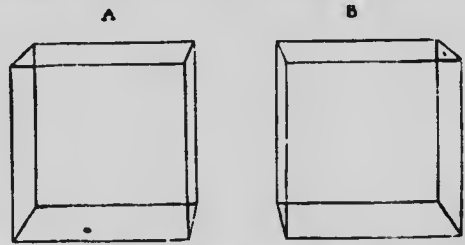

Fig. 599.—Diagrams to illustrate how a judgment of a figure of three dimensions is obtained.

The estimation of the form of bodies by sight is the result partly of the mere sensation, and partly of the association of ideas. Since the form of the images perceived by the retina depends wholly on the outline of the part of the retina affected, the sensation alone is adequate to the distinction of superficial forms from each other, as of a square from a circle. But the idea of a solid body like a sphere, or a cube, can only be attained by the action of the mind constructing it from the different superficial images seen in different positions of the eye with regard to the object, and, as shown by Wheatstone and illustrated in the *stereoscope*, from two different perspective projections of the body being presented simultaneously to the mind by the two eyes. Hence, when, in adult age, sight is suddenly restored to persons blind from infancy, all objects in the field of vision appear at first as if painted flat on one surface; and no idea of solidity is formed until after long exercise of the sense of vision combined with that of touch.

Thus, if a cube is held at a moderate distance before the

eyes, and viewed with each eye successively while the head is kept perfectly steady, A (fig. 599) will be the picture presented to the right eye, and B that seen by the left eye. Wheatstone has shown that on this circumstance depends in a great measure our conviction of the solidity of an object, or of its projection in relief. If different perspective drawings of a solid

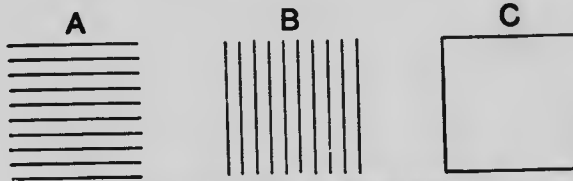

Fig. 600.—Diagram to illustrate visual illusions.

body, one representing the image seen by the right eye, the other that seen by the left (for example, the drawing of a cube, A, B, fig. 599) be presented to corresponding parts of the two retinæ, as may be readily done by means of the stereoscope, the mind will perceive not merely a single representation of the object, but a body projecting in relief, the exact counterpart of that from which the drawings were made.

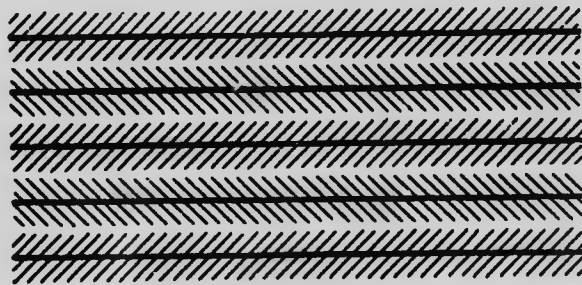

Fig. 601.—Parallel puzzle.

By transposing two stereoscopic pictures a reverse effect is produced; the elevated parts appear to be depressed, and *vice versa*. An instrument contrived with this purpose is termed a *pseudoscope*. Viewed with this instrument a bust appears as a hollow mask, and as may readily be imagined the effect is most bewildering.

The *clearness* with which an object is perceived irrespective of accommodation, would appear to depend largely on the number of rods and cones which its retinal image covers. Hence the nearer an object is to the eye (within moderate limits) the more

clearly are all its details seen. Moreover, if we want carefully to examine any object, we always direct the eyes straight to it, so that its image shall fall on the yellow spot where an image of a given area will cover a larger number of cones than anywhere else in the retina. It has been found that the images of two points must be at least  $3 \mu$  apart on the yellow spot in order to be distinguished separately; if the images are nearer together, the points appear as one. The diameter of each cone in this part of the retina is about  $3 \mu$ .

Visual judgments are not always correct; there are a large number of puzzles and toys which depend on visual illusions. Two of the best known are represented in the preceding diagrams.

In fig. 600, A, B, and C are of the same size; but A looks taller than B, while C appears to cover a less area than either.

In fig. 601, the horizontal lines are parallel, though they do not appear so, owing to the mind being distracted by the intercrossing lines.

---

## CHAPTER LVI.

### TROPHIC NERVES.

NERVES exercise a trophic or nutritive influence over the tissues and organs they supply. The chemical changes that occur during the nutrition of a living cell may be summed up in the word *metabolism*; and this includes two kinds of changes; *anabolic* phenomena, that is the processes of building up protoplasm from food material; and *katabolic* phenomena, those in which there is a breaking down of protoplasm, and a consequent formation of simpler waste products.

Some nerves increase the building-up stage of metabolism; these are termed anabolic. Such a nerve is the vagus in reference to the heart; when it is stimulated the heart beats more slowly or may stop, and is thus enabled to rest and repair its waste. The opposite kind of nerves (katabolic) are those which lead to increase of work and so increased wear and tear and formation of waste products. Such a nerve in reference to the heart is the sympathetic.

There has been considerable diversity of opinion as to whether trophic nerve-fibres are a distinct anatomical set of nerve-fibres,

or whether all nerves in addition to their other functions exercise a trophic influence.

When a nerve going to an organ is cut, the wasting of the nerve itself beyond the cut constitutes what we have learnt to call Wallerian degeneration, but the wasting process continues beyond the nerve; the muscles it supplies waste also, and waste much more rapidly than can be explained by simple disuse. The same is seen in the testicle after section of the spermatic cord; and in the disease of joints called Charcot's disease, the trophic changes are to be explained by disease of the nerves supplying them.

From these, and numerous other instances that might be given, there is no question that nerves do exert a trophic influence; the question, however, whether this is due to special nerve-fibres has been chiefly worked out in connection with the fifth cranial nerve.

After the division of this nerve there is loss of sensation in the corresponding side of the face: the cornea in two or three days begins to get opaque, and this is followed by a slow inflammatory process which may lead to a destruction not only of the cornea, but of the whole eyeball. The same is seen in man; when the fifth nerve is diseased or pressed upon by a tumour beyond the Gasserian ganglion the result is loss of sensation in the face and conjunctiva, an eruption (*herpes*) appears on the face, and ulceration of the cornea leading in time to disintegration of the eyeball may occur too. In disease of the spinal ganglia there is a similar herpetic eruption on the skin (*shingles*).

In the case of the fifth nerve the evidence that there are special nerve fibres to which these trophic changes are due, is an experiment by Meissner and Büttner, who found that division of the most internal fibres is most potent in producing them.

Those, however, who do not believe in special trophic nerves, attribute the changes in the eyeball to its loss of sensation. Dust, etc., is not felt by the cornea, it is therefore allowed to accumulate and set up inflammation. This is supported by the fact that if the eyeball is protected by sewing the eyelids together the trophic results do not ensue. On the other hand, in paralysis of the seventh nerve, the eyeball is much more exposed, and yet no trophic disorders follow.

Others have attributed the change to increased vascularity due to disordered vaso-motor changes; but this is negated by the fact that in disease of the cervical sympathetic, the disordered vaso-motor phenomena which ensue do not lead to the disorders of nutrition we have described.



There can, therefore, be but little doubt that we have to deal with the trophic influence of nerves ;\* but the dust, etc., which falls on the cornea must be regarded as the *exciting* cause of the ulceration. The division or disease of the nerve acts as the *predisposing* cause. The eyeball is more than usually prone to undergo inflammatory changes, with very small provocation.

The same explanation holds in the case of the influence of the vagi on the lungs. If both these nerves are divided, the animal usually dies within a week or a fortnight from a form of pneumonia called *vagus pneumonia*, in which gangrene of the lung substance is a marked characteristic. Here the predisposing cause is the division of the trophic fibres in the pneumogastric nerves ; the exciting cause is the entrance of particles of food into the air passages, which on account of the loss of sensation in the larynx and neighbouring parts are not coughed up. Another trophic disturbance that follows division of the vagi is fatty degeneration of the heart.

We shall conclude by giving one more instance of trophic disturbance due to nervous disease, and this is the case of bed-sores. Many bed-sores are due to prolonged confinement in bed with bad nursing ; these are of slow onset. But there is one class of bed-sores which are acute ; these are especially met with in cases of paralysis, due to disease of the spinal cord ; they come on in three or four days after the onset of the paralysis in spite of the most careful attention ; they cannot be explained by vaso-motor disturbance, nor by loss of sensation ; there is, in fact, no doubt they are of trophic origin ; the nutrition of the skin is so greatly impaired that the mere contact of it with the bed for a few days is sufficient to act as the exciting cause of the sore.

## CHAPTER LVII.

### THE REPRODUCTIVE ORGANS.

THE reproductive organs consist in the male of the two testes which produce spermatozoa, and the ducts which lead from them, and in the female of the two ovaries which produce ova, the Fallopian tubes or oviducts, the uterus, and the vagina.

---

\* The proof, however, that there are distinct nerve-fibres anatomically is not very conclusive.

## MALE ORGANS.

The testis is enclosed in a serous membrane called the *tunica vaginalis*, originally a part of the peritoneum. When the testis descends into the scrotum it carries with it this part of the peritoneum, which then gets entirely cut off from the remainder of that serous membrane. There are, however, many

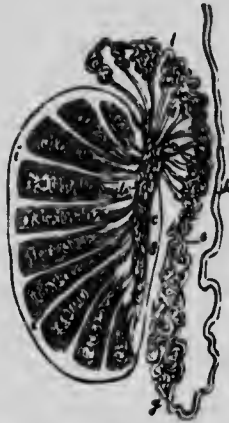

Fig. 602.—Plan of a vertical section of the testicle, showing the arrangement of the ducts. The true length and diameter of the ducts have been disregarded. *aa*, tubuli seminiferi coiled up in the separate lobes; *b*, tubuli recti; *c*, rete testis; *d*, vasa efferentia ending in the coni vasculosi; *l, e, g*, convoluted canal of the epididymis; *h*, vas deferens; *f*, section of the back part of the tunica albuginea; *i, i*, fibrous processes running between the lobes; *s*, mediastinum.

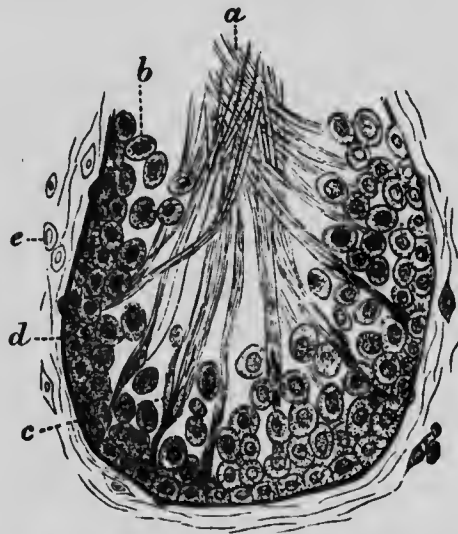

Fig. 603.—Section of a tubule of the testicle of a rat, to show the formation of the spermatozoa. *a*, spermatozoa; *b*, seminal cells; *c*, sustentacular cells, to which the spermatozoa are adherent; *d*, basement membrane; *e*, connective tissue. (Cadiat.)



Fig. 604.—From a section of the testis of dog, showing portions of seminal tubes. *A*, seminal epithelial cells, and numerous small cells loosely arranged; *B*, the small cells or spermatoblasts converted into spermatozoa; *C*, groups of these in a further stage of development. (Klein.)

animals in which the testes remain permanently in the abdomen. The external covering of the testicle itself is a strong fibrous capsule, called, on account of its white appearance, the *tunica*

*albuginea*. Passing from its inner surface are a number of septa or trabeculae, which divide the organ imperfectly into lobules. On the posterior aspect of the organ the capsule is greatly thickened, and forms a mass of fibrous tissue called the *Corpus Highmoreanum* (body of Highmore) or *mediastinum testis*. Attached to this is a much convoluted tube, which forms a mass called the *epididymis*. This receives the ducts of the testis, and is prolonged into a thick walled tube, the *vas deferens*, by which the semen passes to the urethra.

The testis is itself composed of *convoluted* tubes. Each of these

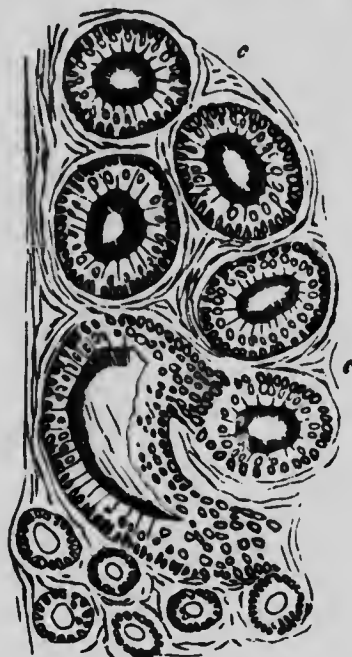

Fig. 605.—Section of the epididymis of a dog.—The tube is cut in several places, both transversely and obliquely; it is seen to be lined by a ciliated epithelium, the nuclei of which are well shown. c, connective tissue. (Schofield.)

commences near the tunica albuginea, and terminates after joining with others in a *straight tubule*, which passes into the body of Highmore, where it forms a network (*rete testis*) by communicating by branches with those of other straight tubules. From the rete about twenty efferent ducts (*vasa efferentia*) arise, which become convoluted to form the *coni vasculosi*, and then pass into the tube of the epididymis.

The *convoluted* or *seminiferous* tubules have the following structure: each is formed externally of a thick basement membrane, consisting of several layers of flattened cells. Next comes the *lining epithelium* of clear cubical cells, a few of which show

karyokinetic figures in their nuclei, indicating they are about to divide. Some of these cells are longer than the rest, and project into the cavity of the tube, where they form a connection with groups of developing spermatozoa. They are called *sustentacular cells*.

Next to the lining epithelium is a zone of larger cells, two or three deep. These are called *spermatogenic cells*; the nuclei of nearly all of these show karyokinetic figures. Most internal of all are a large number of small cells with circular nuclei. They



Fig. 606.—Dissection of the base of the bladder and prostate gland, showing the vesiculae seminales and vasa deferentia. *a*, lower surface of the bladder at the place of reflexion of the peritoneum; *b*, the part above covered by the peritoneum; *i*, left vas deferens, ending in *c*, the ejaculatory duct; the vas deferens has been divided near *i*, and all except the vesical portion has been taken away; *s*, left vesicula seminalis joining the same duct; *s s*, the right vas deferens and right vesicula seminalis, which has been unraveled; *p*, under side of the prostate gland; *m*, part of the urethra; *u v*, the ureters (cut short), the right one turned aside. (Haller.)

are called *spermatoblasts*. In other tubules the spermatoblasts may be seen in various stages developing into spermatozoa; they become elongated; their nucleus is at one end, and from the other a tail-like process grows; groups of the young spermatozoa apply their heads to the sustentacular cells, from which they derive nutriment; their tails project into the lumen; they eventually become free.

The *straight tubules* consist of basement membrane and lining cubical epithelium only.

The interstitial connective tissue of the testis is loose, and

contains numerous lymphatic clefts. Lying in it accompanying the blood-vessels are strands of polyhedral epithelial cells, of a yellowish colour (*interstitial cells*).

The *tubules of the rete testis* are lined by cubical epithelium; the basement membrane is absent.

The *vasa efferentia, coni vasculosi, and epididymis* are lined by columnar cells, with very long cilia. There is a good deal of muscular tissue in their walls.

The *vas deferens* consists of a muscular wall (outer layer longitudinal, middle circular, inner longitudinal), lined by a mucous membrane, the inner surface of which is covered by columnar epithelium.

The *vesiculæ seminales* are outgrowths of the *vas deferens*.

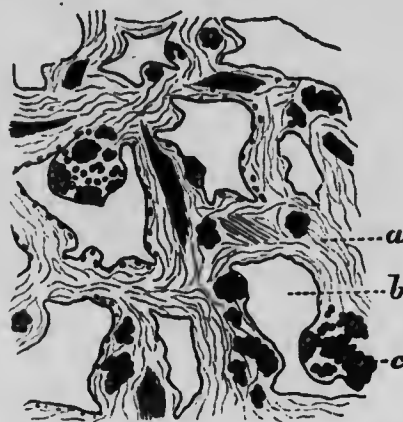

Fig. 607.—Erectile tissue of the human penis. *a*, fibrous trabeculae with their ordinary capillaries; *b*, section of the venous sinuses; *c*, muscular tissue. (Cadiat.)

Each is a much convoluted, branched, and sacculated tube of structure similar to that of the *vas deferens*, except that the wall is thinner.

The *penis* is composed of cavernous tissue covered by skin. The cavernous tissue is collected into three tracts, the two  *corpora cavernosa* and the  *corpus spongiosum* in the middle line inferiorly. All these are enclosed in a capsule of fibrous and plain muscular tissue; the *septa* which are continued in from these, form the boundaries of the cavernous venous spaces of the tissue. The arteries run in the *septa*; the capillaries open into the venous spaces. The arteries are often called *helicine*, as in injected specimens they form twisted loops projecting into the cavernous spaces (see also p. 280). The structure of the urethra and prostate is described on p. 537.

The Spermatozoa, suspended in a richly albuminous fluid, constitute the *semen*. Each spermatozoon is composed of three parts, a *head*, a *middle part*, and a *tail*. The head varies in shape in different animals, but in man it is oval, and pointed anteriorly. The middle piece is short and cylindrical, with a spiral fibre passing round it. The tail is long, tapering, and vibratile; its action resembles that of a cilium, and gives to the spermatozoon its power of locomotion. The end piece of the tail is described by Retzius



Fig. 608.—Spermatic filaments from the human vas deferens. 1, magnified 300 diameters; 2, magnified 800 diameters; a, from the side; b, from above. (From Kölliker.)



Fig. 609.—Spermatozoa. 1, of salamander; 2, human. (H. Gibbes.)

as distinct from the rest, and in some animals is divided into two or three fibrils.

In some animals (newts, salamanders, &c.) a fine filament or membranous expansion is attached to the tail in a spiral manner (fig. 609). A similar appearance has been described by some observers in mammalian spermatozoa.

The spermatozoa are formed from the small spermatoblasts of the third or innermost layer of the seminiferous tubules; these originate from the spermatogenic cells of the second layer, and these from the lining cubical epithelium. When a lining cell divides into two, one becomes a spermatogenic cell, the other becomes elongated to form a sustentacular cell.

In the conversion of a spermatoblast into a spermatozoon, the nucleus forms the head; the tail develops as a fine filament

within the protoplasm, from which it subsequently grows out; it is connected to the nucleus from the first. The greater part of the protoplasm drops off (*seminal granules*); the remainder forms the middle piece of the spermatozoon, and contains an attraction sphere.

#### FEMALE ORGANS.

The **Ovary** is a solid organ composed of fibrous tissue (*stroma*), containing near its attachment to the broad ligament a number of plain muscular fibres. It is covered with a layer of short columnar

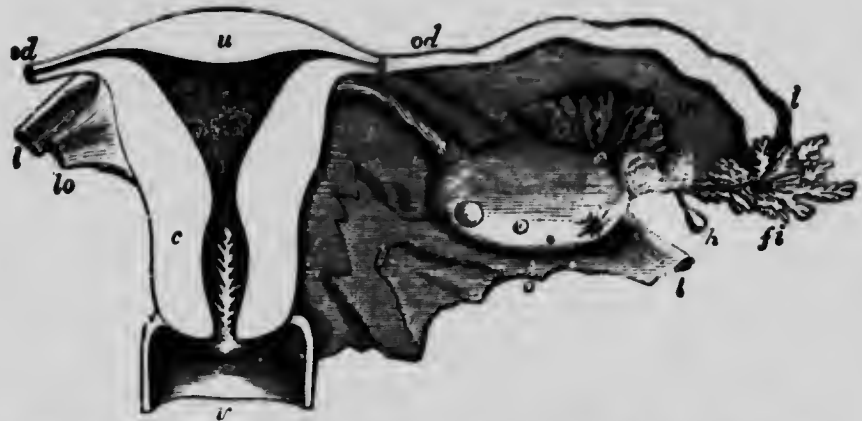

Fig. 610.—Diagrammatic view of the uterus and its appendages, as seen from behind. The uterus and upper part of the vagina have been laid open by removing the posterior wall; the Fallopian tube, round ligament, and ovarian ligament have been cut short, and the broad ligament removed on the left side; *u*, the upper part of the uterus; *c*, the cervix opposite the os internum; the triangular shape of the uterine cavity is shown, and the dilatation of the cervical cavity with the rugæ termed *arbor vitæ*; *v*, upper part of the vagina; *od*, Fallopian tube or oviduct; the narrow communication of its cavity with that of the cornu of the uterus on each side is seen; *l*, round ligament; *lo*, ligament of the ovary; *o*, ovary; *i*, wide outer part of the right Fallopian tube; *fi*, its fimbriated extremity; *po*, parovarium; *h*, one of the hydatids frequently found connected with the broad ligament. *j*. (Allen Thomson.)

cells (*germinal epithelium*), which may be seen, especially in young animals, dipping down into the stroma. The interstitial connective tissue contains a number of epithelial polyhedral yellow cells, like the interstitial cells of the testis.

When cut across, the surface part of the stroma is seen to be crowded with a number of rounded cells (*primitive ova* or *ovigerms*), and vesicles of different sizes are also visible. These are called the *Graafian follicles*. The smallest are near the surface of the organ; the larger ones are deeper, though they extend to the surface as they grow.

A *Graafian follicle* has a proper wall formed from the stroma;

it contains within it an *ovum* formed from one of the primitive ova

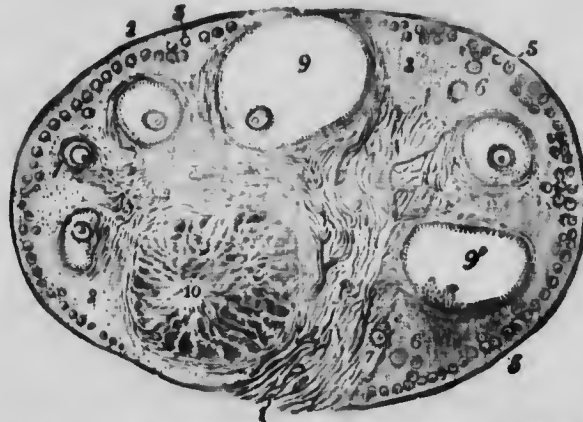

Fig. 611.—View of a section of the ovary of the cat. 1, outer covering and free border of the ovary; 1', attached border; 2, the ovarian stroma, presenting a fibrous and vascular structure; 3, granular substance lying external to the fibrous stroma; 4, blood-vessels; 5, oviducts in their earliest stages occupying a part of the granular layer near the surface; 6, oviducts which have begun to enlarge and to pass more deeply into the ovary; 7, oviducts round which the Graafian follicle and tunica granulosa are now formed, and which have passed somewhat deeper into the ovary and are surrounded by the fibrous stroma; 8, more advanced Graafian follicle with the ovum imbedded in the layer of cells constituting the proliferous disc; 9, the most advanced follicle containing the ovum, &c.; 9', a follicle from which the ovum has accidentally escaped; 10, corpus luteum. (Schrön.)

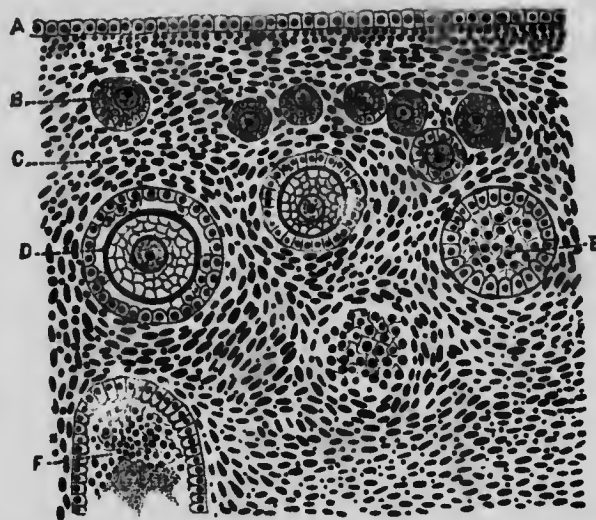

Fig. 612.—Section of the ovary of a cat. A, germinal epithelium; B, immature Graafian follicle; C, stroma of ovary; D, vitelline membrane containing the ovum; E, Graafian follicle showing lining cells; F, follicle from which the ovum has fallen out. (V. D. Harris.)

and it is lined by epithelium. At first there is simply one layer of epithelium cells; this lines the follicle and covers the ovum; later



there are two layers, one lining the follicle, and the other covering the ovum, but the two are close together. A viscid fluid collects between the two layers, and as the follicle increases in size separates them.

The cells in each layer multiply, so that they are arranged in several strata. The lining epithelium of the follicle is then called the *membrana granulosa*, and the heaped mass of cells around the ovum, the *discus proligerus*. The fluid increases in quantity, the follicle becomes tenser and tenser, and finally it reaches the surface of the organ and bursts; the ovum is thus set free, and is seized by the fringed ends of the Fallopian tube and thence passes to the uterus.

The bursting of a Graafian follicle usually occurs about the time of menstruation.

After the bursting of a Graafian follicle, it is filled up with what is known as a *corpus luteum*. This is derived from the wall of the follicle, and consists of columns of yellow cells developed from the yellow interstitial cells previously mentioned; it contains a blood clot in its centre. These cells multiply, and their strands get folded and converge to a central strand of connective tissue; between the columns there are septa of connective tissue with blood-vessels. The corpus luteum after a time gradually disappears; but if pregnancy supervenes it becomes larger and more persistent (see fig. 613).

The following table gives the chief facts in the life history of the ordinary corpus luteum of menstruation, compared with that of pregnancy:—

	Corpus Luteum of Menstruation.	Corpus Luteum of Pregnancy.
<i>At the end of three weeks.</i>	Three-quarters of an inch in diameter; convoluted wall pale.	Three-quarters of an inch in diameter; central clot reddish;
<i>One month.</i>	Smaller; convoluted wall bright yellow; clot still reddish.	Larger; convoluted wall bright yellow; clot still reddish.
<i>Two months.</i>	Reduced to the condition of an insignificant cicatrix.	Seven-eighths of an inch in diameter; convoluted wall bright yellow; clot perfectly decolorised.
<i>Six months.</i>	Absent.	Still as large as at end of second month; clot fibrinous; convoluted wall paler.
<i>Nine months.</i>		One half an inch in diameter; central clot converted into a radiating cicatrix; the external wall tolerably thick and convoluted, but without any bright yellow colour.

Some of the Graafian follicles never burst; they attain a certain degree of maturity, then atrophy and disappear.

An ovum is a large spheroidal cell surrounded by a trans-

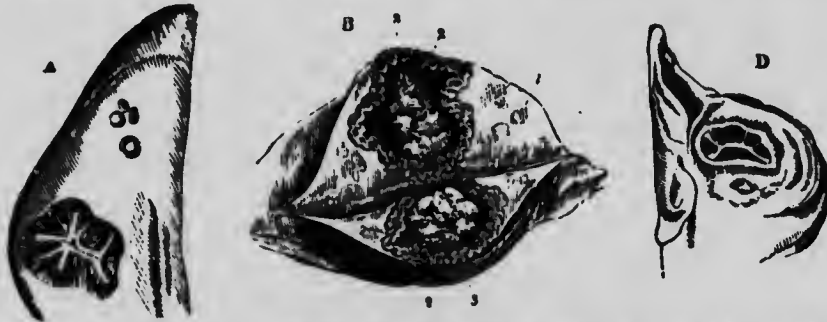

Fig. 613.—Corpora lutea of different periods. B, corpus luteum of about the sixth week after impregnation, showing its plicated form at that period. 1, substance of the ovary; 2, substance of the corpus luteum; 3, a greyish coagulum in its cavity. (Paterson.) A, corpus luteum two days after delivery; D, in the twelfth week after delivery. (Montgomery.)

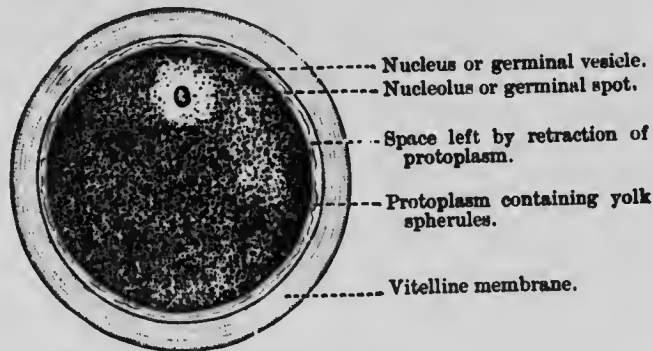

Fig. 614.—A human ovum. (Cadiat.)

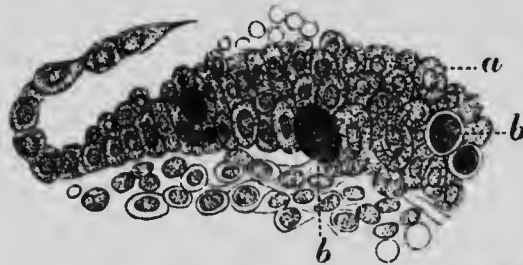

Fig. 615.—Germinal epithelium of the surface of the ovary of five days' chick. a, small ovoids; b, larger ovoids. (Cadiat.)

parent striated membrane called the *vitelline membrane*, or *zona pellucida*. The protoplasm is filled with large fatty and albuminous granules (*yolk spherules*), except in the part around the nucleus, which is comparatively free from these granules. It

contains a nucleus which has the usual structure of nuclei; there is generally one very well-marked nucleolus. The nucleus and nucleolus are still often called by their old names, *germinal vesicle* and *germinal spot* respectively. An attraction sphere, not shown in the figure, is also present.

The ova and the epithelium of the Graafian follicles are developed from the germinal epithelium which in the embryo forms a thick layer over the ovary; cords of these cells, solid in some animals, tubular in others, grow down into the stroma, and in time these are broken up into nests by ingrowths of the stroma. Each nest represents a primitive Graafian follicle. In this, one

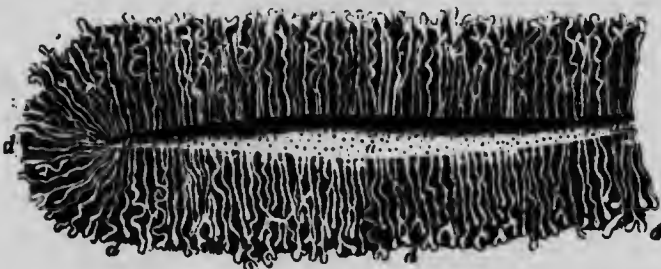

Fig. 616.—Section of the lining membrane of a human uterus at the period of commencing pregnancy showing the arrangement and other peculiarities of the glands, *d, d, d*, with their orifices, *a, a, a*, on the internal surface of the organ. Twice the natural size.

cell in particular becomes enlarged to form the ovum; the remainder form the epithelium of the follicle.

The Fallopian tubes have externally a serous coat derived from the peritoneum, then a muscular coat (longitudinal fibres outside, circular inside), and most internally a very vascular mucous membrane thrown into longitudinal folds, and covered with ciliated epithelium.

The uterus consists of the same three layers. The muscular coat is, however, very thick and is made up of two strata imperfectly separated by connective tissue and blood-vessels. Of these the thinner outer division is the true muscular coat, the fibres of which are arranged partly longitudinally, partly circularly. The inner division is very thick; its fibres run chiefly in a circular direction; the extremities of the uterine glands extend into its internal surface. It is in fact a much hypertrophied muscularis mucosæ.

The mucous membrane is thick, and consists of a corium of soft connective tissue, lined with ciliated epithelium; this is continued down into long tubular glands which have as a rule a convoluted course. In the cervix the glands are shorter. Near the os uteri the epithelium becomes stratified; stratified epithelium also lines the vagina.

At each menstrual period the uterus becomes congested, and some of the blood-vessels of the mucous membrane are ruptured; the blood, together with the secretion of the glands and some epithelial *débris* from the surface, constitutes the menstrual flow, which usually lasts two or three days. The amount of destruction of the surface epithelium is not, however, a marked phenomenon; still less is there any disintegration of the deeper parts of the mucous membrane.

For a description of the mammary glands see p. 460.

---

## CHAPTER LVIII.

### DEVELOPMENT.

THE description of the origin and formation of the tissues and organs constitutes the portion of biological science known as embryology. This subject is a large one, and many books are written which have for their exclusive object its elucidation. All one can possibly attempt in a physiological text-book is the merest outline of the principal facts of development.

In our descriptions throughout we shall endeavour to speak of the development of the mammal principally; it will not be possible to do so altogether, for many of the facts which are believed to be true of the mammal (man included) have only been actually seen in the lower animals. That they occur in the higher animals is a matter of inference.

It will, however, add interest to the subject to draw some of our descriptions from the lower animals; for the scientific discussion of embryology must always start from a wide survey of the whole animal kingdom. Without entering into any arguments in relation to the Darwinian theory of evolution, it will be sufficient to state in general terms that the series of changes which occur in the embryological history of the highest animals, form a compressed picture of the changes which have taken place in their historical development from lower types.

#### The Ovum.

The human ovum is like that of other mammals, a small spherical body about  $\frac{1}{125}$  to  $\frac{1}{100}$  inch in diameter; it is an organised animal cell consisting of a mass of protoplasm enclosing a nucleus and attraction sphere. The protoplasm, however, also

contains a granular material, vitelline or yolk substance which nourishes the protoplasmic part. The way in which ova are formed in the ovary is described in the chapter preceding this.

In many animals, as in birds, most of the changes from ovum to adult take place, not within the body of the parent, but outside of it. The egg can therefore derive no nutriment from the mother; and, as one would expect, the yolk substance is much more abundant. It is due to this fact that the eggs of birds, reptiles, and fishes are so much larger than the mammalian ovum. Each, however, is still essentially a single cell, much bulged by yolk material. The yellow part of the hen's egg which is alone comparable to the mammalian ovum has upon it a whitish speck or *cicatricula* about  $\frac{1}{8}$  inch in diameter; in this the nucleus or germinal vesicle is imbedded; it is here and in the surrounding protoplasm that cell division and growth goes on, the rest of the yolk serving to nourish this part.

Ova in which the whole cell takes part in cell division are called *holoblastic*; but those like the hen's egg, in which only a part, the *cicatricula* just alluded to, divides and subdivides, are termed *meroblastic*. There are, however, gradations between the two extremes.

The structure of the mammalian ovum has already been given (p. 801). The surrounding *zona pellucida* is perforated, at any rate in some animals, by a small hole called the *micropyle*, which enables a spermatozoon to enter. Some observers have described a second more delicate membrane within the *zona pellucida*.

#### Changes in the Ovum previous to Fecundation.

The most important change is the disappearance of the greater part of the nucleus; simultaneously with this two particles called the *polar* or *directing* globules appear on the surface of the ovum, between it and the *zona pellucida*.

The relation between these two phenomena, and many of the facts relating to the impregnation of, and early changes in the ovum were first made out by Oscar Hertwig, and Ed. v. Beneden, in the ova of sea-urchins and other echinoderms; they have been verified in many of the higher animals; and, though they have never been actually seen in the human ovum, there is practically no doubt that they occur there too.

In the case of the sea-urchin, the problem is a comparatively easy one to study. Sea-water containing the elements of each sex can be obtained, the changes watched, and finally the two specimens can be mixed and impregnation observed.

In the ovum, the nucleus travels to the surface of the ovum,

loses its investing membrane, and undergoes the changes associated with karyokinesis. In some cases, however, the chromosomes do not undergo longitudinal splitting, but divide into two equal groups which form the bases of the two new nuclei. The spindle lies at first horizontally under the outer circumference of the cell. At each end of the spindle an attraction sphere is situated; the granules of the protoplasm take a radial arrangement around the two attraction spheres. The spindle then becomes vertical, and the nucleus divides into two; the upper daughter nucleus with a thin investment of protoplasm is extruded from the body of the cell. The other daughter nucleus remains within the ovum; it does not return to the resting stage, but proceeds at once to repeat the process, and a second polar globule is extruded, so that only a quarter of the original nucleus remains within the ovum; this is then called the *female pronucleus*, and it travels towards the centre of the ovum. The first polar globule often divides into two after it is extruded.

Simultaneously the ovum shrinks, not only from the loss of the polar globules; but also from a shedding out of liquid which collects between the ovum and the zona pellucida and is called the *perivitelline fluid*. In this, later on, spermatozoa which have penetrated the zona pellucida, may be seen swimming.

#### Impregnation.

We now have a somewhat shrunken ovum possessing a female pronucleus. Impregnation or fertilization consists in the embedding of the head (nucleus) and middle portion of one spermatozoon in the protoplasm of the ovum; the tail is lost, and the male attraction sphere originally contained in the middle piece of the spermatozoon has around it the same star-like arrangement of the protoplasmic granules of the ovum which we described around the female attraction sphere. The head of the spermatozoon is now called the *male pronucleus*; it travels to the female pronucleus, and in some animals may for a time leave a distinct channel marking its pathway. Having reached the female pronucleus, it fuses with it and forms an ordinary nucleus. The whole cell so produced is then often called the *blastosphere*.

A great deal of discussion has taken place as to the meaning of the discharge of the polar globules. Fertilization consists in bringing to the ovum of a certain amount of germinal plasma from another individual or male, and Weismann assumes that it is necessary that the ovum, prior to development, should get rid both of its old histogenetic plasma, and of so much germinal plasma (*i.e.* matter endowed with heredity) as may be brought to

it by the spermatozoon. This is effected by the extrusion of the two polar globules. The second polar globule is the one which contains the germinal plasma, or the hereditary male element. In those animals which can reproduce their species for many generations without the intervention of a fresh male (parthenogenesis), the second polar globule is not extruded.

Fig. 617 represents a fertilized ovum, and if its appearance is compared with that of the ovarian ovum (fig. 614), there is not much anatomical distinction to be noticed between the two. The fertilized ovum is rather smaller, as it has discharged the polar globules and the perivitelline fluid, and its nucleus is composed of male and female elements; but great indeed is the physiological difference between the two, for the fertilized ovum now is a new individual, though in a very rudimentary condition. These

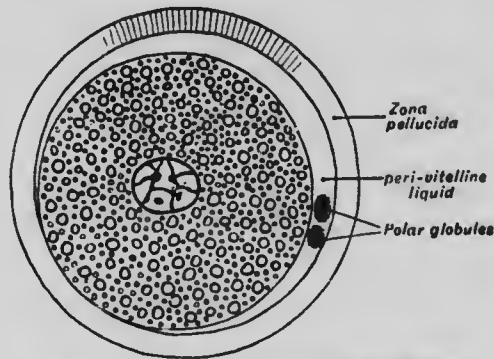

Fig. 617. —The fertilized ovum, or blastosphere.

processes all take place in the Fallopian tube of the mammal as the ovum travels towards the uterus, and then the process of segmentation or cell division begins. There is no doubt that the important hereditary substance is contained in the chromosomes of the nucleus. Of these an equal number is contributed by each sex, and in the subsequent cell division that occurs, the number of chromosomes in the nucleus is therefore always an even number.

### Segmentation.

The ovum first divides into two cells, then each of these into two again, and so on; until at last it consists of a mulberry-like mass of little cells, all still enclosed within the zona pellucida. The polar globules are soon lost to view. Cell division is always accompanied by the usual karyokinetic changes in the nucleus. On cutting a section through the embryo at this stage, it is found to consist of a single layer of cells arranged around a central cavity filled with fluid shed out from the cells. This is called the *blastula* stage or the stage of the *unilaminar* (one layered) *blastoderm*. The cells by mutual compression become columnar in shape, and soon the cells are arranged two layers deep; the

formation of the second layer within the first differs in different animals. In amphioxus and many of the invertebrates, it is formed by a process of invagination; that is, a portion of the surface layer is gradually pushed in until it completes a second layer within the first; the orifice of invagination is called the *blastopore*, and corresponds to a primitive mouth opening into a primitive alimentary cavity surrounded by the inner layer of cells. In mammals, the cells which are going to form the second layer take up a central position from the very start, and the outer cells by multi-



Fig. 618.—Diagrams of the various stages of cleavage of the ovum. (Dalton.)

*blastoderm*. The three layers are called from without inwards the *epiblast*, *mesoblast*, and *hypoblast*, or the *ectoderm*, *mesoderm*, and *endoderm*.

We must next study the way in which the mesoblast is formed between the other two layers. When the outer surface of the ovum is viewed from above, a streak or shadow is visible; this occurs first at its posterior end, and it gradually extends towards the



Fig. 619.—Impregnated egg, with commencement of formation of embryo; showing the area germinativa or embryonic spot, the area pellucida, and the primitive groove and streak. (Dalton.)

plying more quickly than the inner ones grow round and enclose them. This is the *gastrula* stage or the stage of the *bilaminar blastoderm*. Then a third layer is formed between the other two, and thus we arrive at the stage of the *trilaminar*



anterior end. It is due to a thickening of the epiblast, the cells of which multiply so that they are several layers deep. This appearance is called the *primitive streak*.

This is soon marked by a narrow groove along its centre, which is called the *primitive groove* (fig. 619.)

If we cut a transverse section through the ovum at this period, we have the appearance presented in the next figure (fig. 620).

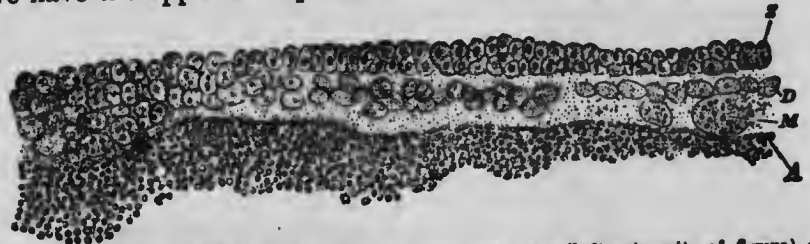

Fig. 620.—Vertical section of area pellucida and area opaca (left extremity of figure) of blastoderm of a fresh-laid egg. *S*, epiblast; *D*, hypoblast; *M*, large "formative cells," filled with yolk granules, derived from the hypoblast; *A*, the yolk immediately underlying the segmentation cavity. (Stricker.)

The actual preparation is from a chick's egg; the cicatricula has divided into a number of cells, and these are arranged in two layers, epiblast and hypoblast, but these, instead of surrounding the whole ovum, lie spread out on the surface of the yolk. This part of the embryo is subsequently pinched off from the yolk-sac. The area which actually gives rise to the embryo is called the

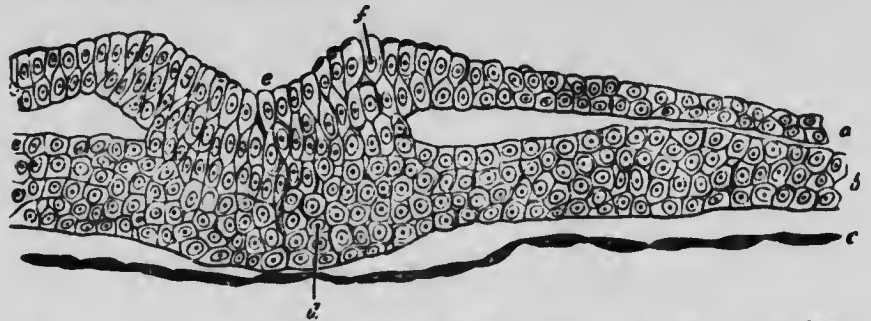

Fig. 621.—Transverse section through embryo chick (26 hours). *a*, epiblast; *b*, mesoblast; *c*, hypoblast; *d*, mass of cells at primitive streak; *e*, primitive groove. (Klein.)

*germinal disc*, and the *area opaca* in the middle, seen at the left extremity of the figure, is the opacity produced by the primitive streak, and this is seen to be caused by the proliferation of epiblastic cells, so that at this point they come into close contact with the hypoblast.

Fig. 621 shows a rather later stage; this mass of cells, chiefly epiblastic (*d*), gives origin to the intermediate layer or mesoblast (*b*) which grows between the other two layers.

The mesoblast, however, is not exclusively epiblastic in origin, for some of the cells in the mass *d*, fig. 621, are doubtless hypoblastic. Moreover, certain large 'formative cells' seen in fig. 620 *M* and in the next figure (fig. 622), originate from hypoblast and wander into the middle layer, and it is these cells which give origin to the connective-tissues and blood-vessels.



Fig. 622.—Vertical section of blastoderm of chick (1st day of incubation). *S*, epiblast, consisting of short columnar cells; *D*, hypoblast, consisting of a single layer of flattened cells; *M*, "formative cells." They are seen on the right of the figure, passing in between the epiblast and hypoblast to contribute to the mesoblast; *A*, white yolk granules. Many of the large "formative cells" are seen containing these granules. (Stricker.)

The three layers of the blastoderm show from the first distinctive characters; the epiblast and hypoblast present the appearance of epithelium, whereas the mesoblast is composed of cells which are not arranged close together, and many of them are branched.

The primitive streak and groove are evanescent structures; they indicate the longitudinal axis of the embryo, but they are soon replaced by a new and larger groove. This is formed by two new thickenings of epiblast which rise up like walls on each side of the middle line; they are united together in front, and they extend backwards, enclosing and then (fig. 623) obliterating the primitive groove.

These two walls are called the *medullary plates* or the *dorsal ridges*; the valley between them is called the *medullary groove*; this is the first appearance of the central nervous system. They approach one another, and meet in the middle line, and so convert the medullary groove into a canal.

Fig. 624 shows this diagrammatically in transverse section.

The epiblastic cells which line the medullary canal are, by the union of the two dorsal ridges, entirely cut off from the surface

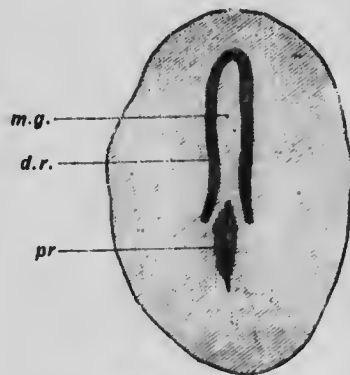

Fig. 623.—Embryonic area of a rabbit's ovum (7 days). *pr.*, primitive streak and groove; *m.g.*, medullary groove; *d.r.*, dorsal ridge. (After Külliker.)

epiblast; these cells multiply and the tube of epiblast gets much thicker; anteriorly it forms the brain and its cavity the cerebral ventricles; behind this it forms the spinal cord with its central canal. The nerves grow out from brain and cord at a later date.



Fig. 624.—Diagram of transverse section through an embryo before the closing-in of the medullary groove. *m*, cells of epiblast lining the medullary groove which will form the spinal cord; *h*, epiblast; *d*, hypoblast; *ch*, notochord; *u*, protovertebra; *sp*, mesoblast; *w*, edge of dorsal ridge, folding over medullary groove. (Külliker.)

The same diagram shows that the mesoblast is collected into large masses on each side of the neural canal; these are called the *protovertebræ*; a rod of cells has been also pinched off from the

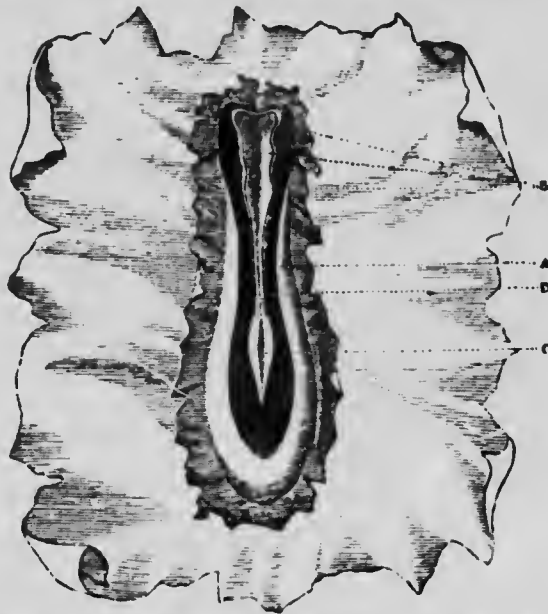

Fig. 625.—Embryo of dog. The neural groove, *A*, is not yet closed, and at its upper or cephalic end presents three dilatations, *B*, which correspond to the three divisions or vesicles of the brain. At its lower extremity the groove presents a lancet-shaped dilatation (*sinus rhomboidalis*), *C*. Along the bottom of the groove is observed a faint streak, which is the notochord. *D*, Dorsal ridges. (Bischoff.)

hypoblast, and is seen in transverse section (*ch*); it is called the *notochord*.

Fig. 625 shows a surface view of the embryo at rather a later stage. The union of the dorsal ridges takes place first about the neck of the future embryo; they soon after unite over the region of the head, while the closing in of the groove progresses much

more slowly towards the hinder extremity of the embryo. The medullary groove is by no means of uniform diameter throughout, and even before the dorsal ridges have united over it, is seen to be dilated at the anterior extremity and obscurely divided by constrictions into the three primary cerebral vesicles. The part from which the spinal cord is formed is of nearly uniform calibre, while towards the posterior extremity is a lozenge-shaped dilatation, which is the last part to close in.

The notochord is just visible underneath the neural canal.

The thickenings of the mesoblast called the *protovertebræ* are not continuous longitudinal structures like the neural canal and notochord, but consist of a number of quadrilateral masses situated down each side of the neural canal. They are seen in fig. 626, which also shows the primitive heart, and other structures to be described later on. The neural or medullary groove has by this time been quite closed in.

A transverse section through the embryo at this or a rather later stage (fig. 627) shows the points already mentioned, but there is also seen a splitting of the general mesoblast into two layers. One adheres to the epiblast and is called the *parietal mesoblast*, or *somatopleur*; the other adheres to the hypoblast and is called the *visceral mesoblast* or *splanchnopleur*; the space between them is the *body-cavity*, *cælom* or *pleuro-peritoneal cavity*; it is subdivided subsequently into the cavities of the pleuræ, pericardium and peritoneum.

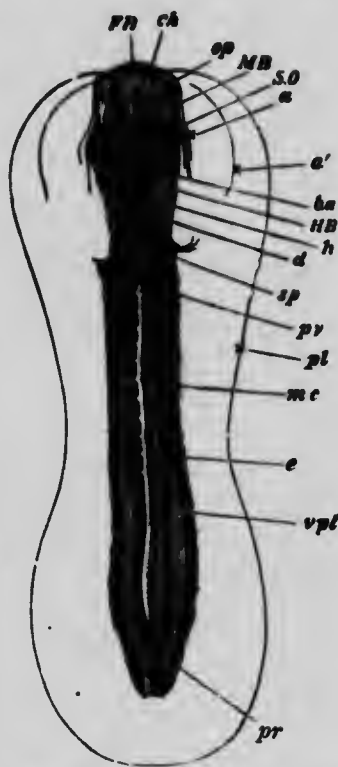
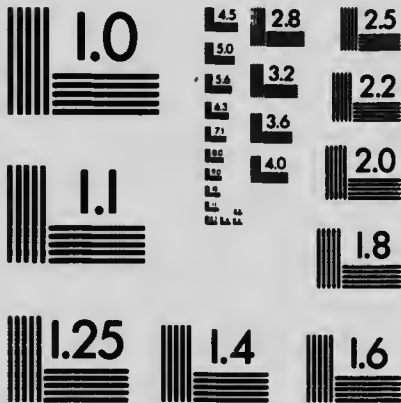

Fig. 626.—Embryo chick (36 hours), viewed from beneath as a transparent object (magnified). *pl*, outline of pellucid area; *FB*, fore-brain, or first cerebral vesicle; from its sides project *op*, the optic vesicles; *SO*, backward limit of somatopleur fold, "tucked in" under head; *a*, head-fold of true amnion; *a'*, reflected layer of amnion, sometimes termed "false amnion"; *sp*, backward limit of splanchnopleur folds, along which run the omphalo-mesenteric veins uniting to form *h*, the heart, which is continued forwards into *ba*, the bulbus arteriosus; *d*, the fore-gut, lying behind the heart, and having a wide crescentic opening between the splanchnopleur folds; *HB*, hind-brain; *MB*, mid-brain; *pr*, protovertebræ lying behind the fore-gut; *mc*, line of junction of medullary folds and of notochord; *ch*, front end of notochord; *vpl*, vertebral plates; *pr*, the primitive groove at its caudal end. (Foster and Balfour.)



# MICROCOPY RESOLUTION TEST CHART

(ANSI and ISO TEST CHART No. 2)



**APPLIED IMAGE Inc**

1653 East Main Street  
Rochester, New York 14609 USA  
(716) 482 - 0300 - Phone  
(716) 288 - 5989 - Fax

*Head and Tail Folds. Body-cavity.*—Every vertebrate animal consists essentially of a longitudinal axis (vertebral column) with a neural canal above it, and a body-cavity (containing the alimentary canal) beneath.

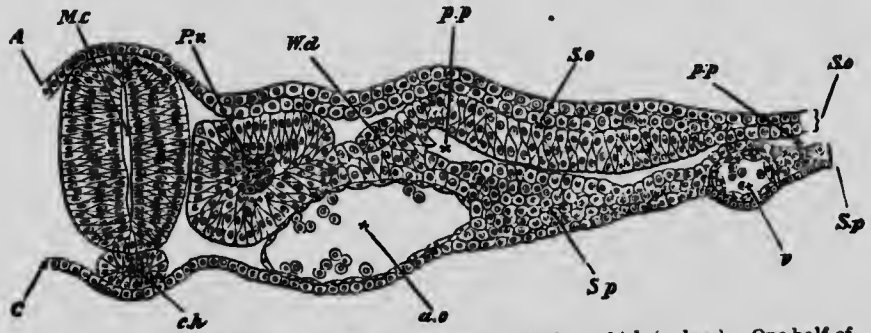

Fig. 627.—Transverse section through dorsal region of embryo chick (45 hrs.). One half of the section is represented; if completed it would extend as far to the left as to the right of the line of the medullary canal (*Mc*). *A*, epiblast; *C*, hypoblast, consisting of a single layer of flattened cells; *Mc*, medullary canal; *Pv*, protovertebra; *Wa*, Wolffian duct; *So*, somatopleur; *Sp*, splanchnopleur; *pp*, pleuro-peritoneal cavity; *ch*, notochord; *ao*, dorsal aorta, containing blood-cells; *v*, blood-vessels of the yolk-sac. (Foster and Balfour.)

We have seen how the earliest rudiments of the central axis and the neural canal are formed; we must now consider how the general body-cavity is developed. In the earliest stages the embryo lies flat on the surface of the yolk, and is not clearly marked off

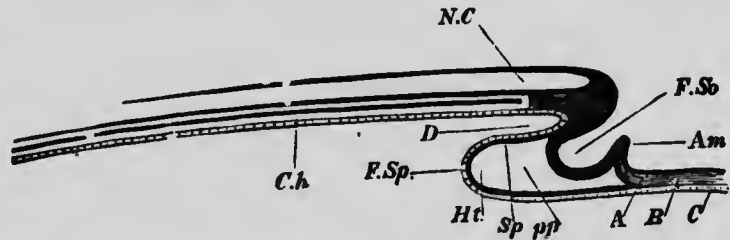

Fig. 628.—Diagrammatic longitudinal section through the axis of an embryo. The head-fold has commenced, but the tail-fold has not yet appeared. *F.Sb*, fold of the somatopleur; *F.Sp*, fold of the splanchnopleur; the line of reference, *F.so*, lies outside the embryo in the "moat," which marks off the overhanging head from the amnion; *D*, inside the embryo, is that part which is to become the fore-gut; *F.so* and *F.sp*, are both parts of the head-fold, and travel to the left of the figure as development proceeds; *pp*, space between somatopleur and splanchnopleur, pleuro-peritoneal cavity; *Am*, commencing head-fold of amnion; *N.C*, neural canal; *Ch*, notochord; *Ht*, heart; *A, B, C*, epiblast, mesoblast, hypoblast. (Foster and Balfour.)

from the rest of the blastoderm; but gradually the head-fold, a crescentic depression (with its concavity backwards), is formed in the blastoderm, limiting the head of the embryo; the blastoderm is tucked in under the head, which thus comes to project above the general surface of the membrane: a similar tucking in

of blastoderm takes place at the caudal extremity, and thus the head- and tail-folds are formed.

Similar depressions mark off the embryo laterally, until it is completely surrounded by a sort of moat which it overhangs on all sides, and which clearly defines it from the yolk. It will be understood that in mammals the yolk-sac is comparatively small.

This moat runs in further and further all round beneath the overhanging embryo, till the latter comes to resemble a canoe turned upside-down, the ends and middle being, as it were, decked in by the folding or tucking in of the blastoderm, while on the ventral surface there is still a large communication with the yolk, corresponding to the *well* or undecked portion of the canoe.

This communication between the embryo and the yolk is gradually contracted by the further tucking in of the blastoderm from all sides, till it becomes narrowed down, as by an invisible constricting band, to a mere pedicle which passes out of the body of the embryo at the point of the future umbilicus.

The downwardly folded portions of blastoderm are termed the *visceral plates*.

Thus we see that the body-cavity is formed by the downward folding of the visceral plates, just as the neural cavity is produced by the upward growth of the dorsal laminæ, the difference being that, in the visceral or ventral laminæ, all three layers of the blastoderm are concerned.

The folding in of the splanchnopleur, lined by hypoblast, pinches off a portion of the yolk-sac, enclosing it in the body-cavity. This forms the rudiment of the alimentary canal, which at this period ends blindly towards the head and tail, while in the centre it communicates at first freely, and then by a narrow tube with the yolk-sac.

The cavity within the hypoblast thus becomes divided into two portions which communicate through the vitelline duct; the portion within the body gives rise, as above stated, to the digestive canal, and that outside the body remains for some time as the *umbilical vesicle* or yolk-sac (fig. 629, *v*). The hypoblast forming the epithelium of the intestine is continuous with the lining membrane of the umbilical vesicle, while the visceral plate of the mesoblast is continuous with the outer layer of the umbilical vesicle.

The above details will be clear on reference to the accompanying diagrams, some of which, however, allude to structures we have not as yet touched upon. We may here mention three



other terms that are employed. The part of the primitive alimentary canal enclosed by the head-fold is called the *fore-gut*; that enclosed by the tail-fold is called the *hind-gut*; the remainder is called the *mid-gut*.

We have now seen the way in which a distinct embryo with foreshadowings of the future organs is formed. In subsequent

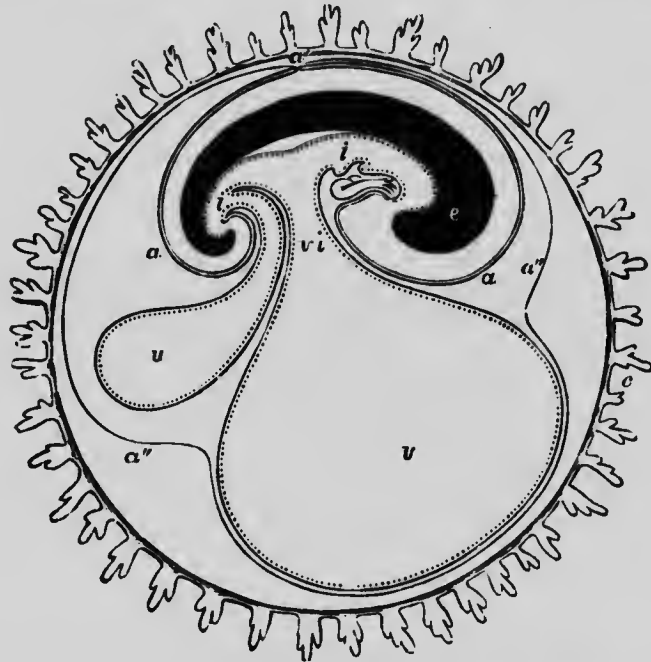

Fig. 629.—Diagrammatic section showing the relation in a mammal between the primitive alimentary canal and the membranes of the ovum. The stage represented in this diagram corresponds to that of the fifteenth or seventeenth day in the human embryo, previous to the expansion of the allantois; *c*, the villous chorion; *a*, the amnion; *a'*, the place of convergence of the amnion and reflexion of the false amnion *a''a''*, or outer or corneous layer; *e*, the head and trunk of the embryo, comprising the primitive vertebrae and cerebro-spinal axis; *i, i*, the simple alimentary canal in its upper and lower portions. Immediately beneath the right hand *i* is seen the foetal heart, lying in the anterior part of the pleuro-peritoneal cavity; *v*, the yolk-sac or umbilical vesicle; *vi*, the vitello-intestinal opening; *u*, the allantois connected by a pedicle with the hinder portion of the alimentary canal. (Quain.)

sections we shall have to study the way in which each set of organs is elaborated from these primitive structures. We may conclude this section by giving a list of the organs which are formed from the several primary embryonic layers:—

1. **From Epiblast.**—*a*. The epidermis and its appendages.
- b*. The nervous system, both central and peripheral.
- c*. The epithelial structures of the sense-organs.

- d. The epithelium of the mouth, the enamel of the teeth.
- e. The epithelium of the nasal passages.
- f. The epithelium of the glands opening on the skin and into the mouth, and nasal passages.
- g. The muscular fibres of the sweat-glands.

2. **From Mesoblast.**—a. The skeleton and all the connective-tissues of the body.

b. All the muscles of the body except those of the sweat-glands.

c. The vascular system, including the lymphatics, serous membranes, and spleen.

d. The urinary and generative organs, except the epithelium of the bladder and urethra.

*The Somatopleur* forms the osseous, fibrous, and muscular tissues of the body-wall including the true skin.

*The Splanchnopleur* forms the fibrous and muscular walls of the alimentary canal, the vascular system, and the urino-genital organs.

3. **From Hypoblast.**—a. The epithelium of the alimentary canal from the back of the mouth to the anus, and that of all the glands which open into this part of the alimentary tube.

b. The epithelium of the respiratory cavity.

c. The epithelium of the Eustachian tube and tympanum.

d. The epithelium lining the vesicles of the thyroid.

e. The epithelial nests of the thymus.

f. The epithelium of the bladder and urethra.

### The Fœtal Membranes.

This subject will be best understood by taking a view (fig. 630) of the uterus and its contents after the formation of all the membranes. We can then pass to the way in which the several membranes are formed.

The uterus, the muscular walls of which are hypertrophied, is lined by a greatly thickened mucous membrane, which is called the *decidua*, because after the delivery of the child it comes away from the uterus with the other membranes. The decidua is divided into three parts; the lining of the uterine cavity is called the *decidua vera* (*dv*); a continuation of this reflected over the fœtus and its membranes is called the *decidua reflexa* (*dr*); the portion of the decidua vera which is situated within the line of attachment of the decidua reflexa is called the *decidua serotina* (*ds*). These membranes are maternal in origin. Within the decidua reflexa are situated the fœtal membranes; the outer-

most of these is called the *chorion*; at first this is covered with villi containing blood-vessels; the villi dip into the surrounding decidua, but soon all of them atrophy and disappear, except those that dip into the decidua serotina, where they become greatly enlarged.

The chorion is really formed by a fusion of two foetal mem-

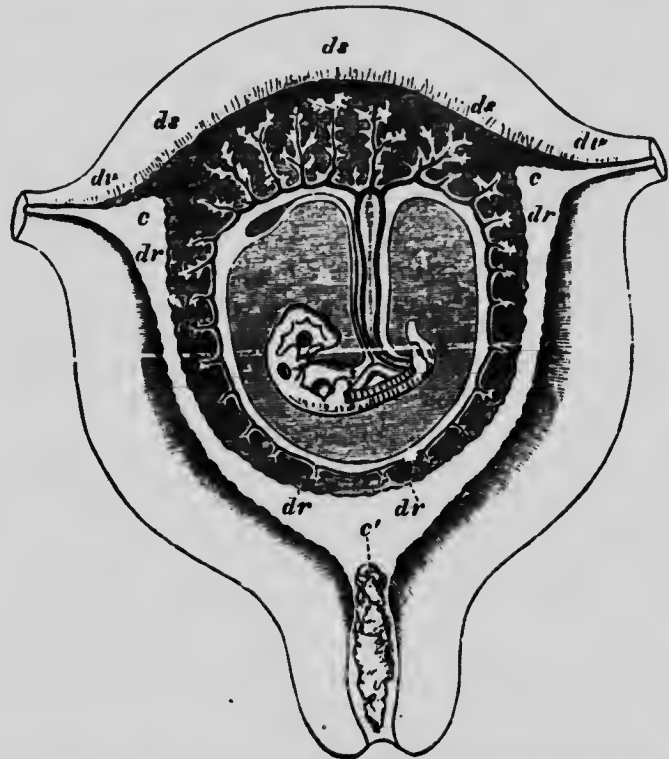

Fig. 630.—Diagrammatic view of a vertical transverse section of the uterus at the seventh or eighth week of pregnancy. *c, c'*, cavity of uterus, which becomes the cavity of the decidua, opening at *c, c'*, the cornua, into the Fallopian tubes, and at *c'* into the cavity of the cervix, which is closed by a plug of mucus; *dv*, decidua vera; *dr*, decidua reflexa, with the sparser villi imbedded in its substance; *ds*, decidua serotina, involving the more developed chorionic villi of the commencing placenta. The foetus is seen lying in the amniotic sac; passing up from the umbilicus is seen the umbilical cord and its vessels passing to their distribution in the villi of the chorion; also the pedicle of the yolk-sac, which lies in the cavity between the amnion and chorion. (Allen Thomson.)

branes; the *false amnion* and the *allantois*; the allantois begins as an outgrowth from the hind-gut; the mesoblast which covers it becomes developed into blood-vessels, and thus the false amnion to which it becomes adherent is vascularised; the main vessels in the stalk of the allantois convey blood to and from between the foetus and the *placenta*. The placenta is formed

partly of maternal tissue (*decidua serotina*); partly of foetal tissue (*chorion*). Within the chorion is another foetal membrane, which is attached to the ventral wall of the embryo; it is called the *amnion*. This forms a sheath to the allantoic stalk or *umbilical cord*, and is then reflected over the rest of the embryo. In the umbilical cord are seen the remains of the *yolk-*

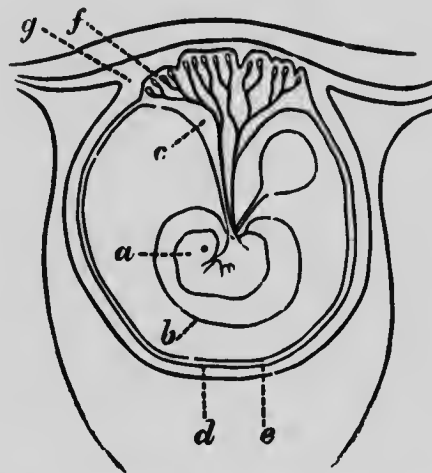

Fig. 631.—Diagram of an early stage of the formation of the human placenta. *a*, embryo; *b*, amnion; *c*, placental vessels; *d*, decidua reflexa; *e*, chorion; *f*, placental villi; *g*, mucous membrane or decidua vera. (Cadiat.)

*sac* or *umbilical vesicle*. The amnion is filled with *amniotic fluid* in which the foetus floats, and is thus protected from external violence. The *os uteri* is closed by a plug of mucus.

Fig. 631 is a rather more diagrammatic view of the same structures in outline, the villi over the general surface of the chorion having disappeared.

### Development of the Decidua.

The ovum which has been fertilised in the Fallopian tube usually arrives in the uterus in the condition of the trilaminar blastoderm. It is larger than the undeveloped ovum, but still it is extremely small. The mucous membrane (*decidua*) becomes thicker, more pulpy, and has longer glands than it would have had if fertilisation had not occurred. In this the ovum is speedily imbedded, usually near the fundus of the uterus; the mucous membrane grows over the little ovum and encloses it, and so the decidua

reflexa is formed ; the decidua serotina is that part of the decidua vera which intervenes between the ovum and the uterine wall within the circle of attachment of the decidua reflexa.

With the subsequent growth of the ovum, the decidua reflexa expands also, encroaching more and more on the uterine cavity, and ultimately coming into contact with the decidua vera, with which it blends.

The glands of the decidua were at one time supposed to receive the villous outgrowths of the chorion. It has since been shown that these grow into the substance between the glands. The glands, however, furnish a secretion called *uterine milk*, which assists the nourishment of the embryo previous to the establishment of the placental circulation. Later on the glands are obliterated.

The decidua serotina is the part which undergoes most change ; an irregular spongy tissue is formed in this situation ; and the spaces in the spongework are filled with blood ; the spongework of vascular spaces is incompletely divided into what are called *cotyledons* by fibrous bands ; and each cotyledon receives a much hypertrophied chorionic villus. It is this conjunction of chorionic villi with decidual tissue that makes up the placenta, which at full term is seven or eight inches across and weighs nearly a pound.

The placenta is the situation where the fœtus receives its nutriment and its oxygen. There is no direct communication between the vascular systems of the mother and fœtus. The sinuses of the placenta are filled with maternal blood from the uterine arteries ; the uterine veins carry it away ; but in these blood-spaces the tufts of fœtal blood-vessels are hanging. Oxygen and nutriment pass through the walls of the fœtal blood-vessels from the maternal to the fœtal blood, and carbonic acid, urea and other waste products pass in the contrary direction. The fœtal blood leaves the fœtus by the two umbilical arteries, which are the terminal branches of the fœtal aorta ; these pass in the stalk of the allantois to the placenta, and after undergoing oxygenation in the placental tufts the blood returns by the umbilical vein to the fœtus once more.

#### Development of the Fœtal Membranes.

**The Yolk-sac.**—We have already considered the way in which the body of the embryo is pinched off from the yolk-sac. Numerous blood-vessels are developed in its wall, and the

nutriment thus absorbed from it passes to the fœtal heart by two veins called the *omphalo-mesenteric veins*. The blood-vessels are first formed at the circumference of a clear area surrounding the embryo; and the place where they are situated is called the vascular area. This is shown about the natural size in the hen's egg in fig 632.

In birds the yolk-sac affords nutriment till the end of incubation, and the omphalo-mesenteric vessels are developed to a corresponding degree; but in mammalia the office of the umbilical vesicle

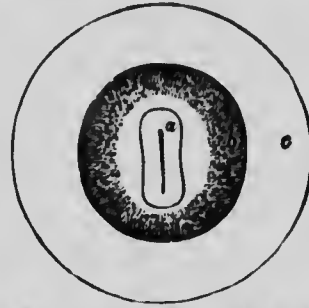

Fig. 632.—Diagram showing vascular area in the chick. *a*, area pellucida; *b*, area vasculosa; *c*, area vitellina.

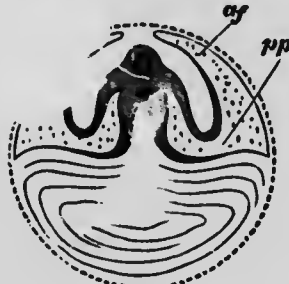

Fig. 633.

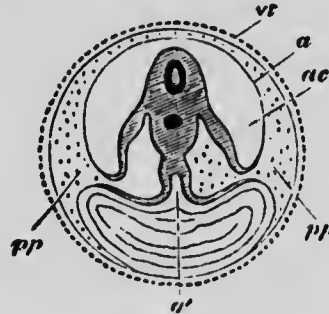

Fig. 634.

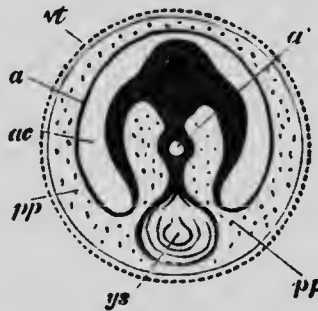

Fig. 635.

Figs. 633, 634, and 635.—Diagrams showing three successive stages of development. Transverse vertical sections. The yolk-sac, *ys*, is seen progressively diminishing in size. In the embryo itself the medullary canal and notochord are seen in section. *a'*, in Fig. 621, the alimentary canal, becoming pinched off from the yolk-sac; *a'*, in lower figure, alimentary canal completely closed; *a*, in last two figures, amnion; *ac*, cavity of amnion filled with amniotic fluid; *pp*, space between amnion and chorion continuous with the pleuro-peritoneal cavity inside the body; *vt*, vitelline membrane, or zona pellucida; *ys*, yolk-sac, or umbilical vesicle. (Foster and Balfour.)

ceases at a very early period, as the quantity of the yolk is small, and the embryo soon becomes independent of it by

the connections it forms with the parent. Moreover, in birds, as the sac is emptied, it is gradually drawn into the abdomen through the umbilical opening, which then closes over it: but in mammalia it always remains on the outside; and as it is emptied it contracts (fig. 635), shrivels up, and together with the part of its duct external to the abdomen, is detached and disappears, either before or at the termination of intra-uterine life, the period of its disappearance varying in different orders of mammalia.

When blood-vessels begin to be developed, they ramify largely over the walls of the umbilical vesicle, and are actively concerned in absorbing its contents and conveying them away for the nutrition of the embryo.

At an early stage of development of the fœtus, and some time before the completion of the changes which have been just described, two important structures, called respectively the *amnion* and the *allantois*, begin to be formed.

**Amnion.**—The amnion is produced as follows:—Beyond the head- and tail-folds before described (p. 812), the somatopleur coated by epiblast, is raised into folds, which grow up, arching over the embryo, not only anteriorly and posteriorly but also laterally, and all converging towards one point over its dorsal surface (fig. 637).

The folds not only come into contact but coalesce. The inner of the two layers forms the *true amnion*; it is composed externally of mesoblast and is lined by epiblast; the outer layer is termed the *false amnion*; it is composed externally of epiblast and is lined by mesoblast. It coalesces with the inner surface of the remains of the original vitelline membrane or zona pellucida.

The cavity between the true amnion and the external surface of the embryo becomes a closed space, termed the *amniotic cavity* (*ac*, fig. 635).

At first, the amnion closely invests the embryo, but it becomes gradually distended with fluid (*liquor amnii*), which, as pregnancy advances, reaches a considerable quantity.

This fluid consists of water containing small quantities of albumin, urea, and salts. Its chief function during gestation appears to be the mechanical one of affording equal support to the embryo on all sides, and of protecting it as far as possible from the effects of blows and other injuries to the abdomen of the mother. It is an exudation from both fœtal and maternal blood; the urea in it comes from the fœtal urine, which is passed into it in the later months of pregnancy.

On referring to figs. 633, 634 and 635, it will be obvious that

the cavity outside the amnion, between it and the false amnion, is continuous with the pleuro-peritoneal cavity at the umbilicus.

This cavity is not entirely obliterated even at birth, and contains a small quantity of fluid, which is discharged during parturition either before, or at the same time as the amniotic fluid.



Fig. 636.—Human embryo of fifth week with umbilical vesicle; about natural size. (Dalton.) The human umbilical vesicle exceeds the size of a small pea.

**Allantois.** — Into this space the allantois sprouts out, its formation commencing during the development of the amnion.

Growing out from the hinder portion of the intestinal canal (c, fig. 637), with which it communi-

icates, the allantois is at first a solid pear-shaped mass of splanchnopleur; it becomes vesicular by the projection into it of a hollow outgrowth of hypoblast. The hypoblast, however, does not extend very far. The mesoblastic part of the allantois very soon becomes vascular, and insinuates itself between the amniotic folds, just described. It unites with the outer of the two folds (false amnion), which has itself, as before said, become one with the remains of external investing membrane of the egg. As it grows, the allantois becomes exceedingly vascular; in birds it envelops the whole embryo—taking up vessels to the outer investing membrane of the egg, and lining the inner surface of the shell with a vascular membrane, by these means affording an extensive surface in which the blood may be aerated. In the human subject and in other mammalia, the vessels carried by the allantois are ultimately distributed only to a special part of the false amnion, where, by interlacement with the vascular system of the mother, the *placenta* is developed.

In mammalia, as the visceral layer close in the abdominal



Fig. 637.—Diagram of fecundated egg. a, umbilical vesicle; b, amniotic cavity; c, allantois. (Dalton.)



Fig. 638.—Fecundated egg with allantois nearly complete. a, inner layer of amniotic fold; b, outer layer of ditto; c, point where the amniotic folds come in contact. The allantois is seen penetrating between the outer and inner layers of the amniotic folds. This figure, which represents only the amniotic folds and the parts within them, should be compared with figs. 629, 630, in which will be found the structures external to these folds. (Dalton.)



cavity, the allantois is thereby divided at the umbilicus into two portions; the outer part, extending from the umbilicus to the *chorion*, soon shrivels; while the inner part remaining in the abdomen, is in part converted into the urinary bladder; the portion of the inner part not so converted, extends from the bladder to the umbilicus, under the name of the *urachus*. After birth the umbilical cord, and with it the external and shrivelled portion of the allantois, are cast off at the umbilicus, while the *urachus* remains as an impervious cord stretched from the top of the urinary bladder to the umbilicus, in the middle line of the body, immediately beneath the parietal layer of the peritoneum.



Fig. 639.

Fig. 640.

Figs. 639 and 640.—*a*, chorion with villi. The villi are shown to be best developed in the part of the chorion to which the allantois is extending; this portion ultimately becomes the placenta; *b*, space between the true and false amnion; *c*, amniotic cavity; *d*, situation of the intestine, showing its connection with the umbilical vesicle; *e*, umbilical vesicle; *f*, situation of heart and vessels; *g*, allantois.

**The Chorion.**—This is formed by the fusion of three membranes, namely, the original vitelline membrane, the outer layer of the amniotic fold (false amnion), and the allantois which supplies it with blood-vessels.

Very soon after its formation, its outer surface is beset with fine processes, *chorionic villi* (*a*, figs. 639, 640), which give it a rough and shaggy appearance. At first only cellular in structure, these little outgrowths subsequently become vascular by the development in them of loops of capillaries (fig. 641); and the latter at length form the minute extremities of the blood-vessels which are conducted from the fœtus to the chorion by the allantois. The function of the villi of the chorion is evidently the absorption of nutrient matter for the fœtus; and this is probably supplied to

them at first from the fluid matter, secreted by the glands of the uterus in which they are soaked. Soon, however, the fetal vessels of the villi come into more intimate relation with the vessels of the uterus. The part at which this relation between the vessels of the fœtus and those of the parent ensues, is not, however, over the whole surface of the chorion; for, although all the villi become vascular, yet they become indistinct or disappear except at one part where they are greatly developed, and by their branching give rise, with the vessels of the uterus, to the formation of the *placenta*. The structure and functions of the placenta, however, we have already described in connection with the decidua.

The *umbilical cord* is composed of the following parts:— (1.) Externally, a layer of the amnion, reflected over it from the umbilicus.

(2.) The umbilical vesicle or yolk sac with its duct and appertaining omphalo-mesenteric blood-vessels. (3.) The remains of the allantois, and continuous with it the urachus. (4.) The umbilical vessels, two arteries and one vein, which ultimately form the greater part of the cord. These are embedded in a jelly-like connective tissue called the Whartonian jelly.

*The After-birth.*—In parturition, the pressure of the uterine and abdominal walls upon the uterine contents, and especially on the amniotic fluids, causes a bulging of the membranes (combined deciduæ, chorion and amnion) through the os uteri. When the membranes are ruptured the fluid escapes, and then the fœtus is expelled. Later contractions of the uterus detach the placenta from the uterine wall, and this is in turn expelled; the separation extends around the decidua lining the rest of the uterus, and, turned inside out, this follows the placenta, carrying with it the other membranes. This constitutes the after-birth. The severance of the umbilical cord should not be done until some minutes after the birth of the child, or it is deprived of a good deal of the blood which is subsequently squeezed out of the placenta into it.



Fig. 641.

### Development of the Framework of the Body.

The **notochord** is a primitive vertebral column which, unlike the true vertebral column that replaces it, is a single rod. In amphioxus and the lampreys, however, it remains in the adult as a permanent skeletal support. In structure it closely resembles cellular cartilage (p. 57), and is enclosed in a sheath. It is composed of a very insoluble proteid-like matter, which is, however, not collagen. Collagen, and gelatin which is formed from collagen by boiling, are characteristic of true connective tissues; these are formed from mesoblast; the notochord is hypoblastic. It contains also, like all embryonic tissues, a large quantity of glycogen. Its place is ultimately occupied by the vertebral bodies, but traces of it are found even in the adult in the centres of the intervertebral discs.

The **protovertebræ** or protovertebral somites form the vertebræ and other structures as well. Each divides vertically into two parts, an inner and an outer. It is the inner division that forms the vertebræ; the outer division is called the musculo-cutaneous plate, and it is continued into the general mesoblast which divides into the splanchnopleur and somatopleur with the pleuro-peritoneal cavity between them.

The inner portion of each pair of protovertebræ grows around the notochord and in time almost obliterates it; this forms the body of the vertebra; it also grows around the primitive spinal cord, and so forms the neural arch of the vertebra. This part of the protovertebra is more distinctly separated from the other segments of the protovertebral column from the first, and so allows the spinal nerves which are sprouting out from the spinal cord to leave the spinal cord for the body walls.

At first, all these parts are composed of protoplasmic embryonic cells, but as development progresses the cells become specialised in function and structure, some becoming cartilage cells, others muscular fibres, &c. At a later date still, the cartilaginous vertebræ are replaced by bone.

The vertebræ do not exactly correspond in their position to the protovertebræ; each vertebra is developed from the contiguous halves of two protovertebræ. The original segmentation of the protovertebræ disappears, and a fresh subdivision occurs in such a way that the intervertebral disc is developed opposite the centre of each protovertebra. In the musculo-cutaneous plate are developed the muscles and true skin of the body wall, and the ribs.

While these changes have been going on, the ventral walls of the embryo have been formed by the downgrowth of the cephalic fold in the head region, the caudal fold at the tail end of the animal, and the two lateral or umbilical folds which grow last and enclose the thoracic and abdominal organs.

The embryo also undergoes certain changes in form and attitude; in the first place *torsion* takes place; this is more marked in birds and reptiles than in mammals; by this term one means that the embryo no longer lies ventral surface downwards facing the yolk-sac, but turns slightly over so that the left side is lowermost; in birds the embryo may turn through a quarter of a

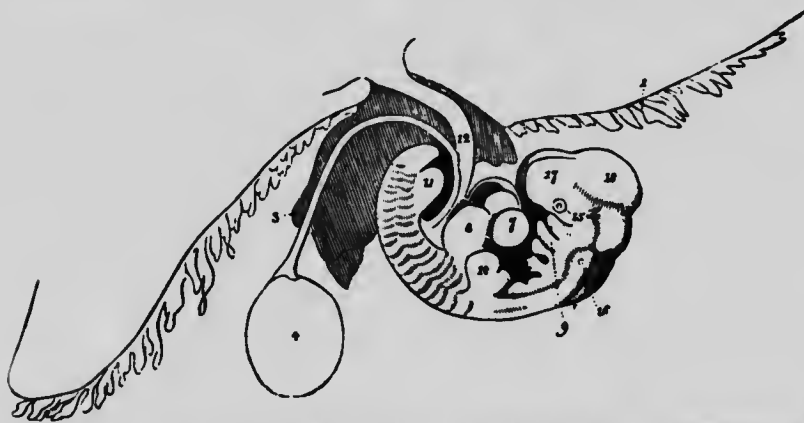

Fig. 612.—A human embryo of the fourth week,  $3\frac{1}{2}$  lines in length.—1, the chorion; 3, part of the amnion; 4, umbilical vesicle with its long pedicle passing into the abdomen; 7, the heart; 8, the liver; 9, the visceral arch destined to form the lower jaw, beneath which are two other visceral arches separated by the branchial clefts; 10, rudiment of the upper extremity; 11, that of the lower extremity; 12, the umbilical cord; 15, the eye; 16, the ear; 17, cerebral hemispheres; 18, optic lobes, corpora quadrigemina. (Müller.)

circle. Then the vertebral column becomes curved, but the chief bend is known as the *principal cephalic flexure*. This occurs at the anterior end of the notochord; it is a strong angular flexion in the region of the mid-brain, which is subsequently the position of the *sella turcica*.

In connection with this must be mentioned the development of the *pituitary body* which occupies the *sella turcica* in the adult. It is formed by the meeting of two out-growths, one from the foetal brain, which grows downward, and the other from the epiblast of the buccal cavity, which grows up towards it. The surrounding mesoblast also takes part in its formation. The connection of the first process with the brain becomes narrowed, and persists as the infundibulum, while that of the other process with the buccal cavity disappears completely.

**The Limbs.**—The muscles of the body developed from the lateral extensions of the protovertebræ are, at first, like the vertebræ, arranged in successive segments or myotomes. This is very well seen in the ringed condition of the muscles in such simple vertebrates as amphioxus. Even in fishes, where the limbs are not in a high state of development, the muscular segments are well seen. They are seen also in man in the intercostal muscles, and in the abdominal region are indicated by the transverse septa across the rectus abdominis, but here, as in other mammals, this simple metameric segmentation is masked by the great development of the large muscles which attach the limbs to the four corners of the trunk.

The limbs are lateral extensions of segments or somites in certain situations. They consist of parietal mesoblast covered by epiblast. At first there is simply a bud, but this grows, and in time divides into three segments, arm, fore-arm, and hand in the upper limb; thigh, leg, and foot in the lower limb. The hand and foot then give rise to buds corresponding to the digits. Each limb is connected to a limb girdle. The epiblast here, as elsewhere, forms the epidermis; the true skin, subcutaneous tissues, muscles, blood-vessels, and cartilages (subsequently replaced by bone) are formed by differentiation from the mesoblast. In further development the positions of the limbs become shifted by rotation, so that the anterior (radial) border of the upper limb becomes outermost, and the anterior (tibial) border of the lower limb becomes internal.

#### Formation of the Head.

In the formation of the head, a number of elements are concerned. There is first the notochord, which extends as far forwards as the *dorsum sellæ*; this, however, as in the vertebral column, is transitory, and is soon replaced by a primitive cartilaginous cranium developed from the mesoblast around it, as the vertebræ are developed from the protovertebræ. This forms the base of the skull. The roof or cranial vault is formed by membrane bones, that is, bones not preceded by cartilage; sense capsules which are formed around prolongations of the brain, and the visceral arches and slits contribute to the formation of that part of the head which is called the face. The mesoblast, which continues up the protovertebræ into the head region on each side of the notochord, is not separated into parts corresponding to vertebræ. Cartilage is formed in it; two cartilaginous bars, one on each side of the notochord, are called the *parachordal cartilages*,

and two other bars embracing the pituitary body situated in front of these are called the *trabeculae cranii* (fig. 643, A). These unite in front, and with the parachordal cartilages behind to form a continuous mass (basilar cartilage), which completely invests the notochord posteriorly (fig. 643, B). The parachordal part of this represents the basi-occipital and basi-sphenoid; the prechordal part represents the pre-sphenoid and ethmoid portions; posteriorly and at the sides, cartilaginous plates grow over the cerebral vesicles, but this only occurs to a small extent in mammals. In these animals the occipital region alone is roofed in by cartilage; the rest of the cranial vault being formed of membrane bones.

Anteriorly the united trabeculae form the ethmoid cartilage and the nasal septum, and enclose the nasal pits externally.

From the sides of the pre-sphenoid, the lesser wings or orbito-

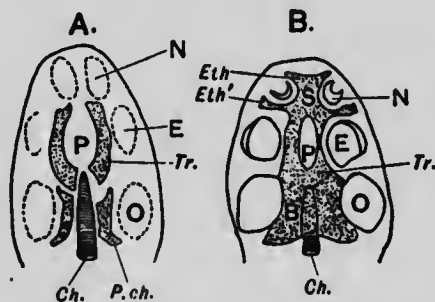

Fig. 643.—Diagrams of the cartilaginous cranium.

- A, first stage. *Ch*, notochord; *Tr*, trabeculae cranii; *P.ch.*, parachordal cartilages; *P*, situation of pituitary body; *N*, *E*, *O*, situations of olfactory, visual, and auditory organs.
- B, later stage. *B*, basilar cartilages; *S*, nasal septum and ethmoidal cartilages; *Eth*, *Eth'*, prolongations of ethmoid around olfactory organ, completing the nasal capsule; *N*, *E*, *O*, *Ch*, *Tr*, *P*, as before. (After Wiedersheim.)

sphenoids containing the optic foramina are developed, and from the sides of the basi-sphenoid the greater wings or alisphenoids. A cartilaginous capsule invests the auditory vesicle and becomes connected to the parachordal cartilage on each side. It is called the periotic capsule; within this bony centres are formed, and the bone constitutes the petrous and mastoid portions of the temporal bone.

**The Visceral Clefts and Arches.**—In all vertebrata there is at one period of development a series of slits in the neck region; these are formed as inpushings from the exterior, and open into the anterior end of the alimentary canal. These are six in number, but in man the two hinder ones rapidly disappear; the first enlarges and forms the mouth; and at the sides of this the

eyes are formed by depressions of the skin which meet the optic vesicles, outgrowths from the brain. The nasal pits take origin as two simple depressions, the primary olfactory or *nasal pits*; these become connected to the first cleft or mouth. The second slit, which corresponds to the spiracle of fishes, becomes the external auditory meatus and the Eustachian tube. The remainder, which correspond to the gill slits of fishes, entirely close up in mammals, and no gills are developed on their margins.

The anterior border of each cleft forms a fold or lip, the **branchial** or **visceral fold**. The posterior border of the last cleft is also formed into a fold, so that there are four clefts and five folds, but the three most anterior are far more prominent than the others, and of these the second is the most conspicuous. The first fold nearly meets its fellow in the middle line, the second less nearly, and the others in order still less so. The first arch



Fig. 644.—A. Magnified view from before of the head and neck of a human embryo of about three weeks (from Ecker).—1, anterior cerebral vesicle or cerebrum; 2, middle ditto; 3, middle or fronto-nasal process; 4, superior maxillary process; 5, eye; 6, inferior maxillary process, or first visceral arch, and below it the first post-oral cleft; 7, 8, 9, second, third, and fourth arches and clefts. B. Anterior view of the head of a human fetus of about the fifth week (from Ecker).—1, 2, 3, 5, the same parts as in A; 4, the external nasal or lateral frontal process; 6, the superior maxillary process; 7, the lower jaw; x, the tongue; 8, first post-oral cleft becoming the meatus auditorius externus.

gives off a branch from its front edge, which passes forwards to meet its fellow, but these offshoots do not quite meet, being separated by a process which grows downwards from the head. Between the branches, or maxillary processes, and the main first fold is the cavity of the mouth. The branches represent the superior maxilla, and the main folds the mandible or lower jaw. The central process, which grows down, is the fronto-nasal process.

From or in connection with these arches the following parts are developed:—

The first arch (mandibular) contains a cartilaginous rod

(Meckel's cartilage), around the distal end of which the lower jaw is developed, while the malleus is ossified from the proximal end.

When the maxillary processes on the two sides fail partially or completely to unite in the middle line, the well-known condition termed *cleft-palate* results. When the integument of the face presents a similar deficiency, we have the deformity known as

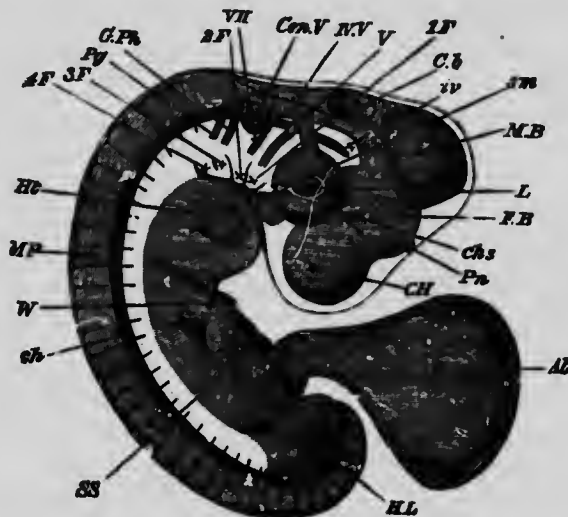

Fig. 645.—Embryo chick (4th day), viewed as a transparent object, lying on its left side (magnified). *CH*, cerebral hemispheres; *FB*, fore-brain or vesicle of third ventricle, with *Pn*, pineal gland projecting from its summit; *MB*, mid-brain; *Cb*, cerebellum; *IV*, *V*, fourth ventricle; *L*, lens; *ch s*, choroidal slit; *Cn. V*, auditory vesicle; *sm*, superior maxillary process; *1F*, *2F*, &c., first, second, third, and fourth visceral folds; *V*, fifth nerve, sending one branch (ophthalmic) to the eye, and another to the first visceral arch; *VII*, seventh nerve, passing to the second visceral arch; *G. Ph*, glossopharyngeal nerve, passing to the third visceral arch; *Pg*, pneumogastric nerve, passing towards the fourth visceral arch; *iv*, investing mass; *ch*, notochord; its front end cannot be seen in the living embryo, and it does not end as shown in the figure but takes a sudden bend downwards, and then terminates in a point; *Ht*, heart seen through the walls of the chest; *MP*, muscle-plates; *W*, wing, showing commencing differentiation of segments, corresponding to arm, forearm, and hand; *SS*, somatic stalk; *Al*, allantois; *HL*, hind-limb, as yet a shapeless bud, showing no differentiation. Beneath it is seen the curved tail. (Foster and Balfour.)

*hare-lip*. Though these two deformities frequently co-exist, they are by no means always necessarily associated.

The upper part of the face in the middle line is developed from the *frontal-nasal process* (A, 3, fig. 644).

From the *second arch* are developed the *incus*, *stapes*,\* and *stapedius* muscle, the styloid process of the *temporal bone*, the *stylo-hyoid ligament*, and the *smaller cornu of the hyoid bone*.

\* The origin of the ear ossicles given in the text is only one of five or six different views that have been advanced by different observers.



From the *third* visceral arch, the *greater cornu* and *body* of the hyoid bone arise. In man and other mammalia the other arches disappear. They occupy the position where the neck is afterwards developed.

A distinct connection is traceable between these visceral arches and certain cranial nerves: the trigeminal, the facial, the glosso-pharyngeal, and the vagus. The ophthalmic division of the trigeminal supplies the fronto-nasal process; the superior and inferior maxillary divisions supply the maxillary and mandibular arches respectively.

The facial nerve distributes one branch (*chorda tympani*) to the first visceral arch, and others to the second visceral arch. Thus it divides, enclosing the cleft next behind the mouth.

Similarly, the glosso-pharyngeal divides to enclose the third visceral cleft, its lingual branch being distributed to the second, and its pharyngeal branch to the third arch.

The vagus, too, sends a branch (pharyngeal) along the next arch, and in fishes gives off paired branches, which divide to enclose the remaining branchial clefts.

#### Development of the Vascular System.

We have already mentioned that at an early stage in development the *area vasculosa* makes its appearance in the part of the yolk-sac which is separated from the body of the embryo by a clear space (see fig. 632). This is produced by mesoblastic cells becoming hollow, filled with blood, and uniting to form embryonic capillaries (see p. 422). These vessels converge to two trunks, one on each side, which are called the *omphalo-mesenteric* or *vitelline* veins, and these lead to the embryonic heart.

The heart is developed in the splanchnopleur, by a folding off of the pleuroperitoneal cavity. It appears beneath the posterior end of the fore-gut. Its first appearance, however, is as two tubes, one on each side of the fore-gut. This is shown in outline in the next diagram (fig. 646).

It will be seen that the medullary groove is enlarged anteriorly, and the primary optic vesicles are growing from the first cerebral enlargement. Eight pairs of protovertebræ are shown; and on either side of the head the primitive tubular heart (H) is seen.

If we look at a rather later stage, shown in transverse section in the next figure (fig. 647), we see the two tubular hearts cut across, and approaching one another beneath the alimentary canal, which is being cut off from the yolk-sac.

Fig. 648 shows how the two primitive tubes have coalesced to form one (H) beneath the anterior end of the alimentary canal,

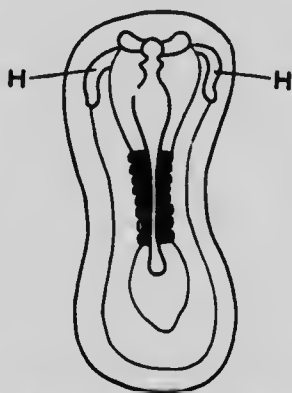

Fig. 646.—Rabbit embryo of the ninth day, seen from the surface. (After Kùlliker.)

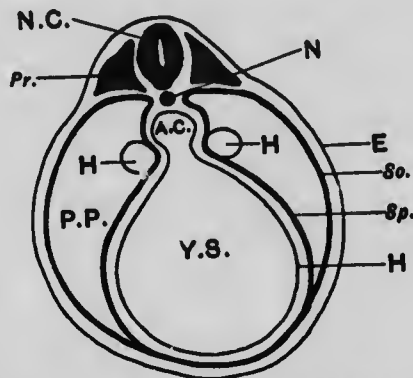

Fig. 647.—Diagrammatic section of embryo. *E*, epiblast; *So.*, somatopleur; *Sp.*, splanchnopleur; *P.P.*, the pleuro-peritoneal cavity between them; *H*, heart; *N.C.*, neural cord; *N*, notochord; *Pr.*, protovertebra; *A.C.*, alimentary canal; *Y.S.*, yolk-sac.

which is in this region quite cut off from the yolk-sac. On each side of the notochord are seen two smaller tubes (*A A*)

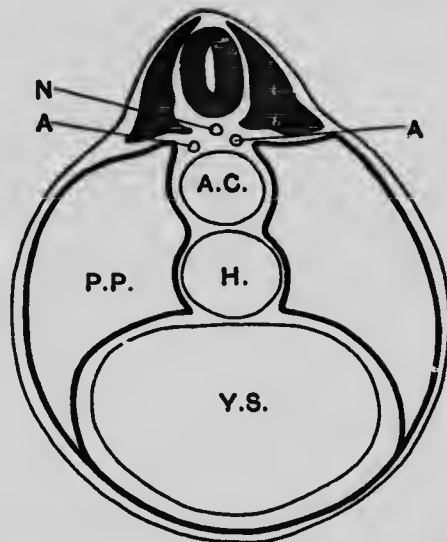

Fig. 648.—Diagrammatic transverse section of embryo. *N*, notochord; *A.C.*, alimentary canal; *H*, heart; *Y.S.*, yolk-sac; *P.P.*, pleuro-peritoneal cavity.

in section; these are the transverse sections of the primitive aortæ.

The heart so formed presents the appearance depicted in fig.

649; this is viewed from below, so that the heart (*h*) receiving the

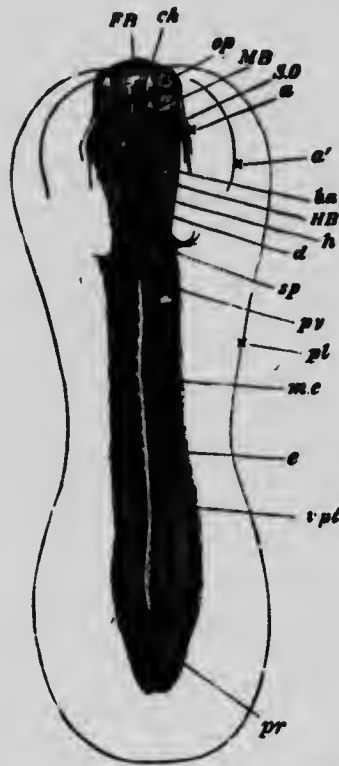

Fig. 649.—Embryo chick (36 hours), viewed from beneath as a transparent object (magnified).

two omphalo-mesenteric veins at its hinder end is seen above the alimentary canal, the yolk-sac having been removed.

The heart gives off anteriorly the primitive aorta, which soon divides into two; these pass round the blind anterior end of the alimentary canal, and then pass back along its dorsal aspect on each side of the notochord, as seen in transverse section (*A, A*) in fig. 648.

The heart is at this time a simple tube, but soon is divided into a longitudinal series of chambers which contract in the order named from before backwards: (1) the sinus venosus, where the veins enter; (2) the auricle, which in



Fig. 650.—Heart of the chick at the 45th, 65th, and 85th hours of incubation. 1, the venous trunks; 2, the auricle; 3, the ventricle; 4, the bulbus arteriosus. (Allen Thomson.)

mammals fuses with the sinus to form a single chamber; in fishes and amphibians sinus and auricle are distinct; then comes (3) the ventricle, and (4) the commencement of the aorta, which is called the aortic bulb. Later on the heart is twisted upon itself in the way represented in fig. 650, so that the auricle gets on the top of the ventricle, and the ventricle increases in relative strength and size.

Fig. 651 represents the primitive heart and vessels in outline.

The omphalo-mesenteric veins (1, 1) enter the auricle (2); then come the ventricle (3) and aortic bulb (4); the two primitive aortæ arising from this pass forwards and then turn backwards over the end of the fore-gut, and join together to form the dorsal aorta (6) lower down; the big branches (7, 7) which it gives off are the two omphalo-mesenteric arteries to the yolk-sac.

The smaller allantoic or umbilical arteries (8, 8) pass to the

allantois, the circulation in which begins soon, and this replaces the circulation from the yolk-sac, which in mammals is very in-

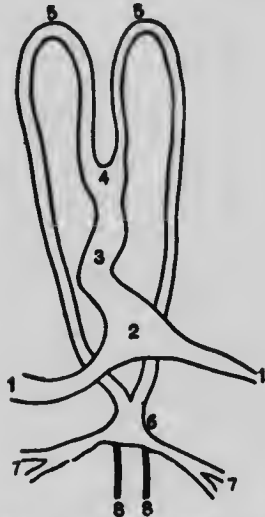

Fig. 651.—Early stage of embryonic heart and blood-vessels.



Fig. 652.—Diagram of young embryo and its vessels, showing course of circulation in the umbilical vesicle; and also that of the allantois (near the caudal extremity), which is just commencing. (Dalton.)



Fig. 653.—Diagram of embryo and its vessels at a later stage, showing the second circulation. The pharynx, œsophagus, and intestinal canal have become further developed, and the mesenteric arteries have enlarged, while the umbilical vesicle and its vascular branches are very much reduced in size. The large umbilical arteries are seen passing out in the umbilical cord to the placenta. (Dalton.)

significant. The umbilical arteries then become the terminal branches of the fetal aorta; the common iliac arteries to the lower limbs arise later, when the limbs begin to form.

The replacement of the circulation in the yolk-sac, or umbilical vesicle, by the allantoic or placental circulation is illustrated by the two preceding diagrams (figs. 652, 653).

As the body develops, new arteries and new veins form, and the heart becomes more complicated. The ventricle is divided into two (right and left) by a septum; the bulb divides into two, and one division leads from the right ventricle to the pulmonary artery; the other leads as the main aorta from the left. The auricles are also divided into two (right and left), but the complete separation of the two auricles does not take place till after birth. Before birth, as we shall see when describing the later fetal circulation, some of the blood which enters the right auricle passes into the left auricle by a wide opening called the *foramen ovale*.

The pulmonary artery leads direct into the descending aorta; the branches to the lungs are small and unimportant: it is not till the child is born, and begins to use its lungs, that the arteries to them assume importance; then also the communication with the aorta is closed, and remains as a cord, called the *ductus arteriosus*.

These changes will be grasped better if we look at the two next diagrams (figs. 654, 655).

The heart (fig. 654) is in a rather more advanced stage than in fig. 651; it is beginning to get a twist which is bringing the ventricle, now increasing in size, into its subsequent position; but it is seen that instead of two simple arches uniting to form a dorsal aorta, there are now five. These correspond to the gill arteries of fishes, but in mammals never break up into capillaries, as in a fish's gills. They, however, run in the visceral arches, between the visceral clefts. In amphibia, three pairs persist through life.

In reptiles the fourth pair remains throughout life as the permanent right and left aorta; in birds the right one remains as the permanent aorta, curving over the right bronchus instead of the left as in mammals.

In mammals the left fourth aortic arch develops into the permanent aorta, the right one remaining as the subclavian artery of that side. Thus the subclavian artery on the right side corresponds to the aortic arch on the left, and this homology is further confirmed by the fact that the recurrent laryngeal nerve hooks under the subclavian on the right side, and the aortic arch on the left.

The fifth arch disappears on the right side, but on the left forms the pulmonary artery. The distal end of this arch originally opens into the descending aorta, and this communication (which is permanent throughout life in many reptiles on both sides of the

body) remains throughout fetal life under the name of the *ductus arteriosus*: the branches of the pulmonary artery, to the right and left lung, are very small, and most of the blood which is forced into the pulmonary artery passes through the wide ductus arteriosus into the descending aorta. The first and second arches soon disappear, but the third arches and portions of the aortic roots remain as the carotid arteries (see fig. 655).

As the umbilical vesicle dwindles in size, the portion of the omphalo-mesenteric arteries outside the body gradually disappears, but the part inside the body remains as the mesenteric arteries.

Meanwhile with the growth

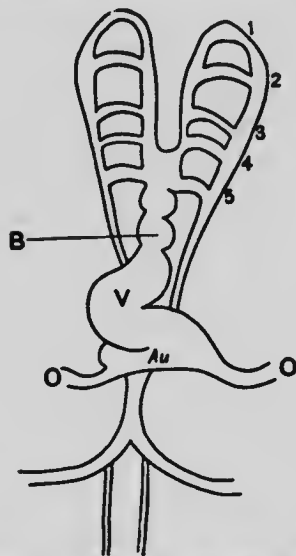

Fig. 654.—Embryonic heart and vessels. O, veins; Au, auricle; V, ventricle; B, bulb; 1, 2, 3, 4, 5, primitive aortic arches.

of the allantois two new arteries (*umbilical*) appear, and rapidly increase in size till they are the largest branches of the aorta;

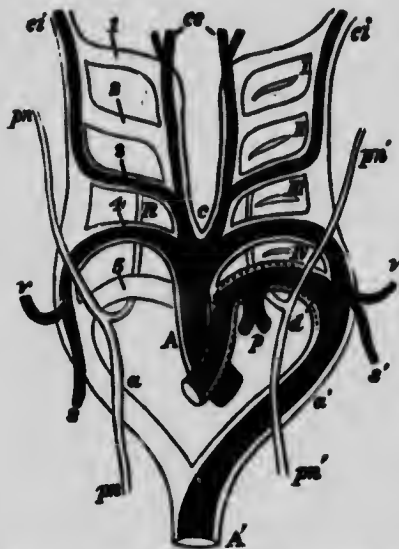

Fig. 655.—Diagram of the aortic arches in a mammal, showing transformations which give rise to the permanent arterial vessels. A, primitive arterial stem or aortic bulb, now divided into A, the ascending part of the aortic arch, and p, the pulmonary; a a', right and left aortic roots; A', descending aorta; 1, 2, 3, 4, 5, the five primitive aortic or branchial arches; I, II, III, IV, the four branchial clefts which, for the sake of clearness, have been omitted on the right side. The permanent systemic vessels are deeply, the pulmonary arteries lightly, shaded; the parts of the primitive arches which are transitory are simply outlined; c, placed between the permanent common carotid arteries; c c', external carotid arteries; c c'', internal carotid arteries; s, right subclavian, rising from the right aortic root beyond the fifth arch; v, right vertebral artery, arising from the fourth arch; v v', vertebral and subclavian arteries, arising together from the left, or permanent aortic root, opposite the fourth arch; p, pulmonary arteries rising together from the left fifth arch; d, outer or back part of left fifth arch, forming ductus arteriosus; p n, p n', right and left pneumogastric nerves descending in front of aortic arch, with their recurrent branches represented diagrammatically as passing behind, to illustrate the relations of these nerves respectively to the right subclavian artery (s) and the arch of the aorta and ductus arteriosus (d). (Allen Thomson, after Rathke.)

they are for a long time considerably larger than the external iliacs which supply the comparatively small hind-limbs.

*Veins.*—The earliest veins to appear in the foetus are the omphalo-mesenteric or vitelline, which return the blood from the yolk-sac to the developing auricle. As soon as the placenta with its umbilical veins is developed, these unite with the omphalo-mesenteric, and thus the blood which reaches the auricle comes partly from the yolk-sac and partly from the placenta. The right omphalo-mesenteric and the right umbilical veins soon disappear, and the united left omphalo-mesenteric and umbilical veins pass through the developing liver on the way to the auricle. Two sets of vessels make their appearance in connection with the liver (*venae advehentes*, and *revehentes*), both opening into the united omphalo-



Fig. 656.—Diagrams illustrating the development of veins about the liver. *B, d, c*, ducts of Cuvier, right and left; *c a*, right and left cardinal veins; *o*, left omphalo-mesenteric vein; *o'*, right omphalo-mesenteric vein, shrivelled up; *u u'*, umbilical veins, of which *u'*, the right one, has disappeared. Between the *venae cardinales* is seen the outline of the rudimentary liver with its *venae hepaticae advehentes* and *revehentes*. *D*, later stage; *l*, ductus venosus; *V*, hepatic veins; *ei*, vena cava inferior; *P*, portal vein; *P' P'*, *venae advehentes*; *m*, mesenteric veins. (Kölliker.)

mesenteric and umbilical veins, in such a way that a portion of the venous blood traversing the latter is diverted into the developing liver, and, having passed through its capillaries, returns to the umbilical vein through the *venae revehentes* at a point nearer the heart (see fig. 656). The portion of vein between the afferent and efferent veins of the liver is called the *ductus venosus*. The *venae advehentes* become the right and left branches of the portal vein, the *venae revehentes* become the hepatic veins, which open just at the junction of the ductus venosus with another large vein (*vena cava inferior*), which is now being developed. The mesenteric portion of the omphalo-mesenteric vein returning blood from the developing intestines remains as the mesenteric vein, which by its union with the splenic vein, forms the portal.

Thus the foetal liver is supplied with venous blood from two

sources, through the umbilical and portal vein respectively. At birth the circulation through the umbilical vein of course completely ceases and the vessel begins at once to dwindle, so that now the only venous supply of the liver is through the portal vein.

Another system of veins which appears early, consists of two short transverse veins (ducts of Cuvier) which open into the right auricle on either side; each is formed by the union of an

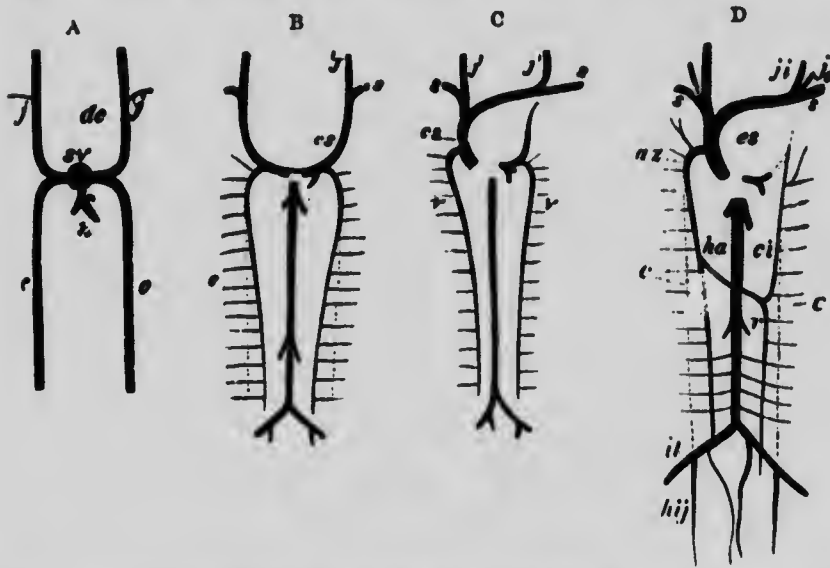

Fig. 657.—Diagrams illustrating the development of the great veins. *dc*, ducts of Cuvier; *j*, jugular veins; *h*, hepatic veins; *c*, cardinal veins; *s*, subclavian vein; *ji*, internal jugular vein; *j'*, external jugular vein; *az*, azygos vein; *ci*, inferior vena cava; *r*, renal veins; *il*, iliac veins; *hi*, hypogastric veins. (Gegenbaur.)

anterior cardinal, afterwards forming a jugular vein, collecting blood from the head and neck, and a posterior cardinal vein which returns the blood from the Wolffian bodies, the vertebral column, and the parietes of the trunk. This arrangement persists throughout life in fishes, but in mammals the following transformations occur.

As the kidneys are developing a new vein appears (vena cava inferior), formed by the junction of their efferent veins. It receives branches from the legs (iliac) and increases rapidly in size as they grow: further up it receives the hepatic veins, which by this time have lost their original opening into the ductus venosus. The heart gradually descends into the thorax, causing the ducts of Cuvier to become oblique instead of transverse. As the forelimbs develop, the subclavian veins are formed.



A transverse communicating trunk now unites the two primitive jugular veins, and gradually increases, while the left duct of Cuvier becomes almost entirely obliterated (all its blood passing by the communicating trunk to the right side) (fig. 657, c. d.). The right primitive jugular vein remains as the right innominate vein, while the communicating branch forms the left innominate. The right duct of Cuvier becomes the superior vena cava. The remnant of the left duct of Cuvier generally remains as a fibrous

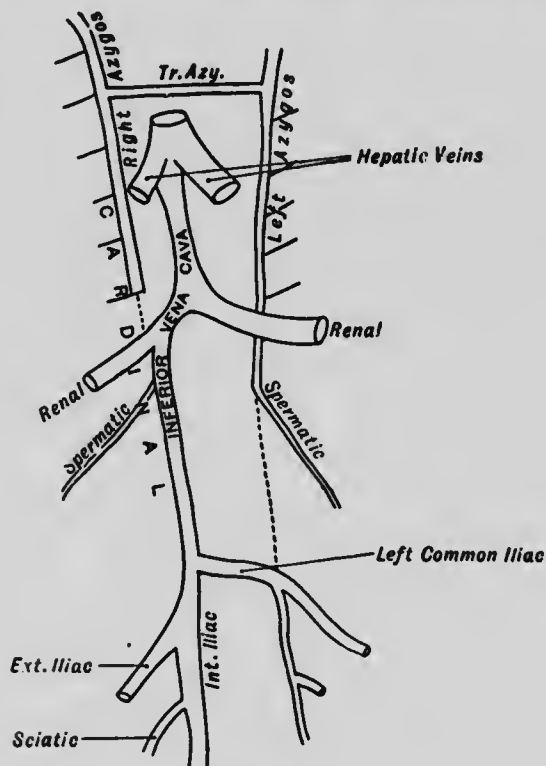

Fig. 658.

band, running obliquely down to the coronary vein, which is really the proximal part of the left duct of Cuvier. In front of the root of the left lung, another relic may be found in the form of the so-called *vestigial fold* of Marshall, which is a fold of pericardium running in the same direction.

In some of the lower mammals, such as the rat, the left duct of Cuvier remains as a left superior cava.

Meanwhile, a transverse branch carries across most of the blood of the left posterior cardinal vein into the right; and by this union the great azygos vein is formed.

The upper portions of the left posterior cardinal vein remain as the left superior intercostal and vena azygos minor.

The azygos veins receive the intercostal veins as shown in the diagrams.

These views of the origins of the veins are chiefly derived from the observations of Rathke and Gegenbaur. They have been generally accepted by embryologists. Hochstetter, however, has more recently stated that some modification of these views is necessary. According to him, the right common iliac vein and the portion of the inferior vena cava below the renal vein are parts of the right cardinal vein, and the greater part of the left common iliac is the transverse iliac vein, a vein which grows across at a lower level than the transverse azygos. According to these views, the lower part of diagram 657D would have to be altered as in fig. 658.

#### CIRCULATION OF BLOOD IN THE FŒTUS.

The circulation of blood in the fœtus differs considerably from that of the adult. It will be well, perhaps, to begin its description by tracing the course of the blood, which, after being carried out to the placenta by the two umbilical arteries, has returned, cleansed and replenished, to the fœtus by the umbilical vein.

It is at first conveyed to the under surface of the liver, and there the stream is divided,—a part of the blood passing straight on to the inferior vena cava, through a venous canal called the *ductus venosus*, while the remainder passes into the portal vein, and reaches the inferior vena cava only after circulating through the liver. Whether, however, by the direct route through the *ductus venosus* or by the roundabout way through the liver,—all the blood which is returned from the placenta by the umbilical vein reaches the inferior vena cava at last, and is carried by it to the right auricle of the heart, into which cavity is also pouring the blood that has circulated in the head and neck and arms, and has been brought to the auricle by the superior vena cava. It might be naturally expected that the two streams of blood would be mingled in the right auricle, but such is not the case, or only to a slight extent. The blood from the superior vena cava,—the less pure fluid of the two—passes almost exclusively into the right ventricle, through the auriculo-ventricular opening, just as it does in the adult; while the blood of the inferior vena cava is directed by the fold of the lining membrane of the heart, called the *Eustachian valve*, through the foramen ovale into the left auricle, whence it passes into the left ventricle, and out of this into the aorta, and thence to all the body, but chiefly to the head and neck. The blood of the superior vena cava, which, as before said, passes into

the right ventricle, is sent out thence in *small amount* through the pulmonary artery to the lungs, and thence to the left auricle, by the pulmonary veins, as in the adult. The greater part, however, does not go to the lungs, but instead, passes through a



Fig. 659.—Diagram of the Fetal Circulation.

canal, the *ductus arteriosus*, leading from the pulmonary artery into the aorta just below the origin of the three great vessels which supply the upper parts of the body; and there meeting that part of the blood of the inferior vena cava which has not gone into these large vessels, it is distributed with it to the

trunk and other parts,—a portion passing out by way of the two umbilical *arteries* to the placenta. From the placenta it is returned by the umbilical *vein* to the under surface of the liver, from which the description started.

**Changes after Birth.**—Immediately after birth the foramen ovale begins to close, and so do the ductus arteriosus and ductus venosus, as well as the umbilical vessels; the closure is completed in a few days, so that the two streams of blood which arrive at the right auricle by the superior and inferior vena cava respectively, thenceforth mingle in this cavity of the heart, and passing into the right ventricle, go by way of the pulmonary artery to the lungs, and thence, after purification, to the left auricle and ventricle, to be distributed by the aorta to the body generally.

### Development of the Nervous System.

The central nervous system originates from the thickened walls of the medullary groove, which by the meeting of the dorsal ridges is converted into the medullary canal. These walls are composed entirely of epiblast. The anterior part of this mass of epiblast becomes the brain, the rest of it the spinal cord, the canal itself is seen in the adult as the ventricles of the brain and central canal of the spinal cord. The nerves are formed of epiblast too, they are outgrowths from masses of cells called neuroblasts, the primitive nerve-cells. In the case, however, of the olfactory and optic nerves we have not to deal with solid outgrowths, but with hollow protrusions from the brain, which become solid at a later stage.

**The Spinal Cord.**—The cavity formed by the closure of the neural canal soon becomes a cleft running from before backwards. It is bounded at first by columnar epithelium; these cells afterwards become ciliated; on their exterior is a homogeneous basement membrane. The wall soon becomes thicker, and the basement membrane is thus separated further and further from the central canal. This increase in thickness is due in part to the increase in length of the columnar cells: in part to the appearance of new cells. The inner part of the columnar lining retains its palisade-like character, and forms ultimately the lining epithelium of the central canal. The cells are called *spongioblasts*. The external ends of the cells break up into a reticulum called the *myelospodium*, and this is limited externally by the basement membrane at the circumference. The myelospodium forms the neuroglia.

Between the inner ends of the spongioblasts (fig. 66o, S) numerous rounded cells called *germinal cells* (G) next appear. These rapidly divide, and so form *neuroblasts* (N). The neuroblasts are pear-shaped; each has a large oval nucleus, and its tapering stalk is directed towards the outer surface of the cord;

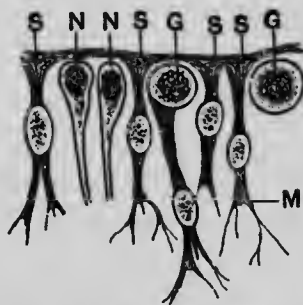

Fig. 66o.—Inner ends of spongioblasts (S), with germinal cells (G) between them. N N, neuroblasts which have resulted from the division of a germinal cell; M, myelospangium formed by the branching outer ends of the spongioblasts. (After His.)

the process ultimately pierces the basement membrane (fig. 661). These are the primitive nerve cells; their processes are the axis cylinder processes which grow out as nerve fibres. The nerve



Fig. 661.—Three neuroblasts, each with a nerve fibre process, growing out beyond the basement membrane of the embryonic spinal cord. (After His.)

fibres are first without sheaths; the formation of the sheaths comes later (see pp. 105, 609).

The neuroblasts collect into groups, one of which, especially large, is at the situation of the future anterior horn; the processes of the primitive nerve-cells pass out of the cord as the beginnings of the anterior roots (fig. 662). The somewhat oblique coursing of these fibres before they leave the cord forms the beginning of the anterior white column. The posterior white columns simultaneously begin to appear on each side of the narrow dorsal part of the canal. They are formed by the posterior roots entering the cord.

As the cornua of grey matter grow out from the central mass,

the fissures of the cord begin to appear. The anterior or ventral fissure is simply a cleft between the enlarging lateral halves of the cord. The posterior fissure is formed by the closure of the dorsal portion of the neural canal which meets an ingrowth of connective tissue from the exterior. The characteristic cylindrical form of the cord is attained by the development of the lateral columns, which are formed by the processes from neuroblasts in the brain growing down the sides of the cord, and these become medullated at a

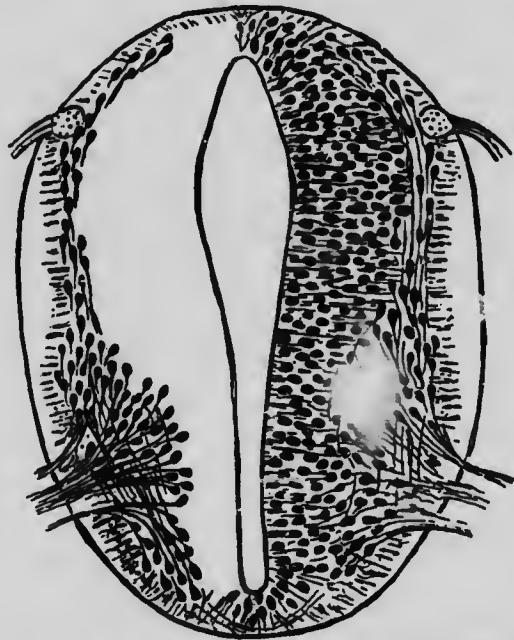

Fig. 662.—Section of spinal cord of a four weeks human embryo. The posterior roots are continued within the cord into a small longitudinal bundle, which is the rudiment of the posterior white column. The anterior roots are formed by the convergence of the processes of the neuroblasts. The latter, along with the elongated cells of the myelospore compose the grey matter. (His.)

later d. The membranes and blood-vessels are formed from mesoblast.

Up to the fourth month the cord and vertebral canal increase in length *pari passu*, but after that, the vertebral canal grows faster, so that at birth the coccygeal end of the cord is opposite the third lumbar, and in the adult opposite the first lumbar vertebra. This gives an obliquity to the lower nerve roots, which together with the *filum terminale* form the *cauda equina*.

**The Nerves.**—These grow from the spinal cord; the origin of the anterior roots we have already considered. The posterior roots are formed in the following way.

Along the dorsal aspect of the primitive cord, a crest of epiblast appears and is called the *neural crest*. Special enlargements of this appear opposite the middle of each pair of protovertebræ; these grow downwards on each side, and their attachment to the cord is then entirely lost. These little islands of epiblast contain numerous neuroblasts; each island forms a spinal ganglion, and the neuroblasts within it become the cells of that ganglion. Two processes grow from each cell; one directed towards the spinal cord, where it contributes to the formation of the posterior white column, and ultimately arborises around the cells of the grey matter at a higher level. The other grows to the

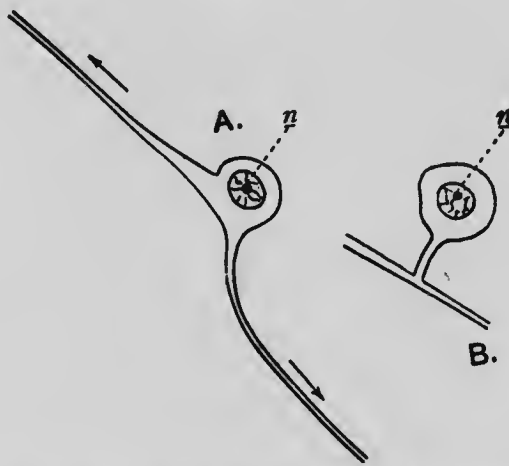

Fig. 663.—A, Bipolar cell from spinal ganglion of a  $4\frac{1}{2}$  weeks embryo (after His). *n*, nucleus; the arrows indicate the direction in which the nerve processes grow, one to the spinal cord, the other to the periphery. *B*, a cell from a spinal ganglion of the adult; the two processes have coalesced to form a T-shaped junction. (Diagrammatic.)

periphery. The two processes become blended in the first part of their course and so the T-shaped junction is formed (fig. 663).

**The Brain.**—The histological details of the formation of the epithelium of the ventricles from spongioblasts, of neuroglia from the myelospongium, of nerve cells from neuroblasts, and of the nerve fibres of the white matter and of the nerves as the outgrowths from the neuroblasts, are all essentially the same, as already described in connection with the spinal cord. But the grosser anatomical details differ.

The front portion of the medullary canal is almost from the first widened out and divided into three vesicles. From the anterior vesicle the two primary optic vesicles are budded off laterally: their further history will be traced in the next section.

Somewhat later the same vesicle divides into two, and thus the *prosencephalon* and *thalamencephalon* are formed.

In the walls of the posterior (third) cerebral vesicle, a thickening appears (rudimentary cerebellum) which becomes separated from the rest of the vesicle by a deep inflection.

At this time there are two chief curvatures of the brain (fig. 664). (1.) A sharp bend of the whole cerebral mass downwards round the end of the notochord, by which the anterior vesicle,

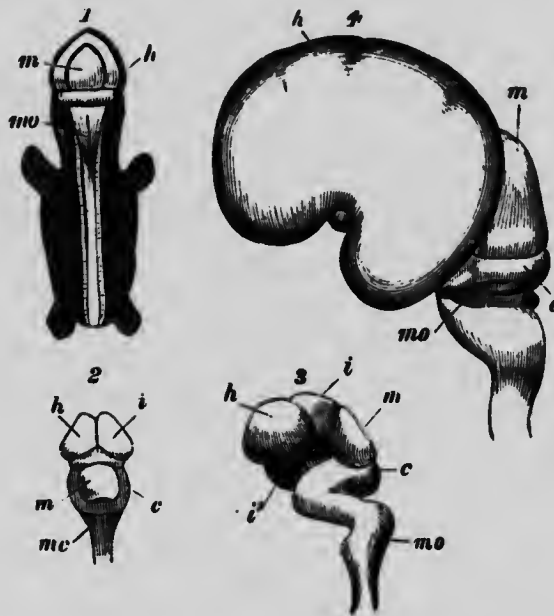

Fig. 664.—Early stages in development of human brain (magnified). 1, 2, 3, are from an embryo about seven weeks old; 4, about three months old. *m*, middle cerebral vesicle (mesencephalon); *c*, cerebellum; *mo*, medulla oblongata; *i*, thalamencephalon; *h*, hemispheres; *i'*, infundibulum; fig. 3 shows the several curves which occur in the course of development; fig. 4 is a lateral view, showing the great enlargement of the cerebral hemispheres which have covered in the thalami, leaving the optic lobes, *m*, uncovered. (Kölliker.)

N.B.—In fig. 2 the line *i* terminates in the right hemisphere; it ought to be continued into the thalamencephalon.

which was the highest of the three, is bent downwards, and the middle one comes to occupy the highest position. (2.) A sharp bend, with the convexity forwards, which runs in from behind beneath the rudimentary cerebellum separating it from the medulla.

Thus, five fundamental parts of the foetal brain may be distinguished, which, together with the parts developed from them, may be presented in the following tabular view:—



TABLE OF PARTS DEVELOPED FROM FUNDAMENTAL PARTS OF BRAIN.

I. Anterior Primary Vesicle.	First Secondary Vesicle, Prosencephalon, or Fore-brain.	{ Anterior end of third ventricle, foramen of Monro, lateral ventricles, cerebral hemispheres, corpora striata, corpus callosum, fornix, lateral ventricles, olfactory bulb.	
			Second Secondary Vesicle, Thalamencephalon, or "Twixt-brain."
II. Middle Primary Vesicle.	Third Secondary Vesicle, Mesencephalon, or Mid-brain.	{ Corpora quadrigemina, crura cerebri, aqueduct of Sylvius.	
III. Posterior Primary Vesicle.	Fourth Secondary Vesicle, Epencephalon, or Hind-brain.	Fourth ventricle.	{ Cerebellum and Pons. Medulla oblongata.
	Fifth Secondary Vesicle, Metencephalon, or After-brain.		

The cerebral hemispheres grow rapidly upwards and backwards, while from their inferior surface the olfactory bulbs are budded off. The middle cerebral vesicle (mesencephalon) for some time is the most prominent part of the foetal brain, and in fishes,

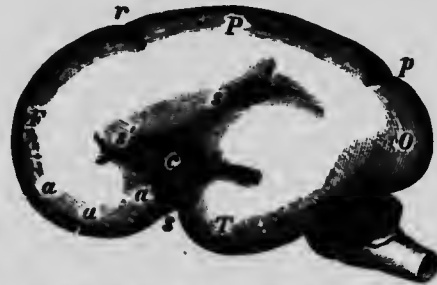

Fig. 665.—Side view of foetal brain at six months, showing commencement of formation of the principal fissures and convolutions. *F*, frontal lobe; *P*, parietal; *O*, occipital; *T*, temporal; *a a*, commencing frontal convolutions; *s*, Sylvian fissure; *s'*, its anterior division; *c*, within it the central lobe or island of Reil; *r*, fissure of Rolando; *p*, parieto-occipital fissure. (R. Wagner.)

amphibia, and reptiles, it remains uncovered through life as the optic lobes. But in birds the growth of the cerebral hemispheres thrusts the optic lobes down laterally, and in mammalia completely overlaps them.

In the lower mammalia the backward growth of the hemispheres ceases, but in the higher groups, such as the monkeys

and man, they grow still further back, until they completely cover in the cerebellum, so that on looking down on the brain from above, the cerebellum is quite concealed from view. The surface of the hemispheres is at first quite smooth, but as early as the third month the great Sylvian fissure begins to be formed (fig. 665).

The next to appear is the parieto-occipital fissure; these two great fissures, unlike the rest of the sulci, are formed by a curving round of the whole cerebral mass.

In the sixth month the fissure of Rolando appears: from this time till the end of foetal life the brain grows rapidly in size, and the convolutions appear in quick succession; first the great primary ones are sketched out, then the secondary ones. The

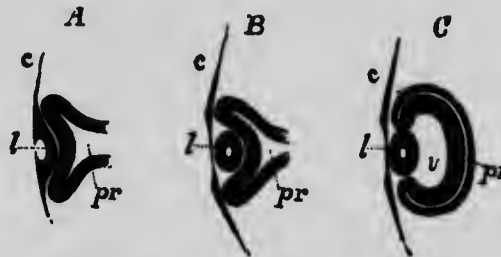

Fig. 666.—Longitudinal section of the primary optic vesicle in the chick, magnified (from Remak).—A, from an embryo of sixty-five hours; B, a few hours later; C, of the fourth day; *c*, the corneous layer or epidermis, presenting in A the open depression for the lens, which is closed in B and C; *l*, the lens follicle and lens; *pr*, the primary optic vesicle; in A and B, the pedicle which forms the optic nerve is shown; in C, the section being to the side of the pedicle, the latter is not shown; *v*, the secondary ocular vesicle and vitreous humour.

commissures of the brain (anterior, middle, and posterior), and the corpus callosum, are developed by the growth of fibres across the middle line.

The Hippocampus major is formed by the folding in of the grey matter from the exterior into the lateral ventricles.

**The Eye.**—Soon after the first three cerebral vesicles have become distinct from each other, the anterior one sends out a lateral vesicle from each side (primary optic vesicle), which grows out towards the free surface, its cavity communicating with that of the cerebral vesicle through the canal in its pedicle. It remains connected to the thalamencephalon. It is soon met and invaginated by an in-growing process from the epiblast of the surface (fig. 666). This process of the epiblast is at first a depression, which ultimately becomes closed in at the edges so as to produce a hollow ball, which is thus completely severed from the epidermis with which it was originally continuous. From this

hollow ball the crystalline lens is developed. The way in which this occurs has been described in a previous chapter under the head of structure of the lens (see p. 747). By the in-growth of the lens the anterior wall of the primary optic vesicle is forced back nearly into contact with the posterior, and thus the primary optic vesicle is almost obliterated. The cells in the anterior wall are much longer than those of the posterior wall; from the

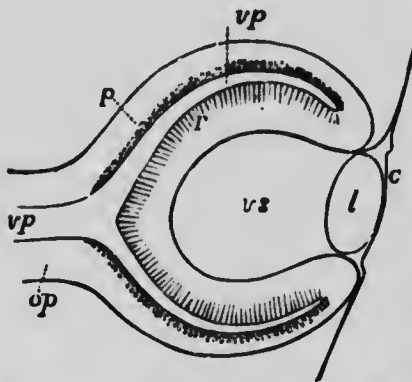

Fig. 667.—Diagrammatic sketch of a vertical longitudinal section through the eyeball of a human foetus of four weeks. The section is a little to the side, so as to avoid passing through the ocular cleft; *c*, the cuticle where it becomes later the corneal epithelium; *l*, the lens; *op*, optic nerve formed by the pedicle of the primary optic vesicle; *vp*, primary medullary cavity or optic vesicle; *p*, the pigment layer of the retina; *r*, the inner wall forming the remaining layers of the retina; *vs*, secondary optic vesicle containing the rudiment of the vitreous humour.  $\times 100$ . (Kölliker.)

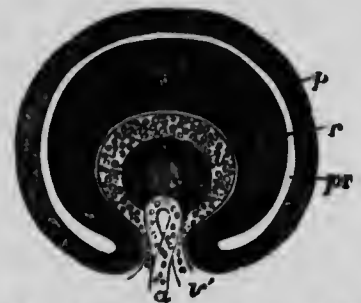

Fig. 668.—Transverse vertical section of the eyeball of a human embryo of four weeks. The anterior half of the section is represented: *pr*, the remains of the cavity of the primary optic vesicle; *p*, the inner part of the outer layer forming the retinal pigment; *r*, the thickened inner part giving rise to the other structures of the retina; *v*, the commencing vitreous humour within the secondary optic vesicle; *v'*, the ocular cleft through which the loop of the central blood-vessel, *v*, projects from below; *l*, the lens with a central cavity.  $\times 100$ . (Kölliker.)

former all the layers of the retina are developed, except the layer of pigment cells which is formed from the latter.

The cup-shaped hollow in which the lens is now lodged is termed the secondary optic vesicle: its walls grow up all round, leaving, however, a slit below where it meets the lens.

Through this slit, termed the *choroidal fissure*, a process of mesoblast containing numerous blood-vessels projects, and occupies the cavity of the secondary optic vesicle behind the lens, filling it with vitreous humour and furnishing the lens capsule and the capsulo-pupillary membrane. This process in mammals projects, not only into the secondary optic vesicle, but also into the pedicle of the primary optic vesicle invaginating it for some distance from beneath, and thus carrying up the *arteria centralis retinae* into its permanent position in the centre of the optic nerve.

This invagination of the optic nerve does not occur in *birds*, and consequently no *arteria centralis retinae* exists in them. But they possess an important permanent relic of the original protrusion of the mesoblast through the choroidal fissure, in the *pecten*, while a remnant of the same fissure sometimes occurs in man under the name *coloboma iridis*. The cavity of the primary optic vesicle becomes completely obliterated, and the rods and cones get into apposition with the pigment layer of the retina. The inner segments of the rods are the first formed, then the outer. The cavity of its pedicle disappears and the solid optic nerve is formed. Meanwhile the cavity which existed in the centre of the primitive lens becomes filled up by the growth of fibres from its

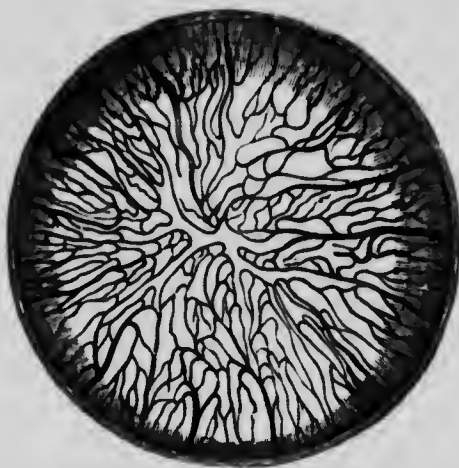

Fig. 609.—Blood-vessels of the capsulo-pupillary membrane of a new-born kitten, magnified. The drawing is taken from a preparation injected by Tiersch, and shows in the central part the convergence of the network of vessels in the pupillary membrane. (Kölliker.)

posterior wall. The epithelium of the cornea is developed from the epiblast, while the corneal tissue proper is derived from the mesoblast which intervenes between the epiblast and the primitive lens which was originally continuous with it. The *sclerotic* coat is developed round the eye-ball from the general mesoblast in which it is embedded. The *choroid* is developed from the mesoblast on the outside of the optic cup, and the iris by the growing forwards of the anterior edge of the optic cup. The ciliary processes arise from the hypertrophy of the edge of the optic cup which forms folds into which the choroidal mesoblast grows, and in which blood-vessels and pigment-cells develop.

The iris is formed rather late, as a circular septum projecting inwards, from the fore part of the choroid, between the lens and

the cornea. In the eye of the fœtus of mammalia, the pupil is closed by a delicate membrane, the *membrana pupillaris*, which forms the front portion of a highly vascular membrane that, in the fœtus, surrounds the lens, and is named the *membrana capsulo-pupillaris* (fig. 669). It is supplied with blood by a branch of the *arteria centralis retinæ*, which, passing forwards to the back of the lens, there subdivides. It is obliterated in the adult, and is then called the canal of Stilling. The *membrana capsulo-pupillaris* withers and disappears in the human subject a short time before birth.

The eyelids of the human subject and mammiferous animals, like those of birds, are first developed in the form of a ring. They then extend over the globe of the eye until they meet and become firmly agglutinated to each other. But before birth, or in the carnivora after birth, they separate.

**The Ear.**—Very early in the development of the embryo a depression or ingrowth of the epiblast occurs on each side of the head which deepens and soon becomes a closed follicle. This *primary otic vesicle*, which closely corresponds in its formation to the lens in the eye, sinks down to some distance from the free surface. As it are developed the epithelial lining of the *membranous labyrinth* of the internal ear, consisting of the vestibule and its semicircular canals and the *scala media* of the cochlea. The surrounding mesoblast gives rise to the various fibrous bony and cartilaginous parts which complete and enclose this membranous labyrinth, the bony semicircular canals, the walls of the cochlea with its *scala vestibuli* and *scala tympani*. The auditory nerve is gradually differentiated and grows towards the internal ear.

The Eustachian tube, the cavity of the tympanum, and the external auditory passage, are the remains of the first post-oral cleft. The *membrana tympani* divides the cavity of this cleft into an internal space, the tympanum, and the external meatus. The mucous membrane of the pharynx, which is prolonged in the form of a diverticulum through the Eustachian tube into the tympanum, and the external cutaneous system come into relation with each other at this point; the two structures are separated only by the membrane of the tympanum.

The pinna or external ear is developed from a process of integument in the neighbourhood of the first and second visceral arches, and probably corresponds to the gill-cover (operculum) in fishes.

**The Nose.**—The nose originates like the eye and ear in a depression of the superficial epiblast at each side of the fronto-nasal process (primary olfactory pit), which is at first completely

separated from the cavity of the mouth, and gradually extends backwards and downwards till it opens into the mouth.

The outer angles of the fronto-nasal process, uniting with the maxillary process on each side convert what was at first a groove into a closed canal. The olfactory nerve which meets this is, like the optic nerve, primarily a hollow process of the brain.

### Development of the Alimentary Canal.

The alimentary canal in the earliest stages of its development consists of three parts—the fore and hind gut ending blindly

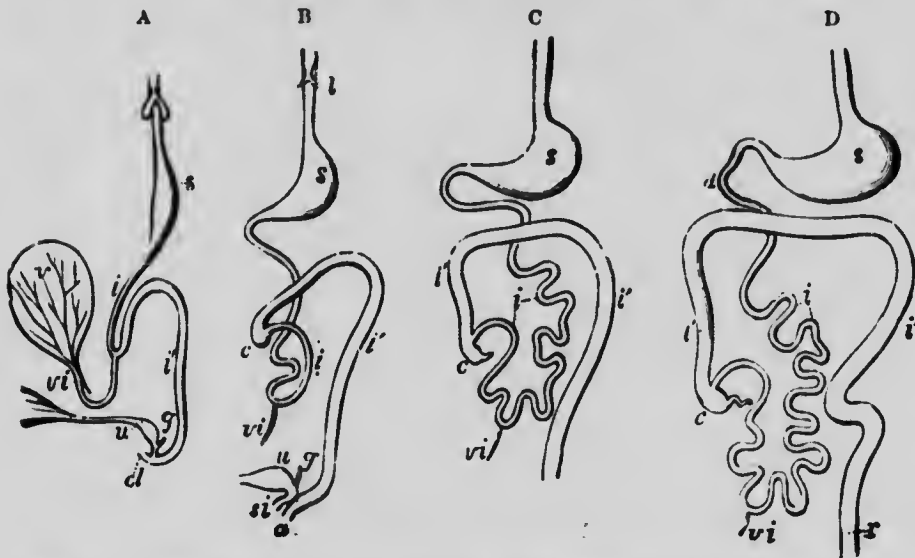

Fig. 670.—Outlines of the form and position of the alimentary canal in successive stages of its development. A, alimentary canal, &c., in an embryo of four weeks; B, at six weeks; C, at eight weeks; D, at ten weeks; *l*, the primitive lungs connected with the pharynx; *s*, the stomach; *d*, duodenum; *i*, the small intestine; *i'*, the large; *c*, the cæcum and vermiform appendage; *r*, the rectum; *cl*, in A, the cloaca; *a*, in B, the anus distinct from *si*, the sinus uro-genitalis; *v*, the yolk-sac; *vi*, the vitello-intestinal duct; *u*, the urinary bladder and urachus leading to the allantois; *g*, genital ducts. (Allen Thomson.)

at each end of the body, and a middle segment which communicates freely on its ventral surface with the cavity of the yolk-sac through the vitelline or omphalo-mesenteric duct.

From the fore-gut are formed the pharynx, œsophagus, and stomach; from the hind-gut, the lower end of the colon and the rectum. The mouth is developed by an involution of the epiblast between the maxillary and mandibular processes, which becomes deeper and deeper till it reaches the blind end of the fore-gut, and

at length communicates freely with the pharynx by the absorption of the partition between the two.

At the other end of the alimentary canal the anus is formed in a precisely similar way by an involution from the free surface, which at length opens into the hind-gut. When the depression from the free surface does not reach the intestine, the condition known as imperforate anus results. A similar condition may exist at the other end of the alimentary canal from the failure of the involution which forms the mouth, to meet the fore-gut. The middle portion of the digestive canal becomes more and more



Fig. 671.—Lobules of the parotid, with the salivary ducts, in the embryo of the sheep, at a somewhat advanced stage.

closed in, till its originally wide communication with the yolk-sac becomes narrowed down to a small duct (vitelline). This duct usually completely disappears in the adult, but occasionally the proximal portion remains as a diverticulum from the intestine. Sometimes a fibrous cord attaching some part of the intestine to the umbilicus, remains to represent the vitelline duct. Such a cord has been known to cause in after-life, strangulation of the bowel and death.

The alimentary canal lies in the form of a straight tube close beneath the vertebral column, but it gradually becomes divided into its special parts, stomach, small intestine, and large intestine (fig. 670), and at the same time comes to be suspended in the

abdominal cavity by means of a lengthening mesentery formed from the splanchnopleur which attaches it to the vertebral column. The stomach originally has the same direction as the rest of the canal; its cardiac extremity being superior, its pylorus inferior. The changes of position which the alimentary canal undergoes may be readily gathered from the accompanying figures (fig. 670).

**Pancreas and Salivary Glands.**—The principal glands in connection with the intestinal canal are the salivary glands, pancreas, and the liver. In mammalia, each salivary gland first appears as a simple canal with bud-like processes, lying in a mass of mesoblast, and communicating with the cavity of the mouth.

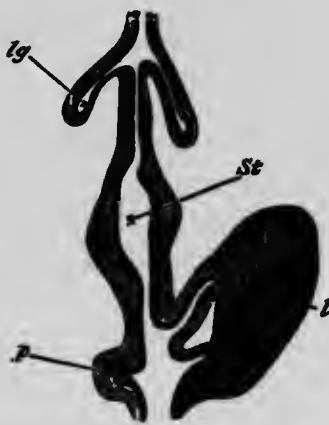

Fig. 672.—Diagram of part of digestive tract of a chick (4th day). The black line represents hypoblast, the outer shading mesoblast. *lg*, lung diverticulum with expanded end forming primary lung-vesicle; *St*, stomach; *l*, two hepatic diverticula, with their terminations united by solid rows of hypoblast cells; *p*, diverticulum of the pancreas with the vesicular diverticula coming from it. (Gotte.)

As the development of the gland advances, the canal becomes more and more ramified (fig. 671). The pancreas is developed exactly in the same way, but its cells are derived from the hypoblast lining the intestine, while those of the salivary glands are formed from the epiblast lining the mouth. In both cases the blood-vessels and connective tissues are formed from the mesoblast into which the glandular structure grows.

**The Liver.**—The liver is developed by the protrusion of a part of the walls of the fore-gut, in the form of two conical hollow branches (figs. 672, 673). The inner portion of the cones consists of a number of solid cylindrical masses of cells, derived from the hypoblast, which become gradually hollowed by the formation of the hepatic ducts, and among which blood-vessels are rapidly



developed. The secreting cells of the organ and the lining epithelium of the ducts are derived from the hypoblast, the connective-tissue and vessels from the mesoblast. The gall-bladder is developed as a diverticulum from the hepatic duct.

The *spleen* and *lymphatic glands* are developed from the mesoblast: the *thyroid* originates from the hypoblast; it grows as diverticula from the fore-gut, opposite the second and also opposite the fourth visceral arches. The hypoblastic cells form the lining epithelium of the vesicles; the stroma of the gland is formed by the surrounding mesoblast. The *thymus* is formed in a similar



Fig. 673.—Rudiments of the liver on the intestine of a chick at the fifth day of incubation. 1, heart; 2, intestine; 3, diverticulum of the intestine in which the liver (4) is developed; 5, part of the mucous layer of the germinal membrane. (Müller.)

way opposite the third and fourth visceral arches. These hypoblastic cells form the nests called the corpuscles of Hassall; the lymphoid tissue by which they are invaded and ultimately surrounded is mesoblastic.

#### Development of the Respiratory Apparatus.

**The Lungs**, at their first development, appear as small tubercles or diverticula from the ventral surface of the œsophagus (figs. 672, 674).

The two diverticula at first open directly into the œsophagus, but as they grow, a separate tube (the future trachea) is formed at their point of fusion, opening into the œsophagus on its anterior surface. These primary diverticula of the hypoblast of the alimentary canal send off secondary branches into the surrounding mesoblast, and these again give off tertiary branches, forming the air-cells. Thus we have the lungs formed: the epithelium lining the air-cells, bronchi, and trachea is derived from the hypoblast, and all the rest of the lung-tissue, nerves, lymphatics, and

blood-vessels, cartilaginous rings, and muscular fibres of the bronchi from the mesoblast.

The *diaphragm* is early developed as a partition of mesoblast

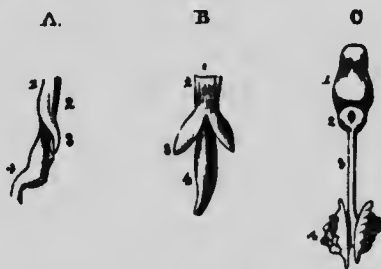

Fig. 674 illustrates the development of the respiratory organs. A, is the oesophagus of a chick on the fourth day of incubation, with the rudiments of the trachea on the lung of the left side, viewed laterally; 1, the inferior wall of the oesophagus; 2, the upper portion of the same tube; 3, the rudimentary lung; 4, the stomach; B, is the same object seen from below, so that both lungs are visible. C, shows the tongue and respiratory organs of the embryo of a horse; 1, the tongue; 2, the larynx; 3, the trachea; 4, the stomach, viewed from the upper side. (After Rathke.)

dividing the original pleuro-peritoneal cavity into thoracic and abdominal serous cavities.

### Development of the Genito-urinary Apparatus.

In the early stage of the development of the urino-genital organs, the most striking thing seen is their resemblance to the

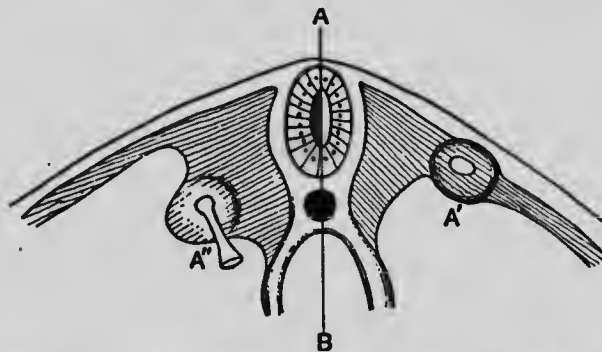

Fig. 675.—Diagram of transverse section of embryo dogfish. On the right of the middle line, A B, the primitive segmental tube (A') is seen in transverse section; on the left side a later stage is represented; it here forms a well marked projection into the pleuro-peritoneal cavity, and the section is represented as passing through the trumpet-shaped opening of the tube into that cavity (A'').

segmental organs, or nephridia of worms. The subject was first worked out by Balfour in the elasmobranch fishes; we may therefore first describe what he found here, and then pass on to what occurs in mammals.

In the preceding diagram (fig. 675) we have a transverse section through the embryo in which the structures represented will be familiar from our previous studies. About the fifth segment a thickening in the mesoblast occurs, which grows backwards as a solid column of cells, this becomes hollow, and is seen in transverse section at A'; later on the hollow extends at one part into the pleuro-peritoneal cavity by a trumpet-shaped opening, and this is seen cut through at A".

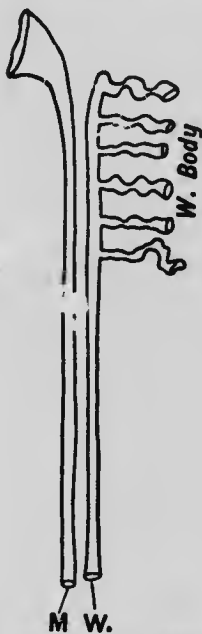

Fig. 676. — Diagram representing the splitting of the archinephros into Müllerian (M) and Wolffian (W) ducts.

This duct may be termed the *archinephros*. The prominence created by this duct grows into the pleuro-peritoneal cavity; and a number of convoluted tubes, one in each segment, open into the duct, which soon splits into two longitudinally; one division, the *pronephros* or *Müllerian duct* (fig. 676, M), has the original opening into the body cavity; the other convoluted tubes open into the other division of the tube; they become united together by connective tissue, and form a solid organ called the *Wolffian body*, or *mesonephros*. The duct is called the *mesonephric*, or *Wolffian duct* (fig. 676, W). The two ducts open into the *cloaca* which also receives the hinder opening of the alimentary canal.

The tubules of the Wolffian body become more convoluted and form the tubules of the head-kidney; some of their original openings into the peritoneal cavity can be traced, however, even in the adult.

From the lower end of the Wolffian duct a protrusion or growth takes place, and this also becomes hollow, and a number of segmental tubes develop and form with it an organ similar to the Wolffian body; this is called the *metanephros*, and it forms the hind kidney, which represents the true kidney of the higher vertebrates; the *metanephric duct* becomes the ureter. It is represented at K, in fig. 677.

In the female the Müllerian ducts become the oviducts, and, where they join, the uterini. In the male they disappear. The head or Wolffian kidney, and the hind or true kidney both execute renal functions in both sexes; but in the male, the Wolffian tubules apply themselves to the testis and constitute its efferent ducts; the main Wolffian duct becomes the vas deferens.

Thus in fishes and amphibians, the semen passes through tubules which are also renal in function.

In the higher vertebrates the subject has been chiefly studied in the chick, but most of the facts have been confirmed in the mammal.

The archinephros which is first formed becomes the Wolffian duct, and the segmental tubules, which are rather more numerous

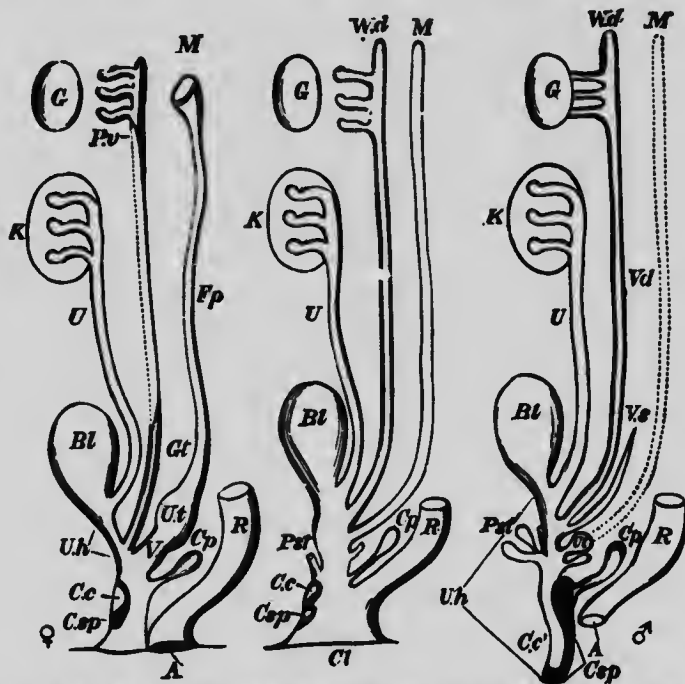

Fig. 677.—Diagram showing the relations of the female (the left-hand figure ♀) and of the male (the right-hand figure ♂) reproductive organs to the general plan (the middle figure) of these organs in the higher vertebrates (including man). *Cl*, cloaca; *R*, rectum; *Bl*, urinary bladder; *U*, ureter; *K*, kidney; *Ua*, urethra; *G*, genital gland, ovary, or testis; *W*, Wolffian body; *Wd*, Wolffian duct; *M*, Müllerian duct; *Pst*, prostate gland; *Cp*, Cowper's gland; *Csp*, corpus spongiosum; *Cc*, corpus cavernosum.

*In the female.*—*V*, vagina; *Ut*, uterus; *Fp*, Fallopian tube; *Gt*, Gaertner's duct; *Pv*, parovarium; *A*, anus; *Cc*, *Csp*, clitoris.

*In the male.*—*Csp*, *Cl'*, penis; *Ut*, uterus masculinus; *Vs*, vesicula seminalis; *Vd*, vas deferens. (Huxley.)

than one to each segment, get bound into the Wolffian body. The Müllerian duct is not split off from this, but is formed separately by a longitudinal folding in of the pleuro-peritoneal cavity; the hind or true kidney is formed in both sexes as before by a growth backwards from the Wolffian duct. The tubules are at first solid columns of cells which are subsequently hollowed out.

The Wolffian bodies, or temporary kidneys, as they may be termed, give place at an early period in the human foetus to their successors, the permanent kidneys, which are developed behind

them. Each diminishes rapidly in size, and loses all renal functions. In the male it is developed into the *vasa efferentia*,

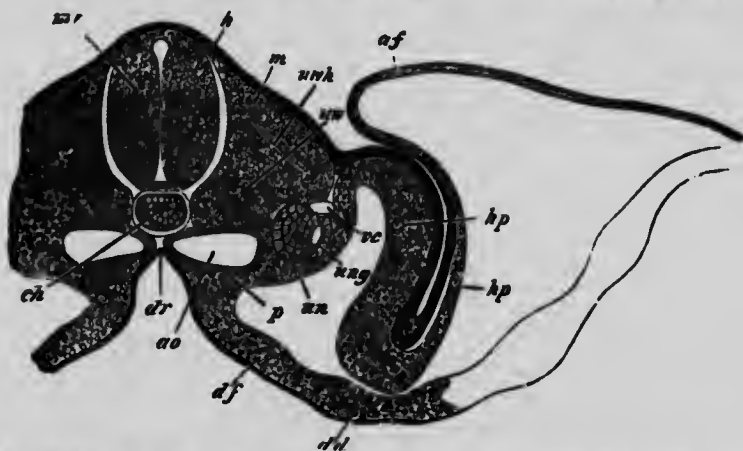

Fig. 678.—Transverse section of embryo chick (third day). *mr*, rudimentary spinal cord: the primitive central canal has become constricted in the middle; *ch*, notochord; *uwl*, primordial vertebral mass; *m*, muscle-plate; *dr*, *df*, hypoblast and visceral layer of mesoblast lining groove, which is not yet closed in to form the intestines; *ao*, one of the primitive aortae; *un*, Wolffian body; *ung*, Wolffian duct; *vc*, vena cardinalis; *h*, epiblast; *hp*, somatopleur and its reflection to form *af*, amniotic fold; *p*, pleuro-peritoneal cavity. (Kölliker.)

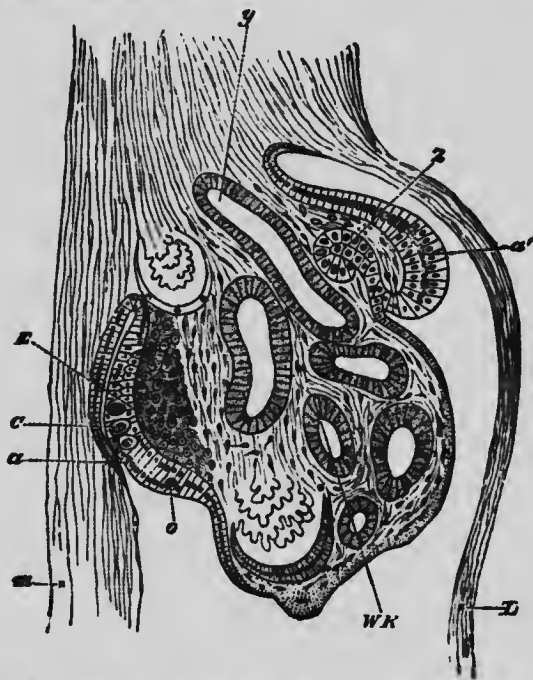

Fig. 679.—Section of intermediate cell-mass on the fourth day. *m*, mesentery; *L*, somatopleur; *a*, germinal epithelium, from which *z*, the duct of Müller, becomes involuted; *n*, thickened part of germinal epithelium in which the primitive ova *O* and *o*, are lying; *E*, modified mesoblast, which will form the stroma of the ovary; *WK*, Wolffian body; *y*, Wolffian duct.  $\times 160$ . (Waldeyer.)

*coni vasculosi*, and *globus major* of the epididymis; and thus a direct connection between the secreting part of the testicle and its duct is brought about. The Wolffian ducts persist in the male, and are developed to form the body and globus minor of the epididymis, the vas deferens, and ejaculatory duct on each side; the vesiculæ seminales form diverticula from their lower part. In the female a small relic of the Wolffian body persists as the *parovarium*, a functionless collection of tubules lined with ciliated epithelium near the ovary (see p. 798, fig. 610, *po*); in the male a similar relic is termed the *organ of Giralaldès*. The lower end of the Wolffian duct remains in the female as the duct of

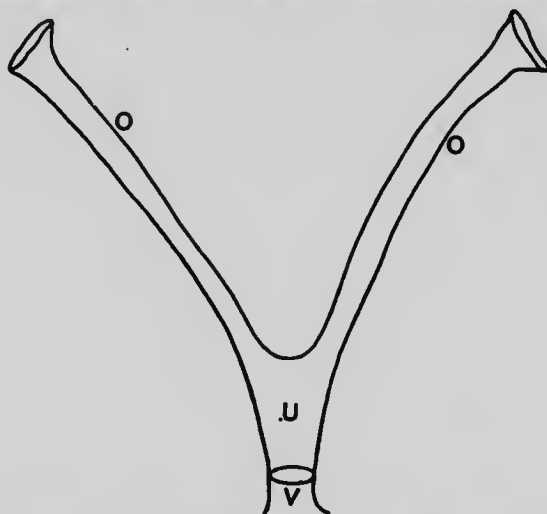

Fig. 680.—Diagram of two-horned uterus. The body of the uterus (U) is formed by the fusion of the two Müllerian ducts, the ununited portions of which form the oviducts, Fallopian tubes or horns of the uterus (O, O); V, vagina.

*Gaertner*, which descends towards, and is lost upon, the anterior wall of the vagina.

The Fallopian tubes, the uterus, and the vagina are developed from the Müllerian ducts. The two Müllerian ducts are united below into a single cord, called the *genital cord*, and from this are developed the vagina, as well as the cervix and the lower portion of the body of the uterus; while the ununited portion of the duct on each side forms the upper part of the uterus, and the Fallopian tube. In certain cases of arrested or abnormal development, these portions of the Müllerian ducts may not become fused together at their lower extremities, and there is left a cleft or horned condition of the upper part of the uterus resembling a condition which is permanent in certain of the lower animals (see fig. 680).

In the male, the Müllerian ducts have no special function, and are but slightly developed. The hydatid of Morgagni is the remnant of the upper part of the Müllerian duct. The small prostatic pouch, *uterus masculinus*, or *sinus pocularis*, forms the atrophied remnant of the distal end of the genital cord, and is, therefore, the homologue, in the male, of the vagina and uterus in the female.

We must now pass to the development of the ovary and testis.

Between the Wolffian body and the mesentery, the mesoblast covering the ridge produced by the projecting Wolffian body, is converted into a thick epithelium called the *germ epithelium* (see fig. 579). From this the reproductive gland (ovary or testis as the case may be) is developed.

The manner in which the ovary is formed is described in outline in Chapter LVII. (p. 802); the testis is formed in a similar way, only the downgrowths of cells which become nests of cells to form ova and Graafian follicles in the female, become hollowed out as seminiferous tubules in the male.

For some time it is impossible to determine whether an ovary or testis will be developed; gradually however the special characters belonging to one of them appear, and in either case the organ soon begins to assume a relatively lower position in the body; the ovaries are thus ultimately placed in the pelvis; while towards the end of foetal existence the testicles descend into the scrotum, the testicle entering the internal inguinal ring in the seventh month of foetal life, and completing its descent through the inguinal canal and external ring into the scrotum by the end of the eighth month. A pouch of peritoneum, the *processus vaginalis*, precedes it in its descent, and ultimately forms the tunica vaginalis or serous membrane of the organ; the communication between the tunica vaginalis and the cavity of the peritoneum is closed only a short time before birth. In its descent, the testicle or ovary of course retains the blood-vessels, nerves, and lymphatics, which were supplied to it while in the lumbar region, and which accompany it as it assumes a lower position in the body. Hence the explanation of the otherwise strange fact of the origin of these parts at so considerable a distance from the organ to which they are distributed.

*Descent of the Testicles into the Scrotum.*—The means by which the descent of the testicles into the scrotum is effected are not fully and exactly known. It was formerly believed that a membranous and partly muscular cord, called the *gubernaculum testis*, which extends while the testicle is yet high in the abdomen, from its lower part, through the abdominal wall (in the situation of

the inguinal canal) to the front of the pubes and lower part of the scrotum, was the agent by the contraction of which the descent was effected. It is now generally thought, however, that such is not the case, and that the descent of the testicle and ovary is rather the result of a general process of development in these and neighbouring parts, the tendency of which is to produce this change in the relative position of these organs. In other words, the descent is not the result of a mere mechanical

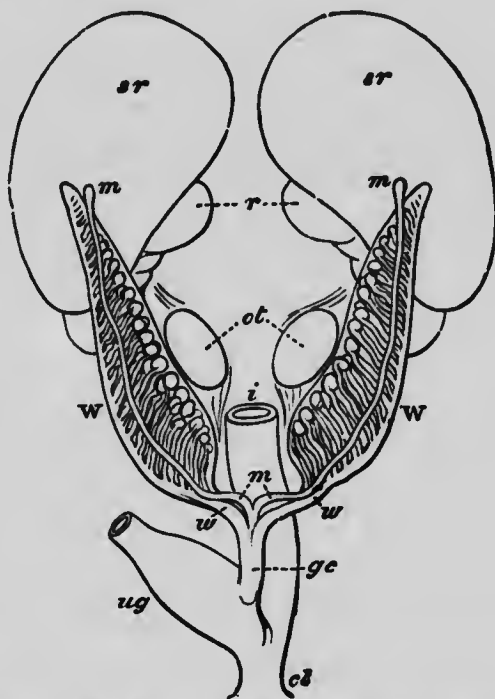

Fig. 681.—Diagram of the Wolffian bodies, Müllerian ducts and adjacent parts previous to sexual distinction, as seen from before. *sr*, the supra-renal bodies; *r*, the kidneys; *ot*, common blastema of ovaries or testicles; *W*, Wolffian bodies; *w*, Wolffian ducts; *m*, Müllerian ducts; *gc*, genital cord; *ug*, sinus urogenitalis; *i*, intestine; *cl*, cloaca. (Allen Thomson.)

action, by which the organ is dragged down to a lower position, but rather one change out of many which attend the gradual development and rearrangement of these organs.

The homologue, in the female, of the gubernaculum testis is a structure called the *round ligament of the uterus*, which extends through the inguinal canal, from the outer and upper part of the uterus to the subcutaneous tissue in front of the symphysis pubis.

At a very early stage of foetal life, the Wolffian ducts, ureters,



and Müllerian ducts, open into a receptacle formed by the lower end of the allantois, or rudimentary bladder; and as this communicates with the lower extremity of the intestine, there is for the time a common receptacle or *cloaca* for all these parts, which opens to the exterior of the body through a part corresponding with the future anus, an arrangement which is permanent in reptiles, birds, and some of the lower mammalia. In the human foetus, however, the intestinal portion of the cloaca is cut off from that which belongs to the urinary and generative organs; a separate passage or canal to the exterior of the body, belonging to these parts, is called the *sinus uro-genitalis*. Subsequently, this canal is divided, by a process of division extending from before backwards or from above downwards, into a 'pars urinaria' and a 'pars genitalis.' The former, continuous with the *urachus*, is converted into the urinary bladder.

The external parts of generation are at first the same in both sexes.

The opening of the genito-urinary apparatus is, in both sexes, bounded by two folds of skin, whilst in front of it there is formed a penis-like body surmounted by the glans, with a cleft or furrow along its under surface. The borders of the furrows diverge posteriorly, running at the sides of the genito-urinary orifice internally to the cutaneous folds just mentioned. In the female, this body becoming retracted, forms the clitoris, and the margins of the furrow on its under surface are converted into the nymphæ, or labiæ minora, the labia majora pudendæ being constituted by the great cutaneous folds. In the male foetus, the margins of the furrow at the under surface of the penis unite at about the fourteenth week, and form that part of the urethra which is included in the penis. The large cutaneous folds form the scrotum, and later (in the eighth month of development), receive the testicles, which descend into them from the abdominal cavity. Sometimes the urethra is not closed, and the deformity called hypospadias then results. The appearance of hermaphroditism may, in these cases, be increased by the retention of the testes within the abdomen.

The *supra-renal capsules* originate in a mass of mesoblast just above the kidneys; soon after their first appearance they are very much larger than the kidneys (see fig. 681), but by the more rapid growth of the latter this relation is soon reversed (see also p. 335).

# INDEX.

## A.

Abdominal muscles, action in respiration, 349  
 Abducens nerve, 625  
   centre, *ib.*  
 Aberration,  
   chromatic, 765  
   spherical, *ib.*  
 Absorption  
   of carbohydrates, 512  
     fats, 513  
     food, 512 *et seq.*  
     proteids, 513  
     solutions from the intestines, 516  
   by the skin, 576  
 Accelerator nerves, 164  
   urinae, 546  
 Accommodation of eye, 759  
   defects of, 763  
   mechanism of, 760  
     Beer's experiments, 763  
 Acetonæmia, 511  
 Acetyl, 391  
 Achromatin, 11  
 Achroo-dextrin, 389, 478  
 Acids in gastric juice, 482  
 Acid-albumin, 398, 484  
 Acini of secreting glands, 469, 471  
 Acromegaly, 336  
 Acrylic series, 391  
 Adamantoblasts, 80  
 Adamkiewicz reaction, 395  
 Adenine, 330, 558  
 Adenoid or lymphoid tissue, 51  
   in intestines, 454  
 Adenyl, 558  
 Adipose tissue, 47. *See Fat.*  
   development, 49  
   situations of, 47  
   structure, *ib.*  
   uses, 49  
   vessels and nerves, *ib.*  
 Afferent nerves, 97, 164  
 After-birth, 823  
 After-images, 770  
 Age, influence on capacity of respiration, 355  
 Agraphia, 73

## AMIDO-ACETIC ACID.

Air,  
   atmospheric, composition of, 374  
   breathing, 354  
   changes by breathing, 374  
   complemental, 354  
   quantity breathed, *ib.*  
   reserve, *ib.*  
   residual, *ib.*  
   tidal, *ib.*  
   transmission of sonorous vibrations  
     through, 722  
   undulations of, conducted by external  
     ear, *ib.*  
 Air-pumps, 382  
 Air-sacs, 344  
 Air-tubes. *See Bronchi.*  
 Alanine, 492  
 Albumin, 394, 397  
   acid, 398  
   alkali, *ib.*  
   chemical composition, 394  
   egg, 397  
   crystallisable, 395  
   lact-, 397  
   serum, *ib.*  
   crystallisable, 395  
   of blood, 413  
 Albuminates, 398  
 Albuminoids, 401  
 Albuminometer, Eshach's, 567  
 Albuminous substances, 393  
   action of gastric fluid on, 487  
 Albumins, 397  
 Albumoses, 393  
 Alcohol as an accessory to food,  
   466  
 Alimentary canal, 438 *et seq.*  
   development of, 851  
   nerves of, 523  
 Alkali-albumin, 398  
   properties of, *ib.*  
 Allantoin, 557  
 Allantois, development of, 816, 821  
 Alloxan, 557  
 Alloxuric or purine bases, 400  
 Amacrine cells, 750  
 Amido-acetic acid, 491

## AMMONIA.

Ammonia,  
 cyanate of, isomeric with urea, 549  
 urate of, 557  
 Amnesia, 739  
 Amnion, 817  
 development of, 820  
 fluid of, 817, 820  
 Amœbæ, 6  
 Amœboid movements, 12 *et seq.*, 419  
 cells, 6  
 colourless corpuscles, 420  
 cornea-cells, 744  
 protoplasm, 12, 106  
 Tridescantia, 14  
 Amphiaser, 19  
 Amphioxus, circulatory system of, 229  
 Amyloids or Starches, 389  
 action of pancreas and intestinal  
 glands, 488  
 of saliva on, 478  
 Amylopsin, action of, 488  
 Amyloses, 386  
 Anabolic phenomena, 581, 790  
 Anacrotic pulse, 271  
 Anelectrotonus, 180  
 Angio-neuroses, 311  
 Angulus opticus seu visorius, 758  
 Animal cell, structure of, 8 *et seq.*  
 Animal gum, 399  
 Animal heat. *See* Heat and Tempera-  
 ture.  
 Ankle-clonus, 662  
 Ano-spinal centre, 528  
 Antagonistic muscles,  
 reciprocal action of, 664  
 Antero-lateral ascending tract, 615  
 Antero-lateral descending tract, 614  
 Antihelix, 713  
 Antitragus, *ib.*  
 Aphasia, 678, 739  
 Aphemia, 739  
 Apnœa, origin of, 361  
 Appendices epiploicæ, 452  
 Appendix veriformis, *ib.*  
 Aqueductus cochleæ, 718  
 Aqueduct of Sylvius, 619, 624  
 Aqueous humour, 754  
 Arachnoid membrane, 603  
 Arches, visceral, 827  
 Archinephros, 856, 857  
 Area germinativa, 807  
 opaca, 808  
 pellucida, 807, 808  
 vasculosa, 819, 830  
 Areas of Cohnheim, 87  
 Areolar tissue, 38  
 development of, 43  
 Arginine, 402, 488, 554  
 Arteria centralis retinæ, 749, 754, 848,  
 850  
 Arterial tension in asphyxia, 371  
 Arteries, 213  
 bronchial, 345

## BASILAR MEMBRANE OF EAR.

Arteries—*continued*,  
 circulation in, velocity of, 262  
 coronary, 238  
 development of, 832, 833  
 distribution, 213  
 elasticity, 266  
 muscularity, 267  
 nerves of, 215  
 nervous system, influence of, 306  
 pressure of blood in asphyxia, 371  
 pulse, 267 *et seq.*  
 renal, ligature of, 545  
 rhythmic contraction, 267 *et seq.*  
 structure, 214 *et seq.*  
 umbilical, 823, 833, 835  
 velocity of blood flow in, 261  
 Articulate sounds, classification of,  
 vowels and consonants, 738  
 Artifacts, 9  
 Arytenoid cartilages, 728  
 effect of approximation, 730  
 movements of, *ib.*  
 Arytenoid muscle, 731  
 Ascending tubule of Henle, 532  
 Asphyxia, 368 *et seq.*  
 causes of death in, 369  
 conditions of the vascular system in,  
*ib.*  
 symptoms, 368  
 Assimilation, 7, 512, 581  
 Association fibres, 650, 681  
 Astigmatism, 765  
 Atmospheric air, 373. *See* Air.  
 composition of, 374  
 pressure in relation to respiration, 372  
 Atropine, effect of,  
 on heart, 252  
 on salivary secretion, 475  
 Attraction sphere, 12, 798, 802, 803, 805  
 Auditory area, 679  
 Auditory nerve, 627, 719  
 distribution, 719  
 origin, 628  
 Auerbach's plexus, 104, 447  
 Auricles of heart. *See* Heart.  
 Auricular diastole, 232  
 systole, *ib.*  
 Auriculo-ventricular valves. *See* Heart  
 valves.  
 Auto-intoxication theory of the ductless  
 glands, 321  
 Avogadro's law, 374  
 Axis-cylinder of nerve-fibre, 99

B.

Bacterial action on intestinal digestion,  
 490  
 Bacterium lactis, 388  
 Barnard's cardiometer, 246  
 Basement-membrane, 51, 451  
 Basilar membrane of ear, 718, 719

## BASOPHILE CELLS.

- Basophile cells, 419  
 Batteries and keys, 112  
   Daniell cell, *ib.*  
 Beer's experiments on accommodation of the eye, 763  
 Bernard's experiment on muscular irritability, 106  
 Bezold's ganglion, 106  
 Bicuspid valve, 106  
 Bladder's ganglion, 254  
 Biedermann's fluid, 107, 108  
 Bilaminar blastoderm, 807  
 Bile, 501  
   absorption by lymph, 507  
   analyses of human, 503  
   capillaries, 499  
   characters of, 503  
   constituents of, 502, 503  
   digestive properties, 489, 506  
   doubtful antiseptic power, 506  
   influence of, on fat absorption, 516  
     fasting on secretion, 588  
   mixture with chyme, 506  
   mucin, 503  
   pigments, 504  
   process of secretion, 501  
   quantity secreted, 502  
   salts, 503  
   secretion and flow, 502  
   specific gravity, *ib.*  
   uses, 506  
 Bile-expelling mechanism, 507  
 Bilirubin, 417, 502, 504  
 Biliverdin, 504  
 Binocular vision, 782  
 Bipolar nerve-cells, 192, 712, 844  
 Birth, changes after, 841  
 Biuret test, 395  
 Bladder, urinary. *See* Urinary Bladder.  
 Blastema. *See* Protoplasm.  
 Blastoderm, bilaminar, 807  
   trilaminar, *ib.*  
   unilaminar, 806  
 Blastopore, 807  
 Blastosphere, 805, 806  
 Blind spot, 768, 787  
 Blocking, 255  
 Blood, 82, 406  
   arterial and venous, difference between, 211  
   buffy coat, 410  
   carbonic acid in, 377, 379  
   circulation of, 226 *et seq.*  
     in the fœtus, 839  
     local peculiarities, 277  
     schema of, 228  
   coagulation, 82, 408 *et seq.*  
   colour, 82, 406  
   colouring matter, 426  
     relation to that of bile, 430  
   corpuseles or cells of, 82, 414. *See* Blood-corpuseles.  
   red, 415

K.F.

## BLOOD-PRESSURE.

- Blood—*continued.*  
 corpuseles, white, 418  
 crystals, 427 *et seq.*  
 extractive matters, 414  
 fatty matters, *ib.*  
 fibrin, 409  
   separation of, *ib.*  
 gases of, 377  
 hemoglobin, 415, 426 *et seq.*  
   photographic spectrum of, 434  
 nitrogen in, 377  
 odour or halitus of, 407  
 oxygen in, 377  
 oxyhæmoglobin, 426 *et seq.*  
   photographic spectrum of, 434  
 plasma, 406, 411  
 protoids of, 413  
 quantity, 407, 408  
   Haldane's and Lorrain Smith's experiments, 408  
 reaction, 407  
 salts, 414  
 serum of, 409, 411  
 specific gravity, 406  
 splenic, 325  
 structural composition, 415  
 taste, 407  
 temperature, *ib.*  
 tests for, 437  
 transfusion of, 317  
 venous, 212  
 Blood-corpuseles, red, 82, 415  
   action of reagents on, 417 *et seq.*  
   composition of, 417  
   development, 422  
     intracellular, 425  
   disintegration and removal, 325  
   methods of counting, 420  
   origin of matured, 424  
   rouleaux, 417  
   specific gravity, 415  
   stroma, *ib.*  
   tendency to adhere, 417  
   varieties, 414  
   vertebrate, various, 416  
 Blood-corpuseles, white, 418  
   action of reagents on, 420  
   amoeboid movements of, 419  
   composition of, 426  
   emigration of, 275  
   formation in spleen, 325, 424  
   locomotion, 419  
   origin of, 425  
   varieties, 418  
 Blood-crystals, 427 *et seq.*  
 Blood-platelets, 420  
 Blood-pressure, 281 *et seq.*  
   in capillaries, 289  
   in veins, 288  
   action of respiratory movements on, 277  
   measurement in man, 295 *et seq.*  
   schema to illustrate, 282, 283

3 K

## BLOOD-VESSELS.

- Blood-vessels,  
 circulation in, 261  
 effect of gravity, 293  
 elasticity of, 266  
 of eyeball, 754  
 in intestines, 450  
 of kidney, 534  
 of muscle, 93  
 of stomach, 445  
 influence of nervous system on,  
 296
- Body-cavity, 811, 812
- Bone, 58  
 canaliculi, 60  
 cancellous, 58  
 chemical composition, *ib.*  
 compact, *ib.*  
 lamellæ of, 62  
 development, 63 *et seq.*  
 growth, 69  
 Haversian canals, 61  
 lacunæ, *ib.*  
 marrow, 59  
 medullary canal, 58  
 microscopic structure, 60  
 ossification in cartilage, 64  
 periosteum and nutrient blood-vessels,  
 59  
 structure, 58 *et seq.*
- Bowman's glands, 711  
 muscle, 719
- Brain. *See* Bulb, Cerebellum, Cerebrum, Pons, etc.  
 capillaries of, 277  
 child's, 653  
 circulation of blood in, 277 *et seq.*  
 convolutions, 652  
 development, 844 *et seq.*  
 dog's, 673  
 extirpation of, in mammals, 668  
 in fœtus, 621  
 grey matter, 190  
 lobes, 655  
 lunatic's, 684  
 membranes of, 603  
 monkey's, 674  
 motor areas, 675  
 orang's, 654  
 quantity of blood in, 278  
 sensori-motor area, 679  
 sensory areas, 678  
 vertebrate (section), 621  
 ventricles, 619  
 white matter, 190
- Branchial clefts, 828
- Bread as food, 464
- Breathing. *See* Respiration.
- Broca's convolution, 678, 739
- Bronchi, arrangement and structure of,  
 338
- Bronchial arteries and veins, 345
- Brownian movement, 106
- Bruch, membrane of, 745, 746

## CAPILLARIES.

- Brücke on the self-steering action of  
 the heart, 238
- Brunner's glands, 451
- Buffy coat, formation of, 410
- Bulb, pons and mid-brain, 622  
 anterior aspect, *ib.*  
 internal structure, 631 *et seq.*  
 posterior aspect, 624
- Bulbus arteriosus, 832
- Burch's experiments on colour vision, 779
- Burdach's column, 609, 612, 624, 632
- Burdon-Sanderson's stethograph, 351
- Bursæ, synovial, 468
- Butyric acid, 388, 491
- C.
- Cachexia strumipriva, 331
- Caffeine, 466
- Caisson disease, 372
- Calcification of bone, 66
- Calcium carbonate, 58  
 in urine, 566  
 fluoride, 58  
 oxalate in urine, 565  
 phosphate, 58
- Calorimeters, 598, 599
- Calyces of the kidneys, 530
- Canal, alimentary. *See* Stomach, Intestines, etc.  
 external auditory, 713  
 function of, 722  
 spiral, of cochlea, 720
- Canal of Schlemm, 748  
 of Petit, 754  
 of Stilling, 850
- Canaliculi of bone, 60
- Canals, semicircular, of ear, 717  
 development of, 850
- Cancellous tissue of bone, 58
- Cane sugar, 387
- Cannon, shadow photographs of the  
 stomach, showing peristaltic move-  
 ments, 524
- Capacity of chest, vital, 354
- Capillaries, 219  
 bile, 499  
 circulation in, 263, 273  
 velocity of, 263  
 development, 830  
 diameter, 219  
 form, 220  
 influence on circulation, 273  
 network of, 220  
 number, 222  
 passage of corpuscles through walls  
 of, 275  
 pressure in, 289 *et seq.*  
 resistance to flow of blood in, 273  
 still layer in, *ib.*  
 size, 220  
 structure of, 219

## CAPSULE OF BOWMAN.

- Capsule of Bowman, 532  
 of Glisson, 497  
 of Tenon, 743, 781  
 Capsules, Malpighian, 532  
 Carbamide. *See* Urea.  
 Carbohydrates, 385 *et seq.*  
 absorption of, 512  
 Carbonates in urine, 561  
 Carbonic acid in atmosphere, 373  
 in blood, 377  
 effect of, 379  
 increase in breathed air, 373  
 influence of, on nerve, 188  
 in lungs, 377  
 Carbonic oxide, poisonous action of, 371  
 Carbonic oxide hæmoglobin, 435  
 Cardiac cycle, 231  
 Cardiac glands, 443, 479  
 Cardiac orifice of stomach, action of, 524  
 sphincter of, 525  
 relaxation in vomiting, *ib.*  
 Cardiac sympathetic, 249  
 Cardiogram from human heart, 241  
 Cardiographs, 238 *et seq.*  
 Cardiometer, Barnard's, 246  
 Roy's, 247  
 Carnic acid, 488  
 Carotid gland, 337  
 Cartilage, 53  
 articular, 53, 54  
 cellular, 57  
 chondrin obtained from, 55  
 classification, 53  
 costal, 53, 54  
 development, 56  
 elastic, 53, 56  
 fibrous, 55, 56. *See* Fibro-cartilage.  
 hyaline, 53  
 matrix, *ib.*  
 ossification, 64  
 perichondrium of, 54  
 structure, 53  
 temporary, 54  
 transitional, *ib.*  
 varieties, 53  
 Cartilages of larynx, 727  
 Casein, 458. *See* Milk.  
 Caseinogen, 458  
 Cauda equina, 604, 843  
 Caudate nucleus, 644  
 Cavity of reserve, 81  
 Cell division, 16  
 Cells, 5  
 amœboid, 6  
 blood. *See* Blood-corpuscles.  
 bone, 61  
 cartilage, 53 *et seq.*  
 characteristics of, 12  
 ciliated, 30  
 connective tissue, 39  
 definition of, 6  
 epithelium, 27. *See* Epithelium.  
 fission, 16

## CEREBRUM.

- Cells—*continued.*  
 formative, 809  
 gustatory, 707  
 hepatic, 495  
 nerve, 191  
 olfactorial, 711  
 parietal, 444, 479  
 pigment, 106  
 structure, 9 *et seq.*  
 varieties, 24 *et seq.*  
 vegetable, 6, 13  
 distinctions from animal cells, 6  
*et seq.*  
 Cells of Deiters, 721  
 of Purkinje, 195, 641  
 Cellular cartilage, 57. *See* Cartilage.  
 Cellulose, 380  
 Cement of teeth, 74, 77, 81  
 Centres, nervous, &c. *See* Nerve-centres.  
 of ossification, 64  
 Centrifugal machine, 412  
 nerve-fibres, 163  
 Centripetal nerve-fibres, 164  
 Centro-acinar cells, 487  
 Centrosome, 8, 12, 18  
 Cerebellar ataxy, 683  
 Cerebellum, 638  
 effects of removal or disease, 683  
 equilibration, *ib.*  
 functions of, 681 *et seq.*  
 grey matter, 195, 621, 639  
 hemi-extirpation, results of, 682  
 semicircular canals, 685  
 extirpation of, 688  
 sensory impulses, 684  
 structure, 638  
 Cerebral cortex, 647  
 histological structure, *ib.*  
 Cerebral hemispheres. *See* Cerebrum.  
 Cerebral nerves, origin of, 625 *et seq.*  
*See* under names of nerves.  
 Cerebro-spinal axis, 189, 603  
 Cerebro-spinal fluid, 605, 620  
 Cerebro-spinal nervous system, 189, 603  
*See* Brain, Spinal Cord, etc.  
 Cerebrum, 642  
 convolutions of, 652 *et seq.*  
 crura of, 619  
 degeneration tracts after injury of  
 Rolandic area, 671  
 development, 844  
 effects of injury, 671  
 removal, 667, 670  
 external capsule, 645  
 functions of, 667 *et seq.*  
 early notions, 667  
 grey matter, 194, 643  
 internal capsule, 645  
 localization of functions, 668  
 motor areas, 671, 675, 679  
 relation to speech, 739

## CEREBRUM.

- Cerebrum—*continued*.  
 sensory areas, 672  
 extirpation, *ib.*  
 stimulation, *ib.*  
 structure, 642 *et seq.*  
 white matter, 646  
 Ceruminous glands of ear, 576  
 Chambers of the eye, 754  
 Chauveau's dromograph, 263  
 Chemical composition of the human body, 384 *et seq.*  
 Chest, expansion in inspiration, 347  
 Chest-voice, 736  
 Cheyne-Stokes' respiration, 362  
 Chlorides in urine, 561  
 Cholagogues, 507  
 Cholic acid, 503  
 Cholesterin, 99, 392, 505  
 Choletelin, 504  
 Choline, 392  
 Chondrin, 55, 401  
 Chorda tympani, 474, 627  
 effects of stimulation of divided, 475  
 Chordæ tendinæ. *See* Heart.  
 Chorion, 816, 822  
 Choroid coat of eye, 741  
 blood-vessels, 745  
 development, 849  
 structure, 745  
 Choroidal fissure, 848  
 Chromatic aberration, 765  
 Chromatin, 11 (*see* 400)  
 Chromatolysis, 201  
 Chromatoplasm, 200  
 Chromogen, 334  
 Chromophanes, 780  
 Chromoplasm, 10  
 Chyle, 224, 313, 514  
 molecular basis of, 313  
 Chyme, 501  
 Cilia, 30  
 Ciliary epithelium, *ib.*  
 function of, 31  
 Ciliary motion, *ib.*  
 nature of, 32  
 Ciliary muscles, 746  
 action of, in adaptation to distances, 760  
 Ciliary processes, 746  
 Cilio-spinal centre, 666  
 Circulation of blood, 203, 226 *et seq.*  
 action of heart, 203  
 in brain, 277  
 capillaries, 273  
 course of, 211 *et seq.*  
 erectile structures, 280  
 influence of respiration on, 363  
 of gravity, 293  
 peculiarities of, in different parts, 277  
 portal, 212  
 pulmonary, 211  
 renal, 212  
 systemic, 211

## CONTRACTILITY.

- Circulation of blood—*continued*.  
 in veins, 215  
 velocity of, 264  
 Circulatory system, 203 *et seq.*  
 Circumvallate papillæ of the tongue, 706  
 Claustrum, 645  
 Cleft-palate, cause of, 829  
 Clefts, visceral, 827  
 Clerk-Maxwell's experiment, 774  
 Clitoris, 280  
 development of, 862  
 Cloaca, *ib.*  
 Clonus, 128  
 Clot or coagulum of blood. *See* Coagulation.  
 Coagulated proteids, 398  
 Coagulation of blood, 82, 408 *et seq.*  
 conditions affecting, 410  
 theories of, *ib.*  
 of milk, 458  
 Cocaine, 466  
 Coccygeal gland, 337  
 Cochlea of the ear, 717  
 theories in connection with, 725  
 Cœlom, 811  
 Cohnheim, areas of, 87  
 Cold spots, 703  
 Collagen, 40, 58, 401  
 Colloids, 394  
 Colostrum, 457  
 corpuscles, 458, 462  
 Colour-blindness, 778  
 Colour sensations, 776  
 Burch's experiments, 779  
 theories of, 777-9  
 Colours, optical phenomena, 776 *et seq.*  
 Columnar epithelium, 27  
 Comma tract, 610, 612, 614  
 Commissural fibres, 650  
 Complemental air, 354  
 Complementary colours, 776  
 Compound tubular glands, 469  
 racemose glands, 470  
 Conception, 691  
 Condiments as accessories to food, 466  
 Conducting paths in cord, 657 *et seq.*  
 Conical and filiform papillæ of tongue, 706  
 Coni vasculosi, 794, 796  
 Conjugate deviation of head and eyes, 679, 682  
 Conjunctiva, 741  
 Connective tissues, 37  
 classification, 37  
 corpuscles, 40  
 elastic, 46  
 fibrous, 44  
 general structure of, 38  
 jelly-like, 52  
 retiform, 50  
 varieties, 37  
 Contractility of muscle, 106

## CONTRACTION.

- Contraction of pupil, 762  
 Convulsions, cerebral, 652 *et seq.*  
 Cooking, effect of, 465  
 Co-ordination of muscular movements, 130  
 Copper sulphate, or Piotrowski's test, 395  
 Cord, spinal. *See* Spinal Cord.  
 Corium, 469  
 Cornea, 741  
   corpuscles, 744  
   nerves, *ib.*  
   structure, 743  
 Corneo-scleral junction, 747  
 Coronary arteries, 238  
 Corona radiata, 645  
 Corpora cavernosa, 280, 796  
   quadrigemina, 637  
 Corpus Arantii, 210  
   callosum, 642, 643  
   dentatum  
     of cerebellum, 639  
     of olivary body, *ib.*  
 Highmorianum, 794  
 luteum, 800  
   of human female, *ib.*  
   of menstruation and pregnant,  
     compared, *ib.*  
   spongiosum, 280, 796  
   striatum, 644  
 Corpuscles of blood, 82, 414. *See*  
   Blood-corpuses.  
 Corpuscles, Malpighian, 323, 532  
 Corpuscles of Grandry, 697  
   of Herbst, 695  
 Corti's rods, 720 *et seq.*  
   office of, 725  
 Coughing, mechanism of, 361  
 Cowper's glands, 537  
 Cranial nerves, 189, 625 *et seq.*  
 Crassamentum, 409  
 Creatine, 553  
 Creatinine, 559  
 Crescents of Gianuzzi, 473  
 Cretinism, cause of, 331  
 Crico-arytenoid muscles, 730, 731  
 Cricoid cartilage, 727  
 Crico-thyroid muscle, 730  
 Crista acoustica, 687, 719  
 Crossed pyramidal tract, 613  
 Crosses of Ranvier, 100  
 Crowbar accident, 680  
 Crura cerebelli, 639  
   cerebri, 619  
     grey matter of, 621  
 Crusta, 637  
   petrosa, 77, 81  
 Crypts of Lieberkuhn, 451  
 Crystallin, 747  
 Crystalline lens, 741, 746  
   in relation to vision at different  
     distances, 759  
 Crystallisable proteids, 394

## DEVELOPMENT.

- Crystalloids, 394  
 Cupula, 687  
 Curdling ferments, 458, 484  
 Currents of action,  
   constant, 113  
   induced, 114  
   nerve, 110  
 Cuticle. *See* Epidermis, Epithelium.  
 Cutis vera, 571  
 Cystic duct, 495  
 Cystin in urine, 565
- D.
- Daltonism, 778  
 Daniell's battery, 112, 113  
 Decidua, 815  
   development of, 817  
   menstrualis, 803  
   reflexa, 815  
   serotina, *ib.*, 817  
   vera, 815  
 Decussation of fibres in medulla ob-  
   longata, 633  
   in spinal cord, 658  
   of optic nerves, 786  
 Defæcation, mechanism of, 528  
   influence of spinal cord on, *ib.*  
 Degeneration method, 167, 170, 609  
 Deglutition. *See* Swallowing.  
 Deiters, cells of, 721  
   nucleus, 628, 683  
 Dental germ, 78  
   papilla, *ib.*  
 Dentine, 74  
   formation of, 79  
   structure, 75  
 Depressor nerve, 306  
 Dermis, 571  
 Descemet's membrane, 744  
 Descending tubule of Henle, 532  
 Deutero-albumose, 484  
 Development, 803 *et seq.*  
   adipose tissue, 49  
   alimentary canal, 851  
   allantois, 816, 821  
   amnion, 820  
   arteries, 832, 833  
   blood-vessels, 832  
   bone, 63 *et seq.*  
   brain, 844  
   decidua, 817  
   ear, 850  
   extremities, 826  
   eye, 847  
   eyelids, 850  
   face, 826  
   Fallopian tubes, 859  
   fetal membranes, 818  
   genito-urinary apparatus, 855 *et seq.*  
   head, 826  
   heart, 830



## DEVELOPMENT.

Development—*continued*.  
 intestines, 852  
 limba, 826  
 liver, 853  
 lungs, 854  
 medulla oblongata, 845  
 muscle, 95  
 nerve-fibres, 104  
 nervous system, 841 *et seq*  
 nose, 850  
 œsophagus, 851  
 optic nerve, 848  
 organs of sense, 850  
 ovum, 803  
 pancreas, 853  
 pharynx, 851  
 pituitary body, 825  
 respiratory apparatus, 854  
 salivary glands, 853  
 spina. cord, 841  
 stomach, 851  
 teeth, 77  
 vagina, 860  
 vascular system, 830  
 veins, 836  
 vertebræ, 824  
 visceral arches and clefts, 827 *et seq.*  
 Wolfian bodies, urinary apparatus  
 and sexual organs, 856 *et seq.*  
 Dextrin, 389  
 Dextrose, 386  
 in urine, 567  
 tests for determining, 386, 568  
 Diabetes, 510, 592  
 artificial production in animals, 510,  
 511 (*see* 567)  
 Dialysis, 394  
 Diapedesis of blood-corpuscles, 274  
 Diaphragm. *See* Inspiration, etc.  
 development, 855  
 Diastase of liver, 509  
 Diastole of heart, 231  
 Dirotic pulse, 272  
 Diet, 585 *et seq.*  
 nutritive value, 455  
 tables, 456, 457, 585 *et seq.*  
 Diffusion and osmosis, distinguished, 394  
 Digestion,  
 in the intestines, 486 *et seq.*  
 duration of, 528  
 mechanical processes, 518 *et seq.*  
*See* Gastric fluid, Food, Stomach.  
 Dilator pupillæ, 746  
 Diplopia, 783  
 Direct cerebellar tract, 615  
 pyramidal tract, 614  
 Disaccharides, 386  
 Discus proligerus, 800  
 Disuse atrophy, 202, 680  
 Diuretics, 541  
 Dobie's line, 88  
 Dorsal ridges, 809  
 Double vision, 783

## EMULSIFICATION.

Dromograph, Chauveau's, 263  
 Drugs, action of, 528  
 on the eye, 767  
 on the heart, 252  
 on perspiration, 579  
 Ductless glands, 320 *et seq.*  
 theories of secretion, 321  
 Ducts of Bellini, 532, 534  
 of Cuvier, 837, 838  
 Ductus arteriosus, 834, 835, 840  
 closure of, 841  
 venous, 836, 839  
 closure of, 841  
 Dudgeon's sphygmograph, 269  
 Dulong's calorimeter, 599  
 Duodenum, 446  
 Duprè's urea apparatus, 550, 551  
 Dura mater, 603  
 Dyspnœa, 358

E.

Ear, 713  
 bones or ossicles of, 715  
 function of, 723  
 development, 850  
 external, 713  
 function of, 722  
 internal, 716  
 function of, 722  
 middle, 714  
 function of, 722  
 Eck's fistula, 553  
 Ectoderm, 807  
 Efferent nerves, 97, 163  
 Eggs as food, 455, 462  
 Ehrlich's experiments with methylene  
 blue, 378, 670  
 Elastic cartilage, 53, 56  
 fibres, 44  
 tissue, 46  
 Elastin, 40, 401  
 Electrical currents of retina, 781  
 nerves, 164  
 phenomena of muscle, 139 *et seq.*, 184  
 Electricity,  
 action on blood-corpuscles, 418  
 in muscle, 147 *et seq.*, 184  
 nerve, 184  
 Electrodes, non-polarisable, 142  
 Electrometer, Lippmann's capillary, 146  
 Electrotonus, 175  
 Eleidin, 571  
 Elementary substances in the human  
 body, 384  
 Embryo, 803 *et seq.* *See* Development.  
 Embryological method, 609  
 Embryonic heart and blood-vessels, 832,  
 833  
 spot, 807  
 Emetics, 526  
 Emulsification, 392, 489, 513

## ENAMEL OF TEETH.

- Enamel of teeth, 76  
 formation of, 79  
 Enamel organ, *ib.*  
 Enchylema, 8  
 End-bulbs, 695  
 End-plates, motorial, 93, 102  
 Endocardiac pressure, 241 *et seq.*  
 Endocardium, 205  
 Endoderm, 807  
 Endolymph, 686, 717, 720  
 Endomysium, 85  
 Endoneurium, 101  
 Endosmometer, 317, 318  
 Endothelium, 26  
 distinctive characters, *ib.*  
 germinating, 25  
 Eosinophile cells, 418  
 Epencephalon, 622, 846  
 Epiblast, 22, 807  
 organs formed from, 814  
 Epicardium, 203  
 Epidermis, 570  
 Epididymis, 794, 796  
 Epiglottis, 733, 734  
 Epimysium, 85  
 Epinephrine, 335  
 Epineurium, 101  
 Epithelium, 23  
 chemistry of, 36  
 ciliated, 30  
 cogged, 35  
 columnar, 27  
 compound, 24  
 cubical, 27  
 germinal, 798  
 goblet-shaped, 29  
 nutrition of, 36  
 pavement, 26  
 renal, 541  
 simple, 24  
 spheroidal, 27  
 stratified, 34  
 transitional, 33  
 Erectile structures, circulation in, 280  
 Erection, *ib.*  
 cause of, *ib.*  
 centre, 666  
 influence of muscular tissue in, 281  
 Ergograph, Mosso's, 157  
 Erythroblasts, 424  
 Erythro-dextrin, 389, 478  
 Esbach's albuminometer, 567  
 Eustachian tube, 714, 723  
 function of, 723  
 Exchange of material, 583  
 in diseases, 591  
 with various diets, 589  
 Excitability of tissues, 105  
 Exercise,  
 effects on temperature of body, 596  
 Expiration, 350  
 force of expiratory act, 356  
 influence on circulation, 366

## FATTY ACIDS.

- Expiration—*continued.*  
 mechanism of, 350  
 muscles concerned in, *ib.*  
 relative duration of, 353  
 External capsule, 645  
 sphincter muscle, 527  
 Extraventricular nucleus, 644  
 Extremities, development of, 825  
 Eye, 740  
 action of drugs on pupil, 767  
 adaptation of vision at different distances, 759 *et seq.*  
 blood-vessels, 754  
 causes of dilatation and contraction of pupil, 768  
 chambers of, 754  
 development, 847  
 optical apparatus of, 755  
 defects in, 763  
 refractive media of, 755  
 resemblance to camera, *ib.*  
 Eyeball, 741  
 blood-vessels of, 754  
 electrical currents of, 781  
 muscles influencing movement, 781  
 various positions of, 783  
 Eyelids, 740, 741  
 development of, 850  
 Eyes, simultaneous action in vision, 782
- F.
- Face, development of, 826  
 Facial nerve, 627  
 effects of paralysis of, *ib.*  
 origin, *ib.*  
 relation of, to expression, *ib.*  
 Faeces, composition of, 517  
 quantity passed, 518  
 Fallopian tubes, 802  
 development of, 859  
 Falsetto voice, 736  
 Faradisation, 127  
 Far-point, 763  
 Fasciculus solitarius, 628  
 Fasting,  
 influence on secretion of bile, 588  
 Fat. *See* Adipose tissue.  
 action of bile on, 506  
 of pancreatic secretion, 489  
 situations where found, 47  
 uses of, 49  
 Fats,  
 absorption of, 513  
 action of pancreatic juice on, 489  
 chemical constitution, 391  
 decomposition products, 392  
 emulsification, *ib.*  
 of milk, 459  
 saponification, 392  
 Fatty acids, 391

## FEMALE GENERATIVE ORGANS.

- Female generative organs, 798  
 pronucleus, 805  
 Fenestrated membrane of Henle, 214  
 Fenestra ovalis, 715, 717  
 rotunda, 715, 718  
 action of, 724  
 Ferment coagulation, 396  
 Ferments, 403, 480  
 classification of, 404  
 in pancreatic juice, 487  
 Fibres of Müller, 749  
 of Remak, 102  
 Fibrils, 87  
 Fibrin, 409, 411, 413  
 ferment, 411, 413, 414, 459  
 formation, 409, 411  
 Fibrinogen, 82, 410, 413  
 Fibrinoplastin, 414  
 Fibro-cartilage, 55  
 classification, *ib.*  
 development, 56  
 white, 55  
 yellow, 56  
 Fibrous tissue, 44  
 white, *ib.*  
 yellow, 46  
 Fick's spring kymograph, 289, 290  
 Fifth cranial nerve, 625  
 Filiform papillæ of tongue, 706  
 Fillet, 637  
 Filum terminale, 604  
 Fishes, circulatory system in, 229  
 Fleischl's hæmoglobinometer, 437  
 Flesh of animals, 455  
 Flour as food, 463  
 Fluids, swallowing, 521  
 Fluoride of calcium, 58  
 Focal distance, 759  
 Foetal membranes, 815  
 development of, 818  
 Fœtus,  
 circulation in, 839  
 communication with mother, 823  
 Follicles, Graafian. *See* Graafian vesicles.  
 Food, 455  
 absorption of, 512 *et seq.*  
 accessories to, 466  
 cooking, 465  
 digestibility of articles of, 455  
 value dependent on, *ib.*  
 heat-value of, 597  
 of man, 456  
 too little, 587  
 proximate principles in, 455  
 vegetable, *ib.*, 465  
 Foramen ovale, 834  
 of Magendie, 620  
 of Monro, 645  
 Fore-gut, 814  
 Formative cells, 809  
 Formic acid, 391  
 Fornix, 645

## GLOBULINS.

- Fourth cranial nerve, 625  
 Fovea centralis, 748, 753, 772, 774  
 Fromann's lines, 101  
 Frontal-nasal process, 829  
 Fundus of eye, 770  
 of urinary bladder, 536  
 Fungiform papillæ of the tongue, 706  
 Funiculus solitarius, 628, 635  
 Furfuraldehyde, 504  
 Fuscine granules, 781
- G.
- Galactose, 387  
 Gall-bladder, 500  
 structure, *ib.*  
 Galvanism, 139  
 Galvanometer, 141  
 Gangee, photographic spectrum of hæmoglobin and its derivatives, 434  
 Ganglia. *See* Nerve-centres.  
 sympathetic, functions of, 303  
 Ganglion spirale, 722  
 Gas analysis, 383  
 Gases,  
 extraction from blood, 377  
 in blood, *ib.*  
 in the lungs, *ib.*  
 of plasma and serum, 413  
 Gastric glands, 479  
 innervation of, 482  
 Gastric juice, 479  
 acids in, 481  
 test for, 482  
 action on food, 484 (*see* 521)  
 artificial, 479  
 bacterial action, 490  
 composition of, 481  
 pepsin of, 480, 481  
 secretion of, 481  
 influence of nervous system on, 482  
 Gelatin, 40, 401  
 as a constituent of food, 463  
 Generative organs of the female, 798  
 of the male, 793  
 Genito-urinary apparatus, development of, 855 *et seq.*  
 Gerlach's network, 606  
 Germinal cells, 842  
 disc, 808  
 epithelium, 798  
 spot, 22, 802  
 vesicle, *ib.*  
 Giant cells, 59  
 Glands. *See* names of different.  
 Glisson's capsule, 497  
 Globin, 428  
 Globulins, 394, 396, 397  
 distinctions from albumin, 394

## GLOSSO-PHARYNGEAL NERVE.

- Glosso-pharyngeal nerve, 628  
 communications of, *ib.*  
 functions, 629  
 motor filaments, 630  
 a nerve of common sensation and of taste, 629
- Glottis, movements of, 735, 736
- Glucoproteids, 399
- Glucosamine, *ib.*
- Glucose  
 in liver, 507  
 test for, 390
- Glycerides, 391
- Glycerin or Glycerol, *ib.*
- Glycocholic acid, 503
- Glycocine, 491, 558
- Glycogen, 390, 508  
 characters, 390  
 destination of, 509  
 preparation, *ib.*  
 quantity formed, *ib.*  
 source of, 508  
 variation with diet, 509
- Glycosuria, 510
- Gmelin's test, 504
- Goblet cells, 29, 709
- Goll's column, 609, 612, 624, 632
- Gowers' hæmacytometer, 420, 421  
 hæmoglobinometer, 436
- Graafian vesicles, 798  
 formation and development of, *ib.*  
*et seq.*  
 relation of ovum to, 799  
 rupture of, changes following, 800  
*et seq.*
- Grandry, corpuscles of, 697
- Granular layers of retina, 750
- Grape-sugar. *See* Dextrose.
- Gravity, influence of, on circulation, 293
- Gréhant, output of the heart, 246
- Grey matter of cerebellum, 195, 621, 641  
 of cerebrum, 195, 643  
 of crura cerebri, 621  
 of medulla oblongata, 624, 632, 633, 635  
 of pons Varolii, 621  
 of spinal cord, 190, 606
- Groove, primitive, 808
- Grossmann, on the course of the inhibitory fibres in mammals, 252
- Growth of bone, 69
- Guanine, 558
- Gubernaculum testis, 860
- Gullet, 440. *See* Œsophagus.
- Gustatory cells, 707

## H.

- Hæmacytometers, 420, 421
- Hæmadrometer, Volkmann's, 263
- Hæmatin, 428
- Hæmatoblasts, 325, 416

## HEART.

- Hæmatochrometer, Vicrorrdt's, 263
- Hæmatoidin, 429, 502
- Hæmatoporphyrin, 429
- Hæm-autograph, 272
- Hæmin, 429
- Hæmochromogen, 428
- Hæmoglobin, 83, 399, 415, 426 *et seq.*  
 analysis of, 428  
 compounds of, 430  
 crystallisable, 394  
 distribution, 426  
 estimation of, 436  
 photographic spectrum of, 434
- Hæmoglobinometers, 436, 437
- Hæmoglobinuria, paroxysmal, 569
- Hair-cells, 721
- Hair-follicles, 573
- Hairs, 573  
 structure of, *ib.*
- Haldane's apparatus for estimating the carbonic acid and aqueous vapour given off by an animal, 375
- Hamulus, 719
- Hardy, microscopic structure of cells, 9
- Hare-lip, cause of, 829
- Hassall, concentric corpuscles of, 329
- Haversian canals, 61
- Head, development of, 826
- Head and tail folds, 812, 813
- Hearing, anatomy of organ of, 713 *et seq.*  
 influence of external ear on, 722  
 of middle ear, 723  
 physiology of, 722  
 range of, 726  
*See* Sound, Vibrations, etc.
- Heart, 203 *et seq.*  
 action of,  
 accelerated, 249  
 force of, 245  
 frequency, *ib.*  
 inhibited, 249  
 self-steering, 238
- auricles of, 204, 231
- chambers, 204  
 capacity of, 208
- chordæ tendinæ of, 210
- columnæ carneæ of, *ib.*
- course of blood in, 211
- cycle, 231
- development, 830
- endocardiac pressure, 241
- endocardium, 205, 208
- fœtal, 830
- force, 245
- frog's, 230  
 instruments for studying, 258  
 nerves of, 250
- ganglia of, *ib.*
- influence of drugs, 252  
 of pneumogastric nerve, 247  
 of sympathetic nerve, 249
- innervation, 247

## HEART.

- Heart—*continued*.  
 intracardiac nerves, 253  
 investing sac, 203  
 muscular fibres of, 93  
 musculi papillares, 210  
 nervous system, influence on, 247  
 output of, 246  
 pericardium, 203  
 physiology, 231 *et seq.*  
 reflex inhibition, 252  
 situation, 203  
 size and weight, 208  
 sounds of, 235  
   causes, 236  
 structure of, 208  
 valves, 209  
   auriculo-ventricular, 208  
     function of, 233  
   semilunar, 210  
     function of, 234  
   structure, 211  
 ventricles, their action, 204, 207  
 work of, 246
- Heat, animal. *See* Temperature.  
 influence of nervous system, 601  
   of various circumstances on, 600  
   *et seq.*  
 losses by radiation, etc., 598  
 variations of, 596
- Heat coagulation, 396  
 Heat-rigor, 159, note  
 Heat spots, 703  
 Heat-value of food, 597
- Height, relation to respiratory capacity,  
 355
- Helicine arteries, 796  
 Helicotrema, 720  
 Helix of ear, 713  
 Heller's nitric-acid test, 567  
 Helmholtz's induction coil, 117  
   myograph, 118  
   phakoscope, 761
- Hemianopsia, 678, 787  
 Hemiplegia, 646, 672  
 Hemisection of spinal cord, 616, 657  
 Hemispheres, Cerebral. *See* Cerebrum.
- Hensen's line, 89  
 Hepatic cells, 497  
   colic, 507
- Herbst, corpuscles of, 695  
 Hering's theory of colour, 778  
 Hetero-albumose, 484  
 Hexone bases, 402  
 Hiccough, mechanism of, 362
- Hill (Croft) on inverting ferments,  
 405  
 Hill (Leonard) on the circulation of  
 blood in the brain, 277 *et seq.*  
   on the influence of gravity on the cir-  
 culation, 294  
   on alterations in atmospheric pressure,  
 372  
 Hill's air-pump, 382, 383

## INTERNAL CAPSULE.

- Hind-gut, 814  
 Hippuric acid, 558  
 Histone, 428  
 Holoblastio ova, 804  
 Horopter, 785  
 Hürthle's manometer, 243, 290  
   differential manometer, 245  
 Hyaline cartilage, 53  
   corpuscle, 419  
 Hyaloplasm, 8  
 Hydrobilirubin, 504, 547  
 Hypermetropia, 763  
 Hypoblast, 22, 807  
   organs formed from, 815  
 Hypoglossal nerve, 630  
   distribution, 631  
   origin, 630  
 Hypoxanthine, 330, 558  
   presence in the spleen, 325

## I.

- Ileo-cæcal valve, 445, 452, 454  
 Ileum, 446  
 Image, formation on retina, 757  
 Impregnation of ovum, 805  
 Inanition or starvation, 587  
 Incus, 716  
   development of, 829  
 Indican, 561  
 Indigo, *ib.*  
 Induction coil, 114 *et seq.*  
   current, 114  
 Infundibulum, 344  
 Inhibitory centre for heart, effect of  
 venous blood on, 371  
 Inhibitory influence of pneumogastric  
 nerve, 247  
 Inhibitory nerves, 164  
 Inogen, 155, 160  
 Inorganic compounds in body, 384  
   salts in protoplasm, 9  
 Inosite, 390  
 Insalivation, 518  
 Inspiration, 347  
   elastic resistance overcome by, *ib.*  
   expansion of chest in, *ib.*  
   extraordinary, 349  
   force employed in, 354  
   mechanism of, 346 *et seq.*
- Instruments for demonstrating muscular  
 action, 112 *et seq.*
- Intercellular material, 5, 39  
   passage, 344  
 Intercentral nerves, 166  
 Intercostal muscles, action in inspira-  
 tion, 349 *et seq.*  
   action in expiration, 350  
 Intercrossing fibres of Charpey, 63, 64  
 Intermittent pulse, 269  
 Internal capsule, 645, 669  
   importance of, 645

## INTERNAL SECRETION THEORY.

- Internal secretion theory of the ductless glands, 320, 321  
 Internal sphincter muscle, 453, 527  
 Interstitial cells, 796  
 Intestinal juice, 490, 528  
 Intestines, 445  
   absorption of solutions from the, 516  
   action of drugs, 528  
   digestion in, 486 *et seq.*  
   duration of, 528  
   development, 852  
   large, 452  
     glands, 454  
     structure, 452  
   movements, 526  
   nervous mechanism, 527  
   small, 445  
     glands, 451  
     structure, 446  
 Intracardiac nerves, 253  
 Intraventricular nucleus, 644  
 Inversion, 387, 490  
 Invertin, 490  
 Involuntary muscles, 84 (*see* 161 *et seq.*)  
   structure of, 84  
 Iodo-thyrin, 332  
 Iris, 746  
   development of, 849  
   functions, 766  
   reflex actions, 767  
 Irradiation, 766  
 Irritability of tissues, 105  
 Iso-cholesterin, 505, 575  
 Iso-maltose, 388  
 Isometric contraction, 138  
 Isotonic contraction, *ib.*

## J.

- Jacksonian epilepsy, 672  
 Jacobsen's nerve, 629  
 Jaundice, 507  
 Jecorin, 334  
 Jejunum, 446  
 Jelly of Wharton, 43, 823  
 Jelly-like connective tissue, 52  
 Juice, gastric, 479  
   pancreatic, 487

## K.

- Kaiser's views on muscular contraction, 139  
 Karyokinesis, 17 *et seq.*  
   phases of, 21  
 Katabolic phenomena, 582, 790  
 Katelectrotonus, 180  
 Keratin, 37, 401, 571, 578  
 Key, Du Bois Reymond's, 113

## LARYNX.

- Kidneys, 529  
   blood-vessels of, how distributed, 534  
     effect of ligaturing, 540  
   calyces, 530  
   capillaries of, 534  
   development of, 857  
   diseases of, effect on the skin, 579  
   extirpation of, 545  
   function, 537. *See* Urine.  
   Malpighian corpuscles of, 532  
   nerves, 538  
   pelvis of, 529  
   structure, *ib.*  
   tubules of, 530 *et seq.*  
   weight, 529  
   work done by, 542  
 Kinæsthetic area, 679  
 Kinetoplasm, 200  
 Kjeldahl's method of estimating urea, 551  
 Klein on the stages of karyokinesis, 17  
 Knee-jerk, 662, 664  
 König's apparatus for obtaining flame-pictures of musical notes, 737  
 Kossel on protamines, 402  
 Krause's membrane, 88, 90, 92  
 Kronecker's perfusion cannula, 259  
 Kühne's gracilis experiment, 173 (*see* 303)  
 Kymograph, Fick's spring, 289, 290  
   Ludwig's, 287  
   tracings, 289, 291

## L.

- Labia externa and interna, development of, 862  
 Labyrinth of the ear. *See* Ear.  
 Lacrimal gland, 741  
 Lact-albumin, 458  
 Lacteals, 224, 449, 450, 513  
   fermentation, 388  
 Lactiferous ducts, 460  
 Lactose, 388, 459, 567  
 Lamina cribrosa, 749  
   spiralis, 718  
   supra-choroidea, 745  
 Laminae viscerales or ventrales, 813  
 Langley's experiment on vagus and cervical sympathetic nerve, 303 (*see* 694)  
   ganglion, 474  
   nicotine method, 301, 475  
 Large intestine. *See* Intestines.  
 Laryngoscope, 732  
 Larynx, anatomy of, 727  
   cartilages of, *ib.*  
   mucous membrane, 729  
   muscles of, 730 *et seq.*  
   nerves of, 732  
   vocal cords, 727, 733  
   movements of, 734

## LATERAL SCLEROSIS.

- Lateral sclerosis, 661  
 Lateritious deposit, 557  
 Lecithin, 99, 392, 491  
 Lens, crystalline, 746  
 Lenticular nucleus, 644  
 Leucine, 330, 491  
 Leucocytes. *See* Blood corpuscles (white).  
 Levulose, 387  
 Lieberkühn's glands, 451, 454  
   jelly, 399  
 Ligamentum pectinatum iridis, 747  
 Limbs, development of, 826  
 Lippmann's capillary electrometer, 146  
 Liquor amnii, 817, 821  
   sanguinia, or plasma, 82, 411  
 Liver, 494  
   blood-vessels, 497  
   capillaries, 499  
   cells of, 495  
   circulation in, 498  
   development of, 853  
   extirpation in mammals, 553  
     in frogs, *ib.*  
   formation of urea by, 501, 553  
   functions, 500  
   glycogenic function of, 507  
   nerves of, 511  
   secretion of. *See* Bile.  
   structure, 497  
   sugar formed by, 507 (*see* 509)  
   supply of blood to, 494, 501  
 Localisation of tactile sensations, 700  
 Locomotor ataxy, 658, 663  
 Loop of Henle, 532  
 Ludwig's air-pump, 382  
   kymograph, 287  
   Stromuhr, 262  
 Lunatic's brain, 684  
 Lungs, 342  
   air-sacs of, 344  
   blood-supply, 345  
   capillaries of, 344  
   changes of air in, 374  
   circulation in, 345  
   coverings of, 342  
   development of, 854  
   diffusion of gases within, 377  
   lobes of, 344  
   lobules of, *ib.*  
   lymphatics, 345  
   muscular tissue of, 344  
   nerves, 346  
   nutrition of, 345  
   position of, 338  
   structure, 342  
 Luxur consumption, 592  
 Lymph, 222, 312  
   composition of, 312  
   current of, 316  
   formation of, 317

## MEDULLARY GROOVE.

- Lymph capillaries, 219  
   origin of, 224  
   structure, 225  
 Lymph-hearts, structure and action of, 316  
   relation to spinal cord, *ib.*  
 Lymphagogues, 318  
 Lymphatic glands, 224, 313  
   development, 854  
 Lymphatic vessels, 222  
   of arteries and veins, 218  
   communication with blood-vessels, 222  
   structure of, 225  
 Lymphocytes, 312, 418  
 Lymphoid or retiform tissue, 50. *See* Adenoid tissue.  
 Lysatinine, 554  
 Lysine, *ib.*
- M.
- Macula, 687  
   lutea, 748, 750, 753  
 Macula acustica, 719  
 Magnesium phosphate, 58  
 Male organs of generation, 793  
   pronucleus, 805  
   sexual functions, 796  
 Malleus, 715  
 Malpighian bodies or corpuscles of kidney, 532. *See* Kidney.  
   corpuscles of spleen, 323  
 Maltase, 405  
 Maltose, 388, 478  
 Mammal, nerves of, 251  
 Mammary glands, 460  
   evolution, 462  
   involution, *ib.*  
   lactation, *ib.*  
   structure, 460  
 Mandibular arch, 828  
 Manometer, Hürthle's, 243, 290  
 Marey's sphygmograph, 268  
   tambour, 129, 240  
 Mastication, 518  
 Mastoid cells, 715  
 Meat as food, 462  
 Meatus of ear, 719  
 Meconium, 518  
 Mediastinum testis, 794  
 Medulla oblongata, 189, 619, 622 *et seq.*  
   columns of, 623  
   decussation of fibres, 632  
   development, 845  
   fibres of, how distributed, 623  
   grey matter in, 616  
   pyramids of, anterior, 623  
     posterior, 624  
   structure of, 631  
 Medullary groove, 809  
   plates, *ib.*

## MEIBOMIAN FOLLICLES

- Meibomian follicles, 469, 741  
 Meissner's plexus, 448  
 Melanin granules, 781  
 Membrana capsulo-pupillaris, 850  
   chorio-capillaris, 745  
   decidua, 815  
   granulosa, 800  
     development into corpus luteum, *ib.*  
   hyaloidea, 754  
   limitans externa, 751, 753  
     interna, 749  
   propria or basement membrane. *See*  
   Basement Membrane.  
   pupillaris, 850  
   tectoria, 721  
     action of, 725  
   tympani, 715, 723  
 Membrane, vitelline, 801  
 Membranes of the brain and spinal cord,  
 188  
 Membranes, mucous. *See* Mucous Mem-  
 branes.  
   serous, 468  
 Membranous labyrinth, 717, 718. *See*  
 Ear.  
 Menstruation, 800, 803  
   coincident with discharge of ova, 803  
   corpus luteum of, 800  
 Mercurial kymograph, 286  
 Meroblastic ova, 804  
 Mesencephalon, 622, 846  
 Mesoblast, 22, 807  
   organs formed from, 815  
 Mesoderm, 807  
 Mesonephros, 856  
 Metabolic balance-sheets, 585 *et seq.*  
 Metabolism, 7, 790  
   general, 580 *et seq.*  
 Metanephros, 856  
 Metencephalon, 622, 846  
 Methæmoglobin, 435  
   photographic spectrum of, 434  
 Micrococcus ureæ, 565  
 Microcytes, 416  
 Micro-organisms, types of, 403  
 Micropyle, 804  
 Micro-spectroscope, 432  
 Micturition, 546  
   centre, 546, 666  
 Middle ear. *See* Tympanum.  
 Mid-gut, 814  
 Milk, as food, 457  
   alcoholic fermentation of, 460  
   chemical composition, 458  
   coagulation of, *ib.*  
   fats of, 459  
     chemical composition, *ib.*  
   proteids of, 458  
   reaction and specific gravity, *ib.*  
   salts of, 460  
   secretion of, 457  
   souring of, 459 (*see* 388)  
   uterine, 818

## MUSCLE.

- Milk-curdling ferment, 489  
 Milk-globules, 457  
 Milk-sugar, 388, 459  
   properties of, 388  
 Milk-teeth, 70 *et seq.*  
 Millon's re-agent and test, 395  
 Mitosis, 17  
 Mitral cells, 712  
 Modiolus, 718  
 Molars. *See* Teeth.  
 Molecular layers, 750, 751  
 Moleschott's diet table, 457  
 Monaster stage of karyokinesis, 19  
 Monkey's brain, 674  
 Monoplegia, 672  
 Monosaccharides, 386  
 Monro-Kellie doctrine, 278  
 Moore's test for sugar, 386  
 Mörner and Sjökiest's method of esti-  
 mating urea, 551  
 Morphological development, 22  
 Mosso's ergograph, 157  
   experiments on the effects of fatigue,  
   157  
 Motor areas of cerebrum, 671, 675,  
 679  
   impulses, transmission in cord, 659  
   nerve-fibres, 98  
 Motor nerves, 164  
 Motor oculi nerve, 625  
   origin of, *ib.*  
 Mountain sickness, 373  
 Mouth, 439  
 Movements of protoplasm, 13, 106  
   peristaltic, of intestines, 526  
   of involuntary muscle, 161  
   of stomach, 521  
 Mucic acid, 387  
 Mucigen or Mucinogen, 29, 37, 472  
 Mucin, 29, 36, 399, 469  
 Mucoids, 399  
 Mucous membrane, 469  
   digestive tract, *ib.*  
   epithelium-cells of, *ib.* *See* Epithe-  
   lium.  
   gastro-pulmonary tract, *ib.*  
   genito-urinary tract, *ib.*  
   gland-cells of, *ib.*  
   of intestines, 448, 452  
   respiratory tract, 469  
   of stomach, 443  
   of uterus, changes in pregnancy,  
   802  
 Müller's fibres, 749  
 Müllerian duct, 856  
 Multipolar nerve-cells, 193  
 Murexide test, 556  
 Muscarine, action of, on the heart, 252  
 Muscle, 111  
   blood-vessels of, 93  
   cardiac, 94  
   changes in form, when it contracts,  
   112 *et seq.*



## MUSCLE.

Muscle—*continued*.  
 chemical changes in, 155  
 composition of, 159  
 clot, *ib.*  
 columns, 87  
 contractility, 106  
 curves, 119, 122—124  
 development, 95  
 dynamometer, 137  
 elasticity, 131  
 electrical phenomena of, 139 *et seq.*, 184  
 extensibility of, 131 *et seq.*  
 fatigue, effect of, 124, 156  
   curves, 124  
 Hensen's line, 89  
 involuntary, 84 (*see* 161 *et seq.*)  
 irritability, 108  
   evidence of, *ib.*  
 nerves of, 93  
 pain, 94  
 plasma, 159  
 red, 93  
 response to stimuli, 109 *et seq.*, 184  
 rigor, 157, 163  
 sarcolemma, 85  
 sensory nerve-endings in, 698  
 serum, 159  
 shape, changes in, 128  
 skeletal, 85  
 sound, developed in contraction of, 128  
 spindle, 93, 664. *See* Neuro-muscular spindle.  
 stimuli, 109  
 striated, structure of, 87 *et seq.*  
 tetanus, 128  
   negative variation of, 147  
 thermal changes in, 153  
 tonus, 136, 163  
 twitch, 122 (*see* 147)  
 voluntary, 85 (*see* 161 *et seq.*)  
 wave, 125, 148  
 work of, 136  
 Muscles, reciprocal action of antagonistic, 664  
 Muscular action, conditions of, 138  
 Muscular contraction, 111, 123  
   effect of two successive stimuli, 126  
   of more than two stimuli, 127  
   voluntary tetanus, 128  
 Muscular fibres,  
   development, 95  
   plain, 84  
   transversely striated, *ib.*  
 Muscular force, 136  
 irritability, 108  
 sense, 703  
 tissue, 84 *et seq.*  
   composition of, 160  
 Muscularis mucosæ, 341, 443, 449, 450, 454  
 Musical sounds, 736  
 Mydriatics, 767

## NERVES.

M, *duplexes*, 59  
 Myelospangium, 841  
 Myograph, 112  
   Helmholtz', 118  
   pendulum, 120  
   spring, *ib.*  
   transmission, 129 (*see* 172)  
 Myopia, or short-sight, 763  
 Myosin, 159  
 Myotics, 767  
 Myosinogen, 159  
 Myxœdema, 331 (*see* 336)

## N.

Nails, 572  
 Nasal cavities in relation to smell, 710  
   *et seq.*  
 Nasmyth's membrane, 74, 81  
 Near point, 761, 762  
 Nerve-cells, structure of, 191 *et seq.*  
 Nerve-centres, 188 *et seq.* *See* Cerebellum, Cerebrum, etc.  
   ano-spinal, 528  
   cilio-spinal, 666 (*see* 767)  
   defecation, 528  
   deglutition, 520  
   erection, 666  
   micturition, 546, 666  
   parturition, 666  
   respiratory, 357  
   secretion of saliva, 474  
   speech, 678  
   vaso-motor, 298, 661  
 Nerve-corpuscles, 191 *et seq.*  
   bipolar, 192  
   unipolar, *ib.*  
 Nerve epithelium, 692  
 Nerve-impulse, velocity of, 172  
 Nerves, 97  
   accelerator, 164  
   action of stimuli on, 109, 546  
   afferent, 97, 164  
   axis-cylinder of, 99  
   cells, 98, 191  
   centrifugal, 163  
   centripetal, 164  
   cerebro-spinal, 189, 602  
   changes in, during activity, 172  
   classification, 163  
   conductivity of, 178, 187  
   cranial, 189, 625 *et seq.*  
   degeneration, 167, 199  
   reaction of, 186  
   development, 841  
   direction of a nerve impulse, 173  
   efferent, 97, 163  
   electrical, 164  
   stimulation of, 184  
   fibres, 98  
   development of, 104

## NERVES.

- Nerves—continued.**  
 functions of, 166  
 funiculi of, 101  
 grey matter, 98  
 inhibitory, 164  
 intercentral, 166  
 intracardiac, 253  
 irritability of, 105  
 laws of conduction, 164 *et seq.*  
 medullary sheath, 99  
 medullated, 98  
 motor, 164  
 termination of, 102  
 nodes of Ranvier, 99  
 non-medullated, 98  
 olfactory, 625, 711  
 physiology of, 163 *et seq.*  
 plexuses of, 102  
 reflex actions, 165, 196  
 secretory, 164  
 section of, 165, 474  
 size of, 101  
 spinal. *See Spinal Nerves.*  
 splanchnic, stimulation of, 357  
 stimulation of cut, 164, 357, 475  
 structure, 98  
 sympathetic, influence on heart, 249  
 taste, 707  
 terminations of,  
 in corpuscles of Golgi, 699  
 in corpuscles of Grandry, (x)8  
 in corpuscles of Herbat, (x)5  
 in end-bulbs, *ib.*  
 in motorial end-plates, 102  
 in networks or plexuses, 699  
 in Pavinian corpuscles, 694  
 in touch-corpuscles, 696  
 trophic, 164, 774  
 Nervous circles, 652, 665  
 Nervous system,  
 cerebro-spinal, 189, 602  
 development, 841 *et seq.*  
 influence on the heart, 368  
 sympathetic, 249  
 vaso-motor, 296 *et seq.*  
 Nervous tissues, chemistry of, 174  
 Neural crest, 844  
 Neuroblasts, 842  
 Neuroglia, 190, 606  
 Neurokeratin, 90, 191, 401  
 Neuro-muscular spindles, 93, 698, 699  
 Nicotine, action of, 301, 335, 475  
 Nissl's granules, 193 *et seq.*  
 significance of, 200  
 Nitric oxide hæmoglobin, 436  
 Nitrogen in the blood, 377  
 eliminated in the form of urea,  
 455  
 Nodal point, 755  
 Nodes of Ranvier, 99  
 Nose. *See Smell.*  
 development of, 850  
 Notochord, 810, 824

## OSTEOBLASTS.

- Nuclear layers, 750, 751  
 sap or matrix, 10  
 Nucleic acid, 400  
 Nuclein, 11, 400, 401, 459  
 Nuclei pontis, 636  
 Nucleoli, 10  
 Nucleo-proteids, 400  
 Nucleus of animal cell, 6, 10 *et seq.*  
 chemical composition, 11  
 division, 16  
 staining of, 10  
 structure, *ib.*  
 Nucleus ambiguus, 628, 635
- O.
- Odontoblasts, 74, 76, 78, 79  
 Odontogen, 79  
 Odours, 713. *See Smell.*  
 Oesophagus, development, 851  
 structure of, 440  
 Oleaginous principles, 399  
 Oleic acid, 391  
 Olein, 49, 397  
 Olfactory bulb, 712  
 cells, 711  
 nerves, 625, 711  
 tract, 711  
 "roots" of *ib.*  
 Olfactory body, 624, 635  
 Oliver's hæmacytometer, 422  
 Omphalo-mesenteric veins, 810, 830  
 Onco-graph, Roy's, 311  
 Oncomet, 540  
 Roy's, 310, 326  
 Ophthalmoscope, 770 *et seq.*  
 Optic disc, 749  
 Optic nerve, 625  
 decussation of fibres in, 786  
 development of, 848  
 Optic thalamus, 644  
 vesicle, primary, 844  
 Optic angle, 757  
 apparatus of eye, 755  
 fovea, 763  
 pterium, 780  
 striata of retina, 748, 754  
 Ovarian brain, 654  
 Organ of Corti, 720  
 of Gualdès, 859  
 Organic compounds in body, 384  
 Organised ferments, 404  
 Osmosis, 317, 516  
 distinguished from diffusion, 394  
 Osmotic pressure, method of estimating,  
 543, 544  
 Ossein, 401  
 Osseous labyrinth, 717. *See Ear.*  
 Ossicles of the ear, 715  
 action of, 723  
 Ossification, stages of, 64 *et seq.*  
 Osteoblasts, 64, 68

## OSTEOCLASTS.

- Osteoclasts, 68
- (Osteogen, 64
- Otic vesicle, primary, 850
- Otoliths, 687
- Ovary, 798
  - development of, 803
  - Graafian vesicles in, 798
- Oviduct, or Fallopian tube, 802
- Ovigerms, 798
- Ovo-mucoid, 399
- Ovum, 22, 801, 803
  - action of seminal fluid on, 805 *et seq.*
  - changes in ovary, 803
    - previous to fecundation, *ib.*
  - cleaving of yolk, 806
  - development, 803
  - fertilised, 806
  - formation of, 802
  - germinal vesicle and spot of, 802
    - et seq.*
  - impregnation of, 805
  - segmentation, 806
  - structure of, 803
    - in mammals, 801—802
  - subsequent to cleavage, 806 *et seq.*
  - unimpregnated, 804
- Oxygen in the blood, 377, 384
- Oxyhæmoglobin, 83, 426 *et seq.*, 430
  - spectrum of, 433, 434 (see coloured plate)
- Oxyntic cells, 479, 480
- Oxyphile cells, 418

## P.

- Pacchionian bodies, 604
- Pacinian corpuscles, 694
- Pain, 692 (see 658)
- Palmitic acid, 391
- Palmitin, 49, 390
- Pancreas, 486
  - development of, 853
  - extirpation of, 493
    - diabetic condition produced in animals by, 494, 510
  - functions of, 493
  - secretory nerves of, 492
  - structure, 486
- Pancreatic juice, 487
  - action on fats, 489
  - composition and action, 487
  - ferments in, *ib.*
- Papillæ
  - of the kidney, 530
  - of skin, distribution of, 572
  - of tongue, 705, 706
- Parachordal cartilages, 826
- Paradoxical contraction, 178
- Paraglobulin, 414
- Parallel puzzle, 789
- Paramucin, 399
- Parapeptone, 484
- Parathyroids, 332
- Parietal cells, 444, 479
  - mesoblast, 811
- Parotid gland, 476
- Parovarium, 859
- Paroxysmal hæmoglobinuria, 569
- Pars ciliaris retinae, 754
- Parturition centre, 666
- Par vagum. *See* Pneumogastric nerve.
- Pathological urine, 566
- Pavy's views as to the liver being a sugar-forming organ, 509
- Pawlow's method for obtaining pure gastric juice, 483, 493
- Pelvis of the kidney, 529
- Pendulum myograph, 120
- Penis, 796
  - structure, *ib.*
- Pepsin, 479, 483
- Pepsinogen, 480
- Pepsin-hydrochloric acid, 481
- Peptones, 393, 398, 484
  - characters of, 484
- Peptonuria, 567
- Perception, 691
- Perforating fibres of Sharpey, 63
- Perfusion cannula, Kronecker's, 259
- Pericardium, 203
- Perichondrium of cartilage, 54
- Perilymph, or fluid of labyrinth of ear, 686, 717
- Perimeter, 774
- Perimysium, 85
- Perineurium, 101
- Peristaltic movements of intestines, 526, 527
  - of involuntary muscle, 161, 162 (see 521)
  - of stomach, 522
- Perivitelline fluid, 805, 806
- Permanent teeth. *See* Teeth.
- Perspiration, cutaneous, 577
  - insensible and sensible, *ib.*
  - ordinary constituents of, 578
- Pettenkofer's reaction, 504
- Peyer's patches, 452
- Pfûger's law of contraction, 181
- Phagocytes, 275, 419
- Phakoscope, Helmholtz's, 761
- Pharynx, 439
  - action in swallowing, *ib.*
  - development, 851
- Phenyl hydrazine test, 389 (see 569)
- Phloridzin-diabetes, 511
- Phosphates in urine, 562, 565
- Photographic spectra of hæmoglobin, oxyhæmoglobin, and methæmoglobin, 434
- Phrenograph, 353
- Physiological methods, 3
  - rheoscope, 152, 162
- Pia mater, 603
- Picric acid test, 568

## PICRIC ACID TEST.

## PIGMENT CELLS.

- Pigment cells of retina, 106, 753  
 movement of, 781  
 Pineal gland, 336  
 Piotrowski's reaction, 395, 402  
 Piperidine, action of, 335  
 Pituitary body, 336  
 development, 825  
 effects of removal, 336  
 Placenta, maternal, 816, 817  
 foetal, 821  
 Plasma of blood, 82, 406, 411  
 gases of, 413  
 Plethysmograph, 308  
 Schäfer's, 260  
 Pleura, 342  
 Pleuro-peritoneal cavity, 811  
 Plexus, terminal, 699  
 of Auerbach, 104, 447  
 Pneumogastric nerve, 628  
 distribution of, 631  
 functions, 629  
 influence on  
 deglutition, 520  
 gastric digestion, 524  
 secretion, 483  
 heart, 247  
 lungs (trophic), 792  
 muscles of stomach, 524  
 pancreatic secretion, 493  
 respiration, 359  
 vomiting, 526  
 mixed function of, 629  
 origin, *ib.*  
 Poggendorf's rheochord, 177  
 Pohl's commutator, 175  
 Polar globules, 804, 806  
 function of, 805  
 Polarimeter, 402  
 Polysaccharides, 384  
 Pons Varolii, 619, 621  
 grey matter in, 621  
 Portal canals, 498  
 circulation, 212  
 vein, 498. *See* Liver.  
 Porus opticus, 749  
 Postganglionic fibres, 301  
 Preganglionic fibres, *ib.*  
 Pregnancy,  
 corpus luteum of, 800  
 Presbyopia, 766  
 Pressor nerves, 306  
 Pressure, sense of, 702  
 Pressure-measurers, 281  
 Primitive groove, 808  
 nerve-sheath, or Schwann's sheath, 98  
 ova, 798  
 streak, 808  
 Processus gracilia, 716  
 vaginalis, 860  
 Projection fibres, 650  
 Pronephros, 856  
 Pro-nucleus, female, 805  
 male, *ib.*

K.P.

## REFLEX ARC.

- Propeptone, 484  
 Prosencephalon, 622, 845, 846  
 Prostate gland, 537  
 Protamines, 402  
 Proteid metabolism, 7  
 Proteids, 7, 392  
 absorption of, 513  
 action on polarized light, 395  
 of blood, 413  
 classification, 397  
 coagulated, 398  
 colour reactions, 395  
 composition, 393  
 conjugated or compound, 397  
 crystallisation, 394  
 indiffusibility of, *ib.*  
 precipitants of, 396  
 simple, 397  
 solubilities, 393  
 Proteoses, 393, 398, 485  
 characters of, 485  
 Prothrombin, 411, 426  
 Proto-albumose, 484  
 Protoplasm, 6, 8, 803  
 chemical structure, 9  
 irritability, 15  
 movements, 12 *et seq.*, 106  
 Proto-vertebrae, 810, 811, 824  
 Pseudo-mucin, 399  
 Pseudo-nuclein, 400  
 Pseudopodia, 13, 16  
 Pseudoscope, 789  
 Pseudo-stomata, 219  
 Ptosis, 783  
 Ptyalin, 473, 478  
 Ptyalinogen, 474  
 Pulmonary artery, 834  
 Pulse, anacrotic, 271  
 arterial, 267 *et seq.*  
 dicrotic, 272  
 Purine bases, 400, 558  
 Purkinje's cells, 195, 641  
 fibres, 96  
 figures, 769  
 Pyloric glands, 444, 479  
 Pyramidal tracts, 613 *et seq.*  
 Pyramids of medulla oblongata, 623  
 of Kidney. *See* Kidney.

Q.

Quinquand, output of the heart, 246

R.

- Racemose glands, 469  
 Ranke's metabolic balance-sheet, 585  
 diet table, 457, 585  
 Raynaud's disease, 311  
 Reaction time in man, 665  
 Reduced eye, 756  
 Reflex arc, 661

3 L.

## REFLEX ACTIONS.

- Reflex actions, 657  
 inhibition of, 660  
 in frog, 660, 668  
 in man, 661  
 superficial, 662  
 tendon, *ib.*  
 of nerves, 165, 196  
 of spinal cord, 659 *et seq.*
- Refraction, laws of, 755
- Refractive media of eye, *ib.*
- Regions of body. *See* Frontispiece.
- Reid, Waymouth, experiments on the absorption of secretions from the intestines, 516
- Remak, fibres of, 102  
 ganglion of, 254
- Renal circulation, 212  
 epithelium, activity of, 541  
 oncometer, 540
- Rennet, 459
- Reproductive organs, 792 *et seq.*
- Requisites of diet, 585
- Reserve air, 354
- Residual air, *ib.*
- Respiration, 337  
 abdominal type, 350  
 alteration in atmospheric pressure, 372  
 breathing or tidal air, 354  
 chemistry of, 373  
 effect on circulation, 363  
 gases in relation to, 371, 377  
 influence of nervous system, 368  
 mechanism of, 346 *et seq.*  
 nervous, 357  
 movements, 346  
 of vocal cords in, 734  
 quantity of air changed, 354
- Respiratory acts, special, 361  
 apparatus, 338  
 development of, 854  
 capacity of chest, 354  
 circumstances affecting, 355  
 movements of glottis, 353  
 methods of recording, 350  
 muscles, 347 *et seq.*  
 nerve-centre, 357  
 rate, 355  
 relation to pulse rate, *ib.*  
 size of animal, *ib.*  
 relation to will, 357 *et seq.*  
 rhythm, 353  
 sounds, *ib.*
- Restiform bodies, 635, 638
- Rete testis, 796
- Reticulum, 8
- Retiform tissue, 50
- Retina, 748  
 blind spot, 768  
 blood-vessels, 754  
 changes in, during activity, 780  
 duration of impression on, 770  
 of after-sensations, *ib.*

## SAPONIFICATION.

- Retina—*continued.*  
 electrical variations in, 781  
 excitation of, 768  
 focal distance of, 759  
 fovea centralis, 748  
 functions of, 768  
 image on, how formed distinctly, 757  
 layers, 749  
 ora serrata, 748  
 pigment-cells, 106, 107, 753  
 movement of, 781  
 pigments of, 780  
 in relation to single vision, 782  
 structure of, 748  
 visual purple, 752, 780
- Retractor lentis muscle, 763
- Rheochord, 176  
 Poggendorf's, 177
- Rheoscope, physiological, 152, 162
- Rheoscopic frog, 152
- Rheotome, 146
- Rhodopsin or visual purple, 780
- Rhythmicality of movement, 107, 161
- Rigor mortis, 157, 159  
 affects all classes of muscles, 157, 163  
 phenomena and causes of, 163
- Ritter's tetanus, 184
- Rods and cones, 752, 768, 781
- Rolandic area, 671, 674, 679  
 injury of, 671
- Roy's cardiometer, 247  
 oncograph, 311  
 oncometer, 310, 326  
 tonometer, 259
- Rumination, 519
- S.
- Saccharic acid, 387
- Saccharoses, 386
- St. Martin, Alexis, case of, 479, 522
- Saccule, 719
- Salathe, effect of gravity on the circulation, 293
- Saliva, 471  
 action of, 478  
 composition, 477  
 process of secretion, *ib.*  
 reflex secretion, *ib.*  
 secretion following stimulation of nerves, 308, 475 *et seq.*
- Salivary glands, 471  
 development of, 853  
 extirpation of, 477  
 influence of nervous system, 475  
 secretory nerves of, 474  
 effect of section of, *ib.*  
 structure, 471
- Sanderson's cardiograph, 240
- Sanson's images, 760
- Saponification, 392, 489

## SARCOLEMMMA.

- Sarcolemma, 85  
 Sarcomeres, 89  
 Sarcoplasm, 87  
 Sarcosine, 559  
 Sarcostyles, 87  
 Schäfer, heart plethysmograph, 260  
   researches on the structure of a sarco-  
   style, 89  
   views regarding the function of the  
   Rolandic area, 680  
 Scheiner's experiment, 762  
 Schematic eye, 756  
 Schenk on muscular contraction, 139  
 Sclerotic, 741  
   development of, 849  
 Sebaceous glands, 575  
 Sebum, 575; 577  
 Secreting glands, 467 *et seq.*  
   classification of, 469  
 Secreting membranes. *See* Mucous and  
   Serous membranes.  
 Secretion, internal, 320  
   of kidney, 545  
   pancreas, 492  
   suprarenal, 334  
   thyroid, 331  
 Secretory nerves, 164  
   of pancreas, 492  
   of salivary glands, 474  
   effect of section of, *ib.*  
 Segmentation of cells, 806  
   in chick, 808  
   ovum, 806  
 Sella turcica, 825  
 Semen, 797  
   spermatozoa, 797  
 Semicircular canals of ear, 717  
   development of, 850  
   structure, 685 *et seq.*  
 Semilunar valves. *See* Heart valves.  
 Seminal granules, 798  
 Seminiferous tubules, 794  
 Sensation, 690 *et seq.*  
   conception, 691  
   homologous stimuli, 693  
   nerves of, 165  
   pain, 692 (*see* 658)  
   perception, 691  
   subjective, 693  
   tactile, 679, 691  
 Sense, organs of, development, 850  
 Sensori-motor area, 648, 679  
 Sensory areas in cerebral cortex, 672  
 Sensory impressions, conduction of  
   by spinal cord, 657  
   in brain, 678-681  
 Sensory nerve-endings in muscle,  
   698  
 Serous membranes, 204, 468  
 Serum,  
   albumin, 397, 413  
   of blood, 409, 411  
   globulin, 413

## SPERMATOGENIC CELLS.

- Fifth cerebral nerve, 627  
 Cox, influence on respiratory capacity,  
   355  
 Sexual organs in the female, 798  
   in the male, 793  
 Sherrington, reciprocal action of anta-  
   gonistic muscles, 664  
 Sighing, mechanism of, 362  
 Sight. *See* Vision.  
 Simple tubular glands, 469  
 Sinuses of Valsalva, 211  
 Sinus pocularis, 860  
   uro-genitalis, 862  
 Sixth cerebral nerve, 625  
 Skeletal muscles, 85  
 Skeleton. *See* Frontispiece.  
 Skin, 570  
   absorption by, 576  
   dermis, 571  
   epidermis of, 570  
   functions of, 576  
   papillæ of, 572  
   respiration, 576  
   rete mucosum of, 570  
   sebaceous glands of, 575  
   secretions, 577  
   sensory nerves of, 357  
   sweat, 577  
   sweat-glands, 575  
   varnishing the, 580  
 Small intestine, 445 *et seq.* *See* In-  
   testines.  
 Smell, sense of, 710 (*see* 679)  
   anatomy of regions, 710  
   delicacy of sense of, 713  
   tests for, 712, 713  
   varies in different animals, 710  
 Smith's perinometer, 775  
 Sneezing, mechanism of, 362  
 Snoring, mechanism of, *ib.*  
 Soap, 392  
 Sobbing, 362  
 Sodium chloride method, 400  
 Solitary glands. *See* Peyer's patches.  
 Somatopleur, 811, 815  
 Sonorous vibrations, how communicated  
   in ear, 722 *et seq.*  
   in air and in water, 722. *See* Sound.  
 Soret's band, 434  
 Sound,  
   conduction by ear, 722  
   heart, 235  
   production of, 735  
 Soup, value as food, 466  
 Spaces of Fontana, 748  
 Speaking, mechanism of, 737  
 Special senses, 694 *et seq.*  
 Spectroscope, 432 *et seq.*  
 Speech, 727, 737  
   centre, 678  
   defects of, 738 (*see* 678)  
 Spermatoblasts, 795  
 Spermatogenic cells, *ib.*

## SPERMATOZOA.

- Spermatozoa, 797  
 form and structure of, *ib.*  
 Spherical aberration, 765  
 correction of, *ib.*  
 Sphincter ani. *See* Defæcation.  
 pupillæ, 746  
 Sphygmographs, 268, 270  
 tracings, 270 *et seq.*  
 Sphygmometer, Hill and Barnard's, 295  
 Sphygmoscope, Anderson Stuart's, 281  
 Spinal accessory nerve, 629  
 functions of, 630  
 origin, 629  
 Spinal cord, 604  
 canal of, 605  
 centres in, 666  
 columns of, 606  
 commissures of, 605  
 conduction of impressions by, 657 *et seq.*  
 course of fibres in, 611  
 development of, 841  
 fissures and furrows of, 605  
 functions of, 657 *et seq.*  
 of columns, 613, 614  
 grey matter, 190, 606  
 cells in, 607  
 hemisection, 616, 657  
 injuries of, 657, 661  
 membranes of, 603  
 morbid irritability of, 664  
 nerves of, 611  
 reflex action of, 659 *et seq.*  
 inhibition of, 660  
 in frog, *ib.*, 667  
 in man, 661  
 superficial, 662  
 regions of, 616  
 special centres in, 666  
 structure of, 604 *et seq.*  
 tracts, 606, 613, 658  
 transverse section of, 615  
 white matter, 190, 606  
 tracts in, 608  
 Spinal nerves, 169  
 functions of roots of, 169  
 origin of, 169 *et seq.*  
 physiology of, 169  
 Spindle-shaped cells, 487  
 Spirom, 18  
 Spirometer, 355  
 Splanchnopleur, 811, 815  
 Spleen, 322  
 development, 854  
 functions, 324  
 influence of nervous system upon, 325  
 Malpighian corpuscles of, 323  
 pulp, *ib.*  
 structure of, *ib.*  
 trabeculæ of, *ib.*  
 Spongioblasts, 750, 841  
 Spongioplasm, 8  
 Spot, germinal, 802  
 Spring myograph, 120

## SUPERIOR OLIVARY NUCLEUS.

- Staircase phenomenon, 124, 162, 257 (*see* 188)  
 Stannius' experiment, 254  
 Stapedius muscle, 716, 724  
 development of, 829  
 Stapes, 716  
 development of, 829  
 Starch, 389  
 Starvation, 587  
 effects of, 588  
 Steapsin, 487  
 Stearic acid, 391  
 Stearin, 49, 390  
 Stercobilin, 504, 547  
 Stethographs, 351  
 Stewart's diet-table, 456  
 experiments on the circulation of the  
 blood, 265  
 on the output of the heart, 246  
 Stimulants as accessories to food, 466  
 Stimuli, varieties of, 15, 109  
 Stolnikow, measurement of the heart's  
 output, 246  
 Stomach, 441  
 blood-vessels, 445  
 development, 851  
 digestion in, 489  
 glands, 443  
 lymphatics, 444  
 movements, 521  
 influence of nervous system on, 524  
 mucous membrane, 443  
 muscular coat, 442  
 nerves, 445  
 peritoneal coat, 442  
 secretion of. *See* Gastric juice.  
 shadow photographs of, 524  
 submucous coat, 443  
 structure, 442  
 Stomata, 25  
 Stratum granulosum, 571  
 intermedium of Hannover, 80  
 lucidum, 571  
 Striated border, 451 (*see* 27—29)  
 Striated muscle, 86 *et seq.* *See* Muscle.  
 Stroma, 415, 798  
 Strombr, Ludwig's, 262  
 Structure of cells, 9 *et seq.*  
 Stuart's sphygmoscope, 284  
 Submaxillary gland of dog, 476  
 Submaxillary and sublingual glands, 474  
 Substantia gelatinosa of Rolando, 607,  
 632, 634  
 nigra, 638  
 Subthalamic area, 645  
 Succus entericus, 489, 490, 527  
 functions of, 490  
 Sucroses, 386  
 Sugar. *See* Dextrose.  
 Sulphates in urine, 561  
 Superior laryngeal nerve, effects of  
 stimulation of cut, 357  
 olivary nucleus, 636

## SUPRA-RENAL CAPSULES.

- Supra-renal capsules, 333  
 development, 862 (*see* 335)  
 function, 334  
 structure, 333  
 Suprarenine, 335  
 Sustentacular cells, 795  
 Swallowing, 519  
 centre, 520  
 fluids, 521  
 nerves engaged, 520  
 Sweat glands. *See* Skin.  
 Swim-bladder of fishes, 380  
 Synovial fluid, secretion of, 468  
 membranes, *ib.*  
 Syntonin, 398  
 Siringomyelia, 658  
 Systemic circulation, 211. *See* Circulation.  
 Systole of heart, 231

## T.

- Tactile end organs, 694  
 sensibility, 679, 700  
 variations in, 701  
 Taste, sense of, 704  
 classification of, 709  
 connection with smell, 704  
 delicacy of, 710  
 nerves of, 707  
 Taste-buds, *ib.*  
 Taurine, 503  
 Taurocholic acid, *ib.*  
 Teeth, 70  
 development, 77  
 eruption, times of, 71  
 structure, 72 *et seq.*  
 temporary and permanent, 70 *et seq.*  
 Tegmentum, 637  
 Temperature, 595  
 average of body, 596  
 changes of, effects, 596 *et seq.*  
 circumstances modifying, 600  
 effect on muscular contraction, 124  
 of cold-blooded and warm-blooded animals, 596  
 in disease, *ib.*  
 loss of, 600  
 maintenance of, 596  
 of Mammalia, birds, etc., *ib.*  
 regulation of, 600 *et seq.*  
 sensation of variation of, 703. *See* Heat.  
 Tendon-reflexes, 662  
 Tension, arterial, in asphyxia, 371  
 Tensor palati muscle, 723  
 tympani muscle, 716  
 action of, 724  
 Testicle, 793  
 development, 860  
 descent of, *ib.*  
 structure, 793 *et seq.*

## TRIGEMINAL NERVE.

- Tetanus, 127 (*see* 147)  
 Ritter's, 184  
 voluntary, 128, 162  
 Thalamencephalon, 622, 845, 846  
 Thalami optici, 644  
 Theine, 466  
 Theobromine, *ib.*  
 Thoma-Zeiss haemacytometer, 421, 422  
 Thoracic duct, 83, 224  
 innervation of, 316  
 Throat deafness, 723  
 Thrombin, 411, 426  
 Thymus gland, 328  
 development, 854  
 effects of removal, 330  
 function, 331  
 structure, 328  
 Thyro-arytenoid muscle, 730  
 Thyro-epiglottidean muscle, 731  
 Thyroid cartilage, 727  
 Thyroid gland, 330  
 development, 854  
 function, 331  
 structure, 330  
 Thyro-iodin, 332  
 effect of intravenous injection of, on blood-pressure, 332, 336  
 Tigerstedt, measurement of the heart's output, 246  
 Timbre of voice, 736  
 Tissue fibrinogen, 400  
 Tissue-respiration, 374, 381  
 Tongue, 704  
 action in deglutition, 519  
 epithelium of, 707  
 muscles of, 704, 705  
 papillæ of, 705, 706  
 parts most sensitive to taste, 707, 708  
 structure of, 704  
 Tonometer, Roy's, 259  
 Tonsils, 439  
 Tonus, 136, 163, 664  
 Torsion, 825  
 Touch, 694 *et seq.*  
 muscular sense, 703  
 sense of locality, 700  
 of pressure, 702  
 of temperature, 703  
 tactile end organs, 694  
 Touch-corpuscles, 696  
 Trabeculæ cranii, 827  
 Trachea, 338  
 Tract of Gowers, 615, 659  
 of Lissauer, 612, 615  
 Tracts in the spinal cord, 606, 613, 658  
 Tragus, 713  
 Transfusion of blood, 317  
 Transmission myograph, 129 (*see* 172)  
 Traube-Hering curves, 305, 367, 541  
 Tricuspid valve, 209  
 Trigeminal nerve, 625  
 function, *ib.*  
 origin of, 627



## TRILAMINAR BLASTODERM.

- Trilaminar blastoderm, 807  
 Trochlear nerve, 625  
   origin of, *ib.*  
 Trommer's test, 386  
 Trophic nerves, 164  
   influence of, 790  
 Trypsin, action of, 488  
 Trypsinogen, 487  
 Tubercle of Rolando, 632  
 Tubuli seminiferi, 794  
   uriniferi, 530 *et seq.*  
 Tubulo-racemose or tubulo-acinous glands, 460  
 Tunica albuginea of testicle, 793, 794  
   dartos, 94  
   propria, 687  
   vaginalis, 793, 860  
   vasculosa, 745  
 Tympanum or middle ear, 714  
   development, 850  
   membrane of, 714  
   muscles of, 716  
   structure, *ib.*  
 Tyrosine, 492

## U.

- Umbilical arteries, 823, 833, 835  
   cord, 817, 823  
   vesicle, 813, 817  
 Unicellular organisms, 6  
 Unilaminar blastoderm, 806  
 Unipolar nerve cells, 192  
 Unorganised ferments, 404  
 Urachus, 822  
 Uræmia, 552, 579  
 Urate of sodium, 564  
 Urea, 549  
   apparatus for estimating quantity, 550, 551  
   chemical composition of, 549  
   formation of, by liver, 501, 553  
   isomeric with ammonium cyanate, 549  
   quantity, 551  
 Ureters, 536  
 Urethra, 537  
 Uric acid, 556, 558  
   condition in which it exists in urine, 558  
   deposit of, 564  
   forms in which it is deposited, 556, 564  
   origin of, 557  
   presence in the spleen, 325  
   proportionate quantity of, 557  
   tests, 556  
 Urina potus, 548  
 Urinary apparatus, 529 *et seq.*  
 Urinary bladder, 536  
   development, 861, 862  
   nerves, 537  
   structure, 536

## VASO-CONSTRICTOR NERVES.

- Urinary deposits, 563 *et seq.*  
 Urine, 547  
   analysis of, 549  
   bile in, 569  
   blood in, *ib.*  
   chemical sediments in, 566  
   colour, 547  
   composition, 548  
   cystin in, 565  
   expulsion, 546  
   flow into bladder, 545  
   hippuric acid in, 558  
   inorganic constituents, 560  
   mineral salts in, 561  
   mucus in, 562  
   pathological, 566  
   phosphates in, 562, 565  
   physical characters, 547  
   pigments, *ib.*  
   pus in, 570  
   quantity, 547  
     varies with blood-pressure, 539  
   reaction of, 548  
     in different animals, *ib.*  
     made alkaline by diet, *ib.*  
   saline matter, 549  
   solids, 547  
   specific gravity of, 548  
   variations of, *ib.*  
   sugar in, 567 *et seq.*  
   tests for estimating, 568  
   tests for inorganic salts of, 563  
   urates, 564  
   urea, 549  
   uric acid in, 556  
 Urobilin, 504, 507, 547  
 Urobilinogen, 547  
 Urochrome, 548  
 Uro-erythrin, 564  
 Uterine milk, 818  
 Uterus, 802  
   change of mucous membrane of, *ib.*  
   development in pregnancy, 802  
   follicular glands of, *ib.*  
   round ligament of, 861  
   structure, 802  
 Uterus masculinus, 860  
 Utricle, 719
- V.
- Vagina, development of, 860  
 Vagus nerve. *See* Pneumogastric.  
 Vagus pneumonia, 358, 792  
 Valves of heart, 209. *See* Heart.  
 Valve conniventes, 448  
 Vas deferens, 794, 796  
 Vasa efferentia of testicle, 794, 796  
 Vasa vasorum, 215  
 Vascular system, development of, 830  
   in asphyxia, 369  
 Vaso-constrictor nerves, 299

## VASO-DILATATOR NERVES.

- Vaso-dilatator nerves, 300, 308, 475  
 Vaso-motor nerves,  
 distribution of, 298  
 effect of section, 298 *et seq.*  
 experiments on, 306  
 influence upon blood-pressure, 304  
 Vaso-motor nerve-centres, 298, 661  
 nervous system, 296 *et seq.*  
 reflex action, 306  
 Vegetables as food, 455, 464, 466  
 Vegetable cells, 6  
 protoplasmic movement in, 13, 14  
 Veins, 215  
 cardinal, 837  
 circulation in, 276 *et seq.*  
 velocity of, 264  
 collateral circulation in, 216  
 development, 836  
 distribution, 215  
 pressure in, 291  
 rhythmical action in, 276  
 structure of, 216  
 umbilical, 823  
 valves of, 216 *et seq.*  
 Velocity of blood in arteries, 262  
 in capillaries, 264  
 in veins, *ib.*  
 of circulation, *ib.*  
 of nervous force, 172  
 Venæ adhehentes, 836  
 vevehentes, *ib.*  
 Ventilation, 381  
 Ventral cerebellar tract, 615  
 Ventricles of heart. *See* Heart.  
 Ventricular diastole, 232  
 systole, *ib.*  
 Ventriloquism, 737  
 Veratrine, effect of, on muscular contraction, 125  
 Vermicular movement of intestines, 526  
 Vertebra, development of, 824  
 Vesical, germinal, 22, 802  
 Vesicular seminales, 796  
 Vestigial fold of Marshall, 838  
 Vibrations, conveyance of to auditory nerve, 722 *et seq.*  
 Vierordt's hæmatochrometer, 263  
 Villi in chorion, function of, 822  
 of intestines, 448  
 Visceral clefts and arches, development of, 827 *et seq.*  
 connection with cranial nerves, 830  
 Visceral mesoblast, 811  
 plates, 813  
 Vision, 740  
 angle of, 757  
 at different distances, adaptation of eye to, 759 *et seq.*  
 corpora quadrigemina, the principal nerve-centres of, 637  
 correction of aberration, 765 *et seq.*  
 of inversion of image, 787

## WOLFFIAN BODIES.

- Vision—*continued.*  
 defects of, 763 *et seq.*  
 distinctness, how secured, 789 *et seq.*  
 duration of sensation in, 770  
 estimation of the size and form of objects, 787—9  
 focal distance of, 759  
 impaired by lesion of fifth nerve, 791  
 single, with two eyes, 782 *et seq.*  
 Visual area, 678  
 judgments, 787 *et seq.*  
 Visual purple, 752, 780  
 Vitellin, 462  
 Vitelline duct, 852  
 membrane, 801  
 spheres, *ib.*  
 veins, 830  
 Vitreous humour, 741, 754  
 Vocal cords, 727, 733, 734  
 action in respiratory actions, 734  
 approximation of, effect on height of note, *ib.*  
 vibrations of, cause voice, 734, 735  
 Voice, 727, 735  
 range of, 737  
 Volkmann's hæmadromometer, 263  
 Voluntary muscle, 85 *et seq.*  
 nerves of, 93  
 Voluntary tetanus, 128, 162  
 Vomiting, 525  
 action of stomach in, *ib.*  
 centre, 526  
 nerve actions in, 525  
 voluntary and acquired, *ib.*  
 Vowels and consonants, 738

## W.

- Waldeyer, stages of karyokinesis, 18 *et seq.*  
 Wallerian degeneration method, 167, 170, 609  
 Waller, apparatus for gas analysis, 383  
 on the electrical currents of the eye-ball, 781  
 Water hammer pulse, 269  
 Wave of blood causing the pulse, *ib.*  
 velocity of, *ib.*  
 Weber-Fechner law, 692, 702  
 Weber's paradox, 135  
 Weight, influence on capacity of respiration, 355  
 Whey proteid, 458  
 White corpuscles. *See* Blood-corpuscles, white; and Lymph-corpuscles.  
 White fibro-cartilage, 55  
 fibrous tissue, 44  
 spot, 749  
 Wolfian bodies, 856 *et seq.*  
 duct, 856

## WOOLDRIDGE'S METHOD.

Wooldridge's method of preparing  
tissue-fibrinogen, 400  
Word-centres, 739, 740  
Worms, circulatory system in, 229

## X.

Xanthine, 325, 330, 558  
presence in the spleen, 325  
Xantho-proteic reaction, 395

## Y.

Yawning, mechanism of, 362

## ZYMOGEN.

Yellow elastic fibre, 46  
fibro-cartilage, 56  
spot of Sömmering, 748, 772  
Yolk-sac, 813, 817, 818 *et seq.*  
Yolk-spherules, 801  
Young-Helmholtz theory, 777, 779

## Z.

Zona pellucida, 801, 806  
Zonule of Zinn, 754  
Zuntz, output of the heart, 246  
Zymogen, 473, 480

THE END.



