

PUBLISHED EVERY WEEK. \$1.50 PER YEAR.

# THE FARMER'S ADVOCATE

AND HOME MAGAZINE

\*AGRICULTURE, STOCK, DAIRY, POULTRY, HORTICULTURE, VETERINARY, HOME CIRCLE.\*

ENTERED IN ACCORDANCE WITH THE COPYRIGHT ACT OF 1875.

Vol. XLVII.

LONDON, ONTARIO, APRIL 25, 1912.

MAY 17 1912 No. 1022

## This Year Own These Haying Helpers

Publications Branch.

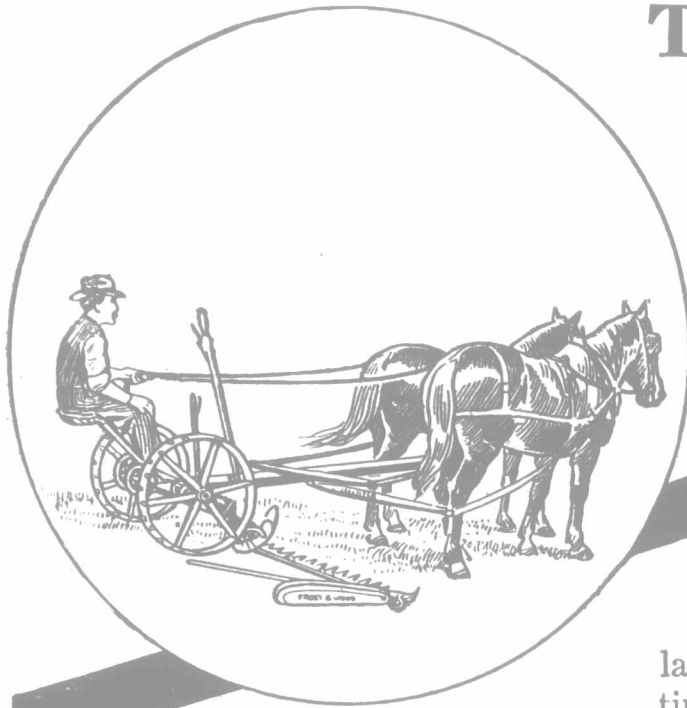

Decide that you'll no longer labor under a handicap at haying time. Secure the services of these

Frost & Wood Haying Helpers—Giant 8 Mower and Tiger Auto Dump Rake. For twenty years and more these efficient haying implements have saved time, money, labor and horseflesh for thousands of progressive Canadian Farmers. Think of the next score or more haying seasons.

## Frost & Wood Giant 8 Mower Tiger Rake

The Frost & Wood Giant 8 Mower is not merely a "fair-weather" machine. It's right there with the power and cutting ability when other mowers are apt to fall down. Put it to work in a heavy or tangled crop and watch how easily it handles the job. You can start it anywhere in the field and the knives will begin cutting the instant the horses move forward. "Flying starts" are not necessary.

The Giant 8 has great driving power because of the simple and compact arrangement of the gears. Smooth-running and light draft are assured by a plentiful supply of large roller bearings. The cutter bar is protected against wear by steel plates. Large bearings—not pins—are used for the connection between cutter bar and main frame.

At every point, in its construction, is put the skill

and knowledge gained in over 70 years' experience in building farm machinery to meet Canadian conditions.

The Tiger Automatic Dump Rake is the best sulky rake made. It has given satisfaction for many haying seasons. The teeth are shaped to do the most efficient work. They are made of a special grade of steel, that has proven by test, the best adapted to withstand heavy work and severe usage.

Strongly constructed throughout, is the Tiger Automatic Dump Rake. It is a rake that will pay you large dividends of satisfaction at haying time. When you require anything in the way of farm equipment remember our agents can supply your wants. We have catalogs describing and illustrating the different lines; they are cheerfully mailed free for asking. Let us send you one to-day.

For Sale in Eastern Ontario, Quebec and the Maritime Provinces by  
**The Frost & Wood Company, Limited, Smith's Falls**

In Western Ontario and Western Canada by  
**Cockshutt Plow Company, Limited, Brantford, Winnipeg**

"Branches and distributing warehouses in all the larger centres."

"Ask our local agent, or nearest Office for further particulars."

**FREE**

A Sample of Pedlar Culvert and a Special Book about it to every Farmer or Reeve or Municipal Officer —

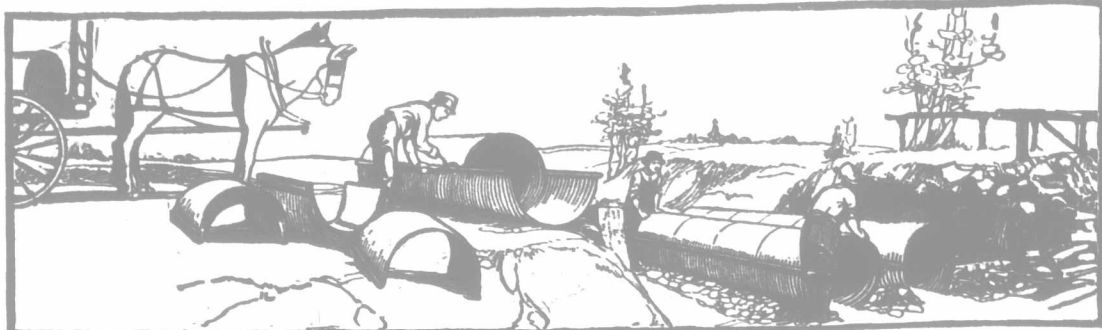

**E**ASILY-LAID Pedlar Corrugated Culvert made in non-rusting 'Toncan Metal' is handled "right at the job" and placed by a couple of men in a few hours' time. It makes a frost-proof and freshet-proof culvert

Remember you can use Pedlar Culvert on your farm—at the gate, in open drains, as well casing, etc. It saves time. Cannot wash out. Lasts years and years. Let us hear from you. Sizes—8 inches to 7 ft. in diameter. Get the free sample. See how strong it is. Write to-day.

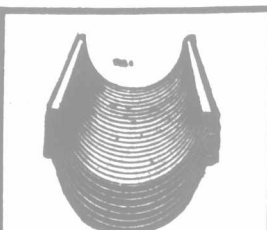

These nested bundles are carried to the job by wagon—

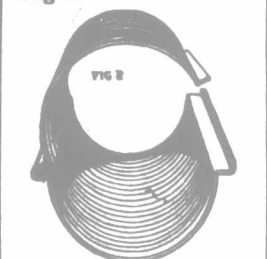

and fit together like this—



when they are firmly clamped by this three-pronged flange. After that you simply can't break down the culvert.

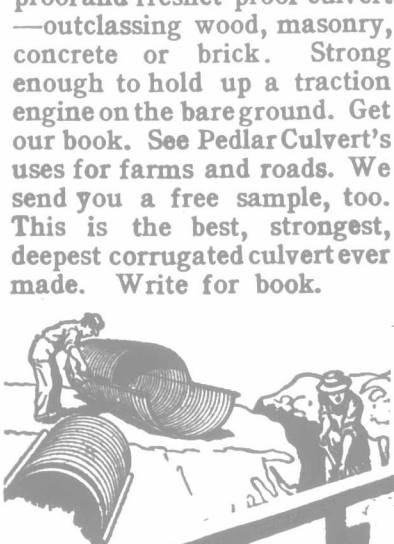

Equip your ditches like this. Saves wagon, team and load.



**PEDLAR**

**CULVERT**

Send to-day for the Culvert Book and the free sample—nearest office below will care for you. Improve your highways and farms. Established 1861.



- EDMONTON 563 Third St. W.
- CALGARY Crown Block
- CHATHAM 200 King St. W.
- ST. JOHN, N.B. 86 King St.
- LONDON 42-46 Prince William St.
- QUEBEC 127 Rue du Pont
- PORT ARTHUR 45 Cumberland St.
- HALIFAX 16 Prince St.
- REGINA
- OTTAWA 423 Sussex St.
- MONTREAL 321-3 Craig St.
- TORONTO 111-113 Bay St.
- WINNIPEG 76 Lombard St.
- VICTORIA 434 Kingston St.
- VANCOUVER 108 Alexander St.

WHEN WRITING ASK FOR CULVERT BOOK NO. 250

**\$\$\$ \$**  
**DOLLARS**  
*in your TREES*

Right in your own grove—waiting for you to take them out. All you need is an "American" Saw Mill to cut that timber into lumber, which you can use yourself or sell at a good price. You can belt the "American" Mill to your farm engine and run it yourself, turning out first class lumber faster and cheaper than any other mill. We've written a book "Making Money Off the Wood Lot" which tells a number of ways in which you will find an "American" Mill profitable. We can send you a copy. Write to us at once.

American Saw Mill Machinery Co.  
143 Hope Street, Haverhill, Mass., U.S.A.  
1764 Belmont Road, New York, N.Y.  
Chicago—Slovakia—New Orleans



MENTION "FARMER'S ADVOCATE"

Why Don't You Plant **EWING'S** Reliable Seeds?

What's the use of giving your land, your time and your work for a season for anything less than the *best* crops? Ewing's Reliable Seeds have proved, for more than forty seasons, favorable and unfavorable, that they will produce the biggest crops of the best quality. Ask your neighbors who plant Ewing's Seeds all about them. Plant them yourself this spring and get the full reward for your work. Your dealer should have Ewing's Reliable Seeds, but if he hasn't, write for our illustrated catalogue and order from us direct.



W. E. EWING & CO.  
SEEDSMEN  
CHICAGO, ILL.

Sold Over 850,000 Acres in Five Years

**WESTERN LAND FOR SALE**

In areas to suit purchasers, from 160 acres upwards, situated on or near railways in the

Best Wheat, Oat and Stock - growing Districts of

**SASKATCHEWAN**

AND

**ALBERTA**

450,000 ACRES TO CHOOSE FROM

Prices low. Terms most generous and helpful.

Special Inducements Given Actual Settlers

Our crop payment plan requires no payment on land bought until the purchaser sells his first crop. He can use all his capital for cultivation and improvements.

Write for particulars.

RELIABLE AGENTS WANTED IN EVERY COUNTY.

**F. W. HODSON & CO.,**  
Room 102, Temple Building  
Toronto, Ontario, Canada.

Branch Office: North Battleford, Sask.  
Also Agents Canadian Pacific lands.

"GOOD as GOLD"

are the Policies of the

**London Life INSURANCE CO'Y**

Head Office: London, Canada

BEAUSE:

The assets of the Company are most carefully invested 85% of the total assets consist of loans on first mortgages upon which form of investment the Company has incurred no losses in a quarter of a century. Bonds, Stocks and Debentures are carried at a figure much below market value.

Ask for pamphlet "Reasons Why"

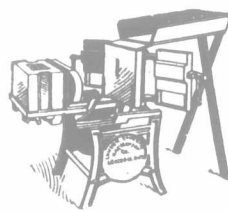

Build Silos, Dwellings, or any class of building from **Concrete Block**. The London Adjustable Concrete Block Machine makes every kind and size of block. High grade. Moderate price. We manufacture a full line of Concrete Machinery. Tell us your requirements.

**LONDON CONCRETE MACHINERY CO.,**  
Dept. B, London, Ont.

## Valuable Book on Barn Building FREE



Write at once for this valuable book. It contains information that every farmer should have regarding the satisfactory housing of dairy cows. It explains every fundamental of correct construction and gives proper dimensions and arrangements. It describes lighting, ventilation, stable floors, and their construction, and contains suggestions about silos, site, exposures, appearance, design, drainage and inside equipment. Besides, you will find in this book a number of practical barn plans and other information that may point the way to your saving many a dollar. We have designed many of the finest and most modern dairy barns in this country and this book is based on our long experience and expert knowledge in dairy barn construction. The book contains in concise, clear and condensed form, information necessary to any farmer who is planning to build or remodel. Understand, we send you this book absolutely free without any obligation on your part—just for answering these few questions: Do you intend to build or remodel? How soon? How many cows have you? Will you want a litter carrier? Will you want a hay fork outfit? Send to-day.

BEATTY BROS. BOX A FERGUS, ONTARIO

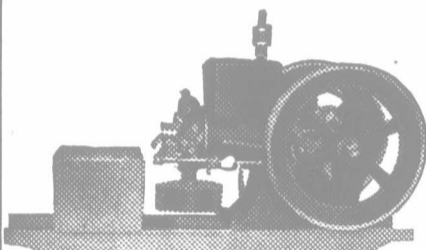

### Simple, Durable

With no complicated working parts, "Bull Dog" Gasoline Engines are built especially for use on the farm. They will stand long and hard service out of doors.

## "BULL DOG"

### Gasoline Engines

are built in six sizes, from 1 1/2 to 16 h.p. Adapted for stationary, semi-portable or portable mounting. Liberal bearing surfaces and up-to-date construction throughout. Get prices and catalogue from our Canadian agents.

### BATES & EDMONDS MOTOR COMPANY

Lansing, Michigan

General agents for Canada:

A. R. Williams Machinery Co., Limited  
Toronto, Ont. St. John, N. B.



Buchanan's Self-Compressing Long Sling—the result of 33 years experience in making Pitching Machines. Consists of three slings and sectional pulley for drawing ends together. Easy to operate, quick to work, and exceptionally strong. We make all kinds of Pitching Machines—Swivel Carriers and Tracks, Slings, Harpoon Forks, etc. Write for catalogue.

M. T. BUCHANAN & CO., INGERSOLL, ONT. 2

When Writing Mention This Paper.

# Vanco Did it

When the Buds on your fruit trees are swelling, spray the trees from the top to bottom with

## "Vanco" Lime Sulphur Solution

Clean trees mean sound fruit. Spring spraying means fall profits. San Jose Scale, Apple and Pear Scab, Aphid, Fire Blight, Mildew and other Fungi attack fruit trees before the leaves come out.

The time to attack them is before they can damage the tender buds. One spraying before the leaf buds burst, and another just before the blossoms come out—with perhaps a third when most of the blossoms have fallen—will mean hundreds of dollars profit when the fruit is ready for packing.

"VANCO" LIME SULPHUR SOLUTION is a true chemical solution of uniform strength and efficiency. It is prepared by scientific men in a scientific way—with the specific gravity on every barrel.

It does away with all guess-work—saves the trouble of home-boiling. It is ready for use after mixing with water—has no sediment—sprays easily—and does not clog the nozzle.

You get results when you spray with "VANCO" LIME SULPHUR SOLUTION—because it is strong, uniform, clear, efficient.

FERTILIZERS—We are the only house in Canada selling only the straight Fertilizing Chemicals—Nitrate of Soda, Muriate of Potash, Sulphate of Potash and Acid Phosphate. YOU CAN SAVE FREIGHT by buying your Fertilizers and Spray Chemicals together, and have all come in one shipment.

WRITE FOR THE "VANCO" BOOK, and turn the information it will give you into dollars. We'll gladly send you a copy, free.

CHEMICAL LABORATORIES LIMITED, 126-136 Van Horne St., TORONTO.

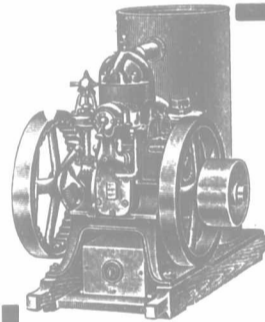

## This Engine Runs on Coal Oil

Every farmer can afford an Ellis Coal Oil Engine. They give as more power from coal oil than other engines do from gasoline. They are safe, as well as cheap; no danger of explosion or fire.

The strongest and simplest farm engine made; only three moving parts: nothing to get out of repair. Anyone can run it without experience. Thousands of satisfied customers use these engines to grind feed, fill silos, saw wood, pump, thresh, run cream separators, and do dozens of other jobs. Cheaper than horses or hired men. Fill up the tanks and start it running, and no further attention is necessary; it will run till you stop it.

FREE TRIAL FOR 30 DAYS. You don't have to take our word for it. We'll send an engine anywhere in Canada on Thirty Days' Free Trial. We furnish full instructions for testing on your work. If it does not suit you send it back at our expense. We pay freight and duty to get it to you and we'll pay to get it back if you don't want it.

Absolutely guaranteed for 10 years. Write for free catalog and opinions of satisfied users. Special offer in new territory.

3 to 15 horse power  
We Pay Duty and Freight

Ellis Engine Co., 94 Mullett Street  
DETROIT, MICH.

## FREE STYLE BOOK FOR 1912 OF "Quality Line"



### VEHICLES AND HARNESS

EIGHTEENTH YEAR OF SELLING DIRECT TO THE USER.

Our Catalogue will help you to choose just the vehicle or harness you require, and SAVE YOU MONEY. It describes and pictures many styles, gives prices, RIGHT PREPAID, and fully explains our method of Selling Direct and saving you the Middlemen's Profit. Remember, we pay the freight in Ontario and Eastern Canada. The Catalogue is Free, for the asking. Send for it To-day.

INTERNATIONAL CARRIAGE CO.,  
Dept. "A," Brighton, Ontario.

## EUREKA Harness Oil

KEEPS YOUR HARNESS SOFT AS A GLOVE TOUGH AS A WIRE BLACK AS A COAL

SOLD BY DEALERS EVERYWHERE  
The Queen City Oil Co., Limited.

## DRAIN TILE

Mr. Farmer, now is the time to make arrangements for putting Tile in that wet or springy field on your farm, but be sure and get the best Tile possible, which is always the cheapest. Large capacity, stock of all sizes on hand. Also dealer in Fence Posts, Ties, Wood, etc.

WRITE TO:

The W. W. SMITH  
BRICK & TILE WORKS  
Shallow Lake, Ont.



CREAM WANTED  
At the Guelph Creamery. Business run on the co-operative plan. Write for prices and particulars. It will pay you well. Stratton & Taylor, Guelph.



**Let Your Next Binder be a Deering**

**T**HE Deering name has always stood for progress. The Deerings bought the patents of the first knotter. A Deering tag was on the first single strand fibre twine, and the first company to grow dissatisfied with the steel it purchased, and build its own roller mills was the Deering. It was this spirit of leadership which led them to make the Deering New Ideal binder to meet the demands of farmers in Eastern Canadian provinces.

These machines are made in Hamilton, Ontario, by Canadian workmen for Canadian harvest work. Ask the Deering agent to show you these points on Deering binders: The main frame made of high carbon steel bars, hot-riveted together, forming a unit which the hardest usage cannot twist out of shape; ball and roller bearings to make the machine light running; equipment for the use of either a smooth section or serrated knife, and, last but not least, the venerable Deering knotter, simple, accurate, unailing.

The Deering line is complete and of the same quality, whether binders, twine, mowers, rakes, tedders, or hay loaders. See the I H C local agent and make an inspection yourself, or, write the nearest branch house for a catalogue.

Eastern Canadian Branches  
International Harvester Company of America  
(Incorporated)  
At Hamilton, Ont. London, Ont. Montreal, P. Q.  
Ottawa, Ont. St. John, N. B. Quebec, P. Q.

I H C Service Bureau  
The purpose of this Bureau is to furnish, free of charge to all, the best information obtainable on better farming. If you have any worthy questions concerning soils, crops, land drainage, irrigation, fertilizer, etc., make your inquiries specific and send them to I H C Service Bureau, Harvester Building, Chicago, U S A

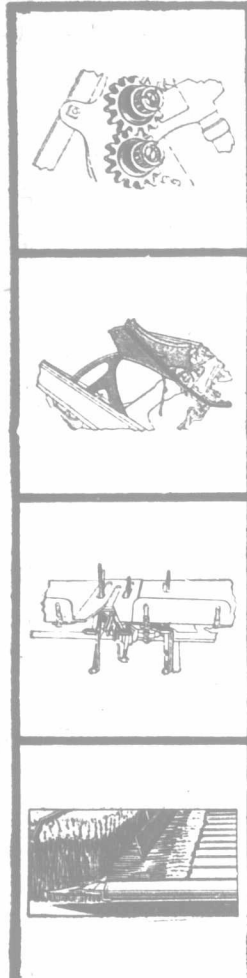

**High-Class Telephones and Construction Materials**

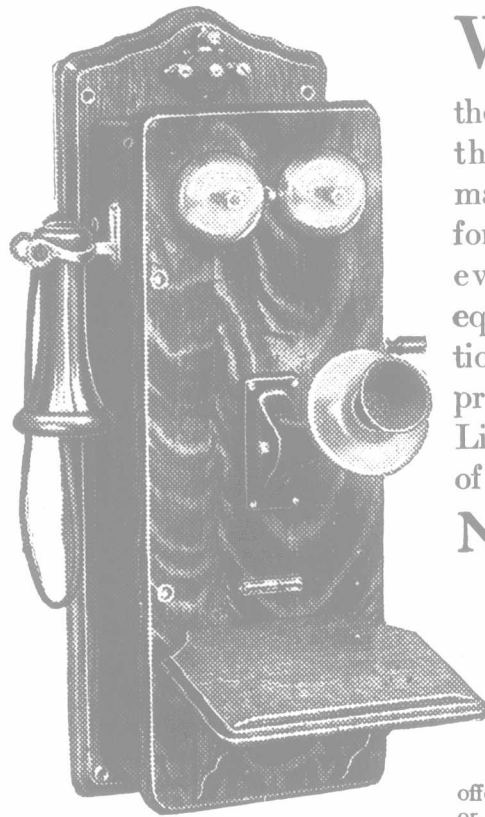

The strongest ringing and talking telephone made.

**W**E make the highest-grade telephones on the market. We guarantee them against defects in material and workmanship for 10 years. We handle everything in high-grade equipment and construction materials. We ship promptly. Write for Price List. Also send for a copy of our

**No. 3 Bulletin**

It contains the latest information on how to build, equip and maintain rural telephone lines. At the same time ask for particulars about our

**Free Trial**

offer, which enables any municipality or company to test, try and judge the efficiency of our telephones before investing a dollar.

**Canadian Independent Telephone Co. Limited**

20 DUNCAN STREET, TORONTO

33

**This Well-Drilling Machine**

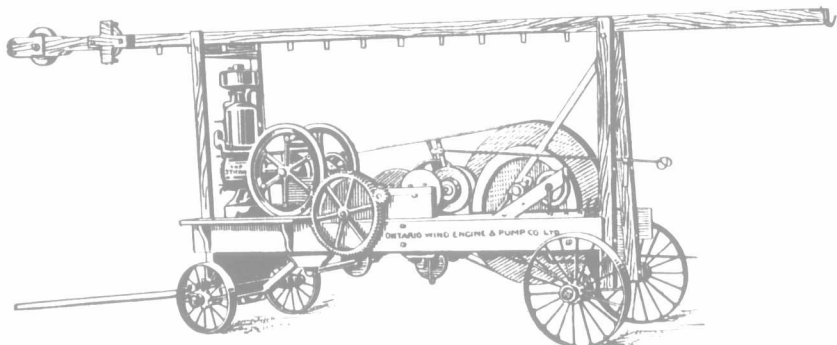

**Earns \$10 to \$20 a Day for the Man Who Owns One**

Why not be the "well-driller" in your neighborhood. The driller pays for itself very quickly, then keeps on earning easy money for you. Drills either deep or shallow wells in any kind of soil or rock. Get our free proposition and full particulars before your neighbor gets busy. Write to-day.

**ONTARIO WIND ENGINE & PUMP CO., LIMITED**  
Winnipeg TORONTO Calgary

We supply Well Casings and General Deep Well Supplies or all kinds. Write for prices

Are you anxious to save time and money on the work you are doing on your farm at present, and to get larger crops from your farm or orchard? If so, let us send you, **FREE OF CHARGE**, our pamphlets on the use of

**Stumping Powders**

USED FOR

**Removing Stumps and Boulders  
Digging Wells and Ditches  
Planting and Cultivating Orchards  
Breaking Hard Pan, Shale or Clay Subsoils  
Etc., etc., etc.**

Figure yourself what clearing your farm is costing now, or what you are losing in crops through not clearing. Write us about arranging demonstrations.

**CANADIAN EXPLOSIVES, LIMITED**  
Montreal, P. Q.

\$15 00 and Upwards

**We Give a Free Trial**

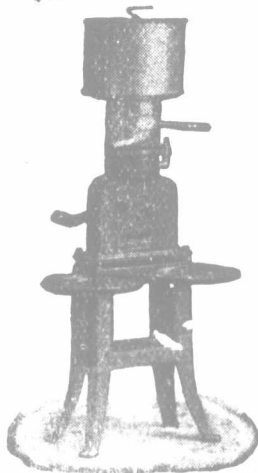

of the Domo Cream Separator, which excels any other separator in the world.

The Domo Separators are of the highest quality, well-built, and durable. They are close skimmers, turn easy, handsomely finished and guaranteed. Prices cut in two.

We gladly send a machine to you on free trial, **FREIGHT PREPAID**, and if you are not perfectly satisfied, return it to us at our expense. If you are satisfied, enables you to prove to your neighbors, and to the world, what we mean, **TEST IT AT YOUR OWN RISK**. **NO EXPENSE** to you. **ALL** the risk. Can we do any more for you?

Write to-day for a free trial. We will send you a copy of our machine, trial order, and what you can do with it. All costs received from users. This is our trial. No return. It's free.

**DOMO SEPARATOR CO.**  
BRIGHTON, Ont. ST. CATHARINES, Ont.

**Standard Wire Fence**



In the "Standard" Wire Fence, you get the durability that comes with strength. Made of all No. 9 Hard Steel Wire, well galvanized—which means no rust and long wear.

"The Tie That Binds" hooks on the running wire and locks smooth on both sides. Then—there's the Standard Steel Fence Posts that hold the wires without staples—won't rot and are very durable.

We make a specialty of Galvanized Gates, too. Our new hooks are chock full of fence facts. Write for free copies and sample lock.

The Standard Wire Fence Co. of Woodstock, Limited  
Woodstock, Ont. Brandon, Man.

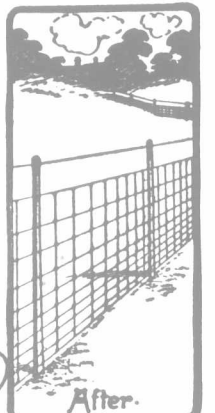

## You are going to buy

a Cream Separator this year. You have your choice of a number of standard makes, including the famous

# EMPIRE

## Cream Separators

which will do some things others won't do—because Empires have some patented features that have never been successfully imitated, although competitors would gladly copy them if it were not for Empire Patents. Just what these features are, is fully explained in the Empire booklet.

### Get a copy—Learn the facts

If they interest you deeply, as we believe such facts will, go to our agent in your locality (we will furnish you his name) and tell him to deliver an Empire to you for Free Trial, without obligation on your part to buy, unless it is proven to you that the Empire fulfills our claims. We are willing to let the Empire demonstrate its efficiency to you. It's your ultimate choice—the machine you'll buy sooner or later. Just hasten that day by writing to us by first mail.

### The Empire Cream Separator Company of Canada, Limited

Makers of CONE and DISC Separators 32  
WINNIPEG, TORONTO, MONTREAL, SUSSEX.  
Agents everywhere in Canada—Look for the Empire Sign.

# EUREKA

## Seed Drills and Cultivators

The best working drill on the market today—that's the "EUREKA". It sows evenly to the last seed—and handles the most delicate seeds without bruising or breaking. Unique Feed Cut out prevents waste of feed when turning rows. Seed Feed driven from rear wheel where weight naturally rests. Can be converted from straight drill sower to hill dropper in an instant. Just what you need for sowing Onions, Carrots, Sugar Beets, in fact all garden seeds. • The new model "EUREKA" is a marvel of lightness. The addition of a few parts will convert it into a complete wheel hoe, plow or cultivator.

#### Some of the other Eureka Lines

"Eureka" Sanitary Churn is the ONLY sanitary churn. Barrel is finest stoneware—not absorbent wood. Top is clear glass. Churns by hand lever, cleanest, easiest, best churn on the market, 4, 10 and 15 Imperial gallon sizes.

Combination Wagon Box and Rack. Easily adjusted to any position for any load without wrench, hook or rope. Makes the best possible rack for Hay, Stock, Wood, Poultry, Corn or Fruit.

"Eureka" Fountain Sprayer is just what you need for small Fruit Trees, Plants and Shrubs. Light, strong, compact. Two nozzles with hose attachment. Tested to stand Five Times the pressure required to expel liquid. Two gallon capacity and all expelled by one pumping.

"Eureka" Combination Arvil. Best iron arvil, with vice, pipe vice and drill attachment, and saw clamps. Just what you need for repairing tools and machinery. Weighs 60 pounds.

Write for Catalogue. Every farmer should have one. 13  
EUREKA PLANTER CO., Limited, 4 WOODSTOCK, Ont. 6

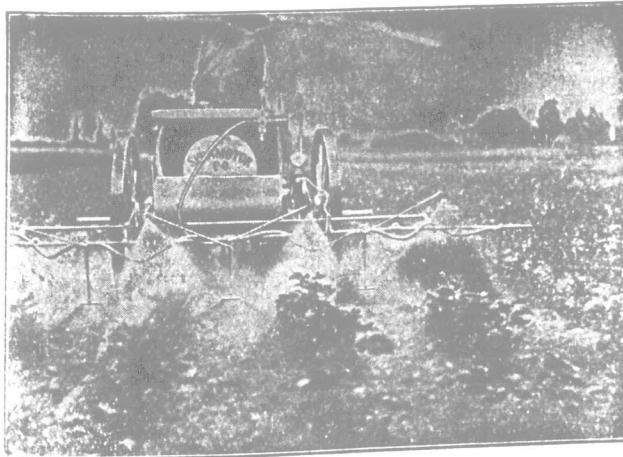

### 15 MINUTES TO THE ACRE

Does the work with the Horse-Power SPRAY-MOTOR, and does it well. Four rows, three nozzles to a row, adjustable up to 40-inch rows. Nozzles will not clog. 12-gal. air tank, automatic and hand-controlled. Guaranteed pressure of 125 pounds with all 12 nozzles working. Agita or clean-out, pressure relief into tank, nozzle protector under driver's seat. For 1 or 2 horses. Adjustable for vineyards, row crops or orchards. Write for free treatise on crop diseases. AGENTS WANTED.

Spramotor, Limited, 1362 King Street, London, Canada

# Atlantic Red Engine Oil

Unsurpassed as a Lubricant for Moderate Speed Engines and Machinery

**Atlantic Red Engine Oil** is just the right oil for slow and moderate speed engines and machinery. It is a medium bodied oil; works freely between the wearing surfaces, and forms a cushion that lasts.

**Capitol Cylinder Oil** is all lubricant. It lifts the load off the engine and saves all the wear and friction possible. Cut down your fuel bill. Lasts much longer than other cylinder oils. Equally good on all "bearing" surfaces.

**S. Peerless Oil.**—The best general lubricant for farm machinery on the market. Specially suitable for reapers, mowers and threshers, Uniform body. Heat and moisture do not affect it.

We have made a special study of the requirements of farm machinery. Read our "Easier Farming" booklet; free, postpaid. Call or write

## The Queen City Oil Company, Limited

Head Office, 63 Bay Street, Toronto  
Also Offices at Ottawa, Hamilton, London, Kingston, Stratford, St. Thomas, Brockville, Owen Sound, Sault Ste. Marie

## Reliable help for the farmer

Farm labor is scarce. Wages are high. All the more need for a BARRIE ENGINE. Soon pays for itself in time and labor saved. Grinds grain, shells seed corn, pumps water, cuts straw, threshes beans, saws wood, drives churns, separators and washing machines. Does many other things, too.

## BARRIE ENGINES WORK LONG

hours without getting tired. Very simple in construction. Reliable in operation. 3 to 100 h.-p. Stationary or portable. For gasoline, distillate, natural gas, producer gas. Write for catalogue. Agents wanted.

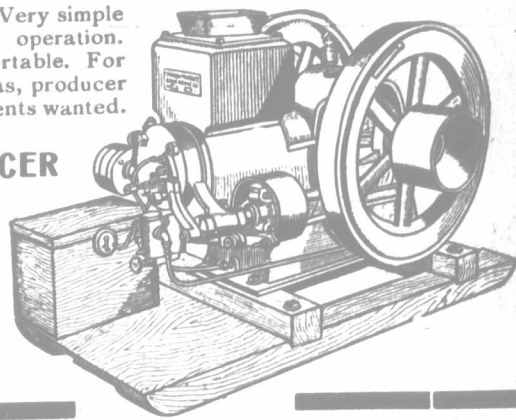

The CANADA PRODUCER & GAS ENGINE CO., Ltd.  
Barrie, Ontario, Canada

Distributors:  
James Rae, Medicine Hat;  
Canada Machinery Agency,  
Montreal; McCusker Imp.  
Co., Regina

## CENTRAL NURSERIES — QUALITY STOCK

Bartlett and other Pear Trees. Duchess, Wealthy and varieties of Apple Trees. Plum, Cherry, Peach, Nut and Ornamental Trees in variety. Grape Vines. Berry Plants — terbur, St. Regis, Himalaya, Superlative and Cuthbert—think of berries from July till October. Shade Trees. Evergreens, California Privet Hedge, Shrubs and Roses—just the kinds wanted.

Send for our Priced Catalogue, and order quick for variety. No Agents.

A. G. HULL & SON  
St. Catharines, Ontario

BEST RESULTS ARE OBTAINED FROM ADVOCATE ADVERTISEMENTS.

**Come to Canada!**  
**SASKATCHEWAN**  
**THE GOLDEN**

"The Land That Pays for Itself  
 in a Single Season"  
 —Prof. THOMAS SHAW.



WILLIAM PEARSON  
 of  
 Winnipeg,  
 known as  
 "Last  
 Mountain  
 Pearson"

**T**HOUSANDS of Eastern Canadians—some, your own former neighbors—are now in Golden Saskatchewan. They were struggling along five years ago, "back home"—just like you are to-day. Many were renters—didn't own a square foot of land. To-day they could buy out the richest farmer in your county. Not because these men are smarter or work harder than you, but because they now live where an industrious man has a fair chance.



Saskatchewan Land Maps Free

#### Last Mountain Valley

Saskatchewan farmers in Last Mountain Valley grow 40 bushels of wheat on \$30 land. Result: "Land cleared in one year." They are making money hand over fist. Crop failures? We don't have 'em here! Seven great railroads form a veritable network over this district. You're right in civilization.

And whoever saw a finer place to live! Good neighbors, fine climate, phones, railroads, churches, schools, rural mail, stores, good roads, fishing, hunting, etc.

#### Two Big Land Openings— New Settlers Pouring in by Thousands

Last year 351,593 settlers came to Canada—and fortune. This year will see 500,000 follow them. The bulk of them are bound for the Prairie Provinces. And they'll never go back! They'll never leave this land of health, happiness, sunshine and fortune.

We are putting on two gigantic new land openings—one at Raymore, in Last Mountain Valley, on the main line of new Grand Trunk Pacific—finest wheat land in the world.

WM. PEARSON CO., Ltd., 807 Temple Court, Minneapolis, Minn.

East of Last Mountain Valley lies the rich Touchwood Hills Country. Also to be opened up. Great land for mixed farming—stock raising—and wheat, oats, flax, barley, grasses, etc.

#### Lowest Prices

We have land bargains such as were never before known. Our prices are positively lowest. No other colonization company can ever hope to meet our terms and prices, because none can buy land now in such enormous tracts.

#### Land Books Free

Don't wait! Don't let this opportunity slip by. Saskatchewan land prices are doubling fast. Buy now—make a killing. Chances are if you lay this paper aside now, without further investigating this offer, you may overlook it entirely—may never make the big success that every real man deserves to win. So—act now—on the impulse—send in a postal that says: "I want to know about the land openings." You will receive by return mail the most complete and authoritative land information ever published—free—all about the big Land Openings—full reports on Crops, Climate, Soil, School, Churches, Towns, Maps, Description of land, etc. Our special list of land bargains will be included. Address your postal to our Minneapolis office, not our Canadian office. Write:

### The "Bissell" has the capacity

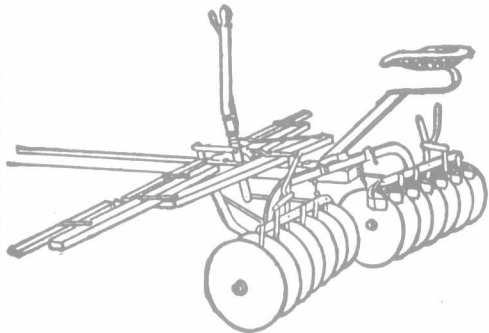

Because of its capacity, time after time the "Bissell" Disk Harrow has done DOUBLE THE WORK in field competition against all competitors, under the same conditions.

The special shape of the "Bissell" plates cause them to enter the ground naturally and TURN THE SOIL EASILY. Steel scraper blades meet the

Disk Plates chisel fashion and keep the plates clean of trash by movable clod irons—the only Harrow that has this feature.

Anti-friction balls (40) are used in the bearings, on every "Bissell" Disk.

The seat is placed back on the Harrow so that the weight of the driver when riding balances over the frame and REMOVES NECK WEIGHT. The hitch is well back, MAKING LIGHT DRAUGHT.

Search the Continent over and you will not find a Harrow with such cutting capacity, easy draught and correct proportions as the "Bissell." A postcard to Dept. W will bring you a free catalogue.

T. E. BISSELL CO., LTD., ELORA, ONT.

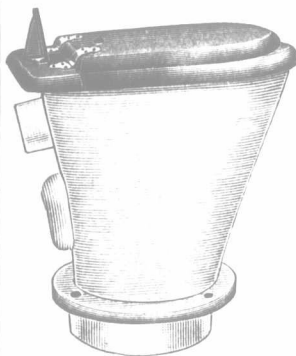

#### ARCHITECTS, CONTRACTORS SCHOOL TRUSTEES

We have the closets you need in your up-to-date buildings. Sanitary, odorless chemical closets, used in all best schools and public buildings, and giving perfect satisfaction. Does not require water or plumbing. Our closets placed in your schools save your children many serious illnesses, caused from running out in all kinds of weather to filthy closets. Write for catalogue to our office.

RED CROSS SANITARY APPLIANCE CO.  
Grimsby, Ontario

## SEE AND TRY A DE LAVAL CREAM SEPARATOR

We cannot believe that there is a sensible man living who would purchase any other than a DE LAVAL Cream Separator for his own use if he would but see and try an improved DE LAVAL machine before buying.



It is a fact that 99% of all separator buyers who do SEE and TRY a DE LAVAL machine before buying purchase the DE LAVAL and will have no other. The 1% who do not buy the DE LAVAL are those who allow themselves to be influenced by something else than real genuine separator merit.

Every responsible person who wishes it may have the Free Trial of a DE LAVAL machine at his own home without advance payment or any obligation whatsoever.

Simply ask the DE LAVAL agent in your nearest town, or write direct to the nearest DE LAVAL office.

DE LAVAL DAIRY SUPPLY CO., LIMITED

173 William St., MONTREAL

14 Princess St., WINNIPEG

The Oil You Need for Your Separator

## STANDARD HAND SEPARATOR OIL

Never Gums. Never Rusts. Never Corrodes.



Standard Hand Separator Oil feeds freely into the closest bearings and gives the best possible lubrication.

It makes your separator last longer and do better work as long as it lasts.

One-gallon cans. All dealers, or write to:

The Queen City Oil Company, Limited  
Head Office, 63 Bay Street, TORONTO

Also offices at Ottawa, Hamilton, London, Kingston, Stratford, St. Thomas, Windsor, Brockville, Owen Sound, Sault Ste. Marie

### A FARMER'S POWER HOUSE ON WHEELS

Complete with Line Shaft, Truck, Pump Jack and interchangeable Pulleys capable of 60 changes of speed.

An engine that carries its own line shaft, pulleys, belt tightener and hangers. The Gilson 60 Speed Engine is a complete power plant in itself. You can haul engine anywhere, attach it and get just the speed desired—the only engine of its kind made. Gives 100 per cent service. Runs the whole farm. Goes like sixty—sells like sixty—has sixty speeds. 12 H. P., also 3 H. P. and 6 H. P. Engines up to 27 H. P.

WRITE TODAY. Write at once for illustrated, descriptive literature with full information. Agents wanted.  
GILSON MFG. CO., Ltd. 61 York Street  
Guelph, Ontario

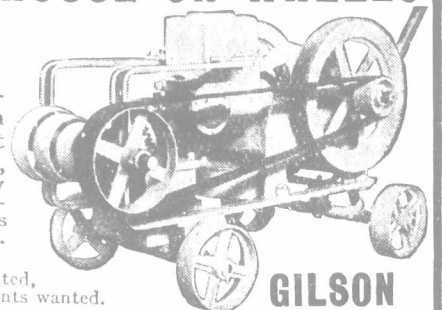

GILSON  
"60 SPEED" ENGINE

## Seed Oats

offering 75c. per bushel. LINCOLN. Weighing 42 lbs. per measured bushel. Seed procured last year from Toronto seedsmen. Good cotton bags, 25 cents. J. S. D. J. Campbell, Fairview Farm, Woodville, Ont.

# The Farmer's Advocate and Home Magazine

PERSEVERE  
AND  
SUCCEED

ESTABLISHED

REGISTERED IN ACCORDANCE WITH THE COPYRIGHT ACT OF 1875

Vol. XLVII.

LONDON, ONTARIO, APRIL 25, 1912.

No. 1022

## EDITORIAL.

Taxes are going up, but the roads keep going down.

What sort of highways are you getting in return for the taxes you pay?

Wide implements save time and do just as effective work as narrow ones.

The loss and inconvenience to farmers through bad roads is beyond computation.

Practice rotation of crops in the garden with as much care as on the main portion of the farm.

Have you got your garden in? Growing vegetables for the table is an easy matter. Get them in early, as they do better and are more appreciated.

If no clover is handy to the buildings, sow some oats and peas for fodder for the calves and pigs. Green feed in season is necessary for these classes of stock.

Railway promoters have absorbed a large share of the public domain and revenue of Canada. Now, for a change, suppose we let the country roads in on the ground floor.

Last summer was an especially hard season on new seeding. Much of the clover seeding was plowed last fall, but some was left till spring to give it another chance. With a small acreage of new seeding for hay and clover seed, the price of the latter is almost sure to be high a year hence. In view of this fact, if the seeding is at all worth leaving, give it a chance. Cut it early for hay, and keep the weeds down, and make conditions favorable for seed production. The growing of clover seed should be a branch of every farmer's business.

While agriculture is a calling which gives its followers a large amount of independence, yet they, too, are more or less dependent upon their fellow man. The scarcity of labor serves to bring this fact home with great force. It should make farmers more neighborly. A prosperous farmer was once heard to remark, "There is no use having neighbors unless you use them," and what could be truer. If you cannot get hired help, what is the matter with exchanging work with your brother farmer? Try it, rather than neglect work which requires extra hands. This would be a good beginning for a great co-operative movement on the part of farmers.

Ontario now has, according to statistics, over three million acres of pasture, and the area is likely to increase if farm labor does not become more plentiful. Too many of these pastures are composed largely of timothy. A great many farmers sow timothy and common red clover when seeding down, take one crop of hay, and then pasture. Better results could be obtained if more grasses were sown—orchard grass, Kentucky blue grass, meadow fescue, meadow fox-tail, tall oat grass, and alfalfa, alsike and white Dutch clover, give an excellent list to choose from. A mixture containing a large number of these grasses gives better pasture over a longer season than one or two of them alone.

## Solutions of the Labor Problem. University Agricultural Teaching

Probably on a par with poor roads, in many sections the most serious hindrance to the satisfactory working of the farms is the lack of efficient help. The condition this season is even more acute than it was a year ago, and unless righted ere long is bound to bring deplorable results. Want of men hinders the development of many of the most desirable branches of farming, and curtails production. Officers of experience in the Salvation Army immigration work find that they could place two or three times the number of men coming under their auspices from the Old Country, many of whom are from the cities and towns. In time, the reformation of the public-school system, and other influences, will tend to correct the townward drift of the youth, but meanwhile the area of good arable land laid down to grass is certain to increase. Even in districts not especially adapted to pasturage, it will carry a certain amount of stock and lighten the labor bill. It has been noted by the immigration officers referred to that the applications for help are much fewer from the grazing than from the dairy, fruit or mixed-farming districts. It should and probably will encourage the keeping of larger numbers of sheep, which, more than any other stock, give a good return, with the least amount of manual labor or trouble. Sheep are not only a profitable class of live stock, but are one of our best allies in the war with weeds. The next and more immediate remedy will likely be found in neighborly co-operation among farmers, on plans corresponding with suggestions recently made by a correspondent in "The Farmer's Advocate." Four or five neighbors clubbing together can do with less costly machines and horse-flesh, and can accomplish work in the fields more speedily and with greater pleasure than when wrestling away each on his own hook, with boy help or one man, when he really requires two. It will be a return to the good old days when "changing work" and "bees" were more in vogue than now. Sheep, grazing cattle on the pastures, and co-operation among neighbors, seem the most promising and immediate ways out of the labor shortage.

## "Adequate" Protection.

The latest definition of "adequate protection," as promulgated by one of its Canadian exponents, is that the tariff shall be "sufficient that an industry pay a fair dividend on the investment and enable the industry to be doubled out of profits every three years."

What do Canadian farmers think of this elastic proposition? A fair dividend on investment—including, no doubt, water equal to three or four times the actual capital, and then double the business every three years, besides! Have prices for agricultural produce yet reached a pinnacle where you could take out of your business from five to ten per cent. per annum, and then buy a new farm as large and good as your own in three years; then, in three years more buy another as valuable as these two together, and three years later another four times the size of your present one, and so on, till you owned a township or county? Failing such a condition of opulence, is there any valid reason why you, as a farmer and consumer, should be burdened with a scale of prices for living and supplies necessary to insure your neighboring manufacturer such a smooth and rapid avenue to wealth? Is it not about time to speak up?

In our last week's issue, an article dealing with agriculture in the Universities, was published. This was composed largely of three letters from the heads of Toronto, McMaster and Queen's Universities, in which they stated that they were about to introduce agricultural courses in conjunction with the Ontario Agricultural College at Guelph. The proposed plan is to give the students the regular university course for two years, and then send them to Guelph for their third and fourth years, leading to the degree of Bachelor of the Science of Agriculture. The proposal has the concurrence or is at the suggestion of the Provincial Department of Education. The object, as stated by the several University Presidents, is to train high school teachers in agriculture.

The purpose is very commendable. The teaching of agriculture should be one of the important phases of our educational system, and any well-considered plan which the Department of Education puts forward to further this purpose should receive the support of the people. We are pleased to know that those in authority are gradually becoming familiar with the needs of our educational system, and are making an effort to remedy some of its defects. We cannot hope to evolve a perfect system in a year—not even in several years. A beginning is necessary. But the questions arise: Does the proposed scheme commence at the logical beginning? Will it give the men a sufficient grasp of the subject to make them proficient agriculturists? Can a student not knowing anything about agriculture when he enters the university, take two years in arts or science and top off with the final two years at Guelph and become an agricultural expert, fitted by practical experience and theoretical training to make him an agricultural expert in anything more than the mere name?

\*\*\*

Agriculture is the "backbone" of our country. Politicians and educationists have very little hesitancy in stating this fact—yet they have been very slow to grasp the importance of a thorough system of agricultural education. Gradually the accumulating pressure has been brought to bear upon them, and now they are trying to make agricultural teaching a reality. It seems, however, that, to rectify the educative system, they continually persist in commencing at the wrong end. The university is not the best place to mould the mind. The common school, where the minds of the youth are in the formative state, and where it is easy for the teacher to instil ideas into the child's very being, there to gain force and be a factor in his particular vocation in after life, is the one place where the need of agricultural teaching is most imperative: Commencing with the high school or the university is starting at the wrong end of the ladder. What is necessary is that each and every public school teacher have a thorough training, practical and theoretical in the underlying principles of agriculture by teachers properly equipped, and that this subject be given a prominent place on the curriculum and equipment of our public schools.

We are glad to see the Government and universities so eager to take up the work of agricultural education in the higher schools, but let us look into the proposed scheme. There is now in Ontario an agricultural college second to none on the American continent, from which farm boys can get a diploma in two years, or a B. S. A.

## THE FARMER'S ADVOCATE AND HOME MAGAZINE.

THE LEADING AGRICULTURAL JOURNAL  
IN THE DOMINION.

PUBLISHED WEEKLY BY  
THE WILLIAM WELD COMPANY (LIMITED).

JOHN WELD, MANAGER.

Agents for "The Farmer's Advocate and Home Journal,"  
Winnipeg, Man.

1. THE FARMER'S ADVOCATE AND HOME MAGAZINE is published every Thursday. It is impartial and independent of all cliques and parties, handsomely illustrated with original engravings, and furnishes the most practical, reliable and profitable information for farmers, dairymen, gardeners, stockmen and home-makers, of any publication in Canada.
2. TERMS OF SUBSCRIPTION.—In Canada, England, Ireland, Scotland, Newfoundland and New Zealand, \$1.50 per year, in advance; \$2.00 per year when not paid in advance. United States, \$2.50 per year; all other countries 12s.; in advance.
3. ADVERTISING RATES.—Single insertion, 25 cents per line, agate. Contract rates furnished on application.
4. THE FARMER'S ADVOCATE is sent to subscribers until an explicit order is received for its discontinuance. All payments of arrears must be made as required by law.
5. THE LAW IS, that all subscribers to newspapers are held responsible until all arrears are paid and their paper ordered to be discontinued.
6. REMITTANCES should be made direct to us, either by Money Order or Registered Letter, which will be at our risk. When made otherwise we will not be responsible.
7. THE DATE ON YOUR LABEL shows to what time your subscription is paid.
8. ANONYMOUS communications will receive no attention. In every case the "Full Name and Post-office Address Must be Given."
9. WHEN A REPLY BY MAIL IS REQUIRED to Urgent Veterinary or Legal Enquiries, \$1.00 must be enclosed.
10. LETTERS intended for publication should be written on one side of the paper only.
11. CHANGE OF ADDRESS.—Subscribers when ordering a change of address should give the old as well as the new P.O. address.
12. WE INVITE FARMERS to write us on any agricultural topic. We are always pleased to receive practical articles. For such as we consider valuable we will pay ten cents per inch printed matter. Criticisms of Articles, Suggestions How to Improve "The Farmer's Advocate and Home Magazine," Descriptions of New Grains, Roots or Vegetables not generally known, Particulars of Experiments Tried, or Improved Methods of Cultivation, are each and all welcome. Contributions sent us must not be furnished other papers until after they have appeared in our columns. Rejected matter will be returned on receipt of postage.
13. ALL COMMUNICATIONS in reference to any matter connected with this paper should be addressed as below, and not to any individual connected with the paper.

Address—THE FARMER'S ADVOCATE, or  
THE WILLIAM WELD COMPANY (LIMITED),  
LONDON, CANADA.

degree in four years, the degree being granted by the University of Toronto, with which the College is affiliated. Boys, to enter these courses, must have actual farm experience—the more the better. None others are admitted. If the boy has been raised on the farm (as most of the present-day O. A. C. students are), his chances of success are so much the better. In short, practical experience forms the basis of the system. During the first-year course, students are required to do three half-day's work per week, which also serves to familiarize them with new, practical methods in the several departments of agricultural work. Lectures during the first two years are intended to prepare the student for the farm or for the B. S. A. or four-year's course. The second year is intensely practical, the student getting a training in Animal Husbandry, Agronomy, Horticulture and Poultry, which no university can hope to give without a special agricultural staff and the animals, birds and plants for practical demonstrations. These two years are of extreme importance to the student. Under the proposed plan, the university-trained men will miss all this training, and will join the two-year O. A. C. men in the third year, to complete identically the same course. Which is likely to be the better agriculturist or the better teacher of agriculture, the university student, with no agricultural training, or the farm boy with a fair education to commence with, supplemented by years spent in practical farm experience and two years of excellent ground-work in theory and practice at Guelph? Moreover, the English course at the O. A. C. leaves nothing to be desired. It is in fact the honor course in the second year, students being required to make 60 per cent. in English subjects to be eligible for third and fourth year work, which is of so high an order as to compare favorably with that taken in the

sity for the arts degree. The English staff is efficient, and the course broad in its scope, so that students receiving degrees are fairly good English scholars. The university student will be at a great disadvantage. He must take the same work as the other students when he reaches Guelph. These students are specially trained and prepared during the first two for the two final years. The third year is all science, but the fourth year demands a wide, practical knowledge. Imagine a town or city boy placed in a judging arena to judge several difficult classes of animals or poultry, or perhaps grains or seeds, and give reasons for his placings, without previous training! It is impossible to gain the knowledge necessary in the final year. Yet this is what will be required of them. True, they will learn much, and many will be benefited by the change, but if these men are to be given B. S. A. degrees, and be classed as agricultural experts, they need more agricultural training than the third and fourth year at the O. A. C.

\* \* \*

At the present time we have a number of District Representatives in the Province who are graduates of the O. A. C., and are men with practical experience at their backs, and they find the work which they are called upon to do requires all their ingenuity, and time and again they are forced to rely more on practical experience than on their theoretical training. These men are competent to teach agriculture in the high schools, and are willing to do so. The course, as now taught in the high schools by these men is inadequate. It is necessary that students taking up this work be allowed to matriculate, the same as those taking up the regular science course. Until this is done, classes in agriculture will not be large in the high schools and collegiate institutes. True, more of these men are needed. This being the case, why not so enlarge the Agricultural College as to accommodate the men which it is hoped will take the proposed new course during the entire four years. As it is, the O. A. C. is overcrowded. This lack of space is felt particularly in the laboratories in the third and fourth years. These will necessarily have to be enlarged to meet the demands of the students entering from the universities for the final two years. This being so, the additional cost of making the class-rooms large enough to accommodate these same students in the first and second years would be trifling, and the students would have the advantage of two years more agricultural education. The teaching staff at Guelph is made up of practical, scientific men of wide experience, and the value of the first two years of training under them cannot be estimated. We would say, encourage all the students who can do so to take the B. S. A. course. The university portion of the course has commendable features, but, notwithstanding these, by enlarging the O. A. C. to cope with the increased demands, it could be profitably made sufficiently large for the entire four years' course. To sum up: The proposals in question are doubtless well intentioned by the authorities, but will obviously multiply difficulties at the Ontario Agricultural College; the presence of the new type of B. Sc. men as teachers, if they have the requisite prior training, would not be without advantage on the staffs of the high schools or collegiate institutes; the influence on the rural schools would be indirect and remote.

If we are to be able to boast of an agricultural population, and of people whose love for the country and things of nature is unexcelled, we must have more thorough agricultural teaching. The agitation for this is slowly making itself felt. We believe that, to have the desired effect, the teaching must commence in the public school, be followed up in the high school, and finally concluded in the agricultural college or university, the whole course based on practical experience, then agriculture will come into its own.

Don't let your pasture field for the season of turning the grass over, before the grass gets a chance to grow, the best hard way against the elements.

## HORSES.

### Good Advice for Horsemen.

From a pamphlet issued by the American Humane Association.

#### STABLE MANAGEMENT: THE WRONG WAY.

Harness stripped off roughly, and horses rushed into stalls without rubbing, cleaning or sponging.

Horses allowed to drink their fill, no matter how hot; or not watered at all.

Grain fed before horses are rested and while overheated.

Feet not washed or examined until horse goes lame.

Horses receiving no water after eating their hay, until next morning.

Scanty bedding, and rough and uneven floors. No bedding on Sundays until night, and horses watered only twice.

Hay and grain of poor quality and insufficient quantity.

Bran mash not given because it is too much trouble.

Hayloft dusty and dirty, and dust shaken down into horses' eyes and noses.

Stable full of cobwebs, and in unsanitary condition.

Harness unclean; sweat allowed to accumulate on inside of collars.

Narrow stalls, and sometimes damp and undrained.

Horses tied short for fear of their being cast, which is more likely when they are put up dirty.

Stable close and without ventilating shaft, or open and too drafty.

Windows dirty or too small, or even lacking altogether.

Manure pit ventilates into stable. It should be outside of stable.

Men loafing in the stable in the evening and on Sunday, and late at night.

Horses not cleaned on Sunday, and stable neglected.

No slatted outside doors for tight box stalls on hot nights.

No place for drying wet blankets or proper cleaning of harnesses.

Stable foreman addicted to drink, and careless and rough with horses.

Worst of all—Horses handled roughly, knocked about; general atmosphere of noise and profanity.

Owner not looking after his horses to see that they are properly cared for.

Horses often greatly overworked, or left standing without exercise for a long time.

Horses not shod frequently enough and left too smooth for slippery streets.

Too much hoof cut away in shoeing, and shoe fitted by burning, instead of cutting.

#### STABLE MANAGEMENT: THE RIGHT WAY.

Men bring the horses in at night cool and breathing easily.

Legs well rubbed if wet or muddy, or if the horses are tired.

Head, ears and neck well rubbed, if wet from rain or sweat.

Horse sponged under collar and saddle, and same to fit properly.

Horses well brushed if dry, and not left in draft if wet.

Feet washed and examined for nails and stones. Eyes, nose and dock sponged in summer.

In very hot weather, horses wiped all over with a wet sponge on coming in.

Horses given a little water, but not much, on coming in warm.

No grain fed for at least an hour.

Horses watered when cool, then hayed, watered again and grained (in any case, watered twice after coming in at night).

Plenty of bedding, and horses bedded down all day Sunday.

Hay and grain of the best quality.

A bran mash Saturday night; cool in summer, hot in winter.

Hayloft kept clean and free from dust, cobwebs or must.

Harness, especially collars, kept clean, well oiled and flexible.

Wide, smooth stalls, and plenty of ventilation.

Horses tied long, so that they can lie with heads on the floor.

Plenty of fresh air, but no drafts. Good light.

No fumes from manure pit, and drains clear and clean.

Stalls not boarded up, but grating in the upper part.

Drying room for wet blankets, and dry, warm blankets used for horses if wet and cold.

Stable quiet at night and on Sundays.

Horses cleaned Sunday morning, and food changed as necessary.

Slatted outside doors for hot weather.

Stable free an equal-tempered, and not a drafty barn.



Most important of all—Horses handled gently, neither struck, nor yelled nor sworn at. A veterinarian called promptly if horse is sick, and recovery not left to chance or quack medicines.

**Veterinary Prescriptions for Farm Use.**

**INSECTICIDES.**

Insecticides are used for the destruction of the different varieties of insects or lice by which the various classes of farm animals are troubled. There are very many drugs which destroy insect life; some can be used with impunity, without danger to the health of the patient, while others are equally poisonous to both patient and insects, hence must be very carefully used. Carbolic acid in a 5-per-cent. solution, acts well, and if applied over only a limited surface at a time, is reasonably safe to use; but it is readily absorbed by the vessels of the skin, and if used too freely or over too great a surface, will, by absorption, exert its poisonous action, the same as if given by the mouth. This applies especially to dogs, which are very susceptible to its action, and from whose skin the acid is readily absorbed.

Any of the commercial sheep dips, if used according to directions, give good results in most cases. A warm 5-per-cent. solution of Creolin, Zenoleum, Kreso, Phenyle, West's Fluid, Jay's Fluid, or other of the coal-tar products, also give good results. Any of these applications require to be used at intervals of about a week, as, while they destroy insect life, they do not destroy their eggs, hence must be used when a fresh brood hatches out. A safe and effective preparation is an infusion of stavesacre seeds. One ounce of the seeds is boiled in water sufficient to make a quart of the infusion. This can be used freely with impunity, as it is not poisonous to animals. If the seeds be boiled in vinegar, the infusion will destroy the albuminous coverings of the eggs in addition to killing the lice. A solution of corrosive sublimate, say 15 grains to a pint of water, also destroys the eggs, but it is poisonous to animals in such small quantities that it must be used only by careful persons, and care must be taken that the patient may not be able to swallow it by licking himself or otherwise. Mercurial ointment is also an excellent insecticide, but its poisonous nature also necessitates very careful application. Almost any greasy or oily substance well rubbed in is effective as an insecticide, but such applications attract so much dirt and dust, and soil the clothes of the attendants to such an extent, that they are not much used.

**PARASITICIDES.**

Insecticides are also parasiticides. The principal use stock-owners have for parasiticides is for the treatment of ringworm, which is due to a parasite. Almost any of the insecticides mentioned will be effective, but the tincture of iodine, or an ointment made of 1 dram of white hebebores, mixed with 1 ounce vaseline, are especially effective. Either of these is too poisonous to be used freely, but in ringworm the areas to be treated are small, hence there is little or no danger. In order to effectively treat ringworm, the scales under which the parasites are found must be softened and removed either by oil or grease, or soap and warm water, in order that the application may reach them. When an ointment is used, the first application softens the scales, and during the second they are rubbed off, which, of course, exposes the parasites to the action of the application.

**CAUSTICS.**

Caustics are drugs that corrode or destroy animal tissue. They are applied for the removal of warts, small tumors, fungoid growths, a form of granulation commonly called proud flesh, which appears in wounds or cracks of low reparative power; ulcers, foot-rot in sheep, foul in the feet of cattle, etc. There are many caustics, as nitrate of silver, butter of antimony, sulphate of copper, nitric acid, sulphuric acid, muriatic acid, etc. The above mentioned strong acids are so actively caustic they should be used only by those thoroughly conversant with their nature, and are usually applied with a glass rod or splinter of wood. A pencil of the nitrate of silver is a convenient and comparatively safe caustic to use, as, with careful handling, there is no danger of coming in contact with tissue other than that upon which its action is desired. Butter of antimony is a favorite caustic with many practitioners. It is usually applied with a feather. It is a strong caustic, but when it is considered too strong it can be diluted to any strength by the addition of tincture of myrrh. Any of these caustics are usually applied once daily until the desired action is established. For the removal of proud flesh, two or three applications are all that is usually necessary; but, for the removal of warts or other growths, many applications are generally necessary.

**CAMPHORATED OIL.**

Camphorated oil can be purchased at almost any druggist's, or can be homemade. It can be made of various strengths. The usual method is to place 1 ounce of camphor in a vessel containing a pint of sweet oil. Place this vessel in a larger vessel containing hot water, and keeping it hot until the camphor becomes dissolved. This oil is useful for local inflammation and soreness, and is considered especially valuable in cases of mammitis or inflammation of the udder. It has a soothing effect, and also forms a coating over the parts to which it is applied and prevents contact with the air, and is supposed to have an influence in checking the secretion of milk. It gives better results if applied warm.

**COLLYRIA OR LOTIONS FOR THE EYE.**

A lotion used to allay irritation or inflammation of the eye is called a collyria—a saturated solution of boracic acid in distilled or recently-boiled water, is much used. This is made by adding to the water all the boracic acid it will dissolve, and then filtering to remove all undissolved acid. Another favorite collyria is composed of:

- Sulphate of zinc—10 grains.
- Fluid extract of belladonna—20 drops.
- Distilled water—2 fluid ounces.

A solution of 5 grains of atropia in a fluid ounce of distilled water is also used as a collyria.

When an opacity of the cornea (commonly spoken of as a scum or film over the eye) is present, a useful collyria consists of a solution of nitrate of silver in a fluid ounce of distilled water. A few drops of the collyria is introduced into the eye two or three times daily by the use of a feather or dropper, often after bathing well with hot water.

(To be continued.)

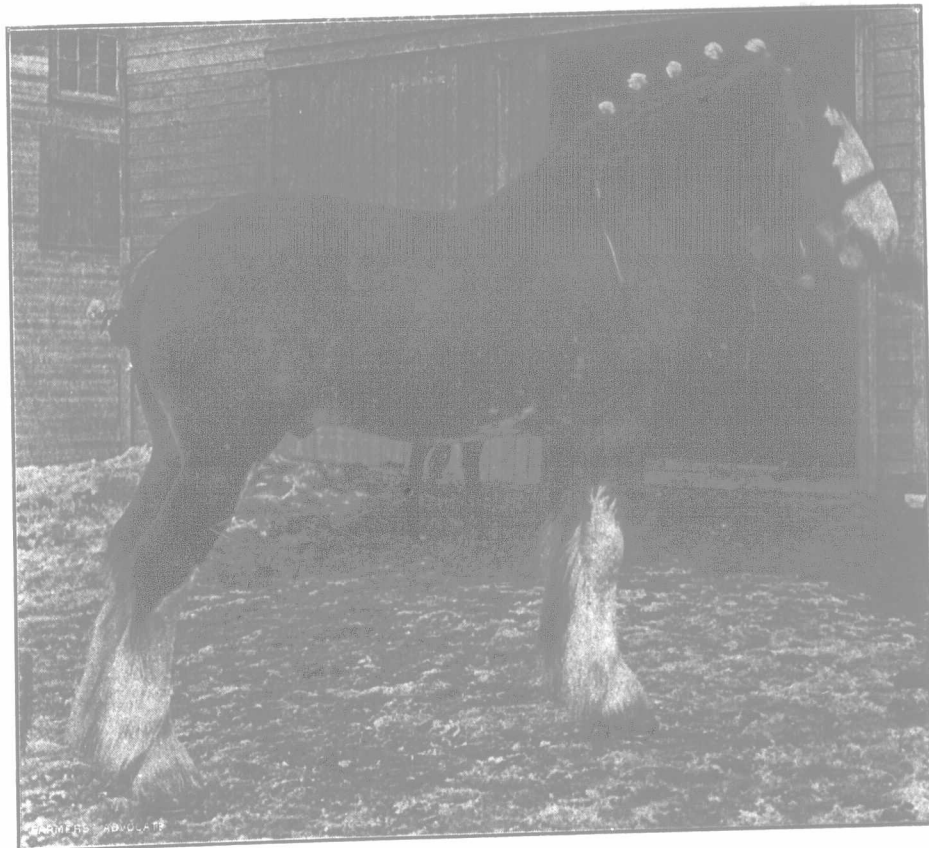

Connaught [13177] (15777).

Two-year-old Clydesdale stallion, imported by Wm. Mossip, St. Mary's, Ont., now owned by W. J. Henderson, Evelyn, Ont. Sire Hiawatha (10067).

**Measuring Medicinal Doses.**

We recognize the difficulty a person who has no graduate for measuring liquids nor scales for weighing solids may have in determining the doses given in formula, in grains, drams and ounces, etc. For measuring liquids, ordinary household utensils may be used, with reasonable safety, but, for determining the weight of solids, this is not the case, as the weight of medicines in proportion to bulk varies so greatly that no rule of measurement can be given, and the only method of determining such is by actual weighing or dividing into a given number of portions a bulk whose weight is known.

- In measures of weight, a grain is the smallest. When the dose is less than that, it is spoken of as a certain fraction of a grain:
  - 60 grains make 1 dram, or dr.
  - 8 drams make 1 ounce, or oz.
  - 16 ounces make 1 pound, or lb.
- In measures of capacity, a minim (a drop of a certain capacity) is the smallest. When the dose is less than a drop, it is spoken of as a fraction of a minim or drop:
  - 60 minims make 1 fluid dram, or F. dr.
  - 8 F. drs. make 1 fluid ounce, or F. oz.
  - 16 F. oz. make 1 fluid pound, or F. lb.
  - 20 F. oz. make 1 pint, or pt.

2 pts. make 1 quart, or qt.

The following rules may be observed in measuring fluids when a graduate cannot be obtained, but it must be remembered that, as household utensils vary so much in size, those of ordinary size should be used.

- Tumblers of ordinary size contain about 8 F. oz.
- Tea-cups " " " " 5 F. oz.
- Wine glasses " " " " 2 F. oz.
- Tablespoons " " " " 1 F. oz.
- Dessert spoons " " " " 2 F. drs.
- Teaspoons " " " " 1 F. dr.

or 60 drops.

" WHIP."

**Hand-Feeding a Colt.**

Could you kindly publish instructions for feeding a colt by hand, as the mother does not seem to have milk, and will not claim the colt at all. The colt is two days old. What should we give it? How much, and how often? The colt at present is bright and smart.

J. R.

Middlesex Co., Ont.

A colt whose dam dies or has little or no milk, may be raised on cow's milk, but the work requires patience and intelligence. Cow's milk is considerably richer in fat than that of the mare. It also contains less sugar. The colt, when foaled, and for some time afterwards, especially under conditions which are not normal, is likely to be somewhat frail; and even under most favorable conditions, care is necessary to rear him. A mare's colostrum is the best "first food" of the colt, as it is usually of sufficient strength to start the action of the bowels, and at the same time is not so strong as to cause diarrhea. The usual trouble with cow's milk is that it causes purgation. For feeding the colt, select milk from a cow that has calved quite recently, preferably

one which gives milk rather low in butter-fat. The milk should be sweetened with brown sugar. Dilute the milk with about one-third its volume of water, and add the sugar at the rate of a good-sized teaspoonful to a teacup of diluted milk. Carefully mix the milk, sugar and water, and feed about one-half cupful every hour at first. An ounce of lime-water added to each pint of prepared milk, is a good precaution. As the foal grows, the amount of milk fed can be gradually increased, and the intervals between meals lengthened. The second week the feed can be increased to a cupful, given every two hours, or about six or eight times daily. The third week the amount can be

increased to a pint, provided the colt is doing well. If not thriving, be careful about increasing the feed. When a month old, a quart at a feed may be safely given, and four feeds per day is sufficient. At first, a nursing bottle, with a large rubber nipple, will be necessary. Care must be taken to keep this thoroughly scalded, and the nipple scrupulously clean. Cleanliness is half the battle in raising the colt. As soon as it can be accomplished, the colt should be taught to drink from a pail, which should always be kept sweet and clean. It is also important that the feed be at a temperature of from 98 to 100 degrees, and do not allow the temperature to vary. Never change and feed the milk from another cow. The colt's digestive organs are very sensitive to changes, and much harm is likely to result, unless great care is taken.

Until the colt's bowels move freely, it is often advisable to give injections of warm water per rectum morning and night. In case the colt has an attack of diarrhea or scouring, from 2 to 4 tablespoonfuls of a mixture of sweet oil and castor oil, thoroughly mixed with milk, is recommended. In this case, cease giving the milk for two or three feeds, giving only sweetened warm water or lime water.

As soon as the foal will eat, allow him access to crushed oats and wheat bran. When he has reached the age of from six weeks to two months old, sweet skim milk can gradually be substituted for the whole milk, but, remember, it must be sweet, and the change made gradually. When three months old, skim milk may form the entire milk ration in place of sweet milk, and feeding three times daily will be found sufficient. Do not give too large quantities, as it is likely to make the colt "pot-bellied." Give pure cold drinking water at all times. As soon as grass comes, allow the colt to run in a paddock. Feed grain and bran liberally to make up for the loss occasioned by not getting the dam's milk. With reasonable precautions, good success should result from rearing the colt "by hand."

A Clydesdale colt was recently sold by a Western Ontario horseman, which, at two days less than ten months of age, weighed 1,075 pounds, girted six feet, and stood 15 hands 1 1/4 inches high. This is the class of colt the dealer is looking for—size, accompanied by quality. If the colt, which is a filly, goes on making gains at the rate she has grown so far, she will weigh, when mature, nearly 2,500 pounds. The big drafter is the class of heavy horse to produce.

## LIVE STOCK.

### Mineral Food Requirements of Swine.

The Agricultural Chemistry and Animal Husbandry Departments of Wisconsin University have done considerable work, as brought out in the Director's report, on the lime (or calcium) requirements of swine during various stages of development. The normal grain feeds are found to contain insufficient lime for the best development of growing animals, and the addition of floats (calcium phosphate), ground limestone (calcium carbonate), or finely ground leguminous hays, such as alfalfa or clover (which are rich in lime), are especially helpful in developing a strong skeleton. The experimental results indicate that mature swine, not forming new muscular tissue, or undergoing such physiological processes as milk secretion and reproduction, can be maintained in a normal condition on a low lime supply. It has been claimed that if pregnant animals are supplied with an abundance of lime, the skeleton of the offspring will be larger and heavier than normally, and contain increased quantities of lime. A study of this particular problem with swine indicates no apparent influence where the mother received a high-lime intake.

The theory has been advanced that rations containing a large amount of magnesium, compared with the amount of calcium present, will not produce a normal development of skeleton, and may even lead to disease. It is asserted that when an excess of magnesium is taken into the body, the calcium salts are withdrawn from certain tissues, to counteract the poisonous effect of magnesium, and that later both calcium and magnesium are excreted from the body. The so-called "bran disease," "shorts disease," or "miller's horse rickets" in horses (which is an affection of the bone) has been attributed to an excess of magnesium in relation to calcium in the food. This problem has been studied with swine, and it has been found that where magnesium salts are directly injected into the blood or added with the food as sulphates or chlorides, an increased excretion of calcium occurs in the urine. However, where such feeds as wheat middlings or wheat bran are given, which contain a large amount of magnesium, compared to the content of calcium, this increased calcium excretion does not occur. The poor results with such feeds do not appear to be due to the excess of magnesium, but possibly to an insufficient amount of calcium.

### Community Breeders' Association

Almost every live-stock country or section of country contains breeders of a number of widely-diversified breeds of live stock. Nearly all the various breeds of horses, cattle, sheep and swine, particularly the last three, are kept within a radius of a few miles. This does not prove to be in the best interests of any one particular breed. Often there are not enough animals of a breed in the locality to warrant the keeping of the very best type of sire. The large number of breeds offers an easier opportunity for cross breeding, which is seldom advisable. A breeder tiring somewhat of his breed, is curious to know what the product would be if he crossed his cows with his neighbor's bull of an entirely different breed. To satisfy his curiosity, he tries it. The results seldom justify the practice, yet it continues, and more cross-breeds result. There is room for all our best-known breeds, but if they could be so distributed as to confine a neighborhood to the breeding of one breed of horses, one breed of cat-

tle, one breed of sheep, and one breed of hogs, more uniform results in breeding, feeding and selling of live stock would result.

The State of Wisconsin now has forty-seven community breeders associations of dairy cattle in thirty-two counties. Lectures are given to the various associations by members of the Animal Husbandry Department of the University. The use of pure-bred dairy sires and better selection of dairy cows, also better management in the dairies, are encouraged. As an example of what is being accomplished, the director of Wisconsin University cites the Waukesha County Guernsey Breeders' Association, organized in 1906 by ten men owning only a few Guernseys. The association now has a membership of eighty breeders who own 1,500 pure-bred animals. The demand for high-grade and pure-bred cattle in the county has doubled since the organization of the associations. Assistance has been given the members in purchasing cattle, and better methods of breeding, feeding and managing the herds have been fostered. Other associations have been equally prosperous.

How many communities in Canada could be benefited by such a system? What a boon such a project could be made to the sheep industry, which now needs considerable fostering to bring it up to its deserving position in our agriculture. There is scarcely a class or breed of stock that would not be benefited, and the breeders would reap the reward. In place of a conglomeration of different breeds in each district, largely composed of cross-bred, pure-breds of a distinct breed would be dominant in each locality, and that locality would become noted for its stock. Buyers would know where to go and just what kind of stock would be offered. Prices would advance, and interest in live stock increase.

### Give the Grass a Chance.

Conservation is the cry of the age. Governments are paying more attention each year to conserving the countries' natural resources. Those interested in soil cultivation know how important it is to conserve soil moisture by thorough tillage. In fact, farmers have various means of practicing conservation, and one of the most reasonable just now is to conserve the pasture grass. We have had a long, steady, hard winter. Feed has been scarce on many farms, and market prices of hay and other roughage have reached almost famine proportions. Reports state that live stock is in a healthy condition, but rather thin, owing to feed scarcity. In view of the fact that all kinds of feed, both grain and roughage, are so scarce, much of the live stock is likely to be turned out on pasture before the grass is old enough to contain much real feeding value. Pasture grass is nature's most palatable and easily-digested stock food. It is sweet and tender, and contains all the food constituents necessary to the maintenance or replenishing of the animal body. However, very young grass is not of great value as a feed. It is rich in nitrogen and ash constituents. It requires sunlight and warmth to fix the carbon compounds. The greater the leaf-surface and the more sunlight obtained, the greater the amount of carbohydrate material in the grass. It is also known that very young grass contains over twenty-five per cent of its nitrogenous material in the amide form. Amides cannot take the place of albuminoids (the higher form of protein material) as muscle-forming constituents, so are not so valuable as a food. As the grass becomes older, the proteid content is made up more largely of albuminoids. While the amides do not take the place of albuminoids, they have the power to protect them from waste. Very young grass, then, not having attained its highest value in protein content, and not having had access to sufficient sunlight to give it a high carbohydrate content, is largely composed of sap or water. It is extremely tender, and, after months on dry feed, and often a scant supply of that, stock eat greedily of it, and, in fact, if their hunger is to be satisfied, they must consume large quantities to get sufficient nourishment.

These young grass shoots, when eaten in large quantity by the stock, have a somewhat detrimental effect on their digestive system. True, the laxative effect is often beneficial after the dry feed of winter, but the watery grass, eaten too freely, very often causes severe purgation, which tends to weaken the animal. Care must be taken, when the stock is turned on any grass for the first time, but when the grass is very young and tender there is need to be doubly cautious. It is better to keep the animals off until the grass contains some substance, because, once they get a taste of green food, they become restless, and it is with great difficulty, very often, that they are made to eat dry food.

Pasturing too early also is ruinous to the meadow. It is said that over three thousand weight of grass may be taken in a year from an

acre which the stock have not been turned until it had gained a considerable start, than from one on which the grass was fairly eaten out by the roots from the very day the snow disappeared in the spring. Allowing the grass to get a start gives the land a mulch, which prevents rapid evaporation of moisture and retains the soil water for summer use of the crop, insuring a much longer period of fresh green pasture. Pastures eaten bare in early spring very often grow up to weeds, as there is nothing to keep them down. The very heart is eaten out of the meadow, and it never recovers throughout the season. Just at the time the young grass plant is putting forth every effort to re-establish itself after the long, severe winter, along come the live stock and clip off its only means of getting food from the air, leaving only a weakened, struggling root-system, which has great difficulty in surviving the shock. This process is repeated throughout the summer, and the meadow becomes bare and brown, the stock gaunt and thin, and the owner wonders what is wrong with his pasture.

The whole secret is, give the grass a chance to become established in the spring. Keep the stock off the meadow as long as possible. A few days on short rations in the spring will not injure the animals half so much as an entire season of poor pasture, and a few days often makes a great difference in the spring. Another point to observe is not to let the live stock wander over meadows intended for hay. They give the grass a setback which is always apparent in the hay crop, and they very often punch the meadow full of holes, which not only injure the grass, but make very rough cutting. Keep the animals confined until the grass gets a start and has a feeding value considerably above that of the colored and slight-sweetened water, which is a fair approximation of the value of very young grass.

## THE FARM.

### Eight-foot Silos.

Editor "The Farmer's Advocate":

Although not a subscriber, I notice an inquiry in "The Farmer's Advocate" about an 8-foot silo. I have two, 8 x 23, and 8 x 27. I have no difficulty about waste, except a little at doors, which are continuous. Corn settles perfectly. One in silo can do the work all right. Mine are side by side, about a foot and a half apart, under east gable of barn, well protected from wind; have roof over both, holding them together and to the barn. Year before last I filled into peak of roof, allowed to settle, and filled again, and fed at once to ten cows, heaped bushel each a day, seven and a half months. Had enough over to feed six weeks last summer. It took four acres of well-earred corn, ten or eleven feet high, Southern Sweet variety, ripe enough to grow on top of silo. In my opinion, no one need be afraid of using an 8-foot silo, except for danger of blowing over. Two 8-foot silos are much better than one 11 or 12-foot silo. J. R. JOB.  
Halton Co., Ont.

[Thanks for this note. Experience is always assuring. However, we note that ten cows are fed from this silo. Were there only three or four, as our inquirer proposed, the layer daily removed would be much thinner, and the tendency to spoilage very much greater. In these small silos, too much depends upon the silo walls and upon the stage at which and the manner in which the corn is ensiled. In general, we favor deep, rather than wide silos, but, so long as one has adequate depth to permit removal of 1 1/2 or 2 inches each day, the greater the width, the more economical.—Editor.]

### Controlling Wild Oats.

I have just noticed an inquiry in your paper as to how to get rid of wild oats. As I have had a good deal of experience with them, I will give you my idea of ridding a field of them, without losing a season's crop. Have your field plowed in the fall, so as to expose them to the frost, then cultivate in spring and sow a few oats and peas. Use your own judgment as to how many wild oats you sow, as it depends upon how many wild oats are in the soil. It is well to have a very thick crop, then cut out before wild oats are matured and make hay of the crop. Well-saved hay of this kind is as good as clover. Skim plow and harrow as soon as the field is stripped then give a covering of manure and sow to fall wheat, and seed to clover and timothy. When broken up again, repeat the operation, until all are rotten and dead.

Of course, a good crop is good where you have not too much land affected, but the above is good where there is considerable acreage to attend to. J. R. JOB.  
A. S.

**Farm Section in Public Libraries.**

At an institute in London of librarians and others interested in promoting the usefulness of public libraries in the Counties of Middlesex and Elgin, Ont., a request was made for a list of approved books which wholly or in part might be chosen to constitute a section especially for the farm and farm home. Though limited to about half a hundred volumes, the following are suggested from many others which "The Farmer's Advocate" have found useful. In most cases the prices given include postage:

LIVE STOCK.	
Types and Breeds of Farm Animals—Chas. S. Plumb .....	2.25
Feeds and Feeding—W. A. Henry.....	2.25
Swine—G. E. Day .....	1.35
Live-stock Judging—J. A. Craig .....	2.10
Horse Book—J. H. S. Johnstone.....	2.15
The Farmer's Veterinarian (Practical treatise on the diseases of farm animals), by Chas. W. Burkett, assisted by fourteen eminent veterinarians .....	1.50
Modern Sheep (Breeds and Management)—Shepherd Boy .....	1.50
GENERAL AGRICULTURE.	
Book of Alfalfa—F. D. Coburn .....	\$2.00
Successful Farming—W. Rennie .....	1.55
Physics of Agriculture—F. H. King.....	1.90
Farm Machinery and Farm Motors—Davidson & Chase .....	2.00
Fertilizers and Manures—A. D. Hall .....	1.65
Ten Acres Enough—Edmund Morris.....	1.50
Meadows and Pastures—Jos. E. Wing.....	1.50
The Cereals in America—T. F. Hunt.....	1.75
POULTRY.	
American Standard of Perfection.....	\$1.60
Principles and Practice of Poultry Culture—John H. Robinson .....	2.50
Common-sense Poultry Doctor—Robinson.....	.50
DAIRYING.	
Science and Practice of Cheesemaking—Van Slyke & Publow .....	\$1.75
Canadian Dairying—H. H. Dean .....	1.05
Questions and Answers on Buttermaking—Chas. Publow .....	.50
Farm Dairying—Laura Rose (Mrs. W. F. Stephen) .....	1.35
APIARY.	
The Honeybee—L. L. Langstroth .....	\$1.10
FRUIT, FLOWERS AND VEGETABLES.	
Vegetable Gardening—S. B. Green .....	\$1.10
Agricultural Botany—John Percival .....	2.00
The Pruning Book—L. H. Bailey .....	1.60
The Flower Garden—Ida Bennett.....	2.25
The Canadian Apple-growers' Guide—L. Woolverton .....	2.00
Manual of Gardening—Bailey .....	2.00
The Farm and Garden Rule-book—Bailey.....	2.00
The Fruits of Ontario—Department of Agriculture Report (bound), 1906.....	5.00
The Cyclopaedia of American Horticulture (four Vols.)—Bailey, each.....	5.00
PLANT AND ANIMAL LIFE—NATURE STUDY.	
Insects Injurious to Fruits—W. Saunders.....	\$2.15
How to Teach the Nature Study Course—John Dearness, M. A., London Normal School. Best work issued on this subject. Illustrated .....	.65
Manual for the Study of Insects—J. H. Comstock .....	4.00
Insects Injurious to Staple Crops—E. D. Sanderson .....	1.00
The Outlook to Nature—Bailey .....	1.00
Farm Weeds—Dept. Agriculture, Ottawa.....	1.00
MISCELLANEOUS.	
Uncle Henry's Letters to a Farm Boy—Hy. Wallace .....	.50
American Tanner—N. R. Briggs .....	.30
Taxidermy—P. N. Hasluck .....	.55
Bacteria, Yeasts and Molds in the Home—Prof. W. H. Conn .....	\$1.05
Traction Engine—J. H. Maggard .....	1.05
Farm Buildings—J. H. Saunders .....	2.15
Young Engineer's Guide—J. H. Rohan.....	1.00
Gas Engine Troubles and Installation—J. Rathbun .....	1.00
Home Waterworks—C. J. Lynde .....	.84
From Kitchen to Garret—Van de Water.....	.84
Ventilation for Dwellings, Schools and Stables—F. H. King .....	.75
Farm Boys and Girls—Wm. A. McKeener.....	1.50

**Feeding Wireworms.**

Editor "The Farmer's Advocate":  
In regard to W. L.'s trouble with wireworm, as in the issue of April 4th, if he will sow one bushel and a half of peas and one-half bushel of oats, he will get a crop of peas, as the wireworm will eat the oats, but, not liking the taste of the pea-vine, they will not touch it when there are oats.  
WM. H. McALLISTER.

[Note.—This is an ingenious idea, and where the wireworms are not too thick we surmise that it might work.—Editor.]

**Water Supply at Weldwood.**

A convenient system of water supply, working automatically, or nearly so, and safe so far as reasonably possible, from freezing in severe weather, as well as from other mishaps, but nevertheless affording opportunity to get at all valves and other parts where trouble might occur, is one of the prime needs of an up-to-date farm. If one feature should be emphasized more than another, it is perhaps the factor of safety. A system which breaks down at a crucial time, as in the midst of spring seeding, or during a cold snap in winter, when the usual difficulties of keeping stock comfortable and thriving are complicated enough without having to carry water in pails two or three hours after the usual time for watering—such a system falls far short of being ideal. As a rule, the farm waterworks should comprehend provision for supplying house, as well as barn. On a dairy farm it should usually be arranged to cool the milk incidentally with a current of running water. It may or may not carry water to basins or troughs in front of the stock, but it should by all means

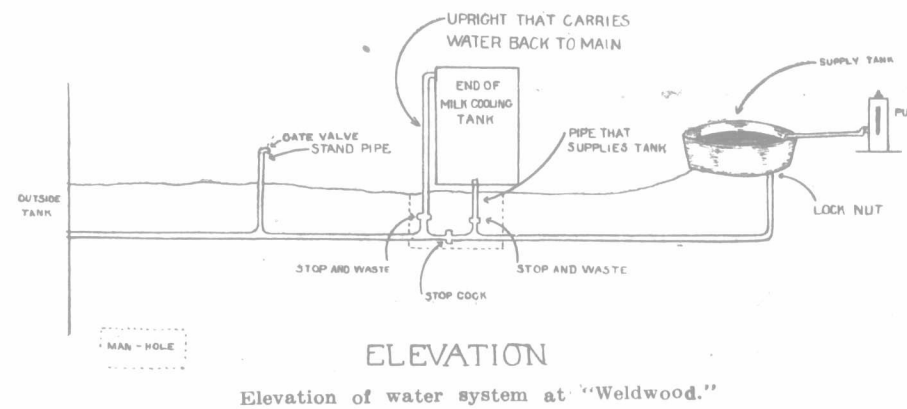

Elevation of water system at "Weldwood."

provide for a conveniently-placed stand-pipe in the stable, with a large tap or gate valve. It should include a good-sized outside stock-watering tank, and should provide a blind T, from which water may at any time be carried to the pasture fields, if desired.

On taking possession of the property now known as "Weldwood," we found a water system consisting of a first-class well, a windmill and an old tub-tank right at the well and near the wood-shed door. Here the cattle came to drink all the year round, tramping the whole back dooryard into a slough of mud. To stop this, we went the length of carrying water in pails for a while, though it did consume a good deal of valuable time. At the first opportunity we laid a line of inch-and-a-quarter galvanized-iron pipe from tank to barn, just outside of which it entered the bottom of a ten-foot-long, wood-jacketed, galvanized-iron milk-cooling tank. During the early summer, water was dipped from this tank. Afterwards, when the stable was rearranged, the pipe was continued on through the stable to a new cement tank on the south side of the barn.

The layout of the system will be more or less clearly indicated by the accompanying cuts, show-

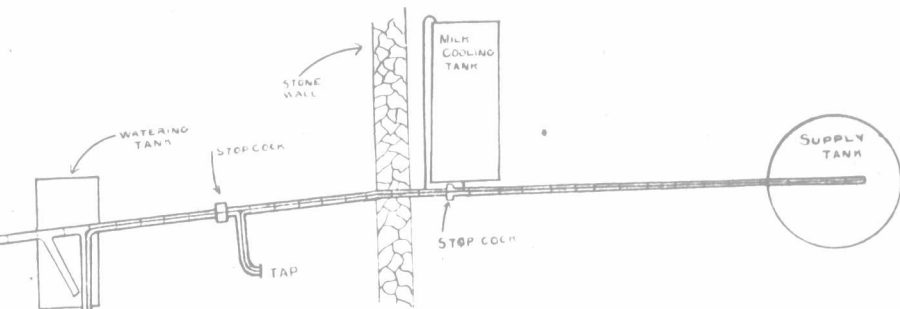

ing plan and elevation, though it is impossible to represent every angle clearly on either plan or elevation. Commencing at the wooden supply tank (to be replaced this summer with a cement one), the 1 1/4-inch pipe runs down three feet through a box packed with sawdust, then through 3-inch tile, slightly down grade, three feet deep or more all the way, to a cement-lined manhole just outside the basement. Here a T upright lifts the water to the milk-cooling tank, which it enters near bottom through a short horizontal spur, fitted to the galvanized tank by means of a lock-nut. After circulating around the cans, the warmed water leaves the tank near the top at the opposite end, and, by means of three elbows and a T is led around behind the tank and down again to the main pipe, flowing thence underneath the stable floor. On both uprights—i.e., the one carrying the water up to the milk-cooling tank, and the second one carrying it back to the main—are stop-and-waste cocks; while on the short length of pipe between the uprights is a simple stop-cock. A stop-and-waste cock is one which

when closed will allow water in the pipe above it to drain out through a small hole in the side. In summer time, the stop-and-wastes on the two uprights are opened, and the stop-cock on the main is kept closed. This forces the water to circulate through the tank. In winter the stop-cock is opened, while the stop-and-wastes are closed. The water then goes directly through the main, while the upright pipes drain out and stand empty all winter, free from injury by frost. The manhole is stuffed with straw in the fall, to prevent frost getting down to the main.

The pipe, laid in the tile, continues from this manhole to a second one under the feed passage, where a spur juts off to the left to supply an upright from which water may be drawn in pails or through hose. Just beyond this spur is a stop-cock, turned by a long-shanked wrench to force water back to stand-pipe, when desired to draw off here while water is flowing at a tap farther on. From this manhole the pipe continues to the water tank, where it is drawn off through a hydrant packed in a straw-stuffed box. For the rest of the description, see following

article on the water tank. Enough to note here that the tank is provided with overflow and drain. The line of tile being continued south-easterly to a point where it joins the silo drain.

The idea of having the pipe laid in tile seems to be a good one. At any rate, the pipe did not freeze during last winter's 30-below-zero weather, although at times the ground about it was

almost bare of snow. One certain advantage of the tile is that it drains the yard under which it passes, and also affords free drainage for hydrants and waste-cocks. As a rule, the waste from these is left to seep away into the earth. We have found the large-sized pipe and large-sized taps economical of time. The economy of galvanized, as compared with black pipe, was debated, but experts strongly recommended the former. The difference in cost is not great.

With a view to getting a first-class job, a plumber and steam-fitter was engaged to visit the farm, cut and thread pipe, make joints, and so forth. He worked faithfully, but seemed to have no adequate idea of what was wanted. He made a few general suggestions, but so far as displaying a grasp of the situation and planning the layout was concerned, we had to do it ourselves; and, with a few tools, could also have done the work for considerably less than he charged—and done it better, too. Anyone contemplating the installation of a system we would advise to study the matter out in his own mind, hire, borrow or buy the necessary tools, and do the work himself, assuming, of course, that he has any degree at all of mechanical aptitude.

It will be noted that we have not installed drinking basins. Our preference is to turn stock out daily to drink at a trough or tank in a sheltered barnyard. During the past stormy winter, an exception had to be made, and the cattle were frequently watered with pails. Indeed, in January, the outside hydrant froze up, mainly, we think, because of rain water soaking

the packing in the box around it. Until then it had stood some very cold weather, though it had to be oiled, and was not turned down too tight. It is all right again now. As a handy means of watering inside, when inside watering is necessary, we use a hose and movable wooden trough, slid along in the manger. We are thinking of utilizing the cement mangers themselves, but, in order to prevent sloppiness, a drain-out must be provided for each section of the manger.

By packing the stable stand-pipe with sacking on cold nights, serious trouble with it has been avoided, and the system has in every respect worked out exactly as we planned that it should.

The cost is shown in the separate statement, but to this must be added the cost of the cement watering tank, elsewhere given, and the cost of carrying the pipe through the stable. See article on "Remodelling Stables at Weldwood," issue April 11th. Estimating this portion of the cost of rearranging stables at \$20, and counting the cost of the watering tank, \$16.40, we have a total cost of \$108.02, not counting the elevated

supply tank yet to be constructed. It costs, of course, but the money has been well invested all the same.

**COST OF WATER SYSTEM**

Galvanized tank for cooling milk .....	\$ 9.15
Other fittings and steamfitter's bill for labor (less a credit of \$6.00 for unused material on hand) .....	44.35
Cement and gravel for piers under tank.....	.95
Second-hand lumber, and nails .....	1.00
Three-inch tile, 240, at \$13 per M.....	3.12
<b>All material .....</b>	<b>\$ 58.57</b>
Labor, 68½ hours men's time, and a few hours by horses .....	13.05
<b>Cost of water system (excepting cost of stock watering tank and cost of excavation and cement work in stable).....</b>	<b>\$ 71.62</b>
Estimated cost of carrying water through stable (charged to stable account).....	20.00
Cost of cement stock-watering tank.....	16.40
<b>Total cost of water system to date....</b>	<b>\$108.02</b>

**Our Stock Watering Tank.**

A 470-gallon cement stock-watering tank was built in September, 1911, on "The Farmer's Advocate" farm. Its interior dimensions are 12 ft. 2 in. by 2 ft. 8 in., by 2 ft. 4 in. The walls are 6 inches thick, made of cement and clean, gritty gravel, mixed in proportion of 1 to 6. The whole tank, including foundation, required four barrels cement and two and a half loads of gravel. The equivalent of three days' time for one man was occupied in its construction.

**LOCATION, SUPPLY, OVERFLOW AND WASTE.**

The tank is located in an open yard on the south side of the barn, against the foundation wall of which it is built. It is supplied by a line of 1½-inch galvanized-iron pipe, laid in 3-inch cement tile, 2½ to 3 feet under the floor of the stable. Passing out through the foundation of the stable wall, the tile continues in a straight line to an outlet in a field, being intersected 50 feet from the tank by a similar drain from the silo foundation. The galvanized supply pipe turns with an elbow to the left after emerging through the stable wall, and leads by a spur to a hydrant six inches or so beyond the east end of the tank. This spur pipe is laid in tile, with a fall towards the main drain to carry into it waste water from the hydrant. A blind T at the hydrant provides that water may subsequently be carried on to a new horse stable intended to be built, and thence down the lane to the pasture fields.

To provide both an automatic overflow and a means of draining out the tank upon occasion, an upright shank of 1½-inch pipe, threaded on the upper end, leads from a small basin-shaped depression in the floor of the tank at the northeast corner, down to an old four-inch drum under the tank bottom, which angles towards the main tile drain. On the threaded end of the upright an ordinary thimble screws, and into this another upright pipe, just long enough to come within an inch of the top of the tank. This upper end is protected with a 4 x 4-in. box, screened on one side to exclude litter. When it is desired to drain the tank to exhaust stale or discolored water, this upright shank is unscrewed, and as the tank is nearly emptied, the box screen may be placed over the projecting threaded end of the length below to exclude floating debris that might clog the drain.

The water pipes (see Fig. 1) having been laid at proper depth, and duly connected, further excavation was made for the foundation walls. A trench two feet deep and ten inches wide (except along barn wall where it was only 8 inches), was dug just inside a rectangle 13 ft. 8 in. x 4 ft., giving a broad, solid foundation for tank wall. It was filled up with cement and cobble stone. The cement was composed of one part cement to eight parts clean, sharp gravel, ranging from the size of coarse sand up to that of grains of wheat or corn. Proportions were gauged by filling a bottomless box, 3 ft. x 2 ft. 10 in. inside, and one foot deep, with gravel, raising the box and putting one sack cement on top. The cement was shovelled three times dry and three times during and after water was applied, as for the silo, but made somewhat moister. For details of mixing, etc., see article on silo construction, issue Feb. 1st, 1912.

The tile containing water pipes, and also the waste-water drum, were covered with cement concrete.

**CRIB WORK**

Foundation laid, the crib work necessary for building the part above ground was constructed. To support the inside cribbing, six 4-foot scantling, A A A, A A A, were set three on each side, each one two inches in from where inner surface of wall was to be (see Fig. 2). B B B were similar scantling set opposite A A A, spaced 10 inches from them. These uprights, A A A, A A A, B B B, were connected with six horizontal stays, three lengthwise and three crosswise, as shown in diagram, the ends of the cross-stays being tacked to the barn. Between opposite uprights, A A A, A A A, pieces of board sawn to fit were placed near the bottom, and also near the top, to prevent uprights being crowded together when curb

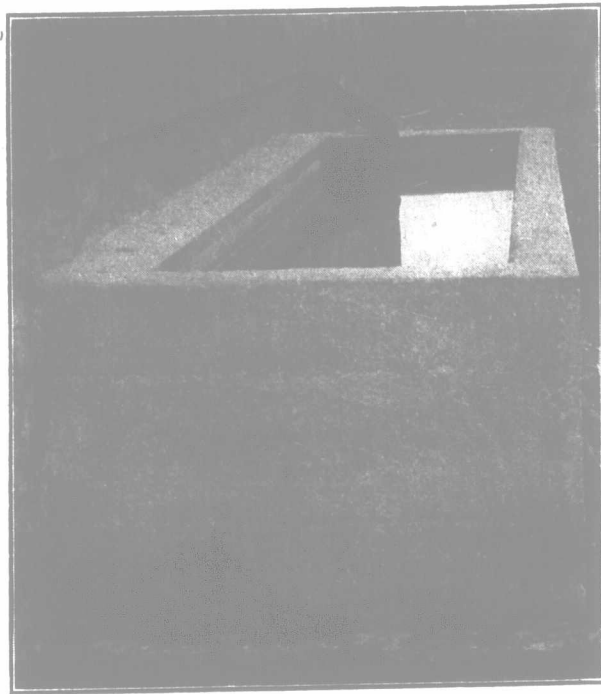

Cement Stock-watering Tank at Weldwood.

plank were filled. The first course of curbing was now set in position on the edges of the foundation, which had been finished level. For the inside of each course, two 12-foot plank were used, and for the outside a 14-foot plank. The inner and outer curb plank were held apart by dividers (small sticks with square ends, six inches long, this being the thickness that the wall was to be built). To each end of each inside curb plank, the lower end of an upright A strip, about three feet long was tacked in such a manner that the hypotenuse face would bevel the inside corner of the tank (see diagram). These A strips, cut from inch stuff, left an inch offset on the end of the two-inch plank, and this offset gave support

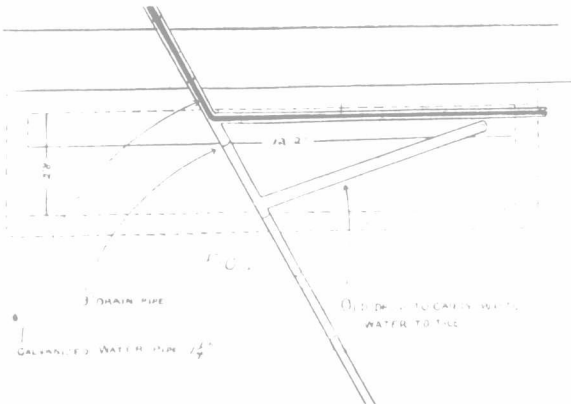
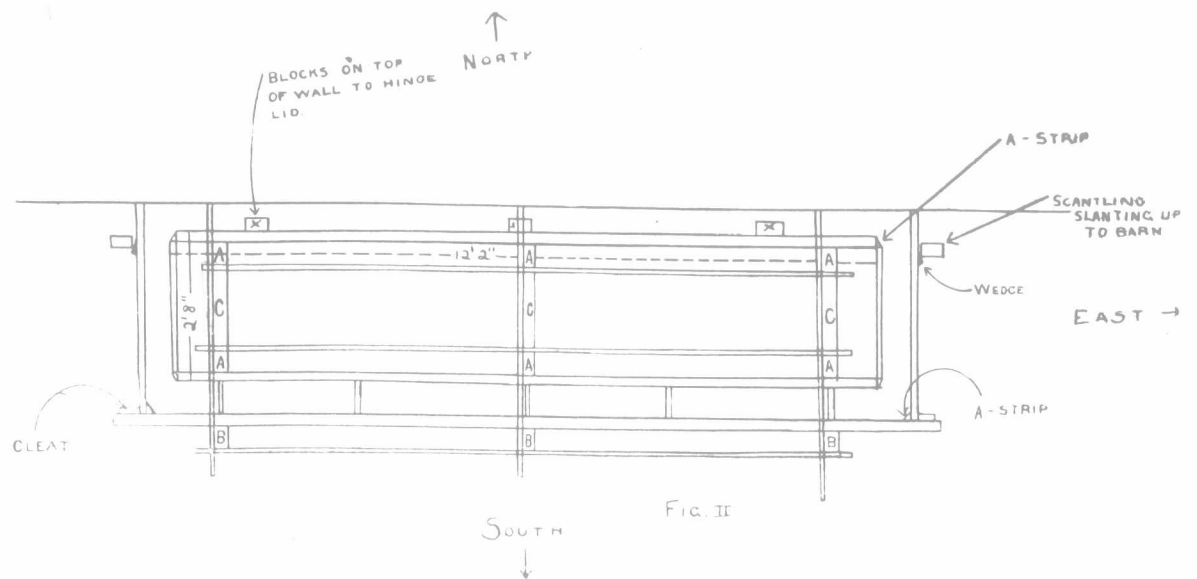

Fig. 1.—Supply over-flow and drainage pipes for stock-watering tank.



Unit of curbing for construction stock-watering tank at "Weldwood."

to the inch board used to curb the inner face of the end wall. The A strips thus fitted nicely into the corners, and made a very neat level. They projected two feet above the first plank, but were subsequently tacked to the second and third course plank as these were put in place. On the outer curb plank, four inches from each end, cleats were tacked to hold the end of the inch board used to curb the outer face of the end wall. To hold the other end of this board, a scantling, planted firmly at the bottom, was inclined toward the barn wall and nailed to it. It being impracticable to locate this scantling to a nicety, a little space was allowed between it and the curb board, and wooden wedges were driven in between. Two more A strips, as shown in diagram, were used to bevel the south-east and south-west outer corners of the tank. All was now ready for filling, which was done with cement-concrete, 1 to 6, after manner described in article on construction of silo. The filling was very carefully done, a little cement being shoveled in all around the course and well tamped, then more all the way around, and so on till the first course was filled. One complete strand of plain, galvanized wire was imbedded in this course all around the tank, and one strand in each subsequent course, making three in all. A second and then a third course of curbing (each course 12 inches deep) was put on in the same manner, but the last course was filled only to within about six inches of the top. A nine-inch piece of board, about a foot long, was sawn two-thirds through at each end, and the saw ends split off so as to give an offset, the six-inch block in the center fitting down between the parallel curbing, and serving to level the mortar all around the wall before it was trowelled. Along the top of back wall three 2 x 4 blocks were embedded, face flush with top of wall. These were to attach hinges for tank lid, which is also to be hinged along its center, so that only half of the lid need be thrown back for ordinary use. Top of wall was trowelled down and slightly rounded with trowel, care being taken to work down the corners neatly.

**FLOOR.**

When wall had set for two days, all curbing was carefully removed and any burr edges rubbed off. Floor was now laid, with two coats, bottom one three inches thick, composed of cement concrete mixed 1 of cement and 8 of gravel; top coat one inch thick, mixed 1 to 4. The whole tank, both walls and floor, was now washed inside and out with cement wash applied with a whitewash brush. The wash was composed of cement and water mixed as thick as it would work well with a brush.

Our photograph shows this tank before the lid was put on, and before it had been filled up properly with earth in front. It is, however, in use, and gives excellent satisfaction, having shown no slightest sign of leaking or checking. If building another, we would change nothing but the depth, which is six inches more than necessary, since the cattle cannot reach to the bottom.

The complete cost of the cement-concrete material and labor is as follows:

<b>STOCK-WATERING TANK.</b>	
Cement, 4 barrels, at \$1.75, laid down.....	\$ 7.00
Gravel, 1 load, at \$1.44, laid down .....	1.44
Stone .....	.25
Wire .....	.31
<b>Labor, 20 hours, at 27c. ....</b>	<b>5.40</b>
Labor, 10 hours, at 20c. ....	2.00
<b>Total .....</b>	<b>\$16.40</b>

**Rural School Fairs.**

A commendable feature in the rural-school programme of the Province of Ontario this season is the development of exhibitions of products and work by the scholars. Prof. S. B. McCready, of the Ontario Agricultural College, Director of Elementary Agricultural Education, furnishes "The Farmer's Advocate" with the following information on the subject:

Regarding the work to be done in Ontario public-school fairs, I beg leave to say that this scheme at the present time is largely under development. The plans to be worked out by the County Representatives are somewhat as follows:

Distributions of seeds, eggs, etc., will be made by the representatives to a select number of schools in one or more townships. The Representative will work with the teacher in giving the pupils instruction for carrying on the work at home. At the close of the season a school fair will be held at some central school, prizes being given, and addresses made by teachers and others. The plans vary in different counties. In Carleton County, Mr. Jackson, co-operating with the Canadian Seed-growers' Association, and assisted by R. B. White and others, is organizing a potato-growing contest amongst the boys between the ages of 12 and 18. The plots are to be one-tenth of an acre in size, and exhibits are to be made at the Richmond Fall Fair. Medals and very liberal cash prizes are to be given to the winners. This scheme, you see, includes boys who are out of school. In Grey County, Mr. Duff's plans are for a distribution of corn, to show the possibilities of corn-growing in that county. In Elgin County, Mr. Clement is arranging to have the work done along the lines of poultry improvement, and is distributing a number of settings of eggs among the pupils of the schools of Dunwich Township. Corn-growing will also be encouraged in school plots and home farms. In Hastings County, Mr. McIntosh has arrangements made for competitions amongst pupils for collections of mounted weeds, etc. In Norfolk County, Mr. Smith will continue the work of poultry improvement by distributing eggs of selected stock among the pupils in some of the schools. In Peterborough County, Mr. Hopkins is arranging to carry on work in potato, bean or corn growing amongst the pupils, and will supply flower seeds to the girls. In Essex and Kent Mr. Edwards is pushing forward the organization of corn-growing competitions amongst the pupils. These have been very successful during the past three years in arousing interest in the schools in this phase of agricultural teaching. In Waterloo County, Mr. Hart will follow up the plans that he has been working on for the past three years, in distributing seeds of farm crops for children's competitions in home plots. Most of the other Representatives are arranging similar lines of work to suit local conditions.

Apart from this work that is being carried out under the guidance of the District Representatives, all the schools of Ontario that are taking up garden work under the Schools' Division of the Experimental Union are being encouraged to hold school fairs at the close of the season. These school fall fairs have been very successful in the past few years in many places, and are conducted somewhat along the same lines as the old-fashioned public examinations at Christmas time: The school is decorated, exhibits of garden products are made, parents and visitors come for the afternoon, prizes are distributed for competitions, speeches made, a programme rendered, and possibly a picnic carried out, with athletic competitions among the children. Our report for 1911, published in Circular 13, issued by the Education Department, shows how some of these fairs have been carried on. This work is now prescribed as a phase of the teaching of agriculture in the schools. In those schools where agriculture is given a place as a school subject, the teachers are advised to hold these school fairs. It may be expected that, as trustees arrange for the teaching of agriculture in their schools more and more, we shall have more of these school fairs; they will become a very common feature of school work. There is no doubt that they will help in arousing public sentiment to the possibilities of the schools for teaching Elementary Agriculture. The school fair is only a part of the course in agriculture. The new regulations permit trustees to expend money for prizes (these being agricultural books, bulbs, etc., but not cash) for children's competitions. The schools will be given perfect freedom in the matter. The only danger in the work would seem to be that, through the prize-giving, the work may become somewhat too commercialized, or that teachers and trustees may come to think that the holding of a school-fair is the be-all and end-all of agricultural teaching, instead of merely one phase of the year's work in this subject. The new arrangements call for agriculture to be taught one hour a week

throughout the year from January to December, in those schools that receive special grants. And furthermore, it should be widely known that any school in Ontario taught by an enterprising teacher may take up this work and qualify for these grants.

**Thinks Sweet Clover Valuable.**

Editor "The Farmer's Advocate":

I notice, in "The Farmer's Advocate" of April 11th, R. J. McG. inquired about Bokhara clover—first, as pasture; second, as hay. What I have to say about it is as follows: It is equal to alfalfa in every respect, and very much superior

**Seed Corn Testing.**

W. E. J. Edwards, Secretary of the Ontario Corn-growers Association, in a pamphlet just issued, gives some timely hints on seed corn, as follows:

The first essential of successful corn-growing is the planting of good seed. Good seed corn is scarce this spring. The wet fall resulted in much soft corn that failed to dry out properly, and the extremely cold weather of the past winter injured much of it, so that a larger percentage of it is unfit for seed purposes.

The Essex Branch of the Department of Agriculture this winter tested large quantities of seed corn.

Samples were taken from the farmers' wagons at the elevators, from the cribs, or in some cases the corn was brought to be tested. Of all the samples tested not over fifty per cent. germinated strong and quick. From the samples that were well dried and kept in the house, from 85 to 95 per cent. germinated. See Fig. No. 2.

No corn-grower can afford to plant corn this spring that has not been tested. Ten or twelve ears will plant an acre. If you plant only two ears that will not grow, out of ten or twelve, that means that you are working and cultivating ten acres of corn, but in reality harvesting but eight acres. This loss would pay for the testing many times over. With poor

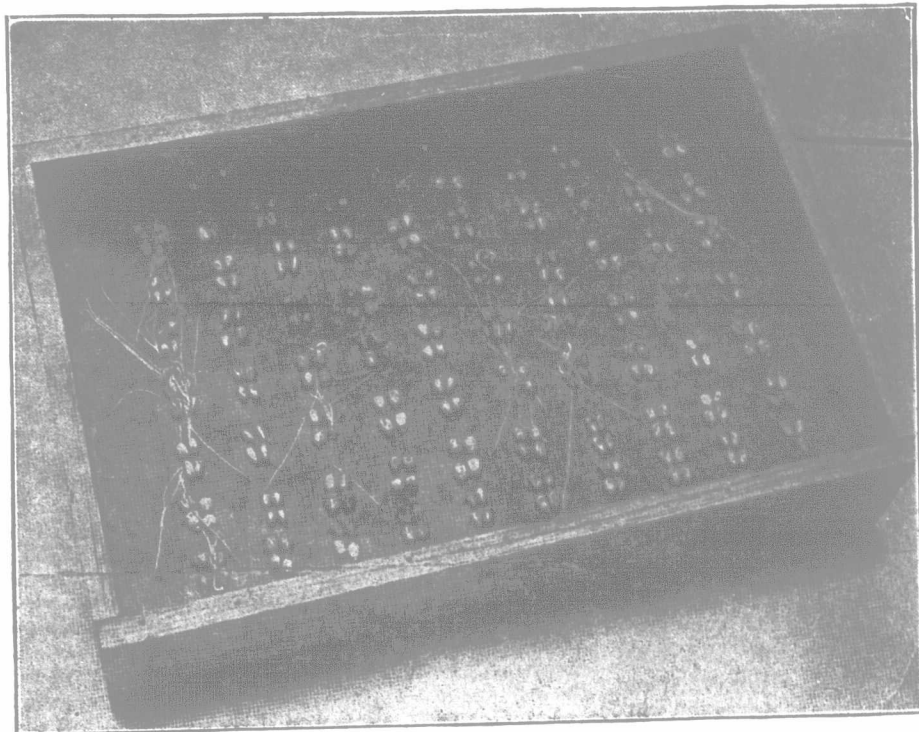

Fig. 1.—Showing bottom of homemade seed tester. A cloth is spread over the corn, and then damp sawdust is placed on top. A very low test is shown above. Practically all ears from which this seed was taken should be discarded, or crop would be a failure.

to it in some. Cattle, when they get accustomed to it, will eat it in preference to any other clover. It makes the best of hay, but is rather hard to cure. It makes a good bite for cattle the first of anything in the spring, and it remains green after everything else is brown in the fall. It is the greatest land-builder of all the clovers. It will grow on the hardest, poorest clay or the lightest sand. It grows from seven to eight feet high. You can plow it down and it fills the land with humus and bacteria, and fits it for alfalfa and all other farm crops. It makes splendid

seed you often get but half a crop, but by testing every ear before planting, and discarding the poor ones, you can be absolutely sure of getting a good stand. You should plant strong seed, so that it will grow if the weather conditions are unfavorable. With our late spring, it is essential that you plant this season only seed corn that will germinate quick and strong.

**HOW TO TEST SEED CORN.**

It is easy to test seed corn, and it takes but little time. Make a shallow box, 30 inches long, by 3 inches wide, by 3 inches deep, inside measurements. Any box will answer, but the above size is very convenient. Fill the box about 1 1/2 inches deep with damp sawdust or sand. Over this sawdust place a cotton cloth ruled into spaces 2 x 2 inches. Number the spaces along the top of the box from 1 to 15, and along the left-hand edge from 1 to 10. In this way each square can be located readily. See Fig. No. 1.

Having selected the corn to be tested, take each ear, and in the butts drive a nail to hold small pieces of cardboard, numbered from 1 to 150. Take ear No. 1 and remove two kernels from near the butt, two from the middle, and two from near the top, from opposite sides in each case. Do not take all the kernels from one place, or from one side of the ear. Place six kernels in space No. 1, with the germs upward, and the tips pointing down. After all the spaces have been filled, place a cotton cloth over the kernels very

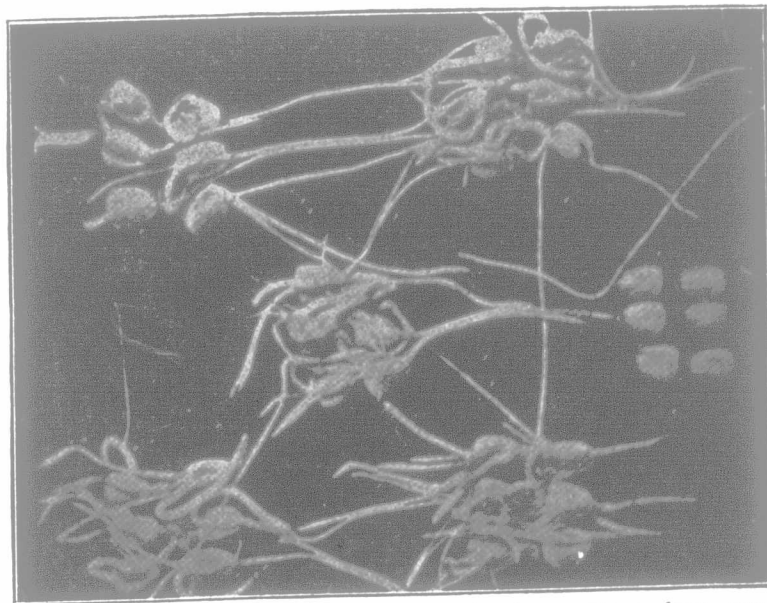

Fig. 2.—Showing strong and weak germination. From four ears the germination is exceedingly good; from one it is weak, and from another no germination at all. The corn should not be used for seed that comes from ears of low vitality, or from ears the kernels of which do not germinate.

carefully. Then put on another large cloth that laps over the box a foot or more in all directions. Fill up the box with sawdust or sand, fold edges of cloth over the top, and dampen with warm water. Place in a warm place, and keep moist. In about five days the test will be complete. Lift out the top cloth containing the sawdust, and then lift the next cloth off very carefully. Start at No. 1, and throw out all ears that did not grow. Keep only those ears in which every kernel of corn grew and that germinated strongly. If seed corn is limited, keep those ears in which five kernels out of six grew, and in no case plant

WM. LINTON.

York Co., Ont.

for seed corn of poorer germination or that germinated weak.

By testing 150 ears at a time, seed sufficient for 12 to 15 acres may be tested at once if seed is good. By having more boxes, larger amounts may be tested quickly. After testing and throwing out all poor ears, remove the tops and butts of the ears, and plant the remainder.

The only way to be sure you have good seed corn is to test it. As a rule, replanted corn amounts to very little. You cannot afford to have to replant it, especially this year, as the spring is backward, and the season likely to be shortened.

### Soil Bacteria and Evaporation.

Until recently, the question of evaporation of moisture from the soil has been considered largely a physical problem. Recently, however, investigations made by Prof. Hoffmann, of Wisconsin University, indicate that bacterial activity in the soil may so change the nature of substances in solution in the soil water as to exert a real influence upon surface tension, and therefore upon evaporation. Conditions which permit of rapid multiplication of soil organisms increase capillarity, and thus permit of a material increase in rate of evaporation.

## THE DAIRY.

### Crops for the Dairy Farm.

Different branches of farming require the growing of different crops. The grain farmer grows those grains which give the highest yields on his soil, and which are most in demand on the market. The stock farmer grows crops suited to beef, mutton or pork production, and the dairy farmer produces those crops intended to stimulate the milk flow. The crops, then, for the dairy farm are essentially somewhat different from those required for other methods of farming. To keep the milk flow from falling off, an abundance of easily-digested nitrogenous feed, both concentrate and roughage material, must be on hand winter and summer.

During the early summer, pasture-grass forms the greater portion of the cow's ration, but, as the summer progresses, and the heat and drouth become intensified, it is necessary that the pasture be supplemented by other fodder and more grain. Very little grain is required when grass is plentiful, but many find a little profitable during the greater part of the year.

Perhaps the most important roughage crop on the dairy farm is corn. Fodder corn can be used for fall feed, fed as a soiling crop, and is invaluable during the winter as silage. Corn seems to be the most reliable of the hoed crops, does not taint the milk, is succulent, easily digested, relished by the cows, keeping their digestive tracts in good condition, and stimulating the flow of milk. There are few, if any other crops which will give as much actual feed per acre as corn. It is the stand-by of many dairy farms, and silage can be profitably used for summer feeding during the early or midsummer months, before the season's crop is ready for silage.

Mangels or beets are perhaps the best root crop for the dairy. They give large yields per acre, but, on account of the amount of labor required, are not as much in favor as the corn crop. Turnips are all right for the young stock, but because they taint the milk, are not extensively used in feeding cows in milk. They are also an expensive crop to produce.

Of the clovers and grasses, alfalfa, as a feed, stands at the head of the list. It can be cut several times during a season, so is a good soiling crop. It also makes the best of cattle hay. It is the most nitrogenous of all these crops, and is in high favor, being a very heavy yielder.

Red clover, the best known and most widely-grown clover crop, makes the best of pasture and hay for the dairy farm. Cows relish it at any time, and give good results from it.

For spring sowing for silage, a mixture of peas and oats is often used. This crop, sown at intervals of two or three weeks in the spring, insures green feed for summer where no other crop has been supplied for this purpose.

The grain crops most widely grown consist largely of barley and oats. Peas, owing to the fact that they have been rather an uncertain crop during the past few years, and on account of the ravages of the weevil, are not so extensively grown as formerly. Peas make a valuable portion of a mixed-grain ration for the milk cows. Wheat is not in great favor with the dairy farmer. The grains grown on the farm can be well supplemented by adding bran or some of the recognized valuable by-products or specially prepared dairy foods.

The question then arises, what is the best rotation on a dairy farm. A three-year rotation seems to suit conditions admirably. Of course, the alfalfa field cannot be worked into this, but the land devoted to this crop yields good returns and keeps in good condition, so it can be left down for years, with no evil results. The remainder of the land can be sown to corn and roots, followed by the cereal grains, seeded to clover, giving the clover crop the third year, the corn to follow the clover. For the horses, a portion of the clover seeding could be mixed with timothy, and this portion left for two years, the second cutting being used for the horses. In this way a very suitable rotation could be followed, and the cows would be always well fed. A portion of the hoed-crop land could easily be devoted to silage crops, and not interfere with the rotation. Such a rotation, together with returning the manure made, could not fail to keep the land in good tilth, and good crops of hay, corn and grain would be almost certain. Few well-managed dairy farms do not yield profitable crops; in fact, most dairy farms are the heaviest croppers in the country.

### Remedy for Punctured Teat.

From time to time I see inquiries in "The Farmer's Advocate" regarding a cure for hole in cow's teat. Having had some experience with this trouble, I may say, for the benefit of readers, that I found ordinary shoemaker's or harness-maker's wax a sure cure. Warm the wax just enough that it will drop—that is, until it is quite soft—press the hole full of this material and allow to cool. The wax hardens and closes the opening, and the cow can be milked without further trouble. I used this same treatment for a cow which had her udder punctured, leaving a hole about the size of a fork-tine right into the milk duct, and the injury healed, giving no further trouble. Care must be taken that the wax is not so hot as to burn the cow, and also that it is sufficiently warm to be soft and pliable. The fact that the cow can be milked all the time adds to the value of the remedy. It is simple and easy to apply, and can be used with perfect safety.

R. J. TEMPLE.

Middlesex Co., Ont.

## POULTRY.

### Geese on the Farm.

The goose requires plenty of free range and water. Many raise geese without natural running water on the place, but, for best success, it is necessary. There are many farms which have spaces more or less worthless for cultivation that could be profitably utilized for the raising of geese. Any low or springy places traversed by streams or filled with bubbling springs are ideal places for the goose. The care and attention necessary in the raising of geese, when such a place is provided, are very trifling, and the cost of food is practically nothing, because geese on free range will pick up most of their food from grasses, insects and material found in wet places. The housing required costs very little. Small, inexpensive shelters, provided they are kept clean, are all that is necessary. Geese are comparatively long-lived birds, but ganders should not be kept after three years of age. Goose feathers find ready sale on any market, and are recognized to be the best feathers for household uses. There is nothing difficult about managing geese. A gander is usually mated with two geese. The geese lay in the early spring. Nests should be provided. They are usually allowed to hatch their own eggs; some however, place the eggs under hens. The goslings require a dry place, with access to plenty of fresh water and young grass. They will thrive on grass and insects alone, but grain can well be given in form of mash to the very young birds. For fattening, corn, peas or other grain is good, and a supply of pulped roots will be found very beneficial in keeping down expense of feeding. Geese will bring anywhere from one to two dollars and a half when ready for sale. Counting the cost, they would be found profitable on many farms.

### Winter Eggs.

Editor "The Farmer's Advocate":

I am going to give my experience of winter-egg production. I keep 65 hens, four kinds: Barred Rocks, White Leghorns, White Wyandottes and Black Minorcas. Since the second week in December, 1911, to the end of March, I have sold 133 dozens eggs, and they have laid the year round, with the exception of a few days. I feed them at noon and evening. I give them a bucket of buckwheat or oats at noon, and a mash of potatoes and provender in the evening; also, all the gravel they can eat, and milk and water. I mix the buckwheat in the straw, so as to make the birds work. If any farmer's wife wants eggs, she must attend to the feeding of her hens herself.

Stamont Co., Ont.

(MRS.) J. S.

### Rules for Rearing Incubator Chicks.

New Mexico Agricultural College gives the following rules for rearing incubator chicks:

1. Start the brooder a day or so before the incubator hatches, so as to regulate and thoroughly warm all parts.

2. Remove the chicks from the incubator when they are about 12 to 24 hours old, or when dry and sprightly. Put them in a box containing some fine chaff, and cover with a cloth until they are about 36 hours old.

3. Kill all the crippled chicks or those that are so weak that you believe they will not live. The growing period is so short that it is not worth while to attempt to raise them.

4. Put all the healthy chicks in the brooder when they are about 36 hours old. Do not put too many in the brooder so as to crowd them. Usually, a brooder which is rated to hold 100 chicks will give much better results with about 60.

5. After they have been in the brooder a little while, to get accustomed to it, give them their first feed. This may be done by putting it on a paper in the front part of the brooder.

The first feed should consist of either the yolks of hard-boiled eggs, or old dry bread soaked in milk, and allowed to drain before feeding. The infertile eggs or those that had weak germs, and which were taken from the machine during the first half of incubation may be used.

7. Do not feed much at first, but feed every three hours during the first week. This would bring the feeds about as follows: 6 a. m., 9 a. m., 12 a. m., 3 p. m., 6 p. m.

8. After the second day, ground grain or rolled oats may be gradually substituted for eggs and soaked bread. A mixture similar to the following may be used: Ground wheat, 2 parts; ground corn, 1 part; ground oats or beans, 1 part; beef scraps,  $\frac{1}{4}$  to  $\frac{1}{2}$  part.

9. Keep clean, fresh water before them at all times.

10. Generally speaking, the temperature of the brooder should be kept at about 90 to 95 degrees the first three or four days, then may be lowered to 82 to 90 for the next week and one-half. After this, it will not be necessary to burn the lamp, except at night, unless the day is cold.

11. However, watchfulness and good judgment are usually better than a thermometer. When chicks are warm and comfortable, they will be scattered around under the hover; if cold, they will huddle and crowd in the corners; and if too hot, they will hunt the openings, spread their wings, and are liable to contract diseases from being in drafts.

12. Be very careful not to leave the lamp turned too high, as it always crawls up after burning a little. See that it has plenty of air, as carelessness here may result in fire.

13. If any water is spilled on the floor, put in some more litter, as wet floors cause disease.

14. If the weather is cold, the chicks can be kept in the brooder the first two days, then allowed to run out through the small openings, and, after the third or fourth day the large opening may be used. If the weather is warm, allow them to be out from the first day.

15. Keep fine grits, oyster-shell or gravel so they can have access to it at all times.

16. Clean the brooder thoroughly every week, and spray with some disinfectant.

17. When the chicks are six or seven weeks old, remove the brooder and put low roosts in the brooder house.

18. Feed meat scrap, ground green bone, or any other form of animal food, together with green vegetables, at least three times a week, and a little every day is better.

19. Always see that the chicks are comfortable and contented. They are usually fairly quiet if they are.

20. It is very essential that you give careful attention to the small things, as young chicks are very delicate, and carelessness will mean failure.

### Value of Poultry Manure.

Fresh poultry manure is, according to values of commercial fertilizers, worth 60 cents per 100 pounds. Figures from different experiment stations give the product of 25 hens for the winter season of six months as 375 pounds from the roost droppings only.

Poultry manure is especially adapted as a top-dressing for grass, because of its high content of nitrogen in the form of ammonia compounds which are nearly as quick in their effect as nitrate of soda. A ton of the manure, preserved with sawdust and chemicals, would be sufficient for an acre, when compared with a chemical formula for top-dressing.

On the same basis of comparison, 100 fowls ranging at large on an acre should in a summer season of six months have added to its fertility the equivalent of at least 200 pounds of sulphate

of ammonia, 100 pounds of high-grade acid phosphate, and 60 pounds of kainit.—[U. S. Farmers' Bulletin, 384.]

**Raising Chickens.**

With the usual spring crop of chickens there comes the usual difficulties attached to the raising of them. It is not so hard to hatch them, but it is a problem, sometimes, to keep them growing afterwards. Chicks, like all other young things, have to face the strain of getting a start, and, to prevent diarrhoea getting them before they get the start, they need constant care.

**CARE OF THE SITTING HEN.**

With eggs placed under hens, it is always wise to have a low nest where the hen will not have to jump down onto the eggs, for fear she might break them. The best nest is a box turned on its side, that will give about 24 inches of a bottom for the nest. The hen should be dusted with insect powder or sulphur (sulphur is rather severe) the day she is set, and again two days before the eggs are due to hatch.

The day before the eggs are to hatch, take the hen off the nest and see that she is well fed and watered. Never give a hatcher soft mash. Feed on hard grain (wheat and whole grain), with an occasional feed of dry, chopped oats.

**DATES TO HATCH.**

For Orpingtons and other English breeds, eggs should be out by May 1st to get the best winter layers, and they may be hatched with safety in April. For Wyandottes, Rocks and other American breeds, eggs should be hatched by May 10th to get the best winter layers. If American breeds are hatched earlier than April, there is a tendency for the chicks to molt with the old hens; and then, if they should molt, they will cost more to keep than the returns from their eggs will warrant.

**COOPS.**

When the chickens are hatched by hens, have a coop with a slatted front ready for them. It never pays to let the hen go free with them when they are young; she will invariably make them walk more than they can stand. It is best to have the coop so made that you can lift it right off its floor, and then, by simply sweeping this floor once or twice a week, and sprinkling coal-oil, etc., on it occasionally, there will be little danger of mites getting a hold. The best coop, or the one which seems to give the best results, has a floor 24 x 28 in., the coop itself being 24 in. high in front, and 16 in. high at the back. To clean this coop, all that is necessary is to shove the coop forward, raising it a little off the floor while the back is being cleaned. When cleaned, coop may then be moved back again. With this coop, it is not necessary to let the hen out while cleaning, which is an advantage with a fussy or frightened mother. A strip of wood at the back and sides of the coop keep it from slipping off the floor, and the extra length of the floor will be quite an advantage when feeding in bad weather.

The best litter for chicken coop or brooder is gravel. Never use long straw nor deep litter. The chicks are not strong enough to walk through it or untangle themselves. If chaff is used, they sometimes take to eating it too freely when first taken from the nest.

The first feed need not be hurried, as 48 hours after the first chick is out is soon enough. For the first feed, dry breadcrumbs and hard-boiled eggs, mixed half and half, and fed about every three hours, is as good as can be given. They should have plenty of clean water always handy, and in vessels shallow enough to prevent chickens drowning. A good fountain is made by melting one end off a tomato can and cutting a V-shaped notch in the side. Fill the can with water, and place flower-pot saucer or any shallow dish over it, then turn the outfit upside down, and the water will keep up to the top of the notch. This will serve quite a number of small chickens.

When chickens are a week old, add a little oatmeal to the egg and breadcrumbs; they will relish the change, but they will not do well on oatmeal alone, as is often advocated. They tire of oatmeal quicker than anything else. After four weeks of age they can use the commercial chick feeds or cracked wheat, and then they may be started on hopper-feeding, which is simply filling a box with ground grains and letting them help themselves at will. When hopper-feeding is used, give the chicks at least one feed a day of grain, and twice a day will not be wasting good food. The hopper mixture that gives as good results as any is made by using three parts ground oats, two parts shorts, one part corn meal, one part blood meal. A convenient hopper is quickly made by using a box about eight inches deep. Half fill this with the mixture, and place a wooden screen on top of the mixture. The screen is made of narrow strips of wood, nailed together

in such a way as to make squares about four inches to a side. Make the screen small enough so that it will fit quite loosely in the box. This screen will keep the chickens from scratching the food out on the ground. A box fitted this way is better than a hopper, as less of the food is wasted, and it is not a task to make one.

Chicks that are kept growing are the ones that will lay earliest in the fall, and the ones that are kept growing the steadiest are hopper-fed. Try hopper-feeding one season, and see if it is not a good method.

WALTER M. WRIGHT.

B. C.

**Artificial Incubation and Rearing**

Since I have succeeded in incubating and rearing, artificially, a satisfactory number of chicks from the number of eggs used, the few observations I have made in operating my incubator and in handling the young chicks later in the brooder, may be of value to others interested in poultry. I have been obliged to make some departure from the printed directions accompanying my incubator, which directions we are advised to follow most carefully.

The first requisite towards success is a reliable incubator; this, I believe, will be found in any of the machines placed on the market by reliable manufacturers, the principal of incubation employed being the same in all, and do not know that any one machine possesses any outstanding features over another.

A good machine would embody these features: Substantially built; one that will maintain a uniform temperature (not being very susceptible to changes of outside temperature); convenient to operate, and with the danger of fire from the heating appliance reduced to a minimum; and last, but by no means least, equipped with a thoroughly reliable thermometer.

As regards the questions of ventilation and moisture, over which there still hangs divided opinion, I will give my experience, and then operators can do as I have done, use their judgment, substantiating this by results.

No system of incubation can produce strong chicks from weak germs. This cannot be too strongly emphasized, as a great deal of the trouble in incubating and rearing artificially (in the brooder, particularly) comes from this cause, and even with the breeding stock properly cared for, thereby correcting this trouble, all the eggs gathered should not be used, but rather careful selection practiced towards uniformity of shape, size, shell, etc., of all eggs used in the machine.

As before stated, I was not wholly successful at first—so much so that I abandoned the machine entirely for a few seasons, while all the time I had a good incubator, and had followed printed directions specifically.

First, I have changed the location of the machine to a large room where there is abundance of pure air, no dampness, and in which the temperature remains about the same throughout the day, no artificial heat reaching it, and with no windows towards the afternoon sun. The next point that I have observed is that disinfecting the incubator thoroughly before every hatch, by washing the inside of the machine, the egg trays, and soaking the canvas underneath the egg trays (which I replace with new every season) with a disinfectant. This done, I warm the machine up to the desired temperature and hold it there for twenty-four hours before placing the eggs. I am particular to have the temperature for the first three or four days slightly higher, rather than slightly lower, than the temperature held for the remaining days of the hatch, which is 102½ degrees. This, however, may vary in machines of different makes, it being determined by the position of the thermometer in relation to the egg-trays.

During these early days, I might almost say, little attention is paid to airing, cooling, moisture or ventilation. At about the 5th day I add moisture, by placing the canvass under the egg trays, on the floor of the machine, a couple of shallow pans of sand, which is kept well moistened throughout the hatch, there being no provision made for moisture, or any mention made of this in the directions accompanying the machine. At about this time, I open the ventilators gradually for two or three days, until they are wide open. I cannot see that this small amount of pure, fresh air, entering the machine at this time, with a higher temperature than before during the hatch, can do the young chicks, crowded as they usually are, any harm.

After the first week, I observe airing the eggs, gradually cooling more each day as the hatch progresses, until the nineteenth day. When the atmosphere is mild, as it is in April, May and June, I cool the eggs outside of the machine, closing the machine up while the eggs are out. If we observe eggs hatching in the natural way, we will note that the hen leaves the nest quite often, until the eggs are quite cool. Why, then, should not the eggs in an incubator be aired and cooled likewise, and then placed in the warm machine?

In warm weather, I cool the eggs every evening until they are quite cool. If the weather is severe, less cooling would be given, as the eggs would be found quite cool with turning and reversing the trays.

As regards variations of temperature, I find that the eggs will withstand a great deal of low temperature, when promptly brought up to normal again, but extremes of high temperature are dangerous, and more and more to be avoided as the hatch progresses.

I allow the hatch to finish up well before removing any chicks to the brooder, the earliest chicks being from 36 to 48 hours old before being removed.

The brooder is as thoroughly disinfected as the incubator before placing the chicks in it, and disinfectant is used at least twice a week afterwards. The brooder is taken to the barnyard, which is well protected, and where the young chicks find abundance of insect life, an imperative need to their welfare, and where they are spared the wettings from the wet grass that so often surrounds the brooder.

The feed at all times, while in the brooder, is fed dry, consisting of breadcrumbs, crumbled corn cake, pin-head oatmeal, and chick feed, being a mixture of several kinds of grain, coarse and fine, with the coarse cracked, so that the small chicks can use it. This preparation can be obtained from any dealer in poultry supplies. As soon as small wheat and cracked corn can be substituted for this, it is used, while the other parts of the ration are substituted with a cheaper and more bulky mixture of bran, shorts and cornmeal, or buckwheat flour.

Abundance of pure water and coarse sand for grit is always supplied.

As soon as artificial heat in the brooder can be dispensed with, it is well to do so.

Following these methods, I have not made any phenomenal hatches, or succeeded in rearing 100 per cent. of the chicks hatched, but have succeeded in hatching as large a percentage of the hatchable eggs as could have been hatched with hens, and in rearing, on an average, upwards of 85 per cent. of these.

Dundas Co., Ont.

**GARDEN & ORCHARD.**

**Laying Out the Ground for Setting Trees.**

Address delivered at O. A. C. Short Course in Fruit-growing, by P. E. Angle.

The problem to be solved is to set the trees straight and in their exact position in the cheapest possible manner, and do it in such a way that the men doing the work cannot go wrong. There are several systems which may be followed:

System 1.—Mark out the field with a plow by plowing furrows both ways and planting the trees at the intersections. This is a good plan for one man to work, but where a number of men are depended upon, there is enough chance for error that the trees in all probability will be very uneven in the rows, because there is a space about six inches square at each intersection in which the tree may be planted. It is also difficult to plow a perfectly straight line through the field. This system is not recommended on a large scale.

System 2.—The stake system and planting board. By a system of sighting and measuring, a stake is placed in the position that each tree will occupy, and the planting board is used in order to have the tree in the position occupied by the stake. The system is subject to inaccuracies, owing to the placing and replacing of so many stakes, and also entails a good deal of extra labor.

System 3.—Sighting system. By which a row of stakes, properly measured, is placed around the field, and two rows at right angles to each other across the field. The position of the tree is then obtained by sighting in line with two stakes on at least two sides of each tree; that is, the two lines will meet at right-angles where the tree is to be planted. This is a difficult method to get absolutely correct, and may require extra men to sight if those doing the planting are incompetent.

System 4.—Wire system. The wire should be unstretchable, or as near as it is possible to obtain that quality. A woven wire, composed of several strands of 17-19 steel wire, made in Hamilton, is recommended. It is also easy to attach the marks to this wire. A wire five hundred feet long is used, and is marked by attaching a small piece of copper wire through the strands to mark the location of the trees. The wire is first stretched parallel to the fence, and the stakes are placed along it where the outside row is to go. The same is done parallel to the fence at right-angles to the first, and so on around the field, providing the ends and side pieces of the field are parallel to each other. A row is then staked across the center of the field in the same manner,

to act as checks to accuracy. We then have three rows of stakes across the field one way, and two the other way. Now stretch the wire at right-angles to the three rows of stakes, and proceed to plant the trees at each mark on the wire. In order to make the wire taut and secure, an anchor stake is used at each end, and a block and tackle at one end to stretch it. The work of planting may now proceed across the field one row at a time, and each tree will come exactly in its place, without any special effort of sighting by the planter. The wire should be remeasured after planting ten or twelve acres, and any inaccuracies due to stretching corrected, which may be easily done with the movable marks.

### Topical Fruit Notes.

The nurserymen have started delivering their stock, and ground is being prepared for thousands of new orchards throughout the Provinces. Are you one of these planters, and if so, are you seriously into the business? This question is pertinent, because it has been stated on good authority that not over twenty to twenty-five per cent. of trees planted ever attain a profitable position in the economy of the owner, and some even place the percentage lower. That is, a great many of the trees and orchards never attain any considerable age, and thus never become a productive factor. This is owing to the orchards not being planted in suitable localities, sites or soils; to carelessness on the part of the planter, or to absolute neglect in later years. The climate may prove too severe, varieties may be injudiciously chosen, transportation facilities may be inadequate, or there simply may be too small profit in periods of overproduction (or lack of demand or distribution, as you wish to call it).

Well, supposing you are serious in your undertaking, to begin with, it will pay you to give considerable care to the young tree. Very likely, it has been packed away all winter in a storage cellar with many thousands of such trees, with general attention given to the multitude, but little care to the individual. It may be that it is packed roughly in a big box, and then sent on a several days' freight journey. By the time you get it out of the shipping box, that tree needs particular attention.

First, if you are getting the trees from an agent at a distributing point, be sure and have some sacks or blankets to cover their roots in your wagon as you are hauling them home. The sun is merciless to the careless. Then, as soon as you get home, moisten the roots by placing them in running water or by throwing water over them from a pail, and as soon as possible heal them until ready for planting. If there is not too much to be done, the planting might be done at once, and thus save the extra work of healing in; but, in any case, the fundamental principle to be fully recognized is to keep the roots from drying out. It cannot be impressed too deeply on intending planters that they are handling a living organism which has been uprooted from a suitable environment, and, until planted again, which is surrounded by most unfavorable circumstances for retaining its vitality.

The distance apart to plant trees varies considerably, and depends on the kind of fruit, variety, soil, method of pruning adopted, and choice of the individual grower. It would be unsatisfactory to recommend any definite distances here; the planter should consider the above factors, study neighboring conditions, and take advantage of any expert advice he can get near his home, such as that gladly given by the District Representative of the Department of Agriculture. Many of our growers plant on the square system, others plant slightly closer in the rows than between rows. Thus, peaches might be planted 18 x 18 ft., or 18 x 20 ft., in the latter case having the wider spaces running north and south. Other average distances, as used in the Niagara district, may be mentioned, as follows: Plums, 18-20 ft.; cherries (sour), 18-20 ft.; cherries (sweet), 25-30 ft.; pears (standard), 20-25 ft.; pears (dwarf), 12-15 ft.; grapes, 9 x 10 ft.; currants, 4 x 5 ft.

Before planting, any broken and bruised roots should be cut back, and, in general, the whole root system should be pruned to about from 3 to 8 inches. There is no use in filling the hole up with a lot of straggling roots, and more injury than good is done. All the fine rootlets and root-hairs have been destroyed in digging from the nursery, so that the tree has to produce new rootlets and feeding fibres. This it can do better if cut back as mentioned. The top, also, should be cut back severely before or after planting to counterbalance the checking of the root system and to outline a strong and open framework for the tree.

With reference to the root pruning of young trees, G. Harold Powell, of the U. S. Department of Agriculture, some years ago conducted extensive experiments, and drew the following conclusions, in brief:

1. That trees with roots pruned to about 3 inches did best; that trees with roots pruned

from 6 to 8 inches also did well; but that stub roots did very poorly.

2. That new roots arise (a) from near the end of the pruned roots, (b) from fibrous roots, (c) from adventitious buds at the base of the tree, (d) sometimes from the sides of larger roots, (e) seldom from the callus.

3. That the direction which a new root system assumes is governed by the character of the soil; by the distribution of plant food and moisture in it; and by the natural habit of the tree. The roots seek the strata of most congenial moisture and accessible plant food.

4. That there is an individuality of root systems. They differ in various varieties and species. There is a wide variation in the form of roots, in the direction they take, in their size, in their distribution on the tree, and in the manner of branching. The apple and pear differ from the plum and peach, in having a large number of small and fibrous roots arising from the body of the tree.

5. Earliest growth in spring takes place at the expense of the reserve food stored in the tree, in its branches and roots. So the roots should be able to supplement this at an early date.

\*\*\*

Georgia and California have been the pioneers in the pre-cooling of fruit, and in many cases have brought it from the experimental stage to that of commercial expediency, both with citrus and deciduous fruits. Oregon and Washington fruits are now receiving attention, and last summer, experimental work in pre-cooling cherries, raspberries, loganberries and prunes was conducted by their Department of Agriculture. Their results so far indicate that pre-cooling is a big aid in helping the refrigerator car to maintain a low and uniform temperature during the entire trip. Pre-cooled cherries, at the end of fifteen days, showed less decay than unprecooled by 4.1 per cent.; loganberries, at the end of ten days, 25.6 per cent. Indications point to a successful outcome of the work. Will our Department be at work this summer?

\*\*\*

"What is there in a name?" A dispute is at present on the front in Oregon over the spelling of Oregon's famous apple, the Spitzenburg, or Spitzberg. See? The question is, shall we use "e" or "u"? The Federal Department of Agriculture favors the "u," but reminds the Oregonians that, according to the ruling of the American Pomological Society, the accredited name of the variety is "Esopus." In many places the name is combined, and it is known as the "Esopus Spitzenburg." Familiarly, we like "Spitz." It eats well, at that.

However, there is a great deal in a name, as evidenced by the universal use of "brands" by Western fruit-growers. Eastern growers will come to use them more frequently as their value dawns upon them; for, what is the use of putting up first-quality fruit, and not letting the consumers know where to get more of it. By your brand ye shall be known. An extensive dealer in citrus fruits told me that, until recent years, he would always pay 50 cents a case more for a similar grade of oranges from Redlands than from Riverside. Now there has come to be not such a discrepancy, if any. Why? Because the brand told, and the Riverside growers have improved their article until it would compete with the better Redlands brand. Watch the auction markets and note the regular premier position taken by certain well-established brands. It takes time to earn such a reputation, but it is worth a lot when one gets it. This use of a brand is of especial value to co-operative societies where smaller local associations sell their output through a central sales agency. Each local association must be given credit purely on a basis of quality or grade of fruit put out, and this can be adjudicated to a great extent by the consumers or buyers, who are willing to pay a better price when they know that they are getting better quality of fruit. However, don't let anyone run away with the idea that this can be accomplished at once. It takes time to establish a brand, as it does a business. But it all works out that there is something in a name that has something at the back of it which is good, bad or indifferent.

\*\*\*

Walter E. Biggar, of Winona, has been appointed Provincial Inspector of fruit-tree pests. Mr. Biggar has been for many years one of the inspectors for the Township of Saltfleet, in Wentworth County, and it has been largely owing to his careful and intelligent work that that township has long held a premier position in its control of those tenuous diseases and insect pests that require legislative enactment and communal effort to successfully combat them. The appointment is a great one amongst those who know him, and should prove satisfactory to the Province at large.

W. R. D. Wentworth Co., Ont.

### Exhibition Apples for London.

The Department of Agriculture shipped lately to Wm. Hutchison, Exhibition Commissioner, London, what is believed to be the finest lot of exhibition apples ever sent out of Canada.

The apples were collected last fall under the direction of J. A. Ruddick, Dairy and Cold Storage Commissioner, by members of his staff who went direct to the orchards at time of harvesting, making their own selections and packing them in a special manner. As soon as possible after packing, the apples were placed in cold-storage, and held at a temperature of 32 degrees. By these means it has been possible to preserve, in excellent condition even such early-maturing varieties as McIntosh Red and Fameuse.

All the fruit-growing Provinces are well represented in the collection, which comprises nearly 800 boxes. Some of these apples will be shown at the great International Horticultural Exhibition to be held in London next month, and the balance will be used to continue the exhibition at the Crystal Palace.

## THE FARM BULLETIN.

### The Wonderful Du Pont Road.

Probably the most remarkable object-lesson in road-making ever given on this continent is that afforded by the public-spirited generosity of Coleman du Pont, in his native State, Delaware. By itself and tributary roads, the value and productivity of a wide belt of farming land should be promoted to their fullest development, in so far as a public highway makes this possible. It will run through a variety of country, and the road-bed will be laid down according to different systems, including surfacing in relation to automobile traffic. Accurate records will be kept not only of construction cost, but of subsequent upkeep for years, so that the relative outlay and efficiency will in due time be determined. The road will be 110 miles long, beginning at the north-east, and running right down through the State. It follows the course where the greatest number of feet of right of way have been offered free by the people. Thus, those who desire the road most, receive it. The whole right of way is 200 feet wide. At present, the central 40 or 50 feet is being constructed as a first-class road, and, as the country develops, provision is made for two trolley tracks, two side roadways for heavy freight traffic, and foot-walks at either side, with rows of trees. As described by Mr. du Pont, himself, in the Scientific American, the main roadway will be built of water-bound macadam or concrete base, on top of which will be laid asphalt and stone mixed, or a surface composed of water-bound macadam, with a half-inch covering of asphalt and trap rock, to make it dust-proof and water-proof. Width will vary according to the probable traffic, the narrowest part being 20 feet, 13 feet of which will be metalled, and curves limited to five degrees. As to the possibilities of future development in fruit and vegetable farming in the country drained by this road, some idea may be formed from the fact that already, at one shipping-point alone 62 carloads of strawberries and 63 carloads of peaches have been forwarded in one day. When completed, therefore, the du Pont road will be one of the greatest and busiest in the United States. Now, suppose that a few of our Canadian millionaires get busy with similar good-road schemes to make themselves famous as public benefactors.

### N. S. Agricultural College Growing.

The 1911-12 session at the Nova Scotia Agricultural College closed on Friday, April 12th. The session has been by far the most successful in the history of the institution, the attendance in the regular course having been 80, in comparison with 65 the previous year, and the short course 312, in comparison with 230 the previous year.

In order to accommodate the increasing number of students at the College, considerable additions will be made to the institution during the ensuing summer. An addition will be added to the main building, which will increase its capacity about two-thirds. A separate horticultural building and greenhouses will be erected, and a new horse barn will also be erected during the summer.

It is extremely satisfactory to note the progress that has been made at this Agricultural College of the East, not so much because of the institution itself, but because it is indicative of the new interest in Maritime Agriculture, which spells a new life in these Eastern Provinces of Canada.



**Jack Miner and the Bear.**

It is as a lover of birds, and one who has almost magical skill in protecting and taming them, that Jack Miner is known to "Farmer's Advocate" readers. But to those who are more intimately acquainted with him, he is known also as a keen hunter of big game. Every fall he makes one of the number who go to the northern woods of Ontario or Quebec to shoot deer and moose. In his house there are so many deer or moose heads sticking up or lying around that the dusting of them is a formidable chore, and his wife threatens to give several of them away, so that visitors may be able to walk through the rooms without bumping their heads. But in all the years in which Mr. Miner has hunted large game, he had never, until the season of 1911, come across a bear. The story of his encounter with one of that species of game it was the privilege of the writer to hear from his own lips, and will be given as nearly as possible in his own words.

"It was up in the Spanish River district," said he, "where I went to hunt moose last November. One day I was out in the woods with my rifle looking for what might be seen. Up there, you know, the woods are rough. There is not only the standing green timber, there are lots of dead trees standing, too, and, interspersed with these, fallen trees abound, many of them not lying on the ground, but held up by their roots and limbs about breast-high, or so. And all through there is an undergrowth of birch and poplar, so that one can't see very far unless he is on a hill-top, and through which he seems to make dreadfully slow speed if he gets in a hurry. Well, as I said, I was out one day, and, peering about as I cautiously made my way through the brush and logs, I saw in a kind of open space what looked something like a muskrat's nest. It was made of ferns that had been gathered and put in a heap.

"Says I to myself, as I considered the thing, 'that must have been done by a bear, sure. Nothing else here could have collected the ferns and piled them up so. And he must have used that for a sleeping-place, I believe.' The heap was wet and sodden, but looked as if it might have been comfortable in dry weather.

"Keeping pretty still, but yet looking around, I noticed a pine log that had quite a little sand in the cracks of the bark at one place. There were also, just there, marks as if some animal had a track across the log. Having, by this time, bear on the brain, I concluded that a bear had made a practice of getting over the log at that spot. 'But how,' thinks I, 'did the sand get there?'

There was no sand to be seen—nothing but leaves and brush. Still peering about, and keeping quiet, mind you, I noticed, by-and-bye, where two pine trees had fallen apart—they were leaning pretty well over, but not nearly down—and between the two trees their roots had raised up off the ground, so that there was a sort of cave under, and down in there I saw the subsoil exposed clear sand.

"Now I've got it," says I. 'The bear must have lain in there some nights, and when he crossed the log he shook himself. That's how the sand got there.'

"I came up—cautiously, you bet—and examined around those trees. There was quite a large open space below where the roots had lifted up to form a canopy. At the side nearest to me there was an opening large enough for a man's body to enter, and I discovered hair sticking on the sharp ends of some roots around this hole. 'Bear's hair,' I was sure. Next I saw tracks—'bear's, and no mistake'—in the sand, but they were not fresh tracks; might have been made a month before. Growing more confident, and looking closer, I could see that ferns like those in the heap outside had been dragged in and placed to one side. Could just see the edge of them. Didn't care to get too close.

The whole situation, as I thought, was now quite clear to me. 'That bear must have dragged those ferns in to make a comfortable nest when it got too wet to sleep on the heap outside. And now, since the weather has become colder, he has gone somewhere else. Oh, yes! that's quite plain! Those tracks were made weeks ago!'

I got up on top where there was a little hole—a skylight, as it were—and looked down, but could see nothing. It was too dark. I prowled around to see if there were no other means of getting a peep in, still keeping my rifle in hand and tried ready, you understand. Stooped down and tried to look in at the big hole, but there wasn't light enough to see anything. 'I'd like awfully well to go in there,' said I to myself, 'but guess I'd better not.' But the longer I looked, the more eager I grew to see what was there. 'Where the bear had been,' you know. Got desperate at last and said, 'I'm going in, anyhow.' So, setting the gun up carefully, I crawled slowly in, head first, until there was nothing outside but my moccasins. I was trying hard to see what was

in one side of the cave when that bear swung his nose slowly around within eight inches of my face. Say! Nobody told me to get out, but if you had seen my moccasins flying around just then, as I frantically struggled backwards, you would have thought something was going on underground. Of course, I got out. How long it took, I can't say, but you may be sure it was no longer than I could help. I know it took longer to get my breath after I was out. But, grabbing my rifle, breath and reason both came back after a time, and I reflected that bear is not dangerous. He must have gone to sleep for the winter ever so long ago. I needn't have been so scared.

"So, with a rebound my courage returned, and I said, 'I'm going to get that bear, and I forthwith climbed up on the roof, and with a long stick made a hole through right above where he was, and punched him to make him go out. He would grunt, but he wouldn't move. I then sharpened the stick and prodded him until he stuck his head out, and I shot him.'

The story excites one's sympathy for the poor bear. No one can wish that the bear had got Jack Miner. And the hunter's quick self-possession and daring are beyond praise. But many will have wished that he had left the bear to his dreams. A vivid imagination will picture the possible feelings of the animal who had his sleep first disturbed by an unwelcome visitor, and then was afterwards routed out to be killed. It may well be hoped that Mr. Miner, who, from being

many sections tobacco-growing will be dropped, owing to the difficulties experienced in disposing of last season's crop. Tomatoes are clear y in the ascendancy, as is indicated by the numerous hotbeds which may be observed all over the vegetable-growing section.

The system of municipal drainage, vs. taxation, which has been pursued by the different localities under the antiquated "Drainage Act," is provoking heated discussions at this season of the year. The man who can produce and champion a system which can be conducted on a fairer and more just basis will be heralded as a public benefactor.

A. E.

**Home and School Should Co-operate.**

Editor "The Farmer's Advocate":

I have been interested in reading, in "The Farmer's Advocate" of March 21st, the letter on "Rural School Criticism," by Mr. Dearness, and from it back to the letters in Feb. 29th issue, by J. O. Duke and Jas. Love.

When we note the decrease in our rural population, the doubling up of our farms as the "young men go West," or to "street cars or factories," we may well look into the "Why" and "Wherefore" of this live social question. Is Mr. Duke right in throwing the chief onus on the public school and our educational system? An all-round and thorough discussion of this crying need, and the most effectual means of meeting it for the prosperity of our country, might encourage people to think and act. Would it not be wise for "The Farmer's Advocate" to devote a weekly column to these questions on education, and invite teachers, parents and all interested to contribute? Our Government is giving generous support to education and to moral uplift in our Province, through its educational curriculum and training schools, through its Farmers' and Women's Institutes and Children's Aid Societies.

In my opinion, this egress from the country to the towns is due to the false ideal set up by the home, rather than to the Public School. When children are taught that the most important thing in life is to make money, to secure the largest return for the least work, they will rush to that, even though the supply end of the social balance may lose. A secondary reason is the failure of rural life to meet the natural tastes and needs for our

of social, intellectual and aesthetic development. Wiser and more cordial co-operation between the parents and teachers would help much in this. The church and the school, the minister and the teacher, are usually the leaders in social, intellectual and moral life in the country. When these co-operate with the home, we may expect a manhood and womanhood to grow up in our land of which we may be justly proud, which shall make Canada second to no community in the world in intellectual and moral power.

I quite agree with Mr. Love that arithmetic should be retained and especially stressed upon a teacher's High School course. Upon no subject are the older boys of the school, bright or otherwise, so ready to find a chance to trip the teacher. How can she teach that of which she is not master herself?

I must, however, take decided exception to the outruling of Psychology from the Normal Training. It would be almost as sensible to outrule Physiology, or the study of the functions and operations of our bodily organs from the medical training of the doctor. Psychology teaches the operations and functions of the mind and their relation to the physical organs. "Education is the science of human development. Teaching is the art of promoting human growth or development." Education is wider than teaching, but embraces

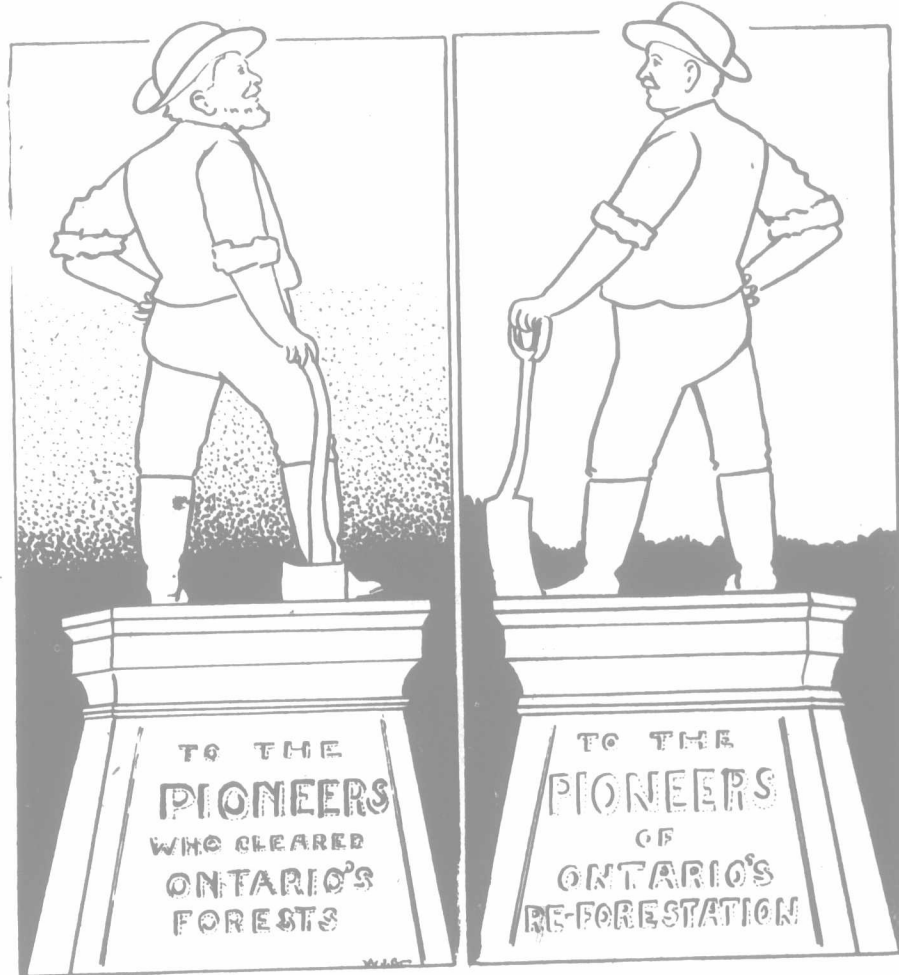

Past and Future.

Much as we appreciate the work of the former, it may be that the next generation will still more appreciate the labor of the latter.

a slaughterer of quail, has come to be their lover and protector, may also have the spell of the hunter overpowered by compassion for the larger victims of the chase.

T. B.

**The Season in Essex, Ont.**

The farmers are busy plowing and sowing in many localities. Seeding started on underdrained lands during the week ending April 13th, and is now quite general throughout the clay belt. Continuous wet weather during the autumn months of last year left considerable plowing to be done this spring, which will retard seeding.

Fall wheat, which promised well last fall, is very much damaged; scarcely one-third will be worth leaving. Many fields, owing to snow filling the ditches, were submerged by an early thaw, and then a sudden drop in the temperature completely covered them with a heavy coat of ice, which, shutting out the air supply, destroyed the roots by smothering. A few fields on the higher lands, however, give promise of a good crop. This loss will very materially increase the acreage of spring seeding. Barley is much in demand, and farmers are complaining of a scarcity, and likewise an exorbitant price. Despite the high prices quoted for potatoes (viz., \$2.00 per bushel), many of our truck gardeners are preparing to plant a much larger area than last year. In

it. Psychology is the science of mind or soul or self with which the teacher deals. Someone has said, very wisely, "Tact is only applied psychology." Psychology teaches us to place ourselves in others' places, to see things from their viewpoint, not merely our own narrow or dogmatic one, even if it may be a truer one. But, having looked at things from another's focus, we should be able to show the child or adult how to read-just his glass so as to take a wider view. It should help the teacher to see how hazy at first everything seems to the little tots first coming to school.

From several works on psychology I have lately read, three things have been impressed upon my mind: First, this need of parents and teachers being able to put themselves in the child's place, and thus be led to use that tact, which is, after all, the practical expression of the Golden Rule, and is the most effectual instrument used by any leader in public or private life; second, the great importance of habit formation, especially in the early years, when the brain is plastic and the nerve centers run into those automatic grooves, so that "habit becomes second nature"; thirdly, the ability to look at life in its true proportions and relative values between the practical and the ideal.

Herbert Spencer was one of the foremost and most radical advocates of a practical education, that should fit one to meet the duties of real life. He lays the main stress upon the teaching of science, as the foundation of all arts and industries, and of the study of psychology as the most necessary training for both teacher and parent.

It is possible to grow so intensely practical that we become a practical failure. The men and women of the world who have accomplished the most practical reforms have been those of high ideals, of great faith and enthusiasm, and untiring patience. Raise the ideal of the home and of the school; encourage the teachers to zealously carry out their Normal ideals, rather than kill them by criticism; and help them by hand and heart, and look for results.

MARGARET BRUCE.

### Good Roads and Other Legislation in Quebec.

#### THE GOOD ROADS ACT, 1912.

Any rural, village or county municipality wishing to improve its roads may pass a by-law ordering the macadamizing, stoning or grading of the roads therein described, and order, by resolution, the borrowing of the sums necessary for the making or improvement of the roads mentioned in the above by-law.

When such by-law and resolution have been approved by the Lieutenant-Governor-in-Council, the Provincial Treasurer shall be authorized to pay one-half of the interest and all the sinking fund payable in respect of loans contracted in virtue of the above resolution.

The annual interest on each loan shall not be more than four per cent.; the annual sinking fund shall be sufficient to pay off the loan in not more than forty-one years; and the total amount of the sums borrowed by municipalities, with the guarantee of the Government, shall not exceed ten million dollars.

If a municipality does away with statute labor and maintains its roads by direct taxation, it will moreover receive from the Government an annual grant equal to one-half of the expenditure made for such maintenance, but not exceeding four hundred dollars a year.

Two other laws have been also adopted, giving greater facilities to the ratepayers for the obtaining of the Government grants for the macadamizing or grading of roads.

#### THE "ROADS DEPARTMENT."

A law has been enacted to establish a Roads Department, with a deputy minister, under the control of the "Minister of Agriculture and Roads."

#### PROTECTION AGAINST BEES.

A law now enacts that no hive containing a swarm of bees shall be left upon any land unless it is at least thirty feet from the nearest highway or dwelling in a rural municipality, and at least fifty feet therefrom in a town or village municipality.

#### CO-OPERATIVE AGRICULTURAL ASSOCIATIONS.

Different amendments have been made to the law respecting co-operative agricultural associations, with respect to loans, the reserve fund and the dividends. The dividend on paid-up capital can never exceed six per cent.; no other dividend can be paid so long as the reserve fund is not equal to the subscribed capital.

When the reserve fund is greater than the subscribed capital, the association, after having paid dividends not more than six per cent. of the paid-

up capital, may distribute the remainder of the profits among the shareholders, in proportion to their dealings with the association, upon the basis established by the directors.

### Field Horsetail Poisonous.

Editor "The Farmer's Advocate":

In the issue of "The Farmer's Advocate" for April 11th there appeared a letter in reference to the suspected poisonous nature of the common field Horsetail (*Equisetum arvense* L.), to which my attention has been called.

In reply to this, I desire to put on record my experience with this far-too-common weed, collected during the poisonous plant investigation carried on by the Division under my charge. The poisonous nature of a closely-related species of Horsetail (*Equisetum palustre* L.)—by no means rare in this country—has been established beyond any doubt. This plant is correctly considered a highly-injurious weed, both in the green and dry state. It is the common experience of observers, however, that in the green state this plant, and indeed a large number of other poisonous plants, is rarely eaten by stock; their power of discrimination serves as a pretty safe protection. As a rule, young and inexperienced animals fall victims to poisoning by plants more readily than older animals. In the dry condition—in hay, for instance—no animal is able to select its food, and hence the largest number of indisputable cases of plant-poisoning are due to giving contaminated hay as food. Another point of interest is that some kinds of animals are far more susceptible to plant toxins than others. Thus, pigs and sheep are singularly immune. Cattle and horses also vary greatly in their susceptibility. *Equisetum palustre* L. is far more serious to cattle; indeed, often proves fatal, while it causes but slight trouble to horses.

*Equisetum palustre* L. has long been recognized as being a fatal poison, and the most recent investigations confirm this conclusion.

As regards the common field Horsetail (*Equisetum arvense* L.), however, opinions continue to differ, some investigators regarding it as quite harmless, others of slight importance as a weed injurious to stock from a mere mechanical aspect. In our experience, cattle do not suffer any inconvenience at all from this weed, or only very slight disturbances of their digestive organs, while horses seem conspicuously subject to fatal poisoning by this species.

In co-operation with Dr. Rutherford, Veterinary Director-General, I have been enabled to collect some very important data concerning this herb. A considerable number of cases of horses being mysteriously poisoned, led to my causing an examination of the herbage to be made by a trained botanist, and the constant association of this weed in such cases ultimately induced me to publish an account in my report for the year ending March, 1910, warning farmers against this weed (Dominion Experimental Farms Report, 1910, p. 280). Meanwhile, I have continued my investigations, which have now established that the common field Horsetail is seriously poisonous to horses, at any rate.

A considerable number of cases of horses being poisoned have been reported during the last year, and an examination of the hay on which they were fed revealed in every case the presence of this species of *Equisetum*; moreover, as soon as the food was changed, the horses, if not too seriously affected, made a rapid recovery. In no case was there present any other poisonous weed that could have been responsible for the trouble. Also, the symptoms recorded by experienced veterinary surgeons were the same in every case, so that the evidence is very conclusive.

After calling attention to the properties of this weed, I received a large number of inquiries which show that cases of poisoning are occurring far more frequently than one would have been led to believe.

One typical case came to hand but a day or two ago, which I quote, to enable your readers to draw their own conclusions:

"We have a very common and peculiar disease in this locality, which I call a form of spinal meningitis.

"Symptoms—Staggering gait, partial loss of motive power, very excitable, and good appetite.

"As disease progresses, mucous membrane congested, constipation, urine highly colored, complete loss of motive power, deglutition lost, heavy breathing, convulsions, and death.

"In all the numerous cases that have come under my notice and treatment, I find a certain rush or weed in the food, which I am forwarding to you.

"I honestly believe the toxins from this weed are the cause of this disease, and I further know that there is little use in treating patient if allowed food with weed in it, for they seem to have a craving for weed if once affected with this disease; and if this weed is kept away from them,

and the patient able to stand with internal antiseptics, etc., will recover to perfect health."

The weed submitted to me for examination was *Equisetum arvense* L., common field Horsetail. The description of the symptoms of the diseased animals agrees very closely with all other records and those known of cases of poisoning by *Equisetum palustre* L.

Anyone observing these symptoms should at once change the food and submit a sample to me for examination. Dr. Rutherford kindly informs me that the treatment which he recommends, and which has been proved successful by those who have had the opportunity of investigating cases of poisoning by this weed, consists of a liberal allowance of clean, easily digestible foods, the administration of a sharp purgative, followed by good-sized doses of nuxvomica (two teaspoonfuls in food three times a day).

When this treatment is begun before the horses loose the power to stand, and can be kept on their feet, their lives can be saved in practically all cases.

In conclusion, I might say that these weeds grow commonly in moist, undrained localities. They will soon disappear if proper drainage is provided. It may also be useful to encourage the growth of good fodder grasses by giving the land a top-dressing with seed at the rate of 10 pounds per acre. This would tend to reduce the percentage of the Horsetail in the hay, though this practice should not be considered a solution of the problem.

I trust this reply will answer Mr. Dearness' letter, and will be of interest to your readers generally.

H. T. GUSSOW,  
Dominion Botanist.

### A Day with a Pioneer.

By Peter McArthur.

The Pioneer came in the morning, and I promptly declared a holiday. He wanted to see Mr. Clement's tree—that is, the tree that Mr. Clement pruned last February. He had ideas of his own about pruning which were based on many years' experience, and I was quite prepared to listen with respect, for his apples were famous when I was a boy. They took the prizes at the local shows, and he always had apples whether there were others in the country or not. But before I would take him out to the orchard, there was a session by the fire, for it was a raw morning, and that gave me my chance. Although I was not only willing, but anxious to hear all he had to say about orcharding, there are more important things to discuss with a pioneer. There will be orchards for ages to come, and wise men to tell how they should be handled and cared for, but only a few years more will we have the privilege of hearing of the building of Canada from the lips of the Pioneers. My friend is 86 years of age, still hale and bright, and with a vivid memory of his early experiences in the country. His visit to me was on the sixty-second anniversary of his arrival in the country. That was before the building of the railways in these parts, and was sufficiently far back to be altogether different from anything we have now. His work was done in the log age—the age of log houses, log barns, log fences, log heaps—logs everywhere that had to be got rid of. He had retired from active farming long before the beginning of the cement age—so that his experiences were sufficiently removed from those of to-day to have the charm of novelty. The young people of the cement age know absolutely nothing of the log age or of what was endured and enjoyed in this country less than a lifetime ago.

\*\*\*

He had much information that I wanted, but the trouble was to get it. He was willing enough to talk and tell me all I asked about, but I did not know what to ask. My trouble is that the things I want to know about pioneer life always seem unimportant. What I am hunting for is the things that cast a light on the pleasures and hardships of the early days. And that doesn't mean the clearing of the land and the building of the houses and barns. All pioneers start in by telling me that sort of thing, and it is only once in a while that I get something illuminating. For instance, I had been delving into these matters for years before I found out that the greatest hardship many of the early settlers had to endure was homesickness. The loneliness of the wilderness made them long for their old homes as the children of Israel longed for the flesh-pots of Egypt. But none of the Pioneers I talked with ever thought of mentioning that to me. Perhaps they considered it a sign of weakness. In time, most of them learned to love the new land in which they had hewn out homes for themselves, and that made them forget the old. But homesickness was a very real hardship when Canada was being cleared. Few were free from it, and some it drove to madness. I am mentioning it here merely to show how hard it is to get at the real facts. No questioner would think of asking about homesickness. I stumbled on it by

accident, and now every pioneer I talk with gives me further evidence about it. Because of this experience, I am always on the alert for new lines, and I usually get the new things unexpectedly. On this occasion I got at least one new fact about pioneer difficulties that was entirely worth while. It may sound amusing enough to the good people of to-day, but it was once a matter of grave concern, even to practical business men.

\* \* \*

In the most casual way, as if it were a matter of no importance, the Pioneer mentioned that it took twice as many men as it should have to put through the Grank Trunk railway. I was interested at once, and came at him with an eager "Why?"

The reply was sufficiently surprising:

"Ague. Not more than half the men were able to work at any time. Half of them were always shaking with the ague."

Now, I had often heard of people having the ague in the past, but had thought of it as something ordinary—like measles or whooping-cough among the children. It had never dawned on me that ague was at one time a real force to be contended with. But the Pioneer assured me that there were times when every man and woman for miles around was suffering from the ague, and that some years it was almost impossible to get necessary farm work done because of the chills and fever. Further questions gave me some idea of the prevalence of this discouraging complaint, which, for some reason, most people are inclined to laugh at. There seems to be something humorous about the memory of ague that persists in the country. It got itself impressed on my mind as a mere matter of chattering teeth, and, as I never had the ague, or happened to see anyone suffering from it, it was a surprise to find that it once occupied the center of the stage. I am now convinced, however, that no man should attempt to picture pioneer life in these parts without letting his characters have a real good shake. Probably it was because the ague was not a fatal ailment that people did not respect it properly, but if it could tie up the operations of the railway builders, it must have added misery to the lives of the pioneers. Shaking with the ague in a hut in the wilderness, miles from a doctor, and perhaps even from a neighbor, with spring work to do among logs and stumps, does not make pioneer life look very alluring. From now on I shall add ague to the homesickness that made pioneer life so hard.

\* \* \*

Another matter that interested me was an account he gave of a walk through the woods sixty years ago. He was travelling from Ekfrid to some place near Toronto, and during one day's trip the only human being he saw was an Indian and a little boy. Stopping places where he could get refreshments were far apart, and there was something wistful about the description he gave of a man he met at, I think, Brewster's Mills. He had stopped to ask the only man he had seen in some hours' travel to direct him on his way. The information was given, and then the settler told him that it would be at least five o'clock in the afternoon before he would come to another settler's clearing or to any place where he could hope to get food and refreshment. With the ready hospitality of those early days, he offered to share his lunch of bread and cheese with the traveller, and as he told this, the Pioneer commented, in a heart-felt tone, "I have often wished that I could meet that man sometime and give him something that would seem as good to him as that bread and cheese seemed to me."

\* \* \*

I got altogether too much good information about other days to try to compress it within the limits of an article, and equally interesting were his comments on orcharding. He examined Mr. Clement's tree carefully, and was pleased with it. Then he told me how he got results. In planting his young trees, he did not simply dig post-holes and push them in, but allowed himself plenty of room and worked up the soil so as to give the roots a chance. Every spring, and several times during the summer he gave the trunks and branches a thorough washing with weak lye or washing soda. This kept his trees clean and thrifty. In pruning, he had found that he got better results by pruning when the trees were in blossom. Winter pruning tended to develop new wood, while spring pruning developed fruit. When Mr. Clement was here a few days later I asked him about this, and he told me that the pioneer's observation was correct. He also said that the lye wash did much of the work that is now done by the use of lime-sulphur. The pioneer also gave me some notes he had prepared on dairying and tile-draining, and I am going to forward them to the editor of "The Farmer's Advocate." In my opinion, the experiences of a man who was able, by the practice of farming, to prosper and retire well provided, are worth the careful consideration of men who are still in the struggle.

But there is a side-light on his success that seems worth noting. Early in life he resolved to set apart a certain percentage of his possessions for a worthy object. This made it necessary for him to keep strict account of all his work and products. Once each year he had to take stock of all his possessions. I am not sure but his success lay in that as much as in his careful methods of farming. This practice enabled him to know just where he stood at any particular time and to make his plans carefully.

\* \* \*

But, most of all, I cherish the glimpse that I got of early days during the Pioneer's visit. Somehow, while listening to his narrative of homely events and everyday happenings, I seemed to be transported back to those days of struggle and triumph, when the foundations of the country were being well and truly laid. I got a touch of the spirit of helpfulness and fellowship that existed among so many of those who were battling with the wilderness, and of hope that inspired them. Some day I may be able to hit on a way of putting the charm of these things in words, so that others may enjoy them, also. Someone must do it, and that soon, if the memory of the pioneers is to be preserved and made the force it should be in the life of the country.

### Storing Brewers' Grains.

Editor "The Farmer's Advocate":

In your issue of April 11th, page 717, a question is asked by "A. M." on silo for brewer's grains. I thought, from your answer, you had never seen brewer's grains stored for winter feed. I have seen them stored, and they have kept in splendid condition. The usual way is to dig out a hole in the ground large enough for the quantity you wish to store, lining the hole with stone or brick set in lime-mortar, a little higher than the surrounding ground. The floor generally was made of flat stone set closely together. The grains were packed into this pit and well tramped, making them as solid as possible around the sides all the way up until full. Cow manure was often used to cover over top, after the pit was filled, or earth, or both, the object being to keep out the air. When taking out the grains for use, remove two or three feet square of covering and the few spoiled grains next to cover, and dig out with a spade straight down from the top to bottom of pit, taking care to keep the bottom cleaned up, thus leaving nothing to go bad from exposure to the air. By using every day, they will keep all right, and are an excellent, palatable feed for cattle. Do not take all the top off, like silage, but just a little at a time. Concrete would make a better lining and floor for a grain pit, I would think.

A. H. HASLAM.

Wentworth Co., Ont.

### Cutting Out the Middleman.

Editor "The Farmer's Advocate":

In giving the following sketch, I am giving information which has never been given to anyone, to my knowledge. It cost months of work every night, into the wee sma' hours, until it was finally perfected.

It all happened because a very good rich friend once said that he wished that he could get one fresh egg to eat. He had been eating "salted" and cold-storage eggs so long that he was sick of them. So we sent him a dozen eggs which we had, and marked the date they were laid on each egg. The next day came a check for one dollar, and an order for more eggs whenever we had them. So then we sold eggs to him each week all that year, and charged him just what the market price was. That was the beginning.

After we got into the thing this far, we wondered if there wouldn't be some chance to sell prime-fed chickens and ducks; so we tried out this plan, and had wonderful success. From this we went into a little truck business, and sold all we could raise. So here is our plan.

You will find hundreds of people in the towns and cities who would like to get all their vegetables, eggs, poultry, and so on, from some reliable man. Very few have that chance, for the producer sells to the middleman, and then it comes on a few days later to the consumer. We visited numerous homes and found out what was wanted, and then agreed to furnish what we could at the regular market price, plus a small premium. We were obliged to add to this premium for the service that we gave.

I will start with the poultry end and tell you what we did. One thing we specialized in was eggs. We had several different strains of pure-bred chickens, and secured several kinds of eggs. Each egg was dated when it was laid and the kind of chicken it was from. This was done with a special stamp which had our monogram. The eggs were sorted as to size and color and date, and then packed in special neat pasteboard egg boxes, for which we paid one cent each. These were marked Plymouth Rock (or whatever breed

it happened to be). Eggs from ..... Farm. Laid .....; and this was signed by one of us.

The chickens were fed with only clean, wholesome food, and given the best of care. One requisite was cleanliness at all times. People said that our eggs had a flavor which no other eggs had. We could not fill the orders we received from outside sources, and only supplied just a certain number of customers, but supplied them well. We always saw that they had a few more eggs than they really wanted.

Then the poultry. We found out that our customers always wanted a certain number of "squab broilers," frys and roasters each month, and so raised chickens accordingly. For the first we used Leghorns, and force-fed them. One thing we used was sweet corn. It was surprising the fine taste these broilers had, and we couldn't even supply our own regular customers. We killed these birds in our own way, and when they were cleaned we trussed them into a good shape and wrapped them, first in oil paper, and then in our own monogrammed wrapping paper. All our paper was of one color, and string, etc., was used to match. To each package was attached a card which read: "One..... Farm Broiler..... weeks old. Packed especially for ..... Weight.....lbs.

Later in the year, we used ripe muskmelon with the feed once a day, and had a flavor all our own. We were very careful about all of the feed and exercise our chickens got, so knew that we could give the best at all times. We added six cents per pound to the regular market price for these birds.

Our frys and roasters were treated in practically the same way, except we made the flavor of the roasters different by using a lot of corn, milk and wheat. We made special telephone arrangements, and had the roasters all ready for the oven; they were even drawn, stuffed when asked for, and delivered in our own special packages ready for the oven. We found this telephone arrangement a great convenience. At a certain time each day we would take telephone orders, and at only that time—not one minute earlier or later. Our customers respected this.

Then, we had capons. The farmer doesn't know what he is missing in not having at least fifty capons on the farm each year. They bring big prices and are easily cared for. The work of caponizing is very easy. I lost but two cockerels we caponized last year. Many of our capons weighed as much as 17 pounds. Figure that at 35 cents per pound, and see what fifty would bring.

Then, we sold our hen manure, and that helped for the feed of the chickens.

And let me say right here, anyone wanting to work a service like this must take care of their poultry. The common barnyard fowl will not do. To make a success of it, you must have pure-bred fowls, and feed them clean, wholesome grains and foods. I am not going to say here what you ought to feed them, for there are too many books on poultry, dealing with the subject, to waste space here.

Now, to the garden. Our main crop was musk melons. There were eight or ten people close around us raising musk melons, but I am ashamed to say they lost money. We got our seeds from a man down in Southern Illinois. I would tell you here what his name is, but I forget his address at the present. He called his melons Tip Tops, and they were some that he brought out a year or so ago by crossing two well-known kinds. I used to detest even the odor of a musk melon, but now I can hold my own with the best of the eaters. Some of these melons were twelve inches through the center. They were all so mellow and sweet that they would melt in one's mouth. We made six hundred dollars an acre from what we had. I am now trying to find out where that melon man lives, and will give his name to the readers of "The Farmer's Advocate" when I find out.

I might mention here that all the melons delivered were carefully scrubbed and washed and tagged before they left the place, and then covered with a tarpaulin so that they could not get dusty on the road. We had people come in autos for forty miles around to take home a dozen or two of these melons. The highest we charged was twenty cents for the "whoppers." We might have made infinitely more had we wanted to make a deal with some of the large hotels in near-by cities, but we derived more pleasure from sending home a happy load of people from the farm. Whenever people came, we always had a melon feast for them and showed them around the place, and told them what we were doing.

Then, we had little onions, several varieties of sweet corn, tomatoes and lettuce. Everything was the best we could buy. We watched carefully over everything to see that no one got anything poor. Each ear of corn was examined, and all the green leaves pulled off before we let it go out. Even when people came for their things

and were in a hurry, they had to wait until we got things ready for them. Many said, "Oh, never mind if there are a few poor ears, just throw them in here." We always tied things up carefully in packages, and we always had repeat orders from these people.

We were known in all the small cities around, and in many of the larger ones, too, for that matter. We were the envy of every market man, and had numerous chances to sell our goods to markets all down the North Shore. We found that people demanded things from our garden from their marketmen. One fellow came and begged us to sell to him, so that he could satisfy his customers. We told him that we would sell to him and give him the same price that we would give to the customer, on a written guarantee that he would not charge them any more. He had to do it. And he kept his agreement, because he had other things to sell and had to keep his trade.

We even went so far as to plan to have greater things for our clientele. We were going to have little milk-fed pigs for roasters. We were going to have prime-fed baby heeves for the holiday trade, and add to our garden truck. Canada called one of us, and the other went to Louisiana to work on a larger scale a farm of 5,500 acres.

All of these things were carried out by a young man who knew how to farm and a young man who held an office position and knew the value of the right kind of advertising.

Questions in regard to our methods will be cheerfully answered through the columns of this paper.

EDWARD DREIER.

Waterloo Co., Ont.

[Note.—This article, based on actual experience of the writer, was inspired by the cartoon, "The Juggler," in our Issue of April 18th. The real value of selling direct to the consumer is clearly set forth. Better satisfaction for all concerned would follow if more of this were practiced.—Editor.]

### Ontario Highway Legislation.

Following the account recently published in "The Farmer's Advocate," of what the different States in the neighboring republic are doing for road improvement, we addressed an inquiry to the premiers of the different Provinces of Canada on the same subject. From the office of Hon. J. P. Whitney, Premier of Ontario, we have received the following statement:

Ontario road laws provide, primarily, that responsibility for all work of highway improvement and maintenance rests with the local municipalities, and that each township, village, town, and city shall have control of the highways and streets within their limits. An exception to this is the provision for county roads. Under the Highway Improvement Act, any county council is authorized to assume for construction and repair a system of main roads within the county—usually about 15 per cent. of the total road mileage of the county. To this work of main road construction, the Provincial Government contributes one-third of expenditure, or one dollar for each two dollars raised by the county. In Northern Ontario, opening and improving of colonization roads rests largely with the Provincial Government. Wherever township organization has been established, the Colonization Road Act provides that a township may be voted, by the Legislature, a grant proportionate to the amount raised by the township for specified work. But a large part of this road work is unorganized territory, where the entire cost devolves on the Province.

At the session of the Ontario Legislature, just prorogued, a number of important measures were adopted by the Government. An expenditure of \$5,000,000 was authorized for the further development of Northern Ontario, and it is intended that a considerable proportion of that amount will be expended on roads. In addition, the sum of \$525,000 was voted by the Government for ordinary expenditure of the year on colonization roads. The Highway Improvement Act was so amended as to provide for:

1. More efficient supervision of the work.
2. The publication of complete statements of expenditure by county councils.
3. Contribution by cities to the cost of improvement in certain cases.
4. The construction of a partial system of main roads within a county, and the equitable apportionment of the cost among townships.
5. The construction of object-lesson and experimental roads by the Provincial Highways Engineer.
6. Authority was provided to enter into agreement with the Federal Government to receive subsidies for the purposes of the Highway Improvement Act.
7. And the one million dollars originally set aside under this Highway Act has now been exhausted, a second million was voted for the continuation of county work.

### Census of Canada's Dairy Industries, 1911.

The Dominion Census and Statistics Bulletin for March, 1912, gives the records of butter, cheese and condensed milk, as collected at the census of last year. There were 3,628 factories in operation in 1910. The quantity of butter made in the year was 59,875,097 pounds, having a value of \$15,682,564. This is 23,818,358 pounds more than in 1900, and the value is more by \$8,441,592. The quantity of cheese is 231,012,798 pounds, which is more than at the previous census by 10,179,529 pounds, but the value is less by \$600,776. The total value of butter, cheese and condensed milk in 1910 was \$39,143,089; and in 1900 it was \$29,731,922, being an increase of \$9,411,167 in ten years.

Taking butter alone, the value of the factory product was \$7,240,972 in 1900, and \$15,682,564 in 1910; and the value of cheese alone was \$21,890,432 in 1900, and \$21,620,654 in 1910. The average price of factory butter was 20 cents per pound, and of cheese 10 cents per pound; whilst in 1910 the average price of butter was 26.2 cents per pound, and of cheese only 9 cents per pound.

A comparison of the quantities and values of the production of butter and cheese is given in the following tables, by Provinces, for the census years 1901 and 1911 for the preceding years, respectively:

CENSUS OF FACTORY CHEESE.

Provinces.	Lbs.	1900.	\$	Lbs.	1910.	\$
Alberta .....	27,693	3,970		193,479	23,473	
British Columbia .....						
Manitoba .....	1,289,413	124,025		694,713	81,403	
New Brunswick .....	1,892,686	187,106		1,166,243	129,677	
Nova Scotia .....	568,147	58,321		264,243	29,977	
Ontario .....	131,967,612	13,440,987		157,631,823	14,845,661	
Prince Edward Island .....	4,457,519	449,400		3,293,765	354,378	
Quebec .....	80,630,199	7,957,621		67,741,802	6,152,689	
Saskatchewan .....				26,730	3,396	
Totals .....	220,833,269	\$22,221,430		231,012,798	\$21,620,654	

CENSUS OF FACTORY BUTTER.

Provinces.	Lbs.	1900.	\$	Lbs.	1910.	\$
Alberta .....	406,120	82,630		2,149,121	533,422	
British Columbia .....	395,808	105,690		1,206,202	420,683	
Manitoba .....	1,557,010	292,247		2,050,487	511,972	
New Brunswick .....	287,814	58,589		849,633	212,205	
Nova Scotia .....	324,211	68,686		354,785	88,481	
Ontario .....	7,559,542	1,527,935		13,699,153	3,482,171	
Prince Edward Island .....	562,220	118,402		670,913	156,478	
Quebec .....	24,625,000	4,916,756		37,346,107	9,895,343	
Saskatchewan .....	339,014	70,037		1,548,696	381,809	
Totals .....	36,056,739	\$7,240,972		59,875,097	\$15,682,564	

The increased price of factory butter led to a larger production in 1910 than in 1900, and this was made especially in Quebec, at the cost of a lower production of cheese. The change was further induced by the lower rate of duty on cream in the United States, which encouraged larger exports to that country.

The number of condensed milk factories in operation increased from four, in 1900, to twelve in 1910, and the value of product increased from \$269,520 to \$1,839,871. There are now six factories in Ontario, with a product value of \$1,335,689; two in Nova Scotia, with \$133,956; two in Quebec, with \$275,000; one in British Columbia, with \$44,326, and one in Prince Edward Island, with \$50,900. In 1900 there were two factories in Nova Scotia, and one each in Prince Edward Island and Ontario.

ARCHIBALD BLUE,  
Chief Officer.

### Foot-and-mouth Disease Again.

We are informed by Dr. George Hilton, acting Veterinary Director-General, that the Dominion Government issued an order on April 16th, to take effect on said date, prohibiting for three months the importation or introduction into Canada of any hay, straw, fodder, bedstuffs or litter accompanying horses from continental Europe. The shipment into Canada of cattle from Great Britain, Ireland and the Channel Islands on steamers carrying horses from continental Europe, is also prohibited for the same period. This move was taken in order to safeguard the interests of Canadian live stock, owing to the fact that foot-and-mouth disease is at present prevalent in the countries of continental Europe.

### Favors Wire Fences and Trunk Roads.

Editor "The Farmer's Advocate":

In discussing the problem of bad roads and their improvement, the social drawback is a question that might be taken up from a great many viewpoints, but it is not my intention to enter into a many-sided article on this question, but just as it has had its effect on the community in which I live.

In the first place, when is social life most indulged in in the rural community? In my experience, I would say the winter months, especially by the younger class of people. Now, the greatest drawback to the social functions in rural districts in winter is the snow-blocked condition of the roads for about three or four months. This condition of affairs is being partly overcome by the use of wire fences. The council of this municipality (Pickering Tp.) have enacted a by-law granting a bonus of 15 and 25 cents per rod for wire fence, to be erected on the north-east and west sides of the highway, wherever the snow has a chance to fill the road. It not only has the effect of giving a good road that can be travelled at any time after a storm, but it also makes a marked improvement on the roads in the spring, when the snow begins to melt, instead of having large snow-banks gradually melting and trickling on the roads for two or three weeks, and in some instances longer, causing washouts in the road, rendering it almost impassable. With the wire fence, the sides of the roads are clear of snow

first, opening the ditches, and making room for the snow that may have accumulated during the season, thus causing the roads to be dry much sooner than they otherwise would be with the large snowbanks on the sides. I claim that bonusing wire fences is a great step in the right direction in overcoming the bad-road question, especially in the winter and early spring months, when rural social life is most indulged in. Now I don't wish to be understood as opposed to any good-roads scheme, as what can we enjoy any better than a nice pleasure trip on a first-class road? Then, the question might arise in rural districts about time to have those pleasant trips. When it is pleasant to drive, it is not always convenient to take time. As the old proverb goes, the farmer must make his hay when the sun shines; and during the summer almost any road is good, unless it has been covered with very coarse gravel—in some cases you might say stone, uncrushed—causing a great amount of annoyance, as well as a very great loss in damage to vehicles.

In my opinion, there are only about from three to five weeks of bad roads in the spring and fall. I find by experience that bad roads can, without any very great expense, be considerably improved by the use of a split-log drag on the road as soon as it dries sufficiently to use it. A man and team will smooth up a mile in about two hours that you might think equal to a park drive.

I think one fact that has been overlooked in the construction of roads in the past is proper underdrainage of the low places. This brings to my memory a very bad piece of road that was almost impassable every spring. It always got boggy. A 4-inch tile was placed about 3½ feet

deep just alongside of the track, and then the road was nicely rounded up with the grader, in the summer of 1908, and up to the present time it has shown no signs of being springy. Where it was formerly very often necessary to drive several miles out of the way to avert being stuck in the mud, there is now a good permanent road, thus overcoming some of the economic losses sustained by the farmer in making this extra drive. I believe that a clay road, properly graded and underdrained is a better road than a low, flat, metal road with the water lying on it and no provision for drainage, especially where the traffic is not too heavy.

We believe the time is not far distant, if not already here, for a different system of roadmaking and maintenance from the old method of statute labor, although the statute-labor system is in use yet with us. The commutation system was in use about seven years here, but, sorry to say, did not come up to the expectation of its warmest supporters, the fault not being in the system, but in the management. I think the commutation system is the proper way, as every ratepayer is forced to pay his proper share; while, in statute labor, they very often fail to perform their work as faithfully as they should.

Then, the great question arises, how to get good roads, owing to the increased scarcity of good road material, the increased cost of labor and the large mileage of roads, and the increased cost of constructing bridges, the individual municipalities are unable to keep pace with the times. It is very evident that the country is getting alive to the fact that aid must come from sources other than individual ratepayers of the rural districts. I would suggest that a trunk road be built from Windsor to Montreal, taking in the county towns of Chatham, St. Thomas, Simcoe, Cayuga, Hamilton, Milton, Toronto, Whitby, Port Hope, Cobourg, Belleville, Kingston, Brockville, Prescott, Cornwall and Montreal, with a branch from Chatham to Sarnia, one from St. Thomas to London, Woodstock, Stratford, Goderich, Walkerton and Owen Sound; one from Hamilton to Galt, Guelph, Brampton, Orangeville, and also to St. Catharines and Welland; one from Toronto to Barrie and Collingwood; one from Port Hope to Peterborough, Lindsay and Orillia; one from Ottawa to Perth, and from Ottawa eastward, taking in the county towns to Montreal; these roads to be subsidized from the Dominion treasury, under Provincial control; the Provincial Government and all cities of 100,000 and over to subsidize all leading roads converging to above cities within a radius of 25 miles; the Provincial Government and all cities of 10,000 and up to 100,000 to subsidize all leading roads converging to above cities within a radius of 15 miles; the Provincial Government and all towns of 2,500 and up to 10,000 to subsidize all leading roads converging to above towns within a radius of 10 miles; the trunk lines not to be considered in this class of roads, and all other macadamized roads other than the above mentioned, to make any connections where they fail to meet, to be constructed by the Provincial Government. And all other roads to be constructed and maintained by the rural municipalities and the Provincial Government equally, for Government standard roads, as we believe we have a great many roads in the Province that it would be impossible and also very unnecessary to bring up to the standard of a macadamized road. For instance, take a road that has not very much heavy traffic. If such road were properly underdrained where necessary, and graded and kept smoothed up with a split-log drag, it would be all that is necessary. The Provincial Engineer to adopt a certain standard or grade for the municipalities to comply with before they would be entitled to the grant, and this would have a tendency to formulate a uniform grade of road—one point that is greatly overlooked in the present system. You will notice the above plan will give almost a complete network of leading roads connecting all or nearly all the larger centers of trade and commerce.

The Dominion grant could be controlled by the Province, and all roads to be constructed and maintained equally by the Provincial Government and the different corporations connected therewith. Having formulated a plan of roadways, the great and vital question arises as to the most economical way of constructing these roads, and the maintenance of same after they are constructed. My suggestion would be to commute all statute labor, divide the municipalities into sections or wards, engage a permanent force of teams and men, and keep them on the road all the time—that is, during the summer season—to perform the work that would be necessary, such work to be under the control of a commissioner or engineer, to be appointed by the council of the municipality, such person to be a qualified person in the art of roadmaking. Just here, I think a course could be established, and lectures given on the subject, that would greatly assist in the making of a uniform class of road. I believe it

would be advisable to pass an examination and have a certificate of qualifications for doing business. The Farmers' Institute lecturers could well afford to take up the subject. Much education is needed.

Now, just one thought on engaging a permanent force of men. Such men get accustomed to their work, will perform more work in a given time, and make a better job than the ordinary farmer or laborer, simply because they take more interest in their work.

Ontario Co., Ont.

E. B. HOOVER.

[Note.—This was an essay consigned for competition, and, while not receiving a prize, contains many good hints. The trunk system is not favored by all, but this gives an idea where the roads might be located if such a system was ever followed.—Editor.]

### East Middlesex, Ont.

Spring and grass, already beginning to coat the pasture land, were never more welcome than this season, for daylight shows through most of the barns, and many persons have been forced to buy hay and other fodders for the stock, at almost famine prices. Meadows and new clover seedings in some cases show the ill-effects of too close pasturing last fall, but the weather this spring has not been unfavorable for the new clover roots, nor yet on fall wheat where it acquired a sufficient autumn top, which it did when sown early on properly-prepared land; but it is too much to expect something from nothing. The day when people could take liberties with the soil is long since past, particularly for an exacting crop like wheat. As usual, the advantages of tile drainage are apparent in most localities. The speedy removal of surface water prevents soil baking and facilitates early cultivation and seeding. With proper cultural methods to hold what we have, thoughtful students of the relation of weather and vegetation are looking for grass and grain crops of even more than old-time luxuriance this season. For probably eight or ten years the soil has not had such a thorough saturation as it has since last fall, and the heavy blanket of soil lying long has tended to enrich the soil and prevent its drying out; so, with proper tillage, there is an ample supply of moisture—prime requisite of a great crop. Cheese factories are mostly in operation, but their preserve is being steadily encroached upon in some localities for supplies of town milk and cream. The competition may not be unwholesome, but the cheese factory has points that commend it to a great many dairymen, and it has stood the test of many years' experience. So, with good prices for the product and an enlightened and liberal policy on the part of factorymen, it is likely to continue one of the mainstays of dairying in this section of Western Ontario.

### Sandy's Spring Medicine.

Editor "The Farmer's Advocate":

Noo that spring is here once mair, and a' o' us wha hae escaped the dangers o' the winter, wi' its hot-air furnaces an' badly-ventilated hooses, an' its overeatin' an' oversleepin, are thankin' Providence for bringin' us through alive, ye an' yer readers will na doot be wantin' a dose o' spring medicine. So gin ye're no' objectin' ower muckle, I'll be gettin' the bottle an' the spoon an' giein' ye a wee bit drappie o' somethin' that I hope will no' do ye any harm, at the worst. I'm no' ony great doctor in the way o' settin' broken bones an' the like, but I can write prescriptions by the yard, an' gin ye do not ask me to try them on mysel', we'll no' quarrel. An' the kind o' prescription that I was thinkin' o' writin' the noo is not one ye can get filled at the druggist chap's, but aye that ye'll hae to fill an' tak' a' by yersel'.

Na doot ye're sayin' tae yersel' by this time, "I see Sandy is in for giein' us some mair free advice about somethin' that he kens na mair about that we dae oorselves." Weel, maybe ye're richt. An' gin ye ken sae muckle, ye'll juist hae tae tak' this as a reminder that ye should act, as weel as understand. But what I hae been thinkin' is that we farmers should tak' a day off at this time o' year to mak' two or three guid resolutions, an' think oot a coorse o' action for oorselves for the comin' summer. We all want this year tae be a wee bit o' an improvement over last, in the way we do oor wark an' the pay we get for it. Noo, there's a hale lot o' us in the business o' keepin' coos an' makin' oor livin' oot the mair money we are likely tae hae, an' the higher oor standard o' living, as a rule. There are exceptions tae this, I ken, but it's a fact that a mon wi'oot means canna' avail himsel' o' the opportunities that may be before him, as he otherwise could. The mon wi'oot onything is generally a tramp. So I'm sayin' it's up tae us tae do a bit thinkin' hoo we can improve oor methods o' handlin' oor stock this comin' sum-

mer, an' at the same time gie the dairy industry o' oor country a boost that will mak' oor competitors in ither parts o' the world sit up an' tak' notice.

I mind weel, a few years back, the way a guid mony o' the cheese factories were rin. The maker wad tak' in maist ony kind o' milk, an' gin it were na' sour eneuch tae guarantee his gettin' through his day's wark by two o'clock, he wad gae oot tae the whey-tank an' get a pail or two o' the whey that had been layin' there, maybe a week or mair, an' dump it intae the milk vat, wi' the result that he got through on time, but the patrons lost mair money than they kened about by the operation.

Nooadays we hae, as a rule, guid cheesemakers, an' na doot the milk comes tae the factory in better shape, too, but there's a hale lot tae be learned yet by the maist o' us. Some o' us seem tae forget that cheese an' butter are made tae be eaten by some o' oor fellow men, judging by the amount o' attention we gie tae cleanliness an' sae on. I heard tell o' a cheesemaker wha put a lead pencil mark on the inside o' a milk can that was comin' tae his factory, an' it was mair nor twa weeks before it was washed off. An' what like condection dae ye think milk is in that is left uncovered near a coo-stable door on a warm nicht, an' in a can that was not overly clean in the first place? There's nae use talkin', gin we dinna' pay mair attention tae keepin' oor coos clean, an' everything else that comes intae contact wi' the milk, as weel, we canna' expect tae get the best price for oor produce, be it cheese, butter, cream, or milk. Gin ye're gaein' tae pit a fancy article on the market, ye've got to hae the raw material kept in guid condection. When ye hae tae pay war-prices for feed for yer stock, ye canna' vera weel afford to sell yer stuff for the price that ye'll get for a second-class article. It tak's some time tae a wee bit o' effort tae hae things up tae the mark a' the time; but it pays, an' it doesna' pay not to. As I said once before, cleanliness is ahead o' godliness, for gin ye're no clean, ye canna' be godly.

Noo, this is juist the medicine I was talkin' about giein' ye, when I started oot. I'm no' gaein' tae gie ye ony salt or sugar along wi' it, an' ye can tak' it or leave it, but I'll say this, that, gin we could juist mak' this one improvement in oor farm operations in the year 1912, we wad be daein' mair for oorselves an' oor country than we may think possible. Frae a financial point o' view, we're bound tae gain, an' frae a moral point o' view we canna' lose. Sae I commend the proposition for yer conseederation.

SANDY FRASER.

### Weak Wheat — How to Help It.

"Winter Wheat in Bad Condition" is the general report of the condition of this important cereal throughout the Middle West States. A large percentage of the millions of acres devoted to this crop is reported to be weak and to have been severely injured by adverse wintering conditions. In many places the ground is baking, and still further injury is threatened. Such serious conditions call for immediate action.

The farmer knows that the wheat plant requires heat, air, moisture and available plant food in order to live and make satisfactory growth. The lack of any one of these essentials means death to the crop. As the warm sun of spring beats upon the hardened wheat fields, it causes the evaporation of hundreds of barrels of water per day from a 50-acre field, because the water connection between the surface soil and the water supply below is complete. Now, to stop this great evaporation, and to allow air to enter into the soil spaces, the farmer must act quickly if he is to save his crop.

He should roll his wheat field as soon as it will bear a team upon it, and follow this rolling immediately with a light harrowing. If he has a weeder, he can accomplish a great deal of good by going over the wheat crop with this tool. If he has harrows with adjustable teeth, he should throw these teeth back at an angle of 45 degrees, and harrow the field, going back and forward over the field parallel with the wheat rows. This harrowing will not stir the surface deep enough to injure the wheat roots, but will help the soil conditions greatly by preparing a surface mulch. This surface mulch will break up the water connection in the soil and effectively prevent an injurious amount of evaporation. Always follow rolling with a light harrowing.

If, however, the farmer does not have a roller, or if he does not think it wise to roll the wheat, he can help the weak wheat crop a great deal by a careful harrowing.

The above operations can be carried on even until the wheat is up four inches, without injury to the crop. This practice is common among European wheat-growers.

If grass and clover seed is sown upon the wheat field in early spring, practice of this early sum-cultivation will bury the seed sufficiently deep to

insure good germination. The addition of valuable plant food in the forms mentioned, will greatly increase the chances of a successful "catch of grass."

By such treatment, weak wheat will be greatly benefited and materially assisted towards a profitable yield of superior quality of grain.

### Reforming the Teachers.

A document issued by the National (United States) Bureau of Education sets forth the proposition that "rural school teachers are a positive force to depopulate the country districts. The courses of study, the methods of teaching, the general tone and influence of the country schools tend to drive the young to the towns." This is by no means a new discovery. But that rural teachers have been, and often still are, such an inimical force, is due chiefly to the system to which, until recently, they were obliged to conform if they would obtain an education fitting them for a teacher's certificate. Now, however, that system is being gradually reformed by the introduction of courses directly bearing upon country life; by the revision of text-books, so that examples and exercises shall be based upon agricultural affairs, and by the exaltation of rural topics as equally interesting and mind-expanding with those of the counting-room and factory. Even the Bureau of Education has caught some inspiration to activity in the interest of "education toward the farm," and has compiled "A Course of Study for the Preparation of Rural School Teachers," for free distribution to those aspiring to the greatest usefulness in the country school.—[C. R. Barns, of Minnesota.

### Some Wheat Growing Comparisons.

(Our English correspondence.)

Statistics are ordinarily considered to be "dry" reading, and certainly, when one is confronted with scores of pages of solid figures, they present rather an unattractive appearance. But when the figures are examined, and comparisons made, many most interesting and important facts are brought to light, and much valuable information gained.

An elaborate return was recently presented to the British Parliament by the Board of Agriculture, containing exhaustive sets of statistics covering British, colonial and foreign agriculture for a series of years. Every country and every possession is dealt with, both as regards the leading crops and live stock, and in every case the figures are from reliable sources.

We are all more or less "insular" in our ideas, and with the general impression that our methods lead to results superior to those obtained in other lands. Our ideas are based on ignorance, usually from lack of the means of acquiring actual knowledge of conditions in other lands. The Britisher, for instance, usually holds the idea that his country produces more wheat to the acre than any other country. The British wheat average for the five years preceding 1910 was 33.37 bushels to the acre, a capital average on a fairly large

acreage, but the Belgian average for the same period was 35.80 bushels, and that of the Netherlands 34.54. By far the largest acreage of wheat in any one European country is in Russia. Excluding Poland, Russia had, in 1910, about 52 million acres, but the five-year average yield was only 8.87 bushels. Germany has about as much land under wheat as Saskatchewan, and her average is 29.73 bushels. The Saskatchewan average, from Provincial Government figures, is 18.25 bushels. Food for consideration here—when the virgin soil of Saskatchewan is remembered, and German cropping for centuries. Hungary is a good wheat-growing country, and in 1910 had about the same acreage as Canada, excluding British Columbia. The Hungarian average for five years is 17.47 bushels, and the Canadian (1907-1909), 18.20.

Although the Dominion average of wheat is by no means flattering, still it compares favorably with the sister commonwealth, Australia, as the Australian five-year average is but 10.22 bushels. Argentina, another big wheat-growing country, has an average of 11.39, and the United States average is 14.31.

While your Western wheat area has been extending with marvellous rapidity of late years, other countries can also show wonderful expansion. Comparing 1910 with 1909, your area increased by just over 1,500,000 acres; that of India by nearly 1,750,000, Australia by 750,000, Argentina by 1,000,000, and the United States by almost 2,500,000. The total British increase was just over 4,000,000 acres.

F. DEWHIRST.

### GOSSIP.

Five lambs at a time is the birth record reported of a gray-face ewe, the first week in April of this year. The ewe and her quintette of youngsters are the property of Mr. Fortune, of Portsoy, Scotland, and the whole lot are alive and hearty.

George Gier & Son, Grand Valley, Dufferin Co., Ont., breeders of Shorthorn cattle, whose young stock won several important prizes at Toronto last year, send, too late for this issue, a change of advertisement in which they offer at a low price, a nice red bull 12 months old, of the excellent Bellona family, the heifers of breeding age recently advertised having been all sold.

At an auction sale of Jersey cattle, the property of J. Michael, at Fairmount, West Virginia, the second week in April, the bull Golden Fern of Rockland, by Golden Fern's Lad, sold for \$2,000, to W. E. Shaver, West Virginia. The six-year-old cow, Raleigh's Silver Duchess (imp.), went to A. R. Howard, at \$625. Four other cows brought prices ranging from \$400 to \$460, and nine others from \$300 to \$360 each.

At the dispersion sale in the first week of the present month, of the Sunnyside Clydesdale stud of Alexander McRobie, Aberdeen, Scotland, good prices prevailed. The top price was \$1,450, for the bay four-year-old stallion, Leonarda (15917), bred by the Seaham Harbour Co., sired by Gamecock, and purchased by John Gibson, Brechin. The bay four-year-old horse, Craigievar, by Cassablanca, sold for \$1,130, to W. Marshall, V. S., Aberdeen, and the bay four-year-old Sunnyside Conqueror, by Baron's Conqueror, was taken by W. Rutherford, Crail, at \$1,050.

Richard Honey & Sons, Brickley, Ont., breeders of Holsteins and Yorkshires, too late for insertion in this issue, send a change of advertisement which will appear next week. Messrs. Honey also report recent sales of Yorkshires to Thos. McBride, Niagara Falls South; John J. Minaker, Black River Bridge; Henry Chesterfield, Dundonald; Edward Fleming, Hastings. They have only one boar left that is old enough for service, but have some choice ones just weaned. In Holsteins, they have some very choice bull calves for sale, sired by their stock bull, Lakeview Burke Fayne, whose dam and sire's dam average 23.14 lbs., and his sire has ten sisters that average 30.63 lbs. butter in seven days, while the calves are from large producing dams.

Col. Ferguson, of Inverary, and Samuel Jamieson, of Battersea, Frontenac Co., Ont., have purchased from Hayward Ripley, of Elgin, at a fancy figure, a Holstein bull, a brother of the cow owned by W. C. Stevens, of Philippsville, which died April 7th. This bull is a son of the cow, Jewel Princess Pet.

### TRADE TOPIC.

The lawn or garden swing is a pleasant and inexpensive comfort in the summer months for the children, and grown-ups as well. The Stratford Manufacturing Company, Stratford, Ont., make these and other out-door furniture solid and strong. See their advertisement in this paper, and write for their free booklet.

### QUESTIONS AND ANSWERS. Miscellaneous.

#### HORSE COUGHS.

Horse rising five years has been fed on straw all winter, and about 6 quarts of oats a day. Seemed all right until about a week ago, when he started to cough some and sides would roll. Is in good condition and feels well, but does not drink much. Would like to have your advice.

Ans.—The description of the trouble is scarcely ample enough to justify a diagnosis of the case. He may have cold or distemper, or the trouble may be heaves. If still coughing and breathing heavily, feed only on first-class food. Dampen all he eats. Increase the grain ration, and avoid hard work soon after feeding or watering. It might be advisable to call your veterinarian, as he is a young horse, and horses of this age rarely contract heaves.

#### STEEL SILO.

In looking up my old "Farmer's Advocate" in regard to steel silos, I found that some men wrote letters in 1910. They had just put them up year before. Will you be so kind as to ask them to write again and tell us how they are standing it; if the paint on inside is giving satisfaction, and if they freeze much, etc.?

Ans.—Correspondents writing to this office on this subject state that there is some difficulty in protecting the inside of the silo against the acid of the silage. W. C. Good, of Brant Co., found a rubber roofing felt to be the only effective means of averting this trouble. This is stuck to the walls of the silo, the lap joints that goes with the roofing. He is now trying a mixture of red lead and oil, covered by a wash of Portland cement this summer. Other readers owning steel silos are invited to communicate their experience to our readers through their papers.

### MOLES.

Will you kindly tell me how to get rid of moles in our lawn? Would mouse traps be of any use, and if so, what bait should be used? E. H.

Ans.—Moles are insectivorous animals, and it is doubtful whether they can be successfully trapped. By using baited traps, a specially devised cylindrical trap set in their runways or burrows is sometimes used. They prove a pest in some lawns, and are hard to get rid of. Carbon-bisulphide, if it can be made to reach them, will do the trick. As their borings are often quite extensive, this is not always successful, but can be tried. Place some of the material in the hole and carefully plug it so that the fumes penetrate the moles' holes and smother them.

### FEATHER PULLING.

My hens have been eating their feathers this winter, and are still at it. Some have few left other than their tail and wing feathers. They are all last year's pullets, and have laid well all winter, fed mostly on wheat, boiled potatoes, with oat or barley chop mixed. They have had oyster-shell all winter. What is the cause, and what will prevent it? T. M.

Ans.—Eating or pulling feathers is generally supposed to be due to a lack of meat food. Sometimes a few birds seem to contract the habit of feather pulling. Give the hens free run, and milk to drink. Some claim a little sulphur added to their mash or drinking water is beneficial. Little trouble is likely after the hens get plenty of green feed and meat food in their diet, and free summer range.

### MISCELLANEOUS QUERIES.

1. Have a young bull with one visible testicle. If he is deprived of this, would it be safe to turn him out with young heifers?  
2. Have about forty hens. Does it make any difference to the number of eggs we get if I haven't a male bird in the flock?  
3. How should cow's milk be diluted to feed very young lambs?  
4. Will posts heave up more if planted when moon is growing?

#### A SUBSCRIBER.

Ans.—1. Not likely. The other testicle is likely present, but not down in the scrotum.  
2. Not a particle. The male should be removed from the flock during the summer season, unless eggs are to be used for hatching.  
3. Ewe's milk is said to be richer than cow's milk. Use the milk of a fresh cow. If very rich, add about 25 per cent. water, and always add brown sugar. As the lamb gets stronger, it will stand stronger milk.  
4. Why about that?

### SHOE BOIL.

What would produce a swelling on my mare's front leg, right close to the elbow joint, about the size of a double fist, and now all the leg is swollen a little? F. S.

Ans.—This is a shoe boil, or capped elbow. It is caused by the mare lying with the elbow resting on the heel or shoe. It is rare in unshod horses. If serum or pus is present, it should be removed. If a fibrous tumor, it must be dissected out and dressed as for an ordinary wound. Absorbents sometimes apparently effect a cure.

### CEMENT FOR WALL.

My brothers and I are talking of building an outside cellar that would be in the side of a bank. The bank is eight feet high, and we think we will build it out of cement, wall 8 feet high and 16 inches at base, 8 inches at top. The building will be 40 x 30, 8 feet high. How many barrels of cement will it require to build this wall, and how much gravel would you advise to be put to one barrel of cement, and would it be all right to use large rock well washed; rock 8 and 10 inches thick, and how much had a wall of that size ought to cost? F. W. S.

Ans.—Mixing one to eight would require 42 barrels of cement and 10½ cords of gravel. Some large stones could be used in the wall.

### FEEDING MOLASSES.

1. Of what value is feeding syrup for cows and horses, and what amount should be fed?  
2. Did the Stallion Enrollment Act, before the Provincial House some time ago, pass? If so, what are the principal points?  
3. In plan given for septic tank in "Home Waterworks," tile are laid from 8 inches to a foot below surface of ground for contents of tank to pass out through. Aren't these likely to freeze during winter and stop the flow of refuse?  
4. How should cow's milk be diluted to feed very young lambs?

Ans.—1. We presume molasses is meant. Cane molasses has a feeding value about equal to corn. It is palatable, and in small quantities is much relished by animals. Beet molasses is bitter and not relished, often purge the animals, and of little feeding value. There is little to be gained by feeding even cane molasses over results obtained from corn, although it acts somewhat as an appetizer. It is sometimes used in preparing animals for show-ring purposes. Two or three pounds daily with the grain ration would do no harm.  
2. Yes. See article in our issue of February 29th, page 369.  
3. Very little. Bacterial activity keeps the sewerage rather warm, and the overflow tiles are not running continually.

## THE CANADIAN BANK OF COMMERCE

ESTABLISHED 1867

Capital, paid-up, \$15,000,000.  
Rest, \$12,500,000.

The Canadian Bank of Commerce extends to farmers every facility for the transaction of their banking business, including the discount or collection of sales notes. Blank sales notes are supplied free of charge on application.

Accounts may be opened at any branch of the Canadian Bank of Commerce to be operated by mail, and will receive the same careful attention as is given to all other departments of the Bank's business. Money may be deposited or withdrawn in this way as satisfactorily as by a personal visit to the Bank.

## MARKETS.

### Toronto.

At West Toronto, on Monday, April 22nd, receipts of live stock numbered 81 cars, comprising 1,835 cattle, 324 hogs, 50 sheep, 36 calves; quality of cattle good; prices strong. Exporters, \$6.90 to \$7.40; export bulls, \$5.50 to \$6.25; butchers' steers and heifers, 1,000 to 1,150 lbs., at \$6.60 to \$7.20; cattle, 800 to 900 lbs., \$6 to \$6.50; common, \$5 to \$6; cows, \$4.50 to \$6; canners', \$2.75 to \$3; bulls, \$4.50 to \$5.50; milkers, \$40 to \$60; calves, \$40 to \$70. Sheep, \$5.50 to \$6.50; yearlings, \$6.50 to \$9; spring lambs, \$4 to \$8 each. Hogs, \$8.50 for selects fed and watered, and \$8.15 f. o. b. cars.

REVIEW OF LAST WEEK'S MARKETS  
The total receipts of live stock at the City and Union Stock-yards last week were as follows:

	City.	Union.	Total.
Cars	241	200	441
Cattle	2,777	2,487	5,264
Hogs	6,859	5,920	12,779
Sheep	926	415	1,341
Calves	1,524	186	1,710
Horses	—	152	152

The total receipts of the two markets for the corresponding week of 1911 were as follows:

	City.	Union.	Total.
Cars	182	145	327
Cattle	2,105	1,881	3,986
Hogs	5,422	2,158	7,580
Sheep	1,188	2,301	3,489
Calves	655	162	817
Horses	22	108	125

The combined receipts of live stock at the City and Union Stock-yards for the past week show an increase of 114 carloads, 1,278 cattle, 5,199 hogs, 893 calves, and 27 horses; but a decrease of 1,148 sheep, compared with the corresponding week of 1911.

Deliveries of live stock, especially cattle, at both yards, were much larger than for several weeks. Trade was fair, although at the commencement of the week prices were a little lower, and on Monday there was no demand for the export class at the price asked by drovers. Later in the week orders were received by a few of the dealers which enabled them to practically clean up the market, at prices which were about the same as for several weeks past, excepting for one load of extra choice steers that sold for \$7.50 per cwt., which was the top.

Exporters.—Export steers sold from \$6.75 to \$7.25, and one load of twenty steers, 1,282 lbs., of extra choice quality, fed by three farmers in Waterloo county, and brought on the market by A. Barber, of Guelph, and sold by Rice & Whaley to Alex. McIntosh, for J. Shamberg & Son, at \$7.50; export bulls sold at an average of \$5.65.

Butchers'.—Heavy steers for local kill sold at \$6.90 to \$7.15, and \$7.25 for a few; loads of good, \$6.50 to \$6.80; medium, \$5.90 to \$6.40; common, \$5.10 to \$5.35; inferior, from \$1.25 to \$3; cows, \$3 to \$6, and some extra quality loads of 1,300 to 1,500 lbs. weight

brought \$6.25 to \$6.75; bulls, \$4.50 to \$5.25. H. P. Kennedy bought 340 cattle for the Montreal, at \$6.40 to \$7.30, all for the Montreal Abattoir Co.

Stockers and Feeders.—The demand for stockers and feeders was greater than the supply. Steers, 700 to 900 lbs., sold from \$5 to \$5.75; short-keep steers, 1,000 lbs., sold as high as \$6.

Milkers and Springers.—Trade for milkers and springers was no more than steady, and prices ranged from \$40 to \$65 each. Extra cows of heavy weights would bring more money, up to \$70.

Veal Calves.—Receipts of veal calves were liberal, and many of poor quality were on sale. Prices generally were weaker. Bobs sold at \$1.75 to \$3 each, and medium to good calves at \$4 to \$8 per cwt.

Sheep and Lambs.—Receipts were fair. Ewes sold from \$5 to \$6, with a few light, of good quality, at \$6.50; rams, \$4 to \$5; yearling lambs sold from \$6.50 to \$8.50 per cwt., and a few of extra quality brought \$9.

Hogs.—The hog market was a little easier. Selects, fed and watered at the market, sold at \$8.50 to \$8.65, and \$8.15 to \$8.25, f. o. b. cars at country points.

Horses.—The various Horse Exchanges reported a good trade. At the Union Stock-yards' stables on Wednesday, 75 horses were offered by auction, out of which 46 were sold at fair prices. Drafters sold at \$175 to \$250; general-purpose, \$150 to \$200; expressers, \$160 to \$200; drivers, \$90 to \$150; serviceably sound, \$30 to \$90. There were instances of extra quality bringing more money, but the above are fair, average quotations.

### BREADSTUFFS.

Wheat.—No. 2 red, white or mixed, 98c. to \$1, outside points. Manitoba No. 1 northern, \$1.14; No. 2 northern, \$1.11; No. 3 northern, \$1.07; track, lake ports. Oats.—Canadian Western extra No. 1 feed, 53c.; No. 1 feed, 52c., all rail, Toronto; Ontario No. 2, 49c. to 50c.; No. 3, 47c. to 48c., outside points; No. 2, 50c. to 51c., track, Toronto. Rye.—No. 2, 85c. per bushel, outside. Buckwheat—72c. to 78c. per bushel, outside. Peas.—No. 2, \$1.20 to \$1.25, outside. Barley—For malting, 90c. to 92c. (47-lb. test); for feed, 60c. to 70c. Corn.—American No. 3 yellow, all rail from Chicago, 85c. Flour—Ontario 90-per-cent. winter-wheat flour, \$3.80, seaboard. Manitoba flour—Prices at Toronto are: First patents, \$5.60; second patents, \$5.10; strong bakers', \$4.90, in jute; in cotton, \$5.

### HAY AND MILLFEED.

Hay.—Baled, car lots, track, Toronto, No. 1, per ton, \$17 to \$18; No. 2, \$14.50 to \$15. Straw.—Baled, car lots, track, Toronto, \$9 to \$10 per ton. Bran.—Manitoba, \$25 per ton; shorts, \$27 per ton; Ontario bran, \$25 in bags; shorts, \$27, car lots, track, Toronto.

### COUNTRY PRODUCE.

Butter.—Market easier. Creamery pound rolls, 36c. to 37c.; creamery solids, 34c.; separator dairy, 34c.; store lots, 31c. Cheese.—Large, 16c.; twins, 17c. Honey.—Extracted, 13c.; combs, per dozen sections, \$2.50 to \$3. Eggs.—Market about steady, at 23c. to 24c., for case lots. Beans.—Market strong. Broken lots, \$2.40 to \$2.50 for primes, and \$2.60 to \$2.70 for hand-picked. Potatoes.—Market firmer. New Brunswick Delawares, car lots, track, Toronto, \$1.85 to \$1.95; Ontario stock, \$1.70 to \$1.75; English and Irish, \$1.55 to \$1.60, for car lots, track, Toronto. Poultry.—Receipts very light. There is plenty of cold-storage of all kinds selling.

### HIDES AND SKINS.

Prices for hides and skins at Toronto for the past week: No. 1 inspected steers and cows, 12c.; No. 2 inspected steers and cows, 11c.; No. 3 inspected steers, cows and bulls, 10c.; country hides, cured, 11c. to 11c.; green, 10c. to 10c.; calf skins, 13c. to 16c.; sheep skins, \$1 to \$1.40 each; horse hides, No. 1, \$3.25; horse hair, per lb., 35c.; tallow, No. 1, per lb., 5c. to 6c.

### TORONTO SEED MARKET.

Following are the prices at which cleaned seeds are being sold to the trade:

Alsike No. 1, per bushel, \$15 to \$15.50; alsike No. 2, \$13 to \$14; red clover No. 1, per bushel, \$15 to \$15.50; red clover No. 2, per bushel, \$13.50 to \$14.50; alfalfa No. 1, per bushel, \$11 to \$12; alfalfa No. 2, per bushel, \$9.50 to \$10.50; timothy No. 1, per cwt., \$17.50 to \$18.50; timothy No. 2, per cwt., \$15.50 to \$16.50.

### FRUITS AND VEGETABLES.

Apples.—Spies, \$4 to \$6 per barrel; Baldwins, \$3 to \$4.50; Ben Davis, \$3 to \$3.50; Russets, \$2.50 to \$3.50; Canada Reds, \$3. Onions, Egyptian, sack, \$3.75; parsnips, per bag, \$2; turnips, per bag, 75c.; carrots, per bag, \$2; cabbage, per case, \$5; beets, per bag, \$1.25 to \$1.50; celery, per case, \$1.50 to \$2.

### Montreal.

Live Stock.—In the local market the undertone for cattle was quite firm, and the market advanced a fraction. Buyers were coming forward freely, and there was a scarcity of choice cattle. There were quite a few animals selling at 7c. to 7c. per lb., and the bulk of the really nice steers brought not less than 6c. Good cattle would bring 6c., and medium stock sold at 5c. to 5c., while common sold down to 4c. Canners' cattle were 3c. to 3c. Choice milkers were steady, at \$70 to \$75 each, common being about \$15 less. Springers sold at \$35 to \$45 each. Sheep sold at 5c. to 5c. per lb. for ewes, bucks and culls being 4c. to 4c. per lb., and lambs 7c. to 7c. per lb. Calves were in good supply, and prices continued at \$2 to \$10 each, according to quality. The market for hogs showed another advance, stock being scarce, at 9c. per lb. for selects, weighed off cars.

Horses.—The market is more inclined to advance than decline, but on the whole prices are about steady, as follows: Heavy draft horses, weighing from 1,500 to 1,700 lbs., \$300 to \$350 each; light draft, 1,400 to 1,500 lbs., \$225 to \$300 each; light horses, 1,000 to 1,100 lbs., \$125 to \$200 each, and broken-down animals, \$50 to \$100. Choice saddle or carriage animals sell at \$350 to \$500.

Dressed Hogs.—The market for dressed hogs was decidedly firmer, and prices are 12c. to 13c. per lb. for fresh-killed, abattoir-dressed hogs. Cured meats are also firm.

Potatoes.—The market for potatoes is not very active, but it is firm. Green Mountains, on track, are selling at around \$1.75 per 90 lbs., carloads, while in a jobbing way they are selling at \$2 per bag of 90 lbs. Syrup and Honey.—The market for syrup holds steady. It is understood that the season has been a pretty fair one, the weather having been quite favorable during a portion of the time. Some very good quality is said to be available, and prices are firm, the offerings being none too heavy. Syrup is 7c. to 7c. per lb. in wood, and 70c. to 75c. in tins. Sugar is 8c. to 9c. per lb. White clover comb honey is 10c. to 11c. per lb., and extracted is 8c. to 10c. Dark comb is 7c. to 8c., and extracted is 7c. to 8c.

Eggs.—The market shows very little change, although the past few days the temperature is much higher, and the result should be increased production. Packers ought to be beginning presently, even though prices are so high. Round lots are quoted at 23c. to 23c., single cases being 24c. to 25c. per dozen.

Butter.—The market for butter is gradually declining as the season advances and the make increases. Cowansville sold down considerably at the end of last week, from 28c. to 28c. per lb., and the local market declined in sympathy from 28c. to 30c. per lb.

Cheese.—Dealers are beginning to show more interest. Prices of foders are 14c. to 14c. per lb.

Grain.—The market for oats was very strong this week, and prices were higher. No. 2 Canadian Western being quoted at 5c. to 5c. per lb.; No. 2 extra feed oats being 5c., and No. 3 Canadian Western at 50c. per bushel; No. 2 feed oats are 49c. to 49c.; No. 2 local being 50c.; No. 3 being 49c., and No. 4 being 48c.

Flour.—The market advanced 10c. per barrel, being now \$6.10 per barrel, in wood, for Manitoba spring-wheat first patents; \$5.60 for seconds, and \$5.40 for strong bakers'. Ontario patents are \$5.10 to \$5.35 per barrel, and straight

## The Safe Investment of Small Sums

is a difficult matter. Many a man has lost all his money through unwise investment or some get-rich-quick scheme.

A Savings Account at the Bank of Toronto for your spare dollars will prove safe, convenient and profitable to you.

Interest paid on all Savings Balances.

Capital - - - \$5 000,000  
Rest - - - 6,000,000

## Bank of Toronto

rollers \$4.65 to \$4.75. In jute, prices are 30c. per barrel less.

Millfeed.—The market for mouille has advanced, pure grain mouille being \$34 to \$38 per ton, and mixed being \$28 to \$32. Bran is still \$25 to \$26 per ton, and shorts \$27 to \$28, while middlings are \$29.

Hay.—Hay continues steady in price. No. 1 hay is \$15.50 to \$16 per ton; No. 2 extra is \$14.50 to \$15; No. 3 northern is \$13.50 to \$14, and No. 2 is \$11.50 to \$12, while clover mixture is \$10.50 to \$11.

Seed.—The present warmer weather will have the effect of stimulating demand. Timothy of lower grades is rather plentiful, and prices are lower, at 14c. to 20c. per lb., red clover being 23c. to 27c., alsike being 22c. to 26c. per lb., Montreal.

Hides.—Prices are unchanged. Calf skins, 17c. per lb.; lamb skins, 10c. each; sheep skins, \$1.10; horse hides, \$1.75 and \$2.50 each. Beef hides are 11c., 12c. and 13c. per lb., and tallow is 1c. to 2c. per lb. for rough, and 6c. to 6c. for rendered.

### Chicago.

Cattle.—Beeves, \$5.60 to \$8.75; Texas steers, \$4.75 to \$6.10; Western steers, \$5.60 to \$7.10; stockers and feeders, \$4.30 to \$6.65; cows and heifers, \$2.65 to \$7.25; calves, \$4.50 to \$7.50.

Hogs.—Light, \$7.50 to \$7.90; mixed, \$7.55 to \$8; heavy, \$7.60 to \$8; rough, \$7.60 to \$7.75; pigs, \$4.90 to \$7.20.

Sheep and Lambs.—Native, \$4 to \$6.50; Western, \$4.25 to \$7; yearlings, \$5.90 to \$7.25. Lambs—Native, \$5.25 to \$7.00; Western, \$5.50 to \$8.40.

### Buffalo.

Cattle.—Prime steers, \$8 to \$8.50; butcher grades, \$3.50 to \$7.75.

Calves.—Cull to choice, \$5.75 to \$8.25. Sheep and Lambs.—Choice clipped lambs, \$7.00 to \$7.50; wool lambs, \$7 to \$8.65; cull to fair, \$5.50 to \$6.90; yearlings, \$6 to \$6.50; sheep, \$8 to \$6.10.

Hogs.—Yorkers, \$8.20 to \$8.25; pigs, \$7.25; mixed, \$8.25 to \$8.80; heavy, \$8.30 to \$8.35; roughs, \$7 to \$7.80; stags, \$6 to \$6.50.

### Cheese Markets.

Kingston, Ont., 12c.; Brockville, Ont., 13c.; Iroquois, Ont., 13c.; Belleville, Ont., 12c.; St. Hyacinthe, Que., butter, 27c.; Cowansville, Que., butter, 28c., 28c., 28c.

### British Cattle Market.

John Rogers & Co., Liverpool, cable States and Canadian steers making from 15c. to 16c. per pound.

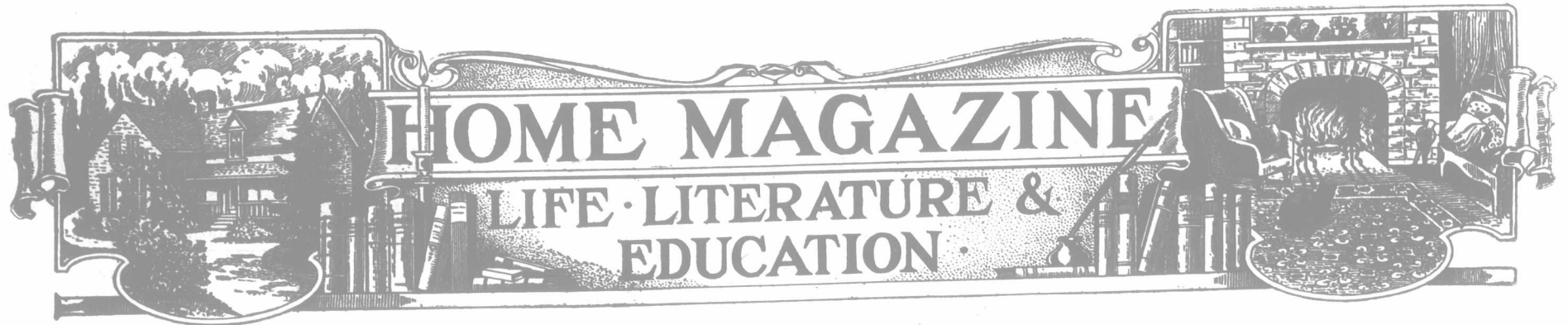

## Home Sanitation

By T. A. Tefft.

A farmhouse of the forties, low, narrow in front and extending far back into the yard, stands just under the hill, shaded by a thick foliage of locusts. The windows are fitted with small old-fashioned panes of glass, showing from without the dark closely-drawn shades. The front door and windows are closed in winter to keep out the cold, and in summer to exclude the flies and to keep the room dark and cool. The half-story above discloses small windows which are shaded not only by the locusts and willows but by a picturesque clematis that twines over the surface of the outer wall. The soil about the house is damp and springy. Grass is driven from the doorway for want of sunlight, and mosses thrive upon the roof. Not far from the house, and on higher ground, is the barn, of the same age as the house, with a spacious barnyard, in the center of which, with the ground sloping toward it, is a large watering trough. The cows stand up to their knees in mud. A rim of sod, close up to the fence, is the only safe though circuitous path to the barn. From the big pen between the barn and the house comes the satisfied grunting of the pigs, which is mingled with the gobble of the turkeys and cackling of the hens as they roam over the yard. On the other side of the house is a half pond and half swamp, where the ducks dive their heads in deep and the frogs sing to the micro-organisms a soothing lullaby. At the corner of the house stands the old rain barrel—the joy of the mosquito and an offence to the nostrils during dry weather. Where the eaves did not feed the barrel they have emptied the water over the door yard from the moss-covered roof and the water has percolated the soil until the only product is moss and myrtle.

There is a brook running near, but before it joins the brimming river it chatters over stony rills to the pasture land and the edge of the meadow not far from this house of Farmer James. Here, when the cows are in pasture, they satisfy their thirst, and under the shade of a large tree they stand in the water in the heat of the day.

Its head waters are gathered from swampy land several miles away, where there is a strong suggestion of miasma. It is in the region of a tannery and waste products are poured into this swamp. As it travels it widens into a little stream, which here washes over a dairy farm, furnishing drinking water in the barnyard and the water with which the cans are washed. Now it receives the refuse from a large boarding house. It flows through the village as a reservoir for sewage, and is dammed below for a duck pond in summer and an ice pond in winter. It receives another lease of life and reaches the farm yard, innocent in appearance but full of poison and badly vitiated.

The outside closet is fifty feet from the house. The grass and weeds grow close to the narrow path in summer, and in winter the path fills with snow. The door swings hardly shut on its worn hinges and the snow or rain is drifted in. In rain or melted snow great drops of water fall from the eaves in front of the door. Bare and exposed, the screened outlines suggest a deathly gloom.

At the side door for many years a woman has appeared several times to fling as far away from her as possible the contents of a dishpan. During these years she has done this daily washing on the porch and thrown the water on the same spot. Here the water stop on their way to meals, fill the basin with the refreshing cold water from the

well near by, bathe their hands and faces and add the contents of the basin to the dish-water and wash-water. Here the hired man, returning from the factory, washes the milk cans and empties the water. The bacterial crop of the dishpan, washtub and milk-can fight each other, thrive, go deeper and deeper, and finally rejoice in the moisture found near the well.

Every season there is an overflow of water in the undrained cellar, at which time the housekeeper picks her way over boards to the potato bin and apple barrel. When the inundation comes, barrel-hoops, washtubs, turnips, onions and apples are loosed from their resting places and float upon or sink beneath the surface of the water. Accidents happen to the milk, pork and vinegar. When the water subsides, it is spring-time, and the decaying cabbage, potatoes and onions lend their disagreeable odor to those of the gases escaping from the damp soil.

The clothes-line hangs across the yard in the rear of the house, and a woman pins a light shawl over her head, goes in a heated condition from the steaming washtub to the snowy pathway, and with the wet clothes stiffening in her fingers, hangs them on the line, to freeze harder before drying. The result on many occasions is a disagreeable cold, from which she hardly recovers before the next wash day.

The parlor, always closed, is musty and damp. The little sleeping room adjoining is used only for the occasional guest, who shivers between the sheets and is kept awake by the smell of must and disused bedding. The rooms are filled with bric-a-brac and heavy draperies, which serve as a lodging place for dust. An ingrain carpet covers the floor. It was bought in the earlier days when carpeting was of better quality and the colors are bright and the figure large. The housekeeper religiously stirs up the dust on the sweeping day, only removing it from its resting place of the week before to allow it to settle in new spots.

The children hug the sheet-iron heater during the evening with backs cold and faces warm, and dread going to their sleeping rooms, where the snow drifts in if the rooms are ventilated, and where they lie awake shivering until they "warm the bed," or sleep makes them forget they are cold.

There are many dark corners and dark closets where dangerous dirt has accumulated, and where mice and moth escape the eye of the most diligent housekeeper. The space underneath the kitchen sink is encased with boards, and it is difficult to clean around the pipes. Dirt and damp have full sway, and one is reminded of the old expression, "Where daylight cannot enter the doctor must."

Farmer James and his wife have lived in this home fifty years, amid varying prosperity and adversity. They have had seven children, two of whom died in infancy with cholera infantum and two at the age of sixteen and nineteen with fever. It has never occurred to the family that conditions in or out of the house could have caused these deaths, and in looking to the decree they thought themselves yielding to an all-wise Providence, resolutions of respect always are made available when they say, "Whereas Providence has removed from our midst," instead of, "As a bad thing happened, we prepared drinking water, and we."

When John came home from school on a holiday vacation, he told the home folk that he had a bad cold, but as he came to bed he felt the whole scene of his life in a state of discontent. He had not had a drop of pure water.

While the farmer was a progressive man and his wife a thoughtful woman, they had accustomed themselves to surroundings which John determined to change for the sake of the health of the family.

Then, too, at several farmhouses in the neighborhood there were summer boarders who had asked numerous questions regarding the source of water, condition of soil and ventilation. These visitors had come from the city to regain health, and were thinking not so much about the danger from disease germs they had brought with them as the proper conditions in the country for getting rid of them. The neighborhood was thoroughly awakened upon the subject, and the excitement grew greater when it was learned that scarlet fever had broken out in a small village through which the much-loved brook found its way.

The father and son put their heads together and drew one plan after another without settling on any, before it occurred to them that it might be well to consult the women concerning this house, since they occupied it most of the time. These consultations prevented many mistakes, which only a practical housekeeper would notice.

John explained how impurities may be transmitted by the porosity of the soil, and how germs of disease may float in the air. The soil all these years had received neither tillage nor drainage. Organic matter—matter once living, now dead—had been falling upon it, loading it with impurities, while the house and its occupants had received the disease-laden gases made from constant putrefaction.

They decided that the site must be drained. They dug a trench on all sides of the house, from which water flowed towards it at a depth below the level of the cellar bottom. In this was laid a tile drain which led to the brook.

Then Mr. James said: "I wonder if that cellar is the cause of the fever the hired man has gone home with." Mr. James knew that the only way to reduce a death rate was to consider the conditions for health. He was haunted by an expression he had heard, "A damp cellar weaves shrouds for the upper chamber." He was wise enough to see that he could get no richer returns for his money than to secure healthful conditions at home.

They decided that the cellar should extend under the entire house, because a greater amount of ventilation and dryness could be secured, and because a larger one was needed for storing provisions. A closet was built for milk and butter. Bins were provided for storing the potatoes and vegetables. The walls were whitewashed; the ceiling was high. Windows easily opened were placed opposite each other. Another important addition was a cement floor, which proved very durable, since the cellar would be made dry by the outside drainage.

Probably the most difficult problem they had to consider was how to dispose of the slops without polluting the water supply. There were serious objections to a cesspool. However, the only alternative was to have a small pipe attached to the kitchen sink, with trap connection, united outside with a large venting pipe, which also received the wash water from a funnel on the back porch. This drain emptied into a cesspool a long distance from the house and on lower ground.

The well on this farm had always furnished cool and refreshing water, and although Farmer James had some misgivings, he was content until the first visiting physician had seen the water no longer cool, and the children were sick. He had been so long a stranger to the water that he had not noticed that it was no longer so pure. He had not noticed that the children were sick. He had not noticed that the water was no longer so pure.

company, and since the prices of farms have improved, a larger number of prospective buyers have come to inspect the farm; while peddlers, hired help and tramps are frequent visitors. There was therefore danger from typhoid and other disease germs finding their way to the drinking water. They had a dug well. The wash and dishwater were thrown near it, and John said there was danger of pollution from household and barn excreta.

They decided that a drilled well was the safest and cheapest of all. This would furnish the drinking water for the family, but it was too hard for household use. They planned a cistern under the steps, 6 ft. deep and 5 ft. wide, covered with two layers of plank. This was lined up to within a foot of the surface of the ground with water-lime cement, without the use of brick or stone, as the subsoil was hard and tenacious. An outlet was furnished near the surface by a pipe leading to the brook, and another pipe connected the cistern with a pump in the kitchen.

They decided to raise the roof and have the second story extend over the entire floor with higher ceilings, larger rooms and better windows; the chambers would thus be made healthful and comfortable in cold weather. Where windows could not be had in a closet they were to place transoms over the door, and where these were impracticable the closet could be so arranged that the door on being opened would let in the light from an opposite window. John knew each member of the family would appreciate the difference between the vigorous, healthful sleep in a well-aired, comfortable room, and that in a room where the air is close and stifling.

John discussed with his mother the dangers from dust which might be laden with bacteria. They decided that the draperies and bric-a-brac should be replaced by white wash curtains, and fewer, more simple ornaments. John explained also that the "bacteria of the dishcloth" might be a dangerous source of pollution. As a precaution against the accumulation of grease and the clogging of the pipes, Mrs. James now had in her sink a fine sieve through which the water was poured. This was cleaned often and the contents burned. Before emptying liquids into the sink, which might leave on the sides of the pipes a greasy deposit, she allowed them to stand until cool and removed from the surface the coating of grease, the cleanest of which was utilized for soap-making or other purposes. They planned to use small pipes in connection with this sink, because the velocity of the water thus became greater to wash out the dirt which otherwise would collect.

The doorway between the parlor and guest chamber was to be enlarged, and the little room added to the larger one as a cosy sitting-room, though having still possibilities as a guest chamber. The parlor wool carpet was sent to the weaver's to be converted into two rugs, one for the larger room and a smaller one for the cosy. The cracks of the floor were to be filled with putty and the floor painted a rich dark color. A great advantage would be gained in that the former hard sweeping and dusting would be reduced to the lesser work of placing the rug on a line outside, to have the dust whipped out and the floor wiped with moist cloths.

The old stoves were to be replaced by better ones, whose dampers would prevent the access of air. John showed how the stoves regulated by dampers in the pipes exhausted the oxygen and drove the burned air back into the room.

"The fireplace is a waste of heat and does not warm the rooms in very cold weather," Farmer James reasoned. "But



then," John said, "it is an excellent ventilator and there is abundant fuel supply on the place. The rooms are easily ventilated in summer, but in winter the fireplace will supply the demand, besides adding greatly to the attractiveness of the rooms."

When the June days come, John returns from college anxious to see the changes on the old farm. A few trees with luxuriant foliage wave in the sunlight, and give a grateful shelter with a sense of repose and comfort. A dry, firm, grassy sod extends over the yard and comes to the edge of the gravel walk. The June roses, massed at the side, are in full bloom, filling the air with a delicious fragrance. A wide veranda extends across the front of the house, offering ease and hospitality. Doors and windows are flung wide open. Mosquito netting and wire screens shut out the unwelcome fly. The breezes play with the white curtains and waft into the house the odor of honeysuckle and wild rose—a grateful change from the musty, stifling air of the old parlor. On the surface of the pond, a little way from the veranda, cleansed of its slime and filth, fleeting shadows of fish play fitfully, while on its surface are mirrored the cat-tails and bushes which fringe the bank. The ducks dive among the lily pads. A rustic bridge spans the little brook, which is now bordered with forget-me-nots.

The well, driven deep into the rock past all danger of pollution, has built over it a covering which affords a shelter in time of storm and furnishes a refreshing draft to the weary passerby. Across the side veranda hangs the week's wash, the line strung from end to end, out of all danger of exposure to the housekeeper.

If John had loved the old home, how much more could he care for this one? They all delight in the rest which comes at the end of the day in the delicious coolness of the nights on the open veranda, and in winter the reveries, the reading aloud, the stories told around the fireplace with the weird shadows of the burning back log and the crackling of the hickory. Farmer James said: "It is better to have our money bringing health and happiness than yielding interest at the bank."

**Some Old-Time Echoes.**

(Concluded.)

V.

**ON THE WILHELMSHOHE.**

[Extract from a letter written in 1870.]

Cassel, Germany.

As soon as Napoleon had disappeared within the castle, the scene suddenly changed. Everybody rushed off to the hotel and grouped themselves around the tables on the balconies before it. Here there was also plenty to be seen and heard. At one moment my attention was attracted by the numerous domestics, partly French who came here with the Emperor, partly German sent by the King of Prussia from Berlin; at another by the house and stable functionaries in their green and gold embroidered liveries. Now this; now that. The gentlemen attached to the Imperial suite, and in immediate attendance on the Emperor, are twelve in number. Among them are the physicians, Conneau and Covisart, the Adjutants and the Orderly Officers, Hepp and Lauriston. These never come in contact with the public. They live in the castle, and dine at the royal table at 6 o'clock. The culinary department is in the hands of German and French cooks, all of whom have been sent from Berlin. The chef de cuisine, who has been for the last twelve years in the service of the Queen of Prussia, is a Frenchman from the neighborhood of Besancon. The servants occupy rooms over the royal stables, which adjoin the hotel, where they are allowed three meals a day in one of the coffee rooms. On such occasions they are often "taken in tow" by some inquisitive or inquiring "voyageur," and one must confess that they are always most ready, especially the German portion of them, to give any information in their power. They do not themselves know much, as may be easily supposed, and it is rather comical to see how they are sometimes seized upon and asked with the greatest gravity in the world, "whether Napoleon thinks that he will again ascend the French throne;

what he intends doing in future, etc." On such points they have, naturally, no information to give, but they can and do inform you "that of the 80 or 90 horses which the Emperor brought with him, all, with the exception of half a dozen, have been disposed of, that his majesty goes to bed regularly every night at half-past 10 o'clock, that the imperial dinner is a most ceremonious affair, and so forth." One can also learn from the same source at what hour Napoleon intends driving out, i. e., when he does drive out at all. This was the case last week. The servants had mentioned before dinner that the Emperor's carriage was ordered for 2 p. m., so, while the clock was striking, the royal equipage, an open carriage with four magnificent blacks sent from Berlin, two postillions and an outrider in the royal, not imperial, livery, appeared at the grand entrance of the castle; the Emperor, accompanied by his usual attendants, took his seat and drove off to Wilhelmsthal, another royal castle about five or six miles from the Wilhelmshe. On this occasion there was a still larger number of

years, only shown us its closed shutters and its empty solitude.

How long the Emperor will remain at the Wilhelmshe none can say. Many think that the approaching winter will still find him here. A short time since it was reported that he wished to change his residence to Cassel. However, the air here did not agree with him. There is no truth in this report. Every precaution has been taken to protect the apartments which he inhabits against any inclemency of the weather. Besides this, it is said, that in former years the Electors occasionally passed a winter here, although it is true that they generally only make it their summer residence. There is one more remark I must make. The bringing of Napoleon to the Wilhelmshe has very often and very naturally recalled to one's mind the days of his Uncle Jerome, whose motto was, as is well known, "To-morrow we'll be merry again." Now, the most attentive observer would not be able to detect anything approaching to merriment or "jollity" in the demeanor of any of the gentlemen composing the Emperor's suite.

that our eyes became dazzled and our minds somewhat confused. I fear that my Old-time Echoes, if I am encouraged to persevere in offering them, may partake more of the qualities of the primitive lantern than of the moving-picture shows, which represent for us all the recent happenings which appear before the eyes of those absent with nearly as much realism as for those who were present.

But such as they are, as I slip a new slide into my old lantern, I am glad to offer them to the dear readers of our Home Magazine. H. A. B.

**Nursing in Scarlet Fever.**

By Elizabeth Robinson Scovil, author of *The Care of Children, Preparation for Motherhood, etc.*

Scarlet fever is one of the most dreaded diseases of childhood. It is not only frequently fatal, but it is liable to many complications, some of which leave lasting ill effects.

Even very light cases should be treated with the utmost care and strictly isolated; a child who contracts the disease from one having it in a very mild form may develop an extremely serious case. The violence of the disease seems to depend upon the soil into which the germ falls. The system of the one child may be in such a healthy condition that the microbe causing the disease is not able to multiply to any great extent, and so the symptoms are mild and cause very little disturbance. The other child, not having the same power of resistance in the tissues, offers a ready breeding ground for the germs and is made extremely ill by the poison they develop.

**SYMPTOMS.**

The illness usually begins with high fever and sore throat. Sometimes there is pain and difficulty in swallowing. The soreness is caused by the rash which appears in the throat sooner than on the skin. There may be a chill, or vomiting, or severe pain in the head.

The rash comes out on the second day. It is a very bright scarlet, not a dark red as in measles, and does not feel raised to the touch. It usually comes out first on the body and limbs, but may appear first on the face or neck, though this is more unusual. It spreads very rapidly, covering the whole surface of the skin in twenty-four hours. It is brightest and remains longest in places where the skin is thin and delicate, as on the inside of the arms and thighs, and the bend of the knees and elbows.

The strawberry tongue is very often spoken of in connection with scarlet fever. Early in the attack the tongue is covered with a white coating, through which the little papillae, or rough points of the mucous membrane, project, making it look as if it were sprinkled with red pepper. Later the coating peels off, leaving the tongue clean and red, but the papillae being still enlarged the whole surface looks like a ripe strawberry.

**TREATMENT.**

As even very mild cases of scarlet fever may be followed by complications, such as disease of the kidneys; or inflammation of the passages of the ears, it is always wise to send for a physician and follow his directions exactly.

The mildest case should be kept in a well-ventilated room, in bed if possible, until the rash has disappeared, and be strictly isolated. In more severe cases the child is so ill that it is not difficult to carry out the strictest nursing precautions.

When the throat is much inflamed cloths wrung out of cold water are laid around it and changed frequently, or a small ice-bag is used. A fold of cotton should be placed between the bag and the skin. The doctor sometimes orders the throat to be swabbed with a disinfectant wash. Cold water may be given freely, and bits of ice allowed to melt in the mouth. A young child will suck a small piece of ice wrapped in cheese cloth.

A convenient way to chip off morsels of ice is to press the point of a long pin against the edge of the block. A number may be kept in a butter dish with a strainer, so the water will drain away as the ice melts. The dish should be closely covered. A piece of cheese cloth may be fastened over a tumbler with a

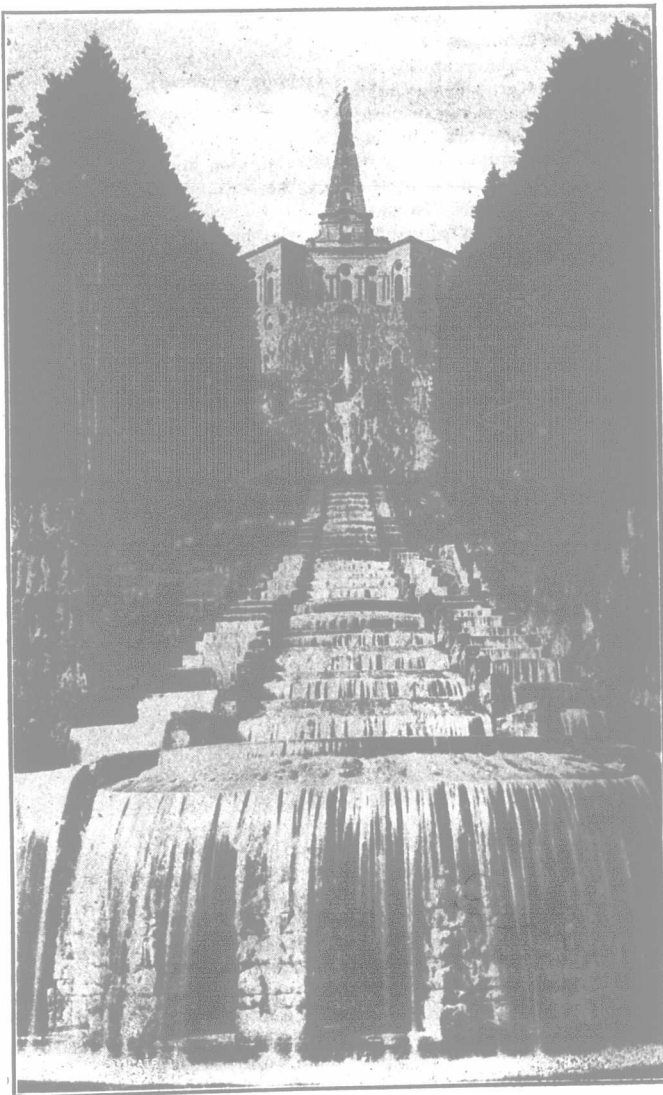

Cascades, Wilhelmshe.

The wonderful cascade in the Wilhelmshe, surmounted by the enormous figure of Hercules with his club.

spectators than usual. Cassel, as is now generally the case on all fine afternoons, had also sent a large contingent, and a picture presented itself so interesting and peculiar of its kind as can only at this present moment be seen here. I need hardly remark that the fair sex were duly represented, while at the same time the masculine portion of the spectators was composed of men out of almost every grade of society. Scarcely, however, had the Emperor returned, which he did about half-past 4, than the crowd, as usual, disappeared as if by magic. The environs of the castle which had been so thickly peopled, were, half an hour later, totally deserted, and the only signs of human vitality were the sentries pacing up and down at their respective posts. As darkness set in, the deepest silence reigned around. Nothing showed that any change had taken place in the usual course of things on the Wilhelmshe except the lighting up of the apartments in the castle, which, until the arrival of the Emperor, and with the exception of a two days' visit of the King of Prussia some time since, has, for the last four

On the contrary, their bearing is so discreet and retiring, in a word so appropriate to the circumstances in which they find themselves, as to merit the most unqualified respect. The same is also said of that man to whom the kindness of the King of Prussia has allotted the Wilhelmshe as a temporary residence, of that man who has so bitterly experienced in himself that "nemo ante mortem beatus est." Who would have thought a few short weeks since that the prophecy made to the Lydian ruler would, with such fearful weight, be again so soon fulfilled? Charles M. Cassel, 7th October, 1870.

By way of postscript I have little to add. Art, to-day, has given us, amongst its many developments, the cinematograph with its moving figures, giving life and motion to its interpretation of the story, without words, which it sets out to tell us. In my younger days we had but the homely magic-lantern with, at its best, dissolving views, and at its worst, such sudden withdrawals of the pictures

rubber band and hollowed in the middle to receive the ice. The tumbler should be covered with a newspaper cap to exclude the air.

#### BATHS.

When the temperature is very high the doctor may order a cold sponge bath, or a wet pack to reduce it. The former is given by placing a folded blanket under the patient, removing the night dress, covering him with a single blanket and sponging him from head to foot beneath it. In a wet pack the bed is covered with a rubber sheet, or a large piece of table oilcloth; after the night clothes are removed the patient is wrapped in a sheet wrung out of cold water, the face being bathed also. If the sheet dries quickly it is sprinkled with cold water. The doctor watches the temperature by means of a clinical thermometer to see that it does not fall too rapidly.

When there is great restlessness, or it is desirable to produce perspiration, the wet sheet is covered with one or two blankets. After an hour, or when the skin is moist with perspiration, the patient is wiped off and put between dry sheets. This will sometimes quiet delirium and give much relief. There need be no fear of driving the rash in.

#### IRRITATION.

The itching in scarlet fever is very great, and something must be done for its relief. Rubbing the body from head to foot with pure eucalyptus oil is said to prevent infection, as well as soothe the patient. Anointing with benzoated lard, which can be procured at a druggist's ready prepared, is useful. In milder cases bathing with carbolyzed water, or water in which baking soda has been dissolved, brings ease.

#### DESQUAMATION.

When the fever subsides the skin peels off in flakes, sometimes large patches coming off at once. If the skin is kept oiled these will not be as widely distributed, the cloths used for the purpose being burned, and so the chances of conveying the infection to others lessened.

#### FOOD.

As in all fevers the diet should be light while the temperature is high. It should consist of milk, eggs and cereals in various combinations, these being the staple of all invalid diet. Broths and beef juice are useful, not because they are highly nourishing in themselves, but because they seem to stimulate the appetite, increasing the desire for food and also assist the digestion to do its work. When the child wants a change from liquids beef jelly may be made by squeezing the juice from a thick piece of beef, or drawing it out by heat, and then making it into jelly by adding gelatine. The recipe that comes with the package can be followed, using the beef juice instead of water; season with salt.

Lemonade, or any mildly acid drink, is grateful. Care should be taken that plenty of water, either plain or flavored, is drunk, on account of its effect in flushing out the kidneys.

#### PERIOD OF INFECTION.

The disease may develop in any time from twenty-four hours or less after exposure, to twenty-one days; it is usually about six days. The patient remains contagious for about six weeks. It used to be believed that the contagion was conveyed by the scales of skin that fell off, and that when this process was over it was safe for the patient to come in contact with others. It is now thought that the germ is present in the discharges, especially that from the nose and throat, and that the air of the sick room is laden with poison, which may be carried to others in clothing or other articles.

#### DISINFECTION.

Whoever enters the sick room should be provided with a long cotton wrapper and a large cotton handkerchief or cap, to completely cover the hair. These should only be removed in the hall or an adjoining room. The hands and face should be washed in warm water with soap and the hair well rubbed with a clean towel.

Every piece of clothing that touches the patient should be thrown into a disinfecting solution before being washed. A cheap and good one is made by dis-

solving a quarter of a pound of sulphate of zinc and two ounces of common salt in a gallon of hot water. After the clothes are washed they should be boiled in water to which washing soda is added to prevent their feeling harsh to the touch. Sun and air are good disinfectants, and none is better than steam. Make a sort of hammock inside the wash boiler, by covering the top with cotton hollowed to receive the articles, and tying it round the outside with strong string. Put the cover on tightly, and have enough water in the bottom to boil and generate steam to saturate the things to be disinfected, and you have an efficient germ destroyer.

All the discharges should be carefully cared for. Sulphate of iron, better known as copperas, may be used to cover them and to pour into the closet when they are emptied. Make a saturated solution of the copperas, that is, that the water will take up, and use it freely. If an outside closet is used, cover the discharges thoroughly with quick lime.

Use pieces of soft cotton instead of handkerchiefs. Roll them and all waste from the sick room in newspaper and burn the parcel without opening it.

#### DISINFECTING THE PATIENT.

After recovery the patient should be sponged with a disinfectant. A simple one is a saturated solution of boracic acid, in which the hair also should be thoroughly washed. After this a bath of warm water should be taken, using plenty of soap, the hair sharing in the cleansing process. A complete outfit of clean clothes, which have not been in the sick room, should be provided. In case of death the body should be wrapped in

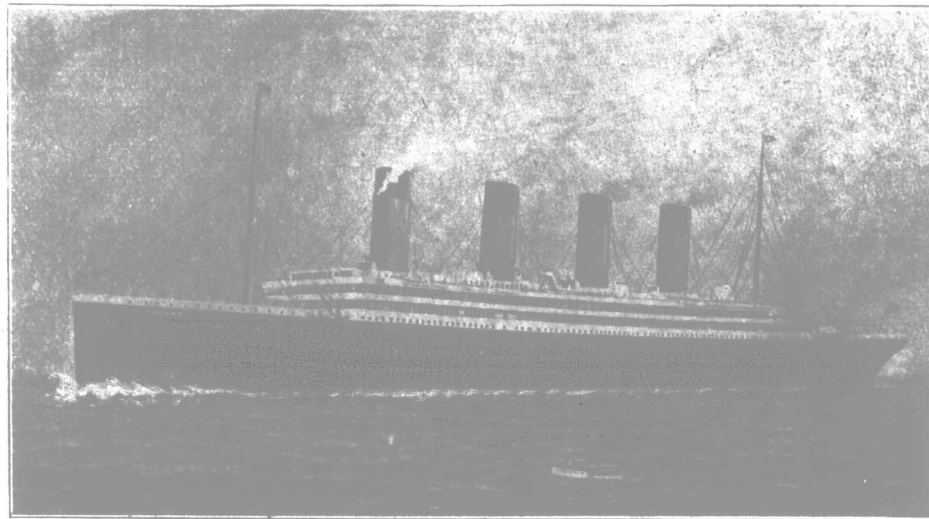

White Star Liner, "Titanic."

Sunk by collision with an iceberg in the North Atlantic, on the night of April 14-15.

a sheet saturated with formalin, a handkerchief steeped in it being placed over the face.

#### CLEANSING THE ROOM.

If there is a carpet on the floor it must be taken up and spread out on chairs. The bed should be stripped and the mattress turned on edge, drawers and closets opened. To disinfect a moderately large room, purchase six and one-half ounces of permanganate of potash and one pint of formalin. Stand an earthen jar, or iron vessel, on two bricks and put the permanganate of potash in it. Pour in the formalin and leave the room as quickly as possible. After twenty-four hours enter the room, open the windows, and when it is well aired scrub and clean it. The walls should be re-papered or painted and the ceiling calomined.

To make the most of dull hours to make the best of dull people, to like a poor jest better than none, to wear the thread-bear coat like a gentleman, to be outvoted with a smile, to hitch your wagon to the old horse if no star is handy—that is wholesome philosophy.

There can be no harm in building castles in the air as long as we build the foundation on earth.

It is the day of days when a man first realizes that his destiny is entirely in his own hands.—M. Maxx.

## News of the Week.

### The Sinking of the Titanic.

Not until Friday, April 19th, after the arrival of the Carpathia in New York, was it possible for the daily press to learn and give out the details of the sinking of the Titanic, on the night of April 14th, to the distressed public. "The greatest marine disaster in history!"—and yet it appears that there was no panic, no display of other than heroism among the 2,340 on board the great vessel, of whom 1,601 went down to death, 739 only being saved.

"Only a slight jar was felt," says a survivor, "and the immediate stopping of the engines." Then men and women came quietly out to learn what was the matter. Some had not yet retired, for the time was not quite midnight. So easily did the vessel settle that at first no great anxiety was felt, and a card game went quietly on. Then came the order for men to stand back and women to take to the lifeboats. Quickly, yet without confusion, the order was carried out. The women stepped in quietly and were lowered into the sea with just enough men to handle the boats. Many of the women, however, refused to leave their husbands and loved ones, and so, as the boats pushed rapidly off into the

drowned. Of the Canadian men on board, only two are among the saved, Major Peuchen, of Toronto, and Mr. Dick, of Calgary. Montreal has suffered heavily, losing eleven of her citizens.

It is notorious—yes, notoriously culpable—that efficient steps for the protection of human life are so seldom taken until some terrible disaster occurs to serve as an object lesson. It needed the awful school holocaust at Cleveland to stir the public into examination of the general conditions of its schoolhouses, and the still more terrible loss of life in the burning of the Iroquois theater at Chicago to awaken inquiry into the fire protection of theaters. To-day it becomes public that ocean-going vessels are not, as a rule, provided with lifeboats enough to carry off the full complement of crew and passengers. The Titanic, the most magnificent type of ocean-going steamer afloat, new—on her maiden voyage—was equipped with only 14 large lifeboats, 2 smaller ones, and 4 collapsible boats. There were sufficient life-preservers for all, but life-preservers are but a poor guarantee of life in an icy sea. Moreover, there are hints of carelessness. "What was the Titanic or any other vessel doing so far north," asks Mr. Andrew Carnegie, "when warned that there were icebergs about? There was a whole open ocean to the southward."—And in reply comes the whisper from a survivor, that the great steamer was out "for a record."—What common sense is there in the mania for "speed" and "records" that seems to have seized the world, with its inevitable lessening of security for human life?

Already Transatlantic lines are ordering their ocean-going vessels to carry double their present number of lifeboats. Already an investigation into the causes of the Titanic disaster has been ordered by the British Board of Trade, and another begun by a Special Committee at Washington. It is to be hoped that the outcome will be drastic measures for the safety of travellers across the sea, and that no considerations of commerce or "record trips" will be permitted henceforth to put human life to risk.

But can the continuance of such measures, even though instituted, be depended upon? Nothing but a never-ending vigilance, that regards human life ever as a value into whose balance trade considerations can never be thrown even for an instant, can ensure this.—But people, even Governments, forget with time, vigilance is too often relaxed, "interests"—money-interests—are permitted to intrude insistently as is their wont, disaster upon disaster must usually come before a constant care and supervision can be relied upon. Can we hope for it in this instance?

Incidentally, the loss to the White Star Line in the sinking of the Titanic, amounts to about \$3,000,000. The total loss is estimated at about \$12,500,000.

The Senate investigation of the Titanic disaster was concluded, so far as the New York hearing was concerned, on April 20th, and was resumed in Washington on April 22nd. By the testimony of Bride, the second wireless operator of the Titanic, it appears that the Frankfurter, of the North German Lloyd Line, was the first to answer to the Titanic's call for immediate help. As she did not come to the rescue, although probably much nearer than the Carpathia, it is surmised that her wireless operator did not understand fully the import of the Titanic's message. It also appears that about half an hour was lost after the repeated calls of the Californian in seeking to warn the Titanic of icebergs in the way, before the message was finally noted and reported to the captain. Bride gave his evidence from an invalid's chair, and almost on the verge of collapse. He was among the last to leave the ship, and is one of the few surviving witnesses of the awful last scenes on the topmost deck of the ill-fated steamer.

The Titanic's orchestra, of which eight members went to their death playing "Nearer, My God to Thee," was under the leadership of Bandmaster Hartley, who had been recently transferred from the Mauretania. The Titanic's orchestra was considered one of the finest, from a musical standpoint, that ever sailed; by their conduct during the last hour of the doomed vessel, the men who composed it revealed that, as men, they were of the mettle that merits a place among the records of the heroes of the world.



of \$4.00, \$3.00, \$2.00, \$1.00, respectively, will be given for the next best compositions. Now, is all this clear? If you want to enter this competition, please notify "Puck" at once, addressing your letter to The Beaver Circle, "The Farmer's Advocate," London, Ont. He will then add your name and address to the list already in.

### OUR JUNIOR BEAVERS.

[For all pupils from First Book to Junior Third, inclusive.]

#### Old Rover.

Old Rover is the finest dog  
That ever ran a race:  
His ear so quick, his foot so fleet,  
And such an honest face.

My playmate, he, in ev'ry sport,  
The moment I begin,  
He's always ready for a race  
And always sure to win.

One day he stole my hat  
And ran across the plain,  
While loudly laughed a man and boy  
Who saw me chase in vain.

So tired, at last, I sat me down  
Upon a green grass-plat,  
When, quick, old Rover turned about  
And brought me back my hat.

At home, abroad, where'er I go,  
There Rover's sure to be—  
There never was a kinder dog  
Than he has been to me.

### Junior Beavers' Letter Box.

Dear Puck and Beavers,—My father has taken "The Farmer's Advocate" for fifteen years, and we all like it very much. I like to read the Junior Beavers' letters. I go to school, and have over a mile to walk, but papa drives me in the winter. We had a Christmas tree and concert at our school, and had a very nice time. I like the summer much better than the winter, because I can be outdoors more. I go to Sunday-school, and have my mamma for a teacher. I have a missionary card, and have been collecting for four years. Now, I will bring my letter to a close, lest you should think it too long to print, and consign it to the w.-p. b.

MINA B. BALFOUR  
(Age 10, Book II.)

Omemece, Ont.

Dear Puck and Beavers,—My father has taken "The Farmer's Advocate" for a long time, and thinks it a very valuable paper. I go to school a half mile from my home. I live in the country, eight miles from Stratford. I have one sister and two brothers. I was nine years old on the 12th of February. I wish some of the Beavers would correspond with me. There are about twenty-one scholars going to our school. We have a lady teacher, her name is Miss Toohey. I hope this will escape the waste-paper basket.

IRENE McDERMOTT  
(Age 8, Class III.)

St. Paul's, Ont., R. D. No. 3.

Dear Puck,—I have been reading the other letters in "The Farmer's Advocate" for some time, and thought I would like to write one too.

We like "The Farmer's Advocate" very much. I like to look at the pictures in it, and enjoy reading the Beaver Circle. I have a sister thirteen years old, and I am nine. My sister Marion and I have about a mile and a half to go to school, and go nearly every day. We take potatoes and apples and bake them over the furnace at school. Our teacher's name is Miss Mitchell. She sometimes lets us go to the hill near the school in winter and coast down it at noon.

We live on a farm three miles from Camlachie. We have three horses and a two-year-old colt. The driver's name is May, and Marion and I can drive her ourselves. We have eighteen Dorset sheep and some little lambs, and it is fun to watch them play. Last summer one lamb's mother died, and we fed her milk out of a dish. She became so tame that she would follow us. One day she came

over and jumped up into the summer kitchen. Papa thought she was getting too free, so he put her with the other sheep. With best wishes for you and the Beavers.

HELEN E. JARDINE  
Camlachie, Ont. (Book Sr. II.)

Dear Puck and Beavers,—My father has taken "The Farmer's Advocate" for nearly four years, and I enjoy reading the Beaver letters very much. I have two and a half miles to go to school, so I cannot attend very regularly in the winter. I have a large Scotch collie dog for a pet. His name is Buster. He gets the cows in the summer, and plays hide-and-go-seek with me. I hope my letter is not too long, so I will close now, wishing the Beaver Circle much success.

BERTHA C. EBERT  
(Age 9, Book III.)

Hagersville, Ont.

Dear Puck and Beavers,—I thought I would tell you about a little bird that came to our window one Saturday night early in December while we were eating our supper, and started to rap and tap. After a little while my brother James went out and caught it. When he came in mother tried to see if it would eat bread or drink milk, but it would do neither. I think I will close for this time.

HELEN MARION STEPHEN (age 7).  
Gildale, Ont.

Dear Puck and Beavers,—I came from the city to live here, and they take "The

### Beaver Circle Notes.

Please, Beavers, do not write to our Circle yet a while unless you have something very important to say. There are still fifty or sixty letters held over, and we must give them "their turn," must't we?

### The Ingle Nook.

[Rules for correspondents in this and other Departments: (1) Kindly write on one side of paper only. (2) Always send name and address with communications. If pen-name is also given, the real name will not be published. (3) When enclosing a letter to be forwarded to anyone, place it in stamped envelope ready to be sent on. (4) Allow one month in this department for answers to questions to appear.]

### The Point of View.

Dear Ingle Nook Folk,—The other day, in a letter, there came to me a bit of news that tickled my funny-bone a bit,—my small niece had made two pies and a cake, "as well as anyone could make them!" Perhaps this does not seem very funny, but if you knew the fly-away little ten-year-old lady herself, what an inveterate player she is, how much skating and baseball and all venturesome outdoor things are the breath of life to her, you would see the point of the joke. I hope she was judiciously praised over the attempt, and made to feel that she had accomplished something worth while.

Children are so very open to suggestion,—drawing from personal experience, I

liked could stay on farms, but—they were there anyhow. Perhaps they loved every tree and stone on the old farm as I did, and that was why they stayed there. One couldn't somehow help loving the old farm.

So the foolish ideas clung until, at the age of thirteen or fourteen, I began to study the high-school work in botany. Then at first vaguely, and then clearly and yet more clearly, came the revelation of the wonderful interest and dignity that might cling about life on the farm. I began to watch the birds and insects, I began to read scraps from agricultural papers, and presently was almost astounded to catch a glimpse, dim enough yet positive enough, of the tremendous extent to which scientific principles may be applied to farming.

A dullard's work? A thousand times No! Rather a scientist's work. None more interesting in the world, if one know enough of science to appreciate the fact. To-day if I had my way, I would make every boy who intends to be a farmer a fairly expert scientist first, teaching him by constant practice mixed with constant precept, then turn him loose on his own place to apply his learning to his own work,—to farm in the true sense of farming. One cannot be a doctor without understanding the principles that govern the preservation of health; one cannot be an architect without understanding the principles that govern strength and beauty of structure; one cannot be the farmer that he might be without understanding the principles that govern growth of plants, health of animals and a thousand other things.

Take warning, then, from this bit of personal history. Be careful of the suggestion that you thrust upon the child-mind; it is not strong enough nor experienced enough to reason out the rights and wrongs of things. You are, to the child, a god of omniscience. Your opinions are, to him, infallible. Then be careful. You may do incalculable harm by just one thoughtless statement.

Let the child feel from the beginning the great truth that work of any kind is really worth while; that it is a privilege to work, and that only mollycoddles and useless creatures try to shirk it. Let him understand that people who do nothing are seldom happy, and never should be, because it is the duty of every man, woman and child in the world to be useful.

Do not represent work as drudgery and the child will not think it is drudgery. Do not hold up play-time as a reward; saying "If you do this I'll let you go out to play." Say, "Would you be kind enough to do this before you go out to play?" This does not suggest that work is a hardship.

Of course I do not think that the child should be given too much work to do. He needs spontaneous play. I am only arguing that he be brought up to feel that he should do a certain amount of work, that work is really no hardship, that he can only be fine and manly (or womanly, as the case may be) by doing it,—work of the hands, work of the brain.

There are thousands of people who find work a drudgery, simply because from childhood they have been led (by suggestion) to think that it is. Whether it be drudgery or privilege all depends on the point of view. What a shame—what a bitter shame, then, to be given the wrong one and to be compelled to face life so handicapped. Many, to be sure, fight themselves out from the misconception, but there is always the chance that this child or that may not, or that he may waste valuable years and opportunities before he does so.

Now, what a "preachment!" But I have been treading on known ground here. That is why I gave you the bit of autobiography at the beginning of this screed.

JUNIA.  
P.S.—Have you ever noticed how persistently, once you have let a certain train of thought run in your mind, references bearing upon the subject in hand keep cropping up? An hour ago I finished writing the screed given above, and since then I have come upon two statements which I should like to quote to you.

The first is from Dean Schneider: "The substance of the law of labor is: Work and you will reach a higher mental development; cease work and you



Old Rover.

Farmer's Advocate." I like the country best. I go to Audley school. Our teacher's name is Miss Madden. I am in the First Book. I have a cat, a dog, and two calves called Billy and Pete. They know their names, and are beginning to like me. I gather ten or eleven eggs every day. I lead the bay horse to drink. We call her Jess.

KATIE LODGE (age 9, Class I).  
Whitby, Ont.

Dear Puck and Beavers,—I thought I would write, as I would like to join your Beaver Circle. I wrote once before on a competition, but my letter found its way to the w.-p. b. I like reading the letters in your Beaver Circle. There are thirty going to the school that I go to. Santa Claus was good to me at Christmas, for he brought me a year's subscription for "The Farmer's Advocate," and some other things. I like skating, but did not have much this winter, for the snow came and covered the ice over-Good-bye.

PERCY NEALE  
(Age 9, Book Jr. III.)  
Pictou, Ont.

Dear Puck and Beavers,—May I join your Circle? My father has taken "The Farmer's Advocate" for as long as I can remember, and enjoys it very much. I like one large brother, and the Farmer's Advocate is the only magazine I read, because I will not read the letter that comes as it is my father's favorite. I will escape the w.-p. b.

LIZZIE LEWIS  
Dunkerton, Ont.

# Freckles

Maybe You Can't Prevent Them, but You Can Easily Remove Them—Quickly, Too.

It is far better not to wait, the hot spring and summer sunshine bring out your freckles in all their unwelcome ugliness. There's a simple remedy—

### Princess Complexion Purifier

that removes freckles and discolorations as if by magic—and it's guaranteed to remove them, too, besides curing Red Nose, Blackheads, Rashes, Eczema, etc. Use it, and get a clear complexion. Price, \$1.50, express paid.

### SUPERFLUOUS HAIR

Moles, Warts, Red Veins, etc., permanently eradicated by our reliable method of electrolysis. Booklet "F" and sample toilet cream mailed free.

Miscott Dermatological Institute  
61 College St., Toronto

## You Try It Free

in your own home. Send us \$25 for an "Automatic" Vacuum Cleaner—use it—test it—for durability, ease in operation and perfect work. If you do not think it the best Hand-power Vacuum Cleaner on the market, return it and we will refund your money. The "Automatic" draws out all dust from carpets, rugs and upholstered furniture—and holds all the dust in the inner tank. Carpets are really clean, through and through, when gone over with the "Automatic," and there is no dust to dust.



\$25  
It gets all the dirt

The air in the room is clean—the woodwork is clean—when you clean with the "Automatic." Write to-day for our free circular.

Onward Mfg. Co., Berlin, Ont.

## MAYPOLE SOAP

Dyes Perfectly

Cotton, wool, silk or mixtures can all be quickly and easily dyed to just the right shade with Maypole Soap. No streaks.



Even, lustrous colors that won't wash out or fade. Colors 10c, Black 15c, at all dealers, or postpaid with

free Booklet "How to Dye" from F. L. BENEDICT & CO., 77A Montreal.

# COWAN'S PERFECTION COCOA

(MAPLE LEAF LABEL)

hits the right spot for breakfast, lunch and dinner. It is satisfying, easy to digest and delicious enough to tempt every appetite.

DO YOU USE COWAN'S?

will degenerate. The law applies to individuals, to communities, to nations, and to civilizations."

Here is the second, from an article written by E. P. Powell, the delightful octogenarian contributor to New York Independent. It may startle you somewhat, yet believe me, Mr. Powell writes in no spirit of irreverence. Perhaps you will not quite accept his generalization. I do not ask you too. The main thing is that you have one more question to think about.

"The fine thing about Jesus," he says, "is that His common sense was so complete. He knew the plants and the trees, and the animals and the birds, and on the whole was what nowadays would pass for a progressive farmer. (Really, —not from a mercenary standpoint.—Ed.) He had a poet's soul, and He had an eye all the time to lilies and wheat-fields. On the top of the Mount, Confucius and Lao-tse and Buddha and Jesus stand together with God in one group, and teach the same Life."

### The Peel Co. (Ont.) Garden Competition.

I have just received word from Mr. James Pearson, who instituted the annual Pearson Flower-garden Competition for Peel Co., and who has just returned from a trip through the West Indies, that the terms for the garden competition this year will be the same as those of last year, viz.:

Three prizes of \$30, \$20, \$10, will be given by him for the three best-laid-out-and-kept flower-gardens in the County of Peel, Ont. All farmers' wives and daughters in Peel County are eligible for the competition, and all who tried last year, whether prizewinners or not, may enter again this year. In every case, taste in arrangement, selection, and care, will count in preference to extent, thus a very tiny, yet very beautiful garden, may stand a better chance of winning the prize than a larger and less luxuriant or more badly-planned one.

Will all who wish to enter this competition send in their names with full address, including township, concession, and number of lot, to this office as soon as possible, addressing the notification to "JUNIA," "THE FARMER'S ADVOCATE," LONDON, ONT.

Next week, if possible, we will publish the account given by Mrs. D. N. Potter, Mono Mills, of her Prize Garden of last year.

"The Farmer's Advocate" must go to the home of each competitor.

### The Terrible House Fly.

Dear Junia,—This is the first time I have addressed you, but how strange it is that we readers of "The Farmer's Advocate" always turn to you when in need of advice. I should like very much to know if there is any disinfectant which one could sprinkle in an outside kitchen that would keep the flies out. The kitchen is used for cooking in only, but it is built in such a way that it is impossible to hang a screen door, and consequently the flies come in very plentifully. MAIMIE, Lincoln Co., Ont.

Mamie, you are a girl after my own heart. You wrote this letter in February, so now, you see, I can get it in just in the nick of time for the fly season. Sometimes I wish we could have a dozen pages for the Ingle Nook, but we can't, so each letter must perforce await its turn—unless in cases of exceptional need.

Now, about those flies,—I am glad you realize the necessity of getting rid of them somehow. They do carry so much dirt around on their hairy little legs, and such thousands of bacteria all ready to increase into millions more. Have you ever read the parody on the nursery rhyme, "Baby Bye"? There's a deal of truth in it, if very little poetry.

Baby bye,  
Here's a fly,  
Let us swat him, you and I,  
While we talk,  
See him walk,  
And for microbes never balk,  
Do you think, with six such feet,  
You and I would walk on meat?  
Will this fly  
Tell me why  
He will walk on bread and pie?  
Sure he knows

That his toes  
Are all covered with typhos,  
I should think, if I were he,  
I'd not fall in milk and tea.

There he goes!  
Shut the doors,  
He may cause you many woes;  
Take a brick,—  
Kill him quick!  
Or he'll make you very sick.  
Flies you strictly should avoid,  
If you would not have typhoid."

If it were only "this fly" one had to deal with,—but as you say, "they" are so likely to come in plentifully. . . . Just another bit of poetry (! ! ! ) and then we'll come to business:

Ten little flies  
All in a line;  
One got a swat!  
Then there were . . . . .  
Nine little flies  
Grimly sedate,  
Licking their chops—  
Swat! There were . . . . .  
Eight little flies  
Raising some more—  
Swat! Swat! Swat! Swat!  
Then there were . . . . .  
Four little flies  
Colored green-blue;  
Swat! (Ain't it easy!)  
Then there were . . . . .  
Two little flies  
Dodged the civilian—  
Early next day  
There were a million."  
(From Buffalo News.)

Now, I suppose I should apologize for imposing doggerel on you, but sometimes, on a subject such as this at least, a bit of nonsense makes more impression than the choicest of effusions by Alfred Noyes or William Butler Yeats,—that is supposing Noyes or Yeats could condescend to write on anything so commonplace as a wretched little household fly. When all has been said, too, I think that second selection rather clever. Don't you?

Now, about abolishing house flies: In the first place, see that conditions for producing them are removed. Flies lay their eggs in any kind of moist filth,—decaying vegetable matter, etc., but above all they delight in horse manure as a breeding place, hence, if all refuse from the horse stable is removed regularly, or covered closely, there is sure to be a marked decrease in the number of flies that find their way into the house. If, then, you would be free from the pest, you must see to it that one of two things is done. (1) That a cement-lined manure pit with a close cover is provided, or (2) That the manure is removed and spread on the fields twice a week. The insects require about a week to develop from egg to fly, through the successive stages of maggot and pupa, hence a semi-weekly removal of the manure is sufficient to keep the fly nuisance greatly in check.

Sometimes, however, a farmer's wife simply cannot contrive to have such measures taken; the men seem eternally too busy, or else they are too careless to take the trouble. "It's all fad!" they declare. "Flies have come into the house for twenty-five years, and no one has taken typhoid fever."

That is all very well, yet the fact remains that some day someone in the house may take typhoid or some other disease whose germs may be similarly carried on the small legs of flies and deposited on food. Even were such a case not possible, think of the filthiness of it! Flies travel over manure, over the pollution of privy pits, over dirt of every kind, then they calmly walk over and over your meat, your pies, your cakes; they are even inconsiderate enough to drop bodily into your milk-pitcher if they have half a chance.

In such case, the only thing one can do is to try to keep them out.

In the first place, kill every one of the large flies that you see in early spring. These are females, all ready to lay their eggs and send down their progeny of "a million" to torment you. Keep the dooryards clean, so that no lump of moist decaying matter may be there to form harborage for even a few maggots. Keep the swill-bucket clean and closely covered, so that the flies may not be attracted to it, and leave no pails of milk

## WHITE SWAN YEAST CAKES

Families who once use White Swan Yeast Cakes for bread baking will never use any other brand. It makes light, wholesome and delicious bread. Sold by your grocer in packages of 6 cakes at 5c. Send for free sample.

White Swan Spices & Cereals, Ltd.  
Toronto, Ont.

16 In. Ostrich Plume  
All Colors

Just the kind of Ostrich Plume you have to pay \$5.00 for at retail stores. Fully 16 inches long, extra wide, willowy tips and large, heavy, drooping head. Send \$1.00 to-day; this opportunity for a limited time only. Also a large, handsome 12.00 Plume at \$2.50. Money back if not entirely pleased.

NEW YORK OSTRICH FEATHER CO., Inc.  
Dept. "00" Fifth Avenue and 23d Street, New York

## TREASURE STEEL RANGES ALWAYS PLEASE



### On Baking Day

The Efficiency, the Economy, the Comfort and the Cleanliness of a Treasure Steel Range are exemplified in a hundred different ways.

EVERY JOINT IS AIR-TIGHT AND DUST-TIGHT—SAVES WORK BECAUSE IT MAKES NO DIRT.

SAVES FUEL BECAUSE IT IS MECHANICALLY CONSTRUCTED, ALL HEAT BEING CONCENTRATED IN THE OVEN, WHICH IS LARGE AND PERFECTLY VENTILATED.

BAKES QUICKLY, EVENLY AND PERFECTLY.

(The result of over 65 years' experience)

Guarantee Bond accompanies every Treasure Stove or Range.

For sale by dealers everywhere. Send for particulars.

The D. Moore Co., Ltd.  
Hamilton, Ont.

PLEASE MENTION THE ADVOCATE.

## For A Soft Healthy Skin

Use Baby's Own Soap. It's "Best for Baby—Best for You".

ALBERT SOAPS, LIMITED,  
Mfrs., - MONTREAL.



Absolutely pure vegetable oils made fragrant by flower extracts, which help the skin, make Baby's Own Soap the best for toilet and nursery use.

Its fragrant, creamy lather delights all.

5-12

# Baby's Own Soap



**GROCER**

**Take A Handful Of "St. Lawrence" Sugar Out To The Store Door**

—out where the light can fall on it—and see the brilliant, diamond-like sparkle the pure white color, of every grain.

That's the way to test any sugar — that's the way we hope you will test

*St. Lawrence*  
**Sugar**

**Compare it** with any other sugar—compare its pure, white sparkle—its even grain—its matchless sweetness.

Better still, get a 20 pound or 100 pound bag at your grocer's and test "St. Lawrence Sugar" in your home.

**THE ST. LAWRENCE SUGAR REFINING CO., LIMITED, MONTREAL.**

67

## Purchase Fertilizers Now

Don't let the rush of Spring Work prevent you from getting your fertilizer supplies.

If you have not already done so, purchase your materials now from some reliable firm.

**Don't forget to use plenty of Potash, which gives Quantity and Quality and promotes Maturity.**

Write us for Free copies of our illustrated Bulletins, which include:

- "Artificial Fertilizers: Their Nature and Use."
- "Fertilizing Fodder Crops."
- "Fertilizing Orchard and Garden."
- "The Potato Crop in Canada," etc., etc.

**THE GERMAN POTASH SYNDICATE**  
1106 Temple Building TORONTO, ONT.

**Please Mention this Paper.**

pits closely covered. Irreparable harm has been done, bowel trouble, and all sorts of things caused, by the simple neglect of this precaution. Flies do fly to great distances, considering their size, and you know not what detestable filth they may carry on their legs.— J.

### DECORATING A HOUSE.

Dear Nookers,—I have lingered a long time on the outskirts of your circle, but you all seem so friendly and so very informal that I have plucked up courage to step out of the shade into the charmed circle round the fire-place, and I find that it is not only "charmed," but charming to be here.

Madam "Junia," a word with you first, if you please. We moved late last fall from a very small house to a lovely large one. I had not much furniture, and tried to do with what I had for the winter, but now when housecleaning time comes, I feel that I would like to have things fixed nice, but living on the Manitoulin I do not have a chance to see any real up-to-date homes, and am not very sure about what is best.

My dining-room is a lovely room, but the walls are dirty. It is wainscotted up part way, and the wood grained a lovely golden brown. There is a large double window facing south, and two windows on the west. I happened to have an oilcloth which covered the floor, and for the sake of economy had to use it, although it is not what I would have chosen had I been buying it for that room in the first place. It is a blue-gray ground, with red flowers and yellowish-brown leaves. The walls at present are white, with a plain, narrow gilt picture moulding, but, as I said before, they are dirty. Now, would you advise me to have them white again, or how shall I treat them? There are so many things I need, and I have so little to get with, that I have decided to have cream cheesecloth for curtains and stencil it, but am not sure what color to use. Would a flat, dull shade of (I don't know just what to call the shade I mean—buff, or deep straw, I guess comes nearest) on the walls to the moulding, with a cream tint above and on the ceiling, look well with curtains stencilled golden-brown, or would dull blue look better?

or stop sitting about uncovered. (These are general directions, Maimie. I am quite sure by the daintiness of your letter that you do not need them personally, but you see we must always make all such information general.)

Screen doors and screens for windows will help, but, as you say, Maimie, you cannot screen off your shed. If there is a window in it, have it taken out entirely so that the flies can at least pass out there as well as at the doorway, instead of being caught and held inside.

Sticky fly-paper is effective to a certain extent, and there is a new kind that may be suspended from the ceiling, which is better than the old, in that it is never about in the way.

Many other methods are given for banishing flies from a room, all effective in helping to abolish flies. Heat a fire-shovel or metal pan, drop 20 drops of carbolic acid on it,—this is a plan highly recommended by those who have tried it. Here is, another that I found in, I think, "Suburban Life."—"A cheap and effective remedy, and one not dangerous to human lives, is bichlorate of potash in solution. It can be bought at any drug store, and used by dissolving one dram in two ounces of water and adding a little sugar, the mixture being placed in shallow dishes." In all the Government bulletins, bearing on the subject, both United States and Canadian, the formaldehyde method is recommended. Put a spoonful of formaldehyde in a pint of water and place the solution in saucers in various parts of the house out of reach of children.

Another method is to close all doors and windows and burn pyrethrum powder. The process stupefies the insects so that they fall to the floor, when they may be immediately swept up and burned.

Even with all these precautions a few flies may gain access, and measures must still be taken to keep them from alighting on food. They do not like darkness, hence, if there are no doors before the pantry shelves, have thick window-blinds with spring rollers hung to serve in place of the doors that should be there. Keep all vessels containing food closely covered (the wire net covers sold for the purpose are excellent), and make large cheesecloth covers to throw over the table after it has been "set," so that the flies have no opportunity to perambulate about over the food while you wait. Sponging the pantry windows daily with a solution of carbolic acid and water is also said to be effective in keeping flies out.

Now, Chatterers, I think I have exhausted about all I know or can find out in regard to the fly question. Just one thing more I may remind you of,—that is to REPEAT any of the methods given at intervals, as needed. You can't get rid of flies with "one fell swoop," for, you know, successive hatches may keep hatching out,—are sure to, if there are any breeding places in the immediate neighborhood.

And—oh, yes,—be sure to keep your

There is a large double parlor, but I am afraid I shall not be able to furnish it all, nor do I think it would be wise, as we are only renting, and hope some day to build a home to suit ourselves, and then I would only have a medium-sized parlor. As there are only our two selves and our wee maid of nine years, I shall only use half the parlor. I have decided on green, with touches of old rose, for that room. Would a green rug (velvet), with border of pink roses, be nice, or would you get just a two-tone green rug? Would you get a parlor suite, or would odd chairs be nicer? I fancied big cane or wicker arm chairs, with a couple of fancy cushions for each, which could be renewed when they got shabby. I want leather-covered furniture for the dining-room when I can afford it.

Now, I am sure I have asked more questions than I have any right to, but you have all borne with me so patiently that I cannot go without something in return for what I expect to get. You know I just love making dainty things for the home, and one of the very daintiest I ever made was so simple that I shall try and explain it to you all.

I got a large-size flower-pot with a hole in the bottom and gilded it inside. Next I got a round stick (five or six inches around will do) and nailed a square, thick piece of board, say ten or twelve inches square, on one end so it will stand firmly on the floor. Then I sawed the other end off so that when the flower-pot sits on top it will reach the window sill. Next I glued a piece of cloth around the top of the pot outside and fastened the pot firmly to the top of the round stick with a large screw nail, and the frame-work was complete. After that I joined a width and a half of soft green silk and gathered it at the top, slipped it over the frame like a short skirt, and sewed it to the strip I glued around the top of the pot. I then gathered it tight around the stick where it joins the board and tacked it down tight with carpet tacks. Next I had to cover the board, so I hemmed a long, straight piece of silk wide enough to come well out over the corners and

**A REAL SUMMER NEED**

**The Stratford Lawn Swing**

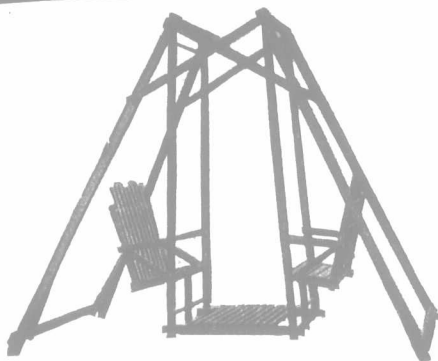

Just the thing for your Lawn or Garden. It is fine for the youngsters and a source of enjoyment for the grown-ups too. It is inexpensive and is built solid and strong.

Write us for Booklet "A" which tells all about this and other Summer and Out Door Furniture.  
**THE STRATFORD MFG. CO.**  
Stratford, Ont. Limited



**O. K. CANADIAN POTATO PLANTER**

The machine that is as easy to operate as a horse rake — and enables you to plant from four to six acres of Potatoes a day.

It opens the trench, plants the potatoes any distance set for, covers them with moist soil, and marks for the next row.

"Money in Potatoes"—our new book—tells all about potato growing. Write for a free copy, and our catalogue.

**CANADIAN POTATO MACHINERY CO. LIMITED,** - - - 5 - GALT, ONT.

**QUEEN'S UNIVERSITY**

**ARTS, EDUCATION, THEOLOGY, MEDICINE, SCIENCE, Including ENGINEERING Arts Summer Session July 3 to Aug. 17**

The Arts course may be taken by correspondence, but students desiring to graduate must attend one session.

Short Course for Teachers and general students July 10th to 31st.

For calendars write the Registrar  
G. Y. CHOWN  
Kingston, Ont.

**UNIVERSITY KINGSTON . . . ONTARIO**

**WANTED-CREAM**

Highest Toronto prices paid for cream delivered at express office.

WE—pay all charges.  
—furnish cans free.  
—pay accounts fortnightly.  
—engage man to collect at some points.  
—not essential. Write for particulars.

**The Toronto Creamery Co., Ltd.**  
Toronto, Ontario

gathered that around very full and tied a ribbon around where the top and under frill joined. The small frill, of course, spreads out in a flat circle on the floor. One may finish the top with a bit of fancy fringe, but I used another frill about eighteen inches deep, put on at the top and held a little bit frill. I caught it up in three places around the pot with a bow, and finished the lower edge of the frill with silk pompons to match. Now, I do hope I have made this clear, and that some of you will make one, for I know you would like it so much as a fancy jardiniere. Then I have one made with a small-size butter-tub, lined and padded inside, and covered first with an old sheet, and then with white cheesecloth on the outside, tied with pale blue ribbon. It is used as a catch, all in a blue and white bedroom. I am going to have one beside my easy-chair for a work-basket, and another beside the secretary as a w.-p. b. (Did I hear someone whisper, "She ought to have it in use now?"). An old silk or muslin skirt makes a fine cover.

My, I had no idea I stayed so long! You will not care to have me come again. A MANITOULINER.

Manitoulin Island, Ont.

A tint is usually better than white for walls; white is rather dead. Personally, I am very fond of buff, and I think the coloring you suggest would be lovely, with the cheesecloth curtains stencilled in brown. Of course, some would prefer a dull blue (rather light in tone) for a room with so much sunshine; it would "go with" your inoleum nicely. If you do not care to go to the expense of papering, why not try one of the dull-surfaced wall-finishes? Muresco, Sherwin-Williams flat-tone wall-coloring, and alabastine, are all good if well put on.

The coloring you suggest for the parlor (I suppose "sticklers" would make us say "drawing-room" nowadays) would be delightful—in just the right shade of green, of course. You seem to have excellent taste, Manitouliner, in spite of not being able to see "up-to-date" things. The old rose would be a pretty contrast to the green in a dainty room.

Some like a regular set of parlor furniture, but the odd pieces are quite as much used (provided they harmonize), and offer the advantage of making it possible to buy one at a time according to the state of one's pocketbook. You might have a few pieces upholstered in some material which can be easily matched, and a few of wicker, with cushions; or you might have all wicker, with tied-on flat cushions of the same color and material. Wicker furniture is always light and pretty, and now you can get it in almost any color you choose. The old-fashioned rush is also much in favor at present. I am not sure that you will be able to find cane easily, but it was always tasteful for certain places, and no doubt there will be a renaissance of it some day before long. The leather would be fine for the dining-room. Of course, as you suggest, it costs quite a deal, because one must have real leather to be sure of both looks and wearing quality. In some fine old-fashioned houses, the old-style wooden Windsor chairs are liked for the dining-room. It is all a matter of taste. Come again, Manitouliner.

**BEDROOM PAPER—LIGHT CAKE.**

Dear Junia,—I am thinking of papering my bedroom this spring and would like your advice on what would be best to put on. The woodwork is done in mahogany. There is one window facing the east. The ceiling is high, and the room is quite a size, 14 x 11 feet. What kind of curtains would be best? The window is one of the large, old-fashioned kind. The room has a green paper on now, so would not like the same. I will send a light cake recipe, which I think very good, and easy to make.

Light Cake.—One cup sugar, 1 1/4 cups flour, 1/2 teaspoon soda, 1 teaspoon cream tartar, 1 tablespoon cornstarch. Sift all together. In a cup put 1/2 cup butter; place on stove till melted. When it boils up, break into it one egg. Quickly remove from fire and beat. Fill the cup with sweet milk, stir this into the flour, flavor, and bake in quick oven. Huron Co., Ont. MAMIE.

Since the ceiling is high, by all means have a drop ceiling, with the drop rather low, below this a wall paper, the join to

be covered by a narrow wooden moulding. Since the rest of the woodwork is stained mahogany, this moulding must also be given that coloring.

If the woodwork were all ivory-white, it would be much easier to choose the paper for your room; very few of the dainty bedroom papers are made to go with dark woodwork, although a much-favored combination is mahogany furniture with white woodwork. However, you may be able to find a soft, rich foliage paper in deep autumnal tints, or a tapestry paper with a conventional design in similar coloring, which will go with the mahogany. These dark papers are more generally used for living-rooms, dining-rooms, dens, and libraries, but occasionally one sees them in bedrooms, and they look very well if all the rest of the coloring in the room is in keeping. With such heavy papering, you must have something dignified, yet light, at the windows to give relief. Swiss or frilled muslin curtains of any kind would be much too "airy fairy" to suit the walls, so perhaps scrim, with heavy cream insertion border, would be the best choice.

If, however, you feel that you want a brighter room, you might like a two-toned cream paper, cream curtains, and a rug in deep rich coloring to harmonize with the mahogany.

**Re Quilt Patterns.**

Several readers have written to asking that the quilt patterns mentioned by "Cook," Quebec, be forwarded them. Oh, Chatterers, how you misunderstood! —But perhaps I did not explain clearly enough. Now, just reason it out: Our subscription list is estimated at something over 30,000. Averaging three readers in each family, we have, at a modest guess, 90,000 readers. Suppose that, say, 10,000 of all this number took a notion to have those patterns directly from "Cook," and you may have some idea of what the poor woman's predicament would be. Why, she would be kept busy for months doing nothing but drawing out or cutting out patterns if she attended to all the requests. Now, Chatterers, you didn't use your "gray matter," or you would have seen that Cook meant that she would forward those patterns, "Kaleidoscope," "Bear's Paw," etc., to "The Farmer's Advocate," to be published, so that you could draw them off for yourselves, enlarging as necessary. If she will be kind enough to do this, we shall be pleased to give you the pictures as soon as possible.—But, positively, we cannot "send" quilt patterns privately to anyone, nor can we forward letters to "Cook," asking for the patterns. We must have some mercy on her, you know.

**RE SONG.**

Dear Junia,—Priscilla may obtain the song she asked about, e. g., "Where the River Shannon Flows," at either Eaton's or Simpson's, for 15 cents. Or almost any one of Knox's stores have it.

VIOLET BROWN.

Elgin Co., Ont.

**Seasonable Recipes.**

Jerusalem Artichokes.—Probably most of you who have artichokes growing about the place know that the tubers of these when dug up in early spring are quite as good for cooking as are parsnips and salsify which have been left in the ground over winter. If you have taken the precaution to dig up a bushel or so to keep them for spring using, you may find the following recipes valuable:

Scraped Jerusalem Artichokes.—Wash and scrape the artichokes and put them into salted water to prevent discoloring. For the same reason, put them to cook in boiling water to which has been added a little milk. Add salt before they are quite done. When tender, serve with a cream sauce.

Baked Artichokes.—Prepare and boil as above until almost done. Drain the artichokes and put them in a greased baking pan. Brush them over with butter or cream, sprinkle with crumbs, and bake brown.

Jerusalem artichokes contain no starch, but they contain considerable nourishment, protein, fat, and carbohydrates, which are not starchy in nature.

Onions.—Butter the kettle in which the

**SEED OATS**

We still offer the Scotch grown **Black Tartarian, Regenerated Banner, Regenerated Abundance** They test 44 lbs. to the bushel and are the finest oats we have handled in years. Price in 5 bush lots or over, \$1.30 per bush., bags free.

**Ontario Grown Seed**

Price in 10 bushel lots or over, bags free.

Daubenev	.....	\$1.25	per bush.
Siberian	.....	85	" "
White Cluster	.....	85	" "
Banner	.....	80	" "

If you order 50 bush. we will reduce the price 3c. per bushel. If you order 100 bushels we will reduce price 5c. per bushel.

**Barley**

In 10 bushel lots or over, bags free.

O. A. C. No. 21, best lot	.....	\$1.35	per bush.
O. A. C. No. 21, next lot	.....	1.15	" "

**Mangels**

In 5 lb. lots or over.

In ordering grain, grasses and mangel seeds for freight shipment you may deduct 5c. per lb. off prices quoted herewith

		Per lb., post paid
Champion Yellow Intermediate	.....	40c.
Yellow Leviathan	.....	40c.
Keith's Prizetaker	.....	40c.
Mammoth Long Red	.....	40c.
Golden Tankard	.....	40c.
Giant Half Sugar	.....	40c.

**Clovers and Timothy**

Herewith find prices good for one week from date of issue of this paper if unsold. If you live in Ontario and order 100 lbs. or more of our clovers and Timothy, we will pay the freight to your nearest station. Otherwise our prices are ex warehouse, Toronto. Cotton Bags for Clover and Timothy at 25c.

<b>Red Clover</b> —	Gov't Stan.	Price
"Sun" brand	No. 1	\$15.50
"Moon" brand	" 2	14.50
"Comet" brand	" 3	13.75
<b>Alfalfa Clover</b> —		
"Gold"	" 1	13.00
"Silver"	" 2	12.00
<b>Alsike</b> —		
"Ocean"	" 1	14.00
"Sea"	" 2	13.50
"Lake"	" 3	13.00
<b>Timothy</b> —		
"Diamond"	" 1	9.50
"Crescent"	" 2	8.50
"Circle"	" 3	8.00

**Fertilizers**

Order along with your seeds

Muriate of Potash	.....	\$48.00	per ton
Sulphate of Potash	.....	58.00	" "
Acid Phosphate	.....	19.00	" "
Nitrate of Soda	.....	57.00	" "

Our Catalogue tells how to mix for the different crops.

Send for Catalogue

**GEO. KEITH & SONS**

Seed Merchants since 1866  
124 King St. E., TORONTO, ONT.

**MAKE YOUR OWN TILE**

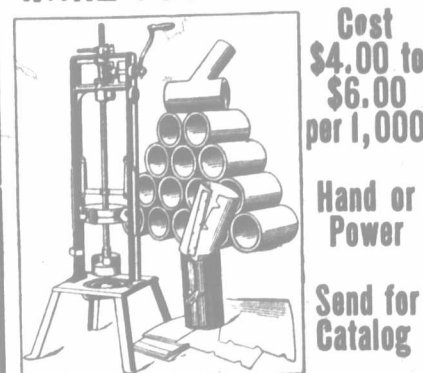

Cost \$4.00 to \$6.00 per 1,000

Hand or Power

Send for Catalog

**Farmers' Cement Tile Machine Co.**  
WALKERVILLE, ONT.

# "HARAB"

## Fertilizers

## Poultry Foods

## Stock Foods

Not always the cheapest, but always the best. Have you tried them?

### FERTILIZERS

(GUARANTEED ANALYSIS)

#### List of "Harab" Fertilizers

	Nitrogen	Phosphoric Acid	Potash
No. 1. A Potato Special.....	3	6	8
No. 2. A General Garden.....	3	7	3
No. 3. A Early Vegetable.....	4	6	4
No. 4. A Berry.....	2	7	5
No. 5. A Orchard.....	2	4	5
No. 6. A Cereal.....	2	9	3
No. 7. A Potash Compound.....	2	7	8
No. 8. A Fine Steamed Bone.....	3.5	22	0
No. 9. A Blood and Beef.....	7	6	
No. 10. A Blood and Bone.....	7	10	
No. 11. A Clover and Hay.....	6	3	5
No. 12. A Beans.....	2	8	8
No. 13. A Beets (Sugar).....	3	7	8
No. 14. A Tobacco.....	3	8	6
No. 15. A Corn.....	2	9	4

### STOCK FOODS

"Harab" Digestive Tankage.....	125 lb. Bags
For Feeding Hogs	
"Harab" Blood Flour.....	50 and 100 lb. Bags
For Feeding Calves, Colts and Sheep	
"Harab" Sugar Food.....	10, 25 and 50 lb. Bags
For Horses—Run Down	
"Harab" Fattine Meal.....	100 lb. Bags
For Milk Cows and Fat Cattle	

### POULTRY FOODS

"Harab" Scrap Beef.....	50 and 100 lb. Bags
For Feeding Fowl	
"Harab" Chick Scrap.....	50 and 100 lb. Bags
For Feeding Chickens	
"Harab" Beef Meal.....	50 and 100 lb. Bags
For Feeding Fowl in Soft Meal	
"Harab" Poultry Bone.....	50 and 100 lb. Bags
For Feeding Poultry	
"Harab" Raw Bone Meal.....	50 and 100 lb. Bags
For Feeding Young Chicks	
"Harab" Red Blood and Bone Tonic.....	10 lb. Bags
For Poultry Out of Condition	
"Harab" Crystal Grit.....	100 lb. Bags
"Harab" Oyster Shells.....	100 lb. Bags
"Harab" Willow Charcoal.....	10 lb. Boxes

If your dealer does not carry a stock of the above lines, write us direct, and we will quote you prices delivered to your station.

### HARAB PRODUCTS

MADE IN CANADA BY

**THE HARRIS ABATTOIR CO., LIMITED**  
Toronto, Ontario

onions are to be cooked. Slice the onions in, cover closely, and set on the stove to heat gradually. Stir them often, and cook very slowly to a light brown. These resemble fried onions, but are much more digestible than onions cooked in a large quantity of fat.

**Breaded Vegetable Oysters.**—Scrape the salsify, and cut into pieces 1½ inches long. Boil the pieces in a very small quantity of water until tender, adding salt just before they are done. Take out, dip in beaten egg, roll in cracker-crumbs, put on a buttered pan, and bake for ten minutes in a hot oven. Serve with a gravy made with milk, and the water in which they were boiled, thickened with ¼ cup flour to the pint of liquid, and nicely seasoned with butter, pepper, and salt.

**Vegetable Oyster Stew.**—Cook the vegetable in a very little water after washing and scraping well. When tender, rub the pieces through a sieve back into the water again, add milk or cream, re-heat, thicken very slightly with flour, season, and serve. You may add a very small bit of codfish to the vegetable while cooking if you choose.

When preparing salsify or vegetable oyster, allow the roots to stand in cold water for a while, then wash them, scrape the skin off quickly, and immediately drop them into cold water into which flour (1 tablespoon to the quart) has been stirred. This prevents discoloring.

#### MILK CHOCOLATES—BROKEN WALL.

Dear Junia,—I noticed in "The Farmer's Advocate" of last week a request for milk chocolates. If it is the candy, I think I can supply the want. Take 3 cups of brown sugar, 1 cup of boiling water; boil for five minutes; shake, but don't stir. Add ½ teaspoon of cream tartar in 1 teaspoon of boiling water, boil ten minutes, or until it forms a soft ball. Grease a platter, pour taffy in, add 1 teaspoon of vanilla, cool till milk heat, then beat till creamy, and form into balls. Melt ½ 10c. cake of unsweetened chocolate with a teaspoon of butter, run hatpin through balls, and dip in chocolate.

I noticed a piece from Sweetheart regarding a boarded kitchen. Some of my friends have bought cheap factory cotton or cheesecloth, and sewed the widths together to fit the space on the wall between doors or windows and doors, as the case may be. Wet it in a size the same as used for papering, stretch it over the space, and tack carefully and evenly all round. I have seen rooms papered over cotton, and would never have known if I had not been told. Hoping you will be able to read this scribbling, I remain,

"THE OLD WOMAN."

Huron Co., Ont.

Many thanks for this information.

#### WEDDING QUERIES.

Dear Junia,—Is it proper at a wedding supper for all relatives of the bride and groom to sit down to the first tables, and allow the invited guests to wait until all the relatives are through? Or should the invited guests sit at the first tables with the bride and groom, and the relatives after? SUBSCRIBER.

Haliburton Co., Ont.

Naturally, the bride's parents sit down at this most important of functions with their daughter. Naturally, also, her sisters and cousins prefer to see first to the comfort of the guests. It would look very ridiculous were all the relatives to sit down at the first tables, leaving the invited guests to wait.

#### HOW GOES IT.

"Well, George," said the president of the company to old George, "how goes it?"

"Fast to middlin'," George answered. And he continued to currycomb a bay horse. "Me an' this here boss," George said, suddenly, "has worked for your firm seven years."

"Well, well," said the president, thinking a little guiltily of George's seven-dollar salary. "And I suppose you are both pretty highly valued, George, eh?"

"H'm," said George, "the boss of us was took sick last week, and they got a doctor for the boss, but they just docked my pay."

### "The Farmer's Advocate" Fashions.



7385 Belted Semi-Princesse Dress for Misses and Small Women, 14, 16 and 18 years



7378 Semi-Princesse Gown, 34 to 42 bust.

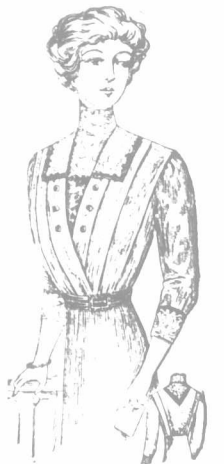

7374 Tucked Surplice Blouse, 34 to 42 bust.

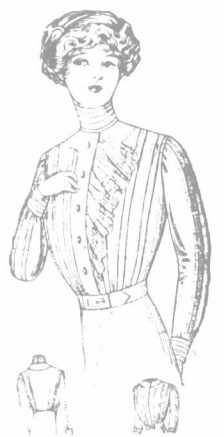

7378 Tucked Blouse or Shirt Waist, 34 to 42 bust.

Please order by number, giving age or measurement, as required, and allowing at least ten days to receive pattern. Address, Fashion Dept., "The Farmer's Advocate," London, Ont.



**March Secrets.**

There's a secret in the thicket, there's a whisper in the air,  
And a stir of sleepy grasses; and although the trees are bare,  
There's a light along their branches, and a thickening of twigs,  
And the pussy-willows don their dainty little periwigs.

All the meadow-pools are twinkling with the breezes and the sun,  
While the wrinkles and the crinkles o'er their laughing faces run,  
Hark! a bullfrog singing gayly at the bottom of his voice  
Is inviting all creation to awaken and rejoice.

From the silence of the woodland comes the tinkle of the brook,  
And a rustle, as of waking, in each sunny, sheltered nook;  
For the west wind has a message, and the gentle rain a hint  
Of earth-odors, and the presage of new melody and tint.

There's a secret in the thicket, there's a whisper in the air;  
There's a mystery a-brewing, of which Lillac seems aware.  
And a busy little lady-sparrow hither flies and yon,  
While her mate upon the fence observes, "There's something going on!"  
—Edna Kingsley Wallace, in *The Broadway*.

**The Hunting Season.**

A hunter popped a partridge on a hill,  
It made a great to-do, and then was still.  
It seems (when later on his bag he spied)  
It was the guide.

One shot a squirrel in a near-by wood—  
A pretty shot, offhand, from where he stood,  
It wore, they said, a shooting-hat of brown.  
And lived in town.

And one dispatched a rabbit for his haul  
That later proved to measure six feet tall;  
And, lest you think I'm handing you a myth,  
Its name was Smith.

Another Nimrod slew the champion fox.  
He glimpsed him lurking in among the rocks.  
One rapid shot! It never spoke nor moved.  
The inquest proved.

A "cautious" man espied a gleam of brown:  
Was it a deer—or Jones, a friend, from town?  
But while he pondered by the river's rim,  
Jones potted him.  
—Philadelphia Public Ledger.

**MUSICAL COW.**

(From the New York Herald.)  
[News Note.—J. Gilbert Hiccox, a Milwaukee farmer, gains \$1,000 a year by providing music on a phonograph for his cows while they are being milked.]

"Oh Jenny, put a record in!"  
It was the farmer's cry,  
And soon old Sukey visions had  
Of "Comin' Through the Rye."  
It made her mouth to water and  
Her nostrils open wide  
As "Breath of New Mown Hay" she caught  
From fragrant river side.

"The Good Old Summer Time" called forth  
The pleasantest of dreams,  
She chewed her cud in calm content  
At Jinks' "corn and beans,"  
And valiant "Wearing of the Green"  
Made verdant visions pass,  
And then knee-deep she was "In Old Kentucky's" bluest grass.

When Gentle Annie's springtime came  
By "Banks o' Bonny Dee,"  
She ate her fill, then sought the shade  
Of an "Old Apple Tree."  
Where "Little Buttercups" so dear,  
Star-scattered she could see—  
She switched her tail, and then she heard,  
"Shoo Fly, Don't Bother Me."

And as old Sukey's cultured ear  
Took in each pleasant strain,  
She gave of milk each drop she had,  
To that wise farmer's gain.  
But fortune balked, there came an end  
To what he set his pride on,  
When—sad mistake—he played one day  
"The Tune the Old Cow Died On."

**Send Us No Money for This Rocker**

Let Us Send it to YOU on 5 Days' Approval at Our Risk

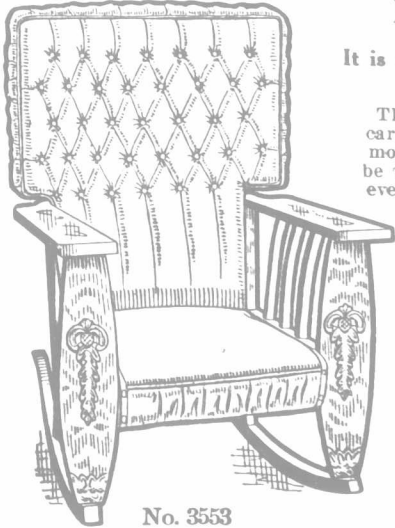

No. 3553

It is one of the big values in furniture contained in our large illustrated CATALOGUE "7"

This rocker is exactly as illustrated, frame of selected quarter-cut oak, hand-carved and polished, with spring seat and buttoned back, both upholstered in moroccoline—an imitation leather that will wear like iron and can scarcely be told from genuine leather. Equal in value to any \$10.00 rocker you ever saw.

**ONLY \$6.35 — FREIGHT PREPAID** to any station within and as far as 200 miles from Toronto. (200 miles freight allowance to points of greater distance.)

Cut out and send this coupon.

(Write name and address plainly.)

Name .....

Address .....

To the Adams Furniture Company, Toronto:

Dear Sirs.—Please ship me, freight prepaid, on 5 days' approval, one NO. 3553 Rocker. I agree to return the 5 days' after receipt thereof—either remit to you the sum of \$6.35—the price of the rocker—or re-ship same to you. (This order implies no obligation on my part to purchase or bear freight charges either way.)

**The Adams Furniture Company, Limited, Toronto, Ont.**

**Help! Help!**

I hitched up old gray Dobbin  
To jog in to our town;  
I met my nearest neighbor,  
He wore a sullen frown.  
"My hired man has left me!"  
Was what he said to me,  
"He niver had wan raisin,  
An' I'm buisy as can be."

I drove up to the blacksmith's shop.  
A dozen min were there,  
They talked in anxious whispers,  
Their brows were lined with care.  
The "hired man" was the subject  
Of the conversational flow,  
Where were they to get him?  
An' would he stay or go?

Says I, "Now, listen to your Dad,"  
Some free advice I'll give;  
Sure, if ye'll only follow it,  
Ye can slape, an' laugh, an' live.

"If ye have no empty houses,  
Build thim double quick,  
An' soon ye'll hear of a married man  
That to his job will stick.  
Aye! have a wide veranda  
With vines all covered o'er,  
No hot days will be found in there.  
No heart-aches at the door,  
An' have a bit av a garden,  
A strip for purty flowers,  
They rest some weary workers,  
They lessen dunpy hours.  
An' give some butter and some milk.  
A wood-pile if ye can,  
An' if your man be not a hog  
Throw in a pig an' a hen.  
Och! trate him like a white man,  
Pay him what he arns,  
Then, both be deaf to gossips,  
And mischief-makers' yarns."  
A. C. McMORDIE.

**THE SAILOR'S CHEST.**

Bobby—"This sailor must have been a bit of an acrobat."  
Mama—"Why, dear?"  
Bobby—"Because the book says, 'Having lit his pipe, he sat down on his chest.'"

**IN A HURRY.**

Magistrate—"What is the charge against this old man?"  
Officer—"Stealing some brimstone, your honor. He was caught in the act."  
Magistrate (to prisoner)—"My aged friend, couldn't you have waited a few years longer?"

**THOUGHTLESS.**

"Your honor," said the arrested chauffeur, "I tried to warn the man, but the horn would not work."  
"Then why did you not slacken speed rather than run him down?"  
A light seemed to dawn upon the prisoner. "That's one on me. I never thought of that."

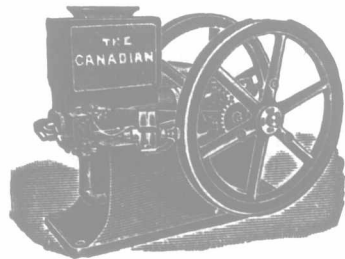

HOPPER COOLED ENGINE

**THE CANADIAN**

Our numerous customers exclaim that the CANADIAN Gasoline Engine IS THE LEADER because it is the most reliable, simple, durable and economical engine on the market. Why not benefit by the experience of those who are using the CANADIAN Engine. Made by

**The Canadian-American Gas & Gasoline Engine Co., Ltd.**  
Dunville, Ontario

**FROST & WOOD CO., LTD., Smith's Falls, Ont.**

Exclusive selling agents for Eastern Ontario, Quebec and Maritime Provinces.

**"Wheel the Scale to what you want to Weigh"**



**The RENFREW Handy Two-Wheel Truck Scale**

The Scale that is guaranteed by the Canadian Government.

The Renfrew insures the farmer his full profit on everything he sells by weight—from one ounce to 2,000 lbs. Simply wheel the Renfrew to what you want to weigh—it saves time and labor.

The Renfrew comes to you with Government certificate attached—an absolute Guarantee of Accuracy.

The Renfrew outlasts all others Scales—it is built for hard and unremitting service.

Write at once for our Booklet "The Profit in the Last Ounce" which shows you how to get every cent of profit on produce you sell by weight using a Renfrew Handy Two-Wheel Truck Scale.

**THE RENFREW SCALE CO.**  
Renfrew, Ontario

**WESTERN AGENTS**

SASKATOON—Western Distributors Co., Ltd.  
CALGARY—Reynolds & Jackson  
EDMONTON—Race, Hunt & Giddy  
MANITOBA—Clare & Brockest

Mail To-day Conpon

Please send me free of charge the booklet "The Profit in the Last Ounce."

Name.....

Address.....

**THE RENFREW SCALE COY.**  
Renfrew, Ont.

MENTION THE FARMER'S ADVOCATE WHEN WRITING ADVERTISERS.

POULTRY AND EGGS

Condensed advertisements will be inserted under this heading at two cents per word each insertion. Each initial counts for one word, and figures for two words. Names and addresses are counted. Cash must always accompany the order for any advertisement under this heading.

ANCONAS—Bred for exhibition and winter egg production. \$2 setting; \$3 for 30. E. W. Wardle, Coriath, Ontario.

BUFF LEGHORN EGGS—\$1.00 per fifteen. J. E. Griffin, Dunnville, Ontario.

BARRED P. ROCKS—Win at Brantford, January, 1912, first cockerel, first pullet, third cock, fourth and fifth hen. Eggs: \$3 per 15. Guaranteed fertile or replace free. W. Postlewaite, Brantford, Ontario.

BUFF ORPINGTONS—Cockerels and pullets from imported cock. Imported cock for sale or exchange. Eggs: \$1 and \$3 per 15. James McGregor, Caledonia, Ontario.

BUFF ORPINGTONS—Winners at Guelph Winter Fair, 1911, of 1st cockerel, silver cup; specials for best shape, best male, best bird, best three cockerels and 2nd utility pen (all classes competing). Over 50% egg yield since December 1st. Eggs from pens headed by above best three cockerels, \$5.00, \$3.00 and \$1.50 per setting of 15. Mrs. E. D. Graham, Queensville, Ontario.

BARRED White Rocks, White Wyandottes, White Leghorns, Black Minorcas, Buff Orpingtons, Aylesbury, Rouen ducks; settings, \$1. R. Laurie, Drumbo.

BARRED ROCKS—O. A. C. bred-to-lay strain. Thirteen fertile eggs for one dollar. Ed. Fulton, Cranbrook, Ontario.

BARRED PLYMOUTH ROCKS—Eggs for hatching; highest winners; grand utility; heavy layers. Prices reasonable. Write me. Leslie Kerns, Freeman, Ontario.

BARRED ROCK EGGS—From strong, healthy, well-exercised birds. Noted egg producers. Eggs, \$1.00 per setting. T. L. Patrik, Ilderton, Ontario.

BUFF ORPINGTON EGGS that will hatch; 9 chicks guaranteed with every setting. Three splendid pens, \$1.00 per setting. Special prices on incubator lots and fancy stock. Hugh A. Scott, Caledonia, Ontario.

BUFF LEGHORNS OF HIGH DEGREE—Eggs, \$1.25 per fifteen. Write for particulars. Charles Watson, Londesboro, Ontario.

BARRED ROCK EGGS FOR HATCHING—One dollar per fifteen. O. H. Chalmers, Smith's Falls, Ontario.

BARRED ROCK EGGS—From well-bred, healthy, heavy-laying, prize-winning birds. \$1 for fifteen; \$2 for forty; \$4 per hundred. Chas. Hilliker, Burgessville, Ontario.

BARRED ROCK EGGS—From good, strong, healthy, vigorous birds, and barred to the skin, mated especially for winter laying. \$1 per 15, or \$2 for 40. Hens have large orchard run. Plenty of exercise should guarantee a good hatch. Harvey Culp, St. Catharines, Ontario.

CLARK'S FAMOUS BUFF ORPINGTONS—Exhibition egg strains. Winners at New York, Chicago and Canadian leading shows. 12 breeding pens; eggs, \$1.00 to \$10.00 per 15. Incubator eggs, \$6.00 per 100. Satisfaction guaranteed. Free illustrated catalogue. J. W. Clark, Cainsville, Ontario.

CHOICE SINGLE-COMB BROWN LEGHORNS—Famous Becker & Gurney strains. Eggs, \$1.50 per 15. David A. Ashworth, Maple Grove, Ontario.

CARLUKE POULTRY-YARDS—Celebrated Barred Rocks. Eggs for hatching from winners at the principal shows in Canada, \$2.00 per setting (cockerel or pullet matings). G. Morton, Box 130, Carluke, Ontario.

DUCK EGGS—Good fertile duck eggs, fifty cents per eleven. Vernon I. Miller, Wroster, Ontario.

EGGS—S.-C. White Leghorns, heavy layers and prize-winners, \$1.00 per 15. A hatch guaranteed. \$4.00 per 100 eggs. Also two choice cockerels for sale; price, \$2 each. Geo. D. Fletcher, Binkham, Ont.; Erin Sta.

EGGS FOR HATCHING S.-C. White Leghorns and White Wyandottes, \$1.25 per 15, from pure-bred stock and heavy laying strain. Can supply Leghorn eggs (only), \$4 per 100. Hugh McKellar, Tavistock.

EGGS FOR HATCHING—From bred to lay, farm raised White Wyandottes. Fifteen eggs, one dollar; larger orders at reduced prices. Write Marshall Smith, Palmerston, Ontario.

EGGS FROM PRIZE-WINNING mating choice White Wyandottes, two dollars per thirty. J. G. Ellerton, Hornby, Ontario.

EGGS from high-class S.-C. W. Leghorns, two fifty per setting. For best quality prize-winners unexcelled. For more particulars, F. S. Burgess, 439 Yonge St., Toronto. Refused ten dollars for single cockerel from eggs bought of me last year. J. McDonough, Nashville, Ontario.

EGGS from prize-winning and laying White Rocks, one and two dollars per dozen, five per hundred. Jas. Coker, Jerseyville, Ont.

EGGS FOR HATCHING—White Wyandottes and S.-C. White Leghorns; mated specially for vigor. Send for mating list. P. Bartram, Grimsby, Ontario.

EGGS FOR HATCHING—From Barred Rocks, Partridge Rocks, Rhode Island Reds, White Wyandottes, White and Brown Leghorns. Bred to lay; grow quickly; fatten readily. \$1.50 per 15; \$6.00 per 100. Norfolk Specialty Farm Co., Ltd., St. Williams, Ontario.

EGGS from exhibition, Pekin, Aylesbury and Rouen ducks, \$4.00 per setting. Barred Plymouth Rock, White Wyandotte, Single-comb Black Minorcas, Light Brahma and Rose-comb Rhode Island Reds, \$3.00 per 15. Alton Stevens, Lambeth, Ontario.

EGGS from thoroughbred Rhode Island Reds; excellent winter-laying strain, \$2.00 setting; also Barred Plymouth Rocks, \$1.50 setting. Lethian Poultry-yards, phone 2695 F. 11, Charles H. Snow, prop., Quarries, via Ottawa, Ontario.

EGGS FOR HATCHING—Single-comb White Leghorns, Wyckoff strain, and S.-C. Rhode Island Reds; one dollar per fifteen. J. H. Stevenson, Copetown, Ontario.

EGGS FOR HATCHING—Regal strain White Wyandottes; good layers; one dollar per fifteen. Two cockerels cheap. S. Zehr, Tavistock, Ontario.

EGGS from prize-winning Bronze turkeys and Partridge Wyandottes. R. G. Rose, Glanworth, Ontario.

EGGS FOR SALE—My birds won over four hundred first prizes at eight shows. Barred Rocks, White and Silver-laced Wyandottes, Houdans, Blue Andalusians, Black Javas, Spangled and Black Hamburgs, Silver-gray Dorkings, Black Spanish, Single and Rose-combed R. I. Reds, Brown Leghorns; \$2.00 per 15 eggs. Half price after June 1st. F. W. Krouse, Guelph.

EGGS FOR HATCHING—From heavy-laying strains White Wyandottes, Silver-laced Wyandottes, Barred Rocks, Single-comb White Leghorns, Rose-comb Brown Leghorns and Rhode Island Reds, \$1.50 for fifteen eggs. W. H. Furber, Dunganon Poultry Farm, Cobourg.

EGGS—Rose-comb Rhode Island Reds; prize-winners. Owen and Shoemakers' strains; 15 for \$2.00; 50 for \$4.50; 100 for \$8.00. H. I. Smith, Comber, Ontario.

EGGS—S.-C. White Leghorns and Black Minorcas; also White Wyandottes and White Rocks, \$1.00 per 13; \$5 per 100. J. C. Collard, Southend, Ontario.

FARMERS' SPECIAL RATE—S.-C. White Leghorns; eggs for hatching, 12 dozen, \$5, including humpy-dumpy crate. Cash with order. Brown Leghorns, White Wyandottes, Buff Orpingtons, White Orpingtons, \$1.00 per fifteen; \$3.00 per fifty. Wm. Kaiser, Mitchellville, Ontario.

FREE handsome catalogue of fancy poultry. Describes and prices fifty varieties land and water fowls. S. A. Hummel, Box 23, Freeport, Illinois.

GOLDEN-LACED WYANDOTTES—Cockerels for sale; also a few pullets. Prices right. Good stock. Peter Daley, Box 25, Sealforth, Ontario.

HATCHING EGGS—Express prepaid to your nearest express office. Turkeys, ducks and geese; also ten different varieties of poultry. Send for price list. J. H. Rutherford, Caledonia East, Ontario.

HIGH-CLASS BARRED ROCKS—From first January to March fifteenth we got four thousand and forty eggs from one hundred and fifteen of our standard-bred heavy-laying Rocks. Pullet started to lay at five months and six days old. Eggs from a select pen, \$1.25 per fifteen. Charles Watson, Londesboro, Ontario.

HATCHING EGGS—Single-comb White Leghorns. Size, vigor, productiveness; unexcelled eggs, dollar setting; four dollars hundred. E. W. Burt, Paris, Ontario.

KULP'S FAMOUS LAYERS—Single-comb Brown Leghorn eggs, one dollar per fifteen. G. M. Howell, Brantford.

ONE DOLLAR for fifteen Plymouth Rock eggs. Bred exclusively from Guelph College laying strata. Mrs. Berry, Box 22, Guelph, Ontario.

PURE-BRED WHITE ORPINGTONS—Eggs, \$2.00 for thirteen. H. Ferns, 715 Wilham St., London, Ontario.

PURE BARRED ROCK COCKERELS, \$2.00. Eggs, dollar per fifteen. Regal White Wyandotte eggs, dollar per fifteen. Mrs. Clapp, Tecumseh, Ontario.

PRIZE-WINNERS—Light Brahmas, weighing up to 154 pounds, \$2.00 setting. Silver Spangled Hamburgs, \$1.50 setting. Golden Poland, \$2.50 setting. 25c per setting off for two or more settings. Harry Wilson, Box 798, Collingwood, Ontario.

RHODE ISLAND REDS—Both combs. Eggs, \$1.50, \$1.00. Rose-comb, 100, \$4.50. Wm. Runchey, Byng, Ontario.

ROSE-COMB Rhode Island Red eggs. Bred to lay. One dollar per fifteen; five dollars per hundred. Leonard J. Gibson, Guelph, R. F. No. 1.

ROYAL WHITE WYANDOTTES—Eggs for hatching, one dollar fifteen; five dollars per hundred. Special mating, headed by gold special winner at Winter Fair, Guelph, two dollars fifteen. Wm. Howe, North Bruce, Ontario.

ROYAL WHITE WYANDOTTES—Eggs for hatching, one dollar fifteen; five dollars per hundred. Special mating, headed by gold special winner at Winter Fair, Guelph, two dollars fifteen. Wm. Howe, North Bruce, Ontario.

ROSE-COMB REDS—Prize stock. Eggs for hatching from number one pen, two dollars; number two pen, one dollar. Fred Colwell, Cooksville.

SINGLE-COMB WHITE LEGHORN EGGS—For hatching, \$1.00 per setting. Wm. Charlton, Ilderton, Ontario.

SPRUCE GROVE Barred Rocks, R. I. Reds, White Wyandottes, S.-C. Brown Leghorns, selected matings. Eggs, \$1.50 per 15. W. J. Bunn, Birr, Ontario.

SILVER-LACED WYANDOTTES—Prize-winners. Eggs for hatching, \$1.50 a setting. Frank McDermott, Tavistock, Ontario.

SINGLE-COMBED BLACK MINORCAS—Eggs from heavy-laying strain, \$1.50 per setting; \$7 per hundred. M. H. Peterson, Norham, Ont.

SINGLE-COMB ANCONAS—Bred to lay, win and pay. Eggs: \$2 per thirty; guaranteed fertile. James Snyder, Wales, Ontario.

SINGLE-COMB BROWN LEGHORNS—Shoemaker strain. Grand layers. \$1.50 per setting. F. Fotheringham, Olinda, Ontario.

TRAP-NESTED PARTRIDGE ROCK EGGS—Leading winners Guelph Winter Fair, \$3 and \$2 sitting. Circular. Otto Schierholtz, Elmira, Ontario.

WHITE Wyandottes, White Rocks, Barred Rocks. Eggs from prize pens, \$2.00 per 15; utility, \$1.00; \$5.00 hundred. E. Hayes, Cannington.

WHITE WYANDOTTE EGGS—From choice matings. \$1.50 per 30; \$3.50 per 100. W. A. Bryant, Cairngorm.

WHITE WYANDOTTES—Eggs for hatching, \$1.00 per 15. W. Readhead, Lowville, Ontario.

WHITE WYANDOTTES—Cockerels, \$1.50; eggs, \$1 per 15. Bred-to-lay stock. J. A. Orchard, Shedden, Ontario.

WHITE WYANDOTTES EXCLUSIVELY—Bred for heavy egg production and standard points. Eggs: \$1.00 per 15. Good hatch guaranteed. Thos. F. Pirie, Banner, Ont.

\$6.41 PER HEN.—Write for our beautifully illustrated catalogue. Photos from life. B. P. Rocks, White Wyandottes, R. C. R. I. Reds, S.-C. White Leghorns. Eggs: \$1.50 per 15; \$2.75 per 30; \$7.00 per 100. L. R. Guild, Box 16, Rockwood, Ont.

EGGS EGGS EGGS PLEASANT VALLEY FARMS

For hatching: White Wyandottes, \$5 per 100; special mating, several prize-winners, \$3 per 15; S.-C. White Leghorns, \$4 per 10; special mating, \$1.75 per 15 eggs. Grand laying strains, both varieties.

GEO. AMOS & SONS, Moffat, Ont. Private phone Milton.

125 Egg Incubator \$10 and Brooder BOTH FOR \$10. If ordered together. Freight paid east of Rockies. Hotwater, copper tanks, double walls, double glass doors. Free catalog described them. Send for it today. Wisconsin Incubator Co., Box 173, Racine, Wis.

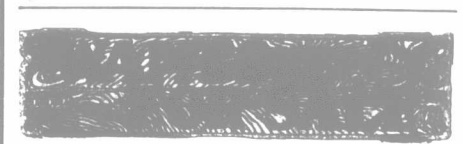

Advertisements will be inserted under this heading, such as Farm Properties, Help and Situations Wanted, and Pet Stock. TERMS—Three cents per word each insertion. Each initial counts for one word and figures for two words. Names and addresses are counted. Cash must always accompany the order. No advertisement inserted for less than 50 cents.

EXPERIENCED SHEPHERD WANTED—Bow Park Farm, Brantford, Ontario.

EXPERIENCED FARM HANDS WANTED—Permanent positions for right people. Bow Park Farm, Brantford, Ontario.

VANCOUVER ISLAND, BRITISH COLUMBIA, offers sunshiny, mild climate; good profits for men with small capital in fruit-growing, poultry, mixed farming, timber, manufacturing, fisheries, new towns. Good chances for the boys. Investments safe at 6 per cent. For reliable information, free booklets, write Vancouver Island Development League, Room A, 23 Broughton Street, Victoria, British Columbia.

WANTED—Cash paid for Military Land Grants in Northern Ontario. Please state price and location. Box 83, Brantford.

WANTED—Refridgerator to assist in general house work. Apply to Box C, Lindsay, Ontario.

800 ACRE FARM—For sale or rent, at Sweet River, Manitoba. 400 acres cultivated. No one out in possession with me. For more particulars, write to J. A. McPherson, 225 St. James St., Winnipeg, Man.

Annapolis Valley Fruit Farm

225 acres; the most wonderful bargain in this celebrated Nova Scotia Valley; good 8-room house; 60 ft. barn, room for 70 tons hay, cellar under all; 40 acres rich loam, machine-worked fields; young apple orchard, 200 trees; wood and timber will make a man independent; pasture for 25 head; spring watered and wire fences; near neighbors and advantages; the sacrifice price for quick sale is only \$1,900, part cash; act quickly or you will lose this. For all details and traveling instructions to see this and another with 15 acres in orchard, see page 62, "Strout's New Mammoth Farm Catalogue No. 35," just out; copy free; profusely illustrated and filled with a wonderful assortment of money-making farms throughout many rich farming sections; stock and machinery included with many at big sacrifices to settle affairs quickly. We pay buyer's R. R. fare. Station 2415, E. A. Strout Farm Agency, 294 Washington St., Boston, Mass.

SINGLE COMB BROWN LEGHORNS!

Eggs for hatching, \$1.25 per 15. Bred from good laying strains.

WM. BARNET & SONS, LIVING SPRINGS, Fergus station, Ont., T. R. and C.P.R.E.S.

Io Victis.

I sing the hymn of the conquered, who fell in the battle of life— The hymn of the wounded, the beaten, who died overwhelmed in the strife, Not the jubilant song of the victors, for whom the resounding acclaim Of nations was lifted in chorus, whose brows wore the chaplet of fame, But the hymn of the low and the humble, the weary, the broken in heart, Who strove and who failed, acting bravely a silent and desperate part; Who youth had no flower in its branches, whose hopes burned in ashes away, From whose hands slipped the prize they had grasped at, who stood at the dying of day With the wreck of their life all around them, unpitied, unheeded, alone, With death swooping down o'er their failure, and all but their faith overthrown.

While the voice of the world skouts its chorus—its paean for those who have won; While the trumpet is sounding triumphant, and high to the breeze and the sun Gay banners are waving, hands clapping, and hurrying feet Thronging after the laurel-crowned victors, I stand on the field of defeat, In the shadow, with those who are fallen, and wounded, and dying, and there Chant a requiem low, place my hand on their pain-knotted brows, breathe a prayer, Hold the hand that is helpless, and whisper, "They only the victory win, Who have fought the good fight, and have vanquished the demon that tempts us within; Who have held to their faith, unseduced by the prize that the world holds on high; Who have dared for a high cause to suffer, resist, fight—if need be, to die."

Speak, History! Who are Life's victors? Unroll thy long annals, and say, Are they those whom the world called the victors—who won the success of a day? The martyrs, or Nero? The Spartans, who fell at Thermopylae's tryst, Or the Persians, and Xerxes? He judges, or Socrates? Pilate, or Christ? —William Wetmore Story

Patrick worked for a notoriously stingy boss and lost no chance to let the fact be known. Once a waggish friend, wishing to twit him, remarked: "Pat, I hear your boss just gave you a brand-new suit of clothes." "No," said Pat, "only a part of a suit." "What part?" "The sleeves iv the vest!"

HER METHOD.

"When I goes a-shopping," says an old lady, "I allers asks for what I wants, and if they have it, and it is cheap, and it's suitable, and I feel inclined to take it, and it can't be got at any place for less, I most allers take it without chaffering all day, as most people do."

**The Scarlet Pimpernel.**

A STORY OF ADVENTURE.  
By Baroness Orczy.

(Serial rights secured by "The Farmer's Advocate.")  
By permission of G. P. Putnam's Sons.

(Continued from last week.)  
CHAPTER XVIII.  
The Mysterious Device.

The day was well advanced when Marguerite woke, refreshed by her long sleep. Louise had brought her some fresh milk and a dish of fruit, and she partook of this frugal breakfast with hearty appetite.

Thoughts crowded thick and fast in her mind as she munched her grapes; most of them went galloping away after the tall, erect figure of her husband, whom she had watched riding out of sight more than five hours ago.

In answer to her eager inquiries, Louise brought back the news that the groom had come home with Sultan, having left Sir Percy in London. The groom thought that his master was about to get on board his schooner, which was lying off just below London Bridge. Sir Percy had ridden thus far, had then met Briggs, the skipper of the Day Dream, and had sent the groom back to Richmond with Sultan and the empty saddle.

The news puzzled Marguerite more than ever. Where could Sir Percy be going just now in the Day Dream? On Armand's behalf, he had said. Well, Sir Percy had influential friends everywhere. Perhaps he was going to Greenwich, or . . . but Marguerite ceased to conjecture, all would be explained anon: he said that he would come back, and that he would remember.

A long, idle day lay before Marguerite. She was expecting the visit of her old school-fellow, little Suzanne de Tournay. With all the merry mischief at her command, she had tendered her request for Suzanne's company to the Comtesse in the presence of the Prince of Wales last night. His Royal Highness had loudly applauded the notion, and declared that he would give himself the pleasure of calling on the two ladies in the course of the afternoon. The Comtesse had not dared to refuse, and then and there was entrapped into a promise to send little Suzanne to spend a long and happy day at Richmond with her friend.

Marguerite expected her eagerly; she longed for a chat about old schooldays with the child; she felt that she would prefer Suzanne's company to that of anyone else, and together they would roam through the fine old garden and rich deer park, or stroll along the river.

But Suzanne had not come yet, and Marguerite being dressed, prepared to go downstairs. She looked quite a girl this morning in her simple muslin frock, with a broad blue sash round her slim waist, and the dainty cross-over fichu into which, at her bosom, she had fastened a few late crimson roses.

She crossed the landing outside her own suite of apartments, and stood still for a moment at the head of the fine oak staircase, which led to the lower floor. On her left were her husband's apartments, a suite of rooms which she practically never entered.

They consisted of bedroom, dressing and reception-room, and, at the extreme end of the landing, of a small study, which, when Sir Percy did not use it, was always kept locked. His own special and confidential valet, Frank, had charge of this room. No one was ever allowed to go inside. My lady had never cared to do so, and the other servants had, of course, not dared to break this hard-and-fast rule.

Marguerite had often, with that good-natured contempt which she had recently adopted towards her husband, chaffed him about this secrecy which surrounded his private study. Laughingly she had always declared that he strictly excluded all prying eyes from his sanctum by fear they should detect how very little "study" went on within its four walls: a comfortable arm-chair for Sir Percy's sweet slumbers was, no doubt, its most conspicuous piece of furniture.

Marguerite thought of all this on this

bright October morning as she glanced along the corridor. Frank was evidently busy with his master's rooms, for most of the doors stood open, that of the study amongst the others.

A sudden, burning, childish curiosity seized her to have a peep at Sir Percy's sanctum. The restriction, of course, did not apply to her, and Frank would, of course, not dare to oppose her. Still, she hoped that the valet would be busy in one of the other rooms, that she might have that one quick peep in secret, and unmolested.

Gently, on tip-toe, she crossed the landing, and, like Blue Beard's wife, trembling half with excitement and wonder, she paused a moment on the threshold, strangely perturbed and irresolute.

The door was ajar, and she could not see anything within. She pushed it open tentatively: there was no sound: Frank was evidently not there, and she walked boldly in.

At once she was struck by the severe simplicity of everything around her: the dark and heavy hangings, the massive oak furniture, the one or two maps on the wall, in no way recalled to her mind the lazy man about town, the lover of race-courses, the dandified leader of fashion, that was the outward representation of Sir Percy Blakeney.

There was no sign here, at any rate, of hurried departure. Everything was in its place, not a scrap of paper littered the floor, not a cupboard or drawer was left open. The curtains were drawn aside, and through the open window the fresh morning air was streaming in.

Facing the window, and well into the center of the room, stood a ponderous business-like desk, which looked as if it had seen much service. On the wall to the left of the desk, reaching almost from floor to ceiling, was a large full-length portrait of a woman, magnificently framed, exquisitely painted, and signed with the name of Boucher. It was Percy's mother.

Marguerite knew very little about her, except that she had died abroad, ailing in body as well as in mind, when Percy was still a lad. She must have been a very beautiful woman once, when Boucher painted her, and as Marguerite looked at the portrait, she could not but be struck by the extraordinary resemblance which must have existed between mother and son. There was the same low, square forehead, crowned with thick, fair hair, smooth and heavy; the same deep-set, somewhat lazy blue eyes, beneath firmly marked, straight brows; and in those eyes there was the same intensity behind that apparent laziness, the same latent passion which used to light up Percy's face in the olden days before his marriage, and which Marguerite had again noted, last night at dawn, when she had come quite close to him, and had allowed a note of tenderness to creep into her voice.

Marguerite studied the portrait, for it interested her: after that she turned and looked again at the ponderous desk. It was covered with a mass of papers, all neatly tied and docketed, which looked like accounts and receipts arrayed with perfect method. It had never before struck Marguerite—nor had she, alas! found it worth while to inquire—as to how Sir Percy, whom all the world had credited with a total lack of brains, administered the vast fortune which his father had left him.

Since she had entered this neat, orderly room, she had been taken so much by surprise, that this obvious proof of her husband's strong business capacities did not cause her more than a passing thought of wonder. But it also strengthened her in the now certain knowledge that, with his worldly manties, his foppish ways, and foolish talk, he was not only wearing a mask, but was playing a deliberate and studied part.

Marguerite wondered again. Why should he—who was obviously a serious, earnest man—wish to appear before his fellow-men as an empty-headed nincompoop?

He may have wished to hide his love for a wife who held him in contempt . . . but surely such an object could have been gained at less sacrifice, and with far less trouble than constant incessant acting of an unnatural part.

She looked round her quite aimlessly now: she was horribly puzzled, and a nameless dread, before all this strange, unaccountable mystery, had begun to

**Your Guarantee of Goodness**  
The name "SALADA" on the sealed lead packages is your strongest guarantee of all that is best and most fragrant in tea

**"SALADA"**

IS THE CHOICEST TEA GROWN ON THE ISLAND OF CEYLON  
—clean, whole leaves—with the delightful flavor of the fresh leaves brought to your table by the sealed lead packages.

BLACK, GREEN OR MIXED

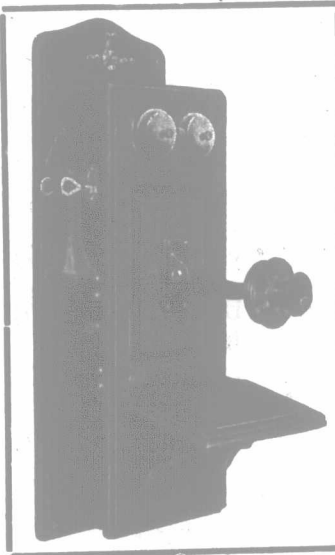

**No. 65 Magneto Telephones**

This is our standard rural line instrument, of which there are at present several thousand in use in Canada, some of which have been in service more than six years.

You will make no mistake in equipping your lines with CENTURY telephones.

Remember, we will send two instruments on 60 days' trial and prepay the freight, you can't lose on this proposition.

Our prices are right and deliveries prompt. Your request will bring catalogue and quotations.

Century Telephone Construction Co.  
Buffalo, N. Y. Bridgeburg, Ont.

**The Best Cream Separator is the Cheapest in the End**

THE cost of manufacturing a cream separator determines the price at which it may be sold. Therefore, when selecting a separator, remember that the machines which are offered at an unreasonably low price can be offered at that price for one reason only—they are built to sell at prices lower than the cost of good material or workmanship. Such separators are costly at any price. Only a good separator is cheap; not because of a low first cost, but because it will last for years and save enough butterfat from the milk of four or five cows every year to pay for itself. The best workmanship and material that money can buy are used in making

**I H C Cream Harvesters Dairymaid and Bluebell**

You will find an I H C the cheapest separator you can buy, because it will do better work and last longer than any other separator. Go to the nearest I H C dealer who handles these separators and see how carefully they are made. You will find that they have phosphor bronze bushings—that the gears are spiral cut—are entirely protected from grit and milk, and at the same time are easily accessible. The neck bearing is trouble-proof. The patented dirt-arrester chamber removes impurities before separation begins. These separators are made in four sizes. Ask the I H C local agent to show you one, and give you a catalogue, or, write the nearest branch house for catalogue and any other information desired.

CANADIAN BRANCH HOUSES  
**International Harvester Company of America**  
(Incorporated)  
At Brandon, Calgary, Edmonton, Hamilton, Lethbridge, London, Montreal, North Battleford, Ottawa, Quebec, Regina, Saskatoon, St. John, Weyburn, Winnipeg, Yorkton.

I H C Service Bureau  
The purpose of this Bureau is to furnish, free of charge to all, the best information obtainable on better farming. If you have any worthy questions concerning soils, crops, land drainage, irrigation, fertilizer, etc., make your inquiries specific and send them to I H C Service Bureau, Harvester Building, Chicago, U. S. A.

**BEST RESULTS ARE OBTAINED FROM ADVOCATE ADVERTISEMENTS.**

*The*  
**DOMINION  
PIANO**



**"Canada's  
Old  
Reliable"**

**80,000  
in  
Use**

**"The Piano of Sweet Tone"**

Is the term that the "Dominion" has won in every part of the world, from the arctics to the tropics, in the homes of more than 80,000 music-lovers. Its wonderful grand-piano like construction is responsible. Alone amongst uprights, it uses a patent iron arch-plate frame to support the strings and keep them ever true and in tone. You will never be satisfied with any instrument but a "Dominion" if you want art and tonal beauty, not cheap commercialism built only to look pretty and to sell.

**\$100 or More Saved**

Not on'y tonal beauty, but a heavy money-saving gce with the "Dominion." We sell direct from our factory at factory price, or through our own agent, and allow easy terms. We buy no "testimonial," and build no showy warehouses. You deal direct with the factory. Send for our catalogue (free) and read our offer.

**The Dominion Organ & Piano Co., Limited**  
Manufacturers of Pianos, Organs and Flayer Pianos  
BOWMANVILLE, CANADA

Write for "Dominion"  
catalogue to-day.

seize upon her. She felt cold and uncomfortable suddenly in this severe and dark room. There were no pictures on the wall, save the fine Boucher portrait, only a couple of maps, both of parts of France, one of the North coast and the other of the environs of Paris. What did Sir Percy want with those, she wondered.

Her head began to ache, she turned away from this strange Blue Beard's chamber, which she had entered, and which she did not understand. She did not wish Frank to find her here, and with a last look round, she once more turned to the door. As she did so, her foot knocked against a small object, which had apparently been lying close to the desk, on the carpet, and which now went rolling, right across the room.

She stooped to pick it up. It was a solid gold ring, with a flat shield, on which was engraved a small device.

Marguerite turned it over in her fingers and then studied the engraving on the shield. It represented a small star-shaped flower, of a shape she had seen so distinctly twice before: once at the opera, and once at Lord Grenville's ball.

(To be continued.)

### How Southey Worked.

Southey was a methodical and rapid literary craftsman. "I am a quiet, patient, easy-going hack of the mule breed; regular as clockwork in my pace, surefooted, bearing the burden which is laid on me, and only obstinate in choosing my own path," he wrote to a friend. But his method was by no means simple.

He was a poet, a historian, a critic and a miscellaneous writer; he turned out an enormous quantity of matter, and succeeded in doing so by working fourteen hours a day and diversifying his labors within his daily round. He had six tables in his library. He wrote poetry at one, history at another, criticism at a third, and so on with the other subjects upon which he was engaged;

and when he was tired of spinning his brains into verse, he turned to history and criticism.

There is a story that he once described to Mme. de Stael the division of his time: Two hours before breakfast for history, two hours for reading after, two hours for the composition of poetry, two hours for criticism, and so on through all his working day. "And pray, Mr. Southey," queried the French woman, somewhat unkindly, "when do you think?"—[Cornhill Magazine.

### Nobody Knows But Mother.

How many buttons are missing to-day?  
Nobody knows but mother.

How many playthings are strewn in her way?  
Nobody knows but mother.

How many thimbles and spools has she missed?  
Nobody knows but mother.

How many burns on each fat little fist,  
How many bumps to be cuddled and kissed?  
Nobody knows but mother.

How many hats has she hunted to-day?  
Nobody knows but mother.

Carelessly hiding themselves in the hay,  
Nobody knows but mother.

How many handkerchiefs wilfully strayed,  
How many ribbons for each little maid,  
How, for her care, can a mother be paid?  
Nobody knows but mother.

How many muddy shoes all in a row?  
Nobody knows but mother.

How many stockings to darn, do you know?  
Nobody knows but mother.

How many little torn aprons to mend,  
How many hours of toil must she spend,  
What is the time when her day's work shall end?  
Nobody knows but mother.

How many lunches for Tommy and Sam?  
Nobody knows but mother.

Cookies and apples and blackberry jam,  
Nobody knows but mother.

Nourishing dainties for every "sweet tooth"—  
Toddlers Dottie or dignified Ruth,  
How much love sweetens the labor, forsooth?  
Nobody knows but mother.

How many cares does a mother-heart know?  
Nobody knows but mother.

How many joys from her mother-love flow?  
Nobody knows but mother.

How many prayers by each little white bed,  
How many tears for her babes has she shed,  
How many kisses for each curly head?  
Nobody knows but mother.

How many lunches for Tommy and Sam?  
Nobody knows but mother.

Cookies and apples and blackberry jam,  
Nobody knows but mother.

Nourishing dainties for every "sweet tooth"—  
Toddlers Dottie or dignified Ruth,  
How much love sweetens the labor, forsooth?  
Nobody knows but mother.

How many cares does a mother-heart know?  
Nobody knows but mother.

How many joys from her mother-love flow?  
Nobody knows but mother.

How many prayers by each little white bed,  
How many tears for her babes has she shed,  
How many kisses for each curly head?  
Nobody knows but mother.

How many lunches for Tommy and Sam?  
Nobody knows but mother.

Cookies and apples and blackberry jam,  
Nobody knows but mother.

Nourishing dainties for every "sweet tooth"—  
Toddlers Dottie or dignified Ruth,  
How much love sweetens the labor, forsooth?  
Nobody knows but mother.

How many cares does a mother-heart know?  
Nobody knows but mother.

How many joys from her mother-love flow?  
Nobody knows but mother.

How many prayers by each little white bed,  
How many tears for her babes has she shed,  
How many kisses for each curly head?  
Nobody knows but mother.

How many lunches for Tommy and Sam?  
Nobody knows but mother.

Cookies and apples and blackberry jam,  
Nobody knows but mother.

Nourishing dainties for every "sweet tooth"—  
Toddlers Dottie or dignified Ruth,  
How much love sweetens the labor, forsooth?  
Nobody knows but mother.

How many cares does a mother-heart know?  
Nobody knows but mother.

How many joys from her mother-love flow?  
Nobody knows but mother.

How many prayers by each little white bed,  
How many tears for her babes has she shed,  
How many kisses for each curly head?  
Nobody knows but mother.

How many lunches for Tommy and Sam?  
Nobody knows but mother.

Cookies and apples and blackberry jam,  
Nobody knows but mother.

Nourishing dainties for every "sweet tooth"—  
Toddlers Dottie or dignified Ruth,  
How much love sweetens the labor, forsooth?  
Nobody knows but mother.

How many cares does a mother-heart know?  
Nobody knows but mother.

How many joys from her mother-love flow?  
Nobody knows but mother.

How many prayers by each little white bed,  
How many tears for her babes has she shed,  
How many kisses for each curly head?  
Nobody knows but mother.

How many lunches for Tommy and Sam?  
Nobody knows but mother.

Cookies and apples and blackberry jam,  
Nobody knows but mother.

Nourishing dainties for every "sweet tooth"—  
Toddlers Dottie or dignified Ruth,  
How much love sweetens the labor, forsooth?  
Nobody knows but mother.

How many cares does a mother-heart know?  
Nobody knows but mother.

How many joys from her mother-love flow?  
Nobody knows but mother.

How many prayers by each little white bed,  
How many tears for her babes has she shed,  
How many kisses for each curly head?  
Nobody knows but mother.

How many lunches for Tommy and Sam?  
Nobody knows but mother.

Cookies and apples and blackberry jam,  
Nobody knows but mother.

Nourishing dainties for every "sweet tooth"—  
Toddlers Dottie or dignified Ruth,  
How much love sweetens the labor, forsooth?  
Nobody knows but mother.

How many cares does a mother-heart know?  
Nobody knows but mother.

## The Roofing Test That Tells

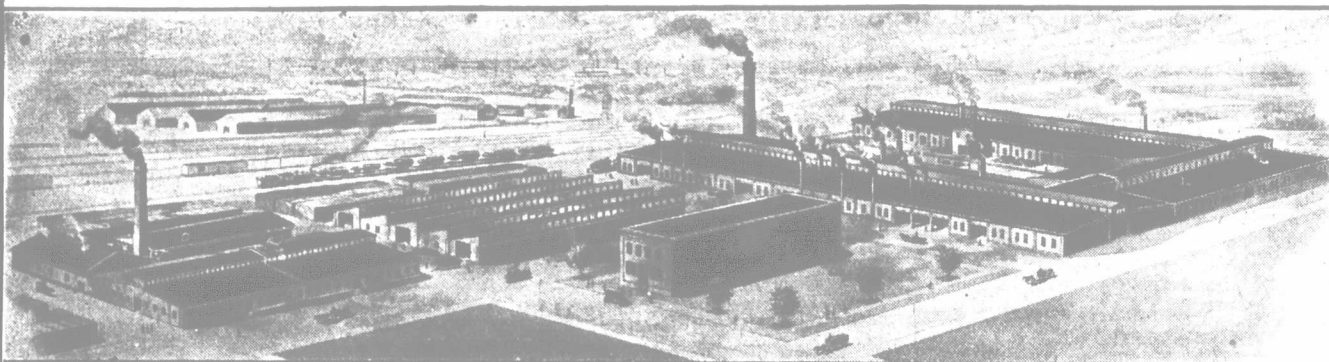

The cut shows the big plant of the George White & Sons Co., Ltd., manufacturers of threshing machinery and engines. It is situated in London, Ontario, right beside the main through line of the Grand Trunk Railway. If you were to examine the roofing of this big plant carefully you would see that even the Boiler House and Foundries were covered with

### BRANTFORD ROOFING

Now—before you decide on the roofing for your new building, before you allow your architect to specify any roofing, before you invest a dollar in a new roof for the old building—consider the plain facts.

The roofing on the Boiler House and Foundries of this big plant are subjected to the fiercest tests—not for a day, or a month, but for year after year. Heat and penetrating acids that would simply devour any ordinary roofing attack these roofs from within. Volleys of live cinders and red hot sparks, flung from the funnels of passing trains, batter them continuously from without.

Add to this the biting frosts of winter—gale-driven rains, sleet and snow and the almost resistless heart-drawing rays of summer suns and you are bound to conclude that this roofing is practically imperishable. BRANTFORD ROOFING is the only roofing manufactured that can successfully defy this extreme test—a continual assault of roofing's most relentless foes.

BRANTFORD ROOFING is made differently—better than any other roofing. There is more money put into it to begin with. The 'Base' of BRANTFORD ROOFING is long fibred wool soaked through and through with pure asphalt—a

FACTORY AND HEAD OFFICES:

**Brantford Roofing Co. Ltd., Brantford, Canada**

Branch Warehouses: Montreal, 9 Place D'Youville.

Winnipeg 117 Market Street.

37

When writing advertisers please mention The Farmer's Advocate

### In the Heart of the Woods

Such beautiful things in the heart of the woods!  
Flowers and ferns, and the soft green moss!

Such love of the birds, in the solitudes  
Where the swift wings glance, and the tree-tops toss;

Spaces of silence, swept with song,  
Which nobody hears but the God above;

Spaces where myriad creatures throng,  
Summing themselves in His guarding love.

Such safety and peace in the heart of the woods,  
Far from the city's dust and din,

Where passion nor hate of man intrudes,  
Nor fashion nor folly has entered in.

Deeper than hunter's trail hath gone,  
Glimmers the tarn where the wild deer drink;

And fearless and free comes the gentle fawn  
To look at herself o'er the grassy brink.

—Margaret E. Sangster.

QUESTIONS AND ANSWERS.

1st.—Questions asked by bona-fide subscribers to "The Farmer's Advocate" are answered in this department free.  
 2nd.—Questions should be clearly stated and plainly written, on one side of the paper only, and must be accompanied by the full name and address of the writer.  
 3rd.—In Veterinary questions the symptoms especially must be fully and clearly stated, otherwise satisfactory replies cannot be given.  
 4th.—When a reply by mail is required to urgent veterinary or legal enquiries, \$1.00 must be enclosed.

Miscellaneous.

POOR DRAIN.

In order to get an outlet, we called a meeting and decided on a township drain, the Engineer being called on and the by-law adopted July, 1909, the then inefficient open drain to be converted into a tile drain. The drain is not a success. I ordered on the Engineer last year—the Council taking no action. Kindly inform me the proper mode of proceedings to obtain an outlet.  
 READER.  
 Ontario.

Ans.—The case seems to call for some steps to be taken to stir the Council up to action, and we think you would do well to have a solicitor take the matter up with them.

LAWN MIXTURE.

What is the best plan for seeding and preparing a lawn, and what is the best seed mixture to use? So many of these lawn grass seeds advertised are no good. I am ready to prepare a lawn around my new residence.  
 A. D. S.

Ans.—In making a new lawn, it is advisable to plow the soil and cultivate it thoroughly before the grass seed is sown. If the soil is poor, a heavy dressing of well-rotted manure should be applied and worked well in. A mixture of Red Top, Blue Grass, and White Dutch clover, in equal parts by weight, is good. This should be sown thickly, or at the rate of about two measured bushels per acre.

SEEDING WITH MILLET.

1. I have a low, flat field, that is not good for growing grain, so I am intending to sow millet on it. I also want to seed it down with timothy seed, and thought I would write to ask your opinion as to the time for sowing the timothy. Would it be better to sow it the same time as sowing the millet, or harvest the millet and plow the ground, and sow the timothy in the fall?  
 2. Would also like to know if I were to sow the timothy by itself this spring, would I be able to take a crop of hay off it this fall?  
 R. E.

Ans.—1. Owing to the late date at which millet should be sown (in Ontario, June is the best month), and its graminaceous character of growth, we should not expect successful results from an attempt to seed down with it. Would rather wait until the millet is removed, and then try the autumn seeding.  
 2. No.

ALFALFA—OAT AND PEA HAY—POTATO SCAB.

1. I have eight acres of oat stubble on clover sod that I intend sowing to alfalfa. I will have to spring plow. Would you advise to work and sow first of July, or would it be as well to sow it with oats and peas to cut for hay if I could sow middle of May, or would it be better to wait until after the oat and pea hay was cut?  
 2. Is oat and pea hay as good feed for dairy cows as millet?  
 3. In sowing oats and peas for hay, do you sow them both at the same time, in what quantities?  
 4. Is there anything to prevent potato scab? If so, kindly state.  
 T. H. S.

Ans.—1. If you get the spring plowing done early, you could sow the alfalfa with a nurse crop of 1 bushel of barley per acre. Would not advise seeding with oats and peas. It often does well sown alone in July. If sown in July, would advise thorough cultivation until that time. Would not try to get a catch after a crop of oats and peas for hay.  
 2. Yes; properly cured, would prefer it.  
 3. Sow them together, 1½ bushels oats and 1½ bushels peas to the acre. This is a heavy seeding, but is all right for it.  
 4. Yes; soak them in formalin ½ pint to 15 gallons of water for two hours.

RAPE, SOY BEAN AND KALE PASTURE.

I have a field gravel and sand loam. What would be best to sow for pasture as green feed? Clover is scarce on account of hot sun last season.

1. Would rape sown in May be good for pasture for cows? Will it grow up after being pastured off?
2. Are cow, or Southern peas, good for pasture or to cut?
3. Would you recommend early yellow soy beans for pasture, and how much to sow per acre?
4. Is Thousand-headed kale good for cow pasture?

A. L. W.

Ans.—1. Rape makes very good pasture, particularly for hogs or sheep. It will taint the milk of dairy cows. It is all right for dry cows or young cattle. It does best on rich soil. It will grow up again after being eaten off, provided a few leaves and stems are left to give it a start. If pastured so closely that all these are removed, the plants are destroyed.

2. Cow peas are a warm-weather crop, do well on light soil, and should not be sown until after corn-planting time, or when the weather is warm. They are sometimes used for hog pasture. They are coarse, and not so valuable for cattle. Would not advise using them for this purpose.

3. Not for cattle pasture. In a mixture, they are valuable for hog pasture, or feeding to hogs as a soiling crop. Sown for fodder or pasture, some close every other tube in the grain drill, and sow from two-thirds to one bushel per acre.

4. We would not advise trying kale for cow pasture. It belongs to the cabbage family, and is not as good a success as rape. It is valuable as a sheep pasture. Why not try Prof. Zavitz's annual pasture mixture of 7 lbs. common red clover, 30 lbs. Early Amber sugar-cane, and 51 lbs. oats. This gives good summer pasture. For a soiling crop, try a plot of peas and oats.

GOSSIP.

The Canadian National Spring Horse Show, slated this year for the dates April 30th, May 1st to 4th, is always an exceedingly interesting exhibition, principally of light horses. The show will be held in the Toronto Armories. Reduced railway rates will be available.

In a recent letter ordering a change in their advertisement of Shorthorns and Clydesdales, A. B. & T. W. Douglas, Strathroy, Ont., state that they have for sale at moderate prices, four good young bulls, sired by His Grace (imp.) =69740=; also one stallion rising three years, a big, quality colt. Have also a few heifers and cows for sale. Correspondence, or better, a visit from prospective purchasers, is invited. Farm is only a mile from Strathroy Station, G. T. R.

BRITISH SHOW DATES.

Bath and West of England, at Bath, May 22-27.  
 International Horse Show, Olympia, London, June 17-29.  
 Royal Agricultural Society, at Doncaster, July 2-6.  
 Highland and Agricultural, at Cupar, July 9-12.  
 Royal Northern Agricultural Society, at Aberdeen, July 18.

TRADE TOPIC.

Good roofing is essential to all building operations. Roofing material must be durable and effective in preventing leakage. See the advertisement in another column of the General Roofing Manufacturing Co., manufacturers of Certain-teed roofing, York, Pa.; Marselles, Ill.; East St. Louis, Ill.; Minneapolis, Minn.; and San Francisco, Cal., and write for their free book, "How to Build for Less Money."

Be Fair. Buy a sack or barrel before judging PURITY FLOUR

SOME people have attempted to judge PURITY FLOUR before knowing the facts about it—before using it. So we ask you to be fair and to buy a sack or barrel of PURITY FLOUR and give it a thorough try-out before attempting to arrive at a judgment.

Look at the beauty and loftiness of the golden-crust, snowy-crumbed loaves, fit for a king. Count them and see how many more of them PURITY yields to the barrel than ordinary flour does.

Taste the creamy, flaky pie crust, and the deliciously light cakes PURITY FLOUR rewards

you with. My! How they make your mouthwater!

Such high-class results can only be obtained when using a flour consisting exclusively of the high-grade portions of the best Western hard wheat berries.

And remember, that, on account of its extra strength and extra quality, PURITY FLOUR

requires more water when making bread and more shortening when making pastry, than you are accustomed to use with ordinary flour.



PURITY FLOUR

"More bread and better bread"

Buy a bag or barrel of PURITY FLOUR. Test it for a week. Then pass judgment.

Add PURITY FLOUR to the grocery list right now.

103

150-Acre Farm FOR SALE

In the Township of Tuckersmith, in the County of Huron, one and one-half miles from the town of Seaford, which is one of the best markets in the Province of Ontario. Twenty acres hardwood bush, balance cleared. Well fenced, tile underdrained, good water and a never-failing spring creek. There is an ever-bearing orchard of ninety trees, mostly winter apples. Soil clay loam. There is a ten-roomed brick house, with all modern conveniences, including hot-water heating; telephone, woodshed and ice house. Good bank barn, piggery, implement shed, carpenter shop and other outbuildings. Selling to close an estate.

R. E. Cresswell, Egmondville, Ont.

GOSSIP.

R. H. Keene, Marlow, Buckinghamshire, England, an experienced farmer and feeder, has been invited by the directors to officiate as judge at the 1912 International Exhibition, at Chicago, Ill., Nov. 30 - Dec. 7, of the classes of grade and cross-bred, and the championships. Mr. Keene is said to have been highly recommended by J. J. Cridlan and H. M. Kirkham, who officiated in the same capacity at Chicago last year. Mr. Keene having had extended experience in the production of prime beef, and in judging bullocks at leading British shows.

## THIS WASHER MUST PAY FOR ITSELF.

A MAN tried to sell me a horse once. He said it was a fine horse and had nothing the matter with it. I wanted a fine horse, but I didn't know anything about horses much. And I didn't know the man very well either.

So I told him I wanted to try the horse for a month. He said "All right," but pay me first, and I'll give you back your money if the horse isn't all right."

Well, I didn't like that. I was afraid the horse wasn't "all right" and that I might have to whistle for my money if I once parted with it. So I didn't buy the horse, although I wanted it badly. Now, this set me thinking.

You see I make Washing Machines—the "1900 Gravity" Washer.

And I said to myself, lots of people may think about my Washing Machine as I thought about the horse, and about the man who owned it.

But I'd never know, because they wouldn't write and tell me. You see I sell my Washing Machines by mail. I have sold over half a million that way. So, thought I, it is only fair enough to let people try my Washing Machines for a month, before they pay for them, just as I wanted to try the horse.

Now, I know what our "1900 Gravity" Washer will do. I know it will wash the clothes, without wearing or tearing them, in less than half the time they can be washed by hand or by any other machine.

I know it will wash a tub full of very dirty clothes in Six Minutes. I know no other machine ever invented can do that, without wearing the clothes. Our "1900 Gravity" Washer does the work so easy that a child can run it almost as well as a strong woman, and it don't wear the clothes, fray the edges, nor break buttons, the way all other machines do.

It just drives soapy water clear through the fibres of the clothes like a force pump might.

So, said I to myself, I will do with my "1900 Gravity" Washer what I wanted the man to do with the horse. Only I won't wait for people to ask me. I'll offer first, and I'll make good the offer every time.

Let me send you a "1900 Gravity" Washer on a month's free trial. I'll pay the freight out of my own pocket, and if you don't want the machine after you've used it a month, I'll take it back and pay the freight too. Surely that is fair enough, isn't it?

Doesn't it prove that the "1900 Gravity" Washer must be all that I say it is?

And you can pay me out of what it saves for you. It will save its whole cost in a few months in wear and tear on the clothes alone. And then it will save 50 to 75 cents a week over that in washwoman's wages. If you keep the machine after the month's trial, I'll let you pay for it out of what it saves you. If it saves you 60 cents a week, send me 60 cents a week 'till paid for. I'll take that cheerfully, and I'll wait for my money until the machine itself earns the balance.

Drop me a line to-day, and let me send you a book about the "1900 Gravity" Washer that washes clothes in six minutes.

Address me personally—C. M. Bach, Manager, 1900 Washer Co., 357½ Yonge street, Toronto.

## Couldn't Break the Will

Lawyers Could Not Help Disappointed Relatives

Some disappointed relatives tried recently to break the will of a deceased farmer in Ontario. Their legal advisers told them it would not be difficult, as it was known that the farmer had not consulted a lawyer when making the will.

It seems that he had had some unpleasant experiences with lawyers' fees that had created a decided prejudice in his mind against the entire legal profession. The relatives, however, were doomed to a second disappointment, as it was found that the deceased had used a BAX Copyrighted Will Form.

Their lawyer was compelled to advise them that the BAX Will Form is made absolutely in accordance with the law and is indisputable.

The BAX Will Form costs 35 cents, and with each form is included a specimen will and full instructions for your guidance, so that mistakes are impossible.

The BAX Will Forms can be obtained at all Druggists and Stationers at 35 cents, or will be sent on receipt of price by the BAX Will Form Company, 275 "F." College St., Toronto.

## 25,000 Rods Wire Fencing for Sale

at 25% to 40% cheaper than elsewhere, new, all No. 9 galvanized steel wire, list and prices free. Also belting, piping, etc.

## THE IMPERIAL METAL CO'Y

Queen Street, MONTREAL  
200 bus. O. A. C. No. 21 Barley (Six rowed)

This is the heaviest yielding, longest and stiffest strawed barley ever grown in Ontario, and we have been the leading growers and distributors to present time. Price, \$1.25 per bus; best bags, 25c

JOHN ELDER & SON, Hensall Ont.

## QUESTIONS AND ANSWERS.

Veterinary.

### DISEASED CALF.

Calf one month old has a hard lump on her jaw. It is about the size of a hen's egg. It is not sore, and there is no discharge. Her hair is falling out, and she has an offensive breath.

J. B.

Ans.—While the animal is very young, the lump on the jaw indicates lump jaw, which might be cured by the iodide-of-potassium treatment, which would consist in giving it iodide of potassium three times daily, commencing with 10-grain doses, and increasing the dose by 5 grains daily until appetite and thirst fail, and fluids run from eyes and mouth. When any of these symptoms become well marked, the administration of the drug should be ceased. The offensive breath indicates disease of some of the respiratory organs, for which probably nothing can be done. In cases like this, in so young an animal, it is generally wise to destroy it.

### LUMPS ON JAW.

Since last June my mare has had a hard lump the size of a hen's egg on her jaw. It breaks out and discharges matter for a time, and I treat it with hydrogen peroxide. It heals up, then, after a time, breaks again, etc. It has spread under the jaw near the throat, where a lump as hard as a stone and the size of a goose egg, formed. This swells and breaks same as the other. Otherwise she appears perfectly healthy and looks well.

A. Q.

Ans.—The bone is doubtless diseased, and it is possible a cure can be effected by an operation, which would consist in casting and securing her, cutting down freely upon the bone, and if any loose portions or other foreign substance be present, removing it. The bony growth could be removed by bone forceps or chisel. If it be possible to remove all diseased bone, the skin should be stitched and the wound dressed three times daily until healed with an antiseptic, as the one you have been using, or a five-percent. solution of carbolic acid. If the disease involves the greater part of the jaw bone, a cure cannot be effected.

### Miscellaneous.

#### ABSENCE OF OESTRUM.

I have a cow which had a calf last summer, but she has not come in heat yet. She is in good condition. Can I get anything to make her come in heat? I would like to get her in calf again, as she is a very good cow.

J. B.

Ans.—We can suggest very little but waiting patiently, except that extra feeding might have the desired effect. It is good practice to allow a bull to run with the cows, and under these conditions nature usually asserts itself. Two drams of nux vomica three times daily has sometimes apparently had the desired effect by stimulating the nervous system.

#### RENTING ORCHARD—SILO CONSTRUCTION.

Kindly let me know, if possible, through your splendid paper, the address of some reliable company or firm to whom I might be able to lease our orchard for the season, or possibly, for three seasons, they to take full charge. Orchard contains a good variety of marketable fruit trees, there being about fifty Spy, twenty-five Baldwin, King, Ben Davis, and such like. Have too much other work for this summer to attend to it, yet do not like to see good fruit wasting.

2. Would you advise using No. 9 wire in construction of silo, or five-sixteenth iron rods, hooked together, one being placed in each ring, wire being placed closer together? Silo will be 40 feet high, with about 10 feet in the bank, and 12 feet inside diameter.

3. What distance above ground would you commence using wire or rods?

A SUBSCRIBER.

Ans.—1. Place a small advertisement in our condensed advertising columns.

2. The iron rods would likely make a better job, being a little easier to fasten. The wire would answer, however.

3. The first ring.

#### LEAF CURL ON SNOWBALL.

Is there any remedy for curly leaf and green louse on a snowball tree? \* I tried a concentrated lime and sulphur spray last year just before buds opened, but had very little improvement?

S. F. W.

Ans.—The curling of the leaves is doubtless due to the work of the green louse or aphid on the shrub. A contact remedy should kill these, but it must be applied so that it hits them. Try kerosene emulsion when you see the aphids working.

#### FOUR-HORSE PLOW.

Could you tell me whether four horses can be worked to advantage on a two-furrow plow? I would like to put three of them on the land. I plowed with three on the land last fall to try it, but it seemed to have too much side draft. I had one long doubletree, and two horses hitched to each end. I am told that there is an evener of this kind to be had. If you know of one, please publish, as it would greatly oblige.

A SUBSCRIBER.

Ans.—To place three of the horses on the land requires a short doubletree on the off side, and even then it is difficult to avoid side draft. We much prefer allowing one horse to walk on the plowed ground. The plow can be worked to good advantage in this way.

#### NITRO-CULTURE.

1. Is Northern-grown alfalfa seed as well adapted to the soil of Norfolk county as home-grown seed?
2. How many pounds should be sown to the acre?
3. Of what benefit is nitro-culture to the seed?
4. Where could it be obtained?
5. How much would be required to inoculate sixty pounds of seed?
6. What would be the cost of same?

A SUBSCRIBER.

Ans.—1. Seed grown in Norfolk county would be northern-grown as well as home-grown, and should be suitable for your locality.

2. Twenty pounds.

3. Treating the seed with nitro-culture is a means of inoculating into the soil a supply of the nitrogen-gathering bacteria which inhabit the nodule-like excrescences which may be seen scattered singly or clustered through the root system of the plant. Some of these bacteria are usually introduced on the seed naturally, but not always enough for best results. Once alfalfa has been grown on a farm, the soil becomes inoculated, and artificial treatment is then unlikely to produce much results.

4. Bacteriological Department, O.A.C., Guelph, Ont.

5 and 6. A twenty-five-cent bottle.

#### RHEUMATISM—VOMITION.

1. One of my milk cows is very stiff in her joints; something like rheumatism. Has been that way about two months.

2. Another one vomits up her feed occasionally, but has a fair appetite. Their ration is as near equal parts as possible, silo feed, wheat chaff, straw, and a certain amount of salt, mixed up a day ahead; also gluten meal, with chop.

J. D.

Ans.—1. The symptoms indicate rheumatism. Keep her in a dry, comfortable place, and feed well. Purge her with 2 lbs. Epsom salts and 1 ounce ginger. Follow up with 2-dram doses of salicylic acid three times daily, and rub the joints well three times daily with camphorated liniment.

2. Vomition in cows is usually due to either a constriction or a dilatation of a portion of the gullet. In the former case, coarse food cannot pass into the stomach; the cow continues to swallow until the gullet becomes full, and then vomits. Treatment consists in passing probangs of different sizes, commencing with a small one, and gradually increasing in size, to gradually dilate the gullet. In the meantime feeding only sloppy food. The probang should be carefully passed three or four times daily. If dilatation exists, the food lodges there until it and the gullet becomes full, and then vomition takes place. Treatment consists in locating the dilatation, applying pressure to it, if possible, and feeding on slops only for a couple of weeks to give the fibres of the gullet an opportunity to regain their normal tone.

**Dyer's Big Cut in Lawn Fence**

Oval top pickets, crimped No. 9 wire, 2 7/8 inches apart. Galvanized finish. Handsome and sturdy. Price per foot

86 in. 7 1/2 c. high 8 1/2 c. high 9 1/2 c. high

Freight paid in Ontario, south of North Bay. Outside district 1-2c. per foot and you pay the freight.



Painted fence, green or white, add 2c. per foot to above prices. Scroll top walk gates, to match, \$3.00. Drive gates, \$6.50. I supply fencing for every purpose direct from factory and save you big money. Satisfaction guaranteed or money refunded. Remit money order (any kind) or registered letter.

**DYER, The Fence Man, Dept. C Toronto**

## A Fortune in Chicks

**One Man and His Son Made \$12,000 In One Year With Poultry**



You will want to read his letter telling how it was done. And best of all any one who will follow the same simple practical rules will be sure to make big money with poultry. Every one who keeps poultry or who is thinking of starting in this business should have a copy of this big

## 112 Page Book-Free

Nothing like it has ever been published before. It is filled from cover to cover with splendid illustrations and bristles with money making—money saving facts. You will be interested in the articles by Prof. W. R. Graham of Guelph, Ontario, "Hatching and Rearing" and "The Automatic Henhouse." Other subjects discussed are "How to Select Layers," "Which Breed is Best," "How to Treat Diseases." Just think of it—75 of the 112 pages contain no advertising—just helpful information from the greatest authorities on poultry raising. This book will save you a thousand mistakes and make poultry raising profitable if you will follow the advice it gives.

**Write Your Name on a Postal**

and mail it to us at once. We will send the complete book free and postpaid. You will want to know about the new PRAIRIE STATE INCUBATOR with Sand Tray—also the PRAIRIE STATE UNIVERSAL HOVER BROODERS which you can make at home and save money. All leading agricultural colleges and experiment stations endorse Prairie State Incubators because they hatch chicks that live. Write for free book *Ship your eggs to us and get highest market prices.*

**Gunn, Langlois & Co., Ltd.**  
Box 116 Montreal, Canada  
Main Office in Canada of the famous Prairie State Incubators.

## MERCHANTS PRODUCE CO.

**Butter Eggs Poultry Honey Beans Apples Potatoes, etc.**

Our constantly growing trade demands large supplies of choice farm produce. We need yours. Write for weekly market letter.

57 Front St. E., Toronto  
Established 1899

## Seed Corn

We have 4,000 bushels Seed Corn—leading varieties grown in Kent County, and cured in our own cribs, which we will sell in small quantities—ON THE COB or shelled.

Dent varieties.....\$1.40 per bushel  
Flint.....1.75

**Special prices on orders of 10 bushels or more.**

Terms cash with the order.

MONEY REFUNDED IF NOT SATISFACTORY.

**M. W. SHAW & CO.**  
JEANNETTE'S CREEK, ONTARIO

## Island Seed Oats

The only really high-grade, absolutely safe seed oats in Canada this year. No danger frosted germs.

**JOSEPH READ & CO'Y, LTD.**  
Summerside, P. E. Island

Essex-grown, White Cap Yellow Dent Seed Corn, \$1.00 per bushel. Money refunded if not satisfactory.

**JOS. TOTTEN, North Ridge, Ont.**

QUESTIONS AND ANSWERS. Miscellaneous.

BUCKWHEAT.

Am thinking of sowing a field with buckwheat. Would it be advisable to seed down to clover with it? What would be considered a fair yield for this grain on light, sandy soil? What feed value has buckwheat as compared with corn?

L. J. T.

Ans.—Some have reported pretty fair success from seeding with buckwheat. Fifteen to twenty or twenty-five bushels per acre should be a fair yield for such soil. Buckwheat stands in feeding value slightly lower than the grains commonly used for feeding stock. It is fairly rich in protein, but the hulls have little feeding value. It should be fed in a mixture, one or more other grains being used.

DOCKING EWE—BOOK ON BREEDING.

1. Will you kindly inform me if I can safely dock a two-year-old sheep? I bought her when a lamb, and the tail was never cut. Now I fear it is the cause of her not getting in lamb. She is almost a pure-bred Leicester, and an extra fine sheep. I hate to kill her.

W. H. E.

Ans.—1. This operation may be performed with safety. There is, of course, considerable danger if proper precautions are not taken. Tie a cord tightly round the tail just above the cut. Make a clean cut with a sharp knife, from below, upward. Disinfect the knife in an antiseptic solution. Perform the operation before the hot weather sets in.

2. This is a very old book. We do not carry it in stock, but have some other excellent books on the subject, as "Principles of Breeding," by Davenport; "Cattle-breeding," by Warfield; "Swine," by G. E. Day; "Swine in America," by Colburn, and several others, any of which may be had by mail through this office.

GIRDLED TREES—GEESE.

1. Three years ago I set out a young orchard, which was doing well. This winter the little cotton-tail rabbits came from the woods and barked almost all the trees. Some are barked completely around. Is there anything I can put on to save them, or are those barked right around beyond saving? Have been told to paint with pine tar. Would you recommend that? I intend setting out five acres more this spring, and would like to know if there is any contrivance for protecting the little trees while cultivating a young orchard. So often, with the greatest care, the whiffletrees knock against them.

2. What is the difference between African geese and Brown Chinese geese? I have kept African geese (pure-bred) for several years, and sold a number of them; also eggs for hatching. Yesterday a man who thinks himself an authority, told me they were Brown Chinese geese.

J. M. M.

Ans.—1. Bridge grafting, which consists in inserting scions reaching across the girdled part and joined at either end to living wood, will sometimes save girdled trees. Where a small tree is girdled, two of these scions should be sufficient. Where the tree is not completely girdled, waxing over and wrapping to prevent drying, is necessary. Where the trees are girdled close to the ground, banking soil up over the girdled portion will often save the tree. Tar would likely be effective. Where there is danger of rabbits or mice working on young trees, wrapping with tar paper in the fall is a good preventive. Tramping snow around the trees is also a good thing in preventing mice injury.

A short whiffletree is the best preventive measure in cultivating the young orchard.

2. Brown Chinese geese resemble the African geese in color and shape, and also have the knob on the beak, but are much smaller, adult ganders weighing from 12 to 14 lbs., while the adult African gander weighs 20 lbs. The Brown Chinese are more pliable than the African. They are two distinct breeds.

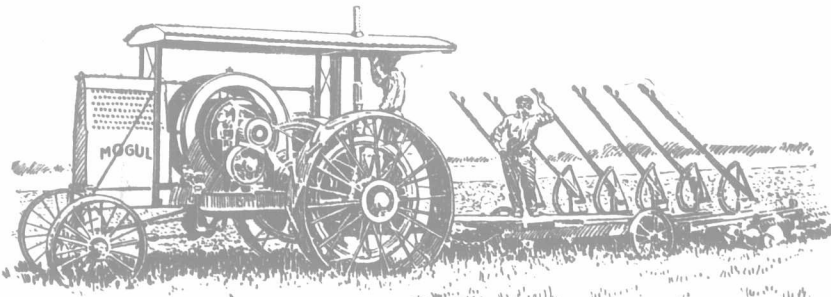

Field-Proved IHC Tractors

THE men who designed IHC tractors were practical farmers, as well as engine builders. Knowing field difficulties, they designed their tractors to overcome those difficulties. They protected the mechanism from dust, dirt and grit. They made their engines simple, easy to understand and manage. They cut out rapidly moving parts to increase durability. They planned for strength, but avoided all unnecessary weight. They placed dependability above appearance and draw-bar pull above theories of construction. They worked for fuel economy. The result is the

IHC Kerosene-Gasoline Tractor

—a field-proved machine which does its work at the right time and with the least expense, a machine upon which a farmer can depend for plowing, disking, seeding, harrowing, harvesting, threshing, baling hay, ditching, road making, pumping, sawing—a many-sided machine which saves money wherever it is used.

IHC tractors are made in styles and sizes (12 to 45-H. P.) to meet the needs of large and small farms. IHC general purpose engines for farm, shop and mill are made in every style and in all sizes from 1 to 50-H. P. The IHC local agent will show you why IHC tractors and engines are the best you can buy. See him or write nearest branch house.

CANADIAN BRANCH HOUSES

International Harvester Company of America

(Incorporated) At Brandon, Calgary, Edmonton, Hamilton, Lethbridge, London, Montreal, North Battleford, Ottawa, Quebec, Regina, Saskatoon, St. John, Weyburn, Winnipeg, Yorkton.

IHC Service Bureau

The purpose of this Bureau is to furnish, free of charge to all, the best information obtainable on better farming. If you have any worthy questions concerning soils, crops, land drainage, irrigation, fertilizer, etc., make your inquiries specific and send them to IHC Service Bureau, Harvester Building, Chicago, U.S.A.



GRAFTING WAX.

Please give us a recipe for grafting wax in the next issue of "The Farmer's Advocate."

A. B. H.

Ans.—One part tallow, two parts beeswax, four parts resin. Melt these together, pull and cut into convenient size for use. Apply grease to the hands when using.

SEEDING WET LAND.

I have a piece of swamp land. It was formerly a cedar swamp, consisting of black muck from one to three feet deep. Have open ditches through it. Have plowed it when dry. In a wet time can hardly drive team across it. I wish to seed it down for hay. What kind of seed would you recommend?

G. A. C.

Ans.—Is underdrainage practicable on this land? If so, why not try it. A good mixture for low land seeding would be composed of orchard grass, 4 lbs.; red top, 4 lbs.; Kentucky blue grass, 3 lbs.; timothy, 2 lbs.; alsike clover, 3 lbs., and white clover, 2 lbs. This, of course, would be a better pasture than hay crop, but these grasses properly cured would make fair hay.

SICK PULLET.

We have a White Wyandotte pullet that a month or more ago lost the power of her legs; could hardly walk. She's better of that now, but has a peculiar croak. Her comb is very red, almost purple. She eats very little, and when she does she seems to choke, and it is very hard for her to get her breath. Could you, from the above symptoms, tell us what is the trouble with the hen? She has been laying till a week or two ago. Is it contagious, and is there a remedy?

F. T.

Ans.—Lameness is sometimes due to rheumatism from being confined in damp quarters. It also at times accompanies tuberculosis. If the pullet is very light and emaciated, would kill her and destroy the body. If plump and heavy, the trouble has likely been a trivial attack of rheumatism. The difficulty in breathing is due to the choking when eating. Give run in an open yard and keep the pens clean, dry, light, and free from drafts.

The Paint That Is Easiest To Apply

is surely the paint you ought to buy when there's anything you want to paint. M-L Pure Paint spreads so evenly and easily that it satisfactorily covers more surface than most other paints.

M-L PURE PAINT Best You Can Buy

also leaves the smoothest, glossiest surface—and takes the least paint to do a good job. Wears longest, too. Any surface it covers will not need re-painting for the longest possible time. That's why M-L Pure Paint is by far the most economical paint you can buy. Try it. Note the clear, clean colors and the beautiful gloss it gives. Only purest materials and skilful mixing can make paint like that!

THE exceptional durability of M-L Pure Paint is due to a special ingredient which we alone have learned how to mix with other pure materials to make a paint that is not easily affected by extremes of wear or weather. You get the biggest money's worth in M-L Pure Paints.

Made in 47 colors for all paint uses by Imperial Varnish & Color Co., Limited, Toronto.

USE M-L FLAT WALL COLORS to obtain pleasing and artistic treatment of walls and ceilings. Best for up-to-date stencil decoration—sanitary, washable, durable, very economical. 16 shades. Easily applied. Full directions with can.

712

DECORATION SCHEMES FREE!

Messrs. Imperial Varnish and Color Co., Limited, 624 Morse St., Toronto.

Dear Sirs,—Please send me, free of all charge, full information about M-L Paints and your suggestions for decoration, inside and out.

Name.....

Address.....

Fill in and mail this coupon to us.

# HOUSEHOLD NECESSITIES

Below are described some of the premiums which we are offering this season. You will be highly pleased with any of them you secure. The required number of new yearly subscriptions to "The Farmer's Advocate and Home Magazine" is marked after each.

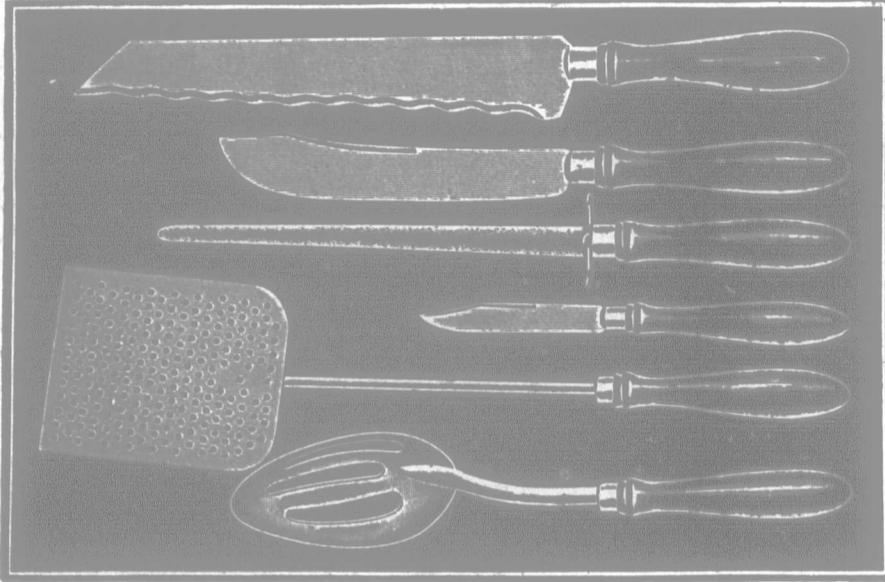

**COMPLETE KITCHEN EQUIPMENT.**—A utensil for every purpose. All made of the highest grade of crucible steel. Rubberoid finished, hardwood handles, mounted with nickel-plated ferrules. All six articles for **ONE NEW SUBSCRIBER.**

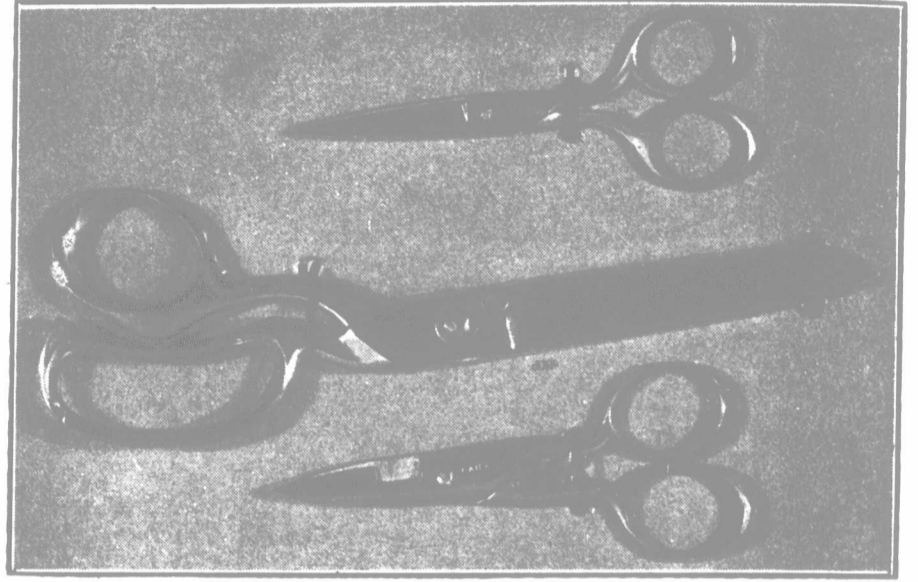

**SET SCISSORS.**—One self-sharpening scissors, one embroidery scissors, one buttonhole scissors. All good quality steel. **ONE NEW SUBSCRIBER.**

**FARMER'S ADVOCATE KNIVES.**—Manufactured by Joseph Rodgers, Sheffield, England. Jackknife and Penknife, both nickel-handled and having two blades. Manufactured especially for "The Farmer's Advocate," worth, retail, \$1.00 each. **ONE NEW SUBSCRIBER FOR EACH KNIFE.**

**40-PIECE AUSTRIAN CHINA TEA-SET.**—Handsome and dainty in shape, coloring and design, ordinarily retailing from \$4.00 to \$6.00, depending on locality. We have only a few sets left, so send your names as soon as possible. **FOUR NEW SUBSCRIBERS.**

**BIBLE.**—Old and New Testaments in beautifully clear, legible type; references, concordance to both old and new testaments. Index to names of persons, places and subjects occurring in the Scriptures. Twelve full-page maps; all excellent in type and outline. This book is of most convenient size, being 7 x 10 inches when open; weight, 23 ounces; and would sell at regular retail price from \$1 to \$1.50. **ONLY ONE NEW SUBSCRIBER.**

**"THE VISION OF HIS FACE,"** by Dera Farncomb, writer of Hope's Quiet Hour in "The Farmer's Advocate," contains 18 chapters, 224 pages, in cloth with gilt lettering. One of the many expressions received regarding it is: "I am pleased, edified and comforted in reading it. It is better, fuller and richer than I expected." Cash price, cloth binding with gilt lettering, 75 cents; handsomer binding, richly decorated with gold, \$1.00. **ONLY ONE NEW SUBSCRIBER.**

**"CARMICHAEL,"** by Anison North—A Canadian farm story, bound in cloth, illustrated. Buffalo Courier says: "It is far above the ordinary run of fiction." Toronto World says: "Should be in all the homes of the people." Cash, \$1.25, or **TWO NEW SUBSCRIBERS.**

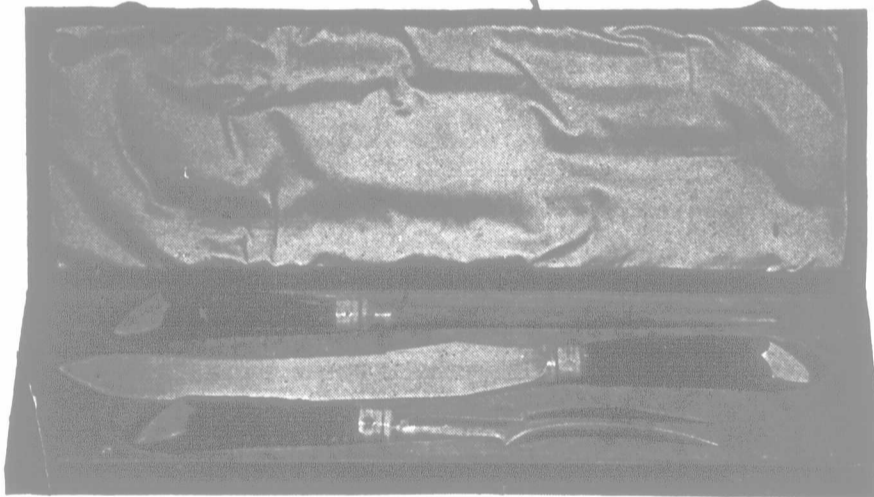

**SET STAGHORN CARVERS.**—First quality steel, with staghorn handles and handsome nickel mounting. These carvers will retail from \$3.50 to \$5.00 per set. **THREE NEW SUBSCRIBERS.**

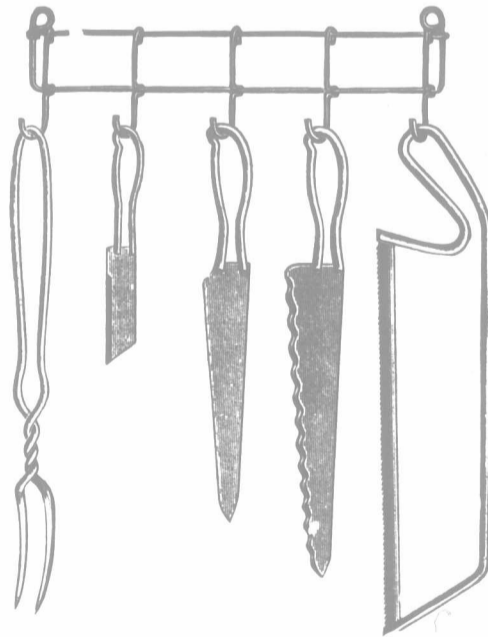

**SANITARY KITCHEN SET.**—Best quality steel; five pieces and rack which can be hung on the wall. **ONE NEW SUBSCRIBER.**

**TWENTY-ONE-PIECE AUSTRIAN CHINA TEA SETS.**—These would retail at from \$2.50 to \$3.50 per set, depending on locality. **FOR ONLY TWO NEW SUBSCRIBERS.**

**BARON'S PRIDE.**—Handsome picture of the champion Clydesdale. Size, 17 x 13 in., including margin. Suitable for framing. **ONE NEW SUBSCRIBER.**

**DICTIONARY.**—An indispensable volume in every home. The Chambers' Twentieth Century Dictionary, cloth bound, contains 1,200 pages, profusely illustrated, printed on superior quality of paper. **TWO NEW SUBSCRIBERS.**

**THESE PREMIUMS ARE GIVEN ONLY TO OUR PRESENT SUBSCRIBERS FOR SENDING IN BONA-FIDE NEW YEARLY SUBSCRIPTIONS ACCOMPANIED BY \$1.50 EACH.**

**EIGHT MONTHS CREDIT.**—Any subscriber may have the date on his own label advanced 8 months by sending us the name of one new subscriber and \$1.50.

**These premiums are all extra good value, and excellent remuneration for the short time necessary in securing the required number of new subscribers.**

**Send for sample copies and agents outfit to-day.**

## The William Weld Co., Limited

LONDON, ONTARIO



**Ornamental Fencing**

affords protection to your lawns, flowers and children, in addition to adding a finishing touch of beauty that is most pleasing to the eye and satisfying to the owner.

Peerless Ornamental Fencing is unequalled for beauty of design, artistic finish and strength of construction.

We have spent years in the manufacture of fencing and consequently we know what is best to give real fence service and how to make such a fence at a price you are willing to pay. Don't be misled by the inferior and cheap article offered by catalog houses, because such fencing is dear at any price.

Our Agent will supply you, but if there is none near write us direct, mentioning the name of your dealer, and we will see that your requirements receive prompt attention.

Write for our printed matter. It is mailed free on request.

The Banwell-Hoxie Wire Fence Co.  
Winnipeg, Man.  
Hamilton, Ont.



**SYNOPSIS OF CANADIAN NORTHWEST LAND REGULATIONS.**

ANY PERSON who is the sole head of a family, or any male over 18 years old, may homestead a quarter section of available Dominion land in Manitoba, Saskatchewan or Alberta. The applicant must appear in person at the Dominion Lands Agency or Sub-agency of the district. Entry by proxy may be made at any agency, on certain conditions, by father, mother, son, daughter, brother or sister of intending homesteader.

Duties—Six months' residence upon and cultivation of the land in each of three years. A homesteader may live within nine miles of his homestead on a farm of at least 80 acres solely owned and occupied by him or by his father, mother, son, daughter, brother or sister.

In certain districts a homesteader in good standing may pre-empt a quarter-section alongside his homestead. Price, \$3.00 per acre.

Duties—Must reside upon the homestead or pre-emption six months in each of six years from date of homestead entry (including the time required to earn homestead patent) and cultivate fifty acres extra.

A homesteader who has exhausted his homestead right and cannot obtain a pre-emption may enter for a purchased homestead in certain districts. Price, \$3.00 per acre. Duties.—Must reside six months in each of three years, cultivate fifty acres and erect a house worth \$300.00.

W. W. OORY,

Deputy of the Minister of the Interior.

N.B.—Unauthorized publication of this advertisement will not be paid for.

**160 Acres of Land for the Settlers**

Large areas of rich agricultural lands, convenient to railways, are now available for settlement in Northern Ontario. The soil is rich and productive, and covered with valuable timber.

For full information regarding homestead regulations and special colonization rates to settlers, write:

The Director of Colonization  
DEPARTMENT OF AGRICULTURE  
TORONTO.

**FARMS FOR SALE**

Choice stock, grain and fruit farms to sale. We specialize in high-class properties, and aim at offering good value only. We have a special department devoted to listing and selling Ontario farms. Write for list.

UNION TRUST CO., LTD  
Real-estate Department.  
201 Temple Bldg., Toronto

PLEASE MENTION THE ADVOCATE.

**QUESTIONS AND ANSWERS.**  
Miscellaneous.

**FEATHER PULLING.**

Could you tell me what is the cause of hens picking the feathers off their necks and heads? My hens are doing this. Will you please tell me a remedy?  
W. N. E. M.

Ans.—The cause of this trouble is sometimes ascribed to the lack of meat food in the ration. Vermin will sometimes cause it. Examine them, and if lousy, apply insect powder. Give them milk to drink, and a little meat food. Give free run on grass plot. Feed well. The pulling is sometimes done by one or two individuals, which have contracted the habit, and it is sometimes profitable to kill them. Some claim a little sulphur in the mash, or in the drinking water, will cure the habit.

**PUMPING WATER.**

My barn is 150 feet from the house. I have a never-failing well at house, and would like to draw the water from well at house to the barn, having pump at the barn. There is a fall of three feet or more from house to barn. Could I get a pump to raise water and draw it down hill to barn, or would the horizontal pipe have to raise from well at house to pump at barn? Kindly inform me, through the columns of your valuable paper, if this can be done.

**CONSTANT READER.**

Ans.—It is a rule among pumpmakers that the sucker must be within 25 feet of the surface of the water in the well for satisfactory work. This means that if the water in your well is never lower than 25 feet below the sucker in your pump, the pump will work all right situated at the barn. If the fall is continuous, the pump could be used at the house and the water piped to the barns.

**SORGHUM AND PIG QUERIES.**

1. What is the feeding value of sugar-cane in comparison to corn?

2. Which gives most feed per acre?

3. Which is better to keep in shocks for feeding in March and April?

4. Could sugar-cane be sowed 30 lbs. per acre, and cut for hay? If so, what would be an average yield per acre?

5. If sowed in drills, about 30 inches apart, would 10 pounds seed per acre be sufficient?

6. To what distance apart should it be thinned to get best results?

7. Neighbor has what he claims to be a pedigree Yorkshire sow; she has some black spots on her, and always has some pigs spotted with black whether bred to Yorkshire or Tamworth hog. Does that prove that she is not pure-bred, or is it possible for her to have black or red pigs, and still be pure-bred?

**HIRED MAN.**

Ans.—1. We presume green fodder is meant. In actual digestible nutrients contained, the corn has the advantage. Sugar-cane, however, when sown thickly, makes a very palatable fodder.

2. The corn would likely give the best yields, although, under favorable conditions, sugar-cane is a heavy yielder of fodder.

3. Corn. Sugar-cane is more difficult to cure and keep in the shocks.

4. We would not advise sowing sorghum for hay. The growth is too coarse. Thirty pounds would be a light seeding for this purpose. A bushel or more would be better.

5. No. It would need to be sown in larger quantity to keep down weeds, as the rows are too close for cultivation.

6. A good plan is to plant like corn, in rows, about 30 inches apart, and two feet apart in the rows, placing about five seeds in a hill, and thinning to three or four when the plants are up. This, of course, makes a coarser fodder, but sorghum suckers profusely. This would not do for a hay crop, but for fodder has been found successful. It can also be sown with the tube drill in rows, from 32 to 40 inches apart. Cultivate like corn.

7. If the spots are on the hide and not in the hair, she is likely all right. The American Standard for Yorkshires calls for a pig white in every part. The hogs to which she was bred may not have been pure-bred individuals, and in combining colors one is never sure as to what the color of the offspring may be.

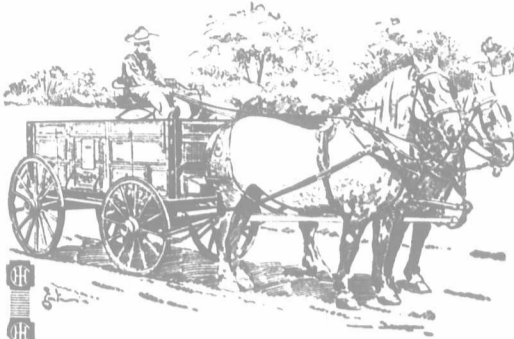

**Facts for Buyers To Know About I H C Wagon Material**

WAGON material must stand two destructive strains—one caused by the constant vibration due to travel over rough roads, the other caused by the weight of the load. These two strains affect every piece of material which enters into the construction of farm wagons. That being the case the quality of the material used is a very important factor.

Good, hardwood lumber is becoming so scarce that it is difficult for manufacturers to obtain wood of the highest grade. Foreseeing this difficulty and having ample storage facilities, the builders of I H C Wagons made contracts far in excess of immediate requirements. As a result of these contracts I H C Wagons:

**Petrolia Chatham**

are made of choice material throughout. Read a few interesting facts about I H C wagon material.

All the wood used for the more important parts of I H C wagons is carefully selected and then air-dried under cover in buildings with concrete foundations, which raise the wood above the moisture line. The lumber is held in these buildings at least two years; most of it three years; some of it, particularly the pieces intended for hubs, which receive special attention, even longer.

Air-drying produces tough wagon lumber because the sap, instead of being driven out as by kiln-drying, dries naturally with the wood and forms a resinous glue or cement, which binds the fibres of the wood together, gives the lumber flexibility and resilience, and retains its maximum strength and toughness. Air-drying of selected lumber produces just the qualities necessary to make it resist constant vibration and load strain. All the wood used in I H C wagons is air-dried.

The experience of many years of successful wagon building, combined with the highest degree of structural material knowledge, guarantee satisfactory service from every I H C wagon.

The I H C local agent knows points about I H C wagon construction that you should be familiar with. He will show you some things that you will recognize as money savers. Get literature and full information from him, or write nearest branch house.

**EASTERN CANADIAN BRANCHES**

**International Harvester Company of America**  
(Incorporated)

At Hamilton, Ont.      London, Ont.      Montreal, P. Q.  
Ottawa, Ont.      St. John, N. B.      Quebec, P. Q.

**I H C Service Bureau**

The purpose of this Bureau is to furnish, free of charge to all, the best information obtainable on better farming. If you have any worthy questions concerning soils, crops, land drainage, irrigation, fertilizer, etc., make your inquiries specific and send them to I H C Service Bureau, Harvester Building, Chicago, U.S.A.



**BASIC SLAG**

(Thomas Phosphate Powder)

Sydney Works now in full operation

Best Fertilizer for renovating old pastures without re-seeding

Farmers from Old Country know all about BASIC SLAG. Others who have no experience of its merits are invited to write for descriptive pamphlet giving full particulars. Until arrangements are made for its sale in every district, farmers who can take delivery in minimum carloads of twenty tons and pay cash with order can be supplied direct from works.

**THE CROSS FERTILIZER CO'Y, LIMITED**  
Sydney, Nova Scotia

Branch of Alexander Cross & Sons, Ltd., Glasgow, Scotland  
Correspondence invited from agricultural merchants

**Please Mention The Advocate**



**"Why Don't You Mix Your Own Fertilizers?"**

Buy "Vanco" straight Fertilizing Chemicals—mix them at home—and thus save duty on "imported mixtures" and get genuine fertilizers of guaranteed analysis.

**Vanco**

- MURIATE OF POTASH—guaranteed 50% actual Potash
- SULPHATE OF POTASH—guaranteed 48% actual Potash
- NITRATE OF SODA—guaranteed 15% Nitrogen
- ACID PHOSPHATE—guaranteed 14% to 16%

The "Vanco" Book will tell you how to mix all your own Fertilizers. Write for a free copy. **CHEMICAL LABORATORIES LIMITED, 148-158 Van Home Street, Toronto.**

**CANADIAN PACIFIC HOMESEEKERS' EXCURSIONS**

TO Manitoba, Saskatchewan, Alberta

Special Trains leave Toronto 2.00 p.m. on APRIL 2, 26, 30 MAY 14, 28 JUNE 11, 25 JULY 9, 23 AUG. 6, 20 SEPT. 3, 17

Second class tickets from Ontario stations to principal Northwest points at

**LOW ROUND-TRIP RATES**

Whitney and return \$34.00; Edmonton and return \$42.00, and to other points in proportion. Tickets good to return within 60 days from going date.

**TOURIST SLEEPING CARS**

through to Edmonton via Saskatoon, also to Winnipeg through the Main Line on all excursions. Comfortable berths, fully equipped with bedding, can be secured at moderate rates through local agent.

Early application must be made.

ASK FOR HOMESEEKERS' PAMPHLET containing rates and full information.

Apply to nearest C.P.R. Agent or M. G. MURPHY, Dist. Pass. Agt., Toronto.

**ONLY DIRECT LINE NO CHANGE OF CARS**

**You Need This Light 'Most Every Night**

Indoors—outdoors—in the stables and driving shed—hundreds of times—in dozens of places—you need the

**"NINE LIVES" ELECTRIC FLASHLIGHT**

with its bright but economical little Tungsten incandescent lamp. Compact, handy, and safe! Easily carried in your pocket or under your arm. Simply press the button and you have instantaneous flash. Can't set fire to anything.

We'll send you a "Nine Lives" Electric Flashlight, fully prepaid. Pocket type for \$1.50. Tubular type for \$2.00. It's too convenient to be without—write to-day.

**CANADIAN CARBON CO., Limited**  
96 King St. West . . . . . Toronto  
AGENTS AND DEALERS WANTED

**MOVE TO CHILLIWACK BRITISH COLUMBIA**

On the Sunny Pacific slope, where the winter lasts one month, and where the farmer receives larger returns on his investment than anywhere else in Canada. Write for free illustrated booklet.

**Sec'y Board of Trade, Chilliwack, B. C.**

PLEASE MENTION THE ADVOCATE.

**GOSSIP.**

M. W. Show & Co., of Jeanette's Creek, in the famous Essex corn belt of Western Ontario, are offering for sale elsewhere in this issue, 4,000 bushels of seed corn.

An imported Shorthorn bull, also a one-year-old bull and two young cows with calves at foot of desirable breeding, are advertised for sale by W. J. Shean & Son, of Owen Sound, who are giving up farming.

A. W. Smith, Maple Lodge, Ont., ordering a change of his advertisement of Shorthorn cattle, writes: The two young bulls I offered last week are sold, but I have the most promising youngsters I ever had, so choicely bred, too, and the dams of most of them are excellent milkers.

Imported Clydesdale stallions and fillies, Percheron stallions, and a Thoroughbred stallion that received the \$250 Government grant last year, comprise the offering of T. D. Elliott, of Bolton, Ont., in his new advertisement in this issue. Bolton is a station on the Toronto-Owen Sound branch of the C. P. R., 26 miles north of Toronto, and is connected with long-distance 'phone.

The Chilliwack, B. C., Progress says: "The prolificness of Oxford Down sheep has been demonstrated to a rare degree this spring on the farm of Captain W. S. Hawkshaw & Sons, on the Prairie Central road. A flock of eight ewes has yielded a crop of 20 lambs. At the present price of spring lamb, it seems that sheep farming should pay." Our old-time friends, Captain Hawkshaw & Sons, were formerly breeders of Shropshire sheep in Middlesex County, Ont., and have registrations in recent volumes of the American Shropshire Records, so the probability is that the ewes referred to in the above report are Shropshires.

The cut appearing in this issue, of the excellent imported Clydesdale stallion, Connaught, rising three, recently purchased from Wm. Mossip, St. Mary's, Ont., by W. J. Henderson, Evelyn, Ont., is sired by the invincible champion, Hiawatha, which is one of Scotland's best sires. Connaught's dam is sired by the Glasgow prize horse, Prince of Erskine, by Prince of Albion, by Prince of Wales (673), dam by Darnley (222). This colt is exceptionally well bred, is up to a big size, with a grand top, and the most fashionable underpinning, and should do well for the improvement of stock. Mr. Henderson should be congratulated, and the people of his district should be pleased to have so good a horse to breed to.

Oswald Sorby, Guelph, Ont., writes: I have recently sold to William H. Kerr, of St. George, Ont., the Clydesdale stallion, Lord Charming [2264] (7564). I would say that I have had a lot of Clydesdale stallions in the last thirty years, some that have been considered good breeders in Scotland, such as Acme, that was eighth best in the list of breeding stallions, and Rozelle, that was exported to Scotland last spring, and is now standing for mares at five pounds down and five pounds to follow when the mare proves in foal. As a stock-getter, I consider Lord Charming ahead of these horses, and easily the best stock-getter I ever have owned. Mr. Kerr's neighbors will find it greatly to their advantage to use this horse at whatever fee is charged.

The Saskatchewan Cattle-breeders' Association have decided to hold sales of pure-bred beef and dairy cattle at five different points throughout the Province. There will be three sales of beef cattle on the following dates: Carlyle, May 23rd; Yorkton, May 30th, and North Battleford, June 6th, whilst those of dairy stock will be held at Moosomin and Birch Hills on May 28th and June 4th, respectively. It is probable that the majority at least of the dairy stock will have to be purchased in the East, whilst the beef offerings will mainly be composed of local contributions as in former years. Rules and regulations for these sales will be printed shortly, and can be had on request from the Secretary, Department of Agriculture, Regina.

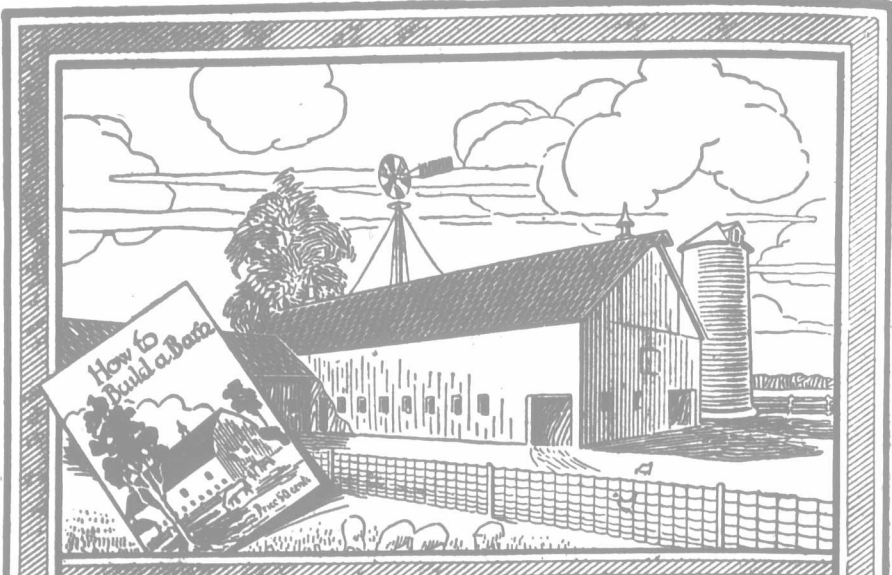

**SEND FOR THIS BOOK— It tells you how to build your barn**

**YOU** know the kind of barn you need and how much you are willing to spend on it. We have published a book that will enable you to build your barn, fitting it with all modern conveniences and new equipment and yet bring the cost within your limit.

This book contains numerous complete plans and specifications by which the barn framer may figure his materials and complete the work at once. It also contains many suggestive new ideas which if carried out in your present barn will add to its convenience and make it thoroughly up-to-date in every detail. Every farmer should have a copy of

**"HOW TO BUILD A BARN"**

The next barn you build should be planned to meet your requirements for years to come. Even though you do not intend building, this book is valuable to you for the suggestions it offers, enabling you to have an up-to-date arrangement of your present barn as regards floor space, partitions, fittings, roof, siding, ventilators, etc. The plans shown in the book will not only provide you with a barn giving the greatest possible space, but also will guide you in the selection of the most suitable and durable materials. It is worth money to you to have a copy of the book. It may put hundreds of dollars in your pocket. For instance, it explains the superiority of GALT STEEL SHINGLES AND SIDING and gives you definite reasons why they are the best for use in your barn. You know how wooden shingles become leaky, invite fire, corrode with moss and require extra heavy bracing on account of their weight. Galt Shingles are absolutely weather-proof, lightning proof, and fireproof. They protect your buildings from lightning, which each

year becomes a greater danger, owing to lack of timber. They provide the lightest, strongest, most durable and economical roof you can buy. They save you money every year. They have numerous patented features which you should look carefully into. The same thing applies to Galt Steel Siding.

**THIS 50c. BOOK FREE**

This book is not the product of one man, but of the combined experience of some of the best barn builders in Canada, assisted by Architects, Engineers and General Contractors, and the work is further advanced in value by consulting authorities on sanitation, ventilating, and drainage, lightning and lightning protection, interior barn fittings, arrangements, etc. It is hard to estimate its value to the farmer as a work of present and future reference, in connection with his barn, but in order that he may appreciate its value and retain it, we may say that duplicate copies will cost him 50c. each, unless these are for a friend who is also interested in barn construction.

**THE GALT ART METAL CO., Limited**  
150 STONE ROAD, GALT

**BRANCHES**—General Contractors Supply Co., Halifax, N.S.; Estey & Co., St. John, N.B.; R. Chestnut & Sons, Fredericton, N.B.; J. L. Lachance, Ltd., 253 St. Paul St., Quebec, Que.; Wm. Gray Sons-Campbell, Ltd., 583 St. Paul St., Montreal, Que.; Montague Sash & Door Factory, Montague, P.E.I.; Pife Hardware Co., Fort William, Ont.; Galt Art Metal Co., Ltd., 319 Henry Ave., Winnipeg, Man.; Gorman, Clancy & Grindley, Ltd., Calgary, Alta.; Gorman, Clancy & Grindley, Ltd., Edmonton, Alta.; D. R. Morrison, 714 Richard Street, Vancouver, B.C.

Send me your book on Barns.

F.A.



**8¢ PER RUNNING FOOT** Regal Oval Top Ornamental Lawnfence  
**SOLD DIRECT TO CONSUMER. FREIGHT PREPAID TO NEAREST STATION. ARTISTIC, DURABLE, INEXPENSIVE. GUARANTEED OR YOUR MONEY BACK.**

**REGAL FENCE & GATE CO. SARNIA, CANADA.**

SEND FOR CATALOG

**Imp. Stallions and Mares**—Percheron, Shire, French Coach and Standard-bred, ages medal winners at Ottawa Fair, 1911. All for sale cheap. Many first prize, champion and gold purchasers. Stallions two winters in Canada makes them much surer as foal-getters. Sixty miles from Ottawa on C. P. R. North Shore line, and one mile from C. N. R.

**J. E. ARNOLD, Grenville, Que.**

**Peachblow Clydesdales and Ayrshires** I am offering some choice young heifers and cows due to freshen in January in sale the imported hares, Hareson 247 and the yearling stallion Nessmore, 11032. They are both good animals and will be sold with the money. For prices write:

**R. J. BROWNLEE, Peach Blow Farm, Hemmingford, Que.**



The farmer who does not use Ready Roofing is wasting money—

### Certain-teed Roofing

—the big money saver

When buying roofing you should consider carefully these two points—quality and price. **Certain-teed Roofing** means quality certified and durability guaranteed—a better roofing for less money, fully guaranteed for fifteen years.

Millions of rolls in use on farm buildings to-day

You do not need to take our word as to the quality and durability of **Certain-teed Roofing**—there are millions of rolls of it in use to-day throughout the Provinces of Canada. Our sales are increasing at a tremendous rate. One trial will convince you. It is made in rubber shingles as well as rolls—on each roll or bundle we paste a **Certain-teed** label for your protection.



General Roofing Mfg. Co. Winnipeg, Manitoba.



How to Build a Less Money

### Have City Conveniences

REPLACE the pestilent, draughty, dangerous and offensive out-of-doors closet with an indoors closet which requires no sewer, no plumbing, and no flushing system. Have city conveniences in your home. Safeguard family health by installing a



### "Tweed" Closet sanitary and odorless

"Tweed" Closets can be installed in the bath-room, cellar, or any other convenient place indoors, merely requiring to be connected by a pipe for ventilation with a chimney hole. "Tweed" Liquid Chemical, used in connection with "Tweed" Closets, is both a deodorant and a disinfectant. Many hundreds of "Tweed" Closets have been sold in Canada. Send for illustrated price-list.

The Steel Trough & Machine Co., Ltd. Dept. 102 TWEEED, ONT.

### WE PAY THE DUTY

\$147.50 Six Horse Power Gasoline Engine \$147.50

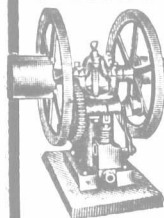

A slow speed, heavy duty engine constructed on the only correct principle.

One-third less weight, one-third less bulk and one-third stronger than any other engine in the world.

Write for catalogue and special proposition. United States Engine Works 1538 Canal Street, Chicago, Ill.

### FREE AGENTS

**BIG MONEY MAKER** THE AUTOMATIC FREE STROPPER. Similar stroppers sell for \$1.00. You should have one. Trouble giving it away. Write at once for free catalogue. Thomas Stropper Co., 5714 Barre St., Dayton, O.

PLEASE MENTION THE ADVOCATE.

### QUESTIONS AND ANSWERS. Miscellaneous.

#### SUFFOLK PUNCH WANTED.

Can you inform us as to any people in Ontario, or Canada, who have a breed of horses known as the "Suffolk Punch"? We are in the market for two or three pairs of good Suffolk Punch draft horses. (Mares for breeding purposes.)

J. d' E.

Ans.—Breeders of Suffolk Punch horses should note this inquiry and advertise.

#### O. A. C. COURSES.

Having read the article on the O. A. C. school graduates in your paper, I should be pleased if you could answer the following questions:

1. Could a person graduate in the twelve weeks?
2. What possibility is there of getting better wages?
3. To whom should one address their letters for information concerning fees, board, etc.?

A. B.

Ans.—1. The article referred to announced the successful students in the free three months' dairy course. The regular course requires four years to graduate.

2. Any of the various courses given at the O. A. C. place the student on a better level to procure higher wages than he was before, provided, of course, reasonable attention is paid to the course and the student studies diligently.

3. Write President G. C. Creelman for the College Calendar.

#### TILING BARNYARD—FEEDING HORSES AND COWS—POULTRY HOUSE.

1. What size of tile would you recommend to run through a barnyard? Would 3-inch be too small? There is a good fall.
2. Do you always advise feeding idle horses three times per day, or is twice sufficient?
3. Is it ever advisable to feed milk cows three times per day?
4. What value has fresh skim milk as a feed for milk cows who will drink it? How many pounds per day would it pay to feed?
5. Would you approve of the following cross-section for a poultry house, to be 40x15 feet, to face south-east, the front 3 feet high to be entirely open, and a row of windows to be along north-west side near peak of roof?
6. Do you recommend cement floors? Would you recommend dividing a house such as I describe into three pens? Would one ply of lumber be sufficient, covered on north side and ends with some felt roofing, or something similar?

W. S. M.

Ans.—1. Tiling a barnyard is not to be recommended. If any holes are present, fill them up, and improve the surface drainage so as underdrainage is unnecessary. Three-inch tile would be rather too small under ordinary circumstances. A high, dry barnyard is much to be preferred to a lower underdrained one.

2. Under ordinary conditions; yes. The horse has a small digestive capacity and requires frequent feeding. Feeding three times daily also tends to keep the animals quiet in their stalls.

3. Some feeders claim that it is. Many feed silage and grain twice daily, giving hay at noon. It really makes little difference whether they are fed twice or three times daily, as long as one method is adhered to regularly, and plenty of feed is given.

4. It is questionable whether it is ever advisable to feed skim milk to dairy cows. Very few cows will take it, and experiments under the most favorable circumstances of which we have any record, give its value as 19 cents per cwt., which are not as good returns as if it had been fed to pigs.

5 and 6. This pen should be all right, but we would advise partitioning it into at least two pens. Long pens are liable to be drafty. Two feet would be enough to leave open in front, instead of three. Cement floors are very good, but not so clean. One ply of lumber with the cracks battened, would be sufficient. Why not try the 20 x 20-ft. house recommended by Prof. Graham?

## Write NOW for Your Copy of DRUMMOND'S New Catalog

52 pages full of pictures, particulars and prices of everything for the dairy—including Aerators and Coolers, Sterilizer Sanitary Pails, Cow Testing Apparatus, Milk Scales, Babcock Testers, Surgical Instruments, Sanitary Milking Stools, Hand Separators, Farm Creamery Outfits, Churns, Butter Workers, etc. Feed and Litter Carriers.

With this catalog to guide you, you can buy wisely and well—and always be sure of perfect satisfaction. Write for a copy at once, and



Learn How to Save Time and Money Buying Your Dairy Supplies

You will surely find many suggestions for making your work easier and results better.

Promptly Sent FREE to any address. Write a postal asking for it to-day. W. A. DRUMMOND & CO. 217 King St. East Toronto

## PERCHERON STALLIONS

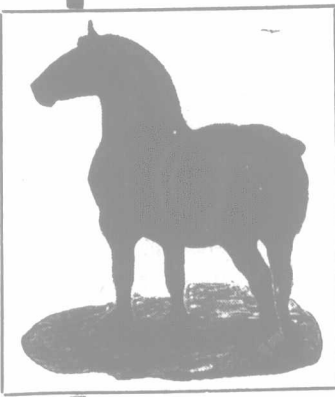

Prizewinners. We still have a few Percheron stallions to offer, among them being the first-prize three-year-old at the Toronto Exhibition last September, and the first-two-year-old at the Dominion Exposition, Regina, last August.

We don't sell all our best horses first, and can show intending buyers ton horses of the finest quality, both blacks and greys, and right in every way.

We are not looking for fancy prices, and these horses will be all sold worth the money.

Guarantee and terms the best obtainable. Phone, write or wire.

### HODGKINSON & TISDALE

Simcoe Lodge, Beaverton, Ont.



### Mount Victoria Stock Farm, Hudson Heights, P.Q.

We have for service this season the Champion Imp. Clydesdale stallions Netherline, by Pride of Blacon, dam by Sir Everard; also Lord Aberdeen, by Netherline, and the Champion Hackney stallion Terrington Lucifer, by Copper King. For terms and rates apply to the manager. T. B. MACAULAY, Prop. ED. WATSON, Manager.

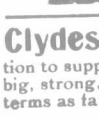

Clydesdales, Imp., Just Arrived Our new importation has arrived safely, and we are now in a position to supply the trade with stallions from 1 year old up to 4, with more draft character, big, strong, flat bone, and better breeding than any other firm in the trade. Prices and terms as favorable as any other importer in Canada. BARBER BROS., GATINEAU PT., QUEBEC, NEAR HULL.



Shire Stallions and Mares, Shorthorn Cattle (both sexes); also Hampshire Swine. Prices reasonable. Porter Bros., Appleby, Ont., Burlington Sta. Phone.

### ORMSBY GRANGE STOCK FARM, Ormstown, P. Que.

A large importation of specially-selected 2-year-old stallions, fillies and show mares. Will arrive early in May. D. McEACHRAN, PROPRIETOR

### CLYDESDALES (Imported) CLYDESDALES

SPRING HILL Top Notchers. Stallions, mares and fillies. 65 per cent. guarantee with stallions. Every mare guaranteed in foal. Ages, 3 years old and upwards. J. & J. SEMPLE Milverton, Ontario, and La Verne, Minnesota



IMP. CLYDESDALE STALLIONS AND FILLIES In my late importation of Clydesdale stallions and fillies I have exceptionally choice breeding idea draft characters; as much quality as can be got with size, and I can undersell any man in the business. Let me know your wants. GEO. G. STEWART, Howick Que. L.-D. Phone.

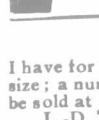

IMPORTED CLYDESDALES I have for sale mares and fillies, from foals up to 5 years of age; richly bred and big in size; a number of them in foal; matched pairs, the kind to make you money. They will be sold at prices that defy competition. L.-D. phone. ALEX. F. McNIVEN, St. Thomas, Ont.



Imp. Clydesdale Stallions of Size and Quality Our latest importation of Clyde stallions include several that were 1st prizewinners in Scotland. We have them from one year old up, of choicest breeding, big, flashy quality fellows, full of draft character. Our prices are the lowest, and our terms the best. L.-D. phone. CRAWFORD & McLACHLAN, Thedford P.O. and Sta.



We still have on hand a few good Clydesdale Stallions with both size and quality, all prizewinners and breeding of the best blood in Scotland. Prices and terms the best in Canada. John A. Boag & Son, Bay View Farm, Queensville, Ont. Long-distance Phone. On the Toronto & Sutton Radial Railway Line.



16 Clydesdale Stallions and Fillies 5 years and under. Some winning in Scotland and Canada. Bred from such noted sires as Hiawatha, Everlasting, Prince of Carruchan and Baden Powell—horses that will make a ton, with quality. Prices right. W. B. ANNETT, ALVINSTON, ONTARIO Watford station, G. T. R., 30 miles west of London.

**HORSE OWNERS! USE**  
GOMBARTZ'S  
**CAUSTIC BALSAM.**



A safe, speedy and positive cure. The safest, Best BLISTER ever used. Removes all lumps from Horses. Impossible to produce scar or blemish. Send for circulars. Special advice free.

Wm. Pearson & Son, West Flatboro, N. Y.

**INSURE YOUR HORSES**



**FOALING INSURANCE.**  
A small premium will secure a policy in our Company by which you will be fully insured against any loss resulting from the death of your mare or its foal, or both. All kinds of insurance on Live Stock. Transit Insurance covering horses on board cars for 5, 10, 15, 20 or 30 days.

PROSPECTUS FREE ON DEMAND.  
General Animals Insurance Company of Canada  
Head Office: 71A St. James St. Montreal  
OTTAWA BRANCH:  
No. 106 York Street, Ottawa  
Toronto Agency: J. A. Caesar, Room 2, Janes Building, Toronto, Ont.

**Mr. Farmer, Listen!**  
YOU CAN GET A

**Wilson Gold Medal Scale**



Freight paid by Wilson to your nearest station for less than wholesale prices. 100 styles Hay and Cattle Scales. Easy terms to pay if you

WRITE TO-DAY.  
C. WILSON & SON,  
79 Esplanade St. E.  
Toronto, Can.

**ABSORBINE**



Removes Bursal Enlargements, Thickened, Swollen Tissues, Curbs, Filled Tendons, Soreness from any Bruise or Strain; Cures Spavin Lameness, Allays Pain. Does not blister, remove the hair or lay up the horse. \$2.00 a bottle after bottle delivered. Book 1 E free.

ABSORBINE, JR., Liniment for mankind. For Synovitis, Strains, Gouty or Rheumatic Deposits, Swollen, Painful Varicose Veins, Allays Pain. Will tell you more if you write. \$1 and \$2 per bottle at dealers or delivered. Manufactured only by W. F. YOUNG, P. D. F., 258 Lyman Bldg., Montreal, Ca.

**Messrs. Hickman & Scruby**  
COURT LODGE, EGBERTON, KENT, ENGLAND  
EXPORTERS OF PEDIGREE

**Live Stock of all Descriptions.**  
In the spring months we shall be shipping large numbers of Percherons, Shires, Belgians, Clydesdales, Suffolks, etc., and all those who wish to buy imported stock should write us for full particulars.

**NOTICE TO HORSE IMPORTERS**  
**GERALD POWELL**  
Commission Agent and Interpreter  
Nogent Le Rotrou, France  
will meet importers at any port in France or Belgium, and assist them to buy Percherons, Belgians, French Coach horses. All information about shipping, banking and pedigrees. Many years' experience; best references. Correspondence solicited.

**Imported Shires**

I have for sale an imported stallion rising 4 years, two 2-year-old stallions, imported; also a pair of imported mares, matched, in foal.

**R. D. FERGUSON, Port Stanley, Ont.**  
Bell Telephone

**For Sale** Valley Dale Shires. Imported and Canadian bred Stallions. Mares and Fillies from 1 to 7 years old. For description and particulars apply to  
**Wm. Pearson & Son, West Flatboro, N. Y.**  
Address 103 York Street, HAMILTON, ONT.

**Shires and Shorthorns**  
In Shire stallions and fillies, from the best blood in England, we are offering some rare animals at very low prices. Scotch Shorthorns of either sex of the highest breeding and quality. **John Gardiner & Son, Highfield, Ont.** L.-D. phone.

PLEASE MENTION THE ADVOCATE.

**QUESTIONS AND ANSWERS.**  
Veterinary.

**ENLARGED KNEE.**

Three-year-old gelding while pawing in the stall injured his knee, and a lump formed about two months ago. I have blistered it three times with Caustic Balsam, but the lump is still there.

N. S. R.

Ans.—In the first place, the cause must be removed by placing him in a box stall or removing the manger. It requires a lot of time and patience to reduce enlargements of this nature. Get a liniment made of 4 drams each of iodine and iodide of potassium, and 4 ounces each of glycerine and alcohol. Rub a little of this well in once daily, and have patience. It will probably require a few months of treatment.

V.

**PARTIAL DISLOCATION OF PATELLA.**

Heavy yearling colt has a soft lump just below the stifle joint. I consulted my veterinarian, and, following his advice, I blistered it four times, but it seems no better. It stands all right, and can work fairly well, but is lame when it trots, and is knuckling on the other leg.

J. H. M.

Ans.—The patella (stifle bone) becomes partially dislocated during progression. The colt will never be right, but should make a fairly useful horse. All that you can do is to keep it as quiet as possible and blister the front and inside of the joint repeatedly. Details for blistering are given in answer to L. A., this issue. The knuckling is due to too much weight upon the leg on account of weakness of the other. A blister applied to the affected joint will tend to strengthen it.

V.

**DISLOCATION OF PATELLA.**

Mare seems weak in her stifle; sometimes one and sometimes the other, but never both at once. The leg becomes set and stiff, and she trails it for a few steps.

L. A.

Ans.—The patella (stifle bone) becomes dislocated. Get a blister made of 2 drams each of biniodide of mercury and cantharides, mixed with 2 ounces vaseline. Clip the hair off the front of stifle joints. Tie so that she cannot bite the parts. Rub the front and inside of the joint well with the blister once daily for two days. On the third day apply sweet oil. Turn loose in box stall now and oil every day. As soon as the scale comes off, tie up and blister again. It may require a third blistering. If possible keep her loose in a box stall while in the stable.

V.

**Miscellaneous.**

**GROWING CARROTS—POTATO PLOW.**

1. My carrots in places 10 to 12 feet long in the drill, only grow from 1 to 3 inches long, and are covered with small, white, fibrous roots, about the size of thread. The tops turn a light reddish color. What is the cause and remedy?

2. Could you describe something for dressing the tops of drills before sowing? I use a hand-sower, and do all the dressing with a garden rake, and would like to see something described to go over them at first to take the rough off with the horse. My harrows seem to be too heavy for that purpose.

3. In March 21st number, Mr. Hutchinson says he lifted the potatoes with a potato plow. Now, why couldn't he, or you, describe that plow, even to telling us the maker's name, if it is a good thing, or give us Mr. Hutchinson's address in full?

F. D. N. B.

Ans.—1. The carrot has no insect enemies of any importance. Wet places in the soil may cause the trouble, as in wet soil carrot roots branch greatly, and many fibrous roots appear.

2. Get the land in first-class condition before making the drills. Use a double-mold plow in making the drills, and very little extra should be needed. A very light harrow is all that is required to level the ground.

3. A potato plow is a simple implement fitted with rods instead of a moldboard. These run under the potatoes and, as they pass, the dirt falling through the plow is made by several different plow blades. Try an implement agent in your locality.

**INTERNATIONAL**  
**3 FEEDS FOR ONE CENT**  
**WE POSITIVELY GUARANTEE**

that a 25-pound pail of  
**INTERNATIONAL STOCK FOOD**  
will save you \$7.00 worth of Corn or Oats

Because it promotes digestion and assimilation and enables you to cut down the grain ration 15% to 25% and still get better results. The saving of grain represents a saving of good hard cash to you.

**WE WANT YOU TO FEED 100 LBS. AT OUR RISK**

It will not cost you a cent if you are not satisfied. See our dealer in your town or write us for particulars. Mention this paper and the stock you own and we will send you a litho, size 16 x 22, of our three champion stallions.

Read what James L. Hill, of Fredericton Junction, P.E.I., wrote us on February 15th:

I think International Stock Food is a great thing for stock. We wouldn't be without it for anything. It keeps our horses in fine condition; in fact, every person admires them, they have such a glossy skin and always look well. We give it to young calves and pigs and find it agrees with them splendidly, and the Poultry Food shows itself in a very short time. Our hens have been laying most of the winter. I cannot say too much for your food for all kinds of animals.

**INTERNATIONAL STOCK FOOD CO., Limited - - - TORONTO**

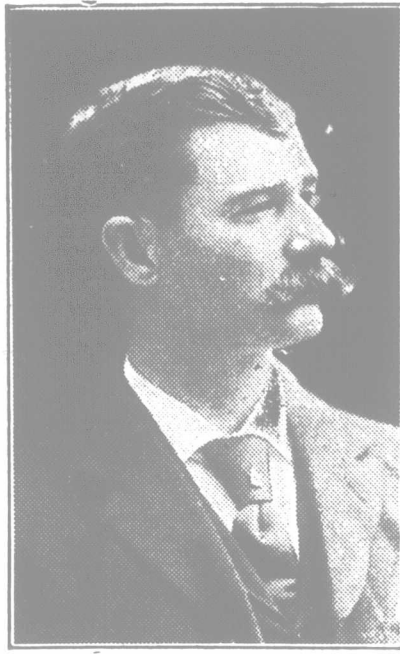

WESTON, ONT. BRANDON, MAN.  
**J. B. HOGATE**  
DIRECT IMPORTER  
**Percherons and Clydesdales**

My barns at Weston and Brandon are full of Percherons—stallions, mares and fillies and Clyde stallions—the very best that money could buy, in both greys and blacks, ages from two to five years. The stallions weighing from 1,700 to 2,200 lbs.; the mares from 1,600 to 1,900 lbs., some safe in foal.

In order to get my Weston barn sold out, so that I may go to my Brandon barn, no reasonable offer will be refused. Write, and come early, and get a bargain in a first-class stallion or mare.

TERMS TO SUIT. For further particulars write:  
**J. B. Hogate, West Toronto, Ont.**

**Union Stock Yards of Toronto, Ltd.**

**HORSE DEPARTMENT**

Auction Sale Every Wednesday Private Sales Every Day

Railroad Loading Facilities at Barn Doors

**W. W. SUTHERLAND, J. H. ASHCRAFT, JR.,**  
In Office. Manager.

**Toppers in Clydesdales at Markham, Ont.**

I have sold more Clydesdales in the last four months than I ever did before in the same time. Why, because I can show more good horses than any other man in Canada. I have some crackers left. Come quick if you want the best the breed produces. No man can undersell me.

**T. H. HASSARD, Markham, Ont.**  
Markham, G. T. R. Locust Hill, C. P. R.

**CRAHAM & RENFREW COMPANY**  
**CLYDESDALES AND HACKNEYS**

Our winnings at all shows are your guarantee that whatever you buy from us will be the best in the land. You cannot afford to buy without first seeing our importations.

Address all correspondence to Bedford Park P.O., Ont. Telegrams to Toronto. Telephone North 4483, Toronto.

**Clydesdale Stallions and Fillies**

Our past record for many years in the leading show-rings of Canada and in the year's increase in value of our horses is our best recommendation. This has been our best year. We have still imported the best of last year's importation in both stallions and fillies. We will accept your order at once.

**SMITH & RICHARDSON, Columbus P.O., Ont.**  
Percherons, Shires, Clydesdales, Hackneys, etc.

Percherons, Shires, Clydesdales, Hackneys, etc.

Percherons, Shires, Clydesdales, Hackneys, etc.

Percherons, Shires, Clydesdales, Hackneys, etc.

Percherons, Shires, Clydesdales, Hackneys, etc.

Percherons, Shires, Clydesdales, Hackneys, etc.

Percherons, Shires, Clydesdales, Hackneys, etc.

Percherons, Shires, Clydesdales, Hackneys, etc.

Percherons, Shires, Clydesdales, Hackneys, etc.

Percherons, Shires, Clydesdales, Hackneys, etc.

Percherons, Shires, Clydesdales, Hackneys, etc.

Percherons, Shires, Clydesdales, Hackneys, etc.

Percherons, Shires, Clydesdales, Hackneys, etc.

Percherons, Shires, Clydesdales, Hackneys, etc.

Percherons, Shires, Clydesdales, Hackneys, etc.

Percherons, Shires, Clydesdales, Hackneys, etc.

Percherons, Shires, Clydesdales, Hackneys, etc.

Percherons, Shires, Clydesdales, Hackneys, etc.

### Who Pays the Duty?

You can't get away from the fact that **directly** or **indirectly** the DUTY has to be paid by the consumer; therefore, why pay fancy prices for calf meals of foreign manufacture when you can buy CALFINE 15 to 20 dollars a ton cheaper and secure at least equal, and in most cases superior, results.

### CALFINE

"The Stockman's Friend"

has been most carefully experimented with at Macdonald Agricultural College, where it has given excellent results. It is now in use on some of the largest and best equipped dairy farms in the Dominion.

Ask your dealer for a 100-lb. bag of CALFINE as a trial—you will soon be back for more. If your dealer does not handle it, write us. We will do the rest.

Feeding Directions Sent on Application.

Canadian Cereal & Milling Co. Limited  
TORONTO, CANADA

### CHURCH BELLS CHIMES AND PEALS

MEMORIAL BELLS A SPECIALTY  
FULLY WARRANTED  
McSHANE BELL FOUNDRY CO.,  
BALTIMORE, Md., U. S. A.  
Established 1856



**Aberdeen Angus**—A few bulls to sell yet; also females. Come and see them before buying. Drumbo Station.

Walter Hall, Washington, Ont.

### Scotch Shorthorn Bulls

Have a number of good, thick-fleshed bulls of up-to-date type and breeding, from 8 months to 14 months old, also cows and heifers at reasonable prices. Write to, or call on  
**H. J. DAVIS**  
Woodstock, Ontario  
Breeder of Shorthorns and Yorkshires.  
C. P. R. and G. T. R. Long-distance Bell 'phone.

### MAPLE LODGE STOCK FARM

1854-1912  
Have desirable Shorthorns and Leicester sheep. Cows are high-class milkers. A handsome young Clydesdale stallion for sale.

### A. W. SMITH, Maple Lodge, Ontario

Lucan Crossing, G. T. Ry., one mile.

### OAKLAND SHORTHORNS

Our present offering: Bulls from 8 months to 22 months, roans and reds; all got by Scotch Grey 72,692. Prices from \$75 to \$150.

### JOHN ELDER & SON, HENSALL, ONTARIO

**Shorthorns of Show Calibre**  
Only one bull for sale now, but 13 grand heifers by Mildred's Royal must be sold, as we have no bull to breed them to. Come and see them, or write.

### GEO. GIER & SON, Grand Valley, Ont.

**GEDARDALE SHORTHORNS**—Shorthorns of all ages, pure Scotch and Scotch topped, imp. and Canadian-bred, choice heifers, choice young bulls, also the stock bull Lord Fyvie (Imp.); anything for sale.

### Dr. T. S. Sproule, M. P., Markdale, Ontario

**Clover Dell Shorthorns**  
Real bargains in females. Dual-purpose a specialty. **L. A. Wakely**, Bolton, Ont. Bolton Sta., C. P. R.; Callan East, G. T. R. Phone.

### Spruce Lodge Shorthorns and Leicesters

Very price cheap young bull from 6 to 14 months; also 2-year-old heifers, some from imp. sires and Leicesters at all times of both sexes for sale. Phone. **W. A. Douglas**, Tuscarora, Ont.

### Shorthorns

Nine bulls and a number of heifers for sale at very reasonable prices.  
**Robert Nichol & Sons, Hagersville, Ont.**

### QUESTIONS AND ANSWERS. Miscellaneous.

#### HOLIDAYS FOR HIRED MAN.

Kindly let me know if a man hires with a farmer for one year, beginning first of January, how many holidays he can claim, and what days?

A SUBSCRIBER.

Ans.—A hired man may claim as holidays, after doing all necessary chores, Sundays, New Year's Day, Good Friday, Easter Monday, Victoria Day, Dominion Day, Labor Day, Christmas Day, and, possibly, henceforth, the King's Birthday, together with any other day appointed by official proclamation as a holiday.

#### FEEDING CALVES.

1. Please give date of paper that had an article in it on "Onions," by Mr. Rush, of York Co., and also the article on "Potatoes," by the same gentleman.

2. Please give a good system of feeding calves, and what amount.

D. E. S.

Ans.—1. "Try Onions," on page 94 of January 18, 1912, issue. "Early Potatoes," on page 228 of February 8, 1912, issue.

2. The systems of calf feeding vary with the calves and the breeds, and the purposes for which the calves are fed. The calf should have new milk for the first week or ten days. The change from new to skim milk should be made gradually, and to cover a period of about ten days. For the first two weeks of skim-milk feeding, 3 to 4 lbs. at a feed will be sufficient. When the calf is a month old, it may take 10 to 12 lbs. per day, and at two months old, 15 to 16 lbs. will be required. Twenty pounds per day may be given at from 60 to 90 days of age. Give the calf all the good clover hay it will eat, or green feed as soon as it is ready. Keep them in during the day in summer, and turn out in a grass paddock at night. In addition the calves may be fed all the oats, either whole or chopped, that they will eat up clean. Where little milk is available, clover hay tea can be substituted; also a little oil meal.

#### RATION FOR STEERS.

Have a bunch of 1,200-lb. steers that have been getting the following ration: Well-matured corn silage, 30 lbs.; cut oat straw, all that is eaten up clean, mixed with silage; corn meal, 2 lbs.; oat meal, 6 lbs.; clover and timothy hay mixed, all that can eat up clean.

1. Is this ration lacking in protein?

2. If so, had I better add linseed meal?

3. Of the two following foods, which is the best value for the price given, and which would be the best to use to balance up the above ration?

(a) — Water 9.1, crude protein 30.4, fat 7.1, soluble carbohydrates 36.9, crude fibre 10.6, ash 5.9. Price, \$40 per ton.

(b) — Protein 4.61, fat .81, fibre 2.71, sugar 39.16, total carbohydrates 64.56. Price, \$38 per ton.

4. The latter analysis is not intelligible to me. Could it not be given the same as the former. We are not accustomed to seeing "sugar" given in the analysis of a food?

S. J. M.

Ans.—1 and 2. Assuming that in addition to the 30 lbs. of ensilage, 2 lbs. of corn meal and 6 lbs. oat meal, 6 lbs. of oat straw and 10 lbs. of hay, half timothy and half clover, were fed, the ration would give a nutritive ratio of 1 to 8.7, which is a trifle wide for fattening steers, and if a larger amount of straw and hay were used, it would be still a little wider. As the grain ration is comparatively light, two pounds of linseed meal would improve it considerably.

3 and 4. Not knowing what these materials are, it is scarcely safe to pass an opinion, because one cannot rely wholly on the chemical composition of a food. Some are more palatable than others, and some are far more digestible than others. From the data given, the first mentioned in the letter feed to add to the ration given in question 1. It contains a far larger percentage of crude protein, which generally indicates greater digestibility. Sugar is only a carbohydrate material, and its point in favor of the ration is the low percentage of

You can build cheaper—Your buildings will look better and will last a life-time if you build with



"Eastlake" Steel Shingles.

Metallic Stone and Brick, Steel Siding.

Metallic Ceilings and Walls.

Corrugated Iron Siding and Roofing.

Eaves-troughs, Conductor Pipes, Cornices, Ventilators Finials and all Building Accessories.

It will pay you to send a postal card to us and let us know your requirements. We shall be pleased to offer you plans and suggestions that will help you.

## THE METALLIC ROOFING CO. Limited

MANUFACTURERS

1189 King Street, West, Toronto

Branch Factory: WINNIPEG. Agents in principal cities.

\$15<sup>95</sup> AND UPWARD SENT ON TRIAL FULLY GUARANTEED.  
—AMERICAN—  
SEPARATOR



A brand new, well made, easy running, easily cleaned, perfect skimming separator for \$15.95. Skims one quart of milk a minute, warm or cold. Makes thick or thin cream. Thousands in use giving splendid satisfaction. Different from this picture, which illustrates our large capacity machines. The bowl is a sanitary marvel and embodies all our latest improvements. Our richly illustrated catalog tells all about it. Our wonderfully low prices on all sizes and generous terms of trial will astonish you. Our twenty-year guarantee protects you on every American Separator. Shipments made promptly from WINNIPEG, MAN., ST. JOHN, N. B. and TORONTO, ONT. Whether your dairy is large or small get our great offer and handsome free catalog. ADDRESS, AMERICAN SEPARATOR CO., BOX 1200, BAINBRIDGE, N. Y.

### ORCHARD GROVE HEREFORDS

Champions of 1911 shows, winning both senior and junior herds at Winnipeg, Brandon, Regina, Edmonton, Toronto and London; also fifteen championships. Young stock, both sexes, for sale at reasonable prices. Long-distance 'Phone **L. O. CLIFFORD** Oshawa, Ont



**Suffolk Down Sheep**—Shearing rams and ewes; also lambs.  
**Aberdeen-Angus Cattle**—Extra good young bulls, the best in Canada.

**James Bowman**  
Elm Park  
GUELPH, ONTARIO

# "I want to Tell You a Big Secret of Building"



DEAR FRIEND:

I am sitting here at my desk, thinking how I shall write many people. I am an old man now—70 years old. 50 long years of my life were given over to making a perfect roof for any kind of building (for everybody has to use roofs), and the right roof works day and night to help a man's daily work.

A roof on a building is the weak link in a chain. Good foundations and good timbers rot—good products stored under a poor roof are spoiled because the roof doesn't protect. I want to stop that big waste. After years of work, I now know how to do it.

I worked for a long time to get a roof that could be easily laid by anybody. It had to be neither too heavy nor too light. It had to be smooth and clean. It had to be a real water shedder, no matter how long it was laid. It had to be proof against ice, snow, lightning, sun and time.

My Oshawa Shingles are the result. I worked for years to find a metal that wouldn't rust. I worked on an iceproof lockjoint. I have a shingle to-day that is the best ever put on the market. People buy it from me all around the world, it is so good. These people see how worth-while a good roof is.

I know my Oshawa Metal Shingles so well,

and anybody can lay a roof in them so well and easily, that it makes the safest and best roof you can get. But I have a new 100-year metal now. My Oshawa Shingle is Perfected. A 100-year roof is a mighty good article—far better than even old-style, hand-shaved cedar shingles. I know my roof is four times as good—and it won't burn.

Not only that—when you get a roof, get the best you can find. Here is fireproof and lightning-proof protection for you for a century. Yet the roof costs a common, every-day price.

My "Roofing Right" book lets you dig down into my Oshawa Shingle proposition. I want you to send for it. You can get all the facts. Even if you do not use my roof this book is worth money because it gives valuable building hints. My Oshawa Shingles are on the best and most modern buildings. These are pictured in the book. You can get it for a post-card. Send that card to-day. My book will help you in your plans.

Yours truly,  
G. R. Pedlar

## The PEDLAR PEOPLE Limited, of Oshawa

Established 1861  
 OTTAWA WINNIPEG QUEBEC REGINA EDMONTON VICTORIA CHATHAM LONDON  
 423 Sussex St. 76 Lombard St. 127 Rue du Pont 563 Third St. W. 434 Kingston St. 200 King St. W. 86 King St.  
 VANCOUVER TORONTO CALGARY ST. JOHN, N.B. PORT ARTHUR MONREAL HALIFAX  
 108 Alexander St. 111-113 Bay St. 1112 First St. W. 42-46 Prince William St. 45 Cumberland St. 321-3 Craig St. 16 Prince St.

### WHEN WRITING ASK FOR PEDLARIZATION BOOK NO. 150

#### Cattle and Sheep Labels

Size	Price doz.	Fifty tags
Cattle	75c.	\$2.00
Light Cattle	60c.	1.50
Sheep or Hog	40c.	1.00

No postage or duty to pay. Cattle sizes with name and address and numbers; sheep or hog size, name and numbers. Get your neighbors to order with you and get better rate. Circular and sample. Mailed free. F. G. JAMES, Bowmanville, Ont.

#### Shortshorns, Berkshires, Cotswolds

Nine bulls from 9 to 11 months, cows, heifers and heifer calves; over 50 head on hand. No Berkshires to offer at present. A few shearing ewes for sale.

Chas. E. Bonnycastle,  
P. O. AND STA., CAMPBELLFORD, ONT.

#### Woodholme Shorthorns

I have for sale a number of choicely-bred Scotch Shorthorn heifers and several young bulls, all of high-class quality and sired by Imp. Dorothy's King =5509=, a Lady Dorothy. I am also offering this bull for sale.

G. M. FORSYTH, North Claremont P. O. & Sta

#### SPRING VALLEY SHORTHORNS

Herd headed by the two imported bulls, Newton Ringleader, =7378=, and Scottish Pride, =3619=.

KYLE BROS. - - Ayr, Ontario

#### IMPORTED BULL FOR SALE

Our Green Grove herd of Shorthorns is headed by the two imported bulls, Imp. Spectator =50094= and Imp. Royal Bruce =55038=. Present offering: Stock bull Imp. Spectator and two choice young bulls, herd headers, fit for service; also good females

THIS IS A GOOD TIME, AND I HAVE A GOOD PLACE, TO GET A HIGH-CLASS SCOTCH SHORTHORN BULL CALF by my great Whitehall Sultan sire, or a young cow in calf to him, to start a herd that will be gilt-edged. SHROPSHIRE RAMS AND EWES, too, at low prices. CHILDREN'S PONIES. A CLYDES DALE FILLY, such as I can send you, is one of the best things any man can buy. Just write me and say as nearly as possible what you want, and I will surprise you with prices on goods that are genuine ROBERT MILLER, STOUFFVILLE ONTARIO

Scotch Shorthorns FOR SALE—One of our imported herd bulls and eight heavy-boned, deep-bodied, low-down bull calves, 12 to 16 months old. Also twenty-five heifers and young cows bred to imported bulls. Farm 1/4 mile from Burlington Jet. Station. MITCHELL BROS., Burlington, Ont.

BLAIRGOWRIE STILL TO THE FRONT SHORTHORNS—2 red bulls, 12 and 15 months; 1 red bull, 9 months; 2 roan bulls, 12 and 14 months. CLYDESDALES—One mare in foal, one filly rising three, two filly foals. Inspection invited. Myrtle, C. P. R. Sta. L.-D. Phone. JOHN MILLER, JR. Ashburn, P. O.

Shorthorns and Clydesdales—We are offering 10 choice young bulls, serviceable age, sired by His Grace (imp.) =6974=; who is also for sale horses, from imported sires and dams; also cows and heifers, mares and fillies. Write us, or come and see them. A. B. & T. W. DOUGLAS Strathroy, Ont. Farm one mile north of town.

Scotch Shorthorn Females for Sale I am offering at very reasonable prices, females from one year to five years of age. The youngsters are by my grand old stock bull, Scottish Hero (imp.) =55042= (90065), and the older ones have calves at foot by him, or are well gone in calf to him. Their breeding is unexcelled, and there are show animals amongst them. A EDWARD MEYER, Box 378, GUELPH, ONT.

Pleasant Valley Farms Shorthorns For Sale: Scottish Signet, best son of imp. Old Lancaster, and several good young bulls of the best Scotch breeding, at prices to suit everyone. Write us for exactly what you want, or visit us. Farm 11 miles east of Guelph, C. P. R. Half mile from station. Geo. Amos & Sons, Moffat, Ont.

SALEM SHORTHORNS Headed by (imp.) Gainford Marquis, undetested in Britain as a calf and yearling, and winner of junior championship honors at Toronto, 1911. Have on hand two yearlings and a number of bulls under a year for sale at reasonable prices. J. A. WATT, Salem, Ont. Elora Sta, G. T. R. and C. P. R.

Springhurst Shorthorns I can supply a number of choice young bulls, cows and heifers, fit for service, and also good females, of equal quality as good, show propositions among them. HARRY SMITH, Hay P. O., Ont. Exeter Sta. G. T. R.

### QUESTIONS AND ANSWERS. Miscellaneous.

#### MAIL DELIVERY.

As I live in from the road a considerable distance, and intend to have my mail delivered on the road, which is about 200 rods from house, is there any contrivance that will run on a wire and carry mail to house? If so, would you please give me address of any making such an article? W. E. M.

Ans.—We do not know of any such appliance for this purpose.

#### PLANT QUERIES.

As you have so often helped me before, I am coming again to ask you some questions. I bought a Whirlwind anemone three years ago. It grows; the root is getting larger, but it never forms a top or flowers. I have it in an open flower border of loamy, deep soil, where other flowers do O. K. Can you tell me why it does not flower?

We intend making a new garden this spring. The ground was in corn last year and fall-plowed. Will cultivating a coat of manure into it be all right for this spring, or what should it have? We intend planting part of it into berry and currant bushes.

Also, can I plant some asparagus into a rather damp corner this spring, or must I plant them in fall?

We planted a Mountain ash tree nine years ago too near a Manitoba maple, which is crowding it out of shape (it is also too near the house). Could we remove it this spring in safety? Also, would a rather gravelly place be a fit place for it (it is rather exposed to wind, too, where we want it), or would a rather damp place of loamy soil be better, if safe to transplant it?

X. Y. Z.

Ans.—The best we can do for you is to quote what Bailey says in regard to this beautiful flower. "The plants thrive best in a fresh, rather rich, sandy loam, well drained, but most of the species will do well in any good garden soil. They require essentially the same handling as tulips and hyacinths, and are usually classed with bulbous plants. . . . Good seasons for outdoor planting are September, October, November, and March. . . . The bulbs may be ripened after flowering time by being taken from the ground to dry, or by covering the bed to keep out rains."—Perhaps you will see by this description of right conditions the mistake you have made, something that you have done that you ought not to have done, or something you have left undone that you ought to have done. By the way, do you know that if you place anemone tubers in pots in September or October, you may have fine bloom from January to March?

Good corn ground should be excellent for a garden. If not very rich, you may find it advisable to work some well-rotted manure into it; fresh manure should never be used on a garden.

Asparagus plants may be set either in spring as soon as possible after the ground is fit, or in the fall when the tops are thoroughly dry. They need a very, very rich, deep bed (use plenty of old manure), well drained, and with, preferably, a southern exposure. If very clayey, sand should be worked in to induce porosity; if acid, lime should be added. When setting out the plants, make furrows eight inches in depth and about a foot wide at the bottom, and set each root on a little knoll made firm by the hand. Cover the roots immediately with about three inches of soil, water, and mulch with a little dry earth. Later, fill in the trench until the surface is level at snow-time. During the summer, cultivate clean, spray if rust appears, give water when necessary, and liquid manure every two weeks. In fall, cut and burn the stalks, and dress the bed with manure.

Asparagus may be raised from seed planted in early spring, but, of course, time may be saved by buying the plants. Only seedling plants should be used.

Transplanted plants should grow two years at least before cutting; better leave them until the fourth year. From that time every stalk should be cut or broken down until about the middle of June.

We cannot say whether or not the transplanting would be a success. Gravel, so far as it will do all right if the tree is not too old to this class of soil.

# HEADACHE

## Seems To Be Habitual With Many People.

Some are seldom, if ever, free from it, suffering continually and wondering why they can get no relief.

Headaches are generally caused by some derangement of the stomach or bowels, or both.

Burdock Blood Bitters removes acidity of the stomach, improves digestion, regulates the constipated bowels, and promotes a perfect circulation of pure blood to all portions of the body, thereby curing the headaches by removing the cause.

Mrs. L. Maguire, Kinmount, Ont., writes:—"I am writing you a few lines to tell you what your Burdock Blood Bitters has done for me. I used to be greatly troubled with headaches, but after using two bottles of Burdock Blood Bitters I was completely cured. This was two years ago and I have had no return of headache since."

Burdock Blood Bitters is manufactured only by The T. Milburn Co., Limited, Toronto, Ont.

## Six Shorthorn Bulls must be sold.

Different colors, and their breeding is good enough for any herd. Write me for prices before purchasing.

W.M. SMITH, COLUMBUS, ONTARIO

A company of Edinburgh students were starting for Glasgow on a football excursion, and meant to have a carriage to themselves. At the last moment, however, just as the train was starting, in hastened an old woman.

One of the young fellows, thinking to get rid of her easily, remarked:

"My good woman, this is the smoking car, don't you know?"

"Well, well," answered the woman, "never mind. I'll mak' it due." And she took a seat.

As the train started, the word was passed round, "Smoke her out." All the windows were closed accordingly, every student produced a pipe, and soon the car was filled with a dense cloud of tobacco smoke. So foul was the air that at last one of the boys began to feel ill. As he took his pipe from his mouth and settled back into his seat, the old woman leaned forward to him.

"If ye are dune, sir," she said, in a wheedling tone, "wad ye kindly gie me a bit draw? I came awa' in sic a haste I forgot mine."

## WIFE OF THE P. M. TALKS TO WOMEN

### Tells What Dodd's Kidney Pills Did For Her.

She Suffered for Two Years and Found a Cure for all Her Troubles in a Single Box.

Lower Caraquet, Gloucester, N. B., April 22.—(Special).—Mrs. Jos. O. Chiasson, wife of the police magistrate here, who for two years has been practically an invalid, is again in the best of health, and she is telling her friends how quick and complete was her cure when she took Dodd's Kidney Pills.

"My illness," Mrs. Chiasson says, "was caused by a strain, and for two years I was a sufferer. My back ached, I was always tired and nervous, there were dark circles under my eyes, and after sleeping I had a bitter taste in my mouth.

"I had a pressure and sharp pain on the top of my head, I was always thirsty, and my skin had a harsh, dry feeling. I was often dizzy, I perspired easily, and my perspiration had an unpleasant odor. "Almost from the first dose, Dodd's Kidney Pills helped me, and by the time I had finished the first box I was a well woman."

Mrs. Chiasson's symptoms showed that the trouble was her kidneys. That's why Dodd's Kidney Pills cured her so quickly.

## QUESTIONS AND ANSWERS. Miscellaneous.

### CEMENT FOR WALL.

Would you kindly advise me as to how much cement it would take to build a cellar 16 x 24 feet, 7 feet high, 14 inches thick, mixing it 5 to 1, and what kind of cement is the best to use?

A SUBSCRIBER.

Ans.—At this rate of mixing, the wall would require about 33 barrels of cement. Use Portland cement.

### TAPPING TREES.

1. Does the sap run up or down a maple tree in the spring?  
2. What is the proper distance from the ground to tap a tree, or does it make any difference?

A. D.

Ans.—1. The sap travels upwards in spring.  
2. Tap anywhere between the ground and the top. A few feet from the ground is a convenient height.

### SEED OATS.

Have on hand a small quantity of Stirling oats. Can you recommend them for seed on clay soil?

J. S. R.

Ans.—We are not familiar with the variety. There are so many names employed in different localities, and by different seedsmen, for what are in reality the same kind of oats, that it is sometimes hard to recognize an old variety under its new name. If the seed is clean and heavy, and the variety has yielded well in your locality, we would not hesitate to sow them.

### RAILWAY RIGHTS.

1. A owns a farm and a railway company wants to buy a right of way across the farm. The railroad will cut the water from his cattle, and they will not grant him a cattle-pass. Can A compel them to put in a cattle-pass, providing the grade is high enough to allow it?

2. Can A prevent them from working on his farm until they have settled? Will a notice in writing be sufficient to stop them?

SUBSCRIBER.

Ans.—Refer the matter to Hon. J. P. Maybee, Chairman of the Railway Commission, Ottawa.

### CAKED UDDERS.

Would you attribute bare cement floors as the cause of cows having caked udders? I have had ten cows come in, and have had no end of trouble. Straw is at a premium here.

HIRE MAN.

Ans.—There are several causes of caked udders, among them cold floors, drafts, injuries caused by other cows tramping on them, etc. This looks as though the cement floor was at fault, owing, no doubt, to the scanty supply of bedding. Bathe the udders affected with hot water and vinegar, and apply a little goose grease.

### MAMMOTH CLOVER.

I have ten acres that I seeded with Mammoth clover in 1911, and would like information regarding how best to handle it so I can get the seed off it next fall? When should I cut first crop, and also second? What would be a fair yield per acre? The land is in good condition, and was seeded part in March with fall wheat, and part in April with barley.

X. Y. Z.

Ans.—Cut the crop for hay the fore part of June, and leave the second crop for seed, which should be cut when ripe. From three to five bushels per acre would be a very good yield. Larger yields have been obtained, but this is a good average. After cutting for seed, it is generally good practice to plow the clover sod. The production of seed lowers the vitality of the clover, which is a biennial plant, the Mammoth variety showing a little more of the perennial tendency than the common red.

Hon. Martin Burrell, Dominion Minister of Agriculture, has authorized the purchase of 320 acres as an addition to the Alberta Experimental Farm at Lacombe. This land joins the farm on the west and south, and is well situated for extension of the station. This purchase has been made by the Minister with the object of carrying on more extensive experiments with the various classes of live stock.

## CALVES WITHOUT MILK

Write for Free Booklet

"How to Raise Calves Cheaply and Successfully Without Milk"

Contains full information and complete feeding directions for using

## Blatchford's Calf Meal—The Perfect Milk Substitute

Three or four calves can be raised on it at the cost of one where milk is fed. No milk feed. The only calf meal manufactured in an exclusive Calf Meal Factory. Established at Leicester, England, in 1899.

STEELE, BRIGGS SEED CO., LTD. WINNIPEG, MAN. HAMILTON, ONT. TORONTO, ONT.

## Present Special Offering

- 20 High-Class Scotch Shorthorn Heifers
10 High-Class Young Shorthorn Cows
5 High-Class Scotch Shorthorn Bulls

At moderate prices, including Marr Missies, Emma, Cruikshank No. 3, Duchess of Glosters, Village Girl, Bridesmaids, Butt flies, Kinel ar Claretts, Miss Ramsdens Crimson Flowers; also a number of the grand old milking tripe, which have been famous in the showing.

ARTHUR J. HOWDEN & CO. Columbus, Ontario

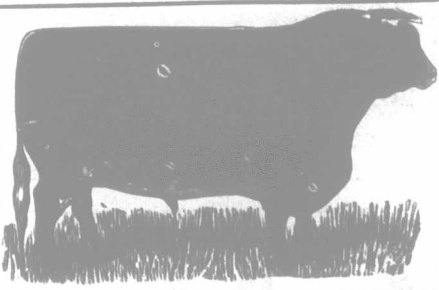

## Shorthorn Bulls and Clydesdale Mares

If you are in the market for a young bull, write us for particulars, or, better still, come and see them. We have 13 young bulls, from 8 to 14 months old, of good breeding and quality. We also have four imported Clydesdale mares, safe in foal.

W. G. PETTIT & SONS, Freeman, Ontario

Bell phone.

Burlington Jct. Sta., G. T. R., 1/2 mile from farm

## SHORTHORNS

Have now a choice lot of young bulls to offer; also with something nice in heifers. Catalogue of herd and list of young animals on application.

H. CARGILL & SON, Proprietors, Cargill, Ont., Bruce Co. JOHN CLANCY, Manager



## 10 SHORTHORN BULLS 10

If you are looking for a young bull to head a purebred herd, or one to cross on grade cows to raise first-class steers, I have them to suit all customers at very reasonable prices. They are reds and roans, and one extra good white show calf; ages from 9 to 14 months, nearly all sired by imported bulls and from the best Scotch families of cows. Will be pleased to furnish breeding and prices.

Claremont Sta., C.P.R., 3 miles. Pickering Sta., G.T.R., 7 miles.

JOHN MILLER, Brougham P.O., Ont.

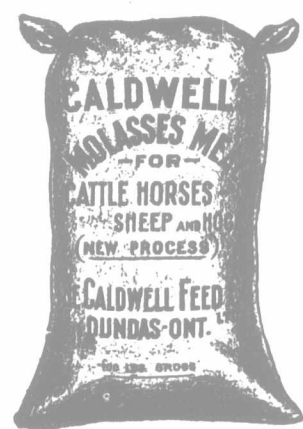

## MR. DAIRYMAN

Have You Tried

## Caldwell's Molasses Meal

for Your Cows?

If not, now is the time to get the very best results from its use.

Cows that come through the winter in a thin condition are not in shape to do their best at the milk pail.

When turned on grass it takes a month or two before they are back to normal condition.

Can you afford to lose the time, when one bag of Caldwell's Molasses Meal fed to each cow from now until the pasture is ready will insure perfect condition and profitable returns?

Caldwell's Molasses Meal contains no spices or drugs, is manufactured in the largest and most modern feed mill in Canada under expert supervision. No beet molasses enters into its composition. It is dry to the touch, of a pleasant odor, palatable, highly nutritious and best of all gives results.

And please remember that it costs you nothing extra to use it as it takes the place of an equal quantity of ordinary chops.

Mail the coupon and we will send you booklet and all particulars as to cost, etc., together with current copy of our magazine.

CUT ALONG HERE

"Farmer's Advocate."

Please send me booklet and full particulars as to cost, etc., of Molasses Meal.

The Caldwell Feed Co. Limited Dundas, Ont.

Name .....

Post Office .....

County..... Province.....



BIBBY'S CREAM EQUIVALENT

# CALF MEAL

No other food except fresh milk itself contains so much nutriment for calves and young pigs as this meal. The Government test shows a much higher percentage of real (fat) value than others. Not a "drug," but an extremely wholesome food. Made in England by an honorable firm—the largest manufacturers of Oil Meal in the world.

50-lb. bags, \$2.25, at all dealers.

CANADIAN REPRESENTATIVE:  
**WM. RENNIE CO., Limited, TORONTO**

## The Engine That Costs Nothing to Run

The wind furnishes the "fuel" free, and you get all the power you need when you have a

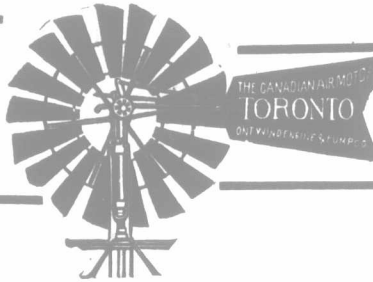

### Canadian Airmotor

Investigate. Learn the cost and the advantages of wind power. Write for our free book.

**Ontario Wind Engine & Pump Co., Limited**  
Winnipeg TORONTO Calgary

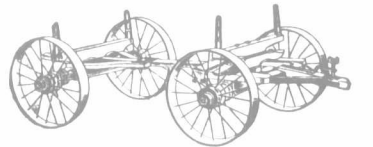

## Buy a Wagon You Can Depend On!

For convenience, strength and durability—get a T-A Handy Farm Wagon. Designed especially for farm work, will give everlasting service under the roughest usage to which a wagon can be put. And besides—it is easy on horses.

### T-A Handy Farm Wagons & Wide-Tire Steel Wheels

Carefully and strongly built, of the highest grade material, these T-A Wide-Tire Steel Wheels will carry 25 to 50 per cent. heavier loads without the least danger of breaking down or getting stuck.

We will be pleased to send you descriptive catalogue. Write for it.

**Tudhope-Anderson Co'y, Ltd.**  
Orillia, Ontario

### QUESTIONS AND ANSWERS. Miscellaneous.

#### PLANTING MANGEL SEED.

Would a corn-planter (check rows) successfully plant mangel seed, or would it have to be especially made for the purpose? OLD SUBSCRIBER.

Ans.—Some manufacturers claim that their particular planter will successfully plant mangel seed, but we have never seen it tested. It might be tried on a few rows as an experiment.

#### FODDER CROP—COW.

1. Please advise what crop to sow to make green feed for milch cows during the summer months, and about how far apart for each sowing?

2. Kindly give any information regarding the Ayrshire cow, Nellie Osborne? I understand she was a great cow.

A. J. D.

Ans.—1. As an annual pasture crop, 51 pounds of oats, 30 pounds of Early Amber sugar-cane, and 7 pounds red clover, sown early in May, makes a good pasture to turn on about July 1st. For a soiling crop, a mixture of peas and oats is good, and, of course, corn, as soon as it can be had, is one of the best fodders known. Two or three sowings of oats and peas at intervals of two or three weeks, should be enough to carry the cattle until corn is ready for use.

2. Nellie Osborne 5358 was an imported cow, sired by Lessnessock (2187). She was first-prize aged cow and grand champion female at the World's Columbian Exposition, Chicago, in 1893. She was a great show cow, and a good breeder.

#### MISCELLANEOUS QUERIES.

1. Would it be possible to operate a pump and engine on a bank 125 or 150 feet from the water, instead of having them near the water? Could some means be devised to enable the pump to draw it that far?

2. After having levelled and seeded a lawn last fall, am inclined to believe that I didn't get a very good catch of seed. Which would be the best way to make it a first-class lawn this spring? What would be the best kind of seed to sow?

3. Intend planting a spruce hedge this spring. Which is the best way to plant it to insure success? About when should it be planted? To make a windbreak, how far should the spruce trees be planted apart?

4. How should gooseberries and currants be trimmed in the spring? Will hoeing around them do them harm? One writer says it will.

5. After plowing up a strawberry patch after crop has been harvested, what do you consider the best or most paying thing to plant or sow? Kindly mention a number of things one might produce.

W. S.

Ans.—1. Yes.  
2. Rake in a good seeding of lawn-grass mixture; equal parts by weight of red top, white Dutch clover, and Kentucky blue grass, sown thickly. For quick work, to make a good lawn, there is nothing like sodding.

3. Some get very small trees and grow them in a nursery row for a year or two; others get larger trees and plant them in their permanent position at first planting. Either gives good success, as the spruce is not a hard tree to grow. There are various distances apart to plant. Some plant the trees in one row about six feet apart; others use two rows about ten feet apart, with the trees alternating about eight feet apart in the rows. Would not plant the trees too close together, as the limbs die off at the bottom when they get large.

4. Cut out all dead wood. Leave a number, usually from four to eight healthy stocks. Cut out all wood over three years old. The best fruit is obtained from year-old wood, but some older wood must be left to insure production. The cross-section bears most fruit, and three-year-old wood. All that is necessary is to keep the shoots healthy and discard all sickly or dying ones. Hoeing around them should improve them.

5. A potato crop would be profitable under the soil. A crop which permits enough cultivation is necessary, as the soil is usually more or less grassy.



### The Feed That Makes The Cream

Livingston's Oil Cake is the cheapest feed for cows—cheaper than corn, shorts or even hay. Because it actually increases the richness of cream—and also increases the amount of butter that you get out of the milk. Test your cows before and after feeding Livingston's Oil Cake for a month—and your "butter money" will show its economy.

Fine Ground, Coarse Ground, Pea Size and Nutted Grindings. If your dealer cannot supply you write us for prices and samples.

**DOMINION LINSEED OIL CO'Y, LIMITED**  
Manufacturers J. & J. Livingston  
Brand Oil Cake  
BADEN, ONTARIO



## Don't Pay for This Sheep Shearing Machine Until You See and Examine it

Most dealers have it. If yours hasn't, ask him to get one for you, and when it comes have it set up and try it. If you are convinced that it is what you want, buy it and try it on your sheep with the distinct understanding that it must do the work O. K. or no sale.

### This STEWART BALL BEARING MACHINE No. 9

is just the easiest of all shearing machines to turn. A boy can run it all day without tiring. It is ball bearing throughout, including a ball bearing shearing head, shears quick and evenly all over.

The price including four sets of knives is only \$15.75

It is really a wonderful machine and you will be agreeably surprised at the work it does.

Get your dealer to send now, or if you prefer send \$2 and we will ship C. O. D. for balance and you may try the machine and if not satisfied we will refund all you paid out. Send for copy of new 1913 catalogue and Expert Instructions on shearing sheep.

**CHICAGO FLEXIBLE SHAFT COMPANY**  
110 La Salle Ave. CHICAGO



## Brampton Jerseys

cows and some calves for sale. Production and quality

Bulls hit for service are getting scarce. Just a few left. Yearling heifers in calf are in great demand; 6 for sale; 6 now being bred. Brampton Stockwell the sire. A few good

**B. H. BULL. & SON, BRAMPTON ONT.**

## Balaphorene A. J. Jerseys—Foundation

St. Lambert, Coomassie, Combination; stock from a grandson of Rim of Dentonia; also a grandson of the great Blue Blood of Dentonia, for sale. W. Wyandotte eggs, \$1 per 13. Joseph Seabrook, Havelock, Peterboro Co., Ont.

Raise them without milk. Booklet free. **CLOUGH & CO., Lennoxville, Que.**

## Don Jersey Herd

Offers young bulls and heifers for sale; heifers bred to Eminent Royal Fern.

**D. Duncan, Don, Ont., Duncan Stn., C.N.R.**

Phone Long-distance Agincourt.

## High Grove Stock Farm

No better Jersey blood in Canada. Stock all ages and both sexes for sale. **Arthur H. Tufts, P. O. Box 111, Tweed, Ont.**

## Burnside Ayrshires

**R. R. NESS, Howick, Quebec**

Champions in the show ring and dairy tests. Animals all ages and both sexes for sale. Long-distance phone in house

## SPRINGBURN AYRSHIRES

Cwing to remodelling our barns, we do not care to carry any bulls over right for prompt delivery. Always about 50 head of females of all ages to select from. Tuberculin tested. **McMILLAN & LUGGAT, Trout River, Que.** Bell telephone, Huntingdon 81-21, Carr's Crossing, G. T. R., Huntingdon, N. Y., C. R.

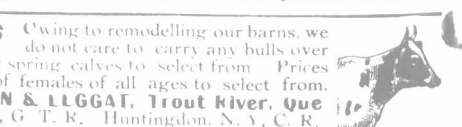

## SPRINGBANK AYRSHIRES

The world's leading herd of Record of-Performance Ayrshires. Conquers and big teats a specialty. A few bull calves, true to color and type, from R. O. P. dams, for sale at reasonable prices. **A. S. TURNER & SON, Ryckman's Corners, Ont.** Three miles south of Hamilton. Visitors welcome. Trains met by appointment.

The world's leading herd of Record of-Performance Ayrshires. Conquers and big teats a specialty. A few bull calves, true to color and type, from R. O. P. dams, for sale at reasonable prices. **A. S. TURNER & SON, Ryckman's Corners, Ont.** Three miles south of Hamilton. Visitors welcome. Trains met by appointment.

## Choice Ayrshires

10 choice cows and heifers for quick sale. Good teats, heavy producers, high testers. Prices low considering quality. **WILLIAM T. CRN, Trout Run Stock Farm, Lynedoch, Ont.** Phone in house.

Ayrshires of production, type and quality. I can supply Ayrshires that will please the most exacting critic. Young bulls or females of any age, the kind that swell the bank account. **R. M. Howden, St. Louis Sta., Que. L.-D. phone**

## STONEHOUSE AYRSHIRES

Are coming to the front wherever shown. Look out for this at the leading exhibitions. Some choice young bulls for sale, as well as cows and heifers. **HECTOR GORDON, Howick, Quebec.**

Are coming to the front wherever shown. Look out for this at the leading exhibitions. Some choice young bulls for sale, as well as cows and heifers. **HECTOR GORDON, Howick, Quebec.**

## City View Ayrshires

One very choice bull, 20 months old; four 1911 bulls, all grand individuals, and from R. O. P. ancestor; could spare two or three more cows. Write or phone. **JAS. BEGG, R. R. No. 1, St. Thomas**

Record of-Performance work a specialty. Fifty head to select from. Prices right. **FRANK HARRIS, Mount Elgin, Ont.**

## Ayrshires and Yorkshires

We have still some good young bulls. Now is the time to buy for the coming season, before the best go. We have females any age, and can also supply cows of Ayrshires. Pigs of either sex on hand. **ALEX. HUME & CO., Menie, Ont.**

We have still some good young bulls. Now is the time to buy for the coming season, before the best go. We have females any age, and can also supply cows of Ayrshires. Pigs of either sex on hand. **ALEX. HUME & CO., Menie, Ont.**

BEST RESULTS OBTAINED FROM ADVOCATE ADVERTISEMENTS



QUESTIONS AND ANSWERS. Miscellaneous.

FLAXSEED.

Will you please tell, through your valuable paper, how many bushels of flaxseed you would advise to sow to an acre?

R. J. W.

Ans.—Sow from 20 lbs. to half a bushel per acre.

GOVERNMENT STOCK CARS.

Could you tell me, through your paper, whether the Government is sending any cars of pure-bred stock to the Northwest, or where to apply to find out?

F. W. C.

Ans.—Correspond with A. P. Westervelt, Director Live-stock Branch, Department of Agriculture, Toronto.

INDIGESTION IN HORSE.

What is best to do for a horse, twelve years old, subject to indigestion, especially when I change his feed, and is there anything that can be fed to him to prevent him taking it?

A SUBSCRIBER.

Ans.—Be careful that he gets no sudden change of food. Make all changes gradually. Giving two drams each of gentian and ginger twice daily in damp food, might be beneficial in warding off attacks. Another cause is bad teeth. Have the animal's mouth examined and teeth dressed. A purgative might also be given of 6 to 8 drams aloes, previous to giving the gentian and ginger.

PERCHERON REGISTRATION.

I wish to ask a question in regard to the rules of the Canadian and American Percheron Studbooks. How many crosses from imported sires will entitle an entry, or will any number permit of registration?

"The Farmer's Advocate" is a welcome visitor, and we always look for it. We have been a constant reader for thirty-five years, and it is too old a friend to give up while we have a farm.

W. F. J.

Ans.—Neither the rules of the Percheron Society of America or the Canadian Percheron Horse-breeders' Association allow the registration of graded-up animals, no matter how many crosses they may have. Mares or stallions, to be eligible, must be by registered sires, and out of registered dams, in the case of both associations. Formerly, mares were eligible for registration if they had four crosses. The rule was discontinued a couple of years ago.

SOY BEANS.

- 1. Would Soy beans be a paying crop to sow to cut for hay?
2. Would they do well in Simcoe County, on a rich, heavy clay, plowed in spring?
3. When should they be sown, and in what stage of growth should they be cut for hay, or could they be cut and fed to cows during summer?
4. How much feed should they give per acre?
5. What feeding value have they?
6. How much seed should be sown per acre?
7. How would Soy beans compare with Early Amber sugar-cane for feed?

H. A. L.

Ans.—Most varieties of Soy beans require a long season to mature, and are not suited for growing in Ontario. The varieties recommended are Early Yellow and Medium Green. The crop furnishes very rich feed for stock, but we would not advise sowing them for hay. They should grow on the kind of soil indicated. They could be cut and fed as green feed, making a nitrogenous fodder. The time to cut for this purpose is from the time they commence to flower until the time they are ready to cut for hay, which is just after the seeds have formed in the pods. In a favorable climate, and on good soil, Soy beans yield about ten tons of green feed per acre, and of a feeding value said to equal if not rather better than alfalfa. About one-half bushel of seed is required per acre, sowing in rows from two to three feet apart, and cultivating as ordinary beans. Compare with Early Amber sugar-cane, we would prefer the latter in your district. We would not advise sowing the Soy beans. Better try other crops for your annual hay crop.

Buy Drummond's Dairy Supplies By Mail—Satisfaction Guaranteed

Wherever you are, whatever your need, you can buy from DRUMMOND and be sure that what you get will be entirely satisfactory. Dairy farmers, milk dealers, creamerymen, cheese makers, buy their apparatus and equipment of all kinds, from a milk pail to a refrigerating or pasteurizing plant from DRUMMOND. Any of the following articles promptly shipped on receipt of price.



Decimal Automatic Scale Sterilac Milk Pail

is made especially for weighing milk in the pail. There is a loose indicator on the dial that can be set back by a thumb-screw when the pail is on the hook. Then when the pail of milk is placed on the hook this indicator gives the exact net weight of the milk. It has another indicator that records the same as any spring balance, so it can be used for weighing anything up to 30 pounds—larger sizes weighing 60 and 120 pounds.

\$ 350

The Facile Jr. Babcock Tester

Used by all the Gov't Testing Stations. This 4-bottle Tester is the same as carried by all the Canadian Gov't Testers, who travel all over the country on their official trips. It is extremely simple in construction and operation. The working parts consist of but two cut gears and they are enclosed in a cast iron case to keep them free from dirt and to prevent their catching clothing, towels, etc. It turns easily without vibration or jar. It is sent complete with glass-ware, bottle brush, acid and full directions for use. It will pay you to have this scale and tester whether you milk 3 or 30 cows.

4-bottle Tester - - \$5.50
2-bottle Tester - - \$4.25

Drummond's Guarantee Prevents Disappointment

We guarantee all our goods to be and do as we say. If you have trouble in getting results or if there is any defect in what you buy, let us know and we will adjust it satisfactorily.

The Dairy Car on the Ontario Government Demonstration Train was Equipped Entirely with "Drummond Supplies."

MILK STRAINER DIRT SHELF

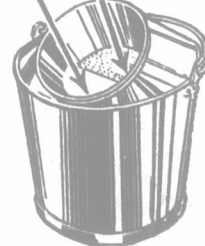

Note its clever construction. The funnel is detachable. As the milk falls on the slant towards the milk, it passes direct through the strainer into the pail. All dirt falls on a deep shelf inside the funnel—not on the strainer—thus milk and dirt never come in contact. You can use ordinary cheese cloth for straining. Capacity 14 quarts, no joints on the inside; it is easily cleaned. Price \$2.50. Used by all up-to-date farmers and dairymen.

Other Things Every Dairyman Needs

- Straight Spring Scales, 25 lbs. by 1/2 lbs. - - - 38c.
50 lbs. by 1 lbs. - - - 59c.
40 lbs. by 1 lbs. - - - 75c.
Roto Salt Cakes and Feeders - - - 50c.

Cattle Instruments, Trocars, Milk Fever Outfits, Garget Cure, Hard Milker Outfit, Horse and Cattle Syringes, Etc. Bestov Coolers and Aerators Everything for the Dairy

Write Now for FREE Catalogue

full of suggestions for making dairy work easier and more profitable. Sent FREE on request. Address

W. A. DRUMMOND & CO.

217 King Street E. Toronto

LAKEVIEW HOLSTEINS!

Bull calves sired by Dutchland Colantha Sir Mona, and out of heifers sired by Count Hengerveld Fayne De Kol.

Telephone. E. F. OSLER, BRONTE, ONTARIO

Fairview Farms Herd

is where you can secure a son of Pontiac Korndyke, admitted by all breeders to be the greatest Holstein sire that ever lived. Look what his daughters are doing. Two of them with records over 37 lbs. each. Then, look at the work his sons are doing. HE IS THE GREATEST PRODUCING SIRE OF THE BREED, THROUGH HIS SONS. Every son of Pontiac Korndyke that has daughters old enough to milk is a sire of good ones. We can offer you several young ones that will give you great daughters.

E. H. DOLLAR, HUEVELTON, N. Y.

SUMMER HILL HOLSTEIN CATTLE and YORKSHIRE HOGS

Our senior herd bull, Sir Admiral Ormsby, is the sire of the world's record 2-year-old for yearly butter production. Also sire of the three highest record four-year-olds in Canada. The dam of our junior herd bull made 34 60 lbs. butter in 7 days, and gave 111 lbs. milk per day. Come and make your selections from over 70 head.

Buy Summer Hill Yorkshires, the big, quick-maturing kind, and double your profits.

D. C. FLATT & SON, R. F. D. No. 2 Hamilton, Ontario, Bell phone: 2471, Hamilton.

Centre and Hillview Holsteins—We are offering young bulls from Sir Ladie Cornucopia Clothilde, the average of his dam sire dam and grand dams is 662 8 lbs. milk and 30.58 butter, 7 days, and 2,750.80 milk and 114.5 butter in 30 days; also Brookbank Butter Baron, who is a proven sire. He is sire of champion 3-year-old 30-day, 2-year-old 7-day and 2-year-old 30-day. Long-distance phone. P. D. EDE Oxford Centre P.O. Woodstock Sta.

Evergreen Stock Farm—High class Registered Holsteins for Sale. A splendid lot of heifers, rising one year old, and heifer calves, good enough for foundation stock. Come and see them, or write for what you want. Satisfaction guaranteed.

A. E. HULET, Norwich, Ontario

Maple Hill Holstein-Friesians—Special offering: Bulls from one to fifteen months old. The growthy kind that will give good service. One from a son of Evergreen March, and all from Record of Merit dams. Write for particulars.

Bell Telephone. G. W. CLEMONS, St. George, Ont.

IMPERIAL HOLSTEINS I can supply bulls ready for service and younger ones, also heifers out of R. O. M. cows, female relatives have records averaging 27.19 pounds. W. H. SIMMONS, New Durham P.O., Oxford Co.

Woodbine Holsteins—Herd headed by King Segis Pontiac Lad, whose sire's dam is the champion cow of the world. Sire's sire is the only bull that has sired five four-year-olds that average 30 lbs. each. Dam's sire is the bull that has sired two 30-lb. three-year-olds. His two great grand sires are the only bulls in the world that have sired two 37-lb. cows. Bulls and bull calves for sale. A. KENNEDY, Ayr, Ontario.

Elmwood Holsteins—Chicely bred, registered Cows, Heifers, Calves, Spring Crop 1912. March, April and May delivery; Sired by Imported Y Rema Sir Poch and Elmwood Sarcastic, Grandson of Sarcastic Lad. Best breeding, right prices. Express pre. aid. Safe delivery guaranteed. E. D. GEORGE & SONS, Putman, Ont.

Ridgedale Farm Holsteins—We have four high-testing dams; sired by Imperial Pauline De Kol, whose 15 nearest dams average 26.20 lbs. butter in 7 days. Shipping stations: Port Perry, G. T. R., and Myrtle, C. P. R., Ontario County. R. W. WALKER Utica, Ont.

PLEASE MENTION THE ADVOCATE.

HOMESTEAD HOLSTEINS

Headed by Canary Rachel Clothilde, whose dam, sire's dam and two grand-dams average over 27 lbs. butter in 7 days. Yearling bulls and bull calves, also one bull rising two for sale.

G. & F. GRIFFIN, Box 43, Burgessville, Ont.

Glenwood Stock Farm 5 HOLSTEINS fit for service, out of big milking strains, at low figure for quick sale. THOS. B. CARLAW & SON, WARKWORTH, ONT. Campbellford Sta.

Purebred Registered Holstein Cattle. The most profitable dairy breed, greatest in size, milk, butter-fat and in vitality. Send for FREE illustrated descriptive booklets. HOLSTEIN-FRIESIAN ASSO. F. L. Houghton, Sec'y, Box 127, Brattleboro, Vt.

Holsteins of Quality

Write us to-day for our proposition, telling you how any good dairyman may own a registered Holstein bull from a Record-of-Performance cow without investing a cent for him. Monro & Lawless, "Elmdale Farm," Thorold, Ont.

Welcome Stock Farm Holsteins

Out of "Netherlands Pride" (gave 55 lbs. milk as a three-year-old), by "Winnier Count Pa-ma" a nice straight, well grown, bull calf, quality all over, considerably more white than black, and nicely marked. Sh. uld be ready for light service soon. First check of \$45 takes him.

C. BOLLERT, R.R. No. 6, Tavistock, Ont. J. LEUSZLER, R.R. No. 1, Cassel, Ont.

Maple Soil Stock Farm

of High-Testing Holsteins—I have at present some bull calves, with dam and sire; dam averaging over 25 lbs. of butter in 7 days, testing better than 4 per cent.

H. C. Holtby, Belmont P. O., Ont. Belmont Stn., C. P. R., or Glanworth Stn., G. T. R.

The Maples Record of Merit

A few choice bulls ready for service, sired by King Poch De Kol; also a few young bull calves, sired by Prince Aaggie Mechthilde, whose dam was first at Toronto, 1911, and sire's dam first in dairy test at Guelph, 1908 and 1909; his three nearest dams average over 25 lbs. butter in 7 days.

WALBURN RIVERS, FONDEN'S, ONTARIO

Evergreen Stock Farm offers a choice lot of bulls ready for service, from high-testing, de p-milking Record of Merit ancestors. Also a few females for sale. Herd headed by Francy Sir Admiral; dam's record 26.71, sire Sir Admiral Ormsby. Write for prices. F. E. PETTIT Burgessville, Ont.

Holstein Bulls for sale—Springbank farm is offering two choicely bred Holstein bulls for sale at reasonable prices. For particulars write to: Wm. Barnet & Sons, Living Springs P. O., Ont. Fergus station, C. P. R. and G. T. R.

Maple Line Holsteins and Yorkshires—Herd headed by Homestead Colantha Sir Abbecker 2nd, whose dam, sire's dam, g. dam, average 39 61 lbs. butter 7 days. For sale at bargain prices, choice bull calves from R. O. P. cows. W. A. BRYANT, Middlesex Co., Cairnform, Ont.

Maple Grove Holsteins—Herd headed by King Lyons Hengerveld, the greatest 30 lbs. back butter bred bull of the breed in this country. For stock of this kind, address: H. BOLLERT, Tavistock, R. R. No. 5, Ont.

## BACK WAS SO LAME LIFE WAS A BURDEN FOR TWO YEARS.

Mrs. Joseph Throop, Upper Point de Bute, N.B., writes:—"I cannot speak too well of Doan's Kidney Pills. For two years I was so tired life was a burden and I got up more tired than when I went to bed, and my back was so lame I could hardly straighten up. I took different kinds of medicine, but none of them did me any good until a friend advised me to try Doan's Kidney Pills. I did so, and to-day I don't know what it is to be tired, and my lame back is all gone. I can recommend them to any person suffering with lame back, and that terrible tired feeling."

Doan's Kidney Pills are a purely vegetable medicine, realizing quick, permanent relief, without any ill after effects.

Doan's Kidney Pills are 50 cents per box, or 3 boxes for \$1.25, at all dealers or mailed direct on receipt of price, by The T. Milburn Co., Limited, Toronto, Ont.

If ordering direct specify "Doan's."

**UNWASHED  
WOOL  
WANTED**  
The Horn Bros. Woollen Co., Limited  
Lindsay, Ontario

### Southdown Sheep

Orders taken now for this season's delivery. A few choice lambs and shearlings on hand. Every animal shipped is guaranteed.

### Angus Cattle

Write, or come and see my young bulls and heifers. They are going at farmers' prices.

ROBT. McEWEN, Byron, Ont.

### Hilton Stock Farm

Present offering: 6 yearling heifers and several younger ones. All very choice. Of Tamworths, pigs of all ages and both sexes; pairs not akin. R.O. MORROW & SON, Hilton, Ont. Brighton Tel. & Sta.

**SWINE OF ALL BREEDS FOR SALE.** Yorkshires, Tamworths, Berkshires, Hampshires, Chester Whites, Poland-Chinas, and Duroc-Jerseys. I have constantly on hand both sexes of all ages. Show stock a specialty. John Harvey, Freilighsburg, Que.

### FAIRVIEW BERKSHIRES

Ontario's banner herd. Prizewinners galore. For sale are: Young sows bred and others ready to breed, and younger ones. A number of young boars coming on. JOHN S. COWAN, Donegal, Ont.

### CRUSHED.

Mr. W. S. Gilbert was once at the house of a wealthy but ignorant and pretentious woman. She asked Mr. Gilbert several questions about musical composers, to show that she knew all about them.

"And what about Bach?" she asked. "Is he composing nowadays?"

"No, ma'am," answered Gilbert; "he is decomposing!"

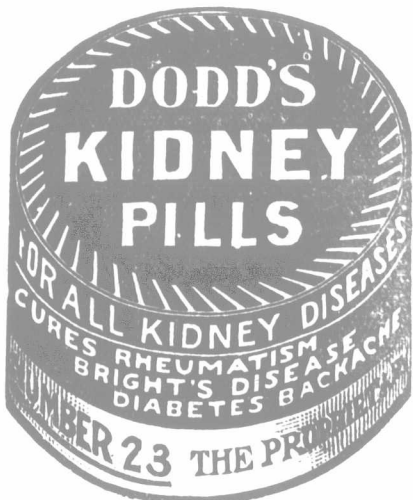

### QUESTIONS AND ANSWERS. Miscellaneous.

#### ITCHY LEGS.

I have seen in "The Farmer's Advocate" recipes for horses with scratches, or itchy legs. I have a mare in foal. She has stamped her hind feet a good deal this winter, and would rub one leg with the other. I have watched her frequently to see if there were any cracks to be seen, but I could not see any till lately. I have treated them with sulphate of zinc, acetate of lead, and carbolic acid, which seems to dry them, but it does not stop them. As she is a registered mare and in foal, I do not know whether it would be wise to give her a purgative of aloes and Fowler's Solution of Arsenic or not, for fear of injuring the foetus. The mare is in fair condition. She was worked hard last fall, and fed well, but this winter she has been fed on cut straw, oat and wheat straw (bran, shorts, and oatmeal, about one-third of each). Looks well, and is feeling well. Has a fair amount of exercise. Would you tell me what to do as I don't want to have her legs go bad?

W. J. D.

Ans.—1. Many beefy, hairy-legged horses are predisposed to this trouble. Swelling and itchiness of the legs is also often much more noticeable in in-foal mares. As she is in foal, do not give her any internal medicine. Do not purge. Depend upon local treatment. Where itchiness is not accompanied by raw places or cracks, it can usually be checked and prevented by applying once or twice daily a solution of one teaspoonful of Gillett's Lye in a quart of warm water, but where rawness or cracks exist, this dressing is too irritant. Dress once daily with a solution of 15 grains of corrosive sublimate in a pint of warm water. The hair must be carefully parted, and the lotion rubbed on the skin. Rub well after dressing, and do not apply ointments, oils, or anything of a greasy nature.

#### MISCELLANEOUS QUERIES.

1. What is the best way to introduce debating clubs in a locality?
2. Can a school teacher be compelled to stay in charge of her or his school during noon hour?
3. How can I top-graft apple trees?
4. Has water paint proved to be of any use to farm buildings?
5. Is there any cheap oil paint that can be applied with force-pump on old buildings?
6. How does the average township handle the difficulty of highways blocking with snow?
7. What can be done with a heifer when her udder gets very hard, and appears to be very sore? This is before she freshens.
8. Is there any way to grow balsam trees from seed, instead of looking for them in the woods?
9. What is the proper way to take slips off black currant bushes?

J. S. K.

Ans.—1 Do as much missionary work in connection with the subject as you can. Then call a meeting and organize the work. It can be profitably carried on in connection with farmer's clubs, literary societies, and young people's organizations.

2. We think not. They must have time for lunch.

3. Do not graft limbs larger than 2½ inches in diameter. Do the work late in March or early in April. Use scions from last year's wood. See article in "The Farmer's Advocate," issue of April 11th, 1912.

4 and 5. It seldom proves profitable to apply a poor paint. Some mix up paint and apply it with a spray pump.

6. Some clear it away by statute labor; others hire men by the hour. Wire fence bonising is becoming common.

7. Massage it, and rub well with hot water and vinegar and grease well with vasoline. After the washings, milk and rub the udder well three times a day. Bathe and massage.

8. Get the seed and plant it in as good a soil and in as good a position as possible. Get them from last year's wood which has grown well.

# Ruptured People— Try this for Relief and Cure

No Loss of Time from Work—You Keep on Earning Money—No Belt, Elastic, Springs, or Leg-Straps to Wear—Sent on 60 Days Trial to Prove It

#### Curing Begins At Once

This massage is so beneficial—so curative—that 100 people out of every 200 begin to get better and stronger almost the minute a Cluthe Truss is put on—so beneficial that among the thousands of people completely cured by this truss are some of the worst cases of rupture on record.

#### Free Book Tells All About It

So that you can judge for yourself, we want to send you—free—our cloth-bound book of advice—it is full of facts for the ruptured never before put in print—facts we have learned during forty years of day-after-day experience.

It explains the dangers of operation. Explains why wearing ordinary trusses is simply slow suicide. Tells why drug-trusses should no more be allowed to sell trusses than a schoolboy would be allowed to perform an operation. Also exposes the fake "methods," "appliances," "plaster pads," fake "free cures," etc.

And it tells all about the Cluthe Massaging Truss—how little it costs—how it ends all expense—how it is waterproof and can be worn in the bath how it has no belt, elastic bands, springs or leg-straps—no "harness" of any kind. And it tells how you can get a Cluthe Truss on 60 days trial without risking a penny.

Book also tells—in their own words—the experiences of many who have tried this truss—gives the names and addresses of over 4,000—probably some of them right in your neighborhood.

Simply say in a letter or postal "Send me the book." Address us giving our box number—

**Box 109, CLUTHE COMPANY**

125 East 23rd Street, New York City

Don't fail to get this book—the minute it takes to write us may free you from misery and suffering for the rest of your life.

You can try this—the greatest boon to the ruptured world has ever known—without having to risk a single cent of your money. It's a way to get well while working. If you don't find yourself getting better right from the first, then it won't cost you a penny.

#### Trusses Like These Are a Crime

You Don't Risk a Penny

This is far more than a truss—far more than merely a device for holding your rupture in place.

We are so sure it will work wonders for you just as it has for thousands of others that we want to make a Cluthe Truss or Cluthe Automatic Massager especially for your case and send it to you to test—



And won't cost you a cent if it doesn't result in improvement—if it doesn't keep your rupture from coming out—when you are working, exercising, etc., all day long.

Don't judge this by other trusses. This is the only truss guaranteed to hold. And in addition to that the Cluthe Truss provides the only way ever discovered for overcoming the weakness which is the real cause of rupture.

While taking all strain off the rupture, this truss is constantly strengthening the weak ruptured parts—

Does that by automatically massaging them—this soothing, heating massage does for these parts exactly what exercise does for weak arms—soon restores their lost strength—soon makes them so strong that a truss is no longer needed.

## WE WILL IMPORT OXFORDS

the coming season, or any other breed. Breeders wishing to get a few head of their favorite breed should write at once to us. One of the firm selects in person, and will select yours if you write us stating just what you want. We are in the market for Oxford rams, and will buy from one up to any number. State price, age and it recorded or eligible.

PETER ARKELL & SONS, TEESWATER, ONT.

## Imported Sheep

I am leaving for England about the middle of April to personally select my sheep. Anyone wanting imported sheep will do well to write me. Will import any breed. On account of my connections in England, I can import cheaper than any other importer. Write me at once for all information.

C. HODGSON,

Box 92, Brantford, Ont.



### Woodburn Berkshires

We are offering for sale 100 head of young Berkshires of both sexes and any size required. We can supply pairs or trios not akin; our Berks are noted for strength of bone, length, depth and quality, conforming to bacon type. Snow and breeding stock a specialty.

E. BRIEN & SON Ridgetown, Ont.

### Pine Grove Yorkshires

Bred from prizewinning stock of England and Canada. Have a choice lot of young pigs of both sexes, pairs not akin, to offer at reasonable prices. Guaranteed satisfaction.

Joseph Featherston & Son, Streetsville, Ont.

### SUNNYSIDE CHESTER WHITE HOGS

I am now offering some very choice young things of both sexes, of breeding age. A few Shropshire sheep of both sexes. Also Mammoth Bronze turkeys. W. E. WRIGHT, Gleanworth P.O., Ont.

### Chester White Pigs

O. I. C. Thoroughbred stock for sale. Apply to:

GLEN ATHOL FRUIT RANCH

DAVID SMITH Mgr. St. Catharines, Ont.



### ELMHURST LARGE ENGLISH BERKSHIRES

Present offering: Select sows bred for spring farrow. Choice boars ready for service. Also younger stock, the get of Duke of Somerset imp., and out of imported dams. Satisfaction and safe delivery guaranteed. H. M. VANDERLIP, Breeder and Importer, CA NSVILLE P.O., Langford station, Brantford and Hamilton Radial.

### Newcastle Tamworths and Clydesdales

Present offering: 15 boars, from 2 mos. to 1 year. Sows same age, some bred, others ready to breed several yearling sows that have raised one litter each. All by imp. bar, dam by Colwill's Choice, Canada's champion boar, 1901, 2, 3 and 15. Also one or two choice Clydesdale hies for sale. L. D. Phone. A. A. COLWILL, NEWCASTLE, ONTARIO

When writing please mention The Advocate

### Duroc Jersey Swine

A choice lot of boars fit for service. WANTED—Twenty dairy calves, seven to twenty days old, grade or pure bred; state price F.O.B.

Mac Campbell & Sons, Northwood, Ont.

Maple Villa Yorkshires and Oxford Downs. We offer 30 splendid service boars; 50 strictly choice sows, bred and ready to breed; also ewes of quality bred to imp. rams.

J. A. CERSWELL, Bond Head, Ont.

### Hampshire Hogs

We have the greatest prize-winning herd of Hampshire Swine in Canada, bred from the best strains of the breed; stock of both sexes not related. Hastings Bros., Cross Hill P.O., Linwood Sta., C.P.R., Newton Sta., G.T.R. Telephone in residence.

### Morrison Tamworths

Bred from the prize winning herds of England; choice stock for sale; also Shorthorns of the deep milking strain. CHAS. CURRIE, Morrison, Ontario



### Hampshire Pigs

Get acquainted with the best bacon hog in existence. Both sexes for sale from imported stock. Write for prices. Long-distance phone. J. H. RUTHERFORD, Box 62, Caledon East, Ont.



**Know the make-up of roofing you buy**

On the make-up depends how long it will last, and how little it costs you in the end.

**Genasco**  
THE TRINIDAD-LAKE-ASPHALT  
**Ready Roofing**

is made of *genuine* asphalt, produced by Nature in Nature's slow sure way. It has the lasting life that gives it greatest resistance to weather.

Genasco costs about the same as ordinary roofings in the beginning, and costs less in the end, because it lasts so long.

Comes in rolls with either mineral or smooth surface. Ready and easy to lay. Ask your dealer for Genasco. Write us for the valuable Good Roof Guide Book and samples—free.



**The Kant-leak Kleet**, for smooth-surface roofings, does away with cement and prevents nail-leaks.

**The Barber Asphalt Paving Company**

Largest producers of asphalt, and largest manufacturers of ready roofing in the world.  
**Philadelphia**  
New York San Francisco Chicago

**Canadian Distributors:**  
Caverhill Learmont & Company  
Montreal, Quebec and  
Winnipeg, Man.  
D. H. Howden & Co., Ltd.  
200 York St., London, Ont.



**DO YOU KNOW**

THAT WORN-OUT LANDS MAY BE MADE PRODUCTIVE AND PROFITABLE BY THE JUDICIOUS USE OF THE RIGHT KIND OF FERTILIZER?

NOW IF YOU HAVE A PIECE OF LAND THAT WONT GROW ANYTHING BUT WEEDS, TALK WITH US ABOUT IT AND LET US SUGGEST THE RIGHT FERTILIZER

WE FEEL VERY SURE THAT WE CAN SHOW YOU HOW TO USE FERTILIZERS WITHOUT GREAT EXPENSE SO YOUR LAND WILL PAY

CONSULT US FREELY IT IS OUR BUSINESS TO KNOW ENQUIRIES FREELY ANSWERED AGENTS WANTED FOR TERRITORY NOT TAKEN UP

**W. A. FREEMAN CO. LIMITED**  
HAMILTON ONTARIO

Writing Mention This Paper.

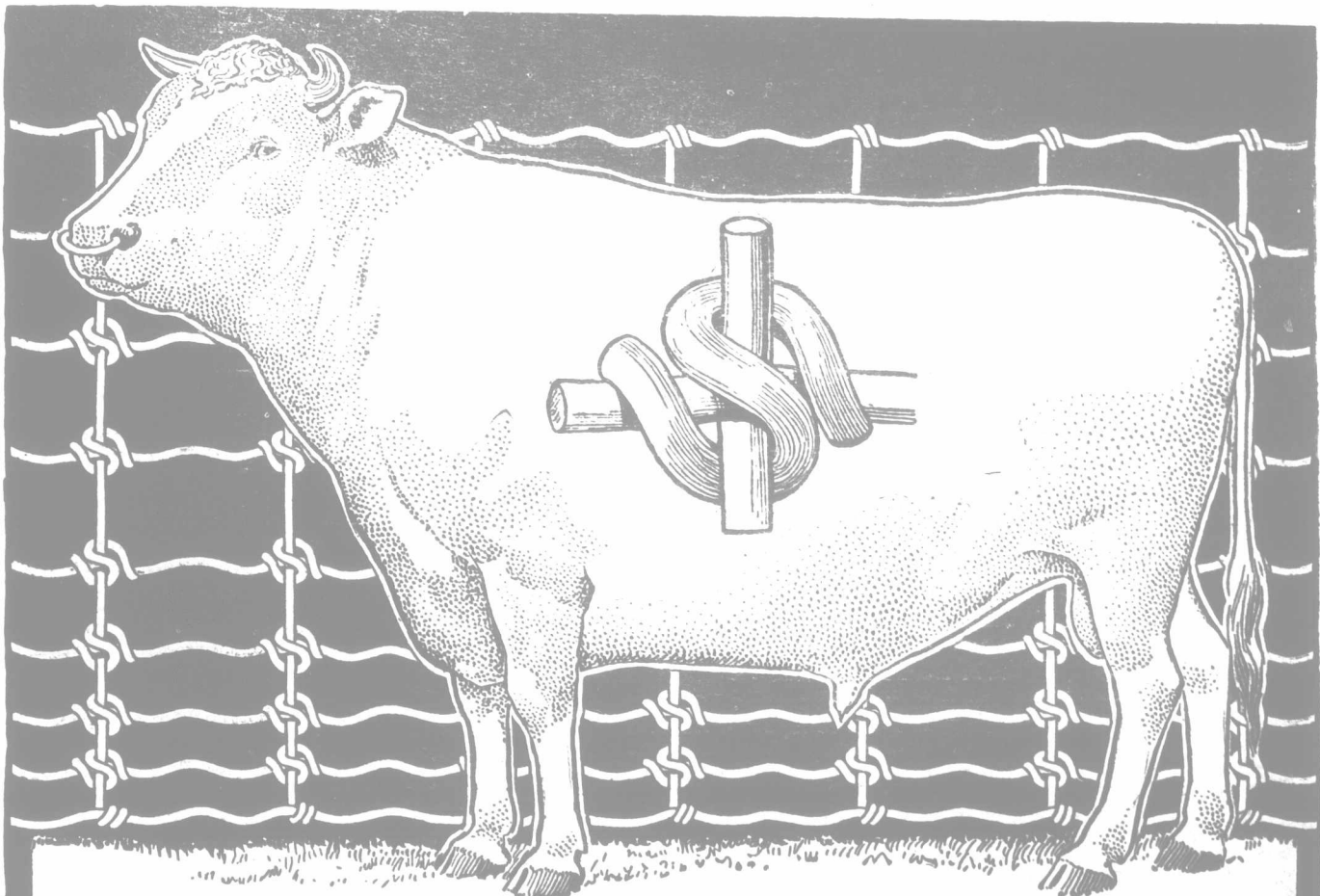

**Is Anything On Your Farm Stronger Than A Bull ?**

**YES!** If your fences are "IDEAL" Woven Wire, made of large gauge No. 9 HARD STEEL wire, heavily galvanized and with the verticals and horizontals clamped together with the Ideal Lock—that CANNOT SLIP. Bull-strong; hog-tight; horse high—a REAL fence.

**NO!** If you have wire fences of the ordinary kind—fairly good for a few years, but with no reserve strength to stand hard usage—because poorer wire makes them, and stretching them taut takes the utmost of their little strength to start with.

**All Large Gauge Number 9 Hard Steel Galvanized Wire**

From top to bottom Ideal Fence is all the same—large gauge No. 9 hard steel wire, heavily galvanized and therefore rust-proof. Note lock and its uniform smooth curve—no sharp turns to weaken the strength of the lock and yet a most positive grip—in FIVE different places. This is the fence that has ample springiness, immense strength, and the ONE LOCK THAT'S GOOD. Drop us a card and get our catalog telling all about the many styles and merits of IDEAL FENCE. Sample lock comes with it. Write us today.

**McGREGOR BANWELL FENCE COMPANY, LIMITED, WALKERVILLE, ONTARIO**

**ATTENTION, FARMERS!**

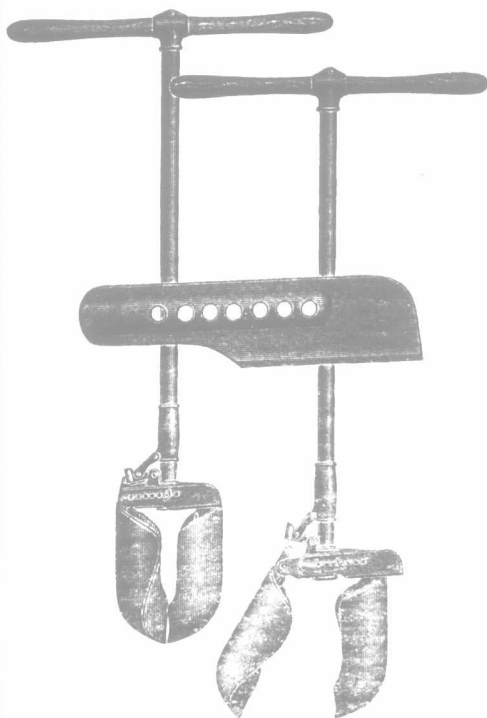

**Twelve Reasons Why Standard Earth Augers Are Best**

The STANDARD is the ONLY Auger

- That really bores.
- That will enter hard earth.
- That has an EXTENSION blade.
- That will hold fine dry sand.
- That does not bind in the hole.
- That opens to discharge the contents.
- That bores in all conditions of earth.
- That has double "V" point cutting blades.
- That is guaranteed to save half the time.
- That individually bores more than ONE sized hole.
- That individually bores NINE different sized holes.
- That is guaranteed to do the work with half the effort.

If your hardware or implement man cannot supply you, order direct from  
**Canadian Logging Tool Company, Limited**  
Sault Ste. Marie, Canada

**POLES OF STERLING QUALITY**

Michigan White Cedar Telephone Poles  
**W. C. STERLING & SON COMPANY**  
Older Cedar Pole Firm in Business  
Producers for 32 Years  
MONROE, MICHIGAN 1912

**GRAND TRUNK RAILWAY SYSTEM**

**Homesekers' and Settlers' EXCURSION**

**Western Canada**

Via Chicago  
**APRIL 16th, 23rd and 30th**  
and every Second Tuesday thereafter until Sept. 17th, inclusive.

SPECIAL TRAIN WILL LEAVE TORONTO AT 10.30 P. M. ON ABOVE DATES FOR EDMONTON AND POINTS IN MANITOBA AND SASKATCHEWAN, via Chicago and St. Paul, carrying through coaches and Pullman Tourist Sleepers. NO CHANGE OF CARS.

Full particulars from any Grand Trunk Agent, or C. R. McCutcheon, Alberta Government Agent, Palmer House Block, Toronto, Ont.

The most popular route to MONTREAL, BUFFALO, NEW YORK, PHILADELPHIA, DETROIT, CHICAGO is via Grand Trunk, the only Double Track Route.

**Steamship Tickets on Sale via All Lines.**  
For Tickets and all information apply to any Grand Trunk Agent.

**A COW PEA THRESHER**

Threshes Canada Field Peas, Cow Peas and Soy Beans from the mown vines, breaking less than 2 per cent. Also threshes wheat and oats. "The machine I have been looking for 20 years." Prof. W. E. Massey. "A machine that will meet every demand." Prof. H. A. Morgan, Tenn. Experiment Station. Nothing like it. Booklet "T" FREE.

**KOGER PEA & BEAN THRESHER CO.**  
Morristown, Tenn.

PLEASE MENTION THE ADVOCATE.

# FREE ROGERS CEMENT BOOK

**HOW TO MAKE FARM FIXTURES RIGHT, AND AT LOWEST COST. READ OUR OFFER**

**F**ARMERS who get this wonderful book on Portland Cement need spend only \$1 in cash for a better improvement than \$5 now buys in wood. The book illustrates and explains the easiest ways to build farm improvements in concrete---strong, clean improvements that cannot burn, decay or easily break. This book secures you big money savings, and is the first farm book on concrete with special designs for the Canadian climate.

■ A farmer with this book can easily make everything he needs in spare time, including big tanks, silos, etc.

■ Besides, the book shows him how to handle Portland Cement to the best advantage. This knowledge is worth hundreds of dollars to any farmer. Despite its value, this book may be had by any progressive farmer free of charge. Act on our offer promptly.

## If You Have This Book You Can Both Save Money and Make Money

**T**HE improvements shown in Rogers Book are fire-proof, weather-proof and frost-proof, and they don't need repairs, because the designs in it are planned for Canada. As we said, improvements shown in it cost about one-fifth that of wood. Concrete costs little, and work is laid out in the book for spare time. Besides this saving in first cost, on anything built from the book, there is a steady after-saving of labor and repairs. This makes a big sum, especially when you know that Rogers Book improvements are so well designed that they are still as good as new after you have used them twenty years. All work shown will stand the hardest frosts, besides being done in the easiest, simplest way possible. Canadian farmers should all have this Rogers Cement Book, while our offer is open.

## How You Get This Book from Us

Regular Price  
\$1.00

**Free of Charge**

Regular Price  
\$1.00

**E**VERY applicant is asked to send us \$1.00, which is the regular price of this book. But we send with the volume an order on the nearest Rogers dealer for \$1.00 worth of Rogers Portland Cement. Thus, you get the book free of charge, while the Portland Cement itself makes an improvement worth \$5 on your farm. With the easy directions in the book, your free cement will make you your choice of these:

- 6 10-ft. fence posts (non-rotting)
- 6 clothes poles (strong, clean)
- 1 partition, 80 sq. ft. (fire-proof)
- 3 chimney caps (fire protection)
- 1 hog trough (sanitary, everlasting)
- 4 door sills (wear-proof, clean)
- 1 flight of steps (permanent door entrance)
- 2 hitching posts (ornamental, unbreakable)
- 1 horse block (with your name on)
- 12 hen nests (clean, vermin-proof)
- 1 pantry floor (clean)

When you get the book without charge this way, and add a valuable improvement worth several dollars on your farm, we feel you cannot spend \$1.00 more wisely. The offer brings you knowledge worth hundreds of dollars in your farm work as well. Send \$1.00 for the book and the free order for cement. Act now.

## How We Made This Book a Farm Help

**T**HERE had never been a farm book on Portland Cement specially prepared for Canada, until we got out this volume at great expense. We made it up with 170 special drawings, and very plain easy reading matter, given in full. This matter foresaw all the probable mistakes a beginner would make and guarded against them. That makes this book a perfect guide for every farmer who gets it, as he cannot make a mistake, if he has never used Portland Cement before. Concrete work is made as easy as building in wood—in fact, in many cases, a great deal easier.

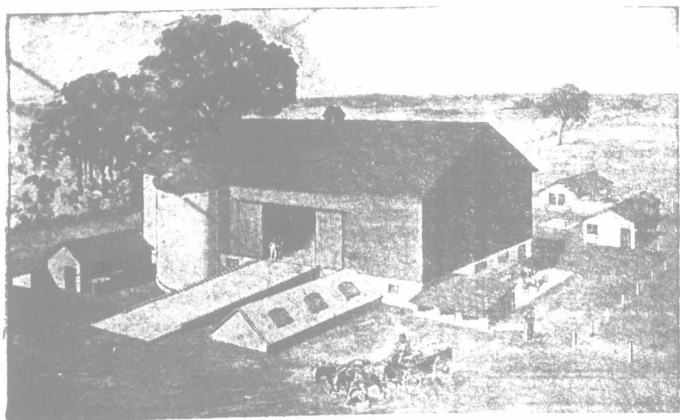

Get the Rogers Book to Show you How to Outfit your Farm with these Everlasting Cement Improvements at Low Cost.

We put in about 80 improvements the Canadian farmer uses most. These were designed to take simple molds, and make the work very easy. We avoided special tools—all you need is just ordinary farm shovels, buckets, etc. You do perfect work, with little trouble and at low cost, for everything Rogers Book shows.

You have never even seen just this kind of a farm book before, because it shows things for Canada, and shows how to make them in an easy, simple, plain way. We know concrete work is now easy and understandable for any farmer. The book is well worth having, because of the valuable knowledge in it. Send for it at once.

**ALFRED ROGERS Limited** 28F WEST KING ST. **TORONTO**