

J. P. F.

with the best wishes of
the author

July 15-

A TEXT - BOOK
OF
RADIOLOGY

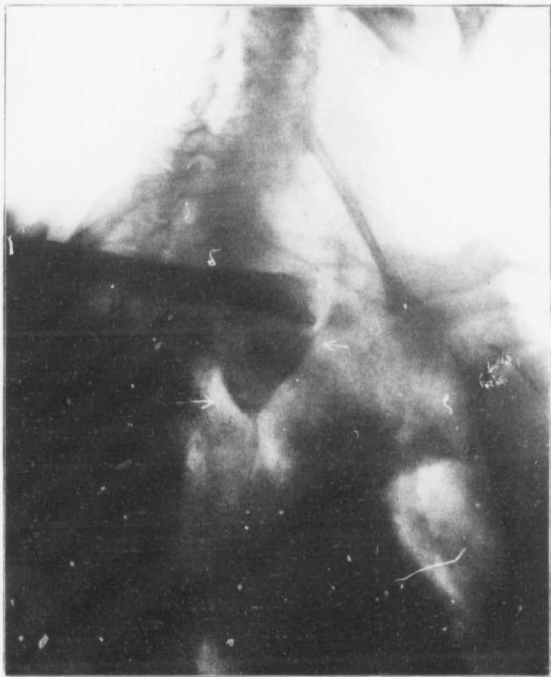

STRICTURE OF THE ESOPHAGUS.

The opaque food is arrested at the level of the top of the arch of the aorta, forming a triangular shadow from the apex downwards. From the lowest point the food trickles through the stricture in a stream so narrow that its shadow had to be slightly accentuated on the original plate so as to remain visible in this reproduction. Note how the esophagus is dilated above the stricture, from repeated efforts to force the food through the obstruction.

A TEXT - BOOK
OF
RADIOLOGY

BY

EDWARD REGINALD MORTON 1867-

M.D., C.M. (TRIN. TOR.), F.R.C.S.ED., ETC.

PAST PRESIDENT, SECTION OF ELECTROTHERAPEUTICS, ROYAL SOCIETY OF MEDICINE
IN CHARGE OF THE X-RAY DEPARTMENT, WEST LONDON HOSPITAL, ETC.

WITH 26 PLATES AND 72 ILLUSTRATIONS.

LONDON
HENRY KIMPTON
263 HIGH HOLBORN, W.C.
AND 40 AND 42 UNIVERSITY AVENUE, GLASGOW
1915

Copyright.
All rights reserved.

PREFACE.

This volume does not aim at being in any way comprehensive, but rather to form a useful guide to those taking up Radiology for the first time; to help them to understand the various appliances and the methods of using them, and to take them along the first steps in the application of the X-rays to the investigation and treatment of disease.

A considerable amount of space has been devoted to the study of the X-ray tube, even to the risk of tedious repetition at times. Though modern tubes are a great improvement on the best to be had only a few years ago, this knowledge is just as important as ever it was if the best results are to be secured, and only by working with X-ray tubes for many weeks, or perhaps months, can that confidence be secured that does so much to make satisfactory results the rule rather than the exception.

In the chapters dealing with the thorax, the digestive, and the urinary systems, only such conditions as are most commonly met with are referred to, and even these but briefly, but it should be enough to prepare the student to approach larger works with a proper appreciation of what is before him.

The volume concludes with a chapter on X-ray therapeutics. This has been prepared with great care but nevertheless is put forward with not a little diffidence, even anxiety. The practice of X-ray therapeutics is not without risk, both to the patient and to the radiologist, but if the rules and methods here given are carefully followed, the results ought to be both safe and satisfactory.

The author wishes to thank his colleagues, especially the staff of the West London Hospital, for the use of the cases from which the radiographs illustrating the volume were prepared; also all those instrument makers who have so kindly lent blocks showing many of the appliances referred to in the text. The drawings and the radiographs are all original. In selecting the latter an effort has been made to keep as far as possible to ordinary cases, at the same time the temptation to illustrate exceptional or extreme cases is a very strong one, and not always to be resisted. The author's most sincere thanks are due to Dr. A. I. Simey, of Rugby School, for kindly undertaking to read the proof sheets and for many valuable suggestions.

TABLE OF CONTENTS.

| | PAGE. |
|---|-------|
| CHAPTER I.—ELECTRICAL PRINCIPLES. | |
| Electricity—Analogy to water—Batteries as Electrical Pumps—Pressure or Voltage—Resistance—Conductors of Electricity—Series Resistance—Ohm's Law—Shunt Resistance—Electromagnetic Induction—Self-Induction—Solenoid—Transformer—Capacity—Condensers—Alternating Currents—Dynamoes and Motors. | 1-21 |
| CHAPTER II.—THE ORIGIN AND PROPERTIES OF THE X-RAYS. | |
| Historical notes—Sir W. Crooke's—Lenard—Roentgen—Electric discharge in vacuo—Electrons—Cathode Rays—The X-Rays—Crooke's Tube—Jackson's Tube—Properties of the X-Rays. | 22-30 |
| CHAPTER III.—THE X-RAY FOCUS TUBE. | |
| The X-ray tube, the most important part of the X-Ray outfit. Jackson's Tube—Subsequent development—Present design—Method of working—Effect of reverse current—"Hard" and "Soft" Tubes—Parallel Spark-Gap as a measure of resistance of tube—Changes in tubes after continued use—Alterations in vacuum—Regulation of vacuum—Cooling arrangements—Water-cooled Anodes—Heavy Anode Tubes—Precautions in using—Changes in the glass walls. ... | 31-48 |
| CHAPTER IV.—TYPES OF X-RAY TUBES. | |
| The Chabaud Tube—Other Light Anode Tubes—Heavy Anode Tubes—Tungsten Anode Tubes—Choice of tube for special work—The Coolidge Tube. | 49-55 |
| CHAPTER V.—THE SECONDARY CIRCUIT. | |
| Milliampère meter—Its value and uses—Inverse current—Methods of suppressing Inverse current—Spark-gaps—Valve tubes—Plan of the Secondary Circuit. | 56-61 |
| CHAPTER VI.—THE ELECTRICAL SUPPLY. | |
| Static Machines—High Tension Rectifiers—The Induction Coil—Details of Induction Coils—Portable Coils—Coil Outfits for Consulting room or Hospital use—Current for working Coils—Current from the Main—Alternating Currents—Chemical Rectifiers. | 62-72 |

viii. TABLE OF CONTENTS.

CHAPTER VII.—INTERRUPTERS.

Platinum Interrupters or "Breaks"—Mercury Breaks—
Dipper and Jet Breaks—"The Morton Apparatus"—
Béclère's Break—Disadvantages of high rate of interruption
—Centrifugal Interrupters—Dielectrics for mercury breaks
—Electrolytic interrupters—Wehnelt and Caldwell types—
Advantages of each type, and as compared with mercury
breaks—Diagram of connections for the coil outfit—
Advantages of control by shunt resistance where voltage of
electrical supply exceeds 100. 73-89

CHAPTER VIII.—ACCESSORY APPARATUS.

Tube Stands—X-Ray Couches—Diaphragms—Changing box
—Penetrometer—Wehnelt's Radiometer—Precautions in
use—X-Ray protection of operator and patient. 90-100

CHAPTER IX.—RADIOSCOPY.

X-Ray proof Gloves—Fluorescent Screens—Method of
using—Choice of tube for screen examination—Advantages
of screen examination—Application to investigation of
internal diseases. 101-105

CHAPTER X.—X-RAY PHOTOGRAPHY.

Advantages and disadvantages—Choice of tube for Radio-
graphy—Management of Tube—X-Ray Photographic Plates
—Development—Exposure—Secondary Rays—Penetration
of rays for different classes of work—Intensifying Screens—
Practical details—Instantaneous Radiography. 106-120

CHAPTER XI.—EXAMINING PHOTOGRAPHS.

Viewing Box—Atlas of Normal Radiographs—Fractures and
Dislocations—Bone diseases—Arthritis—Malignant diseases
—Abscess—Localisation of Foreign Bodies—Stereoscopic
Radiography—Wheatstone's and other forms of Stereoscope
for radiographs—Simple and efficient method of localisa-
tion—Mackenzie-Davidson method. 121-134

CHAPTER XII.—REGIONAL RADIOGRAPHY.

The Head—The Face—Lower Jaw—Teeth—The Spine—
The Atlas and Axis—The Dorsal Spine—Lumbar Vertebrae
—Sacrum and Coccyx—Clavicle—Shoulder—Scapula—Arm
—Forearm—Wrist and Hand—Hip Joint—Femur—Knee—
Tibia and Fibula—Ankle.... .. 135-147

TABLE OF CONTENTS.

ix.

CHAPTER XIII.—INTERNAL DISORDERS.

Increasing importance of the X-Ray method—Care necessary to avoid error—Apparatus—Screening stand—General directions—Examination of the Thorax—Normal Thorax—Details of mediastinal shadow—Pulmonary Tuberculosis—Fibrosis—Pleurisy—Emphysema—Bronchiectasis—Heart and Aorta—Pericardial Effusion—Intra-Thoracic Aneurysm—Foreign bodies in the Thorax. 148-164

CHAPTER XIV.—THE DIGESTIVE SYSTEM.

Œsophagus—Opaque substance to show outline of digestive organs—Œsophageal obstruction—The Stomach—The Opaque Meal—Preparation of the Patient—Appearances of the normal Stomach—Atonic Stomach—Gastroptosis—Gastric Ulcer—Hour-glass Stomach—Pyloric Obstruction—Malignant disease—The Duodenum—Small and large Intestine—Duodenal Ulcer—Alimentary Stasis—Diagnostic Rules 165-183

CHAPTER XV.—THE URINARY SYSTEM.

Advantages—Preparation of Patient—Technique—Necessity for arresting normal movement of kidney—Compression Method—Precautions—Interpretation of plates—Use of Ureteric Catheters—Injection of Collargol to show pelvis of kidney, &c.—Rules for interpretation of results. 184-193

CHAPTER XVI.—X-RAY THERAPEUTICS

Difficulties attending—Principles involved—Changes induced in living tissues after application of the X-Rays—Apparatus required—X-Ray Protection—Dosage—Saboraud's Method—Precautions to be *observed—Fractional doses—Massive doses—X-Ray Filters—Effects of using Filters—The use of Secondary Rays—Method of producing Secondary rays—Choice of rays for superficial and deep lesions—Skin Diseases—Rodent Ulcer—Hypertrichosis—Malignant Disease—Leukæmia—Enlarged Prostate—Uterine Fibroids—Relief of Pain. 194-197



LIST OF RADIOGRAPHIC PLATES AND FIGURES WITH NOTES.

FRONTISPIECE.

Oesophageal Stricture. Male, age 54 years. Opaque food arrested at the level of the top of the arch of the aorta, forming a triangular shadow with apex downwards. A thin line of food can be seen passing down from the apex of the shadow. Note the dilatation of the œsophagus above the stricture. This is an instance where an X-ray examination gives evidence at once, that is positive and decisive, and without pain or discomfort to the sufferer. Other internal conditions where it is equally valuable are intra-thoracic aneurysm, hour-glass stomach, and urinary calculus.

PLATE I. *Facing page 128*

Stereoscopic radiographs of the left shoulder, showing fragments of shrapnel casing received at the Battle of the Aisne. Examined with a simple stereoscope, or by allowing the eyes to slightly diverge from the normal convergence, the two images are combined into a stereoscopic image and the true relations of the fragments to the bones are accurately shown. *See also page 129.*

PLATE II. *Facing page 160*

An approximately normal female adult thorax taken with the front of the chest next the plate while the patient held the breath in deep inspiration. The heart is thus brought nearer to the central line than usual. The streakiness near the hilum on both sides is usual in the chests of those who have spent the greater part of their lives in towns. The remarkable feature of this chest is its great vertical length, coming just within that of a 15' × 12' plate. *See pages 152 to 154.*

PLATE III. *Page 160*

A Normal Chest, Right-Anterior-Oblique Position. *See pages 155 and 156.*

- PLATE IV. Page 160
 Young male adult chest showing changes due to early pulmonary tuberculosis. No physical signs. Note the extent of the shadows springing out from the hilum, the dulness of the apices, which during the screen examination did not brighten up on deep inspiration, and the small spots in both lungs due to small tuberculosis foci. The finer and more important details cannot be reproduced in a block. *See pages 156 to 159.*
- PLATE V. Page 160
 A more advanced case of pulmonary tuberculosis. Note the coarse mottled appearance of patches of infiltration on the right side. On the left side the lung is collapsed and the heart displaced to the right. Pneumothorax in the upper left chest.
- PLATE VI. Page 160
 A large aneurysm of the arch of the aorta, taken anteroposteriorly. Very little, if any, pulsation was observed.
- PLATE VII. Page 160
 The same case taken in the right-anterior-oblique direction. Note the "clubbed" form of the greatly dilated arch of the aorta, and how the normal space in front of the vertebræ is closed. *See page 162 and compare Plates III and IX.*
- PLATE VIII. Page 160
 A half-penny in the lower pharynx of a child age $3\frac{1}{2}$ years. A fairly common event in hospital out-patient practice. The coin may have been swallowed some days previously. *See page 163.*
- PLATE IX. Facing page 176
 Œsophageal Pouch. The patient is in the R. A.-O. position and as opaque food was swallowed it first made the semi-circular shadow at the root of the neck before any passed down the œsophagus, as seen by the sinuous broken line leading from the lower edge of the pouch shadow down between the vertebræ and the aorta. This condition of œsophageal pouch is not very common but it is very important that it should be recognised when present.
- PLATE X. Page 176
 Young female adult. The lower pole of the stomach is well below the line joining the top of the iliac crests. The tone of the muscular walls is good and during the screen observation peristalsis was normally active. The condition is that of Gastroptosis. The curved indentation of the upper part of the greater curvature is most likely due to pressure from without—new growth, or possibly an enlarged spleen.

LIST OF PLATES.

xiii.

PLATE XI. Page 176

A lateral view of the same case as Plate X. It shows how the stomach lies in the abdominal cavity from before backwards. This view does not give much valuable information and is not always easy to secure. *Compare Plate XIV.*

PLATE XII. Page 176

A case of "dropped" stomach due to atony. Note how the food has fallen to the lower part of the stomach which is dilated and "baggy." The middle portion is drawn out by the weight of the food, and the muscular coats are unable to hold up the contents of the stomach against gravity. *Compare Plates X and XVI.*

PLATE XIII. Page 176

Young female adult. Showing the effects of a gastric ulcer on the shape of the stomach. The ulcer was situated on the lesser curvature opposite the arrow 1. The irritation set up caused a contraction of the circular fibres indenting the stomach as if it were tied with a ligature at arrow 2. This indentation was permanent, and peristaltic waves were seen on both sides of it, arrow 3. The patient had to be turned a little to her right to show the indentation. *See page 173.*

PLATE XIV. Page 176

A lateral view of the same case as Plate XIII. Note the distortion and puckering of the stomach from spasmodic contraction set up by the irritation of the ulcer. *Compare Plate XI.*

PLATE XV. Page 176

Female age 46 years. Gastric ulcer 10 years ago and more or less constant attacks of indigestion ever since and gradually getting worse. Plate made one hour after the opaque meal was taken. Note how the stomach is divided into sacs with a narrow channel between through which the food slowly trickles. After two hours there was still more than one third of the meal in the upper sac. This may be considered as a fairly typical case, and the condition is found in all degrees of severity from a fairly free communication between the two sacs to an almost complete closure.

PLATE XVI. Page 176

An approximately normal stomach pushed towards the middle line by a tumour, marked x, which could be easily felt through the anterior abdominal wall. The X-ray examination proved that the growth was extra-gastric.

- PLATE XVII. Page 176
 Female, age 31 years. Plate made 24 hours after the opaque meal was taken. The rounded shadow just above the symphysis is the dilated distal end of the ileum; higher up on the patient's right side is the large irregular shadow of the cæcum and ascending colon. Joining the two is a thin narrow channel, constricted and probably "kinked" and constituting an ileal stasis. Stasis also exists in the cæcum and colon, otherwise the opaque food would have been passed on instead of accumulating there. See page 182.
- PLATE XVIII. Facing page 192
 Female adult of slender build. Plate shows the renal regions with calculi in both kidneys. This plate was made according to the method described on page 185.
- PLATE XIX. Page 192
 Female, age 38 years, of average build. Plate made by the "compression method" described on page 187 *et seq.* It shows a group of calculi in the right kidney and the outline of the kidney is well marked.
- PLATE XX. Page 192
 Plate shows two calculi in the bladder of a young male adult.
- PLATE XXI. Page 192
 A large oval calculus in the left ureter of a boy age 15 years.
- PLATE XXII. Page 192
 The same case as Plate XXI. after the ureter was catheterised and injected with collargol. The latter has surrounded the calculus making a bigger shadow, thus proving the calculus to be in the ureter. The ureter above the calculus was seen to be dilated to about the size of the small intestine, but it was not possible to get a clear shadow of this owing to the great dilution of the collargol solution with the contained urine.
- PLATE XXIII. Page 192
 Showing an unusual form of the pelvis of the kidney—Dichotomous. Note the clear outline of the kidney and the ureteric catheter showing the line of the ureter. Through this the pelvis of the kidney was filled with collargol solution just before the plate was exposed.
- PLATE XXIV. Page 192
 Large hydronephrosis of the left kidney after injection with collargol solution as in the previous case.
- PLATE XXV. Page 192
 Male, age 56 years. Showing the bladder after injection with an emulsion of bismuth. Two sacculi are seen on the right side. The openings of these were observed on cystoscopic examination. The plate shows their situation and extent.

LIST OF FIGURES.

xv.

- FIG. 51. Page 137
A lateral view through the head in a case of acromegaly. The arrow points to the cavity of the sella turcica which is enlarged owing to absorption of the posterior clinoid processes, from pressure by hypertrophy of the pituitary gland.
- FIG. 52. Page 138
Showing fragments of shrapnel received at Ypres. The large piece behind the angle of the jaw entered above near the zygoma where two very small pieces were left.
- FIG. 53. Page 140
Cervical Ribs. The one on the right side is what is usually termed a "false" rib; it is more probably an exaggeration of the normal transverse process. It is quite rigid and is causing pressure symptoms. The one on the left side is a "true" cervical rib. It is complete with articulations and causes no symptoms. Light pressure with the finger easily controlled the radial pulse.
- FIG. 54. Page 141
A severe case of osteoarthritis of the lumbar vertebrae. The characteristic "lipping" of the edges of the bodies is shown in different stages even to the extent of fusion. This is not uncommonly found in cases sent for X-ray examination because the symptoms suggested the possibility of urinary calculus.
- FIG. 55. Page 142
Male age 51. Fracture near the surgical neck of the humerus. Accident one month before seeking advice. Patient did not think he had suffered more than a sprain, and had fairly good movement without much pain. The head of the bone is trying to attach itself to the side of the shaft where some callous is thrown out.
- FIG. 56. Page 143
Showing the appearances of a Colles's fracture and a fracture of the scaphoid. The latter is not a very common injury and still less so in association with a Colles's fracture from the same accident.
- FIG. 57. Page 144
Showing the characteristic changes found in rheumatoid or infective arthritis. Note the absorption of the articular cartilages, allowing the close approximation of the articular ends of the bones, many of which are eroded. Some joints are more severely affected than others. The deflection of the fingers to the ulnar side is frequently found in the later stages of this distressing disease.

FIG. 58. Page 145

Traumatic Myositis Ossificans. Came on after a contused wound to the front of the thigh. The condition is probably more often found in the thigh than any other part.

FIG. 59. Page 146

Calcaneodynia or "Painful Heel." Usually the result of a blow on the heel, such as jumping off a vehicle in motion. The spur on the underside of the os calcis is the result of ossification of the origin of the long plantar ligament. It is here seen in profile, and is in reality a lamina of bone that may be from 1 cm. to 2 cm. broad. On operation it was found to be associated with a fibroma between the bone and the surface, and this is probably the real cause of the pain.

CHAPTER I.

ELECTRICAL PRINCIPLES.

In view of the steadily increasing use of electricity in nearly every phase of our existence, there is not the same mystery attached to the subject, especially among educated minds, as was the case only a few years ago. It has been an almost invariable custom to begin every book on medical electricity and radiology with an epitome of the whole science of electricity, because even medical men had for the most part an almost complete ignorance of the science. It is doubtful if this is necessary at the present time since it is almost impossible for those whose work lies within the field of science to avoid becoming familiar with at least some of the elementary principles underlying the practical application of electricity in the service of mankind.

In the present instance it is not proposed to deal with the technical side of electricity except as regards a few of the more important points bearing on the working and management of X-ray apparatus and tubes. There are numerous excellent text books available for those who require more extended information, and the latter cannot do better than attend classes where demonstrations are given and practical work done by the students themselves. In this way they will obtain an understanding of the subject scarcely possible from any amount of reading alone, and it is a procedure that should be carried out by every medical student and many others as well.

Probably the greatest difficulty in the way of a proper understanding of electricity arises from the fact that none of our ordinary tests can be applied to it, as in the case

2 TEXT-BOOK OF RADIOLOGY.

of solids, liquids, and gases; it becomes difficult to form a mental picture of what is imponderable and invisible, and of the nature of which we know nothing except by the effects it produces.

For the purposes of the subject here treated it will be a help to consider electricity as a fluid and in many respects behaving as such; this makes the first principles easier to explain and easier to follow, and once these are properly understood the further developments of the subject are comparatively easy to appreciate.

Let us, then, consider electricity as a fluid such as water and subject to laws that are at least analagous if not similar. Its presence can be demonstrated everywhere, but under normal conditions it is in a state of equilibrium, and it is only when we disturb this equilibrium that its effects become manifest in its efforts to return to its former condition. We may consider the ocean as water in a state of equilibrium, and if any is taken out the balance is disturbed. That which is removed is constantly trying to return, and will do so the moment resistance to its passage is taken away. If we pump water from a pond to a tank on the roof we may consider the tank as positively charged, while the pond is negative to a corresponding degree, and the balance will not be restored until all the water in the tank (positive) has flowed back to the pond (negative). A large pipe will allow it to flow back more quickly than a small one on account of the higher resistance of the latter, and with a stop-cock in the large pipe we can control the flow to any extent we please, and it gives us a convenient method of varying the resistance the water has to overcome. On its way back to the pond we can make it perform work for us, such as driving a water-wheel. Now all these conditions apply equally well to electricity. We may consider batteries and dynamos as pumps for raising electricity to high levels, and we make use of it as it returns to the normal state. The return will take place more rapidly through a short and thick wire than through one which is long

and thin, and we may cause it to drive a motor, light a lamp, or perform any one of the many things for which we now use electricity.

Pressure.—Water engineers frequently speak of pressure as equal to that of so many feet of water, that of one foot of water being taken as the unit. A pump of given power may be designed to raise a large quantity of water to a moderate height, or a smaller quantity to a greater height. The electrical unit of pressure is called a volt, and it will be convenient to think of the volt as corresponding to the foot of water pressure. A certain type of electric battery—Daniell's—has the property of raising electricity to the level of one volt for each cell. No matter how large we may make the cell it will never raise the electricity any higher, but a large cell will raise a larger quantity to this height than a small one. If we divide up our large cell into six independent ones, each of one-sixth the capacity of the large one, the electricity will now be raised six times as high, but only one-sixth of the quantity will be available. Consequently if we want a high voltage or pressure we must use a large number of cells, and if we require a large quantity as well, the cells must be large ones. These conditions are exactly the same as apply to pumps for raising water, just as reasonable and just as obvious.

Resistance.—We may now consider the question of resistance by which we may control the rate of flow. Resistances are merely convenient arrangements by which we can introduce longer or thinner wires as we wish and so regulate the current to our requirements. Metals vary in the resistance they offer to the passage of electricity; copper is almost the best conductor we have, while iron offers nine times the resistance of copper. Alloys usually have a higher resistance than the metals composing them, and German silver and platinoid wires are frequently used as resistances, as well as iron which has the advantage of cheapness.

4 TEXT-BOOK OF RADIOLOGY.

The action of a resistance is best explained by reference to the case of water, and we may compare the current from our battery or dynamo to water in a tank at, say, 100 feet above the ground, with a pipe leading down and provided with a stop-cock. The pressure at the valve will be that of the height of the water—100—and will remain so, provided the pipe is a large one to keep down internal friction, whether the valve is open or shut. If the valve is slightly opened water will dribble out slowly, but only because the rate of flow is under control, and we have not reduced the pressure (voltage) behind it, as we shall find out if we attempt to check this dribble with the finger; the pressure only becomes manifest when further resistance is offered to its escape. Similarly with electricity a resistance of this kind controls the rate of flow (ampères), but if we open the circuit on the distal side of the resistance we will find the voltage is there as before. To avoid confusion, remember that *closing* the water tap cuts off or *opens* the water circuit.

A resistance arranged this way is called a *series* resistance and is indispensable for the control of our apparatus; it is very important to have a proper idea of its action from the beginning, as it explains many matters that constantly crop up in the course of our work. To speak of a *series* resistance as reducing, or "breaking down," the voltage is a misuse of terms that has added greatly to the difficulties of beginners. It only controls the rate of flow, and the voltage or pressure is always there and ready to assert itself the moment an opportunity arises.

If the foregoing has been made clear, when we speak of the 100 volt main, we mean that the electric current available from the supply company is at a pressure of 100 volts, similarly as we might speak of the water main supply being at a pressure of 100 lbs. per square inch. If we open the water tap to a certain extent we will get a strength of current equal to one gallon in a minute, and if opened twice as much the current will be

twice as strong, and twice as much water will escape in the same time, because the resistance to its flow has been reduced to one-half of what it was before. So also can we adjust our resistance to the flow from the electric main to a strength of current we call one *ampère*, or, if we make it half the amount of resistance, the strength will be two ampères, and so on.

It will now be obvious that the strength of current depends not only on the voltage, but also on the resistance offered to its passage; we now need some standard or unit of resistance if we are to be in a position to arrange our circuits according to any given set of requirements. The unit of resistance is called the Ohm, in honour of the scientist who formulated the law which is known by his name. The resistance of a copper wire one-twentieth of an inch in diameter and 100 yards long is almost exactly one ohm. It has been mentioned that a Daniell's cell has a voltage—usually written e.m.f., meaning electro motive force—of one volt. If we join the two terminals of this cell by the two ends of a copper wire as specified, the strength of current through the wire will be one ampère.

The resistance of a conductor varies—

- (a) Directly as the length.
- (b) Inversely as the area of the cross section.
- (c) With the nature of the material of which the conductor is made.
- (d) To a certain extent with the temperature.

The first two are sufficiently obvious, and the different conducting properties of substances has been briefly referred to. The influence of temperature is not very great under ordinary circumstances and may be ignored for the present.

Ohm's Law.—We are now in a position to understand Ohm's law, the importance of which may be gathered when it is stated that it underlies every intelligent application of electrical science. It is as follows:—The strength of the current in any circuit varies directly as

6 TEXT-BOOK OF RADIOLOGY.

the electro-motive force in that circuit and inversely as the resistance of the circuit.

Expressed in symbols it is:—

$$C = \frac{E}{R} \quad \text{where}$$

C = the current ;

E = electro motive force ;

R = resistance.

From the above equation we obtain—

$$E = CR.$$

$$R = \frac{E}{C}$$

so that with any two of the factors given, the value of the third is obtainable by a simple calculation. The student should take any necessary trouble to become thoroughly familiar with this law and all that it means, for which he will be well repaid.

Shunt Resistance.—Before leaving the subject of resistance it may be well to explain another arrangement by which we can adjust the *voltage* to suit most ordinary requirements. It is by what is known as a *shunt* resistance, and this is very useful for many purposes, but many beginners find it very difficult to understand how it works. Let us return to the case of our water tank 100 feet high, and at the end of the down pipe let us join another at right angles and parallel with the ground, also 100 feet long, and provided with 100 small stop cocks one foot apart for testing the pressure. The water is allowed to escape freely at the distant end and there the pressure will be nil. Where the horizontal pipe joins the upright one the pressure is 100, so that as we test the water pressure from this end to the other we shall find that there is a steady fall of pressure all the way. Half way along it will be 50, and the pressure between any two stop-cocks will be as the number that separate them. We may have them all numbered from 1 to 100, starting from the open end, and

in this instance the number of any one will represent the pressure at that point. The difference in pressure between any two points would be got by subtracting the smaller number from the larger. The essential feature of this arrangement is that the water must be allowed to flow freely from the distant end of the pipe; if it were stopped by a valve there would be a uniform pressure of 100 from end to end and our whole scheme upset. If the above arrangement is properly understood there will be no difficulty in following the application of the same principle to electricity.

Let us suppose that a current from the main is available at 100 volts, and that we want to get a lower voltage with a certainty that it will never rise above this. Wire of moderately high resisting metal is wound closely on to a cylinder of some non-conducting material, such as slate, in a single layer, but adjacent turns must not touch each other. Now let us suppose that when finished there are exactly 100 turns of this wire, and when we join its two ends to the 100 volt current the latter flows through. Exactly as in the water pipe we may consider the pressure at the positive end as 100, and 0 at the negative. Also there will be a constant fall of pressure from the positive end to the negative; the fall will be one volt for each turn of wire, and if the latter were numbered we could tap off any desired voltage. Here, again, it is essential that the current continue to flow from end to end and back to the main, and being joined in this way across the two main terminals independently is called a *shunt*, or parallel, connection; hence the name "shunt resistance." An ordinary electric lamp is connected to the main current in exactly the same way.

To use this device we connect one wire to one end of the resistance, and the other is usually connected to a metal slider that may be moved along from end to end, touching all the wires in turn. When it is at the same end as the wire already connected, the voltage between them is, of course, nil, but as we move the slider towards the other

end the difference is one volt for every turn of wire separating them, and it remains the same for any given position, whether current is being used in this second circuit or not. The principal use for a shunt resistance is to make electrical applications to patients, and as the currents required are very weak, they can be made very small and compact. For this purpose they are generally wound with fine wire and have about ten turns for each volt. This enables us to vary the potential by tenths of a volt, and the resulting flow of current to the patient is correspondingly delicate. A diagram of the usual arrangement is shown here. (Fig. 1.) The lamp and

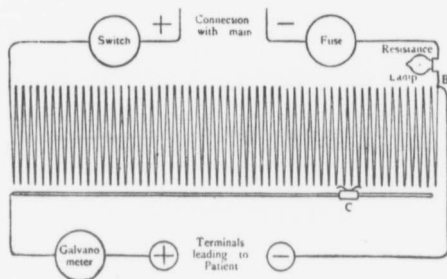

Fig. 1. Plan of Shunt Resistance.

fuse are for safety, and the switch is to disconnect it from the main when no longer required.

While shunt resistances are not much used in radiology, they have many advantages, especially when working with mercury interrupters from high voltage mains, 200 to 250 volts. They have necessarily to be made large and they waste a lot of current, but considering the low price it is supplied at for such work as this, it does not amount to very much. The circumstances under which they would be advisable will be indicated as they arise.

Electro-Magnetic Induction.—If we take a wire through which a strong current is passing and dip it into

iron filings, some of the latter will be found sticking to it and will not readily fall off so long as the current continues to flow. If the current is cut off, the filings fall away at once and will not again attach themselves to the wire until the current is restored. The reason for this is that when an electric current flows through a wire there is always a field of magnetic force surrounding it. The lines of magnetic force are at right angles to the flow of current, and this magnetic field is a necessary accompaniment of the latter. We may cover the wire with paper, rubber, glass, or any non-conductor we please, but the magnetic field is always there and its presence can be demonstrated. If we stand facing the end of a conductor carrying a current that is flowing *from* the observer, the direction of the magnetic field is clockwise; this, at least, is what is assumed, and most of the phenomena can be explained on this assumption. We may go further and assume that every conductor is surrounded by these lines, but in a state of rest and cannot be set in motion except by an electric current. It will still further help explanation if we picture these lines in our minds as a number of wooden discs or wheels threaded on the conductor, without any limitation as to diameter, and ready to rotate when a current passes in or near the conductor.

When we place two conductors side by side we must also assume that these discs are touching at their periphery, so if one set moves, the other set is set in motion, but the direction of rotation will be opposite. If we send a current through one of the conductors, the discs will start rotating and continue so as long as the current flows. This causes the discs on the adjacent conductor to rotate but in the opposite direction, and the effect of setting these lines in motion is to induce a current of electricity to flow in the conductor, which is also in the opposite direction to the first current. The object of this illustration is to show that a flow of current in a conductor induces a current in other closed conductors

near it which is in the opposite direction to the inducing current. Just as a flow of current sets the lines of force in motion, so also if we set the lines in motion by a force from without we get a current of electricity in the wire or conductor they surround.

To complete our illustration we must go further and assume that these lines of force resist displacement from without, and are ready to resume their former position as soon as the disturbing force is removed. The reason for this is that the induced current is a momentary one and subsides after a brief interval—a small fraction of a second. No matter how long the inducing current continues to flow, the *induced* current in the neighbouring conductor subsides at once, but the moment we cut off the inducing current another momentary induced current flows in the adjoining circuit, but this time it is in a contrary direction to the first one. To go back to our illustration of the wooden discs, the sudden movement of those on the primary conductor caused those on the secondary to be displaced in the opposite direction, but the latter after moving a certain amount resisted further displacement, as if they were held back by springs. Though the primary discs continue to revolve they now slip on those of the secondary, though keeping the latter displaced. When the force displacing them is removed by cutting off the primary current, they at once fly back to their original position, and this sudden movement of the lines of force causes a current to flow in the conductor, and as this return movement is in a contrary direction to the first one, this second induced current is also in the opposite direction.

Further consideration will show that the more sudden the movement of the primary lines of force, the greater will be the effect on those around the secondary, also that there is nothing gained by allowing the primary to flow for more than a very brief period of time, and, lastly, that induced currents are always alternating in direction.

This idea of picturing the lines of magnetic force

around conductors as so many discs threaded on it, and the illustrations given in explanation, are necessarily very imperfect. They have been found very helpful to so many who were trying to get the fundamental idea of electro-magnetic induction that they are given here in the hope they will prove equally helpful, and if the student has thoroughly grasped the idea this far, he will have little or no difficulty in following the subject to any extent he is likely to require, even though it may turn out occasionally that our elementary illustrations do not quite fit in with the observed phenomena.

These facts regarding magnetic induction can be demonstrated very easily if one has access to the simple apparatus found in any electrical laboratory. If we take a simple loop of wire and join its two ends to a sensitive galvanometer: by long flexible leads, so that the latter is not disturbed, we will find the needle of the instrument deflected by simply waving the wire loop before the poles of a strong magnet, and, if we observe carefully, the deflection as we approach the magnet will be opposite to that as the wire leaves it. What induces currents in a closed conductor is any *sudden* change in the strength of the magnetic field surrounding it, whether getting stronger or weaker does not matter; the important factor is suddenness of change and the more sudden the more intense is the induced current. The direction of flow in an induced current from the magnetic field getting stronger is opposite to that when it is getting weaker.

If instead of a simple loop we use a coil of wire having ten turns, the electro-motive force of the induced current will be ten times greater. Also, instead of moving the coil before the magnet, the latter may be moved to and from the coil and the effect will be the same; or we may place a second coil inside or outside the first one and send an intermittent current through one of them—secondary alternating currents will be induced in the other coil. Lastly, if these two coils are wound on to a core of iron the effects are greatly intensified, especially if the iron

is in the form of a closed ring or parallelogram. This is due to the very high permeability of iron to lines of magnetic force.

Electro-magnetic induction forms the basis of nearly every practical application of electricity. The dynamo is a machine in which coils of wire are subjected to the influence of a constantly varying magnetic field; the induction coil and the transformer are instances of two coils wound on a common iron core, one usually having many more turns of wire than the other, and the passage of intermittent or alternating currents in one induces corresponding alternations in the other, and may be used either to convert a low tension to a high one or *vice versa*.

We may now consider another phase of this subject, and one that has considerable importance to the radiologist who wishes to have a proper understanding of the appliances he has to use. Keeping in view the effect of electric currents on conductors near by, what is the effect of passing a current through a closely wound spiral? Is it the same as if the wire were straightened out? A moment's consideration will show that it is not the same. As the current rushes round the first turn of the spiral it will induce an opposite current in the second turn, and as it traverses the second turn it will induce opposing currents in the third and also in the first turns, and so on to the end of the spiral. Thus the incoming current is opposed at every turn by these *self-induced* currents, and it is not until these have died out that it can flow freely. Here, again, this effect is intensified if the spiral has been wound on a core of iron, and the greater the number of turns in the spiral or the greater the mass of iron, the greater will be the opposition to the incoming current. It takes a longer time to rise to its full value. When the current is cut off the sudden decrease in the strength of the magnetic field induces a current in the spiral which is now in the same direction as the incoming current, and reinforces the latter to such an extent that a brilliant spark is produced at the points

of the switch where the current is broken. Although the incoming current may be of only 100 volts, that of the spiral at the moment the current is broken may reach many thousands of volts in the case of a large coil as used for X-ray purposes. All these effects are due to what is called self-induction, and it is such an important factor that it is worth while taking some trouble to understand.

Solenoid.—A hollow spiral of wire is called a solenoid, and when traversed by a current of electricity has all the properties of a magnet. When a rod of iron is inserted into it, all its properties are intensified. It becomes, in fact, an electro-magnet.

In view of what has been said above it will not be difficult to see that a solenoid with a considerable number of turns, enclosing an iron core, will, when supplied with a current which rapidly alternates in direction, set up such strong self-induction currents as to oppose the incoming currents to an extent out of all proportion to the resistance of the wire composing it. Again, if we take an iron core made in the form of a closed square or a parallelogram or even a circle and wind a coil on one side of this and apply an alternating current to it, the result of course is the same.

Transformer.—Now let us wind another coil on the opposite side of the core which we will call the secondary coil—the other is, of course, the primary. If we connect the primary again with the alternating current we will find that another alternating current is formed in the secondary coil. This is, in fact, an experimental transformer and differs in no essential particular from those used for the distribution of electrical energy wherever alternating currents are used. The primary coil impresses a magnetism on the core which is constantly varying. As the core is continuous and passes through both coils, the secondary coil is thus exposed to a constantly varying magnetic field. We have already seen

that the effect of this on a conductor is to set up currents of electricity in it. It will also be found that we can vary the voltage or pressure of this secondary current to any extent we please. It is simply a question of the number of turns wound on the secondary as compared to the number of turns on the primary. This will be best explained by an example. Suppose our primary coil has one hundred turns of wire and the alternating current

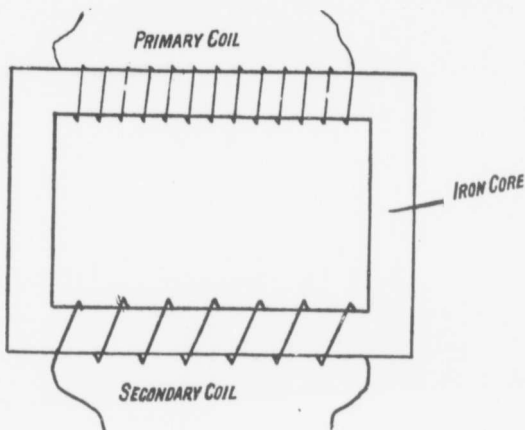

Fig. 2. Diagram of Transformer.

supplied to it has a mean pressure of 100 volts, and we wish to obtain a current to heat a cautery which requires a pressure of say five volts. The primary has one turn per volt and theoretically the same will be right for the secondary—in this case five turns. It will be found that this will come out about right, and if the wire of the secondary has been chosen sufficiently thick plenty of current will be available for even the largest cautery used in surgery. A transformer regulates itself in a most perfect manner. As we draw off current from the

secondary this relieves the primary of so much of its self-induction, and consequently more current flows in. In a well-designed transformer very nearly the same amount of energy is available from the secondary side as is supplied to the transformer on the primary side.

Capacity.—It is known to most students that the poles of an ordinary battery, or one pole of a dynamo generating a pressure of one hundred or two hundred volts, may be handled without fear and probably without any perceptible shock. As we ascend the scale of voltages there comes a time when the current becomes perceptible, and at very high voltages it may be dangerous or even fatal, even though the individual makes contact at one point only, and at no time forms part of the direct circuit between the two poles of the machine. Every conductor is capable of receiving a certain amount of *surface* charge of electricity, which bears a direct relation to the extent of its surface, and the quantity required to raise the potential of any conductor from zero to unity (all other conductors in the vicinity being kept at zero potential) is called its *capacity*. But this is not all the conductor will hold, for if we double the potential twice as much electricity will flow into it. The human body is a conductor with considerable surface, and if we touch another conductor charged to a high potential, enough may flow in to cause a perceptible or possibly fatal shock. A conductor resembles a rubber bag in this respect—the greater the pressure the more it will hold up to the point of bursting.

The capacity of a conductor is also much increased by placing near to it other conducting bodies whose potential is kept at zero by being connected to earth. The nearer these earthed bodies are to the conductor the greater becomes the capacity of that conductor. There are times when it is convenient, even necessary, to transfer rapidly a charge from one conductor to another, and if we can introduce a large capacity into the circuit this transfer will take place. A device for this purpose is called a

condenser, and is called such because a given electromotive force can charge one surface—the other being connected to earth—with a larger quantity of electricity than if it stood alone. From what has been stated already it will be evident that a condenser consists essentially of two conducting surfaces separated by a non-conductor or insulator, and that its capacity will depend directly on the area of the surfaces and the thinness of the non-conductor separating them. It also depends on the material of the non-conductor—glass, for instance, has a greater capacity than the same thickness of air.

If the non-conductor—or dielectric—is too thin, sparks will pass between the plates, and if glass is used it may be pierced or shattered when charged from a powerful electric machine. The Leyden jar is probably the most familiar form of condenser, and in its simplest form is merely a glass bottle coated inside and out with tin-foil for about two-thirds from the bottom; a wire passing through the cork makes connection with the inner coating. The unit of capacity is called the *farad*, and is that capacity which is charged to one volt by a current of one ampère flowing for one second. A condenser having a capacity of one farad would be an enormous affair, and unnecessary for any purpose.

The millionth part of a farad—microfarad—is the unit usually employed, and standard condensers in fractions or multiples of this can be obtained. The Leyden jar is not the most convenient form for all purposes, and for practical use they are generally made up of sheets of tin-foil separated by slightly larger sheets of glass or waxed paper, building them up to any desired number, and arranging that alternate sheets of foil are all connected together at one end, while the rest are all joined up at the other end. In this way a large capacity can be obtained within a small space. The importance of a condenser will be appreciated when we come to study the working of the induction coil—the most generally useful and popular method of exciting our X-ray tubes to action.

The accompanying diagram (Fig. 3) shows the arrangement of a condenser. The horizontal lines represent the sheets of metal foil joined up in two sets by the vertical lines A and B. The spaces between the sheets represent the dielectric, which may be air, glass, or other non-conductor. In practice these are as thin as possible, and where waxed paper is used the whole is squeezed together while warm in an hydraulic press. This increases the capacity besides converting it into a solid block, making it stronger and more easily handled.

Measurement.—In practical work we use instruments for measuring the potential and strength of the currents

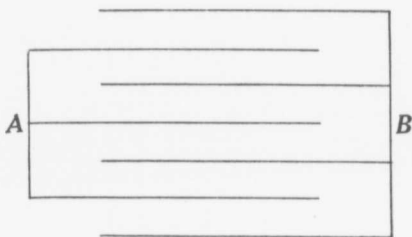

Fig. 3. Plan of Condenser.

passing through the apparatus. These may differ much in detail, and occasionally in principle, but nearly all consist of an electro-magnet through which the current passes, and in doing so causes it to attract a moveable armature to which the index finger is attached. The best instruments are made with as much care as an expensive timepiece, and are correspondingly accurate and reliable. In most instances a voltmeter is not required for the X-ray outfit, but we do need an ampèremeter to show the strength of current from the main supply, and also a milliampèremeter to indicate the number of milliampères passing through the X-ray tube.

Before leaving this part of the subject there are a few other matters that demand some explanation.

Alternating Currents.—As the name implies, an alternating current is one in which the direction of flow is constantly alternating. The pressure or voltage rises from zero to a maximum—depending on the mean pressure—falls again to zero, when immediately a reversed

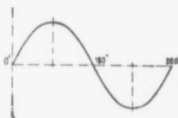

Fig. 4. Double Sine Curve.

current takes place, which goes through the same series of changes, thus completing the cycle. The voltage curve for any alternating current can be plotted out by instruments made for the purpose. In a well-designed machine this curve comes out practically as a true sine curve. Such a curve is called sinusoidal. The adjoining figure shows the curve for one complete cycle. The "frequency" or periodicity of an alternating current refers to the number of these complete cycles per second. Frequencies used to be from 100 to 130 per second, but lately lower frequencies have become much more common—from 40 to 60. The symbol \sim is used to designate an alternating current, and "50 \sim " would mean an alternating current having a frequency or periodicity of 50 cycles per second.

While it is possible to evolve a sinusoidal current directly from an ordinary battery current, we may say that all alternating currents have their origin in a dynamo machine. When a closed circuit is rotated between the poles of a magnet an alternating current circulates in it, there being one complete cycle for each revolution.

The Dynamo.—It is a fair estimate that over 99 % of the electricity used is obtained from dynamos. The dynamo is a device for converting mechanical into electrical power. It consists of three essential parts—(a) The field magnet; (b) The armature; and (c) The commutator and collecting brushes.

(a) The field magnet, which generally forms part of the framework of the machine, is usually an electro-magnet, the poles of which have their opposing faces hollowed out to the arc of a circle, in which space the armature revolves. When the field magnet is excited this space will be the seat of a powerful magnetic field. The essential point about the field magnet is that its poles never change; one is always north and the other is south.

(b) The armature consists of an iron core, upon which are wound one or more closed conductors, and is so designed as almost completely to fill the space between

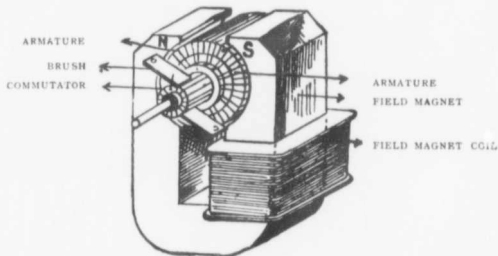
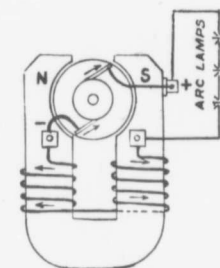

Fig. 5. Parts of a 2 Pole Dynamo.

the field magnet poles, leaving just sufficient room for it to revolve without touching. It has been shown that to rotate a closed conductor in a magnetic field is to set up an alternating current in it—so to rectify this alternating current the third essential part is devised.

(c) The commutator. This consists of a number of copper bars mounted in the form of a cylinder, and insulated from the shaft and from each other. There are as many bars as there are coils on the armature. The beginning of one coil and the end of the coil just preceding it are joined together, and the two attached to a commutator bar. Two brushes of copper gauze or carbon are arranged to touch the commutator at opposite ends of a diameter; and as the armature is revolved the com-

mutator bars pass in succession under the brushes which collect the current from them. Most dynamos which have a commutator are arranged so that the whole or part of the current generated in the armature passes round the field magnet, and are thus self-exciting. The iron of the field magnet always retains a small amount of permanent magnetism. This is sufficient to give rise to a small initial current in the armature, which circulating round the field magnet coils gives rise to a stronger current in the armature, and so on, until the full power of the machine is attained. If an alternating current is required, the armature winding is tapped at diametrically



SERIES WOUND DYNAMO

Fig. 6.

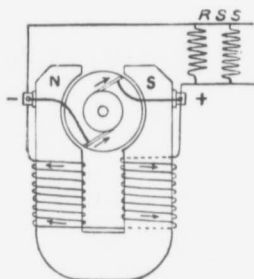

SHUNT WOUND DYNAMO

Fig. 7

opposite points, and the ends connected one to each of two slip rings which are also insulated from the shaft and from each other, and by means of brushes the alternating current generated in the armature is collected. In the case of a very small alternator, one or more permanent magnets may be used for the field magnet. This is the case in the magneto machines which are found in motor cars for ignition purposes.

The direct current dynamo is a reversible machine, that is to say, it will not only generate electricity when driven from some source of mechanical power, but if

supplied with electricity from any external source it will give back the energy in the form of mechanical power. The dynamo and motor are structurally the same—a good dynamo will give good results as a motor and *vice versa*. Direct current dynamos are divided into two main classes—series and shunt. In the former the whole current generated in the armature traverses the field magnet coils as well as the external circuit. In the latter only a portion of the armature current is shunted through the field coils, the rest being available for the external circuit. Each has particular advantages for certain classes of work. The arrangement is shown in Figs. 6 and 7.

CHAPTER II.

THE ORIGIN AND PROPERTIES OF THE X-RAYS.

It is extremely doubtful if any purely scientific discovery was ever more quickly followed, not only by a world-wide and lasting interest, but also by the sudden creation of a very considerable industry, as that of Röntgen towards the latter end of 1895.

While the credit of the discovery is rightly given to Röntgen, it is only fair to state that it was the outcome of a series of investigations carried out by Sir W. Crookes on the electric discharge inside highly exhausted tubes. These experiments are of surpassing interest, and on account of these it may very safely be predicted that so long as exhausted tubes and electric discharges are used together, so long will the name of Crookes survive.

He, from his observations, was under the impression that he had discovered a fourth state of matter—"matter in radiation," but subsequent investigation led him to alter this view, since all the phenomena observed were capable of a different explanation.

As might readily be supposed, the publication of his famous paper started many other scientists, at home and abroad, experimenting in the same direction.

At first all attention was directed to what was taking place inside the tube, but in 1894, Lenard, acting upon a suggestion given him by Hertz, had a tube made with a part of its wall of aluminium. This, when excited by an induction coil, gave rise to radiations which were

recognisable outside the tube by their property of causing phosphorescence and fluorescence of some substances and also of acting upon photographic plates in a manner similar to ordinary daylight. These he called "cathode rays," and in the following year Röntgen found that other rays were given off which penetrated opaque bodies—the degree of penetration depending on the atomic weight of the substance. As they also affected photographic plates, it was possible to make a record of any mass of varying densities by placing a plate underneath and exposing it to the tube for a certain time—and this simple principle underlies the whole science of Radiography. Röntgen called these radiations X-rays, and he in his original papers so thoroughly stated their physical peculiarities that very little that is new has been brought forward by subsequent investigators.

He also showed that the X-rays caused fluorescence in certain bodies, and that by painting a screen of stiff paper with one or other of these substances it was possible to obtain a visible image of the bones of the hand, for instance. The avidity with which this was taken hold of and put to practical use in medicine and surgery can easily be imagined, with the result that no hospital of any importance is now without a more or less complete X-ray outfit, while in some large hospitals there may be nearly a dozen sets in more or less constant use.

A knowledge of the phenomena observed in a tube carrying an electric discharge under a gradually increasing degree of vacuum is a great help in understanding the X-ray tube, and if we arrange a plain tube closed at both ends with electrodes and joined by a side tube to a mercury pump the changes can be readily watched.

If we start the coil before the pump the spark between the electrodes is the same as in ordinary air, presuming the coil is powerful enough to send the spark from one electrode to the other.

The pump being started it will be at once noticed that the spark jumps across between the electrodes much more

easily, and at the same time becomes more soft and flame-like. It will now be found necessary to reduce the primary current in the coil if the tube is not to be damaged by the excessive current flowing through it owing to its greatly reduced resistance. The exhaustion being still further carried on, the whole tube becomes filled with glowing gas of a purple tint, especially at the positive electrode, and a blue violet at the negative. This takes place at a pressure of 2mm. to 4mm. of mercury,

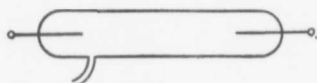

Fig. 8.

and at a certain point it will be noticed that the violet sheath becomes separated from the negative electrode —“the dark space.” This state corresponds to the ordinary Geissler vacuum tubes. These are made in a variety of fantastic shapes, and by varying the composition of the gas, or the glass containing it, or by surrounding parts of the tube with a chamber filled with a fluorescent liquid, they rank amongst the most beautiful of the scientific toys.

We may here stop to consider what is taking place as regards the electric current itself.

Before the pump was started the tube was filled with air at its ordinary atmospheric pressure. When an electric discharge takes place in a gas between two points, it falls to the lot of those molecules in the immediate vicinity of the positive pole to carry the charge across to the negative. If we imagine the molecules of air as so many little pellets and pressed together as they are under ordinary conditions, it is easy to see that they oppose a very considerable resistance to the passage of the spark, and, in fact, when the latter does take place it must be preceded by a forcible separation of the molecules. These immediately fall together again with an audible crack—a miniature lightning discharge, in fact.

After the exhaustion is begun the molecules are less tightly pressed together—the paths between them are widely and more easily opened out—and more of the molecules by their greater freedom of movement are able to act as carriers of the electric discharge between the electrodes. In their rapid movement they collide more or less violently with each other, causing a fluorescent glow and the evolution of some heat.

A moment's consideration will show that at a certain degree of exhaustion the resistance of the tube to this *convection* of the electric discharge will be at its lowest—in other words, the number of molecules remaining in the tube while sufficient to carry the current are not so numerous as to seriously impede each other in their progress from one electrode to the other. It will also be evident that as the vacuum is carried beyond this point of lowest resistance, the resistance of the tube will begin to increase owing to the comparatively small number of molecules left to act as carriers; also it will be seen that the distance any one carrier can travel before colliding with another will be greater. This is spoken of as “the mean free path” of the molecules, and its length is inversely proportional to the number of molecules in the tube.

While the term “molecule” has been used so far to describe the particles that make up a gas, we must abandon it if we are to keep in line with the latest and most generally accepted views on this matter. We have generally been taught that the molecule was the smallest part of a substance that could exist by itself, and that it was made up of two or more *atoms*.

It has been shown that the particles in a highly exhausted tube are neither molecules nor atoms, but something very much smaller, known as *electrons*, having a mass about one-thousandth of that of an atom.

These electrons are thus set in motion from the anode in a tube which has been so highly exhausted that at least

some of them can travel to the cathode without interruption. They there exchange their positive charge for a negative one and are repelled from the cathode at enormous velocity. They are now known as cathode rays, and may be defined as "a moving stream of negatively-charged electrons, having a velocity about one-third of that of ordinary light."

Concurrently with the increase of vacuum will be observed the gradual widening of the "dark space" around the cathode. This would appear to have something to do with the length of the mean free paths of the electrons making up the cathode stream, as at the edge of the dark space is always seen a very bright but narrow zone, suggestive of collisions taking place with other particles, and it is not until the dark space extends to the walls of the tube that the peculiar phenomena described by Crookes becomes manifest. The degree of vacuum at which this occurs may be indicated by saying that the pressure is equivalent to roughly one-millionth of an atmosphere.

The particles forming the cathode stream are given off at right angles from the surface of the electrode and travel in straight lines until arrested by impact against the walls of the tube or some other body deliberately placed in their path. If the cathode is made concave, the rays will be brought to a focus, and as they are negatively charged they can be deflected by a magnet—repelled by a negative and attracted by a positive pole.

A tube at this degree of exhaustion shows no sign of glowing gas throughout its interior as we saw at the beginning of the process, but rather a fluorescence of the walls of the tube particularly opposite the negative electrode. If the tube be of soda glass the colour is of a greenish yellow, or if of English or lead glass the colour will be blue.

There is no doubt that this is due to the impact of the cathode stream, for if we interpose a metallic disc in their path a corresponding part of the wall of the tube does not

fluoresce, nor does it show any phosphorescence after the current is cut off.

(*Fluorescence* is seen only during the time the agent producing it is in action—*Phosphorescence* persists for a time after the exciting agent has been removed. The "Shadow of the Cross" tube demonstrates this fact clearly and prettily.)

As has been stated the cathode particles travel at enormous velocity, and on impact against the wall of the tube excite it to fluorescence. This impact also causes the glass to become heated, and if a powerful coil is being used the glass may be melted at the point of impact and the tube perforated by atmospheric pressure, rendering it useless. It further appears that owing to this velocity a certain number of the electrons become imbedded in the glass. This was the only explanation to account for the fact that a Crookes tube gradually and automatically became of a higher vacuum with use, and experiments have shown conclusively that this is the case. Some of these embedded electrons can be restored to the interior of the tube by careful heating of the latter, but from the fact that it is not possible in this way to restore it to its original condition, some of the electrons must be embedded very deeply or even projected right through the wall of the tube.

While all that has been said is of great importance to everyone who uses and wishes to understand his X-ray tubes, the cardinal fact relating to cathode rays, so far as we are concerned, is that when they are suddenly arrested in their course by impact against a solid body, X-rays are given off.

There is no doubt that X-rays were generated in most highly exhausted tubes many years before their discovery, and it is equally certain that Lenard's cathode rays were mixed with a large proportion of X-rays.

That the X-rays were not observed before must be due to the fact that the attention of every one was directed to what was going on inside the tube, leaving anything

taking place outside to look after itself. Here, as elsewhere, it is very easy to be wise after the event.

The discovery of the X-rays and the first investigations relating thereto were made with the well-known pear-shaped tube in which the cathode was a plane disc mounted in the small end so as to face the larger end of the tube where the anode was placed in a small chamber opening off it. The X-rays were produced by the impact of the cathode rays against the inner surface of the larger end. The amount of rays produced was small, and as they arose from a comparatively wide area there was very little fine definition or sharpness of outline produced in the shadows or radiographs. See Fig. 9.

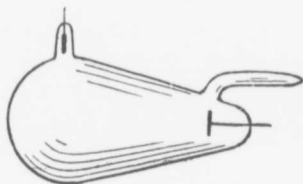

Fig. 9. Crooke's Tube.

The next great step in advance was due to Prof. Jackson, of King's College, London. He made a tube in which the cathode was concave in form, and at or near the focal point of the concave cathode he mounted a flat disc of platinum which also acted as the anode. The result was that the rays all came from a single point or very small surface, resulting in sharp, clear shadows in which minute structure could be made out.

Notwithstanding the numerous forms of X-ray tubes that have been and continue to be placed on the market, they are all made after this plan, which is known as the "focus tube," in contra-distinction to the original forms in which no attempt was made to produce the rays from a single point. The consideration of the X-ray tube proper will be dealt with in the next section, and in the meantime we must clear the ground of the chief physical facts and properties of the cathode and Röntgen rays.

We have seen that the first essential for our purpose is the production of a stream of cathode rays with a sufficiently long mean free path. It will also be observed that the cathodal stream is a particulate one—being made up of the extremely minute particles called electrons—and that these particles travel at an enormous velocity. Further, when this particulate stream is caused to impinge against a solid body—the anti-cathode—the motion is arrested and X-rays are given off at the point of impact.

It might be thought that owing to the extremely small mass of the particles, the impact would not be productive

of any of the ordinary physical effects, but this is not the case.

If the anti-cathode be not securely mounted it may be bent or displaced. In all

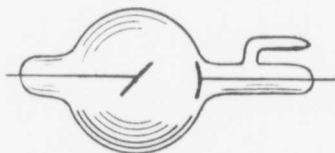

Fig. 10. Jackson Tube.

cases it becomes heated even to incandescence, and the surface after moderately hard use becomes roughened, pitted or even perforated as a result of surface fusion at the point of impact. The nearer to the focal point the anti-cathode is placed the more severe the effect, and, in fact, no substance yet discovered will withstand this bombardment for more than a few seconds if it is placed at the focal point and the tube excited by the powerful instruments at present in use.

For this reason it is the rule to place the anti-cathode so that it receives the bombardment a little beyond the focal point where the stream is beginning to diverge. This adds enormously to the life of the anti-cathode without detracting in any serious degree from the sharpness of definition.

In contra-distinction to cathode rays, the X-rays are non-particulate and consist of irregular solitary impulses

or waves. They are not influenced by a magnet, and they cannot be reflected or refracted by any ordinary means. They easily pass through opaque bodies so long as the substance is one of low atomic weight, while bodies of high atomic weight such as most metals as lead, platinum, mercury, etc., absorb them.

The physical properties of the X-rays themselves may be here briefly enumerated:—

They discharge electrified bodies whether positive or negative, and are capable under certain conditions of imparting a positive charge to other bodies.

They cause fluorescence in certain substances, such as the platino-cyanides of barium and potassium, calcium tungstate, compounds of uranium, and sulphide of zinc. They act on the sensitive salts of silver in a manner similar to ordinary daylight, and finally they penetrate bodies opaque to ordinary light. This power of penetration is dependent on the state of the tube from which the rays are generated, and also upon the atomic weight of the materials making up the body interposed in their path.

An X-ray tube in action gives off rays of several degrees of penetration, and by means of filters we can use almost any degree of X-ray we desire. The less penetrating rays are easily absorbed by clothing, felt, lint soaked in a solution of calcium tungstate, or sole leather. Lead absorbs all except the most penetrating rays, while silver has the peculiar property of absorbing all rays equally.

CHAPTER III.

THE X-RAY FOCUS TUBE.

The first and most important point for anyone contemplating the serious study of Radiology to realise, is that the whole subject centres around the tube from which the X-rays are given off.

The quantity of apparatus used in radiography is very large, as may be gathered from a perusal of any manufacturer's catalogue, and as anyone who has gone into the subject deeply knows only too well, to his very serious cost. The examination of a catalogue or well-equipped X-ray department is likely to give one the impression that the large coil, the complicated tube stand, or X-ray couch, etc., are essentials for producing a successful radiograph.

The X-ray focus tube is the one essential article and all the rest are subsidiary to it—they are conveniences rather than necessities.

A gun, for instance, is a comparatively useless instrument for offence or defence unless it is supplied with its proper cartridge; so also is the most elaborate and expensive X-ray outfit without a suitable X-ray tube, and, what is equally important, in the charge of a person who really understands its vagaries.

While the induction coil is in very common use by radiographers, it is by no means an essential as we shall see subsequently—what we do require is a source of high potential electricity, but this can be obtained in several ways.

It is for these reasons that we take up the study of the focus tube first, and it is proposed to deal with it as fully as the limits of a work of this size will allow.

We have already seen that the design of the modern X-ray tube, however much it may have been modified in detail since, is really due to Prof. Herbert Jackson, of King's College, London. The original tubes, one of which is here illustrated, were about five inches in length between the external electrodes and the bulb about two and a half to three inches in diameter. At one end is seen the concave cathode directed towards a platinum

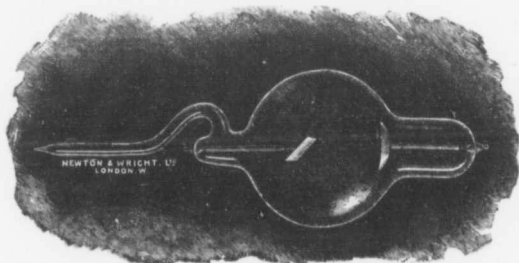

Fig. 11. Original Focus Tube.

disc—the anode or anti-cathode, which is inclined at an angle of about 45° , and so mounted that it is slightly beyond the focal point of the cathode. This mounting of the anode just beyond the focal point is not so difficult as it might at first appear.

The cathode rays, while coming to a focus off the surface of a concave disc just as ordinary light would from a mirror of the same shape, do not behave in the same way after the focal point is passed.

Ordinary light rays begin to diverge immediately—the cathode rays, on the other hand, appear to travel for some distance as a thin pencil of parallel rays, after which they diverge at approximately the same angle as that at which the convergence took place.

CONSTRUCTION OF X-RAY TUBES. 33

This at least is what appears to occur and can be watched in a very low vacuum X-ray tube—so low that practically no X-rays can be detected outside it. Under such conditions the cathode rays are seen as a faint blue stream converging from the cathode to the anti-cathode, and it will be noticed that as the pencil approaches the latter they are usually in a state of slight divergence. I say usually because in some tubes the anti-cathode seems to be so placed as to receive the rays while they are in a more or less parallel condition though still beyond the point at which they came to a focus. It also appears that the anti-cathode so placed is less likely to be damaged than if situated to receive the impact at the beginning of the focal line.

The cathode is always made of aluminium on account of its power of resisting disintegration under the peculiar stresses existent in such surroundings, but this metal is not hard enough, nor has it a sufficiently high melting point to withstand the bombardment of the focussed cathode rays.

Jackson's original anti-cathodes were made of a thin disc of platinum. These tubes were quite satisfactory when worked by the small induction coil then in use, and as the rays came from a small point on the anti-cathode, the shadows were sharp and clear, but owing to the small amount of energy available the screen images were thin and exposures in radiography were unduly prolonged.

As it came to be realised that the X-ray output depended mostly upon the amount of electrical energy put through the tube, larger and more powerful coils were used, and this necessitated the construction of tubes capable of withstanding such conditions. A modern coil even when working at one-half or perhaps one-quarter of its full capacity would melt and perforate the platinum anode of one of the original tubes in a few seconds. The terms "anode" and "anti-cathode" are more or less inter-changeable, as they often refer to the same thing—the anode acting as the anti-cathode in the original and

many of the later X-ray tubes. In most a separate anode is supplied which may or may not be joined externally to the anti-cathode, and this has the effect of making the tube steadier in action. (See Fig. 12.)

In this diagram of an X-ray tube the interrupted lines represent the cathode rays and the straight lines the X-rays.

In use a focus tube as here described is connected to the poles of the instrument from which we get the necessary

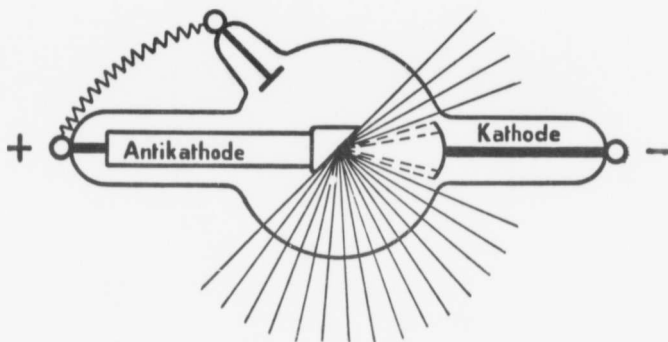

Fig. 12. Plan of a Modern X-ray tube.

high potential current of electricity—the anode of the tube being joined to the positive pole and the cathode to the negative—and as the induction coil is the one in most general use at present, I will assume this except when otherwise specified.

The coil being set in action the tube lights up at once, and that half of the tube lying in front of the plane of the anode is seen to be fluorescing with a bright apple green colour. A little irregular and faint green fluorescence is often seen behind the plane of the anode, but is very small in a well-made tube. This rear half of the tube is generally dark, but so long as the vacuum is

not too high there is usually seen a small blue-violet cloud floating in space, as it were, just behind the anode.

If we now take a barium-platino-cyanide screen and examine the vicinity of the tube we find that the screen fluoresces brilliantly so long as it is in front of the plane of the anode, and that it makes very little difference whether we hold it right in the middle of this field or over near the edge, the image of the bones of the hand, for instance, is almost equally good. We will notice, also, that as we pass the edge of this field we come into another where there are practically no X-rays at all, and that the line dividing the two is a very sharp one and is a continuation of the plane of the anode.

If we now shut off the coil and arrange the tube so that its long axis is horizontal, the front of the anode facing downwards and about ten inches above the table, we may quite easily obtain a radiograph of the hand by placing a photographic plate immediately under the centre of the anode—placing the hand thereon and setting the coil in action for a time which may vary from a few seconds to a minute according to the power of the apparatus. The plate which all through has been enclosed in light-tight paper wrappers is then taken to the dark room and developed and fixed in the usual way.

This comparatively simple procedure represents in its simplest form the science of radioscopy or examination by screen, and radiography or the production of an X-ray negative. From these simple processes the whole subject is developed, but in the meantime we must return to the consideration of the tube itself.

The appearance of the tube just described is very different if accidentally or intentionally the current has been turned on in the reverse direction. Instead of the division into two halves it shows patches and rings of green fluorescence all over, very few X-rays are given off, and such as can be detected outside the tube are faint, and any shadows thrown on the screen are without sharpness.

The worse effects, however, are on the tube itself. As the polarity of the electrodes is reversed, the anode now acting as the cathode becomes disintegrated, fragments being torn off and deposited on the walls of the tube, making it dark or even black. Concurrently with this the vacuum of the tube rises owing to the occlusion of the electrons in the glass, and if this is allowed to go on even for a minute in some cases, the tube becomes so "hard" as to be useless unless something can be done to restore the vacuum to its former condition.

As the terms "hard" and "soft" are frequently applied to X-ray tubes, it will be as well to describe what they mean.

By a "hard" tube we mean one in which the degree of vacuum is very high, and it offers in consequence a high resistance to the passage of the electric discharge through it. The green fluorescence is usually paler than it ought to be, and while in action the tube itself and the wires leading to it give off a distinct crackling sound.

It usually shows more green in the dark half of the tube, and the blue cloud behind the anode is absent.

The X-rays coming from such a tube have also certain characteristics. While the X-ray output is less than in a softer tube, the rays are very penetrating and easily pass through the thicker parts of the body, making a screen examination comparatively easy. Such rays, however, have much less action upon the sensitive salts of silver, and as they penetrate the bones almost as easily as the soft parts, a radiograph made with such a tube is thin, flat, and lacking in both contrast and detail. The influence upon the skin—in producing X-ray dermatitis—is also less.

The chief value of such a tube is for examinations by screen, and also for the treatment of deep-seated conditions where an effect on the skin and superficial tissues is not desired.

A "soft" tube, on the other hand, refers to one in which the vacuum is low and does not offer such a high

resistance to the current. The appearances are essentially those already described, but the softer it is the more distinct and extensive is the blue cloud behind the anode. When the blue cloud shows between the anode and cathode the tube is too soft for any use in radiography. The tube and wires do not “crackle,” and the rays given off, while less penetrating than a “hard” tube, are more profuse and have a much more intense action both on photographic plates and upon skin and other living tissues.

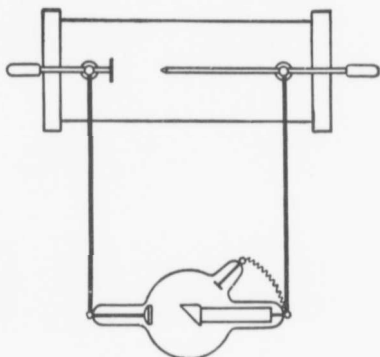

Fig. 13. Parallel Spark Gap.

Such a tube is of no use for screen examinations of the thicker parts, but in the case of the hand, for instance, there is a great contrast between the bones and soft parts, and a radiograph shows great contrast and abundant detail in the structure of bone.

It will have been gathered from the above that the terms “hard,” “medium,” and “soft” bear a more or less direct relation to the resistance of the tube, and if we can by any convenient method determine, even roughly, this resistance, we can make a pretty close estimation of the character of its X-ray output.

Every apparatus for the supply of high tension electricity for X-ray tubes is provided with what is called the "parallel spark gap" which is arranged across the wires leading from the coil to the tube.

As the current passes more easily from a point to a plate, the rod attached to the + wire is the pointed one, the plate being negative. It will be seen that the current from the coil has the choice of two paths—either through the X-ray tube or across the spark-gap from point to plate—Fig. 13. If the spark-gap, which is freely adjustable, be set very narrow, all the current will go across it when the coil is turned on. We now draw back one of the rods of the gap, making the latter wider until a point arrives when the current, perhaps without any warning, suddenly flows through the tube, lighting it up. On a scale provided we can read at once the distance between the point and plate. This represents the resistance of the tube as stated in inches or centimetres of air.

With this equivalent spark-gap, as it is sometimes called, we can give some figures which will help the beginner to tell approximately the kind of tube he is working with at any time. For instance, if the current prefers to go through the tube when the spark-gap is only one inch wide, the tube is too soft for anything and no X-rays are generated, or at least do not get through the glass walls of the tube.

At two inches the tube is *very soft*.

From two to four inches it is *soft*.

From four to six inches it is *medium*.

Over six inches it is *hard*.

This scale is very convenient, but, of course, it is only approximate, and in testing tubes one should endeavour to have always the same current flowing through—say one milliampère. If we set the spark-gap with a small current and then suddenly increase the latter we shall find that it will all go across the gap instead of through the tube. In metallic circuits the current would divide itself among them inversely according to the resistances

of the circuits, but in the case we are dealing with it is either one or the other—showing a marked difference in the behaviour of electricity as regards circuits composed of solids and gases.

After a tube has been in use for some time it will be found that it has undergone some change. More and more current has to be turned on to the coil to get it to light up properly, the fluorescence is paler, there is a crackling sound about the tube and wires leading to it, and if any radiographs are made with it they will be thin and lacking in both contrast and detail. These symptoms, of course, indicate that the tube has become hard with use, and this is what occurs with all tubes.

This was particularly the case with the small bulbs as designed at first, and we shall see presently that to obviate this as far as possible it is now the rule to make the bulbs much larger. The reason for the gradual hardening of the tube is due to the occlusion of the electrons in the walls of the tube.

It was mentioned that when the current was passed through in the wrong direction the vacuum rose very rapidly, and we find that with the current in the proper direction it rises but slowly. In the latter case the great bulk of the cathode rays are focussed upon the anti-cathode—only a very small portion being projected against the walls of the tube itself—and while they may be embedded in the anti-cathode they do not remain there, but are set free again as soon as the metal becomes heated. Thus it is only the few stray electrons that are given off from the edge of the cathode that are likely to be put out of action.

With the reversal of the current, however, the electrons forming the cathode rays are given off from the *anti-cathode* in all directions, and impinging against every part of the interior of the tube become embedded very rapidly and so render the tube useless more or less permanently.

While it is sometimes necessary for some special reason to raise the vacuum of a tube rapidly by reversing the current, it is an expedient that should never be resorted to if it can be helped—a tube so treated even once suffers a considerable shortening of its useful life. It is far better to put the tube away for a time when it will in all probability recover itself.

It is a curious fact that in the case of a tube which has become too hard for any useful purpose, if it be put away for a long period—one or even two years—it will be found to have become softer and can be used for a time at least.

In view of the deleterious effect of a reversed current upon an X-ray tube, it does not require much consideration to show that if a high tension alternating current were used, the effect upon the tube would be almost as bad—not only because the voltage of the current is equal in either direction, but the trouble is accentuated by the fact that the resistance of an X-ray tube to a current flowing from the cathode to the anode is less than from the anode to the cathode, and consequently more reverse current traverses the tube than flows in the proper direction.

The importance of this lies in the fact that the induction coil is most commonly used for supplying the necessary high potential current for exciting X-ray tubes, and as we shall see when we come to study the coil itself, this current is neither continuous nor even uni-directional. It is an alternating current, but not a symmetrical one—that is to say the impulses in one direction are of higher voltage and greater magnitude than those in the other. We use the greater impulses and do all we can to suppress the smaller on account of their deleterious action upon the life of our tubes.

Keeping our attention for the moment on the tubes originally made, it was found that they suffered from many faults, and while the modern tube differs in no essential particular from that first made by Prof. Jackson, such variations in constructive detail as have

taken place have been brought about in the effort to overcome the faults of the originals. The X-ray tube of to-day is a vast improvement upon that of ten years ago, but, as we shall see, it is as yet very far from being a perfect instrument.

The faults referred to may be stated more or less briefly.

1. Irregularity in working; flickering.
2. Tendency to get hard rapidly and permanently.
3. Overheating, displacement and damage of the anti-cathode.
4. Discoloration.

The first two are got over by making the bulbs larger; at one time a tube of five inches in diameter was considered a large one—nowadays, bulbs of seven and eight inches diameter are comparatively common.

The larger the tube the greater the number of residual electrons for any given degree of vacuum, and as there is no reason to suppose the electrons are occluded more rapidly than in a small tube with a given current, a big tube ought to work more steadily and permanently.

The large size of the bulb, however, will not remove the tendency to progressive hardness. This fault is inherent in all tubes as at present constructed, but the process is very greatly delayed by increasing the size. Even the largest tube will become useless from this cause in time, and to meet this difficulty numerous devices have been brought forward, all of which have for their object the setting free of a small portion of gas inside the tube or of introducing a corresponding portion from outside.

It would serve no useful purpose to describe all the methods that have been tried—even did space permit—so only those will be referred to which seem to be the best.

All tubes, with or without any special device for regulation, may often be put right by heating with a spirit lamp or bunsen flame. This acts by releasing a number of the occluded electrons, but it should be done with care

and the flame must be kept constantly moving. The walls of the tube are thin and may be easily melted and perforated by atmospheric pressure. Prolonged baking in an oven is also a very useful method, and seems to produce a much more lasting effect than the heating by a hot flame for a short period.

Another method that answers excellently at times is to connect the tubes to a very much more powerful coil and work it vigorously, even to the extent of making the anticathode red hot. It is, however, not always safe.

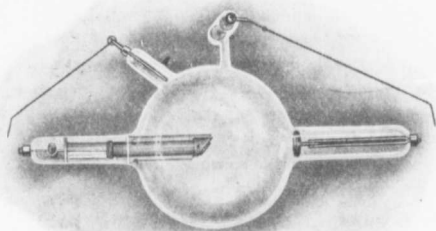

Fig. 14. Mica Regulator—in accessory bulb above.

The special devices for lowering the vacuum may be divided into two main classes.

(a) Those in which gas is liberated from some substance placed inside the tube, or, what is more common, in a small accessory bulb or chamber communicating with it.

A good plan is to put a piece of carbonaceous material in an accessory chamber and mounted on a wire communicating with a terminal outside. In use, one of the wires to the tube was attached to this terminal, and the current passed for a few seconds at a time, until the desired effect was obtained. With this device there is some risk of overdoing the process, and it is to be used

with care. Other substances are used by different makers working on the same principle, all of which are more or less efficient.

Another device having very good qualities is in use by Muller. A number of discs of mica are mounted on a stout aluminium wire in the accessory bulb, and this wire communicates with another outside, which is hinged in such a way that it can be placed close to the terminal leading to the cathode as in Fig. 14.

When the tube gets too hard this hinged wire is brought near the cathode terminal, when sparks are seen to pass between them. The current flowing by this alternative path causes some particles of gas to be set free from the mica. The first few times it is used care must be taken not to overdo the process, or the vacuum of the tube will come down with a rush and be too soft.

At the opposite end of this accessory bulb is another terminal communicating with a small scrap or spiral of platinum. When the tube becomes too soft from any cause the positive wire is taken from the anode and joined to this. The current being passed, the vacuum rises owing to occlusion of particles of gas in the surrounding glass. There are other modifications of this device for lowering the vacuum, but they are the same in principle and need not be referred to further.

This class of regenerative methods suffers from two main faults. In all there is a great tendency to reduce the vacuum more than is desired, especially on the first few occasions it is brought into action. The other fault is that the amount of vapour available is limited, and once this is used up no more can be obtained.

Another noteworthy fact is that once a tube has to be lowered by any of these methods the reduced vacuum is never so permanent as the original vacuum of the tube, and this becomes all the more marked on each subsequent occasion.

Regenerators which restore the vacuum by introducing gas from without are of two kinds—those which act by

osmosis, and those that are dependent upon some sort of valve.

The osmo-regulator was introduced by Villard, and is very successful. It depends on the property certain metals have of becoming more or less porous to gas when heated.

In its usual form it consists of a tube of platinum or palladium about one-sixteenth of an inch in diameter and closed at one end. The open end is sealed in so that its cavity communicates with the interior of the X-ray tube.

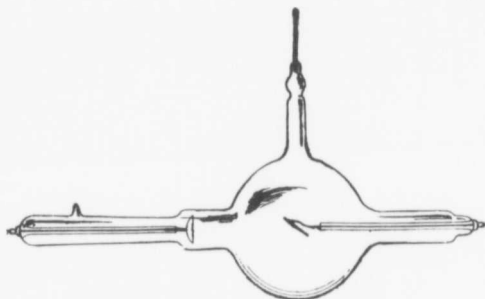

Fig. 15. Chabaud Tube with Osmo-regulator.

As the fine metal tube is very easily damaged it is always provided with a protecting cap or cover.

In use the protecting cap is removed and the flame from a spirit lamp or bunsen applied to it until it becomes a bright red heat. The flame is removed so as to allow it to cool. It is during the cooling that the greatest amount of gas gets into the tube. If insufficiently reduced the process can be repeated as often as necessary.

Tubes regulated by this means seem to have a very long life, and as a means of regulation it is most efficient.

It should be stated that palladium is a much more active metal in this particular respect than platinum, and in reducing a tube having a regulator of this metal great

care should be taken not to overdo it. The flame of a small spirit lamp or even a wax vesta is all that should be used, but if the regulating tube is of platinum a bunsen flame is none too much.

A good tube provided with an osmo-regulator will last for months, or even years, of regular work.

Regulators of the valve type have been introduced, but have not been conspicuously successful.

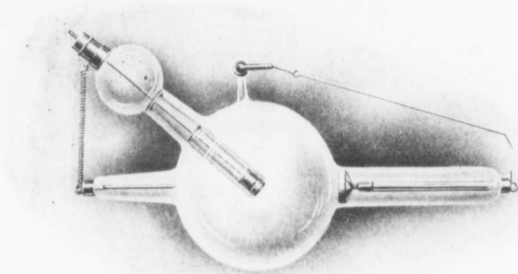

Fig. 16. Water-cooled Anti-Cathode.

It is a waste of money buying X-ray tubes not provided with some form of regulator, and so far as some years of experience can show, the osmo-regulator is one of the best.

The next fault we have to consider relates to the anti-cathode.

We have seen that this is subjected to somewhat rough treatment. If it is not strongly built and firmly mounted in the tube it will soon become displaced, and this is especially the case nowadays, considering the powerful coils in use and the demand for rapid exposures. It is now usually mounted very securely on a stout copper rod, and this enclosed in a glass tube of large diameter

securely fixed to the tube itself. Various modifications of the mountings are practised by different makers, but all aim at the highest degree of rigidity and stability.

The sudden arrest of the electrons forming the cathode stream causes the development of considerable heat, and if the anti-cathode is small and not provided with some cooling device it soon becomes roughened, pitted, or even perforated by the intense heat, plus the mechanical shock of the bombardment. A surface fusion takes place, and the metal is seen to have been heaped up while in a plastic condition around the point of impact, so adding to the apparent depth of the depression.

These effects are seen even with modern tubes, but it does not happen so easily or so soon as in the older ones. Various devices have been brought forward for dealing with this, and while the water-cooled anti-cathode was very popular and is yet for some purposes, most makers now depend upon the heat-absorbing properties of a large mass of metal.

Of the water-cooled anti-cathodes, only those in which the water lies in contact with the back of the metal disc forming the anti-cathode are admissible. (Fig. 16.) Even then, I have seen the face pitted with a moderate current and length of exposure. When it comes to the question of the large currents required in so-called instantaneous radiography, water-cooled anodes are not satisfactory. This is due to the fact that the intense heat produced causes the development of a layer of steam behind the disc, and this holds the water back and out of contact—preventing its acting as a cooling agent altogether.

The "heavy anode" tubes are free from this defect. (Fig. 17.) The face of the disc is backed up with a heavy mass of metal of large section, which absorbs the heat almost as quickly as it is formed, and for short intense exposures it is quite satisfactory.

The heavy anode tube has undergone many improvements lately, so that at the time of writing it is the type

in general use. The impact of the cathode rays is received by a disc of tungsten let into the face of the massive copper anti-cathode. Apart from its higher melting point, it is found that a greater production of X-rays attends the use of metals of high atomic weight. Tungsten is higher than platinum, and other things being equal a tungsten anti-cathode is more efficient than one of platinum. Though of high initial cost they are economical in practice, and the process of exhaustion has been so improved that they are sent out in condition for

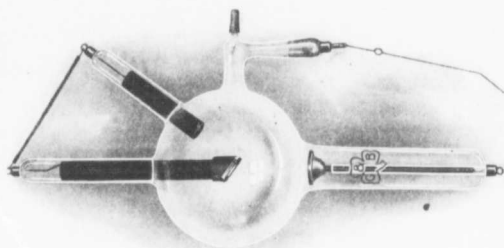

Fig. 17. Heavy Anode Tube.

immediate use for any part of the body. They are provided with an efficient regulator to adjust the vacuum to any degree desired, and even if made very soft they will recover very rapidly and be ready to meet any requirement.

Formerly, and often at present, new tubes were sent out in a soft condition, and if one were used with a current of from one to two milliamperes for about ten minutes, as frequently required in X-ray treatment, the vacuum would get so low as to be of no practical use, and the tube itself severely damaged. It is now well known that all metals absorb gas on cooling which is given off again as the metal is heated, and in the above instance the long-

continued exposure heated the metal of the anti-cathode until it exuded some of the occluded gas. If this has gone too far the tube will have to be re-exhausted before it can be put into use again, but if the vacuum has not been allowed to get too low it will recover its original condition if put away for some days. But any overheating should be avoided if possible, and it will be found that the more care exercised in the use of a new tube of any kind, the longer will be its useful life, and its performance will be more satisfactory in every way.

The discoloration of tubes is chiefly the fault of the user, and if care is taken never to reverse the current and always to have in circuit some means of suppressing the inverse current, common to all coils, no discoloration worth mentioning will occur. The violet tint seen in the active part of the tube corresponding to the green fluorescence when in action, is due to the molecular changes in the glass, said to be more pronounced in glass which contains manganese.

The same tint is seen in glazed windows which have a southern exposure after a very long period of years—a change brought about by the X-rays after a comparatively small number of hours.

A tube uniformly blackened all over is evidence of improper use—either by having the current reversed frequently, or being used with a coil which generates a large inverse current without proper means being taken to suppress it.

CHAPTER IV.

TYPES OF X-RAY TUBES.

While good X-ray tubes have been made in England from time to time, it must be admitted that the best ones come from abroad.

There are a large number of makers, and each has his one or more patterns which are dictated by his own fancy or the requirements of some particular class of work. Only a few typical examples can be referred to here, but it is not to be taken that those chosen and illustrated are necessarily the best.

Of the tubes with small bulbs, that of Chabaud is probably the best. The bulb is about 4" diameter. (See Fig. 15.)

This tube is made with great care in every respect, and all the metal parts—excepting, of course, the cathode—are made of pure platinum. It is provided with an osmo-regulator which can be warmed while the tube is working, and so long as its maximum current is not exceeded it can be run continuously for hours. Though the first cost is high, in practice it is one of the most economical and reliable. It is admirably adapted for X-ray treatment, and radiography of the thinner parts of the body.

The remarkable feature of this tube is that in its normal condition of working—passing about 0.5 milli-ampère when new, but rather more when old—the anode is at a red or nearly white heat, and it shows little tendency to get softer with the increase of temperature. This is due, no doubt, to the very perfect exhaustion as well as to the small amount of metal.

It may be stated as a rule that the longer the period a tube is expected to run continuously, the lighter should be the metal parts.

Another very favourite form is shown in Fig. 18. The bulb is larger than the one just described, being about 5" diameter. It has an anode separate from the anti-cathode, but these are joined together externally.

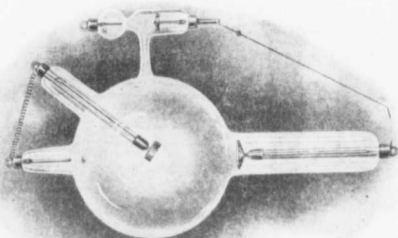

Fig. 18. Light Anode Muller Tube.

During manufacture these are not joined together and the anode is connected to the + pole of the coil. This prevents the tube becoming discoloured during exhaustion, and also saves the anti-cathode from damage to its surface. The anti-cathode is usually of nickel with a thin coating of platinum, and while heavier than that of the tube just described, it still belongs to the "light anode" variety.

It is provided with a regulating device which will be recognised as the mica disc variety from the description already given. It also possesses the small bulb for raising the vacuum.

The regenerating device is automatic—and by setting the hinged wire at any given distance from the cathode end the tube will regulate itself to the vacuum corres-

ponding to that distance, for as the resistance of the path between the proper electrodes increases, current passes around by the mica discs down the wire and jumps across to the negative end. This sets free a minute quantity of gas from the mica and the vacuum is lowered, allowing the current to pass in the usual way again.

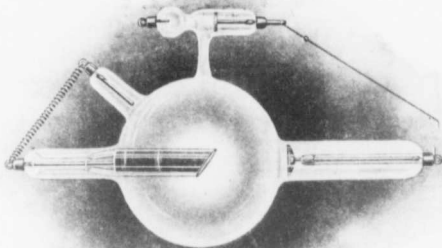

Fig. 19. Heavy Anode Tube.

If a new tube of this type be worked for some time with a moderately strong current it will very soon be found that the vacuum is getting too low. It can be saved if the current is reduced at once, or cut off entirely so as to let the tube cool. If this is not done in time considerable shortening of the useful life of the tube will take place.

On the other hand, if at first it is only used for radiography of the thinner parts as hands and toes, or if in treatment, care is taken to pass but a very small current, the tube will not only be found to remain steady or even rise in vacuum, but concurrently it gradually develops an increasing degree of stability.

A stage may eventually arise when it will not only easily stand double or treble the amount of current, but will do so for more or less prolonged periods of time.

A tube in this condition is said to have become "seasoned." This seasoning of a tube is an art, but a well-seasoned tube is a joy to possess and repays any trouble it has taken to get it into this condition.

Figures 17 and 19 are varieties of the heavy anode

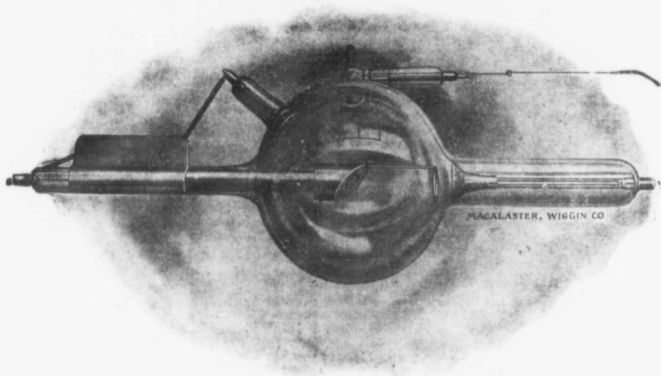

Fig. 20. Tungsten-faced Anti-Cathode.

type of X-ray tube. In the first one the block of metal is mounted on the end of a strong iron tube which is a good fit in the glass stem of the bulb. These heavy anode tubes are very popular among X-ray workers. Figure 16 has a water-cooled anti-cathode, but calls for no further description.

Lately, the metal tungsten has been introduced for facing the anti-cathodes of X-ray tubes, and such tubes, either air or water-cooled, are now obtainable.

In addition to the very high melting point of tungsten, which makes fusion practically impossible in an X-ray

tube under usual conditions of working, we have seen that a target of this metal makes a more efficient producer of X-ray energy than metals of lower atomic weight. For these reasons tungsten is becoming very generally used, and with the great improvements in exhaustion of the bulbs the present-day tungsten-faced, heavy anode X-ray tube is a vast improvement on anything hitherto available. Those from America are among the best, and while they are expensive to buy, their reliability, efficiency, and long life, more than make up for the extra outlay.

It may be stated here that there is no worse form of economy than the purchase of cheap X-ray tubes—none but the best are good enough, and they are by far the most economical in practice. It is also advisable to select one make and pattern of tube for each branch of work, and lay in a stock so that they may be used in rotation. There is no better form of investment for the radiologist than an outlay of from fifty to one hundred pounds for X-ray tubes of the highest class.

Though the design of the X-ray tube continues to undergo modification in detail, it has now reached a stage where some attempt at standardisation can be noticed, and the selection of suitable tubes is now more easy than a few years ago. While there are signs from abroad of what would appear to be a revolution in X-ray tube design, it is likely tubes as at present constructed will continue to be used for a long time yet.

For the purposes of X-ray treatment we require a tube capable of carrying a moderate current—seldom exceeding two milliamperes, and most often about one—for prolonged periods. For currents of 1ma. or less the small carefully exhausted tube answers well and that shown at Fig. 15 is a good example of this class. If larger currents are to be used, as in the treatment of deeply seated organs, a small-bulb water-cooled tube is one of the best, the general design of which is shown in Fig. 16.

For X-ray photography there is no advantage in having different patterns of tubes since it is possible to examine any part of the body with those designed for the heaviest class of work. It is far better to adopt tubes such as shown in Figs. 17 or 19, either of which will be found satisfactory, using that one whose degree of vacuum is most suitable for the requirements of the case in hand. Owing to recent improvements in vacuum regulators there is not now the same necessity for huge bulbs. Those shown in Figs. 17, 19 and 20 are about six inches in diameter only, but are able to stand any demand likely to be made upon them, and are very steady in action.

The departure from standard X-ray tube construction just referred to is the result of experiments made by Dr. Coolidge in America, and tubes made according to his design and known by his name are now available. The essential feature is that the tube is exhausted to as nearly an absolute vacuum as is practically possible. No current can thus pass through it, but it can be made conducting if a body capable of giving off ions (electrons) when heated is placed within it and provided with a means of raising its temperature. Then if we remember that the number of ions set free bears a direct proportion to the temperature, the possibilities of the arrangement become manifest. The resistance of the tube and the quality of the radiation are directly dependent on the number of free ions present, and if this number of ions is under our direct control the management and regulation of X-ray tubes enters a new phase.

In the Coolidge tube there is a small spiral of tungsten wire mounted in a cup of molybdenum, the whole forming the cathode of the tube. The ends of the tungsten spiral pass through the end of the tube, and are connected through a regulating resistance with a battery of accumulators (8 to 12 volts). This heats the spiral to any desired degree, and so long as the battery remains in good order the temperature can be maintained more or less constantly at any desired point. As soon as the

spiral is sufficiently heated the high tension current may be turned on to the tube, and so long as the temperature of the spiral is not altered the quality of the radiation remains constant. The hotter the spiral the softer and less penetrating are the rays from the tube, and these conditions may be altered while the tube is working; in fact, any degree of penetration may be obtained by simply adjusting the rheostat that controls the temperature of the tungsten spiral.

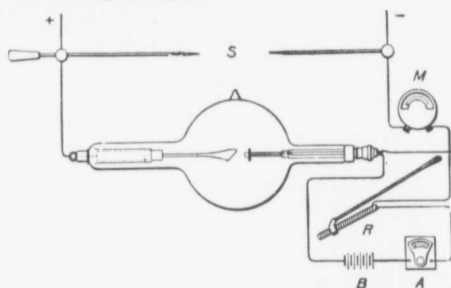

Fig. 21. Shewing arrangements for the Coolidge Tube.

The advantages of such a tube will be evident, and it is to be hoped the scheme will be so modified as to become adaptable to everyday use. At present there are some practical difficulties; the necessity for a separate electrical supply to heat the spiral is a drawback, and they are very expensive, the tube, battery and other necessary appliances costing well over £30 (\$146). It is probable that these difficulties will be overcome, especially if further experience establishes their superiority for all classes of work.

CHAPTER V.

THE SECONDARY CIRCUIT.

Following out the idea that the X-ray tube is the dominating centre of a radiographic outfit, we shall work back towards the source of supply.

There is much yet to be said regarding the tube itself, but what remains can best be considered in conjunction with the various components of the secondary or high tension circuit, which conveys the necessary high potential electric current to excite the tube to action.

In this circuit is arranged the equivalent spark gap, which has been referred to in a previous chapter. Of almost equal importance is a meter for measuring the amount of current flowing. For this purpose a milliampère-meter is used, which differs in no essential particular from those in ordinary use.

Those intended for X-ray work are generally provided with a small condenser connected to its two terminals, and stowed in the case of the instrument. It has the effect of making the meter more accurate, and protects the windings from damage through the sparking of the high tension current.

While the milliampère-meter tells us with great accuracy the current flowing through the tube, it is not in itself a measure of the amount of X-rays given off.

Speaking generally with any given tube at a certain degree of vacuum the X-ray output is in proportion to the current passing through it, but Ima. passing through

a French tube does not necessarily mean the same thing, in terms of X-rays, as the same current through a German tube. Also a given current through a tube that is in a "soft" condition does not mean the same X-ray output when the same tube becomes "hard" through continued use.

The value of the milliampère-meter lies not only in the fact that the X-ray output is in proportion to the current with any given set of conditions, but it enables us to find out the *critical current* for each tube we may have in use. This critical current is that which has been used by the maker when exhausting, and should never be exceeded when using the tube in the early part of its useful life. By taking care in this respect, tubes will last much longer and become very steady in their action.

Also if for any reason we should be using a stronger current in our tube than it is capable of standing, we will get the first indication of this by watching the needle of the meter. If after running steadily for a while the current is seen to increase slowly, though no change has been made in the electrical arrangements, we may be quite sure that the tube is becoming over-heated and the vacuum beginning to fall. If the precaution is taken to reduce the current on any indication of this kind the tube will not suffer any injury, but the number of tubes that are ruined every year through neglect of this simple expedient must be very great.

The aim should be to pass just such a current as the tube will take without falling in vacuum, and if it can be adjusted so that the vacuum very slowly rises, so much the better. Any tendency to undue hardness can be easily corrected by the regenerating device or simple heating. Of course, when we come to rapid exposures we must of necessity use an enormous current, which if left on for even a few seconds continuously would wreck the tube completely, but in practise the duration of the flow is so short, seldom if ever exceeding one second, that there

is not time for the heavy metal anti-cathode to become so hot as to give off any gas. The effect in fact, is generally to make the tube appreciably harder after each exposure—especially if it is not a very large bulb.

For the readings of the milliampère-meter to have any value, it is necessary that the current flowing through it be unidirectional, and if, as is most commonly the case, we are using an induction coil to excite the tube, we must take some means to suppress the inverse current.

We shall see presently, when dealing with the secondary coil current, that this is an alternating one, but the waves in one direction greatly exceed those in the other.

If we work our coil with an accumulator of say 12 volts and a platinum interrupter, the inverse current will be very trifling, but if we increase the voltage to 24 it will begin to show evidence of its presence, especially if the tube be soft. Also, if we use a current of 50 volts and a mercury break the inverse current begins to be troublesome, while with the 200 volts or more through an electrolytic break, it is of such magnitude that it is practically impossible to do work without taking measures to suppress it.

Assuming the possession of a coil so designed that the inverse current is kept at its minimum under any given conditions, all that is necessary when using voltages of 24 and less is to place a little resistance—in the form of a spark-gap—in the secondary circuit. The current on its way to the tube has to jump across this gap, which should be adjustable and set just so wide that the tube glows properly with no patches and rings of green fluorescence in that part which lies behind the plane of the anti-cathode. This spark-gap is, of course, distinct from the equivalent spark-gap which gives a measure of the resistance of the tube. (See Fig. 22.)

The action of a series spark-gap on the inverse current is simply one of resistance which, while of little

importance to the current in the right direction, is sufficient to prevent the inverse current getting across.

For voltages over 24 and under 100, it is better to have a "point and plate" spark-gap instead of two points. Electricity always flows more easily from a point to a plate than from a plate to a point. The resistance is thus greater in one direction than the other—partaking somewhat of the properties of a valve.

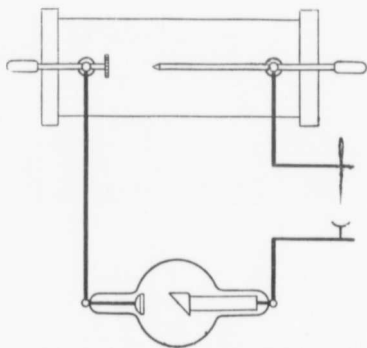

Fig. 22. A Series Spark-Gap between the anode and the coil to suppress any inverse current.

This enables us to get rectification of the current with a shorter gap than if two points were used.

This type of rectifying device is not entirely successful if we are using a big coil and a primary voltage of 200 or more. The gap has to be made so long that too much resistance is placed in circuit with the tube. Further, if we are using an electrolytic break and heavy currents as required in rapid exposures, it is quite useless. Then the discharge between the point and plate partakes of the character of a flame or arc, and once this is established the reverse current gets across quite easily.

To meet these circumstances the valve tube of Villard is highly satisfactory, for moderate currents at least. This is a vacuum tube so arranged that its resistance to the flow of current in one direction, is a mere fraction of

that to current flowing in the opposite direction (Fig. 23).

Since Villard's discovery, other valve tubes have been brought out which are capable of carrying any current ever likely to be sent through an X-ray tube.

Valve tubes and other rectifying devices are of great value in prolonging the life, as well as ensuring the

steady action of the X-ray tube itself. They tend to rise in vacuum with use just as the X-ray tube

does, and in other respects are not entirely satisfactory. They nearly always allow some of the inverse currents to reach the X-ray tube.

It will, of course, be understood that if we had a purely unidirectional supply of current for our tube no rectifying device would be necessary. We shall see later on that such a supply is not only possible but more or less easily available, and in all probability valve tubes and such devices will be relegated to the museum of X-ray antiquities.

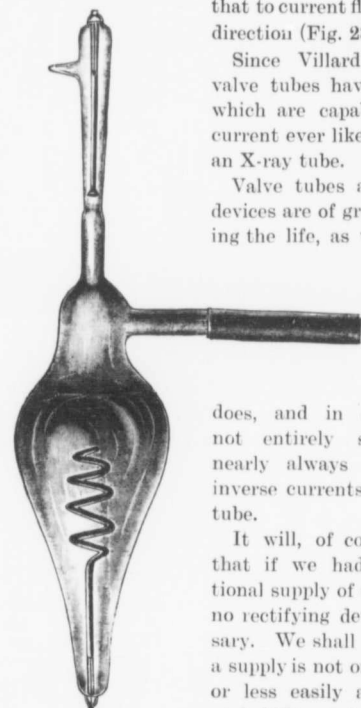

Fig. 23.
Villard's Valve Tube.

The series spark-gap should always be placed between the positive pole of the coil and the anode, and it is

worthy of note that a gap so placed has a material effect in increasing the penetrative power of the tube itself.

Figure 24 shows the general arrangement of the secondary circuit. 1, 2 and 3 show a series spark-gap, a point and plate spark-gap, and a valve tube, as alternative methods of suppressing the inverse current.

In some sets, for instantaneous radiography, as many as three valve tubes are joined across with a view to keeping the resistance of the circuit as low as possible. Another and better method applicable to some forms of mercury interruptor will be given in Chapter VI.

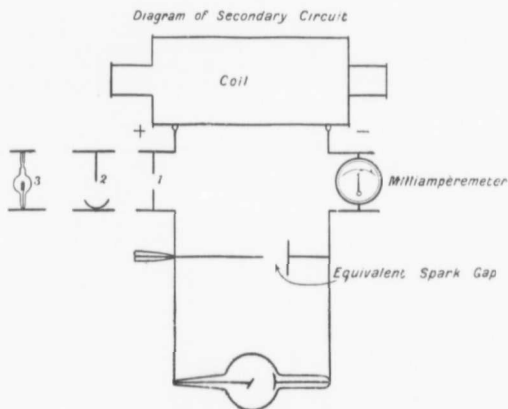

Fig. 24.

It will be noticed that the equivalent spark-gap is so placed as to be in parallel with the tube only, and will always indicate its resistance, when adjusted, without being complicated by the resistance of the rectifying device that may be in use.

CHAPTER VI.

THE ELECTRICAL SUPPLY.

For the excitation of an X-ray tube we require a supply of electricity of very high potential; anything up to 100,000 volts or more.

There are several varieties of apparatus for this purpose, but they all come under two distinct headings.

Under the first we have the Static Machine, and so long as only a small current is required and portability is no object, it answers very well.

Its advantages are that the current is quite uni-directional, and the instrument itself is extremely simple and self-contained. The moment the driving motor is started the tube lights up, and the light is perfectly steady and without flicker.

Owing to the small amount of current available—more often under 0.5 milliampère than over—the tube never gets unduly heated and lasts a very long time, from the absence of the radiographer's bugbear—inverse current.

A Static Machine suitable for X-ray work, requiring as it does at least eight 30-inch plates, is a cumbersome piece of apparatus, and as the requirements of modern radiography necessitate large currents through the tube, it is not likely to increase greatly in favour.

Under the second heading we have the class of high potential transformers, including the Induction Coil, which is the one most commonly used at present.

The High Potential Transformer with valve tubes to suppress the current in one direction has passed out of use.

In 1907, Mr. H. C. Snook, of Philadelphia, brought out an apparatus which is a great advance for rapid and instantaneous work. (Fig. 25.) It consists essentially of a high tension transformer of large capacity and immersed in an oil tank for insulation purposes. It has a synchronous switch or rectifying commutator fixed on

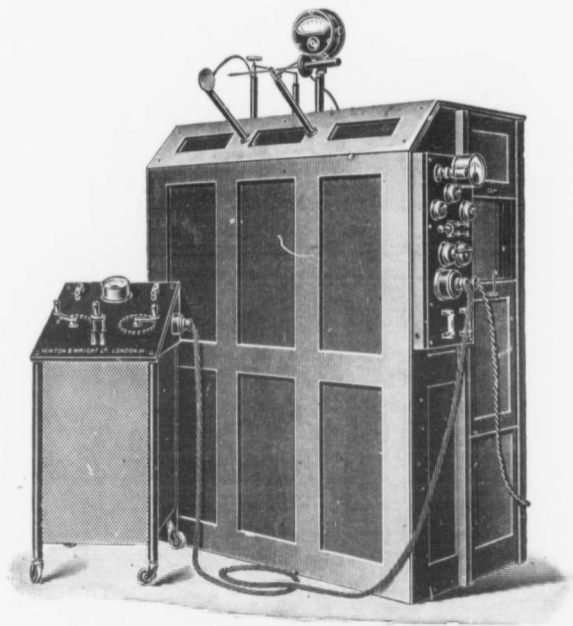

Fig. 25. Snook High Tension Rectifier.

the shaft of the machine, which acts on the high tension current and causes it all to traverse the tube in the proper direction. All the current is made use of, and there is no inverse current whatever. The transformer has such a capacity that as much as 100 milliamperes or more can be passed through the tube, enabling good radiographs of

the abdomen, hip, etc., to be taken in a fraction of a second.

The apparatus is quite self-contained and complete—no interrupters, condensers, spark-gaps, or valve tubes are necessary, and the current through the tube is under the most absolute control from the smallest current to more than any tube yet designed could successfully withstand for more than a very few seconds at a time.

There have been many imitations of this device, and a number of them are in more or less constant use, especially in hospitals. On account of the noise and a certain amount of vibration they are not very suitable for a dwelling-house, nor are they satisfactory where only small currents are required as in treatment. This is due to the rounded sweeping curve of the current as distinguished from the high sharp peak of the current from the induction coil. An X-ray tube has a certain amount of inertia, and a higher voltage is necessary to start it working than is required to keep it running. When connected to a machine of this kind it is not until a relatively high voltage is reached that the tube begins to work, and then the current that passes is too high for many purposes. The case may be compared to that of shifting a heavy weight along the ground; we may be unable to move it by pushing with all the force of which we are capable, but by tapping it with a hammer it is made to alter its position quite readily. The slow steadily increasing pressure of the transformer current does not so readily overcome the inertia of the tube as the sudden sharp blows of the current from an induction coil. This defect of the transformer can be rectified partially by making the collecting blades very short, so that only the higher voltages are used, but this does not overcome the difficulty altogether. Another consequence is that for screening purposes we require about twice as many milliampères from the transformer to get the same effect as when using a coil. This is, of course, very hard on the tubes, but it is possible that a

method of cutting out two or three of every four impulses will overcome this drawback to some extent at least. As usually constructed the tube receives about 100 impulses per second, whereas 25 is quite enough to give a sufficiently steady illumination.

The advantages of machines of the Snook type are their great power and their freedom from inverse current; for rapid radiography they are invaluable, but it is an open question if they will ever become really popular. The induction coil is being continually improved, and as its current is so eminently suitable for working X-ray tubes, it is possible that it will ultimately prevail.

At present it is the high potential transformer most commonly used, and it may be said that the demands of X-rays workers have done more than anything else to develop it to its present high state of efficiency. A further impetus to this has been given by wireless telegraphy.

While the induction coil can never be so highly efficient as a transformer of electrical energy as an apparatus having a magnetic circuit in the form of a closed ring or parallelogram, the straight iron core can be much more rapidly demagnetised, and though more wasteful of primary energy the secondary output is much to be preferred for exciting X-ray tubes.

The construction of a large spark coil differs in no essential particular from those used in medical treatment, but it will be as well to go over the various parts of a modern standard coil which are shown in the accompanying diagram.

If we follow the current from the battery at the lower left-hand corner, at T, it leads first to the screw *d* which carries one of the pair of platinum points B which are normally in contact. The current now travels down the spring which carries the second of the points B and the iron block H, and is then led to the primary winding PP on the iron core T, and so back to the negative pole of the battery.

The current in traversing the core T renders the latter strongly magnetic, and causes it to attract the iron block H, separating the platinum points B. This breaks the flow of current—the magnetisation of T ceases, and by virtue of its spring the iron block H is drawn away from T until the contacts B again come together and the whole process is repeated.

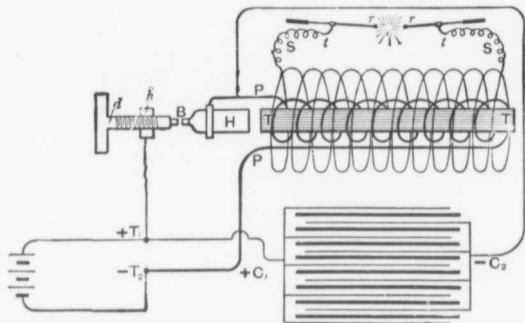

Fig. 26. Diagram of Induction Coil (from Wright's *Induction Coil*).

Owing to the enormous self-induction of the primary coil there would be great flashing and burning of the points B if some means were not taken to suppress it. Also the demagnetisation of the core T would be so slow that the necessary sudden change in the surrounding magnetic field would be absent, and we would get a very short and useless spark from our coil.

For this reason we introduce a condenser C₁ and C₂, which at the moment of "break" absorbs the self-induction current. This immediately rushes back through the primary winding, neutralising any residual current and completing the demagnetisation of the core T. When contact is made again the condenser is short-circuited and idle, but made ready for action at the next "break."

The current from a large spark-coil is an alternating one, but the impulses in one direction are less than in the other. The smaller impulse is known as the "current at 'make,'" and is the result of the flow of current into the primary coil. The larger and more powerful impulse is the "current at 'break,'" and is the one we make use of for our purpose.

While the current at "make" is of such small magnitude compared to the "break" current under ordinary circumstances, it sometimes reaches a magnitude that becomes troublesome—the more easily since the resistance of an X-ray tube is less to an inverse current than to one in the proper direction.

It will be readily understood also that the inverse current will be greater with a high voltage current in the primary than with a low one—the reason being, of course, that with a high voltage the current enters the primary winding more suddenly.

It is also the case that some forms of interrupter facilitate this sudden entry of primary current, tending to create an inverse current of comparatively high value.

In selecting a coil for X-ray work we have to consider the class of work it is desired to do, whether it is to be portable or to remain in one room, and the kind of current available for working it.

Under no circumstances should one be chosen which is not capable of giving a continuous stream of 10-inch sparks under normal conditions of working and without the least risk of the insulation breaking down.

Any reputable maker will give a guarantee of this with his coils, and it should always be obtained before purchasing one.

To describe even a small proportion of the outfits available would take far too much space without any commensurate advantage; so only one or two, typical of the whole class, will be noticed.

Supposing we want a coil outfit for general purposes that could be used either in the physician's consulting

room or at the patient's house. Probably no better exists than the one I had made for my own use by Newton & Co.

It consists of three boxes and the nickel-plated tube which forms the upright of the holder for the X-ray tube.

In the smallest box is a 24-volt accumulator. The cells are of 30 ampère-hour capacity, and will be found quite large enough to meet any ordinary demand.

The next larger box contains the 10-inch coil, interrupter, condenser, regulating resistance reversing-switch, and terminals for attaching the wires from the battery.

The largest box contains two X-ray tubes, screen and

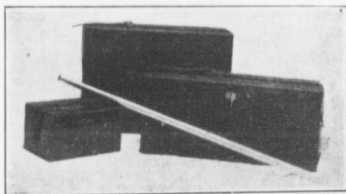

Fig. 27. Portable X-ray Outfit, packed for transport.

fluoroscope, lead-lined cell for X-ray plates up to 12" × 10", and all the accessories.

This outfit can easily be transported to any distance, and is capable of dealing with any work likely to be called for, but it will not do for rapid or instantaneous exposures of the thicker parts of the body.

If, on the other hand, it is desired to have something more powerful and portability does not come into the question, then a larger coil capable of giving 15-inch or even 18-inch sparks will be advisable.

Though we seldom have our tubes harder than a 6-inch equivalent spark-gap, and more often from 3-inch to 4-inch, it is a fact that the larger the coil within certain limits, the better are the final results. Moreover, a tube which seems to be too hard on an 8-inch coil works quite

smoothly on a 15-inch or 18-inch coil, and in fact, carefully used, the life of a tube is greater with a big coil than with a small one. Thus, while more expensive at first, large coils are more economical in running, and, what is the most important point of all, the results are much more uniformly successful. There does not seem, however, to be any advantage in employing coils larger than the 18-inch size. Fig. 29 shows a very useful set for the consulting room.

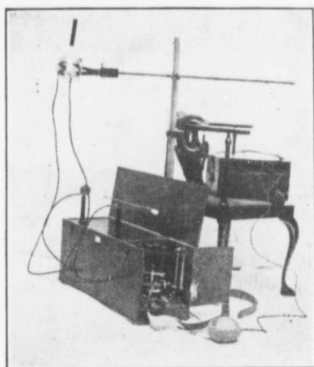

Fig. 28. Portable X-ray Outfit in use. A chair is used to clamp the tube-holder to.

With regard to the current for working the coil, for all ordinary purposes a continuous current of about one hundred volts is to be preferred.

If a continuous current from the main street supply is available, this should be used whatever its voltage—this will be not less than 100 volts and more often 200 volts or even 250 volts, which is the highest voltage that can be taken inside an ordinary dwelling.

The higher voltages enable one to do the most rapid work with a large coil, but on account of the high tension of the secondary current at "make" the X-ray tubes do

not last so long, even though a valve tube is used to suppress this inverse current.

Primary batteries, dry cells, and alternating currents are best avoided for operating spark-coils. They can be used, but the first two are costly and unsteady in action, while the last require special devices which are not too satisfactory.

At the same time if the supply from the main is an alternating one, it is better to obtain the necessary power therefrom than to depend on accumulators which have to be sent away for re-charging at more or less frequent intervals. There are several ways of making it serve our purpose, and perhaps the best is to instal an alternating current motor coupled to a direct current dynamo; the latter should be capable of giving an output of at least 20 ampères at 100 volts. This at once provides continuous current, and standard apparatus can be used without any alteration. Lately there has been introduced a modification of the mercury vapour lamp which acts as a rectifier and provides an undulating current that is quite unidirectional, and can be used in the same way as continuous current. The only part that has to be renewed from time to time is the large vacuum bulb, but as this is required only about once a year, and a spare one can be kept in readiness, the disadvantage is not a serious one. A motor-dynamo requires more or less constant attention, though not very much, to keep it running well.

Still another method is to have a special form of interrupter for use with alternating current which picks up only the waves in one direction, ignoring the others. Some of these appear to work fairly well, and may be recommended where simplicity and economy are important considerations. They are not so good as the ordinary arrangement with continuous current.

There is another method that may suit some cases, and that is to have a Snook transformer specially constructed to work directly from the alternating main. The rectifying device is driven by a small synchronous motor which,

USE OF ALTERNATING CURRENT. 71

being supplied with the same current as the transformer, keeps in correct phase with the high tension current from the latter. It is somewhat cheaper than the usual construction and answers equally well. The only precaution to be taken is to see that the cables from the source of supply are sufficiently heavy to allow the sudden use of from fifty to one hundred ampères without appreciable fall in the voltage. I have found such a machine quite satisfactory in hospital work, and for rapid and

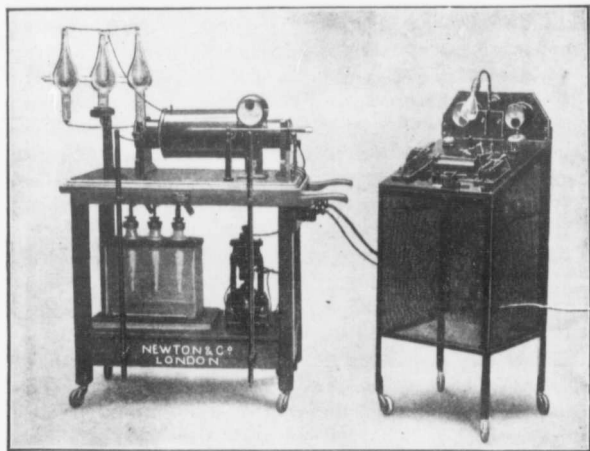

Fig. 29. An X-ray Outfit for Consulting Room or small Hospital.

instantaneous radiography it is perhaps as good an arrangement as there is when the current from the main is an alternating one.

Chemical rectifiers, which were much advocated at one time, have not become popular, though there may be circumstances where it might be advisable to instal them. They depend for their action on the peculiar property of aluminium in offering a high resistance to the passage of

current when it is made the anode of an electrolytic cell; at the same time it offers no particular resistance when it becomes the cathode. A battery of these cells suitably arranged may be used to operate X-ray apparatus designed for the continuous current. They are messy contrivances, and on account of the heating of the electrolyte, have to be made very large. Almost any of the other methods of dealing with the alternating current is preferable to this.

Accumulators, or storage batteries are suitable for working X-ray coils and are necessary for portable sets and where no electrical supply is available, or where it is an alternating one. From 12 to 18 cells are required; they should be of at least 30-ampere-hour capacity and substantially made in every way. On account of their weight they should be arranged in boxes of six cells for convenience in handling. Carefully used they will last for years; if neglected and handled roughly their useful life is very short. To get the best results accumulators should be regularly charged and regularly discharged, taking care never to run them down too far or to exceed the current they are made to stand, and to make it a rule to put more into them than is taken out. Whether used or not they should have a short period of charging every three weeks to keep them in good condition. Probably the greatest trouble about accumulators arises from the carelessness of the electricians, or their assistants, who undertake the charging of them. Seldom is any care taken, they are either only partially charged, or charged with an excessive current to save time; acid is spilt over the terminals, and frequently, to save connecting up a voltmeter, the terminals are short-circuited for a moment with a piece of thick copper wire to see if the cells give a good "flash"; the best accumulator will stand this treatment for only a very short time, and he who would get the best service from them is advised to study the subject and attend to the details himself.

CHAPTER VII.

INTERRUPTERS.

The number of these devices that have been brought out would, for their description, require the space of a fair-sized volume. Happily this is not required, and all we need to concern ourselves with is a consideration of one of each class. In describing any interrupter I do not mean to say that it is the best of its class, though it may be the one I am most familiar with.

The simplest form of interrupter is the "Platinum Hammer," which is essentially the same as made by Apps, though more recently other inventors have so modified it that its efficiency is somewhat increased.

Its action is referred to in the description of the induction coil.

In Fig. 30 it will be noticed that there are two regulating screws—the upper one carries the fixed platinum contact—the other point being mounted on the back of the iron block or armature—H.

The lower screw is for regulating the tension, and by turning to the left the spring carrying the armature is pulled back, causing the contacts to be more tightly pressed together.

When both of the screws are slackened the armature face is about one-eighth of an inch from the end of the core of the coil.

The adjustment of this break requires some practice, as some coils require a different adjustment to get the best result. As good a method as any is the following:—

Both screws being slackened, and the platinum faces C C being nicely smoothed and flattened with a fine file, the upper screw B is turned to the right until the platinum contacts are *almost* touching—leaving a space between equal to the thickness of a visiting card. The clamping nut on B is now run up against the pillar, so as to prevent this screw turning while the coil is in action.

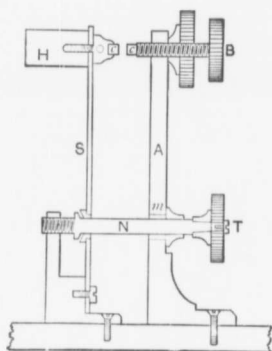

Fig. 30. App's Contact Breaker (from Wright's *Induction Coil*).

The current being turned on, the lower or tension screw T is slowly turned to the left, and the moment the contacts come together the current flows and the coil is in action, very gently at first. As the tension is increased the output of the coil increases, but the interrupter works more slowly owing to the fact that the core of the coil must become more highly magnetised before its pull upon the armature is sufficient to separate the platinum contacts.

This form of interrupter is used only on portable coils or those taken abroad on a campaign for which it is very

suitable from its simplicity, and the fact that almost every case can be radiographed by the aid of a coil fitted with it, but of course in the more difficult cases the exposure has to be inconveniently long.

It works at its best with a current of from 12 to 24 volts, and the amount of inverse current is so small as to be quite negligible.

In buying a big coil outfit it is a good idea to have one of these interrupters fitted to it as a reserve in case of the failure of the break usually employed.

As a matter of fact, no one taking up X-ray work at all seriously should have less than two breaks always ready for immediate use. This will save much annoyance to all concerned in case one should fail at a critical moment. The two breaks should not be the same—this gives a wider range to the usefulness of the outfit. If one is a platinum break the other should be mercurial or electrolytic, or even all three may be installed with advantage.

Mercury Interrupters are more used in induction coil sets than any other form.

Their great advantage lies in the fact that mercury being fluid at ordinary temperatures is very easily manipulated, so that a good contact as well as a sharp sudden "break" is more or less easily obtained. On account of this good contact, the current at "make," other things being the same, is greater with a mercury interrupter than with the platinum form. It is, however, never so great as to give serious trouble, and on voltages of 50 or under it need not be considered. Between 50 volts and 100 volts a plain spark-gap or the "point and plate" form will suppress it quite well. At 200 volts or more some form of valve tube is necessary.

Probably no form of interrupter has been subjected to more various designs than this, but as is most often the case they can all be brought under a comparatively small number of headings.

They are (a) the dipper, (b) the jet, and (c) the centrifugal.

Dipper Breaks.—In the early patterns a curved and pointed copper wire was attached to an iron armature mounted as in the platinum break. The free end dipped into a vessel containing mercury so that when at rest its point was slightly immersed in the latter. When current was turned on the iron armature was pulled forwards, and the point left the mercury, breaking the circuit. The vessel had to be filled up with alcohol or other dielectric fluid to wipe out the intense spark at "break," as well as to prevent the too rapid oxidation of the mercury. In fact in every mercury break some fluid or gas is always employed for this purpose. The fluids are methylated spirit, alcohol, or petroleum, and the gases, ordinary illuminating gas, or, what is perhaps better, pure hydrogen.

The next step was to cause the copper point or blade to enter and leave the mercury by mechanical means, independently of the coil itself.

For this a small electric motor is always used, the dipping wire being connected to a crank attached to one end of its shaft. This gives a much better control since the current through the primary can be varied independently of the speed of the motor.

A modification of this is that designed by Sir James Mackenzie-Davidson, in which an inclined revolving shaft, carrying on its end a copper blade—like a single blade screw propeller—alternately makes and breaks contact at each revolution. This was very popular at one time and worked excellently when first started, but its action falls off as the mercury becomes dirty.

Mercury jet breaks are very popular, and, as a rule, are very satisfactory in practice.

In all forms, of which there are many, some simple form of centrifugal pump is used to pump the mercury from the bottom of the containing vessel to the jet from which it issues in a small stream. This jet impinges on a copper tooth once or oftener in the course of a revolution.

In some breaks the jet is fixed and the copper teeth revolve close to its orifice; but more usually the teeth are fixed and the jet is integral with the rotary pump and revolves with it.

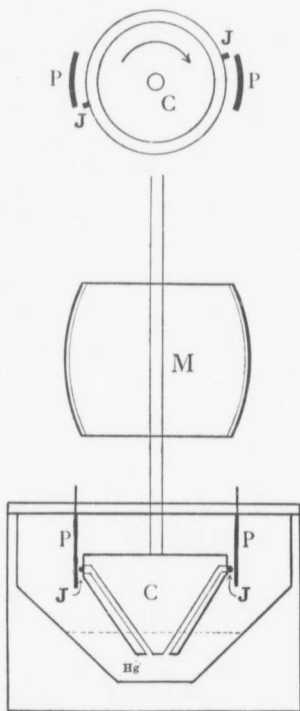

Fig. 31. Principle of Mercury Jet Interrupter.

There are a number of interrupters on the market working on this principle, and any of them made by well-known firms may be trusted to give satisfactory results.

As usually constructed a small motor is mounted on top with its shaft vertical and directly connected to that of the centrifugal pump inside. The accompanying diagram (Fig. 31) shows the general scheme. The whole is contained in an iron pot, provided with stout lid of non-conducting material, such as ebonite or fibre, fitted to be as nearly gas-tight as possible. In the bottom of the pot is placed some mercury, Hg, and dipping into this is the pump C. This is of conical form and made of any suit-

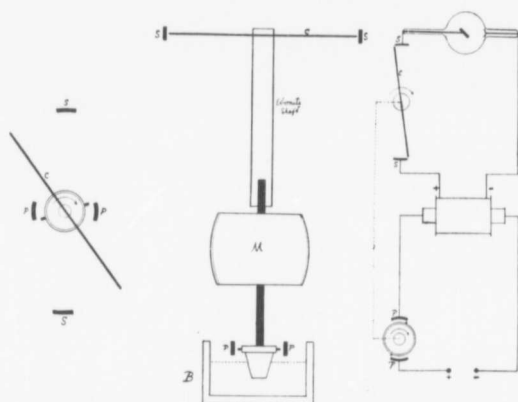

Fig. 32. Scheme of "Morton" Apparatus.

able material not influenced by mercury. It is provided with channels leading from near the centre below upwards and outwards to the jets J J at the periphery above. Rotation of the pump C causes the mercury to pass up the channels and out by the jets J J. The plates P P form part of the primary circuit to the coil, to which the current can flow only when the jets are playing on them. The jets and plates require to be very accurately placed so that they break contact at the same instant; interruption taking place at two points instead of one is a

distinct advantage and makes the "break" more sudden and complete.

I may now describe a method of completely suppressing the inverse current from the coil which was designed by myself some years ago, though only lately developed in practical form. The scheme is shown in Fig. 32, and is seen to be a break as in the previous diagram, with a stout ebonite shaft attached to the upper end of the motor spindle. This, in turn, carries at its upper end a wire connector C, which as it revolves with the motor just clears two segments S S, interposed in one side of the secondary circuit to the X-ray tube. The primary and secondary circuits are effectually insulated from each other by the ebonite shaft. The segments S S are mounted on a large wooden ring placed concentrically with the shaft and adjustable around the latter. It is thus easy to arrange that the connector C comes into line with the segments S S only at the moment of "break." At the left of the diagram is shown the relation of the essential parts at the moment of "make." The jets are just about to play on the primary contacts P P, while the secondary circuit is wide open at the air gaps between the ends of C and the segments S S. In practice the total gap is about eight inches, and is too much for the secondary current at "make" to jump across. It dies out before the connector C reaches the segments, and at the moment of "break" the secondary circuit is closed. This is shown at the right of the diagram, which also shows the connections in the primary and secondary circuits. The scheme is entirely efficient, there is nothing to burn out or wear out, it adds no complication to the X-ray outfit, and the slight extra cost is rapidly saved in the absence of valve tubes and the longer life of the X-ray tubes. Results are improved in every way, and one does not realise what an extremely inefficient and erratic device the valve tube is until such a scheme as this has been in use for a time. A complete outfit, known as "The Morton Apparatus," is now available and likely

to become popular among radiologists. It is supplied with a slow running jet break that can be adjusted to suit most requirements.

In some forms of this type of interrupter the magnetisation of the coil itself is used as the driving force; Bécclère's interrupter is an example of this class, and is one that has gained great popularity, being suitable for large or small coils and for any voltage. (Fig. 33.)

In all forms of mercury interrupter some dielectric fluid or gas must be used to wipe out the spark at "break" very suddenly; coal gas is one of the best and is easily

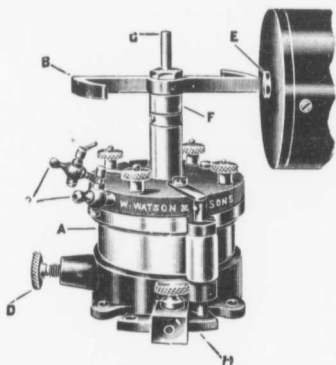

Fig. 33. Bécclère's Interrupter.

available. A small rubber bag will carry enough for a busy day's work, and most interrupters are now made to use it, if desired.

Except where weight and space are considerations, as in portable outfits, every interrupter should be provided with its own motor, so that its speed may be controlled independently of the current through the coil itself; otherwise it is difficult to use the small currents required in treatment, as the break may refuse to work except with a current that is more than we require.

It will be understood that the diagram, Fig. 31, shows this type of interrupter in its simplest form, and only such parts as are necessary to illustrate the principle of working. As here shown there would be two interruptions for each revolution of the motor, but it is easy to see that another pair of plates at right angles to P P could be fitted and so double the frequency of interruption without increasing the speed of the motor. Some are made to give eight interruptions for each revolution of the shaft, but the advisability of this is very much open to question. This is found mostly in breaks meant for voltages of 200 or over, and they are usually driven at very high speed. This gives a high frequency of interruption, the duration of contact is very short, and very little resistance is used in series with the coil. The result is that the current rushes into the primary coil very suddenly, increasing the secondary current at "make," and it is cut off before the iron core is fully magnetised, decreasing the secondary current at "break." Both these effects are in direct opposition to our requirements, and rapid radiography under such conditions means a high rate of mortality among valve tubes and X-ray tubes, as well as frequent disappointments in results. The large iron cores now used in X-ray coils require time to get magnetised as well as large currents, and it is not possible for an interrupter designed for high speed and small currents to get the greatest output from a large coil. A slow rate of interruption gives a series of flashes from the tube of the highest intensity, one of which is of more use to us than a dozen of the relatively feeble impulses obtained when a high speed break is used. Though the high speed break may give the most impressive discharge across an air space, it does so because a large portion of it is reverse current—current at "make"—and for our purposes worse than useless. The proper way to increase the output of a coil for X-ray purposes is to increase the intensity of the individual impulses, and this can be obtained only by a relatively

low rate of interruption. Under favourable conditions one single flash is enough to radiograph the thicker parts

of the body, but this is not within the range of an ordinary coil.

The third class, or centrifugal type of mercury breaks, is of comparatively recent introduction and has many good points. The principle of action is shown in Fig. 34.

The driving force is obtained from a small electric motor M, so mounted that its shaft is in the vertical position. Mounted on this shaft and revolving with it is a cast iron container C, into which is placed some mercury and the dielectric fluid, which may be petroleum or alcohol.

When it is made to revolve rapidly, the mercury, being the heavier fluid, will tend to form an equatorial belt, Hg, round the inside and moving

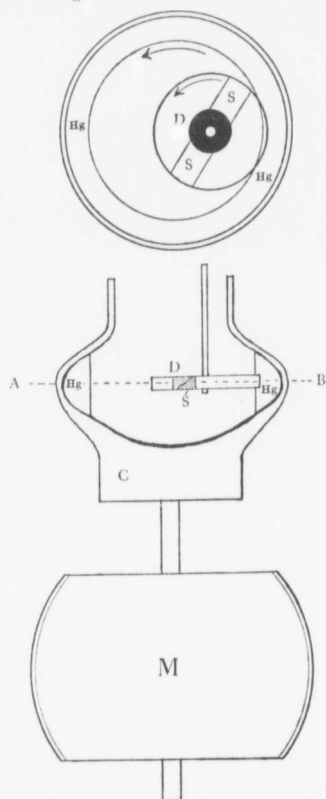

Fig. 34. Principle of Centrifugal Type of Mercury Interrupter. Above is shown a plan of section across the line A B.

at a velocity only slightly less than that of the jar itself.

A fibre disc, D, with two metal segments, S, is mounted on a vertical shaft and so arranged inside the container that its edge can be made to engage the whirling band of mercury more or less at will. The electrical connections are such that contact is made when a metal segment enters the mercury, and the break occurs as it leaves. Owing to the centrifugal action there is no tendency for the mercury to cling to or follow the disc, and the break is very sudden and complete.

I have had one of these interrupters in constant use for five years, and during that time it required no attention whatever except the occasional addition of a small quantity of fluid and mercury, and cleaning at intervals of a year or so.

Instead of the revolving segmented disc, another maker has arranged for a copper plunger to dip in and out of the mercury once or twice to each revolution of the container, and this gives equally good results so far as one can see.

All mercury breaks require a certain amount of care and attention to ensure proper working. Bearings should be kept oiled as well as other moving parts, and these should be adjusted to run as quietly as possible. A noisy, rattling interrupter is an abomination in any room.

As soon as the mercury becomes emulsified it must be cleaned, and no one should do this dirty, messy job so long as he can find anybody else to do it for him. As this is intimately related to the character of the dielectric medium in which the break takes place, we may consider the two together.

In the selection of a dielectric medium for the break, the really essential condition is to choose one which does not contain oxygen, either free, or in an unstable state of combination, and so long as this condition is fulfilled it matters little whether the substance be a gas or a liquid; petroleum and methylated spirit are the liquids most commonly used, and if a gaseous medium is required, ordinary house gas or hydrogen will give excellent results.

Petroleum answers well, but the recovery of the mercury is troublesome. Absolute alcohol is the best but it is expensive. Rectified spirit is practically as good and much cheaper, while methylated spirit is but slightly inferior to either, and is the cheapest of all.

The mercury does not become dirty nearly so quickly as with oils and petroleum, and when it is desired to clean the break and restore the mercury to its original condition, all that is necessary is to draw off the surplus fluid after removing the top of the apparatus and place the open vessel in a warm place but away from a flame of any kind. In a very short time the spirit will have evaporated and most of the mercury returned to the mass. Floating upon the surface of this will be a lot of dark grey friable material, which was the black mercurial mud before the drying took place. A large amount of the mercury is held in the meshes of this dried mass, and, when pulverised, it will be found that only a comparatively small amount of blackish powder remains. This is, of course, derived from the mercury and represents so much waste, but the proportion is so small as to be negligible, and is thrown away. Its origin is probably from traces of air dissolved in the liquid, or churned into it while the break is in action, and this combining with the mercury forms the black oxide of the latter.

While the alcohols are very satisfactory for use in mercury breaks, yet, where circumstances permit, preference should always be given to a gaseous medium. It is cleaner and more efficient in every way, but of course it cannot be used under the conditions of naval and military service except in hospitals, where a supply of coal gas is easily obtainable.

Speaking generally, if we take any mercury break primarily designed for a liquid dielectric and adapt it to the use of house gas or hydrogen, its efficiency will be increased thereby, and, as for cleaning, all that is necessary is to skim off the surface of the mercury the small

quantity of black oxide which forms after running for a very considerable time.

The last group of interrupters we have to consider is the **electrolytic.**

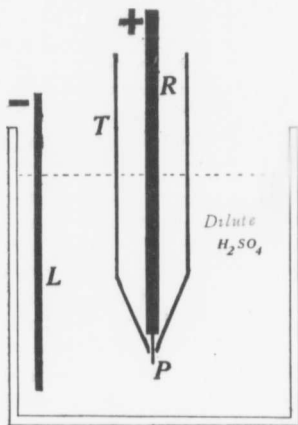

Fig. 35 Wehnelt Interrupter.

There are two kinds the Wehnelt and the Caldwell, or Simon. They differ only in detail, and the diagram (Fig. 35) will serve to show the construction of both. A large jar of dilute sulphuric acid with a lead electrode, L, suspended therein forms the foundation in each case. In the Wehnelt form we have a porcelain test tube, T, in which is placed a lead rod, R, provided with a

platinum wire, P, of such size as just to pass easily through a hole in the lower end of the porcelain tube, T. The amount of platinum protruding through the opening is readily adjustable. In the Caldwell form the platinum is dispensed with and the hole made smaller, or there may be several such holes for the passage of heavy currents. In the Wehnelt form the platinum wire must be the positive pole as shown in the diagram, but with the Caldwell it is immaterial.

With either of these the "break" is so sudden and complete that no condenser is required. It is worthy of note that neither of these will work except in a circuit having a certain amount of self-induction—which the primary winding of an induction coil furnishes.

One of these being placed in series with the main current and the coil, when the current is turned on it has to traverse the narrow path presented by the small platinum wire in the one case or the small hole in the other. The temperature suddenly rises, making a layer of steam or gas at this point which completely cuts off the current. As this occurs beneath the surface of the liquid, condensation immediately follows when the process is repeated. Under favourable conditions this may take place at the rate of about one thousand interruptions per second.

It consumes from three to six times as much current as a mercury break, but from two to four times as much current is forced through the X-ray tube, increasing the X-ray output proportionately. Few, if any, X-ray tubes will stand this for very long, but for radiography this is not necessary as the exposure can be proportionately reduced.

In fact, by using two, three, or even four porcelain tubes in the electrolytic break all joined in parallel, excellent radiographs of the chest, for instance, can be obtained in less than one second, and that with the tube no less than two metres (6ft. 8in.) from the plate. This is known as tele-radiography, and will be more fully described later on.

Batteries should not be used for working this break unless they are very large cells. The Wehnelt form gives the best results with voltages from 70 to 150, while for voltages of 200 and over the Caldwell is much better.

In all forms and under nearly all conditions there is a large amount of inverse current, and it is necessary to use a valve tube capable of withstanding the passage of heavy currents.

There is less inverse current with the higher voltages when the Caldwell break is used, and it gives equivalent X-ray output for about one-half the amount of primary current.

When these interrupters were first introduced, the heavy secondary discharge very quickly wrecked the light tubes then in use. On this account they fell into disfavour, but with the introduction of larger and better tubes capable of standing heavy currents for a time at least, they are becoming popular again.

The electrolytic break is the simplest and cheapest break obtainable both in first cost and upkeep. The power of the coil is vastly increased, but under proper conditions this can be made so small as to be useable for the mild currents used in treatment.

They require a high voltage to work them and a certain amount of study, so as to be sure of getting the desired effects, but, as at present constructed, they are very popular with some radiologists.

The other fittings required for managing our coil are in reality very few, and a very simple form of switch-board is all that is really necessary.

If, however, two or three interrupters are installed so as to be always ready for immediate use, and if arrangements are made for varying the number of effective turns of wire in the primary coil and so on, the switch-board can be made as elaborate and imposing in appearance as anyone could desire; but it does not follow from this that the results will be any better; as a matter of fact, the more experience one has the greater becomes the desire for simplicity in apparatus. The vagaries of the X-ray tube may be safely trusted to prevent the radiographer suffering from *ennui*.

It is advisable to have the following fitted on the switch-board:—Double pole fuse and main switch; reversing switch and regulating resistance; and also an ammeter.

A voltmeter may be added, and if the interrupter is one worked by a separate motor, it is convenient to have a switch and resistance for its control on the board also.

The arrangement of the connections of a coil outfit are shown in the diagram (Fig. 36).

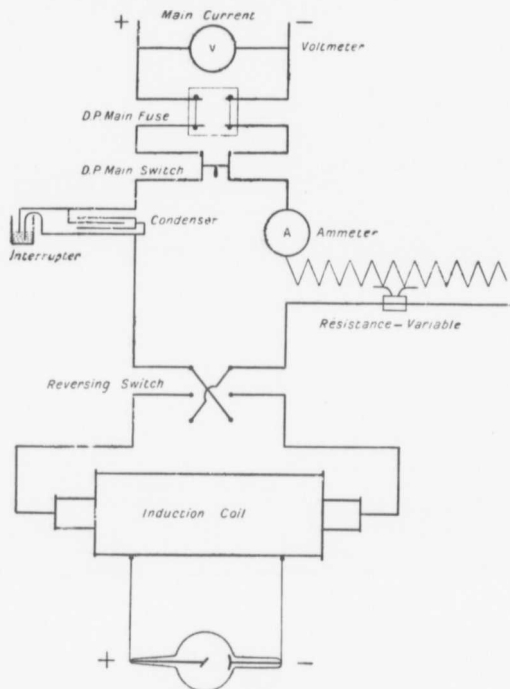

Fig. 36. Diagram of Induction Coil Circuits.

It will be understood that the arrangement given above can be varied in any way that is convenient, so long as the connections are the same. That given here will be found as handy as any, and every switch-board for an induction coil outfit will be found to conform to it. Any apparent variation will be of detail and not of principle.

It can be made more simple without any sacrifice of efficiency. For instance, a voltmeter is not necessary in most cases, and the reversing switch can be made to answer as a main switch as well. The only risk is that of accidentally putting the current on in the wrong direction, and if this is done often the tube suffers.

If an electrolytic break is used, no condenser is required, but, on the other hand, if a mercury break is installed which requires a separate electric motor to work it, then another switch and resistance for regulation of speed will need to be added.

In the diagram on the previous page the control of the current through the coil is by means of a variable resistance placed in *series* with the primary winding. This arrangement is quite satisfactory where the main current voltage does not exceed 100. With higher voltages such as are more commonly used nowadays, it is much better to use a *shunt* resistance, the principle and action of which were described on pages 6, 7, and 8. With this device the voltage applied to the coil never exceeds that just sufficient for the needs of the moment. There is less current at "make," while the "break" is more sudden and complete as the voltage is lower. A series resistance merely controls the volume of current, and the full voltage is present both at the moment of "make" and at the moment of "break." A certain amount of current is wasted, but this is really not worth considering. If the majority of X-ray outfits are supplied with a series resistance it is because it is cheaper to construct, and also because the advantages of the shunt resistance are not generally understood. I am not sure that I completely understood this myself until I had two outfits to work with, one with a series resistance and the other with a shunt. The difference is very striking in favour of the latter when the main current is 200 volts or more. Most switchboards can be readily altered to a shunt resistance at trifling cost and without adding to their complication in any way.

CHAPTER VIII.

ACCESSORY APPARATUS.

Besides the X-ray tube and coil, some other things are required for the practice of radiography, but these need not necessarily be very elaborate, especially if it is only desired to use the outfit occasionally.

We first of all require a Tube Stand and Holder, and unless we are only playing at radiography, let this be a good one, preferably of wood. The upright should rise to a height of five or six feet from the floor and carry an arm having universal movement, with a protective shield for the tube.

The Stand here shown, completely fitted, Fig. 37, is suitable for nearly all classes of work, and anyone starting to practice radiography would do well to have such a one as this.

After having become fairly proficient and experienced it will be time enough to think about selecting one of the many more elaborate and expensive forms to be had from the various makers.

It is necessary to have an X-ray proof shield around the tube itself, and the stand will need to have a fairly heavy foot, so as to give the necessary stability; but this is not so essential if the shield is made of wood and lined with rubber which has been impregnated with lead oxide. While we shall presently be considering the question of protection of both operator and patient from any undesired influence of the rays, it may be here stated

that under no circumstances should an unshielded tube be used for any purpose.

The nicest shields to work with are those of glass, con-

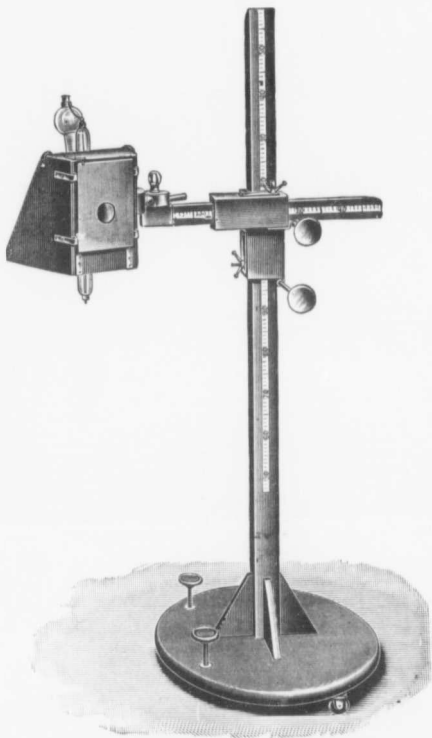

Fig. 37. Tube Stand.

taining a large proportion of lead. This is often spoken of as "English glass," and is that used in the manufacture of cut-glass decanters, bowls, etc. It is very

white and transparent and shows no green when viewed from the edge. One, suitable for a large tube and thick enough to cut off at least 80 per cent. of the rays, is very heavy, and the stand must be made correspondingly strong to carry it with safety.

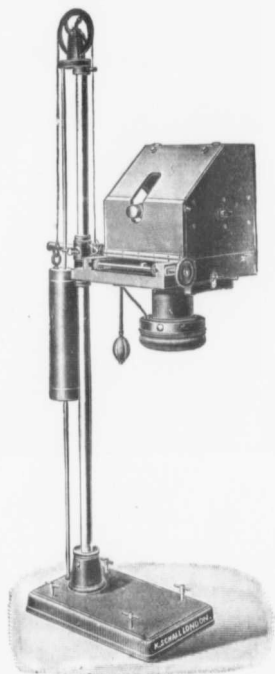

Fig. 38. Tube Stand for compression and fixation of part under examination.

Tube stands are also made to carry not only a tube shield but also tubular and other diaphragms, and may be used to compress the part under examination. This reduces the thickness and ensures steadiness of the part.

Béclère's stand is one of this kind, and very excellent work can be done with it, but it is not suited for stereoscopic radiography, as one of the supporting pillars is in the way.

A modification with only one pillar gets over this difficulty. It is cheaper than the original pattern, but not so rigid. (Fig. 38.)

Another essential is some support for the part to be examined as well as the photographic plate.

So far as the simpler parts are concerned, any ordinary table will do for hands, arms, etc., and a few bags partially filled with clean, dry sand are very useful.

For more serious work an X-ray couch is a real necessity.

In this the user has a wide range of patterns from which to select, from the plain wooden or canvas top table at low price to others which are almost as complicated as a motor car, and correspondingly expensive.

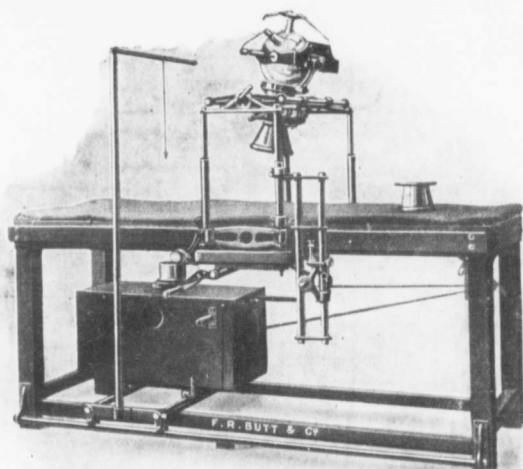

Fig. 39. A useful X-Ray Table for all classes of work.

In this, as in other matters, the simpler forms will be found the most satisfactory.

It is advisable to have one so arranged, that the tube can be used either above or below the patient. In the latter case, canvas or three-ply wood makes the most transparent covering, and a removable top made of wood

can be placed over it when it is desired to radiograph from above. A firm top of this kind is necessary for making stereoscopic radiographs, especially when employing a compression diaphragm. (Fig. 39.)

A very useful couch is that designed by Dr. Ironside Bruce, as it lends itself readily to further additions and modifications as required.

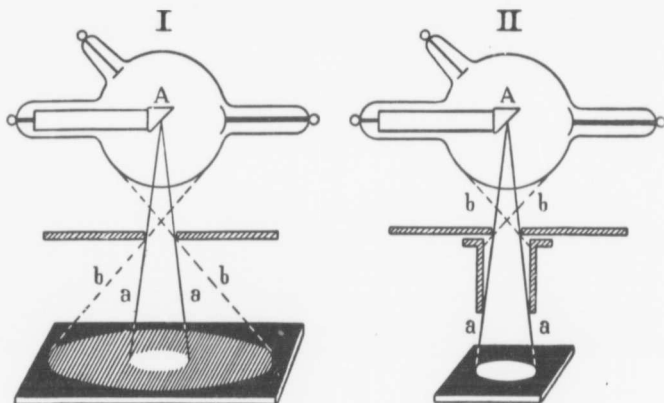

Fig. 40. Effect of Diaphragms.

Diaphragms, by cutting off the stray rays from the walls of the tube, etc., are necessary if sharp outlines are to be secured.

The value of a diaphragm can be very readily demonstrated on the screen. In examining the chest, for instance, the interposition of a metal disc with a central hole, while cutting down the size of the field, brings out details in the illuminated area, which before were quite invisible, besides giving clearer and sharper outlines.

In Fig. 40 it will be noticed on the left that all the stray rays are not cut off, but between the central white

spot and the outer black edge we have an intermediate zone, or penumbra, partially illuminated by some of the stray rays.

The effect of using a tubular diaphragm is seen in the second figure. The central disc is illuminated by the rays from the anti-cathode only, leaving the rest all quite dark. The best and clearest radiographs are obtained by means of this device.

In the compressor diaphragm the tube is about seven inches long and the edge is covered with wood or rubber. The whole is so mounted that it can be made to press down on the part to be radiographed. This is very useful in renal work and about the shoulder joint, as it serves to limit the movements produced by respiration. Also by reducing the thickness of the soft parts there is less diffusion of rays such as always happens when the X-rays pass through an appreciable thickness of partially transparent material. This diffusion increases with the thickness and accounts for the difficulty, even impossibility at times, of obtaining satisfactory radiographs of the renal region in very stout subjects. The increase of density caused by the calculus or the normal bones of the part is so slight compared to the average density that they cast very feeble shadows, giving a flat and unsatisfactory skiagram. Still, by the careful and judicious use of a compressor diaphragm, a very much better result can usually be obtained.

Changing Box or Cassette.—This is a sort of dark slide for the photographic plate and enables us to replace one plate by another without disturbing the patient in any way. It is essential for stereoscopic radiography, and it ought to be used when placing a plate under the thicker and heavier parts of the body—especially if working on a couch without a wooden top firm enough to prevent bending of the plate. To have a plate break under the patient, especially after the exposure is made, is a most annoying accident, and worth taking precautions against. The slide carrying the plate is large

enough to take one measuring $15'' \times 12''$, either position, and provided with thin wooden frames fitting into one another and corresponding to the sizes of plates ordinarily used. By means of guide lines on the top of the cassette, centring is easily secured.

Some form of penetrometer or radiometer for rapidly testing the penetration of the rays at any time is a great convenience.

There are several forms in use, and each has its supporters, but the same figures do not mean the same degree of penetration on the different scales.

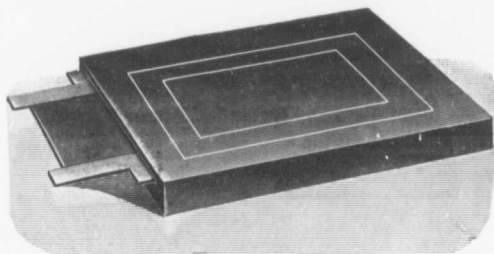

Fig. 41. Changing Box.

Personally, I prefer that designed by Wehnelt, Fig. 42, and it is becoming increasingly popular among X-ray workers. In this a plain strip of silver is fixed alongside a wedge-shaped strip of aluminium. The two are moved across a small barium platino-cyanide screen until the degree of illumination is the same through the two metals. A scale moves with them and is read off directly. No. 9 on this scale is the most generally useful degree of penetration for radiography. It may be one or two degrees above or below this to meet certain conditions.

So far we have been considering the case of the tube being used above the patient and the plate below. This is probably the position mostly employed, but the use of a tube below the couch is one that has many advantages,

X-RAY COUCH FOR SPECIAL WORK. 97

and for making a general skiagram of the urinary system it is probably the best.

Further, it enables one to make a preliminary examination with the screen, and ensure the tube and plate being placed in the best possible position.

Also in renal radiography, by placing an air pillow under the patient's abdomen, the thickness is greatly reduced and the normal movement of the kidney arrested. In this position it is possible at times to diagnose renal calculus with the fluorescent screen.



Fig. 42. Wehnelt's Radiometer.

A couch arranged for the tube below is provided with means for enabling the box containing the tubes to move along and across with great ease.

The box is made of or lined with X-ray proof material, and should be provided with an iris diaphragm that can be actuated while observing the screen image.

Couches, embodying all these and other advantages, can be obtained from most electro-medical instrument dealers. (See Fig. 39.)

Of course the number and variety of appointments one may have in one's room are legion, and anyone wishing

information on such is referred to a larger work, or, what is better, a selection of instrument makers' catalogues.

Those here indicated are sufficient for a beginning, or where the apparatus is used only occasionally.

In view of the great variety in design of X-ray apparatus, it would be useless to attempt to describe the method of setting up for practical use.

This naturally varies in detail with each maker's instrument, but a description is always sent if the purchaser has not had the benefit of a personal demonstration. In any case it is a matter of great simplicity and need not cause any anxiety if one will only follow the simple directions supplied.

Having got it arranged and properly connected up, the coil should be started in the manner required. The room should be somewhat darkened, and the first thing to notice is whether the current is going through the tube in the right direction. If we do not see the clear apple-green hemisphere, the current should be cut off at once and the reversing switch put over the other way. The tube will now glow in the proper manner, and according to what has been said about tubes in a previous chapter, we can form a fair idea of the character of the rays given off.

A still better idea can be obtained by examining one's own hand by means of a fluorescent screen, but this is a most dangerous habit to get into, as many of the pioneers in X-ray work know to their very serious cost.

Some makers supply a skeleton hand embedded in wax and covered with a leather glove, as a test object. It has a metal-guarded handle and should be used instead of one's own hand. It would be impossible to say too much against the use of the latter. So far as our experience goes, once chronic X-ray dermatitis is contracted, complete recovery seems impossible to attain. Even if X-rays are not again allowed to fall on the part, a more or less progressive disease is set up and sometimes amputation has been necessary. On this account the most elaborate precautions have been devised for protecting the operator

from X-rays, and these are necessary for those who have suffered from prolonged and repeated exposure thereto.

As this treatise is for beginners and will be used by them for the most part, it may here be said that for them such devices are quite unnecessary, if they will only exercise a little common-sense and follow a few simple directions.

Through the simple expedient of always standing behind the plane of the anti-cathode, and where possible at a distance of from one to two yards from the tube, the writer has entirely escaped any deleterious influence. Difficulties, of course, arise when conducting screen examinations, but X-ray proof gloves are a full protection.

Owing to the broadcast publication of the sufferings of those who were severely damaged in the early days—with whom I have the deepest sympathy—the public are fully alive to the dangers of X-rays, and anyone coming to be radiographed has more confidence and less fear of being “burnt” if some special protecting devices are in evidence.

Of course the risk of burning a patient in the course of taking one or two radiographs is, under modern conditions, a negligible quantity, but the public are not so sure of that, and, if only for this reason, some form of tube shield should always be used. One of lead glass, Fig. 43, is the nicest, but both heavy and fragile. Equally good are those of wood, lined with rubber which has been impregnated with lead oxide.

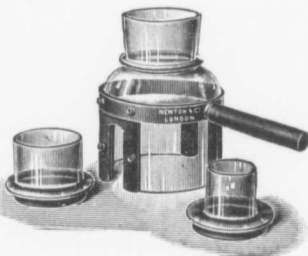

Fig. 43.
Lead glass Shield, with adapters.

If the tube shield has some form of adjustable diaphragm provided at the opening from which the useful rays emerge, it will be found a most useful adjunct.

If anyone now contracts a chronic X-ray dermatitis, it may be said with safety that it is his own fault, and due solely to slackness and extreme carelessness. The best instrument for testing the tube is the Wehnelt penetrometer, which has already been referred to, and it will be found the best policy to get one of these at the beginning and use no other. The most generally useful degree of penetration registers No. 9 on the scale.

CHAPTER IX.

RADIOSCOPY.

Having got our apparatus working satisfactorily, probably the first thing to be attempted is the use of the fluorescent screen—sometimes spoken of as a radiosopic examination, and for this the operator should *always* wear X-ray proof gloves.

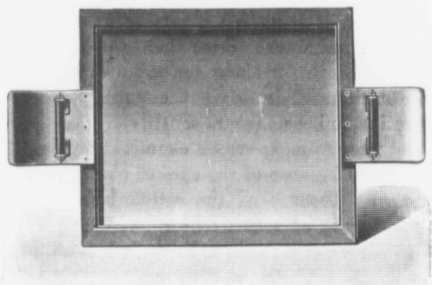

Fig. 44. Screen for Radioscopy.

These screens are made of substances which fluoresce to X-rays, the substance being coated on stiff cardboard and mounted in a wooden frame. Many materials may be used, but the most suitable is the platino-cyanide of barium, and all screens are now made of this. It gives not only a brilliant image, but also a pure fluorescence without any trace of phosphorescence, which would mar the result.

It should be provided with metal guarded handles, and faced with a sheet of stout lead glass—this protects the operator from the rays, and the screen itself from dust and dirt. The screen tends to turn a brownish tinge with use, but is restored by exposure to diffused daylight, but it must not be exposed to the sun.

The light is of a greenish-yellow colour—not unlike that of the tube itself when working properly—and is not very brilliant.

For this reason, the personal factor comes in—some people having a greater acuteness of vision for the screen image than others—and also renders it necessary to have some means of darkening the room in daytime, or else using a dark box made of a conical camera bellows, with the screen at the larger end and two apertures at the smaller end to look through. This is known as the fluoroscope, but it is at best a very poor substitute for a properly darkened room. Even then, the observer should remain in the dark for about ten minutes before making the examination. This gives the pupil time to dilate, and the retina to become more sensitive.

The best time to make screen examinations is after sundown, not only because of the ease of obtaining the darkness, but also because of the retina being then at its maximum degree of sensitiveness.

In the interests of both patient and operator, screen examinations should not be prolonged unduly. The part of the patient under examination is not protected, and long exposure may set up an acute dermatitis, or epilation.

It should be remembered that as nothing is absolutely opaque to the X-rays, the protective devices adopted may let through sufficient to more or less seriously affect an operator who makes a large number of prolonged radioscopic examinations.

Except in special cases and in hospitals, it is a mistake to have too large a screen, as the brilliant fluorescence of the outlying parts is a disadvantage. One twelve by nine

inches is most useful and sufficient for nearly all cases—but it is an advantage to have at hand a larger one for occasional use.

Also convenient is a piece of an old screen without frame, and of roughly circular form, with a broad notch cut out of one side as here shown.

Being flexible, it can be fitted into all sorts of places, and adopted to the contour of the part. It should be coated with one or two layers of celluloid varnish, to protect it from dust and damp as well as to enable it to be cleaned. One of its greatest uses is to assist in the removal of needles, etc., from the hands. As it is not protected it must be used sparingly and with care.



Fig. 45.
Flexible Screen.

Owing to the fact that the barium platino-cyanide is only useful when in crystalline form, these screens are necessarily made up of a layer of these fine crystals, and as such the screen image must possess a certain amount of "grain." Fine detail is thus impossible, even if the illumination were sufficiently intense to observe it. On this account a definite diagnosis should never be given in a case of doubtful fracture, for instance, on the screen evidence alone.

It is hardly necessary to point out that in choosing a screen, only one possessing very fine crystals should be selected. Fortunately, all modern X-ray screens are beyond reproach in this respect.

A screen examination is applicable to most of the cases where the X-rays are used, and very often all that is required can be seen at once. It is not good enough to detect small fractures, such as are sometimes seen in the tarsal bones, where there is little displacement or separation of the fragments. Unless the screen appearances are quite decisive, the safest procedure is to make a radiograph.

The part under examination should be quite uncovered, though a single layer of underclothing is unobjectionable so long as buttons and other fastenings are out of the way. The screen should be pressed firmly in contact with the part, while the tube, on the other hand, should be as far away as the power of the apparatus will permit. This gives sharper and less distorted shadows, besides reducing the risk of dermatitis.

The beginner should take every opportunity that affords itself for making examinations of normal parts, so that he may be all the more ready to recognise the abnormal when met with. In doing this he must follow all the directions given for his own protection, and never expose any part of his friends or patients for more than, say, five minutes at a time, and a part once so exposed to X-rays should not be used again within a fortnight. If this rule is adhered to, there is no need to fear any untoward results, as it allows ample margin for safety.

Radioscopy is a very economical method of examination, and the result, if visible, is obtained at once. The image, however, is not permanent, and except by a very special and complicated device no stereoscopic effects are possible. While an instrument for this purpose has been brought out, it has not proved satisfactory in practice.

The best tube for screening purposes is one that has been in use for some time and become rather hard. It also will have become seasoned, as it were, and capable of carrying a moderate amount of current for some minutes without undergoing any noticeable change. The most generally satisfactory are those of the light anode variety. Heavy anode tubes are best suited for radiography where the current is more intense but not for a sufficiently long time to overheat the metal. Occasionally, however, we do come across a heavy anode tube that becomes so well seasoned as to carry a fairly strong current for several minutes without getting softer, but this is exceptional.

The greatest value of radioscopy is when we wish to observe what takes place when a joint is moved, or for

observations of the heart and great vessels in cases of dilatation, aneurysm, and so on.

Of late years the application of X-ray examination to the investigation of thoracic and abdominal disease has been developed to a remarkable degree; and the method has been so far perfected that it is now being depended upon by many who formerly were quite sure it could never become more than an interesting process for corroboration, after diagnosis by the more usual methods had been made. The situation is now very different, and special chapters on the X-ray examination of the thorax and abdomen will be given towards the end, and the matter of radioscopy still further developed.

CHAPTER X.

X-RAY PHOTOGRAPHY.

The advantages of an X-ray photograph over a screen examination are that we get more detail owing to the cumulative action of the image upon the silver in the sensitive plate. This record is a permanent one from which we can make as many prints as we please, and by a simple modification of the ordinary procedure we can obtain stereoscopic effects which enhance the value of the examination many times.

The disadvantages are the length of the exposure and the difficulty of keeping the patient quite still while it is going on, the time required before the result is known, and the cost of the necessary appliances and X-ray plates which are about double the price of ordinary ones.

The disadvantages, however, are of small account in comparison with the advantages, and the rule should be in all cases to make a radiograph whether a preliminary screen examination is made or not.

We may here briefly run over the requirements for the successful practice of radiography.

In the first place we require an assortment of good tubes. A minimum number is three.

When first obtained they will probably be soft and only suitable for the thinner parts, and at first only one should be used. It will be noticed that it has a tendency to get still softer, especially if the current is not kept fairly low. After a few exposures have been made it will be found that this tendency is not so marked, and the tube

has got harder and more resistant to the passage of the current and more penetrating as regards the quality of the rays it gives out. By virtue of these qualities it can now be successfully used for thicker parts, such as the shoulder or knee, and should be kept for these, taking out one of the others to use for hands, feet, etc., as we did before. Later on the first tube becomes still more penetrating, and is useful for abdominal work, spine and hip, and at a still later stage it becomes very hard and is admirably adapted for screen examinations. Of course, no one now buys tubes without some form of regenerating device, and it is not until the tube has become too hard for screening and is in danger of becoming pierced by the sparks flying round its outside that the regenerating device should be used.

The vacuum of a tube which has been regenerated is never so stable as the original vacuum, and until better means are devised, our aim should be to use the regenerator as little as possible. By working the tubes on the lines here given, and assuming them to be good ones to start with, we make sure of obtaining the maximum amount of satisfactory work from them.

The great thing to avoid is running them too long with a large current. There is for every tube a critical current which it will carry for several minutes without materially altering its vacuum and penetration. This should be found for each one and made a note of. If we start with a current of two milliamperes and find after a minute or two that this current automatically increases, we know that the current is excessive and must be reduced.

If, on the other hand, the current decreases—showing that the occlusion of electrons is taking place more rapidly than they are being set free by the heating of the metal and other parts—we then know that the current is too small and may be safely increased. In taking a radiograph of the thicker parts, nothing is gained in trying to shorten the exposure by increasing the current beyond what the tube will stand.

Though the effect at first is more rapid long before a sufficient exposure is given, the tube becomes soft and ceases to penetrate. It is sometimes possible to get fully exposed plates of the abdomen by passing through the tube currents of twenty, thirty, or even fifty milliamperes for a very brief period—less than one second. This, however, necessitates specially powerful apparatus, and the life of the tubes is very short.

Of equal importance to good tubes is a proper instrument for exciting them. If an induction coil is used, let it be not less than the 12-inch size, and it may be anything from this to 18 inches. Though a coil is seldom, if ever, worked at a greater potential than that represented by an 8-inch spark-gap, the fact remains that the larger the coil the better the results. Also the tubes seem to last longer.

Photographic plates of any kind can be used for thin parts, such as the hand, but they are quite unsuitable for parts which present any difficulty.

The efficiency of a plate for radiography depends not so much upon its rapidity to the action of ordinary daylight as upon the thickness of the coating and the presence of other substances than silver which tend to arrest the rays on their way through, and by a secondary radiation enhance the action upon the adjacent silver compound.

For a long time we were dependent upon foreign sources of supply for our X-ray plates. Fortunately this is no longer necessary, as in the Ilford X-ray plate we have one that is distinctly better than any foreign plate I have ever tested.

It is poor economy to attempt to save money by using ordinary plates. Results are sure to be disappointing, and by taking care not to use a large plate where a small one will do, the expense for plates will not be so very much greater.

These plates are now obtainable in separate wrappers and labelled ready for use without having to place them

in opaque envelopes, as used to be necessary. This is a very great convenience.

The development of X-ray plates presents no difficulty.

A proper dark room with water and a sink is of course necessary, and also dishes and photographic solutions.

If the plates above mentioned are used, the Metol-Hydroquinone developer, as advised on the label, will be found the best as well as the most economical. With an ordinary exposure development is complete in about seven minutes, when the plate will appear quite black all over if held up towards the dark room lamp, and the outline of the bones will be made out on examining the back of the plate.

The dish should be rocked all through the period of development, and care should be taken to see that there is plenty of solution to cover the plate easily. Further, the dish should be covered with a sheet of cardboard so as to protect it from the light of the dark room, which is not entirely innocent of action.

After development, the plate is rinsed under the tap and placed in the fixing bath, which should be made according to the formula given. The best and most economical way is to have a fixing tank arranged with racks for different sizes of plates.

This, when filled with solution, will continue active and satisfactory for weeks, or until it becomes so slow in action as to be inconvenient.

Great care should be taken not to allow any light to fall on the plate until fixation is complete, as this not only increases the time necessary for fixing, but is more than likely to cause a discoloured and foggy negative.

The subsequent operations of intensification or reduction if necessary, printing, mounting, and so on, differ in no way from those in ordinary photography, and the reader is referred to any one of the numerous pamphlets obtainable from dealers in photographic supplies for a few pence or perhaps gratis. These will give all information that may be required.

Exposure.—This is in all probability where the beginner's greatest difficulty arises, and it is none the more easy because it is impossible to give any fixed rules for his guidance.

People vary as regards the size and thickness of their various parts, as well as in the opacity of their tissues. Strong athletic subjects are always more opaque to X-rays than others of similar weight and size.

Also the X-ray tube is a more or less constantly varying quantity, as regards the quality and quantity of X-ray energy emitted; and further variations are likely to take place in the electrical circuit.

With all these factors at variance, the impossibility of laying down any fixed rules is apparent.

At the same time, if we take a standard size tube and work it at its critical current, which will be about one milliamperè, at a standard distance of 24 inches from the plate, it will be found that the subjoined list of exposures will be found very fairly correct.

| | |
|------------------------|-----------------|
| Hand and toes | 20 seconds. |
| Forearm and arm | 30 ,, |
| Shoulder | 60 ,, |
| Thorax | 60 ,, |
| Head | 2 to 3 minutes. |
| Abdomen | 2 to 3 ,, |
| Hip... .. | 2 minutes. |
| Thigh | 1 minute. |
| Knee | 1 ,, |
| Leg... .. | 40 seconds. |
| Ankle | 30 ,, |

In this simple exposure table it is assumed that the penetration of the tube is about 8 or 9 on Wehnelt's scale, and as the current through the tube is one milliamperè, the exposure may be expressed in milliamperè-seconds, that is the product of the milliamperès by the seconds. Provided the tube remains approximately constant, we may use any current it is capable of standing, and as the current is increased the duration of the

exposure is proportionately reduced. With a modern tube and powerful apparatus, a current of ten milliampères is quite ordinary, and the exposures are just one-tenth of those given above. We may go further than this: with a large coil and multiple electrolytic interrupter, or a high tension machine of the Snook type, currents of sixty milliampères and more are available through a normal tube, and this brings us into the field of what is called "instantaneous radiography." No new principle is involved, any given part of a normally sized individual requires a certain number of milliampère-seconds for a proper exposure, and so long as the product of the two factors is correct the result will be satisfactory. At the same time these huge currents are a severe strain on the tube, and in most cases an intensifying screen is used to shorten the exposure still further. These will be referred to later on in this chapter, and under these conditions the exposure may be as little as one-hundredth of a second in some cases.

When in doubt always give a full exposure. Over exposure is far preferable to under exposure, because it can be corrected during development by adding a few drops of 10% solution of potassium bromide to the developer.

No amount of skill and industry can make anything out of a plate which is seriously under-exposed.

The greatest essential to success is experience, but of equal importance are skilful management of the apparatus, an understanding and control of the X-ray tube, and, finally, the proper manipulation of the plate in the dark room.

The distance of the tube from the plate should be as great as convenience and the power of the apparatus will allow, especially when dealing with the thicker parts. This is to prevent undue distortion.

At the same time we have to remember that other things being equal, the exposure varies as the square of the distance. It is a good thing to adopt one distance for

all parts, and save any trouble of calculation on this score. Twenty to twenty-four inches will be found the most generally useful.

The part to be examined should be as near the plate as possible, and, in the case of a joint, the rays should pass through or between the articular surfaces. Should there be any legal question involved, the corresponding part of the opposite side of the patient should be radiographed as well.

Clothing should always be removed, though there is no objection to a single layer of underclothing without seams, buttons or metal fastenings. Ladies should have a retiring room, and be provided with a thin dressing gown made without lining or fastenings of any kind, except a ribbon for tying. They can then take off all skirts and petticoats, and let the underclothing down below the hips, when the abdomen and pelvis have to be radiographed. This obviates any necessity for even the least exposure, and meets with the appreciation of the patient.

Surgical dressings should be removed where possible. Lead plaster, plaster of Paris, zinc oxide, iodoform, etc., all cast shadows and may seriously obscure the result.

Owing to the comparatively small quantity of plaster in an ordinary plaster of Paris bandage, we can generally see through it sufficiently well to say if a fracture has been properly set and the fragments in good apposition.

Ordinary bandages, cotton wool, lint, wooden and fibre splints offer so little obstruction to the rays that they may be ignored.

Secondary Rays.—The X-rays have the peculiar property of giving rise to other radiations when they pass through air and other substances. They are more in evidence with hard than with soft tubes.

These rays may be sufficiently strong to act on the plate, and, if so, give rise to fogging and loss of sharpness in outline.

As a rule, however, these secondary rays are not of very great importance and may be ignored, but it is as well to be aware of their existence and the proper means of dealing with them.

In the first place, do not use too hard a tube, and place a diaphragm between the tube and patient; also let there be as little air space as possible between the patient and the plate, and it is advised to place a sheet of metal under the latter to absorb any rays that might be formed after passing through the plate and affect the latter from behind.

With regard to the diaphragm, the tubular form is much more efficient than the plain disc with central opening.

Penetration of Tube for Radiography.—In the chapters on X-ray tubes we saw that with a low vacuum (soft) tube the action on silver compounds was very intense, but the rays had very little penetration. Obviously if the rays do not get through the part no radiograph will result, no matter how active they may be in the reduction of silver compounds.

On the other hand, we must not use too hard a tube, for though its rays would have no difficulty in penetrating the part, their action on silver is so feeble that the resulting negative would be flat and unsatisfactory.

So it happens that for every part of an average body there is a critical degree of vacuum of a tube where the penetration and photographic effect of its rays are such as to produce the maximum effect in the shortest time, and this is what we must aim at attaining. If we want to show the bones only without the soft parts we must use a soft tube—resistance equal to a 2-inch or 2½-inch spark-gap and give a long exposure. In this case the soft parts are radiographed out of existence, so to speak, and the result is as if they were not present. It is effective to look at, but not so valuable clinically.

If we wish to show the soft parts we should use a fairly hard tube—5 to 6 inches gap—and give a short exposure.

In such a case we must beware of secondary rays—the image is essentially a feeble one, and may be very easily lost through their influence.

Not long since it was noticeable that for renal radiography many operators were using very soft tubes. The result was pleasing to the eye in that the bones came out very white, and the soft parts very dark or even black. It is doubtful, however, if such plates give the best clinical information. It cannot be right for the soft parts to be obliterated in this wholesale manner. It is conceivable that a comparatively transparent stone might be missed entirely.

A harder tube while giving less contrast between the bones and soft parts, makes some discrimination between tissues of different densities, and the size and shape of the kidney itself can be seen in many cases.

A negative diagnosis in the latter case would surely be the more reliable.

A common source of trouble in hot weather is perspiration working through the coverings of the plate, giving rise to a fine spotty mottling which is sufficient to obliterate any detail.

To guard against this it is advisable to use either a changing-box or else a sheet of celluloid between the plate and the patient's skin.

Intensifying Screens are not necessary for ordinary work. They have been very much improved lately, and are made of calcium tungstate coated on a sheet of thin cardboard and placed in the envelope containing the plate, face to face with the latter.

The rays pass through the screen on their way to the plate, and by virtue of the fluorescence produced, the action on the plate is greatly intensified. They give a "grainy" effect which may be sufficient to obliterate fine details of bone structure, but this is not of so much account in radiography of the heart and great vessels, where they are used when it is desired to obtain practically instantaneous exposures. The reason calcium

tungstate is chosen for this type of screen is that the colour of the fluorescent light is so highly actinic—that of the ordinary fluorescent screen being much less so, though the latter is greatly superior for visual effects.

It is important to remember that calcium tungstate tends to phosphoresce for some little time after the exposure, and if immediately afterwards it is slightly shifted in relation to the plate, it is possible to get a double image.

On this account it should be either rapidly and entirely removed from the plate, or care should be taken not to disturb it in any way. In this case the action on the plate will continue, which may or may not be an advantage according to circumstances. About one-fifth of the normal exposure is sufficient in most cases—though the manufacturers claim a much higher efficiency than this.

In Fig. 46 the arrangement of the various parts for taking a simple radiograph is shown.

The plate is enclosed in paper wrappers impervious to ordinary light.

The centre of the area to be examined is placed over the centre of the plate. The X-ray tube in its holder is fixed with its long axis parallel to the plate, and so that a line drawn from the centre of the anti-cathode to the centre of the plate passes through the centre of the part to be examined. All these points being secured, the exposure is made, and the plate developed and fixed as already described.

Such is radiography reduced to its simplest form, but in addition to the considerations already given in this chapter, there are others to take up our attention.

One of the most important is that of securing thorough fixation of the tube, patient, and plate.

Obviously if any one of these move during the exposure the result will not be satisfactory.

The fixation of the tube is secured by having a good tube holder securely mounted on a base free from vibration.

The fixation of the plate is simple, as we generally place the patient on it. Difficulties arise when we come to deal with the patient.

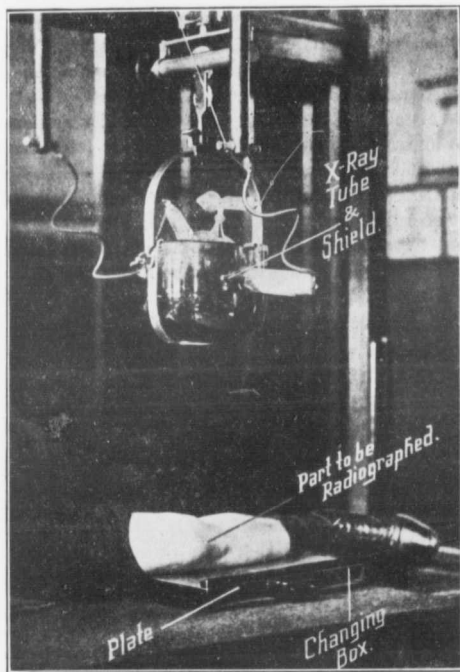

Fig. 46. Showing how to Radiograph a Knee.

We have to take precautions against voluntary or involuntary movements, nervous twitchings, and, what is the most troublesome of all, the restlessness of children. The latter will at times severely test the patience and

temper of a saint, and under such conditions the possession of an apparatus adapted for instantaneous work is of inestimable advantage.

The greatest assistance to anyone to keep perfectly still is that of being in a comfortable position; and to secure this should be our first consideration. With the great majority this is all that will be required.

Many people, however, find it very hard to avoid slight involuntary movements, and they will be grateful for anything we can do to prevent them.

It is as well to turn on the tube for a few seconds before the plate is placed in position. This reassures the patient and prevents our result being impaired by the slight twitch or start some people cannot help giving when they see the tube suddenly light up for the first time. For restraining slight involuntary movements of the limbs a few bags filled with sand—though not too full—are extremely useful. On some X-ray couches, straps and clamps are provided for this purpose. We will deal with the methods of obviating the effects of the respiratory movements in a subsequent chapter.

In making a radiograph of a joint it is important to arrange the tube so that the rays pass through the joint space, unless the structure of the joint is such as to make this impossible. Also in these cases and in those of suspected fracture, always take both an antero-posterior and a lateral view. Cases frequently occur in which a fracture or displacement not visible in one aspect is very clearly so in the other—and had not the second view been taken a wrong diagnosis would have been made inevitably.

INSTANTANEOUS RADIOGRAPHY.

In every calling where time is a factor, there is a continual demand for increased speed, either to save time or because the conditions are such that the saving of time

would of itself give more valuable results. We have seen what increased rapidity has done for ordinary photography, and it has always been the hope among radiographers that the conditions would be so far altered that our work could be satisfactorily done with exposures of one second or less.

In the radiography of parts which are in more or less continuous motion, the advantages are obvious.

At the present time the position is that we have apparatus of more than sufficient power to generate the necessary current to excite the X-ray tube, and we have X-ray tubes which will take this current, but only for very short periods of time.

It appears that a current that would destroy an X-ray tube in, say, five seconds, will yet successfully withstand this same current for a large number of exposures, provided it does not flow through it for more than from one-half to one second at a time, and is given an interval of rest between.

Even under these conditions the life of the tube is very short and the expense on this account is high, because only the most expensive tubes can be used for this work. Such a tube costs at least £5 (\$25), and it may become useless before half-a-dozen exposures have been made—some, however, last a long time, in spite of the severe conditions they are subjected to.

Speaking in a general way, we may say that with a suitable tube the current in milliamperes through it bears an inverse proportion to the exposure. Or, to put it another way, as we increase the current we can decrease the length of exposure so that the product of the milliamperes multiplied by the duration in seconds remains approximately the same.

If we take an ordinary tube carrying one milliamperè the exposure for an abdomen will be, say, 200 seconds—that is, 200 milliamperè-seconds. I have found 10 m.a. and 20 seconds give an equally good result, as also 5 m.a. and 40 seconds. Theoretically 200 m.a. and one second

would be also correct, but though I might be able to get this large current through a tube with the large Snook Röntgen apparatus, I have not sufficient faith in the mechanical strength of an X-ray tube to withstand such a fierce bombardment even for one second, and as no particular advantage would be gained there is less reason for attempting it. In abdominal work there is no object in making the exposure shorter than the time an average person can easily hold the breath.

It is different in thoracic cases, and here an exposure of one-tenth to one-fifth of a second is very useful in giving a sharp outline to the heart shadow, besides bringing out details usually lost in time exposures.

So far as ordinary cases are concerned, instantaneous radiography is of no particular advantage.

Those taking up radiography for the first time will be well advised to leave instantaneous work alone until they have become proficient in making good radiographs in the ordinary way and have gained some understanding of their X-ray tubes. One of the greatest advantages of an instantaneous outfit is that it becomes possible to take good radiographs of the chest with the tube no less than two metres from the plate. Distortion is reduced to a minimum, and as the exposure need not be more than one second, the outlines are very sharp and clear.

This is known as tele-radiography and is of the greatest service in assisting in the diagnosis of thoracic disease. An intensifying screen is always used.

It is an advantage to have an automatic time switch, but these are very expensive—costing about £15 (\$73).

With a good double-pole, quick-break switch, we can do very well, with a simpler device.

Suspend a bullet by a strong thread where it can be easily seen, so that the distance from the centre of the bullet to the point of suspension is nine and three-quarter inches. This, when swinging, is a pendulum beating half-seconds and seconds if we count the beats at one end of the swing only.

With this guide and a little practice it will be easy to make exposures of one-half second, or multiples thereof, sufficiently accurately for all practical purposes.

To those who have become proficient in ordinary radiography, enough has been said to indicate the lines upon which rapid exposures become possible.

The subsequent processes of development, etc., are in no way different from the ordinary procedure.

CHAPTER XI.

EXAMINING RADIOGRAPHS.

The best time to examine an X-ray plate is immediately after it is removed from the fixing bath or during the subsequent washing. It is a well-known fact that more of the fine details and less distinct shadows are to be seen then than after it has become dry.

This does not appear to be the case in ordinary photography, or, if it does take place, it is not sufficient to make any important difference.

In an X-ray plate it happens more often than not that there are only the slightest differences of light and shade to guide us in making a diagnosis, and as these will be more marked when the plate is still wet, it behoves us to make up our minds then and there. It should on this account also be our invariable rule, in doubtful cases at least, not to make a positive diagnosis from a print. The latter is never so good as the original negative, though by the use of special gaslight printing paper, contrasts can be accentuated. In very obvious cases, of course, it does not matter, but in the diagnosis of renal calculi, and difficult medical cases, early changes in disease of bones and joints, etc., it will be found more easy to come to a decision if we make our examination as soon as possible after fixing.

The plate is seen to the best advantage with the aid of a photographer's retouching easel suitably adapted to take plates of the sizes used in radiography. The light

should be cut off from around the plate by masks or screens, and such as reaches the plate itself should be diffused by means of opal glass. See Fig. 47.

If the source of light is an incandescent lamp bulb, it is well to have an adjustable resistance at hand so that it can be slightly dimmed if necessary, as slight differences are obliterated if the illumination is too intense.

It will be found most satisfactory to adopt artificial illumination for this work. It is uniform, always ready, and can be modified at will to suit special requirements.

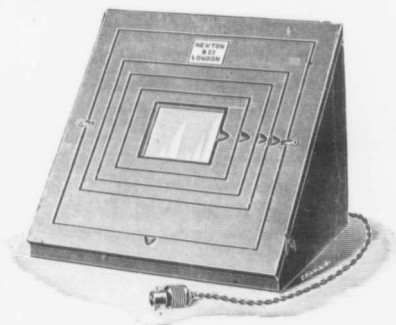

Fig. 47. Illuminating Desk for X-ray negatives.

A very good device is a japanned tin box of semi-cylindrical form, on the flat side of which are grooves for a sheet of opal glass and for the largest size of X-ray plate it is desired to use. An electric lamp is mounted inside, and, in a somewhat darkened room, the plate can be seen at its best. For smaller sized plates suitable carriers are provided. When examining a very thin plate it will be found a great assistance to hold the plate in a slanting direction so as to produce a certain amount of fore-shortening. This enhances the contrasts, and will

sometimes bring out a shadow not easily seen when viewed from straight in front.

The correct interpretation of an X-ray negative is an art not easily acquired except for the simpler cases.

Medical cases give the greatest difficulty, and even after a large experience new and strange appearances are continually cropping up—chiefly because physicians are using this method of examination more and more in doubtful cases.

However, if one is familiar with normal radiographs and is supplied with the essential clinical notes of the case, a careful inspection will generally enable one to determine if anything is present that throws any light on the diagnosis.

Every radiographer should have at hand a set of normal radiographs taken at different ages, and for this there is none better than the "Atlas Typischer Röntgenbilder v. Normalen Menschen," by Grashey. Even to those who cannot read German, the plates are well worth the price of the volume.

It would be quite beyond the scope of this work to describe even a fraction of the abnormal appearances met with, besides being of questionable utility—as it is impossible for anyone to learn much about interpretation, except through examining large numbers of plates of every conceivable kind.

It will not be out of place, however, to indicate a few of the commoner appearances met with.

Dislocations usually present no difficulty, especially if a screen examination can be made, and the part viewed from different angles.

Most fractures are sufficiently obvious, but difficulties arise in those where there is a mere crack in the bone, and practically no displacement. Though the displacement may not be evident clinically, it is very seldom we cannot see it in the radiograph. (See Fig. 56.)

It may be no more than that one part of a long bone is very slightly out of line with the other, in which case the

line of fracture can nearly always be made out as a fine dark line running more or less directly across the shaft. The meta-carpal and meta-tarsal bones often give difficulty in this way—and also the bones of the tarsus which may be severely comminuted without much displacement. Here, again, look carefully for a fine dark line in the bone substance. Green-stick fractures may be easily missed if two views—at right angles to each other—are not taken.

Diseases of bone give more difficulty. Tuberculous disease is very common, and the outstanding feature is a loss of opacity to the X-rays, so that the bone differs very little from the soft parts, and thus a plate showing much contrast is difficult to obtain. This lack of density is, of course, due to the thinning of the trabeculae. A definite tuberculous deposit shows as a dark patch in the substance of the bone.

Caries is easy to detect, as also are the opposite conditions of chronic periostitis and exostoses.

Rheumatoid or infective arthritis is recognised by a narrowing of the joint spaces from erosion and absorption of the interarticular cartilages. The narrowing is usually irregular when we compare neighbouring joints as in the hands. Later on the ends of the bones become eroded, while there is but slight tendency to the formation of osteophytes, and such as do form are close to the articular border. Also there is loss of density in the bones from an early stage, very like that seen in tuberculous disease. In fact, the X-ray diagnosis between these two conditions is at times very difficult. It usually affects several small joints, tends to be more or less symmetrical in its distribution, and young adult females seem to be the most susceptible. (See Fig. 57.)

Osteo-arthritis more usually affects a single large joint, and is more often found in healthy males who have passed middle life. There is marked formation of osteophytes, and while the articular cartilages become fibrillated they are not absorbed to anything like the same extent as in the

rheumatoid form. The bones tend to become more dense with eburnation of articular surfaces, and osteophytes are often found extending down towards the shaft. It occasionally attacks many small joints, as in the hands, but this is rare. (See Fig. 54.)

The sarcomata of bone present many different appearances, according to the site of origin and the rate of growth. A periosteal sarcoma shows as more or less needle-like spicules of bone growing out at right angles to the surface; the appearance is quite characteristic.

Endosteal or myeloid sarcoma shows an area of destruction depending on the rate of growth and the time it has been going on. The outer shell may curve outwards to accommodate the expanding growth, while the latter, if rapid, looks like a puff of smoke. If of slower growth it will be traversed by many lines of new bone which form a coarse fenestration; the slower the growth the more marked is this appearance.

Something of the same appearance is seen in osteomalacia, and the epiphyses are thinned even to the extent of being unrecognisable.

The appearances in rickets are not markedly different from the normal—apart from the curvatures, and a certain degree of rarefying osteitis in the central canal.

The structure of the bone in Paget's disease (osteitis deformans) has a "woolly" appearance, in addition to the characteristic enlargements and deformities found in this condition.

An abscess varies in appearance according to its situation. In soft tissues it generally shows slightly lighter than the surrounding parts with a number of irregular white flakes and lines scattered over the area.

An abscess in bone shows as a dark patch in the midst of the whiter bone, while the same occurring in the lung appears as a light patch because the lung tissue is so transparent.

It will, of course, be remembered that we are speaking of the plates and not of prints made from them in which

the above appearances would be reversed as regards light and shade.

It is important to remember that callus may not show at all in an X-ray negative, even when union is sufficiently firm for the splints to be left off and the limb about to resume its normal functions. This applies chiefly to adults. Children give shadows around a fracture much earlier—sometimes within a few days.

Localisation of Foreign Bodies, Displacements, Etc.—

Often can these be best seen by a screen examination, the part being examined from different points of view and the position thus ascertained.

Simple as this appears, in reality it requires considerable experience and practice to remove small foreign bodies quickly and with certainty. A needle in the hand is a familiar accident, and is often the most difficult of all to locate and extract. The latter operation can often be done with the aid of the screen—but even here practice is necessary to ensure this being done with a minimum of cutting which in the case of patients who have to earn their living is a serious consideration.

At the time of writing, during the progress of the great European War, with a constant stream of wounded from the firing line, this matter of the localisation of foreign bodies has become one of the first importance.

Stereoscopic Radiography.—One of the best methods of ascertaining the position of a foreign body is by stereoscopic radiography.

In addition to this it is probably the best system to adopt in all cases. It enables us to see the part under examination in its three dimensions—the skeleton stands out in relief and a foreign body is shown in its true relationship to the bony points. The surgeon having seen the state of affairs can with the greatest confidence go straight to the proper place, even better than if he is given measurements which may or may not be quite correct. See Plate I.

STEREOSCOPIC RADIOGRAPHY. 127

Not the least important feature of the method is its extreme simplicity.

The only extra pieces of apparatus required are a Wheatstone's stereoscope and a changing-box, which latter has already been described.

This is placed under the part so that the centre of the plate and the area to be radiographed correspond.

The X-ray tube is then adjusted over the same point with the arm of the tube-holder at right angles to the long axis of the limb.

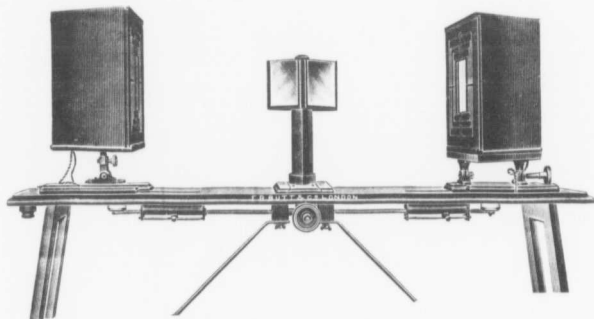

Fig. 48. Wheatstone's Stereoscope.

The first plate being in position in the changing box the clamp holding the tube arm is loosened and the tube moved three centimètres to the right and secured. The exposure is then made and the plate marked "R" and taken to the dark room. Another fresh plate is brought and put in place of the first one.

The tube is now moved across to a corresponding distance to the left of the middle line—six centimètres in all, and a second exposure made.

This exposure may be longer or shorter than the other without affecting the result, and is, in fact, an advantage when the question of exposure is in doubt.

The two plates are now developed, fixed and washed in the usual way, and are then ready for examination.

For this we require a Wheatstone's stereoscope, as shown in Fig. 48.

This consists of two of the semi-cylindrical or square boxes for examining plates, so mounted that they can be raised or lowered and inclined at an angle, or even turned horizontally when required. These are placed on a table or shelf facing each other, and about three feet apart. Exactly in the middle of the shelf is an upright carrying two squares of looking glass, set at right angles with the angle towards the observer. This is arranged to slide to and fro, and permits one to adjust the images to correspond.

On placing one's nose close to the angle each plate is seen by one eye, and when one has got the two images to combine, a perfectly stereoscopic image is obtained.

When first seen it is very impressive, and on account of the very satisfactory results, it ought, in private practice at least, to be carried out as a routine. In hospital it is usually reserved for cases of special interest—for economical reasons.

Sometimes the mirror has four sides, and the plates can be looked at from either side of the table. It is a remarkable fact that if we take a stereoscopic pair of—say a knee—and place them in a stereoscope thus arranged, the view obtained from one side of the table is, say, from the front of the knee, but if we go to the other side we get a view as from *behind* the knee. This is useful at times, but the view corresponding to the way the plates were taken is always the better one.

The proper method of placing the plates in the stereoscope is not always understood. If the plates are wet they should be put in with the film outwards, so as to prevent any damage during insertion. In this case, the one marked R should be placed on the *left* side, and the one marked L on the right.

PLATE I.

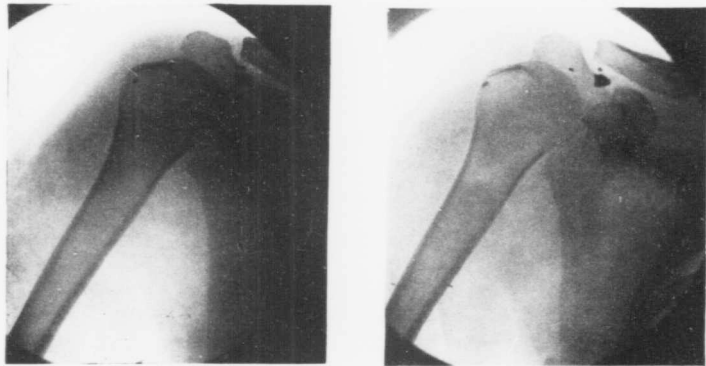

STEREOSCOPIC RADIOGRAPHS OF THE LEFT SHOULDER.

Showing fragments of shrapnel casing received at the Battle of the Aisne. May be viewed with any simple stereoscope, or by causing the eyes to diverge slightly from the normal convergence, the two images can be blended so as to give a perfect stereoscopic effect without the aid of any apparatus. The simple device described on page 129 may be used.

When dry the film is placed inwards, and R and right correspond.

This is the arrangement to get the best view, but by going to the other side, or turning the plates round without reversing, or reversing without altering the side presented to the observer, we get a view as if the plates and tubes were reversed when the radiographs were taken. This, no doubt, seems very confusing to the reader, but if he takes a pair of plates and spends half-an-hour with a stereoscope the matter will become quite clear.

The simplest stereoscope for X-ray negatives or prints may be improvised in a few minutes. Take a piece of cardboard about 6in. by 8in., and cut a rectangular opening in the middle, say 2in. by 1½in. The two plates or prints are set upright side by side in a good light, and from four to six feet from the observer. The card is held at arm's length, more or less, until the observer's right eye sees only the left hand plate, the left eye being closed, while the left eye sees only the right hand plate when the right eye is closed. Now open both eyes, concentrating attention on the edges of the opening in the card; in a few seconds or less the two images will coalesce, giving a perfect stereoscopic effect. At first it may be a little difficult to secure this, and there may be some ocular fatigue from the use of the muscles in an unaccustomed way, but this very soon disappears, and it is worth while learning how to use a device that can be made in a moment from a piece of dark paper if nothing better is at hand.

The Pirie stereoscope is made like an opera glass, one side being plain, while the other is provided with a prism to bring the image of one plate over the other. So long as it is the correct width for the observer's eyes, the result is very pleasing. With this instrument the plates are placed as for the Wheatstone stereoscope; with the simple device just described they are to be reversed, since the lines of vision cross at the opening in the card.

The following method of localisation has the merit of

simplicity and is reasonably accurate in practised hands. An X-ray couch is required with the tube in a box beneath that can be moved readily to any position under the patient. To this box is attached a vertical arm reaching well above the top of the couch, and from this a horizontal one carrying a plumb-bob that hangs exactly over the centre of the anticathode. This "gallows" arrangement must be made accurately and reasonably rigid without being too heavy. The plumb-bob is adjustable for height, and by lowering it on to the patient we know that the anticathode is exactly underneath the spot it touches; also, if the shadow of a foreign body coincides with this spot we know that it must be directly below that point. To put the method into practice, the patient is placed on the couch and the fluorescent screen is laid on the part where the presence of the foreign body is suspected. As soon as its shadow is detected the plumb-bob is lowered until it almost touches the screen, and the tube is moved about until the point of the plumb-bob when at rest corresponds to the centre of the shadow. The screen is then taken away, the plumb-bob lowered until it touches the skin, and a mark made there with an indelible pencil or nitrate of silver. We now know that with the patient in the same position the foreign body is directly beneath the mark on the skin. The next thing is to find the depth. The screen is replaced and a mark made on the glass surface at the centre of the shadow. The tube box is now moved a known distance to one side or the other, say 10cm. to the right. The shadow of the foreign body moves to the left, the distance depending on its depth, and a second mark made as before. The distance between these two marks is carefully measured, and we will suppose that it is found to be 1cm. The only other factor we require is the exact distance from the anticathode to the screen—say 50cm.

We are now in a position to determine the depth of the foreign body. Take a large sheet of paper and upon it draw a vertical line 50cm. long. The lower end repre-

sents the centre of the anticathode, the upper end the

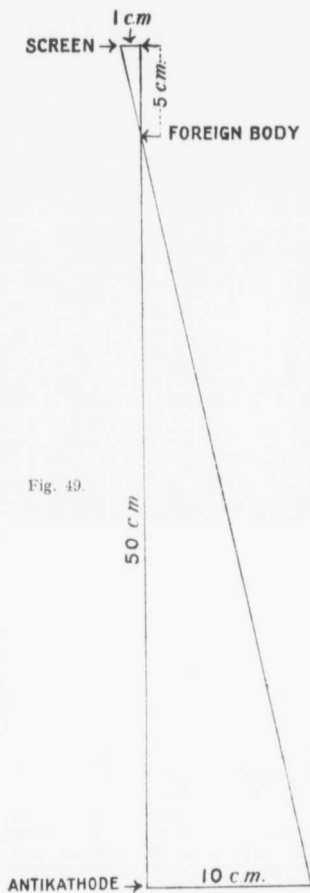

Fig. 49.

centre of the first shadow. The foreign body lies somewhere along this line. At its lower end draw a line to the right exactly at right angles and 10cm. long. At its upper end draw another to the left, also at right angles and exactly 1cm. in length. Lastly, draw an oblique line joining the free ends of the two horizontal ones; where it crosses the vertical line we get the position of the foreign body, and a measurement of the distance from this point to the upper end of the vertical line gives the depth from the mark made upon the skin. In this instance the depth would be 5cm. In drawing this diagram use a fairly hard and very sharply pointed pencil so as not to obscure the point of intersection; also be careful to mark the exact centre of the shadows on the screen. The point of intersection will thus correspond approximately with the centre of the foreign body. If

the latter is of any size the surgeon will strike it just before he has reached the full depth as measured on the diagram—a not undesirable circumstance. The accompanying diagram, Fig. 49, explains the principle clearly.

It will be seen that the method can be carried out quite easily with no special appliance other than can be readily adapted to an existing X-ray couch by any handy man. If something more elaborate is required a special couch can be obtained in which the screen and tube are in fixed relation to each other, so that having made the mark on the skin and the two marks on the screen, the depth of the foreign body can be read off directly by the use of a specially divided scale. This has been designed by Dr. W. Hampson, and is a great convenience where many cases have to be done.

The Mackenzie-Davidson method of localisation is a very accurate one, and is to be preferred in those cases where the above methods are not applicable. The actual taking of the radiograph is very much the same as for stereoscopic work, except that the two exposures are made on one plate—and not on separate plates.

The plate in its wrapper is tied up with a piece of fine wire just as we would tie up a parcel. The wires where they cross in the middle of the front of the plate are smeared with aniline ink.

The position of the foreign body having been first ascertained approximately by the screen, the plate is laid against the skin and underneath the part. The tube is arranged with the anti-cathode vertically over this point, and two exposures made—each about three centimetres on either side of the centre.

On removing and developing the plate we have an aniline mark on the skin, and a corresponding cross on the plate. We have also two shadows on the plate thrown by the foreign body with the tube in its two positions.

The plate is now placed centrally on the Mackenzie-Davidson localiser, which consists of a plate glass table

with two uprights and a graduated crossbar sliding thereon. The crossbar is set at the same height as the anti-cathode was from the plate when the exposures were made. Two threads with small weights at each end to keep taut are brought over the crossbar at points three

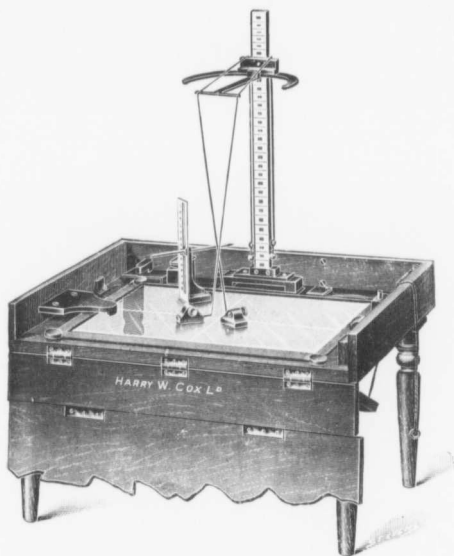

Fig. 50. Mackenzie-Davidson's Localiser.

centimètres from the middle line and led to the centre of the shadow of the foreign body of the opposite side so that the two threads cross at a certain point. The threads represent the central ray when the images were photographed, and, of course, will cross at the position of the foreign body. The height and horizontal distance from the central cross are then measured with calipers. (Fig. 50.)

With these two distances and the mark on the patient's skin, the foreign body can be easily found in most cases.

For the localisation of foreign bodies in the eye special forms of apparatus have been designed, the best of which is probably that of Mr. Mayou.

Even with this device it is a highly specialised class of work and beyond the field of a beginner. A full description will be found in the larger works on Radiography. The importance of knowing the exact position of a pellet of shot or metal chipping in the orbit is extreme—it may make all the difference between the saving and loss of an eyeball.

CHAPTER XII.

REGIONAL RADIOGRAPHY.

In this, as in every other kind of work, it is important to be systematic. It is better in some cases to work with the patient recumbent, the tube above and plate beneath, but there are other parts which are best done with the patient lying prone with the tube underneath and plate above—so those who can should have a couch that gives facilities for both.

If one studies the writings of radiographers in various parts of the world, he will be struck with the different methods practised in taking certain parts of the body—notably the urinary system. To give the technique of everyone's procedure would be interesting, but too lengthy.

Such methods as are here described are known to be good, if properly carried out, and after the beginner has mastered them it will be time enough to investigate the claims of others. Whatever plan is adopted as regards any particular part it should be an invariable rule to adhere to the same routine in all cases. Not only does one become more rapidly an adept, but the interpretation of the subsequent radiographs is more easy and certain.

In the following pages we shall frequently have to make use of the term "normal ray."

This corresponds to a line drawn from the focal point on the anti-cathode to the centre of the X-ray plate, and it is according as we set the part to be radiographed in

relation to this line that a great deal of the success of our work depends.

Consequently, let the utmost care be taken as regards this setting of the various parts—especially with one's earlier efforts—and take plenty of time over it, rather than risk failure from this cause.

The Head.—In taking a lateral view the first care should be to see that the sagittal suture is parallel to the plate.

The normal ray should pass through a bi-auricular line at a point from one to two centimetres above the external auditory meatus.

In this and all lateral views of the head the distance of the tube will depend upon circumstances.

The two sides being symmetrical we can either use the shadows of that further from the plate to accentuate those of the side adjacent to it, by setting the tube at a considerable distance and giving a long exposure to compensate for this distance.

Or by bringing the tube close to the head, the shadows of the side next to it will be diffused, spread out and practically lost, so that we get a radiograph of one side only.

In a good lateral view most of the important points of the skull can be made out, but to ensure success the proper relation of tube, head and plate must be secured and fixation must be perfect.

The sella turcica can be shown by passing the normal ray one inch in front and one-half inch above the external auditory meatus. It is sometimes required in suspected disease of the pituitary gland. (See Fig. 51.)

An antero-posterior view is sometimes useful. The patient lies prone with the face pressed against the plate.

The normal ray should traverse a line drawn from a point midway between the external occipital protuberance and the vertex, to the orbit.

This view is useful in disease of the frontal sinuses and antrum.

The Face.—In a lateral view the normal ray should pass just below the zygomatic arch.

An antero-posterior view is best obtained with the plate in front, and the normal ray passing through from

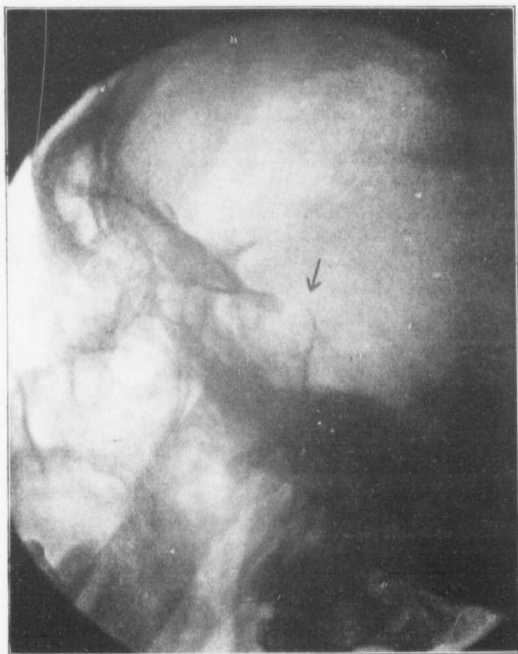

Fig. 51. From Case of Acromegaly.

Cavity of Sella Turcica enlarged from absorption of posterior clinoid processes.

behind, at a point just above the external occipital protuberance.

The Lower Jaw.—Lateral view—the normal ray passes through the last molar tooth, or we may bring the

tube nearer the patient's shoulder so that the ray passes in under the side which is uppermost. It is necessary to



Fig. 52. Fragment of shrapnel behind angle of the lower jaw. Arrow shows point of entry where two small fragments were left.

put a cork between the teeth to keep the jaws separate and to prevent movement.

Teeth.—The method just described for the lower jaw does well in many cases.

Another way is to take small specially prepared dental films. They are wrapped in black paper and an outer covering of gutta-percha tissue, to protect from moisture, and the film is placed in the mouth inside the tooth to be examined and held in position by the patient.

When doing the upper jaw, the tube is set rather above the level of the face, so that the shadow of the tooth is not spread out too much.

For the lower teeth these films are not so necessary, as a radiograph done as for the lower jaw shows the teeth excellently.

The Spine.—The easiest portion to do is, of course the *cervical*. The antero-posterior view is best taken in the recumbent position, and is useful to demonstrate the presence of disease of the vertebræ and cervical ribs. (See Fig. 53.)

The lateral view is best secured by the plate being supported on a pillow and against the side of the neck—the shoulder being to some extent unsupported.

The Atlas and Axis.—The patient lies recumbent with the mouth propped open with a gag, and the normal ray passes through the open mouth.

These bones are not shown very clearly in a lateral view, owing to the interference of the structures forming the base of the skull.

The Dorsal Spine is fairly easy to do in thin subjects and children, but, of course, it is always partly obscured by the heart, great vessels, and liver.

The patient lies recumbent with plate below, and the tube may be brought close to the anterior chest wall so as to diffuse the shadows of the heart and liver as much as possible.

At times these organs form a serious impediment, especially if the case is one of suspected disease of the vertebræ. Then it is useful to have the patient turn half

on his side, so that we get the shadow of the heart thrown clear of the vertebræ, and a better view of the latter results.

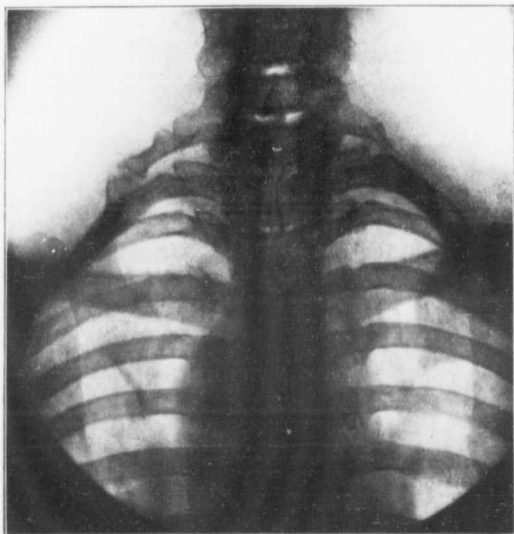

Fig. 53. Cervical Ribs.

On the right side is a "false" rib which is rigid, causing pressure on nerves. On the left side is a "true" cervical rib with articulations—no symptoms, but light pressure with the finger controlled the radial pulse.

Lumbar Vertebræ.—Here, as in all cases of radiography through the trunk, let the patient be prepared by the administration of a *vegetable* purge overnight, and an enema in the morning. Bowel contents often cause shadows on the plate, which obscure important details, besides being confusing in themselves.

The shoulders should be raised, and the knees drawn up and supported by a big cushion. This straightens out the lumbar curve, bringing the bones closer to the plate.

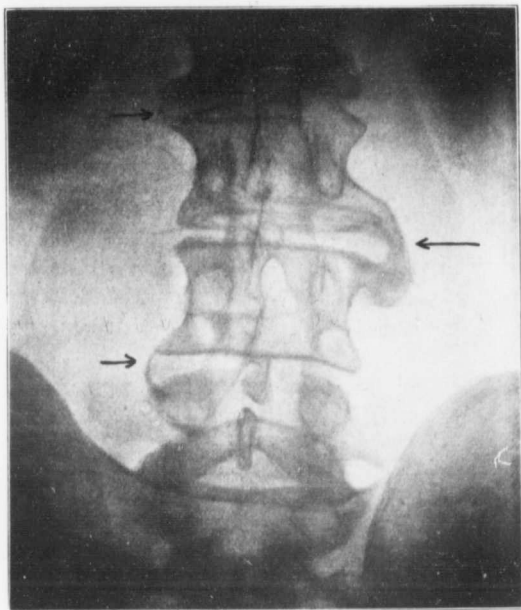

Fig. 54. Osteoarthritis of Lumbar Spine.

The characteristic "lippering" of the edges of the vertebral bodies is seen in different stages even to the extent of fusion.

The normal ray passes through just above the umbilicus, which is opposite the fourth lumbar vertebra.

Sacrum and Coccyx.—The normal ray should pass just above the symphysis. The view of the sacrum is always foreshortened on account of its oblique position.

Clavicle.—In this case it is best to have the tube underneath, while the patient lies in the dorsal position.

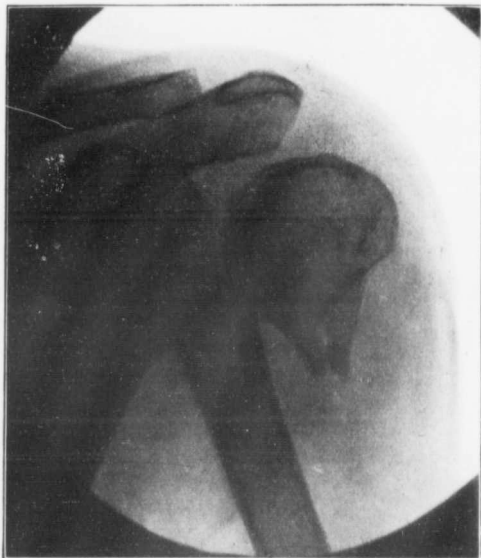

Fig. 55. Fracture just above surgical neck of the humerus. It gave rise to no severe symptoms and advice was not sought until one month afterwards. The head is trying to attach itself to the side of the shaft.

The plate is laid over the middle of the shaft—the tube directly behind. The sternal end of this bone is exceedingly difficult to show well.

Shoulder Joint.—This may be taken from before or behind. Fixation is extremely important, on account of the movement caused by respiration. Whichever side the tube is arranged the normal ray should traverse the centre of the head of the humerus.

If the tube is in front, the opposite shoulder should be propped up by a cushion, so as to bring the affected one as close as possible to the plate.



Fig. 56. Colles' Fracture. Fracture of Scaphoid.

It is frequently very difficult to get a good radiograph of this joint: apart from the slight movement, the bones composing it are mostly spongy and lacking in that density which gives such character to a radiograph of an ankle, for instance.

Scapula.—A soft tube and a short exposure are necessary for success here. The normal ray will be directed inwards between the humerus and the thoracic

wall. The result is a considerable foreshortening of the shadow, but this view is a good one to show fractures of the body of the bone.



Fig. 57. Rheumatoid Arthritis.

See page 124. Note the ulnar deflection of the fingers which is very characteristic of this disease when it affects the hands.

The Elbow.—Antero-posterior and lateral views should be taken in case of doubt. The A. P. view shows the lower end of the humerus and the upper end of the radius to the best advantage, while the lateral view brings out the ulna and its olecranon process.

For the A. P. view rest the olecranon on the centre of the plate, and support the hand. The normal ray traverses the centre of the joint.

The Forearm is best done in supination, but a lateral view should also be taken in cases of fracture.



Fig. 58. Traumatic Myositis Ossificans in front of the Femur.

The Wrist may be taken in pronation or supination, and where there is any doubt or suspected Colles' fracture, a stereoscopic pair should always be made.

The normal ray should pass through the os magnum.

Radiography of the *hand, fingers, and toes* is so simple as to require no special description.

Pelvis.—The plate is placed behind the sacrum and the normal ray passes down through a point midway between the umbilicus and the symphysis.

In doing the bladder the normal ray should correspond to a perpendicular from the centre of the plane of the pelvic brim.

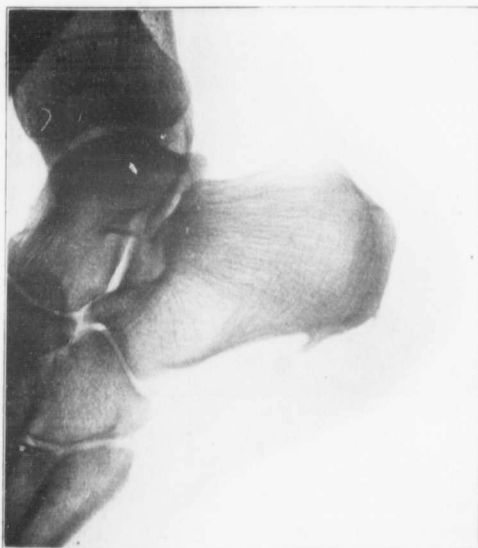

Fig. 59. Calcaneodynia or "Painful Heel."

Hip Joint.—Always tie the feet together, if possible, so as to bring out the necks of the femora.

In adults always use a separate plate for each hip, as there is otherwise too much distortion with the tube over the middle line. The normal ray should pass through the femoral neck. The hip joints are on about the same horizontal level as the symphysis pubis.

The femur should be done in two directions, as otherwise it is not easy to judge the amount of displacement when a fracture is present.

It is a difficult bone to show well in a radiograph on account of the large mass of muscle surrounding it on all sides—a soft tube and a full exposure will give the best results.

Knee Joint.—A very satisfactory joint to radiograph and excellent views can be obtained—either antero-posterior or lateral.

Remember the rule to arrange as far as possible in all joints for the normal ray to pass through the joint space.

The Tibia and Fibula present no difficulty. Two views at right angles should always be made.

The Ankle Joint.—An antero-posterior view with the plate behind the heel and the lower part of leg will show the "mortise" of the joint, and a lateral view will very clearly bring out all the bones entering into it as well as all the tarsal bones, unless a very small plate is used.

Fig. 59 shows the condition of calcaneodynia or "painful heel." It is due to ossification of the origin of the long plantar ligament, and while it appears as a mere spur in this lateral view, on operation it was found to be a broad lamina of bony tissue and associated with a fibroma between it and the surface.

CHAPTER XIII.

INTERNAL DISORDERS.

The situation as regards the value of the X-rays in the diagnosis of purely medical cases has undergone a complete change during the last few years. So great has been this change that many who formerly believed it impossible for the method to become more than an interesting means of corroboration in a few well defined cases, may now be counted among those who consider it one of the most important aids to accurate diagnosis that we possess, and everything points towards a steadily increasing reliance being placed upon the findings of the radiologist. While it is not given to the ordinary mortal to see into the future, it may be said that we are as yet little beyond the beginning of the subject of X-ray diagnosis, and that a vast amount of research remains to be done. At the present time X-ray examination provides the only means of accurate diagnosis in a certain number of diseases, such as thoracic aneurysm and urinary calculus, and among casualties the presence of foreign bodies, and fractures near joints unaccompanied by displacement may be instanced. In many more conditions the X-ray method can give very valuable and important assistance, whilst in others we are as yet unable to be of any great help. Improvements in methods, apparatus, and skill, will steadily increase the number of disorders that can be helped by means of the X-rays, but in the meantime the beginner must be careful not to let enthusiasm outrun discretion and look upon his pet method as the only one worthy of consideration. The number of conditions in which this can be said is comparatively limited and in many cases where it is of the utmost value, it only becomes so when considered

along with the findings of other and more ordinary methods of examination. It is, of course, very tempting to make a positive diagnosis on the appearances in a plate or on the screen, but we must remember that similar shadows may be given by quite different conditions, and conversely the same things may give different shadows under slightly altered conditions—a familiar instance of which is the old, and yet ever new, nursery amusement of making shadows of the heads of rabbits or ducks with our hands which resemble none of these members of the animal kingdom. If we take a piece of lead pipe such as is used by plumbers, and bend it to the shape of the letter "U" and hold it flatwise between a lamp and the wall, it will give a normal shadow which is sharper in outline and more approximate in size to the original the closer it is to the wall, the converse being the case as it recedes from the wall and gets nearer to the source of light. If we turn the object edgewise to the light, the shadow then becomes a straight line and gives us no indication of its actual form. If it is now turned slightly to one side it appears more like the letter "V" and suggests that the bend is a sharp angle or "kink" instead of a round, sweeping curve. No doubt all this seems very simple and elementary, but it is none the less important and necessary for the beginner to keep these simple facts constantly in mind from the commencement of his studies if he is to avoid most of the pitfalls that await the unready.

In dealing with the subject of the application of the X-rays to the diagnosis of internal conditions, it will be convenient to take up the principal systems separately; that is, the respiratory, digestive, and genito-urinary.

Before taking up the respiratory and digestive systems the matter of equipment must be considered. The first requirement is plenty of power; either a high tension rectifier of the Snook type, or a modern fifteen-inch coil with a mercury break for ordinary use and a large electrolytic break for instantaneous exposures. The next

essential is a proper screening stand in which the patient is placed for examination, usually standing upright. The stand is made so that the tube and screen rise and fall together, and the tube may be shifted sideways

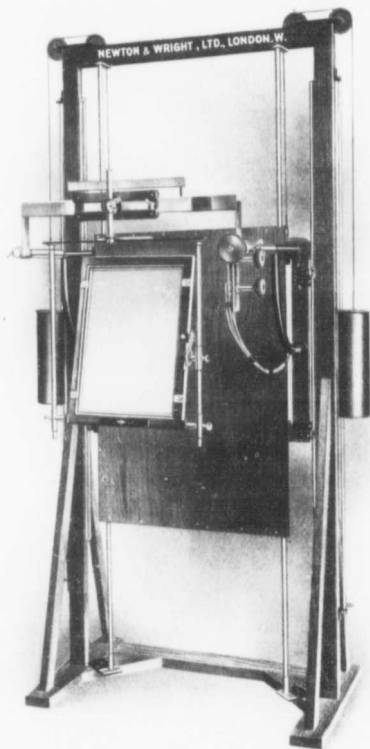

Fig. 60. Screening Stand.

independently. It is also provided with a rectangular diaphragm, adjustable from the screen side during observation. A ledge is provided on the back of the

screen to support a plate during exposure. A stand with all these movements is sufficient for most cases, but there is no limit to the amount of complication that can be introduced to suit individual taste or the requirements of special work. Needless to say the apparatus is to be placed in a room that can be completely darkened and it is as well to remain in this darkness, or at the most, a weak artificial light, for some minutes before the examination begins. The sensitiveness of the retina is largely increased by this and the relatively feeble screen image better seen. It is useful to have a rectangular closed box, longer than its width, and wider than its depth, on which the patient stands. This gives three different heights and is useful to bring the part under examination as nearly as possible to the level of the eyes of the observer. The switch-table for controlling the electrical apparatus should be alongside the observer so that he can vary the current through the tube without taking his eyes off the screen. These arrangements are essential if the examinations are to be made comfortably and satisfactorily. Finally the tube must be enclosed in an X-ray proof (and preferably also light tight) box, and the screen must be furnished with a sheet of thick lead glass on the side next the observer who should wear protective gloves during all examinations of this kind, especially if any manipulation of the patient has to take place, as frequently occurs in examination of the digestive organs.

Considering that several authors have written quite large volumes on the X-ray diagnosis of disorders of one or other of the main systems of the body, it will be readily understood that in a work of this size it would be impossible to deal with the whole subject, even though condensation were carried to extremes. Moreover, the subject of the X-ray diagnosis of internal disorders is one that cannot be learned from a book alone, and only a large experience in a busy X-ray department can impart a knowledge that gives confidence to all concerned.

The chief aim of these chapters is to indicate proper

methods of examination in ordinary cases, as well as to describe and illustrate normal appearances as observed in X-ray examinations. At the same time a certain number of the more ordinary pathological conditions will be referred to more or less briefly, especially such as will help to emphasise departures from the normal, and so lead the student along the first steps in the recognition of disease.

EXAMINATION OF THE THORAX.

To prevent over-lapping it will be more convenient to deal with the contents of the thoracic cavity as a whole rather than to divide them up into the respiratory, circulatory, and digestive systems, all of which are represented in this part.

The patient stands on a low stool so as to bring the thorax on a level with the observer's eyes, and is placed between the tube and the screen with the latter pressed close to the front of the chest. The most favourable subjects for observation are young people of spare build, between the ages of fifteen and twenty, but examinations must not be long and the same individual should not be subjected to repeated examinations, as the danger of producing an X-ray dermatitis is a very real one. An ordinary X-ray examination such as is required for the investigation of even a complicated case, is quite free from any such risk when carried out by an experienced radiologist.

Everything being in order the tube is set in action and the appearances of the normal chest may be studied (Plate II.) It shows two upright transparent areas, each conical in form with a curved base—the convexity of the curve being upwards. The conical areas are bounded externally by the ribs, and are separated by a dark zone in the middle due to the presence of the dorsal vertebræ, the sternum, the heart, and great vessels. These collectively constitute what is known as "the mediastinal shadow."

Above are seen the first ribs and the clavicles, and below are the two arched shadows—the right higher than the left—formed by the diaphragm. As the posterior part of the ribs is more opaque than the anterior, it shows as well as the latter in this position, notwithstanding the greater distance from the plate or screen and we thus get the symmetrical "lattice" pattern of the crossing of the anterior and posterior ribs. If we turn the patient round and look through from behind, the posterior ribs come out very clearly and the anterior ribs faintly, or not at all. It is thus always easy to tell at a glance whether the plate was on the front or back when the exposure was made.

Note the size and movement of the heart and great vessels carefully, so as to appreciate more readily any departure from the normal. Also the movements of the diaphragm; in normal respiration this amounts to half an inch, is equal on both sides, and should take place evenly and regularly. Any inequality between the two sides, or jerky irregular action, may be pathological. In forced respiration the excursion of the diaphragm may be as much as an inch-and-a-half.

The transparency of the lungs requires special attention as variations in this make one of the most important signs in detecting abnormalities. The lungs are more transparent in inspiration than in expiration, and where inspiration fails to increase the transparency of the whole or part of a lung, the condition is not a normal one.

In most adults there will be seen some "tree-branch" markings springing out from the root or hilum of each lung. These are usually found in those who dwell in towns and are due to the inhalation of dust and smoke. These foreign materials are taken up by the lymphatic vessels and glands as part of their function, and become enlarged and make shadows. The condition is much aggravated in some pulmonary conditions, notably phthisis, and the correct interpretation of this hilum

shadow in suspected cases is a matter that calls for the highest skill and experience. The presence of these branching shadows is not necessarily pathological, in the sense of indicating the presence of active disease, but speaking generally, the younger the patient the more likely are these markings the result of active disease—usually tuberculosis. In children under ten years the sign when well developed is almost pathognomonic. Just below the apex of the heart will be seen—best during inspiration—a triangular area known as the “Cardio-phrenic space.” It is bounded by the heart above, the other sides of the triangle being formed by the lateral ribs and the diaphragm. It may be obscured by several conditions, such as pleurisy, with or without effusion, tuberculosis and basal pneumonia.

We must now examine the mediastinal shadow more particularly. If the tube is working well this will be seen to be divided down the middle line of the body by the shadow of the dorsal vertebrae which, owing to their greater density can usually be made out through the heart and vessels. The greater portion of the mediastinal shadow lies to the left of the middle line and its external border is made up of three curves; the upper and smallest one being formed by part of the descending arch of the aorta—“the left lateral aortic bulge”—the middle one by the left auricle and pulmonary artery, and the lower and longest one by the left ventricle.

Only a small portion of the mediastinal shadow lies to the right of the vertebrae, seldom more than a finger's breadth, and is formed by a portion of the ascending arch of the aorta, the superior vena cava, and the right auricle.

Such are the main points to be made out in the examination of a normal thorax antero-posteriorly with the patient facing the observer. If the patient turns the back to the observer the appearances are more or less the same, except that the posterior ribs come out more clearly as well marked, nearly horizontal lines, while the

anterior ribs become less distinct and more difficult to recognise. Frequently the left lateral aortic bulge is seen more clearly in this position. The student should take every opportunity of familiarising himself with these appearances and by the time he has done so he will realise that additional information can be obtained by making the examination in different directions, not only laterally but at various angles. To describe all these would probably lead to much confusion in the minds of those for whom this work is intended, and serve no useful purpose at this stage. There is one diagonal line of observation, however, that must be studied, and fortunately, taken with the antero-posterior examinations, it enables us to make a full and satisfactory inspection of nearly all cases.

It is known as the "right anterior oblique" position. The rays penetrate obliquely from behind, forwards, and from left to right; that is to say, the tube is behind and to the left of the patient, the observer being in front and to the patient's right. The angle of illumination is about 45 degrees, but varies slightly in different individuals.

Supposing the examination, with the patient facing the observer to have been completed, the latter places his hands under the screen on the patient's hips and slowly rotates him towards his (the patient's) left side, watching the screen all the time. The patient should not move laterally, but only rotate on a vertical axis. The arms may hang straight down by the sides, or the hands may be clasped over the head.

As the rotation takes place the shadow of the vertebrae moves to the left of the observer and that of the heart and great vessels to the right until a stage is reached where these are separated by a long vertically-placed narrow space which is curved with its concavity facing the heart. The width of this space is from one-half to three-quarters of an inch and corresponds with the position of the oesophagus. We thus have three clear zones bounded

externally by the ribs and separated by two dark areas. Reading from left to right we have (1) the right lung, (2) the dorsal vertebræ, (3) the œsophageal space, (4) the heart and aorta, and (5) the left lung. (See Plate III.)

A good deal of the detail of the vertebræ can be made out and they should form a regular curve from above downwards with the concavity to the right. The œsophageal space should be of more or less uniform width throughout; if it is definitely encroached upon at any part some pathological condition is present. The heart shadow is triangular with the apex prolonged upwards by the long shadow of the aorta which is ribbon-shaped with a rounded top and of uniform width throughout.

It is essential for the student to make himself quite familiar with the normal appearances in this position of the thorax; it enables us to diagnose many conditions, such as aneurysm, œsophageal stricture, and mediastinal new growths with certainty and rapidity.

Before describing the changes shown in the thorax in the course of the more common diseases, it is necessary to impress upon the student again that there are but few conditions in which it is possible to make a positive diagnosis from the X-ray findings alone and that in nearly all cases this method of examination is valuable only when considered in relation to other signs and symptoms and with the history of the case. This is the only proper attitude to take up, and is one that will command respect and attention and thereby greatly add to the more general use of this method of examination.

Pulmonary Tuberculosis.—It is in the early stages that X-ray examination has become so valuable in recognising this disease. Tuberculous invasion of the lungs takes place much more frequently at the hilum than generally supposed, and when it does so the ordinary methods of examination fail to detect the mischief until it has advanced to some point nearer to the surface. Successful treatment of this disease is directly related to

its early recognition, and considering that in a large number of cases the X-ray method can anticipate a diagnosis made by the older methods, the matter becomes one of the highest importance not only to the individual but also to the nation.

The patient stands facing the observer with the screen on the front of the chest. The tube should be of medium hardness and is centred behind the middle of the pulmonary area. In a typical case some or all of the following signs will be observed. (Plate IV.) Probably the first change that strikes one is the increase of the shadow at the hilum; it is more pronounced than usual and the striations leading therefrom are more clearly seen. In one or more parts will be noticed an increased opacity, giving the lung a dull appearance which does not brighten up on deep inspiration. This sign is best demonstrated with the tube turned down so as to illuminate the lung very feebly, and in this way the test becomes a very delicate one. This is a very important sign since most opacities from other causes clear up on deep inspiration.

The movement of the ribs is frequently diminished, and also that of the diaphragm. The latter may move with a jerky or "stammering" action in addition to being limited in its excursion. These signs are not pathognomonic; free movements of the ribs and diaphragm are presumptive evidence against tuberculosis, but no more than this can be said.

In addition to the above the heart will be found to be smaller than usual and hung more vertically in the chest, so that a part of it shows well to the right of the vertebræ. A small feeble heart is probably an important predisposing factor in this disease.

In more advanced cases we may see dense and mottled shadows (Plate V.), and even cavities, but such are not usually brought for X-ray examination for obvious reasons. In adults small and very dense spots are often found near the hilum—even in those who have never

suffered any active invasion. They are obsolete tuberculous foci that have been encapsuled and even calcified, each one representing a victory of the organism over the invading bacillus. These small dense areas are of no clinical significance and are not to be mistaken for active foci.

While all these signs as seen on the screen are suggestive of tuberculosis, they are not sufficient to justify a positive diagnosis, though there may be little doubt especially if most of them are found in a suspected case. No X-ray examination of an early tuberculous invasion is complete without a satisfactory plate. For this the apparatus must be powerful so that the exposure does not exceed three or four seconds, and is to be made while the patient holds the breath in deep inspiration. The shorter the exposure the better the finer details are shown.

An intensifying screen should not be used if it can be avoided, as it interferes with the finer structure that is so characteristic of pulmonary tuberculosis. The plate is to be slipped between the screen and the patient's chest and should be pressed in close contact during the exposure.

Having secured a satisfactory plate it will corroborate some of the screen observations, such as the size and position of the heart, the presence of enlarged bronchial glands and striæ and areas of relative opacity. The great value of the plate is in the amount of fine details it shows that are impossible to see on the screen. If we trace out the striations they are seen to lead to still finer ramifications, making a fine network over the whole of the affected part—the term "mottling" has been applied to this. Frequently one of these fine ramifications is seen to run through or end in a tiny round or oval shadow—a tuberculous focus. These small foci scattered through the network of fine striæ is quite characteristic and may be considered as positive evidence of a tuberculous invasion of the lungs.

It is necessary to warn the student that the X-ray diagnosis of early pulmonary tuberculosis is not so simple

as it reads; the correct estimation of the value of the several appearances found in screen and plate is not by any means a simple one, and nothing short of an extensive experience will enable him to arrive at an accurate opinion.

Plate IV. is intended to give some idea of the appearances found in a more or less typical case. It is, however, impossible to reproduce the finest details which are the most important of all. Occasionally a case is met with where the ordinary clinical and physical signs are not at all conclusive, and yet an X-ray examination shows both lungs seriously involved. The whole pulmonary area shows numerous dark patches—a very coarse mottling—of dense infiltration. In such a case the infiltrated areas are confined to the deeper parts of the lung so that the usual signs are not readily elicited. Naturally there would be but a short period in which this could happen, especially if the examination were carried out by an expert, but the possibility is worth noting. The case illustrated in Plate V. was an instance of this.

Cavities vary in their appearance according to their contents. If full of pus or retained secretion they may be difficult to differentiate from their surroundings. If filled with air they show as clear spaces within a dense ring of consolidation.

Calcification is recognised as small and very dense localised shadows, usually near the hilum of the lungs.

Fibrosis occasionally gives a mottled appearance, but more generally a uniformly dense shadow that may occupy the whole of one side of the chest. The density is not much, if at all, affected by deep inspiration.

Pleurisy with or without effusion is an interesting subject for X-ray examination. A dry pleurisy that has gone on long enough to cause thickening gives only a slight shadow. There is no cardiac displacement, but the movement of the diaphragm is usually limited. If fluid is present it casts a homogeneous shadow the density of which varies with the thickness and the composition;

purulent effusion is more dense than serous. The shadow shows no mottling, and the diaphragm and some of the lower ribs are usually obscured. If no air is present in the pleural cavity it may be difficult to make out the upper limit of the fluid, as the thickness of the latter diminishes from below upwards. Also the upper limit is not horizontal as a rule, but concave. The greater the amount of fluid present the more nearly horizontal is the upper limit. If air is present also, the upper limit of the fluid is always horizontal, whatever the position of the patient, and the chest above the fluid is very bright and clear; this is accentuated by the dark shadow of the collapsed lung which lies over towards the middle line, probably displacing the heart to the opposite side. Waves may be seen along the surface of the fluid from the action of the heart, and actual splashing when the patient is shaken. These interesting appearances can be best studied in a case of pyopneumothorax.

The determination as to whether a thoracic shadow is pleural or pulmonary provides a useful lesson in differential diagnosis, and a few general rules may be given to aid the student in arriving at a correct opinion.

A pleural shadow is usually due to fluid, which may be recognised from what has just been said, and fluid tends to displace the heart to the opposite side. A pulmonary lesion tends to draw the heart to the same side, and if no fluid is present the small wedge-shaped space between the outer end of the diaphragm and the chest wall remains clear. Also we have to remember that fluid widens the intercostal spaces, while pulmonary disease tends to narrow them, giving the characteristic "roof tile" appearance.

Emphysema gives an appearance of greater brightness than normal in the affected area, which brightness is not increased on deep inspiration. The ribs are more horizontal than usual, and the curve of the diaphragm is flattened or even depressed. The heart shadow shows up very clearly and is more vertically placed.

PLATE II.

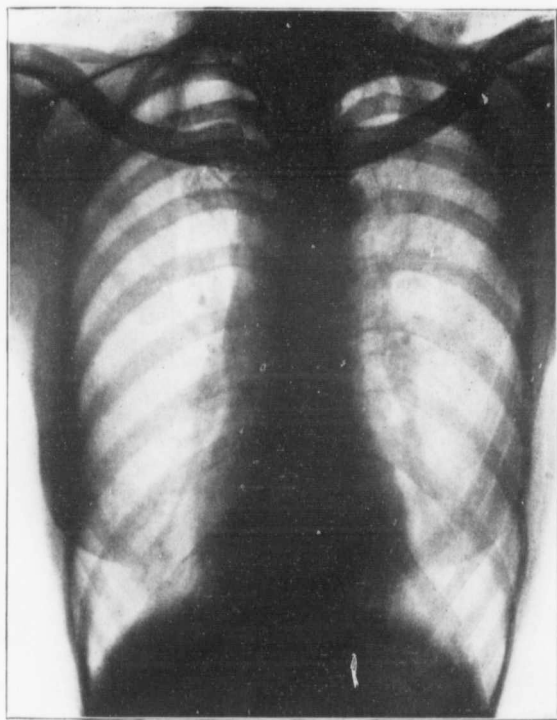

AN APPROXIMATELY NORMAL FEMALE ADULT CHEST

Taken on deep inspiration, thus bringing the heart more into the central line. The slight markings through the lungs are such as are always found in adult town-dwellers.

PLATE III.

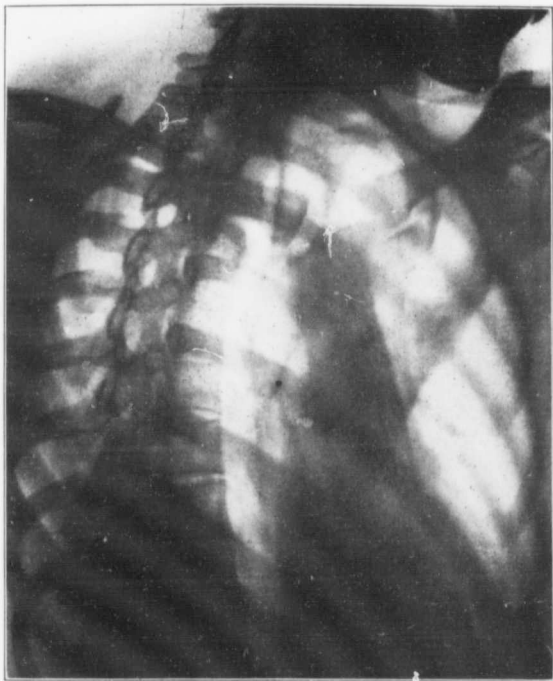

SHOWING CHEST IN RIGHT-ANTERIOR-OBLIQUE POSITION.

See pages 155 and 156.

PLATE IV.

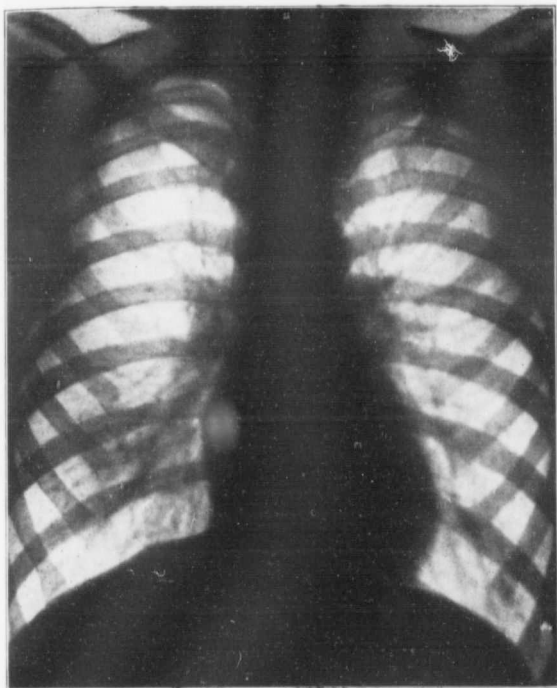

EARLY PULMONARY TUBERCULOSIS. NO PHYSICAL SIGNS.

See pages 136 to 139.

PLATE V.

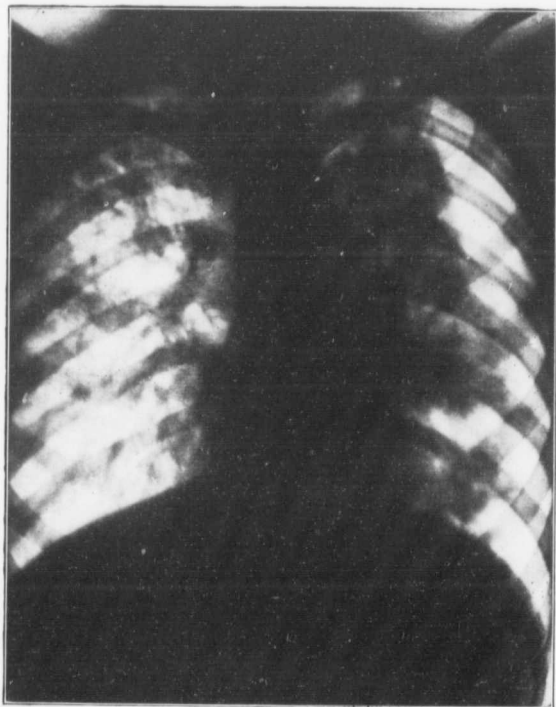

ADVANCED CASE OF PULMONARY TUBERCULOSIS.
Left lung is partially collapsed and pneumothorax in upper left chest.

PLATE VI.

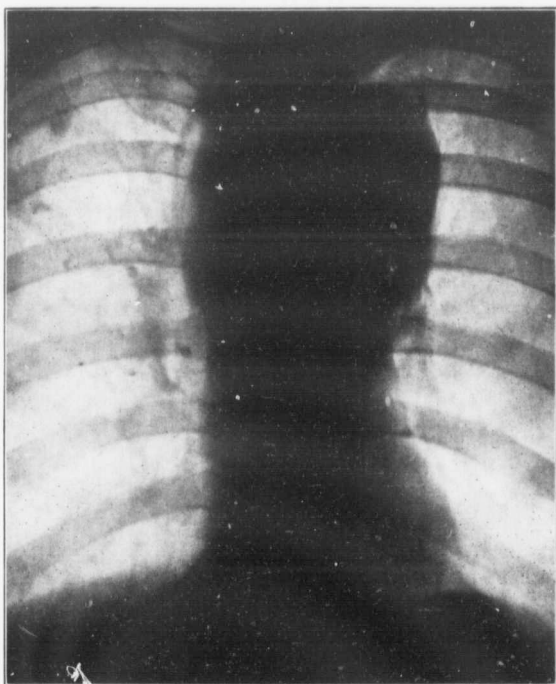

LARGE ANEURYSM OF THE ARCH OF THE AORTA.

Antero-posterior view *See page 162.*

PLATE VII.



Same case as Plate VI., seen in the right anterior oblique position.
Compare Plates III. and IX.

PLATE VIII.

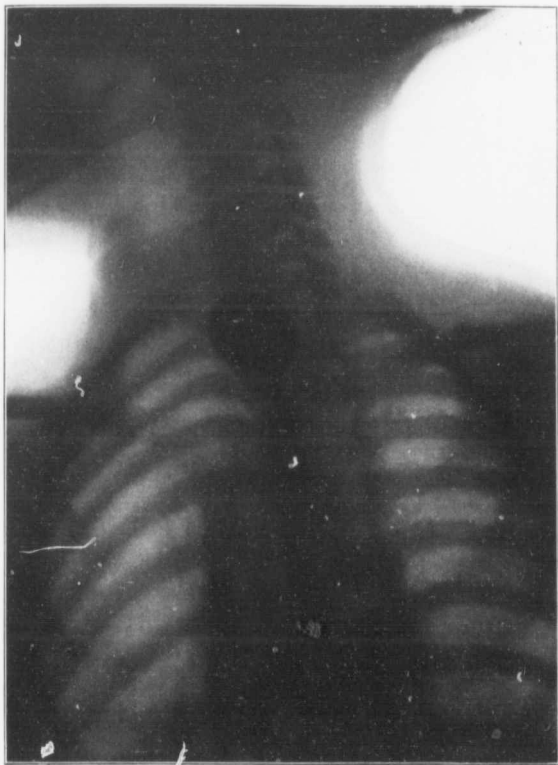

HALF-PENNY IN LOWER PHARYNX OF CHILD AGE $3\frac{1}{2}$ YEARS.

See page 163.

Bronchiectasis is not so easy to demonstrate. The affected area is brighter than normal, and increased on deep inspiration. The ribs are not unduly horizontal, nor is the diaphragm depressed. While the heart shadow is distinct, it is not markedly vertical. The signs are not very tangible, but they are usually sufficient to corroborate other signs and symptoms.

It is impossible to lay down any definite rules for the diagnosis of pulmonary new growths. As a rule they are distinctive and not easily confused with pulmonary disease or aneurysm.

The Heart and Aorta can be made out very accurately by X-ray examination, especially if instantaneous radiographs are made with the tube at a distance—tele-radiography. The screen is the most generally useful method, and the heart is best seen during deep inspiration. This makes the outline more clear and the heart hangs more vertically, bringing the right border more into view. The normal appearances have been already described, and the different parts of the mediastinal shadow identified. Obviously this method of examination must always be more accurate than percussion.

The diagnosis of diseases of the heart from the changes in its size, shape, and position is a very highly specialised branch of work requiring apparatus and technique quite beyond the scope of such a work as this. Some excellent work in this direction has been done by French radiologists.

In **Mitral Stenosis** the heart becomes purse-shaped, or like a triangle with rounded corners—one of which is well to the right side. This is due to the hypertrophy of the right ventricle, and the appearance is quite characteristic.

Pericardial effusion presents different appearances according to the amount of fluid present in the sac. The cardio-phrenic space is obliterated, even in small

effusions, and with increasing amounts of fluid the cardiac shadow becomes larger and more rounded, and the pulsations less distinct, even to the extent of obliteration.

Intra-thoracic Aneurysm, especially of the arch of the aorta, is a condition where the X-ray method of examination is a most conspicuous success. The condition of the patient may make it difficult to carry out, but it is essential to make a screen examination in the antero-posterior and right-anterior-oblique positions. The patient should stand, or sit on a bicycle saddle so mounted that he can be rotated at will.

In the antero-posterior view it will be remembered that normally the aorta is almost entirely hidden within the central shadow. If an aneurysm is present we shall find a rounded shadow projecting to the right, or left, or perhaps both, at the upper part of the mediastinal shadow. The extraneous shadow usually pulsates, but some aneurysms do not pulsate, and other tumours occasionally give an expansile pulsation. While it is strongly suggestive of aneurysm, pulsation is not conclusive evidence thereof. (Plate VI.)

If the bulge is on the right side the ascending arch is involved, and when the descending arch is affected the bulge is to the left. As it is not justifiable to give a diagnosis of aneurysm from the antero-posterior view alone, the patient must now be turned to his left side until he is in the best position to show the space between the heart and dorsal vertebræ. Bearing in mind the appearance of the normal aorta—a ribbon-like shadow with parallel sides and a rounded top—if an aneurysm is present we shall see an alteration in shape; it becomes bulbous or club-shaped, but the greater diameter is not necessarily at the highest point. (Plate VII.)

If the antero-posterior view shows lateral bulging, and no clubbing in the oblique position, the case is one of general dilatation and not a true aneurysm. The bright area between the heart and vertebræ is never completely obliterated by an aneurysm; the lower part remains clear,

but the latter may be darkened by a dilated auricle. This bulbous deformity of the aortic shadow is most characteristic of aneurysm, and when observed the nature of the case ceases to be a matter of doubt.

It is worthy of note that a large aneurysm of the ascending arch tends to displace the whole heart downwards so that it lies more horizontally in the chest.

It will be better perhaps to deal with œsophageal discases in the next chapter, but we may here refer to the presence of foreign bodies in the thorax as a whole.

If the foreign body is one of any of the heavier metals its detection is a very simple matter. A small button might be difficult to see if made of aluminium, but such are not common. Children are naturally the more frequently affected in this way, and coins, buttons, pins, small toys and trinkets and fruit stones are among the most common objects we are asked to find. The site at which an object is found depends on its size and the size or age of the child. Frequently a child of about three years is brought in with a history of having swallowed a halfpenny, perhaps a day or two before. In such a case there is no need to waste time hunting through the thorax and abdomen, as it is not possible for a coin of that size to get further than the lower part of the pharynx, and the first glimpse just above the episternal notch settles the question as to whether the coin has been swallowed or not. See Plate VIII. As the child gets older a halfpenny will pass into the stomach, but few adults could swallow a half-crown. The penny sticks in the œsophagus frequently, and has to be extracted or pushed further down into the stomach and then removed by gastrotomy. Speaking generally a foreign body that passes into the stomach with little difficulty will pass right through the digestive canal in due course, and may be left alone unless there are special indications for interference.

A very troublesome object is a vulcanite tooth-plate, both to the patient and to the radiologist. Vulcanite being very transparent to the rays, the object may be

almost impossible to detect. In this case we may give a spoonful of bismuth food or emulsion, and watch its progress through the œsophagus. The mass will hesitate at the object if it is present, and after the main mass has passed to the stomach some will be seen sticking to the plate, making the position of the latter visible.

Occasionally foreign bodies get into and through the larynx. They are usually small and light objects, and may be difficult to detect. It is a help to know that they are very often arrested in the right bronchus, which is in a more direct line with the trachea than the left.

In all these cases the patient is to be examined standing and from every point of view, if necessary. Usually the antero-posterior and the oblique positions are sufficient.

Fruit stones—even the hardest of them—cast no shadow worth mentioning, but at times they may be made visible with bismuth, as directed in the case of the vulcanite tooth-plate.

CHAPTER XIV.

THE DIGESTIVE SYSTEM.

Except for the examination of teeth the first part of the digestive system of interest to the radiologist is the œsophagus. As all the digestive organs are equally translucent with their surroundings, it is impossible to observe them directly. It thus becomes necessary to administer some innocuous but radiographically opaque substance with food so that the size, shape, and movements of the various organs may be watched. While many substances may be used the choice is practically limited to three, each of which has its advantages and also its disadvantages. They are (1) bismuth carbonate, (2) bismuth oxychloride, (3) barium sulphate. These can all be obtained specially prepared for this purpose, as it is essential that their purity be beyond question. Impurities that mean little or nothing in ordinary doses might have serious results when administered in the large quantities required for X-ray examination. Probably the ideal salt for this purpose is bismuth oxychloride. It is not only the most opaque, but it is also quite inert and passes through the alimentary canal unchanged. The drawback is that it is the most expensive, and in hospital practice this means a great deal in the course of a year's work. Bismuth carbonate is a little less expensive; it is not so opaque, but it neutralises the gastric juice to some extent, and some radiologists object to this on the ground that it introduces a condition that is not normal. On the other hand, this property is considered advantageous in examining the pylorus and duodenum, producing

relaxation of the sphincter and rendering the parts more visible during the copious flow of bismuth. Barium sulphate is the cheapest preparation, but it is not so opaque as either of the others, though it is quite inert and, like bismuth oxychloride, passes through unchanged. Also it has a very high specific gravity, being twice the weight of bismuth carbonate, bulk for bulk. Its cheapness is likely to ensure a very general use, but it is open to question whether we should use such a heavy salt, which when gathered up in a limited space as it does in the last part of the ileum before entering the cæcum, is not unlikely to drag down this part of the intestine, giving rise to "kinking" that does not ordinarily exist. A very light form of barium sulphate has recently been introduced which is free from this possible objection.

These matters are of no importance in the examination of the œsophagus, and what we require is a small quantity of thick bread and milk or porridge—two or three ounces are plenty—into which from one-half to one ounce of the opaque salt is thoroughly mixed. It may be flavoured or sweetened as desired.

The patient is placed in exactly the same oblique position as for examining the aorta. He must be turned so as to show the retro-cardiac space as clearly as possible. A spoonful of the food is then given and retained in the mouth until the observer is quite ready. Its passage down the œsophagus must be carefully watched for obstruction, or narrowing of the canal. Normally the food may take anything up to ten seconds to pass into the stomach. It usually lodges for one or two seconds at the level of the arch of the aorta, and then passes more or less rapidly to the cardiac end. It never stops here except when there is narrowing, but this narrowing may be spasmodic. Individuals vary as regards the performance of the œsophageal function, so that no definite rule can be described as the normal. If during the passage to the stomach no considerable narrowing is seen at any point, though the whole mass passes down slowly or even with

hesitation, we may be reasonably sure no stricture exists. If a wide stricture is suspected we may give a suppository made of bismuth and stiff gelatine, which should be swallowed whole. This will be arrested at any point where the canal is narrowed, and will not pass on until the warmth of the part has melted it sufficiently to pass the constriction. Patients do not, as a rule, seek advice at this stage, since it gives rise to little inconvenience. By the time it becomes difficult or impossible to swallow solids, we shall see the food pass freely as far as the obstruction when it suddenly stops, forming an oval sharply-defined shadow, and if this is carefully watched it will be seen passing through the stricture in a narrow stream, from the end of which drops fall away and pass rapidly into the stomach. A common site is just behind the arch of the aorta, apart from aneurysm which may give rise to obstruction at this point. (See frontispiece.)

Probably the next most common site is at the cardiac end in which case the food passes quickly to this point, and it is then possible to watch the peristaltic action in its effort to force the food through the constriction. Two or three mouthfuls of the food may be given so as to fill the lower part of the tube, and as the contraction passes down from above, the œsophagus becomes dilated at its lower end, forming a pear-shaped shadow. As soon as the contraction passes off the food rises up in the tube again, and this may be repeated several times before it is either returned or gradually passed into the stomach.

It should be remembered that though a patient may have lost considerable weight it does not necessarily follow that his stricture is a very narrow one. In very many cases of œsophageal stricture the act of swallowing is, at a comparatively early stage, attended with, or immediately followed by, severe pain, and it is the fear of bringing this on that causes the starvation quite as much as, if not more than, the actual obstruction. At a later stage of obstruction at the cardiac end the muscle begins to fail and dilatation sets in. Large amounts of

food may be retained in the pouch for many hours before it is returned or passed through to the stomach.

Œsophageal obstruction may be brought about by pressure from without, as an aneurysm or new growth; by changes in its walls, such as carcinoma, or fibrous contraction following the action of corrosive fluids; by the presence of foreign bodies; and, lastly, it may be a spasmodic condition of reflex origin.

Most of the foreign bodies found in the œsophagus are sufficiently opaque to be seen on the screen or plate; but fruit stones and non-metallic tooth plates are not. They may be made visible, however, by giving the patient a little thick bismuth emulsion to swallow; some of this sticks to the foreign body and its position then becomes visible.

Other conditions of the œsophagus are to be made out by X-ray examination, such as diverticula, and the condition known as cardiospasm can be demonstrated. Plate IX. shows an œsophageal pouch just above the level of the episternal notch.

It may be mentioned that if there is reason to believe that a constriction of the œsophagus is of spasmodic origin, this can be relieved sometimes by giving a few minims of tincture of belladonna during the examination.

The Stomach.—The first matter to be settled for an examination of the stomach and intestines is the selection of a suitable opaque meal to give the patient. In the past there has been much diversity in the amount and composition of the meal administered for this purpose, but at the present time the majority of radiologists are of the opinion that some standard formula should be adopted for general use. The matter is still under consideration, but the main details have been practically agreed to. The basis is to be either porridge or bread and milk, made moderately thick. The opacity is provided either by two ounces of the carbonate or oxychloride of bismuth, or by three ounces of barium sulphate—more is required of the last owing to its lower degree of opacity to the X-rays.

The total bulk of the meal is to be ten ounces, and it may be sweetened or flavoured as desired. It is of the highest importance that the meal be made as attractive as possible. It must be nicely made and nicely served. A culinary artist might succeed in making it really attractive to the average patient; carelessly made it can be a most repulsive looking mess, especially to those whose digestions are out of order. This must be avoided, as any feeling of disgust is sure to make a great difference in the behaviour of the stomach, which is very sensitive to mental impressions of this kind.

The preparation of the patient also requires attention. Where possible a laxative should be taken on the second evening before the examination, and the rectum should be cleared out early the same morning. The examination should commence as soon as possible afterwards, the opaque meal being taken in place of the ordinary breakfast.

The patient stands as for examination of the thorax antero-posteriorly, and the screen lowered so as to bring the gastric region into view. An assistant feeds the patient while the operator attends to the screen observation. In all cases the first few spoonfuls should be watched passing down the gullet by turning the patient in the oblique position already described. He is then placed facing the screen and the filling of the stomach can be watched. Below the left dome of the diaphragm will usually be found a clear hemispherical area due to air or gas in the fundus of the stomach. Just about the lower border of this clear area the food will be seen entering the stomach, and at first forms a roughly triangular shadow with the apex downwards—we are considering the case of a normal stomach in a healthy young adult. As more food comes in, the hitherto collapsed stomach is gradually canalised and the apex of the triangle extends downwards and widens out. As it gets near the umbilicus the point of the shadow curves to the patient's right, nearly as far as the middle line, and then turns slightly

upwards so that the complete stomach shadow is like the letter "J." If more food is now given, the shadow does not elongate. Increased capacity is attained by lateral expansion. The stomach is not a fixed organ, it is a hollow muscle hung more or less loosely in the upper abdomen and quite easily displaced by slight forces. There is no one size or shape of stomach that can be said to be more normal than many others, but the stomachs of normal young adults who have never suffered from digestive disorders conform more or less to a general design that experience teaches us to recognise. Consequently descriptions of the stomach as seen by X-ray examination in health and in disease must be more or less vague. Except for the pylorus the stomach is always entirely to the left of the middle line, and it extends from the left dome of the diaphragm to about the level of the umbilicus. In making this examination it is not necessary to place a coin on the umbilicus; the latter is not a fixed point, but it ought to be on a line joining the highest point of the iliac crests, and this line suits our purpose better.

As to the shape of the stomach, we may say the upper third is pyriform and filled with gas, while the lower two-thirds is tubular, the diameter varying with the amount of food present. As to its position, the upper two-thirds is almost vertical, and the lower third is nearly horizontal. The pylorus may be to the right of the middle line, and it should be on a level with the lower pole of the stomach. Usually, however, we find that the lower pole of the stomach is below the umbilicus in average individuals, and it is also below the pylorus. We may regard this as a very mild degree of gastropptosis, in an academical sense only, and of no practical or clinical importance; in fact, the milder degrees of gastropptosis are not at all incompatible with a functionally perfect digestion. The important thing is that the tone of its muscular coats should be good. It is this tonic condition that enables the stomach to maintain its tubular form and hold up its

contents against gravity. It is also this tonic state that gives the stomach the form we see in life; it is the absence of it that gave us such wrong ideas of its proper form because they were based on observations made on the operating table or *post mortem*. See Fig. 61.

Peristalsis may be seen immediately after the food is given. The waves are seen to pass along the greater curvature every fifteen or twenty seconds, gaining in depth and vigour as they approach the pyloric end where the muscular coat is strongest. Foods tend to arrange themselves according to their specific gravity, and the old idea of "churning" of the contents is quite a fallacy. (See Fig. 62).

All the movements of the stomach are less vigorous when the individual reclines.

If the subject is a thin individual it is possible to get a good view of the stomach from side to side. It then shows as a long curved shadow with the convexity upwards and forwards. The upper end is in the centre of the body from where it curves downwards and forwards, the last portion of it hanging almost vertically and fairly close to the anterior abdominal wall. (See Plate XI).

Though both the tonic state of the stomach and its peristaltic movements are the result of muscular action, by all appearances they are quite independent of each other. Peristalsis is often seen in cases of severe atony, and occasionally there is an absence of peristalsis without any sagging of the stomach such as is found in atony.

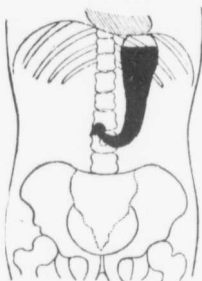

Fig. 61. Normal.

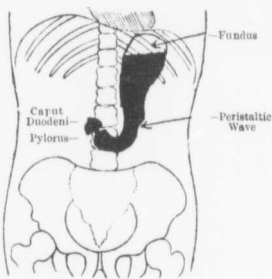

Fig. 62. Normal.

This is about as much as can be said here about the normal stomach; though necessarily brief and necessarily vague, it is probably enough to form a general guide to the student.

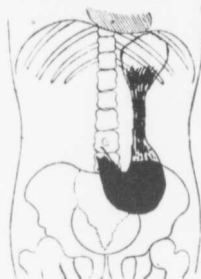

Fig. 63 Atonic Stomach.

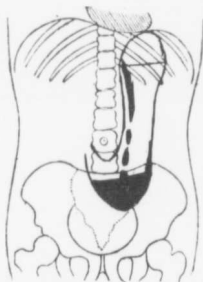

Fig. 64. Opaque Food entering an Atonic Stomach already containing Fluid.

The investigation of gastic disorders has become so vast and important a subject that it will be possible to refer only briefly to a few of the more common ones that come within the field of the radiologist. Of these the one most commonly met with is that of atony, and by this we mean the inability of the stomach to keep its tubular form and hold up its contents. If the food is watched passing into the stomach, it passes quickly to the lowest part, so that this is the only part that is clearly shown. Here it lies, as in a wet towel, forming a curved shadow well below the umbilicus and even down to the level of the symphysis. In the less severe cases the food is held up for a short time, but after a few minutes, or it may be seconds, it falls to the lowest part. It should be a rule in all cases to inspect the gastric region before the bismuth is given.

It is then possible to see if the stomach is full of fluid (secretion). Its horizontal level can be seen and splashing elicited by shaking the patient. If opaque food is given at once to the lower border, being heavier than the fluid which keeps the organ canalised. This is, of course, consistent with perfect tonicity, and care must be taken not to fall into the error of ascribing the rapid fall of food to the lowest point to the presence of atony.

Again, we may find the lowest part of the stomach well below the umbilicus and the tonicity apparently quite good. This is what is called gastroptosis, and is not to be confounded with atony. Plate X. is an instance of this condition; Plate XI. is a lateral view of the same case.

In extreme cases of atony the appearances are very striking; the organ seems to consist of two bags, one above and filled with air—the fundus—and the other down near the pubes, and the two joined by a narrow tube of elongated, stretched out and narrowed middle portion. To see this well it is necessary to give a spoonful of food while watching the screen. Otherwise it passes through so quickly that it may be missed. If a plate is made just after it has passed through, longitudinal lines will be shown of such food as lies in the rugæ. See Plate XII.

Severe atony is the cause of much suffering and discomfort. In the erect posture peristalsis is incompetent to raise up and force the food through the pylorus; food is retained too long, and this tends to aggravate the condition as well as the other effects of too prolonged retention. Then as the transverse colon is attached to the stomach by the transverse meso-colon, it comes down with the stomach. It also is then in a disadvantageous position for carrying out its functions, leading to constipation and auto-intoxication. The condition is aggravated by a lax abdominal wall, and in many great relief is found in wearing a properly fitting belt, and reclining after taking food.

In a proportion of the cases of gastric disorder it is found that the opaque food is kept in the upper part of the stomach for some time, and part of it passes through a narrow channel near the lesser curvature, so that the lower sac gradually fills. At a certain stage we see the meal more or less equally divided between the upper and lower sacs with a narrow channel between—the “hour glass” stomach. (See Fig. 65 and Plate XIII.)

This condition is practically always due to the presence of gastric ulcer; in the early stage the constriction is

spasmodic arising from the irritable state of the ulcer; at a later stage the constriction may be organic, the result of cicatricial contraction. See Fig. 66. As regards the

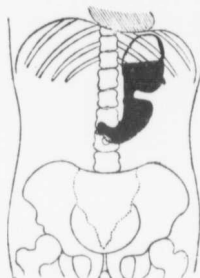

Fig. 65. Showing the cavity of the stomach divided into two sacs by spasm of the circular fibres usually induced by the presence of a Gastric Ulcer on the Lesser Curvature.

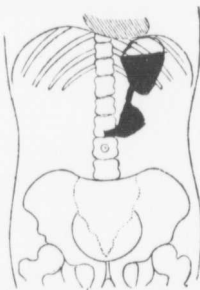

Fig. 66 An Organic Hour-Glass Stomach, due to cicatricial contraction.

constriction and also the symptoms, the spasmodic element is just as important as the organic. When food is observed to be held up in the upper part of the stomach longer than usual, the front of the abdomen should be rubbed more or less vigorously, if necessary, and it frequently happens that the spasm is relieved and the food passes easily to the lower part. If this fails a small dose of belladonna may be given; or possibly the spasm may relax of its own accord for a brief period—in any case, relaxation, however produced, proves the spasmodic character of the constriction. The converse is not necessarily true, as some spasmodic strictures of the stomach cannot be made to relax by any ordinary means. Plate XV. is from a case of gastric ulcer of ten years standing.

The most common site for gastric ulcer is about half-way along the lesser curvature, and when spasms occur the effect is as if a tight string were tied round drawing the greater curvature towards the lesser, which is fixed.

The next most common site is near or at the pyloric end which gives rise to spasmodic contraction of the pylorus. This constitutes a real pyloric obstruction, and at a later

stage this may become organic from cicatrisation of the ulcer. As a result of this obstruction the stomach may become severely atonic from muscular failure after strenuous efforts to force the food into the duodenum. Another point in favour of gastric ulcer is hyper-secretion. The organ is seen to be filled with fluid, which is recognised by the horizontal level it maintains as the patient changes his position, and the splashing when he is shaken slightly. In thin subjects this is seen quite easily, and if bismuth is given it drops down through the clear fluid to the lower border of the stomach. (See Fig. 67.)

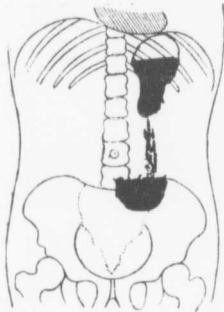

Fig. 67. Hour-Glass Stomach with pyloric obstruction.

Also there will be tenderness on pressure over the site of the constriction, and with all these points to guide us the diagnosis of gastric ulcer will be reasonably safe. Ulcers of the fundus are rare and may be classed among the pathological curiosities.

It should be stated that hyper-secretion is more often found in cases of ulcer of the pyloric end. The fluid is highly acid, and this may be proved by giving a dose of bicarbonate of soda and watching the rapid formation of

gas in the fundus. According to Barclay a diagnosis of pyloric ulceration may be suggested if—the stomach is normal, the peristalsis is rather active, no shadows are seen passing through the duodenum, and there is rapid secretion which gives off CO_2 freely. It should be remembered that various stages of atony may be associated with gastric ulceration.

Pyloric obstruction is further recognised by the fact that in spite of more or less active peristalsis the stomach shows no sign of emptying within an hour. Normally all should have left the stomach in about four hours. Six

hours is too long, but not necessarily due to pyloric obstruction, especially if atony is present to any extent. If food remains after eight hours in a stomach not markedly atonic and in spite of active peristalsis, we may be sure there is obstruction of the pylorus.

There are no characteristic signs by which we may recognise malignant disease of the stomach from other forms of ulceration and obstruction. The chief point is a very unusual course taken by the food after it enters the stomach, due to the inroads of the growth. Examination on a subsequent day shows the irregularity to be permanent. If hyper-secretion be present, little or no evolution of gas takes place after giving bicarbonate of soda.

The shape of the stomach shadow may be altered by adhesions as well as growths on other parts affecting it by pressure from without. All these conditions call for considerable experience if a reasonably accurate diagnosis is to be made from the X-ray examination. (See Plate XVI.)

The Duodenum.—The pyloric end of the stomach and the duodenum are not so easy to observe as the middle portion and fundus. The cavity is smaller so that less of the food is there to render it visible. Also the lumbar vertebræ are in the path of the rays and add to the obscurity of the region. Then as the food is projected into the duodenum in a rather thin jet and immediately diluted with the intestinal juices, its passage through this part is not usually seen under normal conditions. With a thin subject and a large dose of the opaque material the operation at the pyloric end can be easily watched. If we follow a peristaltic wave towards the pylorus it is seen to get deeper and narrower, forming a deep cleft which is joined by another from the opposite side as it approaches the pylorus—just as if a tight ligature were being passed along and almost closing the channel. As this constriction travels along the lower pole and up towards the pylorus the constricted part gets longer, and finally a portion of the tube is separated from the main

PLATE IX.

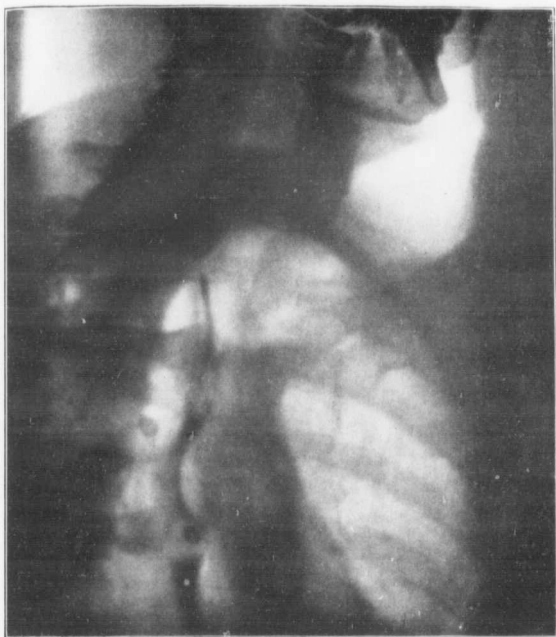

THE SEMI-CIRCULAR SHADOW ABOVE THE EPISTERNAL NOTCH SHOWS
AN ESOPHAGEAL POUCH.

It was not until this was filled that the food passed down the esophagus—the sinuous line between the heart and vertebrae. The upper end of the aorta is seen just below the inner ends of the clavicles where they articulate with the sternum.

PLATE X.



GASTROPTOSIS. *See page 173.*

PLATE XI.

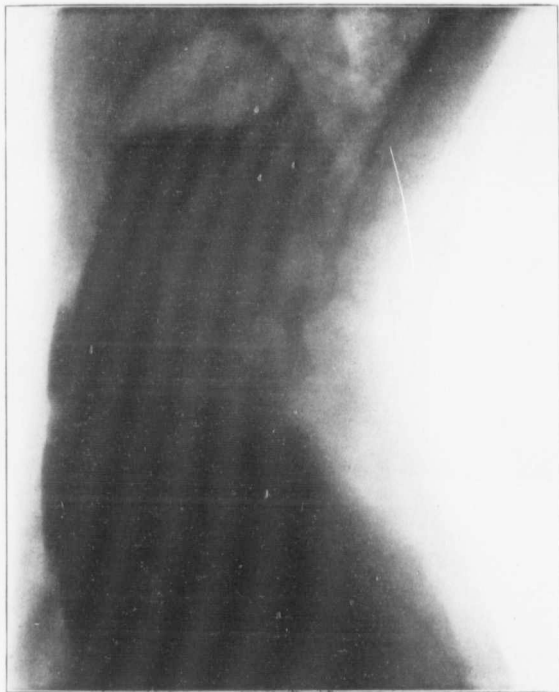

A lateral view of the same case as Plate X. It shows how the stomach is placed in the abdominal cavity in its antero-posterior relations.

PLATE XII.

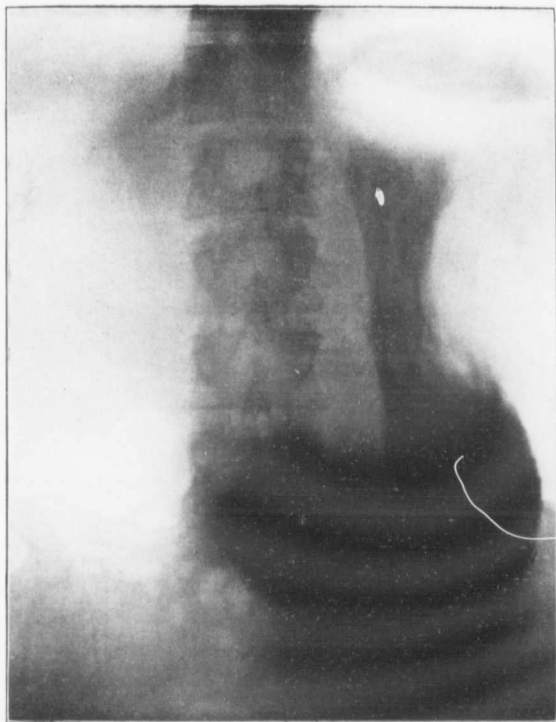

ATONIC STOMACH.

The organ is unable to hold up its contents against gravity, and has become a limp flaccid bag.

PLATE XIII.



GASTRIC ULCER.

- 1—Site of Ulcer causing.
- 2—Segmentation of Stomach.
- 3—A commencing Peristaltic wave.

See page 173.

PLATE XIV.



Same case as Plate XIII., viewed laterally. Note distortion of stomach from spasmotic contractions induced by ulcer. Compare Plate XI.

PLATE XV.

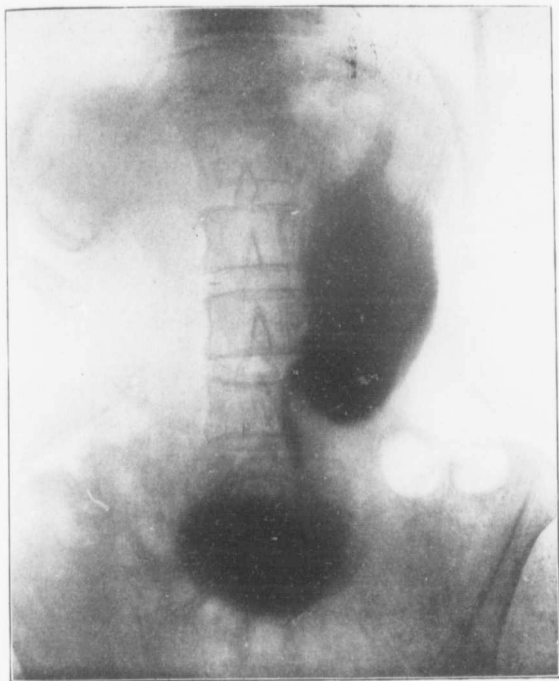

A TYPICAL CASE OF ORGANIC HOUR-GLASS STOMACH.

Taken one hour after opaque meal. Stomach divided into two sacs, with a narrow channel between—the result of cicatricial contraction following gastric ulcer.

PLATE XVI.

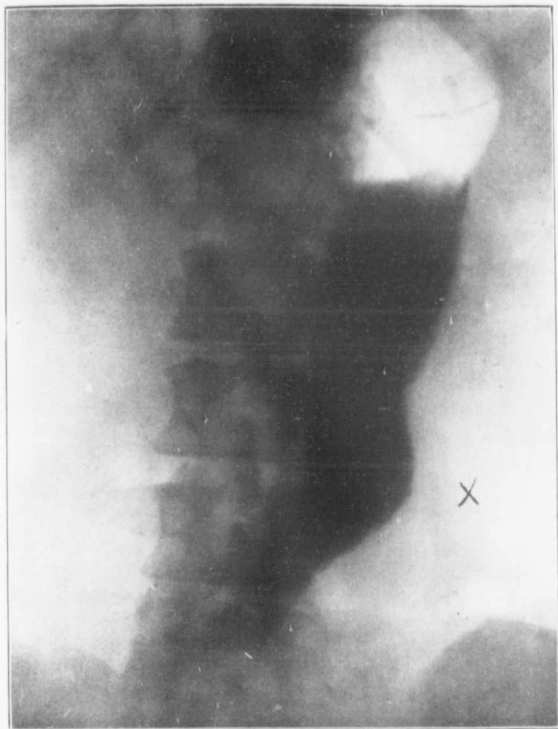

AN APPROXIMATELY NORMAL STOMACH.

Which is pushed towards the middle line by a tumour X, which could be easily felt through the abdominal wall. The X-ray examination proved the growth was extra-gastric.

PLATE XVII.

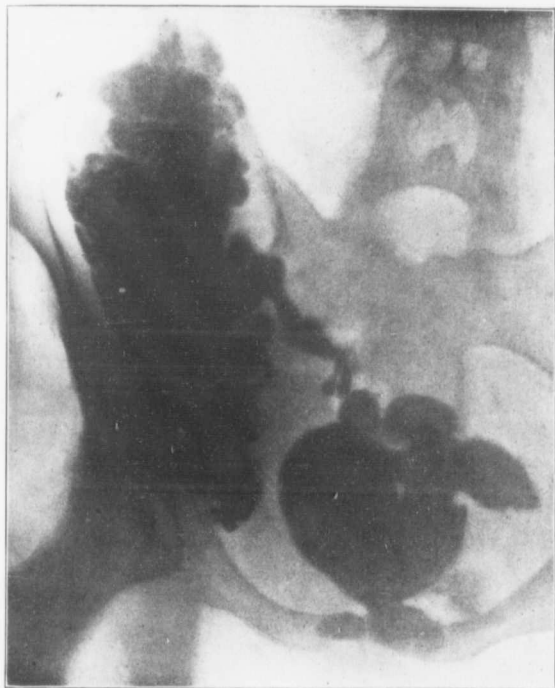

ILEAL STASIS.

24 hours after taking meal. Food still in ileum.

body to which it is connected by the narrow neck. This part is triangular like a cap or helmet, and from its shape and position is called the "caput duodeni," or, more shortly, the "cap." See Fig. 62. It does not last very long before it disappears to make room for another; a little of its contents passes into the duodenum, but most of it falls back into the stomach. The process is repeated every twenty seconds, more or less, so long as food remains in the stomach. This is the nearest approach to "churning" that takes place during the gastric digestion.

It frequently happens that in some individuals the peristaltic waves follow one another so rapidly that the pyloric end of the stomach is seen to be divided up into two, three, or more sacs or segments, each joined by a narrow neck to the one before and after it. This seems to be normal, indicating an active peristaltic action; it cannot be held to be characteristic of any pathological condition.

Before examining this portion of the digestive tract, the patient should be made to lie on the right side for a few minutes, and then turned on his back while the observation is made. It is sometimes a help to turn him *slightly* towards his right so as to get the part clear of the vertebræ.

Small Intestine.—Under normal conditions the passage of the food is not easily seen in any part of the small intestine except the last portion of the ileum. Apart from dilution with the intestinal juices the passage is very rapid; an instantaneous radiogram shows numerous vermicular shadows scattered through the abdominal cavity. As the latter part of the ileum is reached very rapid absorption of the fluid takes place, so that the opaque material tends to become banked up, as it were, in the last few inches of the small intestine adjoining the ileo-cæcal valve. The normal time of passage from the pylorus to the cæcum is from three to five hours, and at intervals the ileo-cæcal valve relaxes to allow a

portion of the mass to pass into the cæcum. If nothing has passed into the cæcum after five hours from taking the meal and the stomach is empty, there is sure to be some obstruction near the cæcum.

Large Intestine.—From the cæcum the fæces passes up the ascending colon to the hepatic flexure which lies at about the level of the iliac crest. Then along the transverse colon which forms a curve downwards slightly and then up to the splenic flexure under the costal border. This is a rather sharp bend, and from here it passes down-

wards gradually bearing to the right near the brim of the pelvis, where it joins the sigmoid flexure. Here the curves follow no fixed rule, and finally the shadow comes to the middle line low down in the pelvis marking the rectum. See Fig. 68. Plates made during this period show the colon segmented usually, and little or no sign of movement, even in a time exposure, except that due to respiration. The normal progress of the contents of the colon is peculiar and consists of single large movements at long intervals. The fæces may pass from the cæcum to the rectum

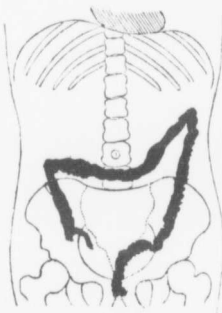

Fig. 68. Showing approximately the normal position of the large intestine.

in a few seconds, though usually the movement is not so extensive as this. It happens most often at the end of a meal or soon afterwards, and except for the resulting desire for defæcation, the individual is quite unconscious of it. At the usual after-breakfast call to stool, the bowel from the splenic flexure onwards is evacuated under normal conditions, but it may be more or less so without being necessarily pathological.

With regard to the whole question of digestive movement, it is impossible to lay down hard and fast rules. Quite wide variations are not incompatible with good

health, and in no branch of investigation is a large experience more necessary to enable one to arrive at correct conclusions.

The normal appearances just described refer to observations made while the patient stands, and probably most investigations are made in this position. The only exception was in the case of the duodenum, and the directions given are to ensure a larger flow of the opaque food through this part, and make it easier to see. Especially does this apply to cases where the duodenum is at fault, as from dilatation or ulceration, and as the latter condition is one that has attracted considerable attention lately, some reference must be made to it here.

Experiments go to show that the presence of acid in the duodenum causes closure of the pylorus, and this does not relax until the acid chyme is neutralised and passed on. For this reason some radiologists give carbonate of bismuth when the duodenum is to be particularly investigated, even adding bicarbonate of soda to decrease still further the acidity of the gastric contents. This delays the pyloric closure, during which a copious flow of food takes place, and the condition of the duodenum more easily noted. In ulcer of the duodenum this is not usually necessary, and in these cases this part is observed more or less readily. The ulcer itself is practically never seen; the diagnosis is made indirectly, and the following points are strongly in favour of its presence. The stomach is normal, its peristalsis is unduly active, and it is rapidly emptied, so rapidly that the food can be seen passing through the duodenum—seldom, if ever, observable under normal conditions and with the ordinary opaque meal. These signs are indicative of duodenal irritation, and the cause is usually an ulcer. The emptying of the stomach is complete within an hour, and the contents pass through the small intestine so rapidly that the cæcum may be reached before the stomach is completely empty. Indeed, the condition is attended with an irritability of

the whole digestive tube, which has led many to look upon the duodenum as the most sensitive point—"the storm centre"—of the alimentary system. More than this, there seems to be a sort of telephonic inter-communication between the various parts enabling them to work in unison, and very little thought shows that such an arrangement is essential to preserve the necessary balance. In the above instance, excessive activity at the duodenum would cause uncomfortable or dangerous distension at the cæcum, only for the corresponding increased activity induced further on to ensure the rapid onward movement of the intestinal contents. This also shows how important it is to make a complete examination of the whole digestive system in all cases, or at least those where the disorder is beyond the cardiac end of the stomach.

The normal duodenum is narrow and short, and not very easily observed under ordinary conditions. In cases of intestinal stasis it may become dilated and lengthened, and strong peristaltic movements may be observed. The ease with which it may be observed is in itself suspicious of an abnormal state.

Stasis of the Alimentary Canal, and the results that follow, is a very large subject, and one that is receiving great attention at the present time. Many points are still the cause of keen discussion, and it cannot be said that our knowledge is crystallised or complete; indeed, it will probably be a long time before such a desirable state is reached. The student of radiology is advised to read all the available literature on the subject of alimentary stasis since it promises to be one of the most important features of his future work.

Stasis may be said to be due to two main causes—atrophy of the musculature of the digestive tube, and obstruction, which may be spasmodic or organic. The latter may be due to cicatricial contraction of some part of the tube, or it may be due to the pressure of external adhesions or bands, causing sharp bending or "kinking"

of the tube. Also it may be due to malignant disease of almost any part of the alimentary canal, though it is more common in some parts than others. Here it will be possible to refer only to the X-ray appearances that attend stasis in the more usual sites and also to give some general rules for guidance in forming a diagnosis of this condition.

Gastric stasis may be said to be present if there is food in the stomach six hours after the meal was taken. To determine this the opaque meal is to be given first thing in the morning, and no more food taken for six hours, when the second examination is made. If food is taken it mixes with the opaque meal, or what is left of it, and delays the complete removal of the latter. Also, the patient should be up and going about his usual duties as far as possible. It is advisable before arriving at a definite conclusion to corroborate the observation by an examination on a subsequent day. The cause of the stasis will be made out from what has been said about gastric disorders.

The next common site for intestinal stasis is in the last few inches of the ileum — ileal stasis. We have seen that it takes about four hours for the food to leave the stomach, and it takes about the same time to pass from the stomach to the cæcum; consequently we must expect

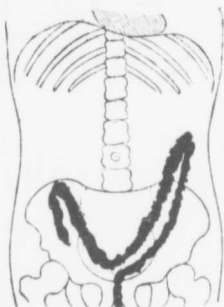

Fig. 69. Showing position of Transverse Colon in atony—commonly associated with alimentary stasis.

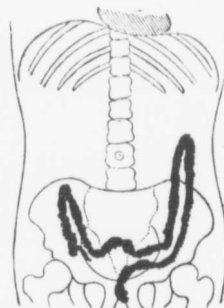

Fig. 70. A still more severe instance of "dropped" colon.

to find food at the cæcum up to at least eight hours after the meal was taken, and as we must allow a margin of from one to two hours for both gastric and intestinal sections of the process, it is reasonable to find opaque food in the last part of the ileum twelve hours after administration. If, however, we find that very little of the food has passed into the cæcum after six hours we may suspect ileal stasis, and if this is the case, later examinations at eight and twelve hours will give corroborative evidence. If opaque material is still in the ileum after twenty-four hours, ileal stasis can be diagnosed with certainty.

The causes of ileal stasis may be atony and ptosis, where this part of the intestine falls deep down into the true pelvis, and is unable to force its contents up over the pelvic brim and into the cæcum. It may also be sharply bent or kinked by bands forming an obstructive stasis, and not uncommonly we have both factors at work. When an obstruction is present we usually find the ileum dilated on the proximal side and weighed down by its contents. On the distal side of the obstruction we may see a thin trickle of opaque material leading towards the cæcum. Plate XVII. shows this well, and was taken twenty-four hours after the meal was given. Needless to say the appearances are seldom if ever the same in any two cases, and at times are most puzzling to the beginner, but cases of stasis at any part of the alimentary system tend to conform more or less to a general rule, and experience teaches us to recognise them.

Owing to the peculiar character of the normal movement in the large intestine it is impossible to make out anything in the nature of a time-table for the progress of our opaque meal after it has passed through the ileo-cæcal valve. The following rules laid down by Hertz (British Medical Journal, October, 1913) will be found useful:—

1. If the greater part of the barium is still in the cæcum and ascending colon at the end of

twenty-four hours, stasis in this situation can probably be diagnosed; if the greater part is still present after forty-eight hours it can be diagnosed with certainty, even if a small quantity of feces has been carried by a big movement to the distal part of the colon or the rectum, from which it may actually have been expelled.

2. If at the end of twenty-four hours nothing has passed beyond the splenic flexure, or if at the end of forty-eight hours the greater part of the barium is still in the transverse colon, the cæcum and ascending colon being nearly empty and little or nothing having passed beyond the splenic flexure to the rectum, stasis at the splenic flexure may be diagnosed.

3. If at the end of twenty-four hours the greater part of the barium has collected in the rectum, and in spite of this no desire to open the bowels is felt, dyschezia can be diagnosed.

4. If stasis in the cæcum and ascending colon, as in Class 1, is associated with delay in the transverse colon, as in Class 2, and perhaps also in the descending colon, general colonic stasis can be diagnosed.

Whenever the delay is confined to a single point it is essential to give a barium enema. If some of a pint and a half of the fluid, injected at a pressure of not more than a foot and a half, does not reach the cæcum in five minutes with the help, if necessary, of massage and change in position, and if the point of delay corresponds with that at which delay took place in the previous examination, an organic obstruction is probably present.

CHAPTER XV.

URINARY SYSTEM.

Fortunately it is no longer necessary to make out a case for the use of the X-ray method in the investigation of disorders of the urinary system. It is now a part of the routine procedure, and few if any cases, are submitted to operation without this having been done. The positive evidence given by radiography is definite and decisive, but the negative evidence is not so definite from the fact that some concretions cast no shadows. The examination is no longer confined to the discovery of calculi; the size, shape, position of the kidney, caseous changes, abscess, and by the injection of an inert opaque solution of collargol the condition of the pelvis of the kidney can be accurately estimated. As the ureteric catheters for injection of the collargol are themselves opaque to the X-rays, we get at the same time a correct delineation of the course of the ureters. In short, radiography furnishes an immense amount of accurate information in urinary disease and it has done much to bring the latter to its present high state of perfection. In this, as in all cases affecting the abdomen and pelvis, the preparation of the patient is a matter that must be attended to properly. The procedure advised for examination of the digestive system would do, but in the present instance the laxative may be given the night before instead of the second evening previous to the examination. It is also advisable to direct the patient to take as little food and drink as possible until the examination is over.

Many patients when told to make a light breakfast, think this leaves them free to drink as much milk or tea as they like. The effect of this is to fill the intestine with a large amount of fluid, and this adds appreciably to the general opacity. The patient who is both hungry and "dry," is in the best condition for an examination of the abdominal and pelvic organs.

All clothing must be removed from the part being examined; ladies should be provided with a thin dressing gown made without buttons or other metallic fastenings.

The apparatus must be powerful enough to ensure a full exposure in fifteen seconds or less, even in a stout patient. With longer exposures important details are lost through secondary radiations, and this we cannot afford with the high standard now demanded in urinary radiography. The tube should be of medium hardness—9 Wehnelt—and one that has been used long enough to become more or less "seasoned" will give the most reliable results. It should be capable of standing a current of about ten milliamperes easily, and with this current an exposure of ten seconds or less will meet most cases.

The two chief difficulties we have to contend with in urinary radiography are the thickness of the abdomen and the movement of the kidney—the latter being about half an inch in ordinary respiration and quite enough to destroy the detail of small calculi. To overcome these difficulties we must use some form of compression. Many methods and forms of apparatus have been devised for this purpose and the two in most common use will be described here. For the first a canvas top X-ray couch is used, with the tube in a box underneath that can be brought under any part. The patient lies on the couch face downwards and a fully inflated spherical air cushion is placed under the front of the abdomen so that it fits in between the costal border and the iliac crests. This cushion should be about five inches in diameter. This is too large for children and for them a roll of cotton wool

($\frac{1}{2}$ lb. size) answers admirably. It is placed across the abdomen below the costal border and casts no appreciable shadow. The patient should be encouraged to relax the abdominal wall, and the arms are to be placed along the sides so as to bring the whole weight of the trunk on the cushion. This compresses the abdomen, the intestines and abdominal fat are pushed aside, the kidneys supported and their movement reduced or even arrested. After the plate is in position extra pressure may be made by a heavy sandbag on top of the plate, or it may be secured by special apparatus.

After the patient is in position the fluorescent screen is placed on the back and the tube adjusted so that the centre of the anti-cathode is under the third lumbar vertebra, and if the apparatus is working well any calculi present, unless the very smallest, will be seen. The diaphragm is opened or closed until the kidneys and the ureters as far as the pelvic brim are included in the field. A 12" by 10" plate is laid on the back in place of the screen, with a sand bag to steady it while the exposure is made. The patient should suspend respiration during the exposure and there is no difficulty about this if the apparatus is sufficiently powerful. Otherwise the patient is enjoined to breathe as lightly as possible and with the chest only, as it is doubtful if any amount of bearable compression will completely arrest kidney movement without this co-operation of the patient. Plate XVIII. shows a case of calculi in both kidneys taken by this method.

The lower ureters and the bladder are explored by moving the tube further down until it is below the centre of the pelvic opening. On the surface this corresponds nearly always with the upper limit of the vertical cleft between the two buttocks, and the centre of the plate—10" \times 8"—is placed accordingly. The exposure should be a little longer than for the kidneys. The air cushion may be taken away and the patient may breathe naturally,

but deep respiration must be avoided. It is considered by some radiologists an advantage to turn the patient over and place the plate over the pubes when examining the bladder.

This method of examining the urinary system is a favourite one in this country and popular with many radiologists; many surgeons also seem to prefer to have both renal areas, including most of the ureters, on one plate. This in itself will settle the choice of method in many instances, but I feel confident that if surgeons would only allow themselves to become accustomed to plates of the urinary system made by the method usually associated with the name of Albers-Schonberg—but modified and improved by others since—they would very soon appreciate the better quality of the results. It is only in accordance with an elementary law of optics that the smaller the diaphragm through which the illumination has to pass the better is the definition of the resulting image. It is equally true with the X-rays at least that a tubular diaphragm gives better definition than a simple disc, other things being equal. Also, it is possible to get more complete fixation of each kidney by compressing them separately than if we attempt to arrest the movement of both at the same time, and what is equally important we leave ample room for the intestines and other local structures under the compressor to move aside during the exposure. All these factors are indisputable and must ~~take~~ ^{be} taken for more accurate results, and it is regrettable that these advantages should be sacrificed for the momentary convenience of having one plate to look at instead of three. It is true that more care, trouble, and more plates are required to carry the method out successfully, but these points are of no account to the radiologist who is interested in his work; it takes no more than twenty minutes to make a complete examination, including one or perhaps two, extra exposures to corroborate suspicious shadows. If development is commenced by an assistant immediately after the first

plate is exposed, the whole result can be known before the patient has finished dressing.

As this method is applicable to almost every part of the body the technique is described more or less fully. The patient lies on his back on a couch like that shown in Fig. 71, with the shoulders well raised on pillows and the knees drawn up and supported. The compressor is

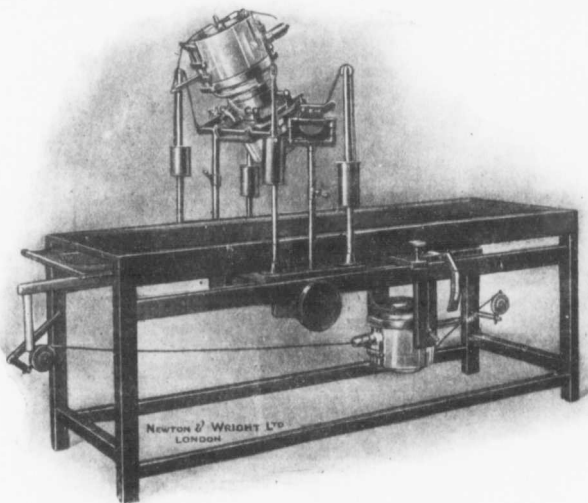

Fig. 71. Universal X-Ray Couch.

moved into position before the knee support is put in place. A mark is made on the skin over each kidney, found by taking points half way between the xiphoid cartilage and the umbilicus and three finger's breadth from the middle line. The compression tube is inclined about 30 degrees from the vertical so as to point up under the costal border and fixed in position with its centre

corresponding with one of these marks. Over the mouth of the compressor is secured a disc of strong calico—this must be firmly fixed in position. An 8" × 10" plate is placed with its centre under the corresponding last rib, and an air ball, made of thin but strong rubber, about five inches in diameter, and enclosed in a calico cover to prevent it bursting, is placed between the mouth of the compressor and the patient. The calico disc on the compressor is to prevent the air ball working up the tube which it would otherwise do. The air ball is a great improvement on pads of cotton wool or loofa originally advised and used. All being in position the locking screws are released and the compressor slowly lowered. This must be done gently and the patient encouraged to relax as much as possible. An assistant looks after the opposite side, but it is quite easy to do this alone, letting down each side alternately, though it naturally takes a little longer. Having made as much compression as the patient will stand the X-ray tube is connected up and the exposure made. (See Plate XIX.) This can be shorter than with the other method owing to the greater reduction in thickness, and there will be less interference by secondary radiations. The outline of the kidney will be clearly seen in quite 80% of renal exposures and the general definition will be very pleasing. The same procedure is gone through for the other kidney area. The compressor tube is then placed vertically and centred over the umbilicus or slightly below and the X-ray plate directly underneath the fourth lumbar vertebra. This plate shows most of the course of the ureters and above it overlaps the first two exposures.

The last plate is placed under the pelvis, its centre corresponding to about the lower part of the sacrum. The compressor tube is now directed so as to point down the axis of the pelvis, lowered into position and the exposure made. This plate will show the lower ureters and the bladder region, overlapping the lower part of the previous plate. (See Plates XX., XXI., and XXII.) Four is the

minimum number of plates that can be used for a urinary examination, and further plates should be made of areas showing doubtful shadows. Sometimes a stone in the lower pole of the kidney will also show in the plate made to show the ureters—a useful corroboration.

The chief difficulty for the beginner in the method of urinary examination is that of correctly placing the plates and the compressor so that the image is properly registered. Like everything else of the kind this is a matter for practice, and by taking great care at first and plenty of time, this trouble soon disappears. Care is necessary at every stage of urinary radiography, whatever method is adopted, and the penalty of slipshod work is both sudden and severe.

Of the various kinds of urinary calculi the most opaque are the oxalates, and are consequently the most easy to find. The most difficult to locate are the uric acid calculi. Uric acid has the same density as the soft tissues, so that a calculus made up of *pure* uric acid can cast no shadow that would differentiate it from its surroundings. Fortunately these are very uncommon, and most uric acid calculi have a coating of phosphates by which their presence can be demonstrated. The fact remains, however, that the uric acid calculus marks one of the limitations of the reliability of the X-ray method in disproving the presence of calculi in the urinary system.

The phosphate of lime and cystine calculi are less opaque than the oxalates, but unless very small they are easy to demonstrate. Triple phosphates are rather transparent to the X-rays and if small will frequently be missed in stout subjects. It is these who give the most trouble in securing satisfactory results, but care and experience are necessary to secure uniformly good plates of the various parts of the urinary system. Even in very stout subjects passable results can be secured, though it may be necessary to repeat the examination once or twice. It is only rarely that we meet with patients whose corpulence is an effective barrier to radiographic examination.

INTERPRETATION OF RESULTS. 191

No plate can be considered quite satisfactory which does not show the following points:—

The lumbar vertebræ including the transverse processes should be quite clear and well defined, also the twelfth rib, the outline of the psoas muscle, and lastly, that of the kidney itself.

This should be the standard to work to, and when the plate is of this quality there should be little difficulty in making a definite diagnosis.

Very often, however, and for various reasons, renal radiographs are not up to this standard, and on this account as well as the fact that shadows, more or less resembling those of calculi, are thrown by (*a*) foreign substances in the intestines, (*b*) calcareous glands, (*c*) phleboliths, (*d*) warts and moles on the skin next the plates, etc., the correct interpretation of the plates is quite as much of an art as is the taking of them.

In examining a plate there are certain anatomical points to be remembered which may be mentioned here.

The trans-pyloric line passes through the pylorus, pelvis of kidneys, and second lumbar vertebra.

The kidneys extend downwards as far as the transverse processes of the third lumbar vertebra. These processes are longer than those above and below, suggesting the idea that they may have something to do with the mechanical support of the kidneys—though it must be admitted they are much too short to do very much in this way.

In a plate made with the X-ray tube in the middle line, the position of the ureters is along the tips of the transverse processes—except the third, which projects outside the ureter—and entering the pelvis passes first inside the line of the sacro-iliac joint, then sweeps round in a curve roughly corresponding to that of the brim of the pelvis—but at a lesser radius and terminates at the symphysis.

This, at least, is the line shown by the ureteric shadow-graph bougie, but of course, the shadow line of that part inside the pelvis represents a very much more complex

curve or curves, and it is difficult to say which particular part of this curve corresponds to the actual opening of the ureter into the bladder.

This ureteric shadowgraph bougie is often inserted by the surgeon prior to the radiograph being taken, and is of the greatest value in settling the position and nature of doubtful shadows.

Instead of bougies ureteric catheters may be used, also opaque to the X-rays, and after being passed up to the pelvis of the kidney the latter may be filled with a solution of collargol (Plate XXIII.), an inert compound of silver opaque to the X-rays. A radiograph of the region shows the size and shape of the pelvis of the kidney, giving positive evidence of the presence or otherwise of a hydronephrosis, for example. (See Plate XXIV.) In the bladder the presence of sacculi may be shown by injecting with an emulsion of bismuth beforehand, and if a stereoscopic radiogram is made successfully the effect is very striking. (Plate XXV.)

A few general rules will be of help in examining renal radiographs, but nothing short of experience in inspecting hundreds of such plates will make one an expert in the matter.

If we take an imaginary vertical line upwards from the highest point of the shadow of the iliac crest to the last rib, we may say that an abnormal shadow between this and the vertebræ is probably due to a renal calculus. If outside it may be renal, but more probably bowel contents. If just on this line, it is probably due to a stone in the cortex of the kidney.

The more dense and well defined the shadow, the more likely it is to be one composed of oxalate of lime.

A shadow *inside* may be due to calcified glands—but if in the lower part of the space between the rib and iliac crest and especially along the line of the tips of the transverse processes, and of oval form with long axis vertical it is almost certainly ureteric.

PLATE XVIII.

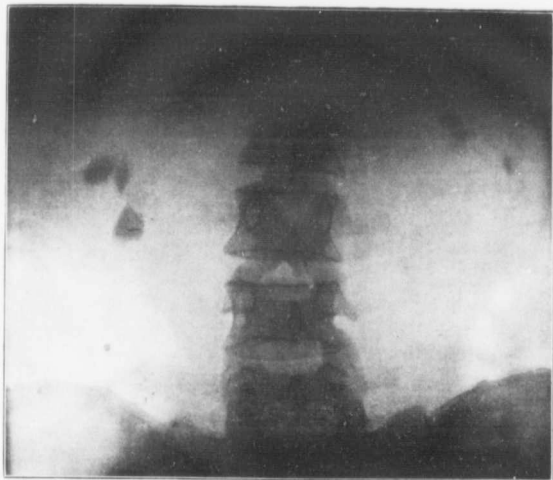

CALCULI IN BOTH KIDNEYS. *See page 186.*

PLATE XIX.



SHOWING GROUP OF CALCULI IN LOWER PART OF RIGHT KIDNEY. 1

See page 187.

PLATE XX.

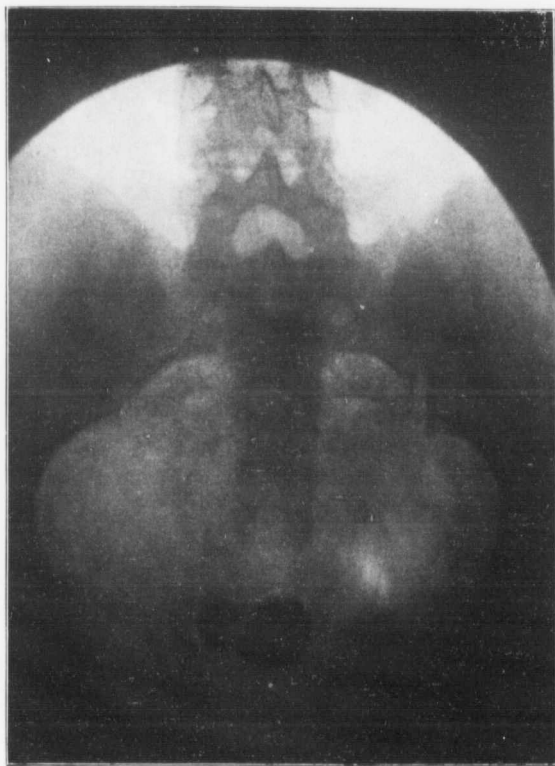

TWO CALCULI IN BLADDER

PLATE XXI.

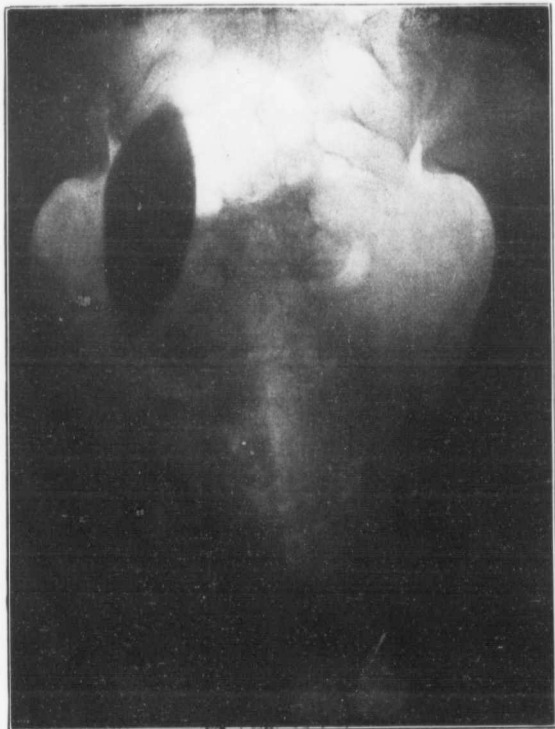

LARGE CALCULUS IN LEFT LOWER URETER IN A BOY AGE 15.

PLATE XXII.

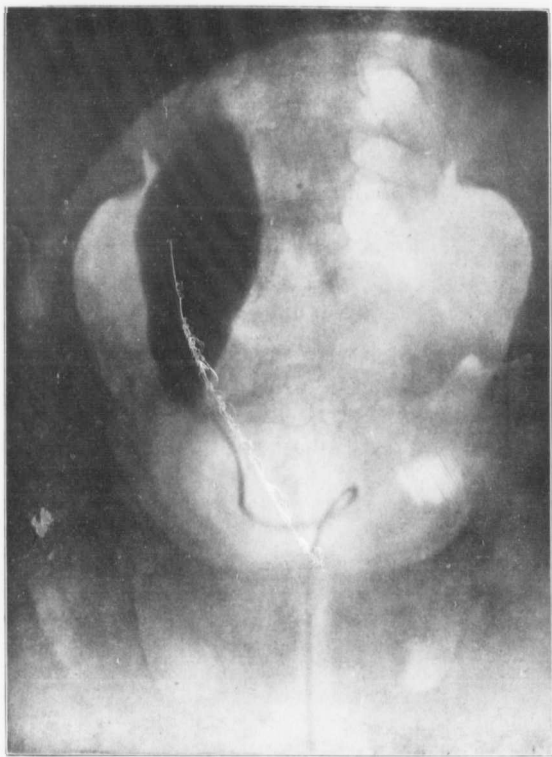

Same case as Plate XXI. After the ureter was injected with collargol to prove that the calculus was in the ureter. The ureteric catheter is seen in the bladder and ureters.

PLATE XXIII.

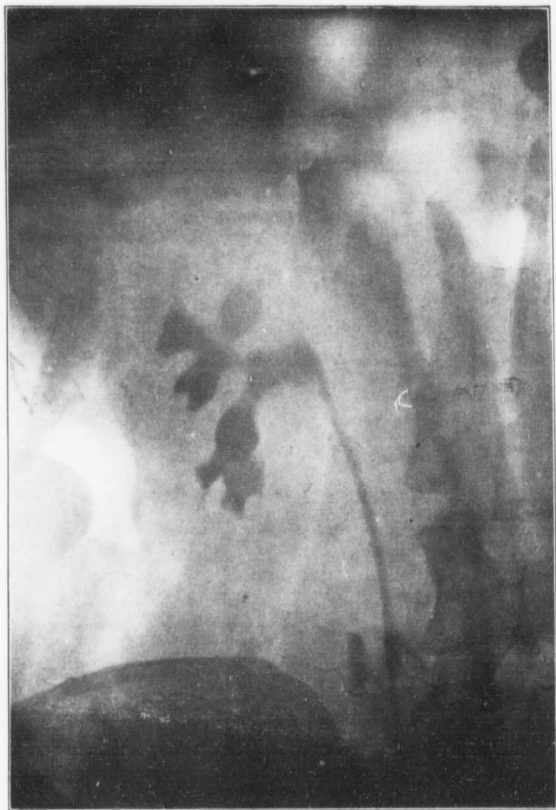

SHOWING ~~DICHAS~~^{STENOSIS} PELVIS OF LEFT KIDNEY
INJECTED WITH COLLARGOL.

The position of the ureteric catheter is clearly shown.

PLATE XXIV.

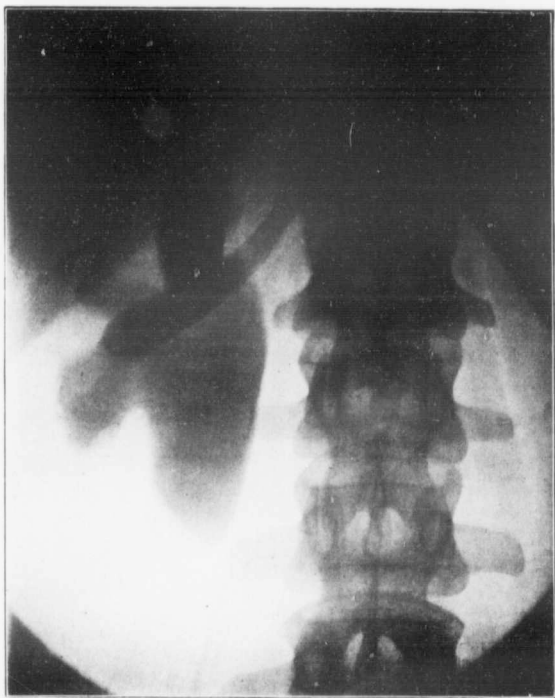

LARGE HYDRO-NEPHROSIS.

The Pelvis of the kidney was injected with collargol before the radiograph was taken

PLATE XXV.

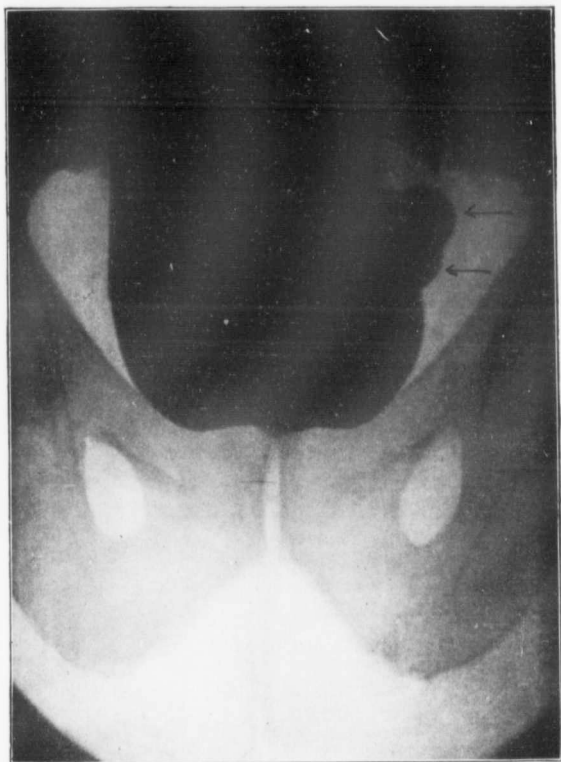

BLADDER.

After injection with an emulsion of bismuth to show presence and position of sacculi.

Sometimes a calculus gets in line with a transverse process—a local alteration in the density of a process is always suspicious, but if a stereoscopic pair is made the difficulty will soon be cleared up.

A triangular shadow in the renal area with point downwards may indicate a stone plugging the entrance to the ureter.

A ureteric stone passing into the bladder lies transversely as it reaches the latter.

Circular well defined shadows in the pelvis, and especially if near the ischial spine are usually phleboliths.

An oval shadow in the pelvis with its long diameter placed transversely, indicates a vesical calculus.

CHAPTER XVI.

X-RAY THERAPEUTICS.

The use of the X-rays as a therapeutic agent in the treatment of disease is almost as old as their employment in diagnosis, and the progress that has been made is almost as remarkable, particularly if we remember how efficacious they have proved in the treatment of conditions peculiarly resistant to the more ordinary applications. Notwithstanding the success that was attained, there was until quite recently a striking reluctance on the part of radiologists to write any systematic treatise on the subject. This reluctance is easy to understand when we remember how difficult or impossible it has been to lay down any definite rules or data. X-ray tubes are notoriously erratic regarding their output, and even yet we have no method of measuring X-ray doses that is completely satisfactory. While the experienced radiologist could get good results his methods were necessarily empirical to some extent, and the "personal equation" was largely in evidence. Improvements in apparatus and technique have altered this very considerably, but even yet X-ray treatment is a matter that is never to be undertaken lightly, and should not be attempted except by those who have attended and worked in a hospital department where a large amount of this work is done.

The use of the X-rays in treatment depends on the principle that after a certain minimum exposure to their influence changes take place in the living tissues.

For successful results in most cases it is not necessary that the changes should be visible to ordinary inspection; many conditions are cured without any visible reaction at any time during or after the treatment. This is what is aimed at more or less always, and the rule is to get as near the stage of visible reaction as possible. This can be done in a single application, or it may be distributed over several; and the same applies to those cases where it is necessary to produce a definite reaction which may amount to destruction of tissue *en masse* if so desired.

If the dose of the X-rays has been sufficient to cause a visible reaction, a microscopic section will show a cellular degeneration affecting the epithelium of the surface and the glands of the skin. Changes are also seen in the endothelial lining of the blood vessels. As these changes develop inflammatory action comes on, the degree depending on the magnitude of the dose, and the blood vessels are dilated with migration of leucocytes and red corpuscles. It is more than probable that this leucocytosis is one of the most important factors in the ultimate result of the application. The changes in the blood vessels are not appreciable in the milder doses where no visible reaction takes place; but when the application has been severe there is proliferation of the endothelial lining which becomes swollen and narrows the lumen of the vessel, even to the extent of blocking the passage of blood. This explains the extreme obstinacy of an X-ray ulcer, as the healing process is retarded for the want of a proper blood supply. This thickening of the intima is also seen after a series of mild applications has been given over an extended period, a property not without its usefulness, as we shall see later on. The cellular degeneration that follows an X-ray application of sufficient strength may be considered as an injury from over-stimulation; some kinds of cells are more resistant than others, but speaking generally the amount any given cell will stand without getting beyond possibility of a complete recovery, bears

a direct relation to its vitality. Also highly specialised cells such as those forming the essential parts of secreting glands, are more susceptible than surface epithelium.

In the case of abnormal cells such as go to make up new growths, the vitality is lower than that of healthy normal cells, and can be destroyed by an application of the X-rays insufficient to seriously affect normal cells in the immediate neighbourhood.

If, for example, we treat a case of rodent ulcer with a vigorous dose of the X-rays, the abnormal cells perish while the healthy cells near them are stimulated to increased activity, and a cure results. Incidentally, the cells of the sweat and sebaceous glands will suffer to some extent through atrophy, and a skin area that has been freely treated always shows a change in appearance that may be described as parchment-like, and resembles that produced by age. It is not right to say that the X-rays have what some are pleased to call a "selective action." A physical agent or force can have no power of selection; the lower resistance of the abnormal cell is quite enough to explain why it suffers first, and this explanation puts less strain on our imagination. In addition to the above changes, the application of the X-rays appears to promote the formation of anti-bodies or vaccines. It is frequently noticed in treating cases of acne vulgaris or psoriasis, where the treatment is applied to several areas in succession with two or three days between each, that parts not directly treated begin to get well almost as soon as those that were irradiated first. This can be explained only on the assumption that some such substances are set free and exert their action on areas at a distance that are similarly affected. This is a matter of common observation, and while it is one that is very difficult to prove by investigation and experiment, most radiologists agree that there is an action of this kind, and that it is an important factor in securing some of the best results obtained from X-ray treatment.

Apparatus.—With an X-ray outfit for diagnostic work there are only a few accessories to be obtained to carry out X-ray treatment. A mercury break is best, and if it is fitted with the device for suppressing the inverse current described on page 79, it will be found a great advantage. A slow rate of interruption is necessary, otherwise the tube rapidly heats, the vacuum alters, and with it the character of the rays from it.

For ordinary work medium size bulbs are to be preferred, otherwise the distance from the anti-cathode to the skin is so great that applications are greatly prolonged. A very useful size is a diameter of 15 cm., but for some work a diameter of 10 cm. is an advantage, especially in treating ringworm by the Saboraud method. For the treatment of deeply seated parts, such as the uterus, large bulb tubes may be used, and they have the advantage of working more steadily than small ones. Whatever tube is used it must be properly "seasoned" in the manner already described, and care must be taken not to pass a larger current than we know it will carry without over-heating. This is essential if the work is to be safe and satisfactory.

Equally important is it to have a suitable tube stand. It must completely enclose the active area of the tube except for an opening opposite the anti-cathode, through which the rays can pass to the part under treatment. To this opening are fitted nozzles of lead glass of different sizes to meet the requirements of the various cases to be treated. The tube holder must be arranged that it can be adjusted to any desired position and clamped rigidly in position. It must also be provided with a holder for the pastille by which we measure the dose of rays. These are the essential features of a stand for X-ray treatment, and they can be obtained from any dealer in X-ray appliances. There is a large variety of patterns to select from among the different makers, so that individual taste can be indulged to almost any extent. (See page 91.)

Personally I prefer one made of hard wood—except for such parts as have to be made of metal—they are lighter and more easily handled, and there is not the same risk of the patient getting shocks from the metal frame. There is always a certain amount of leakage from a tube in action, and a slight movement on the part of the patient may bring some part of the body near enough for a spark to pass—necessitating a readjustment of the tube. All the rules for X-ray protection are to be most rigidly observed, as in the prolonged applications required in treatment the risk of damage to operator and patient are much greater than with the short exposures used in diagnosis. Sheets of leaded rubber are useful for covering parts likely to be unduly exposed, and smaller pieces may be used between the glass applicator and the skin with holes cut therein of any irregular size or shape to fit the particular area under treatment. Thin sheet lead as used by plumbers answers the same purpose, but it is advisable to place a layer of lint or paper between it and the skin.

If the tube is enclosed in a proper shield there will be no need for any of these extra protective methods; at the same time, one can never be too careful, and prevention is far preferable to the best of cures. The practical details of this work will be learnt during attendance in an X-ray department far better than could be described here.

Dosage.—This is a subject that has engaged the serious attention of several of our greatest physicists and radiologists, and the fact that several methods exist is evidence that none of them are all that could be desired. It is not possible to describe even a proportion of all the different schemes that have been elaborated for the measurement of X-ray doses; information regarding them can be obtained in most of the large works on radiology. The one we shall consider is in very general use, and for our purpose probably the best. On the other hand it is possible to get good results by almost any of

the various methods after one has had experience in working at them.

The method advised is that associated with the names of Sabouraud and Noiré, and was first introduced for the production of epilation in the treatment of ringworm. This, like most others, depends on the action of the rays on an inorganic substance, which does not always run parallel with their action on living tissues. This is one weakness of all the methods in use, and the other is that we can only measure what has already been given.

We cannot accurately measure out the dose first and then proceed to administer it, as in the case of drugs. In spite of these difficulties it will be found possible to give doses of X-rays with very fair accuracy, but only after considerable practice and a very thorough understanding of X-ray tubes.

The standard Sabouraud dose acts as a stimulant to healthy tissues, but rather more than this to glandular structures. Accurately given it causes no hyperæmia, or at the most very slight and transient, and the hairs fall out in the exposed area. It is a remarkable feature of X-ray applications that the effects are not produced immediately; if the dose has been enough to cause a slight hyperæmia, this is not seen until from fourteen to twenty-one days afterwards, nor does the hair begin to fall out before this lapse of time. If a very large dose is given the hyperæmia may come on earlier by a week or more, but the effects of all ordinary doses are not developed until two or three weeks from the time of application. After a full dose has been given the same area must not be irradiated again for at least three weeks. It must also be borne in mind that the effects of the X-rays are more or less cumulative so that it becomes more than ever necessary to proceed warily in cases requiring repeated applications. The whole question of X-ray dosage is one of extreme delicacy, and it is really important that the beginner should fully realise this from the very outset of his studies. With this and the

experience of those who have gone before he will be saved much anxiety and possibly disaster.

Sabouraud's method of measuring X-ray dosage depends on the change that takes place in platinocyanide of barium after exposure to the X-rays. Its normal colour is an apple green, not unlike that seen in a new X-ray tube in action. After a certain exposure it becomes more yellow and later on passes through orange to brown. For use it is coated on stiff cardboard and cut into circles or squares about $\frac{1}{4}$ in. across. With each set is supplied a standard tint giving the correct colour the pastille is to be when the proper dose has been given.

The following conditions have to be observed. The tube must be a well-seasoned one that will carry a current of about one milliamperè for at least ten minutes without changing vacuum to any appreciable degree. Its "hardness" as measured on the Wehnelt scale must be 9 (7 on the Benoist scale), the anti-cathode is to be 15 cm. from the skin surface, and the pastille (protected from ordinary light by black paper, and backed with metal) is to be exactly half-way between the anti-cathode and the skin. It is also advisable for the pastille to be not less than 2 cm. from the wall of the tube—this necessitates the use of a tube with a small bulb, and the idea is to obviate the effect of the warmth from the wall of the tube hastening the change in colour. Under these conditions the pastille will be changed in from seven to fifteen minutes, depending on the strength of current and the efficiency of the tube itself. The essential feature of the method is that the pastille must be exactly half way between the anti-cathode and the skin, so that it gets four times as much irradiation as the latter. From time to time the current is to be cut off while the pastille is compared with the standard tint. This must be done in ordinary daylight and as quickly as possible, since daylight soon changes the colour back to the original. This matching of the tints is rather difficult for some individuals whose colour-sense is deficient, but is usually

overcome by practice. If the comparison is made by the light of a metal filament lamp the standard tint is matched sooner than in daylight; this provides a method of giving doses smaller than the standard as required in some instances.

After the pastille has been used it can be exposed to ordinary daylight—not sunlight—for some days, and it will gradually resume its normal tint. It may now be used again but it is not considered wise to repeat this more than once or twice, as there is considerable doubt as to the accuracy of doses measured by old pastilles. They are best restored by exposure in a shallow box with a glass lid in a window facing the north, and should be so exposed for at least a week before being used again.

The climate of Great Britain seems to be very suitable for this method of measurement, as the pastilles work best in an atmosphere that is not too dry. In America it is found necessary to store the pastilles in a chamber having an atmosphere rendered artificially moist, if accurate results are to be obtained.

Some care is necessary in regard to the standard tint supplied with some sets of pastilles. These have been found to vary very much from each other, and before starting work it is necessary to make sure the tint we are working to is correct by comparing it with one that is known to be alright. Those used in a large X-ray department may be taken as standard, and there is little doubt but that the physician in charge will be glad to allow a comparison to be made. It is worth while making sure of this. When a new X-ray tube is obtained a label is to be attached to its stem on which is recorded its diameter; after it has been "seasoned" its "hardness" should also be recorded, as well as the critical current it will carry for long periods without overheating. If always used in the same tube holder and with the same applicators we can also record the distance of the pastille from the wall of the tube. These details once worked out carefully and accurately and

recorded on each tube saves a lot of time and trouble. The hardness and critical current of a tube will vary as time goes on, so that the record must be altered accordingly. After being seasoned the next thing to do is to set the tube in action with all the conditions exactly as if an application were being given, and the time of actual working necessary to give the standard dose accurately noted. Suppose this takes exactly twelve minutes, then so long as the conditions remain the same we know that a half pastille dose will be given in six minutes, or a third part in four minutes. Also, if we wish to give a severe dose to a cancerous or rodent ulcer, the application may be continued for eighteen or even twenty-four minutes—the latter constituting a double dose.

The method of carrying out the procedure is as follows:—The tube to be used is secured in the holder, and the latter fitted with the applicator. The distance from the skin surface to the tube wall is taken, and to this is added one-half the diameter of the tube. This gives the total distance from the skin to the anti-cathode, and this total divided by two gives the distance of the pastille from anti-cathode. From this half distance we subtract the half diameter of the tube, and thus find the distance of the pastille from the wall of the tube. The pastille is usually mounted in the end of a holder that slides through a metal tube let into the shield, so that it comes into the active field of the rays. The holder fits the tube just tightly enough to remain where it is put, and can be pushed in until it touches the X-ray tube itself. A mark is made on the stem of the holder at this point, and from here we measure another mark nearer the pastille end, the distance the latter is to be from the tube; a clip secured at this point prevents the pastille being pushed nearer the X-ray tube than it ought to be, so that after a comparison with the standard it can be put back to the same place without any chance of mistake. It is advisable to practise this procedure several

times, and with different sized tubes, so as to become quite familiar with it.

Having made sure that all the distances have been set correctly, the tube is adjusted to the part to be treated, with the pastille in position, and the current turned on—taking care the critical current of the tube is not exceeded. If during the test exposure it took twelve minutes to change the pastille there is no need to interrupt the treatment for comparing the pastille with the standard, before eight or nine minutes. But as we can never be quite sure of what an X-ray tube is doing, it is not safe to delay the comparison for the full time we think it will take; it is not worth while running this risk of giving an over-dose.

A little consideration will show that the conditions laid down by Sabouraud are possible only with the use of X-ray tubes having a bulb diameter not exceeding 11 cm. So long as there is free circulation of air round the pastille and tube this diameter need not be adhered to exactly, and of course if we use tubes larger than 15 cm. the distances of the pastille and the skin from the anti-cathode have to be increased and also the time of the exposure, which varies as the square of the distance. So if the skin distance from the anti-cathode is doubled it will take four times as long to give the full dose, provided all the other conditions remain the same. With some large tubes special devices are provided for dissipating the heat, as described in Chapter IV., and with these it is possible to pass currents of two or three milliamperes with a corresponding saving of time.

The Use of Filters.—We have seen that every X-ray tube in action gives out rays of different qualities which we have referred to in a general way as soft, medium, and hard rays. The first have a low degree of penetration, and consequently are easily absorbed by the skin. The hard rays have a high degree of penetration and not easily stopped. Thus a "soft" tube produces an abundant radiation that is absorbed by the skin

causing the latter to become inflamed—a condition not readily brought about with a “hard” tube. The essential difference between these two varieties of tube is that while both give out some of every type of X-ray, the output of a soft tube is principally rays of low penetration, though there are a few hard rays present. In the hard tube rays of high penetration predominate, but there are also present some rays of low penetration. It will be easily understood that in those cases where we want to give a series of applications over a long period, we shall be stopped sooner or later by the X-ray dermatitis caused by the rays of low penetration. This will show itself sooner in the case of a soft tube than when we use a hard tube; but in any case it is bound to come. Such a limitation is inconvenient, and anything that will remove this is a great gain to radiotherapeutics.

If we interpose a screen of some material between the tube and the surface under treatment, some of the rays will be absorbed by the screen. The amount of absorption will depend on the material of the screen and its thickness. If made of substances having a high atomic weight the absorption is greater than with those of a lower atomic weight. A sheet of lead has a very high degree of absorption, while aluminium has a very low one. Almost any substance can be used as a screen or filter, but with materials of low atomic weight they have to be inconveniently thick. On the other hand, a substance of high atomic weight like lead has to be inconveniently thin if all the therapeutically useful rays are not to be stopped before they reach the parts under treatment. Consequently we use lead only where we wish to stop the rays altogether, such as the tube shields, protective aprons, and gloves. For the purpose of filtering out the softer rays nothing answers so well as thin sheets of aluminium, and a set of filters of 0.25, 0.50, 1, 2, and 3 millimètres thickness will meet every requirement. These are to be made to fit in the tube holder between the tube and the area under treatment, and in view of the possibility of

complications arising from secondary radiations from the metal itself, it is usual to place a piece of thin cardboard on the under-side of the filter, which is quite sufficient to stop any secondary rays from aluminium.

If we take a tube having a hardness of 9 Wehnelt—the standard as recommended by Sabouraud for ringworm—and set in action, we may assume that we are working with a medium tube giving out rays of the various degrees of hardness in approximately equal proportions.

If we place a filter of, say, 1 mm. of aluminium in the path of the rays, the soft rays will be stopped, and the medium and hard rays will pass through practically unchanged. Neither will they be absorbed by the skin, but by the tissues underneath and their action takes place there. If, instead of 1 mm., we place a filter of, say, 2 mm. thickness in the path of the rays, both the soft and the medium rays are stopped and only the hard rays pass through and exert their influence mainly on the deeper structures. If we increase the thickness of the filter to three millimètres, only the hardest rays will pass through, and we may go on increasing the thickness of the filter until but a small fraction of the total radiation can get through. This consists of the hardest rays and is practically homogeneous or monochromatic. We might picture to ourselves the different degrees of radiation as of different colours, like those of ordinary daylight. The soft rays would be at the red end of the spectrum, while the hard rays would be at the violet end. It is more than likely that if our eyes were adapted to see objects by the X-rays, these rays of different degrees of penetration would appear to us as of different colours. What has been said about the action of filters will, no doubt, seem both crude and inaccurate to the physicist, and probably he will be quite right, but in regard to the practical application of the X-rays in therapeutics it forms a very good working basis, as I have found from a not inconsiderable experience.

The primary beam is polychromatic—to carry on the analogy to visible rays—and as we go on interposing aluminium screens of increasing thickness the resultant beam becomes more nearly monochromatic—composed of rays of the highest degree of penetration only. By this method it is not possible to get a monochromatic beam consisting of soft or medium rays.

The only way this can be done is to employ the secondary rays from metallic substances. When the rays from an X-ray tube fall on the surface of any metal, the latter gives off a secondary X-radiation, the quality of which is constant for that metal whatever may be the character of the primary rays falling on it.

The quality of the radiation from any metal depends on its atomic weight. The higher this is, the harder is the secondary radiation. The radiation from silver is about the lowest that can have any practical value, but the fact is that up to the present the difficulty has been to obtain these secondary rays in sufficient quantity to be of use in therapeutics. When this can be done the gain will be immense, and when the day comes that we can administer a dose of rays purely monochromatic and of any degree of penetration, radiotherapeutics will become something in the nature of an exact science. The matter has been mentioned here in view of possible developments, not as being a part of our daily work at the present time. Fig. 72 shows a method of obtaining secondary rays.

It has been claimed that some cases of rodent ulcer, for instance, that resisted the X-rays alone, have been made to heal by first driving in metallic ions by ionisation and then applying the X-rays, thus getting the effect of the ionisation, also that of the primary X-rays, and the secondary rays from the metal ions. With such a wholesale prescription it is difficult to say which one of the ingredients is the most responsible for the cure, but the matter is one that has been put forward by those whose opinion is entitled to respect, and the method has possibilities.

To return to the use of filters in radio-therapeutics, it is obvious that the interposition of such upsets our scheme for the measurement of dosage, and the question arises as to what we are to do with the pastille. Is it to be placed so as to receive the rays direct from the tube, or after the

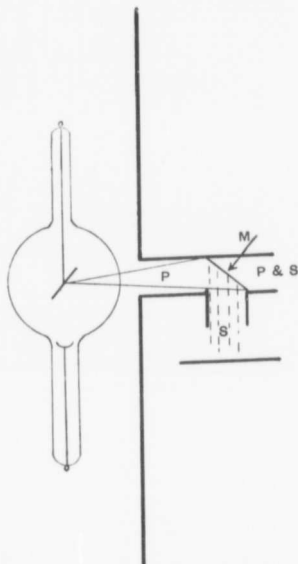

Fig. 72. Scheme for production of secondary rays.

P.—Primary rays from X-ray tube falling on metal plate M. set at angle of 45° .

P. & S.—Mixture of primary and secondary rays.

S.—Pure secondary rays.

The heavy black lines represent thick lead screens impervious to rays.

latter have passed through the filter? This is a point of importance and one that is not easy to settle off-hand. It is a question whether the relation between the action of the rays on the pastille and on the skin is the same after the interposition of a filter and with different thicknesses

of filters, as when no filter is used at all. Also, if placed between the filter and the skin it is very likely by virtue of its position to be influenced by the secondary rays from the filter itself, while the skin is far enough away to be out of range of any such radiations. Thus it would seem that with the interposition of a filter we are likely to be on less certain ground, since we are not quite sure which part of the X-ray spectrum is the most responsible for the change that takes place in the pastille.

Personally, I am of the opinion that the pastille should be placed free of the influence of the filter. Then when a standard dose is registered by it we know that the tissues have had a dose of the hard rays, or hard plus medium rays, represented in a standard dose, according to the thickness of the filter that has been used. Of course as we increase the thickness of the filter the possibility of a skin reaction becomes more remote, and we can give the equivalent of a double or treble pastille dose, so far as the harder rays are concerned, at a single sitting, and repeat the application at short intervals, if necessary. Working in this way we always know what we are doing in terms of the standard dose which is recognised by all radiologists, and a standard dose filtered through one millimètre, or two, or more millimètres of aluminium will always have approximately the same meaning. It is highly desirable that some scheme of this kind should be more or less universally recognised, and the above has the virtue of simplicity and is not difficult for the beginner to understand. In any case he is advised to adopt this scheme at first, since it will not interfere with any views he may decide to follow in the future.

When it comes to treating deeply seated conditions, such as fibroid tumours of the uterus, we require a great preponderance of the hardest rays. If we were to keep our X-ray tube at 9 Wehnelt we should get on very slowly, since it is the usual practice to use an aluminium filter 3 mm. thick, and only a small proportion of the total radiation would get through. In these and kindred

conditions we will obtain better results and more quickly by having the tube much harder, say 11 or 12 on the Wehnelt scale. Such a tube has a resistance equal to an air gap of six or eight inches, and a much more abundant radiation gets through the filter. Though the total radiation from the tube is harder, the pastille can be used in the ordinary way, and while a pastille dose from a tube of 11 Wehnelt is different to that from one of 9 Wehnelt, the difference is not so great as to render the method unsuitable. The tint "B" from a tube of 11 Wehnelt will always have the same meaning, and consequently we are able to carry on treatment of deeply seated parts by hard rays according to a definite system. Exposing a pastille directly to the tube and a filter of 3 mm. of aluminium protecting the skin, it is quite safe to give two pastille doses at a sitting, and this may be repeated three times a week for three weeks—the intermenstrual period—quite safely. In most cases, however, it is found that one-and-one-half pastille doses are enough, and it is better not to exceed this unless there is some special reason for doing so.

Similarly we may go to the other extreme, and where we wish to treat very superficial skin lesions the X-ray tube may be softer than that required for the standard Sabouraud dose. Many cases of this kind do best with a radiation quality of 7.5 Wehnelt, but of course no filter is used, our aim being to keep the action quite superficial. The arrangement of the pastille, &c., is the same as for the standard dose. In doing this work it is necessary to be very accurate, since the risk of dermatitis is greater than when using harder tubes. The beginner is advised to keep to 9 Wehnelt for all these cases at first; there is really very little difference in the ultimate result as a rule, and even if slower in curing the case the extra safety more than compensates for the loss of time.

The principles underlying the practice of X-ray therapeutics may be summarised: for the very superficial conditions the tube is to be from 7.5 to 9 Wehnelt, and no

filter intervening. For subcutaneous lesions the tube should be from 9 to 10 Wehnelt, and the skin protected by a filter of 1 mm. of aluminium. As the lesion is more deeply seated the tube is harder and the filter thicker—the practice regarding the treatment of uterine fibroids representing about the extreme in this direction—the tube at about 11 or 12 Wehnelt and the filter 3 mm. thick. In all cases the pastille is to be placed half way between the skin and the anti-cathode but free of the influence of the filter, and the change of the Sabouraud pastille from Tint "A" to Tint "B" forms the basis of measurement.

Apart from the treatment of skin lesions, the radiologist is called upon to treat a great variety of conditions, not only as regards their character but also as to the depth and locality.

Enlarged cervical glands, spleno-medullary leukæmia, lymphadenoma, carcinoma and sarcoma, chronic periostitis, chronic suppuration, and a host of others. For each case the tube should be selected which best suits the depth of the lesion from the surface—at least this is the counsel of perfection. It is very doubtful, however, if any radiologist works quite so accurately as this, and for the sufficient reason that such accuracy is not required. While all these cases could be treated with a tube of the standard quality of 9 Wehnelt, in a sort of way, by far the best results are obtained with hard tubes; and the results are more rapid and more safe from the intervention of any undesired X-ray dermatitis. For all ordinary work, including that of cancer especially, hard tubes are to be preferred to medium or soft ones. When we consider the results obtained from the use of radium which seems to depend for its chief action of the presence of the very hard gamma rays—about six times the penetration of rays from the hardest X-ray tube—it is no wonder that we come to prefer to use hard tubes for most of our work. It is, indeed, a question if such are not

as good as the softer ones for skin cases, but this point is one that is not settled yet.

This point raises another, that is, is it the primary beam of rays that is responsible for the effects, or is it the secondary scattered rays from the tissues themselves, or a combination of both? These are questions that are still in the process of solution, and, indeed, there are so many of these that at almost any moment discoveries may take place that will completely alter our views concerning the application of the X-rays. Thus, anything said here must be taken as representing our knowledge at the present time—and a very imperfect knowledge it is.

If the student has mastered the principles laid down here regarding the use of the X-rays in therapeutics, he will have little difficulty in deciding as to the proper method to adopt in the treatment of any given case. At first it should be his chief aim to leave a wide margin of safety; brilliant results will come in due course, but at the beginning he should make his doses slightly under the full amount, or have the tube on the hard side, or perhaps use a filter a little thicker than seems best. By keeping well within the limit by one or other of these ways he will save himself anxiety, and more than that for his patient, perhaps.

Skin Diseases.—The use of the X-rays here is a subject on which many volumes have been written, and there are probably many more to come. Only a few of the more common conditions can be briefly referred to here. Those who wish subsequently to go more deeply into the matter are advised to study "The X-Ray Treatment of Skin Diseases," by Dr. Franz Schultz (translated by Dr. J. Burnet), and the general scheme of dosage advised by him is one of the best, with slight modifications. He divides skin lesions into three groups according to the particular method of dosage that answers best, and in my hands the scheme is one that answers well.

For the first group the tube is to be from 7 to 7.5 Wehnelt, and one-third pastille dose is to be given on the first, eighth, and fifteenth days. An interval of three weeks is to elapse before another cycle is given, should further treatment be necessary. No filter is to be used, but the work must be exact.

The diseases in which this treatment gives good results are: Eczema in various forms, Seborrhœa, Pruritus, Lichen, Prurigo, Acne Vulgaris, Sycosis, Psoriasis, and Dysidrosis.

For the second group the principle is to use a tube slightly softer (6.5 to 7 Wehnelt), and give half pastille doses on the first and fifteenth days.

To this group belongs the various forms of tuberculosis of the skin, such as Lupus Vulgaris, Bazin's Disease, and Scrofuloderma; Lupus Erythematosus, Leprosy, and Glanders also come under this group.

The third group consists of those cases that do best with single large doses given at intervals of from three to four weeks, supposing the first application has not been enough. The tube is to be of the standard degree of hardness (9 Wehnelt), or slightly softer if the condition is very superficial.

The diseases coming under this group are Ringworm, Favus, Hyperidrosis, Keloid and Acne Keloid, Warts, Rodent Ulcer, and Paget's Disease. This all seems very simple, and it certainly does make the question of the X-ray treatment of skin diseases easy to understand. In practice, however, it is not quite so simple, and occasionally cases arise that respond better when treated by the method advised for a different group to the one they are classed with. These are matters that only experience can teach, but the above may be taken as a good general guide.

In treating a rodent ulcer, the surface must be scraped clean with a sharp spoon. This usually causes very little pain, and the bleeding soon stops with slight pressure. The shield must confine the rays accurately to an

area that extends about one-eighth of an inch round the outside of the raw surface. The tube should be 9 to 10 Wehnelt, and the dose from 1 to 2 Sabouraud, according to the severity of the case. This may have to be repeated two or three times in an old-standing case, but the result is very satisfactory as a rule.

Hypertrichosis is a condition that is very difficult to deal with in a satisfactory manner. Whatever method is used the treatment is prolonged, and if the X-rays are used the method is decidedly risky. Noiré's method is said to answer well. He gives the standard dose, except that a filter of aluminium 0.4 mm. thick is interposed. This is repeated at intervals of a fortnight at first and later on of a month. From eight to ten applications are required, and the result is said to be permanent.

I have had good results by giving fractional doses with a thinner filter, and carrying on for some weeks or months. It is doubtful if the risk of permanent telangiectases and the anxiety make any method worth while. At the same time a good result can be obtained, and if the case is an urgent one from any cause, and the patient is prepared to take the risk, which should be fully explained to her, the method should be tried. The only cases suitable for X-ray treatment are those with a large number of rather fine hairs—too numerous for removal by electrolysis. The latter is the best method for those cases where the hairs are relatively few and strong.

From the point of view of treatment there are several conditions that can be grouped together, and the method advised for these is as follows: The tube should be from 9 to 10 Wehnelt, and a filter of 1 mm. of aluminium interposed; 0.75 of a pastille dose is given twice weekly up to a maximum of twelve doses, or until a slight degree of hyperæmia shows itself. The skin may become "tanned," which does not signify, but at the first sign of reaction the treatment must be stopped for a week or two.

It does not happen often, but it must be carefully looked for.

The conditions to which this method is applicable are : Enlarged Cervical Glands, Lymphadenoma, Exophthalmic Goitre, Sarcoma, and Carcinoma. At times very successful results are obtained in most of the cases that come under these headings, notably the first three. Occasionally a Sarcoma melts away in a manner that is almost uncanny, and a few of these cases remain well for years afterwards; in others recurrence takes place locally or at a distance with the usual result.

The question of the X-ray treatment of Carcinoma is a large subject—too large to be dealt with fully here. It cannot be too strongly insisted upon that every operable case should be operated upon at the earliest possible moment. As soon afterwards as practicable thorough X-ray treatment of the whole area should be started and twelve doses given as above. If the condition of the patient and other circumstances permit there is no reason to delay the commencement of the treatment more than two or three days after the operation, and in treating cases of this kind we should not attempt to confine the rays accurately to the site of operation, but allow as much as possible of the surrounding area to come under the influence of the irradiation.

After a three months' interval, if all goes well, a further six applications are to be given, and again after a six months interval. If this procedure were carried out for two years in all cases, I am sure we should hear less of recurrences.

The great trouble is that post-operative treatment is not begun soon enough in a large proportion of cases, and in many of them deep extension has commenced, making all efforts to prolong life practically futile. There is not the least doubt that immediate post-operative X-ray treatment in carcinoma cases does definitely increase the patient's chance of making a complete

recovery, and delay in applying this method not infrequently means that we are throwing away a victim's one chance of escape.

In no class of case is it more difficult to lay down definite rules for treatment; every case must be dealt with according to the conditions present. In most instances the treatment will be more vigorous than stated above. Full or even double pastille doses three times a week may be necessary for a time so as to produce a profound impression on the growth more or less quickly. If there seems to be deep extension, this is all the more necessary, but here we must use a thicker filter—say 2 mm. of aluminium. The risk of dermatitis is very small when using such thick filter, but as we are giving massive doses we must act with all caution and discretion. On the other hand, only massive doses will be of any avail in a serious case, and we have to remember that if left alone the patient's life comes to an end in a short time, so that while we must not do anything likely to add to his sufferings through X-ray dermatitis, we are justified in doing anything short of this that gives him a chance of escape or even an extension of comparatively comfortable existence.

Spleno-medullary leukæmia may be treated by this plan, the applications being made over the enlarged spleen, and if the skin eventually shows signs of reaction the treatment may be applied to the sternum and to the ends of the long bones. Treatment must not be too bold; there is considerable breaking down of blood cells, and the patient may be overcome by an overdose of toxines. It cannot be said that the treatment is very satisfactory, and it is doubtful if the patients really benefit by it. Even if we succeed in bringing the blood count to normal or nearly so, life does not seem to be prolonged, though the patient may be more comfortable in some ways. I have known cases apparently very much better for the treatment to die quite suddenly, and for no special reason at the time. It is probably for this reason, that the treat-

ment of such cases by the X-ray method has gone out of use to a large extent.

The treatment of *enlarged prostate* is at times very satisfactory. The technique may be the same as directed for cancer, but need not be so vigorous, and the filter may be thicker with advantage. From eight to twelve applications given twice weekly are usually enough to make a decided improvement.

The X-ray treatment of *uterine fibroids* is now a well recognised procedure, and in certain cases has practically displaced operative methods. It is not advised in women under forty years of age, or where there is much hæmorrhage between the periods. The technique consists in using a tube of 10 to 11 Wehnelt, a filter of 3 mm. of aluminium, and a dose of $1\frac{1}{2}$ Sabouraud three times a week for the three weeks between the menstrual periods. This may have to be repeated for two or three months before relief is obtained. The applications are to be made as far as possible on the "cross fire" principle; that is, directing the rays from as many different points as possible towards the uterus, so that while the latter gets the benefit of every dose, any particular part of the skin only gets a fraction of the whole. Many "ports of entry" are available, and a diagram should be made for each case, numbering the areas and using each in rotation. This cross-fire scheme should always be adopted where the conditions allow it, and especially in treating new growths which require so much irradiation for their removal. A mediastinal growth, for instance, may be attacked from almost every direction and a number of these cases have been largely improved where this system was properly carried out and persisted in. The X-ray technique in such a case would be the same as for uterine fibroid.

One of the most remarkable and gratifying effects of a series of X-ray applications is that of relieving pain, and where present it is often one of the first effects to be noted. It has been applied with success in many cases of

neuralgia, such as in the face, and in sciatica, to mention two of the most common. A hard tube should be used in preference, and the thickness of the filter and length of application will depend on the depth of the affected nerve. For sciatica the filter may be 3 mm. of aluminium and the dose 2 Sabouraud, or even more. With a filter of this thickness the danger of dermatitis is very remote.

This by no means exhausts the list of conditions amenable to X-ray treatment, but probably enough has been said to outline the general principles, and with the details given for some of the more common diseases the student should have a good general idea how to work; but no book can take the place of practical experience and demonstration in a hospital department, and he who undertakes X-ray therapeutics without this training must expect disappointment, even if he is fortunate enough to escape disaster.

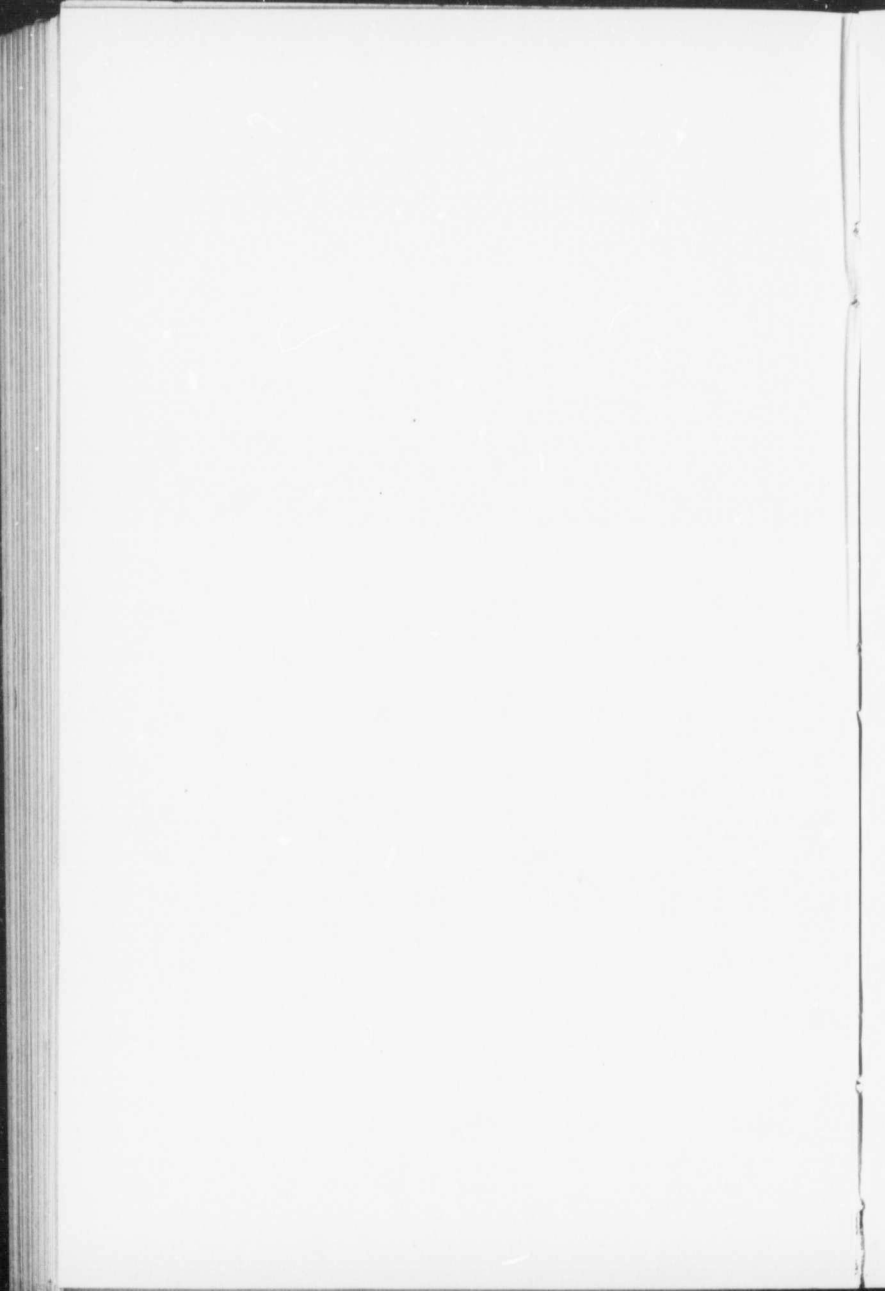

INDEX.

| | PAGE | | PAGE |
|---------------------------|------------|----------------------------|--------|
| Anti-cathode | 45 | Face | 137 |
| " Effect of heat | | Femur | 147 |
| on | 47 | Fibrosis | 159 |
| " Heavy Metal | 46 | Filters for X-rays .. | 203 |
| " Tungsten .. | 47, 52 | Filters, Aluminium .. | 204 |
| " Water-cooled | 46 | " Action of .. | 205 |
| Atlas and Axis | 139 | " Measurement of | |
| Alimentary Canal, Stasis | | Dosage when | |
| of | 180 | using | 297 |
| Alternating Currents .. | 18, 70 | Focus Tube | 28 |
| Aneurysm, Intrathoracic | 162 | " " Effect of re- | |
| Ankle joint | 147 | verse current | |
| | | on | 35, 39 |
| Bronchiectasis | 161 | " " Method of | |
| | | using | 34 |
| Calcaneodynia or "Painful | | Forearm | 145 |
| Heel" | 146, 147 | | |
| Calcification | 159 | Gastric Ulcer | 173 |
| Capacity | 15 | Gastroptosis | 173 |
| Cathode Rays | 26, 32, 33 | | |
| Cavities | 159 | Head, The | 136 |
| Changing Box | 95 | Heart | 161 |
| Clavicle | 142 | Hip joint | 146 |
| Colon, Movements of .. | 178 | Historical Notes | 22 |
| " Atony of | 181 | Hypertrichosis | 213 |
| Condensers | 16, 17, 66 | | |
| Couch, X-ray | 93, 97 | Induction, Electromagnetic | 8 |
| Crookes, Sir W. | 22 | Induction Coil | 65 |
| Crookes' Tube | 28 | " " " Make " & | |
| | | " Break " .. | |
| Diaphragms | 94 | currents | 66 |
| Digestive System | 165 | " " Outfits | 67, 71 |
| Dorsal Spine | 139 | " " Circuit, .. | |
| Dosage of X-rays | 198 | diagram of | 88 |
| " Hints on | 201 | Intensifying Screens .. | 114 |
| Duodenum | 176 | Internal Diseases | 148 |
| " Ulcer of | 179 | " " Equip- | |
| Dynamo, The | 18, 19 | ment for | 149 |
| Elbow | 144 | Interrupters | 73 |
| Electric Discharge in | | " Electrolytic | 85 |
| Vacuo | 23 | " Mercury | 75 |
| Electrical Supply | 62 | " Platinum | 73 |
| " for Coils | 69 | " Simon or | |
| Electricity and Water | | Caldwell | 95 |
| Analogy | 2 | " Wehnelt's | 85 |
| Electro Magnetic Induc- | | Inverse Current | 58 |
| tion | 8-12 | " " from Coils .. | 67 |
| Empysema | 160 | " " Suppres- | |
| Enlarged Prostate | 216 | sion of | 58, 79 |
| Exposure in Radiography | 110 | | |

| | PAGE | | PAGE |
|---|------------|---|---------------|
| Jackson, Prof. | 28, 32 | Pyloric Obstruction .. | 174 |
| Jackson's Tube | 28, 29, 32 | Radiography, the importance of fixation during exposure | 116 |
| Jaw, Lower | 137 | Radiography, Instantaneous | 117 |
| Knee Joint | 147 | " Penetration of Tube for | 113 |
| Large Intestine | 178 | " Photographic plates for | 108 |
| Localisation of foreign bodies | 126, 129 | " Practical hints | 111 |
| " Mackenzie-Davidson method | 132 | " Regional | 135 |
| Lumbar Vertebrae | 140 | " Stereoscopic | 126 |
| Mackenzie-Davidson Interrupter | 76 | Radioscopy | 101 |
| " " Method of localisation | 132 | Rectifiers | 62 |
| Malignant Disease | 214 | " Chemical | 71 |
| Measuring Instruments | 17 | Resistance | 3 |
| Mercury Interrupters | 75 | " Materials | 3 |
| " " Béclère's | 80 | " Series | 4 |
| " " Centrifugal | 82 | " Shunt | 6, 89 |
| " " Cleaning of | 84 | Reverse Current | 58, 79 |
| " " Dielectrics for | 83 | Right - Anterior - Oblique Examination | 155 |
| " " Disadvantages of high speed | 81 | Sabouraud's Method of dosage | 199 |
| Milliampère meter | 56 | " " Pastilles | 200 |
| Mitral Stenosis | 161 | Sacrum and Coccyx | 142 |
| " Morton Apparatus " | 79 | Scapula | 144 |
| Normal Thorax | 152 | Screen for X-ray work | 101 |
| Oesophagus, Diverticula | 168 | Screening Stand | 150 |
| " Foreign bodies in | 163 | Secondary Circuit | 56 |
| " Obstruction of | 166 | " " Diagram of | 61 |
| " " Stricture of | 167 | " " " X-rays | 112, 206, 207 |
| Ohm | 5 | Self-Induction | 12 |
| Ohm's Law | 5 | Skin Diseases | 211 |
| Opaque Meals | 165, 168 | Shoulder | 142 |
| Pain, Relief of | 216 | Small Intestine | 177 |
| Pelvis | 146 | Snook High Tension Rectifier | 63 |
| Penetration of Tube for Radiography | 113 | " " for Alternating supply | 70 |
| Pericardial Effusion | 161 | Solenoid | 13 |
| Pleurisy | 159 | Spark-Gap Parallel | 37 |
| Pressure and Voltage | 3 | " " " Point and Plate " | 59 |
| Protection from X-rays | 98, 198 | " " Series | 58 |
| Pulmonary Calcification | 159 | Spine | 139 |
| " Cavities | 159 | Spleno-Medullary Leukæmia | 215 |
| " Fibrosis | 159 | Stasis of Alimentary Canal | 180 |
| " Tuberculosis | 156 | Static Machine | 62 |
| Penetrometer or Radiometer | 96 | Stereoscope | 127 |
| | | " Pirie | 129 |
| | | " Simple | 129 |

INDEX.

221

| | PAGE | | PAGE |
|------------------------------------|------|--------------------------------|----------|
| Stomach | 168 | X-ray Ph-tography .. | 106-111 |
| " Atony | 172 | " " Plates for .. | 108 |
| " Hour-glass .. . | 173 | " " Tubes for .. | 107 |
| " Malignant Disease | 176 | " Therapeutics .. . | 194 |
| " Normal Form .. | 170 | " " Principles of .. | 209 |
| " Peristalsis .. . | 171 | " " Tubes for 201, 203, 210 | 203, 210 |
| Teeth | 139 | " Treatment, Apparatus for .. | 197 |
| Thorax, Examination of | 152 | " Tubes, Chabaud's .. | 44, 49 |
| Tibia and Fibula .. . | 147 | " " Changes with use .. | 39, 48 |
| Transformer | 13 | " " Coolidge .. . | 54 |
| Tube Stand | 90 | " " Faults of .. . | 41 |
| Urinary Examination .. | 185 | " " "Hard" and "Soft" .. | 36 |
| " " Couch for .. . | 188 | " " Heavy Anode .. . | 51 |
| " " Methods .. . | 186 | " " Light Anode .. . | 50 |
| Urinary Calculi | 190 | " " Mica Regulator for .. | 43 |
| " System | 184 | " " Osmo Regulator .. . | 44 |
| Uterine Fibroids | 216 | " " Regulation of Vacuum .. | 41 |
| Valve Tubes | 60 | " " Resistance of .. . | 38 |
| Wrist | 145 | " " Selection of .. . | 53 |
| X-ray Negatives, Interpretation of | 121 | X-rays, Effects on Tissues .. | 195 |
| " " Viewing .. . | 122 | " " Filtration of .. . | 30 |
| " " Box for .. . | 122 | " " Origin of .. . | 27 |
| | | " " Properties of .. . | 29 |

A SELECTION
OF
HENRY KIMPTON'S PUBLICATIONS.

- ADAM.—Asthma.** By JAMES ADAM, M.A., M.D., F.R.F.P. & S. (Glas.), Fellow of the Royal Society of Medicine, etc. Crown octavo, 192 pages, Illustrated. Cloth. Price 5s. net.
- ASHHURST.—Surgery: its Principles and Practice.** By A. P. COOPER ASHHURST, M.D., F.A.C.S.; Instructor of Surgery in the University of Pennsylvania, etc. Royal octavo, 1141 pages, with 7 Coloured Plates and 1032 Illustrations in the text, mostly original. Cloth. Price 28s net. Roxburgh binding, gilt top. Price 32s. net.
- BALLENGER.—Diseases of the Nose, Throat, and Ear.—** Medical and Surgical. By WILLIAM LINCOLN BALLENGER, M.D., Professor of Otology, Rhinology and Laryngology, College of Physicians and Surgeons, Department of Medicine, University of Illinois, etc. Fourth Edition. Revised and Enlarged. In one very handsome royal octavo volume of 1080 pages, illustrated with 536 Engravings, mostly original, and 33 full-page Plates. Cloth. Price 28s. net.
- BRAUN.—Local Anesthesia: its Scientific Basis and Practical Use.** By Prof. Dr. HEINRICH BRAUN. Translated and Edited by Percy Shields, M.D., A.C.S., from the Third Revised Edition. Crown quarto, 399 pages with 215 Illustrations in black and colours. Cloth. Price 21s. net. Roxburgh binding, gilt top. Price 25s. net.
- FORREST.—Eye, Nose, Throat and Ear.** A Manual for Students and Practitioners. By JAMES FORREST, M.B., Ch.B., Edin. Demy octavo, 412 pages with 12 Coloured Plates and 122 Illustrations. Cloth. Price 10s. 6d. net.
- JARDINE.—Clinical Obstetrics.** By ROBERT JARDINE, M.D. (Edin.), M.R.C.S. (Eng.), F.R.F.P. & S. (Glas.), F.R.S. (Edin.); Professor of Midwifery at St. Mungo's College, Glasgow; Obstetric Physician and Gynaecologist to the Glasgow Maternity and Women's Hospital; Examiner in Midwifery to the Scottish Conjoint Board and to the University of Glasgow; formerly Examiner in Midwifery to the Victoria University, Manchester, etc., etc. Third Edition, entirely Revised and Enlarged. Royal octavo, 744 pages, with 108 Illustrations and 4 full-page Coloured Plates. Cloth. Price 21s. net.
- JARDINE—Delayed and Complicated Labour.** By ROBERT JARDINE, M.D., F.R.F.P. & S. (Glas.), F.R.S. (Edin.). In one handsome crown octavo volume of 368 pages, with 107 Illustrations and 3 Coloured Plates. Cloth. Price 7s. 6d. net.

JACKSON.—**The Ready Reference Handbook of Diseases of the Skin.** By GEORGE THOMAS JACKSON, M.D. Seventh Edition, thoroughly revised. Small octavo, 770 pages with 115 Illustrations and 6 Plates. Cloth. Price 15s. net.

McMURRICH.—**The Development of the Human Body.** A Manual of Human Embryology. By J. PLAYFAIR McMURRICH, M.A., Ph.D., LL.D., Professor of Anatomy in the University of Toronto. Fourth Edition, Revised and Enlarged. Small octavo, 505 pages with 285 illustrations in black and colours. Cloth. Price 12s. 6d. net

MARTIN.—**Practical Electro-Therapeutics and X-Ray Therapy.** With Chapters on Photo-therapy, X-Ray in Eye Surgery, X-Ray in Dentistry, and Medico-Legal Aspect of the X-Ray. By J. M. MARTIN, M.D., Professor of X-Ray Methods in the Medical Department of Baylor University, etc. etc. In one royal octavo volume of 446 pages, with 219 Illustrations. Cloth. Price 18s. net.

MUSSER.—**A Practical Treatise on Medical Diagnosis.** For Students and Physicians. By JOHN H. MUSSER, M.D., Late Professor of Clinical Medicine in the University of Pennsylvania, etc. Sixth Edition, Revised. By John H. Musser, Jr., B.S., M.D. Instructor in Medicine in the University of Pennsylvania, etc., etc. Royal octavo, 793 pages, illustrated with 196 Engravings and 27 Coloured Plates. Cloth. Price 25s. net.

NILES.—**The Diagnosis and Treatment of Digestive Diseases.** A Practical Treatise for Students and Practitioners of Medicine. By GEORGE M. NILES, M.D. Royal octavo, 610 pages with 1 Plate and 86 other Illustrations. Cloth. Price 21s. net. Roxburgh binding, gilt top. Price 25s. net.

PORTNER.—**Genito-Urinary Diagnosis and Therapy.** For Urologists and General Practitioners. By Dr. ERNST PORTNER. Translated and Edited by Bransford Lewis, M.D., B.Sc. Royal octavo, 233 pages with 43 Illustrations. Cloth. Price 10s. 6d. net.

SOHN.—**Nutrition.** A Guide to Food and Dieting. By CHAS. E. SOHN, F.I.C., F.C.S. Crown octavo, 272 pages with 7 Illustrations. Cloth. Price 3s. 6d. net.

WATSON.—**Gonorrhœa and its Complications in the Male and Female.** By DAVID WATSON, M.B., C.M. Lecturer on Venereal Diseases to the University of Glasgow, etc. Royal octavo, 395 pages with 12 Plates and 72 Illustrations. Cloth. Price 15s. net.

HENRY KIMPTON, *Medical Publisher,*

263, HIGH HOLBORN, LONDON, W.C.

AND 40 & 42, UNIVERSITY AVENUE, GLASGOW.