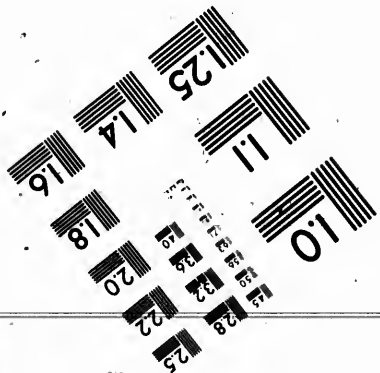
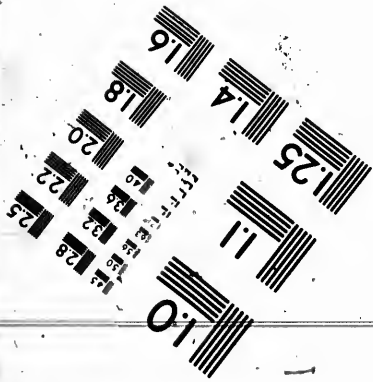
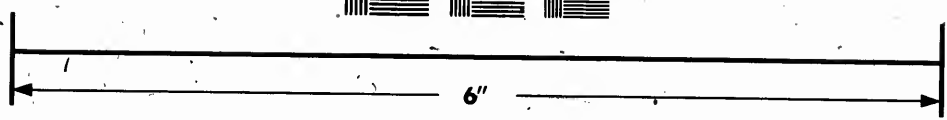
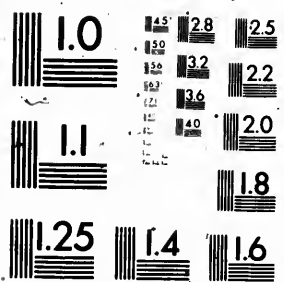

**IMAGE EVALUATION
TEST TARGET (MT-3)**



**Photographic
Sciences
Corporation**

23 WEST MAIN STREET
WEBSTER, N.Y. 14580
(716) 872-4503

15
16
18
20
22
25

**CIHM
Microfiche
Series
(Monographs)**

**ICMH
Collection de
microfiches
(monographies)**



Canadian Institute for Historical Microreproductions / Institut canadien de microreproductions historiques

11
10
57

© 1991

The copy filmed here has been reproduced thanks to the generosity of:

Library of the National Archives of Canada

The images appearing here are the best quality possible considering the condition and legibility of the original copy and in keeping with the filming contract specifications.

Original copies in printed paper covers are filmed beginning with the front cover and ending on the last page with a printed or illustrated impression, or the back cover when appropriate. All other original copies are filmed beginning on the first page with a printed or illustrated impression, and ending on the last page with a printed or illustrated impression.

The last recorded frame on each microfiche shall contain the symbol \rightarrow (meaning "CONTINUED"), or the symbol ∇ (meaning "END"), whichever applies.

Maps, plates, charts, etc., may be filmed at different reduction ratios. Those too large to be entirely included in one exposure are filmed beginning in the upper left hand corner, left to right and top to bottom, as many frames as required. The following diagrams illustrate the method:

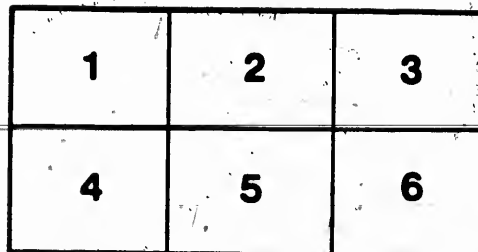
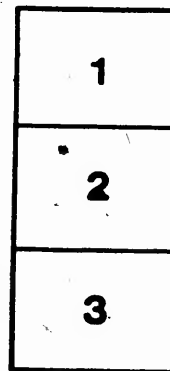
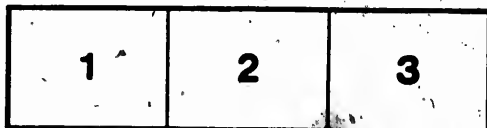

L'exemplaire filmé fut reproduit grâce à la générosité de:

La bibliothèque des Archives nationales du Canada

Les images suivantes ont été reproduites avec le plus grand soin, compte tenu de la condition et de la netteté de l'exemplaire filmé, et en conformité avec les conditions du contrat de filmage.

Les exemplaires originaux dont la couverture en papier est imprimée sont filmés en commençant par le premier plat et en terminant soit par la dernière page qui comporte une empreinte d'impression ou d'illustration, soit par le second plat, selon le cas. Tous les autres exemplaires originaux sont filmés en commençant par la première page qui comporte une empreinte d'impression ou d'illustration et en terminant par la dernière page qui comporte une telle empreinte.

Un des symboles suivants apparaîtra sur la dernière image de chaque microfiche, selon le cas: le symbole \rightarrow signifie "A SUIVRE", le symbole ∇ signifie "FIN".

Les cartes, planches, tableaux, etc., peuvent être filmés à des taux de réduction différents. Lorsque le document est trop grand pour être reproduit en un seul cliché, il est filmé à partir de l'angle supérieur gauche, de gauche à droite, et de haut en bas, en prenant le nombre d'images nécessaire. Les diagrammes suivants illustrent la méthode.



Pass this to your Engineer,
it is instructive, and the
articles are all new and
SCIENTIFIC

STEAM SPECIALTIES



MADE AND SOLD BY
CANADA FOUNDRY COMPANY
TORONTO, CANADA LIMITED

The Squires (Pilot Valve) Pressure Controller OR REDUCING VALVE.

(Class E.)

This device was especially designed to fill a need long felt in steam pressure regulating and elevator pump service, and it fills both requirements with marvelous accuracy, having been thoroughly tested in actual service, under the supervision of mechanical experts during the last three years. It is positive in action, as the Pilot Valve is independent of the Main Valve and the full force of the Boiler Pressure is used to close the Main Valve.

One thousandth of an inch movement of the Pilot Valve either way will close or open the Main Valve without noise or water hammer as the pump pressure does not come in contact with the Diaphragm of Main Valve. By simply closing a small valve it is accessible to inspection without stopping the pump.

Our patented Diaphragms used in all our goods are the result of years of practical investigations as to durability. They are water sealed and steam does not come in contact with them. The Diaphragm Chambers are all provided with drain plug to prevent freezing. All of our goods have removable seats and discs which can be replaced at small cost.

(Class



The Squires (Pilot Valve) Pressure Controller OR REDUCING VALVE

(Class E)

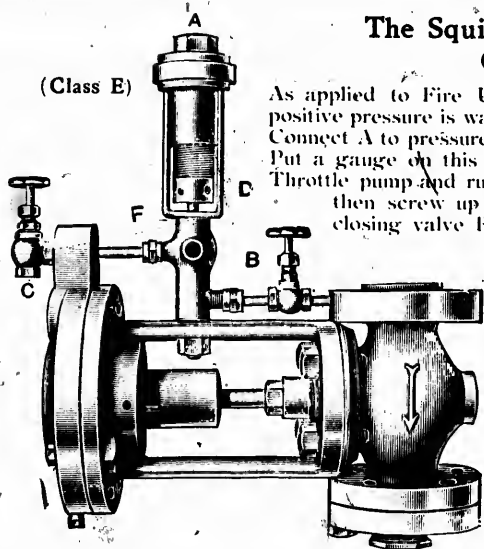

As applied to Fire Underwriters' Elevator and Boiler Feed Pumps. When positive pressure is wanted, install on vertical pipe with arrow pointing to pump. Connect A to pressure end of pump or line where regulated pressure is wanted. Put a gauge on this line to note pressure, open valve B and close valve C. Throttle pump and run slow until governor goes into action, open throttle wide then screw up Pilot Valve at D until pressure wanted is attained. By closing valve B and opening C main valve is by-passed and wide open. Pipe small opening on Pilot Valve Exhaust to Pan or Pit of Pump.

As applied to reduce steam or air pressure ranging from 300 lb. to 50 lb.

Connect reduced pressure side of valve as pointed by arrow to opening A with gauge on line to note pressure. Screw up at D until desired pressure is attained.

Size in inches	-	1 $\frac{1}{4}$	1 $\frac{1}{2}$	2	2 $\frac{1}{2}$	3	3 $\frac{1}{2}$	4
Price each	-	\$35	\$42	\$55	\$68	\$85	\$100	\$115
Face to face of flanges	-	7 $\frac{1}{4}$ "	7 $\frac{1}{4}$ "	8 $\frac{1}{4}$ "	9 $\frac{1}{4}$ "	10 $\frac{1}{4}$ "	11 $\frac{1}{2}$ "	12 $\frac{1}{2}$ "

Made up to order, prices on application.

In starting, unscrew at F, remove Pilot Valve and open B to blow out all dirt and sediment.

The Squires Pilot Valve Pump Governor.

High Pressure Marine and Stationary.

(Class M.)

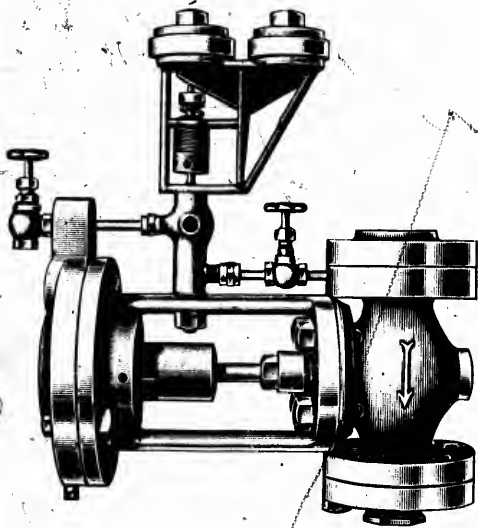

This type is adapted to use where a positive excess pressure on pump is wanted without regard to fluctuation of the Boiler Pressure. In marine service, where 250 pounds is maintained while running and 50 pounds at the dock, the excess being 10 pounds, the pump pressure will stop at 10 pounds over boiler pressure, whether at 250 or 50 pounds.

In the installation of this class proceed as per instructions for Class E (see page 3) and in addition to connecting A to water supply, connect E to Boiler pressure.

nor.

excess
tuation
re 250
at the
re will
250 or

instruc-
ecting

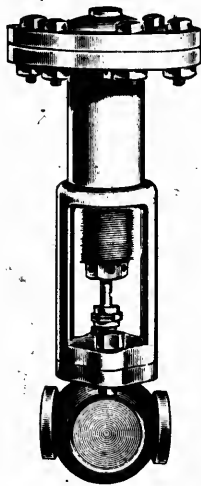

The Squires Class H Pump Governor.

This governor is designed for Brewers' Service on pumps in connection with Beer Filters, for House Pump Service in supplying water for high buildings, Brine Pumps for refrigerating plants and other work where constant pressure is needed.

These governors have removable seats and valves and diaphragms that are practically indestructible.

In ordering state working pressure wanted.

Price List.

3/4 inch Pipe	\$20.00
1 inch Pipe	25.00
1 1/4 inch Pipe	30.00
1 1/2 inch Pipe	42.00
2 inch Pipe	55.00

For large sizes see Class E.

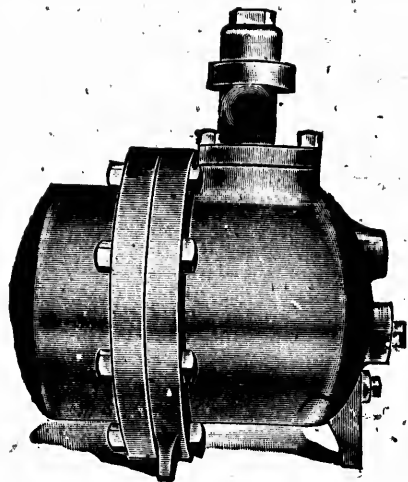

The Squires Steam Trap.

After an exhaustive investigation and trial of all the steam traps now being used throughout the country and noting their defects and the troubles of engineers in their use, Mr. Charles Squires has arrived at the present construction as the most practical and simple method of extracting the condensation from all steam coils and appliances without unnecessary waste of steam.

Its simplicity is its safeguard. It has no floats to collapse or water log. All dirt is caught in separator and blown out through cleanout.

The discharge valve and seats can be removed without disturbing the piping and being at the highest point there is no dirt to clog them.

The valve and seats are made from the best steam metal and can be replaced at small cost.

All traps tested at 500 pounds Hydraulic Pressure and 250 pounds Steam.

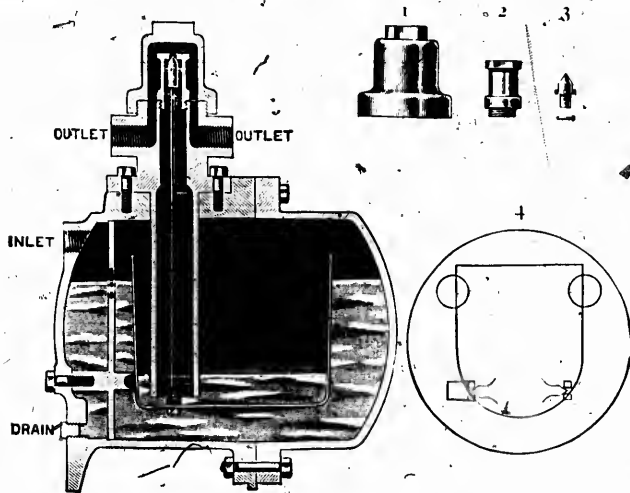

Section of the Squires Trap.

Owners and Engineers
Endorse this Trap
BECAUSE

No. 2 and 3 represent all there is to renew in case of wear. There are no other wearing parts and these can be replaced at a minimum cost.

No. 4 represents the pivotally attached Bucket.

The Squires Steam Trap.

The valve and seat are contained in cap at top of trap and can be inspected by simply unscrewing cap. In ordering, state what pressure is wanted. We furnish at same price for different pressures as follows :

Gravity Traps,	10 lbs. or less.
Low Pressure Traps,	10 lbs. to 30 lbs.
Standard Pressure Traps,	30 lbs. to 125 lbs.
High Pressure Traps,	125 and upwards.

Code Word	Tube	Tick	Tack	Time	Tell	Torn
Number	Q	1	2	3	4	5
Size Pipe Connection	$\frac{1}{2}$	$\frac{3}{4}$	1	$1\frac{1}{4}$	$1\frac{1}{2}$	2
Capacity linear ft. of 1 in. pipe	3000	4000	6000	10000	15000	25000
Capacity in square ft. of Radiation	900	1300	2000	3300	5000	8300
Capacity in lbs. of water per hour	300	500	725	1200	2000	3000
Prices	\$20.00	\$22.00	\$25.00	\$31.00	\$45.00	\$60.00

(State highest pressure under which Trap is to operate.)

Simply
e for

orn
5
2
000
00
00
00
.00

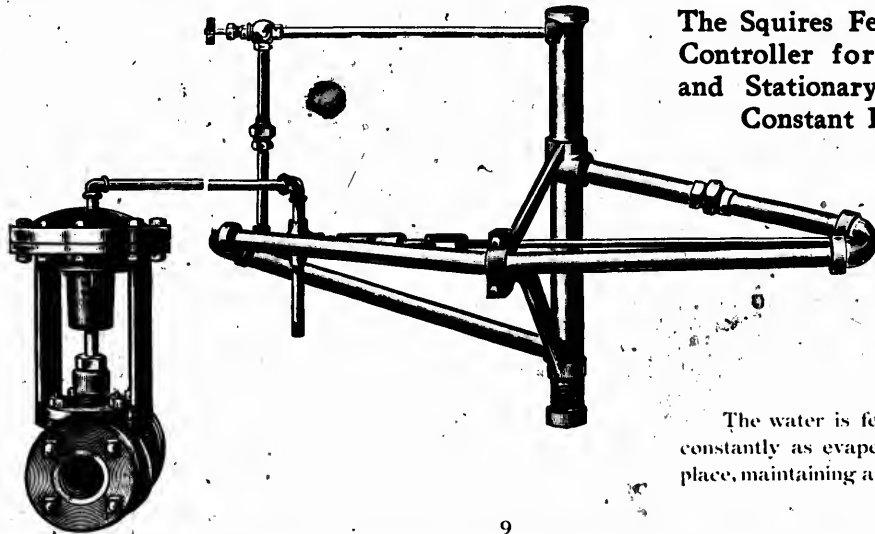

**The Squires Feed Water
Controller for Marine
and Stationary Boilers.
Constant Flow.**

The water is fed into boiler
constantly as evaporation takes
place, maintaining an exact level.

The Squires Feed Water Controller

Is the world's standard. Its marvelous simplicity of construction and durability place it on the high pedestal of public approval. It has weathered the storm of actual service without deterioration for the past five years. The reason is, it is built on the correct principle by the best mechanical skill from material that withstands the most exacting tests. It is manufactured after years of experimental trials with float and other devices. The present construction has been adopted as being the only practical method of controlling the constant inflow of water to steam boilers. Each and every part is made from exact patterns. The feed valves have removable seats and discs and can be replaced at slight cost. The buyer can always feel a sense of security in knowing his boilers are having the constant care of the Squires Controllers. No float to water log; no levers to stick; no stuffing box to watch; no glass to break. The tireless expansion of metal which never grows weak controls it. It takes but three inches of copper tube to operate it. It has 72 inches—24 times 3—giving it great reserve power.

We submit this statement to the prospective purchaser: The Squires Controller is the nearest approach to perfection yet attained by any maker, and we are perfectly willing to send our goods subject to your own approval after 30 days' trial.

Advantages of Squires Controller over Hand Feed.

First: The Squires Controller is not an intermittent feed. It secures constant flow, allowing the water to enter the boiler only as fast as it is evaporated. Your Feed Pump is therefore called upon to run steadily without variation, thereby getting the greatest efficiency from your Feed Water Heater, a greater evaporation from your Boiler, and consequently a corresponding saving in fuel. These conditions are not so with intermittent feed. When the water drops sufficiently to cause float to drop, the Feed Valve opens wide, the Pump speeds up, and a large amount of water is put into the boiler in a few minutes, thereby not only giving the heater no opportunity to heat the water, but in addition having the cooling effect of the water direct in the Boiler. Many of the up-to-date Mechanical Engineers are specifying Feed Water Controllers. They have come to stay, and every reliable device that can be added to boiler plants to make them more efficient and get the greatest amount of evaporation from each pound of coal should be installed without hesitation.

Do not say you would not rely on an automatic device to feed your Boilers. How about the Water Glass? It can clog—but you not only use it but have learned to rely on it.

Price Squires Controllers.

Number.	Size of Feed Valve.	Capacity.	Net Each.
1	1/2 inch.	For 10 to 25 H.P.	\$60.00
2	3/4 "	For 25 to 50 H.P.	65.00
3	1 1/2 "	For 50 to 650 H.P.	80.00
4	2 "	For 650 to 1000 H.P.	90.00

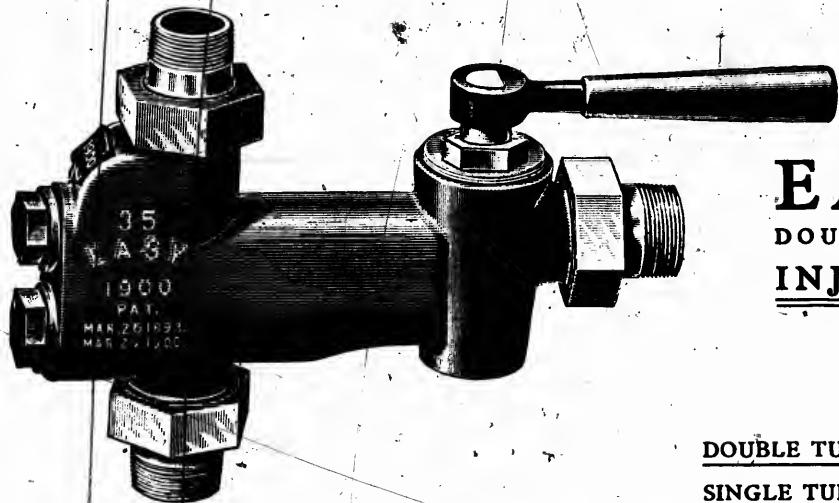

EASY
DOUBLE TUBE
INJECTORS

DOUBLE TUBE MACHINE
SINGLE TUBE PRICE

ONE CASE WHERE THE CHEAPEST IS THE BEST.

ADVANTAGES OF THE

EASY

UNIVERSAL DOUBLE TUBE INJECTOR.

1. Exceedingly simple in construction, with few parts.
2. Quick starting, positive action.
3. Widest range of starting and working pressures, capacity, water temperature and lifts.
4. Prompt lift even with hot suction pipes.
5. Working as lifter or non-lifter.
6. No valves, no movable parts.
7. Greatest reliability and adaptability for all classes of service.
8. No sensitiveness, no affection by violent oscillations, jarring or other unsteady conditions.
9. Minimum cost of maintenance and repairs.
10. Can be operated successfully by inexperienced hands.
11. Never fails to work if properly connected.
12. Simplest, most efficient, cheapest and best injectors known.
13. Continuous feed of hot water, avoiding uneven expansion and injurious strain in boiler.
14. Continuous working, with engine running or shut down.
15. No special attention.
16. Cannot get out of order if instructions are followed.

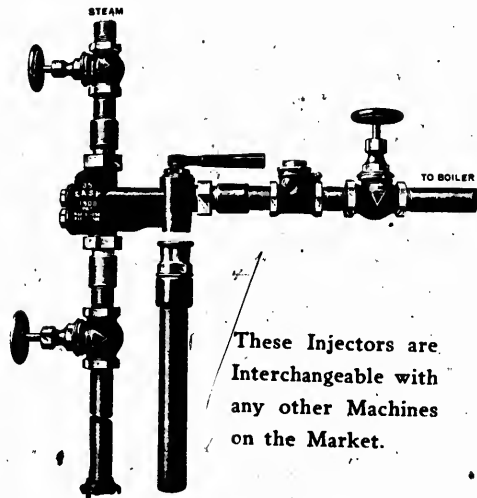

**These Injectors are
Interchangeable with
any other Machines
on the Market.**

These Injectors are specially constructed for successful applications to all kinds of service, and are perfectly reliable under conditions much more severe than any likely to arise in ordinary practice.

No adjustment is required for varying steam pressures. They will lift their supply of water from 25 feet below the Injector or receive it from a head pressure.

They will deliver water as desired at either a high or low temperature, and the range of capacity is fully 60 per cent. They will increase supply of water with increasing steam pressures.

They will not fail to work when body or suction pipe is hot.

Their simple construction and easy operation, by one handle, is readily understood. All parts are interchangeable.

Close and careful attention is given to the material and workmanship, and every Injector is thoroughly tested before it leaves the factory.

Price List, Dimensions and Table of Capacities of EASY Injectors.

Size.	Price.	SIZE OF PIPE CONNECTIONS.			Capacity, in gals. per hour, with 60 lbs. steam pressure.	HORSE POWER.	
		Steam.	Suction and Delivery.	Overflow.		Ordinary Type of Steam Boiler and Engine.	An Evaporation of 30 lbs. of water per Hour per H. P.
6 $\frac{1}{4}$	\$15 00	$\frac{1}{2}$ in.	$\frac{1}{2}$ in.	$\frac{1}{2}$ in.	40	2 to 4	3 to 5
7 $\frac{1}{2}$	16 00	"	"	"	60	4 to 6	5 to 8
8 $\frac{1}{4}$	18 00	"	"	"	90	6 to 8	8 to 15
10	20 00	"	"	"	120	8 to 15	15 to 25
12 $\frac{1}{2}$	25 00	"	"	"	220	15 to 30	25 to 35
15	30 00	"	"	1 "	300	30 to 40	35 to 60
17 $\frac{1}{2}$	40 00	"	1 "	1 $\frac{1}{4}$ "	420	40 to 60	60 to 75
20	45 00	"	1 "	1 $\frac{1}{2}$ "	540	60 to 75	75 to 100
22 $\frac{1}{2}$	55 00	1 "	1 $\frac{1}{4}$ "	1 $\frac{1}{2}$ "	720	75 to 90	100 to 130
25	60 00	1 "	1 $\frac{1}{2}$ "	1 $\frac{3}{4}$ "	900	90 to 120	130 to 175
30	75 00	1 $\frac{1}{4}$ "	1 $\frac{1}{2}$ "	2 "	1260	120 to 165	175 to 235
35	90 00	1 $\frac{1}{2}$ "	1 $\frac{3}{4}$ "	2 $\frac{1}{2}$ "	1740	165 to 230	235 to 300
40	110 00	1 $\frac{3}{4}$ "	2 "	2 $\frac{3}{4}$ "	2230	230 to 300	300 to 400
45	125 00	1 $\frac{3}{4}$ "	2 "	3 "	2820	300 to 375	400 to 500
50	150 00	2 "	2 $\frac{1}{2}$ "	3 "	3480	375 to 500	500 to 650
55	175 00	2 "	2 $\frac{3}{4}$ "	3 "	3650	500 to 600	650 to 700

WRITE FOR DISCOUNTS.

CANADA FOUNDRY COMPANY, Limited.

TORONTO. MONTREAL. HALIFAX. OTTAWA. WINNIPEG. VANCOUVER. VICTORIA. ROSSLAND.

vaporation
lbs. of water
pumped per H. P.

to 5
to 8
to 15
to 25
to 35
to 60
to 75
to 100
to 130
to 175
to 235
to 300
to 400
to 500
to 650
to 700

ND.



DAVENPORT WORKS

DISTRICT OFFICES

NO. 425

MONTREAL

HALIFAX

OTTAWA

WINNIPEG

CALGARY

VANCOUVER

ROSSLAND, B.C.

