

DESIGN BY RICH. B. ROGERS, M. INST. C. E., M. CAN. SOC. C. E., ILLUSTRATING PAPER BY  
 WALTER J. FRANCIS, C. E., M. CAN. SOC. C. E., DIVISION ENGINEER.

Sch

H

No. 15

1901-1902

# PAPERS

READ BEFORE THE

# ENGINEERING

# SOCIETY

OF THE

# School of Practical Science

TORONTO

---

PRICE, - - 50 Cents



TORONTO:  
THE CARSWELL CO., LIMITED  
1902

Entered according to the Act of the Parliament of Canada, in the year one thousand  
nine hundred and two, by the Engineering Society of the School of Practical  
Science, in the office of the Minister of Agriculture.

editi  
of P  
ard  
paper  
acter  
the v  
of e  
Spec  
and  
prof  
relati  
very  
the c  
probl  
uniqu  
comm  
I  
*Scite*  
T

## P R E F A C E .

---

It is with no little satisfaction that this, the fifteenth annual edition of the proceedings of the Engineering Society of the School of Practical Science, is presented to the members. The high standard set in previous editions is quite equalled by the quality of the papers here published. It is an evidence of the *esprit de corps* characteristic of "School" men that the graduates of our college have the will to find the time and energy necessary for the preparation of essays for the information and inspiration of our members. Special attention might be drawn to the papers of Messrs. Haultain and Mitchell dealing with the relation of the young graduate to his profession. The discussion by Mr. MacMurchy defining a special relation of the engineer to his employers is also noteworthy. Two very practical papers are those of Messrs. Thomson and Francis, the one describing an up-to-date method of solving a "ticklish" problem; the other giving information upon an interesting and unique part of the construction of one of our newest highways of commerce.

Let the motto of the Society, as well as of the School, be ever:  
*Scite et Strenue.*

This edition consists of 1,500 copies.

W. G. CHACE.

## CONTENTS.

---

	PAGE.
President's Address .....	R. H. Barrett, '01 1
Our Timber Supply .....	J. A. DeCew, '96 9
Forestry and Engineering .....	Thos. Southworth 13
The Use of Iron and Steel in Mines .....	D. L. H. Forbes, '02 19
Bacterial Method of Sewage Disposal..	
Chas. H. Rust, C.E., M. Can Soc. C.E.	29
The Underpinning of the West Wall of the Stokes Building..	
T. Kennard Thomson, C.E., M. Am. Soc. C.E.	39
Concrete Culverts ..	A. W. Campbell, Asst. Commr. Public Wks. 49
A Modern Ship Building Plant .....	J. Roy Cockburn, '01 56
The Young Graduate and the Profession of Mining Engineer- ing .....	H. E. T. Haultain, C.E., A.M. Can. Soc. C.E. 63
The Position of an Engineer as Arbitrator under the Contract.	
Angus MacMurchy, B.A.	81
Notes on Aluminum Conductors .....	F. C. Smallpeice, '98 90
The Behaviour of Steel under Stress ..	C. H. C. Wright, B.A.Sc. 101
Bridge Foundations and Abutments..	J. H. Jackson, O.L.S. '03 114
The College Graduate and His Specialty..	
Chas. H. Mitchell, C.E., A.M. Can Soc. C.E.	119
The Hydraulic Lift Lock on the Trent Canal, near Peter- borough .. .	Walter J. Francis, C.E., A.M. Can. Soc. C.E. 123
Treasurer's Report .....	E. A. James, '03 167
Auditors' Report.....	169
Index to First Fifteen Numbers .....	170

R. H.

Tr  
E. A. J

Fourth-Y  
H. F

Se

GENERAL COMMITTEE, 1901-1902.

---

President :

R. H. BARRETT, '01.

Vice-President :

R. W. MORLEY, '02.

Rec. Secretary :

F. W. RUTHERFORD, '04.

Cor. Secretary :

T. S. NASH, '02.

Treasurer .

E. A. JAMES, '03.

Librarian :

A. A. WANLESS, '02.

Editor :

W. G. CHACE, '01.

Asst. Librarian :

F. A. GABY, '03.

Graduates' Representative :

W. A. DUFF, '01.

Fourth-Year Representative :

H. P. RUST, '01.

Third-Year Representative :

D. SINCLAIR, '02.

Second-Year Representative :

M. A. STEWART, '04.

First-Year Representative :

P. M. YEATES, '04.



LIFE MEMBERS—Continued.

- McKinnan, H. S., B.A.Sc., '95.  
 McKay, O., O.L.S., '85.  
 McKay, W. N., '95.  
 McMillan, J. G., B.A.Sc., '00.  
 McPherson, A. J., B.A.Sc., D.L.S., '93.  
 McPherson, C. W., O.L.S.  
 McTaggart, A. L., B.A.Sc., '94.  
 McVean, H. G., '01.  
 Merrill, E. B., B.A., B.A.Sc., '90.  
 Middleton, H. T., '01.  
 Milne, C. G., B.A.Sc., '92.  
 Mines, W. H., B.A.Sc., '95.  
 Minty, W., B.A.Sc., '94.  
 Mitchell, C. H., B.A.Sc., C.E., A.M. Can. Soc. C.E., '92.  
 Mickle, G. R., B.A., '88.  
 Mollins, C. B.  
 Moore, J. E. A., C.E., '91.  
 Neelands, E. V., B.A.Sc., '00.  
 Newman, W., O.L.S., A.M. Can. Soc. C.E., '91.  
 Paterson, C. E.  
 Pinhey, C. H., D. & O.L.S., '87.  
 Piper, A. G.  
 Proudfoot, H. W., '97.  
 Raymer, A. R., '84.  
 Richards, E., B.A.Sc., '99.  
 Richardson, G. H., '88.  
 Robinson, F. J., D. & O.L.S., '95.  
 Ralph, H., '94.  
 Rose, K., '88.  
 Rosebrugh, T. R., M.A., '89.  
 Ross, J. E., D. & O.L.S., '88.  
 Ross, R. A., E.E., '90.  
 Russell, T. S., O.L.S.  
 Scott, W. F., '97.  
 Shanks, Thos., B.A.Sc., '99.  
 Shaw, Jno. H., O.L.S.  
 Shields, J. D., B.A.Sc., '94.  
 Shillinglaw, M. H.  
 Shipe, R. R., '96.  
 Shipley, A. E., B.A.Sc., '98.  
 Sifton, E. I.  
 Silvester, G. E., O.L.S., '91.  
 Sims, H. B.  
 Smith, Angus, O.L.S., '94.  
 Smith, A. H.  
 Speller, F. N., B.A.Sc., '93.  
 Squire, R. H., B.A.Sc., O.L.S., '93.  
 Stern, E. W., '84.  
 Stewart, L. B., D.L.S., D.T.S.  
 Stacking, F. T., '95.  
 Stovel, R. H.  
 Stull, W. W., B.A.Sc., O.L.S., '97.  
 Symmes, H. D., '91.  
 Taylor, W. V., '93.  
 Tennant, D. C., B.A.Sc., '99.  
 Thomson, T. K., C.E., M. Am. Soc. C.E., '86.  
 Thomson, R. W., B.A.Sc., '92.  
 Tremaine, R. C. C., B.A.Sc., '95.  
 Troupe, G. E.  
 Tye, A. T.  
 Webster, E. B.  
 Weldon, E. A., '97.  
 Wickson, F. R.  
 Wilkie, G.  
 Wright, C. H. C., B.A.Sc., '88.

ORDINARY MEMBERS.

- Acres, H. G., '03.  
 Alexander, J. H., B.A., '03.  
 Alison, J. G. R., '03.  
 Allen, C. W., '04.  
 Angus, H. H., '03.  
 Arens, H., '04.  
 Baldwin, F. W., '04.  
 Baldwin, G. W., '04.  
 Bangham, J., '04.  
 Barber, H. G., '02.  
 Barrett, J. H., '04.  
 Beatty, H. E., '04.  
 Beatty, J. A., '03.  
 Begg, W. A., '04.  
 Blaine, T. R., '04.  
 Blair, W. J., '02.  
 Boeckh, J. C., '04.  
 Bonnell, M. B., '03.  
 Boswell, M. C., '00.  
 Bowles, G. W., '04.  
 Brandon, E. T. J., '01.  
 Bridgeland, M. P., B.A., '03.  
 Brown, J. H., '02.  
 Brown, T. E., '04.  
 Bryce, R. A., '04.  
 Burd, J. H., '03.  
 Burgess, E. L., '03.  
 Burley, R. J., '04.  
 Burnham, F. W., '04.  
 Burwash, N. A., '03.  
 Calder, J. W., '04.  
 Cameron, N. C., '04.  
 Campbell, A. J., '04.  
 Campbell, A. M., '04.  
 Campbell, A. R., '02.  
 Campbell, W., '02.  
 Cass, G. A., '04.  
 Challies, J. B., '03.  
 Chace, W. G., '01.  
 Chase, A. V., '04.  
 Chilver, C. W., '04.  
 Chilver, H. L., '04.  
 Christie, N. W., '04.  
 Christie, W., '02.  
 Coates, P. C., '04.  
 Cockburn, J. R., '01.  
 Code, S. B., '04.  
 Code, T. F., '04.  
 Conlon, F. T., '02.  
 Connor, H. V., '02.  
 Corbett, J. T., '03.  
 Coulson, C. L., '03.  
 Cousins, E. L., '04.  
 Cowan, W. A., '04.  
 Craig, S. E., '04.  
 Crerar, S. R., '04.  
 Culbert, M. T., '02.  
 Cumming, R., '02.  
 Currie, W. M., '04.  
 Davison, A. E., '03.  
 Depew, H. H., '03.  
 Douglas, W. E., B.A., '02.  
 Dunlop, R. J., '02.  
 Dunn, H. C., '04.  
 Eason, D. E., '01.  
 Edwards, W. M., '02.  
 Elder, A. J., '04.  
 Elwell, W., '02.  
 Empey, J. M., '02.  
 Evans, H. W., '04.  
 Fee, T., '04.  
 Fensom, C. J., '03.  
 Field, J. J., '04.  
 Fleck, J. C., '04.  
 Fletcher, H. M., '04.  
 Forbes, D. L. H., '02.  
 Ford, A. M., '04.  
 Ford, E. A., '04.



ORDINARY MEMBERS—Continued.

Foster, W. J., '04.  
 Fuce, E. O., '03.  
 Gaby, F. A., '03.  
 Gardner, J. C., '03.  
 Gibson, A. E., '02.  
 Gibson, W. S., '04.  
 Gillespie, P., '03.  
 Goodall, J. N., '04.  
 Goodwin, A. C., '02.  
 Gordon, J. P., '03.  
 Gordon, W. C., B.A., '03.  
 Gourlay, W. A., '03.  
 Gray, A., '03.  
 Gray, W. W., '04.  
 Greene, E. A., '04.  
 Greenwood, W. K., '04.  
 Gzowski, H. N., '03.  
 Hamilton, J. T., '03.  
 Hanes, G. S., '03.  
 Hara, L. D., '04.  
 Harcourt, F. T., '03.  
 Harris, C. J., '04.  
 Harvey, Chas., '01.  
 Hayes, L. J., '03.  
 Hellmuth, H. I., '04.  
 Henderson, F. D., '03.  
 Henderson, T. D., '04.  
 Henry, J. S., '02.  
 Henwood, C., '02.  
 Heron, J. B., '04.  
 Hill, E. M., '04.  
 Hill, S., '04.  
 Holmes, O. B., '04.  
 Horton, J. A., '03.  
 Horwood, H. O., '04.  
 Howard, J. A., '04.  
 Ingles, C. J., '04.  
 Irving, T. C., '04.  
 Jackson, E. R., '04.  
 Jackson, J. G., '03.  
 Jackson, J. H., O.L.S., '03.  
 James, E. A., '03.  
 Jamieson, C. W., '04.  
 Jermyn, P. V., '04.  
 Johnston, C. K., '03.  
 Johnston, D. M., '02.  
 Johnston, J. H., '03.  
 Johnston, J. W., '04.  
 Keefe, W. S., '04.  
 Kernahan, M. G., '03.  
 Knight, R. H., '02.  
 Laing, P. A., '04.  
 Lang, A. G., '03.  
 Larkworthy, W. J., '03.  
 Latornell, A. J., '03.  
 Legate, W. B., '04.  
 Legge, A. H., '04.

Little, J. C., '04.  
 Mace, F. G., '02.  
 Mackay, J. J., O.L.S., '03.  
 Mackay, J. T., '02.  
 Mackenzie, C. H., '04.  
 Mackenzie, K. B., '04.  
 Madden, J. T., '02.  
 Maddison, W. W., '04.  
 Manchester, C. S., '04.  
 Manson, C. J., '04.  
 Marquis, G. P., '04.  
 Marriott, F. G., '03.  
 Marrs, C. H., '02.  
 Mathison, P., '02.  
 Maus, C. A., '03.  
 McAuslan, H. J., '03.  
 McBride, A. H., '02.  
 McCuaig, O. B., '04.  
 McEwen, D. F., '04.  
 McEwen, G. C., '04.  
 McFarlane, J. A., '03.  
 McGibbon, C. P., B.A., '04.  
 McKay, C. D., '04.  
 McLennan, A. L., '02.  
 McMaster, A. T. C., '01.  
 McMillan, D., '04.  
 McNaughton, A. L., '03.  
 Mennie, R. S., '02.  
 Merritt, R. N., '04.  
 Miller, M. L., '03.  
 Mills, J. E., '04.  
 Milne, W. J., '03.  
 Mitchell, P. H., '03.  
 Montgomery, R. H., '03.  
 Moore, E. E., '04.  
 Moore, F. A., '02.  
 Moore, H. H., '02.  
 Moorhouse, W. N., '04.  
 Morden, L. W., '04.  
 Morley, R. W., '02.  
 Marton, P. E., '03.  
 Mullins, E. E., '03.  
 Munro, C. G., '04.  
 Munro, W. H., '04.  
 Nash, T. S., '02.  
 Nevitt, T. H., '03.  
 O'Brien, D. E., '04.  
 Oliver, E. W., '03.  
 Oliver, J. P., '03.  
 O'Sullivan, J. J., '04.  
 Pace, G., '04.  
 Pace, J. D., '03.  
 Pardoe, W. S., '04.  
 Park, J. P., '04.  
 Patten, B. B., '03.  
 Peaker, W. J., '04.  
 Phillips, E. P. A., '04.

Philp, D. H., '03.  
 Pickering, A. E., '04.  
 Pinkney, D. H., '03.  
 Plunkett, T. H., '03.  
 Porte, W. B., '03.  
 Powell, G. G., '02.  
 Price, H. W., '01.  
 Pullen, E. F., '04.  
 Ramsay, G. L., '04.  
 Ratz, W. F., '02.  
 Raymon, D.L.C., '04.  
 Reid, F. B., '04.  
 Reynolds, G. B., '04.  
 Riddell, M. R., '04.  
 Rigsby, J. P., '03.  
 Robertson, H. D., '02.  
 Robertson, D. F., '03.  
 Rabinson, L., '04.  
 Roddick, J. O., '04.  
 Rogers, W. R., '04.  
 Ross, R. B., '03.  
 Roxburgh, G. S., '04.  
 Rundle, L. P., '04.  
 Rust, H. P., '01.  
 Rutherford, F. N., '03.  
 Sauder, P. M., '04.  
 Sauer, M. V., '01.  
 Schell, F. S., '04.  
 Scott, G. S., '04.  
 Serson, M. V., '04.  
 Seymour, H. L., '03.  
 Shepley, J. D., '04.  
 Shipe, H. M., '03.  
 Sinclair, D., '02.  
 Slater, F. W., '04.  
 Small, H. S., '03.  
 Smallpeice, F. C., '98.  
 Smart, R. S., '04.  
 Smifh, D. A., '04.  
 Smith, H. G., '03.  
 Smith, J. H., '03.  
 Smither, W. G., '04.  
 Southworth, H. S., '04.  
 Steele, T. J., '02.  
 Stevenson, W. H., '01.  
 Stewart, M. A., '03.  
 Stover, C. B., '04.  
 Street, P. B., '04.  
 Stroud, A., '04.  
 Sutherland, W. H., '02.  
 Sykes, F. H., '04.  
 Tait, R. J., '04.  
 Tait, E. L., '04.  
 Taylor, T., '02.  
 Teasdale, C. M., '02.  
 Thompson, H. P., '04.  
 Thomson, J. E., '04.

Thomson, S. E., '04.  
 Townsend, C. J., '04.  
 Townsend, D. T., '04.  
 Trees, S. L., '03.  
 Trimble, A. V., '04.  
 Tucker, B. B., '04.  
 Umbach, J. E., '03.  
 Vaughn, J., '04.  
 Wade, E., '04.  
 Waldron, J., '03.  
 Walker, E. W., '04.

**ORDINARY MEMBERS—Continued.**

Thomson, S. E., '04.  
Townsend, C. J., '04.  
Townsend, D. T., '04.  
Trees, S. L., '03.  
Trimble, A. V., '04.  
Tucker, B. B., '04.  
Umbach, J. E., '03.  
Vaughn, J., '04.  
Wade, E., '04.  
Waldron, J., '03.  
Walker, E. W., '04.

Wanless, A. A., '02.  
Wass, S. B., '03.  
Watson, J. P., '04.  
Weddell, R. G., '04.  
Weir, J. M., '04.  
Wells, A. F., '04.  
Whelihan, J. A., '03.  
White, H. F., '03.  
Wickett, W. E., '04.  
Wilkie, J. H., '04.  
Williams, C. G., '03.

Wilson, J. M., '04.  
Wilson, N. D., '03.  
Wilson, W. H., '04.  
Worthington, W. R., '03.  
Wright, R. T., '94.  
Wright, W. F., '04.  
Yeates, P. M., '04.  
Young, C. R., '03.  
Young, V. H., '03.  
Zahn, H. J., '02.

## OBITUARY NOTICE.

---

During the present term the grim reaper, Death, has removed one of our undergraduate members, William Edward Costin, who died January 16th, 1902. For several months he suffered from a sarcomatous growth which finally baffled the best medical skill that could be procured.

He was the only son of W. I. Costin, M.D., and was a native of Oxford county. After attaining senior leaving standing at Woodstock Collegiate Institute, he taught for about three years, and then entered S. P. S. in a course of Civil Engineering with the present graduating class, obtaining honor standing in his first and second years.

On account of his many winning qualities he made many warm friends among the students, who feel that they have lost a true and noble-hearted schoolfellow.

---

We regret to have to record the death of another of our undergraduate members, John A. Nelson, a student in the Mechanical and Electrical Department of the first year. He was the youngest son of Mr. J. C. Nelson of St. Catharines, and was a general favorite among those who made his acquaintance during his short term here.

He was taken ill on Wednesday, January 1st, 1902, with appendicitis, and, after a week of intense suffering, died at the home of his parents.

Th

my p  
hond  
the c  
in m  
who  
Our  
none  
resp  
reass  
whic  
we s  
char

depa  
of st  
year  
exter  
Do n  
part  
sion  
by c  
befor  
It w  
need  
I wo

ENGINEERING SOCIETY  
OF  
The School of Practical Science  
TORONTO.

---

**PRESIDENT'S ADDRESS.**

---

GENTLEMEN: As this is the first occasion on which it has been my pleasure to meet the Engineering Society since you did me the honour of electing me President of this honourable body, I welcome the opportunity of thanking you for the confidence you have placed in me. The Engineering Society has been presided over by men who have achieved the highest success in the engineering world. Our Society represents a School of Engineering which is second to none in Canada. These things impress upon me the weight of responsibility I have assumed in accepting this office. But I am reassured when I consider the strong, energetic committee with which you have surrounded me; and with your hearty co-operation, we shall endeavour to continue that progress which has so markedly characterized the history of our Society.

I would call your attention to the great interest taken in the department of engineering, as evidenced by the increasing number of students entering each year. To the gentlemen of the first year who are about to become members of our Society, I would extend a hearty welcome. Enter at once into the life of the Society. Do not wait till your second or third year, to feel that you are a part of its workings. It is unnecessary for me to go into a discussion of the objects of the Society, or the advantages to be gained by contributing papers. These have been very thoroughly laid before you in the addresses of a number of our former Presidents. It will pay you to read them up. Suffice it to say, that the Society needs your help and you need the Society's help. To these ends I would ask you to take an interest in everything pertaining to the

Society, contribute a paper if you can, ask questions and be ready for a discussion after every paper that is read.

The Engineering Society being representative, as it is, of the whole student body of the School of Practical Science, I wish to refer to a few things of general interest.

During the past year there occurred an event which will remain a landmark in the history of our institution. I refer to the banquet tendered by the graduates and undergraduates of the School to our honoured Principal, on the twenty-first anniversary of the birthday of the School of Practical Science. The gathering was a most representative and enthusiastic one, indicating the high esteem in which our Principal is held.

At the conclusion of his address on that occasion, Principal Galbraith made an important announcement. To use his own words: "A week ago the Senate of the University passed a statute which provides that the School of Practical Science, the teaching staff, examiners and students, together with examiners for the degrees in applied science and engineering, shall ex-officio constitute the Faculty of Applied Science of the University of Toronto. By this statute the powers of the Senate with reference to the degrees, and those of the School with reference to the curriculum and work of instruction, as also the statute respecting affiliation, remain unaltered. The result is that the University gains without expense a fully equipped Faculty of Applied Science, and in this respect puts itself on an equality with the other great Universities of the continent; while on the other hand, the School gains public recognition of the fact that its work is of equal rank and dignity with that of the ancient faculties of Arts, Medicine, and Law. This action of the Senate forms a fitting close to the history of the School in the nineteenth century."

In view of the fact that we are now a full fledged faculty, on equal standing with the faculties of Arts, Medicine, and Law, it behooves us that we enter more fully into the student life of our great University.

In respect to athletics no fault can be found. "School-Cups!" has been the war-cry which has cheered on to victory our athletic champions on many a hard fought field. There are, however, other phases of University life into which we do not enter with such zeal. We might mention the Varsity paper, an excellent publication, in

which we should manifest a greater interest. The Dining Hall and the Students' Union are new departures, and should be powerful agents in cementing the union of the different faculties. In loyalty to the School our men have been true to the core. Let us now extend our sympathies, and without lessening in the least our love for old S.P.S., let us join with a fervor characteristic of school men, in sounding the fame of this great University of which we form no unimportant part.

The upper years of the School will remember that last spring an enthusiastic delegation from this institution crossed over to the Parliament Buildings and made representations to the Government setting forth the urgent needs of the School. They will also remember that later the Legislature decided to devote \$200,000 to Science, \$50,000 of which was to be immediately available. During the summer Professors Galbraith and Wright visited many of the American Universities, inspecting the Applied Science Departments with a view to the best methods of constructing and equipping the new buildings. Also J. W. Bain, B.A.Sc., who has been in Europe the past summer, visited the chemical departments of a number of the universities on the continent, with the same end in view. They have submitted their report to the Government. The Provincial architect is busy preparing plans to be submitted to the Council for their approval; and it is probable that the contract for the construction of the new building will be let this Fall. The site of the new building will be somewhere in the vacant plot owned by the University on College Street. It is to be hoped that every effort will be put forth by the Government in order that the new building will be constructed as soon as possible. We all know that already, owing to the insufficient accommodation, small teaching staff and poor experimental equipment, that the needs of the students are far from being supplied.

As a result of the energetic efforts of Capt. Lang and Lieutenant Burnside, the Toronto Engineer Corps is now a reality; and a striking reality it proved itself to be during the recent visit of the Royal Party. In the Royal Review on Friday, the Duke remarked on the smart appearance of the company, and during the afternoon of the same day while forming a "Guard of Honor" for the Royal Party on their visit to the University, it again came in for con-

gratulatory remarks. The company at present musters fifty-eight men, and nearly all are men of the School of Practical Science. We shall hope that before long their numbers may be doubled. When the men have all qualified in drill, the chief work which is the specialty of an Engineer Company will then be proceeded with. This work consists of field work, earthing, use of spar, bridging, etc. Good advancement may be expected, considering the speed with which the preliminary drill was mastered. A full supply of engineering stores has been provided, including outfits for signalling and telegraphing.

There has been some discussion, perhaps some dissatisfaction, in regard to the Library of the School. The following may prove some enlightenment on the subject. The chief officer is the Librarian appointed by the Council, who is made responsible for the management of the Library over which he has control. The students elect by ballot at their general elections two representatives—first and second assistants—who do the actual work in connection with the Library. A catalogue has been printed and is accessible to all members of the Society. In this catalogue, opposite the names of the volumes, are letters indicating the libraries of the Professors in which the volumes may be found. Where no letter occurs opposite the volume, it will be found in the General Library of the School. The volumes in the respective libraries of the Professors are permanently located there. These books may be procured subject to the ordinary regulations, by applying to the Professor. Each Professor in this way acts as an assistant librarian.

We are all glad to know that the health of our Lecturer in Applied Mechanics, Mr. Duff, has so far improved that he is able to resume his duties in the School. We all join in welcoming him among us, and trust that we may have his genial presence at our meetings in the coming year.

I might call your attention to the appointment of Mr. Monds to the position of Demonstrator in Mechanical Engineering, to that of Mr. Chace to the Fellowship in Electricity, to that of Mr. Craig to the Fellowship in Mechanical Engineering, and to that of Mr. Ardagh to the Fellowship in Chemistry.

In preparing this paper on "Engineering as a Profession," I cannot claim entire originality. My experience so far has been

limited, and if you find some of my ideas too far advanced for a Fourth-Year man, I can plead with Kipling—

When 'Omer banged his bloomin' lyre,  
E'd 'eard men sing by land and sea;  
And what 'e thought 'e might require,  
'E went and took the same as we.

## ENGINEERING AS A PROFESSION.

The profession of engineering is an honoured and honourable one, but its place in the public estimation is not yet where its merits and services would place it. In Europe the standing and remuneration of the engineer are second to those of no other professional man. England recognizes the services of her engineers by honours and emoluments. The Engineers of the Forth Bridge were knighted in recognition of their services. Public measures and acts of parliament are largely influenced by their advice and direction. Manufacturing and industrial operations are largely managed by engineers instead of so-called practical men.

When John Smeaton, a little more than a century ago, became the first man to write Civil Engineer after his name, the title gave no prestige to the possessor. The early engineers, Watt, Stephenson, Smeaton and Fulton, had to fight their way through poverty and discouragements to a recognition of their services.

Canada and the United States are very slow in the recognition of the valuable services of their engineers. Either country owes more to the engineer than to any other class of equal numbers. Think of the immense development in any of the different branches. To follow out any one of the numerous lines of work in which he has been engaged, to trace the development of the first crude mechanism, up to the splendid triumphs of the present day in almost any department of industry, would be no idle task.

Engineering is a profession in which a man can be honourable. It is fascinating from the fact that one sees the realization of his mathematical and scientific theories and deductions. Its objects are useful in the highest degree. It is healthful and ennobling in its practice. In fact it is a profession which may well challenge the attention of the young man of earnest endeavour, who is seeking not only material prosperity, but an honoured place among those who have well served their day and generation.



Mr. Charles T. Harvey, an eminent engineer, in a paper read before our Society, said:—"Engineers of the highest degree are born not made. Technical education is helpful, but not determinative of the quality or strength of the will power which you need to best succeed in your profession. You have chosen a profession which calls for intense exercise of trained will power, as its functions are to re-arrange the material features of the earth to serve human purposes to a higher degree. The embankment of a railway, the prism of a canal, and the mechanism of a steam or electrical engine, are triumphs of educated will power over matter."

One great factor very necessary in the make up of a successful engineer is the power of observation. The observation of a simple fact, and the train of thought induced thereby, have led continually to important results. The ability to map localities in the mind, the faculty of noting the workings of a piece of mechanism, the observation of leading features of places and things; all of these are of the utmost value to the engineer. This power, combined with a sound knowledge of natural and mechanical laws, together with a sufficient amount of nerve to put the thing into execution, are the great requisites of an engineer.

The engineer should love his profession. The most simple operations should possess an attraction to him. The application of his theoretical knowledge, both in mathematics and science, should be beautiful to him. The man who sees only the theoretical truth of the fundamental formulae, and has no love for their application, should not adopt engineering as a profession. Obstacles that spring up along the line should not dampen his ardour to obtain a true result.

The engineer should honour his profession. After becoming as proficient as possible in the department which he has chosen, honour and honesty should characterize his policy. When the engineer accepts bribes from the contractor for passing work which does not fulfil the specifications; when he charges his employer a fee for first-class work when he knows it is inferior; when he adopts the practice of "making days" when the "per diem" prescribed by law is too small, he had better blot the name of his profession from his card and devote himself to a trade in which honourable dealing is not expected.

The final success of an engineer probably depends upon more qualities than are absolutely required in most of the other professions. His knowledge must be thoroughly technical, while his methods must be perfectly practical. The clergyman or lawyer is tolerably sure of success, if he is eloquent and respectable. The physician who has an engaging manner, need not be a great practitioner in order to secure a good income. But the engineer, in order that he may attain to success, must possess qualities which would have won much more fame and fortune if they had been applied to some other calling.

A prominent engineer of the day has put it thus: "The demand to-day is for men who can accomplish specific results; not the ancient history of the steam engine, but the ability to construct the most modern and complete form; not the story of how Franklin discovered the relations of lightning to the electric fluid, but the ability to design and construct a dynamo that will run the greatest number of lights at the least expense; not how the subject of alchemy has developed into modern chemistry, but how to conduct industrial manufactories with the least possible waste."

The demands of engineering upon the man are greater than in most of the professions. He must first submit himself to a thorough technical training, in order that he may be able to read and observe. Having secured his diploma, he must seek employment that he may obtain experience, for the glimpse of the real thing which he has got in his college course is far from fitting him for the responsibilities of the work. During the earlier part of his career he will probably find that his work is something more than trying.

The worst feature of the engineer's life is its uncertainty. Especially is this true of the mining and civil branches. One must at all times be in readiness, at a moment's notice, to go to any part of the country where his work may call him. Often he is exposed to great hardships in the way of extremes of heat and cold, rain and drouth, and sometimes scanty fare.

What does the Faculty of Applied Science offer to a prospective engineer? It offers that technical training which is so necessary nowadays in the make up of a successful engineer. "Knowledge is power" is an old adage, a back-number. Power is rather the ability to apply knowledge. Technical schools not only furnish knowledge, but train their students in the application of it. Just

here I would take the opportunity of referring the men of the First Year to Principal Galbraith's address at the Banquet last Christmas. The subject was, "The Function of the School of Applied Science in the Education of the Engineer." The subject is very thoroughly dealt with, and is especially adapted to us as students.

We in our technical training should aim at laying a broad foundation, rather than at specializing along some chosen line. Circumstances in most cases determine our specialization in after life. In fact, it is said by men of authority that a young man thoroughly grounded in fundamental principles and well trained how to apply them, has almost an equal chance for success in all branches of engineering. As a proof of the fact we only need look up the records of our own graduates.

What does the Engineering Society offer to the prospective engineer? I shall not enlarge very much on this, but refer you again to the addresses of our former presidents. With regard to papers, I would say, do not wait to be asked, but set to work and prepare one to be read before the Society during the coming year. The mere act of preparing a paper is a valuable discipline to the writer. Nothing serves so well in systematizing one's ideas, clearing up doubts and exposing deficiencies on a subject, as the compiling of a paper. The benefits which you receive from the Society, will probably depend on the amount of energy you invest in it. If you are simply looking to your own interests, without regard to the interests of others, probably neither will profit much by your presence. Let each member, without thought of year distinctions, feel that his part is necessary in order to make up the finished whole.

In conclusion, what are our professional prospects? In looking about Canada to-day one would say that the prospects never were brighter. Of course times are good, and one cannot tell how long they will continue. Engineering probably is the first profession to feel a depression, as great works are not usually undertaken when the country is suffering from hard times.

However, the immense developments in every kind of industry have created a great demand for competent and trained engineers. Capitalists are beginning to see the necessity of entrusting their great works in the hands of trained men. Let us all strive to come up to the standards required, and thereby render ourselves indispensable as well as honouring to our profession.

## OUR TIMBER SUPPLY.

J. A. DECEW, '96.

The cost of material is generally the factor of prime importance in engineering construction, and the relative amount of each material used depends to a large extent upon its value, as well as upon its suitability for the purpose in hand. A structure which now contains certain proportions of wood, steel and concrete, might have contained these materials in quite different proportions had their respective values been differently related at the time. Therefore, if the cost of our timbers for construction and other purposes keeps steadily on the increase in the future as it has in the past, and if the price of iron, steel and concrete should remain comparatively constant, then the tendency of the future will be to abandon the use of wood as a constructive material, in proportion as its increased cost stimulates the employment of substitutes. What the ultimate result will be is hard to predict, as there are many variable influences to be considered. One thing, however, is quite certain, and that is, if we continue our present rate of consumption, the price of our timber must go on steadily increasing until its stumpage value becomes equivalent to the cost of reproduction.

If a species of timber should become exhausted before the equilibrium between consumption and reproduction is established, or if the demand for it should exceed the capacity of reproduction, then it is certain to become quite expensive and will only be employed for those purposes to which it is peculiarly adapted.

The cost of our timbers in the market may be expressed directly in terms of the cost of labour, supplies, stumpage and the distance between the market and stump. Therefore as we are rapidly consuming the present stand, which we might call our capital stock, the steady increase of the last two factors is sufficiently evident, and with these factors the price to the consumer must also advance.

As an example of a timber which will be commercially exhausted long before any adequate reproduction can take place, we might select the white pine. This is without question our most important and highly prized timber product, on account of its combination of qualities, which adapt it to an almost unlimited number of uses. The white pine is at home in commercial quantities, over an area of about 400,000 square miles, over which the original stand is estimated to have been about 700,000,000,000 feet, board measure. All that remains to us of this inheritance is about 110 billion feet, of which the Lake States (Michigan, Wisconsin and Minnesota) possess 64 billion and Canada about 40 billion. The annual cut in the Lake States is about 6 billion feet, and in Canada from  $1\frac{1}{2}$  to 2 billion feet, so that our total annual consumption is about  $7\frac{1}{2}$  to 8 billion feet. If this rate continues it is quite evident that all of our present stand of pine will be consumed in about 15 years. It is interesting to note in this connection that while the pine manufacturers of Canada have still from 20 to 25 years of stock in sight, the American mills can manufacture all of their remaining white pine in less than 10 years. Nearly all of the white pine is so located that the present rate of exploitation can be and probably will be continued until 75 per cent. of the present supply is cut, when, of course, the lack of logs will lead to a reduction in output. This curtailed output will begin on the American side in a very few years, and then the white pine will gradually cease to be the great staple of our lumber markets. This result is unavoidable, for if recuperative measures were immediately adopted, it would take 100 years to grow a pine tree, with an average diameter inside the bark of 15 inches, and to reproduce forests like those we are now consuming would take about 200 years.

It is erroneous to suppose that other conifers or hard woods may be substituted for or easily adapted to the uses of white pine, which is shown by a comparison with its most natural substitute, the southern pine. A shipping case, made of white pine, requires but half the effort to manufacture, and .5 to .65 the effort to handle or transport, as one made from hard pine, and as for lath, the white pine nails easier and shrinks less. For sash and doors the only satisfactory substitutes are cypress and white cedar, and these are not any too abundant themselves. Although from the scarcity of good

pine  
Pacif  
to fro  
relati  
nut,  
well  
and  
inter  
foun  
years  
ever  
suppl  
the m  
that  
cann  
obtai  
or fe  
trees  
our r  
const  
to ob  
coast  
haust  
cordv  
cubic  
acres  
estim  
35 cu  
if all  
harve  
state  
and a  
one t

pine shingles, we are already using red cedar shingles from the Pacific coast, yet prices must reach a high mark before we can afford to freight lumber such a distance.

It is not only the white pine of which we might say, speaking relatively, that the end is in sight, for the same is true of the walnut, yellow poplar, ash and elm. As the elm and ash are particularly well adapted for the making of barrels, on account of their strength and toughness, the question of paramount importance to all those interested in cooperage stock is, what satisfactory substitute can be found for these fast disappearing woods?

In spite of the fact that there has been a great increase of late years in engineering construction, there has been no increase whatever in our annual consumption of timber. Nevertheless since the supply is decreasing faster than the demand, we shall be forced in the near future to pay still higher prices for those wooden materials that we actually require. It is just this class of timber which we cannot well do without, that we shall find in future very hard to obtain. For although it does not take very long to grow railway ties or fence posts, we shall find it a very different matter to reproduce trees similar to those from which we obtain the wide clear lumber of our markets to-day.

Hemlock may make a fairly good substitute for pine in rough construction, but not for interior work.

Perhaps when the Isthmian Canal is completed, we shall be able to obtain our finest grades of lumber and shingles from the Pacific coast, but even that rich source of supply may in time become exhausted. The annual consumption of timbers, ties, fence rails, cordwood, etc., in the United States amounts to about 25 billion cubic feet. Their total forest area amounts to about 500 million acres, and on each acre it is possible to grow, according to German estimates, 55 cubic feet per annum, but of this growth only about 35 cubic feet is available to the American lumberman. Therefore, if all their forest area were well planted and managed, the annual harvest would not equal the annual consumption. But this possible state of reproductive efficiency is as yet but a dream of the future, and as our present stand is fast disappearing, it is the duty of everyone to conserve as much as possible the present supply. This can

be accomplished only by scientific lumbering, efficient fire protection, a more extended use of wood preservatives and an increased economy, along with the gradual substitution of other materials in construction.

Our wood consumption per capita, outside of fire-wood, is 8 to 10 times that of Germany, and 18 to 20 times that of Great Britain, for we rely more upon wooden structures than they do and are more wasteful in construction.

These facts go to show that we have yet plenty of opportunity to restrict the demand in proportion as the supply decreases, and in this way avoid future scarcity and excessive prices. However, not the engineer alone, but the community as a whole, has a direct interest in the perpetuity and conservative use of our forest resources, as well as in the preservation of favourable forest conditions, both in behalf of the agricultural interests of the country and on account of the resulting beneficial climatic effects.

Socie  
that  
prisin

addre  
too m  
at m

sourc  
write  
stand  
perm  
gener  
syste  
crop  
fores  
nor  
denu

finan  
of fa  
when  
the f  
natur  
and  
secur  
econ

work

## FORESTRY AND ENGINEERING.

THOS. SOUTHWORTH.

My pleasure at being allowed again to read a paper before your Society is somewhat alloyed by the difficulty in presenting matter that will be new or interesting to the critical scientific minds comprising your membership.

Of course Mr. Barrett intimated that I would be expected to address you on forestry, but that is a large subject and presents too many phases to be treated as a whole, even hastily, in the time at my disposal.

In view of the number of letters I have received from various sources giving me advice on the subject of forestry in Ontario, the writers of which seem to regard the subject from such a different standpoint from my own, it has occurred to me that I might be permitted to define the term forestry as I understand it, speaking generally as applied to this Province. Forestry is primarily a system of farming with trees as the principal crop—I say principal crop advisedly—for they do not constitute the only crop in the forest. Forestry is not the mere preservation or protection of trees, nor the planting of trees where the country has been too much denuded, as it is quite often intimated

In farming with trees as the main crop, it is essential that the financial aspect should be had in view just the same as in other lines of farming. The farmer who raises wheat does so for profit, and when he harvests one crop he prepares for another. Just so with the forester, with the difference, in this country at least, that nature has started him with a grown crop ready to be harvested, and it is business with him so to harvest this original crop as to secure the largest financial returns from it consistent with the economical but effective reproduction of similar crops.

In Ontario we have to do with two main phases of forestry work, the one as it applies to the individual owner of woodlands,



the farm wood lot, and the other relating to the larger problem of the forest farm of the whole people on the Crown lands.

Both are important, both affect the general welfare of the Province.

The farmers of old Ontario, in clearing land to grow other and more valuable crops than trees, have removed the forest cover so completely as to seriously affect adversely the fertility of the land in some sections, and, through the drying up of our water sources, increasing the evaporation of moisture from the soil, and in other ways to seriously alter climatic conditions for the worse. At the same time, while the community in general suffers to some extent from this cause, the chief sufferer is the individual farmer himself. I will confine myself at present to a consideration of the larger and more important problem of forestry on the lands of the Crown.

By far the greater portion of the Province of Ontario is still tree covered. The land area of the Province is estimated at about 126 million acres. Of this less than 25 millions of acres are sufficiently settled to be under some form of municipal government. The balance, over 100 millions of acres, may be said to be tree covered. Of this immense area probably another 40 million acres is well suited for agricultural settlement, the rest being broken and chiefly valuable for mining and forest lands. The remaining 60 millions of acres is more or less tree covered and is all capable of growing trees. Mining development is now being prosecuted in several points in this area, and there will be many small villages and towns with the necessary agricultural settlement around them, but we may safely assume that this area will, or rather let me say should, remain permanently in forest—a vast forest farm the property of the whole people. Of the sixty millions of acres remaining, the greater part is still covered with its natural forest crop yet to be harvested; and from this will be seen the vastness of our resources in this line, and the desirability of solving the question of exploitation in the wisest way.

As I have said, forestry, or the growing and harvesting of trees for profit, is mainly a financial proposition, but there are certain other incidental advantages derived from the presence of trees in larger masses, in their effect on climate, water supply, and in other ways, such as to render it advisable that in some cases the mere

financial aspect should be subordinate. These incidental advantages concern the general public rather than the individual, and in the case of the individual holder of woodland, he cannot be expected to sacrifice his personal financial interests for the general good. For this and other reasons, it is wise that forestry on a large scale should be conducted by the State. A private holder might, under pressure of pressing financial need, realize on his forest wealth in a way inimical to the general welfare and disastrous to the industries dependent upon forest products. The State, on the other hand, is free from this danger, and is in position to disregard immediate profits where a close regard for them would adversely affect the general good in other ways. At the same time it is possible to retain these incidental advantages without sacrificing the purely financial results, and it is in this direction that the services of the skilled forester, the trained and scientific observer, will be required.

No formulated system of forestry, no matter how scientific it may be, will serve in this Province unless it is based on observation and practice under our own conditions. We have to solve our problems in our own way.

France and Germany and other European countries have elaborate scientific forestry systems that are well nigh perfect in their way, and for the countries in which they have been developed. They are the result of years of investigation and practice by scientific men; yet their systems are of little use to us except as forming a basis from which to study our own needs.

In our country, where only a third to a half of a small proportion of the more valuable varieties of trees have a market value, we could not afford to establish nurseries and transplant trees on a large scale, as is done in some parts of Europe, where the limbs, roots and even the leaves of the trees are marketable.

The cost of preparing the ground, planting the young trees, plus the cost of protection and care of the forests for 50 to 100 years, plus also the interest on the capital invested during that long period would, I fear, show a balance on the wrong side of the ledger when the crop was harvested. It is true conditions will be changed in this country before a crop planted now will be ready for harvest, but not sufficiently so as to make a financial success of tree planting by the State in a large scale.

However, if we have not much cash, we have plenty of time and plenty of land. A forest will inevitably reproduce itself if allowed to do so, and it is the business of the forester to assist Nature in securing a new crop in the shortest time and composed of the most valuable commercial varieties of trees.

Nature is sometimes slow in her methods and does not always accomplish the work in hand as we would have it done; yet in the reproduction of forests in Ontario, she is apt to reproduce a forest of the highest economic value. The most valuable tree from a commercial point of view in our original forests was the white pine, (*Pinus Strobus*), and in nearly all cases the forest planted by Nature after the original one has been cleared away by the axe of the lumberman and by fire, is largely composed of that tree. It is true that after a forest fire the first succeeding crop of trees is composed largely of poplar and birch, trees that seed yearly, and whose seeds are light winged and are carried miles by the wind; but these broad-leaved trees form the proper condition of shade, and fit the soil for the growth of the young pines that grow up under their protection, in all cases where any pine trees old enough to bear seed have been left in the neighborhood. The young pine plant is very delicate, and liable to extinction in the first few days of its growth, if exposed to the direct rays of the sun. Hence you will see that the presence of the forest weeds, the poplars and birches is necessary as a nursery for the more valuable sorts; and Nature is doing her work well in spite of, nay, in some cases, assisted by fire. That we can assist Nature and hasten the growth of the profitable forest is undoubted, and to apply the trained skill necessary for this object we require educated foresters.

Our forests, besides returning a direct annual revenue to the Province of over a million dollars, support, next to agriculture, by far our largest industry. Though not so attractive as mining, it has produced more wealth in Ontario than mining is likely to do for some time, and upon its continuance depends largely our prosperity. It is not too much to expect that in the not distant future, the best trained men from our scientific schools will find employment in managing the forest industries of the Province. We have no School of Forestry in Canada, though some three or four have been started in the United States. What we need is practical men whose scientific training has taught them how to observe.

It is largely a matter of observing, of finding out the "why" of things. A couple of years ago, in travelling through a pine forest with the superintendent of one of our large lumber firms, I picked up a considerable number of cones to see if there were any seeds left in them after they had fallen from the trees. Upon remarking that I had about concluded that the scales of the cone opened and the seeds dropped out before the cone fell off the tree, my companion remarked:—"Do you mean to say that there were seeds in them things? I have seen plenty of them lying on the ground for years, but never knew what they were." Now I cannot imagine a student of the S. P. S. walking over pine cones for 20 years, as this man had done, without having curiosity enough to find out what they were.

As an instance of the benefit of a scientific training, no matter to what branch of engineering the problem which confronts a man may belong, I may state that I have been assisted recently by a graduate of this School in trying to solve one of the problems that we have to face. A lumberman whose forest contained considerable quantities of hemlock (*Abies Canadensis*) was unable to harvest it profitably. There was no local market for hemlock bark, and this inability to sell the bark removed the profit there should otherwise have been in cutting the timber. I happened to know that Mr. J. A. DeCew, a graduate of the S. P. S., had been investigating the chemistry of woods, and I appealed to him in the matter. I have now in my office a very valuable paper prepared by him on the process of preparing extract of hemlock bark, or liquid tannin, and if moderate sized portable plants can be secured at a suitable price, hemlock lumber may be produced profitably in these limits, as is the case in similar forests near railways or near tanneries.

I mention this merely to show that the problems in forestry practice are either financial or scientific, or, correctly speaking, both. A college training, as I understand it, does not make a man a competent surveyor or engineer, but equips him so that he may become one. He may not have the expert knowledge required, but he knows, or should know, how to acquire it. He has been trained to apply his powers of observation, his "horse-sense," to the various scientific problems as they arise in actual practice.

Another problem in Ontario forestry, largely of an engineering nature, is presented in connection with the Temagami Forest Reserve. This reserve, comprising 1,400,000 acres of virgin forest land, contains a very large quantity of standing timber, some of which is mature and ready to cut. The territory is drained partly into the Ottawa River and partly through the Temagami and Sturgeon Rivers into Lake Nipissing, and thence to Georgian Bay. The height of land separating the two drainage basins is very narrow.

Before beginning to remove the mature timber from this Reserve, it will be necessary to know whether it would be practicable or profitable to connect the two systems of waterways. We will also require a more or less complete topographical map of the Reserve; will need to find out what improvements will be necessary to the various streams to enable the logs to reach the market, as well as to lay down and construct roads in the bush for hauling logs to the water. There are other problems of a purely silvicultural nature, such as ascertaining the rate of growth and present age of the trees to be cut, in order that the cutting may be properly executed, problems to be solved by the expert forester; but many of the problems are of a purely engineering nature.

I have been frequently asked if I thought there was likely to be a chance of employment for scientific foresters in Ontario. I quite unhesitatingly say I do think so, not by the Government alone, but by lumbermen as well, for it will not be long before they will see, as the large forest owners of the United States already recognize, that scientifically trained men, who also have common sense, are better than men with common sense alone.

In this connection I have referred to some of the problems in Ontario to be solved, to show you that the training given in the School of Practical Science is quite in the line required for the special work when the proper time arrives. True, you will need special work in botany and practical forestry, but the instructions you are receiving in civil engineering, as I understand it, are such as you need for the forestry profession. Therefore, let me urge you when engaged in surveying, or in other branches of engineering, to observe conditions in the forest, in saw milling, in lumbering, and in all that pertains to this great industry. The knowledge you thus acquire will be useful, and you do not know how soon you may be called upon to put it to practical use.

their  
mas  
for n  
acter  
alrea  
pract  
collic  
and  
steel  
tend  
man  
mine  
come  
non-  
may  
call a  
which

used  
apart  
sheet  
twice  
maint  
for n  
7  
groun

\* 1

## THE USE OF IRON AND STEEL IN MINES.

D. L. H. FORBES, '02.

The increasing scarcity and cost of large timbers, together with their rapid deterioration in the air of most mines, are bringing masonry, iron and steel more and more into prominence as materials for mine structures which are intended to be of a permanent character. The use of iron and steel as substitutes for timber has already had a place for a considerable time in continental mining practice. They have also been employed in many English mines and collieries. In American mines, however, owing to the abundance and relative cheapness of timber in most mining camps, iron and steel have had but a limited use up to the present. But there is a tendency, even on this continent, to restrict the use of timber for many purposes in mining. This is partly due to the disastrous mine fires which often occur, and which cause mine managers to come to the conclusion that the extra cost involved in the use of non-combustible materials for lining permanent ways in large mines may frequently be justified. It will be the object of this paper to call attention to some typical constructions employing iron or steel which have been tried in mines and have been found satisfactory.

### SHAFTS.

In lining shafts, rings of I-beams or channel-bars have been used extensively as curbs. They are upheld at the proper distances apart by struts of wood or iron, and backed by heavy planks or iron sheeting. The initial cost of iron lining in place is estimated to be twice that of wood and equal to that of masonry, but the cost of maintenance is only one-third that for wood and about the same as for masonry in dry shafts.\*

The most successful methods of sinking shafts in running ground all employ iron tubing. The ordinary methods, as well as

\* Ihlseng, "Manual of Mining," p. 337.

those of Triger, Haase, Kind and Chaudron, are described fully in the textbooks on mining, so that to mention them in connection with this subject will be sufficient.

Steel has recently been used in the form of expanded metal in lining the shaft of a Pennsylvania coal mine.\* The No. 2 shaft of the Manville mine at Scranton had been lined with a double wood cribbing with clay between the cribs. Quicksand and water had caused this work to fail, and the management put in its place slabs of concrete 18 inches thick, reinforced by expanded metal. This construction is said to be satisfactory in keeping back the quicksand and water.

#### TUNNELS, DRIFTS, ETC.

In linings for tunnels, iron and steel have been used quite extensively in Europe, and various forms of construction are employed.

In the Halkyn Drainage Tunnel, Flintshire, where the sides are firm, but the roof weak, frames are employed consisting of two hollow cast-iron cylinders as posts with a 50-lb. rail strung across their tops. The head of the rail is placed downwards and rests in grooved chairs which fit into the tops of the cylinders. These frames are placed about three feet apart and planks or light rails are laid from one to the other. The space between them and the roof is tightly packed with stones. A dry stone wall is built upon each side with an occasional plank or rail to make it firmer. It was estimated that to have secured this part of the tunnel with good masonry would have cost nearly twice as much as this method, using iron, the cost of which was \$10.75 (£2 4s.) per linear yard of tunnel.†

In France, special forms of I-steel are manufactured for frames in tunnels, levels, etc. A favourite form consists of two side pieces suitably bent at the top and united by fish-plates and bolts so as to form a shape like an inverted U. Another French frame much in use is composed of two semicircles of mild steel. For this, two kinds of sections are employed,—channel steel, and bulb tee steel.

\* "The Doings of Expanded Metal," December, 1901, published by the Associated Expanded Metal Companies.

† C. Le Neve Foster, "Ore and Stone Mining," p. 259.

The channel steel used weighs about 16 lbs. to the yard. It is sawn into proper lengths on leaving the rolls and bent into semicircles while still hot. The two pieces are joined by sleeves of sheet steel fastened by a couple of iron wedges. Steel of the bulb tee section weighing about 26 lbs. per yard is employed for heavier ground.

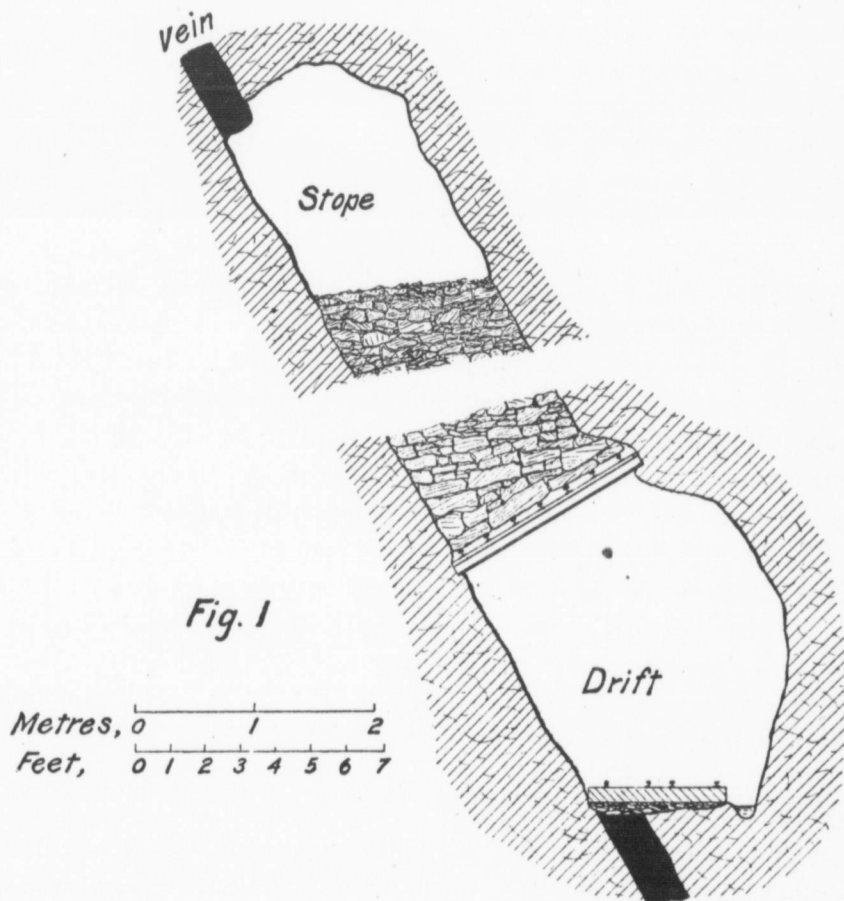

While in Saxony last year, the writer was much impressed by the extensive use to which old rails are put in the silver-lead mines of the Freiberg district. Here it is claimed that, although iron costs about the same as masonry and will not last so long, yet, in setting up, the iron takes much less time and when completed occupies less space than masonry; while, in all probability, the iron will stand for



several generations.\* In the Rothshönberg tunnel two rails are bent so as to form an elliptical shape, and united at top and bottom by fish plates and bolts. Behind these frames light mine rails are strung and flat pieces of rock packed in tightly all around. At other places in the district rails are used as posts and caps. The head of the rail used as cap is let into the upper ends of the upright rails. The feet of the uprights rest directly on the floor of the tunnel. Where the sides are firm and only the roof needs support, as in drifts where overhand stoping is employed, rails are placed across with their ends resting in hitches cut into the wall-rock, thus forming stulls to support the waste material heaped above. The rails used for this purpose are of varying size and cross-section, depending upon the load they have to support. Light mine rails are strung across these rails and spaced 6 to 8 inches apart, with flat pieces of rock laid on top to form the staging on which the miners stand and pile up the waste after each blast. (See Fig. 1.) In some of the Freiberg mines the rails are given a slight bend upwards so as to bring the principle of the arch into play. Where this is done, it is usual to give a bend of about 5 cm. in 100 cm. of length. It is claimed that the strength is increased by doing this, so that much lighter rails may be used than if they were straight under the same load. In places where the mine waters are acid, the use of iron for supports should be avoided. At several places in the upper levels of the Himmelfahrt mine at Freiberg, the rails have to be replaced frequently on account of the rapid corrosion caused by such mine water. Even coating the rails with tar is said to have but little effect in delaying the corrosion.

#### GANGWAYS, ETC., IN COAL MINES.

Steel I-beams have been used with success for some years at the Nunnery Colliery, Sheffield. The usual size is 4 inches wide, 5 inches deep, with 3-8 in. web. They are used either as caps on timber posts (see Fig. 2) or as posts and caps. In both cases the beam used for the cap has a lug or band of wrought iron, 1 in. x 3-4 in., shrunk on about a foot from each end. This prevents the posts from coming in sideways. Such frames or sets are placed 3

\* "Freiberg Berg-und Hüttenwesen," pp. 176-183.

feet apart, and old timber is placed across from cap to cap, supporting the roof. The steel beams are tarred over with unboiled gas tar, and have been in use several years without showing any signs of deterioration; while timber at the same colliery lasts only two years on an average.\*

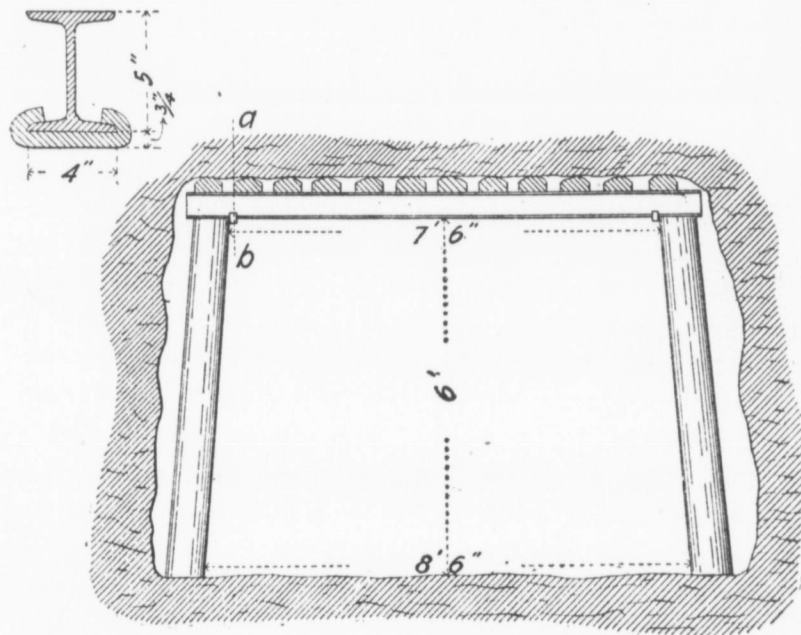
*Section ab.**Fig. 2*

Scale — 0 1 2 3 4 5 ft.

In another English colliery I-beams are similarly employed. As an experiment in this colliery, lengths of roads were timbered alternately with wood and steel (timber being used for props in both cases.) But, before definite results could be obtained, the district fired was dammed off and abandoned. After a lapse of 9 months, the roads were re-opened, and it was found that the steel bars had

\* C. Le Neve Foster, "Ore and Stone Mining," p. 261.

suffered scarcely, at all, only a few being displaced owing to their timber supports breaking. But, at places where timber caps had been set, the roof had fallen in, and considerable expense in wages was involved in repairing it. On a main haulage road in this same colliery 12-ft. girders of a section 6 in. x  $4\frac{1}{2}$  in. with  $\frac{1}{2}$ -in. web, weighing 78 lbs. to the yard, were employed, replacing 9-in. timber bars. The first cost of the steel here was  $2\frac{1}{3}$  times that of wood. The date of fixing each girder was noted, and in many instances the girders outlasted 3 to 4 sets of timber before removal; so that, even if the steel bars were worthless on removal, their actual cost would have been less than for timber. But, after being taken out, they had merely to be straightened and then were practically as good as new.\*

Cast iron cylinders are being used in place of timber posts in many English collieries. It has been said, however, that they are liable to break if any great side pressure comes on them. The Balmer prop is a modification which consists of two cast iron cylinders, of which the lower is filled with loose packing, and the upper telescopes into it as far as the packing will permit. Holes in the side of the lower cylinder allow some of the packing to be removed, so that the prop can shorten itself.†

For withstanding very great pressures coming from floor and sides as well as roof, two forms of construction which were observed by the writer in the Oberhohndorf colliery at Zwickau, Saxony, have been in use for several years. One of these is a tubular form, the frames being rings composed of two semicircles of channel steel joined by fish plates bolted on the outsides of the flanges (Fig. 3). The rings are  $2\frac{1}{2}$  metres in outside diameter, and are placed 1 metre apart, centre to centre, each being held in position by three tie-rods or dogs joining it to the preceding ring. These tie-rods are made from mine rails cut to proper lengths and turned over at the ends. The gangway to be lined with this construction has first to be enlarged until its cross-section is about 14 feet square, the roof and sides being held temporarily by timber props and logging. The excavation is carried about 20 feet in advance of the work of lining. The floor is first covered with concrete up to a certain level. A

\* Hughes, "Textbook of Coal Mining," p. 137.

† Journal of Iron and Steel Inst., 1900, II, p. 472.

Fig. 3

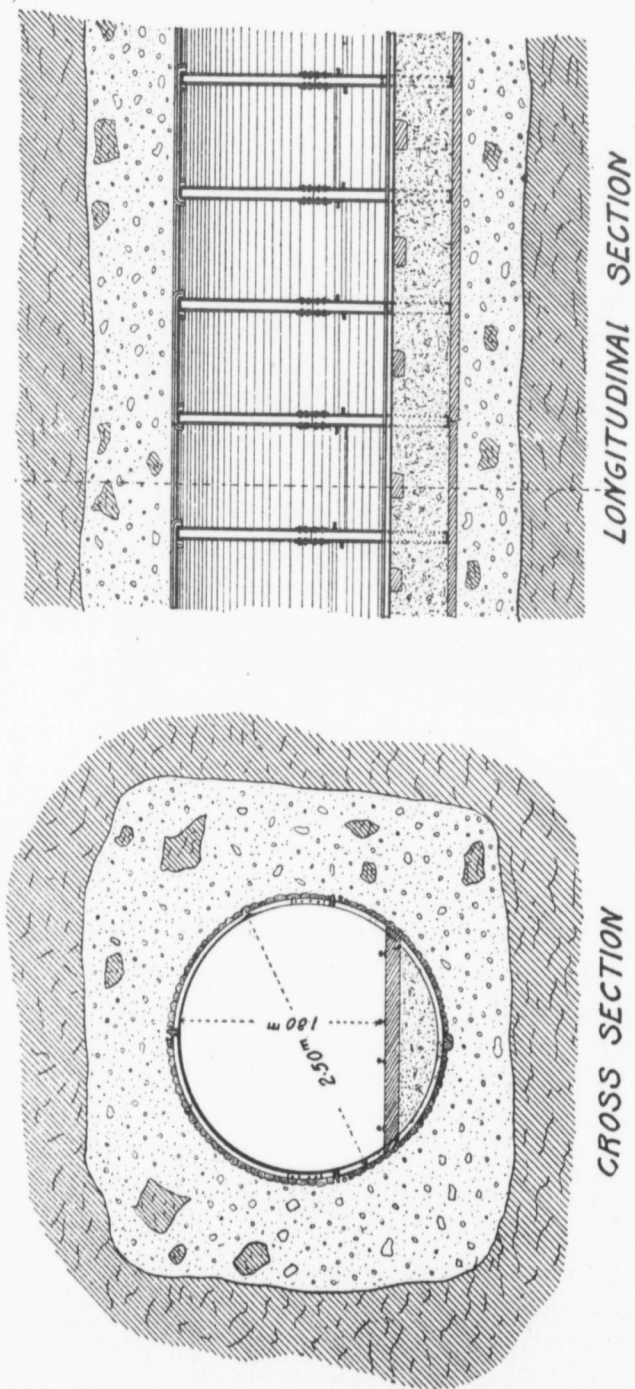

CROSS SECTION

LONGITUDINAL SECTION

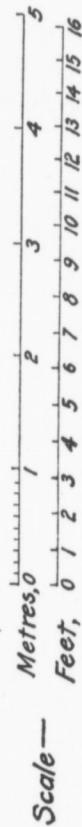

timber sleeper 4 metres long is then laid on the concrete, given its proper leveling and alingment, and then firmly embedded with more concrete. Four of the channel steel rings are then set up and held temporarily by timber props and wedges. Timber slabs from 2 to 3 inches thick and 2 metres long are then placed in position on the outside of the rings, and concrete rammed in firmly all around. Temporary timber supports, which interfere with the work as it is built up, are cut away, leaving the lower parts imbedded in the concrete. When the concrete filling is about two-thirds of the height of the excavation it has to be continued in sections of one metre, the end face of the section being held with boards until it has reached the roof and has set. In a double-tracked gangway this work may go on without seriously disturbing its traffic, by keeping one track constantly supported and having a switch at each end of the place of construction, so that both in and out going trams may use it. The other track is used for hauling concrete to the work. Six men are required—two miners, two masons, and two shovellers. Working two ten-hour shifts per day, a section 4 metres in length is completed in six days. The total cost is about \$50 per metre length of gangway. For single-tracked gangways a construction differing only in the employment of elliptical channel frames is used, but where the side pressure is very great, these frames have occasionally been crushed in at the joints.

The other form of iron construction used in the Oberhohndorf colliery is shown by the sketches in Fig. 4. Cross-rails used as sills are imbedded in a concrete foundation, and side walls resting on them are built up to a height of about  $1\frac{1}{2}$  metres above the floor of the gangway with a thickness of 1 metre. These side walls are constructed of layers of rail lengths laid crosswise and lengthwise alternately. Tie-rods prevent the rails from spreading, and concrete is packed in between and behind them. The roof is formed by lengths of rails, bent slightly at the middle, which arch against an I-beam at the top of the gangway and spring from a rail and angle-iron laid along the tops of the sidewalls. In between the webs of these roof-rails common sized bricks are placed. Concrete is rammed in tightly above the bent rails and the side walls. This construction was first put in about 16 years ago after a fire had caused the collapse of some of the main haulage ways and had necessitated the closing of one of the

Fig. 4

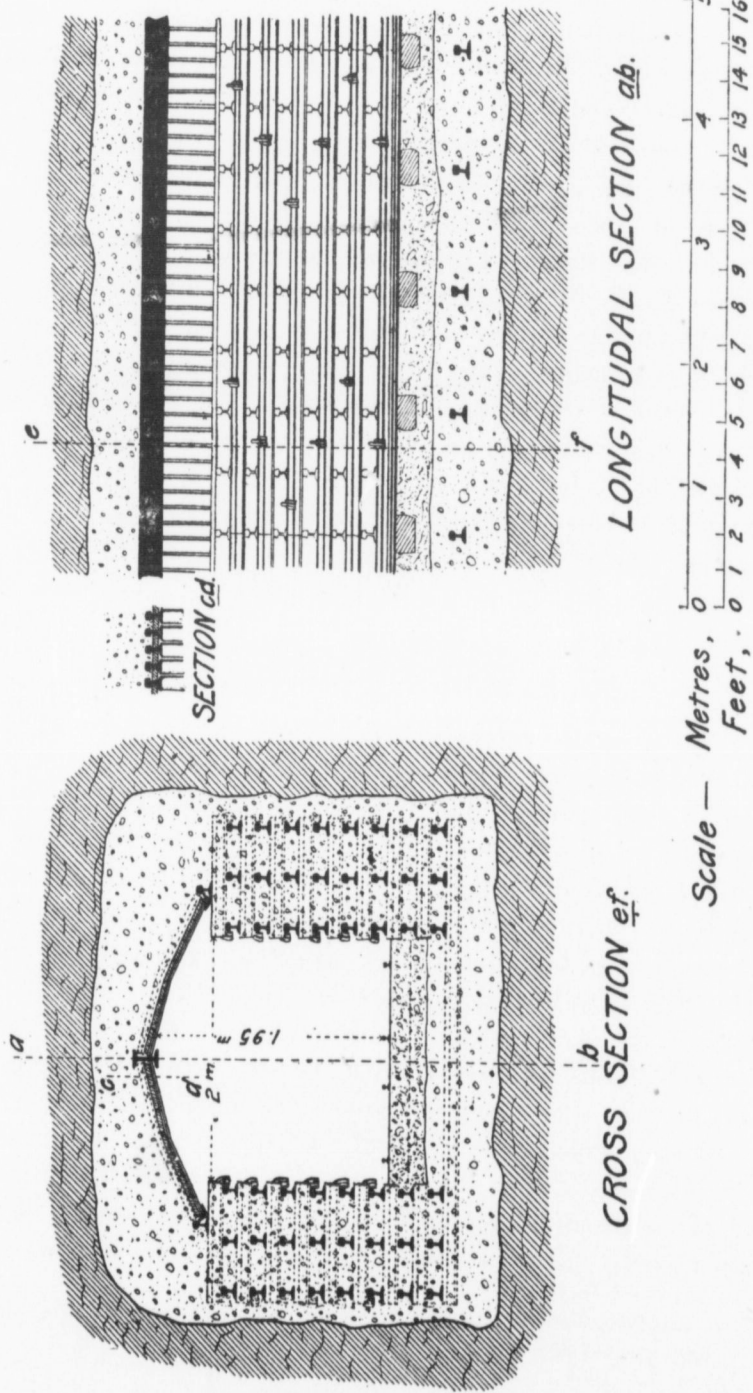

shafts for several months. The work of this kind which was then constructed is still apparently as firm as ever. Only the main gangways are supported in this way, and they only for a hundred metres or so from the shaft, on account of the expense, the cost being about \$85 per metre.

At the Spring Valley coal mines, in Illinois, a new shaft had to be sunk in 1896, on account of a fire which had caused considerable damage. When the gangways and sidings were being constructed at the new shaft, the manager was particularly anxious to use as little timber or other combustible material as possible. The side walls were built of masonry and 15-in. I-beams, weighing 50 lbs. per foot, were placed 4 feet apart to support the roof. These I-beams rested on heavy cap stones in the tops of the walls. The width of the gangway is 14 feet, and its height 7 feet, from top of tracks to bottom of I-beams. The covering of the I-beams is composed of 3-in. oak planks.\*

A similar use of steel girders is made in some of the Pennsylvania coal mines.

#### ADVANTAGES IN THE USE OF IRON OR STEEL.

The great advantage of steel beams over timber ones is in the matter of durability, which means a reduction in the cost of repairs. Besides this, however, there is the possibility of using the beams elsewhere when taken out. When only slightly bent they can be reversed and used over again. If badly bent they can be straightened or sent to the steel works to be worked over. In any case the steel has some value, but timber after failure is crushed and splintered so badly that it is worthless. Another advantage in the use of steel beams is the increased space for ventilation, due to the small size of steel beams compared with timber ones. Decaying timber takes fire very easily, and is moreover an important factor in causing the air of a mine to become foul. Finally, in setting up almost any form of steel or iron construction, the parts can be put together and the structure completed in less time and with less labour than masonry, or even timber used for the same purpose.

\* "Improvements at the Spring Valley Mines," *Trans. Am. Inst. M. E.*, vol. xxix, 1900, pp. 187-209.

## BACTERIAL METHOD OF SEWAGE DISPOSAL.

CHARLES H. RUST, C.E., M. CAN. SOC. C. E.

The following short account of the biological or bacterial method of sewage disposal has been prepared by the writer with the hope that it may be of some interest to the members of your Society.

It is only within the past five or six years that the bacterial method of disposal has been brought prominently before the public, but there is now a large number of small towns in England that have adopted it, and some of the largest cities have been experimenting, with a view of doing so, while in America at the present time several towns have installed sewage works upon the bacterial system.

The following short extract will explain clearly what bacteria are:—"Bacteria are minute forms of vegetable life, whose existence was not even suspected until late in the seventeenth century. They are so small that it requires the most powerful microscope to make them visible at all. There are other low forms of life which bear a part with them. They may be divided into two classes, the anaerobic and the aerobic. The anaerobic live without air, that is, without free oxygen, the aerobic existing with free oxygen. Exposure to air kills the anaerobes, and all bacteria are destroyed if allowed to remain too long in contact with their own products. In the absence of water, or at least moisture, they are unable to multiply and remain dormant. The work bacteria do in the purification of sewage is to oxidize the foul matters of which it is partly composed. To effect a thorough purification three separate processes are needed, viz. (first) anaerobic, (second) partly anaerobic and partly aerobic, (third) aerobic."

The subject may be discussed under two heads, first, the so-called septic tank; second, the contact or bacteria beds; and under this heading comes land treatment, either by broad irrigation or by intermittent downward filtration.



The septic tank consists of a tank or series of tanks, and was first introduced by Mr. Cameron, City Surveyor of Exeter, in 1895, when a small experimental one was installed to dispose of the sewage of Belle Isle, Exeter. These tanks when first introduced were covered, but now this is not considered absolutely necessary, although the writer is of the opinion that in this country, on account of the climate, it would be more satisfactory during the winter months to have some form of cover. This system altogether changed the old methods of treating sewage, when all suspended solids were thrown down by means of chemicals. In a septic tank the solids are liquefied by means of anaerobic bacteria. "It used to be considered necessary to prevent decomposition, but in the septic tank the object is to promote it. It was also considered necessary to exterminate all the bacteria. Now they are cultivated."

The action that takes place in the tank is a process of removing most of the suspended organic matter, some which is in solution, giving an effluent, which, although not chemically pure, is inoffensive, and in some cases pure enough to be turned into large streams or bodies of water without creating a nuisance. This is all brought about by the action of anaerobic bacteria, which are different from those which act in the contact beds, and in land treatment. They thrive in the absence of oxygen and are the organisms which cause putrefaction.

Instead of filling and emptying the tank alternately, as is done in the chemical process of precipitation, the sewage runs continuously through it, the motion being so slow that the contents are practically at rest. This affords an opportunity for the separation of the solid matter, the heavier substances falling to the bottom while the lighter ones rise to the surface. This results in a thick scum forming on the top of the liquid. Bacteria are thus afforded conditions very favourable to their growth. The bottom of the tank is covered with a deposit largely mineral, but is very small compared with the amount of solid matter that comes in with the sewage. It is necessary, especially where the combined system is in use, before putting the sewage into the tanks, to pass it through grit chambers, which should be cleaned out at frequent intervals, and it would be advisable also to have screens in front of these chambers, for the purpose of intercepting bits of wood, rags, etc. These chambers

shoul  
Havin  
will b  
the t

T  
the c  
to pro  
one-h  
much  
day's  
under  
Manch  
one-h

A  
the sep  
in the  
up to  
flow sh  
done s  
mence

TI  
precipi  
of slud  
sludge  
ent for  
effluent

At  
been in  
the wo  
questio  
tank w  
but in  
sewage  
obtain  
for the  
will be  
months  
decomp

should be frequently cleaned out and the sludge burnt, if possible. Having first removed these insoluble substances from the sewage, it will be much easier to obtain a higher percentage of destruction in the tanks.

The capacity of the tanks will vary somewhat, depending upon the condition of the sewage. In England it has been the practice to provide a capacity in the tanks equal to three-quarters to one and one-half day's supply of sewage. In this country, owing to the much weaker nature of the sewage, one-half to three-quarters of a day's supply will probably prove sufficient, although the writer understands from the result of the recent experiments made at Manchester that a system of septic tanks having a capacity equal to one-half the daily flow of sewage will be ample.

After the sewage passes through the grit chambers, it flows into the septic tank, where it is acted upon by the bacteria. It is found in the septic tank that the action begins slowly and gradually rises up to the maximum. It is, therefore, important that the ultimate flow should not be passed through the tanks at first. If this were done sludge would rapidly accumulate before septic action commenced.

The great advantage of the septic tank over the old system of precipitation by chemical means is the large reduction in the amount of sludge produced. Not only does a reduction in the amount of sludge take place, but the tank is of great use in obtaining an effluent for after treatment on contact beds, and it also produces an effluent readily capable of nitrification.

At Exeter, where there is a small experimental tank which has been in use for the past six years, enough gas is produced for lighting the works and for running a small gas engine. It is, however, questionable whether the amount of gas given off in an open septic tank would be of sufficient value to pay for the cost of collection, but in the new plant now being constructed for treating all of the sewage of Exeter, the tanks are to be covered and it is proposed to obtain a sufficient quantity of gas to illuminate and provide power for the extensive works. It is, however, not supposed that there will be a sufficient quantity of gas to do this until a period of some months has elapsed. The gas which is given off as the result of decomposition is marsh gas and free hydrogen.

This description of the septic tanks, although short, will probably explain clearly to the members of your society their working.

The contact system consists in passing the sewage into beds filled with from three feet to four feet of filtering material, usually clinkers. These beds are open and in them the sewage is acted upon by aerobic bacteria, which thrive in the presence of air and light, and the greater portion of the organic matter is removed or changed into harmless compounds. If a higher degree of purification is required, the effluent is passed from the first into another and finer bed. It is absolutely necessary, in order to secure a good effluent, to have these beds thoroughly drained and aerated, for if the water cannot get out the air cannot get in, and the lower part of the beds gradually becomes putrid. These beds are drained in some cases by ordinary drain pipes and also by agricultural drains, 3 to 2½ inches in diameter, the rows being 2 feet apart.

When this system was first introduced it was generally supposed that coke would make a satisfactory filtering material, but that has not been found to be the case, the sewage having a tendency to gradually break down the coke, and as it was necessary to use a more refractory material, clinkers were adopted. In addition to clinkers, coarse gravel or broken stone would be a satisfactory material, and the writer has heard of broken glass being used with satisfactory results. The beds in the majority of cases are constructed of either brick or concrete, although in a few instances where the soil has been suitable, they have been constructed without masonry. There is not sufficient information available at present to know definitely the lifetime of the filtering material or the annual cost of operation. In spite of all precautions it may be necessary, after a period of three or four years, to either replace the material or have it washed. Up to the present time, from the result of the experiments made in the various cities and towns in England, it has been found that the capacity of these beds has decreased 33 per cent. shortly after being installed, but have since shown no further signs of decrease. "The beds must also be worked very slowly at first in order to allow the material to settle and the bacterial growths to form. In this way there would be less danger of suspended matter finding its way into the body of the bed while the material is still loose and open." The beds become choked by reason of the settling together

and breaking down of the material, imperfect drainage, insoluble matter entering the beds, and the growth of organisms. The defective drainage decreases the actual water capacity of the beds and prevents thorough aeration, and other means should be taken, therefore, to make it as perfect as possible.

The manner of putting on the sewage to the beds is generally as follows:

Each bed is filled three times per day, the filling generally taking about three hours, while the time taken to empty is from 1½ to 2 hours, and the beds in some cases are allowed one week's rest in five, and in other cases they are given 7 hours' rest. The flow of sewage is in some cases controlled by an alternating gear and in other cases by the Adams syphon or by manual labour. "The alternating gear automatically opens and closes the various valves in their proper order and at regular intervals, and the supply and discharge valves for each pair of filters are suspended from the outside ends of two levers, which are connected to one shaft. This shaft carried a couple of rubber actuating buckets, which furnish the motive power. As soon as the filter is filled a small quantity of the liquid overflows from its discharge well into one of the actuating buckets belonging to another pair of filters." This action goes on so that each filter is in turn filled, rested full, discharged and aerated.

In addition to the treatment by the ordinary Dibden contact bed, experiments have been made with continuous filters, such as the Whittaker and Bryant, and Stoddart. The patentees for these filters claim that as much as 3,000,000 to 8,000,000 gallons of sewage per acre per day can be treated.

The following is a description of the Whittaker and Bryant filter in use at Rochdale, England, kindly furnished me by Mr. Pratt, Borough Surveyor:—

"There are two filters, each having a surface area of 200 square yards=400 square yards. The volume of sedimented sewage treated thereon is about 160,000 gallons per day of 24 hours. The sewage is continuously applied. Each filter is constructed as follows:—The foundation is of cement concrete rendered to a smooth surface and made to fall towards a channel on one side provided for the collection of the effluent. Resting on the concrete are two courses of

bricks in rows supporting 18-in. perforated half pipes, above which is the filtering material, 9 feet in depth, composed of gas coke which has had all smaller than 1½-in. taken out of it.

"In the centre of each filter is a perforated chamber or shaft of brickwork, pigeon-holed for aeration of the filtering material, on the top of which rests the mechanism for distributing the sewage. This mechanism consists of four revolving arms 1¼-in. and 1-in. iron pipes, which are perforated at varying distances and with holes of varying sizes, so as to ensure a uniform distribution of the sewage over the whole of the upper surface of the filter. The sewage dealt with is not treated at all by chemicals, but passes into an open septic tank, of capacity about 200,000 gallons, or rather more than the daily volume treated. This tank has been in continuous operation since July, 1899, and the sediment accumulated is now about 12 in. deep. From this open septic tank the effluent is syphoned into a small collecting tank of about 750 gallons capacity, placed near the filters, and from this it is pumped by a No. 5 pulsometer pump, which lifts the tank effluent and forces it to the distributors of both filters, and causes the arms to revolve at the necessary rate to ensure the uniform distribution over the upper surface of the filter. The steam used in the pulsometer passes into the sewage, and in addition to that a jet of steam is injected into the sewage (in winter) on its way to the revolving arms, in order that the temperature of the distributed sewage shall be as nearly as possible about 10 deg. F. higher than that of the sewage in the open septic tank, so as to ensure the better bacterial action of the filter.

"The effluent from the bacterial beds contains a certain amount of suspended matter, and with a view of removing this as far as possible it is passed through a settling or deposition tank of about 10,000 gallons capacity.

"The settling tank requires to be emptied twice a week, the effluent and the precipitated matter which cannot be drained away being pumped back into the open septic tank."

The results of experiments made in England with this class of filter are, I believe, fairly satisfactory, and Accrington has adopted these filters for the treatment of all the sewage, but owing to our severe winter, I do not think the continuous filter would be a success in this country. The results so far show that the maintenance of the beds and septic tank will not be costly.

The members of your Society are probably aware that it is not absolutely necessary to have the septic tank followed by after-treatment on contact beds. In places where a high degree of purity is not required, septic tanks alone will be sufficient, or, as is the case in some small towns in England, contact beds with either two or three contacts, without the septic tank, would be satisfactory, but it would be advisable to first pass the sewage through small settling tanks.

Last winter the writer had an opportunity in England of inspecting some of the sewage disposal works, and below is given a description of the method in operation in four small towns, which have adopted, with very satisfactory results, the bacterial method of sewage disposal.

#### HAMPTON.

The plant at this town was one of the best and most complete the writer inspected. Owing to the rigid requirements of the Thames River Conservators, three contacts are used. The Local Government Board ordered the effluent to be discharged on land after coming from the contact beds, and the Council purchased 20 acres of land for this purpose, but it was found that the effluent actually deteriorated after land treatment, and consequently it was discontinued. The effluent is used for condensing, feeding and cooling purposes. The sewage is delivered at a screening chamber, where it passes through  $\frac{1}{2}$ -in. screens, and thence to the beds without sedimentation. There are fifteen beds built in terraces of five each. The coarse or first contact beds are 4 ft. 4 in. deep, 50 ft. x 34 ft. 6 in. filled to within 4 in. of the top with coarse clinkers rejected by a 3-4 in. sieve. The medium or second contact beds are 54 ft. x 35 ft. 6 in., filled with clinkers rejected by a  $\frac{1}{4}$ -in. sieve. The fine or third contact beds are 58 ft. x 35 ft. 6 in., filled with residue from screened bed consisting of finely powdered clinkers and ashes. The beds have a fall of 6 in. and are drained by semi-circular pipes, 5 in. in diameter, formed of concrete. They are 2 ft. 6 in. apart and 6-in. sluice valves are used. The liquid capacity of the coarse beds is 20,000 gallons, or 46 per cent. of the total. This capacity has not been decreased since the beds were first used in 1898. There is a population of about 4,200 now connected with the sewers, and about 100,000 gallons of sewage is being treated daily.

The operation is as follows:—

A coarse bed is filled to within about 4 in. or 6 in. of the surface of the bed material, and allowed to stand full about two hours, then emptied slowly, taking about one hour. The same process is employed with other beds. The beds are allowed one week's rest in five. The coarse beds are charged by shallow bays 8 ft. or 10 ft. wide, running across the entire width of the bed, and sunk about 6 in. below the level, and are cleaned by skimming the surface and lightly turning it over, after a week's rest. On the medium beds the sewage is distributed by 12-in. half channel pipes, having 6-in. branches, 2 ft. 6 in. apart. The spaces for drainage at the bottom of the beds are filled with large clinkers. The surface of the medium beds requires no attention, but the surface of the fine beds requires occasional weeding. No particular method is adopted for distributing the sewage on the fine beds. Tomatoes are grown on the coarse beds.

#### SUTTON, SURREY.

This town was one of the first to adopt the bacterial treatment of sewage, and the beds have now been in use four years, with very satisfactory results. The population of Sutton is about 18,000, and the daily flow of sewage 550,000 gallons. The sewage was formerly precipitated with lime, and the precipitation tanks were converted into bacteria beds when the system was first introduced. These beds are 55 ft. x 35 ft. and 3 ft. 6 in. to 5 ft. deep. There are now seven coarse beds and five fine ones. All the new beds are built in clay, the coarse beds being 125 ft. x 45 ft. and 150 ft. x 135 ft., but the smaller size seems to be preferred. Fine beds are used for second contact and are 160 ft. x 30 ft. and 170 ft. x 30 ft. The filtering material has been used in some of the fine beds for four years, and they are only raked over in summer to prevent growth of weeds. The fine beds are ridged and furrowed, and the material used is coke breeze and burnt ballast. The effluent runs into a small creek and is very satisfactory. There are also a few small septic tanks which are covered with galvanized iron sheeting. The beds take  $1\frac{1}{2}$  to 2 hours to fill, care being taken to prevent the sewage from reaching the surface of the beds, the flow being stopped as soon as the level rises to within a few inches of the top.

In 1891 and 1893 the original works were constructed, and designed for chemical precipitation and broad irrigation, and until 1896 the whole of the sewage was treated by chemicals. The effluent, however, was not such as to satisfy the requirements of the conservators of the River Thames. There was also considerable difficulty in getting rid of the sludge, as there was no demand for it, and in 1896, at the suggestion of Mr. Dibdin, the eminent chemist, they constructed the first bacteria beds for the treatment of crude sewage in England.

Mr. Chambers Smith, borough surveyor, informed me that the bacterial treatment was much cheaper and more satisfactory than the old system of chemical precipitation.

#### EXETER.

The first septic tank installed in England was at Exeter, and was constructed by Mr. Cameron, city surveyor, in 1896. It is a small plant for the treatment of the sewage from the St. Leonard's district, the population being about 1,500, and the daily flow of sewage 90,000 gallons. The septic tank is 65 ft. long by 18 ft. wide and 7 ft. 6 in. deep. There are five filters, one being held in reserve. These have each an area of 80 square yards and a depth of 5 ft. Furnace clinker is used in four of the filters, and broken coke in the other. No attendance is required, the flow and discharge being controlled by an automatic arrangement. The material used in the construction of the tanks, etc., is concrete. The septic tank has not been cleaned since it was constructed; the effluent is very good. A new plant is now being constructed to treat the whole sewage, providing for a population of about 55,000. In the immediate vicinity of the works there are several residences, and the writer was informed that no complaints have been made.

#### BARRHEAD.

The population of Barrhead is 10,000, and the daily flow of sewage is from 350,000 to 400,000 gallons. The works in this town were constructed by the Exeter syndicate, and the septic tank and one contact is used. There are four septic tanks, 100 ft. x 18 ft. x 8 ft.; two settling tanks or grit chambers, 18 ft. x 6 ft. x 5 ft., and also eight contact beds, 54 ft. x 54 ft. x 4 ft. deep, the material used being clinkers. The beds are underdrained with



agricultural tile drains 3 in. to 2½ in. in diameter, placed 2 ft. apart, and the walls are composed entirely of concrete. The time occupied in filling the beds is 1½ hours. The same period is taken to empty the beds, and the sewage is allowed to stand 7 hours. The cost of the works was \$25,000. Alternating gear is used to control the flow and discharge from the pipes, and one man is employed. The effluent appeared very good, and, although there were two dairy farms in close proximity, there have been no complaints. The works have been in operation two years.

In addition to the above places, Manchester, Sheffield and Leeds have been conducting for some years past a series of very elaborate experiments, and Manchester is so satisfied with these that the city is now engaged in constructing works consisting of septic tanks and bacteria beds, for the treatment of all the sewage of the city.

The writer is especially indebted to Mr. Gilbert J. Fowler, Superintendent and Chemist in charge of the Manchester Corporation Sewage Works, for a great deal of the information contained in this paper.

Toronto, January 15th, 1902.

---

UN

a c  
Lib  
mal  
floo  
sup  
wer  
ing  
star  
wri  
pin  
pub  
stru  
pin  
abs  
own  
to t  
take  
whi  
in a  
a g  
with  
star  
wal  
but  
nor  
1 3  
whi  
cast

**UNDERPINNING THE WEST WALL OF THE STOKES BUILDING, 49 CEDAR STREET, NEW YORK CITY.**

---

T. KENNARD THOMSON, C.E., M. AM. SOC. C. E.

---

In February, 1900, the Mutual Life Assurance Company awarded a contract for the foundations of their new building on Cedar and Liberty streets to Arthur McMullen & Co. This contract involved making four stories below the street level and placing the cellar floor 35 feet below the water level, which, of course, necessitated supporting the adjacent walls, as the foundations of the new building were to be from 60 to 80 feet below the foundations of the adjoining walls, which were resting on quicksand near the surface of the standing water. Much of this was described and illustrated by the writer in the Engineering News of March 28th, 1901, but the underpinning of the Stokes Building was only slightly described in that publication. Owing to the fact that this wall was very badly constructed it caused a good deal of worry until it was safely underpinned. The New York Building Law, although full of many absurdities, is very explicit in one respect where it states that the owners of adjacent buildings must give the contractors free access to their property in order to protect the same from damage, or else take the responsibility of making their building secure themselves while the foundations for the new buildings alongside are being put in at a lower level. But in spite of this law the Stokes people caused a good deal of delay to us before giving us access to their property, with the result that it was the middle of June before work was started on this unique wall. It might be termed a combination wall, inasmuch as the Cedar street corner had no iron columns, but consisted of a good brick pier for the whole twelve stories. The northerly corner had a heavy cast iron column 24 x 28 inches, with 1 3-4 inch metal in the basement, first and second stories, above which was brick work alone. Between the two corners were three cast iron columns 16 x 15 inches, 1½ inch metal for the first five

floors with an 8 inch brick wall, and above the fifth floor was nothing but a 12 inch brick wall. The four columns rested on good granite caps supported by good brick piers, which were vertical on the outside of the Stokes wall, but stepped off on the other three sides, making a broad base, but eccentrically loaded. These granite caps had been very badly set and were all cracked through the middle when first loaded. In fact the entire wall seemed to be as flimsy and disconnected as possible, and before sinking any caissons for underpinning purposes it was absolutely necessary to bind the various parts together so that jacking against one portion of the building would not break it in two, and the only possible way to do this was by means of plate girders from one end of the building to the other. As the three centre columns rested eccentrically on the edge of their brick piers, it was not safe to undermine these piers to place the girders below the granite caps, nor was there room to place the girders between the bases and the street floor, and the only place left was just above this floor. It was therefore decided to use 6 feet deep plate girders, one on each side of the columns, with the bottom flange about the level of the ground floor. As it was not desirable to run this girder outside of the building line above the sidewalk, the plan of supporting the corner brick pier by independent girders 18 feet long was adopted, leaving 4 feet between the top of girder A and the bottom of girder B, girder B lapping over girder A about 3 feet, which permitted girders A and B being connected by a heavy column consisting of four 15 inch, 60 pound channels, 16 feet long. The girders A and B were each 15 inches back to back of web plates, which were drawn up close against the sides of the 15 x 16 inch columns. As the corner column was 24 inches wide, and not on the same centre line as the 15 inch columns, it was decided to splice the 6 foot girders about half way between the corner columns and the first 15 inch column, making an offset of 3 7-16 inches on the inside of the building and 5 3-4 inches on the outside, which was done by using 6 x 6 inch angles. (See Fig. 1.)

The corner column was so excessively large that all the holes we wanted to drill in it could not affect the safe strength, so 63 bolt holes for one inch bolts were drilled through the column and both girders without reinforcing the column in any way. But the owners of the Stokes building were afraid to trust the other three

colu  
12 f  
bott

8"  
o  
B

ing u  
each  
blan

columns unless they were reinforced, so four 6 x 6 x 5-8 inch angles 12 feet long were bolted on each side of these columns, having the bottom of the angles flush with the bottom of the girders and stand-

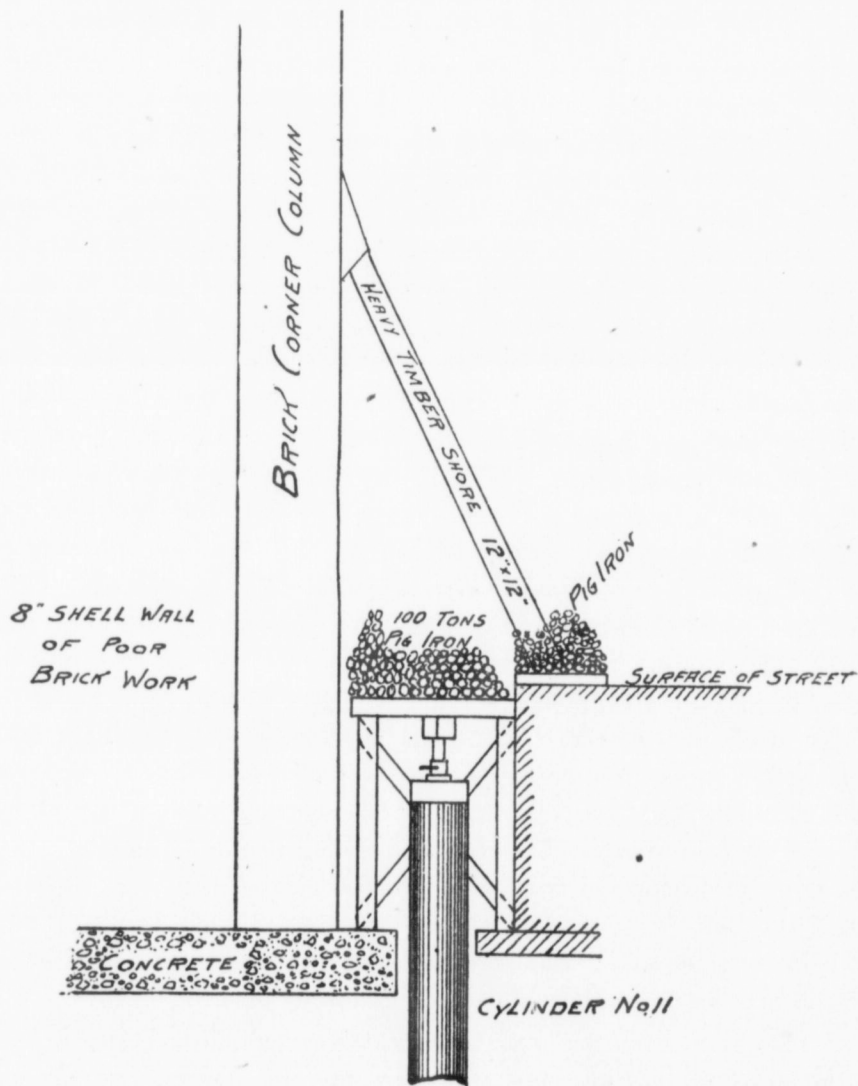

FIG. 1.

ing up 6 feet above the girders. Twenty-five 1 inch bolts connected each pair of these angles of the columns, leaving about three feet of blank angle above the top bolt; this was the only modification in our

plans made by the Stokes people and was made so as to permit clamping the four angles to the column, thus reinforcing the section before getting down to the bolt holes. Twenty-one short bolts connected each of these angles to the girders, which had in addition seventeen long bolts through both girders and column. These girders had 72 x 3-4 inch web plates, one 6 x 6 x 3-4 inch flange angle top and bottom throughout, with base plates where required. The flange angles were of course turned out. All long bolts were nominally 1 inch in diameter, having one end upset to 1 1-32 inch and the other end to 1 3-64 inch for a length of 2½ inches, the middle of the bar remaining one inch in diameter, the screw for the nut end being slightly smaller to prevent injury in driving. This design of bolt permitted tight driving through both girders and both sides of the column. The 12 foot angles were made in pairs with one angle punched in the shop and the other left blank, so that when one was in place the holes were drilled clear through the column, then its mate was put in place and the holes centre punched, the angle was then taken down and drilled, after which the pair of angles were put in position and the holes reamed out. These bolts were driven just as hard as it was considered safe to drive without running a risk of splitting the columns with a line of bolts as wedges. This operation would have been tedious, the bolts going through the girders and column, so a frame was rigged up to permit drilling the holes from each side of the column, which, of course, did not give holes in absolutely true line through both sides of the column and girder, but it was found that all that was necessary was to shove a bolt through from one side and see how far the hole on the other side of the column was off centre, and then give the bolt a slight tap on a log of wood, and with a little practice the men were able to bend the bolts to the exact amount required. Each bolt was put in a lathe, pneumatic, and each end was filed down until both ends of the bolt had a good hard driving fit for its hole.

The first intention was to sink heavy cylinders between the columns of the old building and carry the old columns entirely on the girders, but when the Stokes people raised objections to leaving the girders in permanently, claiming that because the top flange would extend 4 inches into their room and decrease the rental value thereof, it was resolved to put down the caissons between the col-

um  
gird  
addi  
gird  
the l  
the i  
distu  
was r  
and  
Stok  
time,  
direc  
been  
to res  
came  
supp  
unde  
the g  
which  
Cylin  
down  
feet c  
posed  
filled  
caisso  
plete  
cylind  
pound  
togeth  
and a  
per f  
above  
I-beam  
vertic  
previo  
at one  
of cou  
until  
was th

umns first and carry the columns by means of these caissons and the girders, and then undermine the columns themselves by new or additional caissons, which of course would take the strain off of the girders and intermediate cylinders. Before any work was done on the building a partition was placed about 3 feet from the wall on the inside of the Stokes building, so that the tenants would not be disturbed in any way by the operations on the wall. This partition was made of boards and studs with 4 inch terra cotta blocks behind, and was then papered. Coming to an understanding with the Stokes people, and putting in the partition and girders B and C took time, so that it was July 21st before any caissons could be put directly under the wall. In the meantime, however, a trestle had been built at the north end of the wall, to hold 100 tons of pig iron to resist the jacks used to enforce cylinder No. 9 down, as this cylinder came entirely beyond the building and formed half of the temporary support for the end column, for although this cylinder was directly under the end of girder C, it was not considered safe to jack against the girder for fear of putting bending strains in the end column, which as already stated, was of cast iron, and ran up only two stories. Cylinder No. 9, the first eight being under another wall, was jacked down to rock under this platform through 36 feet of quicksand, 12 feet of hardpan, and then through 9 feet of fine sand and decomposed mica. The jacking started on July 9th, and the cylinder was filled with concrete on July 20th, or in 11 working days. As this caisson was intended to be used only until the new cellar was completed, a temporary support was quickly made to go between the cylinder and girder C, by taking four 20 inch I-beams, weighing 65 pounds per foot, and 10 feet 7 3-8 inches long, and bolting them together in pairs with two 8 x 10 inch timbers for separators. Under and also over this post were four 15 inch I-beams weighing 60 pounds per foot and 3 feet long, to distribute the strain from the girders above and to the cylinder below. Between the post and the upper I-beams were two 8 x 1½ x 20 inch plates over each of the four vertical beams, with four steel wedges the same size as used on the previous cylinders, each wedge being 2½ inches wide, ½ inch thick at one end, and 1 inch at the other end, and 18 inches long, and of course planed on top and bottom. These 16 wedges were driven until the girders were slightly deflected upwards. The pig iron was then transferred to a similar trestle built under the curb to jack

down cylindrical caisson No. 11, which was started on July 21st and finished August 9th. By this time the Stokes people had decided that our girders B and C would have to be removed before we left the job; so it was resolved to stop three cylinders that did not come directly under any old column near the top of the hardpan instead of carrying them to rock like the other seven. This kicking by their neighbours however saved the Mutual Life Company quite a little expense and time; for instance, cylinder No. 10, which was started the same day as No. 11, was completed on August 26th, or in six working days, as against ten, No. 11 being delayed a couple of days waiting for cast iron cylinders, although we had two different shops at work on these cylinders since early in April.

The cylinders were the same as those used under the Mutual Life Building on Cedar street, being 3 feet outside diameter and 33 inches inside diameter. The details of these cylinders, with their steel cutting edge, diaphragm caps, etc., are fully described in the Engineering News of March 28th, 1901. Cylinder No. 9, however, had three diaphragms, 4 feet, 9 feet, and 19 feet from the cutting edge, as there was not sufficient head room to jack down 9 ft. of cylinder before striking water and necessitating the use of compressed air. Cylinder No. 10 went through 40 feet of quicksand and  $3\frac{1}{2}$  feet into the hardpan to get a good bearing. Cylinder No. 11 passed through 35 feet of quicksand, 13 feet 4 inches of hardpan and 7 feet of fine material under the hardpan, landing on bed rock. Cylinder No. 12, commencing on July 31st, sank through 35 feet of quicksand and 2 feet 7 inches of hardpan, being concreted on August 4th and 5th. Cylinder No. 13 penetrated 32 feet of quicksand and 3 feet 4 inches of hardpan, taking from August 7th to August 15th. Cylinder No. 10 had five 15 inch at 60 pound I-beams 3 feet 6 inches long on top of the cap, and four vertical beams, the same as for the first eight cylinders, under the opposite wall, but these were wedged directly under the webs of the girders. On cylinders Nos. 12 and 13, the distance from the cap to the girders being shorter, the horizontal beams were omitted.

The entire wall, with the exception of the Cedar Street corner, now being carried by the girders B and C, it was safe to commence undermining the four cast-iron columns. The brick piers and  $3\frac{1}{2}$  feet of concrete were very hard and slow to remove, even with the

aid of  
of cy  
32 fe  
sand  
Five  
and t

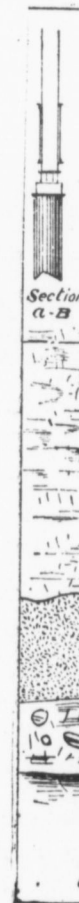

until  
Cylind  
feet o  
under  
etc., b  
the co

aid of a gadder drill, so that it was August 22nd before the sinking of cylinder No. 14 commenced, where the material was found to be 32 feet of quicksand, 15 feet of hardpan, and then 10½ feet of fine sand and boulders. This cylinder was completed on September 5th. Five 15 inch 60 pound beams were placed under the granite caps, and the wedges driven between the beams and the cast iron cap

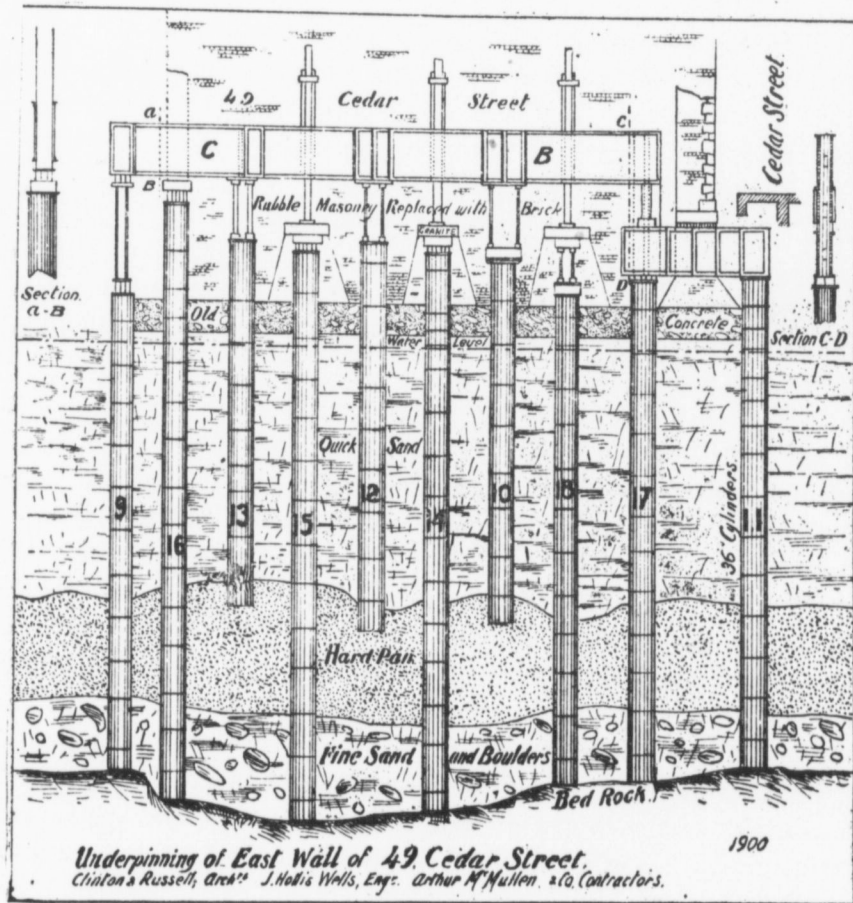

FIG. 2.

until the column and granite cap above were lifted a hair's width. Cylinder No. 15, commencing on August 26th, passed through 30 feet of quicksand, 17 feet of hardpan, and 12 feet of fine material under the hardpan, and was filled on September 4th; the wedging, etc., being similar to No. 14. Cylinder No. 16 is directly under the corner column, and while the shoe and bottom section of the



old column were being removed, thus transferring the entire weight of this corner of the building from the old base to the new girders, a Y level was kept sighted on the girders from a secure position on the opposite side of Liberty Street, and at no time did the weight of the building cause the slightest deflection in these girders, C, showing that the wedging had been sufficient to overcome any tendency to deflect. Cylinder No. 17, which supports one end of girders A and B, and consequently is half the support for the Cedar Street corner brick column, was held back until September 8th, until access could be had to the place, and was landed on rock on September 25th, the hardpan being 14 feet thick and 9 feet above the rock.

As soon as No. 17 was filled and capped, girders A were put in place. The erection of these two girders caused more worry and anxiety than any other part of the work, for this corner consisted of a brick pier, or rather column, 5 feet x 6 feet and twelve stories high, and to cut a notch in one side of this column near the bottom 7 feet high, and about 20 inches into the pier, or, in other words, cutting off about 20 inches out of 60 inches to place the girders A in, was cutting a big slice. Before making this cut four 12 x 12 inch inclined shores of timber were placed side by side, with their tops braced against the floor of the second story and the bottoms firmly secured about the level of Cedar Street. (See Fig. 2.) A similar strut of four timbers was placed on the lot side of the corner. Then seven inches of the 20 inches were stripped off the side of the brick column and three 15 inch beams 6 feet 6 inches long and weighing 60 pounds were put in place and wedged up while the remaining 13 inches were being cut out, and when this was done two of the beams were removed and the inside girder A was put in place and temporarily wedged up, when the third strut was removed and the outside girder A was quickly slid in place and levelled up, and then the two base plates and the cover plates were quickly bolted up. One fact which relieved a good deal of anxiety about this corner, was the fact that a few inches above the girder was a good granite cap 18 inches thick, extending under the whole corner, which greatly reduced the risk of the brick work above cracking. As the vertical space to this cap was only 6 3-8 inches, it was decided to use fifteen 4 inch rails weighing 60 pounds per yard, cut in 2 foot lengths and placed side by side. A filler 3 inches x 5-8 inch x 5 feet was placed

over e  
plate  
girders  
upper  
wedge  
end an  
and 1-  
driven  
up an  
pleted.  
B, whi  
sion w  
any da  
sion to  
Both g  
the str  
to the  
several  
stand t

TH  
secured  
after th  
October  
fine stu  
The en  
of worr  
the floo  
beams;  
were tw  
been pl  
take in  
good.  
these 3  
to drop  
these gi  
and con  
all the  
left con  
ing were

over each web so that the rails would not foul the heads of the cover plate bolts. The rails were of course placed at right angles to the girders, and over each rail were driven two pairs of wedges, the upper wedge bearing directly against the 18 inch granite cap. Each wedge was  $2\frac{1}{2}$  inches wide x 12 inches long x 7-8 inch thick at one end and 1-8 inch at the other. An assortment of shims 1-16, 1-8 and 1-4 inch thick, were used for evening up. The wedges were driven hard, and then all the interstices between the rails were filled up and the most treacherous part of the underpinning was completed. The next operation was the connection of girders A and B, which was designed to carry either tension or compression: tension when the jacks were being used on cylinder No. 18, to avoid any danger of bending the super-imposed old column, and compression to carry the same column when the jacks had been removed. Both girders were placed 15 inches back to back of web plates, and the strut was made by bolting four 15 inch channels 16 feet long to the webs of girders A and B, the channels being coupled by several 12 inch tie plates. The girders proved rigid enough to withstand the application of two 125 ton jacks without deflection.

The entire western wall of the Stokes building being now secured, the last cylinder, No. 18, was sunk to support the column after the girders should be removed. This cylinder was started on October 13th and completed 11 days later. There we had 10 feet of fine stuff under 10 feet of hardpan and 35 feet of quicksand on top. The entire wall was thus wedged off its original supports. One cause of worry was the poor connections of the old iron work; for instance, the floor at one place was carried to the column by two 20 inch I beams; but the only connections between the beams and the column were two 3-4 inch bolts for each beam. It is true that brackets had been placed on the columns under the beams, but through some mistake in the shop they were placed 3-4 of an inch too low to do any good. Several months after the work on this wall was completed, these 3-4 inch bolts were sheared off, allowing the 20 inch beams to drop on the shelf brackets. It is probable that as the ends of these girders were exposed to the winter weather, that the expansion and contraction had snapped the already overstrained bolts. When all the joints exposed to view showed such a bad state of affairs, it left considerable doubt as to what the remaining joints in the building were like, and therefore it was not considered advisable to remove

the girders B and C until the iron work of the new building was erected. It would of course have been vastly better to have left both girders in permanently, but the Stokes people demanded \$10,000 if the inside girder was left in, although they would have had a much safer building at no cost to themselves. Eventually we removed the cover-plates and flange angles of the inside girder, leaving both web plates in place.

In this building, as before, when the concrete was put in the air chamber to the level of the lower door when hanging open, the air was left on for twenty-four hours with a gaugeman to watch the indicator, but one Sunday night the man must have went to sleep and allowed the air pressure to increase probably to the pressure in the receiver, about 40 pounds per square inch, instead of keeping it down to about 20 pounds. The result was that the air forced its way through the 6 feet of hard concrete, bubbled up around the cylinder and raised the surrounding sand a foot, allowing two feet of sand to flow over into the cylinder. This and several other incidents proved the utter unreliability of labouring men for gaugemen. Four hydraulic jacks were used on this job, two of 60 tons capacity and two of 125 tons each. These jacks required a good deal of repairing. Sometimes one jack was used on a cylinder and sometimes two together.

---

## CONCRETE CULVERTS.

A. W. CAMPBELL.

A great many townships throughout the Province have largely discarded timber as a material for small culverts and sluiceways. Cedar where obtainable has been most commonly used, but all varieties of suitable lumber are becoming scarce, the price is constantly increasing, and the quality now available is far from being equal to that of former years.

Those municipalities which have experimented with vitrified and concrete tile, have, with very few exceptions, been favourably impressed with the new materials. Failure and some dissatisfaction are occasionally reported, but this in every case can be traced to causes not in any sense condemnatory of the new materials. Where any kind of tile is used there are certain requirements which must be observed. In the first instance the tile must be of good quality. It is just as necessary to use good tile in culverts as in sewers; where "culled" tile are used, failure is almost of necessity the result. These tile must be perfectly sound and straight, not warped or mis-shaped in any way, otherwise good joints cannot be made, water will lie in hollow places, and culverts are apt to wash out.

Excellent culvert pipe of concrete can be manufactured cheaply in any gravel pit under the immediate direction of the road overseer. The pipes are from two to four inches in thickness, according to diameter; which latter may safely and conveniently reach three feet, in lengths of two and one half feet.

The implements required are of the simplest kind. The most important are two steel spring-cylinders, one to sit inside the other, leaving a space between the two equal to the thickness of the finished concrete pipe. By "spring-cylinder" it may be explained is

meant such a cylinder as would be formed by rolling a steel plate into a tube without sealing the joint. With the smaller of these cylinders the edges overlap or coil slightly; but are so manufactured that the edges may be forced back and set into a perfect cylinder. Accompanying these moulds are bottom and top rings, which shape the bell and spigot ends of the pipe.

The two cylinders with joints flush are set on end, the one centrally inside the other and on the bottom ring, which in turn rests on a firm board base. The concrete, made of first-class cement and well-screened gravel in the proportion of one of cement to three of gravel, is then tamped firmly but lightly into the space or mould between the two cylinders. The tamping-iron used to press the concrete into place is so shaped as to fit closely to the cylinders.

The concrete is allowed to stand in the mould for a short time, when the cylinders are removed; the outer and larger cylinder by inserting an iron wedge into the joint and forcing the edges apart; the inner cylinder, by inserting the wedge into the joint and turning the edges, so as to allow them to again overlap, returning to the shape of a coil. The outer cylinder having thus been made larger and the inner one smaller, they can readily be taken away, and the concrete pipe is then left until thoroughly hardened.

Just such a number of pipe as are actually required for the season's work need be manufactured; the implements required are inexpensive, and the pipe may be made by the municipality for actual cost, which, after a little experience, can be reduced to a very small amount.

If cement concrete pipe are employed, they must be of first-class quality. They must be well shaped, as with sewer pipe, and all the rules for making a good concrete must be observed—that is, the material composing the concrete (cement, sand and stone) must be of good quality, and properly mixed. The making of good concrete is not a difficult matter, but it is sometimes difficult to find men who will follow directions. Dirty sand or gravel, too much water, careless and insufficient mixing, neglect to see that the materials are used in the right proportions, are the defects most commonly found. Concrete cannot be mixed like common mortar, and an attempt to do so is far too often made. It is affirmed by cement manufacturers that masons are the greatest offenders in

this respect; that it is almost impossible to get them to follow any system other than that to which they have been accustomed in the use of common lime; and that therefore an entirely inexperienced but practical man, who will follow directions, will often make the best concrete.

To meet with success in the use of tile culverts they must be put in place properly. They should be laid with a good fall on a regular grade to a free outlet, in such a way that water will not stand in them. The tile should be laid with the spigot end down grade, and the joints made tight with cement mortar. If the joints are open water will work its way along the outside of the culvert, and finally make a considerable channel which will allow the culvert to get out of line and finally result in a "cave-in." To prevent the water finding its way along the outside of the pipe, it is advisable to protect the ends with concrete, stone or brick head walls. Care should be taken to excavate a concave bed for the pipe, with depressions for the bell of the pipe to rest in, thus securing an even bearing, without which a heavy load passing over before the culvert has properly settled into place, may burst the tile. Tile cannot be used in very shallow culverts, but must have a sufficient depth of earth over them, to protect them from the direct pressure of heavy loads. The depth of covering necessary increases with the size of the pipe. At least a foot of earth over the top is advisable in every case, but for culverts of two feet in diameter, or over, this should be increased to at least eighteen inches.

The earth should be well packed and rammed around the tile to secure a firm bearing, and light soils should not be used immediately over or around the culvert. A heavy clay, a firm gravel, or a compact sand or gravel will answer, but vegetable mould, water sand, and light loams are subject to wash-outs. At the outlet the culvert should be set nearly flush with the surface of the ground. If set higher than the surface, the fall of water will wash out a depression, and in time will undermine the end of the culvert. A too rapid grade will have the same effect, and it is well to cobble-pave an outlet where this undermining action is likely to occur.

Culverts, in many townships, are very numerous, and necessarily so. Water should be disposed of in small quantities, along

natural watercourses, otherwise if gathered in large bodies along the roadside, it gathers force and headway, resulting in extensive wash-outs, and is in every way more costly to handle. Water should be taken away from the roads as quickly as possible, for it is excess water that is the great destroyer of roads.

Culverts, in addition to being a matter of considerable expense to municipalities, are too often in a bad state of repair, sometimes dangerous, and when not level with the roadway, are an annoyance and interruption to traffic. Good roadmaking is largely a matter of good drainage, and culverts are a detail of drainage upon which municipal councils should bestow a good deal of attention, with a view to a greater permanency, increased efficiency, and a reduction of cost.

The concrete arch culvert is, in a number of municipalities, replacing the old form of timber structure. Greater in first cost, the concrete culvert, if rightly constructed, is a permanent saving in road expenditure. The greater portion of the annual road appropriation is, in many townships, spent in repairing and re-building wooden culverts and sluiceways. The life of timber in this work is very short. Wooden culverts are quickly upheaved by frost, warped by the sun, and decayed by penetration of moisture. Wherever concrete culverts have been fairly tested they give satisfaction, and their general use by a township will mean, in the course of a few years, a marked reduction in this branch of roadwork.

The stone arch is designed on the principle that it will remain in place without the use of mortar. The concrete arch, on the other hand, is a monolith, dependent upon its cohesive strength. That the concrete arch is dependent upon cohesive strength points to the necessity, in construction, of a generous proportion of cement, very great care in mixing the concrete, and a good quality of all materials employed.

A concrete can best be regarded as a mixture of mortar and broken stone, the mortar being formed from a mixture of sand and cement. Given a sample of broken stone in a vessel, the requisite quantity of mortar can be gauged by pouring water into the vessel until the stone is submerged. The quantity of water used will indicate the amount of mortar required to completely fill the voids in the stone. The proportionate amount of cement needed to fill

the voids in the sand can be gauged in the same way. The proportions of cement, sand and broken stone obtained in this way would provide, with perfect mixing, a mortar in which the voids in the sand are filled with cement and each particle of sand is coated with cement; it would provide a concrete in which the interstices of the stone are filled with this mortar, and each stone coated with mortar. This would be the case with perfect mixing, and would provide a theoretically perfect concrete. Perfect mixing is not possible, however, and it is necessary to provide an amount of cement in excess of the voids in the sand, and an amount of mortar in excess of the voids in the stone.

With proper mixing and good materials, a satisfactory concrete for bridge abutments can be formed from cement and broken stone, in the proportions of one, three and six. It is recognized that the greatest strength in concrete can be obtained by making the mortar rich in cement, rather than by lessening the quantity of stone, but beyond providing for a strong adhesion of mortar and stone, little is gained by making the mortar materially stronger than the stone. The foregoing applies to crushing strength, however, rather more than to the tensile strength required to some extent in the arch. For the arch proper, it will be well to use a richer concrete, in, say, the proportions of one of cement, two of sand, and three of broken stone.

The cost of the abutments may be lessened, where they are of sufficient thickness, by the use of rubble concrete. The casing or curbing must be built up as the laying of the concrete proceeds. Within the casing and firmly tamped against it, there should be placed fine concrete to a thickness of about six inches. This will form a shell for the abutment, inside of which large stones may be placed in rack-and-pinion order, ends up. There should be a space of at least two inches between the stone, filled with fine concrete, and all firmly rammed. The outer shell of fine concrete should always be kept built up six inches or so in advance of the rubble work. The rubble should be placed in layers, each layer well flushed with a layer of fine concrete.

The lumber used in making the curbing or casing should be dressed, tightly fitted and firmly braced, so that the concrete may be well rammed into place. The framework should be closely



boarded up against the work as it proceeds. The centering for the arch should be well formed. The ribs should not be farther than three feet apart. The lagging should be three inches thick and dressed to the intrados of the arch. All the framework, centering and supports should be substantial and well constructed. This framework is a considerable item of expense in the building of a culvert, but it can be used as often as it may be required for arches of similar span. The exterior of the culvert when finished should have a smooth face, free from holes; and a surface coating, which is of little use, should not be necessary.

There is some difference of opinion as to the relative strengths of gravel and broken stone in concrete. The natural inference is to suppose that a rough, irregular surface will secure greater adhesion than one that is smooth. However that may be, there is little reason to doubt that gravel will make a good concrete, but there is a right and a wrong way of using gravel. It is not uncommon to find cement and gravel just as it is taken from the pit, mixed to form a concrete. Remembering the proper composition of a concrete, and placing beside this the fact that gravel usually contains sand, but not in any definite proportions, and that some pockets of "gravel" may be almost completely sand, while in the layers adjoining there may be little if any sand, and that many gravel beds contain much clay or earthy material, it will be readily understood why it is that, in some cases, concrete mixed in this way may be successful, yet it will always be uncertain and hazardous. The only safe method is to separate the stone and sand composing the gravel by screening, then to mix cement, sand and clean stone uniformly and in their right proportions.

A cause of poor concrete is the excessive amount of water used when mixing. The tendency very often is to bring concrete to the same consistency as common mortar. Concrete when ready to be placed in the work should have the appearance of freshly dug earth. Where an excessive amount of water is used, the hardened concrete will have an open, spongy texture.

The concrete should be mixed at a point convenient to the work in a box which is sometimes specified as water-tight, but the concrete will quickly make it so. It should be mixed in just such quantity as is required, and a constant stream kept passing to the

work. It should be laid in layers, each layer thoroughly rammed until moisture appears on the surface.

It is very necessary to see that the sand and stone used in making concrete are clean, that it is free from clay, loam, vegetable or other matter which will act as an adulterant, and result in a weak and friable concrete. If such matter is intermixed with the stone it is well to flush it away with a good stream of water. Large stone used in rubble concrete should be also treated in this way. It is well, particularly in hot weather, to dampen the stone before mixing it with the mortar. The heat of the stone in hot weather causes the moisture of the mortar to evaporate, causes it to set too quickly, and at all times there is more or less absorption from the mortar in immediate contact with the stone, unless the stone, as intimated, has been dampened.

When the work ceases for the day, or is for other reasons interrupted, the surface of concrete should be kept damp until work is resumed. When work is in progress in hot weather, any exposed surfaces should be kept damp and protected from the rays of the sun, otherwise the surface will, in setting too rapidly, be interlaced with hair-like cracks which, filling with water in winter, and freezing, will cause the surface to scale off. The same scaling sometimes results from laying concrete in frosty weather.

Arch culverts of masonry or concrete fail frequently from settlement caused by an insecure foundation. The foundation should always be of at least sufficient depth to be free from any danger of undermining by the action of the water, and of sufficient further depth to be safe from settlement.

---

## A MODERN SHIP-BUILDING PLANT.

J. ROY COCKBURN, '01.

In view of the fact that ship-building is yearly becoming of greater importance in both Canada and the United States, as well as in other parts of the world, I venture these few remarks on the subject.

If Canada wishes to compete with other countries in ocean and lake transportation, it is important that the ship-building industry should be developed. Canada has certainly all the necessary resources. Perhaps the only difficulty is that labour is somewhat more expensive here than in some parts of the world, but it is not more so than in the United States.

Nearly all the great shipyards of the world are the result of a great many years growth and development, and were started years before the advent of great labour-saving machinery, so that when such equipment was afterwards installed it could not be used to the greatest advantage. This objection does not exist, however, in the case of a new plant being built.

To the best of my knowledge there is but one large ship-building plant in the world where everything is arranged and laid out in a thoroughly up-to-date manner. I refer to the plant of the "New York Ship-building Co." of Camden, N.J., where I had the pleasure of working last summer and which I will now try to briefly describe.

The name of the company was so chosen that it should, in any part of the world, be suggestive of America, and also because it was originally intended to locate the plant somewhere in New York harbour.

However, the site was finally chosen at the southern end of the city of Camden, opposite Philadelphia. The property has a frontage on the Delaware River of about 3,600 feet, and a width of about 1,800 feet. The land is very suitable for the purpose of ship-building, the underlying strata being of white sand, gravel and clay.

The area of the property is about 130 acres, besides a two-acre lot on the opposite side of the street on which the main office building is situated.

The following are the chief objects which were kept in view in the designing and building of the plant:—

*First*—Convenience in the transfer of material from one field of operation to another.

*Second*—The arrangement of the ways so that ships up to 1,000 feet in length may be built under cover.

*Third*—An arrangement of shops that will permit of an increase of from 50 to 100 per cent. in capacity.

*Fourth*—Such isolation of structures as will reduce to a minimum danger from fire.

*Fifth*—Facilities for the ready handling of material received by rail and water.

On the side of the property next to Broadway, is a strip of land 120 feet wide reserved for ornamental purposes, and adjoining this is another reservation 128 feet wide for highway and railway purposes. There is ample room on this for six parallel tracks, each 3,000 feet long, connected with both the Pennsylvania and Reading Railroads. The buildings themselves are almost entirely free from tracks, such only being laid as are necessary for unloading material.

Track scales are provided to accommodate two cars of the largest size, and to weigh 300,000 pounds. A coal trestle has been built from which coal is dumped into bins sufficiently large to hold three months' supply.

The main building is enormous in size and unlike that in any other plant. Here all metal working departments are under one roof. The floor space is over 18 acres, and light is admitted by four acres of skylights, and two acres of windows.

There are more than forty travelling cranes ranging in capacity from seven to one hundred tons. All are driven by direct current motors. The one hundred-ton crane is carried on a span of 120 feet, and its field of operation covers the machine shop, ways, and outfitting slip, so that it may be employed to lift an engine or boiler bodily from the machine shop, and deliver it in a vessel, either on the ways or afloat. Each of the smaller cranes has its own field

of operation, and an original type has been installed, which by means of an extension arm, is able to deliver and receive material without re-handling. (this type was installed by Pawling & Harnispfeger, Milwaukee).

A great many of the cranes used for handling steel plates are equipped with powerful electro-magnets controlled by the engineer of the crane. The latter brings his electro-magnets over the plate, turns on the current, and the plate, now the armature of the magnet, can be lifted and carried to any place in the shop. It is instantly released by turning off the current.

#### MACHINE SHOP.

The machine shop is very large and roomy. There are three bays and one lean-to. Along each side of the machine shop run large galleries connected with the main floor by iron staircases. In the east gallery are a miscellaneous storeroom, and an electric repair shop, with lathes, shapers, drill presses, forges, etc. In the west gallery is the pipe shop which is thoroughly equipped with pipe-cutting and threading machines, lathes, drills, and grinding machines.

The lean-to contains the brass shop, a storage, and a tool room, a forge shop, and a tool manufacturing room, where a methodical system is employed for the supply of tools to the workmen, who are not required to sharpen their own tools, but return a dull one, getting a sharpened one in its place. Here also are clothes-closets, wash-rooms, etc., for the workmen, all fitted with the best sanitary devices.

The following very heavy machines are all of special design and specially built for the company: The first is a sixteen-foot vertical Niles' boring mill, fitted with three arms, two for use when the work revolves and one (the central one) for use when the work is stationary. The next machine is a large Sellers' drilling, boring and milling machine with an eight-inch spindle. This machine is equipped with steel scales and verniers for placing the work on the table, and measuring it in each direction.

There are two band saws for cutting steel, such as for cutting out eccentric straps, etc. These were built by the Noble & Fund Co., of England.

There is a horizontal milling machine from Bement-Miles & Co.; two Newton milling machines; an open side planer, 72 in. x 72

in. x 28 inches; a Betts' planer, 96 in. x 96 in. x 36 inches; two double-headed lathes, one 48 inches by 60 feet, and one 60 inches by 60 feet; two Niles' horizontal boring and milling machines, and a great many other smaller machines.

The erecting floor is in the west side of the shop and is served by two cranes, besides the 100-ton crane previously mentioned.

#### BOILER SHOP.

The boiler shop is directly north of the machine shop, and separated from it by a low partition only. It is also adjacent to the plate storage department, from which the plates are taken rolled by the straightening rolls, and delivered to the boiler shop.

The boiler shop is served by four cranes, one 60-ton crane, one 10-ton crane, and two  $7\frac{1}{2}$ -ton extension cranes similar to the one mentioned before.

The hydraulic rivetter, built by Wm. Sellers & Co., is of special design. It is designed to operate with a pressure of either 50, 100, or 150 tons. There is also a 160-ton hydraulic flanging machine equipped with dies for upsetting stay bolts, flanging furnace mouths and making manhole covers.

The large boiler drill which was built by the "New York Ship-building Co." has a capacity for boilers from 6 feet to 20 feet in diameter and 20 feet long. It has three drill heads each containing four spindles, which can be operated at the same time, and which are adjustable in all directions.

#### BLACKSMITH SHOP.

The blacksmith shop is very free from gas and smoke, all the forges being furnished with exhaust hoods. There are several steam hammers as well as a complete drop forging plant, nut and bolt machine, etc.

#### FRAME AND PLATE SHOP.

The frame and plate shops are located side by side and adjoining the blacksmith shop. In this department are drills, countersinks, and like tools, moving over a field of 20 feet or more in diameter. Here is installed the first joggling machine in use in America, and all ships being built are of joggled plating. This machine so bends the edges of the plates that they shall, wherever lapped, present a

plane surface on the outside. There is also a scarphing machine to plane off to a feather edge the steel plates, and two Sellers' plate planers used for planing and calking the edges of the plates. At the end of this shop are the laying off tables, where the plate is marked according to the template made in the mould loft. Those plates which are to be bent are carried to the plate furnace, which is 6 feet 6 inches broad by 28 feet long. At the southern end of the shop are two rolls, one of which can handle a plate 27 feet broad, and the other is used for rolling mast plates.

#### THE MOULD LOFT.

The mould loft where the templates are made is located over the plate shop. At the south end of the loft is a draughting-room entirely distinct from the hull draughting-room, where about twenty draughtsmen are employed to make drawings for each shape and plate that goes into a ship. From the lines furnished by the hull draughting-room the body plan of the ship is laid down on a marble table. The offsets from this table are given to the mould lofts-men who make the templates of the frames, etc.

#### THE LAUNCHING WAYS.

The launching ways are at the end of the frame and plate shop and directly opposite the machine shop, where the engines are assembled. All departments, including the launching ways and outfitting slip, are under one roof, the clear height of which, above the water, is about 125 feet. The depth of water in the slip is about 30 feet at low tide. There are seven parallel launching ways, and each may be extended to build a vessel 1,000 feet long. Adjoining the slip are two piers, one 1,000 feet long, and one 1,200 feet long, each having 30 feet of water on either side.

#### FIRE PROTECTION.

The system of fire protection is very complete. All departments such as pattern shop, joiner shop, power house, paint shop, and rigger's loft are sufficiently removed from each other so that a fire occurring in any one may be confined to that particular one.

Water for fire protection is furnished by three 1,500 gallon pumps, through mains ranging in diameter from 16 inches down, and the outside and inside of each building is thoroughly equipped

with  
so tha

T  
ated c  
horse  
feed p  
and S  
double  
engine  
having  
and m  
to two  
both c  
In ad  
genera  
conder  
machin  
genera  
the off  
presse  
per m  
Hydra  
a capa  
pound

T  
buildi  
system  
obviou  
the su

T  
wells c  
has a  
also a

T  
way. I

with hydrants and hose in addition to a complete sprinkler system, so that fire risk is almost completely eliminated.

#### POWER HOUSE.

The power house is a building about 100 feet by 200 feet, situated on the line of railway reservation. The boilers are of 2,500 horse power and are fitted with a Greene economizer and the usual feed pumps and heaters. The smoke stack is about 200 feet high and 8 or 9 feet inside diameter. It is large enough for boilers of double the capacity of those now in use. There are two main engines of 750 horse power each. They are cross-compound Corliss, having cylinders 18 inches and 36 inches diameter by 42-inch stroke, and make 120 revolutions per minute. They are direct connected to two 500 K. W. generators of the rotary converter type, supplying both direct and alternating current, the latter being of two phases. In addition there is a 50 K. W. direct connected, direct current generator. The exhaust may be led either to the open air, to a jet condenser, or into the heating system of the shops. All the large machine tools are driven by direct connected induction motors. The general illumination is by about five hundred enclosed arc lamps, while the offices and individual tools are lighted by incandescent lamps. Compressed air is supplied by a compressor of 5,000 cubic feet capacity per minute, at a pressure of 120 pounds per square inch. Hydraulic power is supplied by two compound pumps each having a capacity of 400 gallons of water per minute, at a pressure of 1,500 pounds per square inch.

The three kinds of power are carried underground to the main buildings, where they are distributed. The great advantages of a system of power transmission without belts or line shafting are so obvious that it is not necessary here to make further comment on the subject.

The drinking and general service water is taken from artesian wells on the premises. It is pumped to all parts of the plant and has a uniform temperature of about 56 degrees F. The plant has also a complete and up-to-date sewage system.

#### OFFICE BUILDING.

The office building is a plain structure on the east side of Broadway. It contains two large draughting rooms, where about one hun-



dred and sixty draughtsmen are employed, blue print rooms, library, fire-proof vault, and all necessary offices and rooms. The basement contains a bicycle room, a museum, three large dining rooms, with accommodation for two hundred people; and toilet rooms for those employed in the office. There is a complete telephone system connecting the office and all departments, as well as a staff of messenger boys who run errands round the plant.

An ingenious system of marking material has been adopted, by means of which the ultimate destination of any piece is indicated. A whole number is employed, which is the number of the ship to which the piece belongs; the first number to the right designates that the part belongs to the hull or machinery or other part, etc. The number 1.5421 on a casting indicates the following:

- (1.) means that it belongs to ship No. 1.
- .5 means that it belongs to the machinery.
- .04 means that it belongs to the main engine.
- .002 means that it belongs to the bed plate.
- .0001 means that it is No. 1 section of that bed plate.
- 2.5421 would mean the same part for ship No. 2.

They intended to employ about 5,000 men when all departments are full. My number was 4,422, so that gives a fair idea of the number employed.

Last summer the company had under contract about ten ships varying in size from 310 to 625 feet in length. The company was organized in the spring of 1899, with a capital of \$6,000,000.

To sum up, the New York Ship-building Co. has now in Camden one of the greatest of ship-building plants. It has contracts on hand that give it sufficient work to establish it on a firm basis, and it will without doubt, if wisely managed, prove an engineering and financial success; let us hope to see in the near future a similar institution in this country.

THE

gradu  
foun  
coupl  
posit  
a ve  
to m  
to se  
curri  
must  
valua  
room  
of th  
ence  
prom  
the Y

And,  
prim  
deper  
mate  
mine  
and  
neeri  
accor  
sider  
copin

**THE YOUNG GRADUATE AND THE PROFESSION OF MINING  
ENGINEERING.**

H. E. T. HAULTAIN, C.E., A. M. CAN. SOC. C. E.

Both in my own experience and in my observation of young graduates from engineering schools in all parts of the world, I have found a general ignorance of the profession as a whole generally, coupled with a very much distorted view of the young graduate's position in, and relation to, his profession. This is probably to a very large extent unavoidable, but it has always seemed to me a very important point, and I should strongly like to see a series of lectures on the subject embodied in the general curriculum of the school. Doubtless very much of such knowledge must be personally and painfully learned by experience, but a very valuable skeleton of information could be built up in the lecture room. In the short time at my disposal, I will attempt an outline of the profession of mining engineering as I in my limited experience have found it, and attempt to deal with some of the more prominent difficulties that will be encountered in the early days of the Young Engineer's career.

Kipling says:

"When the waters were dried an' the earth did appear,  
The Lord, He created the Engineer."

And, from the first, the mining engineer must have been a man of prime importance in his class. As time went on, and all structures depended more and more, either in their fashioning or in their material, upon the supply of metals, so would the importance of the miner become greater. In France and Germany this is recognized, and mining engineering ranks ahead of all other branches of engineering, but in our English speaking communities it is not officially accorded the same recognition, and possibly the miner is often considered rough and unfinished in his methods, a pioneer occupied in coping with nature in the rough and lagging far behind the polish

and finish of the scientific engineering of the cities. It is true he is a pioneer and that he deals with the forces of nature in her crudest and roughest forms, but he does it with a wider range of scientific knowledge than that possessed by any of his engineering brothers. He needs and he makes use of the specialized knowledge of all other branches of engineering in addition to such that is peculiarly his own.

The profession of mining engineering embodies very much more than any one man's mind could possibly encompass, and there is a limitless number of subdivisions or combinations of subdivisions for the specialist in which to bury himself.

In general, mining engineers are divided into two main classes, viz., *Mining Engineers* and *Metallurgical Engineers*. Under this classification in its closest sense, the mining engineer has to do with the getting of ore to the point where it lies in a broken state at the surface, and the metallurgical engineer carries on the work from this point, until the metals are finally extracted from the ore. But as a general rule the metallurgical engineer's work is confined to smelting operations, while the processes of mechanical concentration of ores, and even the leaching and lixiviation processes, are in the hands of the mining engineer in charge of the other mining work. The reason of this is to be found in the fact that as a rule the mechanical concentration and the lixiviation of ores is carried on at the mine under the one management; while smelting is generally done at some central point at a distance from the mining operations. The department of smelting I must leave out of consideration, and trust some other graduate will take up this very important branch.

Of mining engineers proper, there is a rough classification that will divide them into two classes: the engineers connected with the large permanent mining centres, usually coal and iron; and those connected with the general mining industry scattered all over the world. It is with the work of the latter class that my experience has been, and it is with them that I will deal. This class of mining engineers is again subdivided into two main classes—the consulting engineer and the managing engineer, and the thoroughly competent consulting engineer will have passed through the stage of managing engineer. The work of the consulting engineer can be divided into two main divisions — reporting on the value of properties and reporting on the management of properties. The term managing

engineer would embody in its general sense all the engineers resident about a mine, and would include assayers, chemists, surveyors, mechanical engineers, electricians and those engineers skilled in concentration and lixiviation processes.

The prominent consulting engineer would have his headquarters at some commercial centre—London being the particular home of this class—and he might or might not have assistants or partners in parts of the world nearer to the mining centres. A large part of his work—perhaps his sole work—would be the examining of, and reporting on, the value of mining properties in various parts of the world. This is of course most important work and is correspondingly paid for. In this work experience and judgment, built upon a foundation of wide scientific knowledge, coupled with a well balanced commercial sense and the necessarily ever present disinterested integrity, are the main requirements. It is a position of the utmost commercial responsibility, a single report often controlling the investment of millions. The keynote of success is of course Reputation, and before a man could expect to succeed at this work, he must have built up a reputation, and have made friends. The fees for this kind of work are high. Among prominent London engineers the fee for a report of any consequence would not often be under \$5,000.

Consulting engineers located in either commercial or mining centres also undertake the reporting on the management of mines. They may visit the mine at intervals, or they may simply base their reports and advice on the information, accounts, etc., supplied to the company by the mine manager; and their advice might extend to the supplying of detailed plans for development or for machinery. Consulting engineers in this capacity are frequently engaged by London companies owning mines abroad.

The position of a consulting engineer with a reputation, able practically to choose his own work, travelling in many parts of the world, returning always to his headquarters, and receiving most substantial fees, is a most enviable one, and is one looked forward to as a natural consequence of years of successful work in the field.

But it is to the position of a managing engineer and the steps subordinate to that position that I would more particularly draw

your attention. Perhaps I could not do better than outline the duties and responsibilities in an actual case.

Take the case of a manager of an English Company owning mining territory in Africa. They have one mine partially developed and several prospects giving more or less promise of good values. The Company is managed in London by a board of directors—non-technical men—with a chairman at their head. This Board will meet once a month, or once a fortnight, and will outline the general policy of the Company. The details as far as the London end is concerned are in the hands of the chairman, who relegates them largely to the secretary, who corresponds with the manager in Africa. The manager will have a wholesale power of attorney to do anything and everything in Africa, and will be answerable for all his actions directly to the Board. He will have an agreement or engagement as manager, terminable as a rule by six months notice on either side. He must of necessity have had the full confidence of the Board before he was appointed, and must retain this to the full or his position will become unteppable. The Board will be completely at the mercy of the manager—their only information being what he chooses to give them in his letters and reports, together with that obtained through an annual visit of a director or a consulting engineer. The manager in turn will be very much at the mercy of the misunderstandings and disappointments of the Board, and nothing but full confidence can keep things running. The keeping of the Board well and judicially supplied with information is perhaps one of the most important functions of the manager.

Coming nearer to his work, we find him in charge of an isolated community twenty miles or more from a settlement—100 miles from a railway—with slow-going ox-wagons as the only means of freight transport.

First and foremost he must examine his ore deposits and then with all the knowledge that he possesses of geology and mineralogy, he must form some opinion of their probable value and outline a method of development. With his already partially developed ore deposit, all his past experience of the costs of mining and ore treatment, together with all the information he can obtain in a raw country concerning labour, power, fuel, transportation and markets, will leave him in no high degree of certainty as to probable profits.

He has to study the resources of the country, and to design his plant accordingly. He is alone, single handed, and up against the real thing. And he has to organize in a bare wilderness a large and complex business. While keeping his mind keenly on the deep scientific problems of his various and varying ore deposits, on the problems of haulage, timbering and ore treatment, he has to arrange for the establishing of his camp, the housing of his men and animals, the purchase of innumerable supplies, and transportation over difficult country. He has to procure, and very often to a large extent must be prepared to train, a most varied gang of workmen, skilled and unskilled, in all branches of labour. He has to control a most mixed lot of the roughest class of men, both white and black; at all times he must preserve his personal influence and tone. He is the single-handed autocrat of an isolated community, with nothing to maintain his authority but his own personality. He is spending large sums of money, and spending it in innumerable ways that are difficult to trace and check. On all sides are men trying to get the best of him in every proposition, and he must have the business side—the commercial side—of his work organized to a degree unthought of in many establishments nearer the centres of civilization.

While organizing and personally controlling these varied complexities, he must ever keep a clear mind for the constant, careful and well balanced study of the intricate scientific problems of his work.

Let us consider some of these engineering problems:

In the first place his ore bodies differ in many respects from any he has had any previous knowledge of—no two ore bodies are the same. Nothing but experience—wide and varied experience—founded on a scientific training, is going to save him in the solution of the problems involved in the exploration of his ore bodies.

He has one ore body so far opened up that sufficient values are in sight to justify the installation of machinery on a large scale for the breaking, mining and treating of his ore. Upon all the intricate details I cannot touch, but let us look at some of the main problems involved.

The first problem of mining his ore and protecting his underground workings is one depending almost entirely upon judgment and foresight based on experience, and is one that no amount of

training or reading can solve for him. In any case he must work tentatively—must feel his way. That probably is the keynote of all underground work—certainly of all the early stages. It is impossible to see far ahead, and one must feel his way foot by foot, planning to-morrow's work by to-day's results.

But the planning of the ultimate development which must soon be taken in hand is a large problem involving work spread over many years, and the general skeleton of the plan must be laid out and undertaken at once. Upon the position of his main working shaft or tunnel the position of his surface works will to a large extent depend. Into this problem must enter the problems of pumping, ventilation, and haulage, and much calculation and well balanced judgment are required for a satisfactory solution. The problem involves not only a very large sum in itself, but it will always very seriously affect the working costs.

Inseparable from this problem is the question of power. The case I have in view has practically unlimited water power five miles away, so that the question of power does not affect the hoisting question; and it is found that for the first few years the most satisfactory course is the running of a low level tunnel which will give several years ore supplies above it, and which will always be the main working tunnel.

The next problem is the treatment of the ore, and though the manager ought to be capable of dealing with this problem himself, he may call in the assistance of a consulting specialist.

And here comes in a very nice point:

It is of course out of the question that our mine manager should know everything, or that he should know as much of detail as a specialist in any branch, and very naturally the average business man will say: Here is an isolated problem, let it be solved by the specialist.

In the large mining centres are to be found consulting engineers, who are disinterested specialists in milling and lixiviation processes, and who make a business of such problems. They often are called upon to supply complete plans.

In the first place, there is one statement that will hold under all circumstances:—There is no isolated problem connected with any

mine. The mine and everything connected with it is one vast complex machine, with all its parts and details interdependent, and smooth running—successful running—depends on the balance between all its parts, and upon their perfect inter-working. This can only be achieved in one mind. There must be only one controlling hand, and though it is not necessary for the manager to design all the details, he must fully grasp the essentials of every department. He must be responsible for everything.

If outside consulting advice is called in, it must be in consultation with the manager, and if the manager is incapable of dealing with the subject, a most dangerous element of failure is at once introduced. This is a most essential element of mine management and I will refer to it later on.

If a thorough professional consulting engineer with a reputation is called in to settle the problem of ore treatment, he may be prepared to deal with it in its entirety, in which case he would go carefully into all the conditions surrounding the problem from the ore deposit to the market, and would do this in close consultation with the manager, whom also he would carefully consider as an important condition. Then after designing the plant he would to a certain extent supervise construction, and on its completion would personally attend to the early stages of its operation. For an ore treatment plant is not like a small steam engine which will run when supplied with steam. Even after most careful and capable designing, there will have to be much adjusting of its method of operations before the best results are obtainable, and this adjusting must be done by a capable and responsible head.

If the specialist's connection ceases on the delivery of the plans, the manager's responsibility will only then commence, and if there be any failure in results the manager will blame the design and the designer will blame the method of operation, and the company will be in the position of the man trying to sit on two chairs. This is one of the commonest causes of failure and trouble in mining, and every mining man can point to many incidents of this kind.

In the case I have described, the specialist's fee would be enormous—probably much larger than the manager's annual salary.

Most frequently it would not be possible to obtain the services of a distinguished specialist, and recourse is often had to the



manufacturers of mining machinery. They call themselves specialists in such matters and very often are so, and have much experience and data at their command, but we then have the anomalous position of the consulting engineer and the contractor being one and the same person. It is surprising how frequently this is the case, and it is not surprising that this is most frequently a cause of disaster.

The manufacturer can never be a disinterested party. Conditions do not permit him to make a thorough examination of all the conditions. He will tell you what machinery to put in; it will be his own and there will be as much as possible of it; it will be good machinery, and he will guarantee the smooth running of individual machines, but he will not guarantee the results. And he will have many excuses to show that the blame of failure is not attachable to him. He will tell you that the ore treated in the mill differs from the sample sent him; that the construction was poor and the operation is worse. You cannot pin down the manufacturer to results—he is too old a bird at the game.

What then is the manager to do?

He ought to be capable of designing his own plant. If he feels doubts about it, let him engage a man who has knowledge of such matters, engage him as an assistant—as a head of a department—and let this man experiment on a laboratory scale in co-operation with the manager.

After the manager, with or without outside aid, has decided that his ore is a free milling ore requiring a subsequent treatment of tailings by cyanide, and has decided on the general main idea of his plant, he can safely go to the manufacturer for his machinery, trusting largely to him for all details—for the details are the work of a mechanical engineer, and in this department the manufacturer is the highest specialist.

The first plant will doubtless be a small one, designed with a view to further increase, and also with a view of permitting considerable experimenting.

What I have said in regard to the ore treatment plant also holds good with the tramway from the mine to the mill, and with the water power plant, and with the electric transmission plant, with of course some modifications.

Aerial tramways come nearer to being isolated problems than does any other part of the plant, and they are very frequently given over to contractors, who guarantee to erect the tramway and run it for a short time. To a certain extent the tramway can be looked upon as an isolated machine of the nature of a steam engine. But again to make the contractor and the consulting engineer the same person, even in so simple a matter as a tramway, tends to an unnecessary waste of money and consists in paying to a contractor very much more than what is already paid to the manager or his staff for the same work.

In the case of electric machinery—electricity is perhaps somewhat removed from the mining engineer, but is daily becoming less so, and though the mining engineer would certainly never attempt to design his dynamos, he certainly ought to know enough to decide whether he wanted direct current or alternating machinery and to be able rationally to check over the electrician's figures as to line loss, etc., etc.

To sum up this question of machinery, the manager should be thoroughly conversant with all the standard types of machinery of all the prominent manufacturers that might possibly be of use in mining work, and this includes practically everything except heavy ordnance and marine engines, though the knowledge of heavy guns possessed by the mining staff in Kimberley was of considerable value last year. With the detailed design of this machinery he need not unduly burden himself beyond understanding the why and the wherefore of every part. The manufacturer can be depended on for excellence of detail. Thereon depends his existence.

The erection of his plant is an all-important part of the manager's work or of a most trusted assistant. To let this by contracts generally ends in disaster unless most competent and keen watch is kept on the contractor. Generally speaking, in all mining construction it is more satisfactory and more economical to watch over a good foreman than to check a contractor. The contractor, like the Indian, will be bad if he can be.

The operation of the plant will be the work of the heads of departments always under the personal eye of the manager.

This is a bare skeleton of the work of the mine. It is filled in with an interesting network of details of every kind, from the

niceties of subtle chemical investigation to the handling of a drunken mob, and through it all must run side by side the deepest scientific thought and the most cold-blooded business methods, tempered always by the truest disinterested professional tone.

The manager will have to assist him in his work, besides his own personal assistant, several heads of departments—a commercial superintendent in charge of the buying and of the books and the commercial side of the business generally; a surveyor, an assayer, superintendents or head foremen of mine, mill and cyanide plant, a master mechanic, and foremen of the various sub-departments, and with these the successful manager will keep in very close, intimate touch.

There is another phase of the manager's work that I have not yet touched upon—a department in which he remains alone.

The mine is the property of a company, and the public pay very much more attention to the shares than they do to the mine, and the majority of shareholders expect to make very much more out of the fluctuation in the price of shares than they do out of the mine. There is a constant and active buying and selling of shares. Now the manager's regular reports to his Board can very materially affect the price of shares and his plans of operations do also very materially affect the price of shares; discoveries will be made in the mine that will make enormous differences in the value of the stock. In very many ways the manager has a very large control over the price of the stock, and if there be any deviation on his part from strict honesty, from the true professional spirit of disinterestedness, he may be in a position to make much money for himself or his friends. Here is a wide open temptation—a temptation so coarse and glaring—so palpable—that it will in general be easily avoided, but it has also its more subtle aspects, and the only protection a man has lies in the inherent honesty, the professional spirit and tone of the true engineer.

This is an outline of the position of a manager of by no means large property, and may be taken as a fair general example.

As an example of the extent to which the business of mine management may grow, I would cite the case of The Consolidated Gold Fields of South Africa. In 1897, in their engineering offices in Johannesburg, they had fifteen draughtsmen in the surveying department, and seventeen more in the general department. Their

chief engineer drew a salary of \$60,000 a year, their chief mechanical engineer drew \$25,000, and so on. Of course this office did all the engineering work for a large group of mines.

But it is the smaller propositions that tax the resources of the mining engineer most severely, for in these cases he must himself control every department and must carry out works that in larger concerns would be in the hands of heads of departments in themselves specialists capable of carrying responsibility.

In an examination of the duties of the mine manager, as I have outlined, what do we find as the more prominent points? I think we shall find that the most important point of all is confidence—mutual confidence between the directors and the manager. To obtain this the manager must be a man of experience—a man with a record—a man who has made friends. The next point of importance is the fact that the whole concern, first, last and all the time, is a business proposition undertaken with the sole and only purpose of making money, and as far as our engineer is concerned, making money legitimately, though—and this is a point ever to be remembered by the young graduate—there are always those seeking to make money illegitimately. The whole concern in every department must be organized on a commercial basis. The third point of importance is the essentially scientific character of all the problems involved in the finding, winning and treating of the ore. In the young graduate's technical course, his whole time and energies being occupied with this latter point, he is apt to lose sight almost altogether of the other two. But these three points are as inseparable as the three dimensions of space, and any proposition founded on two only will be a failure.

Of course there is an exception to this rule—the factor known as luck may once in a thousand times upset all rational conceptions.

Besides these three fundamental points there are others of nearly equal importance. All mining work is new work; every problem is a new one, differing in many respects from the engineer's previous experiences; every problem is complex, involving a large number of facts and conditions often very obscure. The engineer must be a man of varied experience, not only conversant with a wide range of scientific knowledge, but with a very wide range of actual experience. He must be essentially quick witted and he must have

a lively technical imagination, ever ready to imagine new combinations and possibilities. But his temperament and technical character must be strong enough to allow this technical imagination full play, without its carrying him off his feet into a wilderness of conjecture.

He must be physically strong—able to live anywhere and eat anything; he must ever be ready to pack his blankets and his scientific knowledge on his own back.

He must be a professional man in the fullest sense of the term. He must have *tone*; I cannot define *tone*, it marks quality, or shall I say *quality* marks *tone*. And *tone* is as unassailable as it is hard to define. From the first step to the last the mining engineer is surrounded by temptations of every kind; every tendency within him will have free opportunity to pull him towards disaster. From the start he is away from the influence of custom and social ties, and he who has never been absolutely free from these influences can have little conception of the extent of their controlling power. But the temptations arising from avarice and ambition are the most continually and persistently present. And these temptations are often of the subtlest kind—most frequently not having even the appearances of temptation, and this is a phase of his work in which the engineer stands alone—a game in which he must play a lone hand.

Somebody—Gilbert Hamerton, I think—has said that the most important characteristic of a critic should be disinterestedness. Disinterestedness is the foundation and skeleton framework of the whole structure of the professional man. If he is not disinterested he is nothing. He is an employee and his interests always must be on behalf of his employer. This explains how the mine manager can be a business man and still a professional man. He is carrying on business for another and he can carry it on only in the cleanest and straightest of business methods.

Another thing to be observed in the work of our mine manager is that he has more to do with human nature than with any of the other forces of nature. He has to deal with his directors on one hand, and with his employees on the other. He has to deal continually with the cleverest scoundrels and rogues of all classes and kinds. He has to depend on his judgment of character in black, red, yellow and white.

Well, gentlemen, have I painted an impossible picture for you? I have outlined the main skeleton frame of a possible structure—a structure for which there is an enormous demand; the completion of the edifice depends upon the individual.

So much for what there is in front of us. Let us now consider our first steps.

The young graduate, despite his hard work and scientific attainments, is, as an engineer, well nigh as useless as the new-born babe. I know you will not believe this—it is not compatible with your years and your efforts—it is probably just as well that you don't believe it, but it is one of the first important things that you must learn in the outside world.

How is this so? Thus: the young graduate has had no experience (I know there are exceptions), consequently can have no judgment, and therefore is absolutely incapable of responsible initiative.

Many people will tell me I am entirely wrong—that the young graduate is full to overflowing with judgment—that he will judge anything or anybody, and as for initiative, he has the nerve and the supreme self-confidence to tackle any proposition—to initiate anything. Exactly—that emphasises what I mean—he has no judgment—that is, no judgment that can be depended upon.

In England they put the embryo engineer in an incubator—that is—he is articulated as a pupil for one, two, or more years to an engineer of standing and experience, and for this privilege he will pay as much as \$1,000 a year, and will receive no pay of any kind in return for his work. With this idea I would be wholly in accord, if the conditions in the colonies permitted it. I would not advise for a colonial mining graduate an articulated pupilage in England; but if a western mining engineer would take him, he could not possibly do better. But out here the conditions are different, and we have to face conditions as we find them.

In the first place, many of our technical graduates have not the means to pay any pupilage fees, nor even to give their services and time for nothing; they must earn soon after graduation. And again I do not think you could persuade any mining engineer in active work on this continent to accept pupilage fees or to have about him a pupil working for nothing.

The young graduate must earn money, and it is a function of the technical school to leave him in a position to do this, and there are two or perhaps three or even four branches of work in which the technical schools can turn out commercially useful men. I refer to assaying and surveying, and to a certain extent, draughting.

The school can—if it chooses—turn out men who could take hold of the position of assayer or of surveyor at any small mine, or who would make excellent assistants on a large property. These positions require practically no judgment or initiative, and the main difference between the work at the school and the work at the mine, consists in the rapidity that is required in commercial work, and a certain ability to make shift with the anything but ideal conditions and appliances that one may be up against. If to a smooth working knowledge of assaying and surveying, the young graduate has added an active knowledge of book-keeping and cost-keeping, he has three strings to his bow that will earn him a living in any active mining camp.

It is a common saying in the West that if you cannot get one job you should take two, by which is meant that you may often be able to get a job as an assayer and book-keeper combined where you could get nothing if you applied for either singly. My advice to any technical school would be—make book-keeping and cost-keeping and the commercial organization of engineering business, an important part of your curriculum. My advice to any student of a school where this is not part of the curriculum is, to take steps to make a special study of these subjects at the earliest possible opportunity.

The obtaining of a position as assayer or surveyor, and, from that position, studying the actual working conditions of a mine, to be ready for further advancement in your profession, is the orthodox method.

The surveyor has the better opportunity—he is here, there and everywhere on the property—mixed with everybody and sees everything that is going on, and will be more naturally given the position of acting manager or assistant manager.

However, before going any further, let us consider more fully the functions of the first few years after graduation. The first function doubtless is the earning of a living, and the orthodox way

of doing this I have outlined. But if you stop at that, you will never be an engineer. The main function is to get experience—wide, varied experience—of everything you will need in after years. Another function is to make professional friends, but the main point is experience.

In your S. P. S. course you have had a most excellent training. You have been trained to think—to reason—to read and to a certain extent to observe—you have been trained to ask the question “why?” and to make an effort to rationally answer that question. You have learnt much about the physical laws underlying all engineering problems. The excavations have been dug and a very substantial foundation has been laid for a very elaborate superstructure; and further than this, the skeleton steel frame work has been in part erected; and even still further, if the material for further erection has not been gathered, the method of obtaining it has at least been indicated. You can live in the cellar if you like, but that will never make a house of it—you will never be an engineer. You must build on the foundation. You must fill in the skeleton frame work—you must erect extensions to your frame work—this you must do alone. Nobody else can do it for you. The elaborating of the structure is by personal experience.

In my student days Prof. Galbraith advised us to devote the first ten years after graduating to the sole function of gaining a varied experience. I think this most excellent advice.

No matter what position you hold you will be gaining experience, and to gain a varied experience you must not stay too long in one position. But you must not trust to hap-hazard luck in the positions you get. There are several points to be remembered. In the first place in your early days you can do things that later on in your professional life, you could not do. For instance, on graduating you could work as a mucker or common labourer underground—or you might innocently be employed by some notoriously corrupt men or companies. In neither case would your reputation suffer and you would be the gainer by some valuable knowledge.

The most prominent feature of mining work in all parts of the world (and in Canada and in Ontario have we had most scandalous examples of it) is the extreme corruption, crookedness and dishonesty that frequently accompanies it. This exists to a degree



beyond all conception by those who have not actually seen it. If you keep this fact in view and remain always ready to quit a job when it looks dirty, you can in your early years take pretty nearly anything you can get, but later on you must be more careful what you do. Then the main point would be to get near good men, near good companies and successful concerns.

In your early years there are several very unorthodox things that I would advise. In all mining work the biggest item is for labour, and there is no other item of expenditure in which money may be lost or saved to the same extent. The human machine is not only the most used, but it is the most complex, and to be a successful mining man you must understand your workman. The best place to study your workingman is alongside of him. I strongly advise every young mining graduate to work as a mucker or trammer underground in some fairly large mine. To do this properly you must do it thoroughly and drop all your engineering business, and your diploma and all that, and get into dirty overalls and get your job from the foreman and sleep in the bunk-house and keep away from the office. This I know is often advised, and in Cornwall and Freiberg there are regular practical courses underground where the students play more or less seriously at work and learn after a fashion to swing a hammer and frame a set. Candidly I don't think much of that—I do not see that such work is of very much use, and in those practical courses you don't learn anything of the men—you don't get round to their point of view. This to my mind is the essential point, and my advice is to get a mucker's job and hold it at least over one pay day and over several if you can. It will hurt and it will be hard, but it will be worth it.

Again, if you have any inclination towards carpenter's work or machine fitting or any opportunity to follow up such work, I say by all means do so. I know of no better qualification for a young man seeking mining experience than a knowledge of machine fitting. There is no part of a mine free from machinery, and the fitter is wanted everywhere and gets a job more easily than any other class of skilled or semi-skilled workman; while a carpenter can often get a job on mill construction or the like that will give him an insight into construction that he could get in no other way. These are not short

cuts to success or by-paths—they are stepping stones and most valuable ones at that. I would strongly advise the mining student to spend at least one of his summers in a machine shop or a carpenter's shop. I would consider this better than a summer spent in an assay office, on survey, or in a mine.

The next question is as to where the young graduate is to go on graduation. Into the question of a post-graduate course I cannot go beyond saying that I am in favour of a post-graduate course, and would still recommend Freiberg despite all the advances made by technical schools on this continent.

After the completion of his technical course he should go to some *active* mining camp, and I certainly would choose the Western States. I am enthusiastically a Canadian, but I do not advise the young mining engineer to remain in Canada. He should go to an older mining country for his experience, and the United States—the Western States—has trained and still is training the world's most prominent engineers. And when you go west leave your diploma behind you, also your testimonials and recommendations. (You will be looking only for subordinate positions, and for these positions men will size you up by looking at you and will discharge you as casually as they engage you. Never be afraid of quitting a job. It is no disgrace—very often it is not a bad thing to be discharged. A willingness to turn your hand to anything and everything that comes your way and do it with your best effort, are traits that will help you more than others. It will be several years before you get to what your heart pines for—that is, real engineering work—but you must not neglect it for that reason; your eyes must always be open to everything about you, and you must read everything you can lay your hands on—technical magazines and catalogues in particular.

You will probably find the life a hard one, full of painful physical effort—full of misunderstandings and disappointments. Hope will be long deferred. Your scientific attainments will seem lost—swallowed up by chance and the force of circumstances. You will think you are losing all your finer feelings—your social niceties; the latest operas and plays will hardly be known by name to you and the popular airs will be three years old when they reach you. Life will be anything but a soft snap and your only consolation will

often be: "Well, it's good experience, and anyway, it's all in the day's work!" You will find that you will have to give up very much, if not all that went to make life pleasant, and you will get in return—if you are lucky—work—and in many years—if you are lucky—well paid work.

But you will see—and if your eyes are open, life will be very full—you will play your own game with a freedom and a scope unknown in any other profession. You will have opportunities to carry your tendencies to the full. You will be with men and you will work with men, and the conditions and surroundings will be such as to bring out, in full prominence, the characters good and bad of men. Veneer and polish will be absent, and if you are a lover of men you will love your life. If you want an easy life leave mining alone. If you are not a tramp and want everything settled—if you are contemplating early marriage—don't go in for mining, for you will have to live and work where it would not be fair to take her.

Let me finish up by giving you some disconnected bits of advice on matters in general.

Treat every friend as if some day he might be your enemy, and treat your enemy as if some day he might be your friend.

In making investigations or examinations take absolutely nothing for granted.

Trust everybody *but* cut the cards.

Keep your face shut.

In everything remember first that you are a professional man.

Kipling says:—

"There are nine and sixty ways of constructing tribal lays,  
And every single one of them is right."

There are also nine and sixty ways of skinning a cat or doing anything else, and very often every single one of them is right; it depends on circumstances.

In other words, different circumstances will demand different methods. Do not be afraid of new methods.

Nelson, B.C., February, 1902.

**THE POSITION OF AN ENGINEER AS ARBITRATOR UNDER  
THE CONTRACT.**

---

ANGUS MACMURCHY.

---

The employer appoints the engineer under the contract, and the contractor has to accept him. He has no choice or option in that matter. Not only must the contractor execute the works in accordance with the directions of the engineer under the contract, but the engineer is usually made the sole judge of the quality and sufficiency of the works when executed, and the engineer is also most frequently made the final judge in any dispute arising under the contract between the employer and contractor. Thus it will be seen that the functions of the engineer/as arbitrator are both extensive and important.

The engineer is responsible to his employer under the contract; to the contractor he is responsible by law only in case of fraud or misconduct. In legal phraseology there is privity between the employer and the engineer, but there is no privity between the contractor and the engineer. The consequence of this is that the contractor has a cause of action against the employer only, unless the engineer has been guilty of fraud or deceit while acting under the contract. But the contractor in a proper case has an action against the engineer for negligence in the discharge of his duties.

For many purposes, the acts of the engineer and the owner or company employing him are identical or rather equivalent. As stated by Lord Cranworth, his position is not quasi judicial. *Ranger v. G. W. Ry. Co.*, (1854) 5 H. L. C. at p. 89.

If an engineer acts bona fide according to the contract, that is quite enough to make his acts valid and binding upon the contractor. So long as the engineer has no concealed interest in the contract or secret relationship to the parties that will certainly bias his judgment, his acts will receive due weight, in fact he may almost be called the judge in his own case.

The contractor, however, is not always bound by the decision of the engineer, as, for instance, in a case decided in 1818, *Kemp v. Rose*, 1 Giff. 258, the builder was bound by the contract to accept the decision and certificate of the architect as to the amount to be paid for his work, but the builder did not know that the architect had promised the employer that the work would not cost more than a certain sum—in that case the Court did not consider the decision of the architect made under such a bias binding.

The last reported case on this subject comes from Chatham and is just to hand. There the superintendent under the contract was the uncle and “drowned in debt” to the owner. This was unknown to the contractor, who brought an action to recover the balance claimed by him without procuring the superintendent’s certificate. It was held by the Court of Appeal, Chief Justice Armour’s vigorous intellect brushing aside, as usual, formal and technical legal defences, that the relationships, “family and financial,” of the superintendent to the defendant owner, for whom the house was built, should have been disclosed to the plaintiff contractor, and that under the circumstances the plaintiff was not bound to obtain the certificate required by the contract from the superintendent at all.

*Ludlam v. Wilson*, (1901) 2 O. L. R. 549.

This whole subject of the circumstances under which a contractor is dispensed from the necessity of procuring the final certificate called for by the contract was much discussed in a notable case in our own Courts some ten years ago, that of *Conmee v. C. P. R.*, which lasted for seven years in the Courts with varying fortune to either party, judgment being given at the trial without a final certificate in favour of the contractors for upwards of a quarter million dollars, which was compromised for a much smaller amount after appeals to the Court of Appeal and Supreme Court.

Before proceeding to discuss some of the more recently decided cases to further illustrate these remarks, let me read a portion of one of the clauses (from the present form of contract used by the City of Toronto) constituting the engineer the sole judge:—

Z 20. “Should any discrepancies appear, or differences of opinion or misunderstanding arise, as to the meaning of the Contract or of the General Conditions, Specifications or Plans, or as

‘ to any omissions therefrom, or misstatements therein, in any  
 “ respect, or as to the quality or dimensions, or sufficiency of the  
 “ materials, plant or work, or any part thereof, or as to the due  
 “ and proper execution of the works, or as to the measurement  
 “ or quantity or valuation of any works executed, or to be executed  
 “ under the contract, or as to extras thereupon, or deductions  
 “ therefrom, or as to any other questions or matters arising out of the  
 “ contract, the same shall be determined by the Engineer . . .  
 “ and his decision shall be final and binding upon all parties con-  
 “ cerned, and from it there shall be no appeal.”

The result of many decided cases is the introduction into such contracts of many safeguards and restrictions drawn from wisdom learned by experience. Now, let us glance at a few of the judgments in which such similar provisions have been discussed by eminent Judges in England and Canada.

JACKSON V. BARRY RAILWAY COMPANY (1892), 1 Ch. Div. p. 258.

Arbitration—Unfitness of Arbitrator—Injunction—Jurisdiction.

A contract by which the plaintiff undertook to construct a dock for the defendant company, provided that any dispute between the company and the contractor as to the meaning of any part of the contract, or as to the quality or description of the materials to be used in the works, should be referred to the company's engineer as arbitrator. The dispute arose whether the contract required the interior of a certain embankment to be made of stone, or whether rocky marl was allowable, so that, if the contractor by the direction of the engineer used stone, he would be entitled to be paid for it as an extra. A correspondence took place between the contractor and the engineer, in which the engineer stated his view to be that the contract bound the contractor to use stone, and that it was not an extra. The company then referred the dispute to the arbitration of the engineer. After this reference, and on the day for which the first appointment had been made, the engineer wrote to the contractor a letter in which he repeated his former view. The plaintiff brought this action to restrain the company from proceeding further with the arbitration.

Kekewich, J., held that the last letter showed that the engineer had finally made up his mind on the point, and was, therefore, disqualified to act as arbitrator, and granted an injunction.

Held, on appeal, that, considering the position of the engineer who, as engineer of the company, must necessarily have already expressed an opinion on the point in dispute, his writing after the commencement of the arbitration a letter repeating the same opinion would not disqualify him from acting as arbitrator, unless, on the fair consideration of the letter, it appeared that he had made up his mind so as not to be open to change it upon argument:

Held by Lindley and Bowen, LJJ. (Dissentiente A. L. Smith, L.J.), that the letter in question did not, upon its fair construction, show that the engineer had precluded himself from keeping his mind open, and that the injunction ought to be dissolved; and whether there was jurisdiction to grant it, quære.

Bowen, L.J.: It was an essential feature between the plaintiff and the railway company that a dispute such as that which has arisen between the plaintiff and the company's engineer should be finally decided not by a stranger or a wholly unbiassed person, but by the company's engineer himself. Technically the controversy is one between the plaintiff and the railway company; but virtually the engineer, on such an occasion, must be the judge, so to speak, in his own quarrel. Employers find it necessary in their own interests, it seems, to impose such terms on the contractors whose tenders they accept, and the contractors are willing in order that their tenders should be accepted, to be bound by such terms. It is no part of our duty to approach such curiously coloured contracts with a desire to upset them or to emancipate the contractor from the burden of a stipulation which, however onerous, it was worth his while to agree to bear. To do so would be to attempt to dictate to the commercial world the conditions under which it should carry on its business. To an adjudication in such a peculiar reference the engineer cannot be expected, nor was it intended, that he should come with a mind free from the human weakness of a preconceived opinion. The perfectly open judgment, the absence of all previously formed or pronounced views, which in an ordinary arbitrator are natural and to be looked for, neither party to the contract proposed to exact from the arbitrator of their choice. They knew well that he possibly or probably would be committed to a prior view of his own, and that he might not be impartial in the ordinary sense of the word. *What they relied on was his professional honour, his position, his intelligence;* and the contractor

certainly had a right to demand that whatever views the engineer might have formed, he would be ready to listen to argument, and, at the last moment, to determine as fairly as he could, after all had been said and heard. The question in the present appeal is, whether the engineer of the company has done anything to unfit himself to act, or render himself incapable of acting, not as an arbitrator without previously formed or even strong views, but as an honest judge of this very special and exceptional kind. I will assume (without deciding) what was assumed by both sides, in the argument at the bar, that the point before us is properly raised in such an action as the present, and consider the matter entirely on its merits. That the letter of the 2nd of August shows Mr. Barry to have had, and retained up to the opening of the arbitration, a rooted view that the contractor was wrong, is obvious. This, Mr. Barry may not have been able to avoid. Has he, then, disqualified himself from pursuing the function of such an arbitrator as the contract contemplates, by informing the contractor, in answer to the contractor's controversial letter, of what the contractor, I am convinced, well knew already, viz.: that Mr. Barry wholly disagreed with him? I cannot see that the letter of the 2nd of August warrants the inference that Mr. Barry would not or could no longer do his best, when the matter finally came before him and his legal assessor, to decide honestly between his own distinct view and that of the contractor. He restates, it is true, what he had already stated, and I daresay he thought it fair and honest towards the contractor to do so. I should agree with my brother Kekewich's judgment, if I thought the letter of the 2nd of August amounted to an intimation that the contractor would not be patiently listened to and receive at the last an honest decision. Where I differ from my brother Kekewich is, that he seems to me not to have made sufficient allowance for the very special character which by the contract this arbitrator had to fulfil, and to have required from the engineer of the company, who must necessarily be a somewhat biassed person, but by whose decision, nevertheless (fairly given), the parties had contracted to be bound—the *icy impartiality of a Rhadamanthus*. The difficulty in the contractor's way arises, not from the engineer's utterances in the letter of the 2nd of August, but from the fact that the contractor, by his contract, had pledged himself to submit this very dispute that has arisen to the person



with whom he virtually is waging it. The contractor is, as it appears to me, catching at a straw; endeavouring on the ground that the engineer had revealed a view which every one was aware he entertained, to escape from an onerous arbitration clause which the contractor accepted as part of the consideration for his bargain. To release him on such a pretext would be to dissolve his obligations under the contract and to substitute, by force of the power of this Court, *a wholly different and far more agreeable kind of arbitration before either some stranger or a jury of strangers*, a tribunal which it was the express object of this contract to exclude.

For these reasons I differ from my brother Kekewich, with whose views as to the importance of judicial impartiality I entirely coincide, regarding them only as not quite applicable to this special case, in which it was part of the very bargain that the scales of justice in the case of a dispute need not be held in a neutral or wholly indifferent hand.

MCNAMEE V. TORONTO (1892), 24 O. R. 313.

By contract between contractor and city for additions and improvements to its waterworks system, all differences were referred to the award of one H., superintendent in charge of the waterworks.

Held that H., being superintendent, did not disqualify him from being arbitrator, and on the evidence no cause existed to restrain him from proceeding with arbitration:

Causes urged: H. furnished estimates of costs of work to city, which were acted upon in accepting plaintiff's tender unknown to plaintiff when he executed the contract.

Held, the fact that the superintendent signed certificate as to penalties to be deducted did not show he had prejudged the case.

Boyd, C.: The Scotch cases show that when arbitrator named is also engineer of works, anything he says or does falling within his ordinary functions as engineer does not disqualify him as arbitrator; this results from his dual character—in one relation acting as agent or representative of proprietors, and in the other changing his function to that of a judge who is to hear both sides before he decides the matter in dispute.

IVES AND BARKER V. WILLANS (1894), 2 Ch. 478.

An arbitration clause referring disputes to the engineer of one party cannot be disregarded on the ground that the engineer is in substance a judge in his own case, unless there is sufficient reason to suspect that he will act unfairly.

Provision: "If any question, difference or dispute shall arise between company and contractor touching the construction or meaning of anything contained in these presents or in said specifications, etc., or as to any works, plant, material, etc., which the company may require the contractor to do, or any extra work ordered or as to price to be charged, or moneys alleged to be due, or rights and liabilities of either parties, etc., the matter or difference shall be referred to the engineer, whose decision thereon will be final and conclusive on both parties."

Lindley, L.J., says:—"That is a very stringent provision and one is surprised at first that any contractor should submit to be bound so tightly, because a dispute between contractor and company is in substance a dispute between contractor and engineer, whose business it is to see that works are done for the company according to agreement, plans and specifications; and the real agreement between the contractor and company is that if there is any dispute between them, the engineer can tell the contractor what to do, and order him to do what he likes consistently with the agreement, his decision must be final."

The learned Judge gives two reasons. First: Competition for this kind of work is very keen and contractors compete with each other to get it. Second: It has been ascertained by long experience that *engineers of the highest character may be trusted*, and when a contractor enters into such a very stringent provision such as this he knows the man he has to deal with.

ECKERSLEY V. MERSEY DOCKS & HARBOR BOARD (1894), 2 Q. B. 66.

The rule which applies to a Judge or other person holding judicial office, viz., that he ought not to hear causes in which he might be suspected of a bias in favour of one of the parties, does not apply to an arbitrator named in a contract, to whom the parties have agreed to refer disputes which may arise between them under it. In order to justify the Court in saying that such an arbitrator is disqualified from acting, circumstances must be shown to exist

which established at least a probability that he will be in fact biassed in favour of one of the parties in giving his decision.

This was a dispute between the contractors and the board above named, in which the former claimed that by the negligence or incompetence of the assistant engineer, who was the son of the engineer under the contract, water had escaped into the Canada Dock which they were excavating, causing them delay and loss. The contractors commenced an action claiming it should not be stayed under arbitration clause, because of probability of bias of engineer in favour of defendants, and that engineer's son hoped to succeed his father in the post of engineer to board.

That eminent Judge, Lord Esher, said:—

“It seems to be admitted that if the engineer had to consider whether he had himself given a negligent or unskilful or incompetent order, it could not be said that the Court would be justified in directing that the matter would not be referred to him, but the Court is asked to act because such an order was given by his son; *i.e.*, a man who could not be biassed in judging of his own acts would be biassed to give a decision in favour of his son which he knew to be wrong. I cannot take that view of human nature.”

“Where you have a man of high character, one whose character for impartiality cannot be impeached when he has to decide as to his own conduct, to say such a man would not have enough honesty and strength of mind to act impartially when his son's conduct came in question, is a statement which I cannot accept. I do not believe it in this particular case.”

GOOD V. T. H. & B. R. CO. (1899), 26 A. R. 133.

The rule that a contractor is bound by a condition in his contract making the employer's engineer the interpreter of the contract and the arbiter of all disputes arising under it, does not extend to a case where a named engineer, while in fact the engineer of the employer, is described in the contract as, and is supposed by the contractor to be, the engineer of a third person.

In a contract between Good and a construction company, the engineer named was that of the railway company. The construction company in reality, though unknown to the contractor, controlled the railway company, and the engineer was really paid by them.

This was also unknown to the contractor. The final certificate was not given under the contract, but Armour, C.J., held that this did not disentitle the contractor from payment for his claim, the engineer being "Young's man from the beginning," Young formed the construction company, and the construction company controlled the railroad company. The learned Chief Justice said that the contractor was entitled to say upon discovering the arrangement between the engineer and construction company: "He is not our choice as judge under this contract, and we repudiate our being bound by the term of the contract which requires a certificate from him;" and Mr. Justice Osler held that the contractor had the right to assume that the engineer was not the servant or agent of the construction company, not their salaried official, that he owed no duty to them as having been employed by them, and that he was independent of them.

---

## NOTES ON ALUMINUM CONDUCTORS.

F. C. SMALLPEICE, '98.

Since the earliest days of electrical engineering the superiority of copper as a conductor for commercial use has been undisputed. The high specific conductivity of copper (almost equal to that of silver), the ease with which it can be drawn into wires, and the high tensile strength of such wires, only exceeded by steel and iron, are properties which have rendered the metal invaluable for electrical purposes. In addition to this, the metal can be freed from its impurities, and a very uniform product obtained by comparatively inexpensive processes.

Within the last two or three years, however, the absolute rule of copper in the electrical world has been somewhat shaken by the rapid advances made in the manufacture of aluminum. Undoubtedly the abnormally high price of copper during the past three years has been largely instrumental in bringing to notice the claims of aluminum; and whether the latter will ultimately displace copper for some purposes is largely a matter of conjecture. Though but recently introduced, aluminum has been used for several long transmissions on this continent and in Europe, and great interest is being manifested in the results obtained on these lines.

Aluminum can hardly be said to have attained importance as a commercial product, or, at any rate, as a rival of copper, as the following figures will show:—

For the year 1900—

The world's output of aluminum was 6,150 tons, of which 2,225 tons were produced in the United States.

The output of copper for the same year was 543,000 tons, the United States producing 300,000 tons.

Thus the output of aluminum was only about 1.1% that of copper.

On this continent the only company manufacturing aluminum is the Pittsburg Reduction Company, operating works at Niagara Falls, N.Y., and at Shawinigan Falls, P.Q. During the past year or two this company has hardly been able to keep pace with the demand for its product.

In Europe there are six firms engaged in the reduction of aluminum from its ores, one of these being an English company. The methods employed are for the most part secret, but in all cases the process involves the use of electric current in a bath of fused electrolyte. It may also be said that all the European companies manufacture calcium carbide, though, of course, this is an entirely distinct branch of their business, the process being quite different from that of aluminum reduction.

The price of aluminum to-day is in the neighborhood of 30c. per lb., while the price of copper being controlled largely by trusts and subject to the trickery of the stock market, has in the last year ranged from 19c. to 12c. per lb. Considering the relative specific gravities and conductivities of the two metals for any given transmission, the weight of aluminum required is, roughly, half the weight of copper. Consequently at 30c. per lb. aluminum is equivalent to 15c. copper; and at 20c. per lb. would be as cheap as copper at 10c. Thus, though the aluminum industry is still young, the metal can to-day be put on the market at a price equivalent to that of copper as a conductor; and it seems probable that as their output increases the manufacturers will be able to produce the metal at still lower prices.

*Specific Gravity.*—Considering the properties of the two metals as affecting their use as conductors, we have first the specific gravity of chemically pure aluminum=2.56, while aluminum wire over 99% pure has a specific gravity of 2.68. This increased density in the com-

mercial wire is not proportional to the amounts of impurities present, but seems to be due to a contraction caused by these impurities, and depends also on the working of the metal. The specific gravity of commercial copper we may take as 8.93. Thus we get 1:3.33 as the ratio between the weights of equal volumes of aluminum and copper.

*Tensile Strength.*—Perhaps nothing has contributed so to the lack of confidence felt by many electrical men towards the new conductor as the failure, due to low tensile strength, of several of the first aluminum lines to be installed in this country.

When first introducing aluminum wire advantage was taken by the Pittsburg Reduction Co. of the fact that almost all foreign metals when alloyed with aluminum increase the tensile strength of the wire.

For instance, a No. 12 B. & S. wire showed a tensile strength of 39,000 pounds per square inch; same wire alloyed with 1% nickel, 45,000 pounds per square inch; same wire alloyed with 2% nickel, 55,000 pounds per square inch.

This increased tensile strength was not gained, however, without offsetting disadvantages. For, taking the conductivity of the pure aluminum as 63 in the Matthiessen standard, one per cent. of nickel reduced this to 58, while the two per cent. alloy showed a conductivity of only about 54. The above is the result of a test made by the Pittsburg Reduction Co.

For all the first lines installed alloyed wire was used, and the result was far from satisfactory. In almost every instance so many breaks occurred in the lines that they had to be replaced. In one instance over fifty breaks were reported in a mile of line, all occurring inside of one month. The cause of these failures seems to be a lack of homogeneity in the alloyed wires. Apparently the copper, nickel or other metal used to give strength to the wires does not form a perfect alloy with the aluminum, but tends to settle in spots in the wire bar. These spots are hard and brittle, and the wire is very apt to break at these points.

The use of alloyed wires has, however, been abandoned, and all wires sold at present are commercially pure aluminum. The results obtained have been very gratifying to the manufacturers.

The following figures are from tests made by the Pittsburg Reduction Co.:

	Elastic Limit	Ultimate Strength	Reduction in Area Per Cent.	Estimated Safe Working Load
Average of tests on wires $\frac{1}{2}$ " to $\frac{1}{8}$ " diameter (wire as drawn).....	12000	24500	58.46%	4500
Same annealed.....	10870	22830	65.57%	4500
Average of tests on wires $\frac{1}{16}$ " to $\frac{1}{32}$ " diameter.....	32000	54000	68.00%	12000
Same annealed.....	21000	33000	62.00%	7000

The tests were made on No. 1 quality aluminum, all over 98% pure. Annealing renders the wire more pliable, and more easily handled.

The practice of the company at present is to make all line conductors up in the form of cables. The reasons are two-fold. First, any weakness in one strand, due to hard spots caused by the concentration of impurities, does not endanger the whole cable. By stranding the conductor there is only a small chance of these brittle places coming together in the cable, and thus though one strand may be weak, the strength of the whole section will not be greatly affected. The second reason for stranding line conductors will be apparent by referring to the table just given. The higher tensile strength in the smaller size of wire is quite marked.

Up to No. 8 B. & S. 3-strand cables are used. For No. 6 B. & S. either 3 or 7 strands; and the number of strands is increased for sizes still larger.

Comparing the tensile strengths of copper and aluminum, Dr. Kennelly's tests for the Bay Counties Co. of California gave an average of 33,000 pds. persq. in. as the ultimate strength of the aluminum wire used. The strength of soft drawn copper is given by Roebling as 32,000 to 36,000 pds. per sq. in., and 45,000 to 68,000 for hard drawn wire. In comparing, however, we must remember that for the same conductivity an aluminum conductor must have a cross-section 1.6 times that of copper. !

The elastic limit of aluminum is not very well defined, for the reason that the wire takes up a permanent set at very low strains.



It appears, however, that somewhere between 14,500 and 17,000 (according to Dr. Perrine) this permanent set increases rapidly, indicating that the safe working load lies within these limits. In one respect this tendency to elongate is an advantage, since it counteracts to some extent the effect of the large co-efficient of expansion referred to later. For instance, a span drawn up in the summer, so as to allow but little sag, might break under the heavy strain due to the contraction in cold weather were it not for the stretching of the wire. It is necessary to exercise care in erecting aluminum spans to avoid reducing the cross-section in drawing up.

Under these conditions copper is much better, though soft-drawn wire has the same tendency. The percentage elongation in hard-drawn copper is very slight, but a loss of about 2% in conductivity can be counted upon, due to hard-drawing.

*Expansion.*—British Board of Trade gives the following figures:

Co-efficient of expansion (linear).

Aluminum.....	0.00001234.	} Per degree Fahrenheit.
Copper.....	0.00000887.	

*i.e.*, expansion of aluminum is 1.39 times that of copper.

Thus in climates subject to extremes of temperature greater care must be taken in erecting aluminum lines to give them the proper sag. In this connection rather complete tests have been made by the Pittsburg Reduction Co. to aid their customers in the erection of lines. In a span the sag at any given temperature cannot be computed from the co-efficient of expansion given above, since every increase in the length of the wire due to rise of temperature causes a decrease in the tension of the wire. Supposing the strain to be within the elastic limit, the decrease in tension causes a proportional decrease in length, so that it has been found that the net expansion is about one-half what it would be if the wire were supported throughout its whole length.

The method of determining the net expansion is as follows:—

Spans of different lengths are chosen and the wires fastened securely at one end. The other end runs over a knife edge to a spring balance. By a standard at the centre of the span the deflection is measured. The deflection being noted and also the corresponding tension, the wire is given more sag by allowing a length

corresponding to the linear expansion for any desired rise of temperature to pass over the knife edge. Then the deflection and tension are again noted. Thus the conditions of the wire over a wide range of temperature can be determined.

The table gives the results of a series of such tests.

TABLE OF DEFLECTIONS AND TENSIONS FOR ALUMINUM WIRE.

X = Deflection in inches at centre of span; S = Factor, which multiply by weight of foot of wire to obtain tension. Maximum Load = 15,000.

Span	t = -20° F		-10°		0°		10°		20°		30°	
	S	X	S	X	S	X	S	X	S	X	S	X
80	12940		1660	5 $\frac{3}{4}$	1176	8 $\frac{1}{2}$	961	10	833	11 $\frac{1}{2}$	781	12 $\frac{5}{8}$
100	12940	1 $\frac{1}{4}$	2083	7 $\frac{1}{2}$	1470	10 $\frac{1}{2}$	1202	12 $\frac{1}{2}$	1042	14 $\frac{3}{8}$	933	16
120	12940	1 $\frac{3}{4}$	2500	8 $\frac{5}{8}$	1768	12 $\frac{1}{4}$	1400	15 $\frac{3}{8}$	1251	17 $\frac{1}{4}$	1120	19 $\frac{1}{4}$
150	12940	2 $\frac{3}{8}$	3038	11 $\frac{1}{2}$	2540	14 $\frac{3}{8}$	1788	18 $\frac{3}{4}$	1552	21 $\frac{3}{8}$	1390	24
175	12940	3 $\frac{1}{4}$	3643	12 $\frac{5}{8}$	2576	17 $\frac{1}{4}$	2104	21 $\frac{3}{4}$	1822	25 $\frac{1}{4}$	1630	28 $\frac{1}{4}$
200	12940	4 $\frac{1}{4}$	4206	14 $\frac{1}{4}$	2947	20 $\frac{3}{8}$	2403	24 $\frac{7}{8}$	2084	28 $\frac{3}{4}$	1930	31 $\frac{1}{8}$

40°		50°		60°		70°		80°		90°	
S	X	S	X	S	X	S	X	S	X	S	X
680	14 $\frac{1}{2}$	630	15 $\frac{1}{4}$	589	16 $\frac{3}{8}$	555	17 $\frac{3}{8}$	527	18 $\frac{1}{2}$	502	19 $\frac{1}{2}$
869	17 $\frac{3}{8}$	768	19	735	20 $\frac{3}{8}$	695	21 $\frac{1}{2}$	658	22 $\frac{3}{8}$	628	23 $\frac{3}{8}$
1022	21 $\frac{1}{8}$	946	22 $\frac{7}{8}$	885	24 $\frac{1}{4}$	835	25 $\frac{1}{2}$	792	27 $\frac{1}{4}$	755	28 $\frac{3}{8}$
1265	26 $\frac{3}{8}$	1177	28 $\frac{3}{8}$	1060	30 $\frac{3}{8}$	1039	32 $\frac{1}{2}$	987	34 $\frac{1}{4}$	941	35 $\frac{1}{8}$
1488	30 $\frac{3}{4}$	1377	33 $\frac{3}{8}$	1279	35 $\frac{1}{4}$	1215	37 $\frac{3}{8}$	1152	39 $\frac{3}{4}$	1099	41 $\frac{3}{8}$
1672	35 $\frac{1}{4}$	1574	38 $\frac{1}{4}$	1473	40 $\frac{3}{4}$	1393	43	1316	45 $\frac{1}{2}$	1256	47 $\frac{3}{8}$

*Electrical Properties.*—The conductivity of the Pittsburg Reduction Co.'s wire has been given as between 60 and 61 in the Matthiessen scale, though within the last few months the writer understands that this has been increased to 62 through improved methods of treatment. Annealed copper averages a conductivity of 99, and  $\frac{99}{62} = 1.6$  is the ratio of the specific conductivities.

It will be remembered that in the B. & S. gauge this corresponds very closely to  $r^4$ , where  $r$  (1.12) is the ratio between the diameters of any two consecutive sizes. Thus a convenient rule for determining the equivalent of a copper wire of any

gauge number is to take the aluminum wire two sizes larger. For example, No. 00 copper has a conductivity equal to No. 0000 aluminum.

For equal conductivity in a given transmission the weights of copper and aluminum required will be as  $1 : \frac{1.69}{3.33} = 1 : 0.48$ .

*Effects of Alternating Currents.*—The self-induction and capacity of a transmission circuit depend upon the ratio of the diameter of the conductors to the distance between them. For the same conductivity the diameter of an aluminum wire is roughly 26% greater than that of a copper wire. Hence we can say:—

(a) If the aluminum wires are 26% farther apart than the copper wires, the capacity and self-induction will be the same.

(b) It can also be shown that if the wires be the same distance apart that the self-induction of the aluminum circuit will be decreased from 3 to 5%, and its capacity increased by about the same amount as compared with a copper circuit of the same conductivity.

Skin effect—or the tendency of an alternating current to flow near the surface of a conductor, thus increasing its effective resistance. This effect is almost always negligible with frequencies ordinarily employed in transmission work, the increase in effective resistance being only ½% for a ½-in. copper wire at 60 cycles. Skin effect is proportional to the square of the frequency and cross-section, and inversely proportional to the square of the specific resistance, hence for aluminum and copper wires of equal conductivity the effect is the same since the cross-section and specific resistance are increased in the same proportion.

From the above it would appear that so far as the effects of alternating currents are concerned, there is little to choose between aluminum and copper. Any difference in their behaviour is in favour of aluminum.

The temperature co-efficients of resistance are about the same, viz.:—Aluminum, .00214 per degree F.; copper, .00217 per degree F.

*Chemical Properties.*—When we consider the chemical properties of aluminum we are confronted with a serious difficulty, namely, the joint problem. With copper, good permanent joints equal in conductivity to the wire itself can readily be made by soldering, but the soldering of aluminum is such a difficult and uncertain operation that it is almost impossible to carry it out in line work.

This difficulty in soldering may be attributed to three causes:—

(1) Aluminum is very highly electro-positive, in fact more positive than any of the commercial metals. Consequently it oxidizes very readily, and its surface is always coated with a thin film of  $Al_2O_3$ , which has to be removed to effect a soldered joint. Ordinary fluxes have no effect, as the oxide film forms as fast as it is removed. The usual method employed is to use a solder of such a composition that it contains its own flux, and thus the removal of the oxide film and the "taking hold" of the solder are simultaneous.

(2) Owing to the high specific conductivity for heat of aluminum, it requires a very high temperature to effect a joint. Also while solder combines with copper at  $460^\circ F$ , over  $650^\circ F$  is required to make a combination with aluminum.

(3) The fact that aluminum is so highly electro-positive is the cause of galvanic action between the metal and its solder, unless the solder be very near aluminum in the electro-chemical series. A few days in water will render useless many an apparently good joint.

The solder recommended by the Pittsburg Reduction Co. is that proposed by Mr. Joseph Richards, and is also that used by nearly all the manufacturers of aluminum in Europe.

Its composition is:—29 parts tin,  
11 parts zinc,  
1 part aluminum,  
1 part phosphor-tin.

The superiority of the solder seems to be due to the phosphor-tin. The parts are heated and the melting stick of solder rubbed hard over the surface to remove the film of oxide. While the solder is still fluid the surface is rubbed with a metal brush to ensure a thorough combination. After the pieces are tinned as above, pure block tin is used to sweat them together. As it is impossible to cause the solder to flow into an aluminum joint, the tin must be put just where it is required.

While the above process appears to be fairly simple, unless the work is done by an expert, the joints are seldom satisfactory. Consequently in nearly all lines recently erected mechanical joints have

been used, and as far as can be learned they have proved quite successful. Several forms of mechanical joints are given below:—

Fig. 1 is an aluminum sleeve employed for sizes up to No. 000. The ends of the wire are inserted and the whole is twisted through three or four turns. Fig. 2 is known as the compression joint, and consists of three parts. The cable ends are inserted in the sleeves 2 and 3, and held in place by hydraulic pressure. This is usually done in the factory, both ends of every coil sent out being furnished



Fig. 1

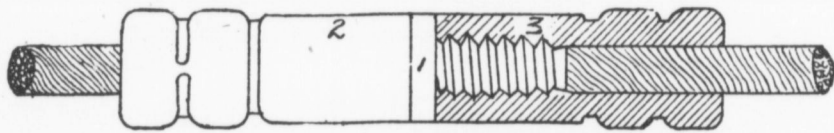

Fig. 2

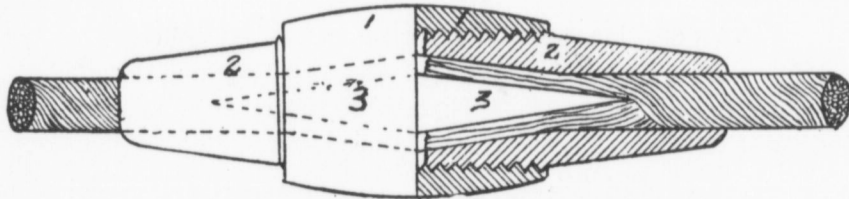

Fig. 3

with sleeves; then all that is necessary in the erection of the line is to couple these sleeves together by means of the right and left hand connector 1. Fig. 3 is called the wedge joint. The ends of the cables are passed through the sleeves 2, and the strands spread by the conical wedges 3. The coupling 1 is now screwed on, and as the bases of the wedges are pressed together the wires are pressed more firmly against the conical recess in the sleeve. Both of the latter forms of joint are quite largely used, the compressive joint being the more common.

The action of gases and vapors upon aluminum wire is still rather a moot point. While the manufacturers claim that the metal is quite equal to copper in its non-corrosive properties, investigations of Kershaw in England show that the wire is corroded by the sulphurous vapors of a city and by hydrochloric acid. It is perhaps hardly fair to judge the American product by the results of Kershaw's tests, as his experiments were with heavily alloyed wire of 51% conductivity. It might be said also, that the tests were conducted at St. Helen's, which is the centre of large chemical industries. A less favourable place could hardly have been chosen. The action of hydrochloric acid is not as great as might be expected, protection being afforded by the coating of  $Al_2O_3$  which always covers the wire. The manufacturers claim that no corrosion takes place on wires exposed to the salt air along the coast.

The galvanic action of aluminum in contact with nearly all metals makes it important that all ties, joints, etc., be made of the same metal. The resistance to corrosion is decreased by small percentages of impurities, notably silicon and iron, which are difficult to remove. Sodium is also most harmful. The Pittsburg Reduction Co. attribute nearly all failures from corrosion to the presence of these metals.

To sum up what has been said, weight for weight aluminum has about double the conductivity of copper, with a tensile strength about 90% that of soft-drawn copper or 60% that of hard-drawn copper. The weakening tendency of impurities is overcome by the use of stranded conductors. It is possible to use longer spans for aluminum wire on account of its lightness.

On the new Niagara-Buffalo aluminum line the poles are 113 feet apart, against 75 ft. spans on the copper line. Thus a saving of about one-third on the poles and insulators was effected.

Chemically the balance seems to be in favour of copper, though the aluminum lines already in use have not been in position long enough to give any definite information on this point. The joint problem has been satisfactorily solved by the mechanical contrivances described. With aluminum we have reduced freights, and gain in the matter of distribution and handling. It is claimed also by those who have used aluminum, that the labour in erection is materially less than where copper is used. The wire can often be

strung along the ground and carried upon the poles on a man's shoulder. It is said also that the care necessary in giving the proper sag has been exaggerated.

Aluminum is not so well adapted for other branches of electrical work, except perhaps for bus bars, where it has been quite extensively used. The large cross-section, as compared with copper, makes its use for armature conductors and all windings where space is an important factor, almost prohibitive. It has replaced brass in the parts of many electrical measuring instruments, and has also been recommended for spacing blocks in iron cores. The large section makes insulation of aluminum conductors more expensive, and the finished wire is very bulky. Mr. Steinmetz says that aluminum has not proved successful for commutators. There are many other minor uses to which aluminum has been put, too numerous to mention here.

---

## THE BEHAVIOUR OF STEEL UNDER STRESS.

PROFESSOR C. H. C. WRIGHT, B.A. SC.

While discussing with one of the members of the Council of this Association the results of certain experimental work of the post-graduate year at the School of Practical Science, I was induced to promise a paper on the behaviour of steel under stress, and in its preparation I have kept in view the younger members and students of the Association.

Inasmuch as the use of steel has completely revolutionized methods of construction and plan, its effect should be and is apparent in the design, not, however, to the extent the material deserves. It has been the custom for years to use rolled shapes, rivets, and joints of an engineering type partly because this branch of the work has been generally relegated to the engineer, and partly because most of the steel work is hidden. Is not much of it hidden because it is considered unsightly? Why should not the parts exposed to view be æsthetically treated and the shapes receive architectural attention.

It has always been considered necessary to study carefully the properties of other building materials. The successful treatment of granite shows boldness or vigor; of marble, delicacy or refinement; of sandstone, elaboration; of terra-cotta, repetition, etc.

While steel has been used very largely during the last decade, it will be used much more extensively in the immediate future. It becomes desirable that the members of our profession should, and imperative that the younger members shall, observe closely the peculiar properties and behaviour of this important material in order that it may be treated satisfactorily in design as well as in construction. It ought not and cannot be left to the engineer.

---

NOTE.—This is a paper read by Professor Wright before the Annual Convention in January, 1902, of the Ontario Association of Architects.—EDITOR.



Another difficulty that might be mentioned is the action of fire on steel. Serious as this difficulty is from the point of view of design, it must be met frankly and not forgotten that this very same property enables it to be rolled and worked into shapes economically.

Interesting as this line of thought is, we must turn our attention to the more elementary stages and consider a few of the properties of steel.

Suppose a steel rod (usually 24" long) is placed in a testing machine and a load applied so as to produce tension in the rod. Now if measurements of the lengths of a part of the rod (usually 8") are made, it will be found that for every load applied or stress induced there is a corresponding change in length, a deformation or strain; further, that when the load is removed the rod will regain its original length.

There is a point, however, beyond which this is not true, or where the deformation or strain is not constant for equal increments of load or stress. Below this point steel is elastic, while beyond it it is plastic. The point at which this change occurs is called the elastic limit. If, however, a piece of steel be stretched (strained) beyond the elastic limit, and the load removed, it will contract more or less, but will not regain its original length.

The measurements of deformation or strain, which must be accurate to the nearest 1-10,000 of an inch, are made with an extensometer of which this Riehle Yale represents a very satisfactory type. As will readily be seen, the points of the screws which fasten it to the specimen are held rigidly 8" apart. After fastening it to the specimen, the bar connecting the two heads is removed, and the two micrometers are read or set at zero (the contact being determined by the ringing of an electric bell on the closing of the circuit by the contact). A load is next applied to the specimen, and the micrometers are again read, the difference between the two sets of readings giving the deformation or strain corresponding to the load or stress. If the stress be doubled the micrometers will show that the strain has been doubled. As the stress is increased it will be found that equal increments of load will produce equal strains so long as the steel remains elastic, or in other words within the elastic limit.

If these measurements were continued and the resultant stress strain curve drawn, plotting the loads as vertical ordinates, and the

strains as horizontal abscissa, it would resemble O A B C of the accompanying figure.

In the complete curve there are four significant points, viz., the true elastic limit, A; the apparent elastic limit, B; the ultimate strength, C; and the breaking point, D. From O to A the ratio of stress to strain or load to deformation is constant and the curve becomes a straight line. Between A and B the ratio of strain to stress increases slightly, while at B a very marked change takes place, hence the term "apparent elastic limit." Micrometer measurements of the length are not necessary to determine this point, and consequently it is widely used in commerce, and is often spoken of as "the commercial elastic limit," or often merely "elastic limit." Beyond the elastic limit the material continues to increase

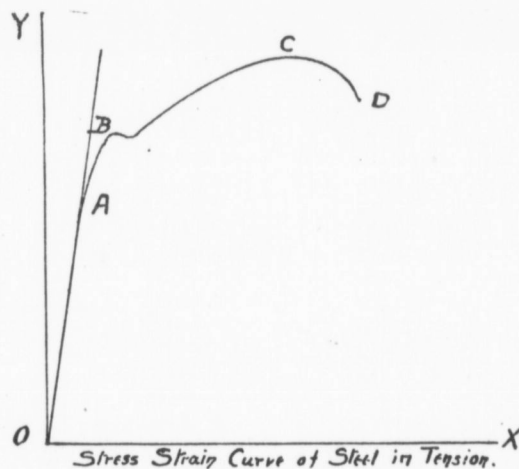

in length as additional loads are added until it reaches its ultimate strength, when it begins to fail. It no longer continues to support the load, but stretches under a decreasing load and finally separates under a greatly reduced one such as is indicated in our diagram by the point D.

Specimen No. 1 is a mild steel made by the open hearth process and gave the following results when tested in tension. The length of the specimen was 24 inches and its diameter 1".015. Punch marks one inch apart were made along the rod. The specimen was then placed in the testing machine and subjected to tension. The load was gradually applied and the material elongated uniformly for a time until it reached a point where it stretched under

a constant load of 21,000 pounds, *i.e.*, the commercial elastic limit of  $21,000 \div (1.015^2 \times 7854)$  *i.e.*, 21,000 divided by the cross-section of the rod or 27,200 pounds per square inch. The rod finally broke under a load of 37,700 pounds or of  $37,700 \div (1.015^2 \times 7854)$  or 47,200 pounds per square inch of its original cross-sectional area. On measuring the distance between two of the punch marks originally 8" apart (4 on each side of the break), it was found to be 11.08" long, *i.e.* the steel had an elongation in 8" of 38.5%. Collecting we have:—

Commercial elastic limit.....	27,200	pds. per sq. in.
Ultimate strength.....	47,200	" "
Elongation in 8 inches.....	38.5%	

The following measurements made on this specimen will show perhaps more clearly the elasticity of the material.

Load in Pds.	Stress in Pounds per sq. inch.	Extensometer readings.	Deformation or Strain.
1,000	1237	8.0005	0.0005
2,000	2474	8.0009	.0004
3,000	3711	8.00125	.00035
4,000	4948	8.00160	.00035
5,000	6185	8.00195	.00035
6,000	7422	8.00225	.0003
7,000	8659	8.0026	.00035
8,000	9896	8.00295	.00035
9,000	11133	8.00325	.0003
10,000	12370	8.00355	.0003
11,000	13607	8.0039	.00035
12,000	14844	8.00425	.00035
13,000	16081	8.00455	.0003
14,000	17318	8.0049	.0003
15,000	18555	8.0052	.00035
16,000	19792	8.00555	.0003

On drawing this stress strain curve, plotting the stresses as vertical ordinates and the strains or deformations as horizontal abscissæ, we get the following diagram.

The complete stress strain curve is given in Fig. 2.

Specimen No. 2 of Milo Steel, made by the open hearth process, gave the following results in tension:—

Length of specimen,.....	24 inches.
Diameter of specimen,.....	1.015 inches.
Apparent elastic limit.....	27,000 pounds per square inch.
Ultimate strength,.....	47,500 pounds per square inch.
Elongation in 8 inches,.....	38.0%

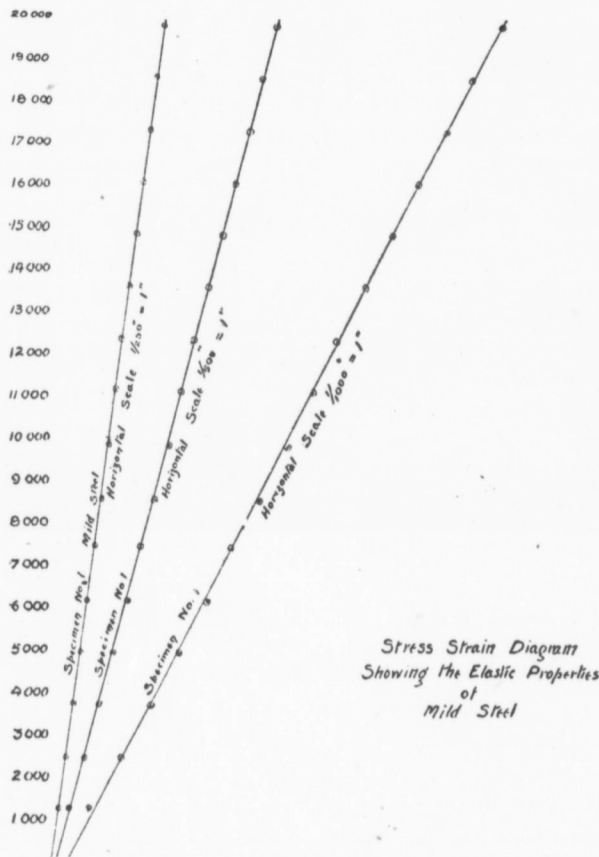

FIG. 1.

Load.	Stress in Pounds per Square Inch.	Extensometer Readings.	Elongation.
0	0	.27135	
1000	1237	.27185	.0005
2000	2474	.27235	.0010
3000	3711	.27265	.0013
4000	4948	.27290	.00155
5000	6185	.27325	.0019
6000	7422	.27355	.0022
7000	8659	.27395	.0026
8000	9896	.27430	.00295
9000	11133	.2746	.00325
10000	12370	.2749	.00355
11000	13607	.2753	.0039
12000	14844	.2756	.0043
13000	16081	.27585	.00455
14000	17318	.27655	.0049
15000	18555	.27655	.0052
16000	19792	.2769	.00555

Specimen No. 3 mild steel made by the Bessemer process gave the following results in tension:

Length of specimen.....	24"
Diameter of " .....	1.0155
Apparent elastic limit .....	29,500 lbs. per sq. in.
Ultimate strength .....	46,400 " "
Elongation in 8" .....	40%

Load.	Stress in lbs. per sq. in.	Micrometer Readings.	Elongation.
1000	1229	.5578	.0003
2000	2457	.5581	.0008
3000	3685	.5586	.0013
4000	4914	.5591	.0017
5000	6145	.5595	.0021
6000	7371	.5599	.0024
7000	8600	.5602	.0028
8000	9828	.5606	.0031
9000	11050	.5609	.0034
10000	12290	.5612	.0038
11000	13510	.5616	.0042
12000	14740	.5620	.0046
13000	15970	.5624	.0049
14000	17200	.5627	.0051
15000	18430	.5629	.0054
		.5632	

Specimen No. 4 of machine steel gave the following results in tension:

Length of specimen .....	24 inches.
Diameter of specimen .....	1.014
Apparent elastic limit .....	
Ultimate strength .....	100,600
Elongation in 8 inches.....	16.5%

Load.	Stress in Pounds per Square Inch.	Extensometer Readings.	Elongation
1,000	1273	.3837	
2,000	2547	.3840	.0003
3,000	3820	.3844	.0007
4,000	5093	.3848	.0011
5,000	6366	.3852	.0015
6,000	7640	.3856	.0019
7,000	8913	.3860	.0023
8,000	10190	.3864	.0027
9,000	11460	.3868	.0031
10,000	12730	.3872	.0035
11,000	14010	.3876	.0039
12,000	15280	.3879	.0042
13,000	16550	.3883	.0046
14,000	17830	.3887	.0050
15,000	19100	.3890	.0053
16,000	20370	.3894	.0057
17,000	21640	.3897	.0060
18,000	22920	.3901	.0064
19,000	24190	.3904	.0067
20,000	25470	.3908	.0071

Figure 3 is the stress strain diagram of specimens Nos. 2, 3 and 4 within the elastic limit. Allowing for reasonable errors of observation, the line joining the plotted points is a straight line showing conclusively that steel is within these limits perfectly elastic.

Before looking at the classification of steel, let us examine very briefly its composition and process of manufacture.

Cast iron, as you will remember, is a combination of from 2 to 6 per cent. of carbon with iron. The large amount of carbon determines its characteristic features or behaviour. Wrought iron is the product resulting from the removal of carbon from cast iron. This leaves with the wrought iron such impurities as sulphur and

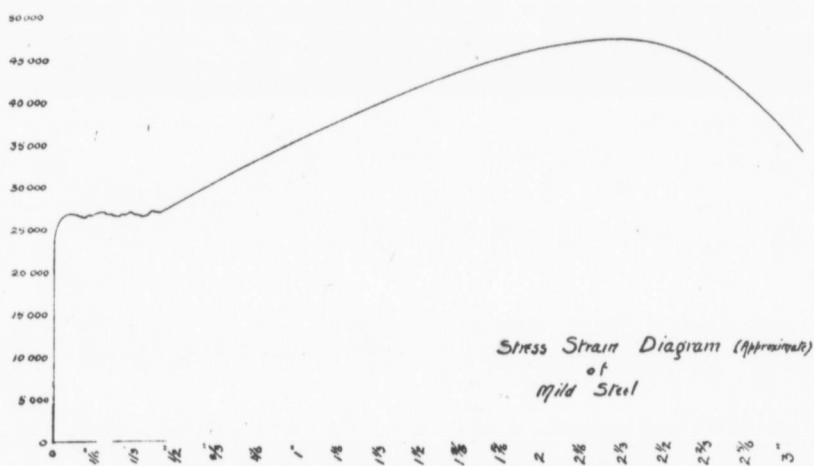

FIG. 2.

phosphorus. When these are present in too large quantities they render the iron red short or cold short respectively.

Steel is a combination of iron with a percentage of carbon varying from minute quantities to as high as 2%. It is manufactured in the three following ways, viz.—1. By adding carbon to wrought iron—the product of such process being known as crucible steel. 2. By removing carbon from cast iron—the product of this process being known as Bessemer steel. 3. By melting together cast and wrought iron—the product of this process being known as open hearth steel.

Cast iron is hard and brittle and can be moulded, while wrought iron is soft and ductile and can be welded. Steel is unlike wrought

iron in that it is fusible, and unlike cast iron, it can be forged, and with the exception of high grades, it can be welded. In addition to these advantages the higher grades can be hardened and tempered.

The term steel is applied to a class of materials which cover a very wide range of properties. One particular grade may be soft and ductile while another is quite hard and brittle. In tensile

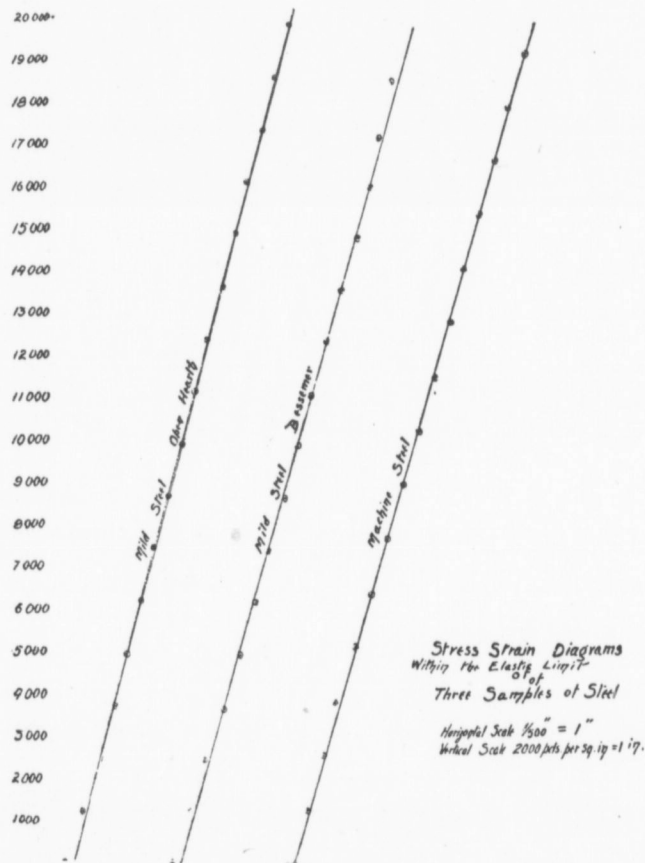

FIG. 3.

strength they may vary from 40,000 to 200,000 pounds per square inch.

It is now customary commercially to classify steels either according to their properties or uses. In the one group there is mild, medium or hard steel, while the other classification includes rivet steel, boiler plate, structural, machine, tool and spring steel, etc.

The following table gives a few of the characteristic physical properties of these different classes:—

Rivet steel should be ductile rather than strong and should have an ultimate strength of 40,000 to 55,000 pounds per square inch; elastic limit, 30,000 to 45,000 pounds per square inch; elongation in 8" = 25 to 35%.

Boiler plate—Ultimate strength 50,000 to 65,000 pounds per square inch; elastic limit, 30,000 to 45,000 pounds per square inch; elongation in 8" = 25 to 30%.

Structural steel—Mild, ultimate strength 40,000 to 55,000 pounds per square inch; elastic limit, 25,000 to 43,000 pounds per square inch; elongation in 8" = 25 to 35%.

Medium—Ultimate strength, 55,000 to 70,000 pounds per square inch; elastic limit, 35,000 to 45,000 pounds per square inch; elongation in 8" = 20 to 25%.

Machine steel—Ultimate strength, 80,000 to 110,000 pounds per square inch; elastic limit, 55,000 to 70,000 pounds per square inch; elongation in 8".

Tool steel and spring steel—Ultimate strength, 120,000 to 200,000 pounds per square inch.

The standard specifications for structural steel proposed by a committee of the American Society of Civil Engineers in 1896 is as follows:

	Lbs per sq. in.
Tensile strength low steel	60,000 + 4,000
"          "      medium	65,000 + 4,000
"          "      high	70,000 + 4,000

Elastic limit 55% of the ultimate strength of the specimen.

$$\text{Per cent. elongation in 8 in.} = \frac{1,500,000}{\text{Ultimate}}$$

$$\text{Per cent. reduction of area} = \frac{2,800,000}{\text{Ultimate}}$$

Rivet steel when heated to a low cherry-red and quenched in water at 82° Fahr., must bend to close contact without sign of fracture. Specimens of low steel when treated and tested in the same manner must stand bending 180° to a curve whose inner radius is equal to the thickness of the specimen, without sign of fracture.



Specimens of medium steel as cut from the bars or plates and without quenching, must stand bending  $180^\circ$  to an inner radius of  $1\frac{1}{2}$  times the thickness of the specimen, without sign of fracture. While those of high steel, also without quenching, must stand bending  $180^\circ$  to a radius of twice the thickness of the specimen without sign of fracture.

In connection with the latter part of this specification, the following test may be interesting and instructive.

Two specimens, one of mild open hearth and the other of machine steel, were heated to a cherry-red, quenched with water and tested with the following results:

	Ultimate strength pds. per sq. in.	Elastic limit pds. per sq. in.	Elongation in. 8"
Mild steel.....	47,200	27,200	38.5%
Mild steel hardened.....	62,200	43,000	broke in strips
Machine steel.....	83,900	55,600	21%
do hardened .....	106,000	60,500	2%

While almost every specification mentions maximum and minimum tensile strengths, it is very seldom that mention is ever made of the compressive strength, although the material is used quite as frequently in compression as in tension. This is because the ultimate strength, elastic limit and deformation or strain are more readily determined in tension than in compression, and because the results in tension are the same as those in compression.

Under a uniformly increasing load steel in compression contracts uniformly within the elastic limit, which fortunately is the same as that for tension. When the load increases beyond the elastic limit the material simply spreads and increases the area of its cross-section indefinitely, so that in compression steel has no ultimate strength. This is well illustrated in the following specimens, originally 2 inches long, which were subjected to a load of 170,000 pounds each.

Specimens numbered 1, 2, and 3, are wrought iron, made in Sweden, England and Ontario respectively; while numbers 4, 5, and 6 are mild steel open hearth, mild steel Bessemer, and machine steel. Those specimens which are cracked open or are etched show very clearly the flow of the material under the stress.

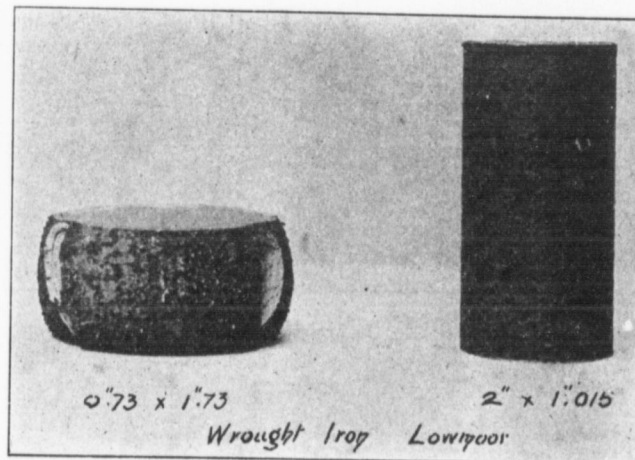
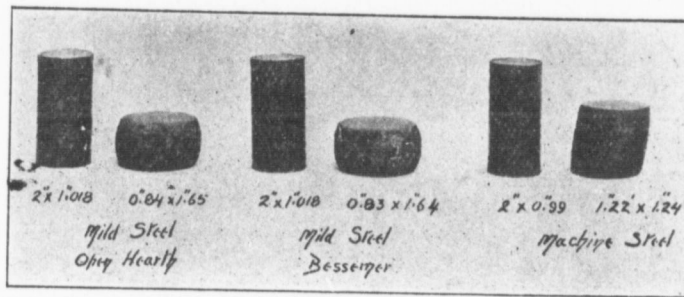
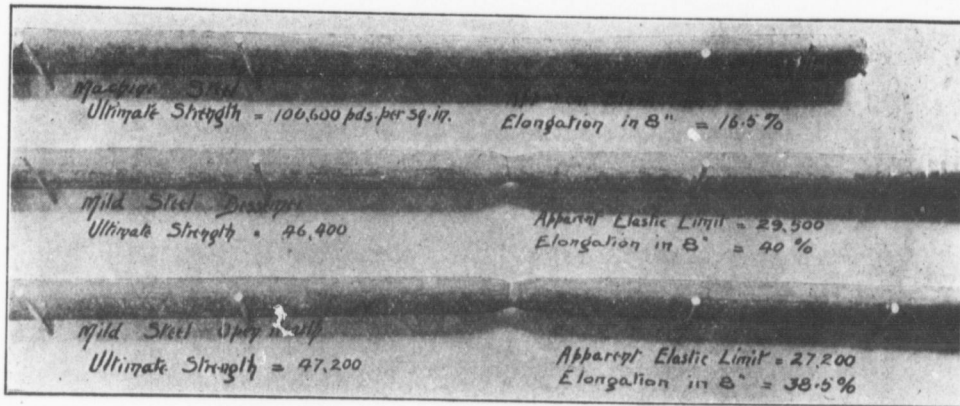

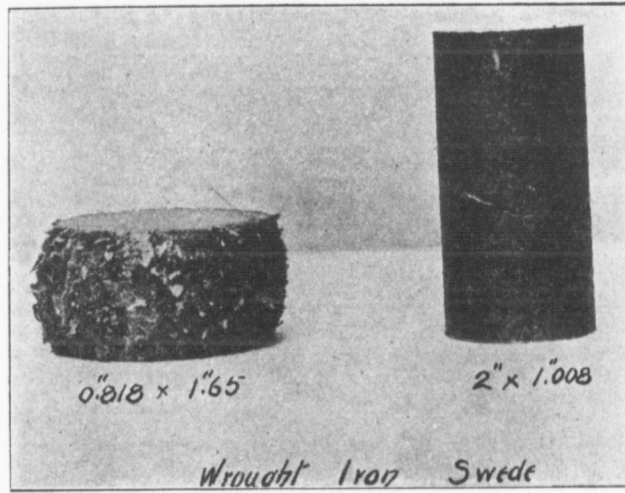

The stress strain diagram for steel in compression when the stress is determined by dividing the load by the original cross-sectional area is as indicated in the annexed diagram, Fig. 4.

These compressive tests were made on a Riehle 200,000 pounds machine, and as the screws were kept running at a uniform rate, a

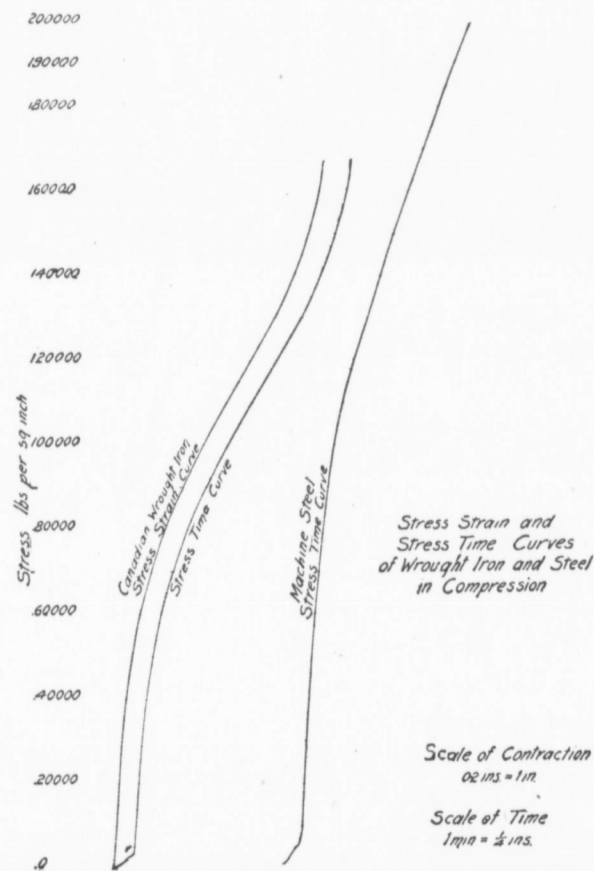

FIG. 4.

set of readings of the times required to produce the stresses were registered on a chronograph simultaneously with the measurements of the deformation or strain. On plotting from these results the stress strain curve and the stress time curve, it is found that they were identical when the scales correspond.

## **BRIDGE FOUNDATIONS AND ABUTMENTS.**

---

J. HERBERT JACKSON, O.L.S., '03.

---

The information for the following paper was gathered last summer from work on which the writer was assistant in charge under C. H. Mitchell, C.E. It is intended as a descriptive paper, only such technical questions being taken up as are thought to be of interest to those unfamiliar with this class of construction.

The work comprised the building of two highway bridges to replace old ones over the Welland River, at points five and eight miles respectively above the town of Welland. The contractor undertook to remove the existent structures and erect others as per plans adopted. The cost of each bridge complete was \$6,000. This included all work necessary to make the highway passable and ready for use by the public.

Looking at the problem from an engineering point of view, it resolved itself into designing a bridge for general highway use which would clear the stream in a single span. This length proved to be 134 feet from centre to centre of end pins. The approaches were to be earth embankments with the surface macadamized for a distance of 200 feet in each direction. The conditions of the soil, etc., on the sites of the bridges were found to be precisely similar, as was also the length of span, so that the two bridges could be built from practically the same set of plans. At the points selected the banks of the Welland are of a soft, black, porous earth on top of plastic clay, and in no way capable of sustaining a load except by piling for the foundations.

The stream is very sluggish, even running back on itself when the waters of the Niagara River are high. This seemed to comprise the total of the information at hand.

From these facts it was decided to put in a steel superstructure with abutments of concrete.

## PILE DRIVING.

The question which now came up was the number, spacing, etc., of the piles, and was worked out as follows:—The bridge selected was one of 16 foot roadway and was to withstand a dead load of 600 lbs. per lineal foot, and a live load of 1,200 lbs. per lineal foot. The weight of bridge designed for these loads was 132 tons, or 61 tons weight to each abutment. The form of abutment gave a content of 90 cubic yards. This amount of concrete, at an average of 4,000 lbs. per cubic yard, made the weight of an abutment 180 tons. To this was added 36 tons for transferred earth pressure and miscellaneous load. Thus the load for each abutment was:—

Superstructure.....	61 tons.
Content of abutment.....	180 tons.
Miscellaneous .....	36 tons.
	—
Total.....	277 tons.

To support this it was thought that thirty-seven piles would be sufficient, and assuming the load to be uniformly distributed each pile had a load of 7.5 tons.

The formula for driving the piles was taken from the *Engineering News*.

$$L = \frac{2Wh}{S+1}$$

Where L= safe load in lbs.

W=weight of hammer in lbs.

h=fall of hammer in feet.

S=penetration in inches at last blow.

In using this a factor of safety of 4 was assumed.

The safe load on each pile was then  $7.5 \times 4 = 30$  tons = 60,000 lbs.

The weight of hammer used was 2,600 lbs., and the fall was 30 feet.

To find S.

$$60000 = \frac{2 \times 2600 \times 30}{S + 1} \text{ or } S = 16 \text{ inches.}$$

In the specifications, 1.5 inches was the maximum penetration allowed at the last blow.

In construction it was found that on both abutments of one of the bridges the centre piles gave a greater penetration than the

above, and it was necessary to add eight supplementary piles to each in order to come up to requirements. These were necessary by reason of the clay being much less solid than was anticipated from tests.

The addition of the eight piles made the strength ample for the weight to be sustained.

The driving of the piles was accomplished by sinking a coffer-dam about the space to be occupied and pumping out, when the usual method of drop hammer was used. The piles were banded to prevent brooming at the ends.

#### GRILLAGE AND PLATFORM.

On the top of piles sawed off true and level at two feet below low water mark was built a grillage of sound white oak timbers. These were 10 x 12 and had a full bearing on each pile and drift bolted with  $\frac{3}{4}$ -inch bolts with upset heads, driven flush. The grillage timbers supported a platform of white oak 5 inches thick. This was kept dry by the coffer-dam, which, being left in place, also acted as a protection after completion.

#### CONCRETE.

The concrete was laid on these platforms in molds built to the form of the abutment. The composition of the concrete for the interior of the abutments was in the proportion of 1 cement, 2.5 sand, 5 broken stone. The proportions for the weather surface to a depth of 6" was 1 cement, 2 sand, 4 broken stone.

The forms for the concrete were held perfectly solid by means of rows of wires placed in at every three or four layers of concrete and fastened to the outside of the form. In this way, when one side of the form was made solid the other could not move. In removing these forms it was only necessary to cut the wires, leaving them in after trimming off the ends. All corners and angles were bevelled so as to give the finished abutment a neat appearance.

In mixing it was required that the cement and sand should be mixed dry and then water added. Finally the stone, which had been previously wetted, was added, and the whole thoroughly mixed.

This concrete was placed in 8" layers; in placing the concrete in the forms the weather surface was mixed and thrown in close to the mold from the platform above. In this way the mass was pretty

well compacted on reaching its position. This was done all round the edge and raked to a comparatively even surface. The interior portion was now added to the height of the weather surface, and the whole was thoroughly tamped and compacted. Layer after layer was added in this manner till the whole was completed. Just at the surface, bridge-seats of limestone were set for the truss bearing of the superstructure.

Great care had to be exercised to keep the whole mass of each abutment from slightly moving out of alignment, and the forms had to be checked on permanent plugs set on the bank at some distance back. As a final precaution, when one abutment was complete the forms of the opposite one were checked on it so that if by any possibility it had shifted, the second one might be made parallel to it, and thus we avoided trouble when the steel work was to be set.

#### APPROACHES.

The approaches were built on an easy grade up to the bridge roadway and had side slopes of  $1\frac{1}{2}$  horizontal to 1 vertical. The surface was of limestone, well compacted, to form a solid pavement, and brought to a true grade.

The posts of the fencing along the sides of the approaches were prevented from leaning by a wire placed under the macadam and tightly twisted.

The superstructure was finally erected when the abutments were completed. To temporarily support this a net work of piles and false work was erected across the stream and removed again on the completion of the bridge.

---



## THE COLLEGE GRADUATE AND HIS SPECIALTY.

C. H. MITCHELL, B.A. Sc., C.E.

[The writer has been requested to prepare a paper on this subject in the hope that it may prove of service to students and graduates upon leaving college. The desire being to refer more particularly to Hydraulic Engineering, this specialty has been followed, but the general principles outlined would be quite applicable for other branches of the profession.]

Not until quite recent years has the true place of a scientific school begun to be assigned in the education of the young engineer. While a quarter of a century ago it was generally admitted that education in an engineering school was good, but not a necessity, it has come of late to be generally considered an indispensable factor in the education of the engineer. This is so, not only in Canada, but throughout all other countries, where, during the past few decades, the industrial activity has been very marked.

Previously the early education of the engineer, in whatever branch he might select, was planned out for him, leading through long terms of pupilage in engineer offices, gaining experience through the different steps of the work in the specialty or group of specialties to which he gave attention. The place of the school or college in this course of training was more to serve as providing the necessary foundation of general education, as distinguished from a scientific education, and the student was expected to derive his scientific attainment in a large measure from his experience and association with his comrades and superiors engaged in his engineering work, doing so by some means of absorption and example perhaps, more than by special devotion to study and research. The result of this has been the production of the famous engineers of experience who have brought us to the modern civilization, who have learned at nature's school, by nature's hand, by success and failure. These are the men who have enabled our modern schools to adapt the actual theory and the underlying scientific principles to the real work, its design, and construction.

Of latter years, however, the process of education has been different, and the school or college has taken a very prominent part. The school has supplied not only the general education, but the foundation, and, in some cases, a considerable portion of the techni-

cal education. Many of the leading schools have, of latter years, also provided a means of specializing in the engineering education, thus providing a means for the student to acquaint himself with not only the theoretical but also with much of the practical work of his chosen specialty. It does not follow, however, that the student graduating from a college in one of these engineering specialties can by any means be termed an expert, although there are some well known institutions which go so far as to lay claim to the distinction of graduating its students as "Engineers" in the full acceptance of the term. The writer believes that the principles laid down in connection with the School of Practical Science and Toronto University, with reference to the engineering courses, meet the modern conditions in an eminently satisfactory manner. The school does not pretend to do more than prepare the student in his theory and application of the theory, to teach him to study and pursue research, and, to a certain degree, "make him immediately useful when he commences actual professional work." Most engineering works, for the design and construction of which students are fitted, are such that their magnitude and general nature render it impossible to study them in such a manner as is possible to students in other professions. Many colleges meet this by arranging excursions and tours of inspection to interesting engineering works, either built or under construction. These, however, cannot be classed as anything but object lessons, and while valuable as such, do not permit of that close insight into methods and design of detail which would be so valuable to the young student. This applies primarily to engineering works of large magnitude, but almost equally so to works of easier access, particularly of a mechanical nature, because of the inability of the student to get to the true inwardness of the work in the short time usually at his disposal. The Toronto courses do not follow this plan, but prescribe a much better means by encouraging the student to employ his vacation periods in actual engineering service under what may be termed "actual working conditions," and in this way at once render him in touch with the professional life. Carrying this still further, he is told, after ordinary graduation, to go out into the professional world, having behind him his college or academic career with its primary scientific education, and its mere "elements" of preparation, and work with those who are designing and constructing, learning all he can as well as he can. After three years of this

active life under working conditions, he is told to come back with his record, and the University is then prepared to call him an Engineer.

The value of this programme of education is but partly appreciated by the under-graduate in his early days at the college, nor is it to be expected that he should see it as do the older and experienced engineers who have, perhaps, learned their work without the advantage of the college education. The young man, upon graduation, has learned many of the things which the early engineer learned after years of experience, and has probably become in a few years much more conversant with his theory and principles than the older man, but he has still to learn those things which the latter learned in his first six months. He has been taught to think and to reason, but he has yet to learn to work and to work hard, and incidentally to compute, design and superintend, to meet emergency, to become a friend and a master of nature and her laws, and above all, to know men.

It is upon graduation that specialization usually manifests itself, although in the college course the election of studies may have already determined it. However, in most cases the nature of the first few years out of college has all to do with the future line of work and may be considered to mould the taste or the talent of the graduate to this particular direction. It is at this time, perhaps, more than at any other, that this adaptability of the student to a particular line of engineering becomes apparent. All the professions have of recent years tended towards a division into specialties and the modern life is made up of the work of the expert to such an extent that even specialists employ other specialists on their work. This is equally true of the engineering profession, and on all large works the designers and constructors are, in reality, a group or staff of experts in the several departments.

Some specialists have for many years formed distinct branches of engineering, and many of these have of late again been subdivided into others, each having its followers. That of hydraulic engineering has existed for many years and has passed through many phases of interpretation. New lines of work have been added to it, and others have been removed, as for instance, that of sewerage, drainage, water works construction, etc., which are now usually classed with sanitary or municipal engineering, a new group. Of late years, and

particularly during the past decade, hydraulic engineering held a somewhat unique position and has consequently come to mean not only canal, river and harbour construction, with kindred works, as before, but water power development in all its branches. In the latter, such work in turn frequently calls for the employment of many other experts or special specialists, comprising mechanical, electrical, architectural, mining and sometimes chemical engineers in the varied classes of work required in water power construction for different purposes.

It is manifestly impossible, therefore, for the young graduate who desires to enter the field of hydraulic engineering, having in view the specialty of water power construction, to take it up as a single study in the same manner as one would many other lines. It is further evident that he must immediately upon leaving college, seek employment on works which will quickly put him in touch with this branch of the work. In this department of engineering, perhaps more than any other, should the student follow the school of experience, outlined as being that in vogue before the days of the science school. It is only in this method of getting out into the actual work, that hydraulic engineering can be studied, for the dearth of literature upon the subject is very marked. Water power engineering in reality is a very new line, and previous to, say, twenty-five years ago, it was studied by scientific men to but a small extent. No doubt the perfecting of long distance electric transmission has, within recent years, brought the whole question very strongly before the engineering profession, and electricity and hydraulic work are now destined to be grouped definitely together. Owing to the recent growth of this branch, the literature on water power questions is nearly all in magazine and periodical form, while the manufacturers of machinery are adding quickly to it by advertising matter, in the form of experimental research.

The writer would advise graduates of the School of Practical Science, desirous of following this line, to obtain employment in, or at any rate to visit and carefully examine designs, methods of construction and operation at water power centres, not only in Canada and the United States, but if possible in Europe. America, while not in the lead in research in this branch of engineering, is doubtless destined to become essentially a water power or hydro-electric power using continent. Already hydraulic enterprise is far beyond that of the

old world, and Canada, on account of her vast power resource, is not to be by any means behind in this progress. It is to Switzerland, Italy and Germany, however, that even yet we have to look for the lead in real scientific work, particularly under high heads. Nearer at home, however, the student should be acquainted with the characteristics of the rivers, watersheds, falls, and physical features, the methods of development, the conditions of operation and maintenance, and of the available markets for power generated, existing in the locality of each power centre. Grouped roughly, these centres might be said to comprise, in Canada: British Columbia, New Ontario, the "Soo," Niagara Falls, St Lawrence and Ottawa, Quebec, and as yet, to a small extent, several centres in the Maritime Provinces. In the United States are Massachusetts and Connecticut, which are probably pioneers, New York State, with Niagara Falls and the Adirondacks, Minneapolis, Colorado, Montana and California, where the boldest transmission work has been attempted, and a few scattered centres in the south. All of these have their own distinct features, and each forms a special study in problems of high or low heads, large units, floods, ice, and cold weather conditions, transmission or peculiarity of use.

The course to be followed by a student is plainly to gain experience by close association with power construction in several of these centres, and particularly in the designing and erection of new propositions if possible. The graduate from college could expect to first obtain employment at tracing, or other subordinate work at which he must some time start, and if ability is displayed, it will be but a short time before he may assist in design of details, or if his inclinations are such, he may get "out on the work" as a field man or superintendent of construction. From this work his real experience will date, and his value as a specialist increase with time. If he applies himself to become thoroughly acquainted with all the details of the work from design to operation, he should become very valuable in his one branch, commanding high remuneration, and not requiring to seek his employment.

To conclude, there is but one school, and that is experience, and but one master, and that is nature. The student, though he be first man in his year at college, must expect to start the humblest scholar, but after, with opportunity and energy, he may hope to earn rapid promotion with golden opinions for himself and his work.

**THE HYDRAULIC LIFT LOCK ON THE TRENT CANAL AT  
PETERBOROUGH.**

---

WALTER J. FRANCIS, C.E., M. CAN. SOC. C. E., ASSOC. M. AM. SOC.  
C. E., DIVISION ENGINEER, TRENT CANAL.

---

[The courtesy of Richard B. Rogers, Esq., M. Inst. C. E., M. Can. Soc. C.E.,  
Chief Engineer of the Trent Canal, in kindly permitting the writing of this paper,  
is thankfully acknowledged by the writer.]

PRELIMINARY.

The hydraulic lift lock on the Trent Canal has been considered worthy of a special paper owing to the fact that it is not only the only one of its kind on the American continent, but also because it surpasses in capacity and in height of lift anything of its type that has hitherto been attempted.

In order to get a clear idea of the route on which this lock is being constructed, it might be well to state that the Trent water-way consists of a series of rivers and lakes connected by artificial canals. It is intended to form a connecting link between the southern end of Georgian Bay, at Midland Harbour, and Trenton, on the Bay of Quinte, leading to Lake Ontario. This canal, which has been under contemplation for a great number of years, and which was originally selected by the Royal Engineers of England as the most practicable route between the upper lakes and the sea board, is now being expeditiously pushed forward by the Government of the Dominion of Canada, and several contracts have been let and many of them completed during the last six years. Of the the total length of 203 miles, only about 33 require to be completed to furnish navigation throughout the whole distance.

Leaving Midland Harbour, where there is a depth of water of about 20 feet, the route is intended to pass by way of the River Severn into Lake Simcoe, this part of it as yet having had no work

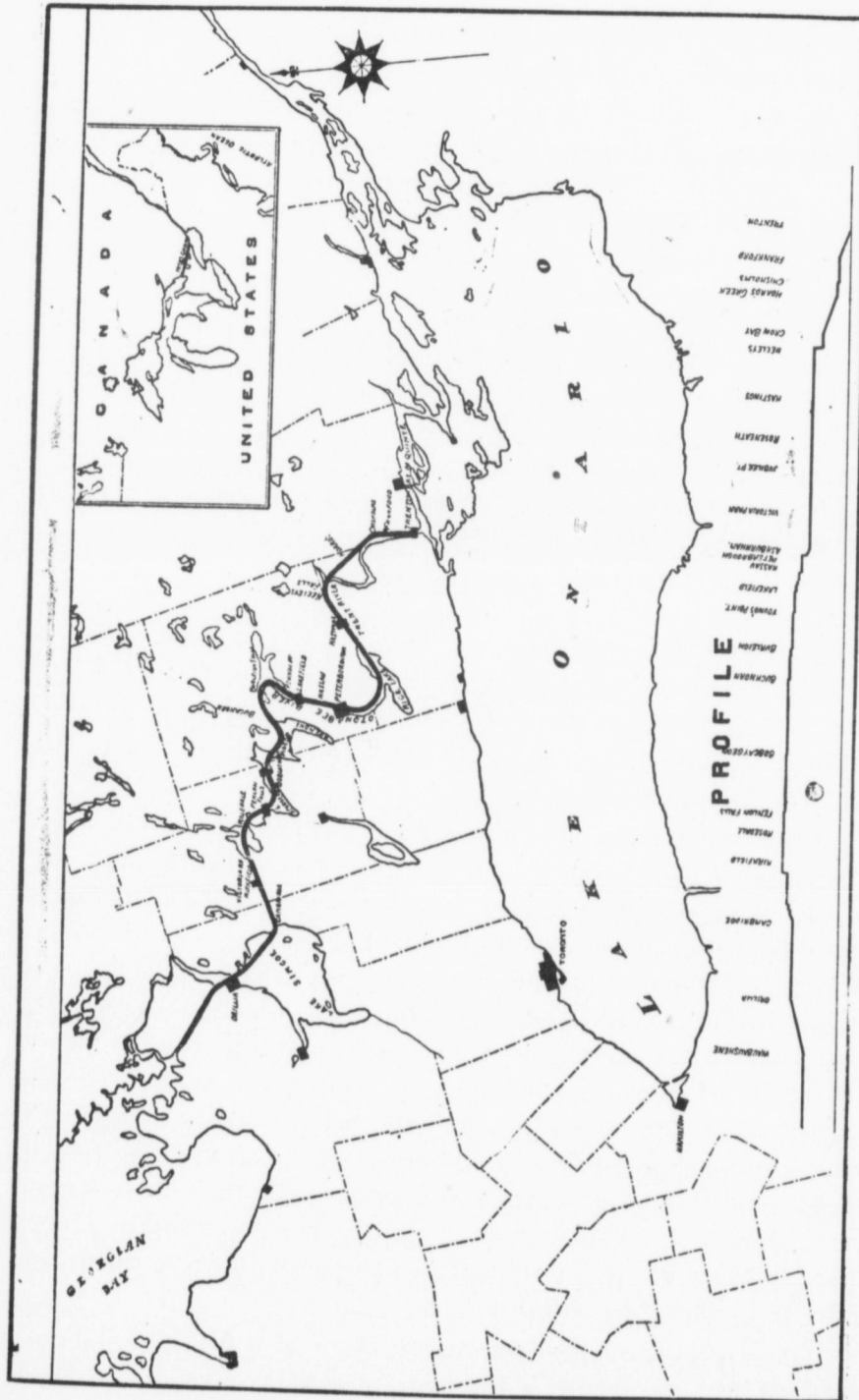

MAP OF THE ROUTE OF THE TRENT CANAL.

done on it. From Lake Simcoe, through the valley of the Talbot River, Balsam Lake is reached, and from here access is had to a chain of magnificent lakes, many of which equal in grandeur of scenery the Thousand Islands. Leaving this chain of lakes the route enters the River Otonabee, which is better known at its lower end as the Trent, passing through the town of Peterborough into Rice Lake and thence to the Bay of Quinte. The whole of the route passes through a fertile and progressive part of the Province, and, from a local point of view, will be of immense benefit to the inhabitants of these parts. Many towns of considerable size and importance are located along the route. The chief importance of the water-way, however, is thought to be its value for barge navigation, permitting grain from the west to be brought in large vessels into Midland Harbour, here breaking bulk and unloading it into barges, which will be towed in lines of from two to six through this route down the St. Lawrence, to the ocean vessels in Montreal.

The works of the canal are being constructed in the most substantial and modern manner. The locks, with the exception of three, are of the ordinary type, and built entirely of concrete; some of them are said to have been the first of the kind in Canada. All the bridges are of steel, and very little timber is used in any structure above water level; so the entire work is carried out with the idea of complete permanency. The hydraulic lock, with which we chiefly deal, is located in a section of four miles of the canal which is built to overcome the obstructions to navigation found in the River Otonabee where it passes the town of Peterborough and where there are many water powers in use for manufacturing purposes. The total difference in elevation in this section is 77 feet. After leaving the river at the upper end about three miles and a half of canal is formed by short lengths of excavation and natural valleys until a slope of a hill is reached, where a difference in elevation of 65 feet is found in a distance of about 800 feet. Here the hydraulic lock is located and the difference in height overcome in one lockage. About a quarter of a mile further along the route has been built a lock of the ordinary type, which leads again into the natural water.

The hydraulic lift lock is, theoretically, an automatic machine, and is devised to take the place of the ordinary lock, where great differences in elevation are found in a comparatively short distance.



The first lock of this type was built by the inventor, Mr. Edwin Clark, of Clark & Standfield, Hydraulic Engineers, London, England, about the year 1872, in England, at Anderton, on the River Weaver, to connect the Trent and Mersey canals. While it differs somewhat in some particulars from the two other locks since constructed, it has answered its purpose admirably and has given no trouble. The same gentleman has also built, or has been connected with the building of, a lock of much larger dimensions at Les Fontinettes, in France, and at La Louviere, in Belgium. The Belgian Government has at present in some stage of construction four other locks of the same type. The chief dimensions of the Anderton lock are: lift, 50 feet; length of chambers, 75 feet; width,  $15\frac{1}{2}$  feet. The two locks already built on the continent, as well as those contemplated, have a lift of about 50 feet, with chambers 140 feet long, 19 feet wide, with 7 feet 10 inches normal depth of water.

With this contrivance a lockage is performed by the vessel floating into a box or tank of water which can be shut off from the adjacent reach. The box, with the water and the floating vessel, is then raised or lowered to the other reach, with which communication can also be made. The power required to control the lowering, or to accomplish the raising, is obtained by having a similar box connected with the other and balancing it. Each of the boxes is carried on the top of a ram working in a hydraulic press. The two presses are filled with water and are connected by a pipe. The rams are arranged so that when one is up the other is down. The uppermost box is made heavier than the other. When a valve on the connecting pipe is opened the heavier box in descending forces down its ram, displacing the water from its press into the other press, making the ram protrude and carrying the lighter box up with it.

The manner of constructing the Canadian lock varies materially from those already built in about the same way that American practice varies from European, and so far as outward appearance is concerned, when the present work is finished, there will be little similarity, although the principles necessarily remain the same.

#### THE SUBSTRUCTURE.

As has been stated, the lock is located on a gradual slope. The excavation was begun in 1896. The exact point of location was chosen so that an average depth of excavation of about 40 feet was

PROFILE, shewing location of Hydraulic Lift Lock.

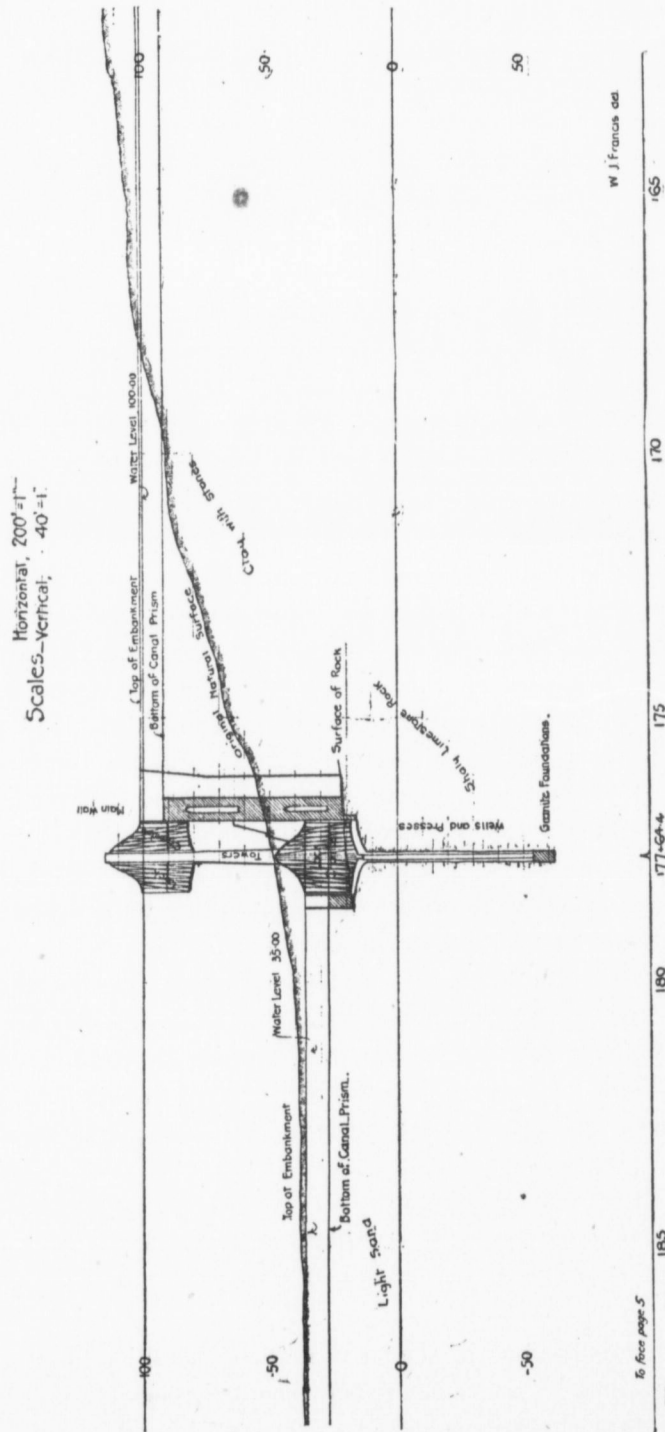

Edwin  
Eng-  
River  
differs  
the con-  
then no  
connected  
at Les  
the Bel-  
in four  
derton  
feet.  
the con-  
0 feet  
r.

float-  
adja-  
s then  
n can  
or to  
con-  
carried  
resses  
s are  
rmost  
nnect-  
n its  
aking

rially  
prac-  
con-  
simi-

The  
was  
t was

required, and the material thus obtained was used in forming embankment to complete the length of the upper reach. The remainder of the material required to finish this embankment was obtained from the earth cutting above the lock.

The excavated material was found to be of a hard clay mixed with small stones and boulders underlying a thin layer of fertile soil. At the northern end of the excavation, where it was a little the deeper, a small amount of hard-pan was encountered, and below this a shaly lime-stone rock. This rock was in layers of from half an inch to eight inches in thickness, between which were thinner layers of clayey and shaly material. The layers of rock, which are of crystalline structure, stand the weather very well, but the shaly parts disintegrate very rapidly under the action of rain and frost.

The elevation at which this rock was found proved to be an exceedingly fortunate one, requiring as it did very little expensive excavation, and at the same time providing an excellent foundation for the heavy substructure and saving much concrete that would otherwise have been required for footings. It might also be added that the discovery of the rock was a pleasant surprise, as many common wells had been sunk in the neighbourhood to considerable depths without having encountered rock, and the borings made on the site had not been sufficiently extensive to discover it. The preliminary plans were prepared for establishing the substructure on earth. Before the work had progressed to any extent, however, extensive borings were made to determine the character of the underlying strata, in order that the contract for the wells, in which the large presses stand, might be let with some degree of certainty. One of the borings was made by a small horse-power machine to a depth of about 130 feet below the surface of the ground, and accurate notes, which have proven themselves correct in the work which has since been completed, were made as the borings progressed. The rock was also a decided advantage for the construction of the wells, which were about 80 feet deep. Its nature permitted it to be blasted and excavated with comparative ease, and no difficulty whatever was experienced in making an excellent job of the excavation at a very small cost.

The foundations in the wells require, as will be seen from what has been already said concerning the principle of the operation of the lift, that the utmost care be exercised in order that there shall

be no failure at this place, the total weight of the lock chamber, with its burden, having to be supported on the comparatively small base which the well affords. Here again the rock proved of great value. The total load at the bottom of the presses is, in round numbers, 2,000 tons, a rather heavy load to trust on so small an area of ordinary masonry foundation, and very much more than was considered advisable to put upon the somewhat poor quality of limestone found in the bottoms. On account of this rather excessive load and its uneven distribution at the press base, it was decided to use blocks of granite so arranged as to distribute the pressure uniformly over a sufficient area of the natural rock to give a bearing which seemed favourable under the conditions, and further, in order that not the slightest risk should be run in incurring possible accident and consequently enormous expense, these foundations were dealt with liberally and more expensive stones were used than would probably be called for under other circumstances.

The courses of granite were specified to be between 24 and 30 inches in thickness, and some of the stones were 7 feet 6 inches square, giving a weight (about 11 tons) requiring care in handling, and affording no little difficulties in the way of setting at such a great depth below the surface. Three courses of granite have been laid and finished in the wells and a very satisfactory job has been made. The design of these foundations will be seen by reference to the drawing on page 131.

The walls of the wells are very regular and reflect credit on the man in charge of the work. By judicious arrangement of the charges of dynamite and blasting very little divergence was made from the truly cylindrical form, 16 feet 6 inches in diameter, which was required by the specification. It was decided, in order to prevent the disintegration of the walls of the wells, to line the sides with concrete. The thickness of the lining is sufficient to form a finished diameter of 14 feet 2 inches, in this way leaving a clearance all round the main presses of 3 feet. It is not necessary that this lining be water tight, although it is believed that it is practically so, as the wells will be constantly full of water and will require to be unwatered at intervals of perhaps five years for inspection purposes. Adequate means in the way of pumps are afforded for this purpose. In putting these linings in, the water was permitted to follow up the concrete work, thus relieving the pressure of any leaks through the

rock on the tender mortar by balancing it. This lining is carried up to the top of the wells and is finished at the floor of the lock-chamber pit.

The substructure of the lock is built entirely of concrete and contains about 26,000 cubic yards. Of this amount some 25,000 cubic yards are already placed. The work has been carried out according to the working general plans which accompany this paper, and which have the special title "Masonry" and are numbered 1 to 10. The substructure may be divided for convenience into (a) main or breast wall, which serves the purpose of a retaining wall for the upper reach; (b) the wings, that further act as retaining walls in holding the side embankments, which will be seen by reference to plan; (c) the side walls, which form retaining walls for the earth along the sides of the lock; (d) the towers, the duty of which is to maintain the lock chambers in their vertical motion; and (e) the lower gateways which end the lower reach. All the walls (excepting the wings) form a dry pit, or rather two dry pits, into which the metal lock-chambers descend.

The main wall is 40 feet in thickness and about 80 feet in height; the length being 126 feet at the base. At about 15 feet from the rock surface there is formed for convenience a chamber or room, which is called the pump room, in which the turbines and pumps are installed. This room is 12 feet wide, 17 feet high and 110 feet long, including partitions 8 feet in thickness, which are intended to assist in taking the shear through the otherwise weakened cross-section of the wall. At about the original natural surface of the ground the wall is pierced longitudinally by a roadway, which will form a continuation of the line of the main street running through the town of Peterborough, giving access for vehicles to the furthest side of the canal and dispensing with the ordinary swing bridge. This roadway is 14 feet wide and 21 feet high. In the top part of the wall are formed recesses for the gates which close the ends of the upper reach. Access is provided from the pump room to the roadway by a staircase formed in the concrete wall, and one may also pass from the roadway to the upper level by a spiral iron staircase placed in a cylindrical void formed in the concrete. Viewed from the side nothing of the main wall will appear below the level of the roadway. On this elevation an attempt has

PRESS WELLS ~ Scale,  $\frac{1}{5}''=1'$ .

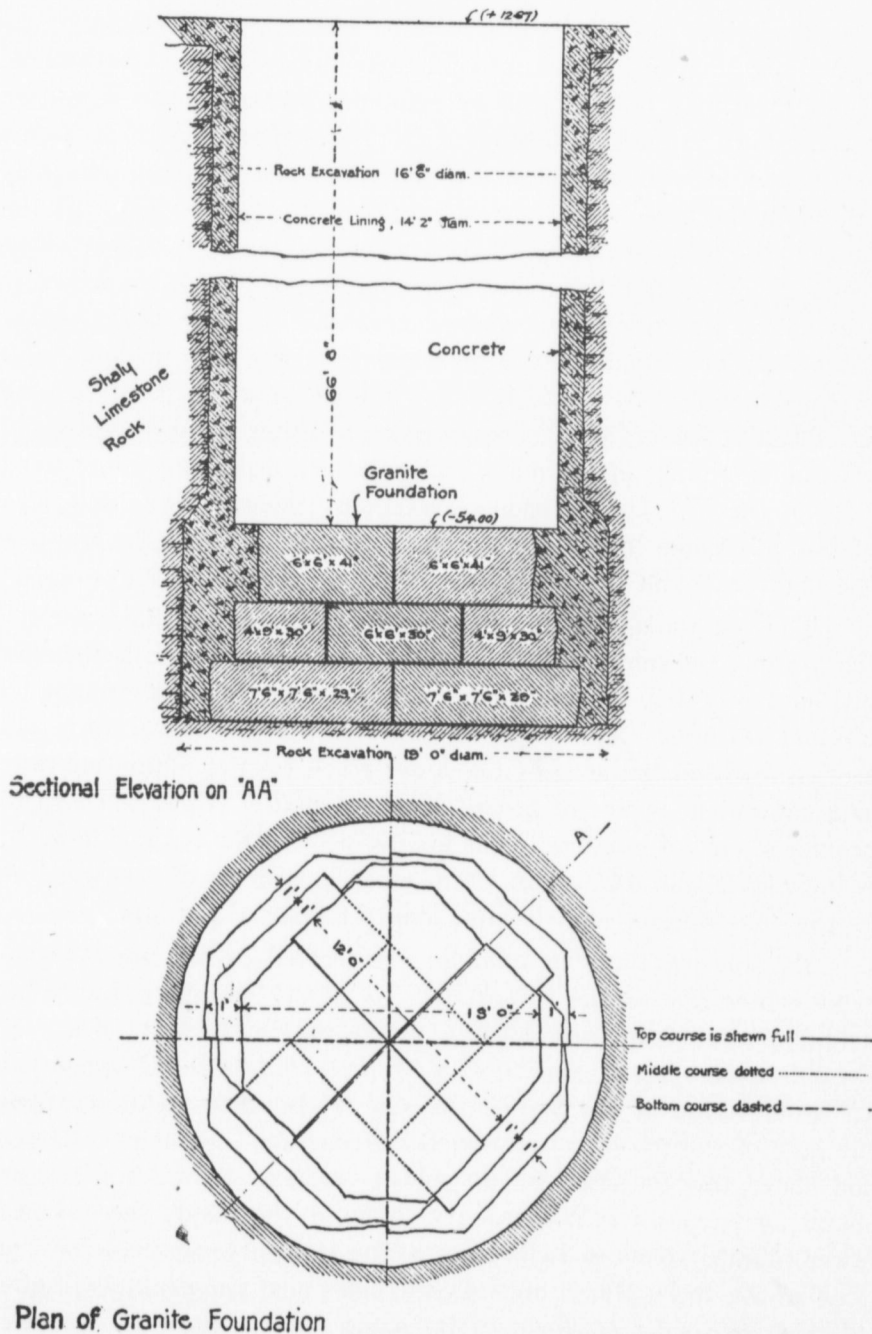

been made to obtain an architectural effect by mouldings and pilasters.

The wings are situated, as will be seen from the plans, at the uppermost side of the main wall, extending 55 feet beyond it. Their form may best be seen by reference to the plans. They are carried down to the rock bottom in order that there may be no undue settlement between the main wall and the wings to cause unsightly cracks on the face and awkward breaks on the top surface. At the bottom the wings are only 40 feet in length, the full 55 feet being made up by cantilevering out 15 feet at the elevation of about 47 feet above the rock level. Considering also the light duty which these walls are called upon to perform, they have been made cellular in construction. Along their outer sides a stairway is carried up as a mean of access from the roadway level to that of the upper reach, and the mouldings of the main wall are continued along the exposed sides of the wings. The side elevation will convey very little idea of the differences in construction of these two parts of the work,—the main wall and the wings.

The side walls, as it has been said, form retaining walls for the earth along the sides and are intended to maintain the lock-chamber pits perfectly dry. These walls are of solid section and present no especial features. At the points next the main wall stairways are carried up from the level of the lower reach to that of the roadway as a convenient means of access from one to the other, and also to provide a sort of buttress to the main wall. In the term, side-walls, is included a wall 12 feet in width extending along the central line of the construction and dividing one pit from the other.

The towers, three in number, are located on the same transverse centre line as the two wells. In round numbers the total height of each from rock bottom to the top is 100 feet. Each of the side towers has a base 29' 6" x 40' 8", which decreases somewhat at the elevation of the top of the side walls. From this upwards the base of the tower is battered for a continual height of 45 feet; and above this the shaft on all sides is vertical 18' x 18' 6". For operating purposes it is necessary to build the inside face of the tower plumb from top to bottom. The central tower has for the same reason to be plumb on both the sides next the chamber, while its other two sides conform to the same lines as those of the side

towers. Its width throughout is 12 feet. The towers have been treated in the same architectural manner as the main wall.

The lower gateways extend from the rock to the top of the side walls, and are formed to accommodate the steel gates which close the ends of the lower reach. In the centre between the gates is a small chamber which contains the hydraulic engine used to operate the gates.

It will be seen by referring to the masonry plans, for instance No. 3, that the concrete work is built in sections—the main wall stands by itself, being separated in construction from the side walls. In the same way the towers are not bonded with the adjacent side walls excepting in a lateral direction, by what is termed on the works a “key.” The object of this system of construction is to obviate unsightly cracks, which occur from uneven loading on the foundation, as well as from contraction and expansion due to the extreme changes of temperature. It has been found in concrete work if lines of weakness are not provided in construction they form themselves in a short period of time. These lines of weakness are formed by placing a partition or “bulkhead” from face to back of the moulding of the wall, and keeping the concrete work on one side of it a few feet higher than the other. Before the lower side is brought up the bulkhead is removed and the new concrete is placed against that formed by the bulkhead. The vertical line thus formed is marked by a small triangular piece of wood 3-8” on a side, tacked to the face forming and which is removed with the forming. These vertical lines are never noticed on the walls, whereas a crack is commented upon by nearly everybody. Where the construction has to provide against unwatering and keep the water from leaking through from the back, the keys above referred to are introduced.

The concrete of the hydraulic lock goes under the general specifications for concrete used on this section of the canal. By the specification the concrete has to be formed of clean sharp sand, gravel, approved field stone broken to about 2-inch cubes, clean water and Portland cement. The cement is provided by the Government.

The cement used is Portland of the best quality. About ninety-five per cent. of that used was of Canadian manufacture. About five thousand barrels of German Portland, which proved to



be of excellent quality, were also used. The Government maintains an excellent cement laboratory, with an efficient chemist in charge, where all the cement undergoes rigid examination before it is used.

The sand and gravel is subjected to very rigid inspection, and none is allowed to be used in which there is an appreciable amount of clay or foreign material. For mortar not to be incorporated into concrete the sand is kept separate, but for concrete purposes the sand and gravel is mixed, and an effort is made to get the sand and gravel uniformly graded from the size which would ordinarily be called sharp sand up to gravel stones an inch and a half in diameter.

About two-thirds of the concrete already in place has been mixed by a "continuous" mixer, which is a long box of square section, open at both ends, set on an incline and caused to rotate. The ingredients of the concrete are fed into a hopper at the upper end, water is forced into the upper end of the box from a hose held at the lower end, and the materials by the time they reach the lower end of the box are pretty well incorporated. With care an excellent concrete can in this way be produced. The remainder of the concrete has been made with a "cubical" mixer, being a cubical steel box pivoted with one of its long diagonals horizontal. The box is charged with the required proportions of material, the lid closed and the box rotated. When the materials have become sufficiently incorporated, which can best be determined from experiment, the rotation is stopped and the contents discharged. This mixer has an advantage over the continuous one above described that the material may be manipulated as long as it may be considered necessary, and one is quite aware of the amount of mixing in a batch of concrete; whereas with the continuous, it is impossible to tell just where one batch ends and another starts. This in many cases is a disadvantage and requires most careful watching, particularly when it is desired to use concrete of varied strength to suit the requirements of special parts of the work.

In the substructure the proportion of the ingredients is varied according to the importance of the parts. For example, in the towers the batches were made by adding an additional bag of cement, making in this manner a stronger mortar, but using about the same amount of stone as in ordinary work. The mixture of ordinary concrete is given by the specification as follows:—To each cubic yard of approved broken stone there shall be added half a cubic yard of

STRESS AND MATERIAL SHEET  
FOR FLOOR BEAMS

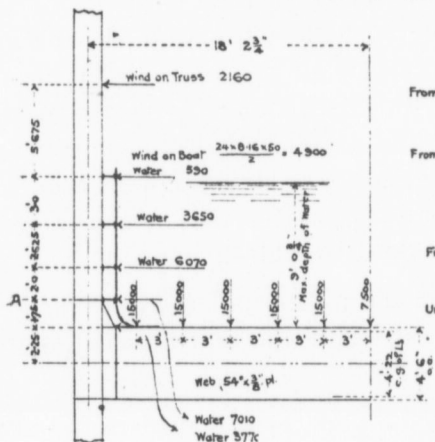

Moment at "A"

From Water Pressure -  $590 \times 7.625 = 4,500$   
 $3650 \times 4.425 = 16,200$  } 33,440  
 $6070 \times 2 = 12,140$

From Wind Pressure -  $4,900 \times 7.625 = 37,400$   
 $2160 \times 15.3 = 28,800$  } 66,200

Fibre stress in Flange,  
 $A_c = 54 \times \frac{3}{8} \times \frac{1}{2} \times 15 + 21 \times \frac{3}{8} \times \frac{1}{2} \times 15 = 21.56 \text{ in}^2$  M. R. = 151

Fibre stress from bending - Water,  $\frac{33,400 \times 17}{151} = 2,650$

Wind =  $\frac{66,200 \times 12}{151} = 5,250$

Unit stress from direct compression =  $\frac{113,000}{21.56} = 5,250$   
 13,420  
 # per in

Stress in Floor Beam.

Stress in top flange, + from bending due to vert. loads  $\left\{ \frac{(15000 \times 5.5 \times 15.25) - (15000 \times 5 \times 5)}{4.22} \right\} = 197,000$   
 - - - - - hor! =  $\left\{ \frac{(590 \times 11.625) + (3650 \times 8.625) + (6070 \times 6) + (7010 \times 4) + (5770 \times 2.25)}{4.22} \right\} = 36,330$   
 160,050 @ 14,000 = 11.42"

2 - 6" x 6" x 1/2" L's = 11.5" gross.

Stress in bottom flange, - from bending due to vert. loads = 197,000  
 + - - - - hor! =  $\frac{113,000 - 21,000}{4.22} = 15,850$   
 181,150 @ 14,000 = 12.92"

2 - 6" x 6" x 5/8" L's = 12.91" net.

A Typical Intermediate Floor Beam.

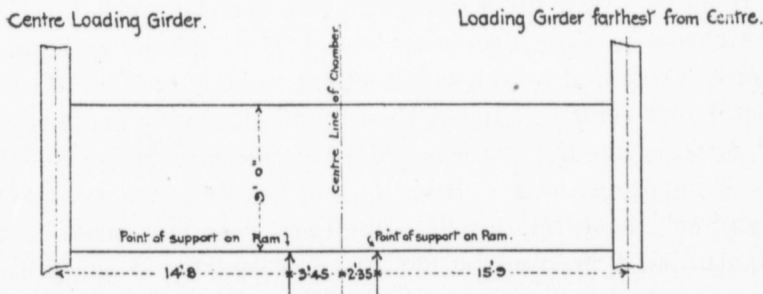

Truss Load 362,500, Stringer React<sup>n</sup> 4,150, (Girder(say) 25000 pounds) Truss load 362,500, Stringer React<sup>n</sup> 9350.

Moment over support  $(362,500 \times 14.8) + (4150 \times 28.2) + (10,000 \times 5.5) = 5,534,400$   
 Flange stress,  $\frac{5,534,400}{615,000} = 9000$  @ 14,000 = 43.8" req'd.  
 2 - 6" x 6" x 3/4" L's 8.3 - 18 x 5/8" pls. = 43.88" net.

Shear, 389,000,  $108 \times \frac{3}{8}$  web = 6075 = 6400 per in

Moment over support  $(362,500 \times 15.9) + (9350 \times 33.25) + (2,500 \times 7) = 6,161,500$   
 Flange stress,  $\frac{6,161,500}{93,000} = 66,250$  @ 14,000 = 49.9"  
 2 - 6" x 6" x 3/4" L's 2 - 18 x 3/4" pls. & 1 - 18 x 1/2" pl. = 48.88" net

Shear, 420,000,  $108 \times \frac{3}{8}$  web = 6075 = 6300 per in

Central Loading Girders

screened gravel, one quarter of a cubic yard of sand and three and one-half cubic feet of Portland cement.

This mixture will not work in these rigid proportions in all cases,—the kind of cement, the fineness of the sand and the gravel and the product of the stone crushers all having an influence. The idea is to have a rich mortar which will bind the coarse materials together, the varying sizes of the gravel and of the broken stone giving uniformity of density to the mass. It has always been found necessary to separate the different parts for trial mixtures, and in these the stone and gravel is added to "fill."

All of the concrete is made and placed under careful inspection and the component parts are watched to see that no changes in the conditions occur.

On all the exposed faces of the work, mortar (generally 1 cement to  $2\frac{1}{2}$  or 3 of sand) to a depth of about three inches is placed. This mortar is mixed at the same time as the remainder of the concrete, and is deposited simultaneously, usually by one man with a shovel, who does nothing else but attend to this matter, keep the moulds clean, and see that none of the coarser material of the concrete is allowed to touch the forming which retains the concrete in position until settling has taken place.

The forming or moulding throughout is made of pine lumber, three inches in thickness and about ten inches wide. The face side of the timber is dressed to a smooth surface and the edges of the planks are rabbeted so as to form a lap joint. The studding to support this surface is required by the specifications to be 6" x 8" stuff set up at about 4 foot centres. It has been found absolutely necessary to use stiff forming like the above in order to preserve uniform lines on the face of important walls. Back lines of the walls are constructed by rough inch boarding which oftentimes does not present a very workmanlike appearance as far as the carpentry is concerned, but so long as the lines are kept reasonably near what is intended nothing more is required in this particular.

#### THE SUPERSTRUCTURE.

The superstructure of the hydraulic lock, which is under contract with the Dominion Bridge Company of Montreal, was let in the spring of 1898. Some slight modifications in the plans,

STRESS AND MATERIAL SHEET FOR MAIN TRUSSES.

Constant dead load on 8' 2" truss panel - 85,190\*

- \* Wt. of water per lin. foot of truss  
 $(12.25 \times 20 \times 62.5 \times 1.67) / (12.25 \times 1.67) = 9384$
- \* Wt. of stringers per lin. foot of truss  
 $(4 \times 15 \times 1) \times (6.5 \times 30) \times (1 \times 42) = 237$
- \* Wt. of plating per lin. foot of truss  
 $= 300$
- \* Wt. of one half of one floor beam  
 $(2384 + 237 + 300) \times 0.5 = 1500.5$

(\* indicates compression; - tension.)

All verticals A, G, I, K, M, O, Q, S, U, W, Y, unless marked.

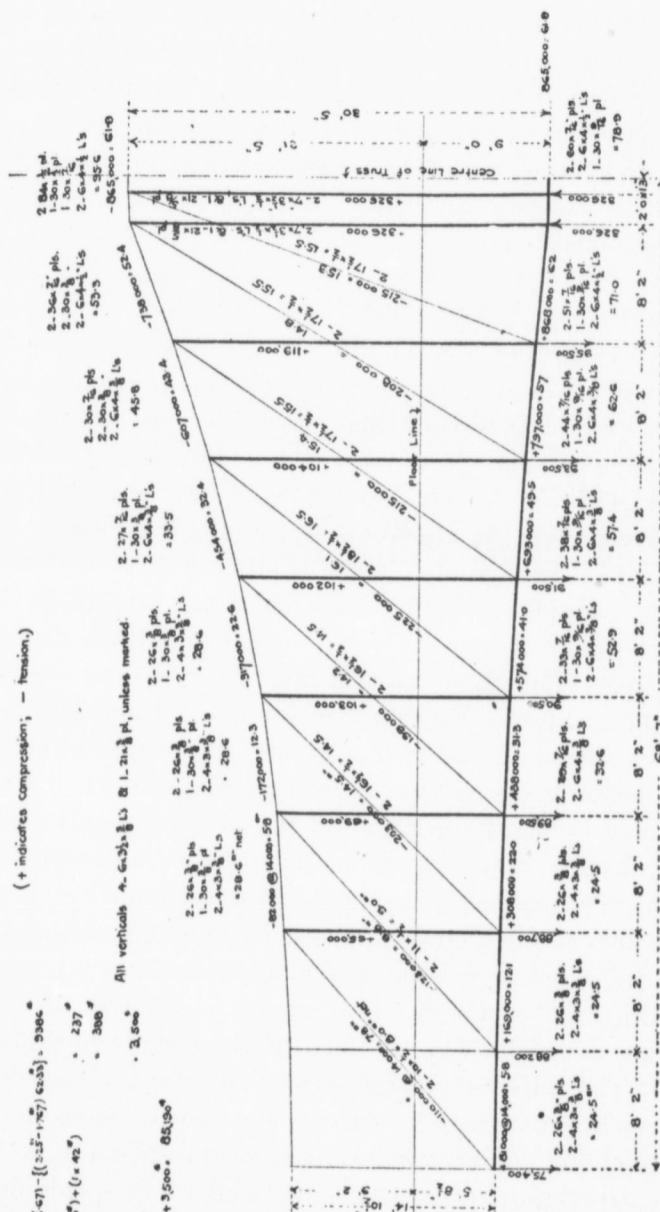

ree and  
 s in all  
 e gravel  
 e. The  
 materials  
 n stone  
 n found  
 and in  
 pection  
 s in the  
 cement  
 . This  
 concrete,  
 shovel,  
 moulds  
 concrete is  
 position  
 lumber,  
 e side of  
 planks  
 ort this  
 t up at  
 y to use  
 on the  
 cted by  
 a very  
 ed, but  
 d noth-

however, have been made from time to time as a more complete and careful study showed that this could be done to advantage; but in the main details the contract plans have been rigidly adhered to. For purposes of description it would perhaps be well to separate the construction into its different important parts,—the lock-chambers, the guides, the gates and their operating machinery, and the auxiliary mechanical plant.

#### THE LOCK CHAMBERS.

As has already been mentioned, the lock chambers of this lock are very much larger than those of any lock previously built, having a width practically double that of the largest of the others. The clear inside dimensions of each of the chambers are 139 feet long and 33 feet wide, with a free board of 9 feet 10 inches. These dimensions, with the exception of the depth of water, are fixed by Government commission; and it is necessary, as well as complying with the conditions above, that a clear headway of 25 feet be left above the water-level. (It would appear that these sizes were determined upon from the construction of the old form of side wheelers in common use on the Trent waters some years ago.) The depth of water for which the lock is constructed would be called in ordinary navigation language "8 feet on the sills," and the whole of the construction of the canal at the present time is being carried on with a view to using this depth of water, although 6 feet is the nominal depth of the canal. The load of water which each of the lock chambers will contain is about 1,700 tons, and this is the maximum load which it is necessary to provide for, since when a vessel is floating in the chamber it is merely a question of displacement. The trusses which carry the load of the chamber are double cantilevers. The form of these girders has been changed from that shown on the drawings by making the chords parabolic in form, in order to obtain a horizontal platform at the ends next to the reaches. The depth of the trusses at the centre is 32 feet, this depth having been chosen with a view to preventing the teetering tendency, which is always present, rather than that of lowering the stresses due to the water load. The trusses are simple, and it is not necessary in any of the members to provide for alternate stresses, as the load is constant and always in the same direction. All the connections are riveted and stiff; the top chord cover-plate is 30 inches in width,

the diagonals are of flat rolled bars throughout. The stresses with the material are given on the drawing on page 137. The floor beams and stringers extend under the whole of the plating and will form a very stiff frame-work for it. No lateral bracing has been provided, as it is considered that the plating itself will be quite sufficient to withstand any wind stresses. The plating of the chambers is, in the lower part, 3-8 of an inch thick, steel, with 5-16 along the sides. The plates are arranged of such a width that there will be very little fouling of the stringers and floor beams, and they are joined by butt splice plates  $4\frac{1}{2}$  inches wide throughout. The riveting of the plating is put in in the same way as for boiler work, and all the edges of the splice plates are caulked by the concave method. The whole of the load of the chambers is, as will be seen, brought directly on to the top of the rams by plate girders 9 feet in depth. There are four of these girders, each taking practically an equal share of the load, as will be seen by an examination of the double system of the trusses.

#### THE GUIDES.

The guides, which will be required to overcome the teetering tendency which is always present, and to overcome also the tendency of rotation due to the unbalanced wind forces, are placed at the centre of the trusses at the sides and the upstream end. The central guides, which have mainly to overcome the teetering, are placed on the line of the top and the bottom chords and connect with the towers. The guide adjacent to the side tower is made of such a form as to withstand a side pressure of the wind, from which ever way it may be blowing, in this way relieving the centre tower of this kind of load and giving it all to the side one. It will be seen by the masonry drawings that the side tower is of much greater width than the centre one, which is only 12 feet in this direction. Those guides which will probably be the more efficient in overcoming the rotating tendency of the wind are placed at the upstream ends of the trusses and work against steel beams embedded in the concrete work.

These guides have, in former locks, also to overcome the unbalanced end pressure of the water when the adjacent gates are opened ready for the chamber to receive the vessel. This end pressure has been so small, compared to what is found in the Canadian

lock, that no extra precautions were necessary to care for it. The unbalanced pressure, however, in the Canadian lock is so great that it has been considered advisable to provide a separate means for overcoming this end thrust. The unbalanced pressure produced in this way is 180,000 lbs. and is taken care of by a special "end thrust arrangement" which engages directly with the concrete work. It consists of a steel casting secured to the trusses of the chamber at about the level of the floor line, and these castings engage with others which are firmly anchored to heavy steel beams imbedded in the concrete work.

#### THE GATES.

The gates and operating machinery are of a very different type from anything that has hitherto been employed for this purpose. The design of the gates is thought to be entirely new. In the European locks it has been the custom to hang and raise them vertically, which has proved to be quite a satisfactory method where the headroom required has not been much more than 8 feet above the surface of the water. However, as it is necessary that 25 feet clear headway be preserved in our case, and as our gates are of necessity about twice the length of the European ones, it did not seem a desirable thing to operate them in the old manner. The method which has been adopted and on which the gates are now being constructed, is clearly seen in the diagram on plan 3, and further in the sketch on page 143.

It will be seen by inspection of one of the gates closing the end of the reach, that it is hinged along the length of its lower edge and arranged so that it will fall flat above the bottom of the gate recesses. As it is never necessary that one of these gates be opened without the other, they are arranged to operate in pairs. The reach gate is controlled directly by a small three-cylinder hydraulic engine and the chamber gate is automatically connected with it. The gates themselves are of steel throughout, the frame work consisting of a series of vertical posts made of I-beams, which connect to the top girder, giving a perfectly determinate system of stresses throughout, and bringing definite abutment loads where they can be readily taken care of. The plating is all on the outer (that is, away from the reach) side of the gate, is 5-16 inches thick on the upper parts, 3-8 inches thick below, is butt-spliced and caulked in

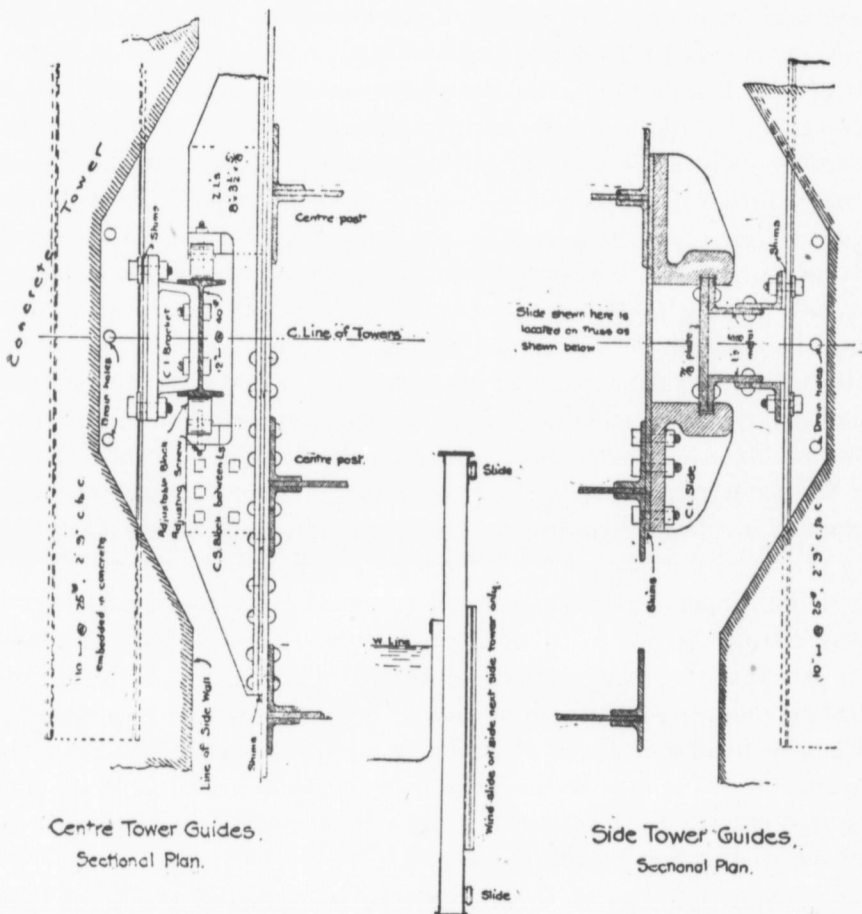

Centre Tower Guides, Sectional Plan.

Side Tower Guides, Sectional Plan.

Section of Main Trusses, showing location of Main Slides, (1/2:1)

End Guides, Sectional Plan.

DETAILS OF GUIDES

Scale - 1"=1'

it. The great that for over- l in this d thrust work. It amber at age with bedded in

rent type purpose. the Euro- vertically, the head- e the sur- feet clear necessity m a desir- od which nstructed, he sketch

g the end lower edge f the gate be opened airs. The hydraulic d with it. work con- ch connect of stresses e they can er (that is, ick on the caulked in

For Location of Guide Anchorage see "Masonry" Plans.



the same manner as the plating of the chambers. In order to render the gates less cumbersome in handling, or rather to make it practicable to handle them, the space between the vertical beams will be taken up by light, water-tight, galvanized-iron boilers of the type commercially known as range or hot-water boilers, and the buoyancy which will be gained by the use of these boilers will make the gate so that it can be readily maintained in any desired position. It was originally intended that this buoyancy should be obtained, as will be seen by an examination of the contract drawings, by plating the gates on both sides and having them caulked. But a further study of the subject seemed to show that this was an undesirable method, as the possible racking of the gates in operation might cause the caulking to become loose, and thus destroy the buoyancy in such a way that it could not easily be repaired; and further the extra amount of plating required to obtain the buoyancy added materially to the weight of the gates. A new method was therefore sought for, and the ranger boiler idea seemed to possess so many merits that it was readily agreed to by the contractors. These boilers are light in construction, thoroughly galvanized within and without, and tested under any required reasonable pressure; and they are cheap. Damage to one or more of them would not materially effect the operation of the gate, and a broken one may be readily replaced at a convenient time. The galvanizing will of course prevent any corrosion of the iron by the water.

Water-tightness is ensured within the gates and chambers, or reaches, by means of a rubber strip, about 3" x  $\frac{1}{2}$ ", fastened along the sides and bottom of the frame against which the gate closes. The pressure of the water itself keeps the strip tightly pressed against the gate, in this way preventing any leakage. The edge against which the rubber bears is machined to a true surface.

The hydraulic engine operating the gates is situated in such a way that its main shaft is on a line with the axis of the gate, and a sprocket pinion is attached to it next to the side of the recesses. A second sprocket, which is connected to the former one by a chain, is attached near the top of the gate rigidly to the same shaft as a pinion which engages with a segmental rack fixed to the side of the masonry. The rotation of the engine shaft causes the gate to be raised or lowered. The shaft extends across the top of the gate, and at its farther end has a similar pinion engaging in a corresponding

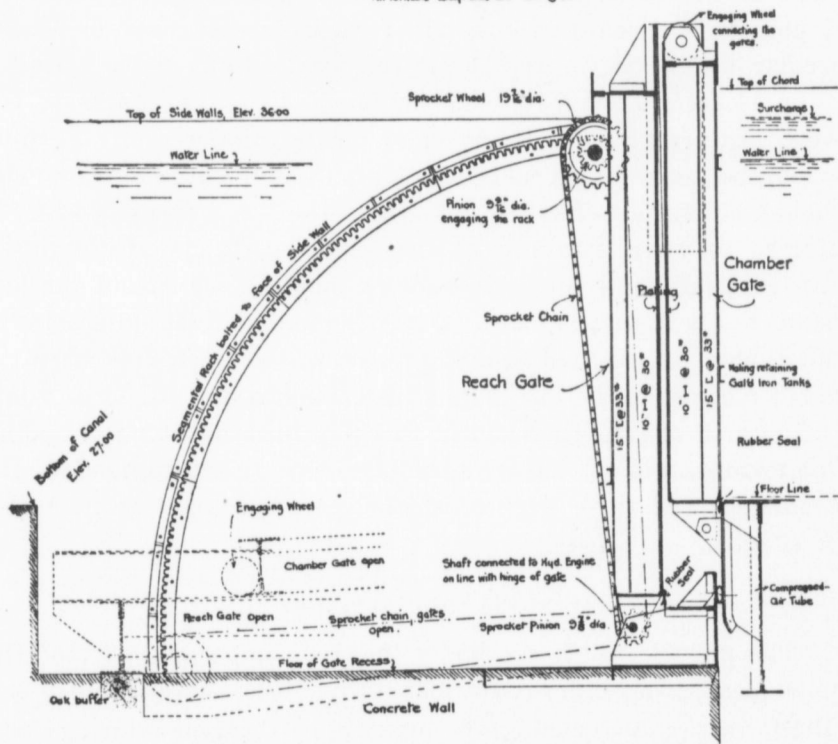
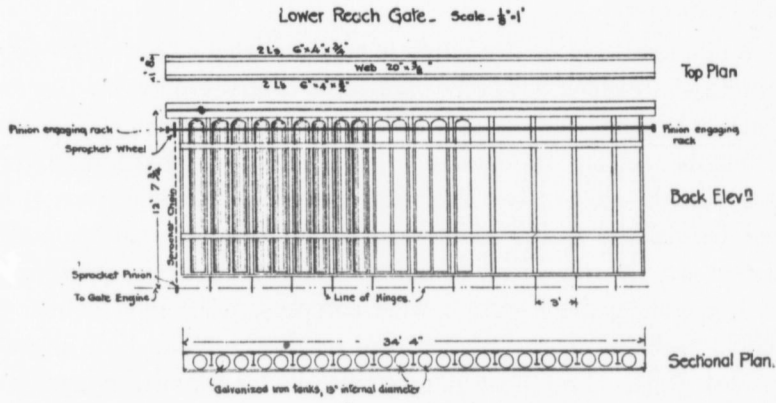

Section thro' Lower Gates, (Galvanized Tanks not shown), Scale -  $\frac{1}{8}$ " = 1'

DETAILS OF GATES.

rack, in this way bringing both ends of the gate up without a twisting motion.

While speaking of the gates it would perhaps be well to describe the method whereby a water-tight joint is made between the end of the chamber and the corresponding end of the reach. The end of the chamber clears the end of the reach by a space of about  $1\frac{3}{4}$  inches, and it will be seen that this space has in some manner to be closed before the water in the canal can connect with that in the chamber, or, in other words, before the gates can be opened. The joint is made by the inflation with compressed air of a rubber tube, which is fastened to the face of the reach along the bottom and up the sides of it. This hose is made flat in form and lies against the frame of the gate. When inflated with air, at a pressure of about 27 pounds per square inch, it will form by its tendency to become circular, a joint which will be perfectly water-tight under a head of 12 or 14 feet, which is the maximum depth of the water at this place. In practice it is intended to inflate this hose only as much as may be necessary to make the joint tight, because the intended amount of pressure increases materially the "end thrust" which is referred to when speaking of the guides. At one of the European lifts this joint has been made by building the end of the lock chamber on a taper and having a movable wedge, faced on both sides with rubber, so adjusted against the end of the reach that when the chamber comes to the top of its stroke, the two inclined faces would bind against one another and in this way form a water-tight joint. This method, while it has its advantages, seems also to have its disadvantages, and these were considered so great that the hose idea was adopted.

#### THE LARGE PRESSES.

The presses, which are really the most important part of the whole mechanism, differ very materially from anything that has hitherto been constructed. The pressure by the gauge during operations will be 600 pounds. The rams have a finished, external diameter of 90 inches, and the inside diameter of the presses is 7 feet  $8\frac{1}{2}$  inches, giving a clear space of  $1\frac{1}{4}$  inches all round the ram. The rams themselves are built of cast iron  $3\frac{1}{4}$  inches in thickness, made up in sections. Each section is 5 feet 3 inches long and is bolted to the adjacent ones by  $1\frac{1}{4}$  bolts through inside flanges. The

MAIN PRESSES.

Scale  $\frac{1}{4}$ " = 1', & 2" = 1'.

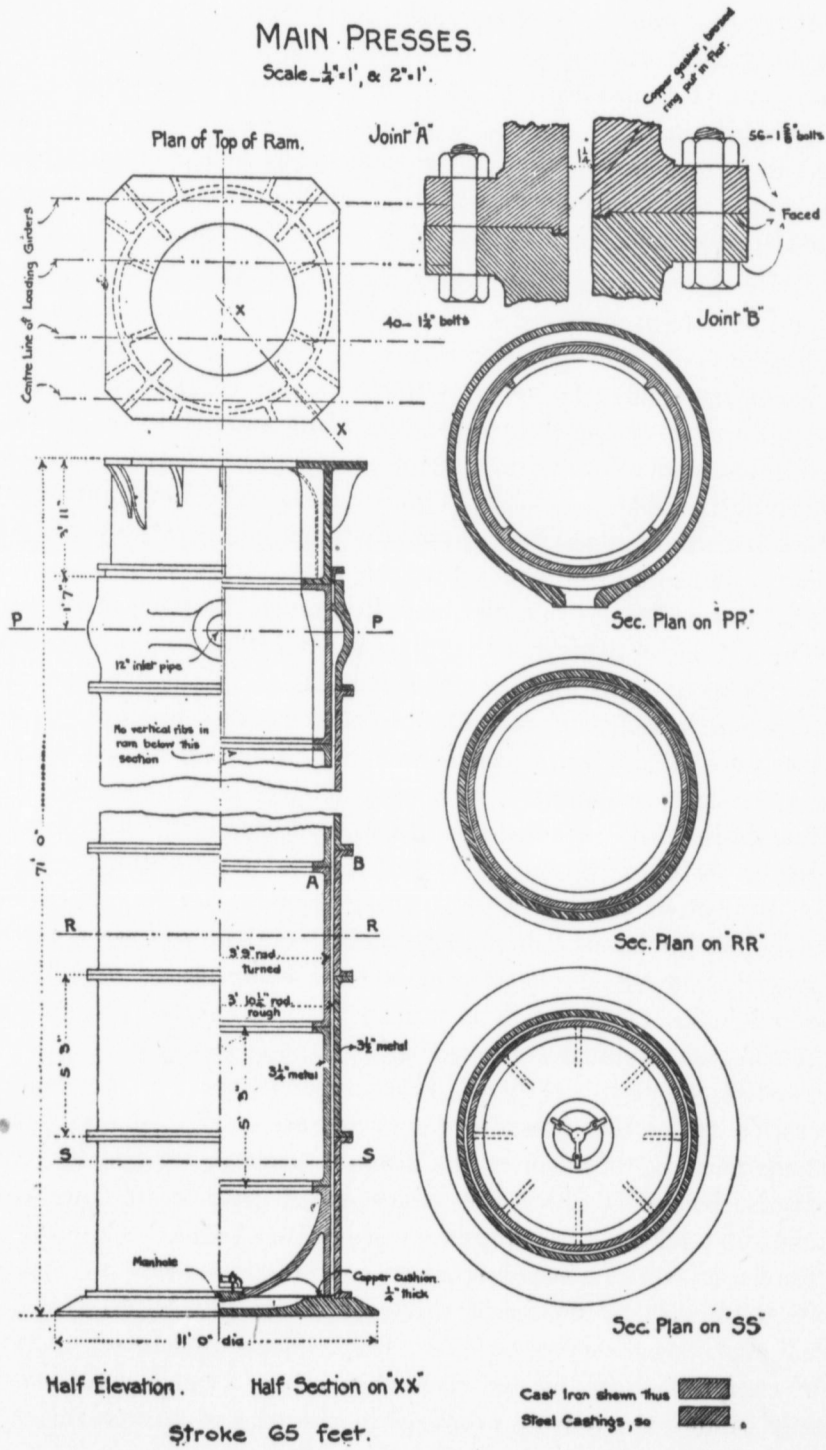

S.P.S.

10

joints between the sections are made perfectly tight by means of a gasket of thin soft copper, rolled true to gauge, of cross section dimensions of  $\frac{3}{4}$  inch by 1-16 of an inch. This gasket is brazed in the form of a ring. The end sections of the ram castings are rabbeted to fit into one another and have male and female corrugations. The copper is put in flat and when the joint is screwed down tightly becomes corrugated, making the joint perfectly tight.

It is, however, in the presses themselves that the important changes have been made. In the presses at Anderton, cast iron sections were used throughout. Failure in these caused Mr. Clark to change his plans. In order to obtain a more satisfactory type of press, cast iron at such high pressure being unreliable in tension, many experiments were tried, and the presses at La Louviere and Les Fontinettes were built on two different plans. The Les Fontinettes presses consist of steel hoops, rabbeted and piled on top of one another to make up the required height, water-tightness being gained by an interior lining of copper brazed, in much the same manner as the inner tube of a bicycle tire gives air-tightness to the tire; the copper is water-tight and the steel hoops take all the tension. At La Louviere a different method was tried. The sections of the presses were of cast iron to get the water-tightness, and the strength was given to these sections by means of steel hoops rolled in the ordinary tire mills, rabbeted so as to fit together, heated and shrunk on to the sections. On either end of the cast iron sections a small lip or projection was left while turning them, to serve as a protection against the hoops being dragged off, but these lips were not so large as to prevent the heated hoops from being passed over them. The end hoops of the sections were flanged and served as a means of bolting the adjacent sections together. This has proved to be a very satisfactory type of press, but it requires not very much consideration to see that it is also a very expensive one. The cast iron sections must be turned with the utmost accuracy; the greatest care must also be used to have the hoops bored out, and an immense amount of machining is required on each of the hoops. The heating of the hoops is also a serious matter, and after the press is finished, while there may be no doubt whatever of its suitability, still the actual stresses are very uncertain. They endeavoured to set up sufficient compression in the cast iron when in the normal condition to exactly balance the tension produced by the load when working, and

in this way leave the cast iron in a neutral state of stress. This style was shown on the plans for the letting of the superstructure, and was tendered on by the European firm which built the La Louviere lift, who asked to have them made the same diameter as those at La Louviere (namely, 2 meters) instead of 7 feet 6 inches diameter as our specification required. The present contractors, however, in their tender, submitted also an alternative tender for presses made of steel castings, at the same time making such a substantial decrease in their alternative figure that the Government felt compelled to enquire very carefully into their proposal, with the result that their tender for the presses of steel castings were accepted. Mr. Clark, in his experiments of presses, had tried steel castings, but in one of the large sections he produced failure at about 40 per cent. of its calculated ultimate strength, owing, as examination showed, to the fact that a large piece of scale had become loosened from the mould and had embedded itself in the wall of the casting. This was really all the information along this line that the Government had when entering upon their investigation as to the feasibility of using steel castings for this purpose, with, of course, the knowledge that immense strides have been made in the manufacture of steel castings since the tests at La Louviere were made ten years before. A careful study of the products of some of the large steel casting manufacturers of the United States, and of their test specimens, coupled with the assurance that they were able to make a satisfactory press in this manner, led to the adoption of steel castings, which are now in shape to be placed in the work. The internal diameter, as has been stated, is 7 feet 8½ inches, the thickness of the metal 3½ inches, the length of the sections 5 feet 3 inches, with flanges on either end for connection purposes. The thickness, 3½ inches, was chosen chiefly as a matter of consideration in casting rather than on account of the stresses. The maximum pressure in the presses will probably give a tensile stress in the walls of about 8,500 lbs. per square inch. The Government required that every casting in the presses should undergo a pressure test by water. The maximum pressure to be applied was decided upon as 2,000 lbs. per square inch, which strains the metal of the casting almost up to the elastic limit; and this pressure may be applied and relieved as many times as the engineer may direct. It is considered that this will insure, beyond a doubt, that every casting is perfect

and that no flaws or large faults exist in them. The tests already made on these castings have been eminently satisfactory, and have far exceeded the most sanguine expectations. Not only have the steel castings taken the load perfectly, but there has not been the slightest oozing, while some of the auxiliary ordinary iron castings used in the test have allowed the water to pour through them like sponges.

The tops of the presses are finished with a stuffing box of rectangular form, 1 inch wide and about 10 inches in depth, and will be filled with braided hemp, which before using is about an inch square in section. It is intended to use about nine rings of this hemp in the stuffing box. The hemp is tightened down by means of a steel gland or follower held by stud-bolts tapped into the top section. The gaskets forming a water-tight joint between the adjacent sections of the press, are of copper, the same as those described for the rams. In the tests already performed there has been no difficulty experienced in keeping this hemp packing quite tight under pressure of 1,200 lbs. per square inch.

Another important deviation from former examples is the manner in which the water is admitted to, or discharged from, the presses. It is necessary that a volume of water equal to the volume of one of the rams be forced from one press into the other during the process of lockage. The chief difficulty with the Anderton press was encountered at the point where the connecting pipe joined the presses. To overcome this, a rather complicated inlet system was devised and patented by the Société Cockerill of Seraing, which has proved very satisfactory on the La Louviere lock. The contractors of the Canadian lock suggested an entirely different form of inlet, which consisted practically in the enlargement of presses at the level of the connecting pipe by a swell, which would permit the water to discharge freely away from the ram. Before approving of this the engineers studied the matter very carefully, and after a most liberal application of hydraulic formulæ, and the most variable results from very slight changes in assumptions, it was decided to perform some experiments to determine if possible what would be the best arrangement of curves for this inlet. A model was made of wood one-fifth full size, and the curves suggested by the contractors were accurately and carefully formed in the model and shellacked. Water from a height of about 30 feet was discharged through this model, which represented as closely as practicable the actual conditions which will

exist, and the curves were correctly and carefully increased, numbers of experiments being performed with each set of curves. It was found that after certain enlargements had been made, that the discharge from the model was no longer effected, and it was assumed from this that these curves would give probably the best results and least friction. These lines were agreed to by the contractors.

The pipe connecting the two presses is 12 inches internal diameter, made of steel castings one inch in thickness, the various lengths being fastened together with bolted flanges. Midway between the presses and immediately under the centre of the central tower is located the main valve, which closes the connection between the presses. This valve is controlled solely by the lock master in his cabin on the top of the central tower. Beside the main gate valve there are two auxiliary valves which are closed or opened automatically by the lock itself during its motion. These valves serve as a protection against possible accident, and each valve is closed by the chamber by the time it reaches the end of its stroke, the closing being started about the last eighth or 8 feet of the stroke.

#### THE AUXILIARY PLANT.

As has been stated, the hydraulic lock is theoretically automatic, but it will be seen that slight leakages about the gland of the main presses cannot be avoided. For this reason it is necessary that some supply of water under pressure be maintained and always ready when required. This supply is provided from an accumulator.

#### THE ACCUMULATOR.

The accumulator consists of a cylinder in which a ram works, the ram carrying a weight which may be increased or diminished according as it may be desired to change the pressure in the water contained in the presses. In the accumulator in question it is intended that the ram will be loaded to give a pressure of about 15 lbs. more than that at which the large presses will work, so that in event of additional water being required in either of the large presses, at any time it can be readily admitted from the accumulator. The accumulator receives its supply of water from a pressure pump located in the pump-room, the pump being driven by a small water-wheel working under the head of the upper reach. The accumulator is built after the same manner as the large presses, having a press



or outside cylinder of steel castings. In the type of accumulator invented by Lord Armstrong, the ballast-box, whereby the weight is applied to the top of the ram, is in the form of a ring encircling the press. But this appears to be undesirable, because when the ram is at the top of its stroke there is practically a pivot joint in the middle of the column, the height of which is twice the length of the ram. This accumulator is now built with the ballast-box directly on the top of the ram, and the top of the press is stayed to the walls of the concrete, where it is installed. It is expected that a much steadier motion will be obtained in the machine by this method. The accumulator is installed in a void in the eastern side tower, and a cylindrical well has been carried down to about the level of the top of the large presses in order to contain the press. The stroke of the ram will be accommodated in the height of the tower. The diameter of the ram is 20 inches and its stroke is 30 feet 6 inches. This will give, without further supply from the pumps, a sufficient quantity of water to raise one of the large rams one foot high.

As it was necessary that the accumulator and pump should be installed, it was thought desirable that the gates and the capstans for towing vessels in and out of the chambers might also be operated to advantage from this power, so it was decided to use Brotherhood three-cylinder hydraulic engines to operate the gates, one for each pair of gates upstream and another for each pair of gates downstream, the gearing being so arranged that only one pair of gates can be worked at a time. The hydraulic capstans are practically of the same form as these engines and are operated by the same power. The engines and the capstans are being constructed by the Hydraulic Engineering Co. of Chester, England.

#### THE PUMPS.

The accumulator receives its supply of water from two high pressure hydraulic pumps located in the pump-room. Each of the pumps has a capacity sufficient to operate the accumulator, the two being provided in order to form a duplicate plant. The pumps are built in the most substantial manner, having bronze pistons and piston rods, and bronze-lined cylinders. They are directly connected to the turbines by which they are driven, and are so arranged that in case of accident both can be connected to pump up the lock-chambers singly so as not to completely stop the traffic on the canal.

A pump having a capacity of about 20 cubic feet per minute is provided for the continual unwatering of the lock-chamber pits and is placed in the lower gateway engine chamber discharging into the lower reach. It will doubtless be impossible to keep the lock-chamber pits perfectly dry, owing to the height of the water back of the walls. This, together with a certain amount of leakage from the presses and other machines, as well as from the gates, will accumulate in the lower portions of the pits around the main presses. When this water reaches a level very nearly the floor of the pits at this place, this pump will be automatically started and work until the water is taken out to the desired level.

#### THE TURBINES.

The turbines operating the pressure pumps are located in the pump-room and derive their power from the 65-foot head of the upper reach. This water is taken in through a screen or rack at the side of the reach, and down a vertical penstock leading into the pump-room, the wheels discharging into the two draft tubes embedded in the concrete wall separating the pump-room from the culvert into which they empty. The culvert conveys the water to the level of the lower reach, where it will be utilized to make up for the evaporation and percolation on this short stretch of the canal. Each of the turbines is 16 inches in diameter and is of the "Crocker" type. The turbines are built in the most substantial manner and have bronze steps. It is ordinarily intended that one of the turbines shall be utilized to operate one of the pumps, while the other will generate electricity for lighting the lock and for supplying electrical power for any other object which may be deemed advisable within reasonable distance of the lock, such as the operating of the swing bridges and the guard gates. The turbines are arranged so that each can work either pump. The working of one pump is all that will ordinarily be required; if necessary, however, both may be operated at the same time.

#### THE DYNAMO.

The type of dynamo has not yet been decided upon, but it will be sufficient to provide about 100 arc lamps. It is intended to install this machine in the central chamber of the pump-room, belting it directly to the turbine nearest to it.

## THE TAYLOR HYDRAULIC AIR COMPRESSOR.

Reference has already been made to the air tube which forms a joint between the ends of the chambers and the ends of the reaches and which is inflated with compressed air, when it is required to make the joint. This air is supplied by a compressor, built under the patents of the Taylor Hydraulic Air Compressing Co. of Montreal, and is located in the south-west corner of the main well. It receives its supply of water from the upper reach and the air is compressed by becoming entangled with the water at the point of inlet, dragged down by the water to a depth considerably below that at which the water escapes, and afterwards collected below and thence delivered into the pump-room. The inlet of the water indicated on the masonry plans is about 13 feet above the outlet, which may be seen passing over the top of the main wall, and into this the inlet or feed-pipe delivers. The headpiece is a device separately patented whereby air is admitted so as to become entangled with the inflowing water.

It is connected through its base by an 18-inch pipe to a tank 85 feet below it. The connection at the lower end of the pipe is made on the side of the tank where the water is given a horizontal and rotary motion, allowing the air to collect in the conical top of the tank. A 4-inch pipe is attached at the top of the cone, delivering the air at the required destination. The lower tank, 11 feet in diameter, is open at the bottom, permitting the water to escape after the air is released. The water then rises around the outside of the tank and up the 42-inch shaft in which the 18-inch down-pipe, before referred to, is placed, and escapes at the outlet above the level of the top of the roadway. The pressure of the air is that due to the column of water from the water-line in the lower tank to the level at which the water escapes in the outlet at the roadway level. The lower chamber also forms a reservoir for, as well as a collector, of the compressed air; the compressor is automatic in its action and runs continuously, a safety valve being provided to allow the air to escape when too much accumulates below.

From the pump-room the compressed air is led in pipes to the various places at which it is required to be used.

## METAL IN THE SUPERSTRUCTURE.

A summary of the amounts and the various kinds of metal included in the superstructure is as follows:—Rolled steel in plates and shapes for the lock-chambers and gates, 1,680,000 lbs.; cast iron in the main rams, accumulator, guides and various machines, 495,000 lbs.; steel castings for the main presses and accumulator, 668,000 lbs.

## OPERATION.

The operation of the lock will require three men—a lock-master and two assistants or gatemen. The duties of the lock-master will be to oversee everything, and he will be fully responsible for the structure. The gatemen will be required, one at the lower end and the other at the upper, to open and close the gates, make good the joints between the ends of the chambers and the reaches and to operate the capstans. It will also be necessary for the gatemen to take charge of vessels at a distance of about two hundred feet above or below the lock, at which point the vessels will pass into the sole charge of the hydraulic lock men.

The lock-master, during operations, will be required to stay in his cabin, located on the top of the central tower, where he will be in full view of all the operations and in full communication with both of his assistants by a simple signal system. The lock-master will have all the levers before him, and will control all the workings of the lock. The levers for controlling the gates, water-tight joints, capstans and all parts of the apparatus will be interlocked so that none of them can be moved out of proper order, thus guarding against possible accident and giving the lock-master complete and sure control of the whole apparatus. In order to get a clear idea of the complete mode of operation, let us assume that both lock-chambers are down at the lower level, and empty, as they will be at the end of the winter, or even when it is desired to prepare them for navigation purposes. Each of the presses will be filled with water by the pumps. The main valve on the connecting pipe will be closed and water will be pumped into one of the presses until the ram with its superimposed chamber rises to the level of the upper reach. An examination of the case will show that it is necessary that the uppermost chamber, in order that it shall be able in descending to cause the other to take the full upward stroke, must

contain a volume of water greater than the rising chamber contains. This extra amount of water is equal to the volume of one of the main rams, since the change that takes place during the relative motion of the two chambers, is that the ram of the descending chamber becomes constantly immersed while the other protrudes. In popular language, the descending chamber is losing weight while the ascending one is constantly becoming heavier. It is also necessary that some extra weight or "surcharge," as it is called, be provided to overcome the friction of the guides and of the stuffing boxes of the main presses. The area of each of the lock-chambers is so great that it requires only an additional depth of  $8\frac{1}{4}$  inches to give an extra load of water of 100 tons, which will, no doubt, be quite sufficient. The addition to this weight will, of course, have the effect of accelerating the time of the relative change in position of the chambers. It is intended that the actual time required in raising the chamber through the whole elevation, will be about three minutes. But this will depend upon the adjustment of the main gland, the nicety of the working of the guides and the controlling of the main valve in the hands of the lock-master. In the European locks this part of the lockage is readily performed in three or four minutes. Suppose that the uppermost chamber will be required to stop, say with its floor  $8\frac{1}{4}$  inches lower than the bottom of the upper reach. When communication is established between it and the reach it will have a load of 100 tons in excess of that in the lower reach, assuming that the depth of water in the two reaches is the same. Then the total operations to perform the lockage, assuming that the gates adjoining the reaches are open and that the water-tight joint between the chambers and the reaches is made, will consist in hauling the vessel into the chamber and mooring her there securely, closing the gates, deflating the water-tight joint and opening the main valve between the presses. The heavier chamber will commence to descend, the motion being allowed to increase gradually by the gradual opening of the valve, until it reaches the maximum speed. At about three-quarters of the stroke the main valve is slowly closed, communication between the presses being entirely cut off when the end of the journey is reached. Theoretically it would appear possible to have an ideal surcharge which would perform the required stroke without the operation of any valve whatever. The change in elevation being made, the water-tight joints are again made

by the air tubes between the chambers and the adjacent reaches, the gates are opened and the vessel or vessels are free to go on their journey, after being towed out by the capstans. The surcharge contained in the descending chamber simply flows out into the lower reach, while a similar quantity to perform the next lockage is admitted into the chamber which has just reached the higher elevation.

It would appear that the hydraulic lift lock possesses many advantages over locks of the ordinary type. First of all it bears the same relation to the ordinary lock as the double track railway does to the single, for one vessel may be locked downwards and another upwards at the same time, this making no difference whatever to the lockage, as the admission of the vessel is merely a question of displacement of so much water. Again, the saving of time is an important item, for the total operation is readily performed within a space of twelve minutes, while with the ordinary locks an hour or more would be considered fast work. The third advantage, and one which is of great importance where there is a scarcity of water in the upper reach, is the small quantity of water required to make the lockage. In the ordinary form of lock the amount of water is equal in volume to the area of the lock multiplied by the height through which the lift is made, which is very many times greater than the quantity required by the hydraulic lift lock; indeed, certain conditions of traffic may arise which make it possible for water to be delivered from the lower level into the upper.

OUTLINES OF WORKING DRAWINGS OF  
MASONRY SUB-STRUCTURE OF LOCK.

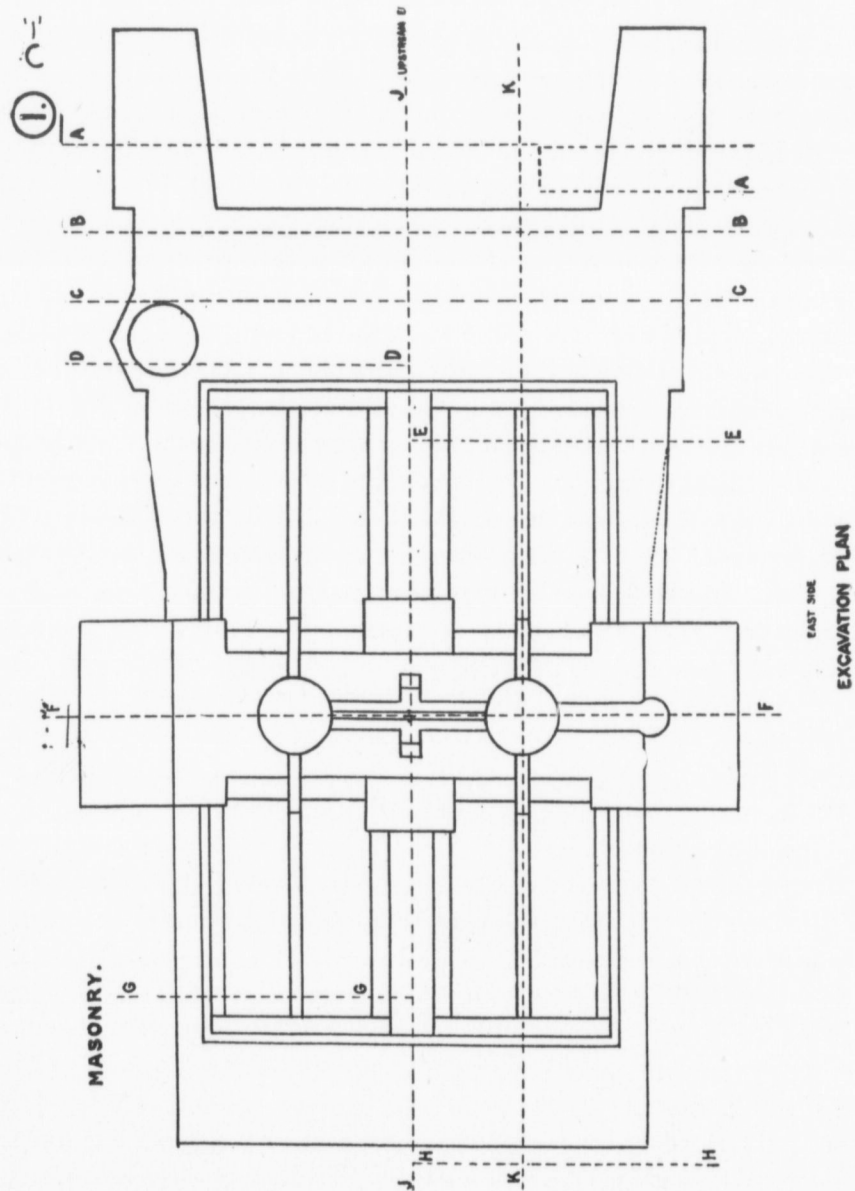

HYDRAULIC LIFT LOCK ON THE TRENT CANAL.

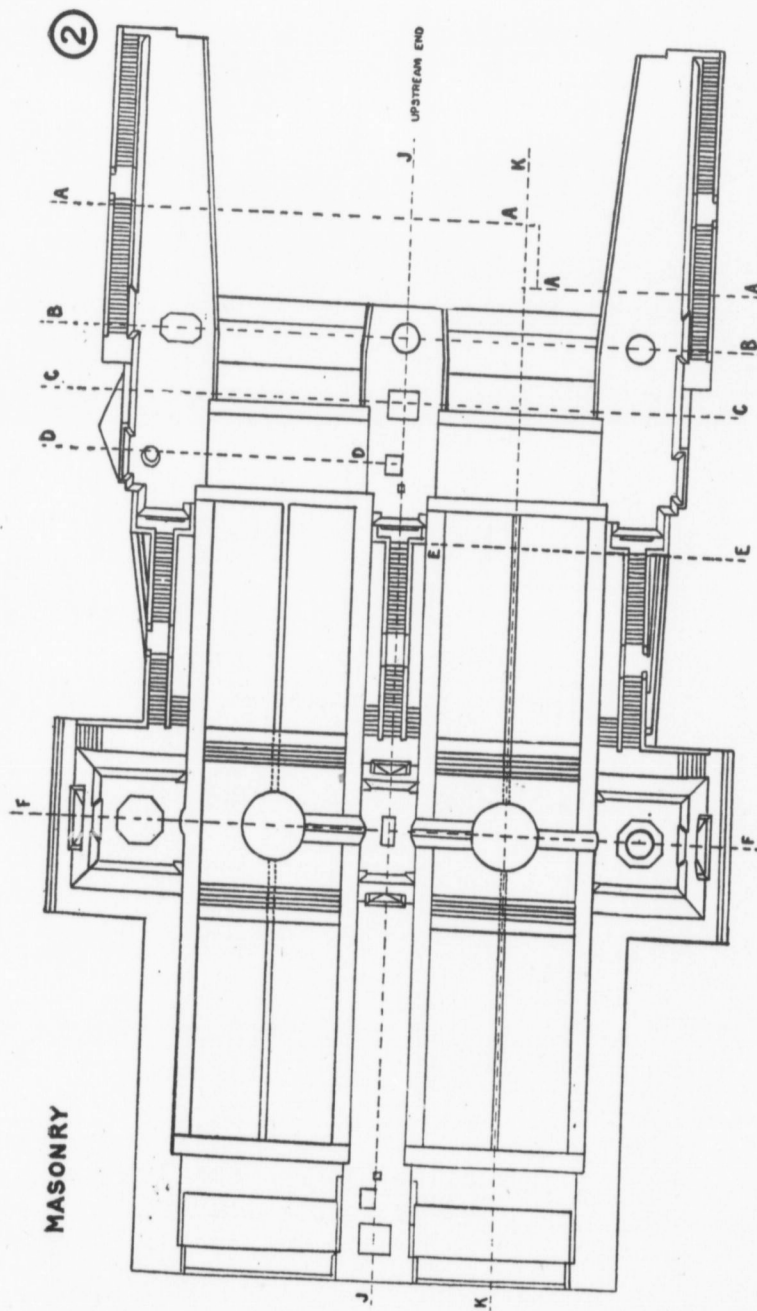

F

EAST SIDE  
EXCAVATION PLAN

MASONRY

EAST SIDE  
TOP PLAN.



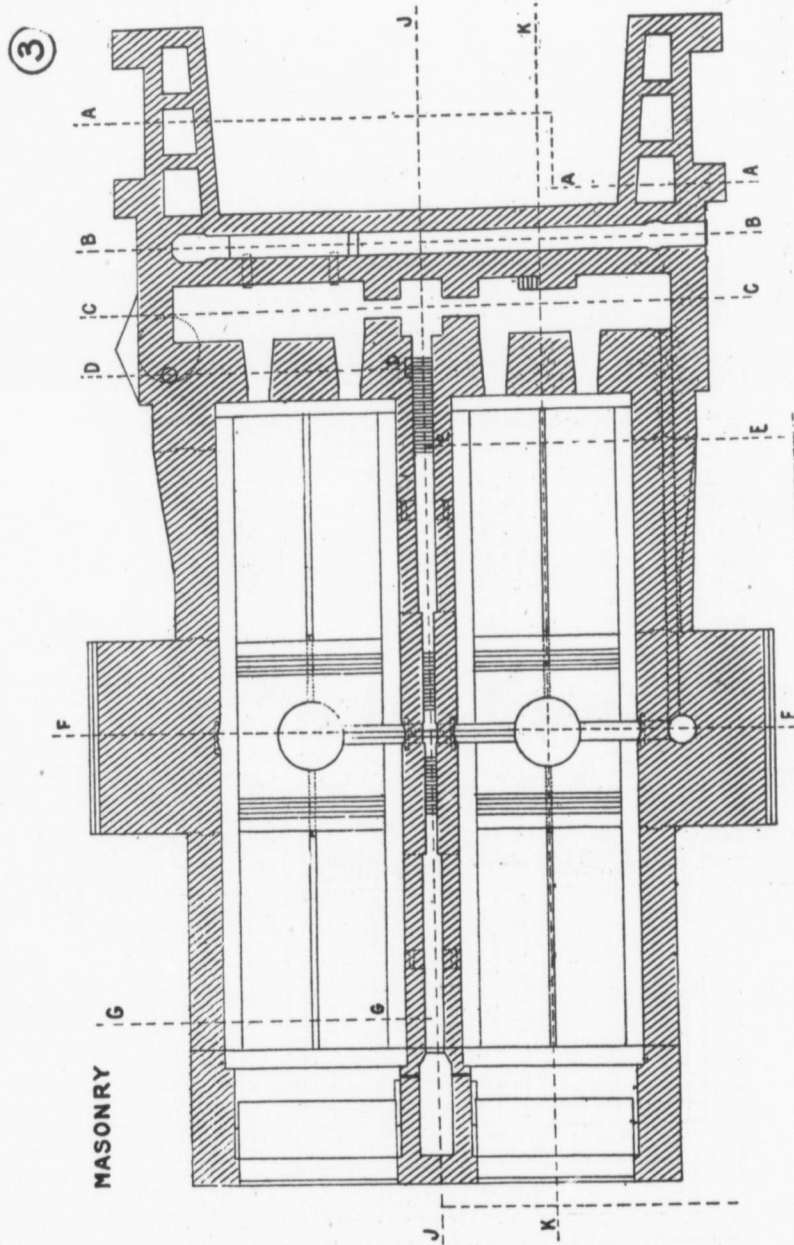

SECTIONAL PLAN AT 'YYZZ'

HYDRAULIC LIFT LOCK ON THE TRENT CANAL.

④

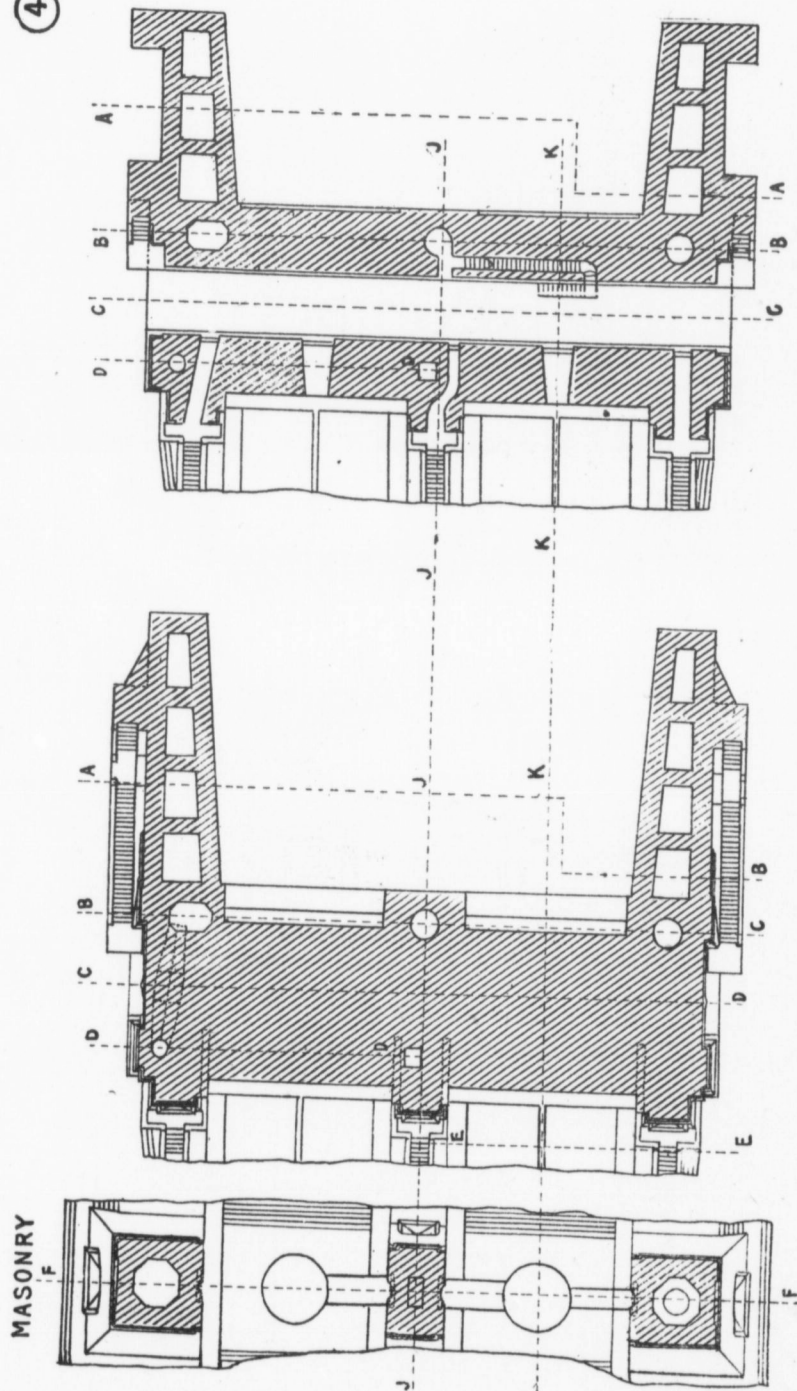

SECTIONAL PLAN AT 'YYZZ'.

SECTIONAL PLAN AT 'XX'

SECTIONAL PLAN AT 'WW'

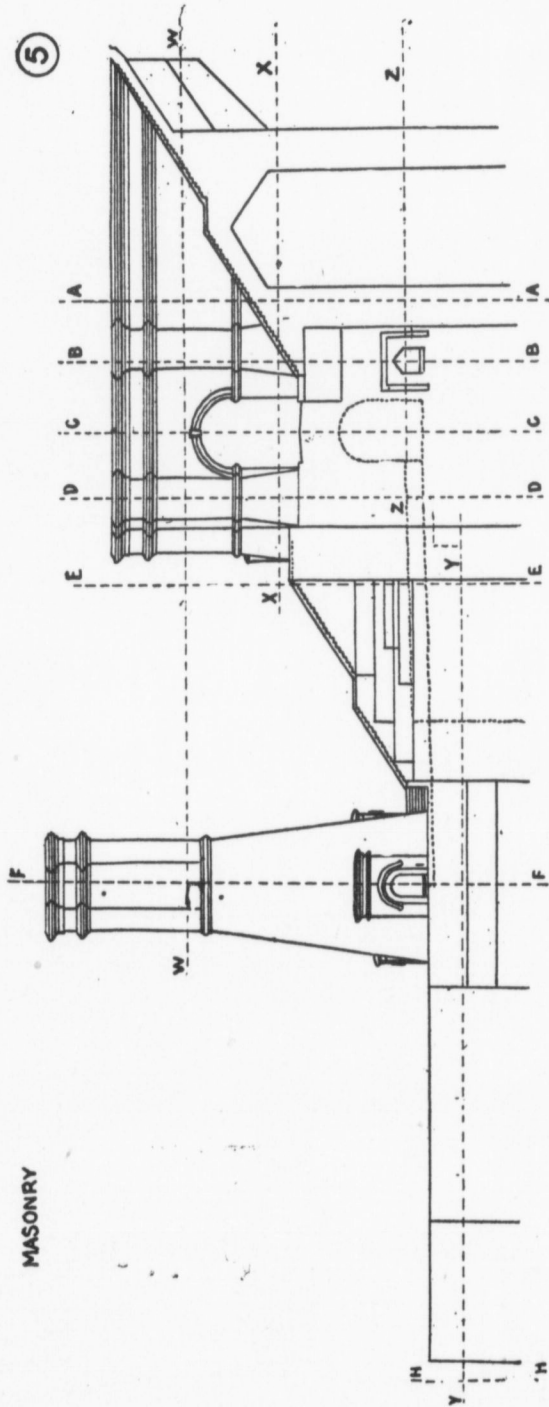



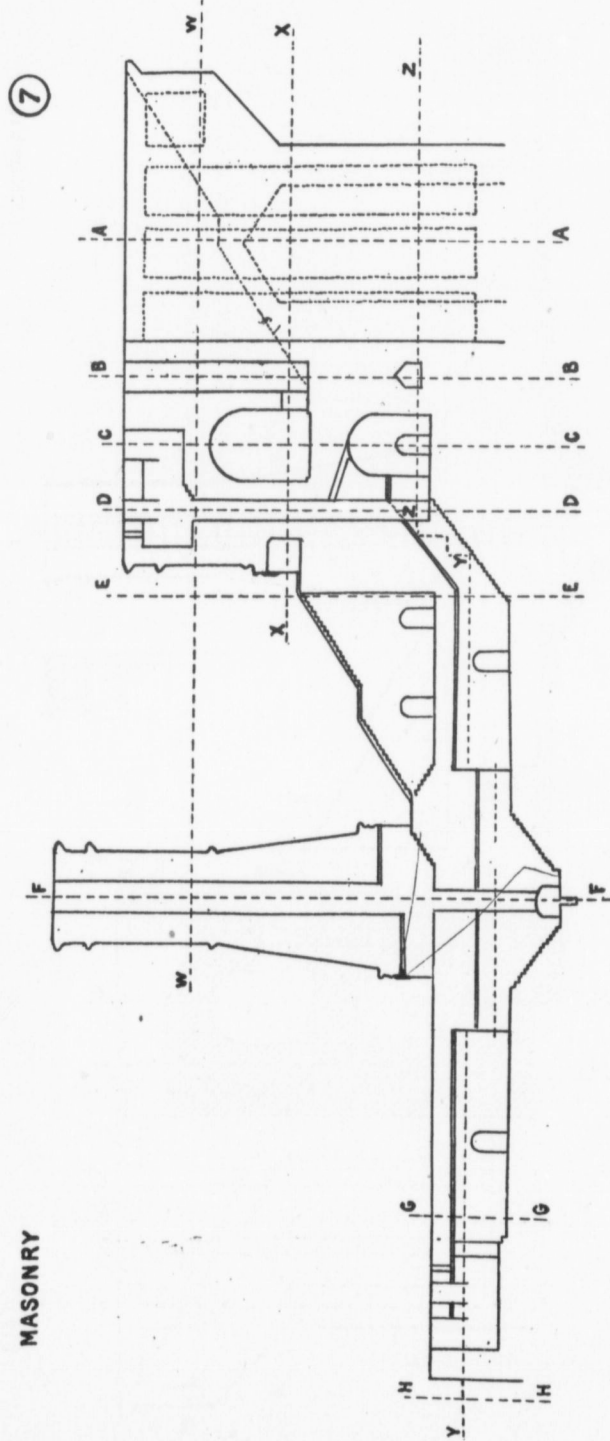

TRANSVERSE SECTION AT "CC"

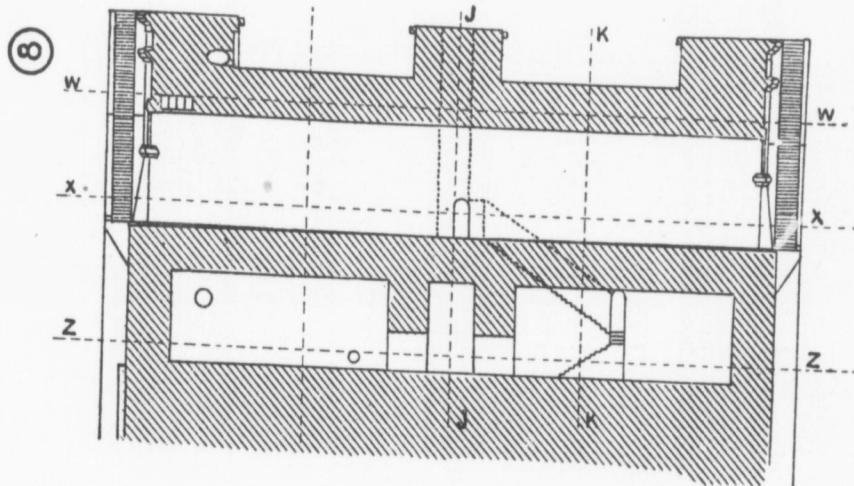

TRANSVERSE SECTION AT "BB"

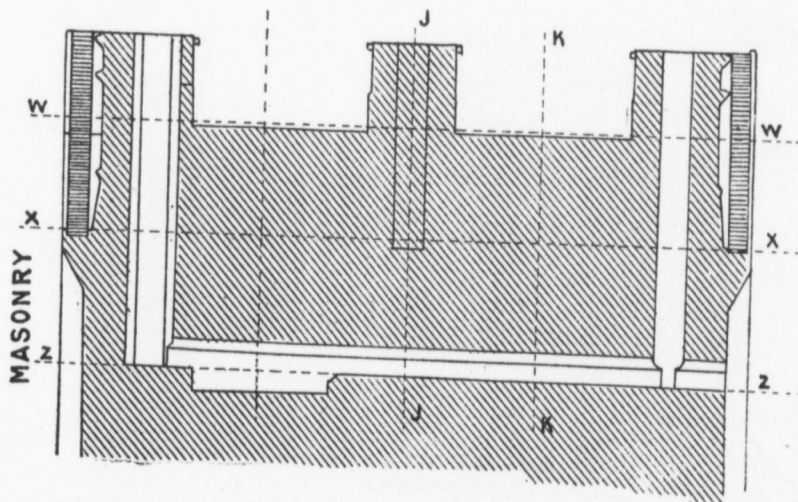

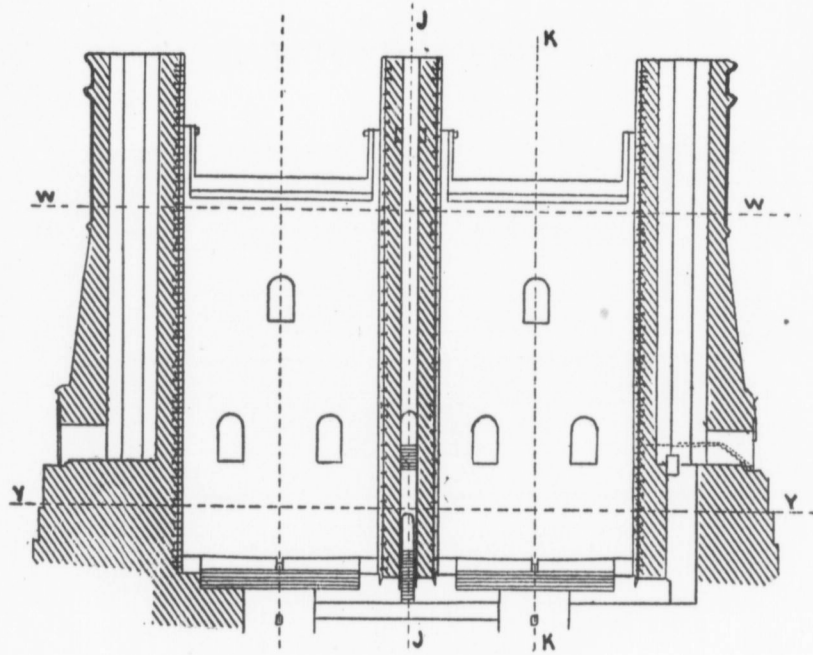

TRANSVERSE SECTION AT "FF"

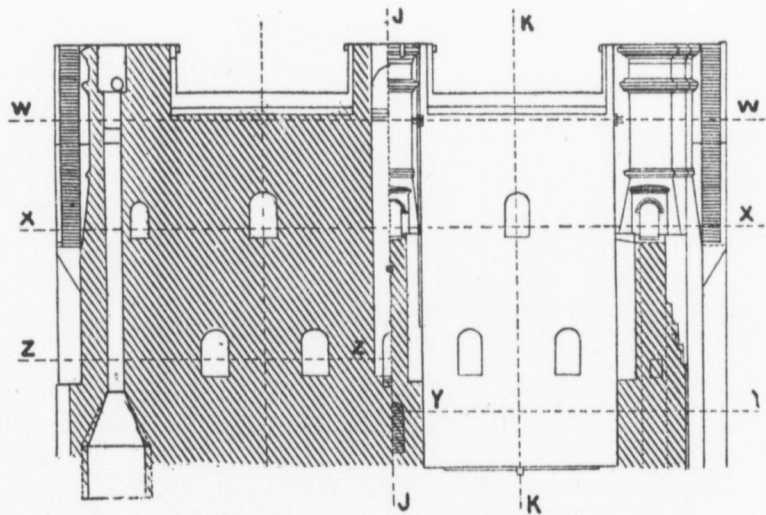
TRANSVERSE SECTION AT "DDEE"  
MASONRY

9

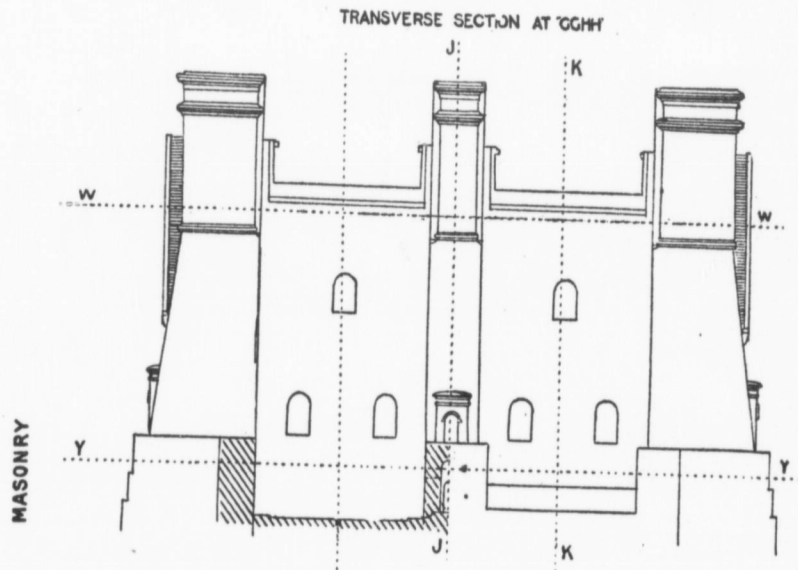
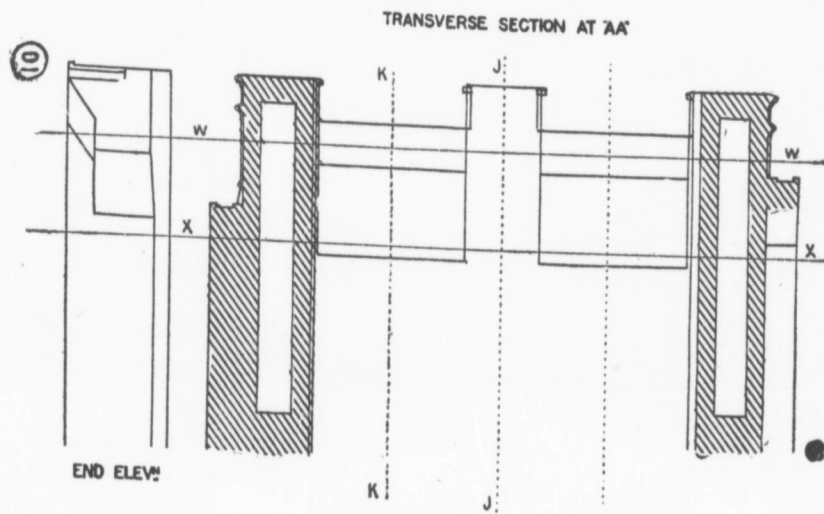





## REPORT OF THE TREASURER.

—

*Mr. President*,—I beg leave to submit the following statement of balances, receipts and expenditures for the period between April 27th, 1901, and March 21st, 1902:

To Balance on hand April 27th, 1901 .....		\$ 219 49
To amount from advertisement and sale of pamphlet No. 14 .....		\$ 157 73
“ “ collected as fees of ordinary mem- bers .....		170 00
“ “ received from Librarian .....		640 95
“ “ received as life-members' fees....		16 00
		984 68
Total .....		\$ 1,204 17

By amount paid for publishing pamphlet No. 14.....		\$ 424 00
“ “ “ postage .....		11 67
“ “ “ photos and frames for library .....		4 50
“ “ “ printing and stationery.		11 25
“ “ “ paper, supplies, etc. ....		546 60
“ “ “ ribbons, flags, etc. ....		18 97
“ “ “ representatives to Queen's and McGill .....		38 35
“ “ “ customs and exchange...		2 94
“ “ “ advertising committee...		3 85
		1,062 13
By Balance in Bank of Commerce .....		142 04
		\$1,204 17

It might be well to bring to the notice of the members the fact that very few of the graduates pay the necessary fee to entitle them to life membership and our annual pamphlet:

Also that the cost of our pamphlet far exceeds the sum received from our advertisers. If our life members would assist us in this matter we would soon be in a position to make our publications more valuable than they now are. All of which is respectfully submitted.

Yours,

E. A. JAMES,  
*Treasurer.*

---

fact  
them  
  
ived  
this  
more  
d.

## AUDITORS' REPORT.

---

We hereby certify that we have this day examined the accounts of the Treasurer, and vouchers therefor, and find a balance on hand of \$142.04.

There is an outstanding debt of \$60.49, and outstanding accounts due the Society of \$28.00.

R. J. DUNLOP,  
F. D. HENDERSON,  
*Auditors.*

March 21st, 1902.

## INDEX TO THE FIRST FIFTEEN NUMBERS.

	VOL. PAGE.
Allison, J. L. Transition Curves .....	ii. 52
Andrewes, E. Notes on the Geology of Rossland Ore Deposits .....	xiii. 128
Angus, R. W., B.A.Sc. The Gas Engine .....	x. 61
The Shaft Governor .....	xi. 76
Ardagh, Arthur G. Peat .....	xiv. 59
Bain, J. W., B.A.Sc. Planimeters .....	ix. 19
Notes on Stamp Mill .....	x. 6
The Accuracy of the Assay of Pyritic Ores .....	xi. 67
Ball, E. F., A.M. Can. Soc. C.E. Asphalt Pavements.....	i. 40
Sewers .....	iii. 39
Water Supply .....	iv. 60
The Computation of Earthwork and Overhaul by Means of Diagrams .....	v. 48
Hydraulic Cements .....	v. 82
Sewage Filtration .....	vi. 44
Barber, T. Notes on the Development of Water Power....	xiii. 189
Barrett, R. H. President's Address .....	xv. 1
Blackwood, A. E. President's Address .....	viii. 1
Description of the Finlayson Marine Pipe Boiler....	viii. 189
Bowman, A. M. System of Survey in British Columbia.....	i. 19
Bowman, H. J., O.L.S. Municipal Engineering in Ontario..	x. 177
Bryce, P. H., M.A., M.D. Underground Water as Sources of Public Water Supplies in Ontario.....	iv. 15
The Chicago Canal and Some Sanitary Problems connected therewith .....	ix. 55
Disposal of Sewerage .....	xi. 44
Land Drainage in its Sanitary Relations .....	xii. 119
Principles of Ventilation in their Application to Public Buildings .....	xiii. 174
Butler, M. J., C.E. Silica Portland Cement .....	xii. 100

INDEX TO THE FIRST FIFTEEN NUMBERS.

171

VOL. PAGE.

	Campbell, A. W., Asst. Commr. Public Works:	
	Concrete Culverts.....	xv. 49
	Road Construction .....	xi. 18
	Pavements .....	xii. 106
	Roadmaking .....	xiii. 167
	Bonding of Broken Stone Roads .....	xiv. 15
	Campbell, G. M. Vise-Work .....	viii. 33
	Carmichael, C. G. Thomson Recording Wattmeter .....	xiv. 49
	Carter, W. E. H. President's Address .....	xii. 1
	Chalmers, J. Double Track Tunnel, Hamilton, T. H. & B.	
	Railway .....	ix. 61
	Rat Portage Water Works .....	xii. 85
	Chubbuck, L. B. Modern Systems of Interior Wiring.....	xii. 58
	Hydraulic and Electric Elevators .....	xiii. 91
	Chewett, J. H., C.E. The Removal and Destruction of	
	Garbage .....	vii. 11
	Christie, Fred. W., C.E. Gold Mining in Nova Scotia .....	xi. 129
	Cockburn, J. Roy. A Modern Ship Building Plant .....	xv. 56
	Coleman, Prof. A. P., M.A., Ph.D. Mount Brown and the	
	Sources of the Athabasca .....	vii. 62
	Connor, W. A., B.A. Solutions .....	viii. 223
	Corrigan, G. D. Modern Copper Smelting .....	iv. 100
	Davidson, J. L. Location and Construction of Crow's Nest	
	Pass Railway .....	xii. 135
	Deacon, T. R. North Bay Water Works .....	vi. 91
	DeCew, J. A. Chemical Wood Pulp .....	xiv. 6
	Our Timber Supply .....	xv. 9
	Dobie, J. S., Grad. S.P.S. The Action of Heat on Cement. .ix.	126
	Duff, J. A., B.A. President's Address .....	iii. 82
	The Fundamental Principles of Dynamics .....	v. 27
	Diagrams .....	v. 61
	The Country Roads of Ontario .....	viii. 49
	Tests on Tensile Strength of Steel Boiler Plate.....	x. 184
	Neely's Formula for the Strength of Wooden Beams. .xii.	194
	Elliott, H. P., B.A.Sc. Lightning Arresters .....	ix. 13
	A Discussion of the Considerations Affecting the Cost	
	of Electric Power .....	xi. 113

GE.  
52  
  
28  
61  
76  
59  
19  
6  
67  
40  
39  
60  
  
48  
82  
44  
89  
1  
1  
89  
19  
77  
  
15  
  
55  
44  
19  
  
74  
100

	VOL.	PAGE.
Ellis, W. H., M.A., M.B. Junker's Gas Calorimeter .....	xii.	143
Fire Making .....	xiii.	201
Forbes, D. L. H. The Use of Iron and Steel in Mines .....	xv.	19
Foreman, W. E. Air Brakes .....	xiv.	133
Francis, Walter J., C.E., A.M. Can. Soc. C.E. The Hydraulic Lift Lock on the Trent Canal, near Peterborough .....	xv.	123
Galbraith, Prof. Technical Education .....	v.	100
Goodwin, J. B., B.A.Sc. Tunnel at Niagara for Development of Power .....	vi.	34
Niagara Falls Sewerage System .....	x.	38
Gray, R. A. L. Power Switchboard and Dynamo Tending. ....	viii.	201
Greenwood, H. F., C.E. Concrete on Trent Valley Canal. ....	x.	80
Gurney, Cromwell. Illustrative Casualties in the Workshop. ....	ix.	8
Haight, H. V. Gear Cutting .....	viii.	178
Standards in Machine Shop Practice .....	ix.	38
Air Compressors .....	x.	123
Hare, W. A. The Process of Manufacturing Mechanical Wood Pulp .....	xii.	12
The Problem of Speed Regulation in Plants Driven by Water Power .....	xiii.	37
Harkness, A. H. Crushing Strength of White Pine. ....	x.	180
Harvey, C. J., C.E. The Conjunction of the Nineteenth and Twentieth Centuries from an Engineering Standpoint .....	xii.	156
Haultain, H. E. T., C.E., A.M., Can. Soc. C.E. Presidential Address .....	iii.	11
Extract from Letter from .....	iii.	109
Some Experiences with a Canadian Turbine in Austria .....	vi.	83
The Young Graduate and the Profession of Mining Engineering .....	xv.	63
Hemphill, W. Construction of the Hamilton Cataract Power Company's Plant at DeCew Falls .....	xii.	76
Ratio of the Cylinders of a Compound Engine and what takes Place in Them .....	xiv.	31
Innes, W. L., C.E. Grading .....	viii.	5
A Brief History of Astronomy .....	ix.	26

INDEX TO THE FIRST FIFTEEN NUMBERS.

173

AGE.  
143  
201  
19  
133  
  
123  
100  
  
34  
38  
201  
80  
8  
178  
38  
123  
  
12  
37  
180  
  
156  
  
11  
109  
  
83  
63  
76  
31  
5  
26

VOL. PAGE.

Jackson, J. H., O.L.S. Bridge Foundations and Abutments. . . . .	xv.	114
James, D. D. Surveying in the City and Suburbs of Toronto. . . . .	iii.	57
James, E. A. Treasurer's Report . . . . .	xv.	167
Johnson, S. M. The Maintenance of English Roads . . . . .	viii.	17
Brickwork Masonry . . . . .	ix.	153
Kennedy, J. H., C.E. Reference Points and Bench Marks. . . . .	i.	27
Laing, A. T., B.A.Sc. The Waterworks System of Amherst- burg and Essex . . . . .	v.	55
Laing's Planetarium . . . . .	ix.	138
Laschinger, E. J. Hirn's Analysis of Heat Distribution in the Cylinder of a Steam Engine . . . . .	viii.	120
Latham, R. Signaling . . . . .	xiv.	163
Lea, W. A. Photography . . . . .	iv.	82
President's Address . . . . .	vi.	1
Leask, W. Corrugations on Mill Rollers . . . . .	iii.	63
Lott, A. E. A Re-Survey in Ontario . . . . .	i.	24
Notes from an Engineer's Pocket Book . . . . .	xii.	145
Ludgate, B. A. Problems from an Engineer's Pocket Book. . . . .	xii.	145
MacDougall, A., C.E. Professional Prospects . . . . .	vii.	7
MacMurchy, Angus, B.A. The Position of an Engineer as Arbitrator under the Contract . . . . .	xv.	81
McAree, J., O.L.S., D.T.S. The Crawford Gold Mine . . . . .	vii.	26
McCulloch, A. L. Mortars and Cements . . . . .	ii.	25
McDowall, R. Foundations . . . . .	iv.	54
McFarlen, T. J. The Nickel Mining and Smelting Industry of Sudbury. . . . .	vi.	48
McKinnon, H. L. The Cleaning and Annealing of Cast- ings . . . . .	viii.	132
McLennan, J. C., B.A. Roentgen Radiation . . . . .	ix.	142
MacNabb, J. C., O.L.S. Proposed St. Clair and Erie Canal. . . . .	vii.	62
McPherson, A. J., B.A.Sc. Specifications for Sidewalks. . . . .	x.	20
Marani, C. J. Historical Review of Sanitary Science and the "Germ Theory." . . . .	iii.	20
The Separate System and the Brockville Sewers. . . . .	iv.	36
Sanitary Plumbing . . . . .	v.	7
Marani, V. G. A Short, Practical Essay on "The Sea and Its Waves." . . . .	v.	73



	VOL. PAGE.
Merrill, E. B., B.A., B.A.Sc. Electric Traction as Applied to the Street Railway .....	vi. 57
Dynamo Design .....	viii. 205
Mickle, G. R. Freiberg Smelting Process .....	iv. 89
The Value of Undeveloped Mineral Claims ..	xii. 181
Minty, W. M., B.A.Sc. Notes on the Relation of the Mechanical Properties of Steel to the Chemical Composition .....	xi. 145
Mitchell, Chas. H., B.A.Sc., C.E., A.M. Can. Soc. C.E. Earthworks on Roads and Railroads .....	v. 37
Triangulation Survey .....	vi. 23
Aerial Mechanical Flight .....	viii. 74
The Conservation of Water for Power Purposes....	xiv. 64
The College Graduate and His Specialty.....	xv. 118
Monds, W. Circulation in Water Tube Boilers .....	xiii. 112
Morris, J. L., C.E. Masonry Foundations .....	iii. 52
Retracing Old Compass Lines .....	v. 70
Mundie, W. B., F.A.I.A. The High Building Problem.....	x. 28
Neelands, E. V. Some Adventures on the Abitibi .....	xii. 149
Mine Timbering .....	xiii. 137
Some Notes on Greater Ontario .....	xiv. 81
Newman, W. The Drainage System in Essex and Kent....	iv. 76
Palmer, R. K. Some Notes on Bridge Drafting .....	xiii. 119
Pedder, J. R., O.L.S. The Beeton Waterworks System....	vii. 18
Raymer, A. R. Railway Surveys .....	ii. 34
Richardson, G. H. Rodding on Railway Work .....	ii. 9
Richards, E. The High Pressure Steam Boiler .....	xii. 9
Cold Storage .....	xiii. 76
Rosebrugh, T. R., B.A. Scale Calculus .....	iii. 48
Ross, D. A., B.A. Railroad Location in the Crow's Nest Pass Railway .....	xii. 29
Russell, S. Track Laying .....	iii. 73
Offsets from Tangent on a 1° Curve .....	iii. 111
Notes on Railway Location and Construction in the North-West .....	iv. 42
Russell, W. Township Survey .....	iii. 98
Rust, Chas. H., C.E., M. Can. Soc. C.E. Bacterial Method of Sewage Disposal .....	xv. 29

	VOL. PAGE.
Scott, A. M., '96 Arts. The Pendulum .....	ix. 81
Shanks, T. President's Address .....	xiii. 1
Shields, J. D. President's Address .....	vii. 11
Shillinglaw, W. H. Hot Water Heating .....	v. 20
Shipe, E. F. The Hardening and Tempering of Steel.....	viii. 169
Smallpeice, F. C. Notes on Aluminum Conductors .....	xv. 90
Smith, C. B., Ma.E. Canadian Steam Railways .....	xiii. 158
Smith, Alexander H. Exploring New Ontario.....	xiv. 22
Southworth, T. Forestry .....	xii. 114
Forestry and Engineering .....	xv. 13
Speller, F. N., B.A.Sc. Asphalt and Asphalt Paving.....	vii. 44
The Use of Asphalt in Engineering Construction....	viii. 150
The Modern Open-Hearth Process .....	xi. 5
Stern, E. W. Notes on Field Work of Railroad Construc-	
tion .....	i. 9
Notes on Iron Bridge Building .....	ii. 44
Cable Railways .....	iii. 36
Stewart, L. B., D.T.S. Description of a Timber Limit	
Survey in the Rocky Mountains .....	iii. 68
Distance Measuring Micrometers .....	iii. 92
An Exploratory Trip Through the Rockies .....	vi. 96
A Canoe Trip on the Saskatchewan .....	vii. 74
A Single Form of Telemeter .....	ix. 148
Longitude by Lunar Distances .....	xi. 53
A Trip to the Yukon .....	xiii. 145
Stovel, H. R. Hints to Prospectors .....	xii. 177
Cement vs. Bone Ash Cupels .....	xiv. 56
Stull, W. W. History and Chemistry of the Cyanide Pro-	
cess .....	xi. 25
Tennant, D. C. Tensile Strength of Rivets and Bolts .....	xiii. 206
Thomson, R. W., B.A.Sc. President's Address .....	v. 1
Sewage Disposal in Ontario .....	viii. 194
Thomson, T. K., C.E., A.M. Can. Soc. C.E. Angle Blocks....	ii. 50
Bridge Specifications .....	vi. 5
Notes on Cement .....	vii. 36
Foundations for a Twenty-one Story Building .....	x. 96
The Underpinning of the West Wall of the Stokes	
Building .....	xv. 39

	VOL. PAGE.
Thorold, F. W. Electrolysis .....	xii. 72
President's Address .....	xiv. 1
Tye, A. T. The Canadian Dawn Animal.....	viii. 138
Tye, W. F. Cross Sectioning .....	i. 31
Tyrrell, H. G. Explorations on the Battle River .....	ii. 20
Madison Draw Bridge at Portland, Oregon.....	xiv. 89
Tyrrell, J. W., C.E. Hydraulic Mining in British Columbia..x.	88
On Snowshoes from the Barren Lands .....	x. 104
Van Buskirk, W. F., A.M. Can. Soc. C.E. The Ventila-	
tion of Sewers .....	viii. 128
Wagner, W. E. Aerial Cableways.....	xiii. 10
Withrow, W. J. Petroleum .....	ix. 38
Handling Daylight .....	xiv. 124
Wright, C. H. C., B.A.Sc. Aspect and Prospect.....	ix. 134
The Strength of Glass .....	xiii. 221
The Behaviour of Steel under Stress .....	xv. 101



*J. Galbraith*