

Technical and Bibliographic Notes / Notes techniques et bibliographiques

The Institute has attempted to obtain the best original copy available for scanning. Features of this copy which may be bibliographically unique, which may alter any of the images in the reproduction, or which may significantly change the usual method of scanning are checked below.

L'Institut a numérisé le meilleur exemplaire qu'il lui a été possible de se procurer. Les détails de cet exemplaire qui sont peut-être uniques du point de vue bibliographique, qui peuvent modifier une image reproduite, ou qui peuvent exiger une modification dans la méthode normale de numérisation sont indiqués ci-dessous.

- Coloured covers /
Couverture de couleur
- Covers damaged /
Couverture endommagée
- Covers restored and/or laminated /
Couverture restaurée et/ou pelliculée
- Cover title missing /
Le titre de couverture manque
- Coloured maps /
Cartes géographiques en couleur
- Coloured ink (i.e. other than blue or black) /
Encre de couleur (i.e. autre que bleue ou noire)
- Coloured plates and/or illustrations /
Planches et/ou illustrations en couleur
- Bound with other material /
Relié avec d'autres documents
- Only edition available /
Seule édition disponible
- Tight binding may cause shadows or distortion
along interior margin / La reliure serrée peut
causer de l'ombre ou de la distorsion le long de la
marge intérieure.
- Additional comments /
Commentaires supplémentaires:

Continuous pagination.

- Coloured pages / Pages de couleur
- Pages damaged / Pages endommagées
- Pages restored and/or laminated /
Pages restaurées et/ou pelliculées
- Pages discoloured, stained or foxed/
Pages décolorées, tachetées ou piquées
- Pages detached / Pages détachées
- Showthrough / Transparence
- Quality of print varies /
Qualité inégale de l'impression
- Includes supplementary materials /
Comprend du matériel supplémentaire
- Blank leaves added during restorations may
appear within the text. Whenever possible, these
have been omitted from scanning / Il se peut que
certaines pages blanches ajoutées lors d'une
restauration apparaissent dans le texte, mais,
lorsque cela était possible, ces pages n'ont pas
été numérisées.

The Canadian Patent Office

RECORD

Vol. VIII.—No. 8.

AUGUST, 1880.

{ Price in Canada \$2.00 per An.
 { United States - \$2.50

CONTENTS.

| | |
|--------------------------|---------|
| INVENTIONS PATENTED..... | 123 |
| INDEX OF INVENTIONS..... | CXXXVI |
| INDEX OF PATENTEES..... | CXXXVII |
| ILLUSTRATIONS..... | 139 |

INVENTIONS PATENTED.

No. 11,375. Improvements on Smelting Ovens. (Perfectionnements aux fourneaux de fusion.)

Riley P. Wilson, New York, U. S., 14th June, 1880; for 15 years.
Claim—1st. The combination of a furnace A with upright retorts B, set in nests of two or more and alternately against the sides of the furnace, the back flue D and lower return flue E. 2nd. A furnace A with upright retorts B, arranged as described and provided with one or more openings a d near the bottom of each retort, for the purpose of withdrawing the metal bullion and slag. 3rd. In combination with the retort, B, the connecting branches a d leading from the lower part of the retort, through the furnace wall, into the bullion and slag receivers. 4th. In combination with a retort B, the opening or branch m near its upper end, connected to the pipe w, for the passage of gases and oxides from the retort into the condensing receiver M. 5th. The combination of retorts B, furnace C, flue D, return flue E and connecting pipes w, in connection with the gas and oxide condenser w.

No. 11,376. Apparatus for Felting Hat Bodies. (Apparatus à feutrer les chapeaux.)

John T. Waring, Boston, Mass., U. S., 14th June, 1880; for 5 years.
Claim—1st. A sizing cloth for felting hat bodies or other articles, having an uneven or irregular raised surface. 2nd. The combination, with a sizing cloth for felting hat bodies or other goods, of a weight W, adapted to be contained within a roll of articles to be sized or felted in such cloth and to produce, automatically therein, a pressure outwards from the interior thereof. 3rd. The combination, with a sizing cloth, of an attached weight W.

No. 11,377. Improvement in Paint Brushes. (Perfectionnement des pinceaux.)

James Russell, Nanpese, Ont., 14th June, 1880; for 5 years.
Claim—1st. The bulged or irregular handle a in one piece, the case b fitted to receive the handle a, and the art or process of driving a and b, in combination through the bristles and ferule of a paint brush.

No. 11,378. Improvements on Car-Couplers. (Perfectionnements aux attelages des chars.)

Jesse T. Rice and Frank J. Hubbard, Grand Rapids, Mich., U. S., 14th June, 1880; for 5 years.
Claim—1st. The drawhead C, provided with a circular socket and socket offset a n, respectively, and curved socket l, coupling hook D having circular inner end, shoulders c f and curved socket k, spiral spring E and U-shaped pivot b. 2nd. The combination, with the socketed and shouldered coupling hook D, of the spiral spring E, whereby said hook D is made to couple and is held coupled. 3rd. As a means for uncoupling the hook D and in combination therewith, the rope or chain G and brake rod F. 4th. As a means for uncoupling the hook D and in combination therewith, the bent pivot e, inclined lever H and rocking lever I.

No. 11,379. Improvements on Wood Grinding Machines. (Perfectionnements aux machines à triturer le bois.)

Albert Fickett and Albert M. Hastings, Rochester, N. Y., U. S., 14th June, 1880; for 5 years.
Claim—1st. A hollow cylindrical disintegrating stone, made up of staves or sections. 2nd. The oblique troughs h capable of being laterally

adjusted with reference to the inner surface of the stone. 3rd. The weights l, with suitable means to raise and lower the same, in combination with troughs h. 4th. The safety stops dl, for the weights, in combination with the troughs h. 5th. The pulp receiver, or stock pan P, provided with a central sleeve b1, for the spindle a. 6th. In combination with a pan P provided with a sleeve b1, an annularly grooved hub d, upon the spindle a.

No. 11,380. Improvements on Concrete Pavement. (Perfectionnements au pavage en béton.)

Hilaire Couillard and Richard McKeown, Montreal, Que., 14th June, 1880; for 5 years.
Claim—1st. As a foundation or underlayer of concrete pavement, a composition of one part of pitch to two parts of coal tar, mixed with coarse gravel, small stones or spawls, and laid down. 2nd. A composition for concrete paving consisting of two parts of pitch to one part of coal tar, with this being incorporated fine gravel or coarse sand in a highly heated condition, the whole being rolled when spread, and finished by passing over it a heated roller. 3rd. Concrete paving composed of two layers of a mixture of pitch and coal tar in differing proportions, and combined respectively with coarse and fine gravel.

No. 11,381. Improvements on Washing Machines. (Perfectionnements aux laveuses mécaniques.)

James G. Walker, Cataract, Ont., 14th June, 1880; for 5 years.
Claim—1st. The spring C attached to the box A and by means of side rods D, connected to the cross bars F of the rubbing frames, exerts a yielding pressure on the clothes, on the roller frame G. 2nd. The swinging rubber frame having a yielding pressure on the roller frame G connected by a spring or springs C attached to box A, and connecting rods D. 3rd. The rubbing frame constructed of rubbing board H, base pieces I, posts g, g, cross bar F and rods L L, supporting hand bar K. 4th. The roller frame G having bar M covered with jacket N, in combination with rollers having metal journals.

No. 11,382. Improvements in Railway Brakes. (Perfectionnements aux freins des chemins de fer.)

Thomas W. Stanford and Samuel Milligan, Melbourne, Australia, 14th June, 1880; for 15 years.
Claim—1st. The application of electricity, in the shape of electromagnets, to the wheel of railway rolling stock as a brake power. 2nd. Railway brakes, so constructed in making the cases which contain the electro-magnetic brake blocks, automatically release themselves by their own weight.

No. 11,383. Improvements in Mowing and Reaping Machines. (Perfectionnements aux faucheuses moissonneuses.)

Charles Taylor and George W. Kendall, Montreal, Que., 15th June, 1880; for 5 years.
Claim—1st. The combination, for operating the knife, of the following elements, viz.: the compound lever formed of the arc e pivoted by a link to the frame, the link G pivoted to said arc and attached to arc F, carrying arm connected with pitman, said arcs having their sides parallel and their edges of obtuse angles, and being moved laterally in either direction by the rotation of two wheels mounted on main axle, and having their edges made of corresponding obtuse angles set with their salient points opposite to each other. 2nd. The combination of central plates with edges formed of indented lines parallel to each other, and revolving side plates or surfaces similarly indented, but with salient points opposite each other operating same.

No. 11,384. Improvements on Balance Slide Valves. (Perfectionnements aux tiroirs de vapeur équilibrés.)

Edgar Robinson, Robert F. Burt, John M. Pugh, William V. McCracken, Harrison B. Beymer and John W. Moore, Columbus, Ohio, U. S., 15th June, 1880; for 15 years.
Claim—1st. The combination, with a slide-valve and lifting stem in-

directly connected therewith, of a piston receiving steam from the valve-chest, and adjustable leverage connections located outside the valve-chest and arranged to connect the outer ends of the piston rod and lighting stem. 2nd. In combination with a slide-valve and lifting stem indirectly connected therewith, a piston adjustably connected with the lifting stem by means of lever bearings and the movable rest G₁. 3rd. The combination, with a slide-valve and lifting stem indirectly connected therewith, of a piston connected with the lifting stem and a spring H. 4th. The combination, with the valve-chest, the bearing surface C E and rollers D, of the valve B lifting stem E₁, levers E₂ G, slide bearing G₁, auxiliary steam cylinder F₂ and piston F.

No. 11,385. Improvements on Oil Cans. (*Perfectionnements aux bidons à huile.*)

Henry C. Bradley, (Assignee of James D. Pierce,) Milwaukee, Wis., U.S., 15th June, 1880; for 5 years.

Claim—The combination of a can having, near the bottom thereof, a faucet consisting of a horizontal tube F with an orifice G, of a pipe H with an arm sleeved on tube F, a case having a vertical opening in one side thereof, and a door for covering the same, the pipe H being adapted to have rotary motion about the tube F, and in a vertical plane, through the opening in the case.

No. 11,386. Improvements on Machines for Cleaning Bran. (*Perfectionnements aux machines à nettoyer le son.*)

Jonathan Mills, Chicago, Ill., U.S., 15th June, 1880; for 5 years.

Claim—1st. The combination of the stationary disk *u* or *l*, bearing a series of concentric slotted partitions herein formed of the pins *b* or *b₁*, with the revolving disc or arms *R* provided with oblique wings formed of the pins *o* or *o₁*. 2nd. In combination with the stationary circular slotted partitions and the central feed opening or eye *E*, the revolving disc *l* provided with the solid wings *W* set eccentric to the disc. 3rd. A double bran machine having stationary concentric slotted partitions or pins *b* or *b₁* and arms *R*, rotating between said partitions and bearing oblique wings or rows of pins *a*, the connecting parts *w* forming adjacent arms and arranged to close the space between the opposite concentric partitions or circles of pins.

No. 11,387. Machine for Degerminating and Reducing Wheat. (*Machine pour enlever le germe du blé et le triturer.*)

Jonathan Mills, Chicago, Ill., U.S., 15th June, 1880; for 5 years.

Claim—1st. The disc *H H₁*, of hard homogeneous material of close texture, having rounded marginal corrugations *m* and smoothly finished or polished surfaces. 2nd. The discs *H H₁*, of solid homogeneous material, capable of receiving a smooth or polished surface and having rounded marginal corrugations and a depressed central bosom in one or both of said discs. 3rd. The discs *H H₁*, having in one or both a depressed central bosom surrounded by marginal rounded corrugations *m* and leaders *n*, and the whole surface smoothly polished. 4th. The discs *H H₁*, of hard material, capable of receiving a smoothly polished surface and having in one or both a central depressed bosom with leaders *n*, and having marginal rounded corrugations, the lower of said discs being the runner and the upper of said discs being fixed and provided with a central feed.

No. 11,388. Device for Measuring and Cutting Garments. (*Appareil pour mesurer et tailler les vêtements.*)

Sarah J. Smith, Montreal, Que., 15th June, 1880; for 5 years.

Claim—1st. A scale or table adapted for giving on inspection the points and lines necessary for shaping and cutting garments for any given size of chest and waist, and with reference to base-lines at right angles to each other, said base-lines representing respectively the middle line of the garment and top of neck. 2nd. A rule graduated with divisions and figures, to show the width from centre-lines to back and front waist seams respectively, said division and figures being arranged and calculated to correspond identically with the actual total width of waist. 3rd. The combination of the rule and scale or table, the rule being provided in addition to its scales with suitable curves.

No. 11,389. Improvements in Shoes. (*Perfectionnements dans les souliers.*)

Guillaume Boivin, Montreal, Que., 15th June, 1880; for 5 years.

Résumé—1o. La taille d'une empeigne de soulier d'un seul morceau A, presque sans perte de matériel et fourrissant un rabat pour y passer des attaches libres qui entourent l'ouverture du soulier et viennent se serrer solidement sur le cou-de-pied sans déformer cette chaussure. 2o. Le bourrelet *e*, qui protège le cou-de-pied sans nuire à la solidité de la chaussure. 3o. La combinaison de l'empeigne A, son rabas, ses attaches avec le bourrelet *e*.

No. 11,390. Improvements on Hinges. (*Perfectionnements aux pentures.*)

Jean B. Parent, Quebec, Que., 15th June, 1880; for 5 years.

Résumé—1o. Le ressort en spirale B. 2o. La combinaison de ce ressort avec la double tête A A qui se termine en jumelle, à l'intérieure. 3o. La combinaison du rivet F, avec le ressort dont il détermine la force.

No. 11,391. Improvements in Reaping Machines. (*Perfectionnements aux moissonneuses.*)

Abraham C. Scarr, Maryborough, Ont., 15th June, 1880; for 5 years.

Claim—A grain lifting and saving appliance for attaching to reaping machines, and consisting mainly of the hook C, arm D, slot *a*, tail *h* and bolt *b*.

No. 11,392. Improvements in Feed Steamers. (*Perfectionnements aux appareils de cuisine à la vapeur.*)

Mortimer B. Mills and Charles B. Rice, Chicago, Ill., U.S., 15th June, 1880; for 5 years.

Claim—The water cylinder *b* in connection or combination with the steam chest *a*.

No. 11,393. Improvements on Car Trucks. (*Perfectionnements aux trains des chars.*)

Sandford Keeler, East Saginaw, Mich., and William Watson, Chicago, Ill., U.S., 15th June for 5 years.

Claim—1st. The combination of the beams G G₁ connecting bars I I and springs F F₁, with the axle boxes D D₁ and frame of a railroad car. 2nd. The combination of the frame of a car and the axles and axle boxes of the same, with springs interposed directly between the boxes of one axle and side bearings, at one end of the car frame, and a spring frame interposed between the boxes of the other axle and central longitudinal bearings, at that end of the car frame.

No. 11,394. Improvements on Flax Scutching Machines. (*Perfectionnements aux machines à teiller le lin.*)

Samuel S. Fuller, (Assignee of William Keane,) Stratford, Ont., 15th June, 1880; (Re-issue of Patent No. 9,464.)

Claim—1st. A grated or perforated trough C, or its equivalent, arranged in combination with a scutching machine. 2nd. A vertical grating D, in combination with the revolving beaters or knives A and scutching board B. 3rd. The grated or perforated trough C, or its equivalent, and grating D, in combination with the revolving beaters A and scutching board B. 4th. The grated or perforated trough C, or its equivalent, in combination with the revolving knives or beaters A and opening E.

No. 11,395. Matting Roller. (*Rouleau de nattes.*)

George H. Longmore, Portland, N. B., 16th June, 1880; (Extension of Patent No. 4,866.)

No. 11,396. Machine for Discharging and Conveying Grain. (*Machine à décharger et transporter le grain.*)

Henry D. Stover, New York, U. S., 19th June, 1880; for 5 years.

Claim—1st. In combination with an exhaust fan A, cutters B and induction pipe D, the partition *d* with point or apex *d₁*. 2nd. In combination with an exhaust fan A, cutters B, feed rolls C and induction pipe D, the flat valves *e* *e₁*. 3rd. In combination with an exhaust fan blower N, the tapering induction pipe D enlarged at its mouth next the fan, its lower half being inclined and set at such an angle as will permit a feed of its contents by gravity. 4th. In combination with an exhaust fan blower N, the pipe E with branches E₁ and F controlled by suitable valves *e* *e₁*. 5th. The combination of the exhaust fan, blowers N O, with the conveyors E M, the latter being provided with suitable branch pipes and valves. 6th. In combination with exhaust fans or blowers, the conducting pipe or pipes lined wholly or partly with glass, porcelain or other smooth faced hard material, or wholly or partly composed of said material. 7th. In combination with the exhaust fan blower N, fans A, cutters B, feed rolls C and tapering glass lined, induction pipe D, the conveying pipe E with branches E₁ F, auxiliary fan blower O, and pipe M with branches M M.

No. 11,397. Improvement in Cant Hand Spikes. (*Perfectionnement aux renards.*)

Alex. Hunter, Carleton Place, Ont., 19th June, 1880; for 5 years.

Claim—1st. The solid metallic sleeve or socket D, having formed on it the lugs *b* *b*. 2nd. The combination of the handle A, point B, grab hook C and sleeve or socket D having the lugs *b* *b*.

No. 11,398. Improvements in Hay Rakes.

(*Perfectionnements aux râteliers à foin.*)

John Moody, Terrebonne, Que., 19th June, 1880; for 5 years.

Claim—1st. In the combination, with the swinging bar or bars carrying the teeth, of a curved arm secured thereto, and a pivoted lever locking said arm in place.

No. 11,399. Improvement in Wood Polishing Machines. (*Perfectionnement dans les machines à polir le bois.*)

Almon Bridgeman, James L. Perry and Charles A. Mather, Berlin, Wis., U.S., 19th June, 1880; for 5 years.

Claim—1st. The combination, with the frame A and the endwise movable polishing roller B, journaled therein and having the pulley *a* and grooved collar *o*, of the shaft C, having the pulley *a* and the endless belt passing around said pulleys, the shaft H having cam *h* and a lever J engaged at one end with the cam at the other with the collar on the shaft of the polishing roller. 2nd. The combination, with the rotating and endwise movable polishing roller B having a grooved collar *o* upon its shaft, of the shaft H having the cam wheel *h* and the lever J fulcrumed on the frame engaged with the cam, and having its forked end engaged with the annularly grooved collar aforesaid. 3rd. The polishing roller, consisting of the cylindrical body provided with longitudinal grooves, the layer or layers of carpeting placed thereon, the layer or layers of paper felted over the carpeting, the rubber envelope drawn down into the grooves, the sand-paper laid over the whole, and the binding strips arranged over the grooves and drawn down into the same, carrying along the paper by fastening screws.

No. 11,400. Improvements on Saw Mills.*(Perfectionnements aux scieries.)*

James H. Watson and George S. Darling, Tawas, Mich., U. S., 19th June, 1880; for 10 years.

Claim—1st. In a feed and gig mechanism for the carriage of circular saw mills, the combination of the friction wheel C₁ with the iron friction wheels J and P to gig the carriage. 2nd. The combination of the two levers *u*, and the two arms *s v*, the three connecting rods R W Y and the U bar Z, with the sliding bearings of the lower friction wheel C₁, and with the levers G that carries the feed friction shaft F and the upper friction wheel H. 3rd. The friction wheels H G composed of combined layers of paper and rubber.

No. 11,401. Improvements in Stove Dampers.*(Perfectionnements aux régistres des poëles.)*

William M. Gartsbore, London, Ont., 19th June, 1880; for 5 years.

Claim—1st. The metal plate A₁ having a channel or slit B formed in it, so as to give sufficient spring to the inner portion A₂ to bite against the flat side of rod C, when pressed into place through covered grooves D E. 2nd. The rod C with shoulder K, for biting against a corresponding shoulder at D.

No. 11,402. Method of Cooling Liquids. (Méthode de refroidir les liquides.)

Zéphirin M. Gélinas, Ste. Anne d'Yamachiche, Que., 19th June, 1880; for 5 years.

Résumé—1o. Le réservoir à deux compartiments B. 2o. Les tuyaux C C C, pour servir à la circulation de l'eau. 3o. Les tubes coudés mobiles D E.

No. 11,403. Apparatus for Discharging Gas Retorts. (Appareil pour décharger les cornues à gaz.)

Abbott G. Ross, Cincinnati, Ohio, U. S., 19th June, 1880; for 5 years.

Claim—1st. In combination with a reciprocating rake operated by variable power, a water governor. 2nd. In a gas retort discharges, the combination of a steam cylinder and piston with the reciprocating rakes and hydraulic governor. 3rd. The combination of the motor, the rakes and the hydraulic governor, with a regulating valve controlled automatically for the purpose of diminishing the speed of the rakes near the extreme end of their movement. 4th. The combination of the cross head guided and supported by the lateral plates I, with the rakes *gr*, pinion *g*, drum G and wire rope or chain for the purpose of actuating the rakes. 5th. The combination of the traveller E, having the grooved guide wheels, with the rods *a z*, and vertical standard *er*. 6th. The combination of the rakes, the traveller E, the wire rope or chain, the guide pulleys J, the drum G, the cross head H, the steam motor and hydraulic governor. 7th. The combination, with a rake or series of rakes hinged to a reciprocating traveller, of an adjustable support for the free ends of said rake or rakes, by which their elevation above and depression below their horizontal position can be controlled at any part of their stroke, at the will of the operator. 8th. The combination, with a rake or series of rakes hinged to a reciprocating traveller, of mechanism for positively elevating and depressing said rake or rakes at any position of their stroke, at the will of the operator. 9th. The combination, with a rake or rakes hinged to a reciprocating traveller, of an adjustable support for said rake or rakes by which their elevation and depression may be controlled at any part of their stroke, or when the traveller is at rest, at the will of the operator, and with a counter balance for assisting in said elevation and depression. 10th. The combination of the rakes with a counter balance located upon the main frame of the machine, and independent of the traveller. 11th. A rake or series of rakes, provided with mechanism by which they are automatically adjusted to the inequalities or irregularities of the interior of the retorts, in combination with mechanism for holding them positively in adjusted positions, at the will of the operator. 12th. The combination of the reciprocating traveller and a series of rakes, one of which can be projected at a stroke, while the others are rendered inoperative by being secured to the rigid frame of the machine, with a support upon said frame for sustaining the free ends of the rakes, whether projected to enter the retorts or retracted therefrom, and secured to the rigid frame of the machine. 13th. In combination, with a reciprocating traveller, a series of rakes and devices for securing said rakes either to the traveller or to the rigid frame of the machine, whereby one or more of said rakes may be held stationary while the others are projected. 14th. The combination of the rakes with the slotted traveller standard *el*, and means for securing the idle rakes to the frame of the machine. 15th. The combination, with the rake or rakes pivoted to a reciprocating traveller or carriage, of means for elevating and depressing said rake or rakes at any part of the stroke, independently of any movement, of the traveller or carriage. 16th. In combination with the reciprocating rakes, the grooved roller *n* and idle roller *n* upon the adjustable support of the rakes, by which they are guided and prevented from lateral movement. 17th. In combination with the rakes and their operating mechanism, the shields L.

No. 11,404. Improvements on Photographic Albums. (Perfectionnements aux albums photographiques.)

Eli S. Glover, Portland, Oregon, U. S., 19th June, 1880; for 5 years.

Claim—1st. A book or album for holding prints, photographs and like matter, having a series of hinge stubs detachably connected together and to the covers of the book, and each of which is removable independently of the other, in combination with a series of leaves, mats or mounts, each of which has a fastening or clasp, on and along its inner edge, that engages and interlocks with a like fastening provided for it, on the front edge of the stub. 2nd. In combination with the stub C having the double hinge fastening plate D, upon its back edge, and the folded plate E₁ upon its front edge, the leaf, mat, or mount B provided with the like plate or fastening E fixed to and along its back edge. 3rd. In combination with the covers A A, having the hinge binding plates D fixed to and along their inner and back edges, the series of stubs C C having the like hinge plates

D upon their back edge, and locking pins *e* *el* when said stubs are adapted to receive and hold a series of leaves, mats or mounts, by which a metallic flexible or hinged back is formed to the book. 4th. The metal fastening plate E secured to the back edge of a leaf, mat or mount, in combination with the similar fastening plate E₁ provided upon the front edge of a stub C. 5th. In combination with the leaf, mat or stub of a book or album, the locking hinge plate formed of the metal plate D, its tubes *d* *d*₁ and alternating spaces *d*₂, and locking pin *e*.

No. 11,405. Improvements on Sash Fasteners.*(Perfectionnements aux arrêles croisées.)*

John Harley and John B. Newman, Wallaceburgh, Ont., 19th June, 1880; for 5 years.

Claim—The combination of the slide A, the holder B and the spring E.

No. 11,406. Improvements on Car-Couplings*(Perfectionnements aux attelages des chars.)*

Martin E. Morningstar and John W. Roberts, Arkona, Ont., 19th June, 1880; for 5 years.

Claim—1st. The spring B having hooked bars C C, or other suitable device, for holding the draw link D by the resiliency of the spring affixed to draw bar A. 2nd. The combination of the draw bar A, sloped on its under side, and spring B having hooked bars C C, the slot forming a recess for the hooks when the spring is in a normal state. 3rd. The draw bar A, having a forward projection G raised over the seat of the cross headed draw pins 5 to prevent it from jumping out of position.

No. 11,407. Improvements on Nut Locks. (Perfectionnements aux arrête-noix.)

James L. De Wolfe, Windsor, N. S., 19th June, 1880; for 5 years.

Claim—In combination with plate A, bolts B B having nuts C C, a curved or bent locking plate D notched at the ends to encompass a portion of the nuts and held fixedly between the nuts by straightening and by a recess in the nuts receiving the ends E, or overturning a silvered portion of the nut.

No. 11,408. Improvements in Heel Trimming Machines. (Perfectionnements aux machines à finir les talons.)

Charles W. Glidden, Lynn, Mass., U. S., 19th June, 1880; for 5 years.

Claim—1st. In a heel trimming machine, the knife and the means to impart to it a tipping motion as the knife trims the heel. 2nd. A knife holder, a knife, a pattern surface adapted to impart to the knife a tipping motion, and intermediate mechanism between the said knife-holder and pattern surface, and means to move the said holder and knife to trim the heel. 3rd. The rocking knife *e* combined with a gauge to rest upon the heel seat, between the free upper end of the knife and the heel seat. 4th. A knife and knife holder, supported by and made movable about an axis at right angles, or substantially so, with the axis of the heel, combined with a pattern surface and intermediate connecting mechanism to operate the said knife. 5th. A knife holder supported by and made movable about an axis at right angles, or substantially so, with the axis of the heel, combined with a sliding gauge and connecting mechanism between them to move the gauge in unison with the tipping movement of the knife carried by the knife holder. 6th. The combination of the stationary plate with the pattern surface adapted control the tipping motion of the knife. 7th. The turn-table plate and its bearing block *i*, combined with the amular block, its plate *g*, the knife-holder and lever *j*. 8th. The knife-holder grooved and combined with the knife and its segmental base adapted to turn in the holder as the knife is rocked. 9th. The foot combined with the lever *j* by means of a pin filled loosely in the head of the foot, to permit the bearing block and knife holder to be adjusted radially. 10th. The combination with the frame of the movable spring *az* composed of a single piece or band of thin metal, and inclined upward and backward and adapted to embrace and hold the shoe to be trimmed. 11th. The spring clamp provided with the turned edge to enter the recess of the shoe clasped by the clamp. 12th. The frame and spring clamp, combined with the links to open and close the clamp.

No. 11,409. Improvements in Piston Packing.*(Perfectionnements aux garnitures des pistons.)*

George C. Phillips, Silver City, Nev., U. S., 19th June 1880; for 5 years.

Claim—The combination, with steam tight wedge pieces or rings *d g g*, having bevelled surfaces, of the conical sleeve A made in sections with wedge-shaped pieces or segments *bb*, the said parts being arranged to break joint at their lines of division.

No. 11,410. Improvements in the Manufacture of Spools. (Perfectionnements dans la fabrication des bobines.)

Charles E. Burns, Lancaster, N. H., U. S., 19th June, 1880; for 5 years.

Claim—1st. The combination of the cylindrical saws having central bits, the vertical movable table and the horizontal sliding plate F. 2nd. The cylindrical saw D, fixed to the shaft or spindle *d* and provided with clearances *gr*, *e* a central boring bite *f*, in combination with suitable feeding mechanism. 3rd. The elevating and depressing table E, with transverse plate F operated by lever *t*, in combination with feed roller G and cylindrical saws D. 4th. The discs *g*, within the circular saws, provided with vertical rods *f* projecting through the saw head stock in combination with the tappet *n*₁ elevating and depressing table E, the cylinders *h* for knocking the blocks out of the saws, when the butts are cut through and the table is depressed. 5th. The cylinder *h* supporting the projecting part of the butt on the table, in combination with elevating and depressing table, cylindrical saws and centre boring bits. 6th. The shaft *u*, one end journalled in a movable bearing, operated by treadle and spring, so as to place the friction roller *sr* in and out of gear with shaft *t*, in combination with the shaft *v* provided with the tappet *y* *yr*, shaft *v* having friction roller *sr*, and elevating and depressing table E. 7th. The saws arranged at distances apart equal to the diameters of their bores and to operate with a table so as to cause the blanks to be cut from the butt.

No. 11,411. Improvements on Hat Felting Machines. (*Perfectionnements aux machines à feutrer les chapeaux.*)

John T. Waring, Boston, Mass., U. S., 19th June 1880; for 5 years.

Claim.—1st. In a sizing machine for felting hat bodies and other articles, a series of three or more rollers having their axis parallel, or nearly parallel with each other, and adapted to receive lengthwise between them a roll of hat bodies or other articles, and having different surface velocities. 2nd, a series of three or more rollers having their axis parallel, or nearly so, with each other and having concave or taper longitudinal profiles, whereby there is formed between the said rollers for the reception of a roll of hat bodies, or other articles, arranged lengthwise of the said rollers, a cavity which is larger at the middle of its length and smaller at the ends.

No. 11,412. Improvements in Reaping Machines. (*Perfectionnements dans les moissonneuses.*)

Samuel Crawford, London, Ont., 19th June, 1880; for 5 years.

Claim.—1st. The pitman crank wheel B constructed with six or more boxings *e* for attaching the pitman *j* thereto. 2nd. The square wheel C and level pinion C cast in one piece and revolving in gudgeon *b*, in combination with square pinion B₁ and pitman crank wheel B also cast in one piece, revolving in gudgeon *b*₁ in arm A, and regulated by set screws C C₁. 3rd. The apparatus for tilting the table, consisting of cogged rack *g*, female cogged arch H, on end of pole, foot bracket E attached to frame D, tilting lever F and latch *f*.

No. 11,413. Improvements on Rigging and Sails for Square Rigged Vessels. (*Perfectionnements aux agrès et aux voiles des vaisseaux à voiles carrées.*)

John H. Bloomfield, Concordia, Arg. Rep., 19th June, 1880; for 5 years.

Claim.—1st. As an improvement in bending sails, top gallant sails and royals, bent to the yards below them, and provided with the sheets and hall-yards and down hauls. 2nd. In combination with the square sails bent to the yards below them, the sheets *c*, clew-lines *m* and down hauls *r* passing blocks on the yards to the deck, whereby the yards may be reefed or furled from the deck. 3rd. The square sails of a vessel attached to the jack stays *k* of the yard at their lower edge, and provided with the sheets *c*, clew-lines *m*, down-hauls *r* and hall-yards *g*. 4th. The outriggers *h* pivoted to the masts under the fore and after stays and sustained by the lifts or struts *i* *i*₁, and the blocks hung on the outriggers combined with the square sails having the hall-yards, clew-lines and sheets, and bent to the yards *b* hung in trusses *t*. 5th. The band *o* provided with an eye bolt for the forestay, and band *o*, carrying trusses *l* for receiving the yards *b*, combined with the yards and masts. 5th. The yards *b* pivoted in the trusses *t* and provided with the supporting slings *q*.

No. 11,414. Improvements on Sewing Machines. (*Perfectionnements aux machines à coudre.*)

John Heberling, Mount Pleasant, and Joseph B. Long, Chicago, Ill., U. S., 19th June, 1880; for 5 years.

Claim.—1st. The combination of a series of circumferentially grooved cog-wheels or pinions, a grooved pinion or feed wheel and one or more bent needles resting in the grooves and arranged to receive the fabric on their points, as it is crimped and fed through the machine. 2nd. A feed pinion provided with a circumferential groove to receive the point of the needle, said groove extending below the point of its teeth, whereby a smooth track or path is provided for the point of the needle. 3rd. Two or more intermeshing cog-wheels or pinions *d* *d*₁ of unequal pitch, the pitch of each separate pinion decreasing from the driver to the point of exit of the fabric. 4th. The combination of the cog-wheel H, drive shaft G, the feed pinion *d* and two or more intermeshing pinions *d* *d*₁ of unequal pitch. 5th. The combination of the cog-wheel H, drive shaft G, feed pinion *d*, two or more intermeshing pinions *d* *d*₁ of unequal pitch, and one or more bent needles. 6th. The combination, with the hollow ended shaft G provided with pin *m*, of the spindle *p* provided with the pinion *d*₂, tenon *n* and notch *z*. 7th. The movable shaft *a* and spring K in combination with cog wheel H. 8th. The combination, with the cog-wheel H and feed pinion *d*, of the adjustable smoother L and spring plate *s*.

No. 11,415. Improvements on Grinders. (*Perfectionnements aux rémouleurs.*)

Richard B. Ashley and Alma J. Peugelly, Walkerton, Ont., 19th June, 1880; for 5 years.

Claim.—1st. The combination of brackets in Fig. 1, 2, 3, comprising bracket spring bolt and leading bar; 2nd. The combination of Fig. 1, 2, 3 and 5 as shown in Fig. 6.

No. 11,416. Machines for Shearing, Punching and Stamping Metals. (*Machines à tailler, poinçonner et étamper les métaux.*)

Joseph Y. Bedford, New York, U. S., 19th June, 1880; for 5 years.

Claim.—1st. The combination of a rotary crank or eccentric power shaft a pendulum connected to the shaft, a lever mechanism which imparts to the pendulum a reciprocating motion, and a clutching mechanism which communicates to the shaft, from the pendulum, a rotary motion and a slide, or its equivalent, which carries the operating tool. 2nd. The combination of rods F F₁ and bevelled gear rod F₂ by which the machine is put in and out of gear, either automatically or at the will of the operator. 3rd. The combination of a slide B and its operating crank shaft, with the clutch D E and pendulum weight *e*. 4th. The combination of a foot or hand lever, a clutch D F, shaft C and the pendulum *e*, whereby the oscillations of the pendulum are converted into revolutions of a punching or shearing shaft. 5th. The combination of the pendulum *e* having a head F and arm *e*₂, connecting rod G, lever H, and treadle J having a pin *j*.

No. 11,417. Improvements on Treble Cylinder Engines. (*Perfectionnements aux machines à triples cylindres.*)

Frederick A. Gardner, Robert Dunbar and George H. Dunbar, Buffalo, N. Y., U. S., 19th June, 1880; for 5 years.

Claim.—1st. The cylinders A A₁ Az having pistons I₂ and connections with the crank, the disc B arranged in front of the cylinder and provided with the endless steam passages C D having ports C₁ D₁ opening into the steam chests E₁, in combination with the valves H₁, their connections G G₂ and grooved eccentric F. 2nd. The grooved eccentric F₁, in combination with two or more curved pieces G connected to valve stems G₂, for operating two or more valves H. 3rd. The connecting rods I₁, provided with a ball shaped end I₂ adapted to work in a socket in the piston heads and provided with the curved side projections K, in combination with the caps J arranged to fit the crank pin and having rims J₂.

No. 11,418. Improvements on Grain Binders. (*Perfectionnements aux lieuses à grain.*)

Daniel Williamson, Sunbury, Pa., U. S., 21st June, 1880; for 5 years.

Claim.—1st. The combination of the three aimed plate S, the rigid bar T, the pivoted bar U, the curved arms V hinged to each other and provided with the points *v*, the spring W, the clutch J₁, the disc K, the lever L and the grooved cam N, with each other and with the three shafts B G O and the five gear wheels D E F Q R for grasping and rotating the gavel. 2nd. The combination of the chain wheels D₁ F₁, the endless chain E₁ provided with the hooks *e*₁, the cylinder H₁ provided with the hooks *h*₁, and the belt-gear wheels J₁ K₁, with each other and with the driving shaft A for taking the straw, twisting it, and passing it around the gavel. 3rd. The combination of the bent lever X, the spring *z* and the cam Y, with the shaft O and with the pivoted bar U of the gavel clamp, for opening the said clamp at the proper time. 4th. The combination, with the arms V and table C₁, of the hook chain E₁ *e*₁, hooked cylinder H₁ *h*₁ and the bent lever L₁.

No. 11,419. Improvements on Car Locks. (*Perfectionnements aux serrures des chars.*)

Henry M. Williston, Halifax, N. S., 21st June, 1880; for 5 years.

Claim.—1st. The combination, with the staple lock casing A, of a locking pin or bolt D, to secure the hasp of a door, an arm to be sealed after fastening has been effected, and a key operating lock mechanism to prevent the movement of the arm, when either sealed or unsealed. 2nd. A staple lock, for car door, consisting of casing A having opening B, plate C hinged thereto and carrying articulated locking pin D passing through holes in the opening B into interior *g* of the casing, said pin engaging therein with spring dog 4, from which passes, through the casing, an arm E having an extremity bent in a sealing recess 5, in the face of the casing, and a sliding block 7 operated by a key and lock mechanism to confine the dog 4 from movement, after sealing the extremity of arm E. 3rd. The combination, with the casing A, of the hinged plate C, pin D, locking dog 4 operated by an inserted key. 4th. The arm E fixed to dog 4 and having a bent extremity within a sealing recess 5, in the face of the lock.

No. 11,420. Improvements in Valves. (*Perfectionnements dans les soupapes.*)

William White, London, Eng., 21st June, 1880; for 5 years.

Claim.—1st. The combination, with the valve *v* fitted to open against the current of water, of lever *l* and handle *h*. 2nd. The valve *v*, levers *l* *h*, and float arms *s* combined for operation.

No. 11,421. Improvements on Sliding Doors. (*Perfectionnements aux portes en coulisse.*)

Monington Roberts, Westfield, N. J., U. S., 21st June, 1880; for 5 years.

Claim.—1st.—The combination, with the sheave and its sliding frame, of rack teeth on the frame, a pinion acting upon the same, a shaft that can be moved from the surface of the door, and mechanism for holding the shaft and pinion from turning after being adjusted. 2nd. The disc *g*, plate *h* and pin *o* in combination with the stem *k*, pinion *i*, frame *c* and sheave *a*.

No. 11,422. Improvements on Pruning Implements. (*Perfectionnements aux sécateurs.*)

John W. Cogswell, Erie, Mich., U. S., 21st June, 1880; for 5 years.

Claim.—The guide or rest D having, integral therewith, a projection E, which forms a hook when attached to the blade.

No. 11,423. Process and Apparatus for Fining Fermented Liquors. (*Procédé et appareil pour épurer les liqueurs fermentées.*)

Alfred E. Feroe, Albuay, and William E. Feroe, Tivoli, N. Y., U. S., 21st June, 1880; for 5 years.

Claim. 1st. The supply tank A, receiving tank C, located one above the other and valved pipes B B₁ D. 2nd. The process of fining malt liquors and removing the same from the sediment, which consists in preventing the rising of the carbonic acid gas, by holding the liquor in closed vessels in which high pressure of air or gas is maintained, whereby the yeast is allowed to settle, then drawing off the clarified liquor into a tank below, in which an equal pressure of air or gas is maintained. 3rd. The combination of an upper tank and of a lower tank, with pressure supplying pipes having stop-valves to shut off either pipe or both, and with a connecting pipe having stop-valves and intermediate bull's eye for observing the liquor.

No. 11,424. Improvement on Stoves. (*Perfectionnement des poêles.*)

Frank Moses and Joseph Moses, Toronto, Ont., 21st June, 1880; for 5 years.

Claim. The combination and arrangement, in a composite stove, of a

cooking stove having a circular front J, movable wood grates B C H I, coal grate E, movable fire pot F, movable front top plate A and the self-feeding attachment G.

No. 11,425. Improvements on Boot and Shoe Heels. (*Perfectionnements aux talons des chaussures.*)

Benjamin F. Locke, Weymouth, Mass., U. S., 21st June, 1880; for 5 years.

Claim. 1st. A heel lift composed of pieces *c* provided, at their contiguous edges, with longitudinal angular lips *d* bevelled from 6 to 9 and adapted to hook one over the other, in such a manner that pressure applied to the face of the lift will tend to tightly close the joint, or joints, between the pieces. 2nd. A heel composed, wholly or partially, of lifts formed of pieces *c* united by means of longitudinal angular lips *d* bevelled from 6 to 9 and adapted to hook one over the other, in such a manner that pressure applied to the face of the lift will tend to tightly close the joint or joints between the pieces.

No. 11,426. Improvements on Horse Collars. (*Perfectionnements aux colliers de cheval.*)

Ebenezer Fisher and John Watson, Kincardine, Ont., 21st June, 1880; for 5 years.

Claim. 1st. In combination with the divided rigid parts *A A*₁ of a horse collar, the spring actuated hasp provided with a socket in its free end and attached permanently to one of the said parts, and the cross bolt *E* which connects the flanges of the other parts. 2nd. The combination of the hasp with the bolt *c* to which it is attached, with the collar part *A* having a series of holes *c* for the reception of said bolt, and the part *A*₁ having cross bolt *E*. 3rd. The combination, with the free socketed end of the hasp, and the cross bolt *E*, of the spring and headed rivet to hold the hasp engaged with said bolt, and also limit its movements. 4th. The combination, with spring hasp and the bolt with which it locks, of the guard bolt *H* arranged below the free end of the hasp.

No. 11,427. Improvements in Harvesting Machines. (*Perfectionnements aux moissonneuses.*)

Samuel Johnston, Brockport, N. Y., U. S., 21st June, 1880; for 5 years.

Claim. 1st. A compressing band *K* in combination with the spring rod *k*₃, compressing arm *o* and band carrying arm *u*. 2nd. An inside divider composed of parts *W W*₁ in combination with a cam *w* for controlling the motion of the part *W*. 3rd. The construction and arrangement of the driving mechanism so that its weight comes upon the side of the driving wheel *B*, opposite to the cutting and binding mechanism. 4th. The feed rollers *u u*₁ so constructed that in the act of feeding the metallic ribbon *t*, they crimp said ribbon to the form, as shown. 5th. The construction of a band holder *z*, so that its outer or holding edge moves in an eccentric line with reference to the fulcrum of said holder and holds the band with a firmer grip as its tension becomes greater. 6th. The construction of clamping jaws *T T*₁, in which the jaws are V-shaped and are provided with teeth, whereby they can close up tightly. 7th. The binding mechanism in combination with a rotating platform. 8th. The combination of the revolving gathering compressing device and band carrier, so arranged and operating that it gathers the grain into a bundle and holds it for binding when it falls upon the platform. 9th. The combination of the revolving gathering compressing device, band carrier, binding mechanism and discharging rake. 10th. The mechanism for throwing in and out of gear the revolving platform and binding mechanism composed of the following parts: gear wheels *z z*₁, cam *z z*₂, roller *z*₁, levers *b b*₂, bevel or driving wheel *z*₂ and clutch *X X*₁. 11th. The combination of a compressing device *s s*₁ and *s s*₂, or moving with a rotating frame, and a vibrating inner divider for compressing the grain into a bundle. 12th. The combination, with a vibrating inner divider, of a compressing arm which is given a rotating movement upon a vertical axis, to carry it against the divider, and oscillating movement, upon its own pivotal point, to gather and release the grain. 13th. The combination, with a revolving rake and reel, of mechanism for controlling the length of sweep of the successive arms to bring grain of different lengths into a proper relation to the binding mechanism, to receive the band at the middle. 14th. The oscillating band carrier *n* moving with the rotating frame *E*, and oscillated by suitable mechanism during such rotation, to carry the band around the bundle of grain. 15th. The combination, with the oscillating band carrier moving with the rotating frame *E*, of suitable band securing mechanism. 16th. The combination of the band carrier and its oscillating shaft, the rotating frame upon which it is carried and the rake for ejecting the bundle after it is bound. 17th. The combination of an oscillating compressing and oscillating band carrying arm mounted upon suitable frame or carriage, and controlled by mechanism which causes the compressing arm to descend at the outer or grain side of the platform, sweep around behind the cutter bar and gather the grain against the inner divider, then actuates the other to descend and grasp the bundle and finally give them a further movement to the rear where they are opened, and the bundle delivered. 18th. The combination, with the platform of a harvester and a discharging rake, of two overhanging oscillating arms mounted upon a suitable frame or carriage, and controlled by mechanism which causes one arm to descend at the outer or grain side of the platform, sweep around behind the cutter bar and gather the grain against the inner divider, then actuates the other to descend and grasp the bundle and finally give them a further movement to the rear where they are opened and the bundle discharged by the rake. 19th. The arrangement of the gearing of the rotating reel arms *H H* and the gearing of the revolving frame *P* which causes the binding mechanism, so that the binding mechanism shall pass across the front of the platform moving the cut grain in front of it, in the interval between the successive passage of two arms of the reel. 20th. The spiral twister in combination with the cutter. 21st. An inner divider composed of parts *W W*₃ *W*₆.

No. 11,428. Improvements on Hoop Machines. (*Perfectionnements aux machines à cercles.*)

Jacob Dobbins, Marine, Mich., U. S., 21st June, 1880; for 5 years.

Claim.—1st. The eccentric *F* arranged to receive the hoop while being planed, and hung upon weight shaft *n* having an arm *g*, in combination

with the shaft *K* having arm *r r*₂, one of which, *r*₂, projects up through a slot *s*, in the table or bed *B*. 2nd. The combination, with the knives *L L*₁, of the cam or eccentric *N*, whose shaft *O* is arranged to be held, at different times, in proper position by the pressure of the yielding bars *t t*, on certain flattened parts *t t* thereon. 3rd. The combination of the slotted bed *B*, shaft *K* having the arms *r r*₂, cutters or knives *m m*, weighted shaft *F* provided with an arm *g*, and eccentric feed-roller *F*, cutter-head *T* with knives *L L*₁ and shaft provided with cam feed roller *N* having flattened parts *t t*, and yielding hands *t t* attached to the frame *A*. 4th. The combination of the levers *I I*₁, the device *V* having a shaft with eccentric pivots supported in yielding bearings.

No. 11,429. Brick Burning. (*Cuisage de la brique.*)

Benjamin Walton, Melbourne, Que., (Assignee of Edwin V. Wingard, Pittsburgh, Pa., U. S.), 28th June, 1880. (Extension of Patent No. 5,077.)

No. 11,430. Process for Making Cotton Yarns. (*Procédé pour faire les fils de coton.*)

Thomas H. Dunham, Boston, Mass., U. S., 28th June, 1880; for 5 years.

Claim.—The improvement in the art of making cotton yarns, consisting in reducing the cotton fibres to a slubber roving, then hand twisting one or more of these slubber rovings, so as to produce a large, coarse, hard, twisted yarn, and lastly saturating this yarn with tar and drying it.

No. 11,431. Improvements on Distributors for Fertilizers. (*Perfectionnements aux distributeurs des engrais.*)

Richard B. Sheldon and Joseph V. Peacock, Shortsville, N. Y., U. S., 28th June, 1880; for 5 years.

Claim.—1st. The detachable clip *C*, forming a cap over the bearing of the bevel pinion *C* and attached to the frame. 2nd. The rotating cup *E* provided with an open or perforated bottom, and having within it a loose rotating cleaner plate *H* and a stationary feeder *F*, whereby the central portion is supported and the bottom of the mass is successively sliced away removed, and discharged in a continuous stream. 3rd. The bed *A* constructed with hollow central hub, the rotating cup *E* and clever *H*, and the stationary feeder *F* and shear plate *I*, combined with the stud *B* projecting above and below the feeder *F*, and locking button *G* and pin *p*, whereby all the parts are securely held together. 4th. The revolving cleaner *H* provided with one or more shearing arms *K* acting against and beneath a stationary shear plate *I*. 5th. The hollow bearing or hub *b* provided with the internal longitudinal groove or grooves *C*, combined with the hub *B* provided with corresponding splines and the locking button *G*. 6th. The revolving cup *E* provided with lugs *m* combined with the loose cleaner plate *H*, the projecting arms *K* whereof engage with said lugs *m* and cause the cleaner plate to revolve with said cup. 7th. The wedge-shaped bottom *G* upon the exterior bottom of the frame *A*, combined with the stud *B* projecting downward from the feeder *F* through the central opening of the frame *A*. 8th. The bed frame *A* provided with the peripheral flange *d* projecting upward therefrom, combined with the cup or trough *E* provided with a circular rib *u*, whereby said cup *E* is seated and centered upon said flange. 9th. The feeder *F* having a projecting elliptical arm and sharpened along its edge *h*. 10th. In a force feed distributor for fertilizers, a cleaner *H* having one or more arms and revolving on a pivot.

No. 11,432. Improvements on Lamps and Lanterns. (*Perfectionnements aux lampes et aux lanternes.*)

Louis G. Massow, Cleveland, Ohio, U. S., 28th June, 1880; for 5 years.

Claim.—1st. The novel combination of the oil receiver *A*, oil faucet *B*, air chamber *D*, pipes *E E* and *d d*, circular opening *d*, burner *C*, glass chimney *G*, casing *K*, chimney *N*, cover *N*₁, cone partition *L* and reflector *F*. 2nd. The oil faucet *B* surrounded by the air chamber *D*, the air pipes *E E* and *d d*, the opening *d*, the burner *C* and oil receiver *A*. 3rd. In combination with the oil reservoir *A*, oil faucet *B*, burner *C*, glass chimney *G* and reflector *F*, the air tubes *d d*, leading to the air chamber *D*, which communicates by pipes *E D* with the outside atmosphere. 4th. In combination with an oil receiver *A* provided with headed pieces *x x*, the disc *J* having eccentric openings *w w*. 5th. In combination with the casing or housing *K*, the chimney *N*, the top cover *N*₁ and cone partition *L*. 6th. In combination with the casing *K* and chimney *N*, the projecting rods *k k* attached to the casing *K*, and the springs *h h* provided with projecting pieces and attached to the chimney *N*. 7th. In an oil receiver *A*, the screw cap *a* provided with openings *n n* and self acting valve *m*.

No. 11,433. Improvements on Advertising Devices. (*Perfectionnements aux appareils de publicité.*)

Elmore W. Taylor, Detroit, Mich., U. S., 28th June, 1880, for 5 years.

Claim.—1st. The advertising device *A* consisting of the parts *A*, *C B*, and the tie *c* adapted to be bent and adjusted so as to be self sustaining. 2nd. The advertising device *A* consisting of the parts *A*, *C B*, and tie *c* adapted to be bent and adjusted, the part *B* being in the shape of a watch, piano or any symbol to denote a particular trade. 3rd. An advertising device consisting of a blank, cut so as to be folded into the shape of an artist's easel, with rearwardly extending legs bent from the main frame, at their upper ends, and stayed, at the lower ends, on said frame by suitable tie or brace, the face of said device adapted for printing thereon a business card or advertisement. 4th. The within described blank cut, stamped or made of a single piece of material.

No. 11,434. Machine for Reducing and Shaping Bars of Metal. (*Machine pour réduire et former les barres de métal.*)

George J. Capewell, Cheshire, Ct., U. S., 28th June, 1880; for 5 years.

Claim.—1st. In combination with pressure rolls, a driving shaft and suitable gearing, a detachable clutch connecting said shaft with the bar-

lance wheel and a lever, and a sliding bar which operates to unstrip said clutch whenever the end of the fed bar is reached. 2nd. In combination with sliding rod S, levers T U Q and suitable retracting spring, a sliding clutch, its operating lever and the driving shaft and balance wheel. 3rd. In a metal working machine having pressure rolls and guide tubes, a set of guide tubes made displaceable at will without separation from the machine. 4th. In combination with block I and the set of tubes carried thereby, a yielding support or attachment for said block, a lever operated by the withdrawal of said block from the rolls, and a spring operated bar which unships the balance wheel clutch. 5th. In combination with pressure rolls, a series of guide tubes and plungers arranged to feed the blanks through said rolls, and to return them also through said rolls. 6th. In combination with guide tubes and plungers feeding and returning the blanks through the rolls, a pair of rolls having the die-grooves shaped in such manner as to prevent the blanks thus returned from again entering the grooves, until the larger forward end of the die-groove comes round again. 7th. In combination with a pair of pressure rolls, a set of tubes H H¹ H² arranged to travel from one pair of die-grooves to another and provided with plungers, which force the blank through the rolls to the receiving tubes. 8th. In combination with a pair of pressure rolls, a travelling set of tubes H H¹ H², all but the last of which are provided with gear wheels, in combination with a relatively fixed rack for partly turning said tubes. 9th. In combination with pressure rolls, a set of receiving tubes G G¹ G² provided with spring pressed plungers having conical recesses. 10th. In combination with blocks I, I¹ carrying the oscillating or travelling tubes and rack, the rod N, spring n, rock-shaft I and the prismatically slanted tube I¹ carrying arm a below said block I¹. 11th. In combination with a retracting spring and a cam on the driving shaft, the rock-shaft I having arms i i¹, whereby block I is caused to vibrate or travel as stated. 12th. In combination with tubes H H¹ H² and plungers h h¹, tent lever L, link l, lever K having additional arm k, a retracting spring and a cam on the driving shaft. 13th. In a machine for compressing and shaping bars of metal, a pair of pressure rolls having both die-grooves and channel grooves, the latter all wing the blanks to return through the said pressure rolls. 14th. In combination with the die-grooves, pressure rolls and suitable transforming devices, a system of inclined guide tubes arranged so that the lower end of each lower tube shall be directly under the upper end of each upper tube. 15th. In combination with the discharge tube H², a supplemental guide tube arranged to be automatically moved out of the way, whenever said discharge tube is lowered. 16th. In combination with the movable set of tubes H H¹ H² and their supporting block I, a supplemental guide tube suspended by an arm pivoted to said supporting block, said arm being provided with a rigid finger adapted to engage with a fixed stop whenever said block I descends. 17th. In combination with compressing devices and guide tubes, a dropping block arranged to receive the blanks in the line of discharge, and rock so as to deliver them in position to be transferred to the gripping, heading and trimming devices. 18th. In combination with the rocking block, the slide covering, the channel thereof and devices for automatically moving the slide from the channel as the block is rock'd. 19th. In combination with the trimming plunger having a bevelled rear end, a correspondingly bevelled blade or bar operating at right angles therewith. 20th. A pair of pressure rolls having their die-grooves provided at one end with flaring guide ways F₃ which direct the blanks into proper position. 21st. A curved guide way conducting from the feeding devices, and provided with a detachable cover Z and spring raised section Z₁ to facilitate the passage of the blanks.

No. 11,435. Improvements on Feather Renovators. (*Perfectionnements aux appareils à rafraîchir la plume.*)

John W. Butcher, Jr., (Assignee of Horace E. Rowe,) Hamilton, Ont., 28th June, 1880; for 5 years.

Claim—1st. The cylinder B and its jacket C mounted on a frame D, to tilt. 2nd. The removable ends E of the cylinder B, constructed in half sections, one perforated and the other solid. 3rd. The cover F of the jacket C having capped apertures with removable wire cloth shells and inclosing the ends E. 4th. The combination, with the cylinder B, of a fan. 5th. The rock shaft G having an agitating frame t, in combination with the fan.

No. 11,436. Improvements on Pumps. (*Perfectionnements aux pompes.*)

George W. McKenzie, Harrington, Me., U. S., 28th June, 1880; for 5 years.

Claim—A pump, the combination with a piston rod, of a foot lever to depress and a spring attached to the piston rod adapted to retract it.

No. 11,437. Improvements in Valves. (*Perfectionnements dans les soupapes.*)

William Wilson, Oakland, Cal., U. S., 28th June, 1880; for 5 years.

Claim—1st. A collapsible tube C suspended in a waste pipe E. 2nd. The short tube B secured in the upper end of the conical pipe section, or enlargement E, and having its upper end connected with the waste pipe above, by means of the collapsible tube D, and having the short collapsible tube C secured to its lower end, in the chamber of the enlargement E. 3rd. A collapsible tube consisting of two flat strips of India-rubber, or other pliable material, placed together and having their edges secured together. 4th. An improved collapsible tube valve to be placed in pipes, and passages for admitting a flow of water, steam, air or gas, in one direction, and preventing a back flow in the other direction.

No. 11,438. Improvements in Heel Counter Machines. (*Perfectionnements aux machines à contreforts des talons.*)

Joseph Kieffer, Montreal, Que., 28th June, 1880; for 5 years.

Claim—1st. The combination of the feed and corrugating rollers K K, with the male and female dies E F F, all being constructed and provided with mechanism for operating them. 2nd. The combination of the delivering slide I with its supporting abutments s, the feed rollers K K and the male and female dies E F F, constructed and provided with me-

chanism for operating them. 3rd. The combination of the stud K₁ with the delivery slide I, the feed rollers K K and the male and female dies E F F, arranged and provided with mechanism for operating them. 4th. The combination of the feeding apron G and the delivery slide I provided with mechanism for operating them, with the feed and corrugating rollers K K and the male and female dies E F F. 5th. The combination of two expellers u v and their operative springs s₁ s₂, with the male and female dies E F F. 6th. The guide plates m n provided with the notches o₁ p₁ q₁ r₁ t₁, arranged in them. 7th. The male die grooved on its flanks. 8th. The corrugating feed rollers K K provided with the movable feeding segments or arcs z z arranged and combined with such rollers. 9th. The female dies provided with the tapering recess a₂ arranged in or at their mouth.

No. 11,439. Improvements in Locomotives.

(*Perfectionnements dans les locomotives.*)

William Mason, Taunton, Mass., U. S., 28th June, 1880; for 5 years.

Claim—1st. The side levers C provided with the axle boxes u and fulcrum pivots g. 2nd. The combination of the side levers C and the cross or brace bars F I K. 3rd. The combination of the controlling springs M and their housings L, with the levers C and with the recessed boxes B thereof. 4th. The combination and arrangement of a leading truck, with the steam bogie of a bogie locomotive steam engine. 5th. The combination of the pocketed pieces B, with the truck and with the rocker levers C and the cross and brace bars F J and K. 6th. The combination of the controlling springs M and their adjusting bolts g s and nuts thereof, with the cross bar F, brace bars J K, levers C and their recessed or pocketed bearings B, applied to the bogie and leading trucks. 7th. The combination of the two sets of springs o M, with the bogie truck and with the levers C, connected by means and with the leading truck axle and applied to the bogie truck, such springs being adapted and arranged essentially as specified.

No. 11,440. Improvements on Grain Binders.

(*Perfectionnements aux lieuses à grain.*)

Philip C. Evans, Philip J. Evans, Brinescombe, and Henry J. H. King, Newmarket, Eng., 28th June, 1880; for 5 years.

Claim—1st. The arranging or combining together of parts, in the improved manner. 2nd. The mode of arranging or combining together of the gathering arms with the needle or binder arm and parts moving such arms, so that as the gathering arm moves the bundle of crop from the back to the front of the needle or binder arm, it protects and forms a clear space for the latter and at the same time makes a good separation between each bundle or sheaf. 3rd. The cam slotted bell-crank lever acted on by a revolving crank pin, for working the needle or binder arm with the upward movement quicker than the downward movement, and the consequent comparatively slow tightening of the binding material. 4th. The application of parts to clamp or nip the strings or binding material at a point between the sheaf and the knot or tie, in order to maintain the tightness of the binding material round the sheaf, after the cutting of the end or ends whilst the tie is being made. 5th. The clamping or nipping of the strings or binding material close to the sheaf by means of the needle or binder arm. 6th. The constructing, arranging and working of the needle or binder arm, so that it reciprocates in a straight line r nearly so. 7th. The lever or wedge action nipper at the end of the needle or binder arm, for preventing the severed end of the binding material from slipping back. 8th. Constructing and arranging or combining together the knotting mechanism and its actuating details. 9th. The method of winding the string to form the loop of the knot, round a mandrel consisting of two bars, by the use of a single hook. 10th. The application of the pointed projection (68) for keeping the loop of the knot from being drawn into the tube (54) into which the ends are drawn and for insuring the tying of the knot close to the sheaf. 11th. The arranging of the knotting mechanism to form the knot loop, after the severing of the end or ends of the binding material. 12th. The curved bottom of the support, or cradle, on which the sheaf rests whilst being bound, in combination with the relative position of the tying or knotting point, the parts being thus arranged for the purpose of retaining the circular form of the sheaf whilst forming the knot close to it. 13th. The multiple cam plate (11) of a disc shape which enables it to be moulded, simply constructed and combined with the knotting mechanism. 14th. The means of retaining the loose end of the string in the ascent of the needle or binder arm. 15th. The method of sharpening the rotating knife or knives without necessitating the removal thereof from the machine. 16th. The combination of main and supplementary gathering arms and the stationary cam groove plate

No. 11,441. Improvements on Sewing Machines. (*Perfectionnements aux machines à coudre.*)

John M. Fair, Buffalo, N. Y., (Assignee of David Leib, Columbus, Ohio,) U. S., 30th June, 1880; for 5 years.

Claim—1st. The combination, with the treadle, of the separate slotted carrying bar a and the separate heel plate b, arranged across the top of the treadle and clamped thereon and to the slotted bar by screws c c passing through the treadle and the slot of said bar a, and secured by nuts. 2nd. A hanging and swinging treadle device for sewing machines, the slotted bar a and the suspension arms d having slotted lower angular terminations d₁, and adjustably secured to said bar by the bolts e. 3rd. The suspension arms d having a series of holes f in their upper ends, in combination with the pivot bearings g g, and a clamping device by which said pivoted arm bearings are secured to the side frames of the machine, whereby to effect the adjustment of the angle of the treadle. 4th. The combination, with a treadle for sewing machines having both a swinging and a rocking movement to operate the driving shaft and in which the axis of said treadle is in line with the ankle joints of the operator's feet, of springs k k having fixed connections at their upper ends, and their free ends extending downward and exerting a force in the direction of the swing of the treadle upon its suspension arms d d. 5th. The slotted treadle bar a, the suspension swinging arms d d₁ having a series of holes f at their upper ends, the pivot bearings g, the slotted and clamping bracket plates h j and reacting springs K.

No. 11,442. Improvements on Glove Fasteners. (*Perfectionnements aux agrafes des gants.*)

Archibald Riddell, Georgetown, and Thomas Board, Glenwilliams, Ont., 30th June, 1880; for 5 years.

Claim—1st. A spring glove fastening, to extend around the edges of the wrist slit of a glove having, at or near the extremities, knobs C to be rivetted or screwed through the material of the glove to the legs B for closing the spring A by compression of the knobs by the thumb and finger. 2nd. A spring glove fastening having interlocking catches D E secured to the spring legs B and knobs C. 3rd. The combination, with a glove having a wrist slit, of a fastening consisting of spring A having diverging legs B, interlocking catches D E and finger knobs C.

No. 11,443. Improvements on Lacing Hooks for Boots and Shoes. (*Perfectionnements aux crochets pour lacier les chaussures.*)

Mellen Bray, (Assignee of Charles J. Humphreys.) Boston, Mass., U.S., 30th June, 1880; for 15 years.

Claim—A sheet metal lacing hook formed in one piece and having a tubular shank closed at top.

No. 11,444. Improvements on Mining Machines. (*Perfectionnements aux machines à miner.*)

George D. Whitcomb, Chicago, Ill., and Orange Butler, Wayne, Mich., U.S., 30th June, 1880; for 5 years.

Claim—1st. In a mining machine, the slide valve D operated by a rotating cam E, said cam being driven by a rotary engine F. 2nd. In a mining machine, the combination of slide valve D annular arcs d, oscillating cup d and rotating cam E. 3rd. In a mining machine, the arms F, sliding guides Q adjustable by means of pins q and the holes p. 4th. In a mining machine, the circular ratchet L on the supporting wheels and pawls K operated by spring M S, shaped cam N and pins k. 5th. The chisel shaped pick R having the v-shaped notch in its edge.

No. 11,445. Improvements on Car-Couplers. (*Perfectionnements aux attelages des chars.*)

Walter J. Stethem, Montreal, Que., 2nd July, 1880; for 5 years.

Claim—1st. The combination of a hook H having incline H₁ on one car set at an angle of 45 degrees from the horizontal or perpendicular, with a similar hook H₂ having incline H₂ on the other car, and similarly situated as to the relative position or direction of the angle in the other car, the said hooks being by the reversed ends of the cars brought together at right angles to each other. 2nd. The hook H having incline H₁, in combination with the lever U and guides A. 3rd. The combination of the hook H having incline H₁, forked strap E, spring C and stirrup strap B. 4th. The combination of the hook H having incline H₁, forked strap E, spring C, stirrup strap B, lever U and connection W. 5th. The hook H set at an angle of 45 degrees and having an incline H₁.

No. 11,446. Art of Making Paper Pulp. (*Art de faire la pâte à papier.*)

James Foley, Montreal, Que., 5th July, 1880; for 15 years.

Claim—In manufacturing paper from the fibre of the plant named "Zizania aquatica," or the "Wild Rice Grass," by means of boiling, the use of a centrifugal dryer and of alkaline substances.

No. 11,447. Improvements on Gauges for Jointing and Filing Circular Saws. (*Perfectionnements aux jauges pour affiler les scies rondes.*)

David Horner, Brome, Que., 5th July, 1880; for 5 years.

Claim—The combination of the main part or body A with its semi-circular recess and adjusting screws, with the adjusting slide B and its movable elbow or guide E, and with the angle adjusting screws G G II H.

No. 11,448. Improvements in Ploughs. (*Perfectionnements dans les charrues.*)

Harry Weard and William R. Bullock, Syracuse, N. Y., U.S., 5th July, 1880; for 5 years.

Claim—1st. The combination of the clamps d and conically formed standard b, for uniting the beam and standard. 2nd. The combination of the standard e and eye bolt, with the beam. 3rd. The combination of the jointer, &c., with the standard by means of the rib r and recess s in the faces thereof. 4th. The clevis t and hitching clevis u, in combination with the plough beam.

No. 11,449. Improvements on Tubular Rivets. (*Perfectionnements aux rivets tubulaires.*)

Mellen Bray and Mellen N. Bray, Newton, Mass., U.S., 5th July, 1880; for 15 years.

Claim—1st. A tubular rivet made of sheet metal, in one piece, consisting of a flat circular head and a cylindrical shank formed in sections, each section having an independent connection with and reinforcing a portion of the head. 2nd. A tubular rivet made of sheet metal, the shank being formed in interlocked and corrugated sections. 3rd. A tubular rivet made of sheet metal, the shank being formed in interlocked sections. 4th. A tubular rivet made of sheet metal, the shank being formed in corrugated sections.

No. 11,450. Improvements on Plough Points. (*Perfectionnements aux socs des charrues.*)

Levi W. Hall, Syracuse, N. Y., U.S., 5th July, 1880; for 5 years.

Claim—1st. The plough point c having a series of corrugations whereby a firm connection between the point and standard is obtained. 2nd. The

plough point c, in combination with the standard with corresponding corrugations.

No. 11,451. Improvements on Locomotives. (*Perfectionnements aux locomotives.*)

Eugène Fontaine, Detroit, Mich., U.S., 5th July, 1880; for 15 years.

Claim—1st. In combination with drivers having their axles arranged above the centre of gravity of the locomotive, the wheels L interposed between said drivers and track of a railway, said wheels being provided with a larger and smaller tread, the former of which rests upon the rail and receives motion by the frictional contact of the latter with the drivers above. 2nd. In combination with the drivers I and wheels L, the compound lever P operated by suitable mechanism to increase or diminish at will, while the car is in motion, the friction between said drivers and wheels by drawing together their axles or allowing them to separate. 3rd. In combination with a driver acting by a rolling friction upon a wheel with treads of different diameters, the compound levers V, piston rods P₁ connected with the compound levers, and air cylinder W provided with means for operating the piston. 4th. In combination with the frame F, drivers I, wheels L and their connections, the truck R, equalizer S provided with elastic bearings, spring T and connections w w.

No. 11,452. Improvements in Draw Plates. (*Perfectionnements aux filières.*)

Charles D. Rogers, Providence, R. I., U.S., 5th July, 1880; for 15 years.

Claim—1st. Forming the draw plate into a shape and then subjecting said plate to the action of properly shaped swaging dies, to condense and temper the same. 2nd. A metal draw plate condensed and tempered by compression, and having a gradually increased sectional area from the rear of the plate toward its front, throughout the whole or a part of its thickness.

No. 11,453. Wire Fence. (*Clôture métallique.*)

The Washburn and Moen Manufacturing Co., Worcester, Mass., (Assignee of Joseph F. Glidden, DeKalb, Ill.,) U.S., 5th July, 1880; (Re-issue of Patent No. 4,916.)

Claim—1st. In combination with a fence wire, a single or double barb formed of a short piece or pieces of pointed wire, secured in place upon the fence wire by coiling between its ends forming two or four projecting points. 2nd. The coiled wire barb a having sharp projecting points, in combination with two or more wires b twisted together in such manner as to hold the barbs in place. 3rd. The wires c in combination with the coiled wire barbs a, provided with projecting points and properly secured to the longitudinal wires e. 4th. A barb for a wire fence made of coiled wire having sharp projecting ends and adapted to be placed upon, and secured to one or more longitudinal wires.

No. 11,454. Wire Fence. (*Clôture métallique.*)

The Washburn and Moen Manufacturing Co., Worcester, Mass., (Assignee of Joseph F. Glidden, DeKalb, Ill.,) U.S., 5th July, 1880; (Extension of Patent No. 11,453), for 5 years.

No. 11,455. Wire Fence. (*Clôture métallique.*)

The Washburn and Moen Manufacturing Co., Worcester, Mass., (Assignee of Joseph F. Glidden, DeKalb, Ill.,) U.S., 5th July, 1880; (Extension of Patent No. 11,453), for 5 years.

No. 11,456. Machine for the Manufacture of Paper Pulp from Wood. (*Machine pour la fabrication de la pâte à papier de bois.*)

Stephen M. Allen, Duxbury, Mass., U.S., 6th July, 1880; for 5 years.

Claim—1st. The method of grinding or reducing fibre from wood, which consists in floating, by means of a sufficient current of water, the prepared wood between grinding surfaces, channelled or grooved. 2nd. The combination, with a revolving cylinder or grinder having conical sides and sloping top, of a casing having a lining of suitable material and a bed plate, the said cylinder casing, lining and bed plate being provided with channels or grooves on the contiguous surfaces, extending radially from or towards the axis of the cylinder. 3rd. The combination, with a grooved cylinder or grinder with conical sides and sloping top, a casing with grooved lining and a bed plate also grooved, of means for adjusting independently the space between the bed plate and top of the cylinder or grinder, and between the sides of the latter and the casing. 4th. In combination with a revolving grinder or cylinder, the casing lined with suitable material having a grinding surface and provided with set screw or similar means, for adjusting said lining or portions thereof with reference to said cylinder or grinder.

No. 11,457. Grinding Cylinders for Reducing Wood to Pulp. (*Cylindres de trituration pour réduire le bois en pâte.*)

Stephen M. Allen, Duxbury, Mass., U.S., 6th July, 1880; for 5 years.

Claim—1st. A cylinder or grinder of artificial stone, emery or corundum for grinding and disintegrating wood and other fibre, having the grinding surface composed of distinct longitudinal sections, logs or staves arranged and held together. 2nd. The combination, with a number of logs or staves of artificial stone, emery or corundum, of a shaft or arbor and means for confining the said logs or staves thereon. 3rd. The combination, with a solid or open cylinder, of a number of logs or staves of artificial grinding material arranged longitudinally on the said cylinder, and hoops, or equivalent means, for coupling said logs or staves.

No. 11,458. Improvements on Devices for the Construction of Ploughs. (*Perfectionnements aux appareils pour la fabrication des charrues.*)

Harry Weard and William Bullock, Syracuse, N. Y., U.S., 6th July, 1880; for 5 years.

Claim—1st. The plow beam constructed, arranged and formed in the

manner specified. 2nd. In combination with the plow beam *a*, the notched and grooved saddle *s*, the ribbed standard *d* and clip *t*. 3rd. In combination with the beam *a* formed with notches in the flanges, the notched and grooved saddle *s* adapted to hold and adjust the standard *d* and affix the same. 4th. The combination of the jointer or coultter, with the standard *d*, by means of a segmental curved shank for changing the pitch of the jointer properly. 5th. The combination of the plow beam having its rear end curved below the pivoted point of contact with the standard, with said standard *b*.

No. 11,459. Improvements on Vehicle Springs. (*Perfectionnements aux ressorts des voitures.*)

Horace M. Keith, Commerce, and Joel P. Harger, Pontiac, Mich., U. S., 6th July, 1880; for 5 years.

Claim.—1st. The combination of end cross bearing bars for the wagon box with a series of semi-elliptical springs, and one or more middle cross bars forming a bolster attachment, said springs arranged to cross the bolster, and their connecting bars broad cross bearing for wagon box. 2nd. The combination of end bearing bars for the wagon box, with a series of semi-elliptical springs, middle cross bars connecting the springs with the bolster, and cross cleats upon the wagon box bottom. 3rd. The combination of the semi-elliptical springs arranged across the bolster, and the end bearing cross bars to which they are connected, with end roller bearings for said springs carried by said end bearing cross bars. 4th. The cross bars under the springs forming the bolster socket, in combination with the end bearing cross bars and the series of springs. 5th. The end bearing cross bars shod with a metallic covering rounded at the edge, to permit of free movement. 6th. The combination of the end bearing cross bars, a series of semi-elliptical springs crossing the bolster and held to action thereby, the socket for the bolster, the bolster and cross cleats upon the wagon box bottom. 7th. The cross bars or bearings provided with receiving holes for the springs, a bearing roller, and shod or covered with metal.

No. 11,460. Improvements in the Manufacture of Vulcanized India Rubber Products Including Hevenoid. (*Perfectionnements dans la fabrication des produits de caoutchouc vulcanisé y comprise l'hévéne.*)

Henry Gerner, New York, U. S., 6th July, 1880; for 5 years.

Claim.—1st. The process of mixing, in proportions productive of either hard, semi hard or soft materials, India rubber, camphor and sulphur, together with the flours of such agricultural germs, fruits, grains and seeds as contain sulphur, such as wheat, rye, barley, oats, corn, rape, flax, mustard, &c., and then properly vulcanizing the mixture. 2nd. The process of mixing, in proportions productive of either hard, semi-hard or soft materials, India rubber, camphor and sulphur together, such as rice, hemp, poppy lentils, clover, sorghum, vetches, &c., and chestnuts, acorns and other nuts and then properly vulcanizing the mixture. 3rd. The process of mixing, in proportions productive of either hard, semi-hard or soft materials, India rubber and sulphur together with the flours of such agricultural germs, fruits, grains and seeds, as have been hereinbefore enumerated, whether containing sulphur or not, and then properly vulcanizing the mixture. 4th. A product or species of hevenoid consisting of a mixture of India-rubber, camphor, sulphur and the flour of such agricultural germs, fruits, grains and seeds, as have been hereinbefore mentioned, whether containing sulphur or not. 5th. A product or species of vulcanized India-rubber, consisting of India-rubber, sulphur and the flours of such agricultural germs, fruits, grains and seeds, as have been hereinbefore mentioned, whether containing sulphur or not.

No. 11,461. Improvements on Pneumatic Grain Elevators. (*Perfectionnements aux élévateurs pneumatiques à grain.*)

John B. Stoner, Toledo, Ohio, U. S., 6th July, 1880; for 5 years.

Claim.—1st. In a grain elevator, a pneumatic tube extending from the point of supply to the point of delivery, having a suitable screen pivoted over the same, and connected with a suitable air-exhausting apparatus whereby the pressure may be relieved from above the grain and the same be elevated by atmospheric pressure to one or more points of delivery. 2nd. In combination with the pneumatic tube, a hopper having two compartments and connected to the tube at its delivery point by means of a flexible connection, the said compartments being provided with suitable valves and mechanism for operating the same, whereby the grain may be alternately received and transferred to a point desired. 3rd. The combination with the pneumatic conveying tube and the receiving hopper of an adjustable screen, whereby the grain may be delivered to said hopper or directed to one or more additional hoppers. 4th. In combination with the grain receiving hopper and the upper and lower alternately acting valves; one or more air tubes in each compartment, adapted to admit and discharge a current of air alternately against the upper valves in the respective compartments, whereby the induction valve in each compartment will be closed as the suction valve is opened. 5th. In combination with the upper and lower alternately acting valves, for admitting grain to the respective compartments of the hoppers, the levers operated by the lower valves to automatically open the upper valves and admit the grain to each compartment. 6th. In combination with a grain conveying pneumatic tube, a rising and falling hopper and air tight flexible connection between said tube and hopper, and devices for latching and unlatching, or opening and closing, a valve or valves of said hopper, said devices being operated or permitted to operate by the rising and falling of the hopper. 7th. In combination with the hopper, a pneumatic tube, the transverse area of which from the point of delivery to the exhaust is larger than from the point of supply to the point of delivery, whereby the friction of the air through the enlarged areas is lessened. 8th. In combination with a pneumatic tube for transferring and delivering grain, one or more hoppers connected with said tube by a flexible connection, whereby the hopper is permitted to rise and fall without destroying the vacuum.

No. 11,462. Improvements on Grain Scorers. (*Perfectionnements aux compteurs à grain.*)

Simon T. Elliott and William D. Elliott, Ettrick, Ont., 6th July, 1880; for 5 years.

Claim.—1st. The combination of the hooked rod A, ratchet wheel B, pivoted arm C, spring D, striker E and bolt F. 2nd. The combination of the plunger G, cog-wheel H, ratchet wheel H₁, springs I I₁ and dog J. 3rd. The combination of the wheels K L M, spring N and dog O.

No. 11,463. Improvements on Injectors Serving as Condensers. (*Perfectionnements aux injecteurs servant de condenseurs.*)

Gaspere Mazza, Turin, Italy, 6th July, 1880; for 15 years.

Claim.—1st. The combination of a condensing and feed injector in which the steam jet, passing in an annular shape through one or more concentric cones C, meets the feed water and is condensed by it before meeting with the central jet of steam coming from the boiler. 2nd. The adjustment of the cones M N combinedly, by which the distance between the same varies whilst regulating the port hole for the admission of the water, whether this result be obtained by means of two eccentrics, each having a different stroke, or by any other means. 3rd. The combination, in one single apparatus, of an ordinary injector and a condensing injector.

No. 11,464. Improvements on Milk Cans (*Perfectionnements aux bidons à lait.*)

Frederick J. Lee, Mallorytown, Ont., 6th July, 1880; for 5 years.

Claim.—1st. A milk can A provided with a spring weighing balance consisting of bars B B, slide C, spring E and arm G carrying a marker H attached to its side with a removable scale card I, whereby when lifting the can by the eye K, the marker will register the weight. 2nd. The door or cover N hinged to the can, to enclose the spring E and card I.

No. 11,465. Improvements on Plough Beams. (*Perfectionnements aux axes des charrues.*)

Harry Wiard, Syracuse, N. Y., U. S., 6th July, 1880; for 5 years.

Claim.—1st. The wrought metal plough beam constructed from a rolled bar. 2nd. The front end of the plough beam with a heading piece A affixed thereto. 3rd. The rear end of the beam formed by bending and cutting into shape without welding.

No. 11,466. Improvements on Pumps. (*Perfectionnements aux pompes.*)

Isaac Shupe, Newmarket, Ont. (Assignee of John O. Stouffer, Green Spring, Pa., U. S.), 6th July, 1880; for 5 years.

Claim.—1st. The combination, with the plunger B, of the pump cylinder A with valve seat b, flat disc c in the eye d, tubular brace D having opening k and spout C. 2nd. The overflow opening k located beneath the cross brace D and opening downward.

No. 11,467. Improvements in Liquid Fuel Burners. (*Perfectionnements aux fourneaux à combustible liquide.*)

Henry A. Bradley, New York, U. S., 6th July, 1880; for 5 years.

Claim.—The combination of the shell A containing chambers a b and outlet k, with the spindle valve F which is hollow above its valve portion, and provided with the aperture i at its valve portion. 2nd. The combination of two or more spindles valves F F with the shell A, having partition D and two or more outlets k. 3rd. The shell A having partition D and inner pipe E, and provided with one or more valve seats f, in the partition, and with an outlet k above each valve seat, for combined action with one or more spindle valves F having aperture i and inner bore j. 4th. The combination of the shell A containing chambers a b, with the spindle valve or valves F, and with the packing box Z above the valve proper e, the spindle valve having a screw thread below said valve proper. 5th. The combination of the shell A which is made in one piece with the bottom plate C, with the removable top plate B and fastening bolts z, and with one or more vertically movable spindle valves.

No. 11,468. Improvements on Horse Shoes. (*Perfectionnements aux fers à cheval.*)

Gelos L. Potvin, Alpena, Mich., U. S., 6th July, 1880; for 5 years.

Claim.—1st. In combination with a horseshoe, a toe calk D provided with a dovetail stud d and a clip c, and secured to the shoe by means of a screw. 2nd. In combination with a horseshoe, the heel calks B provided with dovetail studs b which fit in correspondingly shaped slot a in the heel of the shoe, and secured to place by screws e.

No. 11,469. Improvements in Harvesters. (*Perfectionnements dans les moissonneuses.*)

Christopher C. Bradley, Syracuse, N. Y., U. S., 10th July, 1880; (Re-issue of Patent No. 6,605.)

Claim.—1st. A lever to angle the finger bar mounted upon the frame, at a point outside and in front of the drive wheel, and in combination with the tongue. 2nd. The rectangular main frame, mounted upon the axis of and enclosing the drive wheel, in combination with the cutter bar b by means of a post and slide connection which permits of a movement, in a horizontal plane, of the cutter bar and platform when they are raised or lowered. 3rd. The combination of a rectangular main frame mounted upon and enclosing the drive wheel, a cutter bar connected with the main frame by a slide connection which allows of a movement, in a horizontal plane, of the cutter bar and platform when they are raised and lowered, a device upon the main frame for raising and lowering the platform, and a pole or tongue adjustably hinged to the main frame. 4th. A rectangular main frame mounted upon the axis of and enclosing the drive wheel, in

combination with the cutter bar by means of a round post and slide connection, and a device upon the main frame for lifting the cutter bar. 5th. As a means for connecting the finger bar to the main frame, in an inclined post E set up in the inner end of the finger bar, and passing through bearings in the main frame. 6th. The lever M placed upon the main frame, at a point in front of and outside of the drive wheel, in combination with the tongue by means of the link O and crank axle N. 7th. As a substitute for a hinge in a swivel or other analogous device, as a means of connecting a finger bar to the main frame and controlling the position of the finger bar relative to the main frame, a post or slide connection between said finger bar and main frame. 8th. The post E stayed at its upper extremity by a bracing device D M set upon and springing from the cutter-bar or platform. 9th. In combination with the minor axle L which carries the driving sprocket wheel J, bevel gear X, the composite ratchet pinion Y. 10th. The combination of the chain drum R, ratchet rod Q, ratchet plate F and hand lever U, the whole forming a device for lifting the finger bar vertically. 11th. In combination with the ratchet plate F, the hand lever U and spring V. 12th. In combination with the lifting drum R, the pawl S. 13th. The combination of the pinion F, inferior ratchet plate G keyed to the minor axle L, spring controlled duplex B and key D, the whole forming a device for throwing in or out of gear the actuating mechanism. 14th. In combination with a bushing P serving as an axle of the main drive wheel, the ratchet rod Q journalled between the same as a space saving device. 15th. In combination, a finger bar connected with the main frame by a post E and slide P P' with a device upon the main frame for lifting the cutter bar.

No. 11,470. Feeding Device of Machines for Forging Nails and Spikes. (*Appareil d'alimentation des machines à forger les clous.*)

Lucius A. Dodge, Keeseville, N. Y., U. S., 10th July, 1880; (Extension of Patent No. 5,985.)

No. 11,471. Improvements on the Preservation of Butter. (*Perfectionnements dans la conservation du beurre.*)

John Harger, Toronto, Ont., 10th July, 1880; for 5 years.

Claim.—The preservation of butter by incorporating with the cream before churning, and the butter after churning, boric acid dissolved in boiling glycerine, and sulphate of potassium dissolved in boiling water, the mixtures to be used when cold.

No. 11,472. Improvements in Gates. (*Perfectionnements dans les barrières.*)

William G. Alexander, Oskaloosa, Iowa, U. S., 10th July, 1880; for 5 years.

Claim.—The gate hinge C consisting of the case e provided with brackets g, g', roller f and pivots d, d' combined.

No. 11,473. Machine for Edging Shingles. (*Machines à dresser le bardeau.*)

Francis J. Drake, Belleville, Ont., 10th July, 1880; for 5 years.

Claim.—1st. The combination of the friction pulley I, shaft G, nuts R, clutches S, grooved collars S', friction pulleys T, U, frame V, foot treadle W and pulley Y. 2nd. The combination of three pairs of rollers K, K', L, L', M, M'.

No. 11,474. Improvements in Boots and Shoes. (*Perfectionnements dans les chaussures.*)

Siméon Fortin, Alfred Contant and Joseph Métivier (Assignees of Laurent E. de Warn, New York, U. S.), Quebec, Que., 10th July, 1880; for 5 years.

Claim.—In a boot or shoe, the quarters A A' secured in position by an intermediate back stay piece having its free edges left upon the inside of the shoe, and secured in place by stitching.

No. 11,475. Improvements on Drawbars for Railways. (*Perfectionnements aux ressorts de traction pour les chars de chemin de fer.*)

David Holt, West Albany, N. Y., and Allen Middleton, Philadelphia, Pa., U. S., 10th July, 1880; for 5 years.

Claim.—1st. The combination of two disconnected draw-bars H H, one secured to a draw-head, at one end of the car, and the other to a draw-head, at the opposite end of the car, with the two central transverse beams B B, forming part of the car frame, and the two springs I I, one for a draw-bar and the other for the other draw-bar. 2nd. The combination of the transverse beams B B forming part of the frame of the car and connected by the bolts e with the disconnected draw-bars H H and the springs I I. 3rd. The combination of the draw-heads and their rods, the bumper springs J J and the car frame having longitudinal beams D D, bumper blocks E E and bars a M M secured to said beams D. 4th. The combination of the disconnected draw-bars H H, the tension springs I I and the bumper springs J J with the car frame having the longitudinal beams D D, transverse beams B B, bumper blocks E E and interposed bars a M M.

No. 11,476. Machine for Cutting Screw Threads on Pipes and Couplings. (*Machine à fileter les tuyaux et les manchons d'accouplement.*)

Isaac S. Schuyler, Brooklyn, N. Y., U. S., 10th July, 1880; for 5 years.

Claim.—1st. The combination, with a head having a revolving and forward movement, of revolving arbors carrying circular cutters and fitted for radial movement, a slide rod, at the centre, fitted with a device for expanding the arbors, and a cam roller fitted for moving the slide rod

and cone lengthwise. 2nd. The revolving head D₁ provided with caps d₁ and carrying cutter arbors c₁, in boxes fitted for radial movement, combined with the revolving head D, revolving arbors c and toggle bars c₁ for operation. 3rd. The revolving cutter arbors c₁ combined with revolving head having caps sustaining the arbors, one of which is capable of partial revolution for varying the angle of the arbors. 4th. The revolving head D, the arbors c carrying the cutters or connected to the cutter arbors, the pinions c₁ and revolving internal gear c₂ combined for operation. 5th. The head D fitted with gear b, arbors c carrying pinions c₁, revolving sleeve e carrying internal gear c₂, loose collar c₃ carrying gears g, g₁ that are respectively connected to the driving shaft and to a secondary shaft that is geared to head D. 6th. The head D₁ carrying cutter arbors c₁ and provided with gear c₁ combined with the revolving head D, toggles c₁ and secondary shaft giving motion to head D, whereby the head D₁, with its arbors, is operated synchronously with head D and its arbors. 7th. The revolving rollers m formed with a spiral cam and peripheral cam groove, in combination with the slide rod d, revolving heads D, arbors c c₁, sliding carriage A fitted with roller n and spring n₁, and fixed bed B. 8th. The revolving shaft l and cam roller m combined with the fixed bed B and sliding carriage A. 9th. The shaft l sustained in the bearings l₁ l₂ and fitted with bevel gear m₁, and the second shaft p₂ gearing with wheel m₂ and driven from the secondary shaft k by a worm and pinion. 10th. The serrated circular cutters k attached upon revolving arbors in a head that is fitted for movement forward spirally. 11th. The sliding rod d acting by its movement to cause the expansion or contraction of the cutters and fitted with the adjustable extension o₁ that connects with the operating cam m. 12th. The slide C fitted for movement endwise of bed B and provided with the slide block a that sustains the revolving gear a₁ a₂. 13th. The block a, rod u, cage a₂ a₃, hub o, lever v₁ and adjustable weight v₂ combined together and with slide block C.

No. 11,477. Improvements on Carriage Jacks. (*Perfectionnements aux chèbres des voitures.*)

Alexander Forteous and Charles McKenzie, Port Perry, Ont., 10th July, 1880; for 5 years.

Claim.—A carriage jack constructed of flat posts B B held dividedly apart by base A and side pieces K, and block F having steps G supported upon a rod operated by cam lever C fulcrumed between the posts B B.

No. 11,478. Improvements on Gang Ploughs. (*Perfectionnements aux charrues à plusieurs socs.*)

Thomas Gowdy (Co-inventor with Malcolm McLean), Guelph, Ont., 10th July, 1880; for 5 years.

Claim.—The combination of a coulter, or its equivalent, with the individual ploughs of the gang, said coulter acting as a preliminary cutting device to the plough.

No. 11,479. Improvements on Tool-Holder's. (*Perfectionnements aux porte-outils.*)

Leonard Young, Sing Sing, and Nelson Leyon, Albany, N. Y., U. S., 10th July, 1880; for 5 years.

Claim.—1st. The tool holder j formed by the combination, with the stationary clamping bars m, end portions n₁ provided with recess ways s and yokes o₁, of the clamping piece p carrying clamping jaws and draw bolt. 2nd. The combination, with the arms H H pivoted to the swivel arm F, of the tool holder j held by trunnions k in the end of said pivoted arms. 3rd. The combination, with the tool holder j provided with trunnions k and arms H H pivoted with the swivel arm F, of the clamping bolts f and nut g. 4th. The combination, with the standard D capable of being raised or lowered and provided with sleeve b and set screw, and the swivel arm F working in said sleeve, of a tool holder j arranged to oscillate between arms H H pivoted to said several arms.

No. 11,480. Improvements on Finger guides for Type-Writers. (*Perfectionnements aux guides-doigts pour les machines à imprimer.*)

Albert M. Da Costa, Brooklyn, N. Y., U. S., 10th July, 1880; for 5 years.

Claim.—1st.—As a finger guide in a type writing machine, the combination with the keys thereof, of a rod or rods, or bar or bars arranged above or between straight or curved rows of the keys or key arms. 2nd. As a new article of manufacture, the finger guide for the key board of a type writer consisting of the longitudinal bars B C, and the series of transverse bars suitably curved or shaped to indicate the location of certain keys. 3rd. In a type-writer, the combination, with the keys and a bar or rod arranged between longitudinal rows thereof, of the transverse rods which are curved or hooked at the lower end contiguous to the lower keys. 4th. The combination with the keys of a type-writer and a bar or rod which separates rows of said keys, of another contiguous bar or rod having a different surface which renders it readily distinguishable from the other by the sense of touch. 5th. The combination, with the casing and with the keys of a type writing machine, of a piece or piece of various material, each conveying a different sensation when touched.

No. 11,481. Improvements on Tincture Presses. (*Perfectionnements aux presses à teinture.*)

John G. Baker, Philadelphia, Pa., U. S., 10th July, 1880; for 5 years.

Claim.—1st.—The combination of the tapering casing A, its hopper f, outlet m and perforations, with the metal screw D having a thread, the edge of which fits snugly, but so as to move freely in the said casing. 2nd. The screw D having a pitch gradually decreasing from the large end, in combination with the casing A, its hopper, perforations and outlet m. 3rd. The combination of the screw and casing with the detachable perforated plate n, the surface of which is a continuation of the inner surface of the said casing. 4th. The combination of the screw, detachable perforated plate, and casing having a hollow rib in which is a chamber k. 5th. The combination of the casing, screw and detachable perforated plate, with the cover c by which the said plate is retained

in place. 6th. The combination of the tapering screw with tapering casing grooved internally. 7th. The combination of the tapering casing with the detachable piece G in which is the outlet m. 8th. The combination of the casing and its screw, with a stand B having two clamping legs and being arranged to close the large end of, and form the support for the casing, and to serve as a bearing for the journal of the screw.

No. 11,482. Improvements on Horse Rakes. (*Perfectionnements aux râteliers à cheval.*)

Solon H. Bushnell, Fairport, N. Y., U. S., 10th July, 1880; for 5 years.

Claim. 1st.—The combination, with the lever K, bifurcated at its upper end and having a shoulder between said bifurcation, of the lever J and hand lever L. 2nd. The combination, with the levers J K L pivoted together, of the nut p adjustable in the cross bar c, and lying directly under the pivotal connection of the levers J K L. 3rd. The combination, with the lever K bifurcated at its upper end and having a shoulder between said bifurcation, of the lever J, hand lever L pivoted thereto, and set nut p. 4th. The shafts a having the thill irons e with holes h, in combination with the clip f having holes i, and the removable pins g.

No. 11,483. Apparatus for Cooling Plough Mould Boards. (*Appareil pour refroidir les versoirs des charrues.*)

Harry Wiard, William R. Bullock and Levi W. Hall, Syracuse, N. Y., U. S., 10th July, 1880; for 5 years.

Claim.—The combination of a flask containing a mould and hot chilled casting, with a cover covering the chilled or upper surface of the casting and sealing it practically from the outer air, and enclosing a body of hot air over the casting.

No. 11,484. Method of, and Apparatus for Pulverizing Grain, Ores, &c. (*Méthode de trituration des grains, des minerais, etc., et appareil pour cet objet.*)

Lewis S. Chichester, Jersey, N. J., U. S., 10th July, 1880; for 5 years.

Claim. 1st.—The method of pulverizing fragile substances consisting in imparting to such substances a high velocity of movement by atmospheric air under pressure, and causing them to strike forcibly and at right angles, or nearly so, against one or more rigid surfaces so as to be broken by the impact. 2nd. The combination of a chamber for containing atmospheric air under a high pressure, an orifice for an issuing jet of such air, means for feeding the substance to be reduced, and a target or stationary surface against which the fragile substance is hurled with the velocity necessary to shatter the same into fragments of the required size. 3rd. The combination of a tube through which the fragile material is supplied, a surrounding chamber and annular orifice for air under a high pressure, a target or surface against which the fragile material is forcibly hurled, and a case surrounding such target. 4th. A pulverizing apparatus in which an issuing current of air hurls the fragile material forcibly against a target or stationary surface, a case around such target, to confine the air and cause the same to re-impart the required velocity to the particles that have been shattered against the target, as they rebound through such current and throw such material forcibly against the interior of the case. 5th. The process of preparing wheat and other cereals consisting in hulling the grain in a moist condition, heating the grain to a temperature sufficient to expel the moisture, applying a vacuum to thoroughly dry the grain, and then grinding or pulverizing such grain.

No. 11,485. Improvements in Photography. (*Perfectionnements dans la photographie.*)

John A. Fraser, jr., Toronto, Ont., 10th July, 1880; for 5 years.

Claim. 1st.—A sensitizing bath composed of fused nitrate of silver, iodide potassium, baryta nitrate, boric acid and water worked in a state of neutrality. 2nd. A developing liquid composed of proto-sulphate iron, double sulphate iron and ammonia, sulphate of copper, nitra e baryta, brown sugar and boric acid. 3rd. A sensitizing bath, in combination with a developing liquid composed of the ingredients specified.

No. 11,486. Improvements on Combined Lever Rotary Motion by Impact. (*Perfectionnements aux mouvements rotatoires à leviers combinés, par le frottement.*)

Henry B. Keiper, Lanions B. Keiper and John M. Keiper, Lancaster, Pa., and Alba B. Smith, Newmarket, N. J., U. S., 10th July, 1880; for 5 years.

Claim.—The combination of the raised cam face H upon the covering flange E cast in a single piece, with the double strap way F G and flanges f g, when said cam H enters and forms two side chambers with the inner periphery of the rim of the case D for impact balls I operated by two separate straps M N, one end of each affixed to its respective way F G on the combined cam pulley.

No. 11,487. Improvements on Corsets. (*Perfectionnements aux corsets.*)

Moses K. Bortree, Jackson, Mich., U. S., 10th July, 1880; for 5 years.

Claim. 1st.—A corset in which the busk parts are cut away, and the sides of such cut away parts provided with guides or fastenings adapted to receive and hold in position vertically adjustable busks, which are not otherwise permanently secured to such corsets. 2nd. A detached busk, the sides of which are provided with suitable fastenings, to adapt such busk to be vertically adjusted to a corset. 3rd. The combination of a corset, the sides of the cut away portions of which are provided with suitable guides or fastenings, with the adjustable part C, the sides of which are provided with slides or fastenings adapted to allow the part to be adjusted vertically to the cut away portion of the corset.

No. 11,488. Improvements on Window Curtain Rollers. (*Perfectionnements aux rouleaux des rideaux de fenêtres.*)

Nathaniel H. Shaw, Bedford, Que., 10th July, 1880; for 5 years.

Claim. 1st. The pawl or locking device Q. 2nd. The spindle E F F' made of wood in one single piece. 3rd. In combination with notch J, flange I, journal box O and spring M.

No. 11,489. Improvements in Pump Plungers and Valves. (*Perfectionnements aux pistons et aux valves des pompes.*)

John Mathews, Lynden, Ont., 12th July, 1880; (Extension of Patent No. 4,993) for 5 years.

No. 11,490. Improvements on Flax Scutching Machines. (*Perfectionnements aux machines à teiller le lin.*)

Samuel S. Fuller, (Assignee of William Keane,) Stratford, Ont., 12th July, 1880; (Extension of Patent No. 11,394.)

No. 11,491. Improvements on Flax Scutching Machines. (*Perfectionnements aux machines à teiller le lin.*)

Samuel S. Fuller, (Assignee of William Keane,) Stratford, Ont., 13th July, 1880; (Extension of Patent No. 11,394.)

No. 11,492. Improvements on Road Waggon. (*Perfectionnements aux wagons de promenade.*)

James L. Phillips, Lowville, N. Y., U. S., 13th July, 1880; for 5 years.

Claim. 1st.—The head blocks a connected, by two curved longitudinal side bars b b and central reach C, with the rear axle A, in combination with the springs h i connected by shackles k, the king bolt l, the rear spring m m connected to side bars b b, the spring bars p, the shackles q, loop piece r and the platform E of spring slats. 2nd. The loop piece r made in separate pieces for connection with shackle, and attached to spring by bolts or rivets. 3rd. The tip pieces s formed with a head for retaining the shackles. 4th. The plate spring c, to shackles, to prevent rattling. 5th. The combination of adjustable seat, or seats, and boxes.

No. 11,493. Improvements on Wood Planing Machines. (*Perfectionnements aux machines à raboter le bois.*)

John Ballantine (Co-inventor with Daniel Cameron), and Thomas Cowan, Galt, Ont., 15th July, 1880; (Extension of Patent No. 5,339.)

No. 11,494. Improvements on Moulding Machines. (*Perfectionnements aux machines de moulage.*)

John Ballantine, (Co-inventor with Daniel Cameron), and Thomas Cowan, Galt, Ont., 15th July, 1880; (Extension of Patent No. 5,951.)

No. 11,495. Improvements in Grain Binders. (*Perfectionnements aux lieuses à grain.*)

Moses G. Hubbard, Norristown, Pa., U. S., 15th July, 1880; for 5 years.

Claim. 1st.—In a grain binder, the combination of a tension device with a positive checking device applied to the spool to regulate both the tension and supply of the cord or wire for the band, and to prevent the spinning of the spool from its own momentum. 2nd. In a tension device for grain binders, the combination of the spool F, ratchet wheel E, pivoted lever H and a spring to keep one end of the lever against the ratchet wheel. 3rd. In a tension device for grain binders, the combination of the spool F, ratchet wheel E, provided with a conical flange e, nut G provided with the conical flange g, sleeve D, pin C, lever H and spring K. 4th. The combination of the ratchet wheel E, or its equivalent, with the spool F and pivoted lever H. 5th. The combination of the spool F, ratchet wheel E, pin C, plate B, pivoted lever H provided at one end, with a tooth A, and at the other, with a guide hole J and a spring to keep the tooth against the ratchet wheel. 6th. The spool F in combination with ratchet wheel E, lever H, spring K and adjustment spring M and thumb-screw. 7th. The pivoted lever H in combination with spring K and adjustment spring M, and thumb-screw N, or its equivalent.

No. 11,496. Improvements on Rivets. (*Perfectionnements aux rivets.*)

Quincy E. Packard, Montreal, Que., 15th July, 1880; for 5 years.

Claim.—1st. As a new article of manufacture, a rivet having a solid head E having flat projections B formed in one therewith. 2nd. A rivet having a solid head E and flat projections B made in one therewith, in combination with materials having slits or openings F.

No. 11,497. Improvements on Pumps. (*Perfectionnements aux pompes.*)

Luther C. Abbott, (Assignee of Charles H. Dawellins,) Richmond, Ind., U. S., 15th July, 1880; for 5 years.

Claim.—A double acting force pump having the pipes G G' and I J extending above the platform B, and head C forming raised and inclined valve seats a a' e, and the continuous packing c g interposed between the heads and platforms, above and below, forming valves b b' f' having weights d d' secured thereto.

No. 11,498. Improvements on Churns. (*Perfectionnements dans les barattes.*)

Fred Aldred, Glencoe, Ont., 15th July, 1880; for 5 years.

Claim.—The platform B and springs A fastened solidly thereto, in combination with the churn box C provided with two perforated partitions of dashes.**No. 11,499. Improvements on the Production of Surfaces for Printing, Stamping and Embossing.** (*Perfectionnements dans la production des surfaces à imprimer, estamper et bosseler.*)

Joseph J. Sachs, Manchester, Eng., 15th July, 1839; for 5 years.

Claim.—The production of rollers and other surfaces for printing, stamping or embossing.**No. 11,500. Improvements on Preparing and Decoloring Jute, China Grass, and other Vegetable Fibres.** (*Perfectionnements dans la préparation et la décoloration de la jute, des graminées et la chène et autres fibres végétales.*)

Joseph J. Sachs, Manchester, Eng., 25th July, 1839; for 5 years.

Claim.—The process of decoloring vegetable fibres such for example as jute, china grass and others, and at the same time rendering them pliable by the use of chemical substances which decompose wholly or partially the colouring matter in the raw fibres, and other chemical substances which form soluble compounds with such products of decomposition, whereby the fibres are obtained in their natural whiteness and are rendered flexible and soft, so as to be capable of being employed for spinning, paper making and other purposes.**No. 11,501. Improvements on Life Preservers.** (*Perfectionnements aux appareils de sauvetage.*)

Joseph G. Hill and John D. Harrison, Newark, N. J., U. S., 15th July, 1880; for 15 years.

Claim.—1st. A floatative structure rendered securely buoyant by means of one or more chambers filled with lamp black operating as a water repellent. 2nd. In floatative bodies such as life preservers and mattresses and the like, the combination of a painted canvas, case or structure with a water repellent filling of lamp black.**No. 11,502. Improvements on Grain Binding Machines.** (*Perfectionnements aux liesses à grain.*)

William A. Kirby, Auburn, N. Y., U. S., 15th July, 1880; for 5 years.

Claim.—1st. In a harvesting machine, the combination of the cutter, a transverse endless conveyor in rear of the same, and a rake arranged to carry the butts of the grain backward beyond the cutters. 2nd. The combination of the cutter bar, the endless conveyor in rear of the same, and the sweep rake having its arms arranged to reel the grain to the cutter, rake it backward upon the conveyor until the butts are in rear of the cutter and then rise out of action. 3rd. In combination with the conveyor and the table at its end, the intermediate power driven feed rolls arranged to turn toward each other and away from the conveyor. 4th. The combination of the crank J, binder arm K, sway bar L, divider and pitman. 5th. The combination of the vibrating divider and a reciprocating binder arm with the single rotary crank connected directly to the binder arm, and the link P extending from the crank to the divider.**No. 11,503. Improvements in Axe Cases.** (*Perfectionnements aux porte haches.*)

Atwood Crosby, Waterville, Me., U. S. 15th July, 1881; for 5 years.

Claim.—1st.—The axe case consisting of the leather lining A, metal frame B, hinged cover D, and fastening strap A. 2nd. An axe case of rigid or stiff materials having a hinged and locking cover. 3rd. An axe pocket or case having leather sides and metal frame, a locking cover and stiff bottom. 4th. An axe pocket or case composed of rigid materials and conforming in shape to the blade of the axe, and kept from the axe's edge by bearing against the handle.**No. 11,504. Improvements on Bottle Stoppers.** (*Perfectionnements aux bouchons des bouteilles.*)

Jacob C. Shaffer, Rochester, N. Y., U. S., 15th July, 1880; for 5 years.

Claim.—1st. The yoke C, formed of a single piece of wire, with the vertical arms bent to form the coils *d* between the straight length *f* and the lower ends of the arms, in combination with the wire ring B having eyes to which the lower ends of the yokes are pivoted, and the stopper consisting of a metallic plate carrying the elastic packing E, and constructed, on its upper surface, with the elevated band *h* and saddle *g*, the latter being inclined gradually downward on each side from the notched centre thereof. 2nd. The metallic cap-plate D, constructed with the air vent *l* opening into the hollow projecting cylindrical thimble *k*, in combination with the elastic packing E having the knob *p* constructed to entirely fill the cylindrical thimble and afford a firm connection with the cap plate.**No. 11,505. Process of, and Machine for Separating and Cleaning Vegetable Fibre.** (*Procédé et machine pour séparer et nettoyer la fibre végétale.*)

Thomas Threlfall, San Francisco, Cal., U. S., 15th July, 1880; for 5 years.

Claim.—1st. The process of separating and cleaning vegetable fibre, by first drying the stalks or plants and passing them through or between a seriesof smooth rollers to crush the stalks lengthwise, thence through or between alternate horizontal and spirally corrugated rollers, to break and separate the woody portion transversely and diagonally, and again through or between corrugated rollers having a continuous rotary or reciprocating motion to separate the gum or bark. 2nd. The combination of a series or group of smooth rollers F, longitudinally corrugated rollers F₁ and spirally corrugated rollers F₂, each group or series composed of two rollers. 3rd. The combination and arrangement of a set or series of smooth longitudinally and spirally corrugated rollers, each set composed of two rollers operated on journals *a* in boxes *b* *b*¹, with a rotating fan H between each set of said rollers. 4th. In a machine adapted to separating and cleaning fibre of plants, having a series of transverse rotary rollers operating in journals and journal bearings or boxes, the combination of the spiral springs B, elastic packing *d* and screw studs or cylinders C *C* operated by horizontal shafting and beveled gears D, so as to elevate and depress the rollers and impart to them an elastic and yielding action to engage and operate upon material of unequal thickness passing between the said rollers.**No. 11,506. Improvements on Knitting Machines.** (*Perfectionnements aux machines à tricoter.*)

The Shaw Stocking Company, (Assignee of Benjamin F. Shaw,) Lowell, Mass., U. S., 15th July, 1839; for 5 years.

Claim.—1st. In a knitting machine provided with a cylindrically arranged series of reciprocating needles to produce tubular fabric, the combination with the needles of a cam to operate them for circular or round and round knitting, and a second cam to operate certain of them to fashion or shape the knitted web for heels and toes. 2nd. In a cylindrical bed, a circular series of independently acting needles and a cam to actuate the needles for round and round knitting, in combination with a jacquard to determine the selection of needles for fashioning the web, and a second cam adapted to operate the needles, selected by the jacquard while the machine is being reciprocated to form heels and toes. 3rd. In a cylindrical needle bed and independently acting needles, a cam to operate the needles for round and round knitting, a jacquard to indicate and a cam to operate the fashioning needles for the web, in combination with a pattern surface to indicate the rotations and reciprocations of and with mechanism to rotate or reciprocate the cam carrying ring, according to the requirements of the said pattern. 4th. A series of needles and a series of levers pivoted upon sliding carriages combined with a jacquard and slides, intermediate connection between the jacquard and carriages and the levers and needles, to thereby effect the selection of needles. 5th. In a knitting machine provided with a circularly series of reciprocating needles arranged in a cylindrical bed, the needles, slides, levers and movable carriages upon which the levers are mounted, combined with two jacquard chains or surfaces, and with devices between the said jacquard surfaces and the carriages, to effect the selection of needles at each side of the cylinder. 6th. A series of needles, slides, levers and movable carriages to support the levers combined with a working cam, to operate upon the butts of some of the needles or needle slides and a jacquard cam to operate upon the series of levers. 7th. In a circular knitting machine, a series of independent carriages combined with a series of independent levers pivoted thereon, and an independent carriage for each lever adapted and suited to be actuated or not in effecting the selection of needles. 8th. Needle lifting levers pivoted on carriages combined with devices to move the carriages and a cam to act upon the said levers, when the same have been carried into its path. 9th. The combination of a series of needles and pivoted levers and a cam to act on the levers to lift some of the needles higher than if lifted by the working cam to permit the working cam to be moved into or withdrawn from operative position while the machine is running at full speed. 10th. In combination with the toothed gear *c*, to impart motion to the cam carrying ring, a reciprocating toothed rack and a revolving spur gear, and mechanism to alternately throw the rack and spur gear into, and out of engagement with the toothed gear to alternately move the machine for reciprocating and for circular knitting. 11th. A toothed gear *c*, in combination with a toothed rack, and a spur gear, each adapted to be alternately engaged with or disengaged from the toothed gear and with mechanism to effect the engagement of the rack with the toothed gear, while the spur gear is being disengaged therefrom, and a device of the spur gear with the toothed gear, while the rack is being disengaged to ensure the positive operation of the toothed gear with either the rack or spur gear. 12th. A series of reciprocating needles and a jacquard cam and a working cam having their operating centres arranged in the same radial plane (the working cam, being adapted to be thrown out of operative position when the fashioning needles are to be operated, and into operative position when the machine is moved to knit a tubular web) combined with devices to automatically withdraw and insert the working cam at the proper times. 13th. The gear *d* and spur gear connected, and sleeve and disc provided with cams combined with a skeleton slide, or equivalent, under the control of a pattern surface to move the spur gear laterally at the proper times, and to the described effect. 14th. A circularly arranged series of needles actuated by a cam ring, a gear to engage and rotate and reciprocate the said ring combined with mechanism adapted to automatically rotate the said gear and the cam ring at high speed for round about knitting and to reciprocate it at low speed for to and fro knitting. 15th. A series of circularly arranged needles and mechanism for both rotating and reciprocating the cam ring which actuate them, and with mechanism to rotate the said cam ring at a high speed, and reciprocate it at slow speed, a pattern chain to automatically effect both the change of direction of motion of the machine and the change of speed. 16th. A circularly arranged series of needles and mechanism to both rotate and reciprocate the cam ring for operating the needles, a pattern surface to govern the number of said rotations and reciprocations, combined with a pattern surface and devices controlled thereby, to automatically put the slack yarn, take into and out of operation. 17th. The pivoted take up jaws combined with a movable tongue and means to operate it, to effect the opening of the jaws and to permit them to be closed. 18th. A pivoted take up jaw and an attached balance to assist in maintaining it in its position furthest from the needles combined with a jaw pivoted upon the first mentioned jaw, and adapted to rest upon the thread by its own weight. 19th. The combination with the needles and thread guide of means to automatically unite with the main thread, while it is running into the machine and before it reaches the regular thread guide, an addition for thickening thread and discontinuing it at any desired point in the web. 20th. The combination, with the shaft Q and its escapement slide and fingers of the rack bar and projections to operate the escapement slide. 21st. The working cam *f* and vibrating slotted arm to move it, and the cam and stud moved by the slide bar com-

lined with devices to move the slide bar and pin into position to withdraw or insert the working cam as the toothed rack is thrown into or out of operative engagement with the toothed wheel C. 22nd. The longitudinally reciprocating web holder, constructed with relation to the needles. 23rd. The combination, with the cam ring, of a movable stop to arrest the motion of the ring at a point when the point of the switch cam carried by it, is between the pieces of the two butts of adjacent needles. 24th. A non-rotatory transferring device consisting of a circular head provided with a series of quills upon which the loops of the knitted tubular, or other top are placed, in combination with a cylindrical series of needles, whereby all the loops of the tubular top held by the quills may be placed simultaneously opposite and applied quickly to their respective machine needles to the effect that a circular web may be knitted to it. 25th. The combination, with the circular head, of a series of metallic quills arranged and adapted to receive longitudinally, and partially sheathe all the machine needles at once. 26th. A needle gate provided with inclines to act as a switch and so constructed and connected that it may be moved up or down to switch the needles up or down by the action of its inclines, and so that it may also be moved outwards from the needle bed to permit the withdrawal of the needles. 27th. A needle switch and a knitting cam constructed to permit the switch when placed in one of its positions to act as a prolongation of the knitting cam and lift the butts of the needles into a plane above the knitting path. 28th. A knitting cam having its drawing down inclines separated by a space at their top, and provided with slide stopping surfaces *r*₂ projecting into said space horizontally or angularly. 29th. A cam to be used during a certain part of the knitting process and withdrawn from use during another part of the process, a needle gate and switch united and combined with said cam so as to be moved with it. 30th. An intermediate bevel gear provided with ratchet teeth, in combination with a pawl to act on said ratchet, and with a gear on the one side to be driven by said intermediate and with a gear on the other side to be moved at one time as an idle wheel by the intermediate, and at another to be held and to act as a fixed toothed rack compelling the axial rotation of the said intermediate during the revolutions of the said intermediate around the shaft. 31st. The combination, with the elements of the preceding clause of a sleeve, a surrounding band surface, a sleeve and clutch, or coupling teeth, the whole acting alternately as a driving and as a loose pulley.

No. 11,507. Improvements in Fence Posts.

(*Perfectionnements aux pieux des clôtures.*)

Patrick Coughlin, Prescott, Ont., 19th July, 1880; for 5 years.

Claim.—A metal fence post having the wire holes *c* and the movable feet *C* pivoted through it by the pin *f*.

No. 11,508. Improvements on Wire Fences.

(*Perfectionnements aux clôtures métalliques.*)

Thomas Wright, South Norwloh, Ont., 19th July, 1880; for 5 years.

Claim. 1st.—A fence post constructed in two sections A B, the foot A having flattened terminals, with triangulated hollow centre C into which is fastened the post B horizontally notched to receive the longitudinal wires H. 2nd. An anchor for fence wires and posts consisting of the foot A having flattened terminals and triangulated hollow centre C with inserted eye rod E.

No. 11,509. Improvements on Violins and other Musical Instruments.

(*Perfectionnements aux violons et autres instruments de musique.*)

Faxcel Fowler, Brooklyn, N. Y., (Assignee of Edward R. Mallenbauer, Scotch Plains, N. J.), U. S., 19th July, 1880; for 5 years.

Claim. 1st. A sounding board placed within the instrument between the front and back and with its edges in connection with the sides. 2nd. A board placed within the instrument, and extending its whole length and breadth, and with its edges in contact and connection with the sides, when supported on, and attached to a purfling *c*. 3rd. The board F within the violin, extending the whole length and breadth of the instrument with its edges in contact with the sides E, in combination with the belly or front A, back B, sides E and purfling *c*. 4th. In combination with a violin of the usual construction, a board F arranged in the interior thereof. 5th. In combination with a violin, a board F arranged to extend the whole length and breadth of the instrument, having crescent-shaped sound ports *e* and bass bar *k*; 6th. The board F with convex surface included in the interior of the violin so as to reach the whole length and breadth thereof, and having the edges secured to the sides of the instrument. 7th. In combination with front, back and sides of the sound chamber of a musical instrument, a sounding board placed within the said chamber so as to divide it into two parts.

List of Patents issued up to 8th September, 1880, but not yet Officially published in the Patent Office Record.

- No. 11,644. Charles W. Isbell, of the city and State of New York, "Gas Process and Apparatus," patented 18th August, 1880.
- No. 11,645. Henry Thibault and Thomas Hawkins, both of the city and State of New York, "Rotary Engines," patented 18th August, 1880.
- No. 11,646. William H. Baldwin, of the city of Ottawa, Ont., "Churn," patented 18th August, 1880.
- No. 11,647. Allen Middleton, of Philadelphia, Penn., "Car Springs," patented 18th August, 1880.
- No. 11,648. Wm. Lester, of the city of Sherbrooke, Que., "Gauge Lathe," patented 18th August, 1880.
- No. 11,649. James Livingstone and John Kennedy, mechanic of the city of Toronto, Ont., "Balanced Valves," patented 18th August, 1880.
- No. 11,650. Robert Henry Hudgin, of Whitby, Ontario, "Wicket Gate," patented 18th August, 1880.
- No. 11,651. Joseph Hogue de la ville de St. Jean, Que., "Chaussures," breveté le 18 Août, 1880.
- No. 11,652. Louis Bredannaz, de Montréal, Que., "Bandage de Roue," breveté le 18 Août, 1880.
- No. 11,653. Thomas Crane, of the city of Fort Atkinson, Wis., "Gate Hinge," patented 18th August, 1880.
- No. 11,654. Alfred Vick, of Mount Carmel, Conn., "Velocipede," patented 18th August, 1880.
- No. 11,655. Henry A. Church, of the city of Providence, R. I., "Lacing Hook," patented 18th August, 1880.
- No. 11,656. Alexander Kay, of the village of Ayr, Ontario, "Binder," patented 18th August, 1880.
- No. 11,657. James Shanks Shannon, of the city of Chicago, Ill., "File" patented 18th August, 1880.
- No. 11,658. Frederick A. Gardner, Robert Dunbar and George Howell Dunbar, all of Buffalo, N. Y., "Steam Generator," patented 19th Aug., 1880.
- No. 11,659. Charles Edward Whittlesey and Samuel Andrew Stevens, both of New Haven, Conn., "Shoe Stay," patented 19th August, 1880.
- No. 11,660. George M. Wright, of the city of Philadelphia, Pa., "Printing Machine," patented 19th August, 1880.
- No. 11,661. Edward Leslie, of Orangeville, Ont., (Extension of Patent No. 11,004), "Bolt Fastener," patented 21st August, 1880.
- No. 11,662. Edward Leslie, of Orangeville, Ont., (Extension of Patent No. 11,004), "Bolt Fastener," patented 23rd August, 1880.
- No. 11,663. Josiah D. Heehner, of Marrisonville, and Anthony H. Selph, of Skippackville, both in the State of Pennsylvania, (Extension of Patent No. 5,119), "Governor for Horse Power," patented 24th August, 1880.
- No. 11,664. Josiah D. Heehner, of Marrisonville, and Anthony H. Selph, of Skippackville, both in the State of Pennsylvania, (Extension of Patent No. 5,119), "Governor for Horse Power," patented 24th August, 1880.
- No. 11,665. Allen Middleton, of Philadelphia, Penn., "Car Link," patented 26th August, 1880.
- No. 11,666. Octavius L. Hicks, of Etoblooke, Ont., "Sliding Seat," patented 26th August, 1880.
- No. 11,667. Joseph J. Sacks, of Manchester, England, "Improvements on the Manufacture of Rollers for Printing, Dyeing, Embossing, &c.," patented 26th August, 1880.
- No. 11,668. John Stevens, of Neenah, Wisconsin, U. S., A., "Grinding Mill and Adjuster," patented 26th August, 1880.

- No. 11,669. John Amor, of Hamilton, Ont., "Hose Coupling," (Extension of Patent No. 5,135), patented 26th August, 1880.
- No. 11,670. Phyllipe Vincent, of Jeune Lorette, District and Province of Quebec, "Moccasin Tie," patented 26th August, 1880.
- No. 11,671. John Harrison, of Woodstock, Ont., and Caleb Caister of the same place, "Salt Sower," patented 26th August, 1880.
- No. 11,672. Garret Parsell, Roseboom, and Charles S. Trowbridge, Auburn, New York, "Machine for Grooving Pipes," patented 26th August, 1880.
- No. 11,673. George W. Bell, St. Joseph, Missouri, "Weather Strips," 26th August, 1880.
- No. 11,674. Flewwelling W. Faft, Montréal, "Serrure," breveté 26th Août, 1880.
- No. 11,675. Thomas Hunter, Toronto, Ont., "Oven," patented 26th August, 1880.
- No. 11,676. Charles J. Shuttleworth, Springfield, Joseph D. Lateabee, of Ashford, George P. Kellogg, of East Pike, Edward Wilhelm and John J. Bonner, of Buffalo, "Bolling Machines," patented 26th August, 1880.
- No. 11,677. August B. Wood and Moses A. Rice, of Hamburg, "Match Box," patented 26th August, 1880.
- No. 11,678. Jacob Edson, Boston, Mass., "Diaphragm Pump," patented 26th August, 1880.
- No. 11,679. Stephen C. Taft and Fenner Darling, of Franklin, Mass., "Boiler Tube Cleaner," patented 26th August, 1880.
- No. 11,980. George Goewey and George F. Godley, Philadelphia, Penn., "Whisky Purifier," patented 26th August, 1880.
- No. 11,681. Chauncy C. Parker and Simon B. Parker, of Brooklyn, N. Y., "Spring Scull," patented 26th August, 1880.
- No. 11,682. Frank R. Packham, of Mechanicsburg, Ohio, "Pipe Crimping Machine," patented 26th August, 1880.
- No. 11,683. Nicolaus Kaiser, of Grellingen, Switzerland, "Method and Apparatus for Manufacturing Paper," patented 26th August, 1880.
- No. 11,684. Julius Morlock, of Stephen, Ont., "Pump," patented 26th August, 1880.
- No. 11,685. The American Automatic Organ Co., "Organina," patented 26th August, 1880.
- No. 11,686. Lewis J. Bennett and Thomas A. Jebb, of Buffalo, N. Y., "Process for Obtaining Starch and Gluten from Indian Corn or Maize," patented 26th August, 1880.
- No. 11,687. Daniel T. Lawson, of Wellsville, Ohio, "Means for Preventing Explosions of Steam Boilers," patented 26th August, 1880.
- No. 11,688. Charles S. Watson, (Assignee of Charles W. Woodford), of Montreal, "Finisher," (Extension of Patent No. 7,065), patented 26th August, 1880.
- No. 11,689. Charles S. Watson, (Assignee of Charles W. Woodford), of Montreal, "Finisher," (Extension of Patent No. 7,065), patented 30th August, 1880.
- No. 11,690. Joseph Langlois, of St. John, and Gustave Des Trois Maisons, of Montreal, "Heel Trimming Machine," patented 30th August, 1880.
- No. 11,691. George Raymond and Albert Raymond, of Waupum, Wisconsin, "Grinding Mill," patented 30th August, 1880.
- No. 11,692. John H. Staples, of Worcester, Mass., "Turbine," patented 30th August, 1880.
- No. 11,693. John R. Mote, of Antwerp, Ohio, "Photographic Apparatus," patented 30th August, 1880.
- No. 11,694. Norris D. Martin, of Montreal, and John Beau, "Milk Coolers," patented 30th August, 1880.
- No. 11,695. John Grant, of Gananoque, Ont., "Window Fastenings," patented 30th August, 1880.
- No. 11,696. Robert Dunbar, of Buffalo, N. Y., "Elevator," patented 30th August, 1880.
- No. 11,697. William C. Hale, of Austin Springs, Tenn., "Mill Stone Dress," patented 30th August, 1880.
- No. 11,698. George J. Shinner, of Milton, Penn., U. S. A., "Cutter Head," (Extension of Patent No. 5,134), patented 30th August, 1880.
- No. 11,699. James C. Wilson, (Assignee of George H. Jones), of Rose, N. Y., "Mould for Casting Turbines," (Extension of Patent No. 5,148), patented 30th August, 1880.
- No. 11,700. James C. Wilson, (Assignee of George H. Jones), of Rose, N. Y., "Turbine," (Extension of Patent No. 5,212), patented 30th August, 1880.
- No. 11,701. Charles Stanhope Watson, (Assignee of Charles W. Woodford), of Montreal, "Horseshoe Nail Finishing Machine," (Extension of Patent No. 5,813), patented 30th August, 1880.
- No. 11,702. Charles Stanhope Watson, (Assignee of Charles W. Woodford), of Montreal, "Horseshoe Nail Finishing Machine," (Extension of Patent No. 5,813), patented 31st August, 1880.
- No. 11,703. George S. Long, of Hartford, Connecticut, "Machine Belting," patented 31st August, 1880.
- No. 11,704. Charles Jackson, of California, "Bake Pans," patented 3rd September, 1880.
- No. 11,705. George H. Babcock, Stephen Wilcox and Nathaniel Waterman, of Brooklyn, "Steam Boiler," patented 3rd September, 1880.
- No. 11,706. George Sweet and John Watson, of Danville, N. Y., "Mower," patented Sept. 3rd, 1880.
- No. 11,707. Frank W. Hawley, of Rochester, N. Y., "Snow Plough," patented Sept. 3rd, 1880.
- No. 11,708. Jerome C. Dietrich, of Galt, Ont., "Saw Handle," patented Sept. 3rd, 1880.
- No. 11,709. Charles H. Loverin of Erie, Penn., "Pipe Tongs," patented 3rd Sept., 1880.
- No. 11,710. Arthur L. Burtis and George W. Weaver, of Lockport, N. Y., "Mop Pail and Wringer," 3rd Sept., 1880.
- No. 11,711. Hadley P. Fairfield, of West Medford, Mass., "Leather Asorting Machine," patented Sept. 3rd, 1880.
- No. 11,712. George H. Babcock, Stephen Wilcox and Nathaniel W. Pratt, of Brooklyn, "Power Apparatus," patented Sept. 6th, 1880.
- No. 11,713. Thomas Clarke, of Truro, N.S., "Palace and Sleeping Car," patented Sept. 6th, 1880.
- No. 11,714. George F. Green, of Kalamazoo, Mich., "Binder and Knotter," patented 6th Sept., 1880.
- No. 11,715. Jerome Colwell Dietrich, of Galt, Ont., "Saw Handle," patented Sept. 6th, 1880.
- No. 11,716. Frank M. Campbell and Anthony C. Dunlavy, of St. Louis, Missouri, "Skylight," patented Sept. 6th, 1880.
- No. 11,717. Henry Hough, of Montreal, and John Rourk, of Kingston, Ont., P. J. Coyle and Benjamin Clement, "Five Cock Cock," patented 3rd Sept., 1880.
- No. 11,718. Stephen Struz, of Pittsburg, Penn., "Soap," (Extension of Patent No. 5,142), patented Sept. 6th, 1880.
- No. 11,719. Wm. D. Ewart, of Chicago, Ill., "Drive Chain," (Extension of Patent No. 5,163), patented Sept. 6th, 1880.
- No. 11,720. Hiram G. Farr and Henry C. Copeland, of Baudon, Vermont, (Assignees of John Smalley and Wm. W. Smalley, "Journal Bearing, and Composition therefor," patented Sept. 8th, 1880.
- No. 11,721. James Andrews, of Biddeford, Me., "Levelling Attachment for Earth Cars," patented Sept. 8th, 1880.
- No. 11,722. Wm. Wickersham, of Boston, Mass., "Machines for Mail Cutting," patented Sept. 8th, 1880.
- No. 11,723. Henry Barrett, of Middlesex, England, "Bottles and Stoppers," patented Sept. 8th, 1880.
- No. 11,724. Charles A. Clark and Andrew Lockerby, St. John, N.B., "Freezer and Refrigerator," patented Sept. 8th, 1880.
- No. 11,725. Benjamin Baker, of Montreal, "Swing," patented Sept. 8th, 1880.
- No. 11,726. Martin W. Woodward, of Petrolio, Ont., "Process of Deodorizing Petroleum Tar and Crude Petroleum," patented Sept. 8th, 1880.
- No. 11,727. John Webster, of Detroit, Mich., "Flour Bolt and Bran Duster," patented Sept. 8th, 1880.
- No. 11,728. Seraphin Vigeant and Pierre Desmarais, of Holyoke, Mass., "Spinning Machine," patented Sept. 8th, 1880.
- No. 11,729. Thos. Balmer, of Chicago, Ill., "Plug Tobacco Box," patented Sept. 8th, 1880.
- No. 11,730. Charles E. Larocque, of St. Jerome, and A. Laberge, the younger, of Montreal, "Railway Switch," patented Sept. 8th, 1880.
- No. 11,731. Alexander Atkinson, of Winterest, Iowa, "Washer and Wringer," patented Sept. 8th, 1880.
- No. 11,732. Pierre A. Gendron, of St. Hugues, Que., "Chaloupe," patented Sept. 8th, 1880.
- No. 11,733. Squire Keith and Albert H. Spaulding, Silver Creek, N. Y., "Elastic Cushions for Mill Stones," patented 8th September, 1880.
- No. 11,734. Hugh Fairgrieve and Joseph H. Kelly, Hamilton, Ont., "Steam Engines," patented 8th September, 1880.
- No. 11,735. Wm. A. Boyd Strathroy, Ont., "Fruit Ladders," patented 8th September, 1880.
- No. 11,736. Euchariste E. Goyer, Montreal, "Cabinet Wardrobe," patented 8th September, 1880.
- No. 11,737. Emile Berliner, Boston, Mass., and Charles Williams, the younger, "Transmitter," patented 8th September, 1880.
- No. 11,738. Abner M. Mulholland, Toronto, Ont., "Transmitter," patented 9th September, 1880.
- No. 11,739. Henry G. Yates, New York U. S., "Horseshoes," patented 11th September, 1880.
- No. 11,740. George H. Hurd, Cleveland, Ohio, U. S. A., "Inhaler," patented 11th September, 1880.
- No. 11,741. Alva Warden, Upsilon, Mich., "Shell Capper," patented 11th September, 1880.
- No. 11,742. John H. Haddock, St. Johnsbury, Vt., "Pneumatic Ore Separator," patented 11th September, 1880.
- No. 11,743. William Bell, William Moody Sloane and Robert Potter, New Jersey, U. S. A., "Process for Purifying, Clearing and Refining Paraffine and other waxes," patented 11th September, 1880.
- No. 11,744. John Laxton, Toronto, Ont., "Street Lamp," patented 11th September, 1880.
- No. 11,745. Edouard Julien, Montreal, Que., "Spring Bed," patented 11th September, 1880.
- No. 11,746. James Jones and Charles T. Ballard, Louisville, Ky., "Grinding Mill," patented 11th September, 1880.
- No. 11,747. Jules A. Gondron, Montreal, "Appareil pour Pomper la Bière," Breveté le 11 Septembre, 1880.
- No. 11,748. Jacob P. Wagner, Toronto, Ont., "Self Watering Flower Casket," patented 11th September, 1880.
- No. 11,749. James A. Davis, Henderson, "Water Wheel," patented 11th September, 1880.
- No. 11,750. Samuel Boon, Frank, Charles B. Wheelock, Isaac Reese and John A. Ward, Nashville, "Machine for Cutting Stone," patented 11th September, 1880.
- No. 11,751. Michael D. Connolly, Thomas A. Connolly, Thomas J. McTigue, Pittsburg, Pa., "Automatic Telephone Exchange," patented 11th September, 1880.

INDEX OF INVENTIONS.

| | | | |
|---|---------------|--|---------------|
| Advertising devices, E. W. Taylor..... | 11,433 | Life preservers, J. G. Hill, et al..... | 11,501 |
| Albums, photographic, E. S. Glover..... | 11,404 | Liquid cooling, Z. M. Gellinas..... | 11,402 |
| Brakes, railway, J. W. Stanford, et al..... | 11,382 | Liquor fining, A. E. and W. E. Feroe..... | 11,428 |
| Bran, cleaning machines, J. Mills..... | 11,386 | Locks, car, H. M. Williston..... | 11,419 |
| Brick burning, B. Walton..... | 11,429 | Locomotive, E. Fontaine..... | 11,451 |
| Brushes, paint, J. Russell..... | 11,377 | “ W. Mason..... | 11,439 |
| Burners, liquid fuel, H. A. Bradley..... | 11,487 | Metal bars, reducing, G. J. Capewell..... | 11,434 |
| Butter preservation, J. Harger..... | 11,471 | Mining machines, G. D. Whitcomb..... | 11,444 |
| Boards, cooling plough mould, H. Wiard, et al..... | 11,483 | Motion, lever rotary, H. B., L. B. and J. M. Keiper..... | 11,486 |
| Boots and shoes, M. Bray..... | 11,443 | Mould boards, cooling plough, H. Wiard, et al..... | 11,483 |
| “ “ S. Fortin, et al..... | 11,474 | Moulding machines, J. Ballantine, et al..... | 11,494 |
| “ “ heels, B. F. Locke..... | 11,425 | Mowing machines, C. Taylor, et al..... | 11,383 |
| Beams, plough, H. Wiard..... | 11,465 | Musical instruments, P. Fowler..... | 11,509 |
| Binders, grain, D. Williamson..... | 11,418 | Nails feeding device, L. A. Dodge..... | 11,470 |
| “ “ M. G. Hubbard..... | 11,495 | Nut locks, J. L. De Wolfe..... | 11,407 |
| “ “ P. C. Evans, et al..... | 11,440 | Oven, smelting, P. P. Wilson..... | 11,375 |
| Binding machines, grain, W. A. Kirby..... | 11,502 | Ore pulverizing apparatus, L. S. Chichester..... | 11,484 |
| Cans, milk, F. J. Lee..... | 11,464 | Paper manufacture, A. Fickett..... | 11,379 |
| “ oil, H. C. Bradley..... | 11,385 | “ pulp, J. Foley..... | 11,446 |
| Car draw bars, D. Holt et al..... | 11,475 | “ “ from wood, S. M. Allen..... | 11,456 |
| Cases, axe, A. Crosby..... | 11,503 | Pavement, concrete, H. Couillard, et al..... | 11,380 |
| China grass decoloring, J. J. Sachs..... | 11,500 | Photographic albums, E. S. Glover..... | 11,404 |
| Churn, F. Aldred..... | 11,498 | Photography, J. A. Fraser, Jr..... | 11,485 |
| Collar, horse, E. Fisher, et al..... | 11,428 | Pipes, screw threading, J. S. Schuyler..... | 11,476 |
| Condensers and injectors, G. Mazza..... | 11,463 | Piston packing, G. C. Phillips..... | 11,409 |
| Cooling liquids, Z. M. Gellinas..... | 11,402 | Planing machines, wood, J. Ballantine, et al..... | 11,493 |
| Cooling, plough mould boards, H. Wiard, et al..... | 11,483 | Plough, H. Wiard, et al..... | 11,443 |
| Corsets, M. K. Bortree..... | 11,487 | “ beams, H. Wiard..... | 11,465 |
| Cotton yarn, T. H. Dunham..... | 11,430 | “ gang, T. Gowdy..... | 11,478 |
| Counter machines, heel, J. Kleffer..... | 11,438 | “ mould boards, cooling, H. Wiard, et al..... | 11,483 |
| Couplers, car, J. T. Rice, et al..... | 11,378 | “ points, L. W. Hall..... | 11,450 |
| “ “ W. J. Stethem..... | 11,445 | Plungers and valves, J. Matthews..... | 11,489 |
| “ “ M. E. Morningstar, et al..... | 11,406 | Posts, fence, P. Coughlin..... | 11,507 |
| Couplings screw threading, J. S. Schuyler..... | 11,476 | Presses, tincture, J. G. Baker..... | 11,481 |
| Dampers, stove, W. M. Gartshore..... | 11,401 | Printing, stamping and embossing, J. J. Sachs..... | 11,499 |
| Distributors for fertilizers, R. B. Sheldon, et al..... | 11,431 | Pruning implements, J. W. Cogswell..... | 11,422 |
| Doors, sliding, M. Roberts..... | 11,421 | Pump, G. W. McKenzie..... | 11,436 |
| Drawbars, railway, D. Holt, et al..... | 11,475 | “ J. Shupe..... | 11,466 |
| Draw plates, C. D. Rogers..... | 11,452 | “ L. C. Abbott..... | 11,497 |
| Dusters, feather, L. A. Watson..... | 11,510 | “ plungers, J. Matthews..... | 11,489 |
| Elevators, grain, J. B. Stoner..... | 11,461 | Punching machines, J. T. Bedford..... | 11,416 |
| Embossing, printing and stamping, J. J. Sachs..... | 11,499 | Rakes, hay, J. Moody..... | 11,398 |
| Engines, treble cylinder, F. A. Gardner, et al..... | 11,417 | “ horse, S. H. Bushnell..... | 11,482 |
| Fasteners, glove, A. Riddell, et al..... | 11,442 | Reaping machines, A. C. Scarr..... | 11,391 |
| “ sash, J. Harley, et al..... | 11,405 | “ “ C. Taylor, et al..... | 11,383 |
| Feather renovators, J. W. Butcher, Jr..... | 11,435 | “ “ S. Crawford..... | 11,412 |
| Feeding device, nail, L. A. Dodge..... | 11,470 | Retorts, discharging gas, A. G. Ross..... | 11,408 |
| Felting hat bodies, J. T. Waring..... | 11,376 | Rigging and sails, J. H. Bloomfield..... | 11,413 |
| “ machines, hat, J. T. Waring..... | 11,411 | Rivets, Q. E. Packard..... | 11,496 |
| Fence posts, P. Coughlin..... | 11,507 | “ tubular, M. and M. N. Bray..... | 11,449 |
| “ wire, T. Wright..... | 11,508 | Roller, matting, G. H. Langmore..... | 11,395 |
| “ “ The Washburn and Moen Manufg Coy..... | 11,453 11,454 | Rollers, window curtain, N. H. Shaw..... | 11,488 |
| Fertilizers, distributor for, R. B. Sheldon, et al..... | 11,455 | Sails and rigging, J. H. Bloomfield..... | 11,413 |
| Fibre cleaning, T. Threlfall..... | 11,505 | Sash fasteners, J. Harley, et al..... | 11,405 |
| “ “ J. J. Sachs..... | 11,500 | Saw, filing gauges, D. Horner..... | 11,447 |
| Flax scutching machine, S. S. Fuller..... | 11,490 | “ mills, J. H. Watson, et al..... | 11,400 |
| Garments, cutting, S. J. Smith..... | 11,388 | Scorers, grain, S. T. and W. D. Elliott..... | 11,462 |
| Gas retorts, discharging, A. O. Ross..... | 11,403 | Screw threads, cutting, J. S. Schuyler..... | 11,476 |
| Gates, W. G. Alexander..... | 11,472 | Scutching machines, flax, S. S. Fuller..... | 11,394 11,490 |
| Gauge saw filing, D. Horner..... | 11,447 | Sewing machines, J. Heberling, et al..... | 11,414 |
| Glove fasteners, A. Riddell et al..... | 11,442 | “ “ J. M. Fair..... | 11,441 |
| Grain conveying machine, H. D. Stoner..... | 11,396 | Shearing machines, J. T. Bedford..... | 11,416 |
| “ pulverizing apparatus, L. S. Chichester..... | 11,434 | Shingle edging machine, F. J. Drake..... | 11,473 |
| “ scorers, S. T. and W. D. Elliott..... | 11,462 | Shoes, G. Bolvin..... | 11,389 |
| Grinders, R. B. Ashley, et al..... | 11,415 | Spikes, cant hand, A. Hunter..... | 11,397 |
| Grinding machines, wood, A. Fickett..... | 11,379 | Spool manufacture, C. E. Burns..... | 11,410 |
| Guide, finger, A. M. Dabosta..... | 11,480 | Springs, vehicle, H. M. Keith, et al..... | 11,459 |
| Harvesters, C. C. Bradley..... | 11,489 | Stamping machines, J. T. Bedford..... | 11,416 |
| Harvesting machines, S. Johnston..... | 11,427 | “ printing and embossing, J. J. Sachs..... | 11,499 |
| Hat bobles, felting, J. T. Waring..... | 11,376 | Steamers, feed, M. B. Mills, et al..... | 11,392 |
| “ felting machines, J. T. Waring..... | 11,411 | Stoppers, bottle, J. C. Schaffer..... | 11,504 |
| Heel, boot and shoe, B. F. Locke..... | 11,425 | Stoves, F. and J. Moses..... | 11,424 |
| “ counter machines, J. Kleffer..... | 11,438 | Tool holders, L. Young et al..... | 11,479 |
| “ trimming “ C. W. Glidden..... | 11,408 | Trucks, car, S. Keeler, et al..... | 11,393 |
| Hevenold and India rubber, H. Gerner..... | 11,460 | Type writers, A. M. DaCosta..... | 11,489 |
| Hinges, J. B. Parent..... | 11,390 | Valves, W. White..... | 11,420 |
| Hoop machines, J. Dobbins..... | 11,428 | “ W. Wilson..... | 11,437 |
| Horseshoes, G. L. Potvin..... | 11,468 | “ and plungers, J. Matthews..... | 11,489 |
| India rubber vulcanized, H. Gerner..... | 11,460 | Violins, etc, P. Fowler..... | 11,509 |
| Injectors and condensers, G. Mazza..... | 11,463 | Valves, balance slide, E. Robinson, et al..... | 11,384 |
| Jacks, carriage, A. Porteous, et al..... | 11,477 | Waggon, road, J. L. Phillips..... | 11,492 |
| Jute, decoloring, J. J. Sachs..... | 11,500 | Washing machines, J. G. Walker..... | 11,381 |
| Keiting machine, The Shaw Stocking Coy..... | 11,506 | Wheat reducing machine, J. Mills..... | 11,387 |
| Lamp and lantern, L. G. Massow..... | 11,432 | Wood grinding “ A. Fickett..... | 11,379 |
| Lever rotary motion, H. B., L. B. and J. M. Keiper..... | 11,486 | “ planing “ J. Ballantine, et al..... | 11,493 |
| | | “ polishing “ A. Bridgeman..... | 11,399 |
| | | Writers, type, A. M. DaCosta..... | 11,480 |
| | | Yarn cotton, T. H. Dunham..... | 11,480 |

INDEX TO PATENTEES.

Abbott, L. C., pump..... 11,497
 Aldred, F., churn..... 11,498
 Alexander, W. G., gates..... 11,472
 Allen, S. M., paper pulp from wood..... 11,457
 Ashley, R. B., et al., grinders..... 11,415
 Baker, J. G., tincture presses..... 11,481
 Ballantine, J., et al., moulding machines..... 11,494
 " " wood planing machines..... 11,493
 Bedford, J. T., shearing machines..... 11,416
 Beymer, H. B., et al., slide valves..... 11,384
 Bloomfield, J. H., rigging and sails..... 11,413
 Board, T., et al., glove fastener..... 11,442
 Bolvin, G., shoes..... 11,389
 Bortree, M. K., corsets..... 11,487
 Bradley, C. C., harvesters..... 11,469
 " H. A., liquid fuel burners..... 11,467
 " H. C., oil cans..... 11,385
 Bray, M., boots and shoes..... 11,443
 " " and M. N., tubular rivets..... 11,449
 Bridgeman, A., et al., wood polishing machine..... 11,399
 Bullock, W. R., et al., cooling plough mould boards..... 11,483
 " " " ploughs..... 11,458
 Burns, C. E., spool manufacturer..... 11,410
 Burt, R. F., et al., slide valves..... 11,384
 Bushnell, S. H., horse rake..... 11,482
 Butcher, J. W., Jr., feather renovator..... 11,435
 Cameron, D., moulding machine..... 11,494
 " " wood planing machine..... 11,493
 Capewell, G. J., reducing metal bars..... 11,431
 Chichester, L. S., ore pulverizing apparatus..... 11,484
 Cogswell, J. W., pruning implements..... 11,422
 Contant, A., et al., boots and shoes..... 11,474
 Coughlin, P., fence posts..... 11,507
 Couillard, H., et al., concrete pavement..... 11,380
 Cowan, T., et al., moulding machine..... 11,494
 " " " wood planing machine..... 11,493
 Crawford, S., reaping machine..... 11,412
 Crosby, A., axe cases..... 11,503
 Da Costa, A. M., finger guides..... 11,480
 Darling, G. S., et al., saw-mills..... 11,400
 De Warn, L. E., boots and shoes..... 11,474
 De Wolfe, J. L., nut locks..... 11,407
 Dobbins, J., hoop machine..... 11,428
 Dodge, L. A., nail feeding device..... 11,470
 Drake, F. J., shingle edging machine..... 11,473
 Dunbar, R. and G. H., et al., treble cylinder engines..... 11,417
 Dunham, T. H., cotton yarn..... 11,430
 Duwellins, C. H., pumps..... 11,497
 Elliott, S. T. and W. D., grain scorers..... 11,462
 Evans, P. C. and P. J., et al., grain binders..... 11,440
 Fair, J. M., sewing machine..... 11,441
 Feroe, A. E. and W. E., liquor fitting..... 11,423
 Fickett, A., wood grinding machine..... 11,379
 Fisher, E., et al., horse collar..... 11,426
 Foley, J., paper pulp..... 11,416
 Fontaine, E., locomotives..... 11,451
 Fortin, S., et al., boots and shoes..... 11,474
 Fowler, P., musical instruments..... 11,509
 Fraser, J. A., Jr., photography..... 11,485
 Fuller, S. S., flax scutching machine..... 11,394 11,490
 Gardner, F. A., et al., treble cylinder engine..... 11,417
 Gartshore, W. M., stove dampers..... 11,401
 Gellinas, Z. M., cooling liquids..... 11,402
 Gerner, H., vulcanized india rubber..... 11,460
 Glidden, C. W., heel trimming machine..... 11,408
 " J. F., wire fence..... 11,453 11,454
 Glover, E. S., photographic album..... 11,404
 Gowdy, T., gang ploughs..... 11,478
 Hall, L. W., et al., cooling plough mould boards..... 11,483
 " " " plough points..... 11,450
 Harger, J., butter preservative..... 11,471
 " J. P., et al., vehicle springs..... 11,459
 Harley, J., et al., sash fastener..... 11,405
 Harrison, J. D., et al., life preserver..... 11,501
 Hastings, A. M., et al., wood grinding machine..... 11,379
 Heberling, J., et al., sewing machine..... 11,414
 Hill, J. G., et al., life preserver..... 11,501
 Holt, D., et al., car draw bars..... 11,475
 Horner, D., gauges for filing saws..... 11,447
 Hubbard, F. J., car-couplers..... 11,378
 " M. G., grain binder..... 11,495
 Humphreys, C. J., boots and shoes..... 11,443
 Hunter, A., cant hand spikes..... 11,397
 Johnston, S., harvesting machine..... 11,427
 Keane, W., flax scutching machine..... 11,394 11,490

Keeler, S., et al., car truck..... 11,393
 Kelper, H. B., L. B. and J. M., lever rotary motion..... 11,486
 Kelbt, H. M., et al., vehicle springs..... 11,459
 Kendall, G. W., et al., mowing machine..... 11,383
 Kieffer, J., heel counter machine..... 11,438
 King, H. J. H., et al., grain binder..... 11,440
 Kirby, W. A., grain binder..... 11,502
 Lee, F. J., milk cans..... 11,444
 Leib, D., sewing machine..... 11,441
 Leyon, N., et al., tool holder..... 11,479
 Locke, B. F., boot and shoe heels..... 11,425
 Long, J. B., et al., sewing machine..... 11,414
 Longmore, G. H., matting roller..... 11,395
 McCracken, W. V., et al., slide valve..... 11,384
 McKenzie, C., et al., carriage jack..... 11,477
 " G. W., pump..... 11,436
 McKeown, R., et al., concrete pavement..... 11,380
 McLean, M., gang plough..... 11,478
 Mason, W., locomotives..... 11,439
 Massow, L. G., lamps and lanterns..... 11,432
 Matthews, J., pump valves..... 11,489
 Mazza, G., injector and condenser..... 11,463
 Métiévier, J., et al., boots and shoes..... 11,474
 Middleton, A., et al., car draw bars..... 11,475
 Milligan, S., et al., railway brake..... 11,382
 Mills, J., bran cleaning machine..... 11,386
 " " wheat reducing machine..... 11,387
 " M. B., et al., feed steamers..... 11,392
 Mollenhaner, E. R., musical instruments..... 11,509
 Moody, J., hay rake..... 11,398
 Moore, J. W., et al., slide valve..... 11,384
 Morningstar, M. E., et al., car-couplings..... 11,406
 Moses, F. and J., stoves..... 11,421
 Newman, J. B., et al., sash fasteners..... 11,405
 Packard, J. E., rivets..... 11,496
 Parent, J. B., hinges..... 11,390
 Peugelly, A. J., et al., grinder..... 11,415
 Phillips, G. C., piston packing..... 11,409
 " J. L., road waggon..... 11,492
 Pierce, J. D., oil can..... 11,385
 Porteous, A., et al., carriage jack..... 11,477
 Potvin, G. L., horse shoes..... 11,488
 Pugh, J. M., et al., slide valves..... 11,384
 Rice, C. B., et al., feed steamer..... 11,392
 " J. T., et al., car-coupler..... 11,378
 Richmond, G. M., feather dusters..... 11,510
 Riddell, A., et al., glove fastener..... 11,442
 Roberts, J. W., et al., car-coupling..... 11,406
 " M., sliding doors..... 11,421
 Robinson, E., et al., slide valve..... 11,384
 Rogers, C. D., draw plates..... 11,452
 Roes, A. G., discharging gas retorts..... 11,403
 Rowe, H. E., feather renovators..... 11,435
 Russell, J., paint brushes..... 11,377
 Sachs, J. J., jute decoloring..... 11,500
 " " printing, stamping and embossing..... 11,499
 Scarr, A. C., reaping machine..... 11,391
 Schaffer, J. C., bottle stopper..... 11,504
 Schuyler, I. S., cutting screw thread..... 11,476
 Shaw, B. F., knitting machine..... 11,506
 " N. H., window curtain roller..... 11,488
 Shaw Stocking Co'y, The, knitting machine..... 11,506
 Sheldon, R. B., et al., distributor for fertilizer..... 11,431
 Shupe, I., pumps..... 11,466
 Smith, S. J., cutting garments..... 11,388
 " A. B., et al., lever rotary motion..... 11,486
 Stanford, T. W., et al., railway brakes..... 11,382
 Stethem, W. J., car-coupler..... 11,445
 Stoner, J. B., grain elevator..... 11,481
 Stover, H. D., grain conveying machine..... 11,396
 Stouffer, J. O., pumps..... 11,466
 Taylor, C., et al., mowing machine..... 11,383
 " E. W., advertising devices..... 11,433
 Threlfall, T., fibre cleaning..... 11,505
 Walker, J. G., washing machines..... 11,381
 Walton, B., brick burning..... 11,429
 Waring, J. T., felting hat bodies..... 11,378
 " " " hat felting machines..... 11,411
 Washburn and Moen Manuf'g Co'y, The, wire fence..... 11,453 11,454
 Watson, J., et al., horse collar..... 11,426
 " J. H., et al., saw-mills..... 11,400
 " L. A., feather duster..... 11,510
 " W. J., et al., car trucks..... 11,393
 Whitcomb, G. D., mining machines..... 11,444
 White, W., valves..... 11,420
 Wiard, H., plough beams..... 11,465
 " " " cooling plough mould boards..... 11,488

| | | | | |
|-----------------------------------|--------|--------|-------------------------------------|--------|
| Wiard, H., et al., ploughs..... | 11,448 | 11,458 | Wilson, W., valves | 11,487 |
| Williamson, D., grain binder..... | | 11,418 | Wingard, E. V., brick burning..... | 11,429 |
| Williston, H. M., car locks | | 11,419 | Wright, T., wire fences | 11,508 |
| " R. P., smelting oven..... | | 11,375 | Young, L., et al., tool holder..... | 11,479 |

THE
CANADIAN PATENT OFFICE RECORD.
 ILLUSTRATIONS.

Vol. VIII.

AUGUST, 1880.

No. 8.

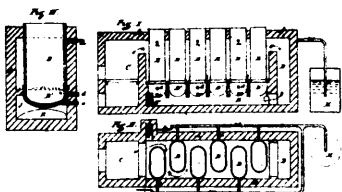

11375 Wilson's Improvements on Smelting Ovens.

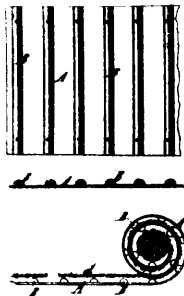

11376 Waring's Apparatus for Felting Hat Bodies.



11377 Russell's Improvements in Paint Brushes.

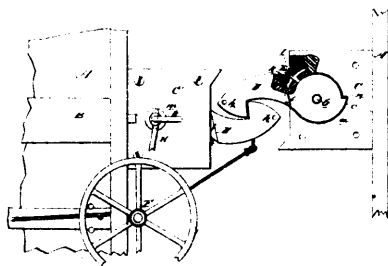

11378 Rice's Improvements on Car-Couplers.

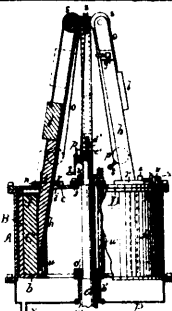

11379 Fickett's Improvements on Wood Grinding Machines.

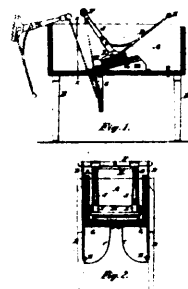

11381 Walker's Improvements on Washing Machines.

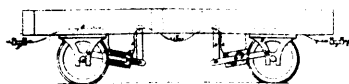

11382 Stanford & Milligan's Improvements in Railway Brakes.

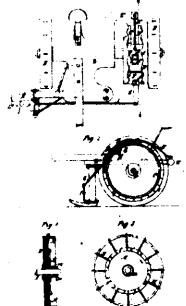

11383 Taylor & Kendall's Improvements in Mowing and Reaping Machines.

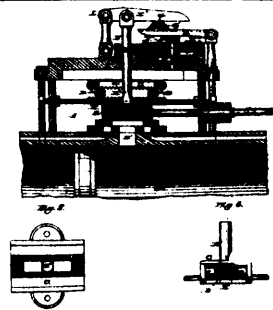

11384 Robinson's Improvements on Balance Slide Valves.

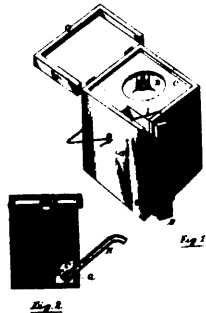

11385 Pierce's Improvements on Oil Cans.

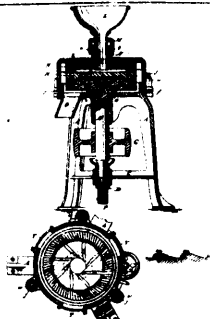

11386 Mills's Improvements on Machines for Cleaning Bran.

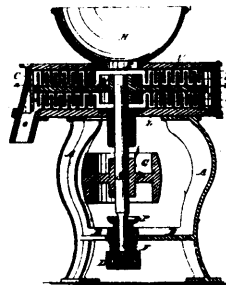

11387 Mills's Machine for Degerminating and Reducing Wheat.

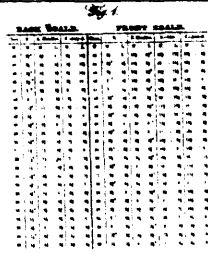

11388 Smith's Device for Measuring and Cutting Garments.

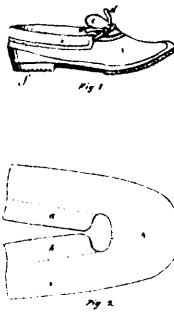

11389 Boivin's Improvements in Shoes.

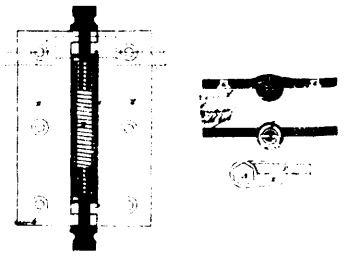

11390 Parent's Improvements on Hinges.

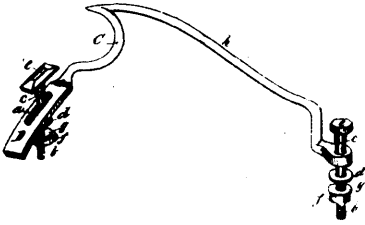

11391 Scary's Improvements in Reaping Machines.

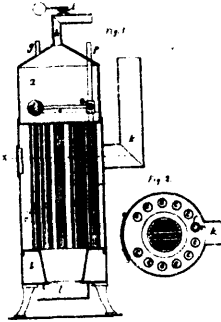

11392 Mills & Rice's Improvement in Feed Steamers.

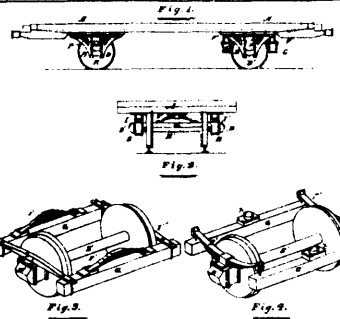

11393 Keeler's Improvements on Car Trucks.

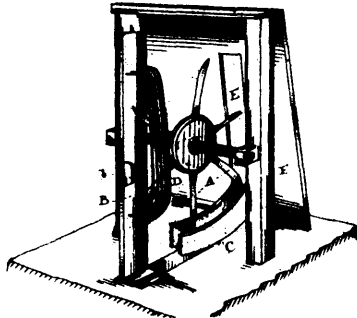

11394 Keane's Improvements on Flax Scutching Machines.

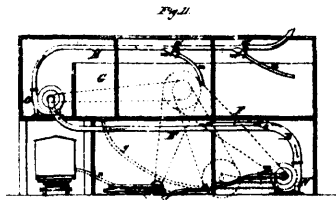

11396 Stover's machine for Discharging and Conveying Grain.

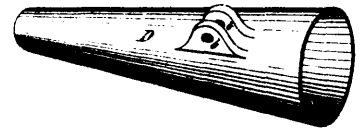

11397 Hunter's Improvements in Cant Hand Spikes.

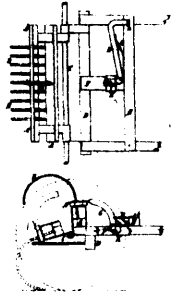

11398 Meedy's Improvements in Hay Rakes.

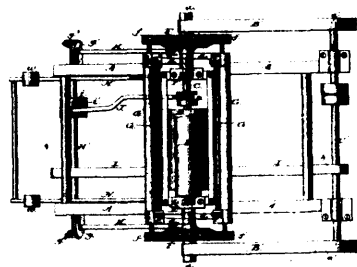

11399 Bridgeman, Perry & Mather's Improvement in Wood Polishing Machines.

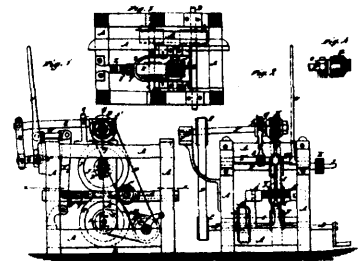

11400 Watson's Improvements on Saw Mills.

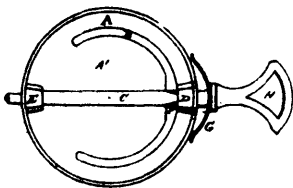

11401 Gartshore's Improvements in Stove Dampers.

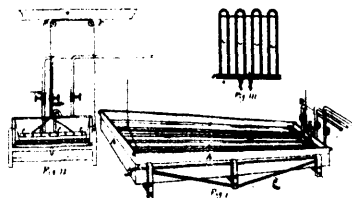

11402 Gálinas's Method of Cooling Liquids.

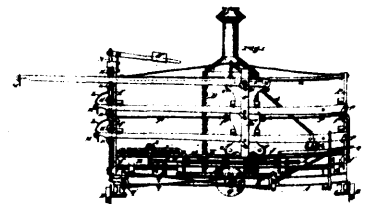

11403 Ross's Apparatus for Discharging Gas Retorts.

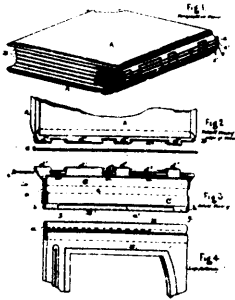

11404 Glover's Improvements on Photographic Albums.

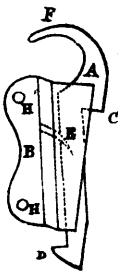

11405 Harley's Improvements on Sash Fasteners.

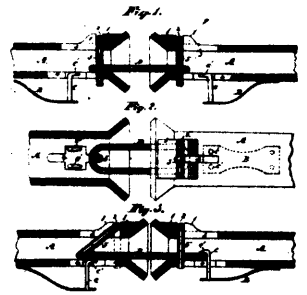

11406 Morningstar & Roberts's Improvements on Car-couplings.

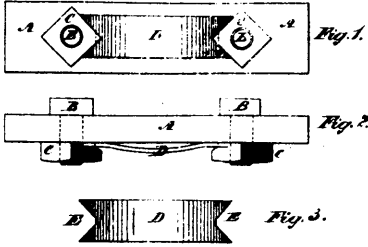

11407 De Wolfe's Improvements on Nut Locks.

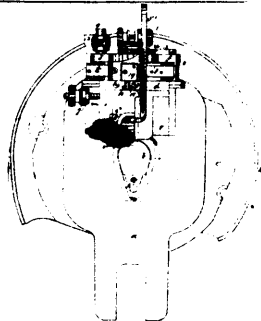

11408 Glidden's Improvements in Heel Trimming Machines.

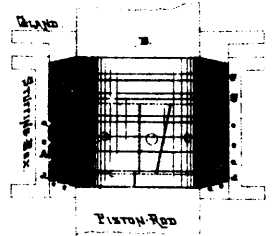

11409 Phillips's Improvements in Piston Packing.

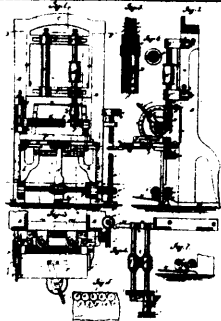

11410 Burns's Improvements in the Manufacture of Spools.

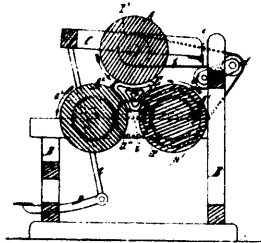

11411 Waring's Improvements on Hat Felting Machines.

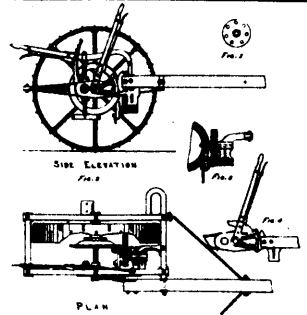

11412 Crawford's Improvements in Reaping Machines.

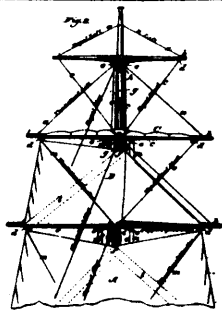

11413 Bloomfield's Improvements on Rigging and Sails for Square-rigged Vessels.

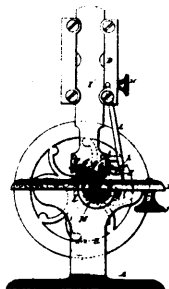

11414 Heberling's Improvements on Sewing Machines.

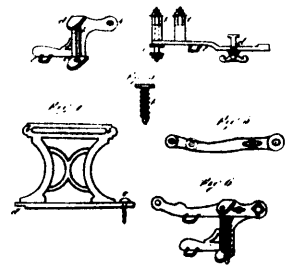

11415 Ashley & Pougelly's Improvements on Grinders.

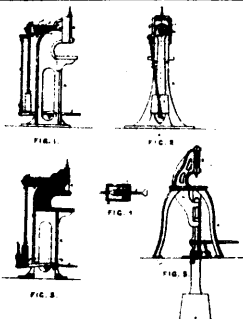

11416 Bedford's Machines for Shearing, Punching and Stamping Metals.

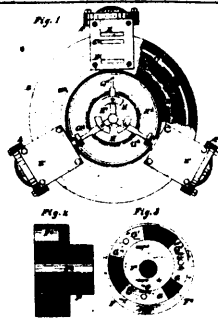

11417 Gardner's Improvements on Treble Cylinder Engines.

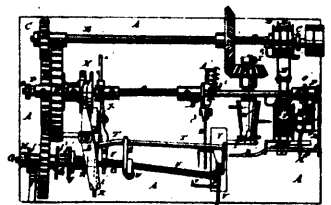

11418 Williamson's Improvements on Grain Binders.

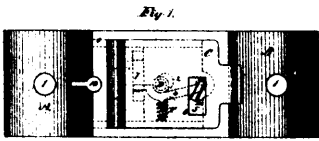

11419 Williston's Improvements on Car Locks.

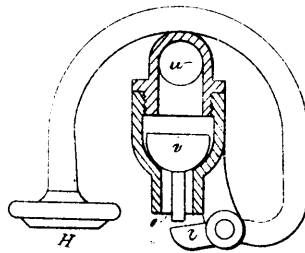

11420 White's Improvements in Valves.

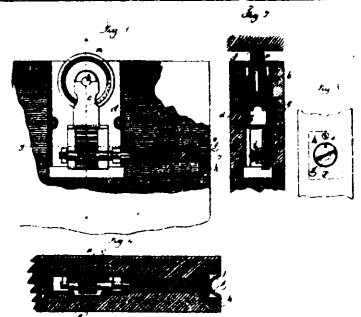

11421 Roberts's Improvements on Sliding Doors.

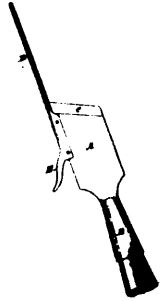

11422 Cogswell's Improvements on Pruning Implements.

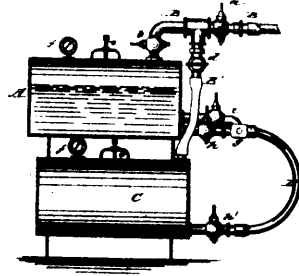

11423 Feroe's Process and Apparatus for Fining Fermented Liquors.

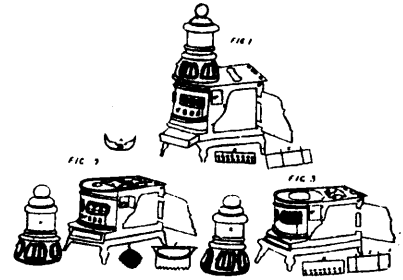

11424 Moses's Improvement on Stoves.

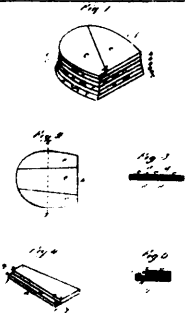

11425 Locke's Improvements on Boot and Shoe Heels.

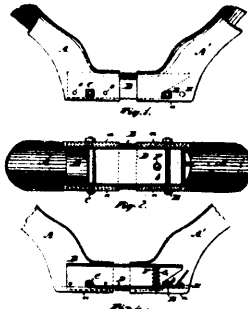

11426 Fisher & Watson's Improvements on Horse Collars.

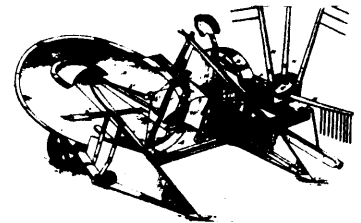

11427 Johnston's Improvements in Harvesting Machines.

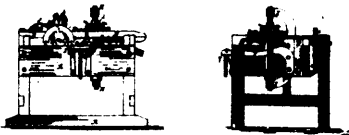

11428 Dobbias's Improvements in Hoop Machines.

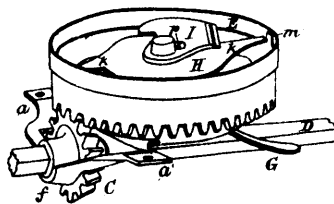

11431 Sheldon & Peacock's Improvements on Distributors for Fertilizers.

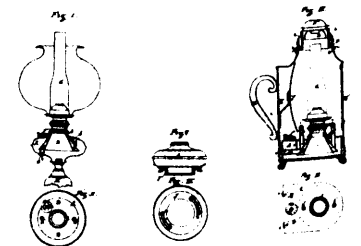

11432 Masow's Improvements on Lamps and Lanterns.

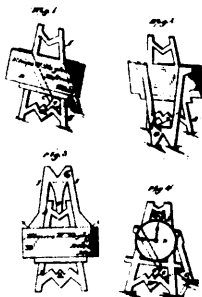

11433 Taylor's Improvements on Advertising Devices.

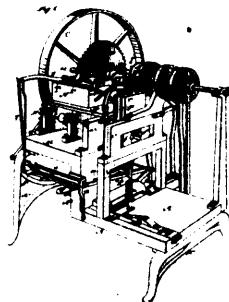

11434 Capewell's Machine for Reducing and Shaping Bars of Metal.

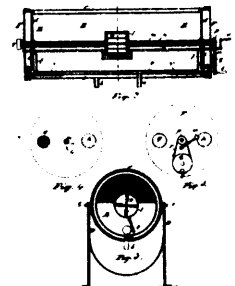

11435 Rowe's Improvements on Feather Renovators.

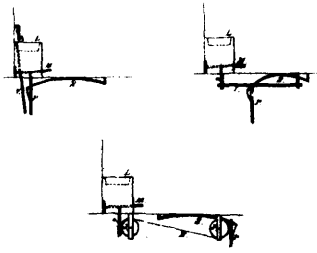

11436 McKenzie's Improvements on Pumps.



11437 Wilson's Improvements in Valves.

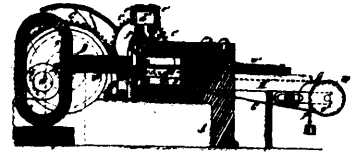

11438 Kieffer's Improvements in Heat Coverage Machines.

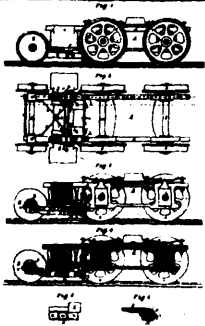

11439 Mason's Improvements in Locomotives.

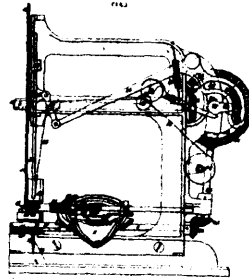

11440 Evans & King's Improvements on Grain Blowers.

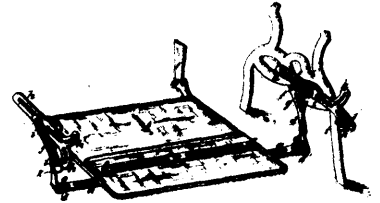

11441 Leib's Improvements on Sewing Machines.

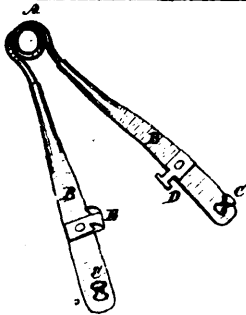

11442 Riddell & Board's Improvements on Glove Fasteners.

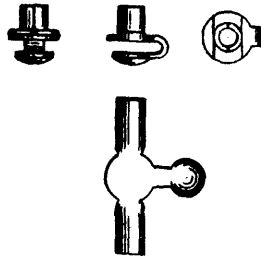

11443 Humphreys's Improvements on Boots and Shoes.



11444 Whitcomb & Butler's Improvements on Mining Machines.

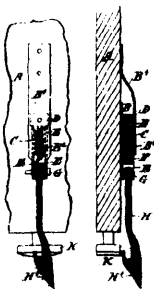

11445 Stearns's Improvements on Car-couplers.

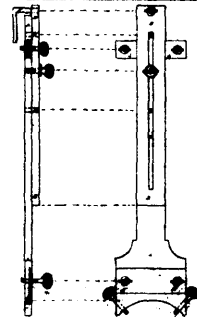

11447 Horner's Improvements on Gauges for Jointing and Filing Circular Saws.

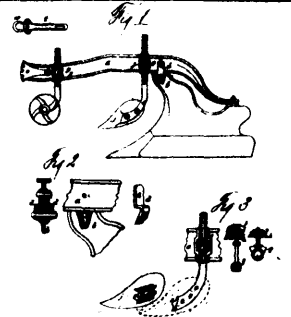

11448 Ward & Bullock's Improvements in Ploughs.

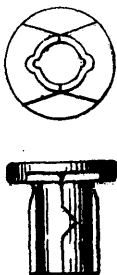

11449 Bray's Improvements on Tubular Rivets.

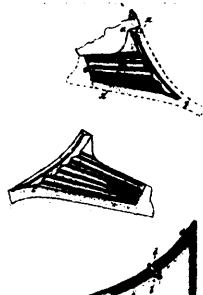

11450 Hall's Improvements on Plough Points.

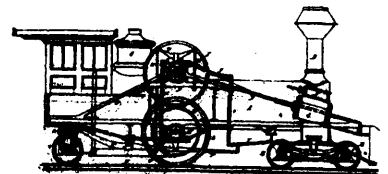

11451 Fontaine's Improvements on Locomotives.

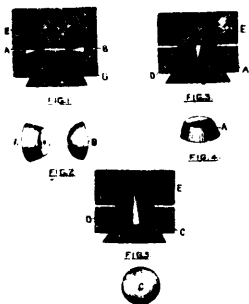

11452 Rogers's Improvements in Draw Plates.

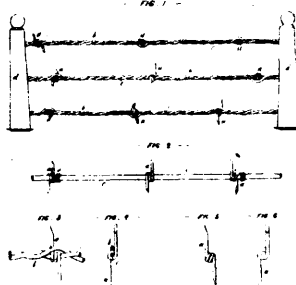

11459 Glidden's Wire Fence.

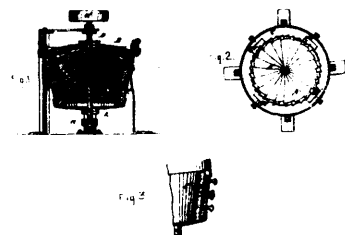

11456 Allen's Machine for the Manufacture of Paper Pulp from Wood.

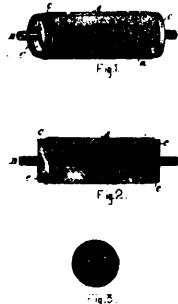

11457 Allen's Grinding Cylinders for Reducing Wood to Pulp.

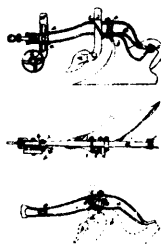

11458 Ward & Bullock's Improvements on Devices for the Construction of Ploughs.

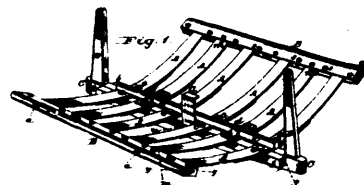

11459 Keith's Improvements on Vehicle Springs.

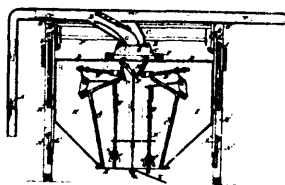

11461 Stoner's Improvements on Pneumatic Grain Elevators.

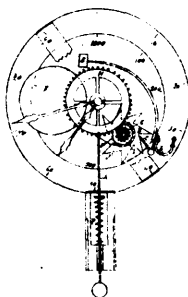

11462 Elliott's Improvements on Grain Scorers.

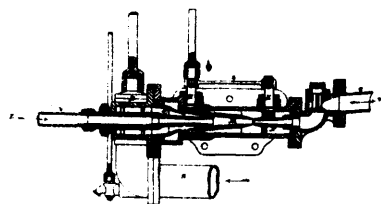

11463 Mazza's Improvements on Injectors Serving as Condensers.



11464 Lee's Improvements on Milk Cans.

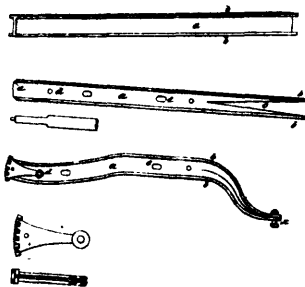

11465 Ward's Improvements on Plough Beams.

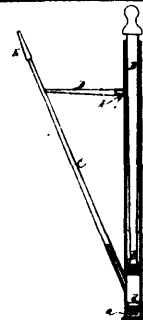

11466 Stouffer's Improvements on Pumps.

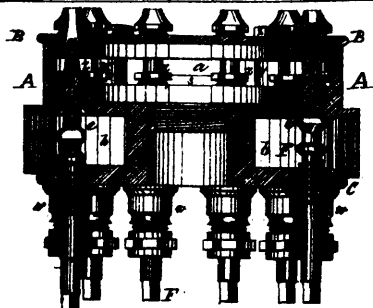

11467 Bradley's Improvements on Liquid Fuel Burners.

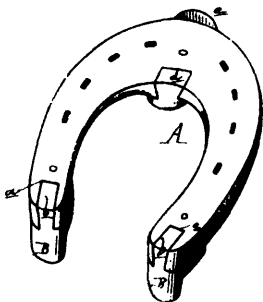

11468 Potvin's Improvements on Horseshoes.

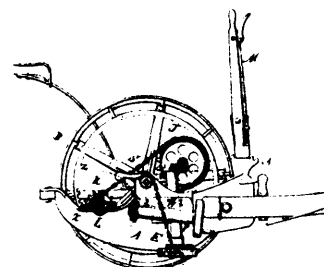

11469 Bradley's Improvements in Harvesters.

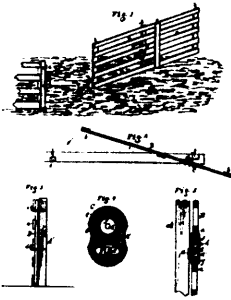

11472 Alexander's Improvements in Gates.

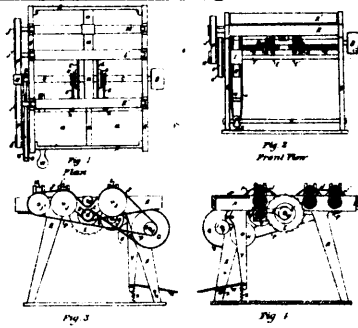

11473 Drake's Machine for Edging Shingles.

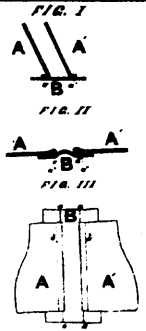

11474 De Warn's Improvements in Boots and Shoes.

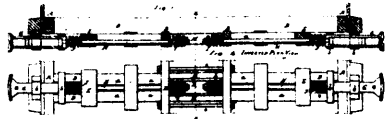

11475 Holt's Improvements on Draw-Ears for Railway Cars.

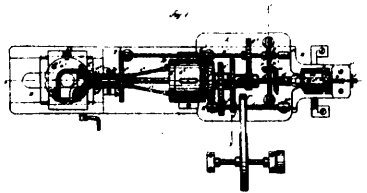

11476 Schuyler's Machine for Cutting Screw Threads on Pipes and Couplings.

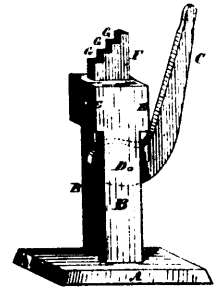

11477 Porteous's Improvements on Carriage-Jacks.

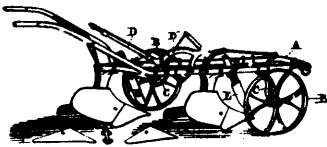

11478 Gowdy's Improvements on Gang Ploughs.

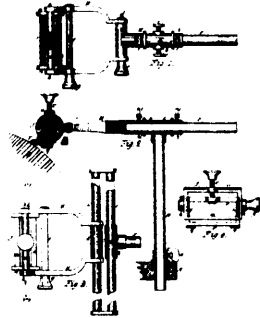

11479 Young's Improvement on Tool-Holders.

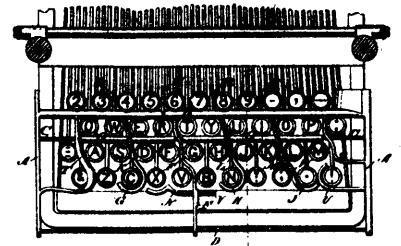

11480 DaCosta's Improvements on Finger Guides for Type Writers.

FIG. 2.

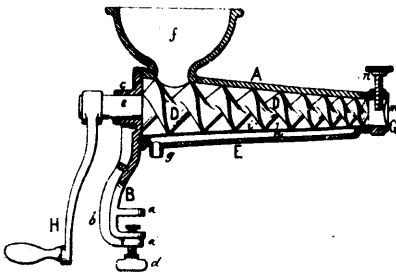

11481 Baker's Improvements on Tincture Presses.

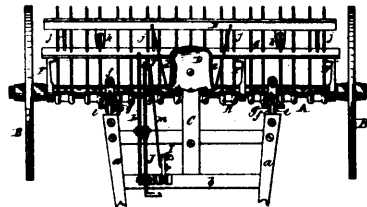

11482 Bushnell's Improvements on Horse Rakes.

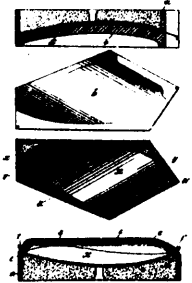

11483 Ward, Bullock & Hall's Apparatus for Cooling Plough Mould Boards.

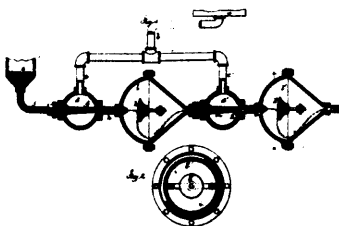

11484 Chichester's Method of, and Apparatus for Pulverizing Grain, Ores, &c.

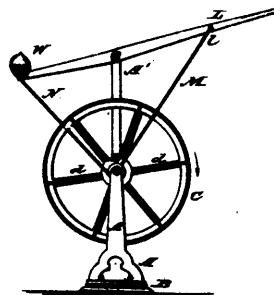

11486 Keiper's Improvements on Combined Lever Rotary Motion by Impact

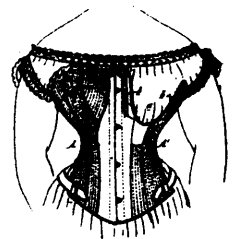

11487 Bortree's Improvements on Corsets.

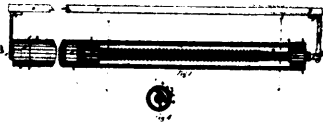

11488 Shaw's Improvements on Window Curtain Rollers.

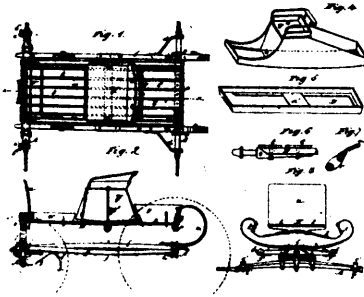

11492 Phillips's Improvements on Road Waggon.

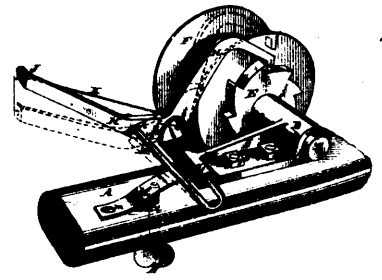

11495 Hubbard's Improvements in Grain Binders.

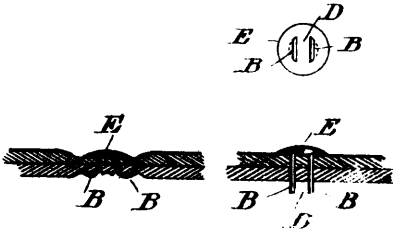

11496 Packard's Improvements on Rivets.

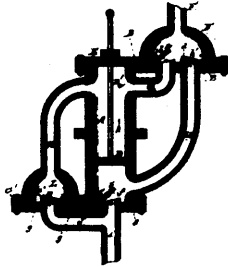

11497 Duellin's Improvements on Pumps.

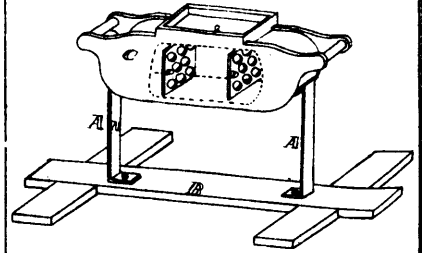

11498 Aldred's Improvements in Churns.

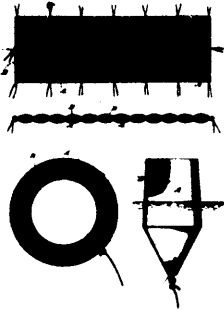

11501 Hill's Improvements on Life Preservers.

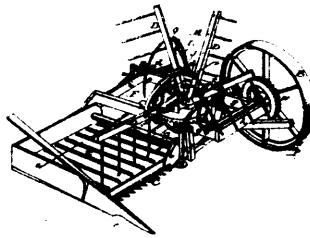

11502 Kirby's Improvements on Grain Binding Machines.

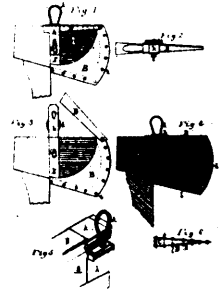

11503 Crosby's Improvements in Axe Cases.

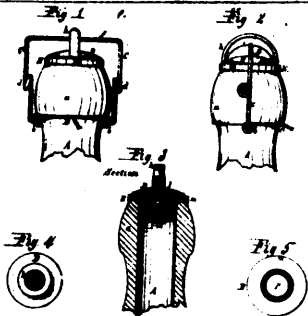

11504 Schafer's Improvements on Bottle Stoppers.

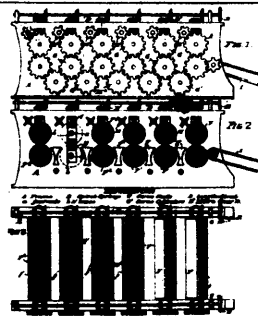

11505 Threlkell's Process of, and Machine for Separating and Cleaning Vegetable Fibre.

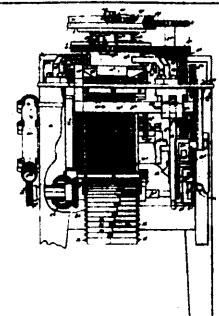

11506 Shaw's Improvements on Knitting Machines.



11507 Coughlin's Improvements in Fence Posts.

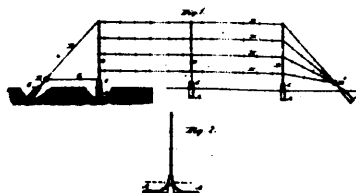

11508 Wright's Improvements on Wire Fences.

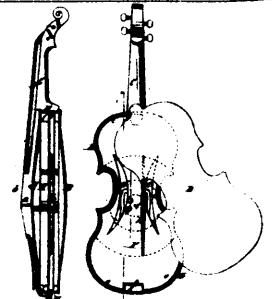

11509 Mollenhauer's Improvements on Violins and other Musical Instruments.