

# Canadian Railway and Marine World

November, 1914.

## Canadian Pacific Railway Locomotive Shops at North Bay.

The great increase in traffic on the Lake Superior division, C.P.R., so far outstripped the facilities for handling the equipment, that it became necessary to consider the enlargement of the divisional shops at North Bay, Ont. Work was commenced early in 1913, requiring about a year to complete. The project included, not only the extension of the shops, but also the mechanical yards, involving the reclamation of a small section of land along the shore of Lake Nipissing. The general layout of the extensions made is shown in the accompanying plan of the shops and mechanical yards. A complete description of the general scheme appeared in Canadian Railway and Marine World, Dec., 1913.

The motive power accommodation prior to this change consisted of a 23 stall locomotive house, with small machine and blacksmith shops attached to the west end, as shown in the accompanying yard plan. This combined building was of a heavy masonry

planking on cedar sills on a 12 in. cinder base. The locomotive doors along the west side are 12 ft. 7 ins. by 17 ft., formed top and sides of 12 in. 20½ lb. channels.

The machine shop, to the east or rear of the erecting shop, is of the same length, but 80 ft. wide and 23 ft. high, of a similar construction to the erecting shop, except that narrower bays are used, with steel I beams on steel columns at 26 ft. centres, forming three bays the length of the shop, with a similarly constructed wing along the face of the old machine shop. The floor is of 3 in. planking on cedar sills.

The track running from one of the locomotive shop stalls through into the old machine shop, is extended through the new machine shop and erecting shop as one of the central pit tracks, through which work can be handled back and forth between the shops and the locomotive house. Another track extends longitudinally through the central machine shop bay, connecting

sills, and the end walls of 2 in. planking and round cedar posts.

The locomotive shop is situated directly across from the southeast corner of the station building, a crossing over the station tracks leading directly to the locomotive shop transfer table, a concrete retaining wall at the north end of the transfer table providing for the change in elevation between the shop tracks and those on the main line, the latter some 3 or 4 ft. above the shop level.

The foreman's office, in the northeast corner of the shop near the main entrance door, is light and roomy, 20 by 25 ft., glassed in on the two shop sides, and is amply large enough for the general foreman and his complete staff. In addition to the usual desks and filing cabinets, there is a locomotive shopping schedule, somewhat similar to that in use at the company's Angus shop, but simpler to meet the more limited requirements of a small shop. It

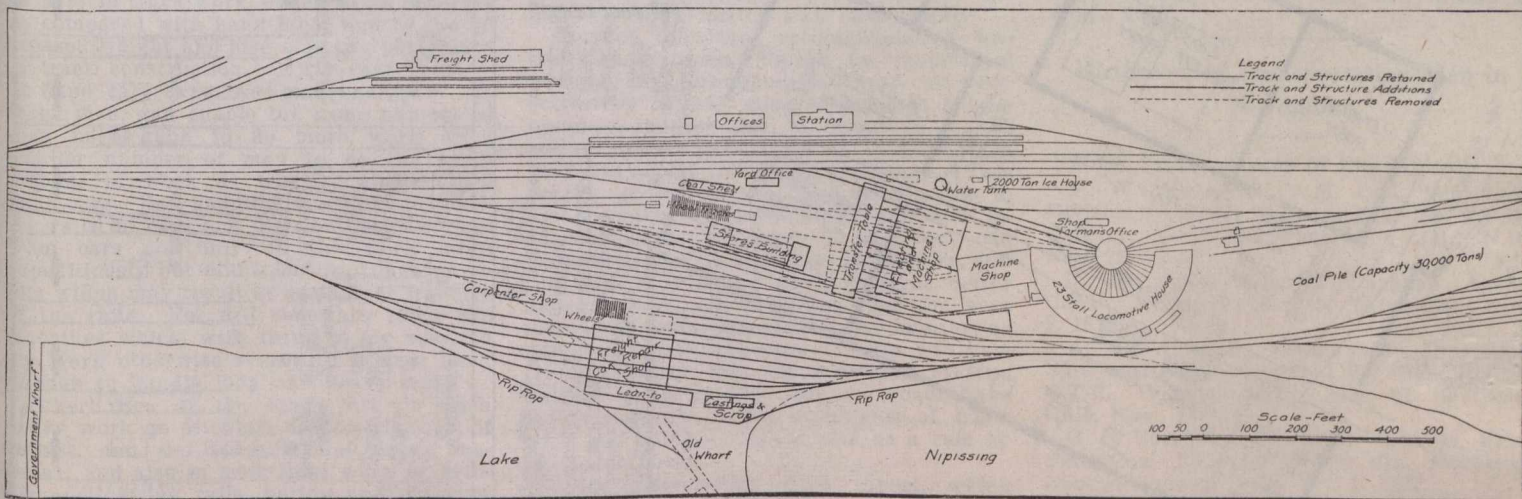

Plan of Shops and Mechanical Yards, Canadian Pacific Railway, North Bay, Ont.

construction, and has been retained in the new layout. To the west of this building, and adjoined thereto, there has been added a combined machine and erecting shop, served by a transfer table along the west frontage of the shop. The erecting shop is 70 by 208 ft., and 43 ft. high, of steel frame construction, resting on concrete foundations. The shop width is spanned by 70 ft. steel trusses, resting on 12 in. 40 lb. I beam columns at 20 ft. centres. It is served by a 5-ton travelling crane operating the full length of the shop, on runways composed of 15 in. I beams, with 56 lb. rails on top. The roof is of mill construction, with 8 by 14 in. purlins, at 8 ft. centres, carrying a 3 in. plank roof, surfaced with tar and gravel. The erecting shop bay contains 10 tracks, each with a convex bottom, concrete locomotive pit 4 ft. wide and 3 ft. deep, and one pit provided with an electrically operated lift for jacking up locomotives for wheeling. Over the main walls of each locomotive pit, the flooring is of heavy 6 in. planking, about 3 ft. wide, to provide a solid jacking surface under the sides of the locomotives. The balance of the erecting shop floor is laid with 3 in.

through a turntable with the locomotive house track, and at either end with outside tracks along the north and south sides of the building, through similar turntables. The two northerly erecting shop pit tracks are extended through to this longitudinal track, forming track space for handling the tender and truck repairs.

There is a 50 ft. transfer table along the full length of the west side of the building, taking in each of the outside end service tracks. Between the transfer table and the building, there is a 40 ft. space for locomotives awaiting entrance to the shop, and across the transfer table there is a similar storage space, abutting against an earthen wall, the shop level being slightly below that of the surrounding ground level. Shop entrance is thus through the two end service tracks, locomotives entering from either side of the yard through either of the run around tracks. A track paralleling the southerly run around track passes by the stores building, facilitating the handling of stores to the shops, over the transfer table. The transfer table runs on 4 tracks. The side walls of the transfer table pit are composed of 8 in. square timbers resting on

has only been introduced recently, but has been found very satisfactory in properly routing the locomotives through the shop, and scheduling each part of the work depending on the nature of the repairs, so that they should be completed by a given date. The time of shopping is thus closely checked.

The erecting shop occupies the whole of the westerly bay, and contains 10 tracks as mentioned, the depth of the erecting shop being 70 ft. Each track in the erecting shop contains a locomotive pit, 50 ft. long, with the northerly pit equipped with an electric wheeling jack. A special feature is the whitewashing of the pits,—bottom, sides and ends—once a week. They are built of concrete, and in consequence of the whitewash will take a good finish. The advantage in the white finish is twofold; not only does it facilitate the handling of repairs in the pit, by giving the workmen better lighting conditions, but it also enables the foreman to see at a glance just what work is progressing in the pit, and to note that the men are not "soldiering" on the job. It is remarkable what a difference in the pit lighting this simple expedient



makes, as it is possible to see every operation in the pit from any position in the shop, provided the view is unobstructed.

The machine tool layout has been planned with a view to ease in handling the parts from the erecting shop to the tools, and as a further analysis will show this idea has been well carried out, as all the departments where the members to be machined are heavy, are either near the erecting shop, or are adjacent to one of the shop tracks.

Back of the wheeling jack, is situated the general department, containing all the heavier tools. They consist of the following:

- 42 in. passenger car wheel lathe.
- 36 by 26 in. by 10 ft. planer.
- 80 in. driving wheel lathe.
- 51 in. boring mill.
- 10 ton driving wheel press.

These four tools are each separately motor driven. The planer and boring mill are served by a 15 ft. 1 ton jib crane, swinging over the central shop track, over which the work is forwarded to the machines. The passenger car wheel lathe, from the nature of its work, does not require a crane to the same degree, as its work can be

- 5 ft. radial drill.
- 16 in. slotter.
- Axle box press.
- Piston clamp.

This department also contains 3 work benches. It is located conveniently to the track from the erecting shop. Immediately to the north of this department is a battery of smaller tools for general work, consisting of the following:

- 36 in. gap lathe.
- Two 36 in. drills.
- 30 in. drill.
- 25 in. drill.
- Nut taper.
- 4 in. pipe threader.
- 2 spindle screw machine.
- Double emery wheel.

These tools are driven in a group, together with the last department, from a 20 h. p. motor. The motion department is

to the south of the locomotive house track, contains the following light equipment:

- Guide bar grinder.
- Drill grinder.
- 10 in. lathe.
- Grindstone.
- Brass turret lathe.
- Turret lathe.
- Landis grinder.

Adjoining this department, there is a small wedge and shoe planer, which belongs to the general group on the other side of the through service track. The car wheel department occupies the whole southeast corner of the shop, and contains the following equipment:

- Double car axle lathe.
- Car wheel borer.
- Car wheel press.

These three tools, in conjunction with

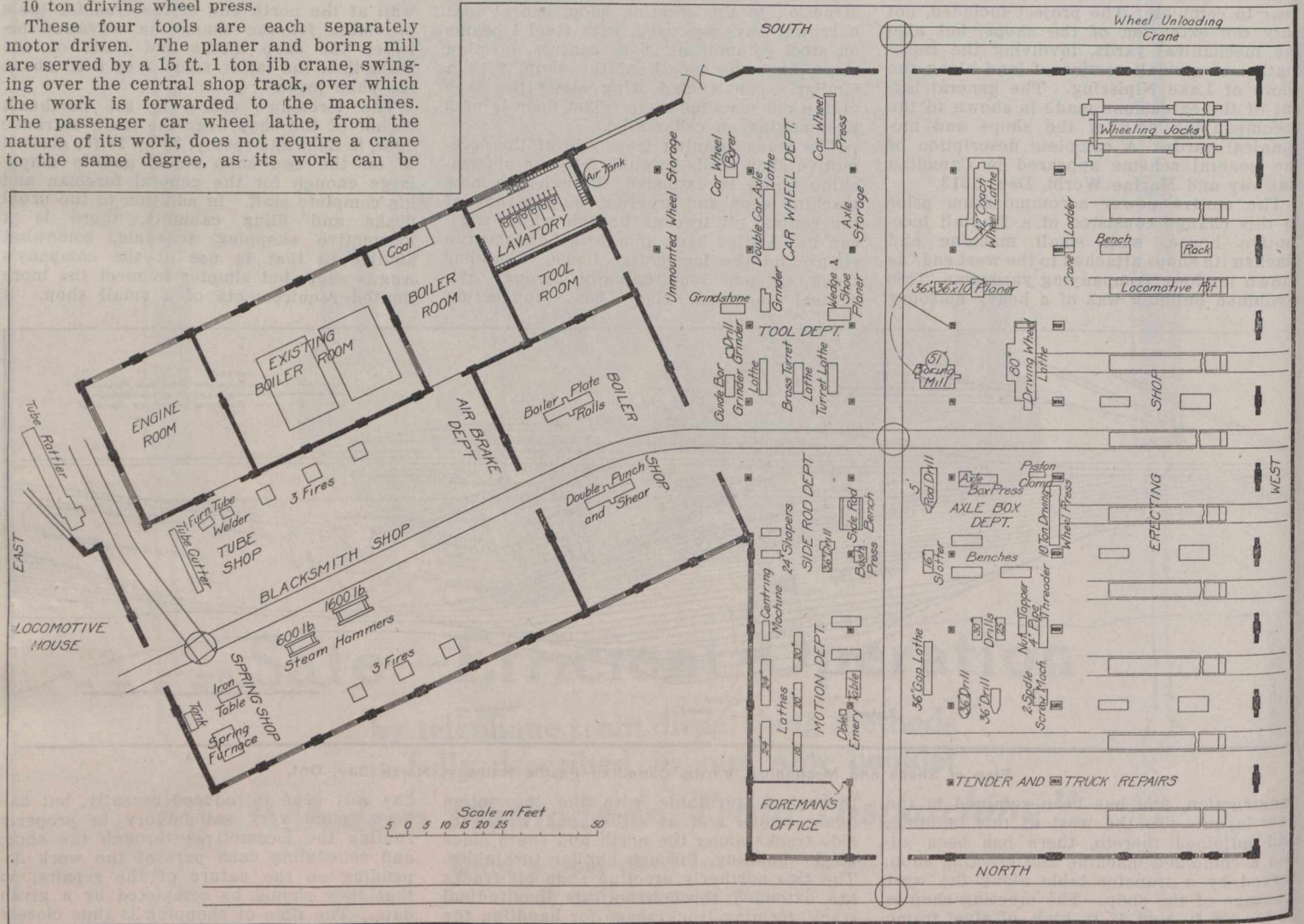

Plan of Locomotive Shop, with Machinery Location, Canadian Pacific Railway, North Bay, Ont.

rolled into the lathe. The space between it and the south wall is a small storage department for these wheels. The driving wheel lathe is directly opposite one of the erecting shop tracks, the track from which extends through to the lathe, over which the wheels are led into the lathe. From the wheeling jack in the end pit, the wheels are carried down the shop by the travelling crane to the lathe track. The driving wheel press is similarly situated to the driving wheel lathe, to the south of the locomotive house track, with the erecting shop track leading through to it. It is served the same as the driving wheel lathe.

The axle box and piston department is immediately to the north of the locomotive house track, and contains the following equipment:

directly south of the office, containing the following equipment:

- Two 24 in. lathes.
- Two 20 in. lathes.
- 18 in. lathe.
- Centring machine.
- Double emery wheel.
- Marking off table.

This work, being of a lighter nature than that on the other side of the shop, has not the handling facilities. Immediately adjoining this department to the south, is the side rod department, containing the following tools:

- Two 24 in. shapers.
- 36 in. drill.
- Bushing press.

There is in addition, a side rod bench. This department, in conjunction with the motion department, is operated as a group from a 20 h. p. motor. The tool department,

those of the tool department, are all driven in a group from a 30 h. p. motor. Wheels from the line are brought to the shop from outlying points on flat cars. Paralleling the run around track on the south side of the building, there is an adjoining track over which these cars of wheels are brought. Spanning these two tracks at the point indicated, is a light wooden hoist, which lifts the wheels from the car, and places them on the run around track, over which they are run into the shop. At the press they are dismembered, with the axles piled in the storage pile indicated, and the unmounted wheels along the east side as indicated, in piles at right angles to the wall. The completed wheels are run out over the same track to the transfer table, and stored on the southerly stub tracks on the op-



posite side of the transfer table, the policy adopted being that of storing sufficient wheels during the slack period to provide for the exigencies of the rush season.

The old machine shop has been rearranged so as to form enlarged blacksmith and boiler shops. The boiler shop contains a boiler plate roll and a double punch and shear, while the blacksmith shop contains, apart from the special departments, six fires and anvils, and a 600 and a 1,600 lb. steam hammer. The spring shop, a department of the blacksmith shop, contains a spring furnace, iron table and tank. The tube shop contains a tube furnace, tube welder, and a tube cutter, with a flue ratter just outside an adjacent door, served by a shop track that connects with the outside, over a small turntable.

The shops have been in operation about a year, long enough to develop normal con-

ditions of production. The normal monthly output is 8 locomotives a month, and it is expected that this will be still further bettered as improved methods are introduced from time to time. A number of time saving devices are in use, several of which have appeared from time to time in the Railway Mechanical Methods and Devices section of Canadian Railway and Marine World. In addition to the heavy locomotive repairs, running repairs are handled for the locomotive house. Conditions in such a shop are somewhat different from those in the usual back shop, as all the machine shop work for the car department is also handled, one section of the shop being entirely reserved, as explained, for car wheel work. The shop is in charge of A. H. Kendall, General Foreman, to whom we are indebted for the information on which this article is based.

## Roadmasters and Maintenance of Way Association Convention.

At the annual convention at Chicago recently, the attendance was large, and there was an exhibit of track materials, tools and appliances. Following are abstracts of the committees' reports:

**Power-Operated Track Tools and Appliances.**—This report, presented by J. W. Dahl, N. Y. Central Rd., opened with an explanation of the increasing use of machinery in track work, owing to its economy as compared with hand labor and to the increased weight and size of many parts used in track construction. Motor cars in place of hand cars save time and energy of the track men, and enable the same number of men in a gang to do more work or a smaller number of men to do the same amount of work as when equipped with hand cars. Rail handling machines for loading rails on cars and distributing new rails from cars not only do the work more expeditiously but eliminate the rough handling which may result in damage or fracture of the rails. For rail renewals, there are machines which, with three to six men, do the work otherwise requiring a large gang of men to handle long and heavy rails.

Other uses of machinery are in such heavy work as ditching, the distribution of ballast, and the spreading of filling material; and also in such light work as drilling and cutting rails, boring and dressing ties, driving screw spikes, tamping ballast, etc.

**Rail Renewals.**—This report was presented by A. M. Clough, N. Y. Central Rd., and was discussed at great length in regard to the various phases of the work. There was considerable discussion as to whether or not ties should be respaced when new rails are laid, and the general opinion was that this is not necessary, while eliminating the work greatly reduces the time consumed. Several railways now leave the ties alone, simply dressing them at the rail seat where necessary, and adjusting them to give proper support at the joints. The report submitted the organization for a rail renewal force, but some members were inclined to object to this, since no two roads would have the same conditions or use exactly the same force.

**Organization of Labor and Material for Track Maintenance.**—This report was presented by P. J. McAndrews, Chicago & Northwestern Ry. It showed the great amount of money expended under the direction of the track department (averaging \$10,000 a month per roadmaster), and advocated a system of organization in which the work of all the roadmasters of any one division would be under the supervision of

some official who would direct the work of the division as a whole. This would avoid the trouble and expense due to operating separate work trains, rail-renewal gangs, extra gangs, etc., on each roadmaster's district. The report recommended the maximum length of line for the roadmasters or supervisors as follows: 50 miles of double track, 100 miles of single track with heavy traffic or 125 miles in easy country with light traffic.

Another important recommendation was that track forces should be maintained permanently, throughout the year. At present, every railway cuts its force to a minimum in winter and increases it in the spring, when the supply of efficient men does not equal the sudden demand. This results in loss of time and money due to the continual employment of new and inexperienced men. Much of the work can be done as well in winter as in summer, and the work as a whole would be done better and at lower cost if spread over the year instead of concentrated in a few months, as under the present system. There was general agreement with the suggested system, but it did not appear that any roads have yet introduced it, the economies of track labor not being comprehended as a rule by railway officers.

**Track Accessories.**—This report, which was presented by M. Donahoe, Chicago & Alton Rd., dealt with a variety of matters, and the first of these were discussed in such detail that the remainder of the report was accepted as information, without discussion. In regard to rail joints, the committee recommended 24-in. angle bars, with four bolts, supplemented by a base or bridge plate where traffic is heavy. For frog guard-rails an 8-ft. length was recommended, but this was struck out, as there was a general opinion that longer rails are preferable, and that it is not desirable to specify the length.

There was considerable discussion as to whether bolts or clamps are the better for securing the guard rail to the track rail, and as to the use of tie-plates and rail braces at guard rails. Cast manganese guard rails were mentioned, but the members present had little experience with these. Other matters covered by the report were switches, frogs, switchstands, tie-plates, rail anchors or anti-creepers, screw spikes and drive spikes, track bolts of nickel-chrome steel, and the narrow-head "frictionless" rail for curves.

As to this last, only one member had experience, and he spoke of tests showing that with a train on a heavy grade the speed increased on curves having this rail

on the inside, while it decreased on curves laid with ordinary rails. Some members spoke of getting the same result by shifting worn rails from the outer to the inner side of the curve, but it was pointed out that in such cases the weight of the wheel comes on the overhanging side of the rail head and not directly over the web, as in the special narrow-head rail. Consequently this shifting of worn rails or curves was hardly desirable for track with heavy traffic and high speeds.

**Clearing and Policing Right-of-Way.**—This report was read by J. P. Corcoran, Chicago & Alton Rd. It dealt with such work as the cutting of weeds and grass, removing old rails and ties, the handling of scrap, maintenance of ditches and fences, and the clearing of yards and station grounds. Trackwalking and bridge inspection were included also. The report recommended the old practice of requiring the trackwalker to do all kinds of miscellaneous work during his trip, but this was objected to in the discussion. It is better for him to be simply an inspector, doing only such work as is essential to the safety of the track. The miscellaneous work of driving loose spikes, repairing fences, etc., can be done to better advantage in periodical trips of the entire section gang.

**Officers for 1914-15** were elected as follows: President, P. J. McAndrews, C. & N.W. Ry., Belle Plaine, Ia.; Secretary, L. C. Ryan, C. & N. W. Ry., Sterling, Ill. The next meeting will be held at Chicago in Sept., 1915.

## Birthdays of Transportation Men in November.

Many happy returns of the day to—

F. W. Alexander, A.M. Can. Soc. C.E., Division Engineer, Alberta Division, C.P.R., Calgary, born at Fredericton Jct., N.B., Nov. 22, 1878.

J. O. Apps, General Baggage Agent, C.P.R., Montreal, born at Tara, Ont., Nov. 9, 1877.

A. B. Atwater, Assistant to President, lines west of Detroit and St. Clair Rivers, G.T.R., Detroit, Mich., born at Sheffield, Ohio, Nov., 1845.

G. B. Burchell, ex-General Manager, Maritime Coal Ry. and Power Co., Montreal, born at Sydney, N.S., Nov. 1, 1877.

J. R. Cameron, Assistant General Manager, Canadian Northern Ry., Winnipeg, born at Truro, N.S., Nov. 5, 1865.

L. D. Chetham, City Passenger Agent, C.P.R., and District Passenger Agent, Esquimalt and Nanaimo Ry., Victoria, born at Matlock, Eng., Nov. 5, 1869.

F. H. Clendinning, Division Freight Agent, B.C. Coast Service and Ocean Steamship Lines, C.P.R., Vancouver, B.C., born at Montreal, Nov. 9, 1881.

F. Conway, City Freight and Passenger Agent, C.P.R., Kingston, Ont., born at Ernestown, Ont., Nov. 19, 1850.

A. S. Cook, Inspecting Engineer, National Transcontinental Ry., Ottawa, born at Penobscus, N.B., Nov. 20, 1873.

W. L. Crighton, Advertising Agent, Canadian Government Railways, Moncton, N.B., born at Derby, Eng., Nov. 9, 1871.

W. B. Cronk, ex-General Superintendent, National Transcontinental Ry., now of Toronto, born at Footville, Wis., Nov. 11, 1862.

A. C. Douglas, Purchasing Agent, British Columbia Division, C.P.R., Vancouver, born at Montreal, Nov. 10, 1881.

W. Downie, ex-General Superintendent, Atlantic Division, C.P.R., born at Rock Currie, Ireland, Nov. 12, 1850.

Jos. Dubrule, jr., Manager, Canadian Paci-



fic Car and Passenger Transfer Co., and President, Prescott and Ogdensburg Ferry Co., Ltd., Prescott, Ont., born at Spencer-ville, Ont., Nov. 14, 1872.

R. L. Fairbairn, General Passenger Agent, Canadian Northern Ry., Toronto, born at Stillwater, Minn., Nov. 24, 1880.

P. J. Flynn, Terminals Manager, Winnipeg Joint Terminals, C.N.R., G.T. Pacific Ry. and National Transcontinental Ry., born at Fishers, N.Y., Nov. 22, 1872.

Grant Hall, General Manager, Western Lines, C.P.R., Winnipeg, born at Montreal, Nov. 27, 1863.

John L. Hodgson, Master Car Builder, G.T. Pacific Ry., Transcona, Man., born at Simcoe, Ont., Nov. 15, 1858.

W. M. Hood, Travelling Passenger Agent, Canadian Northern Ry., and Canadian Northern Steamships, Ltd., Toronto, born at Harrow, Ont., Nov. 25, 1872.

N. B. Jones, Car Foreman, C.P.R., Kenora, Ont., born at St. John, N.B., Nov. 9, 1869.

W. E. Ladley, Superintendent of Motive Power, Reid Newfoundland Co., St. John's, Nfld., born at Leeds, Eng., Nov., 1875.

C. E. Legg, Trainmaster, Winnipeg Terminals, C.P.R., born in Illinois, Nov. 15, 1864.

J. McGillivray, General Manager, Inverness Ry. and Coal Co., Iverness, N.S., born at Nairn, Scotland, Nov. 13, 1867.

J. McMillan, General Superintendent of Telegraphs, Western Lines, C.P.R., Winnipeg, born at Liverpool, Eng., Nov. 2, 1866.

A. S. Munro, Commercial Agent, G.T.R., London, Ont., born at Hamilton, Ont., Nov. 10, 1880.

C. Murphy, General Superintendent, Manitoba Division, C.P.R., Winnipeg, born at Prescott, Ont., Nov. 20, 1865.

A. C. O'Neil, Travelling Freight Agent, G.T.R., London, Ont., born at Point Edward, Ont., Nov. 30, 1866.

W. J. Quinlan, District Passenger Agent, Grand Trunk Pacific Ry., Winnipeg, born at Montreal, Nov. 21, 1883.

F. E. Rutland, Agent, C.P.R. Stockyards, Winnipeg, born in Essex, England, Nov. 17, 1868.

H. P. Sharpe, General Agent, Dominion Express Co., Toronto, born at Brockville, Ont., Nov., 24, 1864.

G. H. Shaw, General Traffic Manager, Canadian Northern Ry., Toronto, born at Smiths Falls, Ont., Nov. 25, 1859.

F. M. Spaidal, General Superintendent, Quebec Grand Division, Canadian Northern Ry., Montreal, born at Gananoque, Ont., Nov. 13, 1858.

J. Sparks, Assistant General Baggage Agent, Western Lines, C.P.R., Winnipeg, born in London, Eng., Nov. 25, 1874.

J. G. Sutherland, Car Service Agent, Alberta Division, C.P.R., Calgary, born at Aulac, N.B., Nov. 24, 1882.

H. P. Timmerman, Industrial Commissioner, Eastern Lines, C.P.R., Montreal, born at Odessa, Ont., Nov. 6, 1856.

H. E. Whittenberger, General Superintendent, Ontario Lines, G.T.R., Toronto, born at Peru, Ind., Nov. 9, 1869.

C. G. Washbon, Trainmaster, C.P.R., Brandon, Man., born at Morris, N.Y., Nov. 27, 1887.

The 24 hour system of time, which has been used on the Western Lines, C.P.R., and on the Intercolonial Ry., for some years and was adopted by the French railways in 1912, is now said to have been adopted in Belgium, Italy and Uruguay.

An order to test all air compressors and other air brake equipment on passenger and freight locomotives before they leave the locomotive house, on one road, has cut the number of air pump failures in half in one year.

## Extensive Improvements on the Dominion Atlantic Railway.

The Dominion Atlantic Ry.'s main line extends from Yarmouth to Windsor, N.S., 170 miles, and it operates through to Halifax, having a lease of the Intercolonial Ry.'s Windsor Branch from Windsor to Windsor Jct., 31 miles; and from Windsor Jct. to Halifax, 14 miles, it has trackage rights over the I.R.C.'s main line. Its Cornwallis Valley Branch extends from Kentville to Kingsport, 14 miles, and its Midland Division from Windsor to Truro, 58 miles. In 1911 the D. A. R. was leased to the C. P. R. for 999 years. Since then a very large amount of work has been done to improve its physical condition and bring it up to C. P. R. standards. A large number of bridges and structures have been replaced, etc., as follows:

Bear River bridge, 1,530 ft. long, has been replaced with an entirely new structure. The substructure consists of 14 piers and 2 abutments, and the superstructure of four 156 ft. truss spans, six 100 ft. d.p.g.'s, one 85 ft. d.p.g., one 50 ft. d.p.g. and one 144 ft. swing span.

At Clementsport the wooden bridge has been replaced with a steel bridge 930 ft. long. It was necessary to build up on top of the existing piers with concrete, to build one new concrete pier and two concrete abutments. The bridge now consists of 8 piers and two abutments. The superstructure consists of three 148 ft. d.t. spans, one 65 ft. d.p.g., three 74 ft. d.p.g.'s, and one 156 ft. swing span.

At Bridgetown the existing light span has been replaced with a standard 150 ft. through span.

At Gaspereau the present bridge is being replaced by a new one 460 ft. long. The substructure consists of three piers and two abutments, and the superstructure of two 170 ft. through spans and two 83 ft. h.t.g.'s.

At Windsor the present light bridge is being replaced by a new structure 1,080 ft. long. The substructure consists of 9 piers and 2 abutments, all of concrete. The superstructure consists of four 150 ft. t.t. spans and six 85 ft. h.d.p.g.'s. This bridge is not entirely completed, three piers remaining to be finished. The steel is being erected.

At Shubenacadie the small lift span has been replaced with a 130 ft. d.p.s. span. It was necessary to build 1 new pier and 1 new concrete abutment.

At Big Joggins the wooden trestle and wooden swing span have been replaced by a 120 ft. d.s. span; filled 785 ft. of the trestle approaches, renewing entirely the remaining 180 ft. of trestling.

At Little Joggins the wooden bridge has been replaced by a 40 ft. d.p.g., and 545 ft. of the bridge has been filled.

At Allen's Creek the wooden bridge, 325 ft. long exclusive of the wooden approaches, has been replaced by a new bridge. The substructure consists of 2 piers and two abutments, all of concrete, and the superstructure of one 150 ft. t.t. span and two 85 ft. t.p.g.'s, with standard trestle approaches at both ends.

At Weymouth the wooden bridge, 1,280 ft. long, is being replaced by a steel bridge. The substructure will consist of 13 piers and 2 abutments, all of concrete. The superstructure will consist of three 156 ft. deck trusses, two 100 ft. lattice girders, two 85 ft. d.p.g.'s, one 136 ft. p.g.d.s., and the remainder will be 50 ft. d.p.g.'s. The substructure of this bridge is nearly completed and the superstructure will be placed during the winter.

At Cambridge bridge and Jordantown sub-way two 30 ft. girders have been placed.

The old Hantsport aboiteau is to be replaced with a new structure.

In addition to replacing these large wooden bridges by steel ones a number of trestles have been replaced by concrete arches and fills, and a number of the smaller wooden bridges by concrete rail top culverts. Numerous wooden culverts have also been replaced by concrete pipe, small arches and cast iron pipe. One 10 ft. concrete arch, six 8 ft. concrete arches, six 6 ft. concrete arches, and four 4 ft. concrete arches have been built. Seven 36 in. concrete pipe culverts, ten 30 in. concrete pipe culverts, seven 24 in. concrete pipe culverts, 24 cast iron pipe culverts, four 14 ft. rail top culverts, one triple 10 ft. rail top, one double 10 ft. rail top, one single 10 ft. rail top culvert, two 8 ft. rail top concrete culverts, and eight 6 ft. rail top concrete culverts have been put in, and concrete rail tops have been placed on eight culverts that previously had wooden decks and stone abutments.

In round figures, 6,000 lin. ft. of wooden bridges have been replaced or will be replaced very shortly by steel bridges, concrete arches and fills and rail top culverts. The quantity of material required in making these fills amounts to over 425,000 cu. yds.

About 45 miles of track have been rebalanced, 30 miles of new 85 lb. rails have been laid and 120 pit cattle guards have been filled and replaced by surface guards.

The water tank at McDonald's, on the Midland Branch, is being replaced by a 10 in. C.P.R. standard stand pipe, and an earth dam some 25 ft. high at the deepest, and 100 ft. long, is being built to form a storage reservoir. At South Maitland, also on the Midland Division, a 10 in. C.P.R. standard stand pipe is being installed, and the pipe line is being carried to a lake about a quarter of a mile from the track and 140 ft. in elevation above it; 25,000 or 40,000 gallon water tanks have been built at Windsor, Middleton, and Hectanooga, all on the main line. 100-ton track scales have been installed at Yarmouth and Annapolis Royal, built in the most substantial manner with concrete scale pits.

New brick stations have been built at Wolfville, and Annapolis Royal, and new stations at Mosherville, Patterson's and Imbertville. During the past two years 35 stations have been repaired and painted, and platforms have been repaired.

A new wharf has been built at Yarmouth, with a new trestle approach from the main line, to enable the trains to be more conveniently located on the wharf for taking and putting off passengers for the Boston steamboats, and a new and larger freight shed has also been built on this wharf.

A new line, the North Mountain Branch, is being built from Centreville to Weston, 14 miles, in the most substantial manner, all the culverts being concrete arches, concrete pipes or cast iron pipes, and the stations are to be set on concrete or masonry foundations. It is expected that this line will be completed and open for service by Jan. 1.

The above, with the exception of the station repairs, has reference only to the permanent work done. In addition the majority of the existing trestles have been greatly repaired and strengthened to bring them up to standard. Many of them have been entirely renewed.

With fuel oil, it is claimed that it is possible to greatly increase the capacity of a boiler without a marked decrease in the boiler efficiency.



# Railway Mechanical Methods and Devices.

## Air Valve Piston Ring Centring Device in Timiskaming and Northern Ontario Railway Shops.

Piston rings for the air valves of locomotive air compressors are made slightly eccentric, and cut on the thin side to give the requisite spring to cause them to form a good tight joint. The piston rings are made from a long ring, from which a large number may be cut. The outside of the stock sleeve is turned to a diameter larger than that finally required, and then the sleeve is offset the required amount, and the inside bored to a correspondingly larger diameter than that of the final inside diameter of the piston ring. The stock sleeve is then cut to form rings of the necessary thickness. These rings are slotted at an angle of 45 degrees to form the spring allowance, and sprung altogether at that point.

In springing the rings together the varying radial thickness of the rings causes them to assume a final shape when compressed that is not a true circle, so that it is essential to take a light final cut over the outer face, so that they will form a true fit inside the cylinder. The object of the device illustrated herewith is to chuck the work so that this final truing may be quickly accomplished. The device consists of a main body, with a shank at one end for chucking in the lathe, and a threaded shank at the other end, over which a washer for clamping is slipped, and secured in position by a  $\frac{3}{8}$  in. nut. Over the main body of the device there is a collar, fitting closely, the inner bore of which at the clamp washer end is tapered.

same tendency to leak as an ordinary ring that has not been re-turned will have.

## Grease Press for Driving Box Cellars on Canadian Northern Railway.

The C.N.R. mechanical department has developed a standard design of grease press for forming grease cakes to be used in driving box cellars. Nearly every railway shop has a grease press of some kind or other, so their object and use is familiar to all, and it will only be necessary to deal with the construction of the machine.

The press consists essentially of two cylinders, hinged to each other in such a manner that one has a handle, in order that it may be

withdrawn. The front end of the grease cylinder has a cast iron cap screwed on, across the face of which there is a recessed space into which the die head slides. There is an opening in the die head, slightly larger than the largest size of grease form that will be pressed. The die is also of cast iron, fitting in the head as explained, and on the forward face of the die there is a formed copper piece 3-16 in. thick of the same cross section as the pressed grease, guiding grease after it passes through the die. The piston in the grease cylinder is  $\frac{1}{8}$  in. less in diameter than the bore.

A feature of this device is the convenient manner of refilling the grease cylinder after the contents have been pressed out. By re-

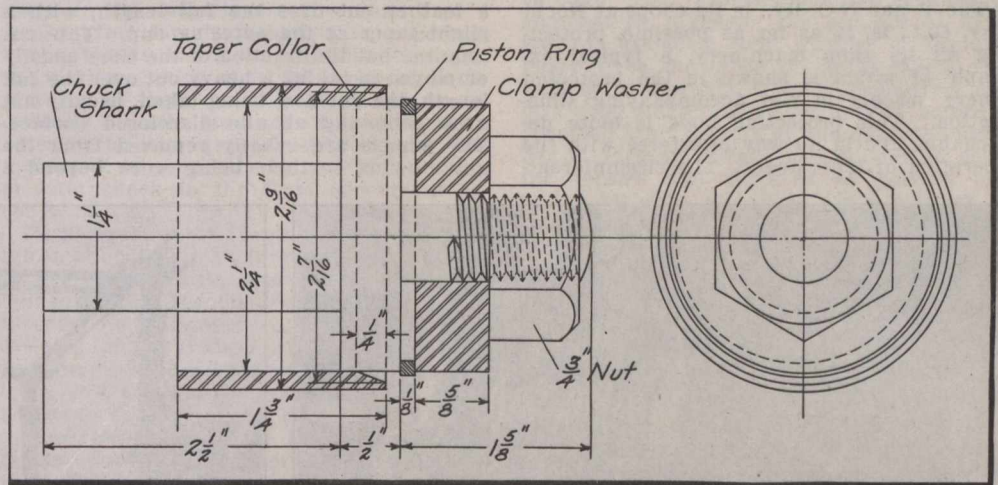

Air Valve Piston Ring Centring Device.

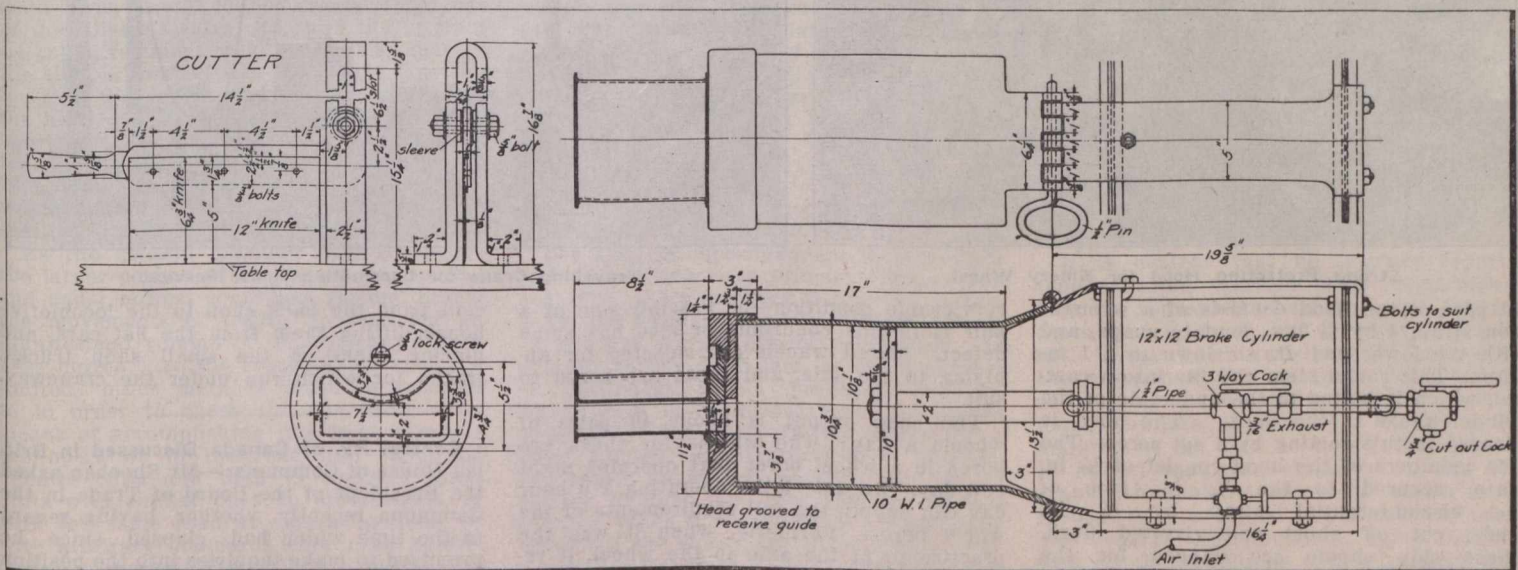

Grease Press for Driving Box Cellars, showing also the Cutter for Sectioning the Formed Grease Strip.

The operation is simple. The ring to be finished is placed between the main body and the clamp washer, which is loosely fitted up to the ring. Over the body the taper collar is slipped, and forced over the piston ring, compressing the latter, and at the same time centring it with regard to its outside diameter. When compressed to the limit the clamping nut is tightened, and the taper collar slipped off from the main body, which is then chucked in the lathe by the chuck shank, and the outside of the ring trimmed down to a true circle.

This tool is devised by E. McGahey, machinist in the shops, who states that particularly rapid work may be accomplished with it, producing a ring that has not the

manner that the grease may be easily placed in the machine. The main portion of the machine, that is the power end, consists of an old 12 by 12 in. air brake cylinder, which may be mounted on a convenient stand or table, with a  $\frac{3}{8}$  in. plate bolted top and bottom, the forward end of each of these forming a hinge connection, engaging with which are similar hinges from the rear end of the grease cylinder.

The grease cylinder is a length of 10 in. wrought iron pipe, the rear end of which is cut out on the sides, leaving flattened sections, one on top and the other below, which form the hinge section, mating with the hinges of the power cylinder. The lower hinge pin is rivetted in place, but the upper

moving the upper hinge pin, the cylinder may be dropped into a vertical position, first of all drawing the piston back into its rear position. In that position, the cylinder is filled, and lifted into the normal position when it is ready for service. To operate, air is admitted to the rear of the power cylinder piston by the arrangement of piping on it, the cylinder forcing the grease piston into the grease cylinder, this forcing the grease through the die and guiding sleeve to a supporting board, which is placed in front. Three grease cakes for a 10 by 12 in. driving box can be made with one filling of the cylinder.

A special knife devised for cutting the long die formed piece of grease, is shown



in the same illustration. It consists of a U frame supported on a table, the arms of the U being slotted to allow of vertical adjustment of a bell crank arm, the long arm of which forms the handle. A knife blade is fastened to this long arm, the cutter acting like a guillotine.

### Machinery Guard in Timiskaming and Northern Ontario Railway Shops.

In view of the widespread safety first movement, it is interesting to note the different manner in which the railways are helping the movement along. While accomplishing the same results, each railway has a different method of going about its task, and in fact a wide range of ideas along these lines will be found in shops on the same railway.

The T. and N.O. Ry., in its shops at North Bay, Ont., is, in as far as possible, protecting all its shop machinery, a typical example of which is shown in the protected emery wheels in the accompanying illustration. This protecting hood is quite detachable, and in no way interferes with the operation of the wheels. The circumferential

### Handling Wheels in Canadian Pacific Railway Shops at North Bay.

Instead of the usual practice of fitting axles to the bored wheel, at the C.P.R. shops at North Bay, Ont., the wheels are fitted to the axles, and it is claimed thereby that a considerable saving both in time and material is obtained. Observations made on axles that have had the wheels pressed off, showed that over 50% of them required no turning at all, and were in such shape as to be capable of pressing on again, without further machine work.

It is the practice in these shops, when the wheels have been pressed off in the usual manner, to put each axle in the lathe between centres, and try the wheel fit for accuracy. While generally not requiring much truing, it is usually advisable to take a feather cut over the full length, with a slight taper at the entering end. This cut requires but the fraction of the time usually employed in taking a heavy cut over the full length, the cut now being taken, usually not even removing all the discolored surface. The wheels are usually removed from the axles owing to their being worn beyond a

### Yard Crane at Grand Trunk Railway Locomotive House, Allandale.

Adjoining the scrap bins of the G.T.R. locomotive house, at Allandale, Ont., there has been erected a small travelling crane, as shown herewith, for handling the various heavier parts that must be cared for at a divisional point. The crane runway consists of four old cast iron columns, removed from the company's old shops at Stratford, Ont., two on each side of the runway, each pair of which is spanned by a trussed rail, which forms the crane track. The crane consists of a pair of trussed rails, suitably mounted at the ends to small carriages, which run on the runway. A small crane carriage, operating on the crane rails, carries an air plunger hoist.

The primary object which led to the installation of the crane, was the demand for some means of lifting tender tanks from off the tender trucks for repairs. For this service it has proved quite valuable. An additional service to which it is put, is the handling of the scrap material from the small shop trucks to the scrap bins on the left. It is also of use in handling castings

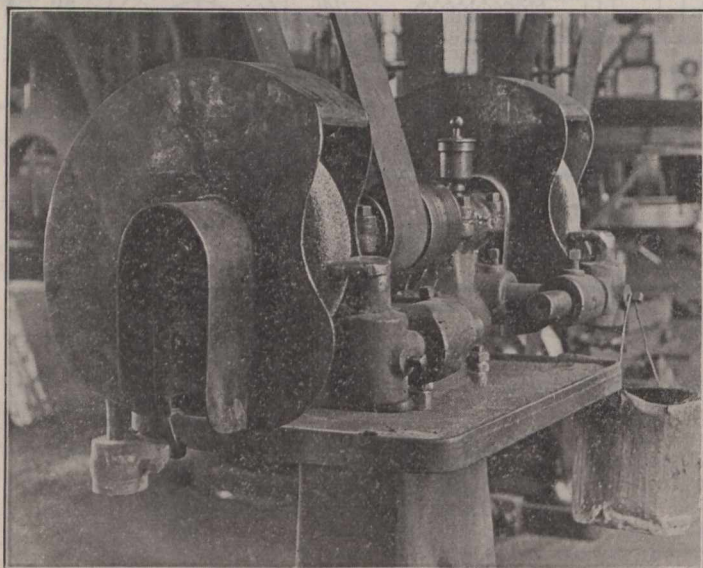

Strong Protecting Hood for Emery Wheel.

part of the hood consists of a wrought iron strap, 4 by  $\frac{3}{4}$  ins., bent to shape, and with the lower end drawn down to a 1 in. diam. This round stem end fits into a casting, which is bolted to the underside of the grinder table at the back. The hood is secured in this casting by a set screw. The side members of the hood consist of  $\frac{1}{2}$  in. plate, secured to the  $\frac{3}{4}$  in. face of the circumferential strap by  $\frac{1}{4}$  in. studs, cut off short and rivetted flush. These side sheets are flanged for the shaft openings, and a similar piece of  $\frac{1}{2}$  in. sheeting, rivetted to the flange mentioned, forms a complete protection from the shaft. The wheel is thus completely protected, the greater strength of the hood being in the periphery, where it is required.

Another good instance of machinery protection is shown in the protection given to the gearing on a large locomotive lathe. The whole outer face of the gearing is covered by a large sheet, with an edging conforming to the contour of the gear arrangement. The whole guard is hinged to the floor, so as to fall away from the lathe when swung, a hinged rod in the centre of the side sheet forming a support to prevent the hood from dropping to the ground. These guards have been applied by E. McGahey, a machinist in the shop.

serviceable condition—or possibly one of a pair is in this condition, or else has some defect. Mated wheels are selected for applying to the axle, and these are bored to suit.

The shop output is about 40 pairs of wheels a day. The wheels for these are bored in a wheel borer that operates night and day. An axle lathe operating a 9 hour day can supply the full requirements of the wheel borer. Formerly, when it was the practice to fit the axle to the wheel, it required both a wheel borer and axle lathe operating night and day to give an even smaller output. This means a direct saving of a machine and operator at night, in addition to an increased output. As it is usually the failure of the wheel and not of the axle that necessitates the shopping, there is an added advantage in conserving the size of the axle, making it possible to pass through a greater number of shoppings, all the machining coming on the wheels.

A number of United States railways, having offices in Toronto, have appealed against the city assessing them for business purposes, and their representatives for income, claiming that they do not do business in Canada within the meaning of the act.

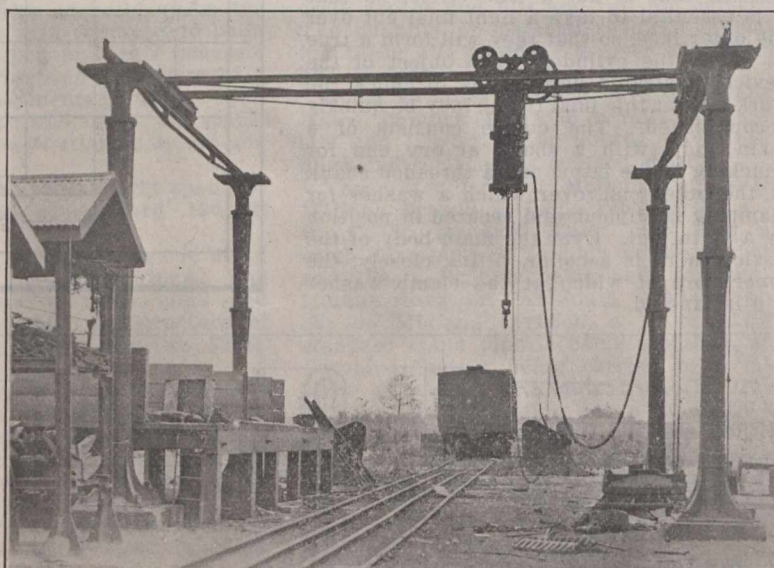

Travelling Crane for Locomotive House Service.

sent from the back shop to the locomotive house, lifting them from the flat cars, and placing them on the small shop trucks, tracks for which run under the craneway.

Central Ry. of Canada Discussed in British House of Commons:—Mr Sheehan asked the President of the Board of Trade in the Commons recently whether, having regard to the time which had elapsed since he promised to make inquiries into the position of the Central Ry. Co. of Canada, and to the fact that the principal question involved was its failure to comply with sec. 274 of the Companies Consolidation Act, he could state whether it was bound to comply with this section by reason of its having a London place of business at 363 Winchester House, E.C., and a London committee consisting of Sir Thos. H. C. Troubridge, T. Carmichael and A. L. Cohen; and, if so, would he take immediate steps to enforce the penalties imposed by the act upon companies who failed to comply with the requirements of the section in question? The President of the Board of Trade said in reply:—"Careful inquiries have been made, and the facts are now before Crown counsel with a view to advise whether proceedings can be instituted."



## Statistical Control of Railway Operations.

By W. M. Baxter, Special Investigator on General Manager's Staff, Eastern Lines, C.P.R.

In the early days of railroading, the use of statistics as a means of controlling the operations was very imperfect. Competition was not usually important and the railways were of short mileage, reaching only a limited territory. The margin of profit was large on rates amounting to only a fraction of the cost of hauling similar goods in wagons or on pack trains. But the profits of the enterprise lured much new capital. Competition became keen, lines were extended, rate wars took place and the solvency of railways soon became a matter of careful management.

The business of a railway may be divided into two distinct departments, namely, acquiring traffic and moving traffic, which is similar in industrial enterprises to the selling end and the manufacturing end. A railway manufactures and sells transportation. The great difference between the producing of the railway's commodity and that of a flour mill, or coal mine, from the viewpoint of management, is in the fact that the plant and equipment of the railway is dissipated or spread over a large stretch of country, while that of the flour mill or coal mine is concentrated, so that all supervision must be delegated, most of the work being done by transportation units, which are continually changing their location, so that they cannot be supervised except in a scattered manner. An unusually large number of employes must work without supervision and the margin of operating profit is exceedingly small, when compared to the average returns on the investments in manufacturing and farming. The gross earnings for 1913 of Marshall Field & Co., Chicago, America's largest wholesale dry goods firm, was \$2,000,000 greater than that of the Illinois Central Rd., and the interest on the investment was 14%, while that of the Illinois Central was 6%. You can well imagine the furore and condemnation and the howl of watered stock that would have been evinced, from the public and politicians, if this railway had earned 14%. The Interstate Commerce Commission would more than likely have been in night session.

As the general manager usually spends the larger portion of his time in inspection, and under normal conditions seldom directs the movements of trains, he sees but an infinitesimal volume of the company's business moved. As the scope of his vision is limited, other methods must be resorted to in order to check the operation. The means of accomplishing this is to separate the operation of the road into rigid and definite units and then to compare these units with similar ones on other roads, or with the same road at various periods, or with arbitrary standards chosen as guides, or bench marks. Controlling a railway by means of statistics might be defined as the process of determining the unit in each operation and then maintaining these units as nearly rigid as possible, seeing that they are collected, reported accurately and promptly.

The basic operating unit in freight traffic is the ton-mile, which is the product of the ton and the distance. The basic unit in passenger traffic is the passenger mile. There are six important statistical units deducible from these two fundamentals, which are defined as follows: 1. The average train load, either freight or passenger, is obtained by dividing ton mileage and passenger mileage by train mileage. 2. The average car load, freight and passenger, obtained by dividing ton mileage and pas-

senger mileage by the respective car mileage. 3. The average length of haul for passengers and freight respectively, obtained by dividing passenger mileage and ton mileage by the total number of passengers carried and the total tons moved. 4. Ton miles per locomotive hour obtained by dividing the locomotive ton miles by the number of hours the locomotives are in service. 5. The average revenue per passenger mile and per ton mile, obtained by dividing the freight receipts by ton miles and passenger receipts by passenger miles. 6. The average density of traffic per mile of road, obtained by dividing ton miles and passenger miles by the length of road. It is unfortunate that this data cannot be given to the executives earlier than 5 or 6 weeks after the operations have occurred, owing to the enormous concentration and calculations which must be resorted to in arriving at them on a large system economically. While they are of final value in determining the general efficiency of the system, it is necessary to have a more immediate check in the form of current records.

Perhaps the most tangible source of daily information is the train sheet, which is received by the train masters, and superintendents, from the dispatchers. This sheet records the movements of all trains on the division, showing their consist as to loads and empties and number of cars in the train, and sometimes shows the number of passengers carried on each of the passenger trains, as well as the general movements of traffic, the observance of schedule time, the cause of delays and weather conditions. By this means of concentrating upon a number of primary officers as much first hand detail information as they can absorb, the foundation of statistical control has been laid. The results of these primary officers' observations are collected and passed on to their next superior, who receives similar reports from many such primary officers and in this way the operations of the road and work performed is reported with diminishing detail, until the chief executive is reached.

The division superintendent is undoubtedly the most important primary officer. The operation of his territory is reported to him daily, and frequently on congested terminals he receives certain information hourly. In addition to this daily data, he has a number of statistical sheets prepared monthly, which show in condensed form, sometimes graphically, the comparative results of a large number of operations on a division, one month as against another, one day as against another, and one year as against another. When these records are graphically presented the sheets are ruled with a number of vertical lines, representing the number of days in a month, or the months in a year, or in other words, progress of time, while a horizontal ruling to scale represents volume or quantity, as is shown in the illustration. In this way the directing officer can readily see for example what has been the average tons per train mile, and the average pounds of coal consumed per 1,000 ton miles for a certain district or territory for a number of months, compared with the same months of the previous year, or if the records have been kept for a number of years fair indication will be had of the season's effect on the traffic.

The important daily returns which a superintendent receives are those showing the number of trains of loaded cars, empty cars, and total cars received and forwarded

in each direction at all of the terminals, also this same information for train movements at important intermediate points. He must know the entire train movement and the tonnage movement, and the failure to perform a given service of these movements as expressed in delays and other causes, must be thoroughly investigated and remedies applied. He is informed about the conditions of each of the yards and terminals on his division and also about outside important terminals, which may affect movements in his territory. He knows the demand for freight and passenger equipment and the class of each required at the various points, as well as the available supply, and the condition and amount of power to move it. All of this information is of a statistical nature.

The officer next superior in rank is the general superintendent. He has received through the superintendents statements showing by divisions the number of locomotives assigned, total number of through locomotives shown on the train sheets, the number of thorough freight locomotives out of a shop and available for service before a specified time, usually at midnight, the number of through freight locomotives in shop for repairs and reported as coming out within 24 hours, and those which will not be completed in 24 hours, and also the average mileage made by these locomotives in service, special locomotive assignments, such as wayfreights, passenger locomotives, switch locomotives, work trains, pick-ups, etc., together with general remarks on the entire power situation. He also receives reports on the cars handled at stations, showing the number of cars of merchandise on hand and when unloaded, together with information relating to special car movements. He is also notified concerning traffic exchange at all foreign line connections and if there is a special traffic, originating in his territory, such as coal mining, or some big manufacturing industry, he is advised of the number of cars moved and supplied, and a statement of detentions and their causes, as well as a report on the weather. While these are the principal reports he receives there are numerous special and minor statements furnished or compiled in his office daily, weekly and monthly, which are beyond the scope of this article.

It is evident that no general superintendent could exercise close watchfulness over the thousands of separate items which these reports cover, and in reality he does not. A man in this position not trained on the property could not make efficient use of them, as the information gained is not so much absolute as relative. As the great majority of the data he thus receives must be judged comparatively to be of use, the graphic method of recording statistics is perhaps most practical and is instantly read. The general superintendent, being familiar with all the conditions of his territory and knowing how it ought to operate, can look for the deviations from the results he is expecting. It may be fairly said that his system of control is by deviations from known standards.

The general manager, however, receives a smaller number of reports dealing only with the principal topics. All of these general considerations and many other local ones, the managing executives have clearly in their minds, but accurate statistical information must be the basis of their judgment in any specific case. They must receive constant advices relative to the current productive power of various localities on the system, the state of the wheat crop, the lumber market, or seaport traffic, so as to be able to foresee the possible future re-







## Wooden Frame Cars in the Freight Trains of Today.

By G. E. Smart, Master Car Builder, Canadian Government Railways.

A few years ago the 30 ton all wood freight car was considered standard, but since the introduction of steel in car building it has replaced wood and today we have all steel coal cars, all steel box cars, lined with wood inside, and steel underframe cars, of all classes of 40 and 50 tons, and a few of 75 tons' capacity. There are a large number of wooden underframe cars still in service, and the question in regard to these is: What can be done to make this class of car safe to be handled in the long trains and meet the severe usage that they receive in yard switching service of today?

The draft gear problem is certainly the most important. The annual cost of repairs to cars that are damaged through the draft gear failure, and loss and damage claims resulting therefrom exceed all other repairs made to freight car equipment. The question naturally arises: What are the causes of these failures? They are as follows: 1. On account of introduction of heavier power and longer trains. 2. Placing of light and heavy cars together in trains. 3. Rough switching of cars in yard. With regard to the first and second causes: The tractive power of locomotives has increased during the last few years from 20,000 lbs., known as the 100% engines, to about 45,000 lbs., or 225% for locomotives in general use in Canada, and the 2-10-2 type used on United States roads, to 84,000 lbs., and in addition to this type there are in use on certain sections of the country, locomotives of the Mallet type, with tractive power of 110,000 to 120,000 lbs., and, notwithstanding this enormous increase, there is a type of locomotive just placed in service, known as the Erie triplex, with a tractive power of 160,000 lbs., with a haulage capacity equivalent to a train consisting of 250 fully loaded cars each of 50 tons' capacity, 1.6 miles long, and a total weight of 18,000 tons. A few years ago, the average number of cars hauled was 25, the trains being approximately 1,000 ft. long. To-day the ordinary trains are 60 to 100 cars, and a train of 100 cars would be approximately 4,000 ft., or about three-quarters of a mile.

What chance has a wooden frame car under the conditions as they exist today on the front end of such a train? In my opinion it is a very good reason why cars of this class are so often found on repair tracks. If a car of this type was to be traced from the time it leaves the terminal it would be found that it was necessary to remove parts of the load quite often, which, beside the expense of repairs, results in delay to freight en route, and it is the fruitful cause for so many claims on account of damage to freight handling in and out of the car.

The solution of the problem is not altogether the physical characteristics of the car or entirely mechanical. The operating official should co-operate with the mechanical department in reducing the freight car repairs by arranging as far as possible that cars with all steel construction or with steel underframe, or those with steel centre sills be placed in the front end of trains. It is a fact that we find light capacity cars with wood underframe or empty flat cars leaving the terminal on the head end of one of the long trains. And in the majority of cases the cars are billed through and will not be set off between terminal points, unless set off on account of draft gear failure. This, no doubt, could have been avoided had the cars been placed towards the rear of the

train before leaving the terminal. There are railways who recognize the necessity of placing weak cars toward the rear of the train, and they provide cards stating that they must not be placed more than 15 cars from the caboose. This indicates that the car is in such a condition that it must be so located in the train, but is safe in ordinary service to be hauled to destination, and if this is done, delay and extra switching on account of draft gear failure along the line would be eliminated, and it would not be necessary to move the lading on account of this feature.

The third cause: rough switching in yard, is a great factor in car repairs. The speed limit for switching in yards is nil, nor are there any rules in force governing the speed of locomotives in switching service. If you were to confer with the car inspectors and obtain their opinion as to where most damage is done to cars, I am safe in saying that their answer would be in the switching yards, as their daily experience in inspecting cars immediately on arrival and after they have been switched in yard will confirm this. This is only a small item as compared with actual damage started in yard and which through the cars being necessarily weakened thereby, is aggravated after leaving terminals, and results in many cases in the cars breaking down before reaching destination. A visit to the freight car yard will convince you that it is just a question how fast the cars can be switched together, the speed that the cars are traveling is not considered, hence cars are found buckled up in yards and the draft gear lying around, having been pulled out due to rough switching. There should be some speed limit in yards to prevent this destruction of equipment. The time lost in switching out bad order cars damaged in yard and taking same to repair track would often offset the time gained by excessive speed that cars are switched together. The cost of repairing these cars must also be considered, and the thousands of dollars of damage done to the contents of cars in yard that are not set off for repairs.

What is the mechanical department doing today to overcome these troubles. 1. They are building steel frame cars to certain specifications with stronger types of draft gear. 2. Applying steel underframe or steel centre sills and steel ends, or otherwise re-inforcing the ends of cars to withstand the heavy shock. 3. Applying different types of steel draft arms to the present wood centre sills in such a manner that it re-inforces the wood centre sills, thus greatly reducing the cost of strengthening up the draft gear. 4. Applying heavier types of couplers and draft gear, and using friction draft gear, for in the past very little attention has been paid to what type of draft gear the cars were equipped with, but the friction type of draft gear is now being used to a large extent.

The demands of modern railroading requires the stopping of a high speed train in about two minutes and the draft gear is expected to absorb the shock. The air brake department can help to eliminate the strain on the draft gear by instructing the engineers as to the proper method of handling long trains. The principle thing is to control the slack to prevent it from running in or out harshly. Slack in draft gear cannot be prevented, as it is due to compression of the springs, and the heavier the locomotive and the longer the train, the greater the care that is required. Engineers

are instructed in the air brake instruction car how this should be done, but the general air brake inspector should see to it that the rules are followed out in actual service.

The vital question today before the car department is how to keep these wooden underframe cars in service. The majority of the railways are destroying the 40,000 lb. cars, but the 60,000 lb. and 80,000 lb. cars that were built with wooden underframe and short draft timbers are not any stronger and cannot withstand the heavy service and severe yard conditions of to-day, and unless the operating department will assist in reducing the damage done to cars and thus reduce freight car repairs, and also keep the cars in service by marshalling this class of car on the rear end of the train, and exercising greater care in switching cars in yard, the cost of freight car repairs will increase and the repair tracks will be full of bad order cars. The only other remedy is to spend money to apply steel centre sills or steel draft arms, so arranged as to strengthen the present wood centre sills, and in addition to this re-inforce the end of this class of cars. But yet the strongest car built cannot withstand the severe usage received in yard switching operations of to-day unless more care is exercised on the part of the yard crews.

The foregoing paper was read before the Canadian Railway Club recently.

**Railways in Saskatchewan.**—The annual report of the Saskatchewan Department of Railways shows that that Province leads all Canada in railway construction. In 1913 the new mileage built was 424 miles in excess of the next nearest Province; and since 1905, the mileage has been practically quadrupled. That there is still abundant room for railway development is shown by the following paragraph of the report:—"The question of railway development in our Province, despite the progress already made, remains one of paramount importance. The rapid development of the country impresses a realization of the need of railways. There are many rich and fruitful districts being retarded and vast regions remaining unopened and unproductive awaiting railway facilities."

**The C.P.R. Offices in St. John, N.B.,** have been removed from the Bank of Montreal Building, where they have been located for many years, to the corner of King and Germain Streets, where the company bought a building some time ago, and has remodelled it into a modern five story structure. The ground floor is occupied by ticket and telegraph offices and the Dominion Express Co. On the first floor are the general divisional offices of the freight and passenger departments. The second floor is occupied by the General Superintendent of the Atlantic Division and staff, the third floor by the engineering department, and the fourth floor by the telegraph staff.

**Dining Car Service at Valcartier.**—During the operation of the military concentration camp at Valcartier, Que., prior to the departure of the Canadian overseas contingent, the Canadian Northern Ry. operated a dining car at its station there, in which meals were served to a large number of camp visitors. A luncheon counter was also operated in a commissary car.

**The C.P.R. has offered a free scholarship** covering four years' tuition in the Faculty of Applied Science, McGill University, Montreal, to apprentices and others on the Company's permanent staff and under 21 years of age, and to minor sons of employees. The examination, which is the regular entrance one, will be held in June, 1915.



## Halifax Ocean Terminals, Intercolonial Railway.

General preliminary plans in connection with the buildings for the new ocean terminals at Halifax have been submitted by the architects, Ross & Macdonald, Mont-

the shore end, and the head of the T at the steamship landing stage. The shore end of the building will provide accommodations for the local Halifax traffic and

to baggage checking room and to ticket lobby. Passengers on entering the building will find all the facilities they require for transacting their business, after which they may pass on to the train concourse or train waiting room.

The general plan provides a landing stage

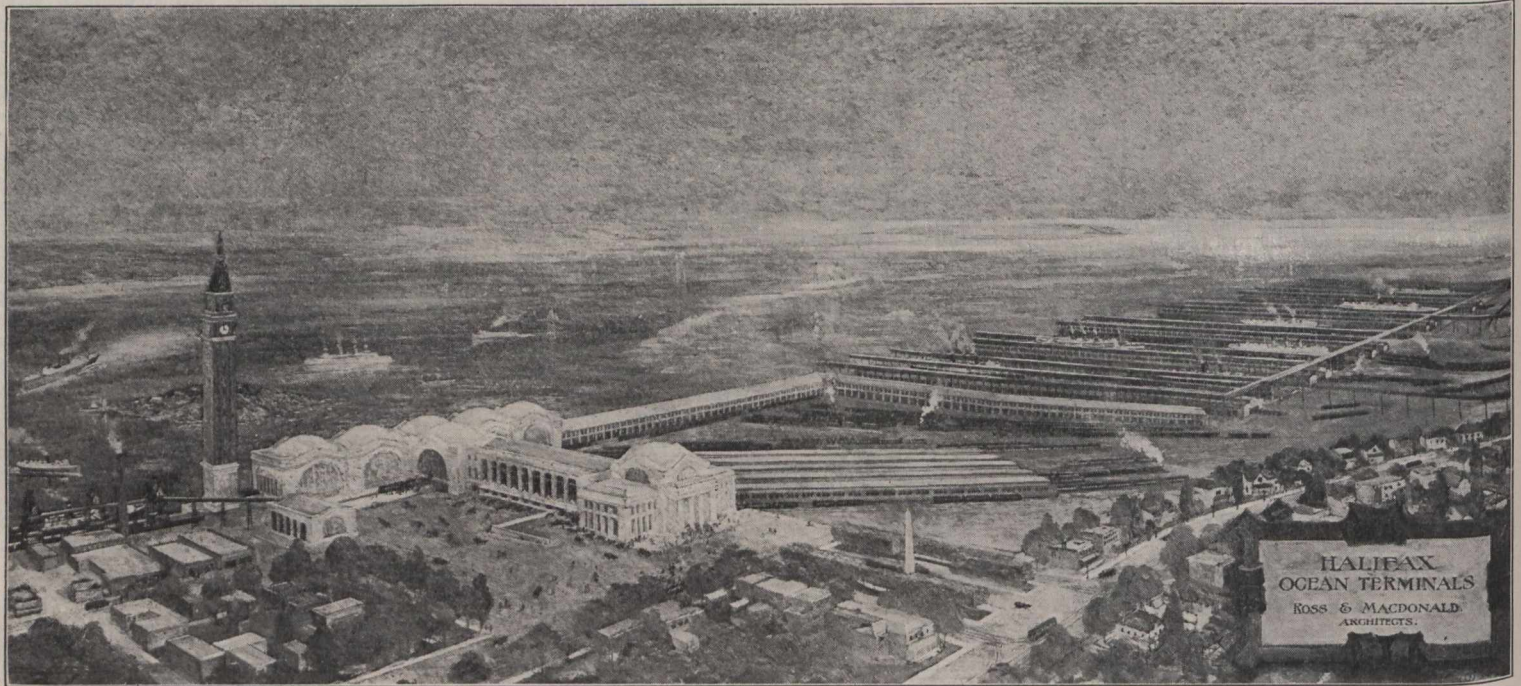

Complete Scheme for Halifax Ocean Terminals, looking towards the Harbor.

real, to the Minister of Railways through F. P. Gutelius, General Manager, Canadian Government Railways. These plans illustrate the general arrangement for the handling of passengers and freight and the facilities provided for the transferring of pass-

engers, baggage, mail and express to and from railway trains and steamships, as well as for the provisions for the handling of local Halifax city traffic. The general scheme consists of a passenger station building in the shape of a large letter T, the foot of the T being at

approximately 2,000 ft. long, which will be divided into two parts, the northerly third for the active handling of passengers, baggage, mail and express, and the remainder for the handling of cargo. It is upon this northerly end of the landing stage that the

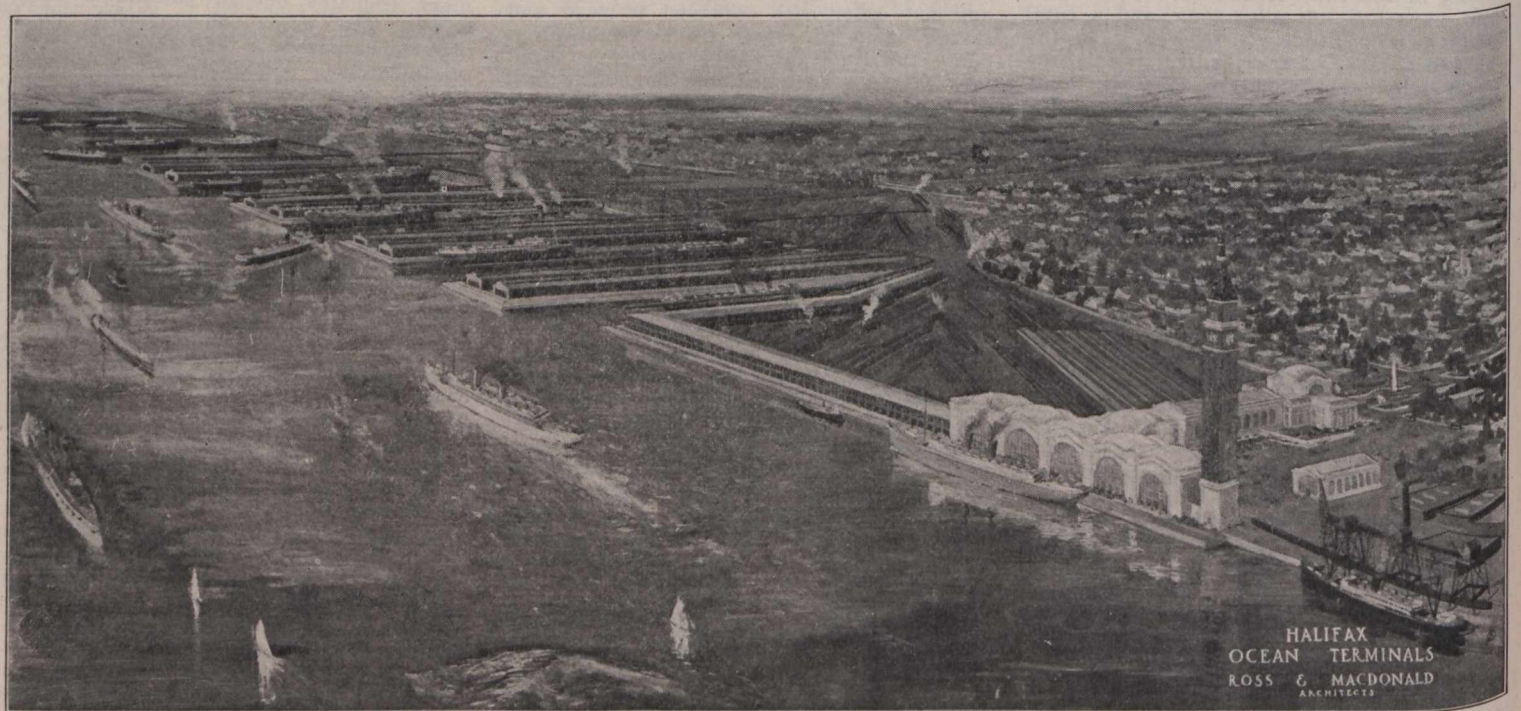

Complete Scheme for Halifax Ocean Terminals, looking from the Harbor.

engers, baggage, mail and express to and from railway trains and steamships, as well as for the provisions for the handling of local Halifax city traffic.

The general scheme consists of a passenger station building in the shape of a large letter T, the foot of the T being at

This portion of the building, which will be known as the Halifax city station, will face on a plaza located between South and Tobin Sts., this plaza extending from Pleasant St. east to the front of the station building, and being about 400 ft. deep. A space for cabs will be provided on the north, with access

top portion of the T shaped building is placed.

Passengers disembarking from steamships will enter the building at the second story level. Passengers' baggage will be discharged at the same level and will be distributed in the usual way for customs ex-



aminations. After baggage has been passed by the customs officers and then checked by the railway staff, it will be transferred to the floor below, by means of chutes or elevators, to a distributing baggage room, from where it will be routed to cars according to destination. Mails will be discharged directly from the steamship to the lower level of the steamship passenger building, to a distributing mail room, from where they will be transferred to cars according to destination. After passengers have landed, and have passed their baggage through the customs, they will pass into a booking hall containing ticket offices for the railway and steamship lines. Here passengers may obtain railway checks for their baggage, secure their tickets and attend to other matters of transportation which they may find necessary. They will then pass into the train concourse or train waiting room, which will connect the steamship station with the Halifax city station and form the stem of the letter T as stated above. The train concourse is designed for the common use of the Halifax city traffic and the steamship passenger traffic. The floor of this room will be placed level with the second story level of the steamship passenger building, and also level with the ticket lobby floor of the Halifax city station. The passenger platforms of the trainshed will be placed at a level between the train concourse and the baggage room beneath. All stairways will be eliminated between the train concourse level and the passenger platforms, the passengers reaching the passenger platforms by means of easy inclines. Separate trucking platforms for baggage trucks will be provided and these will connect with the baggage room beneath the train concourse by similar inclines, but separate from the passenger inclines, thus avoiding all confusion between passengers and baggage.

Ample provision will be made for the large number of immigrants which are expected to come through the port of Halifax and detention rooms and offices will be provided for the various government officials connected with the immigration work, as well as separate lounge rooms, lunch rooms, sleeping rooms, lavatories, etc., for the immigrants. These rooms will not be directly connected with the other portions of the station building.

The general arrangements contemplate the erection of a separate power house for the furnishing of heat, light and power for all the buildings connected with the terminal project, a grain elevator for the handling of grain from cars to the vessels, and large track provisions for handling of freight to and from the pier sheds. The architects are preparing plans for all the work in connection with the buildings to be placed upon the piers. The use of local materials is contemplated as far as possible and practicable, including granite, sandstone, brick and concrete.

A contract for the construction of the sea walls of the landing stage and the first pier was let some time ago to Foley Bros., Welsh, Stewart and Fauquier, and the work is in progress.

**Increased Rates for Spirituous Liquors Refused.**—The Canada and Gulf Terminal Ry. applied recently, to the Quebec Public Utilities Commission, for permission to use a special tariff on spirituous liquors, in excess of the general tariff, giving as a reason therefor the frequent pilfering of liquor consignments. After hearing evidence, the commission decided that nothing had been advanced that would justify the increase asked for, and that if there is breaking into and interference with consignments the remedy for this state of affairs is not by an increase of the rates charged.

## Railway Finance, Meetings, Etc.

**Algoma Central and Hudson Bay Ry.**—There has been deposited with the Secretary of State at Ottawa a deed made between the company and the United States Mortgage and Trust Co., securing an issue of second mortgage 6% gold bonds redeemable in 50 years.

**Canadian Pacific Ry.**—Application is being made to the Board of Railway Commissioners by the C.P.R. for recommendation to the Governor-in-Council for approval of the leasing to it of the Lake Erie and Northern Ry. for 999 years, from Dec. 1.

**Central Vermont Ry.**—The report for the year ended June 30, which was presented at the annual meeting at St. Albans, Vt., Oct. 20, showed an operating loss of approximately \$259,257.75, which has been paid by the G.T.R. under its guarantee. The officers and directors for the current year are,—Chairman, E. J. Chamberlin; President, E. C. Smith; Vice President, C. W. Witters; other directors, E. A. Chittenden, G. C. Jones, W. S. Webb, J. W. Stewart, J. G. McCullough, S. E. Kilner, A. Tuttle, H. S. Marston and W. H. Biggar. Auditor, E. Deschenes; Clerk and Treasurer, W. H. Chaffee.

**Kettle Valley Lines.**—There was filed with the Secretary of State at Ottawa, Oct. 9, a discharge of a mortgage entered into between the K.V. Ry., the C.P.R. and the Royal Trust Co., dated June 2, 1913, and a mortgage made between the same companies, dated Oct. 8, securing an issue of K.V. Ry. bonds.

**Quebec, Montreal and Southern Ry.**—An action for the recovery from the Dominion Government of \$36,765.45, part of a subsidy claimed to be due on account of the construction of one of the lines now amalgamated under this title, was heard at the Court of Exchequer, Oct. 7, when judgment was reserved. The Q. M. and S. Ry. petitions the court for the necessary order as assigners of the rights acquired by F. L. Beique, when the railways were sold Sept. 2, 1905, under an order of the Court of Exchequer. The Dominion Government alleges that the amount claimed is not due, as the balance of the subsidy was retained by the Government as being owing to the Intercolonial Ry. for freight charges.

**Temiscouata Ry.**—We are officially advised that the report for the year, ended June 30, 1914, submitted at the annual general meeting of shareholders and registered bondholders at Quebec, Sept. 29, was considered very satisfactory. Passenger traffic showed an increase of \$1,400 and freight traffic an increase of \$20,000. After meeting all fixed charges a dividend on the consolidated mortgage income bond was declared similar to last year, \$10,000 was appropriated for betterments, and \$4,800 was carried forward. The following are the directors for the current year: J. H. Walsh, President; G. G. Grundy, Secretary and General Manager; A. H. Cook, K.C., F. Murphy, K.C., and W. N. Campbell.

Net earnings for August \$3,667.

**Wabash Rd.**—Plans for the reorganization of the company, which were submitted to the State Commission in May, have been withdrawn by the bondholders' committee. It is stated that the plans have been interfered with by the war, by legislation and excessive taxation.

**White Pass and Yukon Route.**—Gross earnings from Jan. 1 to Sept. 14, \$1,347,782, against \$1,091,835 for the same period 1913.

**Canadian Government Railways officers and employes** have given one day's pay to the Canadian Patriotic Fund, \$20,150.

## Great Northern Railway's Report for 1913-14.

The G. N. Ry.'s 25th annual report covers the operations for the year ended June 30. It shows that the share capital has been increased from \$231,000,000 to \$250,000,000, of which there was outstanding \$230,997,700. The bonded debt outstanding has been increased from \$185,830,909.09 to \$193,124,909.09. There was an increase of \$7,471,000 of bonds held in the treasury, \$3,000,000 of which have been issued on account of construction, and the remainder for the acquisition of stock on various subsidiary companies, the following being in Canada:—Vancouver, Victoria and Eastern Ry. and Navigation Co., \$1,800,000; Crow's Nest Southern Ry., \$30,000; Nelson and Fort Sheppard Ry., \$30,000; Manitoba Great Northern Ry., \$25,000.

The expenditure on new construction was \$2,618,979.94, and included \$256,378.56 on account of the extension from Niobe, N.D., to the International boundary at Northgate, Sask., where connection is made with the Grand Trunk Pacific Ry. branch from Regina; and \$433,047.84 on account of the Orville-Pateros branch of the section of the V. V. and E. Ry. in Washington. The total net increase in the investments in Canadian companies is \$1,583,994.35. The report refers to the arrangements made with the Kettle Valley Lines for the joint use of certain sections by the V. V. and E. Ry., by which the duplication of 92 miles of line through a difficult country is avoided.

Operating revenues were \$75,473,869.09, a decrease of \$3,218,898.13, from the previous year. The operating expenses were \$46,547,956.35, an increase of \$688,701.83. Adding the other revenues, and deducting accrued taxes, bond interest and other charges, the net corporate income was \$20,453,551.38. Dividends absorbed \$15,063,048, and accrued interest and special appropriations \$2,078,934.40, leaving \$3,311,571.98 for transfer to profit and loss account. No separate reports are given as to the operations of the lines in Canada.

In the consolidated general balance sheet the total investments shown in the company's Canadian lines are as follows:—Midland Ry. of Manitoba, \$2,272,570.13; Manitoba Great Northern Ry., \$2,066,000; Brandon, Saskatchewan and Hudson Bay Ry., \$2,150,000; Crow's Nest Southern Ry., \$4,210,197.42; Bedlington and Nelson Ry., \$190,000; Nelson and Fort Sheppard Ry., \$2,119,019.51; Red Mountain Ry., \$310,619.07; Vancouver, Victoria and Eastern Ry. and Navigation Co., \$20,930,000; New Westminster Southern Ry., \$278,232.81.

The company owns 7,528.18 miles of first track, and 216.11 of second track. Of this mileage 167.62 of first track are in Manitoba; and 411.27 of first track and 7.12 miles of second track are in British Columbia. Of the mileage in Manitoba, 6.40 miles of main line track are owned jointly with the Northern Pacific Ry.

**Funds for Alberta Railway Construction.** It is reported to have been announced in the Alberta Legislature, Oct. 20, that there is in the Provincial Government's custody over \$12,000,000, received from guaranteed railway securities and not paid out. The amount in connection with each railway is as follows: Canadian Northern, \$1,148,959; Canadian Northwestern, \$2,759,652; G. T. P. Branch Lines, \$1; Edmonton, Dunvegan and British Columbia, \$1,935,169; Alberta and Great Waterways, \$605,555; Lacombe & Blind Man Valley Electric, \$140,035. Total, \$12,079,371.



## Mainly About Transportation People.

C. R. HOSMER, Director, C.P.R., has been re-elected President, Ogilvie Milling Co., for the current year.

Hon. Donald Howard, grandson of the late LORD STRATHCONA, has been appointed a Lieutenant in Third King's Own Hussars.

Col. J. F. Sweeny, who died at Westmount, Que., Oct. 11, aged 81, was father of H. W. SWEENEY, Local Treasurer, C.P.R., Winnipeg.

SIR THOMAS SHAUGHNESSY was amongst the senders of messages of congratulation to John Redmond, M.P., on the passage of the Home Rule Bill.

JAMES THOM, Manager, White Star-Dominion Line, Montreal, and Mrs. Thom, were in London, Eng., in October, having arrived there from North Wales.

JOHN CARDELL, who died at Calgary, Alta., Oct. 5, was at one time a master mechanic on the Western Lines, C.P.R. He retired from active service about 10 years ago.

GEORGE BURY, Vice President, C.P.R., Winnipeg, was in Montreal early in October for a conference with the President and visited Ottawa and Toronto on his return trip.

R. W. LEONARD, M.Can.Soc.C.E., ex-Chairman National Transcontinental Ry. Commission, has given \$5,000 to the Canadian Red Cross Society to buy a motor ambulance for the war.

J. S. DENNIS, Assistant to the President, in charge of the Natural Resources Department, C.P.R., Calgary, Alta., has been elected First Vice President of the International Irrigation Association.

G. E. SMART, Master Car Builder, Canadian Government Railway, Moncton, N.B., read a paper on wooden frame cars in freight trains before the Canadian Railway Club in Montreal, Oct. 13.

F. W. BERGMAN, formerly Manager-in-Chief of Hotels, Grand Trunk Ry. and Grand Trunk Pacific Ry., has been appointed Manager of the new Hotel Statler, Detroit, Mich., which will open in January.

Lieut. R. F. MORKILL, Signal Engineer, G.T.R., Montreal, who is attached to the Engineers' Corps, was among those who sailed with the Canadian contingent recently for active service in Europe.

C. E. JENNEY, General Agent, Passenger Department, G.T.R. and G.T. Pacific Ry., Vancouver, B.C., has been elected chairman of the executive of the Ocean Steamship Agents' Association of Vancouver.

A. EWAN MOORE, Manager Land Department, C.P.R., London, Eng., was expected in Canada towards the end of October. His marriage with Miss K. Barnard, Vancouver, B.C., is announced for Nov. 14.

FREDERICK NICHOLLS, President, Canadian General Electric Co., Toronto; Vice President Toronto Railway, and director Canadian Northern Ry., has been appointed an honorary colonel of the Canadian Militia.

J. K. L. ROSS, the newly elected C. P. R. director, is the youngest member of the Board. His father, the late Jas. Ross, was not a director but was generally reputed to have been the largest individual shareholder.

C. TRITES, secretary to C. A. Hayes, General Traffic Manager, Canadian Government Railways, Moncton, N.B., was presented, Sept. 29, with a chime clock by the departmental staff on the occasion of his marriage.

SIR THOMAS SHAUGHNESSY is President of the King Edward Memorial Fund Committee, which erected a statue of the

late King in Montreal recently, and which was unveiled by the Governor General, Oct. 1.

W. E. MULLINS, General Manager, Costa Rica Division, United Fruit Co., San Jose, and formerly of the G.T.R., was a passenger by the company's s.s. Matapan, which sank in New York harbor after colliding with the s.s. Iowan recently.

A. T. WELDON, who has resigned as Manager, Black Diamond Steamship Co., Montreal, on his appointment as Assistant General Freight Agent, Intercolonial Ry., Moncton, N.B., was presented with a club bag by his staff recently.

Lieut. C. L. CANTLEY, Assistant General Manager, Nova Scotia Steel and Coal Co., New Glasgow, N.S., is a member of the Canadian contingent, attached to the 13th Battalion, 5th Royal Scots, which sailed recently for foreign service.

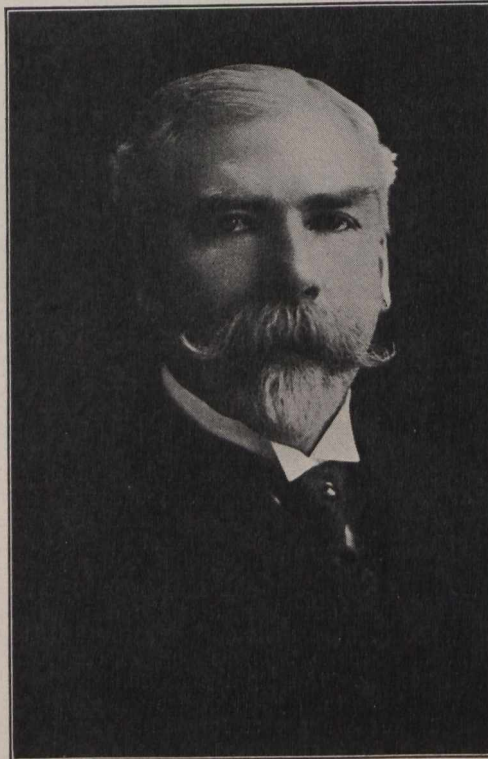

T. J. Kennedy,  
President and General Manager, Algoma Central and Hudson Bay Railway and Algoma Eastern Railway.

Major J. E. Mills, only son of JAMES MILLS, one of the members of the Board of Railway Commissioners, has gone on active service with the R.C.H.A. He has been instructor in gunnery tactics at Quebec, Kingston and Esquimalt.

A. E. VOYSEY, chief assistant to the European Manager, C.P.R., London, Eng., was presented with a side table and plate cabinet, with bronzes and an illuminated address by the European staffs recently, on the occasion of his marriage.

LORD FURNESS has been elected Chairman of Furness, Withy and Co., vice Sir Stephen Furness deceased, and F. W. Lewis, one of the Managing Directors has been elected Deputy Chairman. Lord Furness is a son of the late Lord Furness, the founder of the company.

A. T. FOLGER, whose resignation of the position of Manager, Chateau Laurier Hotel, G.T.R., Ottawa, was announced in our last issue, and who, it was mentioned, would be associated with the management of the

Olympia Hotel, Winnipeg, has been appointed Manager of that hotel.

"F. H. CLERGUE, the great financier and promoter, who took a course of extension lectures at McGill University, in the interval between his last enterprise and his present undertaking of the North Railway, is described by Professor Leacock as the finest student he ever had."—Financial Times.

Among Belgian refugees who arrived in England recently, after the evacuation of Antwerp by the allies, were a number of members of the C.P.R. staff there, who came by way of Holland. W. D. GROSSET and other members of the staff left Antwerp a few weeks ago, and have since been in England.

H. L. DRAYTON, K.C., Chief Railway Commissioner, returned to Canada from England, Oct. 8. He was in England at the outbreak of the war, and immediately offered his services to the acting High Commissioner in connection with the rendering of assistance to stranded Canadians in various parts of Europe.

T. BARCLAY ROBINSON, who died at St. John, N.B., Oct. 15, aged 76, was at one time Secretary Treasurer of the old European and North American Ry., and later occupied a similar position with St. John Bridge and Ry. Extension Co., which built and for some time owned the cantilever bridge and the line between St. John and Fairville.

JAMES BICKNELL, K. C., who died at Toronto, Oct. 22, acted as counsel on behalf of the Dominion Government in the western freight rates case which was heard before the Board of Railway Commissioners last year. As a member of the then firm of Laidlaw, Kappelle and Bicknell, a few years ago, he acted as a solicitor for the Toronto Ry.

H. L. PENNY, General Auditor, C.P.R., Montreal, was presented with a gold watch, chain and locket, by the Audit Department staff, Oct. 3, on his leaving the service for reasons of health. He entered C.P.R. service at Winnipeg in 1881 and worked in various capacities, chiefly in the Auditing Department, and is now returning to the west, where he will live for the future.

M. O. DAFOE, who has been appointed City Passenger and Ticket Agent, G. T. R., Montreal, entered railway service in 1885, and was to 1906, successively, switchman, agent, and freight accountant, jointly for the G. T. R. and Intercolonial Ry., at Quebec. Since 1906 he has been Travelling Passenger Agent, G. T. R., at Montreal, and for the past few months acting C. P. & T. A.

W. H. CLANCY, City Passenger and Ticket Agent, G. T. R., Montreal, has retired after 40 years of continuous service with the company. He entered the service in 1874 as a clerk, and was subsequently engaged as ticket examiner at Cobourg, Stratford and Toronto. In 1884 he joined the city passenger office staff at Montreal, and occupied the position of City Passenger and Ticket Agent from 1897 to his retirement.

J. F. PIERCE, Assistant General Passenger Agent, Canada Steamship Lines, Ltd., has been elected a member of the Eastern Canadian Passenger Agents Association's executive committee, vice H. FOSTER CHAFFEE, resigned, owing to retirement from Canada Steamship Lines service on account of ill health. The association accepted Mr. Chaffee's resignation with regret and expressed the hope that he will soon be restored to his usual good health and place in the association's counsels.

HUGH PATON, President Shedden Forwarding Co., Ltd., who celebrated his 62nd birthday recently, continues to exhibit his love for horses. He is one of the few Montreal business men who continues the old



habit of driving to the office instead of motoring. The motor car has little attraction for him, when compared with the delight which so true a lover of horses finds in handling the reins.—Financial Times.

ALBERT WEBB, who has been appointed Assistant Contract Foreman, Montreal, entered C. P. R. service Oct. 4, 1906, and worked in various capacities in the Car Department at Farnham, Que., until Oct. 1911, when he was transferred to Hochelaga, Que., as chief clerk, which position he held until Apr. 1, 1914, when he was appointed Shop Car Inspector there. On June 1, 1914 he was appointed Assistant Contract Foreman at Hochelaga, and transferred in a similar capacity to Ottawa, Sept. 22.

G. W. COBURN, whose appointment as Resident Engineer, Brandon, Man., was announced in a recent issue, entered C. P. R. service in 1896, as rodman and draughtsman at Farnham, Que. From 1900 to 1902 he was engaged in construction work on various parts of the system, and in 1902 was appointed Assistant Resident Engineer and draughtsman at Souris, Man., and later served in a similar capacity at Moose Jaw, Sask. In 1907 he was appointed Resident Engineer at Souris, Man., which position he held until his transfer to Brandon in July.

JOHN LESLIE, who has been appointed Comptroller, C.P.R., Montreal, was born at Toronto, and entered railway service with the Toronto, Grey and Bruce Ry. as assistant cashier, and was subsequently cashier, accountant and auditor, successively. On the absorption of the railway by the C.P.R. in 1893, he was placed in charge of the accounts of the Ontario lines at Toronto until March, 1895, and until 1897 was at Montreal. From 1897 to Oct. 2, 1899, he was chief clerk to Auditor; Oct. 2, 1899, to Dec. 1, 1908, Auditor of Disbursements; Dec. 1, 1908, to Oct. 1, 1914, Assistant Comptroller.

ROBERT FULTON CHAPMAN, whose appointment as Chief Dispatcher, District 1, Saskatchewan Division, C.P.R., Regina, was announced in our last issue, was born at Coal Branch, N.B., Jan. 21, 1874, and entered C.P.R. service May 26, 1889, since when he has been, to Sept., 1894, commercial telegraph operator, Winnipeg; Sept., 1894, to Mar., 1901, operator at various points on the Western Lines; Mar., 1901, to Mar., 1907, dispatcher at various points, Western Lines; Mar., 1907, to June, 1909, Chief Dispatcher, Moose Jaw, Sask.; June, 1909, to Sept. 17, 1914, Chief Dispatcher, Saskatoon, Sask.

B. A. NEISSER, who has retired from the position of Freight Claims Auditor, G.T.R., Montreal, entered railway service with the Michigan Central Rd., in the local freight department, Battle Creek, Mich., in 1868, since when he has been connected with G.T.R. subsidiary lines, as chief clerk, claims division, Treasury Department, at Port Huron and Detroit, Mich. On the amalgamation of the G.T.R. subsidiary lines, with headquarters at Montreal, in 1896, he was appointed chief clerk to the Freight Claims Agent, and in April, 1908, was appointed Freight Claims Auditor, from which position he retired, Sept. 30.

GARRETT VLIET, Master Mechanic, Western Division, G.T.R., Battle Creek, Mich., who died at Kansas City, Oct. 5, was born at Milwaukee, Wis., in 1856, and entered railway service in 1877, since when he has been, to 1879, draughtsman, St. Louis and San Francisco Rd., Kansas City, Mo.; 1879 to 1889, draughtsman, Wabash Rd.; 1889 to July, 1898, General Foreman, Wabash Rd.; Oct., 1898, to Apr., 1899, General Foreman, G.T.R., Battle Creek, Mich.; Apr., 1899, to Oct., 1910, Assistant Master Mechanic, G.T.R., District 1, Portland, Me. He was

appointed Master Mechanic, Western Division, G.T.R., at Battle Creek, Mich., in Oct., 1910, and held that position up to the time of his death.

G. A. HOAG, who was recently appointed Superintendent of Car Service, Eastern Lines, Canadian Northern Ry., Toronto, was born May 31, 1866, and educated at the Kingston public schools and business college. He entered railway service June 8, 1884, as switchman, G. T. R., and served at various points until May 3, 1886, when he was appointed night operator, and promoted to day operator and relieving agent, Jan. 1888. From 1899 to 1901 he was agent, same road, Trenton, Ont.; 1901 to 1905, Yardmaster, same road, Belleville, Ont.; Oct. 1905 to Mar. 1908, Trainmaster, Central Ontario Ry., Trenton, Ont.; Mar. 1, 1908 to July 1914, Superintendent, same road, Trenton, Ont.

W. H. SAMPLE, who has been appointed Master Mechanic, Western Division, G.T.R., Battle Creek, Mich., was born at Altona, N.Y., Aug. 20, 1864, and entered railway service July 20, 1882, since when he has been, to Apr., 1886, fireman, Central Vermont Ry.; Apr., 1886, to July, 1887, locomotive driver,



W. P. Hinton,  
Assistant Passenger Traffic Manager, Grand  
Trunk Railway and Grand Trunk Pacific  
Railway.

C.V.R.; July, 1887, to Aug., 1889, locomotive driver, Atchison, Topeka and Santa Fe Ry.; Aug., 1889, to Feb., 1901, locomotive driver, Central Vermont Ry.; Feb., 1901, to July, 1906, Road Foreman of Locomotives, C.V.R.; July, 1906, to Mar. 15, 1911, Superintendent of Motive Power and Car Department, Northern Ry. of Costa Rica; Mar. 15, 1911, to Oct., 1914, Master Mechanic, Ottawa Division, Eastern Lines, G.T.R., Ottawa, Ont.

W. H. BIGGAR, K.C., who has been appointed Vice President and General Counsel, G.T. Pacific Ry., Montreal, was born at the Carrying Place, near Trenton, Ont., Sept. 19, 1852, and was educated at the Trenton Grammar School and Upper Canada College. He began the study of law in 1875, after having engaged for a short time in commercial pursuits, and was called to the bar in 1880. He then became associated with John Bell, Q.C., then General Counsel, G.T.R., in general practice in 1881, and was appointed Assistant General Counsel, G.T.R., Montreal, Jan., 1903, and General Solicitor, Dec., 1904, and General Counsel, G.T.R. and

G.T.P.R., Montreal, in Jan., 1910. He was Mayor of Belleville, Ont., in 1887, and represented West Hastings in the Ontario Legislature from 1890 to 1897. He was made a Q.C. in 1900.

A. T. WIELDON, who has been appointed Assistant General Freight Agent, Canadian Government Railways, Moncton, N.B., was born at Dorchester, N.B., Mar. 6, 1876, and entered transportation service in 1890, since when he has been, to April, 1900, in different capacities in the Freight Department, Intercolonial Ry.; Dec., 1901, to Aug., 1904, in Division Freight Agent's office, I.R.C., Halifax, N.S.; Aug., 1904, to May 1, 1907, Secretary, Halifax Board of Trade; May 1 to Nov. 18, 1907, General Sales Agent, Port Hood Richmond Ry. Coal Co., Halifax, N.S.; Nov. 18, 1907, to 1909, Division Freight Agent, I.R.C., Halifax, N.S.; 1909 to Oct. 1, 1914, General Freight and Passenger Agent, Black Diamond Steamship Co., Montreal.

T. McHATTIE, who has been appointed Master Mechanic, Eastern Lines, G. T. R., Montreal, and whose portrait appears in this issue, was born at Dufftown, Banffshire, Scotland, Aug. 8, 1854, and entered railway service in Oct. 1870, since when he has been, to 1878, in locomotive shops, Great Western Ry., Hamilton, Ont.; June 1878 to Aug. 1886, locomotive driver, same road; Aug. 1886 to Apr. 1889, Locomotive Foreman, G. T. R., Palmerston, Ont.; Apr. 1889 to Apr. 1898, General Foreman in charge of locomotives, same road, London, Ont.; Apr. 1898 to Jan. 1909, Master Mechanic, Eastern Division, same road, Montreal; Jan. 1909 to Apr. 1912, Superintendent of Motive Power and Car Department, Central Vermont Ry., St. Albans, Vt.; Apr. 1912 to Oct. 1914, Master Mechanic, Eastern Division, G. T. R., Montreal.

WILLIAM PERCY WILGAR, who has been appointed Professor of Civil Engineering, Queen's University, Kingston, Ont., was born at Cobourg, Ont., Mar. 9, 1878, and entered railway engineering service in 1899, after which he was, during summer vacations, in 1899, chain man, G.T.R., Cobourg, Ont.; 1901, transit man, Kingston and Pembroke Ry., Kingston, Ont.; 1902, locating engineer, Bay of Quinte Ry., Deseronto, Ont.; 1903, Resident Engineer, Bay of Quinte Ry., Tweed, Ont.; 1903 to 1904, locating engineer, Central Ontario Ry., Trenton, Ont.; 1904 to 1905, in charge of a party of exploration, District C, National Transcontinental Ry.; 1905 to 1906, locating engineer, District C, N.T.R.; 1906 to 1908, locating engineer, District E, N.T.R.; 1908 to 1911, Division Engineer, District E, N.T.R.; 1911 to 1914, Assistant District Engineer, Districts C, D and E, N.T.R.

W. P. HINTON, who has been appointed Assistant Passenger Traffic Manager, G.T.R. and G.T.P.R., Montreal, and whose portrait appears in this issue, was born at Hintonburg, Ont., Aug. 30, 1871, and entered railway service in May, 1887, since when he has been, to Aug., 1891, clerk, freight, passenger and car accounts, and travelling auditor, Canada Atlantic Ry.; Aug., 1891, to Mar., 1898, rate clerk, General Freight and Passenger Department, same road, and accountant Canada Atlantic Fast Freight Line; Mar., 1898, to June 30, 1901, Assistant General Freight Agent, same road, and Canada Atlantic Transit Co.; June 30, 1901, to Jan. 30, 1903, General Freight Agent, same road; Jan. 30, 1903, to Oct., 1905, General Passenger and Freight Agent, same road; Oct., 1905, to Jan., 1907, General Agent, Passenger Department, G.T.R., Ottawa; Jan., 1907, to Apr., 1909, Assistant General Passenger and Ticket Agent, same road, Montreal; Apr., 1909, to Feb., 1914, General Passenger Agent, G.T. Pacific Ry., Winnipeg; Feb. to Oct. 1, 1914, Assistant Passenger Traffic



## Railway Development.

### Projected Lines, Surveys, Construction, Betterments, Etc.

**Alberta and Great Waterways Ry.**—Application is being made to the Alberta Legislature for authority to build a branch line starting from Lac La Biche, on the line now under construction from near Edmonton, southeasterly to the eastern boundary of the province.

R. H. Douglas, Provincial Engineer of Railways, returned to Edmonton recently from an inspection of the work on the line. He is reported to have said that the end of steel was at the Redwater River, 28 miles from the starting point at the Edmonton, Dunvegan and British Columbia Ry. At Redwater River a 58 ft. trestle bridge was under construction, which it was expected to have completed by the middle of October. Grading had been completed from that point through to Skeleton Lake, at mileage 76, and was ready for the track layers. Between this lake and Lac La Biche, at mileage 114, a considerable amount of grading had been completed, and three gangs were at work connecting the different sections. A bridge will be built across a ravine at mileage 75, and another over an arm of Egg Lake, mileage 106. It is expected that track laying will be completed to Lac La Biche this year. The location engineers have completed their work to Fort McMurray, and two grading outfits are at work beyond Lac La Biche, working towards Fort McMurray. The distance between these two points is approximately 160 miles. (Oct., pg. 468.)

**Algoma Central and Hudson Bay Ry.**—The Board of Railway Commissioners has authorized the opening for traffic of the line from Oba to Hearst, Ont., mileage 83 to 130.87. The track was laid on this section at the latter end of 1913, and the ballasting and finishing up was done this year. The line is now in operation from Sault Ste. Marie to Hearst, 295 miles, with a branch to Michipicoten Harbor, 26 miles, and other short mining branches, which brings the total operated to 320 miles. The main line connects with the C.P.R. transcontinental line at Franz, mileage 195 from Sault Ste. Marie, the Canadian Northern Ontario Ry. at Oba, mileage 245, and the Grand Trunk Pacific Ry. at Hearst, mileage 295. (Sept., pg. 418.)

**Athabasca and Grande Prairie Ry.**—The Dominion Parliament is being asked to extend the time for the construction of this projected railway from the junction of the Salmon and Athabasca Rivers, in Alberta, to Dunvegan and the Grande Prairie country, west of Bear Lake, B.C. Pringle and Guthrie, Ottawa, solicitors for the applicants. (Aug., 1913, pg. 376.)

**Burrard Inlet Tunnel and Bridge Co.**—It is said that R. Mojeski's report on the designs for the bridge over the second narrows of Burrard Inlet, Vancouver, B.C., has been received and will be studied by the directors prior to the Board's November meeting, when it will come up for action. (Oct., pg. 463.)

**Carquet Ry.**—By an act passed last session of the New Brunswick Legislature the Carquet Ry. is authorized to transfer to the Bathurst Lumber Co. the right of way on which is a Y and sidings between its main line and the Nipisiquit bridge, at Bathurst Harbor. It is also provided that the Carquet Ry. station and tracks are to be moved to another site, and that the Bathurst Lumber Co. is to erect a wharf with approaches on the harbor frontage. In carrying out this work, or any other work, the Bathurst Lumber Co. must not interfere with the right

of way of the Northern New Brunswick and Seaboard Ry. or the Canada Iron Corporation's lands.

**Central Canada Ry.**—The Alberta Legislature is being asked to authorize the company to build, in addition to the lines already authorized, a line from Sucker Creek, on the Edmonton, Dunvegan and British Columbia Ry., to Grouard, Alberta. Short, Woods, Biggar and Collisson, Edmonton, solicitors for applicants.

The Alberta Legislature has approved of the principle of a bill granting special provisions for financing the building of the main line to Peace River Crossing, and granting a guarantee of bonds for \$20,000 a mile for the building of a branch to Grouard, 14 miles.

A press report states that 30 miles of grading have been completed on this line, which starts from McLennan, on the Edmonton, Dunvegan and British Columbia Ry., and it is expected that the grading gangs will reach Peace River Crossing, 20 miles further on by the end of the year. It is also said that track laying will be started as soon as the steel on the E.D. and B.C. Ry. reaches McLennan, and that it is expected to have 30 miles of steel laid by the end of the year. (May, pg. 213.)

**Dominion Government Railway to Hudson Bay.**—W. A. Bowden, Chief Engineer of the Department of Railways and Canals, completed an inspection of the terminal works in connection with this railway under construction at Port Nelson, Man., recently. He is reported to have stated that the various works are well under way, that satisfactory progress is being made, and that unless anything unforeseen occurs the terminals will be completed by the time track on the railway from Pas reaches Port Nelson. The work on the railway is also being gone on with in a satisfactory manner. (Oct., pg. 468.)

**Edmonton, Dunvegan and British Columbia Ry.**—A regular train service has been inaugurated from West Edmonton to Sawridge, on the Athabasca River, mileage 135, where connection is made with steamboats running on Lesser Slave Lake. Station buildings have been erected at four points on the line, and a divisional point is being laid out at Smith, mileage 131. In the terminal yards at West Edmonton, a 12-stall locomotive house and other terminal buildings are being erected.

The line skirts the shores of Lesser Slave Lake for about 20 miles out of Sawridge, and again for about 10 miles in the vicinity of Geroux Bay, 50 miles from Sawridge. Track is reported to have been laid to within five miles of this point, and it is expected that the steel will reach Big Smoky River, about mileage 290 from Edmonton by the end of the year. The second divisional point will be laid out at McLennan at about mileage 260. W. B. Smith is Chief Engineer, and W. J. Pace is Superintendent of Construction. (Oct., pg. 468.)

The Alberta Legislature has passed an act providing for a guarantee of bonds for \$20,000 a mile for the extension of the line to the western boundary of the province, where it will connect with the Pacific Great Eastern Ry. The original act guaranteed the company's bonds up to \$20,000 for 350 miles, and the present act covers the remaining distance to the boundary, 61 miles.

**Erie and Ontario Ry.**—A special meeting of shareholders has been called for Nov. 11 to pass resolutions approving of an agreement of amalgamation with the Toronto, Hamilton and Buffalo Ry. The shareholders

of the T.H. and B. Ry. have been called to meet on the same day for the same purpose. The E. and O. Ry. is to be merged into the T.H. and B. Ry.

Press reports state that the right of way acquired is 75 ft. wide, and that the single track being built is so arranged that if it is found necessary to build a second track it will be the same distance from the centre of the right of way. It is expected that the contract for the station buildings will be let early in November. (Oct., pg. 468.)

**Essex Terminal Ry.**—The Dominion Parliament is being asked to extend the time for the completion of this railway, and to authorize a change in the date of the annual meeting. (Sept., pg. 418.)

**Gananoque and Arnprior Ry.**—A proposition to grant a bonus of \$25,000 towards the building of this projected railway, from Gananoque to Arnprior and other points in the Ottawa River valley, has been defeated by a vote of the ratepayers of Ketley tp., Ont. (Aug., pg. 370.)

**High River and Hudson Bay Ry.**—Application is being made to the Alberta Legislature for amendments to chap. 51 of the statutes of 1910, authorizing various changes in the starting points of the several lines authorized to be built. The company is also applying for an extension of time within which to start construction. Ballachey and Mackenzie, High River, Alberta, solicitors for applicants. (July., pg. 323.)

**Intercolonial Ry.**—It is reported that the track between Moncton and Painsec Jct., N.B., is being relaid with 85 lb. steel.

Tenders are under consideration for the building of a subway under the tracks at Main St., Moncton. This is the beginning of the grade separation work, the agreement to carry out which was approved by the ratepayers Aug. 31. In order to facilitate the work a temporary track is being laid for the Moncton Tramways Electricity and Gas Co.'s electric railway along the street at the subway site. (Oct., pg. 468.)

**Kettle Valley Lines.**—The Premier of British Columbia gave out for publication, Oct. 6, the following telegram received from J. J. Warren, President, K.V. Ry.:—"We connected up the Kettle River and Okanagan Valley on Friday last, the steel meeting at mile 45 east of Penticton. We now have almost 225 miles of steel laid, of which 175 miles are continuous from Midway to Osprey Lake, via Penticton. Over 90% of the grading of the entire line is completed. All grading will be finished in another month. At the beginning of winter there will remain only 60 miles of track to be laid next year." (Sept., pg. 418.)

**Montreal Harbor Commissioners' Railway.**—A press report states that Montreal Harbor Boards' engineering department is preparing plans for the electrification of its lines along the harbor front, and that the work will include the elevation of the entire lines. Steam is now used as motive power.

**Ottawa-Toronto passenger service.** The Canadian Northern Ry., which has been operating one passenger train a day each way between Ottawa and Toronto, has also put on two daily night trains, the westbound one leaving Ottawa at 10.50 p.m., arriving Toronto 7.30 a.m. and the one eastbound leaving Toronto at 11 p.m., arriving Ottawa 7.40 a.m.

**Pacific Great Eastern Ry.**—It was reported, Oct. 3, that track had been laid to mileage 60 from Squamish, B.C. Arrangements are being made for putting on a train service to Alta Vista, mileage 37.5 from Squamish. The grading is completed to Lillooet, mileage 133; from that point to Clinton, mileage 220, the grading is about 80% completed, and it is expected to have the remaining 20% finished by Nov. 30. Between Clin-



ton and Fort George, about 20% of the grading is reported completed. About 60 miles of location has been completed between Fort George and the British Columbia-Alberta boundary, where a junction is to be effected with the Edmonton, Dunvegan and British Columbia Ry. (Oct., pg. 468.)

**Prince Edward Island Ry.**—Work is proceeding satisfactorily on the Carleton Point extension, from the Emerald-Cape Traverse Branch, which starts 8.06 miles from Emerald and 3 miles from Cape Traverse, to run to Carleton Point, where a terminal is being built for the New Brunswick-P.E. Island car ferry. The only structure of any importance is one trestle. Standard gauge ties are being laid, as it is the intention to change from 3½ ft. to standard gauge when the car ferry goes into operation. F. P. Tripp, Cape Tormentine, N.B., is in charge of this work and also of the terminals on both sides of the strait. (June., pg. 267.)

**St. John and Quebec Ry.**—A press report stated recently that it was expected to have the section from Gagetown to Centreville, N.B., completed and ready to be taken over for operation under the agreement with the Intercolonial Ry. by Oct. 31. The line into Fredericton is under construction. In connection with this piece of work some difficulty arose with the crossing of the C.P.R. at Aberdeen St., and an interim injunction was obtained, stopping the work. The matter came before the court for argument subsequent to Oct. 15.

U.S. press reports state that arrangements are being made for the starting of construction of the section of the line from Washburn, Me., to the Quebec boundary, early in 1915.

**Temiscouata Railway.**—At the annual meeting held recently, \$10,000 were appropriated for betterments. We are officially advised that it is possible that during next year the company will commence re-laying the track with heavier steel.

**Winnipeg.**—The Commissioners of the Greater Winnipeg Water District are reported to have let a contract to the Rat Portage Lumber Co., Kenora, Ont., for the delivery of 8,000 ties at Indian Bay, Shoal Lake, Man. (Oct., pg. 468.)

### National Transcontinental Railway Construction.

The Minister of Railways returned to Ottawa, Oct. 14, after a trip of inspection over the line from Quebec to Lake Superior Jct., Ont. He is reported to have said that it would be ready for operation Nov 1. With regard to the taking over of the operation of the railway by the G.T.P.R., he said arrangements had not been finally made, and an announcement as to this would be made later.

An Ottawa press dispatch says there will be a limited train service this winter between Moncton, N.B., and Levis, Que., and probably also from Hearst, Ont., eastward. The line is already in operation, under the Intercolonial Ry. management, from Moncton to Escourt, Que., 286.3 miles, so the probability is that the operation to Levis will be under the same management. No intimation has been given as to how the line will be operated eastward from Hearst, Ont., which is the junction point with the Algoma Central and Hudson Bay Ry. (Oct., pg. 469.)

### Grand Trunk Pacific Railway Construction.

E. J. Chamberlin, President, returned to Montreal, Oct. 6, after an inspection of the line from Winnipeg to Prince Rupert, and of

the branch lines under construction. He is reported to have said in an interview:—"I found our line in British Columbia in much better condition than I expected; in fact, the work done is remarkable, considering that 480 miles were graded and track laid in twelve months through the mountains of British Columbia. We now have a first-class track as far west as Prince George, B. C., and at least half of the track between Prince George and Prince Rupert is fully finished, and the balance of it has a first, and most of it a second, lift of ballast, and compares today very favorably with other railway lines in the northwest. There is a big force at work putting on the finishing touch, and we expect before the close of the season the entire line will be in first class condition. We are now running a through sleeping car train twice a week between Edmonton and Prince

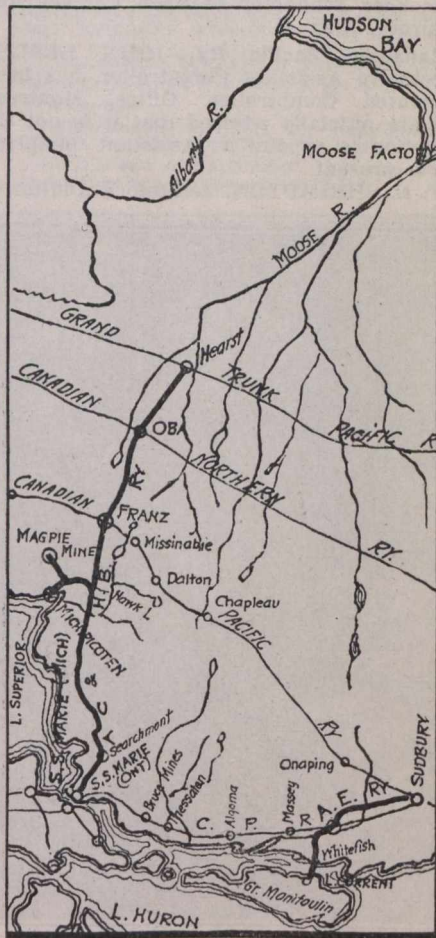

Map showing location of Algoma Central and Hudson Bay Railway and Algoma Eastern Railway.

Rupert, connecting with the through trains to Winnipeg, and this is being well patronized and giving good service to the people. We are also running freight regularly through to Prince Rupert."

A press report states that work was started Oct. 9, on the building of a locomotive house, machine shop and other buildings at Fort George, B. C. The contractors are Carter, Hall and Aldinger, Winnipeg, who are also said to have secured the contracts for putting up the terminal buildings at Endako, Smithers and Pacific, B. C.

The Saskatchewan Legislature has extended the time within which the Grand Trunk Pacific Branch Lines Co., and G. T. P. Saskatchewan Ry. may build certain lines in the province, and for the laying out of terminals at Regina, Moose Jaw and other points, for both of which purposes there is a provincial guarantee of bonds. (Oct., pg. 469.)

### Completion of the Algoma Central and Hudson Bay Railway.

We are officially advised that this line is fully completed from Sault Ste. Marie, Ont., to Hearst, Ont., the junction with the National Transcontinental Ry., a total distance of 294 miles, which finishes the line as far as the company's present plans go. The Board of Railway Commissioners has issued an order for the operation of the line through to Hearst. A very complete illustrated article on the building of the whole line appeared in Canadian Railway and Marine World for June, 1912, pg. 265, and its terminals at Sault Ste. Marie were described in Feb., 1913, pg. 51.

The line north of the C.P.R. main transcontinental line through to the N.T.R. at Hearst is 99.81 miles long, connecting with the N.T.R., one mile west of the station building. This line is built on 0.6 grade and maximum 6 degree curve, all curves being spiralled with serial spiral. The line is on modern standards in every respect, rock cuttings 20 ft. wide at subgrade, earth cuttings the same, excepting north of Oba in the rolling clay belt, where very light cuttings are common, they have been widened to provide additional drainage.

The line from the C.P.R. at the junction point, Franz, to a point half way to Oba, where it crosses the Canadian Northern Ry. is through the same sort of formation as along the C.P.R. in this district. At this point the line enters the clay belt and the country north of that point presents an entirely different formation, gradually verging from a rocky wilderness into rolling clay ridges and rich spruce low lands, which when drained will make excellent farm land. The line north of Oba has a maximum 3 degree curve, with the one exception where it connects with the N.T.R., which is a 4 degree curve. The maximum grade is the same as the section between Franz and Oba, namely, 0.6.

The Algoma Eastern Ry. is fully completed from Sudbury to Little Current, Ont., including the construction of a draw bridge over the channel at Little Current, together with terminal facilities on Goat Island, which lies just across this channel. This line is built to modern standards, but on heavier grades and curvature than the Algoma Central. They are 1.25 compensated and a maximum 11 degree curve. This line was opened for traffic about a year ago, the first train running through to Little Current, Oct. 1, 1913. The company has been busy since then on terminal work, which is now fully completed, and there is at this point, as at Sault Ste. Marie, a modern coal unloading plant, capable of handling coal from a vessel lying alongside the dock and depositing same in storage pile immediately adjacent at the rate of 200 tons an hour, including the cleaning up of the boat. The plant at Little Current is not as yet giving as good service as the one at Sault Ste. Marie. Both are on same design, but the one at Little Current is operated by steam, while the one at Sault Ste. Marie has electric power. The company is somewhat handicapped also at Little Current by the very bad channel approaching the dock from the east. Several boats have been aground in this channel, and it is quite apparent that it will be necessary to do some extensive dredging work to deepen it so that modern draught coal boats can get through. The government is doing considerable dredging work in the immediate vicinity of Little Current, and it is hoped the work will be extended east to take care of the condition noted. In connection with the coal dock at Little Current the company also has a commercial dock, and at both considerable dredging



has been done. Illustrated articles on the building of the Algoma Eastern Ry. and its terminals were published in Canadian Railway and Marine World as follows:—June, 1912, pg. 267; Oct., 1913, pg. 497.

## Transportation Appointments Throughout Canada.

The information under this head, which is almost entirely gathered from official sources, is compiled with the greatest care, so as to ensure absolute accuracy. Anyone who may notice any error in our announcements will confer a favor by advising us.

**Algoma Central and Hudson Bay Ry., Algoma Eastern Ry.**—T. J. KENNEDY, heretofore President, Superior Construction Co., Sault Ste. Marie, Ont., and formerly General Superintendent, A.C. & H.B. Ry., has been appointed President and General Manager, A. C. & H. B. R. and A. E. R. J. Frater Taylor, heretofore President, and W. C. Franz, heretofore Vice President and General Manager, are President and Vice President, respectively, of the Lake Superior Corporation, the parent company. Office, Sault Ste. Marie, Ont.

**Black Diamond Steamship Line.**—A. T. Weldon, General Freight and Passenger Agent, Montreal, having resigned to enter Canadian Government Railways service, all communications and reports previously made to him are now addressed to A. McKENZIE, Superintendent, Montreal.

**Board of Railway Commissioners.**—Hon. W. B. NANTEL, heretofore Minister of Inland Revenue, has been appointed Deputy Chief Commissioner, Board of Railway Commissioners, vice Hon. M. E. Bernier, whose ten year term expired some time since.

**Canadian Government Railways.**—A press report early in October stated that it had been decided to transfer the purchasing department from Ottawa to Moncton, N. B. On Oct. 16, we were officially advised that no decision had been reached on the matter. It would appear that the transfer is at least under consideration.

A. T. WELDON, heretofore General Freight and Passenger Agent, Black Diamond Steamship Co., Montreal, has been appointed Assistant General Freight Agent, Canadian Government Railways. Office, Moncton, N. B. R. E. Perry is also Assistant General Freight Agent, there now being two, both located at Moncton, N. B.

R. W. SIMPSON, heretofore General Fuel Agent, has been appointed General Fuel and Tie Agent, the position General Tie and Timber Agent heretofore occupied by R. A. Klock, having been abolished. Office, Moncton, N. B.

**Canadian Northern Ry.**—G. A. HOAG, formerly Superintendent Central Ontario Ry., Trenton, has been appointed Superintendent of Car Service, Eastern Lines. Office, Toronto.

A. M. YUILL, heretofore Material Agent, Quebec, has been appointed Tie and Timber Agent, with jurisdiction over Eastern Lines, reporting to the Assistant to the President. Office, Toronto.

L. C. THOMPSON, heretofore Division Storekeeper, Ontario Grand Division, has been appointed General Storekeeper, with jurisdiction over Eastern Lines, reporting to the Assistant to the President. Office, Toronto.

N. P. TRACY, Division Storekeeper, Quebec Grand Division, at Limoilou, Que., now reports to the General Storekeeper, Eastern Lines, Toronto, instead of to the General Superintendent at Montreal, as heretofore.

E. D. TOY, heretofore Storekeeper, Toronto, has been appointed Division Store-

The whole of the construction of both lines has been in charge of R. S. McCormick, Chief Engineer, to whom we are indebted for the information above and in the several other articles referred to.

keeper, Ontario Grand Division, reporting to the General Storekeeper, Eastern Lines. Office, Toronto.

H. H. SMITH has been appointed Car Accountant, Eastern Lines, with jurisdiction over all lines east of Port Arthur, Ont. Office, Toronto.

G. W. CHAPMAN, late Trainmaster on 1st, 2nd, and 3rd districts, and formerly General Yard Master at Prince Albert, has returned to train service and is running as passenger conductor between Calgary and Camrose, Alta.

**Canadian Pacific Ry.**—JOHN LESLIE, heretofore Assistant Comptroller, has been appointed Comptroller. Office, Montreal. We are officially advised that it is not the intention to appoint an Assistant Comptroller at present.

F. E. SHRIMPTON, heretofore Auditor of

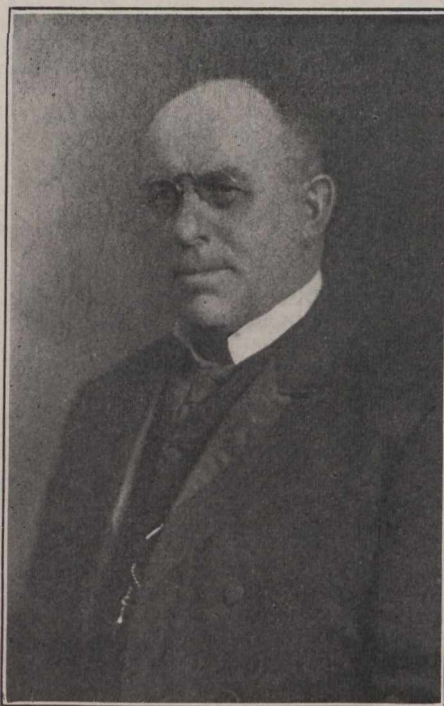

T. McHattie,  
Master Mechanic, Eastern Lines, Grand Trunk  
Railway.

Disbursements, has been appointed General Auditor, vice H. L. Penny, resigned on account of ill health. Office, Montreal.

W. J. MOULE, heretofore Assistant Auditor, has been appointed Auditor of Disbursements, vice F. E. Shrimpton, promoted. Office, Montreal.

W. J. PERCIVAL has been appointed Auditor of Miscellaneous Accounts. Office, Montreal.

A. WEBB, heretofore Assistant Contract Foreman, Ottawa, Ont., has been appointed Assistant Contract Foreman, Montreal, vice A. McQueen, who has joined the Royal Navy on active service.

A. H. BINNS has been appointed District Master Mechanic, District 3, Ontario Division, Toronto, vice I. H. Hamilton, transferred to the company's board of examiners at Montreal and Ottawa.

E. L. LANDORPH, heretofore Resident

Engineer, Brandon, Man., has been appointed Resident Engineer, District 2, Manitoba Division. Office, Winnipeg.

J. N. MURPHY, heretofore Resident Engineer, Suffield, Alta., has been appointed Trainmaster, Souris, Man., vice C. Washbon, transferred.

K. A. DUNPHY, Resident Engineer, Souris, Man., has also been appointed Bridge and Building Master there, vice L. Kinshella, transferred.

R. R. JELLY, heretofore Chief Dispatcher, Regina, Sask., has been appointed Chief Dispatcher, Souris, Man., vice J. H. Scott, whose transfer to Saskatoon, Sask., was announced in our last issue.

L. KINSHELLA, heretofore Bridge and Building Master, Souris, Man., has been appointed Bridge and Building Master, Regina, Sask.

J. H. McDIARMID, heretofore Trainmaster, District 1, Saskatchewan Division, Regina, has been appointed General Yardmaster, Regina, which position he formerly held.

W. E. HAYWARD, heretofore Roundhouse Foreman, Vancouver, B. C., has been appointed Locomotive Foreman, East Calgary roundhouse, Alta., vice W. A. Groves, who resumes his former position as hostler there.

J. B. McTAGGART, heretofore Superintendent, Moose Jaw, Sask., who was recently granted a month leave of absence, has, since his return, been appointed Bridge and Building Master, Edmonton, Alta., vice H. Marshall.

H. MARSHALL, heretofore Bridge and Building Master, Edmonton, Alta., has been appointed Bridge and Building Foreman there.

J. S. CARTER, heretofore in the Steamship Department, Winnipeg, has been appointed District Passenger Agent, Nelson, B. C., vice J. V. Murphy, whose appointment as General Agent, Portland, Ore., was announced in our last issue.

**Grand Trunk Pacific Ry.**—W. H. BIGGAR, K. C., General Counsel G. T. R. and G. T. P. R., Montreal, has also been appointed Vice President and General Counsel, G. T. P. R. Office, Montreal.

W. P. HINTON, Assistant Passenger Traffic Manager, Winnipeg, has also been appointed Assistant Passenger Traffic Manager, G. T. R. Office, Montreal.

D. E. SMITH, heretofore Locomotive Foreman, Biggar, Sask., has been appointed Locomotive Foreman, Regina, Sask., vice A. S. Wright, transferred.

A. S. WRIGHT, heretofore Locomotive Foreman, Regina, Sask., has been appointed Locomotive Foreman, Biggar, Sask., vice D. E. Smith, transferred.

**Grand Trunk Ry.**—W. P. HINTON, heretofore Assistant Passenger Traffic Manager, G. T. Pacific Ry., Winnipeg, has also been appointed Assistant Passenger Manager, G. T. R. Office, Montreal.

Owing to a rearrangement of the general officers of the Passenger Department H. G. ELLIOTT, General Passenger Agent, has retired under the Superannuation and Provident Fund Association's rules. W. P. HINTON, Assistant Passenger Traffic Manager, has assumed the duties of General Passenger Agent.

B. A. NEISSER, Freight Claims Auditor, having retired after over 40 years service, the position has been abolished, and all matters hitherto dealt with by him have been taken over by J. B. McLAREN, Auditor of Freight Accounts. Office, Montreal.

T. McHATTIE, heretofore Master Mechanic, Eastern Division, Montreal, has been appointed Master Mechanic, Eastern Lines. Office, Montreal.

M. O. DAFOE, formerly Travelling Pas-



senger Agent, Montreal, and latterly acting City Passenger and Ticket Agent there, has been appointed City Passenger and Ticket Agent, vice W. H. Clancy, retired.

J. MARKEY, heretofore Master Mechanic, Toronto, has been appointed Master Mechanic, Ontario Lines. Office, Toronto.

J. R. DONNELLEY, heretofore Master Mechanic, Northern Division, Allandale, Ont., has been appointed Assistant Master Mechanic, Ontario Lines. Office, Allandale, Ont. The position of Master Mechanic, Northern Division, has been abolished.

W. H. SAMPLE, heretofore Master Mechanic, Ottawa Division, Ottawa, Ont., has been appointed Master Mechanic, Western Lines, vice Garret Vliet, Master Mechanic, Western Division, deceased. Office, Battle Creek, Mich. The position of Master Mechanic, Ottawa Division, has been abolished.

H. G. SMITH, heretofore City Passenger and Ticket Agent, G. T. P. R., Vancouver, B. C., has been appointed Assistant City Passenger Agent, G. T. R., Grand Rapids, Mich.

The following station agents have been appointed,—Brockville, Ont., pass., A. E. Parker; Seagrave, Ont., F. S. Allin; Middlemiss, Ont., L. E. Baughman; Ekfrid, Ont., A.

**Canadian Northern Railway Earnings, Etc.**

Gross earnings, working expenses, net earnings, increases, or decreases, compared with those for 1913-14, from July 1, 1914:—

	Gross Earnings	Expenses	Net Earnings	Increase or Decrease
July	\$1,594,300	\$1,163,800	\$430,500	x \$83,800
Aug.	1,367,700	1,123,000	244,700	x 163,900
Sept.	2,109,900	1,519, 00	590,700	65,800
	\$5,071,900	\$3,806,000	\$1,265,800	x\$181,900
Decr.	\$ 676,600	\$ 494,700	\$ 181,900	.....

x Decrease.  
Mileage under operation at Sept. 30, 4,670, against 4,520 at Sept. 30, 1913.

**Canadian Pacific Railway, Earnings, Etc.**

Gross earnings, working expenses, net earnings, increases, or decreases, compared with those for 1913-14, from July 1, 1914:—

	Gross Earnings	Expenses	Net Earnings	Increase or Decrease
July	\$10,481,971.72	\$6,703,525.89	\$3,778,445.83	x\$328,347.35
Aug.	8,917,764.33	6,554,606.68	3,373,157.70	x 597,981.54
	\$20,399,736.10	\$13,258,132.57	\$7,141,603.53	x\$936,328.89
Dec.	\$ 3,027,786.05	\$ 2,091,457.16	\$ 836,328.89	.....

x Decrease.  
Approximate earnings for September, \$10,479,000, against \$11,887,000 for Sept., 1913.  
At the end of September, the mileage under operating was increased to 12,319.

**Grand Trunk Railway Earnings, Etc.**

Gross earnings, working expenses, net earnings, etc., compared with those for 1913, from July 1, 1914:—

	Gross Earnings	Expenses	Net Earnings	Increase or Decrease
July	\$4,724,000	\$3,668,200	\$1,055,800	.....
Aug.	4,853,600	3,564,100	1,259,500	x\$61,800
	\$9,577,600	\$7,232,300	\$2,345,300	.....

x Decrease.  
Approximate earnings for September, \$4,671,559, against \$4,870,641 for Sept., 1913.  
Mileage under operation at Sept. 30, 4,533, as at Sept. 30, 1913.

**Grand Trunk Pacific Railway Earnings.**

The approximate earnings of the Prairie Section and Lake Superior Branch, 1,104 miles, for September were \$718,744, against \$756,779 for Sept., 1913. Aggregate earnings for three months ended Sept. 30, \$1,619,197, against \$1,738,371 for the same period 1913.

**N.T.R. Car Ferry.**—In commenting on the final completion of the National Transcontinental Ry., which is expected to take place early in November, the Toronto Mail and Empire of Oct. 15 says:—"The war and its effect on naval shipyards in England has

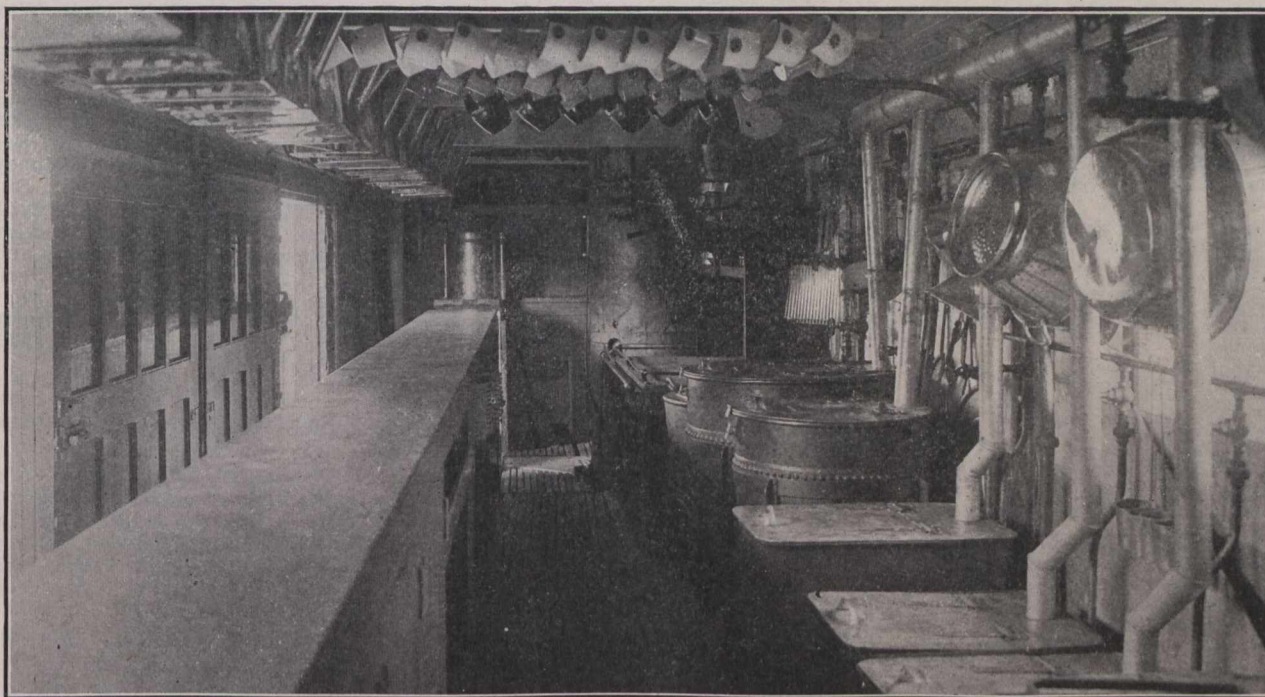

Interior of military commissary car, Canadian Pacific Railway. A full description of these cars with floor plan was published in Canadian Railway and Marine World for October, page 463.

E. Beales; Sebringville, Ont., F. A. Malcolm; Burford, Ont., W. J. Meredith; Harley, Ont., G. Swan.

**National Transcontinental Ry.**—Consequent on the rapidly approaching completion of this line, the following officials have retired from the service. D. Macpherson, M. Can. Soc. C. E., Assistant to the Chairman; R. F. Uniacke, M. Can. Soc. C. E., Bridge Engineer; and A. L. Ogilvie, Purchasing Agent. W. S. Lawson is acting Bridge Engineer and G. A. Briggs acting Purchasing Agent.

GEO. S. HODGINS, Assistant Engineer, Mechanical Department, Ottawa, has resigned and removed to New York.

It is reported that 2,806 C.P.R. employes hold first aid certificates, an increase of 1,830 during the year ended Oct. 1. During the same period these men rendered first aid in 1,370 cases of accident or illness.

**United States Shipping Registry.**—It is reported from Washington, D.C., that 60 foreign built vessels, aggregating 233,781 tons, have been transferred to the U.S. register under the recently enacted laws. Of these, 54 were formerly in the British register, four were German, and two Belgian. Fifty-seven were operated on the Atlantic Ocean, and three on the Pacific Ocean; 19 were passenger vessels, 37 were freight vessels, and 4 were not placed. Of the total 46 were steamships, and the balance sailing vessels and barges.

**London and Lake Erie Ry. and Transportation Co.**—The following directors have been elected for the current year: W. K. George, President; G. B. Woods, Vice President; G. O. Sommers, J. W. Scott, J. B. Holden, T. H. Purdom, J. Purdom, J. Milne. L. Tait has been appointed Secretary-Treasurer, and W. N. Warburton has been reappointed General Manager and Purchasing Agent.

delayed the delivery of the car ferry Leonard for use between Quebec and Levis." The Leonard arrived at Quebec, Aug. 15, and announcement to this effect, with a description and illustrations of the vessel, were given in Canadian Railway and Marine World for September.

**Passenger rates between New York and Buffalo.**—A press report states that the applications of the New York Central and other railways to be allowed to charge a passenger fare of \$9.75 between New York and Buffalo, N.Y., in either direction, has been refused by the Interstate Commerce Commission, which held that as a combination of fares between intermediate points totals only \$8.50, a \$9.75 rate would be unreasonable.

**Cornwall St. Ry. Light and Power Co.**—The ratepayers of Cornwall, Ont., on Oct. 14, passed a bylaw extending the company's franchise for 20 years.



## Canadian Pacific Railway Construction, Betterments, Etc.

A statement as to work on the C.P.R. for this year showed that up to mid September there had been graded 555 miles, as compared with 499 in the same period of 1913, and in addition there had been completed second track for 113 miles. Furthermore, the company is going ahead with extension work, the mileage under construction on western lines, not including double tracking, being 500 miles. The operated mileage between Port Arthur and Vancouver was 7,632 on Sept. 17, as compared with 6,971 a year ago.

The company issued orders recently for the employment of 6,000 men, married men with families having the preference, to engage in ballasting and other work, on the various divisions. A very large part of this work is in progress on the western lines, about 1,000 men being given employment on the lines in Saskatchewan, and 12 work trains, fed by six steam shovels and operated by large gangs of men were put to work on the lines in Alberta, Sept. 28.

**Eastern Division.**—Rapid progress is reported to have been made with the new station building at the Palais, Quebec.

The improvements at Place Viger, Montreal, which included the reconstruction of the station, the enlargement of the hotel, and considerable rearrangement of the yards at Montreal, are reported to have been completed. The work was in progress for about three years.

**Lake Superior Division.**—Second track is now in operation between the following points:—

	Miles.
Romford Junc. and Sudbury .....	6.8
Azilda and Cartier .....	26.6
Cartier and Geneva .....	3.4
Roberts and Woman River .....	25.9
Nemegos and Chapleau .....	16.5
Chapleau and Esher .....	9.0
Healey and Bolkow .....	19.1
Depew and White River .....	5.3
White River and King .....	21.8
Heron Bay and Peninsula .....	8.4
Amy and Rosport .....	5.1
Cavers and Gurney .....	11.0
Fire Hill and Ruby .....	4.0
Navilus and Port Arthur .....	7.9

Total .....

**Manitoba Division.**—A very large amount of work is in progress at the Winnipeg station and at the Royal Alexandra Hotel. Considerable changes are being made in the interior arrangements of the station. New baggage and express rooms are being located on the north side of the station, but beneath the tracks, with which there will be elevator connection. The present baggage and express section is to be turned into a second class waiting room. Stairways will lead from this to a concrete paved area under the tracks, from which stairways will ascend to the platforms, all of which will be covered. A subway is being built underneath the tracks at the east end to connect with the present immigration hall. This building is to be utilized for post office purposes as soon as the new immigration hall is completed. A new subway is under construction at Main St. In the hotel building the new wing will contain a ball room, dining room, grill room, private dining rooms, etc. Other improvements are also being made and a considerable portion of the ground floor is being rearranged.

The line from Boissevain to Lauder, Man., 36.9 miles, forms a cut off between the Napinka and Esteven subdivisions, and connects at Lauder with the Griffin subdivision for Aleda.

The new Virden-McAuley line, 36.6 miles, makes an alternative route with that via Kirkella.

**Saskatchewan Division.**—On the Weyburn-Lethbridge line an additional 77.5 miles of

track was put in operation, Oct. 7, between Shaunavon, mileage 230.8, and Gowanlock, Sask., mileage 307.3. There are 11 stations on the new section.

The extension of the line from Kerrobert to Monitor, 75 miles, which has been opened for traffic, makes a complete line from Moose Jaw, via Outlook and Kerrobert to a junction with the Edmonton subdivision at Lacombe, 444 miles, and gives the choice of seven C.P.R. routes between Winnipeg and Edmonton. On the 75 miles just opened for traffic there are six stations in Saskatchewan and four in Alberta, the track crossing the provincial boundary line between Court, mileage 37.3 from Kerrobert, and Compeer, mileage 43.3.

The Empress-Bassano line is reported completed and in operation. Its completion gives a line of 235.8 miles from Swift Current to Bassano, Empress being 117.5 miles from the first named point. A locomotive house, coaling plant and station buildings are under construction at Empress.

**Alberta Division.**—The newly opened line from Red Deer to Rocky Mountain House, Alberta, built as the Alberta Central Ry., is 64.8 miles long.

A new line, somewhat south of the main line, but passing through new country, has been opened for traffic between Gleichen and Shepard, Alberta, 33.9 miles. This gives two lines between these points.

**British Columbia Division.**—The Board of Railway Commissioners has authorized the opening for traffic of the following mileages of second track:—Mileage 0.4 to 24.00, and mileage 103.4 to 128.9, Shuswap Subdivision; mileage 0.5 to 8.7, Thompson Subdivision, B.C.

### Traffic Orders by the Board of Railway Commissioners.

The dates given for orders are those on which the hearings took place, and not those on which the orders were issued:—

**Rates on Groceries in Mixed Carloads.**  
General Order 132. Oct. 2. Re complaints of Montreal, Toronto, Hamilton and Edmonton Boards of Trade, the Shippers' Section of the Winnipeg Board of Trade, the Ontario Wholesale Grocers' Guild, the British Columbia Wholesale Grocers' Exchange, the Retail Merchants' Association of Canada (Saskatchewan Provincial Board), the wholesale grocers of Regina, the Dominion Wholesale Grocers' Guild, and Balfour, Smye & Co., against the cancellation of mixing privileges in connection with carloads of groceries, dried fruit and liquors from Eastern Canada points to points in Western Canada. It is ordered that the railway companies which, immediately before Sept. 1, 1914, had in effect, by tariffs filed with the Board, arrangements whereby mixed carloads of groceries, classifying 5th class in straight carloads, and dried fruits, classifying 4th class in straight carloads, also foreign and domestic liquors in mixed carloads, were carried in each case at the carload rates applicable to each commodity, respectively, to destinations west of and including Port Arthur, Ont., file tariffs restoring the said arrangements and making them effective from and including Sept. 1st, 1914, until otherwise ordered by the Board, the said arrangements having been abolished by tariffs filed by the following railway companies:—Algonia Central, Boston & Maine, Canadian Northern, Canadian Pacific, Central Vermont; Chatham, Wallaceburg & Lake Erie; Dominion Atlantic, Essex Terminal, Grand Trunk, Grand Trunk Pacific, Great North-

ern, Hull Electric, Michigan Central, Midland of Manitoba, New York Central & Hudson River, Ottawa & New York, Pere Marquette; Quebec, Montreal & Southern; Quebec Railway, Light & Power; Schomberg & Aurora; Thousand Islands; Toronto, Hamilton & Buffalo; Wabash; Windsor, Essex & Lake Shore Rapid.

### Standard Mileage Tariff, C.N.R.

22657. Oct. 2. Re application of Canadian Northern Ry., under sec. 327 of the Railway Act, for approval of its Standard Freight Mileage Tariff, to apply between its stations east of and including Westfort, to supersede C.R.C. no. E. 212, approved by order 19006, April, 9, 1913, and order 21209, Jan., 14, 1914. It is ordered that the Standard Freight Mileage Tariff be approved.

### Rates on Stone.

22664. Oct. 6. Re application of Standard Crushed Stone Co., of Niagara Falls, Ont., for an order directing the G.T.R. to file rates from its siding at Windmill Point to points on its railway and on the Michigan Central Rd., as particularly set forth in the application. It is ordered that the G.T.R. file, with the concurrence of the Michigan Central Rd., the following rates per ton of 2,000 lbs. on cobble, crushed, field or rubble stone, in carloads, of a minimum weight of 60,000 lbs. a car, from its Windmill Point siding to the stations on its line of railway and on the Michigan Central Rd., following, to take effect not later than October 15:—To Ridgeway, 30c.; Amigari and Bridgeport, 35c.; Port Colborne, Humberstone, Stevensville, Wainfleet, Welland and Feeder Siding, 40c.; Black Creek, 45c.; Chippewa and Vichorold, Merritton, Moulton, St. Catharines and Niagara Falls, 50c.; Dunnville, Port Dalhousie, Jordan, Canfield Junction, Vineland, Beamsville, Cayuga, Grimsby and Caledonia, 55c.; Hamilton, Brantford, Paris, Oakville, Port Credit and Toronto, 60c.; Shipyard, 40c.; Black Creek, 45c.; Chippewa and Victoria Park, 50c.; St. Davids and Niagara-on-the-Lake, 60c.

### Great Northern Railway Lines in Canada.

**Midland Ry. of Manitoba.**—A press report states that a contract has been let to W. J. Holmes, for the trestle work on the company's spur line in Winnipeg, and to C. W. Sharp and Sons, for the crossings over streets, and that the work is to be started at once.

**Vancouver, Victoria and Eastern Ry. and Navigation Co.**—It was reported Oct. 10, that track had been laid on about two-thirds of the 26 mile section from the present terminal at Coalmount, to Otter Summit, B. C. Ballasting is in progress, and the construction is expected to be completed by the end of the year.

**New Westminster Station.**—The Mayor has reported to the New Westminster City Council that the agreement with the G. N. R. with respect to the new station in that city has been signed on behalf of the B. C. Government. The work is expected to be started early in 1915. (Oct., pg. 469.)

**The C.P.R. officers' and employes' contribution of one day's pay to the Canadian Patriotic Fund yielded \$140,316.71, and the staff of the Dominion Atlantic Ry., a C.P.R. subsidiary, gave \$1,421.93. The amounts given in the different Provinces were: British Columbia, \$18,000; Alberta, \$18,000; Saskatchewan, \$15,000; Manitoba, \$28,000; Ontario, \$28,000; Quebec, \$28,000; New Brunswick, \$5,316.71; Nova Scotia, \$1,421.93. In addition to this the company gave \$100,000 and directors and officers have also made large personal contributions.**



## Canadian Northern Railway Construction, Betterments, Etc.

**Montreal Tunnel and Terminal Co.**—The tunnel has been widened to the full height and width for nearly 2,000 ft. from the western portal at the Model City. It is 35 ft. wide and 22 ft. high. The work of lining it with concrete blocks has been started. The electrical substruction at the western end of the tunnel is about two-thirds completed.

**Canadian Northern Ontario Ry.**—The first freight train from Toronto arrived in Port Arthur, Ont., Oct. 10. The section of the line from Capreol to Ruel has been operated over for some time, but the Ruel-Port Arthur section has only been finally completed recently. The line from Capreol to Port Arthur forms part of the Montreal-Ottawa-Port Arthur section of the company's transcontinental line. The line from Toronto to Capreol will be the Toronto branch of the transcontinental line.

We are officially advised that although a train of stock cars went over the line as stated, it has not yet been opened for public traffic.

**Canadian Northern Ry.**—It is reported a site has been acquired in Fort William, Ont., for the erection of a new station. The ratepayers will be asked to sanction the plans before the purchase is completed.

Reports were current in Moose Jaw, Sask., Oct. 12, that the clearing of houses and other buildings on the land purchased for the C. N. R. right of way meant the immediate building of a line directly into the city, and the building of a central station to replace the present one at South Hill. The report is also revived that a union station with the Grand Trunk Pacific Ry. is being arranged for.

The Saskatchewan Legislature has extended the time within which the Canadian Northern Ry., and the Canadian Northern Saskatchewan Ry., may build the lines for which the province has guaranteed bonds. This act covers the lines which are under construction and gives an extension of time to Jan. 1, 1917, for their completion; and extends the time for the starting of the other lines to Jan. 1, 1917.

A press report states that a contract has been let for the grading of 23 miles from Medicine Hat to Hanna, Alberta, to the Northern Construction Co. The Mayor of Medicine Hat returned to the city from Winnipeg, Oct. 8, and is reported to have stated that Sir William Mackenzie informed him that this work would be started immediately.

Ballasting is being proceeded with on the line from Camrose to Edmonton, and it is expected that a train service will be put on by the end of the year.

The line from Stettler to Nordegg, Alberta, 123 miles, has been taken over by the operating department, and a train service put on. It is reported that about 900 tons of coal a day are being shipped from the collieries at Nordegg.

Track was laid on the Onoway-Grand Prairie line in 1913 to the Pembina River, mileage 32. A bridge is under construction over the river, which involves 2,000 ft. of trestle work, and 400 ft. of steel work, the latter at a height of 74 ft. Grading is reported to be completed to the McLeod River at Whitecourt, 43 miles from the Pembina. The McLeod River will be crossed by a bridge 600 ft. long, which will not be built until the track reaches Whitecourt.

**Canadian Northern Pacific Ry.**—Sir William Mackenzie returned to Toronto, Oct. 2, from a trip over the line. He is reported to have said in an interview, that there now remains about 90 miles of track to be laid be-

tween the ends of steel being pushed westerly from the Yellowhead Pass, and easterly from Kamloops. The work had been somewhat delayed by the slowness of deliveries of steel for the bridge work, but he expects to see the track laying completed in December.

**Vancouver Terminals.**—A press report states that a contract has been let to H. Peterson, for the erection of a temporary wall, 2,000 ft. long, in False Creek, Vancouver, to hold back material to be dredged from the creek and poured in, and that the work is to be started at once. (Oct., pg. 467.)

### Grand Trunk Pacific Railway Hotel at Edmonton.

The G. T. P. Ry. hotel in Edmonton, Alberta, which is to be known as the Macdonald, is reported to be about completed. It overlooks the Saskatchewan River at an elevation of about 200 ft., and commands extensive views both up and down the river. The building is of the chateau style, which the company has adopted for all its hotels, but each building has an individuality of its own. The building is L shaped, the right wing parallels McDougal Ave., and the left the side street. The right wing is 115 by 55 ft., and the left 165 by 87, with an entrance connecting the two wings. The main doorway gives entrance to the rotunda, lounge rooms, offices, tea room, dining room, ball room, and the other public rooms; while the kitchens, etc., are beneath. The mezzanine floor overlooks the rotunda, and opens on the terrace over the main entrance. It comprises a ladies' drawing room, men's writing room, banquet room and three private dining rooms. There are five floors above for bedrooms, 22 rooms on each floor being fitted with bathrooms. On each floor are public lavatories and bathrooms, service rooms, etc. The interior of the entire building has been most carefully planned, and the decorations and appointments are the most modern. The architects are Ross and Macdonald, Montreal, and the contractors are the Canadian Stewart Co. The date for opening the hotel has not been announced.

### Australian Freight and Passenger Rates Advanced.

Increases in freight rates of 10%; and in passenger fares ranging from 5 to 50%, are the means by which the government railways of New South Wales, Australia, have undertaken to combat the world wide advance in costs of railway operation. The annual report of these railways as analyzed by the Bureau of Railway News and Statistics, presents detailed outlines of the advances, and attributes them almost wholly to the expansion in wages and costs of materials.

This is looked upon as the most striking recent instance of the facility with which state owned railway systems have been adopting advances in rates to cope with the rapid rise of late years in operating expenses, and is in sharp contrast to the experience of the private transportation systems of the United States, where, in spite of recognition by the Interstate Commerce Commission of pressing need, eastern railways have been refused a 5% advance covering only freight rates, and under emergencies caused by the European war the roads have had to petition for a reopening of their case owing to actual threatening of their credit structures.

Increased charges for freight transportation placed in effect by the New South Wales government roads are uniformly 10%, and with the estimated annual increase in revenue are as follows:—

1st and 2nd class freight rates	...\$350,000
Class A, B and C mileage rates	.... 230,000
Live stock rates	..... 300,000

Total added freight revenue ...\$880,000

Advances have been made in passenger fares, despite the fact that "cheap excursion fares" already were on a basis of 4c. per mile first class, and 2c. per mile second class, while "special cheap excursion week end rates" were 3½c. per mile first class, and 1½c. per mile second class, compared with an average of only 2c. per mile received for all passenger traffic by United States railways in 1913. The increases range from 5% in the case of through fares, to 50% in second class excursion fares. The total new yearly revenue from both services is estimated at \$1,750,000, or more than 5.3% of gross operating revenues in 1913. A similar increase in the United States would amount to almost \$169,000,000.

In explanation of the increases the minister of the government railways points out that expenses rose \$3,742,000 in the last year, of which \$2,704,000 was in wages. The operating ratio rose from 68.8% in 1913 to 69.9% in 1914. Wages took up \$49.68 of every \$100 revenue in 1914, against \$48.80 in 1913.—Railway Review, Chicago.

### Railway Rolling Stock Notes.

The Intercolonial Ry. has received 2 express refrigerator cars from its Moncton Shops.

The C.P.R., between Sept. 15 and Oct. 15, ordered 9 refrigerator cars from its Angus Shops.

Randolph Macdonald Co., Toronto, has ordered one 4-wheel switching locomotive from the Montreal Locomotive Works.

The Intercolonial Ry. has ordered 6 steel frame 1st class cars from Canadian Car and Foundry Co., and 1 wrecking crane of 100 tons capacity.

The C.P.R., between Sept. 15 and Oct. 15, received 69 steel frame box cars, 7 steel first class cars and 1 class W locomotive, from its Angus Shops.

In 1913 the C.P.R. built 81 locomotives in its Angus Shops, Montreal. It is stated that only one railway in America built more in its own shops during the year.

The G.T.R. has received 4 suburban type locomotives from the Montreal Locomotive Works; 7 first class cars from the Canadian Car and Foundry Co., and 5 baggage cars from the National Steel Car Co.

The Canadian Car and Foundry Co. during September, delivered 11 wooden colonist cars to the Canadian Northern Ry.; 6 steel frame first class cars to the G.T.R., and built 1 all steel 40 ton box car for its own purposes.

A press report from Edmonton, Alta., states that the Edmonton, Dunvegan and British Columbia Ry., has the following rolling stock:—100 box cars, 12 refrigerator cars, 60 ballast cars, 11 passenger cars, 1 private car and 6 locomotives, while other rolling stock is on order, delivery of which will be made shortly.

**New York Central Merger Approved.**—The consolidation of the New York Central and Hudson River Rd. with the Lake Shore and Michigan Southern Ry. has been approved by the New York Public Service Commission, Second District.



## General Inspection of the Grand Trunk Lines.

Some 50 G.T.R. officials, drawn from all parts of the system, have been making a tour of inspection of the company's various lines. They travelled in a special train of nine cars, including an inspection car, designed for the trip, which is fitted with large glass panels, allowing an uninterrupted view of the line, and with electrically controlled apparatus for recording the impressions of the observers. It has seats arranged in tiers, row above row, in order that every occupant may view the right of way as the train proceeds. Thus every part of the track comes in for the closest scrutiny from men whose business is track construction and maintenance.

The annual inspections have been made in the past by a limited number of the higher officials. H. R. Safford, the Chief Engineer, decided this year to broaden out this inspection. The object was to make the men actually doing the work the judges of what has been achieved in the way of track improvement. The track superintendents and track supervisors, and representatives of other ranks, were summoned from the various districts, as far west as Chicago, to assist their superior officers in the inspection, and they started from Portland, Me., the Atlantic terminus of the system, on Oct. 14. They travelled over some 1,500 miles of track, the inspection proceeding from 6 a.m. to 6 p.m. Each day a special committee was appointed, composed of track supervisors, another the spacing of the ties, others ballast distribution, neatness of station grounds and buildings, fencing, spikes, side tracks, and the level and gauge of the rails. Before each man was a series of electric push buttons, and as each mile post was passed he gave his report, awarding points according to the excellence of the work he was inspecting. These awards were flashed up on an indicator board and clerks recorded them. At the end of every section—four miles of double track, or five miles of single—an average was made and the section showing the best results in each division of the line will very shortly bear a board announcing the fact. There was naturally the keenest competition to obtain these honors. Section was competing against section, and division against division. The committees were so arranged that an absolutely impartial judgment was obtained. The men taking part in the lengthy trip also found it valuable from an educational standpoint, for they were given an opportunity of seeing what was being done on the other sections of the line. They were also brought into close contact with the company's officers and a healthy spirit of co-operation was developed.

H. G. Kelley, Vice President in charge of construction, maintenance and operation, joined the party at Montreal. Others taking part were: H. R. Safford, Chief Engineer; M. S. Blaiklock, Engineer Maintenance of Way; U. E. Gillen, General Superintendent, Western Lines; H. E. Whittenberger, General Superintendent, Ontario Lines; and C. G. Bowker, General Superintendent, Eastern Lines; with divisional superintendents and their staff officers.

**Grand Trunk Trainmasters.**—We are officially advised that the G. T. R. management has no intention of abolishing the positions of trainmasters over the system, as has been persistently stated in daily papers.

**W. J. DeWolfe, Halifax, N.S.,** in writing to have his address changed, says: "I do not care to miss any of the valuable material I find in Canadian Railway and Marine World each month."

## Restoration of the Canadian Pacific Railway Elevator at North Transcona.

The C.P.R. elevator at North Transcona, Man., which settled and listed to an angle of 27 degrees in Oct., 1913, has been brought back to a plumb position except on the east and west axis, after a number of interesting and difficult pieces of work. Both the handling house and storage bin structures were originally constructed on a reinforced concrete mattress, this plan having been followed as the usual tests indicated sufficient strength to carry it without going to bed rock. Other elevators have been erected in like manner in that vicinity without mishap. When the settlement of the bins occurred, the low corner of the foundation mattress settled to a point very much below the mattress of the handling house, but fortunately the latter structure was not disturbed to such an extent that any movement occurred in it. Before, however, the work could be done of underpinning or strengthening the bins, it was necessary to secure the handling house and this was done by first sinking shoring piers to rock outside of the main handling house structure. On these shoring piers were placed timber pushers, or shores, which were figured strong enough to carry a very large proportion of the total weight of the building. The work of underpinning the columns of the handling house was then proceeded with by cutting through the mattress in the panel between columns and drifting in to a point under the centre of the columns, and there sinking a pier to rock by the Chicago method.

After the underpinning of the handling house structure had sufficiently advanced so as to make its stability absolutely certain, work was begun on the straightening of the bins. The latter structure weighs about 20,000 tons and consists of 5 rows of Chicago wells of 14 each; these piers being located under the contracts of the bins. Before any movement was allowed to take place, the mattress was penetrated and Chicago wells sunk underneath the low corner of the mattress; the intention being to avoid any possibility of the structure sinking further into the ground. On the east or high side the general excavation was made to a point about 15 ft. below the high corner of the mattress, the full length of the building. By the use of a belt conveyor placed along this excavation, which delivered into the elevator at the north end, the excavated material was removed at a minimum cost. After the low corner was made secure, work became general on sinking the other foundation piers, at the same time loosening up the supporting ground from the high side of the structure and allowing it gradually to sink back towards a plumb position. This method was followed out until the structure reached an angle of 18 degrees off plumb, when a series of solid oak rockers was introduced in the mattress; on top of the middle line of piers jacks or shoring screws were placed underneath the low side, working on top of the piers that were in place, and by jacking the low side and bleeding the earth out from under the high side the structure was gradually brought back until it was 8 degrees off plumb, when another line of oak rockers was introduced on the next line of piers, east of the middle. This was done in order to give the structure an additional lift, which when it was brought plumb would leave the bottom of the tunnels above the natural ground water level.

During settlement of the elevator, on account of the ground being somewhat softer

on the north end, and the supporting ground on the south end being prevented from flowing, due to location of the workhouse, the north end of the elevator settled about 5 ft. lower than the south end. Therefore in straightening the elevator on the north and south axis, the inclination on this axis, amounting to about 5 ft. in total length, has remained the same, and the elevator at present is not exactly plumb on east and west axis. There is no loss of efficiency, convenience of operation or safety and for this reason it is not intended to take the time to bring the elevator plumb on the east and west axis.

In all, the structure was lifted up about 12 ft. during the process of straightening. The method adopted for restoring the elevator to a condition for operation has proved efficient and very economical, as compared to the question of taking down the old structure and rebuilding.

**The Bridle Belt Ry. and Navigation Co.** proposes to lay out railway and steamship terminals at Seattle, Wash., at a total cost of \$15,000,000. It is stated that as projected the first unit of the terminal will consist of two docks, each 200 by 800 ft., and 4 stories high; an 8 story building 500 by 500 ft. in dimensions, and a 20 story 250 by 500 ft. hotel and office building. The terminals will be connected by a three mile tunnel to Lake Union large enough to provide clearance for a double track railway. The tunnel portion of the project will cost something like \$2,000,000. It is proposed to construct the terminal near lower Pike St. and the 8 story building on Railroad Ave. The 20 story structure would face on First Ave. and 10 stories of the building would be below the level of that street. The reports further state that two Canadian railways will be provided with terminals. A. P. Gillies, Seattle, Wash., is one of the promoters, and the Stone and Webster Corporation, Boston, Mass., are said to be interested.

**Conductors for Light Locomotives.**—The attention of the Board of Railway Commissioners having been called to different interpretations put upon section 4 of order 12225 (general order 65) it is ruled: that in the case of the movement of a light locomotive, or two or more light locomotives coupled, for a distance greater than 25 miles, when the movement is either on a single track or against the current of traffic on a double track, the word "conductor" as used in section 4 of the said order 12225, shall mean one regularly appointed for service as a conductor and possessed of the qualifications set out under sub-section b of sec. 6, of the aforesaid order.

**Railway Lands Patented.**—Letters patent were issued during August, covering Dominion railway lands in Manitoba, Saskatchewan, Alberta and British Columbia, as follows:—

	Acres.
Alberta Central Ry. ....	7.54
Calgary and Edmonton Ry. ...	2,086.61
Canadian Northern Ry. ....	638.00
Canadian Pacific Ry. ....	6.45
Kootenay Central Ry. ....	183.24

Total ..... 2,921.84

Alfred Berglund, son of CHARLES BERGLUND, section foreman, C. P. R., Finmark, Ont., accidentally shot himself dead while moose hunting recently.

The design of drop forge dies should be such that draft be allowed to prevent the forgings sticking to the dies.



# Canadian Railway AND Marine World

ESTABLISHED 1898

Devoted to Steam and Electric Railway,  
Marine, Express, Telegraph, and Railway and  
Canal Contractors' Interests.

Official Organ of the various Canadian  
Transportation Associations.

Published on the first of each month.

ACTON BURROWS, LIMITED - Proprietors,  
70 Bond Street, Toronto, Canada.

ACTON BURROWS, A. Can. Soc. C. E.,  
Managing Director and Editor-in-Chief.

AUBREY ACTON BURROWS - Secretary and  
Business Manager.

Associate Editor - JOHN KEIR  
Associate Editor - DONALD F. KEIR  
Mechanical Editor - FREDERICK H. MOODY, B.A.Sc.  
Canadian Business Representative - W. H. HEWITT  
70 Bond Street, Toronto  
United States Business Representative, A. FENTON WALKER  
143 Liberty Street, New York, N.Y.  
European Business Representative - I. MEREDITH McKIM  
3 Regent St., London, S.W., Eng.

Authorized by the Postmaster General for  
Canada, for transmission in second class matter.

Entered as second class matter, July 25, 1913,  
at the Postoffice at Buffalo, N.Y., under the Act  
of Congress of March 3, 1879.

SUBSCRIPTION PRICE, including postage  
anywhere, \$2 a year.

SINGLE COPIES, 20 cents each, including  
postage.

The best and safest way to remit is by express  
money order. Where one cannot be obtained, a  
post office money order, or bank draft, payable  
at par in Toronto, may be sent. Cheques or  
drafts not payable at par in Toronto cannot be  
accepted. Remittances should be made payable  
to Canadian Railway and Marine World.

#### NOTICE TO ADVERTISERS.

ADVERTISING RATES furnished on applica-  
tion.

ADVERTISING COPY must reach the pub-  
lishers by the 10th of the month preceding the  
date of publication.

TORONTO, CANADA, NOVEMBER, 1914.

#### PRINCIPAL CONTENTS.

Algonia Central and Hudson Bay Ry. Com- pletion .....	501
Appointments, Transportation .....	502
Birthdays of Transportation Men .....	489
Board of Railway Commissioners—	
Orders by, Summaries of .....	509
Traffic Orders .....	504
Canadian Northern Ry. Construction .....	505
Canadian Pacific Ry., Annual Meeting .....	508
Construction, Etc. ....	504
North Bay Locomotive Shops .....	487
Canadian Ticket Agents' Association .....	508
Dominion Atlantic Ry. Improvements .....	490
Electric Railway Department .....	511 to 517
Application of Standard Code of Train Rules to Electric Railways .....	513
Finance, Meetings, Etc. ....	515
Hydro Electric Railways for Toronto Northeastern District .....	516
London and Port Stanley Ry. Equipment. Montreal and Southern Counties Ry. Passenger and Express Cars .....	514
Projects, Construction, Etc. ....	516
Toronto Ry. Service, Consideration of .....	512
Express Companies, Among the .....	517
Grand Trunk Pacific Ry., Construction .....	501
Grand Trunk Ry., Betterments, Etc. ....	508
General Inspection .....	506
Great Northern Ry. Lines in Canada .....	504
Report .....	497
Intercolonial Ry., Halifax Ocean Terminals. Mainly About Transportation People .....	496
Marine Department .....	524
Fort William Shipping Report .....	520
Lights and Fog Alarms on the Great Lakes and St. Lawrence River .....	521
Prince Edward Island Car Ferry .....	513
Sault Ste. Marie Canals Traffic .....	521
Vessels Registered .....	520
National Transcontinental Ry. Construction Railway Development .....	501
Railway Earnings .....	500
Railway Finance, Meetings, Etc. ....	503
Railway Mechanical Methods and Devices. .....	497
.....	491,
.....	492
Railway Rolling Stock Notes .....	491
Roadmasters' and Maintenance of Way As- sociation .....	489
Statistical Control of Railway Operations. Telegraph, Telephone and Cable Matters. Wooden Frame Box Cars in Freight Trains.	493

## Six Thousand Extra Laborers Employed on the Canadian Pacific Railway.

Just after Canadian Railway and Marine World's last issue had gone to press it was announced by the C.P.R. management that the operating departments of its eastern and western lines had been authorized to take on 6,000 extra laborers for suitable work during October and November at current rates of wages. The object of this measure, it is explained by the management, is to help to furnish employment before winter and relieve possible distress occasioned by the temporary dislocation of business due to the war.

## Dominion Subsidies for Electric Railways in Ontario.

In speaking at several meetings in the territory just east of Toronto recently, in advocacy of the construction of radial electric railways by the municipalities, under the auspices of the Hydro Electric Power Commission of Ontario, Sir Adam Beck, Chairman of the Commission, is reported to have said:—

"We are not going on until we secure from Ottawa definite assurance that the railways of the people shall have at least some of the consideration lavished upon promoters of corporate-owned enterprises. This is the people's business. We have no promoters' profits and no watered stock in this enterprise. It is conducted on a business basis. It is true we have no definite word from Ottawa yet, but you people will have the say. It remains for you to determine in the last analysis. If one Government fails to do its duty to the people, they have it in their power to elect another one."

This is in line with the Ontario Legislature's action last session in memorialising the Dominion Government to encourage the construction of municipal hydro electric railways in Ontario and asking that Dominion Government subsidies be given for the building of such lines. Sir Adam Beck's remarks infer that privately owned electric railways have received Dominion subsidies, but such is not the case. Only one electric railway in the whole of Canada received a Dominion subsidy, the exception being the Oshawa Ry. in Ontario, which when the subsidy was granted was projected as a steam line, though it had the right to use any other motive power. It was given a Dominion subsidy of \$3,200 a mile.

We are offering no objection to the granting of Dominion subsidies for municipal hydro electric railways in Ontario, but should such subsidies be granted, then in all fairness similar subsidies should be paid to the suburban or interurban railways already built in Ontario and other provinces by private capital. There is a precedent for retroactive action of this sort in the subsidy granted the Timiskaming and Northern Ontario Ry. by the Dominion Parliament last year.

## The Change in the Postmaster General- ship.

If the retirement from the Government and from Parliament of the Hon. L. P. Pelletier is on account of ill health, as stated, it is of course to be regretted, but on other accounts there will be no regret, and the change is especially welcome to newspaper publishers generally throughout the Dominion and by the management of city electric railways.

For two sessions in succession, Mr. Pel-

letier sought to get Parliament to confer on him the power to decide what compensation shall be paid electric railway companies for the transportation of postmen, and steadily refused to allow the matter to be settled by the Board of Railway Commissioners, until the Canadian Electric Railway Association's representations, before the Senate Committee on Banking and Commerce, compelled him to back down.

Last session, after breaking faith with the Canadian Press Association, he tried to smuggle a bill through Parliament to transfer from Parliament to the Postmaster General, the power to decide the rate to be paid for the transmission of newspapers through the mail. In this attempt he was defeated by the opposition given to his measure on behalf of the Canadian Press Association, particularly by the chairman of its postal committee, P. D. Ross, proprietor of the Ottawa Journal, and a supporter of the Government, and by some other individual publishers, and there is no doubt that the hostility he aroused by his arbitrary course proved a source of weakness to him. In commenting on his actions in July, Canadian Railway and Marine World said:

"The Premier is conversant with the facts. Believing as we do in his high-mindedness and absolute probity, we cannot think that he can approve of such arbitrary methods and we look to him to restrain his colleague. If this is impossible it would be advisable to transfer the P.M.G. to some other position, preferably outside the cabinet, where his opportunities for the perpetuation of glaring injustice would be at least minimized."

We felt that Mr. Pelletier's retirement from the Postmaster Generalship was absolutely necessary in the interest of fair play, and while the alleged cause of his retirement is to be regretted, it is satisfactory that his opportunities for securing dangerous legislation are at an end.

The new Postmaster General, T. Chase Casgrain, has a good record. We hope he will show firmness and independence in his administration of the department, and that he will refuse to be misled by permanent officials, some of whom appear to think that they are the masters of the people and not its servants.

Sir Adam Beck, Chairman of the London, Ont., Railway Commission, is reported to have announced that some 40,000 old ties taken out of the London and Port Stanley Ry. will be distributed among the poor of London and St. Thomas for fuel.

Intercolonial Ry. employes in the first Canadian overseas contingent numbered 149, and it is expected that many more will volunteer for the second contingent. A press report says that they will be allowed full pay during their absence and that their positions will be kept for them.

The Toronto Board of Control has instructed the Corporation Counsel to apply to the Board of Railway Commissioners for an order directing the railway companies to electrify all their lines in the city, and for a distance of two miles from the city boundaries.

British Exhibit Train.—It is stated that included in the scheme which is being worked out by the Canadian Chamber of Commerce in London, Eng., to promote the extension of British trade in Canada, is the idea to send a British built train, with exhibits of British manufactures, to tour the Dominion. It is stated that the whole train, including the locomotive, is to be built to suit Canadian requirements, so that when the purposes of the exhibition have been served, it may be sold to a railway company on this side.



## Canadian Pacific Railway Company's Annual Meeting.

Sir Thos. G. Shaughnessy, President, who took the chair at the annual meeting in Montreal, Oct. 7, in moving the adoption of the report for the year ended June 30, as published in Canadian Railway and Marine World for September, said:—

The contraction in the volume of trade and travel during the last half of the fiscal year under review was greater than your Directors anticipated when they had the privilege of meeting the shareholders a year ago, and the effect on your revenue in every branch of the service was quite pronounced. However, with the property in splendid physical condition, and with the facilities for economical operation that had been provided at large cost in recent years, your operating officials were enabled to make a substantial reduction in working expenses, and the decrease in net revenue was far more moderate than it would have been in other circumstances.

Since the close of the fiscal year the unrest and uncertainty resulting from the outbreak of the European war has created a condition of affairs unique in the company's history, and any attempt to forecast the business situation in the immediate future would, at this stage, serve no useful end.

The crops recently harvested in Western Canada, although probably 15% to 20% less in volume than they were a year ago, owing to an insufficient midsummer rainfall in some sections, will yield the producers a larger gross return because of the high prices that prevail in the markets, and the purchasing power of the producers will be improved accordingly. This should have the effect of stimulating westbound traffic, with a favorable influence on your earnings, but to what extent this influence may be counteracted by the unsatisfactory business conditions that prevail generally cannot be estimated with any degree of accuracy at this time.

When the peace of the world has been restored, emigration from Europe to the newer countries, where lands can be obtained on moderate terms, will doubtless be on a large scale, and Canada should profit very substantially by the incoming of new settlers and the consequent increase in production. The serious setback that our country experienced in the past two years was due unquestionably, in a considerable measure, to our rapid growth and increase of wealth, with the consequent optimism that clouded the effect of unsound speculation in lands and industrial enterprises and of railway schemes years in advance of their time, but it was due in a greater degree to external causes in which Canada had no share. The period of retrenchment and financial conservatism that the country has passed through will have had the effect of liquidating to an important extent the injurious results of domestic mistakes, and Canada, when the tide turns, will be ready with renewed sturdy strength to utilize her almost unlimited resources and prosecute her plans for agricultural, industrial and commercial development on sane and logical lines. Your directors have the same implicit faith in the future growth and prosperity of the country that they have had from the beginning.

The large railway mileage that you had in process of construction has been practically completed, and the only important works now in hand are the tunnel in the Selkirk Mountains, the passenger and freight terminals at Quebec that are to be used jointly by this company and the National Transcontinental Ry., and the station at North Toronto. No new expenditures of any conse-

quence will be required for some time to come.

As indicated by the annual report, your finances are in excellent shape. While the balance in banks is, of course, not as large as it was at June 30, the amount is still a very substantial one, a fortunate circumstance in these trying times, and you have over \$50,000,000 of securities to issue with reference to completed railway lines and rolling stock equipment for which the money was advanced from your treasury. With some improvement in financial conditions such portion of these securities as may be thought desirable can be readily sold.

On May 29 the Company's Atlantic steamship *Empress of Ireland* was rammed by a collier and sunk in the St. Lawrence River near Father Point. The injury to the steamship was of such a character and so serious that there was little opportunity for rescue before the vessel foundered with a lamentable loss of life. A royal commission appointed for the purpose of investigating the circumstances made a report acquitting the company and its officers of all blame, and held the collier accountable for the disaster. Nevertheless, I am sure that all the shareholders join with the directors and officers in a feeling of profound sorrow for those who lost their lives while travelling under the company's auspices, and of deep sympathy for their relatives and friends. The monetary loss was not a matter of any special moment.

Your directors have selected J. K. L. Ross, of Montreal, to fill the vacancy in the Board resulting from the death of the late Lord Strathcona, and his name will be submitted for your ballot with the names of the other two directors whose term of office has expired.

At a special general meeting to be held upon the adjournment of this meeting there will be submitted for your consideration a proposal to increase the authorized ordinary capital stock from \$260,000,000 to \$335,000,000. This is essentially a precautionary measure for the future, establishing your right to issue new capital when your traffic has reached such proportions as to compel further large additions to your property.

The report having been adopted a number of resolutions were passed, as foreshadowed in the report, relating to the Toronto union station; the agreement between the Kettle Valley Ry. Co., and the Vancouver, Victoria & Eastern Ry. Co.; the leases of the Kettle Valley Ry., the Lake Erie and Northern Ry., the Southampton Ry., the Fredericton and Grand Lake Ry., and the Glengarry and Stormont Ry.; relations with the Spokane and International Ry.; and re the office of Assistant Secretary. Sir Thos. G. Shaughnessy, Sir Thomas Skinner were re-elected directors, and J. K. L. Ross was also elected to serve for four years. At a special general meeting, held immediately after the annual meeting, an increase of the capital stock from \$260,000,000 to \$335,000,000 was authorized.

At a subsequent meeting of directors Sir Thos. G. Shaughnessy was re-elected President; D. McNicoll, Vice President, and the following as the executive Committee:— R. B. Angus, H. S. Holt, D. McNicoll, Sir Edmund B. Osler, Sir Thos. G. Shaughnessy, Sir Wm. C. Van Horne.

Canada has not gone to pot yet! Canadian railway presidents, Sir William Mackenzie and E. J. Chamberlin, have "come out of the West," enthusiastic and optimistic.—Financial Times.

## Canadian Ticket Agents' Association.

The association held its annual outing this year in Chicago, where Oct. 6, 7 and 8 were spent. At the opening of the business meeting addresses of welcome were given by two city officials and the President of the British Empire Association. J. Kidd, ticket agent, C.P.R., Goderich, Ont., was elected President, and E. de la Hooke, of London, Ont., who has been continuously Secretary-Treasurer since the association's organization, 27 years ago, was unanimously re-elected.

G. W. Vaux, General Agent, Passenger Department, Union Pacific Rd., Chicago, and formerly of the G.T.R., acted as secretary of the local reception committee and did a lot of work in that connection, the other members of the committee being C. G. Ortenburger, G.W.P.A., Canadian Government Railways; R. H. Bell, G.A., Canadian Northern Ry.; G. A. Walton, G.A.P.D., Canadian Pacific Ry.; J. D. McDonald, A.G.P.A., Grand Trunk Ry.; C. C. Clark, G.A.P.D., Michigan Central Rd., and F. H. Tristram, A.G.P.A., Wabash Rd. The social features arranged for by the local committee included an automobile drive through the parks and boulevards, a tour of the elevated railways, a steamboat trip along the water front, an illustrated lecture on Pacific Coast routes and the San Francisco exhibition for 1915, and an inspection of the Chicago and North Western Ry.'s new terminal, with a luncheon in its restaurant. The ladies were entertained at a luncheon in the grill room of Marshall Field and Co.'s store and also to a theatre party, and the men had a smoker at the hotel headquarters.

Mr. Vaux issued a greeting folder for distribution to the members, having on its title page a facsimile of a Union Pacific Rd. annual pass issued in 1868 to Murray Anderson, President, London and Port Stanley Ry., London, Ont., and which is now in possession of his son-in-law, J. H. Flock, K.C., London, Honorary Counsel, C.T.A.A. Mr. Vaux also issued an historical circular containing a lot of interesting railway information. In recognition of his indefatigable efforts, the members of the association presented him and Mrs. Vaux with a silver cake basket.

## Grand Trunk Railway Betterments, Construction, Etc.

Lachine, Jacques Cartier and Maisonneuve Ry.—Three appeals, arising out of awards by arbitrators in connection with the taking of land for the right of way of this projected railway, were disposed of in the Court of Review, Montreal, Oct. 8. Two of the appeals were made by the company, and one by the landowner. The three appeals, which were entirely on technical points, were dismissed. These decisions bring the construction period a little nearer.

Bonaventure to St. Henri.—The two new tracks authorized by the Board of Railway Commissioners to be laid between Bonaventure Station and St. Henri, Montreal, have been laid. Work was started immediately after the decision had been given, and completed in a few days.

Lindsay Terminals.—The Lindsay, Ont., Town Council was informed, Oct. 8, that the company was considering plans for the laying out of new terminals at that divisional point, but that it was impossible to state when the plans would be ready or when it would be possible to start work. (Oct., pg. 464.)



## Orders by Board of Railway Commissioners for Canada.

Beginning with June, 1904, Canadian Railway and Marine World has published in each issue summaries of orders passed by the Board of Railway Commissioners, so that subscribers who have filed our paper have a continuous record of the Board's proceedings. No other paper has done this.

The dates given of orders, immediately following the numbers, are those on which the hearings took place, and not those on which the orders were issued. In many cases orders are not issued for a considerable time after the dates assigned to them.

22560. Sept. 17.—Amending order 22495, Sept. 3, re Erie and Ontario Ry. branches at Dunnville, Ont.

22561. Sept. 16.—Authorizing G.T. Pacific Ry. to build spur for Inverness Cannery at mileage 12.8 from Prince Rupert east, B.C.

22562. Sept. 16.—Authorizing G.T. Pacific Ry. to build highway between Secs. 34 and 35, Tp. 42, R. 1, w. 4 m., Alta., across its Butze gravel pit spur.

22563. Sept. 18.—Authorizing C.P.R. to operate interlocking plants at Murdock, at mileage 3.5, Winnipeg Beach Subdivision, and at mileage 3.6, Arborg Subdivision, Man.

22564. Sept. 18.—Authorizing C.P.R. and Canadian Northern Ry. to operate over interlocking plant at Woodman, Man.

22565. Sept. 17.—Approving Canadian Northern Ry. location in n.w. ¼ Sec. 19-2-6, w. 2 m., Sask., and authorizing it to take certain C.P.R. lands in n.w. ¼ Sec. 19.

22566. Sept. 17.—Amending order 22469, Aug. 29, re St. John and Quebec Ry. crossings of C.P.R. in Fredericton, N.B.

22567. Sept. 16.—Authorizing C.P.R. to build spur for Hewitt and Black, Ltd., Medicine Hat, Alta.

22568. Sept. 17.—Authorizing C.P.R. to build its ballast pit spur across two highways on its Moosejaw Southwesterly Branch, mileage 0.745 and 1.79.

22569. Sept. 16.—Authorizing C.P.R. to build spur for McDonald Construction Co., Calgary, Alta.

22570. Sept. 18.—Authorizing Canadian Northern Ry. to connect its Vegreville-Calgary Branch with C.N. Western Ry. Brazeau Branch at Warden, Alta.

22571. Sept. 19.—Authorizing Mission City Telephone Co. to erect its wires across C.P.R. at DeRoche, B.C.

22572. Sept. 17.—Approving Bell Telephone Co. agreement with Pelee Tp., Ont.

22573. Sept. 16.—Dismissing application of Town of Parry Sound, Ont., for reconsideration of order 4008, Nov. 26, 1907, and for order directing C.P.R. to build subway at Armstrong St.

22574. Sept. 16.—Approving revised location of Edmonton, Dunvegan and British Columbia Ry. through Tps. 76 and 78, R. 19 and 20, w. 5 m., Alta.

22575. Sept. 16.—Authorizing Edmonton, Dunvegan and British Columbia Ry. to build across 12 highways in Alberta.

22576. Sept. 16.—Authorizing Hydro-Electric Power Commission of Ontario to erect transmission line across C.P.R. wires and tracks at Goderich, near Meneset station, double poles to be erected on each side of railway.

22577. Sept. 16.—Authorizing Canadian Northern Ry., until May 1, 1915, to carry traffic over its Oakland Branch from mileage 42 to end of track, in Manitoba, 12 miles, speed limited to 12 miles an hour.

22578. Sept. 23.—Authorizing Dominion Atlantic Ry. to carry freight over its North Mountain Branch from Centreville to Somerset, 12.09 miles; speed limited to 12 miles an hour.

22579. Sept. 17.—Authorizing Quebec Oriental Ry. to build siding from its main line to Chaleurs Bay Mills, Mann Tp., Que.

22580. Sept. 21.—Authorizing C.P.R. to operate over bridges 81.0, 17.0 and 103.3, Sudbury Subdivision, Ont.

22581. Sept. 21.—Amending order 22446, Aug. 25, re certain grade crossings on C.P.R. Weyburn-Stirling Branch, Sask.

22582. Sept. 19.—Authorizing C.N. Ontario Ry. and Campbellford, Lake Ontario and Western Ry. (C.P.R.) to operate over crossing, in Lot 27, Con. 2, Pickering Tp., Ont., and interlocking plant, without first stopping trains.

22583. Sept. 17.—Authorizing C.N. Ontario Ry. to build across public road between Lots 20 and 21, Con. 7, mileage 204.48 from Ottawa, Chisholm Tp.

22584. Sept. 21.—Authorizing British Columbia Department of Public Works to build level highway crossing at station 546+05, Vancouver, Victoria and Eastern Ry. Phoenix Branch.

22585. Sept. 22.—Authorizing British Columbia Government to build highway over Great Northern Ry. at Hedley, old highway crossing east of station to be closed.

22586. Sept. 22.—Relieving G.T.R. from speed limitation of 10 miles an hour over crossing of James St., Brampton, Ont.

22587. Sept. 18.—Authorizing Toronto, Hamilton and Buffalo Ry. to build spur in Hamilton, Ont., from Grasselli Chemical Co.'s spur, with

three spurs from same to connect with first named.

22588. Sept. 22.—Relieving G.T.R. from speed limitation of 10 miles an hour over crossing of Wilmot St., Berlin, Ont.

22589. Sept. 22.—Approving location of C.P.R. station at Pays Plat, Thunder Bay District, Ont.

22590. Sept. 22.—Approving C.P.R. clearances through rock house on Mond Nickle Co.'s spur at Worthington, Ont.

22591. Sept. 22.—Approving International Bridge and Terminal Co.'s Standard Freight Tariff, C.R.C. 1.

22592. Sept. 21.—Authorizing Niagara, St. Catharines and Toronto Ry. to build siding for G. A. Keyes, in Lot 4, Con. 1, Grantham Tp., Ont.

22593. Sept. 21.—Approving Kettle Valley Ry. location from mileage 69 to 70.15 west of Pen-tiction, B.C.

22594. Sept. 21.—Authorizing Saskatchewan Board of Highway Commissioners to build ditch under Canadian Northern Ry. in s.e. ¼ Sec. 27-32-8, w. 2 m.

22595. Sept. 21.—Amending order 22545, Sept. 14, re highway crossing over G.T. Pacific Ry. north of Rutan siding, Sec. 22-35-27, w. 2 m., to be built by Saskatchewan Government.

22596. Sept. 18.—Authorizing G.T.R. to build two additional tracks across certain highways in Montreal.

22597. Sept. 16.—Approving C.P.R. clearances of structures on Oliver & Webster's sidings, mileage 91.4, Owen Sound Subdivision, Ont.

22598. Sept. 19.—Authorizing St. Marys Portland Cement Co. to receive \$4,000 deposited in bank in St. Marys to the Board's credit.

22599. Sept. 23.—Approving location of Esquimalt and Nanaimo Ry. Co.'s station at Dashwood, B.C., mileage 105.1.

22600. Sept. 23.—Authorizing C.P.R. to open for traffic various revisions of line at points on Lake Superior Division, Ont.

22601. Sept. 23.—Amending order 13827, June 2, 1911, re Manitoulin and North Shore Ry. (now Algoma Eastern Ry.) subway crossing of C.P.R.

22602. Sept. 23.—Refusing application of City of Hamilton, Ont., for authority to extend Birmingham St. southerly to Toronto, Hamilton & Buffalo Ry. spur.

22603. Sept. 23.—Authorizing Algoma Central and Hudson Bay Ry. to open for traffic its line from Oba to east, Ont., mileage 83 to 130.87.

22604. Sept. 24.—Authorizing City of London, Ont., to build storm sewer under G.T.R. at Colborne St.

22605. Sept. 24.—Authorizing C.P.R. to build its Moose Jaw Southwesterly Branch under Canadian Northern Ry. Swift Current South-easterly Branch, at mileage 43.62, in Sec. 13-11-30, w. 2 m., Sask.; C.P.R. to change design of foundations to satisfaction of C.N.R. should ground at bridge prove soft.

22606. Sept. 25.—Authorizing City of St. Boniface, Man., to build highway crossing over Canadian Northern Ry. at Archibald St.

22607. Sept. 23.—Approving Standard Freight Mileage Tariff, C.R.C. 23, effective Sept. 1, to apply between stations on Vancouver and Lulu Island Ry. and the Vancouver, Fraser Valley and Southern Ry. Co.

22608. Sept. 25.—Authorizing Ancaster Tp., Ont., to build grade crossing over Toronto, Hamilton & Buffalo Ry. on Emerson St., West Hamilton.

22609. Sept. 25.—Rescinding order 22069, June 25th, re G.T.R. siding for St. Marys Portland Cement Co., Blanshard Tp., Ont.

22610. Sept. 22.—Extending to Nov. 30, time within which Campbellford, Lake Ontario and Western Ry. (C.P.R.) shall install automatic bell at crossing of Frontenac Road, Farham, Ont.

22611. Sept. 26.—Amending order 22536, Sept. 11, re extension of highway by Ops Tp., Ont., over Georgian Bay and Seaboard Ry. (C.P.R.) at mileage 9, Port McNicoll Subdivision.

22612. Sept. 23.—Ordering Quebec, Montreal and Southern Ry. to rebuild roadway on farm of M. P. Senneville, La Baie Parish, Que., within 30 days.

22613. Sept. 25.—Amending order 22512, Sept. 5, re C.P.R. clearances of gantry crane at Galt, Ont.

22614. Sept. 25.—Amending order 21368, Feb. 17, re operation of Kena Valley Ry. from Pen-tiction wharf westerly for 17 miles, B.C.

22615. Sept. 23.—Relieving G.T.R. from providing further protection at crossing of public highway 1½ miles west of Lancaster station, Ont.

22616. Sept. 26.—Approving location of Glengarry and Stormont Ry. (C.P.R.) station and grounds at Glenbrook, Ont., mileage 20.23.

22617. Sept. 22.—Relieving G.T.R. from speed limitation of 10 miles an hour over crossing ½ mile north of Shallow Lake, Ont.

22618. Sept. 23.—Relieving C.P.R. from speed limitation at Herbert, Sask., as imposed by order 19500, May 29, 1913.

22619. Sept. 28.—Extending, to Oct. 31, time

within which C.P.R. shall install gates at St. Maurice St., Three Rivers, Que.

22620. Sept. 28.—Authorizing Algoma Central and Hudson Bay Ry. and C.P.R. to operate bridge at crossing of C.P.R., Sault Ste. Marie, Ont.

22621. Sept. 30.—Authorizing Saskatchewan Board of Highway Commissioners to build road along south boundary of south ½ Sec. 11-26-7, w. 3 m., across Canadian Northern Ry.

22622. Sept. 30.—Approving G.T.R. clearances at platform on premises of Union Stock Yards of Toronto, south of St. Clair Ave. and west of Dods Ave.

22623. Sept. 29.—Approving location of Glengarry and Stormont Ry. (C.P.R.) station and grounds at mileage 9.05, Lancaster Tp.

22624. Sept. 29.—Authorizing Glengarry and Stormont Ry. (C.P.R.) to build at grade across highways at mileage 26.60, 26.72, 26.86 and 27.00, Cornwall Tp., Ont.

22625. Sept. 29.—Authorizing G.T.R. to build additional track across 18th Ave., Lachine, Que.

22626. Sept. 29.—Amending order 22541, Sept. 14, re C.P.R. ballast pit spur in Van Horne Tp., Ont.

22627. Sept. 28.—Authorizing Canadian Northern Ry. to build spur for the Slocum Howland Coal Properties and to divert certain highways in Secs. 9, 8 and 7, Tp. 29, R. 20, w. 4 m., Alta.

22628. Sept. 29.—Approving location of Esquimalt and Nanaimo Ry. flag stop shelter at Royston, B.C., mileage 135.9.

22629. Sept. 29.—Authorizing C.P.R. to open for traffic portions of double track from mileage 0.4 to 24.0 and 103.4 to 128.9, Shuswap Subdivision, and from mileage 0.5 to 8.7, Thompson Subdivision, B.C.

22630. Sept. 30.—Authorizing C.P.R. to build spur for Campbell, Wilson and Strathdee, Ltd., and alter trackage for Regina Cartage Co., Regina, Sask.

22631. Sept. 27.—Approving location of C.P.R. station in Tp. 36, Sudbury District, Ont., mileage 20.10, White River Subdivision.

22632. Sept. 21.—Extending express collection and delivery area in Swift Current, Sask., as fixed by order 20463, Sept. 30, 1913, and rescinding orders 20463, Sept. 30, 1913, and 22117, July 3, 1914.

22633. Sept. 21.—Recommending to Governor in Council for approval G.T. Pacific Ry. bylaw 16, respecting handling of public at stations and on trains.

22634. Sept. 28.—Authorizing Dominion Express Co. to refund to Edmonton City Dairy, Ltd., 5c. per can on all cream carried to Edmonton, Alta., and not delivered, and declaring Dominion Ex. Co.'s position with regard to such deliveries. This order is given more fully on another page under Among the Express Companies.

22635. Sept. 28.—Rescinding order 16874, June 26, 1912, in so far as it relieves C.P.R. from erecting fences on certain portions of its line in British Columbia.

22636. Sept. 21.—Extending for three months from date time within which G.T.R. shall complete siding for Pilkington Bros., Wainfleet Tp., Ont., authorized by order 22041, June 19.

22637. Sept. 28.—Authorizing G.T.R. to rebuild bridge carrying Victoria Ave., Niagara Falls, Ont., across its tracks.

22638. Sept. 28.—Authorizing C.N. Ontario Ry. to build bridge over Grand Lake Narrows, mileage 127.35 from Ottawa.

22639. Sept. 28.—Amending order 20207, Aug. 27, 1913, re building of road by Saskatchewan Government under Canadian Northern Ry. in s.w. ¼ Sec. 21-29-17, w. 3 m.

22640. Sept. 30.—Amending order 22515, Sept. 5, re C.N. Alberta Ry. Spur for Pembina Coal Co., near Entwistle, Alta.

22641. Sept. 30.—Relieving C.P.R. from speed limitation of 20 miles an hour over its Virden-McAuley Branch from mileage 13.5 to 36.0, Manitoba.

22642. Oct. 1.—Authorizing C.P.R. to revise location of spurs built for Fort William Starch Co., Ltd., in Lots 6 and 7, Con. D, Island no. 2, Fort William, Ont., and to build extensions to them.

22643. Oct. 1.—Authorizing Canadian Northern Ry. to build spur track to mileage 1.93, Birds Hill Branch, for Cusson Lumber Co., Ltd., in Transcona, Man.

22644. Oct. 1.—Amending order 22292, July 28, re rate on sand and gravel from Clover Bar to Edmonton, Alta.

22645. Sept. 30.—Authorizing Michigan Central Rd. and New York Central Rd. to use storm window in front of cabs, shown on plans filed.

22646. Oct. 1.—Directing C.P.R. to stop its train 211, which passes Highlands, Que., at 8.48 p.m., inbound, on flag, for a trial period of two months, company to keep record of number of stops and traffic at this point.

22647. Oct. 1.—Directing that C.P.R. make cattle pass on A. G. Waite's property, Streetsville, Ont., 6 ft. high and 6 ft. wide in clear, and that level crossing there be constructed in accordance with Standard Regulations, work on level crossing to be completed within 30 days and on cattle pass within 60 days.

22648. Oct. 1.—Authorizing Canadian Northern Western Ry. to join its Brazeau Branch with Alberta Central Ry., in Sec. 22-39-7, w. 5 m., Alberta.



22649. Sept. 30.—Rescinding order 22055, directing G.T.R. to establish train service on Haliburton Subdivision.

22650. Sept. 30.—Authorizing Canadian Northern Ontario Ry. to take for purpose of carrying out provisions of order 22056, June 24, portions of Lots 78 and 80, St. Eustache Parish, Que., property of F. X. Boileau.

22651. Oct. 2.—Amending order 22112, July 3, dismissing Canadian Northern Ry. application for repeal of order 20808, Nov. 13, 1913, re diversion of Rue La Verandrye, St. Boniface, Man.

22652. Sept. 30.—Approving agreement between Bell Telephone Co. and Burnt River Telephone Co., Ltd., Sept. 16, and rescinding order 8238, Oct. 5, 1909, in so far as it approved agreement between Bell Telephone Co. and Burnt River Telephone Co., dated June 2, 1909.

22653. Oct. 1.—Authorizing Erie and Ontario Ry. to build bridge across Welland River at mileage 7.95 from Smithville.

22654. Oct. 2.—Amending order 22091, May 26, re charges on cordwood from Richan, Ont., to Winnipeg.

22655. Oct. 2.—Authorizing C.P.R. to operate bridge 45.8, McAuley Subdivision, and 84.55, Bredensbury Subdivision, Manitoba Division.

22656. Oct. 1.—Relieving C.P.R. from erecting and maintaining fences along its right of way between Sudbury and Port Arthur, Ont.

22657. Oct. 2.—Approving C.N.R. Standard Freight Mileage Tariff, to apply between stations on its lines east of and including Westford, Ont., superseding C.R.C. no. E. 212 previously approved.

22658. Oct. 2.—Authorizing C.N.R. to build spur for Worswick Paving Co., in Lots 12 and 13, Block 26, Edmonton, Alta., subject to conditions of consent of Edmonton City Commissioners.

22659. Oct. 1.—Directing G.T.R. forthwith to employ watchman at crossing of public highway just east of Seaforth station, Ont., between 7 a.m. and 7 p.m.; wages to be paid 20% by town and remainder by company.

22660. Oct. 2.—Limiting to 6 miles an hour speed of all trains operated over Grand Trunk Pacific Ry. along Empire Ave., Fort William Ont., from intersection of Syndicate Ave. to Canadian Northern diamond.

22661. Oct. 2.—Approving revised arrangement of interlocking plant at crossing of G.T.R. by Ottawa and New York Ry. at Cornwall Jct. Ont.

22662. Oct. 3.—Amending order 22587, Sept. 18, by authorizing Toronto, Hamilton and Buffalo Ry. to build spur in Hamilton, Ont., from Grasselli Chemical Co.'s spur, by authorizing G.T.R. to operate the same jointly.

22663. Oct. 2.—Authorizing Glengarry and Stormont Ry. to operate, for construction purposes only for 30 days after installation of diamond, over crossing of G.T.R., near Cornwall, Ont.; provided trains be brought to a stop and flagged over crossing by watchman appointed by G.T.R. at expense of G. & S.R.

22664. Oct. 6.—Directing that G.T.R. publish and file, with concurrence of Michigan Central Rd., rates on cobble, crushed, field, or rubble stone, in carloads, of minimum weight of 60,000 lbs., from Windmill Point siding to stations on its line and on M.C.R., effective not later than Oct. 15.

22665. Oct. 5.—Approving revised location of Lake Erie and Northern Ry. from Bruce St., Galt, Ont., to connection with C.P.R. on north side of Main St.

22666. Oct. 5.—Authorizing Public Works Department of Alberta to build highway in Sec. 4-13-13, w. 4 m., across C.P.R.

22667. Oct. 3.—Rescinding order 21413, Feb. 27, 1914, suspending tariffs filed by certain railway companies, requiring additional railway tickets for exclusive use of drawing rooms or compartments in sleeping and parlor cars, the companies having complied with general order 130.

22668. Oct. 5.—Amending order 22550, Sept. 12, 1914, authorizing C.P.R. to alter spur for McCormick Mfg. Co., London Tp., Ont.

22669. Oct. 3.—Authorizing C.P.R. to build road diversion in N.W. ¼ Sec. 24-2-9, w. 2 m., Sask.; and build Estevan-Forward Branch across it at mileage 4.65, at grade.

22670. Oct. 5.—Authorizing C.P.R. to carry third track of main line, Moose Jaw Subdivision, across 9th Ave., Broadview, Sask., on a bridge.

22671. Oct. 6.—Approving C.P.R. plan showing Standard 2A locomotive house.

22672. Oct. 6.—Rescinding order 22392; and directing that G.T.R. build spur connecting with its westbound main track, West Flamboro Tp., Ont., subject to certain conditions.

22673. Oct. 5.—Authorizing G.T.R. to build siding for Pilkington Bros., N. ½ Lot 48, Con. 1, North Cayuga Tp., Ont.

22674. Oct. 5.—Authorizing Great Northern Ry., operating V.V. & E. Ry. & Nav. Co. to discontinue for present year suburban service required to be put into effect by order 19870.

22675. Oct. 5.—Amending order 22346, July 21, re New York Central Rd. stopping certain trains at Adirondack Jct.

22676. Oct. 5.—Approving location Canadian Northern Manitoba Ry. through Tp. 28, and Rgs. 8-10, w.p.m., Man.

22677. Oct. 5.—Approving Campbellford, Lake Ontario and Western Ry. (C.P.R.) plan of galvanized iron fence to be erected from north end of Lot 183 to south end of Lot 179, Bowmanville, Ont.; provided fence be painted.

22678. Oct. 6.—Authorizing C.P.R. to build at grade, tracks of legs of wye across Railway Ave. West, Gowanslock, mileage 308 on Weyburn-Stirling Branch.

22679, 22680. Oct. 5.—Authorizing G.T.R. and Lake Erie and Northern Ry. to operate trains over crossing between Paris and St. George, Ont., at station 538-16.9, and over crossing of G.T.R. by Lake Erie and Northern Ry. at Paris, Ont.

22681. Sept. 25.—Authorizing Kettle Valley Ry. to carry traffic on its line from mileage 17 to 40.9, west of Penticon, B.C.

22682, 22683. Oct. 7.—Authorizing C. P. R. to operate over bridges 27.67 and 65.89, Edmonton, Subdivision, N. B., and over bridges 14.7 and 18.7, Emerson Subdivision, Man.

22684. Oct. 8.—Ordering G. T. R., within 30 days to rebuild fence along right of way on property of J. Lawson, Maple Lake, Ont., between mileage 377 and 378.

22685. Oct. 6.—Approving revised location of G. T. Pacific Ry. from Lot 415 into Lot 731, mileage 235.57 to 256.10 R. 5, Coast District, B.C.

22686. Oct. 6.—Authorizing Campbellford, Lake Ontario and Western Ry. (C. P. R.) and G. T. R., to operate over crossing in Whitby, Ont., without first stopping trains.

22687. Oct. 6.—Approving G. T. Pacific Ry. revised location from Lot 4149 into Lot 3577, mileage 332 to 340.88, Prince Rupert East, R. 5, Coast District, B. C.

22688. Oct. 6.—Ordering that all Michigan Central Rd. train movements on siding to Dominion Chain Co., be flagged across Bender St., Niagara Falls, Ont.

22689. Oct. 5.—Approving Lake Erie and Northern Ry. location in Galt, Ont., from station 1135+50 to 116+30.7, and authorizing it to use C. P. R. right of way from station 1160+78.5 to connection with C. P. R. at station 2921+40, and connect with its own tracks at last mentioned point and authorizing it to use C. P. R. between stations 1114+76.3 and 1135+50, Galt, embankments to be sodded and kept in good condition, opening to be built through embankment to provide approach to park from Beverly St., at a point to be approved by the Board and suggested by Galt Park Commissioners.

22690. Oct. 8.—Approving G. T. Pacific Ry. revised location from Lots 4287 to 5341, mileage 289.24 to 316.26, Prince Rupert East, R. 5, Coast District, B. C.

22691. Oct. 9.—Ordering that grade of highway and railway were C. P. R. crosses Yonge St., North Toronto, be separated by means of a subway for highway traffic, and authorizing City of Toronto to widen Yonge St. there from 66 to 86 ft.; additional strip to be taken on east side of street; city to compensate company for portion of its lands taken; subway to have 18 ft. headroom; all work in connection with subway, except that affecting water pipes, sewers, sidewalks and pavements, to be done by company, city to pay additional cost of subway as provided for herein; all disagreements to be settled by the Senior Judge of York County, who is appointed arbitrator; and rescinding orders 16842, 16846, and 17390 in so far as they are inconsistent with this order.

22692. Oct. 6.—Authorizing G. T. Pacific Branch Lines Co. to build its Salter gravel pit spur across highways between Secs. 28 and 27, and 27 and 26-38-16, w.3.m. Sask.

22693. Oct. 6.—Authorizing G. T. R. to build extension of siding for Ontario Government near Mimico, Ontario.

22694. Oct. 9.—Extending to Dec. 31, time within which C. P. R. shall complete spurs at mileage 2.26, Muskoka Subdivision, Ont., Lot 1, Con. 4, west of Yonge St., York Tp., on Canadian Kodak Co.'s land.

22695. Oct. 6.—Authorizing Erie and Ontario Ry. to divert highway through Lot 4, Con. 2, and Lot 5, Con. 3, Gainsboro Tp., Ont.

22696. Oct. 6.—Approving Halifax and South Western Ry. bylaw authorizing General Freight and Passenger Agent to issue passenger and freight tariffs.

22697. Oct. 9.—Ordering G. T. R. to maintain speed limitation of 10 miles an hour on all south-bound trains over crossing of Norfolk St., near Simcoe, Ont.

22698. Oct. 7.—Ordering C. P. R. within 30 days to lower drain under its Guelph and Goderich Branch, on J. Denholm's farm, Blyth, Ont., by 18 inches.

22699. Oct. 9.—Ordering C. P. R. to install gates at crossing of McLennan Ave., North Toronto, Ont., to be operated by day and night watchmen; one third of cost to be paid by C. P. R. and the balance by the City of Toronto.

22700. Oct. 9.—Relieving C. P. R. from speed limitation of 10 miles an hour over crossing between Lots 34 and 35, Con. k. Scarborough Tp., just east of Wexford station, Ont.

22701. Oct. 10.—Authorizing Lake Erie and Northern Ry., to connect with Toronto, Hamilton and Buffalo Ry. in Brantford, Ont.

22702. Oct. 9.—Authorizing C. N. Ontario Ry. and C. P. R. to operate temporarily, pending

construction of alterations in interlocking plant, over crossing near Hurdman's Bridge, Nepean Tp., Ont., trains to be flagged over crossing.

22703. Oct. 13.—Amending order 22665, Oct. 5, re Lake Erie and Northern Ry. location in Galt, Ont.

22704. Oct. 13.—Authorizing C. P. R. to build spur for Reliance Moulding Co., in Lot 5, Con. west of Great Catarqui, Kingston Tp., Ont.

22705. Oct. 13.—Approving Halifax and South Western Ry. standard mileage tariff of maximum tolls, C. R. C. no. E-1, to apply on merchandise rates on express lines east of Windsor and Sudbury, Ont.

22706. Oct. 10.—Authorizing C. P. R. to make alterations and additions to spurs for Western Canada Flour Mills Co., Calgary, Alta.

22707. Oct. 10.—Authorizing C. N. Quebec Ry. and C. P. R. to operate over crossing at L'Epiphanie, Que., without first stopping trains.

22708. Oct. 13.—Authorizing C. P. R. to connect its spur to Frontenac Floor and Tile Co., Kingston, Ont., with G. T. R. spur.

22709. Oct. 14.—Authorizing Kettle Valley Ry. to build across certain highways in Hope, B. C.

22710. Oct. 13.—Ordering G. T. R. by May 1, 1915, to install gates at crossing of Ottawa St., Hamilton, Ont., to be operated by day and night watchmen; 20% of cost to be paid by the railway grade crossing fund, cost of maintenance and operation to be paid half each by City of Hamilton and company.

22711. Oct. 13.—Authorizing Lake Erie and Northern Ry. to build bridge across Grand River, Brantford, Ont.: Toronto, Hamilton and Buffalo Ry. grade a short distance west of the bridge not to be disturbed.

22712. Oct. 14.—Ordering C. N. Ontario Ry. to improve road at crossing between Cons. 4 and 5, Portland Tp., either by tearing down old west abutment and making easy turn in road, or by carrying road straight down hill from new subway; work to be completed by Dec. 1.

22713. Oct. 15.—Relieving C. P. R. from maintaining agent at Spillimacheen station B. C., until earnings there amount to \$15,000 a year, as provided in general order 54, Jan. 6, 1910.

22714. Oct. 16.—Amending order 22697, Oct. 9, re speed limitation of G. T. R. trains near Simcoe, Ont.

22715. Oct. 16.—Extending for two months from date time within which G. T. R. shall complete building of highway over its line in Tay Tp., Ont., required under order 22344, Aug. 5.

General Order 132. Oct. 2.—Directing railway companies to restore, effective Sept. 1, 1914, arrangements whereby mixed carloads of groceries, classifying 5th class in straight carloads, and dried fruits, classifying 4th class in straight carloads, also foreign and domestic liquors in mixed carloads, were carried in each case at the carload rates applicable to each commodity respectively, to destinations west of and including Port Arthur, Ont.

**Railway Situation in Saskatoon.**—A plan was submitted for consideration to the Saskatoon, Sask., City Council, Oct. 18, upon the railway situation in the city. The plans accompanying the report showed the routes of the C.P.R., the C.N.R., and the G.T.P. Ry. now entering the city, and the suggested improvements. The report suggested the building of an elevated railway through the city, with which all the lines would be connected, the erection of a central passenger and freight station, and the laying out of freight yards at the north east and south west sides of the city. It is suggested in the report that any other railway seeking an entrance into Saskatoon should be connected with the elevated line.

**Frauds by C.P.R. Conductors.**—Eleven C. P. R. conductors were, at Toronto, Oct. 22, each fined \$200, or three months imprisonment, two other employes were sentenced to two months imprisonment, two fined \$50 and one allowed out on suspended sentence, for practising fraud on the company, in connection with a short fare business between Toronto and Sudbury. In connection with the same series of charges, an information clerk at the C.P.R. city office, Toronto, was sentenced to two months imprisonment, a sleeping car conductor to one month imprisonment, and two outsiders were fined \$50 each, and one allowed to go on suspended sentence.

Ralph Lund, Storeman, Grand Trunk Pacific Ry., McBride, B.C., writes: "I am very much interested in the issues of Canadian Railway and Marine World, as I receive them from time to time."



# Electric Railway Department

## Electric Equipment for the London and Port Stanley Railway.

As mentioned in Canadian Railway and Marine World for September, rapid progress has been made in the renovation of the London and Port Stanley Ry., and track laying and ballasting are nearly completed by the Pere Marquette Rd., which has been operating the line for some years, under lease from the owner, the city of London. The city's interests were recently transferred to the London Railway Commission, and this body has arranged with the P.M.R. for a continuation of its services, pending the completion of the electrification. The engineering phases of the electrification are being developed by the engineering staff of the Hydro-Electric Power Commission of Ontario in its railway department, under F. A. Gaby, Chief Engineer.

Complete specifications have been prepared for the initial installation of electric locomotives, cars and trailers, and while specifically calling for 1,500 volt d.c. equipment, the tendering manufacturers are re-

quired to submit alternative propositions, one to use 3,000 volts d.c., and the other, 13,200 volts single, phase a.c., at 25 cycles.

cars each, and the outer two 7 cars each. It can make two round trips a day, delivering to the line 30 loaded cars, and taking away 30 empties, each trip. The Port Stanley switching yard is practically level, and is approximately 1,000 ft. long. For the purpose of specifying the capacity of the locomotives it has been assumed that the traffic will be handled in 800 ton trains, and that certain periods of time would be desirable in handling the switching and interchange at points along the line. For instance, immediately after unloading and re-loading the ferry, the locomotive would be required to classify the cars and make up the train in an approximate time of 45 mins., the maximum train to be moved being assumed at 15 loaded cars of 70 tons each. After this Port Stanley yard switching, the locomotive would haul the assumed loading of 800 tons up grade to St. Thomas, with power to stop and start again at Whites, where a car might be passed. In St. Thomas

there will be a master controller, air brake valves and all other equipment and meters to provide for complete double end control. Wooden floors will be laid in the operating sections of the cab.

The locomotive trucks will be of the swivel type, each with two driving axles and outside journals, and so designed as to be able to operate as single units without load on curves of 50 ft. radius. The wheels will have steel centres and M.C.B. rolled steel tires. The couplers are also to be M.C.B. standard.

Interpole motors, wound for a normal operating voltage of 1,500, will be used, and the locomotives will be furnished with double and non-automatic multiple unit control, so arranged that at least three locomotives may be operated as a unit from either end of any one, with provision for connecting the four motors of each locomotive in full series, series parallel and full parallel. As the locomotives will occasionally be employed for hauling excursion trains of from 8 to 10 cars, there will be a 600 volt bus extending through the train from the locomotive, supplied from a set consisting of a motor-generator, dynamo-motor or resistance, located in the cab. This will also supply power for the control.

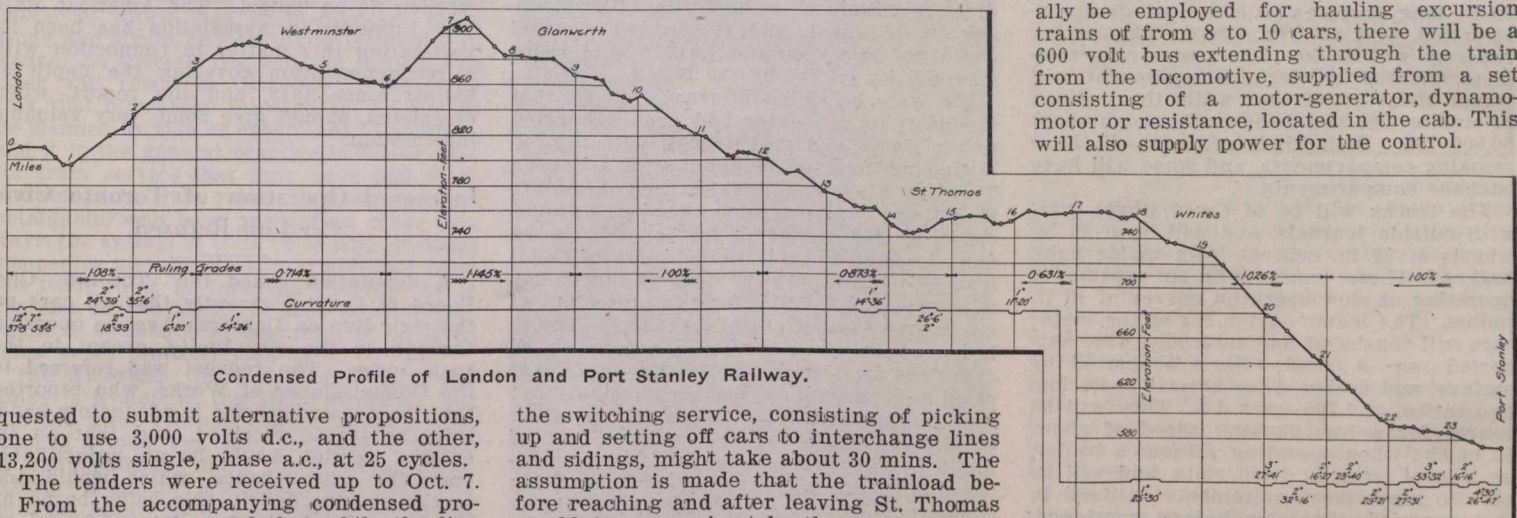

quested to submit alternative propositions, one to use 3,000 volts d.c., and the other, 13,200 volts single, phase a.c., at 25 cycles.

The tenders were received up to Oct. 7. From the accompanying condensed profile, it will be observed that while the line is very short, slightly under 24 miles, the gradients are heavy, presenting a condition that is quite generally conceded to be better adapted to electrical than to steam operation. In developing the electrification scheme, the engineers have been materially guided by the existing traffic conditions. A considerable increase in traffic may be expected, especially in the number of passengers carried, as the nature of the district through which the line passes is such that a frequent service, which would prove unprofitable with steam operation, would increase the travel habit of the people in the district traversed.

**Freight Traffic.** — The freight traffic consists chiefly in hauling loaded coal cars from Port Stanley to St. Thomas and London, a car ferry, operating over 10 months in the year, delivering the cars to the line from the Pennsylvania coal fields across Lake Erie. Some additional traffic, consisting principally of loaded coal and merchandise cars, is delivered to the line at St. Thomas for London, being interchanged from the G.T.R., Michigan Central Rd., and the Pere Marquette Rd. The traffic from London to St. Thomas consists of loaded merchandise cars, and empty coal cars, while between St. Thomas and Port Stanley it consists almost entirely of returning empty coal cars for delivery to the car ferry. This ferry has a capacity of 30 cars on its four tracks, the two central tracks holding 8

the switching service, consisting of picking up and setting off cars to interchange lines and sidings, might take about 30 mins. The assumption is made that the trainload before reaching and after leaving St. Thomas would be approximately the same, on account of the balance between the freight dropped off and the London interchange from the connecting railways. Stops might be required at Glanworth and Westminster, and on arriving in London the cars would be distributed to the various sidings, and a train made up for the return trip, consuming possibly an hour.

**Locomotives.** — To handle this assumed service tenders have been invited for three locomotives, each to weigh approximately 60 tons, capable of developing a maximum speed of about 25 m.p.h. on 1,400 volts, when hauling an 800 ton train on a level track; and further, capable of making the run from Port Stanley to Whites, the heaviest section of the line, with an adverse grade approaching 1% nearly all the way, in 23 mins. A maximum safe speed of 45 m.p.h. is specified. Each locomotive must be capable of accelerating an 800 ton train on a 1% grade with a clean, dry rail, and be able to develop a drawbar pull for a 5 min. period corresponding to a 35% adhesion.

Each locomotive will consist of two 2-axle trucks, supporting a platform and box type cab structure, with all the weight on the driving wheels. The cab platform will consist of structural steel girders and cross beams rivetted to steel plates, which form the cab floor. The sides and roof will be of sheet steel, reinforced by structural steel framework. Cast steel bumpers with push pole pockets will be provided. In the cab

Two pantographs per locomotive, preferably of the pneumatic type, will be arranged for operating from either operative position when operating singly or in multiple, each with a separate cut out to render inoperative any pantograph as desired. The normal trolley height will be 23½ ft. above the top of rail, with maximum and minimum heights of 24 and 16 ft., respectively.

The locomotives will be equipped for combined straight and automatic air brake operation, supplied from two motor driven air compressors, controlled from a governor, each compressor with a capacity of 40 cu. ft. of free air per min. at 110 lbs. per sq. in. The motors will be wound for 1,500 volts, but will also stand short periods of operation at 600 volts. The sanders will be pneumatic, with pipes leading to each of the leading driving wheels, and so arranged that the front and rear sand boxes may be operated independently of each other. They will have a capacity of 5 cu. ft. per pipe.

**Passenger Traffic.** — The passenger traffic on this line during the four summer months is very heavy, with the handling of the crowds to and from the beach at Port Stanley, while at other seasons of the year it is comparatively light. It is the present plan to handle it with 6 motor cars, with 6 trailers for use when the traffic demands. For the purpose of specifying the requirements of these 12 cars it has been assumed that during the summer an alternate limited



and local service might be furnished between London and Port Stanley from 6 a.m. to midnight, the limited trains making stops at the station, the G.T.R. and M.C.R. crossings in St. Thomas, and at such other points as are necessary for passing trains, the local trains making the same stops in St. Thomas, with a possible extra stop on the average of every two miles. During other seasons of the year when the traffic is light, hourly local trains might be run, with limited trains during the rush periods only.

For the purpose of specifying the possible requirements of the line an assumed schedule was developed. Limited trains, consisting of motor car and trailer, making the southbound trip in 47 mins., with an 8 min. layover at Port Stanley, and returning as a local in 58 mins., with a 7 min. layover in London, will make a round trip in two hours. Similarly local trains, travelling southbound in 53 mins., laying over 7 mins. at Port Stanley, and returning to London as a limited in 51 mins., with a 9 min. layover there, will also make the complete round trip in two hours. The maximum safe speed required would be 70 m.p.h.

**PASSENGER CARS.**—Tenders have also been asked for 6 motor cars and 6 trailers. They will be of the double truck type, about 55 ft. long over the knuckles, of steel construction, with an arched roof. The seating capacity will be 60. The motor cars complete, without the electrical equipment, will weigh about 56,000 lbs., while the trailers, of similar size and design, will weigh about 50,000 lbs. Both kinds of cars will have smoking compartments, and some will have baggage compartments.

The trucks will be of the 4 wheel type, with outside journals, and will have 36 in. wheels at 87 in. centres, with inside hung brakes. These trucks will be capable of operating at slow speed on curves of 40 ft. radius. The motor equipment of the motor cars will consist of four interpole, nose supported on a cross beam supported by springs, and designed for normal operation, two series, at 1,500 volts d.c. They will be geared for a free running speed of about 55 m.p.h., when operating without a trailer, on a level track at 1,400 volts, and will be able to meet the requirements outlined in the assumed timetable before mentioned. They will be capable of operating at reduced speeds on 600 volt circuits when necessary.

The motor cars will be furnished with double end non-automatic multiple unit control, so arranged that at least three motor cars may be operated as a unit from either end of any car. Pantographs, two per car, of the same construction and operation as those on the locomotive, will be used.

The brake equipment will allow of 8 motor or trailer cars being operated as one train. Each motor car will be equipped with an air compressor, governor, reservoirs, brake cylinder, valves, etc., for combined straight and automatic air brake operation with double end control, the automatic feature being of the variable release control. Each compressor will have a capacity for 25 cu. ft. of free air per min., delivering against a reservoir pressure of 100 lbs. per sq. in. Electro-pneumatic sanders will be furnished for each end of the motor and trailer cars, to be controlled from either end of the car.

**Overhead Construction and Stations.**—Under the present plans it is proposed to have two substations, one at London containing two 500 k.w. 1,500 volt. d.c. rotary converter units, and the other at St. Thomas, containing two or three similar units. The overhead construction will probably be of the side bracket type with catenary suspension, the pole spacing to be approximately 150 ft. on the tangents, with somewhat closer spacing on curves. The contact wire will be 4-0 grooved trolley wire,

the feeder system consisting of a 4-0 feeder from the London substation for 3 miles towards St. Thomas, a 4-0 from St. Thomas substation to Glanworth, and a 1,000,000 c.m. feeder from the St. Thomas substation to mileage 23.4. All the apparatus will be designed to operate successfully on voltages varying from 50% below normal to 15% above.

### Consideration of the Toronto Railway's Service.

The report made to the Ontario Railway and Municipal Board in May, by C. R. Barnes, assisted by J. H. Cain and J. M. Campbell, on a survey of traffic requirements in Toronto and the service furnished by the Toronto Ry., which was summarized in Canadian Railway and Marine World for July, contained a number of recommendations which have been under the Board's consideration at several sittings. The Board decided that G. R. Geary, K.C., City Counsel, should prepare a draft of an order based on the matters agreed upon between counsel for the city and the company and upon those already decided by the Board, that this draft be submitted to the Toronto Ry.'s counsel for approval, and if the two counsel could not agree on the form of the order it would be settled by the Board.

We were officially informed Oct. 16, that the draft for an order had been submitted to the Board and that it dealt with the following matters:—The building of a line on Teraulay St. from Agnes St. to College St., including the placing of the road in a proper condition for vehicular traffic; this to be done by Nov. 1, 1914; the addition of metal troughs of an approved type on the trolley wires by Jan. 1, 1915, for the protection of grade crossings of steam tracks; the installation of a modern heating apparatus in all cars used for winter service; the equipment of all new cars with passenger push buttons; the improvement of methods of operation at Dundas St. barn; the improvement of method of operation in respect to cars passing other cars while passengers are being discharged from the latter; persons riding in front vestibules with motormen; motormen starting cars without signals from conductors; conductors announcing streets; passengers leaving by front door as far as practicable; passengers standing in rear vestibules when there are vacant seats in car; stationing inspectors at important transfer points; the equipment of all cars with a legible route sign on the righthand side and a destination sign on the front end properly illuminated during hours of darkness; and to cause the platforms on 34 of the cars referred to in the report to be lengthened so that they shall be 6 ft. in length, inside measurement, and that the steps on such cars shall be reconstructed in accordance with such report.

The British Columbia Electric Railway's General Manager, Mr. George Kidd, is hopeful of a turn in business conditions for the better. In an interview recently he said: "I look forward with confidence to the prospects for business in the future, and believe that the present temporary halt in the development of the west will in the end prove very beneficial to all concerned, as it will give us an opportunity to thoroughly overhaul our various undertakings preparatory to the further development which we believe will take place at no distant date, and should be very materially assisted by the increase in trade which we all hope Canada will enjoy on the termination of hostilities in Europe."

### Answers to Questions on Electric Railway Topics.

Following are two questions on electric railway topics, sent to the American Electric Railway Association's question box, recently, with replies thereto by W. F. Graves, Chief Engineer, Montreal Tramways Co.:—

**Street Sprinkling.** What material or composition is there which can be substituted for water in the sprinkling of streets paved with brick or medina, and which will eliminate the use of water in such large quantities as to injure the track and pavement? One of the big oil companies manufactures light road oil for the purpose of laying the dust on macadam pavements and it is very successful, but I do not know whether it would be desirable to use it on brick or medina pavements.

**Ties.** What is the actual bearing area of a wooden tie on crushed stone or gravel ballast with ordinary tamping? This area, of course, would vary with the different sizes of stone or kind of material. Is any data available from which actual figures may be furnished? I do not know of any data available covering bearing area of a wooden tie on ballast. The American Railway Engineering Association has been investigating this matter in connection with a recommendation covering the depth of ballast since 1913, and the report, when completed, should give some very valuable information.

### Increased Operation of Toronto Civic Car Line Refused.

A deputation asked the Toronto City Board of Control recently that all cars on the civic line on Danforth Ave. be operated through to the city limits, except in the rush hours. The request was referred to the Commissioner of Works, who reported that the present service is adequately handling the traffic received, and that an increased service would be an unjustifiable operating extravagance, which would add to the present deficit, this being borne by the general ratepayers. Data of travel on the Danforth Ave. line shows that only 35% of the patrons travel east of Greenwoods Ave., this district being also served by the Gerrard St. line. Approximately 4,500 citizens, to be served by the Danforth line, live east of Greenwoods Ave., and 18,000 live west of it. The following table, compiled from three days' traffic count, shows the average number of through passengers per car on Danforth Ave. for certain periods of the day:—

	From East to Greenwoods.	From Greenwoods to East.
7 a.m. to 10 a.m. ...	19.1	8.7
10 a.m. to 5 p.m. ...	17.1	15.9
5 p.m. to 7 p.m. ...	40.7	55.0

The average number of passengers per car on the through Danforth service for the 12 hours, 7 a.m. to 7 p.m., at Greenwoods Ave., east bound, is 21.3, and west bound, is 20.2. During the lightest hour period of travel during the day, these figures drop to 7.6 and 11.5, or, if the service was given as the deputation asked for, there would be only 5.1 and 7.7 passengers per car, respectively. If an equal service were given over the whole of the Danforth route, operating expenses to serve the people east of Greenwoods avenue would be 66 2-3% of the total cost, this district supplying only 35% of the passengers and revenue.

Niagara Falls, Ont., women collected fares on the local electric cars on Oct. 3, the collections being donated to the Canadian Patriotic Fund.



## Application of Standard Code of Train Rules on Electric Interurban Railways.

By Allan Purvis, Manager Interurban Lines, British Columbia Electric Railway Company.

The adoption of uniform code of train rules on interurban railways has been the subject of committee reports and discussions at various conventions of the American Electric Railway Association, but without any definite conclusion having been arrived at. It has been stated that local conditions must govern in this respect, because many interurban lines operate what might be termed "suburban service" on a very much closer headway than the former, and the placing into effect of rules which would be applicable to the former could not be properly carried out on the latter.

A code of rules based on the principles of the Standard Code, adopted by the American Railway Association, would effect a more uniform knowledge of train service, thereby training men to one general idea or system. When, at a later period, men of this type would find employment with other companies, their experience and training would prove a source of revenue and safety, rather than a handicap, as under the present methods, which lead to involuntary violations, and a rule, no matter how insignificant, cannot be successfully violated, it sooner or later will result in disaster. I mean by this, that interurban railways should always be manned by men of experience, if possible, and it is the general practice in hiring men for train service that they have had some knowledge in train rules. If such men are obtainable, who have worked on other railways, the system of train rules with previous companies may be altogether different from the train rules in force on the line he is applying for work on. In such cases it may result in accidents, as confusion of different rules would probably lead to it.

The American Code of Interurban Train Rules is a step in the right direction, but still the same confusion might occur in the mind of a man, say, who had been working on steam railways under the Standard Code, entering electric interurban service. The rules materially differ from each other in the essential features, and while the Standard Code would not be adopted in its entirety, with one or two deviations from it, it could, in my opinion, be adopted successfully.

The British Columbia Electric Ry. Co. is, I believe, the pioneer in this respect, as the Standard Code of Train Rules, approved by the Dominion Railway Board and the Province of British Columbia, was adopted and has been in successful operation on its interurban lines since Mar. 1, 1911. The daily service on these lines is 477 scheduled trains during a period of from 5 a.m. until 12.30 a.m.—operation covers 7½ minutes to approximately a three hour headway—on one branch a 7½ and 15 minute service is in operation, a total of 208 trains. Prior to the adoption of the Standard Code of Rules referred to, some doubt existed as to the applicability of them—where an infrequent schedule was maintained no difficulty presented itself, but with a close headway of 7½ minutes it was deemed necessary to make a slight change, in order to cover this feature, without departing to any great extent from the strict interpretation of the Standard Code.

It must be admitted that delays are preferable to accidents, but actual experience has proven that delays do not occur so frequently, nor are they of such duration, since trains are operated in strict accordance with the Standard Code of Rules and on time schedules as they were previous to such time. Minor changes in the wording of the Code to suit local conditions

may be made without in any way altering the general principle of safety. A deviation was made in the matter of flagging, Rule 99. The Standard Code reads as follows:—

- (a) In day time, if there is no down grade toward train within one mile of its rear, and there is a clear view of its rear 2,000 yards (40 telegraph poles) from an approaching train. 500 yards  
10 telegraph poles.
- (b) At other times and places, if there is no down grade toward train within one mile of its rear. 1,200 yards  
24 telegraph poles.
- (c) If there is a down grade toward train within one mile of its rear. 1,800 yards  
36 telegraph poles.



Allan Purvis,  
Manager, Interurban Division, British Columbia Electric Railway.

The rule as amended to conform to electric interurban operation is as follows:— (a) Distance the same. (b) Eliminated entirely. (c) 3,000 ft.

In suburban service, where stops are frequent, the continuous acceleration does not exceed 25 miles an hour, therefore the distance for flagging is considered ample. In frequent and isolated service, where train operation is adopted under the multiple unit system, motormen have the reverse feature in addition to quick action of their air brakes, which enables a stop to be made within the limits of safety. In this instance only have the essential features of the Standard Code been amended, the other rules have been successfully carried out without any appreciable delay in train operation.

During very foggy, and other stress of weather, in the operation of heavy suburban service, one minute fuses have been adopted—these fuses are used when a station stop is to be made and before reaching such station. The one minute fuse allows for ample immediate rear end protection and also eliminates any delay in maintain-

ing the running schedule, any other delays whatsoever, Rule 99 governs absolutely. The above illustration of the minute fuse is given to indicate that although such rules can be placed into successful operation, although not covered by the Standard Code, Rule 99, has not in any way been affected by it.

The terminal clearance in double track

BRITISH COLUMBIA ELECTRIC RAILWAY CO.									
Date . . . . .					Leave as Train No.				
RUN ON FOLLOWING SCHEDULE:									
Westbound.					Eastbound.				
45	30	15	00	New Westminster	50	05	20	35	
53	38	23	08	Meads	42	57	12	27	
54	39	24	09	Thorne Road	41	56	11	26	
55	40	25	10	Connaught Hill	40	55	10	25	
56	41	26	11	Leaside	39	54	09	24	
57	42	27	12	McGregor	38	53	08	23	
58	43	28	13	Fraser Arm	37	52	07	22	
59	44	29	14	Highland Park	36	51	06	21	
00	45	30	15	Royal Oak	35	50	05	20	
01	46	31	16	Jubilee	34	49	04	19	
02	47	32	17	West Burnaby	33	48	03	18	
03	48	33	18	McKay	32	47	02	17	
04	49	34	19	Patterson	31	46	01	16	
10 05	55	50	40	Central Park	30 40	45	55	00	10 15 25
11 06	56	51	41	Park Avenue	29 39	44	54	59	09 14 24
12 07	57	52	42	Collingwood E.	28 38	43	53	58	08 13 23
13 08	58	53	43	Collingwood W.	27 37	42	52	57	07 12 22
14 09	59	54	44	Earl's Road	26 36	41	51	56	06 11 21
15 10	00	55	45	Beaconsfield	25 35	40	50	55	05 10 20
16 11	01	56	46	Nanaimo Road	24 34	39	49	54	04 09 19
17 12	02	57	47	Gladstone	23 33	38	48	53	03 08 18
18 13	03	58	48	Lakeview	22 32	37	47	52	02 07 17
40 35	25	20	10	Cedar Cottage	00 10	15	25	30	40 45 55
40 35	25	20	10	Vancouver					

Opr. . . . .  
Through Trains will turn in Clearance on arrival at each Terminal.  
Locals will report arrival at Central Park to Dispatcher, who will clear them. On arrival at Vancouver they will turn in Clearance covering each round trip.  
If for any reason you get 15 minutes late, report to Dispatcher.  
Next train ahead is . . . . .  
Left this station at . . . . .  
ALWAYS PROTECT YOUR TRAIN.  
RUN NO RISK.

operation might be eliminated as serving no good purpose, although for single track operation this is, of course, very necessary. On suburban service, where the train movements are more frequent, the terminal clearance can be eliminated and a method adopted to suit a local condition. I submit a sample copy of a clearance used on one of our suburban lines which also serves as a time table, although crews carry time tables also. This does not preclude crews from consulting train registers or registering the variation of watches as instructed by the rules.

Careful perusal and consideration of the train rules and time tables will show that the Standard Code has not been very materially departed from. They have worked out very successfully, indeed, since their adoption, and I am of the opinion that where employes can be educated to standardization, particularly in such an important matter as train rules, they feel that they are more capable to meet the exacting demands prevailing in railways generally, and it instills confidence in themselves.

One great advantage in train service is that a man who has worked under the Standard Code of train rules for some years has had that many years' experience which it not thrown away when he enters the service of another company—then he becomes a valuable asset of the company employing him.

The American Electric Railway Association's Convention, held at Atlantic City, N. J., Oct. 12 to 16, was well attended, and the manufacturers' exhibits were up to the usual standard of the last few years. The Canadian Electric Railway Association was officially represented by its President, C. B. King, Manager London Street Ry., and its Assistant Secretary, A. A. Burrows, Secretary and Business Manager, Canadian Railway and Marine World, the latter having a desk in the A.E.R.A.'s space at the entrance to the exhibits pier, where he received the registrations of Canadians attending, of whom there was a considerable number.



## Passenger and Express Cars for Montreal and Southern Counties Railway.

### Electric Railway Notes.

The Montreal and Southern Counties Ry. has added to its equipment this year 6 motor passenger cars, 2 trailer passenger cars and 2 motor express cars. The motor and trailer passenger cars are alike in all details, but the power equipment, and have the following general dimensions:—

Length over vestibule .....53 ft. 2 ins.  
Length over buffers .....54 ft. 2 ins.

general design, have the following general dimensions:—

Length over vestibule .....48 ft. 4 ins.  
Length over buffers .....49 ft. 4 ins.  
Height, rail to top of roof .....12 ft. 8½ ins.  
Body bolster centres .....25 ft. 4 ins.

These cars are equipped with trucks, air brake and electrical equipment, the same as the motor passenger cars.

All the motor cars are equipped with

It was reported to the Edmonton, Alberta, City Council, Oct. 3, that of the city's debenture debt, which is \$329.28 per head of the population, \$40.74 per head was incurred on account of the municipal electric railway.

The Brantford Municipal Railway Commission has ordered 6 single truck, p.a.y.e. cars from the Preston Car and Coach Co., Ltd., for the Brantford St. Ry., to be delivered in December. The commission is also having a freight car built.

The Board of Railway Commissioners has

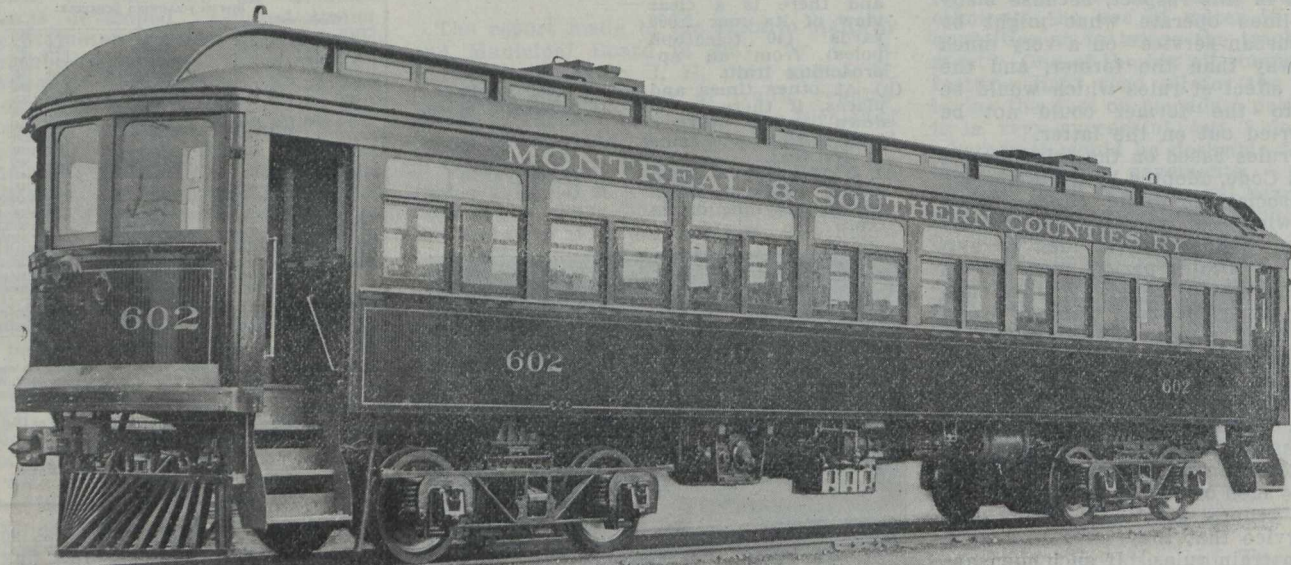

High Speed Interurban Car, Montreal and Southern Counties Railway.

Length over end posts .....43 ft. 4 ins.  
Body bolster centres .....29 ft. 2 ins.  
Width over all .....8 ft. 6¼ ins.  
Height, rail to coupler centre ... 2 ft. 10½ ins.  
Height, rail to car floor line .... 4 ft. 2½ ins.  
Height, rail to top of roof .....12 ft. 8½ ins.  
Weight, car body with equipment ... 25,700 lbs.  
Weight, trucks complete ..... 15,200 lbs.  
Weight, couplers ..... 1,800 lbs.  
Weight, motors ..... 11,400 lbs.  
Weight, air brake equipment ..... 1,300 lbs.  
Weight, total ..... 56,520 lbs.  
Weight, per foot of body ..... 476 lbs.  
Weight, per foot of body with equipment ..... 1,142.8 lbs.  
Weight, per passenger seating capacity ..... 942 lbs.

Westinghouse H.L. control apparatus, Westinghouse automatic air equipment, automatic car couplers, reversible seats, G.T.R. standard window fixtures, parcel racks of standard electric car design, and Ohio Brass Co. air and sand boxes, and with trolley retrievers, electric car heaters and snow scrapers.

These cars were built by the National Steel Car Co., Hamilton, Ont., which also installed all the electrical and air brake equipment, delivering the cars in a complete operative condition.

approved of the British Columbia Electric Ry.'s Standard Freight Mileage Tariff, C.R.C. no. 23, effective Sept. 1, 1914, between stations on the Vancouver and Lulu Island Ry. and the Vancouver, Fraser Valley and Southern Ry.

The Toronto Railway has undertaken to add to the protection of its grade crossings of steam railways, by placing metal troughs on the trolley wires, as recommended in the report made by C. R. Barnes et al to the Ontario Railway and Municipal Board in May.

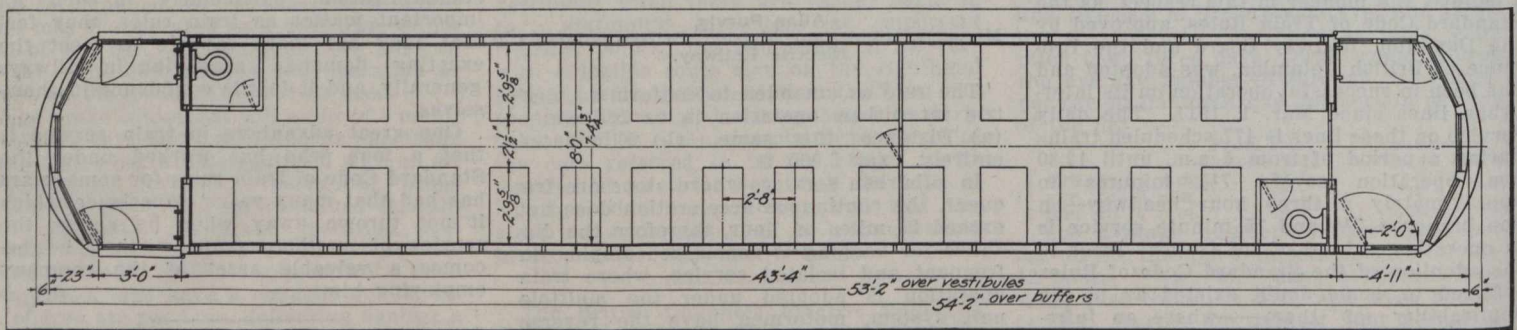

Floor Plan, Interurban Car, Montreal and Southern Counties Railway.

The trucks are of the National Steel Car Co. design, and are each equipped with two 50 h.p. Westinghouse motors. The car underframing is of solid steel design, having side plates of reinforced construction, and steel centre sill. The interior finish is in solid mahogany, in plain design. The interior is divided into a main compartment and a smoking compartment, in each of which there is a toilet room, equipped with dry hopper, water cooler, etc.

The baggage cars, which are of the same

**Montreal Motorbus Service.**—The Montreal City Council is taking steps to ascertain its position under the contract with the Canadian Autobus Co. The contract granted a 10 years franchise, the service to be started in June, 1913, with a provision that if on six months notice after that date the service was not put in operation the franchise would lapse. A citizen has an action for an annulment of the franchise, and the City Attorney has declined to give an opinion of the case.

The Goderich town council decided, Oct. 22, to ask the Hydro Electric Power Commission of Ontario to have its engineers report on the question of completing the partially built Ontario West Shore Ry., and having it operated under the Commission's scheme.

The Ontario Railway and Municipal Board has refused the Toronto Ry.'s application for permission to lay a siding on the west side of Church St., north of King St., opposite its offices, on which to place



a car for the collection of fare boxes from passing cars.

The Toronto Board of Control decided, Oct. 22, to ask permission from the Ontario Government to lay tracks on Bloor St., from Dundas St. west, and also to obtain an order for the Toronto Ry. to operate over them. If the latter portion of the plan is not successful, the line will be operated as a portion of the civic car lines.

The Imperial Privy Council has dismissed the Windsor, Essex and Lake Shore Rapid Ry. Co.'s appeal against the judgment of Canadian courts, in a suit brought by Nelles and Newman for \$30,000 in the company's stock, in connection with the financing of the company. This case has been before the various courts for about seven years.

The Montreal Tramways Co., during the two years since J. E. Hutchison became General Manager, has added to its equipment 350 large double truck p.a.y.e. cars, at a cost of about \$3,000,000. The company now has about 1,000 cars and 240 miles of single track, and employs about 4,500 men, apart from laborers on construction work.

W. D. Baillarge, City Engineer, Quebec, is preparing a report for the city council on flat wheels on the Quebec Ry., Light and Power Co. electric lines. He has discussed the matter with C. J. Pigot, the company's Maintenance of Way Engineer, and reports state that steps will be taken to offset the unusual difficulties which are met with in operating an electric railway in the city.

The Toronto Ry. is equipping one of its widest cars with a centre aisle 21 ins. wide, and cross seats on each side, for the inspection of the Ontario Railway and Municipal Board, which has before it an application from the Toronto Street Railway Men's Union for the issuing of an order to abolish the steps along the whole of one side of the open cars, so as to permit conductors to collect fares inside the cars instead of from the outside steps as at present.

The British Columbia Electric Ry. has arranged to look after the families of all of its employes who have volunteered for active service during the war. A special officer has been appointed to take charge of the work, and the employes are contributing 1% of their monthly wages to the fund. The company has made a contribution of \$1,000 to the general relief fund in Vancouver.

The Manitoba Public Utilities Commissioner was reported, Oct. 10, to have informed the Winnipeg City Council that it was intended to make an order at an early date requiring the Winnipeg Electric Ry. to operate cars over Arlington St. bridge. The Commissioner states that so long as the company is not compelled to operate its cars over the bridge it should not be called upon to pay any rental for its use.

The Appellate Court at Toronto, Oct. 22, dismissed the appeal of the Toronto Suburban Ry., from an order of the Ontario Railway and Municipal Board, directing that it build a line on Annette and Keele Sts., West Toronto. The Board ordered that the company lay the single track so as to allow of double tracking at a later period. The court's decision is that the company must commence construction at once.

The Winnipeg City Council has voted \$3,500 for an investigation into the electrolysis of water pipes, etc., in the city. The investigation is being made by A. F. Ganz, under an order of the Manitoba Public Utilities Commission. A similar investigation was made in 1909 by L. A. Herdt, of Montreal, and nearly all his recommendations were adopted by the Winnipeg Electric Ry. The City Electrician reported, Oct. 5, that

considerable benefit had resulted, but that there is still a heavy loss to the city through the electrolysis of pipes.

The routing of the cars on the Winnipeg Electric Ry., which has been rearranged by the City Council's traffic officer recently, is not generally approved of, and the whole matter has been taken up by the Manitoba Public Utilities Commissioner. The public hearing took place Sept. 30, and the Commissioner stated that he would endeavor to arrange for the re-routing of the cars on the basis of the report presented early in the year by R. M. Feustel.

The British Columbia Electric Ry. has rearranged a number of its routes in Vancouver. Under the new arrangements the services on several lines have been reduced, the service on stub lines affected, and the "owl" cars have been cut out. These alterations have been necessitated to prevent a deficit in operations. The men have waived the terms of their agreement for six months, and will work nine hours a day for six days to meet the altered conditions. The old debentures will be replaced as soon as business warrants.

### Canadian Electric Railway Association.

PRESIDENT—C. B. King, Manager, London Street Railway Co.

VICE PRESIDENT—James D. Fraser, Director and Secretary-Treasurer, Ottawa Electric Railway Co.

SECRETARY-TREASURER—Acton Burrows, Managing Director, Canadian Railway and Marine World.

EXECUTIVE COMMITTEE—The President, Vice President, Secretary-Treasurer and

E. P. Coleman, General Manager, Dominion Power and Transmission Co.

Patrick Dubee, Secretary-Treasurer, Montreal Tramways Co.

A. Eastman, General Manager, Windsor, Essex and Lake Shore Rapid Railway Co.

H. M. Hopper, General Manager and Purchasing Agent, St. John Railway Co.

Wilson Phillips, Superintendent, Winnipeg Electric Railway Co.

C. L. Wilson, Assistant Manager, Toronto and York Radial Railway Co.

ASSISTANT SECRETARY—Aubrey Acton Burrows, Business Manager, Canadian Railway and Marine World.

OFFICIAL ORGAN—Canadian Railway and Marine World, Toronto.

### Report of Saskatoon Municipal Railway Expenses.

A supplementary report was presented by the commissioners to the Saskatoon, Sask., City Council, Oct. 5. Following are extracts:—"In accordance with the instructions of the council, we have enquired into the duties of the employes engaged in the car barns, and upon the street railway tracks, and find that in addition to the six employes whose services have already been dispensed with, an additional saving of \$247 a month can be made by a readjustment of the work carried out by the car barn foreman and mechanic, track foreman and line-man, and by discharging one helper. We have dispensed with the services of the lineman, who was paid \$125 a month, and reduced the wages of the track foreman from \$140 to \$125 less 10%. The work of the lineman will in future be carried out by the car barn and track foremen. We do not see that any further reductions can be made at present without impairing the efficiency of the service. The operating ex-

penses for September, compared with September, 1913, are as follows:—

	1913	Per
	Cost.	Car Mile.
Salaries of employes.....	\$7,105.01	23.562
Stores issued .....	611.00	1.166
Power .....	2,962.03	3.693
Electric light .....	47.83	.090
Water .....	20.00	.038
	<hr/>	
	\$10,745.85	28.549
	1914	Per
	Cost.	Car Mile.
Salaries of employes .....	\$6,863.00	11.976
Stores issued .....	760.54	1.327
Power .....	2,007.09	3.503
Electric light .....	49.94	.087
Water .....	20.00	.035
	<hr/>	
	\$9,700.57	16.928

### Electric Railway Finance, Meetings, Etc.

**British Columbia Electric Ry.**—In September 2,951,980 passengers were carried on the Vancouver city and connecting suburban lines, against 3,840,475 in 1913, and 4,113,552 in 1912. The percentage paid the City of Vancouver for September was \$7,003.31, against \$7,935.21 for Sept., 1913, and \$8,439.03 for Sept., 1912.

Gross earning for August \$674,812; operating expenses, maintenance, etc., \$512,174; net earnings \$162,638, against \$770,628 gross earnings; \$566,541 operating expenses, maintenance, etc.; \$204,087 net earnings for Aug. 1913. Aggregate gross earnings for two months ended Aug. 31, \$1,364,835; net earnings \$325,657, against \$1,526,571 aggregate gross earnings; \$410,083 net earnings for same period 1913.

**Cape Breton Electric Co.**—Gross earnings for August, \$32,742.16; operating expenses and taxes \$17,484.69; net earnings \$15,257.47; interest charges \$5,217.42; balance \$10,040.05; bond sinking and improvement funds \$1,190; balance for reserves, depreciation, etc. \$8,850.05, against \$33,454.18 gross earnings; \$17,299.94 operating expenses, taxes, etc.; \$16,154.24 net earnings; \$4,891.67 interest charges; \$11,262.57 balance; \$1,190 bond sinking and improvement funds; \$10,072.57 balance for reserves, depreciation, etc. for Aug., 1913. Aggregate gross earnings for eight months ended Aug. 31, \$232,941.91; net earnings \$95,632.01; interest, bond sinking and improvement funds \$52,029.93; net balance \$44,595.09, against \$239,212.80 aggregate gross earnings; \$99,425.57 net earnings; \$48,734.49 interest, bond sinking and improvement funds; \$51,113.03 net balance for the same period, 1913.

**Lethbridge Municipal Ry.**—Gross earnings for Sept., \$2,731.34, of which \$2,618.84 were car fares. Passengers carried, 61,798.

**Regina Municipal Ry.**—Revenue for three weeks ended Oct. 17, \$9,645.30; passengers carried, 234,549.

**Sherbrooke Railway and Power Co.**—Gross earnings for 3 months, July to Sept. \$39,195, against \$37,309 for corresponding period 1913. Net earnings \$16,753, against \$14,506.

**Sherbrooke Ry. and Power Co.**—At the annual meeting in Montreal, Sept. 28, the report for the year ended June 30, as published in Canadian Railway and Marine World for October, was adopted. The directors and officers for the current year are:—C. J. McCuaig, President; S. H. Ewing, Vice President; W. Farrell, Sherbrooke; W. J. Thorold, London, Eng.; S. L. Spafford, Lennoxville, Que.; F. Thompson, D. R. McCuaig, Grant Johnston, all of them being of Montreal except where otherwise mentioned. Mr. Spafford was added to the board, the others being re-elected.

**Toronto Ry.**—Gross receipts for September were \$525,264.55 against \$538,822.42 for Sept. 1913. The percentage paid to the city for September was \$42,021.10 against \$43,988.75 for Sept. 1913. For the nine months ended Sept. 30, there is an increase of \$102,-



307 in the aggregate gross earnings, as compared with the same period of 1913.

**Toronto Ry., Toronto and York Radial Ry. and allied companies.**—Gross earnings for August, \$850,639; operating expenses, maintenance, etc., \$432,906; net earnings \$417,733, against \$850,222 gross earnings; \$411,300 operating expenses, maintenance, etc.; \$438,922 net earnings for Aug. 1913. Aggregate gross earnings for eight months ended Aug. 31, \$6,742,786; net earnings \$3,265,427, against \$6,317,674 aggregate gross earnings; \$3,098,367 net earnings for same period 1913.

**Winnipeg Electric Ry.**—Gross earnings for August, \$322,762; operating expenses, \$187,595; net earnings \$135,167, against \$340,507 gross earnings; \$184,335 operating expenses; \$156,172 net earnings, for Aug. 1913. Aggregate gross earnings for eight months ended Aug. 31, \$2,760,944; net earnings \$1,165,291 against \$2,649,702 aggregate gross earnings; \$1,186,294 net earnings for same period 1913.

**Hydro Electric Radial Railways for Toronto Northeastern District.**

By a large majority, 11 of 13 municipalities in the district northeast of Toronto, voted, Oct. 19, in favor of the municipal electric radial railways, on which the municipalities in that district had requested the Hydro Electric Power Commission of Ontario to have a report prepared covering the feasibility of successfully operating such a project. The preliminary investigation by the Commission's engineers, was dealt with in a summary of the report, which appeared in Canadian Railway and Marine World, Nov., 1913, a map of the then projected lines accompanying the article. Since that date, other municipalities in the neighborhood petitioned the Commission for an investigation of their particular districts, which involved a certain rearrangement of some of the lines.

As submitted to the ratepayers of the several municipalities, the proposed system consisted of five sections as follows: 1. From Toronto, through Agincourt, Unionville, Stouffville Jct., Vandorf and Newmarket, following a general northerly direction; 2. From this Toronto northerly line at Unionville, easterly through Markham to Brooklin; 3. From Stouffville Jct. on the Toronto northerly line, easterly through Stouffville to Claremont; 4. From Vandorf on the Toronto northerly line, easterly to Uxbridge; 5. And from Whitby northerly through Brooklin to connect with the line from Unionville, thence to Port Perry. This gave a projected mileage of about 105 miles. The rearrangement consequent on the adverse vote by two municipalities has not yet been considered.

The municipalities voting were: Scarborough tp., Markham tp., Whitchurch tp., Markham village, Stouffville village and Newmarket town in York county, and Pickering tp., Uxbridge tp., Whitby tp., Reach tp., Port Perry village, Uxbridge town, and Whitby town, in Ontario county.

As stipulated in The Hydro Electric Railway Act, 1914, passed by the Ontario Legislature, the bylaws submitted to the electors contained the estimated cost of the work and the portion of the cost of construction and equipment of the line to be borne by the municipality. This apportionment by the engineers of the Commission is as follows:

Scarboro Township .....	\$ 565,714
Markham Township .....	801,929
Whitchurch Township .....	488,152
Pickering Township .....	578,115
Uxbridge Township .....	227,901
Whitby Township .....	554,619
Reach Township .....	235,722

Markham Village .....	48,162
Stouffville Village .....	75,281
Port Perry Village .....	113,308
Newmarket Town .....	266,986
Uxbridge Town .....	204,665
Whitby Town .....	183,774

Total .....

The above estimate was made on the basis of an assumed Dominion subsidy of \$6,400 a mile of main line, but does not include the line within the Toronto city limits, estimates on which are being prepared. The estimated annual operating revenue of the line as proposed, inclusive of the Toronto section, is \$776,400. Of the municipalities which voted on the project Uxbridge tp. and Newmarket town were the only ones to reject it.

The financing of the lines will be in the control of the Commission, which may raise money for the construction and equipment by the issue on behalf of the corpora-

tions, of bonds, charged upon and secured by the railway and all its assets. Neither the Province nor the Commission will be liable for the bonds, except in so far as the Lieutenant Governor in Council is given power to authorize the Provincial Treasurer to do so. The bonds will be issued to run for 50 years, on terms to be determined by the Commission. No provision for a sinking fund will be made during the first ten years, but after that period, it is provided that out of the revenue a sufficient sum may be laid aside each year to redeem the bonds on maturity.

The representatives of the various municipalities will, it is said, hold a meeting, and consult with the Commission as to what modifications will have to be made in the plans, owing to the defeat of the by-law in Newmarket town and Uxbridge tp. (Oct., pg. 476.)

**Electric Railway Projects, Construction, Betterments, Etc.**

**Brantford and Hamilton Electric Ry.**—Application is being made to the Dominion Parliament to extend the time within which the company may commence and complete the line authorized to be built from Langford in Brantford tp. to Galt, Ont. (Jan., 1913, pg. 39.)

**Brantford St. Ry.-Grand Valley Ry.**—The material for the improvement of the line in East Ward, Brantford, Ont., is being delivered, and the betterments are being gone on with. The work in hand covers only the immediate necessary betterments. The plans for the general improvement of the line are under consideration, and an announcement of their nature and cost is expected to be made at an early date. (Aug., pg. 476.)

We are officially advised that the Brantford Municipal Ry. Commission is laying 690 ft. of track on St. Paul's Ave., Brantford, with 80 lb. steel, and is relaying the loop in the East Ward, 6,100 ft., also with 80 lb. steel.

**British Columbia Electric Ry.**—The third unit of the Jordan River power plant, near Victoria, B.C., has been put in operation. (Oct., pg. 476.)

**Cornwall St. Ry. Light and Power Co.**—A bylaw extending the company's franchise for 20 years was carried by the ratepayers, Oct. 14, by 657 to 163. (Oct., pg. 476.)

**Dunnville, Wellandport and Beamsville Electric Ry.**—We are officially advised that this company has secured deeds for a considerable stretch of private right of way, that about 12 miles of grading have been done, that considerable work has been done on culverts, drains and fencing, and that the bridging for the same section is fairly well completed. Hydro Electric Power Commission of Ontario engineers have been going over the route from Dunnville to St. Catharines, in order to prepare a report, there being a proposition that the line be taken over and completed as part of the commission's proposed system of interurban lines. J. A. Ross, Wellandport, Ont., is President. (Aug., pg. 385.)

**Edmonton Radial Ry.**—A recent press report stated that the Edmonton, Alberta, City Council was to spend \$168,000 on improvements on the E.R. Ry. An amount was voted early in the year, and details of the several works, with amounts to be expended upon each, were given in our April issue, pg. 184. The total amount then voted was \$160,056.70, and we are officially advised that no additional sums have been voted since. (Oct., pg. 476.)

**Edmonton Northwestern Radial Ry.**—The Alberta Legislature is being asked to incor-

porate a company with this title to build railway or tramway lines, to be operated by any power other than steam, from Edmonton northwesterly to the Pembina River. Short, Woods, Biggar and Collisson, Edmonton, solicitors for applicants.

**Hydro Electric Power Commission of Ontario Projected Railways.**—Since Oct. 1 a party of engineers, in charge of J. N. Stanley, has been working in the vicinity of Guelph, Ont., making surveys for an electric railway from that city to Toronto. He is reported to have said that the Commission was considering the building of a line from Hamilton to Guelph; that the surveys now being made would connect with it, and that another line would be laid out northerly from Guelph, thus making that city a central point for a Western Ontario system.

**London, Grand Bend and Stratford Ry.**—A letter is reported to have been received in Stratford, Ont., from C. T. McAllister, who is in London, Eng., arranging the finances for the construction of this projected railway. The letter states that an assurance has been given that as soon as business becomes normal, the agreement which was practically ready for signature when the war broke out, will be completed, and the money for construction supplied.

**Montreal Tramways Co.**—J. E. Hutcheson, General Manager, is reported to have said in a recent statement that the company had been employing about 1,000 men upon betterment and construction work on its various lines. New intersections have been placed at St. James and McGill Streets, 132 lb. rails replacing 100 lb. rails; and at St. Catherine St. and Atwater Ave., where a total weight of 85,000 lbs. replaces intersections weighing 45,000 lbs. The devil strip from St. James to Craig St. has been widened to 4 ft. 8½ in. Another new intersection, also 132 lbs. to the yard, is being laid at Bleury and Craig Streets. These are being made so as to permit cars coming in different directions to pass each other on the intersections without stopping, thus increasing their efficiency very considerably. The city is doing a good deal of paving work, and wherever necessary the company is co-operating by relaying its rails. (Aug., pg. 385.)

**Morrisburg and Ottawa Electric Ry.**—We are officially advised that a contract for the construction of this line has been let to the Morrisburg and Ottawa Construction Co., Ltd., incorporation of which was mentioned in Canadian Railway and Marine World for October. G. D. Mumford, 66 Broadway, New York, N.Y., is President. No information is available as to when construction will be gone on with.



The address of J. G. Kilt, President, at the recent annual meeting of shareholders, was made public Oct. 13. The directors express regret that greater progress has not been made, and state that shareholders who have not paid up their shares are largely responsible. If the directors had been able to show that \$75,000 or \$100,000 had been expended on the line it would have been an easy matter to get the bonds on the market. Legal proceedings were being taken against shareholders who had not paid the calls on the shares subscribed for. Shareholders representing about \$60,000 of calls were on the list of delinquents. The contract for construction had been let to the Morrisburg and Ottawa Construction Co., the President of which is G. D. Mumford of New York. It is hoped to arrange the company's finances so as to start construction in the spring of 1915. The directors are confident that the line would be a success, and express regret that the townships through which it would pass have declined to assist the company by giving a guarantee of bonds. (Oct., pg. 477.)

**Ontario West Shore Ry.**—Negotiations were opened, Oct. 2, by a contractor named Campbell, of Strathroy, Ont., with the municipal authorities interested in this incomplete railway, with a view of something being done towards its completion. The contractor, it is said, has agreed to submit a proposition to the municipalities to complete the grading and to do the tracklaying. (Sept., pg. 430.)

**Ottawa and St. Lawrence Electric Ry.**—Ottawa papers of Sept. 30 reported construction started at Russell, Ont., on the first section of this projected electric railway. This section, it is stated, will be 119 miles long, and will extend from Ottawa to Morrisburg, and thence to Beaudet, with a branch from Metcalfe to Russell. There was a public celebration at the turning of the first sod, and the day was observed as a general holiday in Russell. The work undertaken is, it is said, being done by the company, dealing directly with local men. It does not appear from the reports that any extensive work is being done. (Jan., pg. 38.)

**St. John Ry.**—We were officially advised, Oct. 5, that work was in progress on the extension of the line to the Maynor House, 3.5 miles, of which 1.5 miles is within the Glen Falls subdivision. Later press reports state that additional men have been set to work, in the expectation of getting the line finished by the winter. (Sept., pg. 431.)

The western section of the new bridge across the St. John River at the reversible falls is completed and the eastern section is well advanced and is expected to be completed this year. It is to be used by the St. John Ry. as well as for vehicular traffic.

**Toronto Ry.**—Work has been in progress for some time relaying the track on Queen St. West near the subway, and is now about completed. Arrangements have been made for the reconstruction of the track allowance on College St. between Spadina Ave. and Bathurst St. New rails will be laid. (Oct., pg. 477.)

**Toronto Suburban Ry.**—The Ontario Railway and Municipal Board having after an inspection approved of the extension from Weston to Woodbridge, Ont., it was opened for traffic, Oct. 10. The extension is 13 miles long, and has been under construction for over two years. It was practically completed a year ago, but owing to certain difficulties the new section was not connected up. The questions arising in connection with the Main St. subway at Weston have not yet been adjusted, and in order to enable the line to be opened a temporary line has been laid at that point. A one

hour service each way is being given between West Toronto and Woodbridge.

On the Guelph extension tracklaying has been completed from Islington to beyond Eden Mills. Considerable ballasting has been done, trolley poles have been put up, and other work done. While some work is reported to be still in progress west of Eden Mills, operations on other sections of the line were suspended Oct. 8. (Sept., pg. 432.)

**Three Rivers Traction Co.**—The question of granting a franchise to the company for the building of an electric railway in Three Rivers, Que., is, we are officially advised, still under consideration by the City Council. (Sept., pg. 431.)

### Personal Paragraph.

T. J. KENNEDY, who has been appointed President and General Manager, Algoma Central and Hudson Bay Ry. and Algoma Eastern Ry., Sault Ste. Marie, has also been appointed Vice President and General Manager, International Transit Co., and Trans St. Marys Traction Co., in charge of street railways and ferries.

R. W. Dean, St. John, N.B., is reported to be operating an autobus service from Douglas Ave., St. John, to Lorneville, N.B.

The Toronto Street Railwaymen's Union has 85 of its members in the Canadian overseas military force which has gone to the front.

Motor cars for section work are considered an important development towards increase in efficiency, and their use is recommended by the committee on method of rail renewal of the Roadmasters' and Maintenance of Way Association.

Wood preservation by creosoting will, it is claimed, be affected in the U.S. by the war, as more than a third of the creosote oil employed for that purpose in the U.S. is imported from Great Britain and Germany.

**The Postmaster Generalship.**—T. Chase Casgrain, K.C., Chairman of the Canadian Section of the International Waterways Commission, has been appointed Postmaster General, vice Hon. L. P. Pelletier, resigned on account of illness. Mr. Pelletier has also given up his seat in the House of Commons.

Cleaning snow from switches is said to be more effectively handled by the hydro-carbon method than by any other. This method consists in melting the snow by pouring on it ignited hydro-carbon oil, a volatile liquid comparable to gasoline. It is applied to switches by hand distributing cans, which hold about 3 gallons.

Considerable economy may be effected in the wear of switch points in yards at points where the service is extreme, by moving the point of lesser wear back 26 ins., so that the first lug of one point and the second lug of the other point are opposite, and introducing a guard rail 9 or 10 ft. long, curved sharply through 12 ins. at the end which covers the switch, and in the standard manner at the other end.

**Assessment of Railway Bridge at Cornwall.**—The Ontario Railway and Municipal Board has given judgment in favor of Cornwall township in a case between the New York division, and the township. Mr. Justice Britton gave judgment last June, holding the International Bridge crossing the River St. Lawrence, west of Cornwall, assessable. The railway company appealed to the Ontario Railway and Municipal Board, which has now given judgment in favor of the township, upholding the assessment of \$300,000 placed on the bridge by the township.

### Telegraph, Telephone and Cable Matters.

Joseph Townsley, who died at Montreal, Oct. 5, was associated with the C.P.R. Telegraphs from the company's inception until his retirement in 1911, and superintended the building of the system between Halifax, Canso and Port Arthur. He retired from active service Jan. 1, 1911, when Superintendent of Telegraphs at Montreal, having reached the age of 70.

The Western Union Telegraph Co. has announced a reduction in cable rates to points in British West Indies, from Oct. 31. The rate is 36c. a word to all points except St. Thomas and St. Croix, the latter rate being 50c. a word. Deferred rate messages in plain language are at half these rates. The former rates ranged from 48c. a word to Jamaica, to \$1.12 to British Guiana.

The damage which was done to the Pacific Cable Board's cable, near Fanning Island, recently, presumably by a German warship, has been repaired, and communication between Fanning Island and Australia has been restored. The damage to the Canadian section will be repaired as speedily as possible. During repairs, communication was maintained round the world in the other direction.

The Great North Western Telegraph Co.'s annual meeting was held at Toronto, Sept. 30. Following are the directors and officers for the current year: President, Z. A. Lash; Vice President, Adam Brown; other directors, Jas. Hedley, Hon. J. K. Kerr, N. Carlton, Aemilius Jarvis, F. B. Hayes and E. Y. Gallaher. G. D. Perry is General Manager, A. C. McConnell, Secretary and Auditor, and D. E. Henry, Treasurer.

### Among the Express Companies.

The Canadian Northern Ex. Co. has opened offices at Speers, Sask., and Lochearn, Alta., and has closed its office at Rocky Mountain House, Alta.

The City of Quebec has applied to the Board of Railway Commissioners for an order extending the boundaries within which express companies are required to collect and deliver parcels.

The Board of Railway Commissioners has extended the express delivery and collection limits in Swift Current, Sask., and has rescinded the order of July 3, defining the previous limits.

The Board of Railway Commissioners has issued order 22634, Sept. 28, re application of Edmonton City Dairy, Ltd., requiring the Dominion Ex. Co., under rule 3 of its special cream tariffs C.R.C. 4139 and 4202, to refund 5c. a can on its consignments to Edmonton between Oct. 15, 1912, and Sept. 17, 1913, inclusive, the company being outside the delivery limits, no delivery service having therefore been furnished. The order reads: "It is declared that rule 1 of the Dominion Ex. Co.'s special local tariff of rates on cream C.R.C. 4139, Oct. 15, 1912, and C.R.C. 4202, Nov. 28, 1912, was subject to the obligation imposed by rule 3 with respect to any area within municipal boundaries which had, prior to Sept. 18, 1913, been excluded by orders of the Board from the obligation imposed upon the express company by order 13357, Mar. 30, 1911, and it is ordered that the Dominion Ex. Co. be authorized to refund to the applicant 5c. a can on consignments of cream carried to Edmonton between Oct. 15, 1912, and Sept. 17, 1913, which the express company did not deliver in the said excluded area within the municipal boundaries of Edmonton."







pressure. The principle of subdivision has been carried very far, so that the vessel may be pierced in several compartments before she will be in danger of sinking, and in addition a double bottom of the usual system is fitted. The hull is divided into nine compartments by eight watertight bulkheads, and filled with water ballast tanks in the cellular double bottom.

The condensers, which are separate from the main framing, are of the uniflux type, and a pair of feed pumps are fitted in each engine room. The pumping arrangements are complete and have been specially designed to suit the various compartments into which the vessel is divided. A large horizontal duplex ballast pump is fitted, which can discharge through the forward

will alight from the cars and pass to the promenade deck by means of stairways on both sides of the vessel. These stairways lead to the entrance halls of the saloon deckhouses, from which large doors give access to the several apartments. In the pantries are lifts going down to the main deck, where the galley is situated.

The public room, with the officers' and engineers' accommodation, are on the upper promenade deck, entrance to which is obtained by four teak stairways from the promenade deck. The first class public rooms are handsomely fitted and the dining room is a large apartment at the forward end of the promenade deck. The floor is of oak parquet artistically arranged, and the framing and panelling throughout is of

ward end of the railway deck, and two capstans at the after end, for hauling cars on board. A powerful windlass is fitted at the forward end of the promenade deck, and a combined hand and steam steering gear is fitted at the stern on the second deck. The electric light installation is of a very complete nature and includes two 25,000 c.p. searchlights.

The contract was awarded in February, on a tender of £138,000.

**The Stranding of the s.s. Shenandoah.**

Capt. L. A. Demers, Dominion Wreck Commissioner, has given the following judgment concurred in by Captains G. N. Kennealy and M. Cardiff, as nautical assessors,

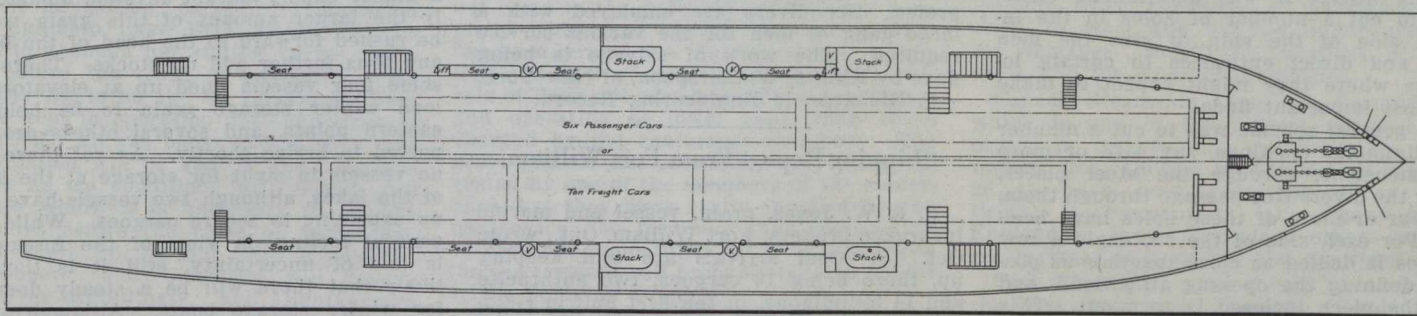

Railway Deck, Car Ferry Prince Edward Island.

condenser, and there are two bilge pumps in each engine room. The circulating water from the forward condenser can be discharged through two outlets at the bow, to free the ship from frazil or lolly ice. There is a surface feed heater and feed filter in each engine room. The whole of the shafting and reciprocating parts have a factor of safety much above the Lloyd's and Board of Trade requirements, and the propeller blades are massive and of great strength, so that they may be brought up by the ice without breaking, when running at full speed.

The car tracks are placed on the main deck, above which are three decks—promenade, upper promenade and boat deck.

solid oak handsomely carved. The ceiling is of plaster with painted panel mouldings. A number of small dining tables are arranged to seat altogether 46 people. The ladies' and smoking rooms are fitted up in somewhat the same style. The general effect of these rooms has been worked out with the view of departing as far as possible from the stereotyped forms of internal decoration peculiar to steamships, and to provide rooms and passages which resemble those of a well appointed house. The second class public rooms, entrances and corridors are handsomely panelled in oak and mahogany, and have swing doors with plate glass panels arranged in small squares. The stairways from the entrance

on the stranding of the s.s. Shenandoah, a single screw vessel of 3,886 tons gross, off Little Musquash, N.B., on Sept. 3:—

The court having carefully weighed the evidence is unanimous in its conclusion that the master, Capt. W. M. Lee, placed too implicit reliance on the courses steered during preceding voyages, and that in view of the prevailing weather conditions, coupled with the ever existing uncertainty of tide velocity in the Bay of Fundy, he should have exercised greater caution in assuring himself of his precise position by more frequent soundings, and furthermore, that the estimated distance of four miles from the Lurcher is unreliable, being based absolutely on a possible variable sound and

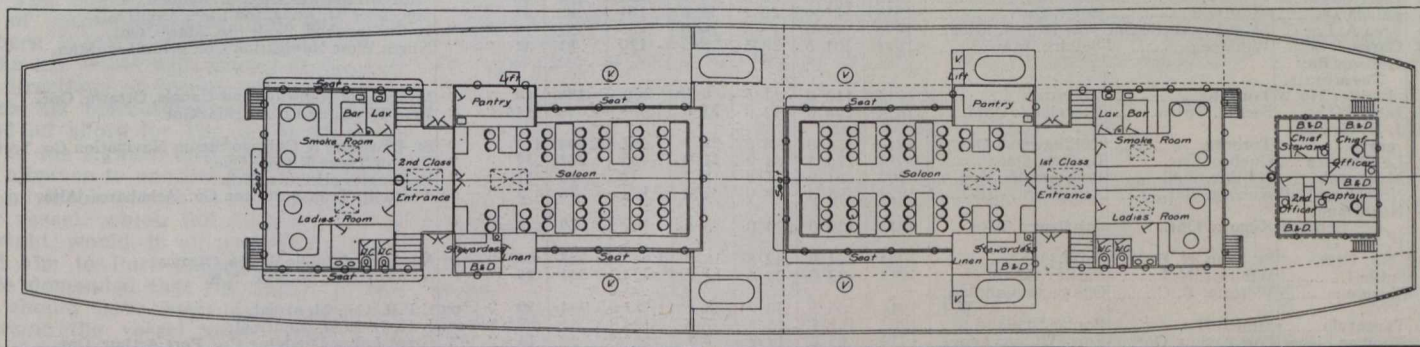

Promenade Deck, Car Ferry Prince Edward Island.

The engineers and crew will be located on the main deck, the former aft and the latter forward. Stores, etc., will be located on other part of the same deck. The promenade deck is immediately above the main deck and extends round the space occupied by the cars. Over this is the upper promenade and saloon deck. The forward house on this deck contains staterooms for the captain, chief and second officers and the first class saloon, with seats for 38 passengers, ladies' room, and smoking room, pantry and stateroom for the stewardess, while the aft deckhouse contains similar accommodation for the second class passengers. Above this is the boat deck, fitted with davits for eight lifeboats, the wheelhouse being forward. The passengers

to the promenade deck are of carved mahogany with rubber treads. The captain's night and day cabins are at the forward end of the upper promenade deck. The accommodation for the officers and engineers is abaft the second class accommodation. The petty officers', cooks' and stewards' accommodation, together with the first and second class men's lavatories, galley, lamp and paint room, messrooms for seamen and firemen, are arranged at the sides of the railway deck inside the superstructure. The crew will be berthed at the forward end of the railway deck. The life saving appliances of this vessel are to comply with the latest requirements of the Maritime Convention.

A large warping winch is fitted at the for-

consequently not in accordance with the dictates of authentic navigation. In view, therefore, of his failure in exercising the necessary caution to determine his position, the court finds it incumbent upon it to reprimand him and warn him to adopt more reliable and authentic methods of navigation in future. The court exonerates the other officers of the ship of culpability in the stranding. The two assessors assisting at the enquiry recommend that an efficient lightship, with a strong fog horn, be placed six miles south of Partridge Island, and that the fog signal now situated at Tiner's Point be removed to Split Rock, and be equipped with a more efficient fog horn; also that a more efficient fog signal be established on Cape Spencer.



### Salvage Operations on the Empress of Ireland.

Inasmuch as it was definitely settled that it was practically impossible to raise the Empress of Ireland so unfortunately sunk in the lower St. Lawrence, the next thing was to save whatever was possible from the wreck—all the bodies of the drowned that could be reached, the mails and the gold, of which there was a large amount.

When working in the interior of a sunken vessel the divers very properly object to following intricate passages where air pipes may be fouled and life lines cannot have a direct pull, and especially where, as in this case, the working pressure approaches the limit of endurance. One diver lost his life on this work. It was determined, therefore, to cut a number of holes in the inclined side of the ship to give the men short and direct entrances to certain locations where they might expect to make the most important finds.

The general scheme was to cut a number of rectangular openings, say 4 ft. or more in dimensions, through the steel plates, giving the divers free passage through them, and four or more of these holes have been cut. For each side of the rectangle a row of holes is drilled as close together as possible, defining the opening all around, and then the piece inclosed is torn out. This job is not as easy as the telling of it, the most difficult part of all, perhaps, being the drilling of the first one or two holes, on account of the difficulty of applying the necessary pressure behind the drill to make it cut. After two corner holes have been drilled, hook bolts can be inserted and these are made to support a steel beam placed at such a distance from the sheet as to form a proper backer for the drill. The work is then comparatively easy for all

that row. The thin portions between the holes are not cut away by chisels or otherwise, but the sheet is torn away bodily by brute force. The surface being inclined at a considerable angle, hooks can be inserted in a number of holes at once along the bottom, and then a powerful pull from a hoisting engine on the wrecker will do the rest. In this case it is not necessary to pull the sheet entirely off; it can be swung up and let remain there like an open door.

At the depth where the drills were employed the water pressure was about 40 lb., so that this had to be provided for by additional air pressure to correspond. The air is supplied by two Rand compressors, RC, of a type now somewhat obsolete, but which have done excellent service in other places. The air for the divers is supplied by hand operated pumps, which the divers prefer. Six divers are employed with a large gang of men for the various service required. The work of salvage is being done by King & Wotherspoon, of New York. —F. Richards, in Engineering Record.

### Shipping Report From Fort William.

F. & W. Jones, grain, vessel and marine insurance brokers, Fort William, Ont., wrote Oct. 15:—Coal arrivals are still keeping up, there being 16 cargoes, two anthracite and 14 bituminous, in the first half of October. Dispatch continues good, and much on the same lines as at our last writing. Western rail shipments have been more active but are not yet up to what is usual at this season of the year. A most noticeable feature is the small amount of tonnage lined up, and docks expect little improvement for the remainder of the season. The current opinion is that stocks are ample for the expected winter western shipments.

The grain situation has been disappointing from a shipping viewpoint. While lake shipments have naturally advanced, on account of the arrival of the new crop, there has been no semblance of rush business. Ninety three cargoes have gone east since the first of the month, 78 of which were in Canadian bottoms and 15 in U.S. bottoms, showing an aggregate of 6,675,116 bush. of all grains. The total stocks in elevators have steadily increased, and at time of writing stand at 22,462,904 bush. against 18,414,290 on Oct. 1. It will thus be seen that movement is by no means over active. There is still a large quantity of grain held in western line elevators yet to come forward. Much of this is said to be still in farmers' hands, who are apparently waiting more active markets. Should a higher export market develop, undoubtedly the larger amount of this grain would be rushed forward to the head of the lakes and thus further add up stocks. There are some four vessels lined up at elevators to load winter storage grain to be held at eastern points, and several others are expected to arrive shortly. As yet there are no vessels in sight for storage at the head of the lakes, although two vessels have laid up expecting to secure cargoes. While the general feeling, in view of the foregoing, is one of uncertainty, still it is thought likely that there will be a steady demand for winter storage boats. Although shippers at the moment do not appear to be active buyers, it is known that they already hold a good quantity of grain, and they will be naturally anxious to carry this over at the least possible cost, which means winter vessel storage. Stocks at date, receipts and shipments, are as follows:—

	Stocks.	Receipts.	Shipments
Wheat ....	17,206,128	11,979,531	11,121,304
Oats .....	3,174,757	2,857,630	1,496,629
Barley .....	553,379	480,238	335,209
Flax .....	1,528,640	430,929	757,549

### List of Steam Vessels Registered in Canada During August and September, 1914.

No.	Name	Port of Registry	Where and When Built	Length	Breadth	Depth	Gross Tons	Reg. Tons	Engines Etc.	Owner or Managing Owner
134367	Dick T.....	Sorel, Que.....	Sorel, Que..... 1914	64 0	15 2	6 3	44	20	16n.h.p. sc.	Sable Union Co., Quebec, Que.
131220	Electrona.....	Sydney, N.S.....	Portland, Me..... 1913	108 0	23 5	9 6	231	157 46	" "	Cape Breton Electric Co. Sydney, N. S.
134358	Felicia D.....	Montreal.....	Sorel, Que..... 1914	81 0	22 2	11 6	161	80 54	" "	Sincennes McNaughton Line, Montreal.
134379	Fred A. Lee.....	Sault Ste Marie Ont	Port Huron, Mich..... 1896	72 0	15 5	10 0	65	32 14	" "	L. Penhorwood, Sault Ste. Marie, Ont.
134253	Garry.....	Winnipeg.....	Selkirk, Man..... 1914	101 6	20 5	8 5	120	81 31	" "	North West Navigation Co., Winnipeg, Man.
134441	Hudson Bay Terminals, Lighter No. 3	Toronto.....	Toronto..... 1914	112 0	21 5	9 0	268	129 19	" "	Minister of Railways and Canals, Ottawa, Ont.
130440	Inland (1).....	Sarnia, Ont.....	Cleveland, Ohio..... 1894	248 0	42 0	21 5	1,889	1,098 146	" "	Reid Wrecking Co., Sarnia, Ont.
134250	J. H. G. Haggarty.....	Toronto.....	Collingwood, Ont..... 1914	536 0	58 3	27 3	7,462	5,704 217	" "	St. Lawrence & Chicago Steam Navigation Co., Toronto.
134138	Le Progres.....	Quebec, Que.....	Lauson, Que..... 1914	126 5	34 2	11 0	465	242 37	" "	City of Three Rivers, Que.
133677	Musquash.....	Halifax, N.S.....	Portsmouth, Eng..... 1894	51 0	11 8	5 2	22	15 12	" "	F. Longley, Halifax, N.S.
134312	Northland Call	Kenora, Ont.....	Athabasca, Alta..... 1911	95 3	18 0	2 4	103	55 3	" pa	Northern Transportation Co., Athabasca, Alta.
134311	Northland Echo.....	Kenora, Ont.....	Athabasca, Alta..... 1912	120 0	24 0	3 6	147	79 5	" "	" " "
134184	P. W. D. No. 1 (2).....	St. John, N. B.....	Sorel, Que..... 1905	244 0	42 8	18 0	1,605	888 66	" sc	Minister of Public Works, Ottawa.
136307	Sable I.....	Windsor, N.S.....	Paisley Scotland..... 1914	183 0	28 6	12 2	734	341 85	" "	A. Farquhar, Halifax, N.S.
134276	Sicamous.....	Victoria, B. C.....	Okanagan Landing, B. C..... 1914	200 5	40 0	8 0	1,787	994 50	" pa	C.P.R. Co., Montreal.
115849	Tarantula.....	Montreal.....	Poplar England..... 1902	152 7	15 3	7 8	124	84 59	" sc.	J. K. L. Ross, Montreal.
134016	Thomas Fisher	Port Arthur, Ont.....	Fort William, Ont..... 1914	65 0	14 7	7 1	52	23 14	" "	Great Lakes Dredging Co., Port Arthur, Ont.
133949	Winnipeg (3).....	Ottawa, Ont.....	Newcastle on Tyne..... 1912	415 0	55 2	31 1	6,330	3,863 597	" "	International Petroleum Co., Toronto.

(1) Formerly J. W. Nicholas.

(2) Formerly W. S. Fielding.

(3) Formerly Adorna.

### List of Sailing Vessels and Barges Registered in Canada During August and September, 1914.

No.	Name	Port of Registry	Rig	Where and When Built	Length	Breadth	Depth	Reg. Tons	Owner or Managing Owner
126127	Bertie Calcins.....	Kingston, Ont.....	Schr.....	Two Rivers, Wis..... 1874	134 4	27 2	9 3	227	H. Vandusen, Deseronto, Ont.
130977	C. S. B. D. and C. Co.'s No. 8.....	Collingwood, Ont.....	Scow.....	Collingwood, Ont..... 1914	130 0	30 0	10 7	389	C. S. Boone Dredging & Construction Co., Toronto.
33653	Ellen, Mary.....	Halifax, N.S.....	Schr.....	Pasbebiac, N.S..... 1878	71 3	20 4	8 3	66	R. Jones & Whitman, Halifax, N.S.
134380	McLean, No. 3.....	Sault Ste. Marie, Ont.....	Scow.....	Sault Ste. Marie, Ont..... 1913	78 0	30 0	7 0	164	A. B. McLean, Sault Ste. Marie, Ont.
134393	Mark A. Tobin.....	Lunenburg, N.S.....	Schr.....	Lunenburg, N.S..... 1914	108 4	25 8	10 4	96	C. Iverson, M.O., Lunenburg, N.S.
134442	O. H. C. No. 51.....	Toronto.....	Scow.....	Toronto..... 1914	108 0	28 0	8 7	241	Polson Iron Works, Toronto
134443	O. H. C. No. 52.....	"	"	"..... 1914	108 0	28 0	8 7	241	" " "
134444	O. H. C. No. 53.....	"	"	"..... 1914	108 0	28 0	8 7	241	" " "
134445	O. H. C. No. 54.....	"	"	"..... 1914	144 0	31 0	11 1	434	" " "
134446	O. H. C. No. 55.....	"	"	"..... 1914	144 0	31 0	11 1	434	" " "
134447	O. H. C. No. 56.....	"	"	"..... 1914	144 0	31 0	11 1	434	" " "
131185	R., No. 1.....	Peterborough, Ont.....	"	Peterborough, Ont..... 1914	144 0	31 0	11 1	434	" " "
131186	R., No. 2.....	"	"	"..... 1914	80 0	28 0	5 4	104	C. H. Rogers, Peterborough, Ont.
134359	S. McN. L. Derrick scow.....	Montreal.....	"	Sorel, Que..... 1914	96 5	27 6	4 0	84	Sincennes McNaughton Line, Montreal
134449	T. & C.....	Toronto.....	Barge.....	Buffalo, N. Y..... 1902	113 0	32 0	11 0	215	Lake Simcoe Ice Supply Co., Toronto
130223	White and Friant.....	Owen Sound, Ont.....	Schr.....	Bay City, Mich..... 1881	158 0	28 0	11 6	278	Peninsula Tug and Towing Co., Wiarton, Ont.



**Lights and Fog Alarms on the Great Lakes and St. Lawrence River.**

The Department of Marine has issued a notice that all Canadian lights and fog alarms on Lake Superior will be kept in operation until the close of navigation, with the exception of those at Caribou Island, Otter Island, Michipicoten Island, Michipicoten Island east end, Gargantua, Michipicoten harbor, Corbell Point and Ile Parisienne, from which stations the keepers may be removed at any time after Dec. 1. Mariners must not rely on finding any of these lights in operation later than Dec. 1. All Canadian lights and fog alarms on Lake Huron, Georgian Bay, Lake St. Clair, Lake Erie, Lake Ontario, and connecting waters will be kept in operation until the close of navigation, except the southeast shoal lightship Lake Erie, which may be forced to abandon her station by ice conditions before the close of navigation. All Canadian lights on the St. Lawrence River will be kept in operation until the close of navigation. All gas buoys and floating aids to navigation will be kept at their stations as long as ice conditions will permit, and in cases where it is necessary to remove gas buoys before the close of navigation, spar markers will be laid down if possible. Lightkeepers and mariners will govern themselves accordingly, and lightkeepers are cautioned to maintain their lights and fog alarms in operation until navigation shall have completely closed. They are required to satisfy themselves that navigation has completely closed before closing their stations. The keepers of the stations named above will maintain their lights in operation until they are called for by Government steamboat.

**The Stranding of the s.s. Floriston.**

Following is a summary of the judgment delivered by Capt. L. A. Demers, Dominion Wreck Commissioner, concurred in by Capt. F. Nash and Mathias, in connection with the striking of an iceberg by the s.s. Floriston, Aug. 29, in Belle Isle Strait, and her subsequent stranding west of Rich Point. The court, while exonerating the master of responsibility for collision with the iceberg, looks askance at his neglect in supplying his vessel with proper charts and sailing directions of recent issue, and also questions his extraordinary conduct when he stood off shore for two hours awaiting answer to his signals, and failed to send a boat in advance to enquire the most practical and advisable course to follow in beaching his vessel, which information, had it been sought, would, in all probability, have directed him to Port Saunders. Ordinary prudence demanded that the nature of the bottom should have been ascertained before driving the vessel ashore, and it is providential that, beached as she was on a rock bottom in an almost perilous position, an exceptional period of fine weather prevailed until she was refloated, and it therefore cannot be attributed to any seaman-like action of the master that she escaped ultimate disaster. The court severely reprimands the master, A. E. Kennedy, for his negligence. The master and second officer were also cautioned to be more careful, prudent and resourceful in future.

The hydraulic dredge Port Nelson, which was built at Polson Iron Works, Toronto, about a year ago for work in the Port Nelson harbor, Hudson Bay, was, after considerable delay, due to weather conditions, placed under operation, Sept. 28. She is making a channel into Port Nelson for the temporary docks to be built there.

**The North Atlantic Conference and the United States Anti-Combine Laws.**

In Jan., 1911, the U.S. Government commenced suit against the shipowning companies comprising the North Atlantic Conference, and also against a number of these companies' officials, complaining that they operated in restraint of trade. When the suit was originally entered, the Allan Line and the C.P.R. were included with the other defendants, but as it transpired at the trial, that both of these companies had withdrawn from the conference, prior to the date of the entry, they were dismissed from the action. Judgment was delivered in New York, Oct. 13, dismissing all of the Government's complaints with one exception, without costs to the defendants. The one complaint which was upheld, referred to what has been termed the "fighting ships," which, it is stated, were used to compete with vessels of lines not members of the conference and operating at lower rates than those charged by the conference members. The court stated that ostensibly they were operated by one of the members of the conference, but they were really supplied by the conference, the members thus cooperating to keep out competition. It is reported that the Government will probably take an appeal to the Supreme Court.

Since this action was entered upon, the European war has broken out, and as the more or less predominating influence in the conference was German, and as the German merchant fleet is now nonexistent, it is scarcely likely that the conference will be continued on the lines on which it was operated before. The action of the Canadian lines in withdrawing altogether from the membership and defying the strong combination, a few years ago, caused a considerable flutter in the shipping world.

**Atlantic and Pacific Ocean Marine.**

It is reported that the Osaka Shosen Kaisha is building in Japan, nine steamships aggregating 37,000 tons. Of these, two of 9,500 tons each, are stated to be for the company's Hong Kong-Vancouver service.

Furness, Withy and Co.'s s.s. Shenandoah, which stranded off Little Musquash, N.B., in September, is being repaired at Halifax,

N.S. About 60 plates have to be replaced and repaired. The cost will be about \$25,000.

It is reported that British interests are negotiating with the Great Northern Ry. for the purchase of the s.s. Minnesota. It is stated that it has not transpired whether the negotiators are the British Admiralty, the C.P.R., or the G.T. Pacific Ry.

The s.s. Elsinore, an oil tank vessel, which was reported recently to have been sunk by a German cruiser off the coast of Chili, was owned by C. T. Bowring and Son, of Liverpool, Eng., and Newfoundland. She was built in 1913, and had a tonnage of 6,542 gross and 4,169 register.

The C.P.R. has amended its claim for damages against the owners of the s.s. Storstad, in connection with the loss of the s.s. Empress of Ireland, by increasing the amount from \$2,000,000 to \$3,000,000, in order to meet any liability under actions for damages brought by relatives of the crew, and for other contingencies.

Canada Steamship Lines s.s. Bermudian, which is one of the vessels engaged recently in transporting the Canadian contingent from Quebec to England, is reported to have been requisitioned by the British Government to take troops from England to India to replace others which are leaving, or have left, for the front.

The C.P.R. and Allan Lines have raised the first class rates between Canada and Great Britain, by \$10, and second class and third class rates by the Cunard and Donaldson Lines have been advanced \$5 and \$2.50, respectively. The increase of \$20 in the first class rates which was made on the outbreak of war, was cancelled a few days after it was made, so that the present is the only increase which has really taken place.

A St. John, N.B., correspondent writes:—"The harbor works on the west side are being pushed with the greatest vigor in anticipation of an increased traffic in grain and other food stuffs between Canada and Great Britain during the approaching winter. The new pier which will probably be utilized by the steamers of the C.P.R. will be ready for business by Dec. 1. A monster warehouse is now in course of erection, and an elaborate scheme of reclamations is being carried out with a view to providing enlarged trackage facilities."

**Sault Ste. Marie Canals Traffic.**

The following commerce passed through the Sault Ste. Marie Canals during September.

ARTICLES		CANADIAN CANAL	U. S. CANAL	TOTAL
Copper.....	Eastbound	Short tons 831	6,628	6,959
Grain.....	"	Bushels 2,487,115	3,102,896	5,590,011
Building stone.....	"	Short tons		
Flour.....	"	Barrels 854,730	1,226,510	1,581,240
Iron ore.....	"	Short tons 3,739,871	1,549,987	5,289,808
Pig iron.....	"	"	2,138	2,138
Lumber.....	"	M. ft. b.m. 1,819	58,146	59,965
Silver ore.....	"	Short tons		
Wheat.....	"	Bushels 15,458,520	6,211,090	21,669,610
General merchandise.....	"	Short tons 15,090	15,261	31,251
Passengers.....	"	Number 1,495	1,552	3,047
Coal, hard.....	Westbound	Short tons 20,47	142,463	162,910
Coal, soft.....	"	" 296,475	1,427,27	1,723,692
Flour.....	"	Barrels	145	145
Grain.....	"	Bushels		
Manufactured iron.....	"	Short tons 4,901	10,383	15,281
Iron ore.....	"	"		
Salt.....	"	Barrels 2,828	66,800	69,628
General merchandise.....	"	Short tons 31,28	103,048	137,76
Passengers.....	"	Number 1,74	1,420	2,794
Summary.				
Vessel passages.....	Number	850	1,846	2,696
Registered tonnage.....	Net	2,351,631	3,551,372	6,403,003
Freight—Eastbound.....	Short tons	4,312,430	2,055,978	6,368,408
—Westbound.....	"	356,655	1,602,653	2,049,808
Total freight.....	"	4,669,085	3,748,631	8,417,716



The C.P.R. s.s. Missanabie sailed from Liverpool, Eng., on her maiden trip to Montreal, Oct. 7, and left for England again on Oct. 22. She is 520 ft. long, 64 ft. wide and 40 ft. deep, with a gross tonnage of 13,000 tons, and cargo capacity of 400,000 cubic feet. She is of the one class cabin type, with accommodation for 520 cabin, and 1,200 third class passengers. Capt. G. C. Evans, formerly of the company's s.s. Lake Manitoba, is in command. A full description of the vessel has already appeared in Canadian Railway and Marine World.

The total of the fund raised for the benefit of dependents on those who lost their lives in the Empress of Ireland disaster is £90,000, which has been paid over to the public trustee in England, who is formulating a scheme of disbursement similar to that adopted at the time of the loss of the Titanic. About 350 claims have been filed, exclusive of Canadian ones, which are comparatively few. It is stated that payments will be made weekly to British claimants in Great Britain, from amounts invested, and by lump sums to Canadians, while certain German claims will be ignored.

The Uranium Steamship Co., which has for some time been operating a steamship service between New York and Rotterdam, Holland, has discontinued operations during the war. This company, which is closely allied with the Canadian Northern Ry. interests, owned the steamships Uranium, Campanello and Principello. The Uranium has been laid up for the present, and the other two vessels have been taken over for operation by Canadian Northern Steamships, Ltd., to fill the vacancies caused by the withdrawal of the steamships Royal Edward and Royal George, requisitioned by the British Admiralty for war service.

The first case to be heard under the Workmen's Compensation Act in England in connection with the Empress of Ireland disaster, was decided in favor of the company recently, in the Liverpool County Court, when Quartermaster Galway, whose evidence in the enquiry at Quebec was severely commented on by Lord Mersey, claimed compensation on the ground that he had contracted pleurisy and neurasthenia as a result of long immersion in cold water. After hearing his evidence, the judge gave judgment in favor of the C.P.R., remarking that he was not satisfied that the applicant at any time suffered as a result of the accident, and that his evidence both in Quebec and Liverpool, was inconsistent.

The British Admiralty has issued the following notice,—For purposes of national defence it is considered necessary that certain channels in the approaches to the Thames should be closed. All incoming vessels flying foreign flags and all British vessels from all foreign and colonial ports must call at the new pilot station in the vicinity of the Tongue lightvessel, or at one of the established pilot stations, viz.,—the Sunk lightvessel, Margate, Deal and Dover, and be conducted to their destinations by a licensed pilot. All outgoing vessels of the same description must before sailing obtain the services of a licensed pilot to conduct them to sea. All incoming vessels not included in the above, before leaving their port of departure for the Thames, and all similar outgoing vessels, must obtain instruction from the nearest Customs authorities as to the channels to be used.

The steamships Brindilla and Platuria, which were recently transferred from the German to the U. S. register, under the new law relating to foreign built vessels, have been taken into British ports and held, on the ground that the transfer of German ves-

sels to the register of a neutral country during the war is not legal, and is a breach of the London Convention. These vessels with the s.s. J. D. Rockefeller, were engaged in conveying oil to neutral ports. The J. D. Rockefeller was also held, but was subsequently released as the British authorities were satisfied as to the destination of the cargo. The question of the two vessels still detained has been dealt with through diplomatic channels and the vessels released. The Brindilla was formerly named Washington, and was built in Stettin, Germany, in 1894; the Platuria, formerly Diamant, was built at Newsastle, England, in 1892.

### Maritime Provinces and Newfoundland.

The C.P.R. has withdrawn its s.s. St. George from the Bay of Fundy service for the winter, the service being performed by the s.s. Yarmouth on a daily schedule, excepting Sundays.

The Dominion Government has entered an action against the s.s. Langan, owned by Furness, Withy and Co., and under charter to the Dominion Coal Co., for the sinking of the s.s. Montmagny. It is stated that the claim is for \$400,000.

The Charlottetown, P.E.I., Board of Trade had under consideration at its meeting on Oct. 14, the constitution of a pilotage district and local pilotage authority for Charlottetown. After considerable discussion it was decided to refer the question to the Board's council for further consideration.

A proclamation has been issued declaring Belle River, P.E.I., to be a port, the limits covering the waters of the Strait of Northumberland and all the navigable waters of the Belle River inside of the depth of five fathoms at low tide, bounded east and west by lines drawn parallel to one quarter statute mile distant from the east face of the west breakwater at the mouth of the river.

The Steamship Cacouna Co.'s s.s. Cacouna, which ran ashore at Hare's Ears, Ferryland Head, near St. John, N.B., at the latter end of September, has become a total loss. She was built at Newcastle upon Tyne, Eng., in 1884, and was screw driven by engine of 142 n.h.p. Her dimensions were, length, 250 ft., breadth 35.4 ft., depth 16.4 ft.; tonnage, 1,451 gross, 931 register. The Steamship Cacouna Co. is a subsidiary of the Black Diamond Steamship Co.

Judgment was delivered at St. John, N.B., Oct. 1, on a claim by R. M. G. Walford against Wm. Thomson and Co., insurance agents, for balance of \$500 due on a claim under an insurance policy issued on the brigantine Marconi, lost at sea, Nov. 27, 1911. It was claimed by the defendants that they issued the policy as agents for underwriters in England, and that it was not binding on them personally, and that throughout the transaction they had merely acted as agents, and that the renewal of the policy, under which renewal the vessel was lost, was not made under the correct conditions of the original policy providing such renewal. Judgment was given in favor of the plaintiff, it being held that the defendants were personally liable.

The Toronto Harbor Commissioners have officially announced that the works under their jurisdiction will proceed without interruption, there being ample funds on hand for all purposes.

MARINE NOTES.—Shipping moves freely, except Austrian and German.—Financial Times, Montreal.

### Province of Quebec Marine.

Capt. J. A. Vibert, a former deputy port warden of Montreal, died at Westmount, Que., Oct. 1, aged 87.

Montreal press reports state that the Harbor Commissioners are considering the extension of their no. 2 elevator, at an approximate cost of \$800,000.

The Davie Shipbuilding and Repairing Co., of Lauzon, has, during this year completed for the Marine Department, six scows, each with hopper capacity of 300 cubic yards. The dimensions of each are, length inside of fenders 104 ft., breadth moulded 28 ft., depth moulded 9 ft.

The Department of Marine has placed a gas buoy, colored green and showing a white light occulting at short intervals, about 150 ft. northward of the wrecked s.s. Montmagny, which sank in the Beaujeu Channel, River St. Lawrence, after colliding with the s.s. Langan, Sept. 18.

Press reports from Montreal, Oct. 16, stated that the Montreal Harbor Commissioners after having received complaints from Great Britain as to shortage in grain cargoes, have held an inquiry and as a result have dismissed four employes. It is stated that the total thefts amount to about 8,000 bush. of oats.

Canada Steamship Lines s.s. Quebec received slight damage when the s.s. W. H. Dwyer backed into her while raising her anchor in Lake St. Peter, Oct. 11. The damage was repaired at Sorel, and during the few days the Quebec was off her run between Montreal and Quebec, her place was taken by the s.s. Murray Bay.

It is announced that the offices of the Quebec Steamship Co., at Quebec, which were taken over by Canada Steamship Lines, Ltd., on the absorption of the former company, have been closed, and the staff transferred to the head office at Montreal. It is stated that A. Ahern, who was Manager, Quebec Steamship Co., for many years, will be superannuated.

The Montreal Harbor Commissioners have commenced an action against the s.s. Cairnross for \$25,000 damages for the sinking of a scow on which was a large stone crusher and concrete mixer. The accident occurred on Oct. 6, when the Cairnross was proceeding to her berth at shed 15. It is said that the Commissioners are to raise the machinery and ascertain the exact amount of damage sustained.

Canada Steamship Lines s.s. Louis Philippe, the launching of which, from the yard of the Davie Shipbuilding and Repairing Co., Lauzon, was mentioned in our last issue, is intended for service in Montreal harbor between Montreal and Longueuil, during the summer, and in the lower St. Lawrence in the winter. She has been specially built for such service, and the dimensions are, length 169.6 ft., breadth moulded 43 ft., depth of hold 12.3 ft. The propelling machinery consists of reciprocating engines of 500 h.p. supplied with steam by one Scotch boiler.

A report is stated to be ready for presentation to the Montreal Board of Control, relating to the proposed municipal ferry service between Montreal and St. Helen's Island. It is estimated that the cost of a steel ferry steamboat, with capacity for about 1,000 passengers, will be \$65,000. The vessel would be double ended, with two decks, arranged for embarking and disembarking passengers from both levels. It is ultimately intended to have two vessels, one operating from the east end, and one from the west end, but it is stated that only one will be proceeded with at first.



The Corporation of Three Rivers s.s. Le Progres, which was launched from the Davie Shipbuilding and Repairing Co.'s yards at Lauzon, recently, is of the following dimensions, length between perpendiculars 126.6 ft., breadth 32.4 ft., depth 12.2 ft. She is equipped with compound engines with cylinders 15 and 30 ins. diam., by 22 ins. stroke, supplied with steam by one boiler 11¼ ft. diam. by 9½ ft. long, at a pressure of 150 lbs. The engine is of 425 i.h.p., and the vessel is propelled by a single screw at about 11½ knots an hour. The hull has been built extra strong, so that she can be used for ice breaking in the winter. There is accommodation for about 450 passengers, in addition to room for cattle, horses and general cargo.

### Ontario and the Great Lakes.

Canada Steamship Lines closed its Niagara River season, Oct. 17.

Capt. T. Sullivan, a veteran lake mariner, died at Toronto, Oct. 21, aged 80.

Capt. S. H. Burnham, a well known lake mariner, died at Port Huron, Mich., Oct. 2, aged 77.

John Lally, lock master on the Cornwall Canal at Cornwall, died there, Sept. 30, after a short illness.

A weather reporting station has been opened at Sarnia, for the supply of information to vessels passing up and down.

John Laxton has been appointed as the Dominion Government nominee on the Toronto Harbor Commission, succeeding F. S. Spence.

Capt. S. Burnham, who died at Port Huron, Mich., Oct. 1, was, until recently, master of the Pere Marquette Rd. car ferry at Detroit.

From a note left behind in his office, it is feared that E. Geddes, freight agent, Canada Steamship Lines, Lewiston, N.Y., has committed suicide.

The s.s. Grenville, which is being built at Polson Iron Works, Toronto, for the Dominion Government lighthouse service in the St. Lawrence River between Lake Ontario and Coteau, will be launched about Nov. 9.

The Canadian Stewart Co.'s steam tug Emslie Stewart was launched at Toronto, Oct. 10. She is of steel, 80 ft. long, and the hull is divided into four compartments with watertight bulkheads. When completed she will be utilized in connection with the Toronto harbor improvements, for which the owners have the contract.

A third lock in the United States canal at Sault Ste. Marie, was opened Oct. 21. The lock is the largest in the world, the dimensions being, 1,250 ft. long by 80 ft. wide with a draught of 24½ ft. It will accommodate any two of the largest vessels on the Great Lakes. The cost of the work is somewhat over \$6,000,000.

The ice breaking steamship J. T. Horne, which, as reported in our last issue had been purchased by the Russian Government for service in Russian waters, was inspected at Montreal, early in October by a member of the Russian Embassy at Washington, D. C. It is stated that she will be utilized in the neighborhood of Archangel.

The Mathews Steamship Co.'s s.s. Edmonton, while bound to Montreal with flour during the first week of October, struck a submerged object near Morrisburg, and was beached to avoid sinking. Some temporary repairs were undertaken to enable her to reach Montreal. The accident is stated to have been due to low water on the route between Montreal and Port Colborne.

Canada Steamship Lines s.s. Juno, which was acquired when the company took over the Richelieu and Ontario Navigation Co., but which has not been operated for several years, is being dismantled at Toronto. She was built at Wallaceburg, Ont., in 1885, and was screw driven by engine of 170 n.h.p. Her dimensions were, length 139.7 ft., breadth 26.8 ft., depth 8.8 ft.; tonnage, 288 gross, 196 register.

Engineers were in Owen Sound recently inspecting sites for the location of the projected dry dock and ship repair plant. This matter has been before the public in many shapes for several years without anything being achieved, and even local people appear to be somewhat pessimistic as to anything being done in the immediate future. The strongest statement used in commenting on the project, is that "it would appear as though the realization of the long considered project is nearer than it has ever reached before."

The United States Lake Survey reports the levels of the Great Lakes in feet above tidewater for September, as follows,— Superior 602.80; Michigan and Huron 580.48; Erie 572.37; Ontario 246.09. As compared with the average September levels for the past ten years, Superior was 0.07 ft. above; Michigan and Huron 0.41 ft. below; Erie 0.07 ft. below, and Ontario 0.25 ft. below. It was anticipated that during October the level of Superior would remain stationary; Michigan and Huron would fall 0.2 ft.; and Erie and Ontario 0.3 ft.

The s.s. Howard M. Hanna Jr., formerly owned by the Hanna Transit Co., Cleveland, Ohio, and which was wrecked in the Great Lakes storm of Nov., 1913, has been purchased from the Reid Wrecking Co., Sarnia, Ont., who acquired the wreck and raised her, by the interests with which Jas. Playfair, Midland, Ont., is associated. The vessel has been thoroughly overhauled and repaired at Collingwood. The shipowning company with which Mr. Playfair is interested is the recently incorporated Great Lakes Transportation Co., of Midland, which has a capital of \$1,000,000. With him in the company, are associated, H. W. Richardson, Kingston, D. L. White and F. W. Grant, Midland, and W. J. Sheppard, Waubaushe, Ont.

### Manitoba, Saskatchewan and Alberta.

The dry dock which has been built at Selkirk, Man., for the accommodation of the Government vessels on the lake, was opened Oct. 20. It is stated that it will also be used for general shipping.

The Canadian Shipping Co., Ltd., has been incorporated under provincial letters patent, with \$25,000 capital stock, and office at Winnipeg, to own and operate steam and other vessels, to act as agents for other vessel owning companies, and to carry on a general navigation business. F. S. Andrews, W. H. Curle, D. L. Bastedo, L. T. S. Norris-Elye and L. D. Morosnick, Winnipeg, are the incorporators.

### British Columbia and Pacific Coast Marine.

The C.P.R. has discontinued its direct steamship service between Victoria and Tacoma, Wash., for the winter.

The Department of Marine has awarded a contract for the construction of a lighthouse on Bonilla Island, in the British Columbia outside channel, to Weldon and Talbot, New Westminster. It is unlikely that the light will be placed until the spring,

owing to the storms which sweep the island during the winter.

The G.T. Pacific Coast Steamship Co.'s s.s. Prince Albert, which was wrecked in Brown's Passage, Aug. 18, and which was reported to have been abandoned as a total loss, was subsequently salvaged and taken to Esquimalt for examination, and later to North Vancouver, where she will be repaired. Sixty shell plates will have to be replaced, besides other repairs. It is expected that she will be again ready for service about the end of November.

The G.T. Pacific Coast Steamship Co.'s autumn schedule, which became effective Oct. 4, covers the s.s. Prince George, leaving Seattle, Wash., on Sundays, calling at Victoria and Vancouver, Mondays, Prince Rupert, Wednesdays, Anyox and Stewart, Thursdays, and returning to Seattle by the same route on Sundays; the s.s. Prince John, leaving Vancouver on Fridays for Prince Rupert and Island ports and returning to Vancouver on the following Tuesday week; and the s.s. Henriette, for freight only, as directed.

The enquiry into the causes of the collision between the C.P.R. s.s. Princess Victoria and the Alaska Pacific Navigation Co.'s s.s. Admiral Sampson, conducted by two United States Steamboat Inspectors recently, resulted in the statement that as both vessels were running under rule 13 of the pilot rules for inland waters of the Atlantic and Pacific Coasts and the coast of the Gulf of Mexico, and from the evidence adduced the inspectors were of opinion that neither of the vessels were in compliance with the rule, and therefore both were to blame. Since the only action which the local inspectors can take would be to revoke the license of the officer in charge of the s.s. Admiral Sampson, those on the Princess Victoria not being under U.S. jurisdiction, and as the officer in charge of the Admiral Sampson went down with his vessel, no penalty will be imposed. The investigation by the Canadian authorities exonerated the officers of the s.s. Princess Victoria from all culpability in connection with the collision.

The C.P.R. s.s. Princess Margaret, which has just been completed on the Clyde, Scotland, for service on the British Columbia Coast, underwent her dock trials about the middle of October, and it was announced that she would be sent on her speed and other trials about the end of that month. The sister vessel, Princess Irene, is still on the ways, and J. W. Troup, Manager, British Columbia Coast Service, C.P.R., was reported to have stated recently, that though the vessels would not arrive at the coast as soon as was originally expected, they would in all probability be there ready for service in the spring.

### Directory of Canadian Ports and Harbors.

—The Department of Marine has issued a directory containing information about a great number of harbors throughout the Dominion, both maritime and inland. The information is intended to afford mariners generally definite knowledge of harbors and aids to navigation, and covers descriptions of the power and order of lights, of fog alarms, buoys and submarine warnings, and also tides and currents and life saving and radio telegraph stations. Brief descriptions are included of the Hudson Bay and Strait, with approximate length, breadth and depth of these waters, and references indicating the natural harbors affording shelter in the strait and along the coast of Baffin Island. This is the second port directory issued by the Department, the first one having been confined to descriptions of harbors where not less than 50,000 tons of shipping had entered during the year of publication.



## The Transportation of Canadian Troops to Europe.

The work of transporting the 30,000 odd members of the first Canadian contingent for war service in Europe, from Valcartier, Que., to Salisbury Plain, England, has been carried out in an eminently satisfactory manner. The gathering of the requisite number of suitable vessels was a considerable task, and the loyal cooperation of the owning companies was undoubtedly one of the main factors in its accomplishment.

The first of the troops left the camp at Valcartier, Sept. 22, and the last of the transport vessels from Quebec, Oct. 1. The troop trains were run down direct to the Louise embankment, and the loading of the vessels proceeded night and day. Thirty steamships were used for the Canadian contingent, and one vessel, the s. s. Florizell, was picked up later, conveying the Newfoundland contingent. The vessels used, with their respective owning companies, are as follows:—

Allan Line—Corinthian, Grampian, Scandinavian, Scotian, Sicilian, Tunisian and Virginian.

Canadian Northern Steamships—Royal Edward, Royal George.

Canadian Pacific Ry.—Montezuma, Montreal, Monmouth, Ruthenia, Tyrolia.

Cunard Line—Franconia, Ivernia, Laconia, Saxonia.

Cunard-Thomson Line—Alaunia, Andania.

Canada Steamship Lines—Bermudian.

Donaldson Line—Athenia, Cassandra.

Furness, Withy and Co.—Manitou.

Red Star Line—Lapland, Zealand.

Royal Mail Steam Packet Co.—Arcadian, Carribean.

White Star Line—Laurentic, Megantic.

The last of the transports sailed from Quebec early on Oct. 1, and the whole of the fleet assembled at Gaspé Bay, which had been made the rendezvous, for final arrangement of the lines and convoys. While this was being carried out, a final message by the Governor General was distributed, together with mail matter, etc. The fleet was also joined at this point by the White Star-Dominion Line s. s. Canada carrying the Lincolnshire Regiment which had been on garrison duty at Bermuda.

The fleet of transports was formed into three columns for convoy across the ocean, as follows:—Column Z,—Alaunia, Bermudian, Cassandra, Florizel, Ivernia, Lapland, Megantic, Montezuma, Ruthenia, Scandinavian, Sicilian; convoy, H. M. S. Eclipse.

Column Y,—Athenia, Canada, Carribean, Franconia, Laurentic, Manitou, Monmouth, Royal Edward, Tunisian, Tyrolian; convoy, H. M. S. Diana.

Column X,—Andania, Arcadian, Corinthian, Virginian, Zealand; convoy, H. M. S. Charybdis (flagship); Grampian, Laconia, Montreal, Royal George, Saxonia; convoy, H. M. S. Glory.

The foregoing formation was maintained until near the British coast, the vessels proceeding with distance of about 1½ miles between, the whole fleet covering an area of about 15 square miles. Other warships joined the fleet in the Gulf of St. Lawrence, these being engaged in the patrol of the North Atlantic, and they returned to their former duty from mid ocean. In addition to the warships, the steamships Royal George and Laurentic, the two fastest vessels of the fleet were utilized as scouts. When nearing the British Coast, the two vessels bearing the Army Service Corps were detached from the main body and sent ahead to assist in the general landing, in charge of H. M. S. Diana, whose place was taken by H. M. S. Majestic. The strictest care was taken to prevent at-

tack of whatsoever nature, and the voyage was accomplished in perfect safety. The troops arrived at Plymouth, Oct. 14, where they landed and entrained for the training camps on Salisbury Plain.

**The Empress of Ireland Disaster.**—In connection with the C.P.R. claim for \$3,000,000 damages for the loss of the s.s. Empress of Ireland, which was run down by the s.s. Storstad, the owners of the latter vessel applied at the Admiralty Court at Montreal, Oct. 19, for an order for the C.P.R. to produce the official log book of the s.s. Montrose on her several voyages between Montreal, Quebec and Liverpool, while under the command of Capt. Kendall, who was in charge of the Empress of Ireland at the time of the disaster; also for a list of all survivors of the crew on watch in all departments at the time of the collision, and for the appointment of a commission in England to take the depositions of one of the passengers. The defendants also demanded admission that at the date of the collision, the Storstad was the property of the Actienelskabet Maritime, a corporation with office in Christiania, Norway, and also that by reason of the collision, the Storstad suffered damage.

**Lift Bridge for Toronto Harbor.**—The Toronto Harbor Commissioners are making preparations for the construction of a lift bridge to carry Cherry St. over the Don River, within the zone of the improvements to be made by the Commission. It is to be of a lift type to permit vessels to pass from the harbor to beyond Cherry St., but it has not yet been decided whether it will be a rolling lift bridge or a bascule bridge. It is expected that an early decision will be arrived at in order that the work may go on without delay. It will have a clear span of 80 ft., it will be 66 ft. wide, and in addition to provision for vehicular and pedestrian traffic along each side, will have a double street car track down the centre.

**Submarine Mines in the North Sea.**—The British Admiralty has issued the following notice:—The German policy of mine laying, combined with their submarine activities, make counter measures necessary on military grounds. His Majesty's Government has therefore authorized a mine laying policy in certain areas. To reduce risks to non-combatants, the Admiralty announces that it is dangerous for vessels to cross the area between latitudes 51 deg. 15 min. and 51 deg. 40 min. north, and longitudes 1 deg. 35 min. and 3 deg. east. The southern limit of the German mine limit is 52 deg. north, but it is not supposed that navigation is safe in any part of the southern waters of the North Sea.

**Regulations Regarding Deck Loading.**—Following on the lead given by the British Government, the Dominion Government has amended the regulations governing the loading of timber on vessels, so as to allow of the exportation of pit props to Great Britain, where they are urgently needed. The Marine Department has been advised that masters or owners of vessels arriving at ports in the United Kingdom from Canadian ports between Oct. 31 and Nov. 15, with summer deck loads of wood goods, will not be proceeded against by the Board of Trade. The Department has therefore decided to allow steamships to load accordingly in Canada, up to Nov. 7.

**G. H. Flood has been appointed Purchasing and Contract Agent, Marine & Fisheries Department, Ottawa, vice C. Doutré, resigned.**

In acknowledging a correction of a news item recently, the Montreal Daily Mail refers to J. A. Farouhar of the s.s. Seal, as the "managing editor of the s.s. Seal."

## The Stranding of the s.s. Monkshaven.

Capt. L. A. Demers, Dominion Wreck Commissioner, has given the following judgment re the stranding of the s.s. Monkshaven, a steel built single screw vessel, on Roix Shoal, in the St. Lawrence River, about a mile from Ste. Felicite, Que., on Aug. 23, it being concurred in by Capt. F. Nash, and Capt. Jas. Murray, Harbor Master of Quebec:—

The court having carefully weighed the evidence adduced is unanimous in its conclusion that while the absence from the bridge of the master, J. E. Millburn, at the time of the accident is not interpreted as neglect, in view of the fact that clear weather prevailed and a properly certificated officer represented him on the bridge, it is nevertheless held that the master relied too implicitly on cursory observations, instead of employing the recognized authentic and reliable methods of ascertaining the exact position of his vessel, for which neglect the court finds it incumbent upon it to censure him. As for the chief officer, P. Gaige, who was in charge of the bridge at the time of the stranding, it is held that he did not exercise due precaution in availing himself of the opportunities offered to determine the position of his ship, which failure is all the more pronounced by the fact of his knowingly approaching a charted shoal, and for his negligence in the exercise of his duty the court severely censures and reprimands him. It is further held that R. W. Thoburn, the second mate, did not comply with the exigencies of his duty in the matter of obtaining adequate fixes to place the exact position of his ship, for which he is censured. The court desires to caution the master and first and second officers to exercise adequate and precise navigation methods in the future in order to insure the safety of their ship, for in merely reprimanding them as above the court holds that they have been leniently dealt with under the circumstances.

**Additional Steamships for C. P. R. Atlantic Service.**—We are officially advised that the C. P. R. has under consideration, the ordering of two additional steamships with a speed of 20 knots an hour, for its Atlantic service.

## Trade and Supply Notes.

The matter which appears under this heading is compiled, in most cases, from information supplied by the manufacturers of, or dealers in, the articles referred to, and in publishing the same we accept no responsibility. At the same time we wish our readers distinctly to understand that we are not paid for the publication of any of this matter, and that we will not consider any proposition to insert reading matter in our columns for pay or its equivalent. Advertising contracts will not be taken with any condition that accepting them will oblige us to publish reading notices. In other words, our reading columns are not for sale, either to advertisers or others.

**H. H. Westinghouse** has been elected President of the Westinghouse Air Brake Co., Pittsburg, Pa., to succeed his brother, the late George Westinghouse.

**Canadian Westinghouse Co., Ltd.,** Hamilton, Ont., has issued from its railway and lighting department circular 506 Westinghouse Turbo-Alternators, 40 pgs., 7 by 10 ins., illustrated.

**The Pedlar People, Ltd.,** Oshawa, Ont., have sold the White Valley Irrigation and Power Co., of British Columbia, about 9,000 ft. of metal flume, varying from 30 to 61 ins. in diameter, for the completion of the Grey Canal.

**Independent Pneumatic Tool Co.,** Chicago, has appointed V. W. Robinson representative in Michigan, with headquarters at Detroit. F. J. Passino, heretofore Michigan repre-



sentative, has been appointed representative in the southwest, succeeding H. F. Finney, promoted to a position in the General Sales Office in Chicago.

**Canadian General Electric Co., Toronto,** has issued the following publications:—Bulletin 42500, synchronous converters for railway, lighting and industrial service; bulletin 906, electric hoists for the efficient handling of all loads, catalogue, H. & H. barrier 600 volts switches for electric railway cars, to control the air brake, headlight, heater and incandescent circuits.

**Butterfield & Co., Inc., Rock Island, Que.,** and **Derby Line, Vt.,** manufacturers of screw plates, are placing on the market the combined automobile screw plate, which contains taps and dies, cutting the S.A.E. standard, and also the regular V thread, or the U.S. standard, as may be wanted, all complete with stocks for holding the dies, and high grade tap wrench, in hardwood case. The claim made for this plate is that heretofore the repair and garage man wanting both forms of thread, was obliged to buy two distinct screw plates, whereas now he gets both styles in one box, and at a reasonable price. These plates are put out in all the various assortments, cutting from  $\frac{1}{4}$  to 1 in., and are made in the Derby plate.

#### Transportation Conventions in 1914-15.

Nov. 17.—National Association of Railway Commissioners, Washington, D.C.  
Nov. 17-19.—Maintenance of Way and Master Painters' Association of the United States and Canada, Detroit, Mich.  
Nov. 18.—American Railway Association, Chicago, Ill.  
Dec. 1-4.—American Society of Mechanical Engineers, New York.  
Dec. 8, 9.—Association of Transportation and Car Accounting Officers, Richmond, Va.  
Jan. 19-21.—American Wood Preservers' Association, Chicago, Ill.  
Mar. 16-18.—American Railway Engineering Association, Chicago, Ill.

April.—American Association of Demurrage Officers, Boston, Mass.

Apr. 28.—Association of American Railway Accounting Officers, Atlanta, Ga.

May.—Association of Railway Claim Agents, Galveston, Tex.

May 4-7.—Air Brake Association, Chicago, Ill.

May 17-20.—International Railway Fuel Association, Chicago, Ill.

May 21-24.—American Association of Freight Agents, Richmond, Va.

June 15.—Train Dispatchers' Association of America, Minneapolis, Minn.

June 16.—Freight Claim Association, Chicago, Ill.

June 22-25.—Association of Railway Telegraph Superintendents, Rochester, N.Y.

July 14-17.—International Railway General Foremen's Association, Chicago, Ill.

#### Transportation Associations, Clubs, Etc.

The names of persons given below are those of the secretaries.

Canadian Car Service Bureau, J. Reilly, Manager, 401 St. Nicholas Building, Montreal.

Canadian Electric Railway Association, Acton Burrows, 70 Bond Street, Toronto.

Canadian Freight Association (Eastern Lines), G. C. Ransom, Canadian Express Building, Montreal.

Canadian Freight Association (Western Lines), W. E. Campbell, 502 Canada Building, Winnipeg.

Canadian Railway Club, J. Powell, St. Lambert, Que. Meetings at Montreal, 2nd Tuesday each month, 8.30 p.m., except June, July and August.

Canadian Society of Civil Engineers, C. H. McLeod, 176 Mansfield St., Montreal.

Canadian Ticket Agents' Association, E. de ia Hooke, London, Ont.

Central Railway and Engineering Club of Canada, C. L. Worth, 409 Union Station, Toronto.

Meetings at Toronto, 3rd Tuesday each month, except June, July and August.

Dominion Marine Association, Counsel, F. King, Kingston, Ont.

Eastern Canadian Passenger Association, G. H. Webster, 54 Beaver Hall Hill, Montreal.

Engineers' Club of Montreal, R. W. H. Smith, 9 Beaver Hall Square, Montreal.

Engineers' Club of Toronto, R. B. Wolsey, 94 King St. West, Toronto.

Great Lakes and St. Lawrence River Rate Committee, Jas. Morrison, Montreal.

International Water Lines Passenger Association, M. R. Nelson, New York.

Niagara Frontier Summer Rate Committee, Jas. Morrison, Montreal.

Nova Scotia Society of Engineers, A. R. McCleave, Halifax, N.S.

Quebec Transportation Club, A. F. Dion, Quebec.

Ship Masters' Association of Canada, Capt. E. Wells, 45 St. John St., Halifax, N.S.

Toronto Transportation Club, W. A. Gray, 143 Yonge St., Toronto.

Western Canada Railway Club, Louis Kon, Box 1707, Winnipeg. Meetings at Winnipeg, 2nd Monday each month, except June, July and August.



#### TENDERS.

TENDERS addressed to the undersigned at Ottawa, and marked on the envelope "Tender for Ice-breaking," will be received up to twelve o'clock noon of the SIXTH DAY OF NOVEMBER, 1914, for breaking ice in the Harbors of Port Arthur and Fort William, Thunder Bay, Lake Superior, in accordance with the specifications prepared by the Department of Marine and Fisheries. A contract will be entered into with the successful tenderer for a period of three years, but the tenderers must quote a price per annum.

Specifications of the work required can be obtained from the Harbormasters at Port Arthur and Fort William and from the Purchasing Agent of the Marine Department, Ottawa. There are no special tender forms for this work.

Each tender must be accompanied by an accepted cheque on a chartered Canadian Bank for a sum equal to 10% of the tender price per annum, which cheque will be forfeited if the successful tenderer declines to enter into a contract or fails to complete the work in accordance with the specifications of the Department. Cheques will be returned to unsuccessful tenderers.

The Department does not bind itself to accept the lowest or any tender.

Newspapers inserting this advertisement without authority will not be paid for same.

A. JOHNSTON,

Deputy Minister of Marine and Fisheries,  
Department of Marine and Fisheries,  
Ottawa, Canada, 28th September, 1914.

**HOW RAILROADS SAVE MONEY  
BY USING THE  
TATE FLEXIBLE STAYBOLT**

## TIME HAS DEMONSTRATED

FIRST—That flexible staybolts produce more satisfactory and more economical results than rigid staybolts.

SECOND—That TATE FLEXIBLE STAYBOLTS are best of all, measured by every standard.

Ask for our New Catalog just issued

Manufactured and Sold in Canada by

CANADIAN ALLIS-CHALMERS, Limited, General Offices, TORONTO, ONT.

FLANNERY BOLT COMPANY, - Vanadium Building, Pittsburgh, Pa.



